



# FCC RF Test Report

**APPLICANT** : Zebra Technologies Corporation  
**EQUIPMENT** : Touch computer  
**BRAND NAME** : Zebra  
**MODEL NAME** : TC700J  
**FCC ID** : UZ7TC700J  
**STANDARD** : FCC Part 15 Subpart C §15.247  
**CLASSIFICATION** : (DSS) Spread Spectrum Transmitter

The product was received on Jun. 18, 2016 and testing was completed on Jul. 11, 2016. We, SPORTON INTERNATIONAL INC., would like to declare that the tested sample has been evaluated in accordance with the test procedures and has been in compliance with the applicable technical standards.

The test results in this report apply exclusively to the tested model / sample. Without written approval of SPORTON INTERNATIONAL INC., the test report shall not be reproduced except in full.

Reviewed by: Joseph Lin / Supervisor

Approved by: Jones Tsai / Manager



## **SPORTON INTERNATIONAL INC.**

**No. 52, Hwa Ya 1<sup>st</sup> Rd., Hwa Ya Technology Park, Kwei-Shan District, Tao Yuan City, Taiwan, R.O.C.**

SPORTON INTERNATIONAL INC.

TEL : 886-3-327-3456

FAX : 886-3-328-4978

FCC ID : UZ7TC700J

Page Number : 1 of 78

Report Issued Date : Aug. 04, 2016

Report Version : Rev. 01

Report Template No.: BU5-FR15CBT Version 1.1



# TABLE OF CONTENTS

**REVISION HISTORY..... 3**

**SUMMARY OF TEST RESULT ..... 4**

**1 GENERAL DESCRIPTION..... 5**

1.1 Applicant ..... 5

1.2 Manufacturer..... 5

1.3 Product Feature of Equipment Under Test..... 5

1.4 Product Specification of Equipment Under Test..... 6

1.5 Modification of EUT ..... 6

1.6 Testing Location ..... 7

1.7 Applicable Standards..... 7

**2 TEST CONFIGURATION OF EQUIPMENT UNDER TEST..... 8**

2.1 Descriptions of Test Mode ..... 8

2.2 Test Mode..... 9

2.3 Connection Diagram of Test System..... 10

2.4 Support Unit used in test configuration and system ..... 11

2.5 EUT Operation Test Setup ..... 11

2.6 Measurement Results Explanation Example..... 12

**3 TEST RESULT ..... 13**

3.1 Number of Channel Measurement ..... 13

3.2 Hopping Channel Separation Measurement ..... 15

3.3 Dwell Time Measurement..... 22

3.4 20dB and 99% Bandwidth Measurement ..... 24

3.5 Peak Output Power Measurement ..... 37

3.6 Conducted Band Edges Measurement..... 39

3.7 Conducted Spurious Emission Measurement ..... 46

3.8 Radiated Band Edges and Spurious Emission Measurement ..... 56

3.9 AC Conducted Emission Measurement..... 62

3.10 Antenna Requirements..... 76

**4 LIST OF MEASURING EQUIPMENT..... 77**

**5 UNCERTAINTY OF EVALUATION..... 78**

**APPENDIX A. RADIATED SPURIOUS EMISSION**

**APPENDIX B. RADIATED SPURIOUS EMISSION PLOTS**

**APPENDIX C. SETUP PHOTOGRAPHS**



### REVISION HISTORY

REPORT NO.	VERSION	DESCRIPTION	ISSUED DATE
FR661812A	Rev. 01	Initial issue of report	Aug. 04, 2016



### SUMMARY OF TEST RESULT

Report Section	FCC Rule	Description	Limit	Result	Remark
3.1	15.247(a)(1)	Number of Channels	≥ 15Chs	Pass	-
3.2	15.247(a)(1)	Hopping Channel Separation	≥ 2/3 of 20dB BW	Pass	-
3.3	15.247(a)(1)	Dwell Time of Each Channel	≤ 0.4sec in 31.6sec period	Pass	-
3.4	15.247(a)(1)	20dB Bandwidth	NA	Pass	-
3.4	-	99% Bandwidth	-	Pass	-
3.5	15.247(b)(1)	Peak Output Power	≤ 125 mW	Pass	-
3.6	15.247(d)	Conducted Band Edges	≤ 20dBc	Pass	-
3.7	15.247(d)	Conducted Spurious Emission	≤ 20dBc	Pass	-
3.8	15.247(d)	Radiated Band Edges and Radiated Spurious Emission	15.209(a) & 15.247(d)	Pass	Under limit 5.55 dB at 72.120 MHz
3.9	15.207	AC Conducted Emission	15.207(a)	Pass	Under limit 13.70 dB at 0.150 MHz
3.10	15.203 & 15.247(b)	Antenna Requirement	N/A	Pass	-



# 1 General Description

## 1.1 Applicant

**Zebra Technologies Corporation**  
1 Zebra Plaza Holtsville, NY 11742

## 1.2 Manufacturer

**Wistron Corporation**  
21F, No. 88, Sec. 1, Hsin Tai Wu Rd., Hsichih Dist, New Taipei City 221, Taiwan R.O.C.

## 1.3 Product Feature of Equipment Under Test

Product Feature	
<b>Equipment</b>	Touch computer
<b>Brand Name</b>	Zebra
<b>Model Name</b>	TC700J
<b>FCC ID</b>	UZ7TC700J
<b>EUT supports Radios application</b>	NFC WLAN 11a/b/g/n HT20/HT40 WLAN 11ac VHT20/VHT40/VHT80 Bluetooth v4.1 EDR/LE
<b>HW Version</b>	DV1
<b>SW Version</b>	10.0.10586.242
<b>FW Version</b>	01078.00161.09001.07002
<b>MFD</b>	04JUN16
<b>EUT Stage</b>	Engineering Sample

**Remark:** The above EUT's information was declared by manufacturer. Please refer to the specifications or user's manual for more detailed description.



### 1.4 Product Specification of Equipment Under Test

Standards-related Product Specification	
<b>Tx/Rx Frequency Range</b>	2402 MHz ~ 2480 MHz
<b>Number of Channels</b>	79
<b>Carrier Frequency of Each Channel</b>	2402+n*1 MHz; n=0~78
<b>Maximum Output Power to Antenna</b>	Bluetooth BR(1Mbps) : 1.73 dBm (0.0015 W) Bluetooth EDR (2Mbps) : 0.55 dBm (0.0011 W) Bluetooth EDR (3Mbps) : 0.70 dBm (0.0012 W)
<b>99% Occupied Bandwidth</b>	Bluetooth BR(1Mbps) : 0.888MHz Bluetooth EDR (2Mbps) : 1.176MHz Bluetooth EDR (3Mbps) : 1.156MHz
<b>Antenna Type</b>	PIFA Antenna type with gain 2.26 dBi
<b>Type of Modulation</b>	Bluetooth BR (1Mbps) : GFSK Bluetooth EDR (2Mbps) : $\pi/4$ -DQPSK Bluetooth EDR (3Mbps) : 8-DPSK

Specification of Accessories				
<b>AC Adapter</b>	<b>Brand Name</b>	Symbol	<b>Part Number</b>	PWRS-14000-249R
	<b>Power Cord</b>	1.75 meter, non-shielded cable, without ferrite core		
<b>Snap-On USB/Charge Cable</b>	<b>Brand Name</b>	Symbol	<b>Part Number</b>	CBL-TC7X-USB1-01
	<b>Signal Line</b>	0.15 meter, non-shielded cable, with w/o ferrite core		
<b>Snap-On Charging Cable Cup</b>	<b>Brand Name</b>	Symbol	<b>Part Number</b>	CHG-TC7X-CBL1-01
	<b>Signal Line</b>	1.85 meter, non-shielded cable, with w/o ferrite core		
<b>Battery</b>	<b>Brand Name</b>	Symbol	<b>Part Number</b>	82-171249-02
<b>Earphone 1</b> (3.5mm Headset for PTT + VoIP)	<b>Brand Name</b>	Zebra	<b>Part Number</b>	HDST-35MM-PTVP-01
<b>Earphone 2</b>	<b>Brand Name</b>	Zebra	<b>Part Number</b>	RCH51
<b>3.5mm to QD Audio Cable Adapter</b>	<b>Brand Name</b>	Zebra	<b>Part Number</b>	ADP-35M-QDCBL1-01
<b>Snap-on 3.5MM Audio Nugget</b>	<b>Brand Name</b>	Symbol	<b>Part Number</b>	ADP-TC7X-AUD35-01

### 1.5 Modification of EUT

No modifications are made to the EUT during all test items.



### 1.6 Testing Location

Sporton Lab is accredited to ISO 17025 by Taiwan Accreditation Foundation (TAF code : 1190) and the FCC designation No. TW1022 under the FCC 2.948(e) by Mutual Recognition Agreement (MRA) in FCC Test.

<b>Test Site</b>	SPORTON INTERNATIONAL INC.		
<b>Test Site Location</b>	No. 52, Hwa Ya 1 <sup>st</sup> Rd., Hwa Ya Technology Park, Kwei-Shan District, Tao Yuan City, Taiwan, R.O.C. TEL: +886-3-327-3456 FAX: +886-3-328-4978		
<b>Test Site No.</b>	<b>Sporton Site No.</b>		
	TH02-HY	CO05-HY	03CH07-HY

**Note:** The test site complies with ANSI C63.4 2014 requirement.

### 1.7 Applicable Standards

According to the specifications of the manufacturer, the EUT must comply with the requirements of the following standards:

- ♦ FCC Part 15 Subpart C §15.247
- ♦ ANSI C63.10-2013

**Remark:** All test items were verified and recorded according to the standards and without any deviation during the test.



## 2 Test Configuration of Equipment Under Test

### 2.1 Descriptions of Test Mode

Preliminary tests were performed in different data rates and recorded the RF output power in the following table:

Channel	Frequency	Bluetooth RF Peak Output Power		
		GFSK / 1Mbps		
		DH1	DH3	DH5
Ch00	2402MHz	-0.15 dBm	-0.20 dBm	-0.22 dBm
Ch39	2441MHz	1.73 dBm	1.68 dBm	1.64 dBm
Ch78	2480MHz	1.07 dBm	1.03 dBm	0.97 dBm

Channel	Frequency	Bluetooth RF Peak Output Power		
		$\pi$ /4-DQPSK / 2Mbps		
		2DH1	2DH3	2DH5
Ch00	2402MHz	-1.20 dBm	-1.22 dBm	-1.30 dBm
Ch39	2441MHz	0.55 dBm	0.43 dBm	0.42 dBm
Ch78	2480MHz	0.04 dBm	-0.03 dBm	-0.06 dBm

Channel	Frequency	Bluetooth RF Peak Output Power		
		8-DPSK / 3Mbps		
		3DH1	3DH3	3DH5
Ch00	2402MHz	-0.75 dBm	-0.80 dBm	-1.04 dBm
Ch39	2441MHz	0.70 dBm	0.56 dBm	0.69 dBm
Ch78	2480MHz	-0.25 dBm	-0.40 dBm	-0.30 dBm

**Remark:**

1. All the test data for each data rate were verified.
2. The data rate was set in 1Mbps for all the test items due to the highest RF output power.
  - a. The EUT has been associated with peripherals and configuration operated in a manner tended to maximize its emission characteristics in a typical application. Frequency range investigated: conduction (150 kHz to 30 MHz), radiation (9 kHz to the 10th harmonic of the highest fundamental frequency or to 40 GHz, whichever is lower). Pre-scanned tests, X, Y, Z in three orthogonal panels, and different data rates were conducted to determine the final configuration from all possible combinations..
  - b. AC power line Conducted Emission was tested under maximum output power.





## 2.2 Test Mode

The following summary table is showing all test modes to demonstrate in compliance with the standard.

Summary table of Test Cases			
Test Item	Data Rate / Modulation		
	Bluetooth BR 1Mbps GFSK	Bluetooth EDR 2Mbps $\pi/4$ -DQPSK	Bluetooth EDR 3Mbps 8-DPSK
<b>Conducted Test Cases</b>	Mode 1: CH00_2402 MHz Mode 2: CH39_2441 MHz Mode 3: CH78_2480 MHz	Mode 4: CH00_2402 MHz Mode 5: CH39_2441 MHz Mode 6: CH78_2480 MHz	Mode 7: CH00_2402 MHz Mode 8: CH39_2441 MHz Mode 9: CH78_2480 MHz
<b>Radiated Test Cases</b>	<b>Bluetooth BR 1Mbps GFSK</b> Mode 1: CH00_2402 MHz Mode 2: CH39_2441 MHz Mode 3: CH78_2480 MHz		
<b>AC Conducted Emission</b>	Mode 1 :WLAN (2.4GHz) Link + Bluetooth Link + NFC Link + Earphone 1 with Audio Adapter connect to EDA + Charging Only Cable + AC Adapter Mode 2 :WLAN (2.4GHz) Link + Bluetooth Link + NFC Link + Snap on USB Cable Data link with Notebook + Copy Data from EDA (eMMC) to Notebook + AC Adapter Mode 3 :WLAN (2.4GHz) Link + Bluetooth Link + NFC Link + Earphone 2 with Audio Adapter connect to EDA + Charging Only Cable + AC Adapter		
<b>Remark:</b> For Radiated Test Cases, tests were performance with earphone 1 with audio adapter connect to EUT, charging only cable, and adapter.			

## 2.3 Connection Diagram of Test System

### <Bluetooth Tx Mode>

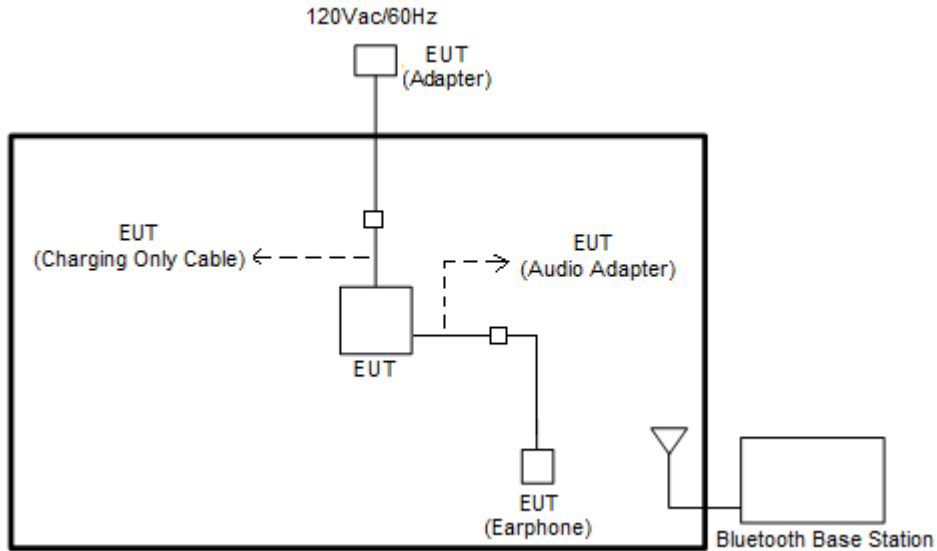

### <AC Conducted Emission for charging mode>

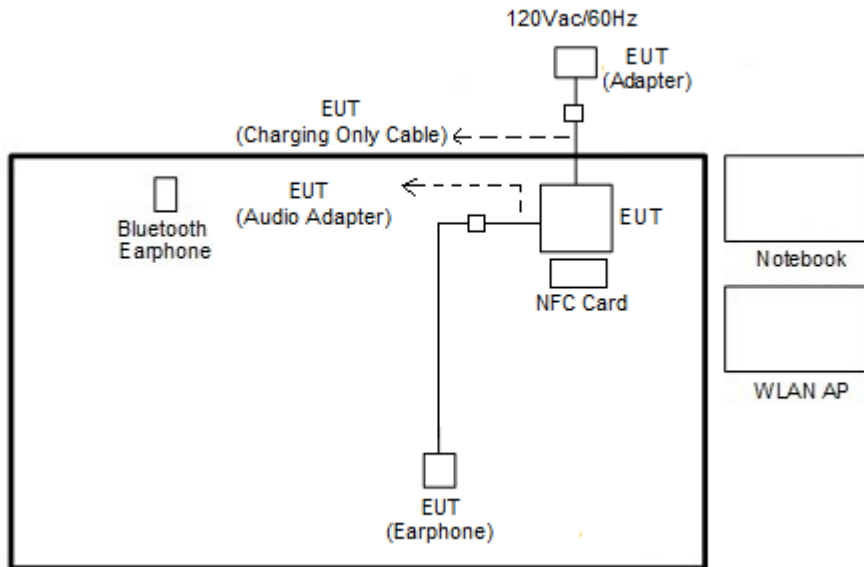

<AC Conducted Emission for data link mode>

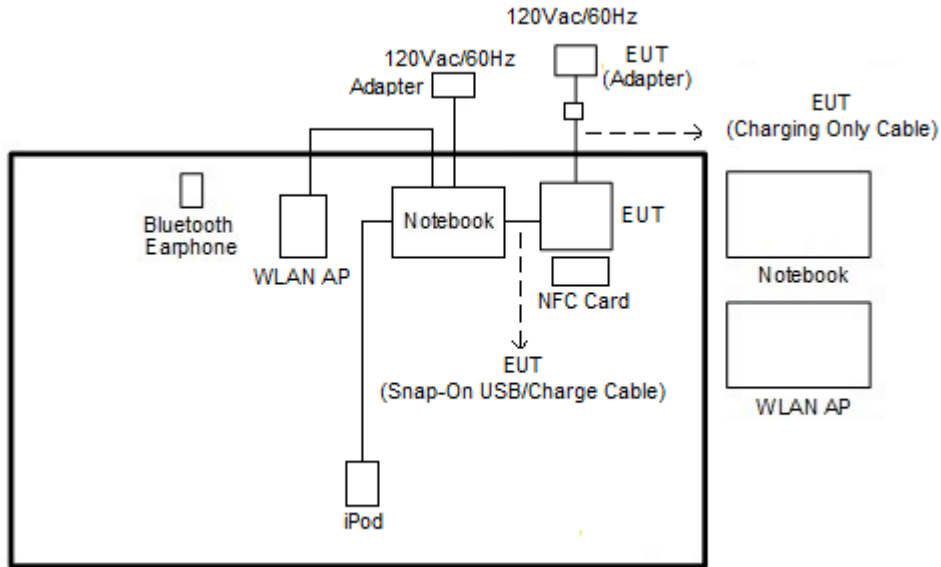

## 2.4 Support Unit used in test configuration and system

Item	Equipment	Trade Name	Model Name	FCC ID	Data Cable	Power Cord
1.	WLAN AP	D-Link	DIR-628	KA2DIR628A2	N/A	Unshielded, 1.8 m
2.	Bluetooth Base Station	R&S	CBT32	N/A	N/A	Unshielded, 1.8 m
3.	Bluetooth Earphone	Sony Ericsson	MW600	PY7DDA-2029	N/A	N/A
4.	Notebook	DELL	Latitude E6320	FCC DoC/ Contains FCC ID: QDS-BRCM1054	N/A	AC I/P: Unshielded, 1.2 m DC O/P: Shielded, 1.8 m
5.	iPod	Apple	A1285	FCC DoC	Shielded, 1.0 m	N/A
6.	NFC Card	Metro Taipei	Easy Card	N/A	N/A	N/A
7.	SD Card	SanDisk	MicroSD HC	FCC DoC	N/A	N/A

## 2.5 EUT Operation Test Setup

For Bluetooth function, the RF utility, “QRCT” was installed in notebook which was programmed in order to make the EUT into the engineering modes to contact with Bluetooth base station for continuous transmitting and receiving signals.



## 2.6 Measurement Results Explanation Example

For all conducted test items:

The offset level is set in the spectrum analyzer to compensate the RF cable loss and attenuator factor between EUT conducted output port and spectrum analyzer. With the offset compensation, the spectrum analyzer reading level is exactly the EUT RF output level.

Example:

The spectrum analyzer offset is derived from RF cable loss and attenuator factor.

*Offset = RF cable loss + attenuator factor.*

Following shows an offset computation example with cable loss 4.2 dB and 10dB attenuator.

$$\begin{aligned} \text{Offset(dB)} &= \text{RF cable loss(dB)} + \text{attenuator factor(dB)}. \\ &= 4.2 + 10 = 14.2 \text{ (dB)} \end{aligned}$$

### 3 Test Result

#### 3.1 Number of Channel Measurement

##### 3.1.1 Limits of Number of Hopping Frequency

Frequency hopping systems in the 2400-2483.5 MHz band shall use at least 15 channels.

##### 3.1.2 Measuring Instruments

The measuring equipment is listed in the section 4 of this test report.

##### 3.1.3 Test Procedure

1. The testing follows ANSI C63.10-2013 clause 7.8.3.
2. The RF output of EUT was connected to the spectrum analyzer by RF cable and attenuator. The path loss was compensated to the results for each measurement.
3. Set to the maximum power setting and enable the EUT transmit continuously.
4. Enable the EUT hopping function.
5. Use the following spectrum analyzer settings: Span = the frequency band of operation; RBW = 300kHz; VBW  $\geq$  RBW; Sweep = auto; Detector function = peak; Trace = max hold.
6. The number of hopping frequency used is defined as the number of total channel.
7. Record the measurement data derived from spectrum analyzer.

##### 3.1.4 Test Setup



##### 3.1.5 Test Result of Number of Hopping Frequency

<b>Test Mode :</b>	1Mbps	<b>Temperature :</b>	24~26°C
<b>Test Engineer :</b>	AC Chang	<b>Relative Humidity :</b>	48~51%
<b>Number of Hopping (Channel)</b>	<b>Adaptive Frequency Hopping (Channel)</b>	<b>Limits (Channel)</b>	<b>Pass/Fail</b>
79	20	> 15	Pass



Number of Hopping Channel Plot on Channel 00 - 78

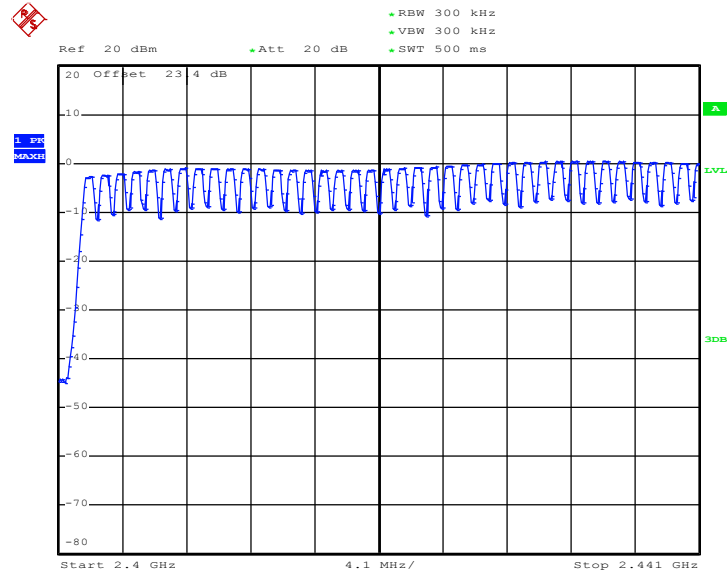

Date: 2.JUL.2016 14:42:07

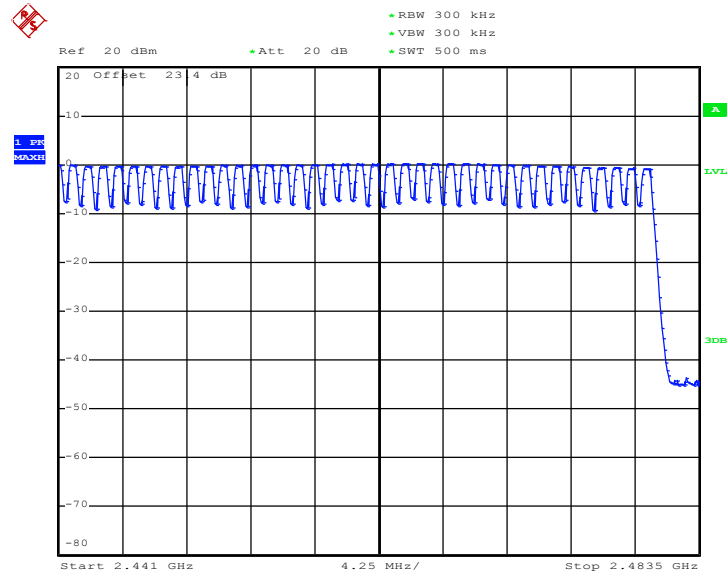

Date: 2.JUL.2016 14:48:52

## 3.2 Hopping Channel Separation Measurement

### 3.2.1 Limit of Hopping Channel Separation

Frequency hopping systems operating in the 2400-2483.5 MHz band may have hopping channel carrier frequencies that are separated by 25 kHz or two-thirds of the 20 dB bandwidth of the hopping channel, whichever is greater.

### 3.2.2 Measuring Instruments

The measuring equipment is listed in the section 4 of this test report.

### 3.2.3 Test Procedures

1. The testing follows ANSI C63.10-2013 clause 7.8.2.
2. The RF output of EUT was connected to the spectrum analyzer by RF cable and attenuator. The path loss was compensated to the results for each measurement.
3. Set to the maximum power setting and enable the EUT transmit continuously.
4. Enable the EUT hopping function.
5. Use the following spectrum analyzer settings:  
Span = wide enough to capture the peaks of two adjacent channels;  
RBW = 300kHz; VBW  $\geq$  RBW; Sweep = auto; Detector function = peak; Trace = max hold.
6. Measure and record the results in the test report.

### 3.2.4 Test Setup

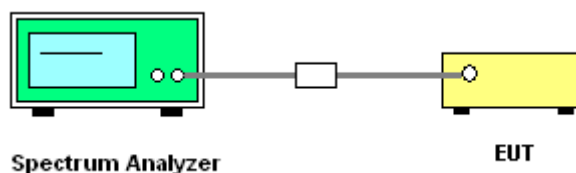



3.2.5 Test Result of Hopping Channel Separation

Test Mode :	1Mbps	Temperature :	24~26°C
Test Engineer :	AC Chang	Relative Humidity :	48~51%

Channel	Frequency (MHz)	Frequency Separation (MHz)	(2/3 of 20dB BW) Limits (MHz)	Pass/Fail
00	2402	1.014	0.6293	Pass
39	2441	1.002	0.6293	Pass
78	2480	1.008	0.6267	Pass

Channel Separation Plot on Channel 00 - 01

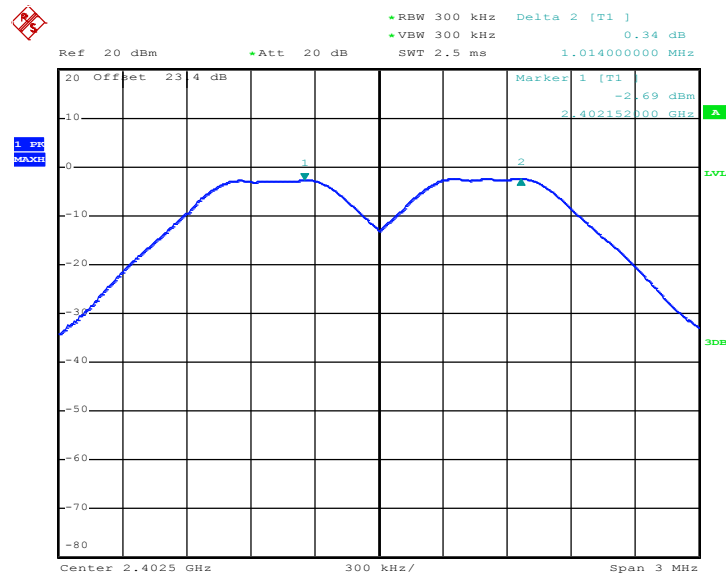

Date: 2.JUL.2016 13:43:27





Channel Separation Plot on Channel 39 - 40

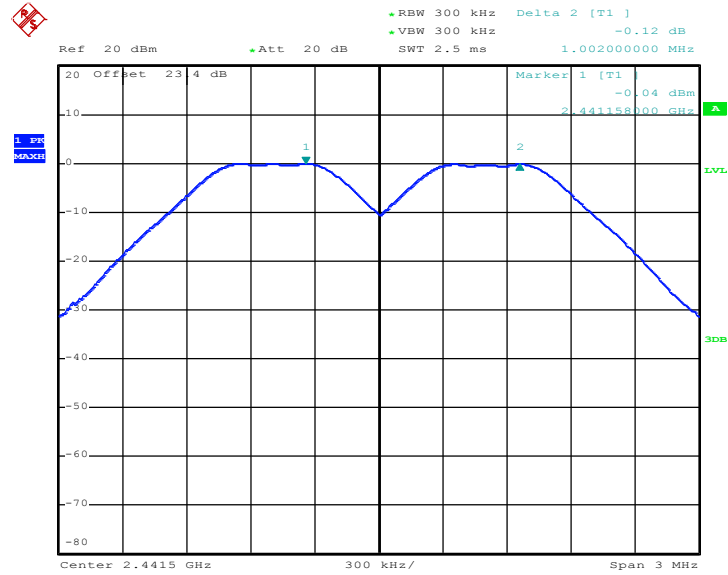

Date: 2.JUL.2016 13:46:55

Channel Separation Plot on Channel 77 - 78

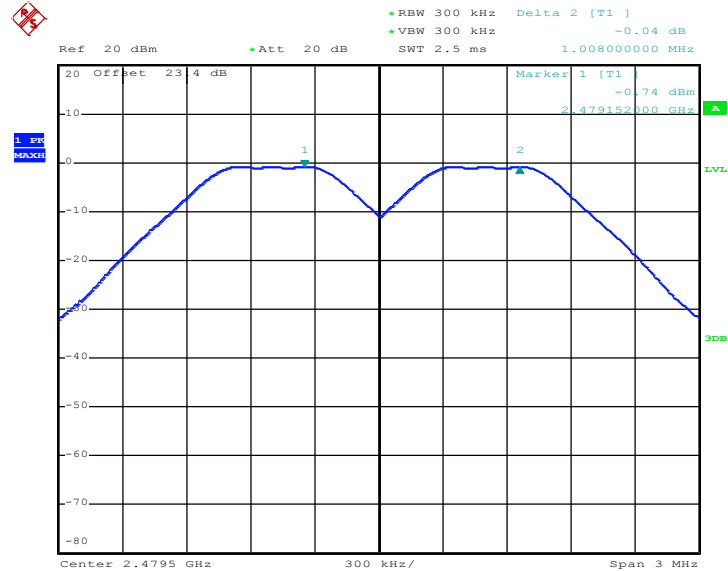

Date: 2.JUL.2016 13:51:13



Test Mode :	2Mbps	Temperature :	24~26°C
Test Engineer :	AC Chang	Relative Humidity :	48~51%

Channel	Frequency (MHz)	Frequency Separation (MHz)	(2/3 of 20dB BW) Limits (MHz)	Pass/Fail
00	2402	1.008	0.8520	Pass
39	2441	1.002	0.8520	Pass
78	2480	1.002	0.8520	Pass

Channel Separation Plot on Channel 00 - 01

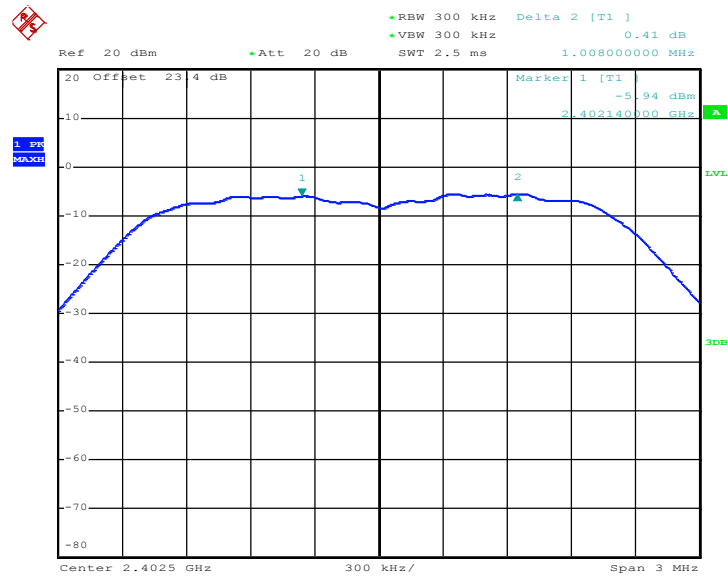

Date: 2.JUL.2016 14:13:14



Channel Separation Plot on Channel 39 - 40

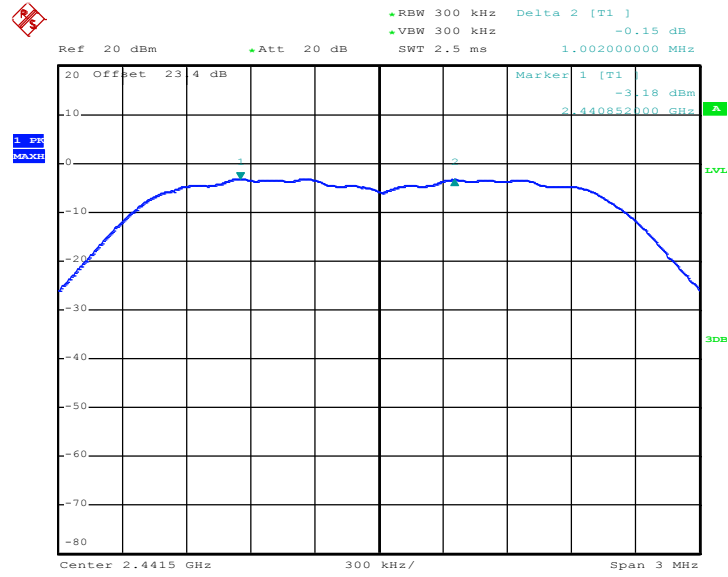

Date: 2.JUL.2016 14:17:08

Channel Separation Plot on Channel 77 - 78

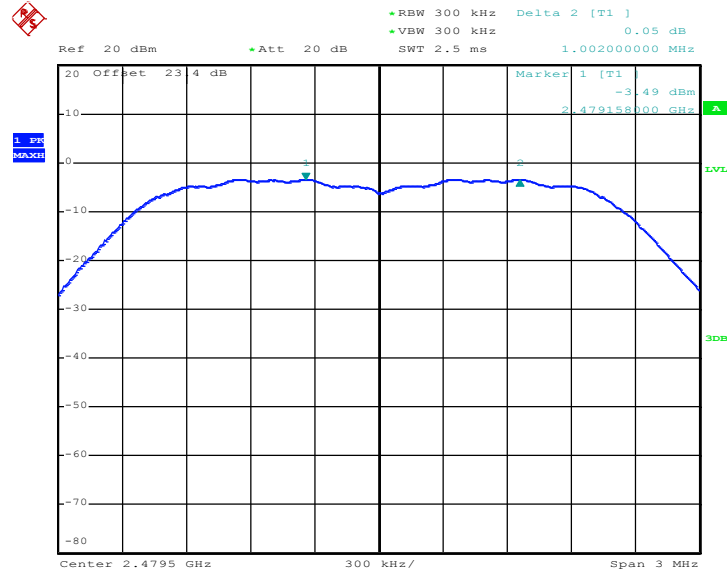

Date: 2.JUL.2016 14:21:28



Test Mode :	3Mbps	Temperature :	24~26°C
Test Engineer :	AC Chang	Relative Humidity :	48~51%

Channel	Frequency (MHz)	Frequency Separation (MHz)	(2/3 of 20dB BW) Limits (MHz)	Pass/Fail
00	2402	1.002	0.8280	Pass
39	2441	1.008	0.8400	Pass
78	2480	1.002	0.8320	Pass

Channel Separation Plot on Channel 00 - 01

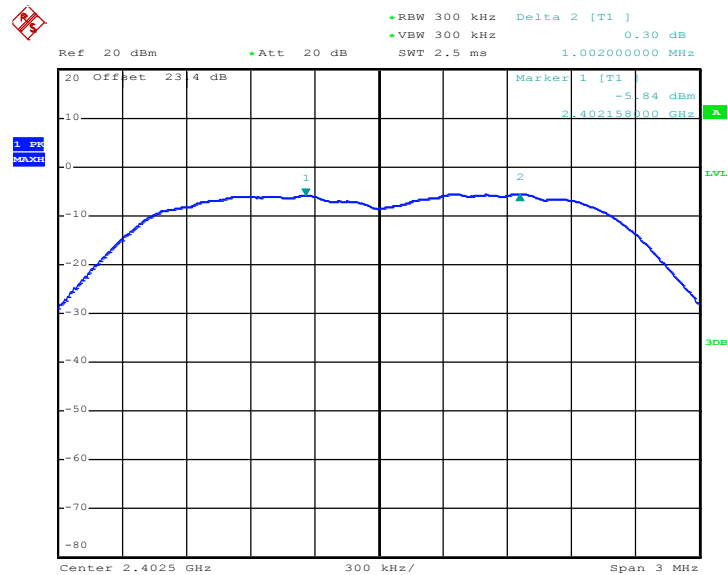

Date: 2.JUL.2016 14:25:03



Channel Separation Plot on Channel 39 - 40

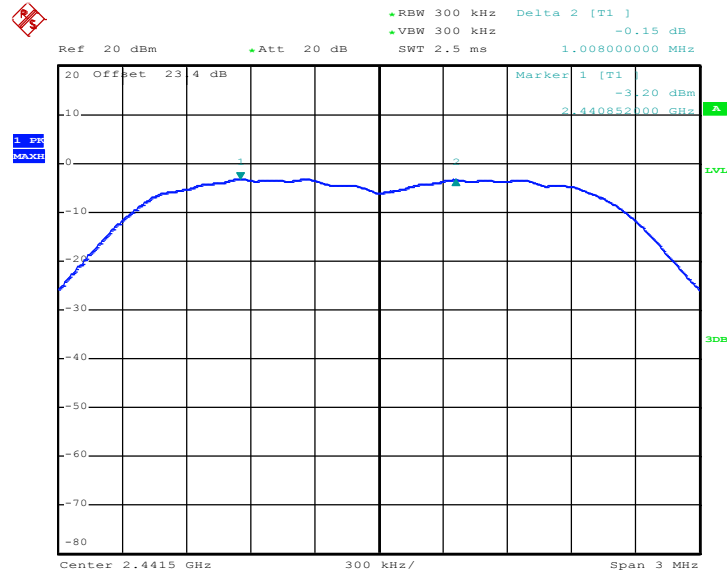

Date: 2.JUL.2016 14:30:11

Channel Separation Plot on Channel 77 - 78

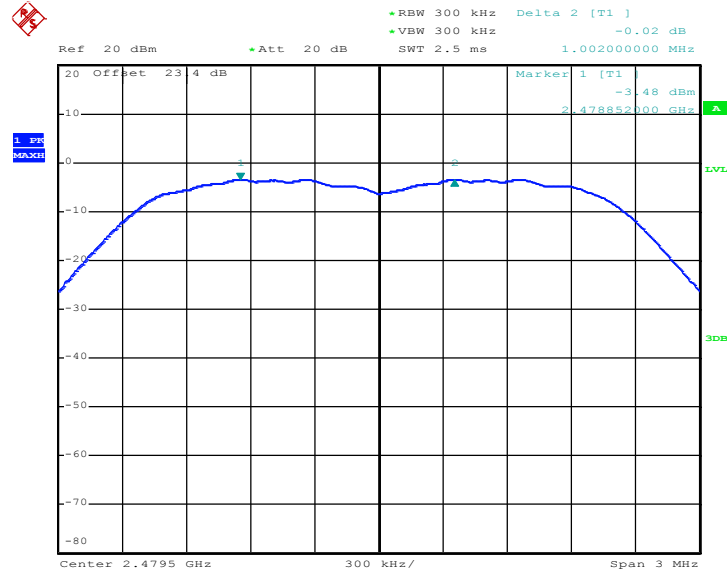

Date: 2.JUL.2016 14:33:25

### 3.3 Dwell Time Measurement

#### 3.3.1 Limit of Dwell Time

The average time of occupancy on any channel shall not be greater than 0.4 seconds within a period of 0.4 seconds multiplied by the number of hopping channels employed.

#### 3.3.2 Measuring Instruments

The measuring equipment is listed in the section 4 of this test report.

#### 3.3.3 Test Procedures

1. The testing follows ANSI C63.10-2013 clause 7.8.4.
2. The RF output of EUT was connected to the spectrum analyzer by RF cable and attenuator. The path loss was compensated to the results for each measurement.
3. Set to the maximum power setting and enable the EUT transmit continuously.
4. Enable the EUT hopping function.
5. Use the following spectrum analyzer settings: Span = zero span, centered on a hopping channel; RBW = 1 MHz; VBW  $\geq$  RBW; Sweep = as necessary to capture the entire dwell time per hopping channel; Detector function = peak; Trace = max hold.
6. Measure and record the results in the test report.

#### 3.3.4 Test Setup





### 3.3.5 Test Result of Dwell Time

Test Mode :	DH5	Temperature :	24~26°C
Test Engineer :	AC Chang	Relative Humidity :	48~51%

Mode	Hopping Channel Number	Hops Over Occupancy Time(hops)	Package Transfer Time (msec)	Dwell Time (sec)	Limits (sec)	Pass/Fail
Normal	79	106.67	2.90	0.31	0.4	Pass
AFH	20	53.33	2.90	0.15	0.4	Pass

**Remark:**

- In normal mode, hopping rate is 1600 hops/s with 6 slots in 79 hopping channels.  
With channel hopping rate (1600 / 6 / 79) in Occupancy Time Limit (0.4 x 79) (s),  
Hops Over Occupancy Time comes to (1600 / 6 / 79) x (0.4 x 79) = 106.67 hops.
- In AFH mode, hopping rate is 800 hops/s with 6 slots in 20 hopping channels.  
With channel hopping rate (800 / 6 / 20) in Occupancy Time Limit (0.4 x 20) (s),  
Hops Over Occupancy Time comes to (800 / 6 / 20) x (0.4 x 20) = 53.33 hops.
- Dwell Time(s) = Hops Over Occupancy Time (hops) x Package Transfer Time

**Package Transfer Time Plot**

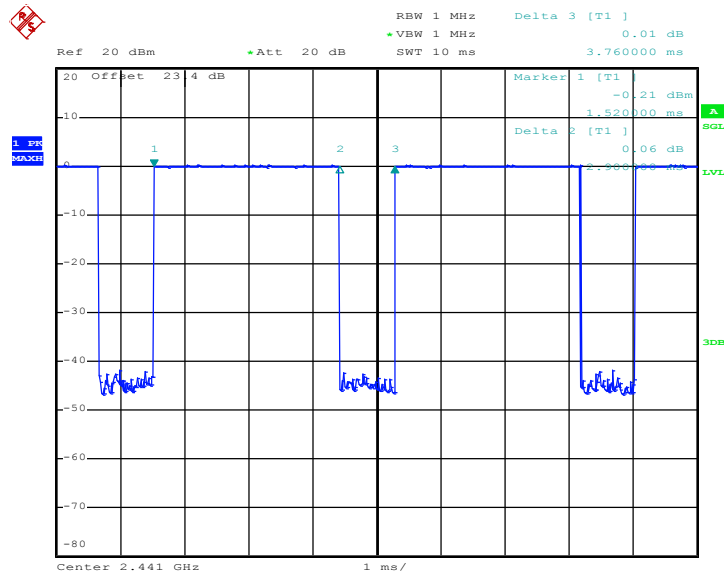

Date: 2.JUL.2016 13:11:53

### 3.4 20dB and 99% Bandwidth Measurement

#### 3.4.1 Limit of 20dB and 99% Bandwidth

Reporting only

#### 3.4.2 Measuring Instruments

The measuring equipment is listed in the section 4 of this test report.

#### 3.4.3 Test Procedures

1. The testing follows ANSI C63.10-2013 clause 6.9.2 and 6.9.3.
2. The RF output of EUT was connected to the spectrum analyzer by RF cable and attenuator. The path loss was compensated to the results for each measurement.
3. Set to the maximum power setting and enable the EUT transmit continuously.
4. Use the following spectrum analyzer settings for 20dB Bandwidth measurement.  
Span = approximately 2 to 5 times the 20 dB bandwidth, centered on a hopping channel;  
RBW  $\geq$  1% of the 20 dB bandwidth; VBW  $\geq$  RBW; Sweep = auto; Detector function = peak;  
Trace = max hold.
5. Use the following spectrum analyzer settings for 99 % Bandwidth measurement.  
Span = approximately 1.5 to 5 times the 99% bandwidth, centered on a hopping channel;  
RBW  $\geq$  1% of the 99% bandwidth; VBW  $\geq$  RBW; Sweep = auto; Detector function = peak;  
Trace = max hold.
6. Measure and record the results in the test report.

#### 3.4.4 Test Setup







3.4.5 Test Result of 20dB Bandwidth

Test Mode :	1Mbps	Temperature :	24~26°C
Test Engineer :	AC Chang	Relative Humidity :	48~51%

Channel	Frequency (MHz)	20dB Bandwidth (MHz)
00	2402	0.944
39	2441	0.944
78	2480	0.940

20 dB Bandwidth Plot on Channel 00

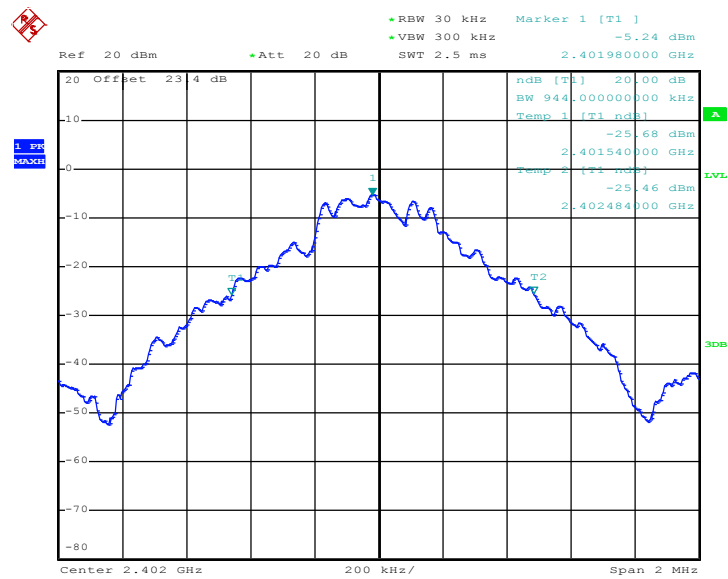

Date: 2.JUL.2016 13:43:59



20 dB Bandwidth Plot on Channel 39

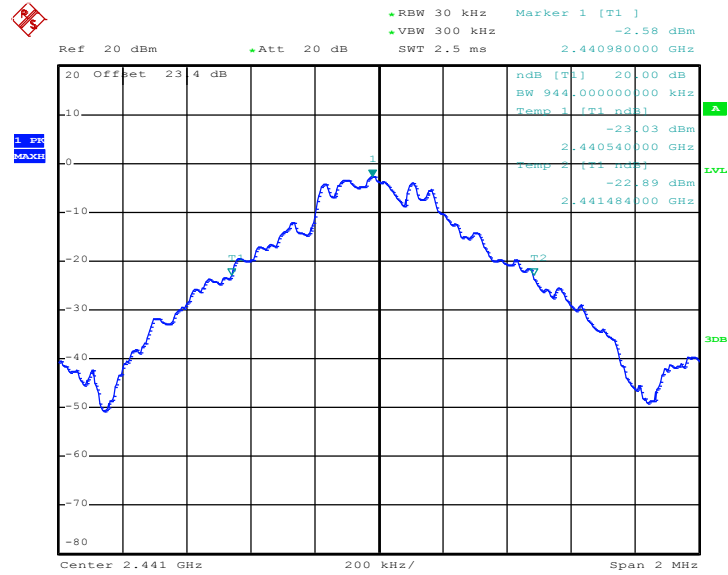

Date: 2.JUL.2016 13:47:25

20 dB Bandwidth Plot on Channel 78

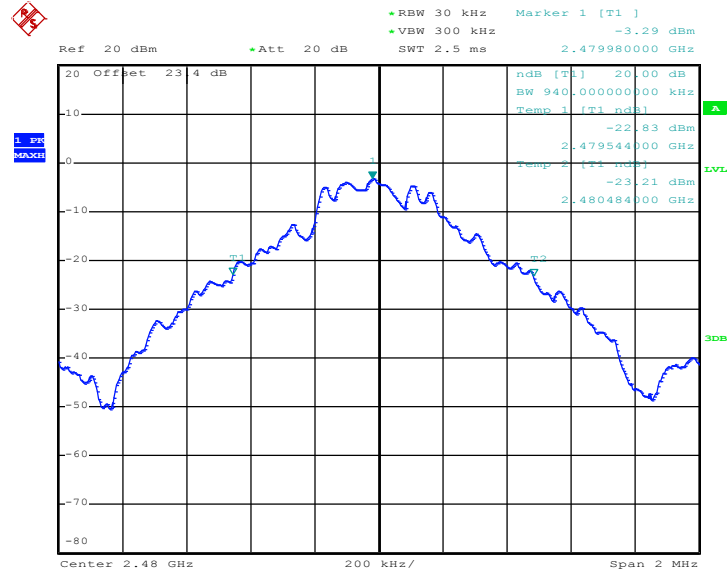

Date: 2.JUL.2016 13:51:46



Test Mode :	2Mbps	Temperature :	24~26°C
Test Engineer :	AC Chang	Relative Humidity :	48~51%

Channel	Frequency (MHz)	20dB Bandwidth (MHz)
00	2402	1.278
39	2441	1.278
78	2480	1.278

20 dB Bandwidth Plot on Channel 00

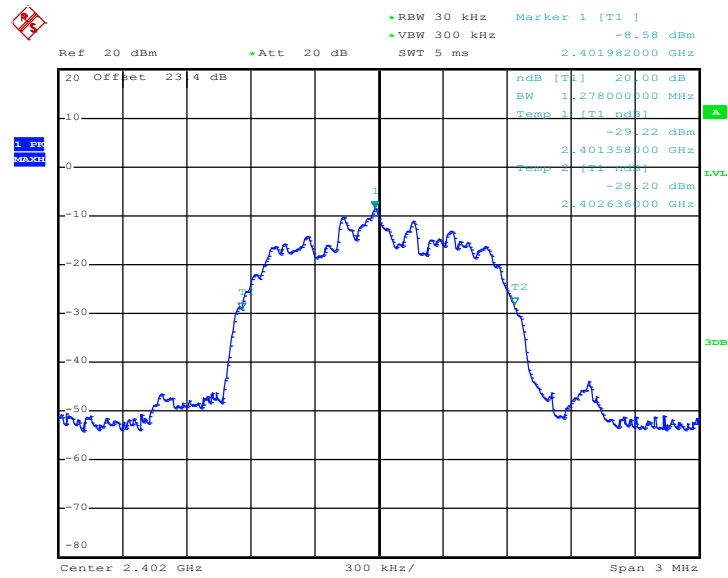

Date: 2.JUL.2016 14:13:45



20 dB Bandwidth Plot on Channel 39

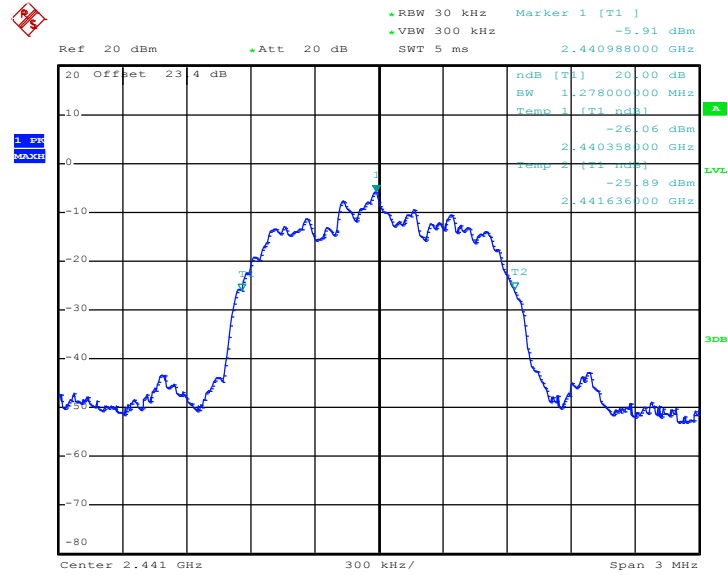

Date: 2.JUL.2016 14:17:34

20 dB Bandwidth Plot on Channel 78

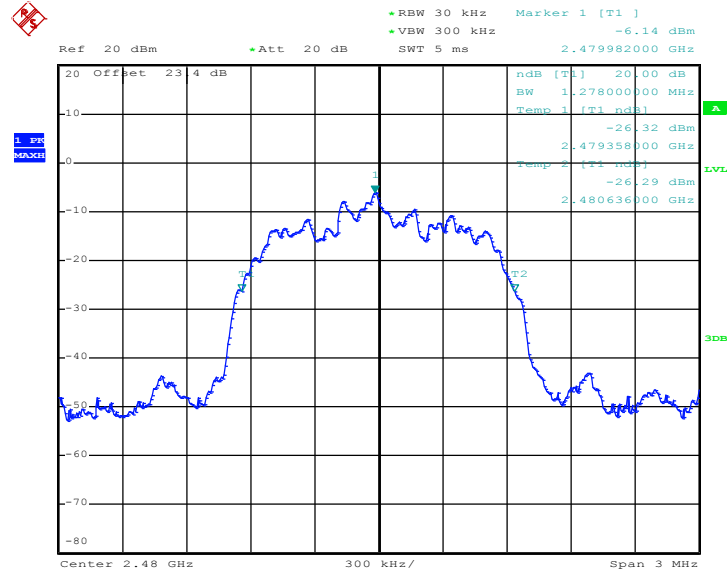

Date: 2.JUL.2016 14:21:57



Test Mode :	3Mbps	Temperature :	24~26°C
Test Engineer :	AC Chang	Relative Humidity :	48~51%

Channel	Frequency (MHz)	20dB Bandwidth (MHz)
00	2402	1.242
39	2441	1.260
78	2480	1.248

20 dB Bandwidth Plot on Channel 00

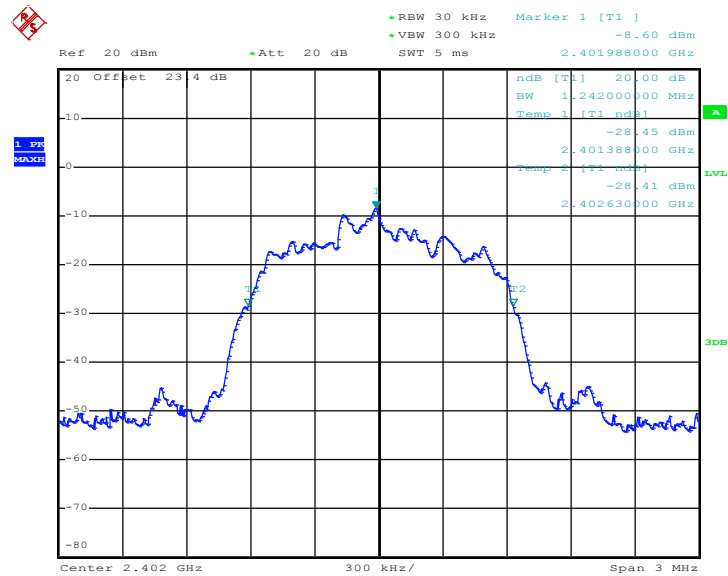

Date: 2.JUL.2016 14:25:34



20 dB Bandwidth Plot on Channel 39

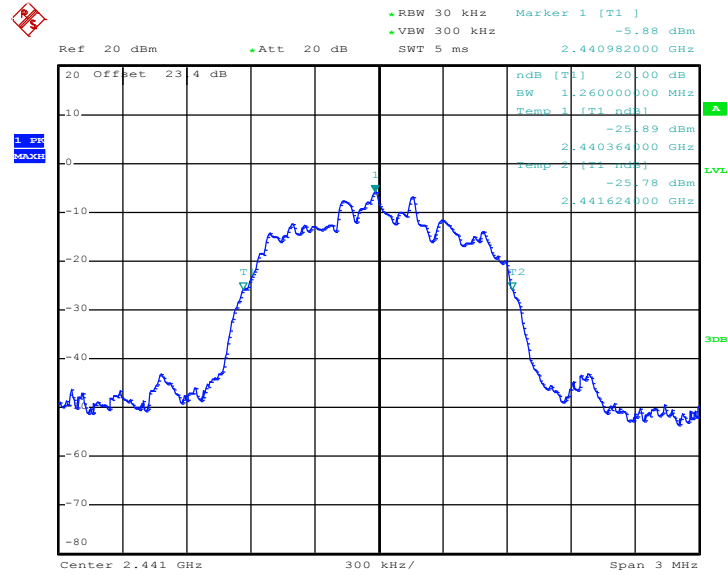

Date: 2.JUL.2016 14:30:37

20 dB Bandwidth Plot on Channel 78

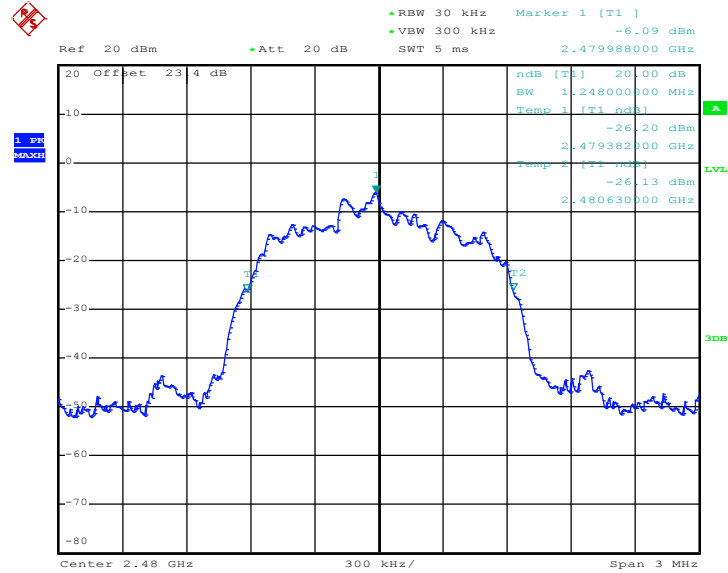

Date: 2.JUL.2016 14:33:53



3.4.6 Test Result of 99% Occupied Bandwidth

Test Mode :	1Mbps	Temperature :	24~26°C
Test Engineer :	AC Chang	Relative Humidity :	48~51%

Channel	Frequency (MHz)	99% Occupied Bandwidth (MHz)
00	2402	0.888
39	2441	0.884
78	2480	0.884

99% Occupied Bandwidth Plot on Channel 00

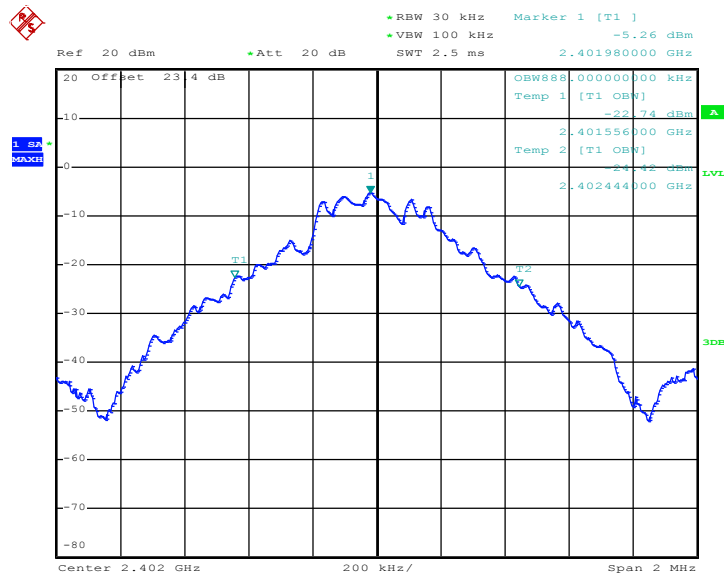

Date: 2.JUL.2016 13:44:39



99% Occupied Bandwidth Plot on Channel 39

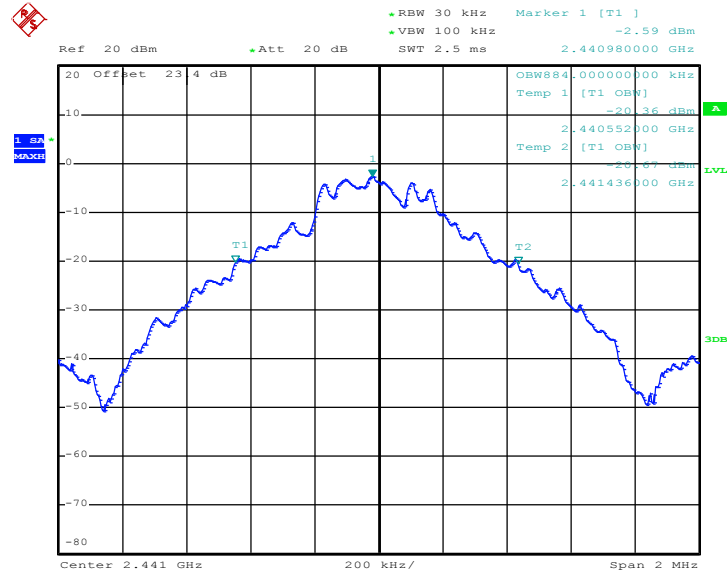

Date: 2.JUL.2016 13:47:59

99% Occupied Bandwidth Plot on Channel 78

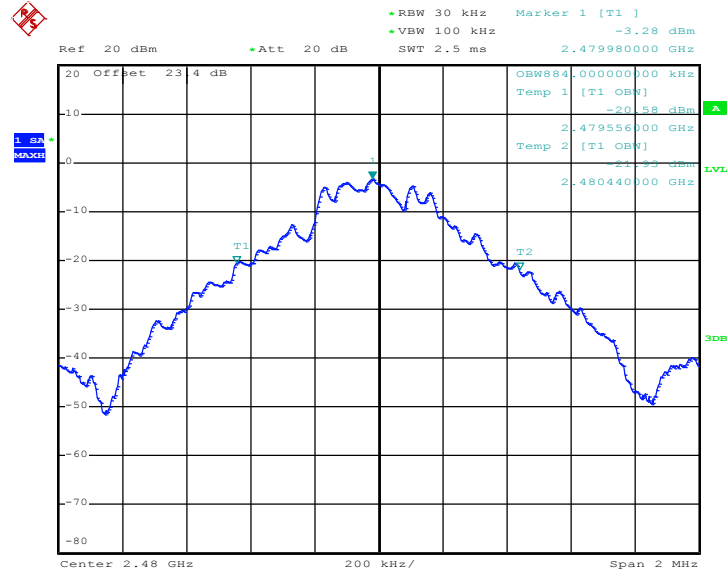

Date: 2.JUL.2016 13:52:21





Test Mode :	2Mbps	Temperature :	24~26°C
Test Engineer :	AC Chang	Relative Humidity :	48~51%

Channel	Frequency (MHz)	99% Occupied Bandwidth (MHz)
00	2402	1.176
39	2441	1.172
78	2480	1.172

99% Occupied Bandwidth Plot on Channel 00

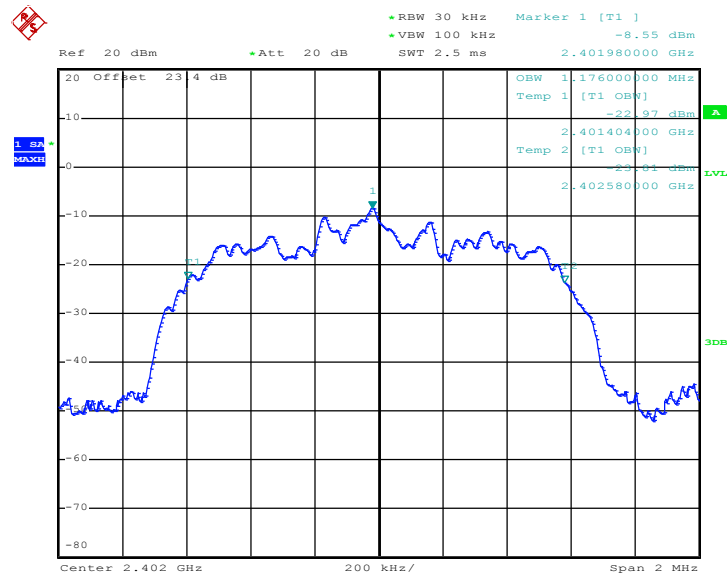

Date: 2.JUL.2016 14:14:21



99% Occupied Bandwidth Plot on Channel 39

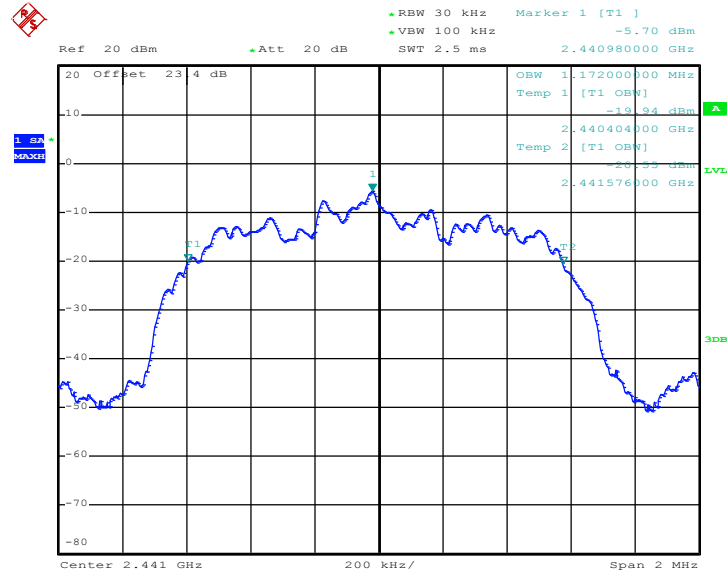

Date: 2.JUL.2016 14:18:09

99% Occupied Bandwidth Plot on Channel 78

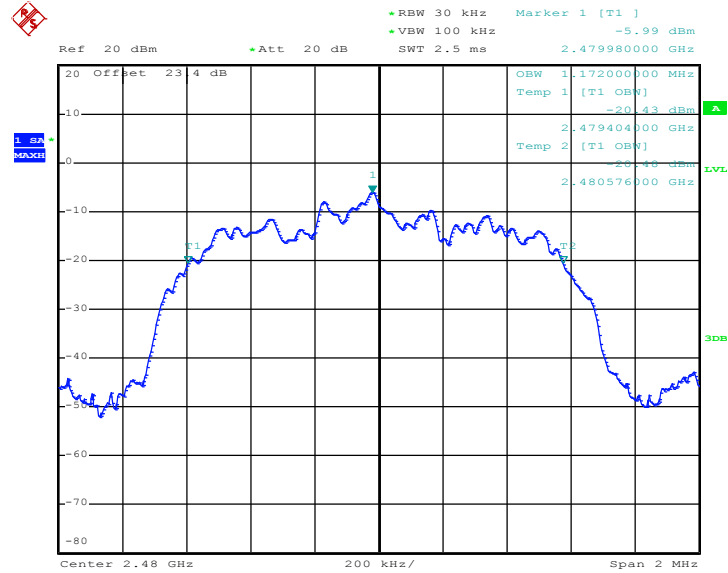

Date: 2.JUL.2016 14:22:32



Test Mode :	3Mbps	Temperature :	24~26°C
Test Engineer :	AC Chang	Relative Humidity :	48~51%

Channel	Frequency (MHz)	99% Occupied Bandwidth (MHz)
00	2402	1.156
39	2441	1.152
78	2480	1.156

99% Occupied Bandwidth Plot on Channel 00

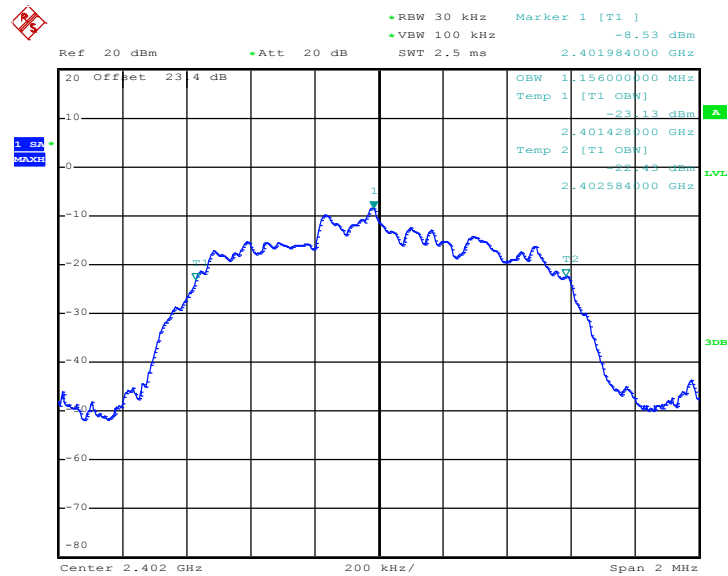

Date: 2.JUL.2016 14:26:14



99% Occupied Bandwidth Plot on Channel 39

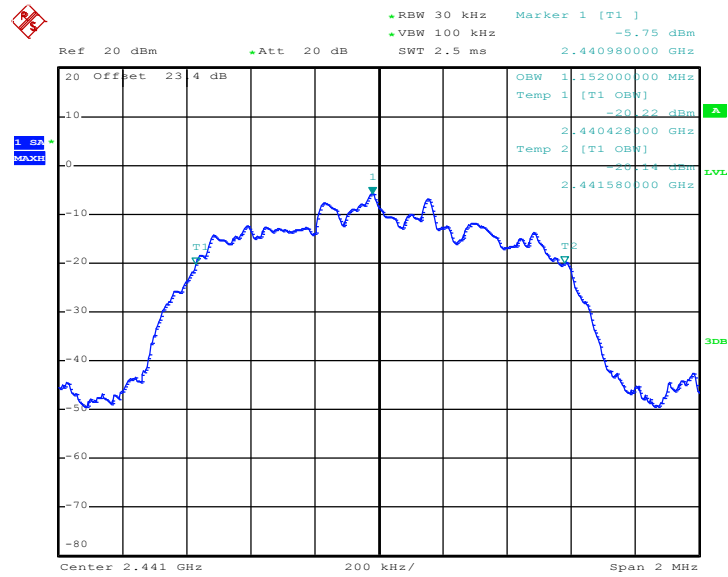

Date: 2.JUL.2016 14:31:28

99% Occupied Bandwidth Plot on Channel 78

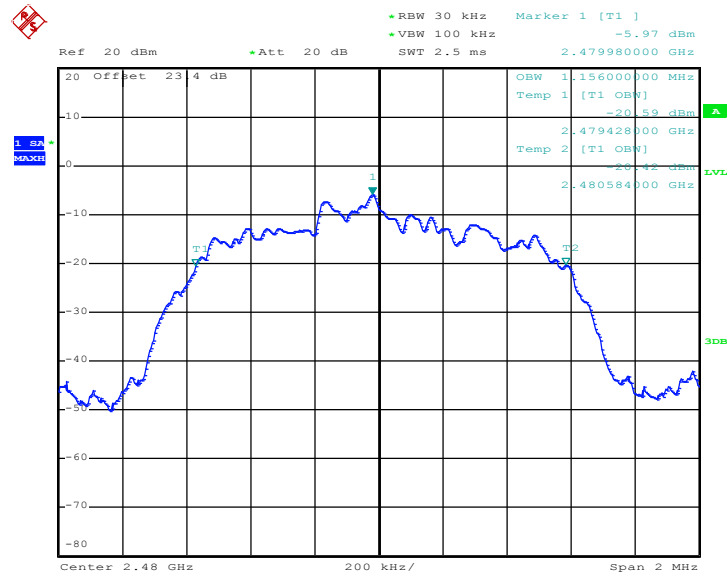

Date: 2.JUL.2016 14:34:28

Note : The occupied channel bandwidth is maintained within the band of operation for all of the modulations.

### 3.5 Peak Output Power Measurement

#### 3.5.1 Limit of Peak Output Power

Section 15.247 (b) The maximum peak conducted output power of the intentional radiator shall not exceed the following: (1) For frequency hopping systems operating in the 2400-2483.5 MHz band employing at least 75 non-overlapping hopping channels, and all frequency hopping systems in the 5725-5850 MHz band: 1 watt. For all other frequency hopping systems in the 2400-2483.5 MHz band 0.125 watts. The power limit for 1Mbps is 1watt, and for 2Mbps, 3Mbps and AFH are 0.125 watts.

#### 3.5.2 Measuring Instruments

The measuring equipment is listed in the section 4 of this test report.

#### 3.5.3 Test Procedures

1. The testing follows ANSI C63.10-2013 clause 7.8.5.
2. The RF output of EUT was connected to the power meter by RF cable and attenuator. The path loss was compensated to the results for each measurement.
3. Set to the maximum power setting and enable the EUT transmit continuously.
4. Measure the conducted output power with cable loss and record the results in the test report.
5. Measure and record the results in the test report.

#### 3.5.4 Test Setup

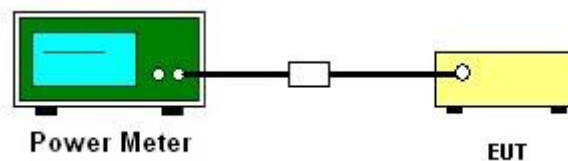



3.5.5 Test Result of Peak Output Power

Test Mode :	1Mbps	Temperature :	24~26°C
Test Engineer :	AC Chang	Relative Humidity :	48~51%

Channel	Frequency (MHz)	RF Power (dBm)		
		GFSK	Max. Limits (dBm)	Pass/Fail
		1 Mbps		
00	2402	-0.15	20.97	Pass
39	2441	1.73	20.97	Pass
78	2480	1.07	20.97	Pass

Note: For AFH mode using 20 hopping channels, the maximum output power limit is 20.97dBm.

Test Mode :	2Mbps	Temperature :	24~26°C
Test Engineer :	AC Chang	Relative Humidity :	48~51%

Channel	Frequency (MHz)	RF Power (dBm)		
		$\pi/4$ -DQPSK	Max. Limits (dBm)	Pass/Fail
		2 Mbps		
00	2402	-1.20	20.97	Pass
39	2441	0.55	20.97	Pass
78	2480	0.04	20.97	Pass

Test Mode :	3Mbps	Temperature :	24~26°C
Test Engineer :	AC Chang	Relative Humidity :	48~51%

Channel	Frequency (MHz)	RF Power (dBm)		
		8-DPSK	Max. Limits (dBm)	Pass/Fail
		3 Mbps		
00	2402	-0.75	20.97	Pass
39	2441	0.70	20.97	Pass
78	2480	-0.25	20.97	Pass

## 3.6 Conducted Band Edges Measurement

### 3.6.1 Limit of Band Edges

In any 100 kHz bandwidth outside the intentional radiation frequency band, the radio frequency power shall be at least 20 dB below the highest level of the radiated power. In addition, radiated emissions which fall in the restricted bands must also comply with the radiated emission limits.

### 3.6.2 Measuring Instruments

The measuring equipment is listed in the section 4 of this test report.

### 3.6.3 Test Procedures

1. The testing follows ANSI C63.10-2013 clause 7.8.6.
2. Set to the maximum power setting and enable the EUT transmit continuously.
3. Set RBW = 100kHz, VBW = 300kHz. Band edge emissions must be at least 20 dB down from the highest emission level within the authorized band as measured with a 100kHz RBW. The attenuation shall be 30 dB instead of 20 dB when RMS conducted output power procedure is used.
4. Enable hopping function of the EUT and then repeat step 2. and 3.
5. Measure and record the results in the test report.

### 3.6.4 Test Setup





### 3.6.5 Test Result of Conducted Band Edges

Test Mode :	1Mbps	Temperature :	24~26°C
Test Channel :	00 and 78	Relative Humidity :	48~51%
		Test Engineer :	AC Chang

Low Band Edge Plot on Channel 00

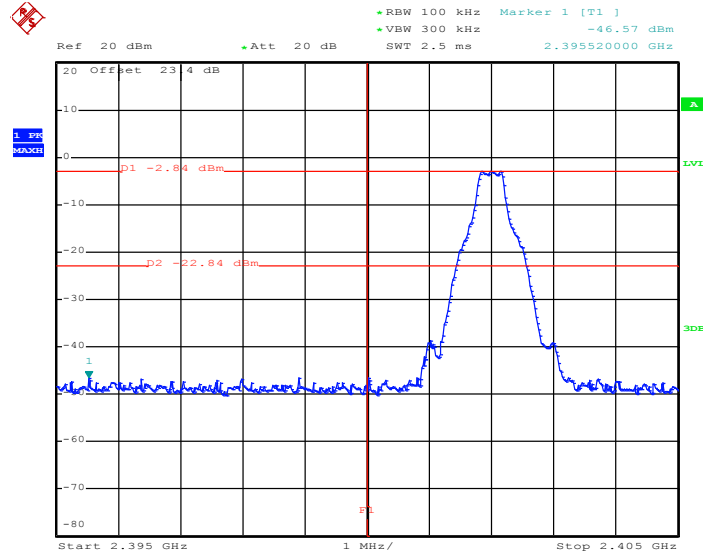

Date: 2.JUL.2016 15:00:17

High Band Edge Plot on Channel 78

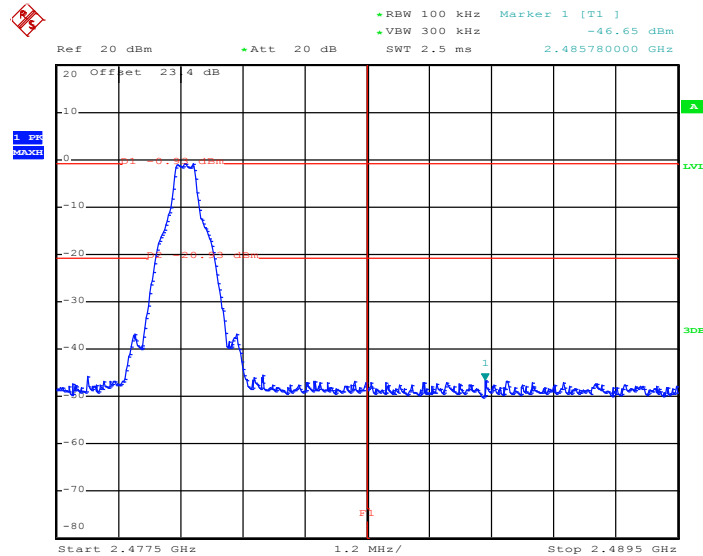

Date: 2.JUL.2016 15:00:45





Test Mode :	2Mbps	Temperature :	24~26°C
Test Channel :	00 and 78	Relative Humidity :	48~51%
		Test Engineer :	AC Chang

Low Band Edge Plot on Channel 00

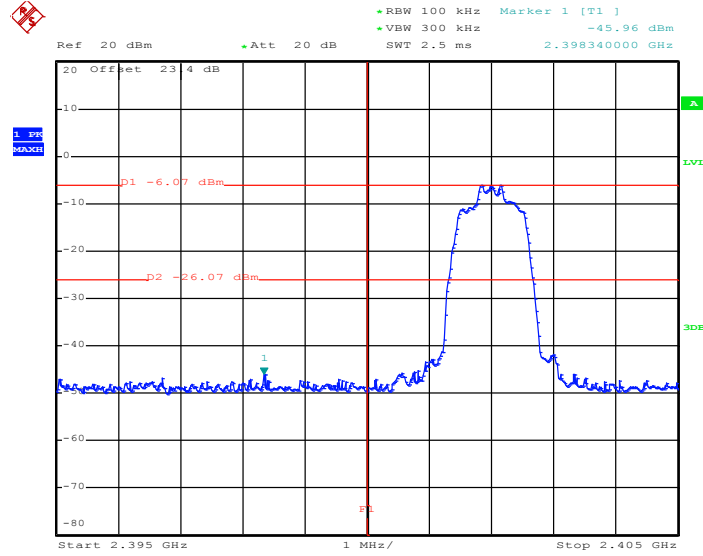

Date: 2.JUL.2016 15:01:29

High Band Edge Plot on Channel 78

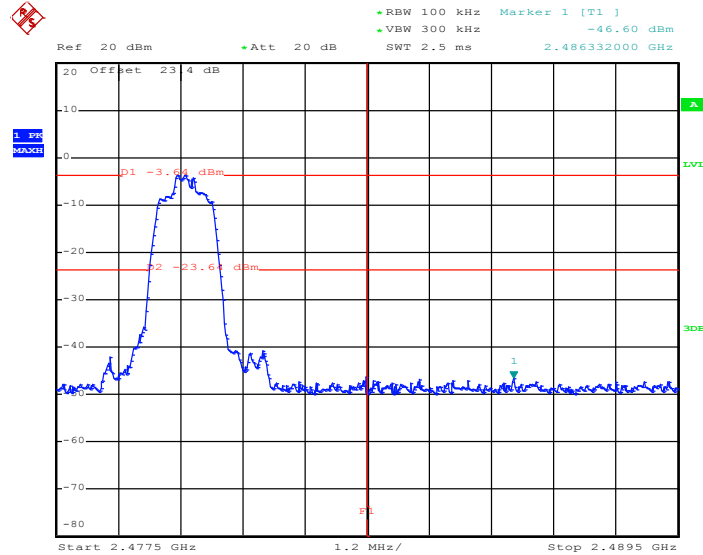

Date: 2.JUL.2016 15:01:59



Test Mode :	3Mbps	Temperature :	24~26°C
Test Channel :	00 and 78	Relative Humidity :	48~51%
		Test Engineer :	AC Chang

Low Band Edge Plot on Channel 00

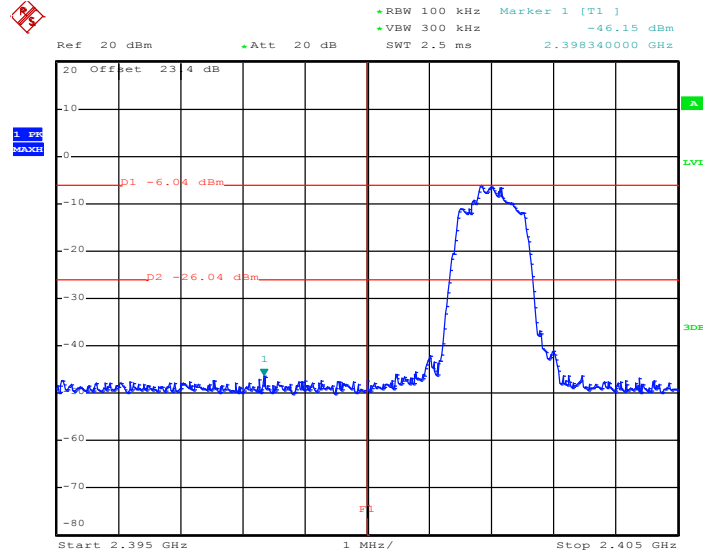

Date: 2.JUL.2016 15:02:28

High Band Edge Plot on Channel 78

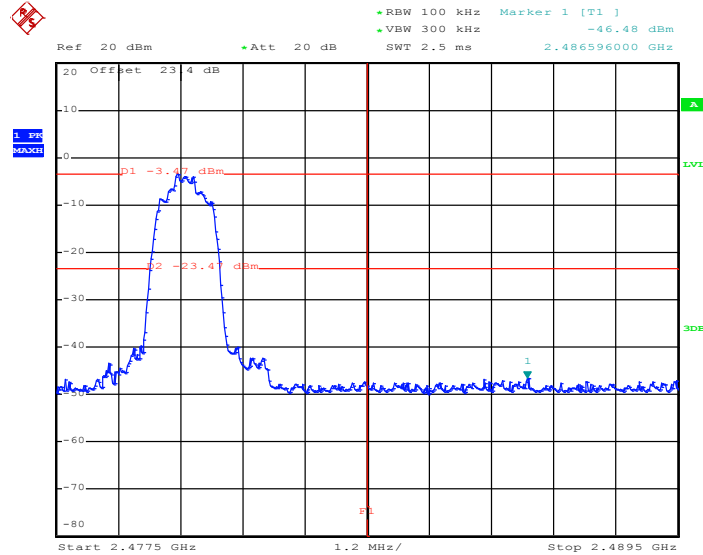

Date: 2.JUL.2016 15:02:58



### 3.6.6 Test Result of Conducted Hopping Mode Band Edges

Test Mode :	1Mbps	Temperature :	24~26°C
Test Engineer :	AC Chang	Relative Humidity :	48~51%

#### 1Mbps Hopping Mode Low Band Edge Plot

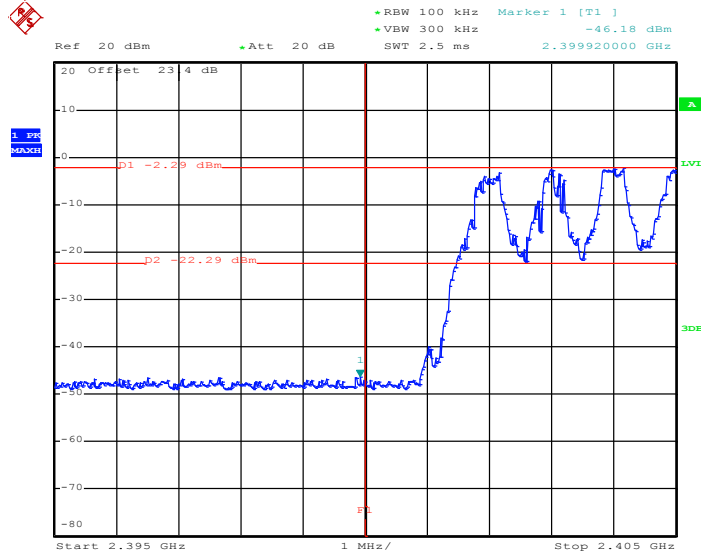

Date: 2.JUL.2016 14:52:36

#### 1Mbps Hopping Mode High Band Edge Plot

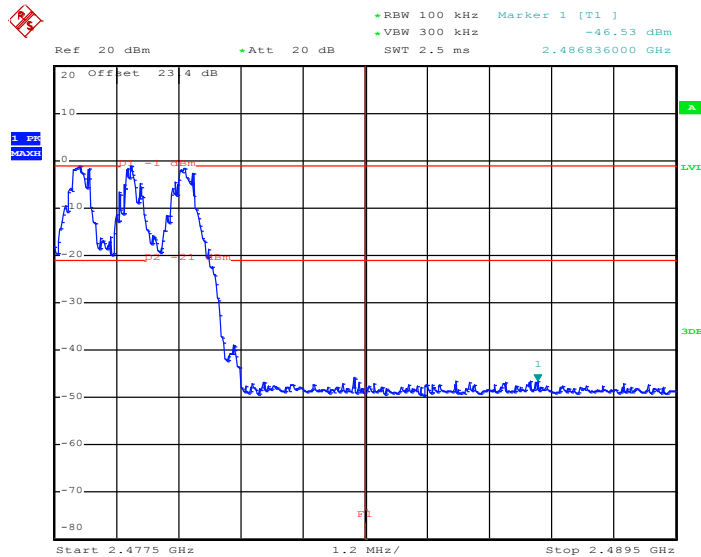

Date: 2.JUL.2016 14:53:16



Test Mode :	2Mbps	Temperature :	24~26°C
Test Engineer :	AC Chang	Relative Humidity :	48~51%

2Mbps Hopping Mode Low Band Edge Plot

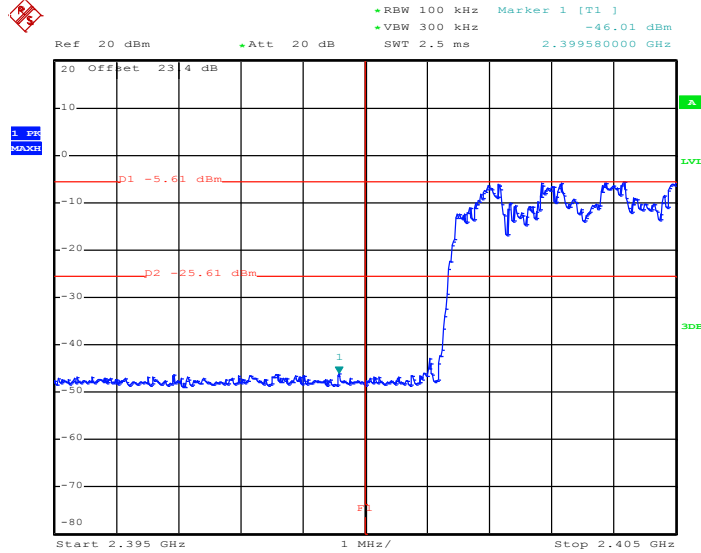

Date: 2.JUL.2016 14:55:11

2Mbps Hopping Mode High Band Edge Plot

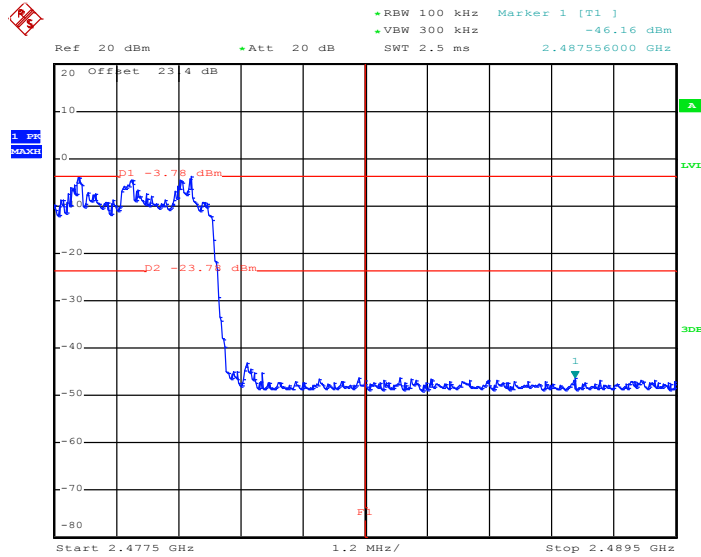

Date: 2.JUL.2016 14:56:15



Test Mode :	3Mbps	Temperature :	24~26°C
Test Engineer :	AC Chang	Relative Humidity :	48~51%

3Mbps Hopping Mode Low Band Edge Plot

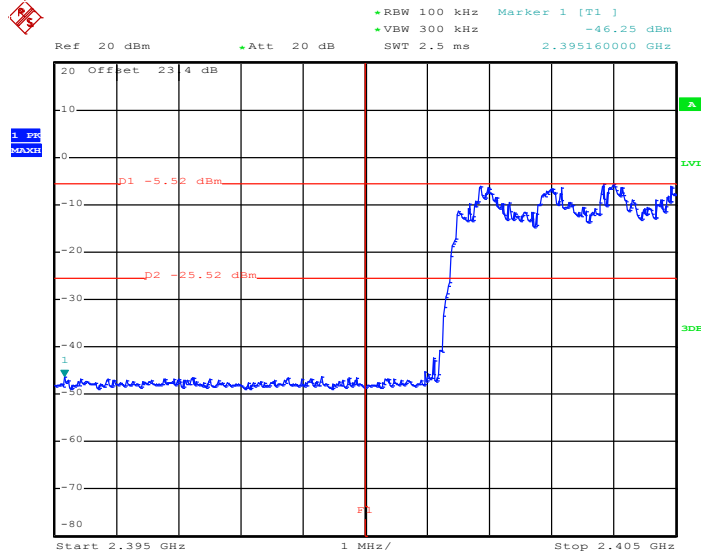

Date: 2.JUL.2016 14:58:18

3Mbps Hopping Mode High Band Edge Plot

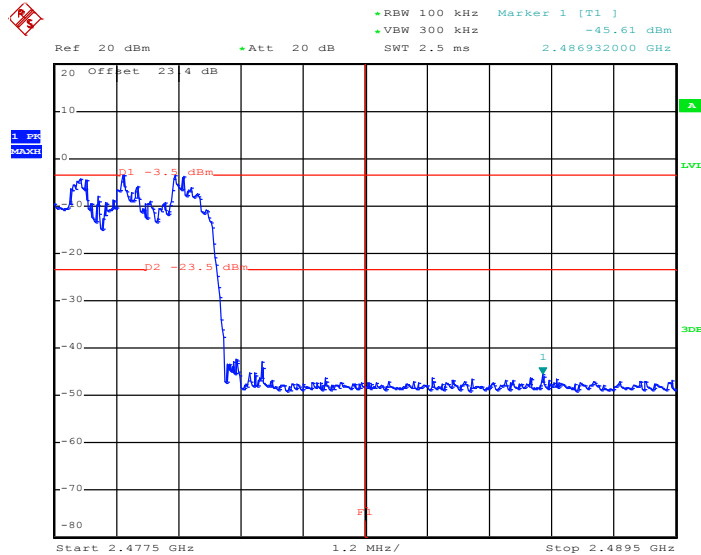

Date: 2.JUL.2016 14:59:35

## 3.7 Conducted Spurious Emission Measurement

### 3.7.1 Limit of Spurious Emission Measurement

In any 100 kHz bandwidth outside the intentional radiation frequency band, the radio frequency power shall be at least 20 dB below the highest level of the radiated power. In addition, radiated emissions which fall in the restricted bands must also comply with the radiated emission limits.

### 3.7.2 Measuring Instruments

The measuring equipment is listed in the section 4 of this test report.

### 3.7.3 Test Procedure

1. The testing follows ANSI C63.10-2013 clause 7.8.8.
2. The RF output of EUT was connected to the spectrum analyzer by RF cable and attenuator. The path loss was compensated to the results for each measurement.
3. Set to the maximum power setting and enable the EUT transmit continuously.
4. Set RBW = 100 kHz, VBW = 300kHz, scan up through 10th harmonic. All harmonics / spurs must be at least 20 dB down from the highest emission level within the authorized band as measured with a 100 kHz RBW.
5. Measure and record the results in the test report.
6. The RF fundamental frequency should be excluded against the limit line in the operating frequency band.

### 3.7.4 Test Setup

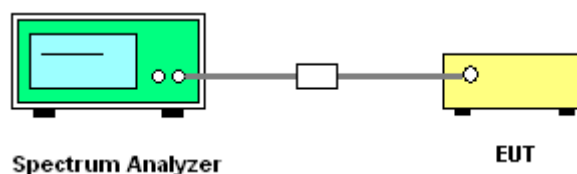



### 3.7.5 Test Result of Conducted Spurious Emission

Test Mode :	1Mbps	Temperature :	24~26°C
Test Channel :	00	Relative Humidity :	48~51%
		Test Engineer :	AC Chang

1Mbps CSE Plot on Ch 00 between 30MHz ~ 3 GHz

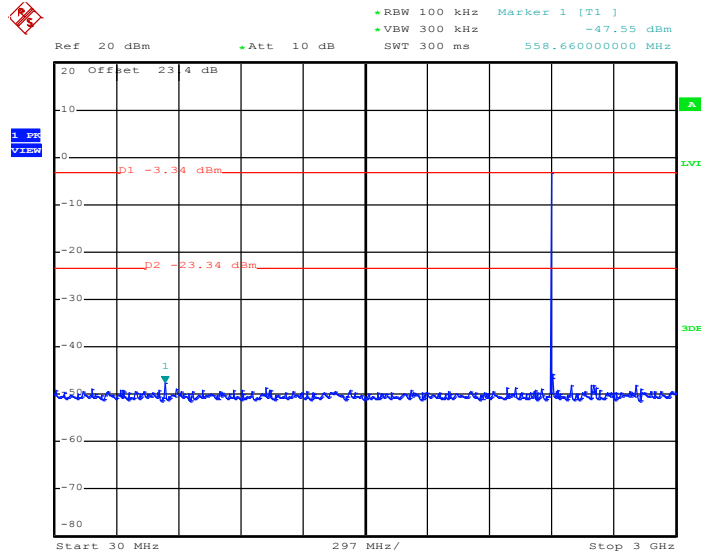

Date: 2.JUL.2016 13:45:02

1Mbps CSE Plot on Ch 00 between 2 GHz ~ 25 GHz

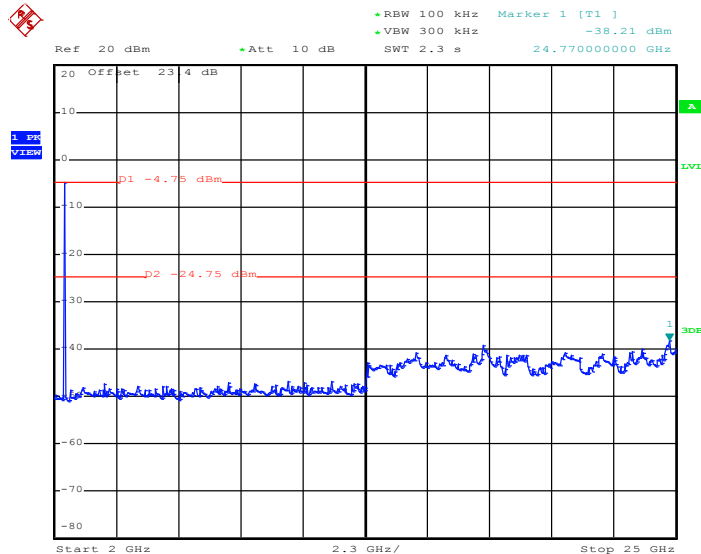

Date: 2.JUL.2016 13:45:23



Test Mode :	1Mbps	Temperature :	24~26°C
Test Channel :	39	Relative Humidity :	48~51%
		Test Engineer :	AC Chang

1Mbps CSE Plot on Ch 39 between 30MHz ~ 3 GHz

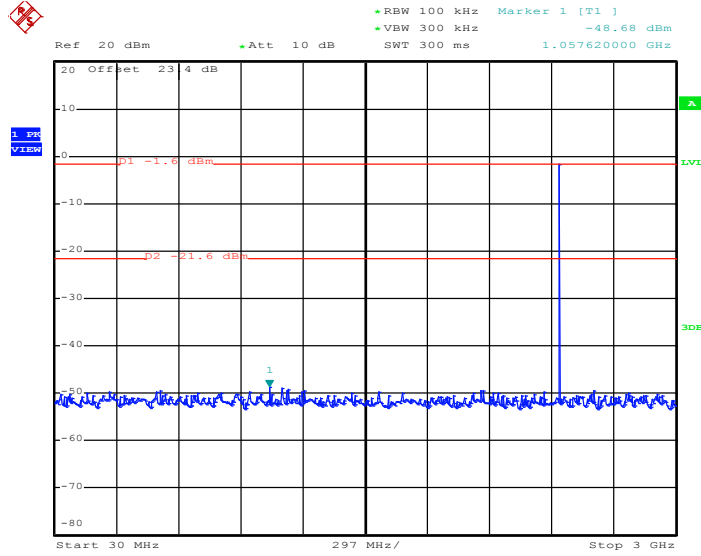

Date: 2.JUL.2016 13:49:20

1Mbps CSE Plot on Ch 39 between 2 GHz ~ 25 GHz

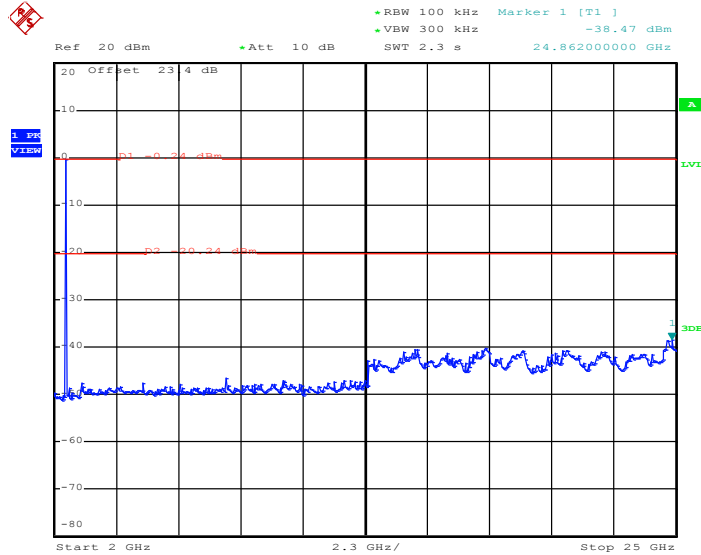

Date: 2.JUL.2016 13:49:42





Test Mode :	1Mbps	Temperature :	24~26°C
Test Channel :	78	Relative Humidity :	48~51%
		Test Engineer :	AC Chang

1Mbps CSE Plot on Ch 78 between 30MHz ~ 3 GHz

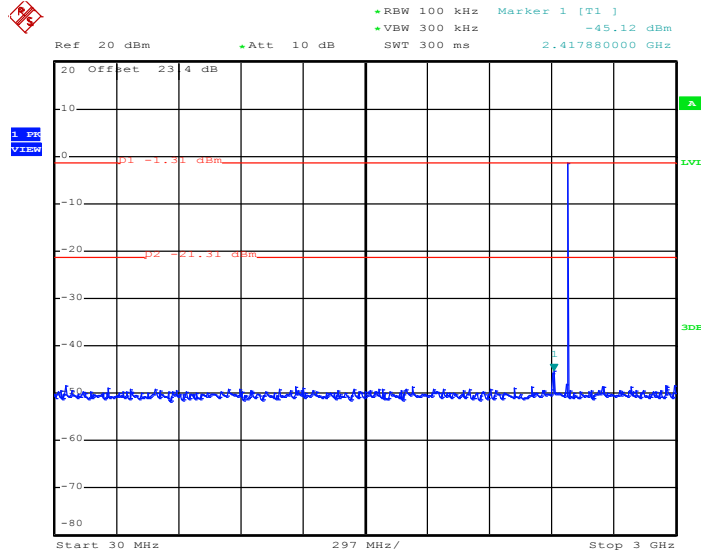

Date: 2.JUL.2016 13:55:14

1Mbps CSE Plot on Ch 78 between 2 GHz ~ 25 GHz

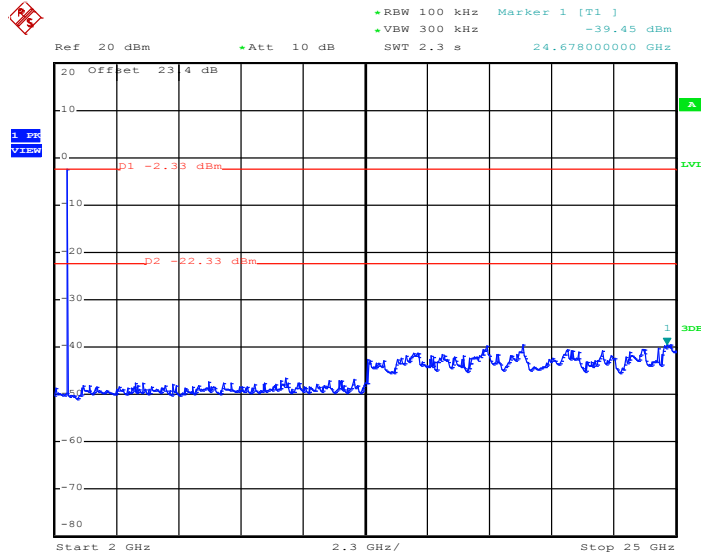

Date: 2.JUL.2016 13:55:36



Test Mode :	2Mbps	Temperature :	24~26°C
Test Channel :	00	Relative Humidity :	48~51%
		Test Engineer :	AC Chang

2Mbps CSE Plot on Ch 00 between 30MHz ~ 3 GHz

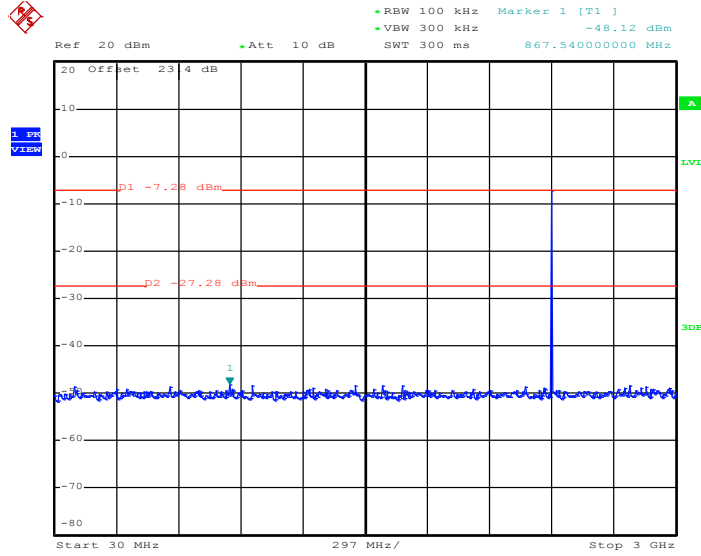

Date: 2.JUL.2016 14:15:39

2Mbps CSE Plot on Ch 00 between 2 GHz ~ 25 GHz

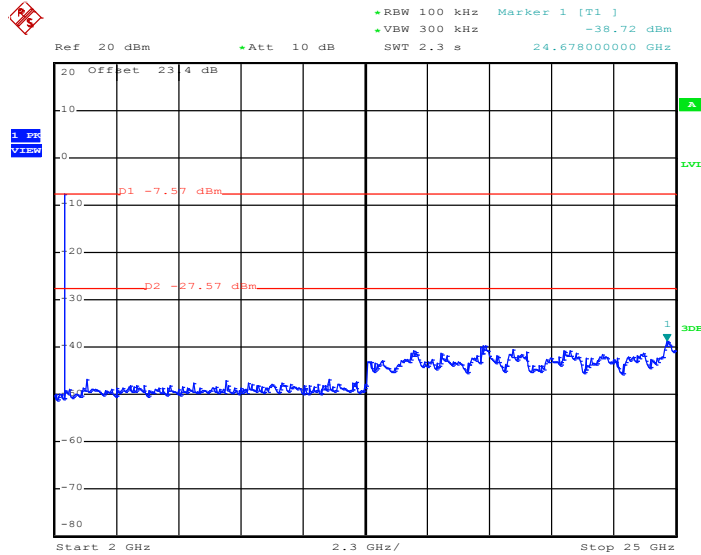

Date: 2.JUL.2016 14:16:00



Test Mode :	2Mbps	Temperature :	24~26°C
Test Channel :	39	Relative Humidity :	48~51%
		Test Engineer :	AC Chang

2Mbps CSE Plot on Ch 39 between 30MHz ~ 3 GHz

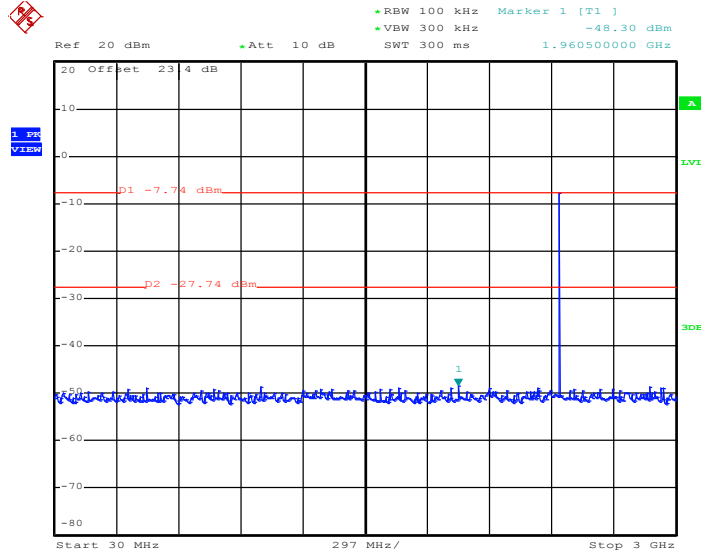

Date: 2.JUL.2016 14:20:15

2Mbps CSE Plot on Ch 39 between 2 GHz ~ 25 GHz

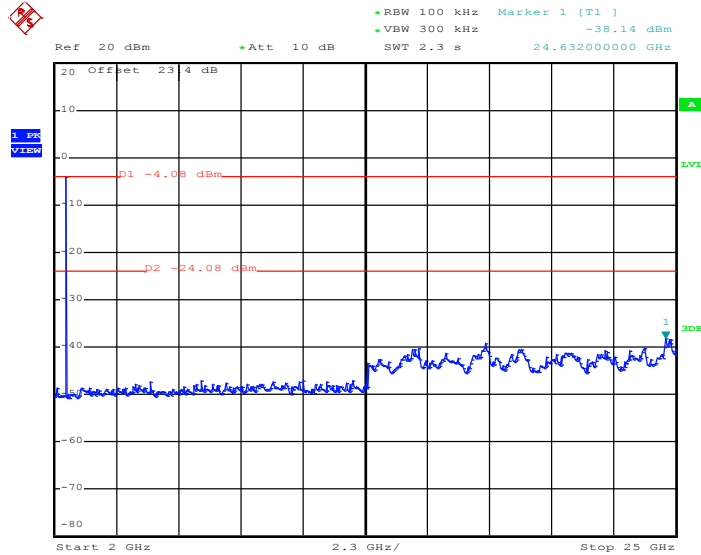

Date: 2.JUL.2016 14:20:37



Test Mode :	2Mbps	Temperature :	24~26°C
Test Channel :	78	Relative Humidity :	48~51%
		Test Engineer :	AC Chang

2Mbps CSE Plot on Ch 78 between 30MHz ~ 3 GHz

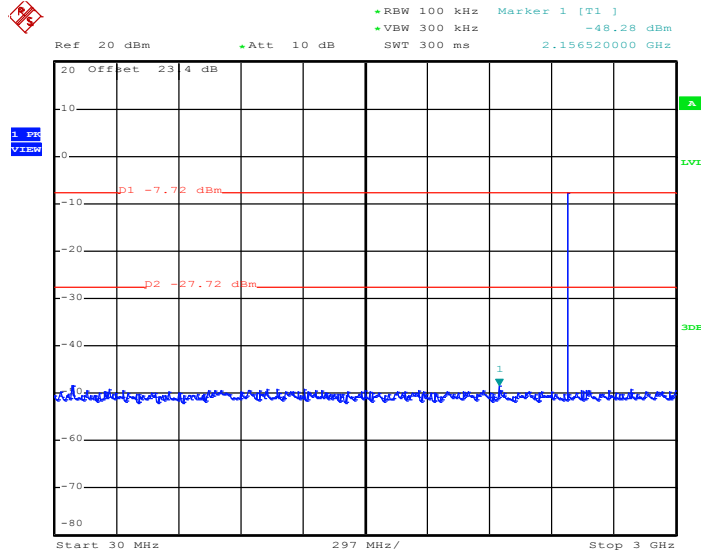

Date: 2.JUL.2016 14:23:44

2Mbps CSE Plot on Ch 78 between 2 GHz ~ 25 GHz

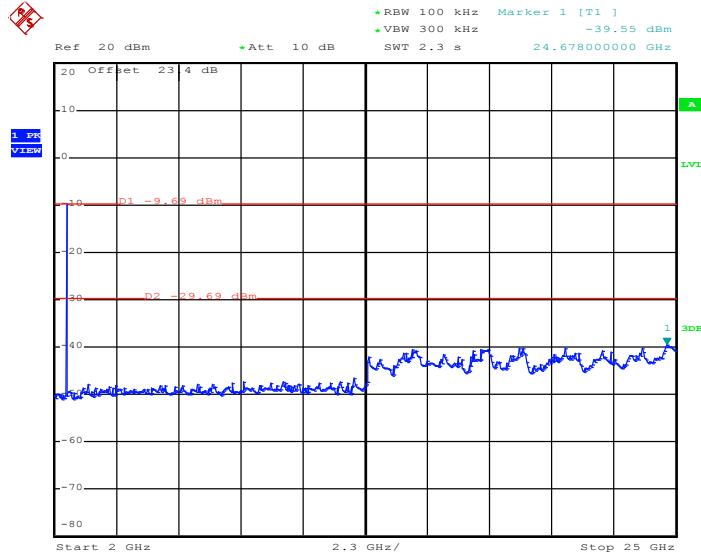

Date: 2.JUL.2016 14:24:05



Test Mode :	3Mbps	Temperature :	24~26°C
Test Channel :	00	Relative Humidity :	48~51%
		Test Engineer :	AC Chang

3Mbps CSE Plot on Ch 00 between 30MHz ~ 3 GHz

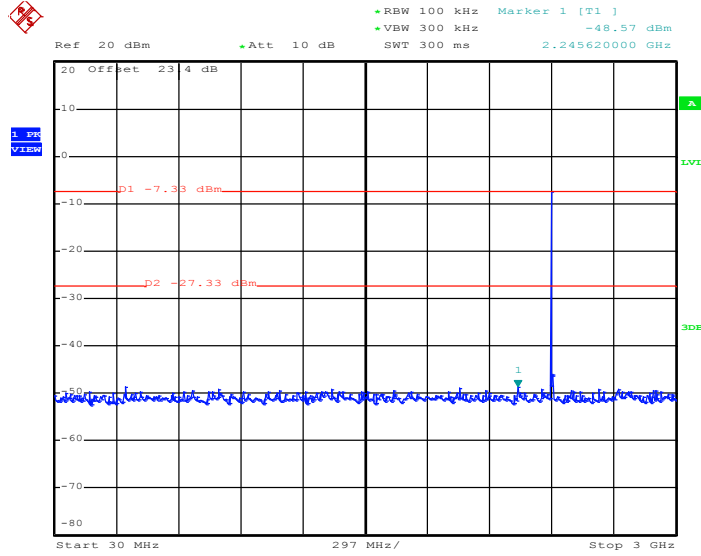

Date: 2.JUL.2016 14:28:24

3Mbps CSE Plot on Ch 00 between 2 GHz ~ 25 GHz

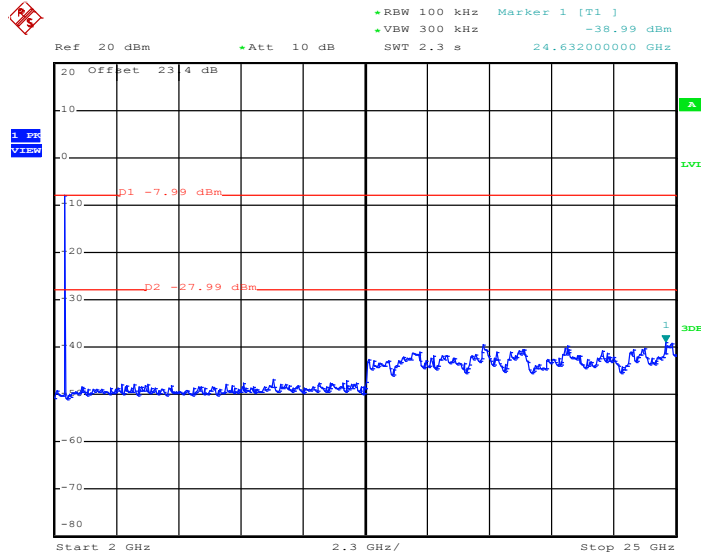

Date: 2.JUL.2016 14:28:46



Test Mode :	3Mbps	Temperature :	24~26°C
Test Channel :	39	Relative Humidity :	48~51%
		Test Engineer :	AC Chang

3Mbps CSE Plot on Ch 39 between 30MHz ~ 3 GHz

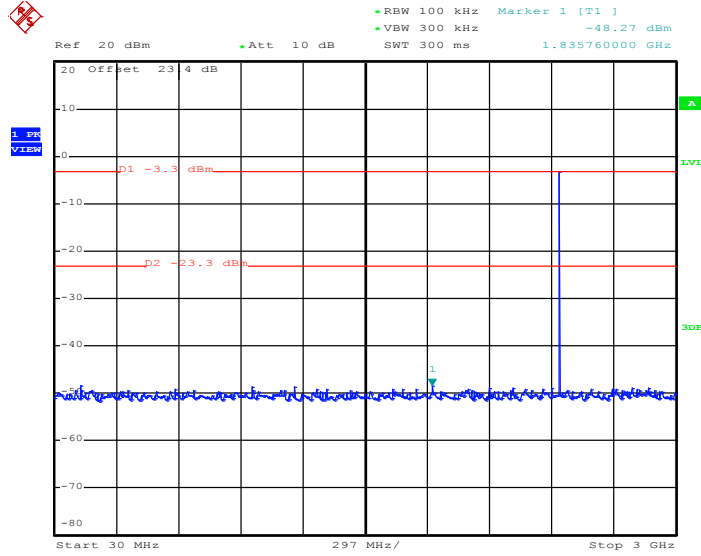

Date: 2.JUL.2016 14:32:02

3Mbps CSE Plot on Ch 39 between 2 GHz ~ 25 GHz

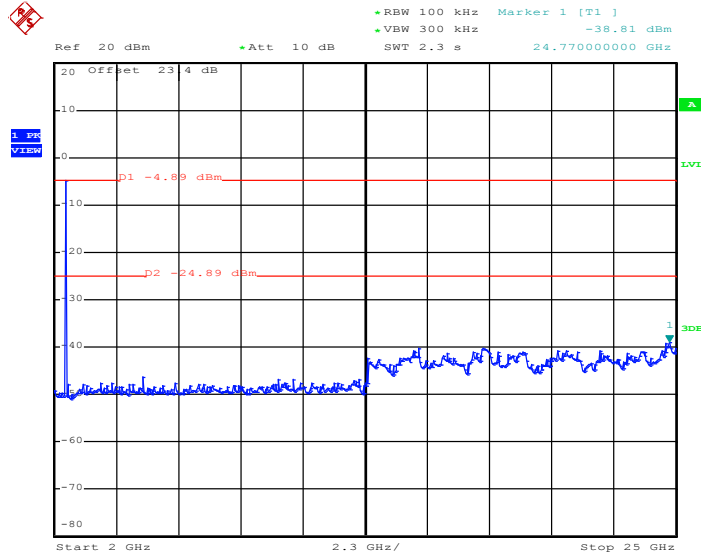

Date: 2.JUL.2016 14:32:23



Test Mode :	3Mbps	Temperature :	24~26°C
Test Channel :	78	Relative Humidity :	48~51%
		Test Engineer :	AC Chang

3Mbps CSE Plot on Ch 78 between 30MHz ~ 3 GHz

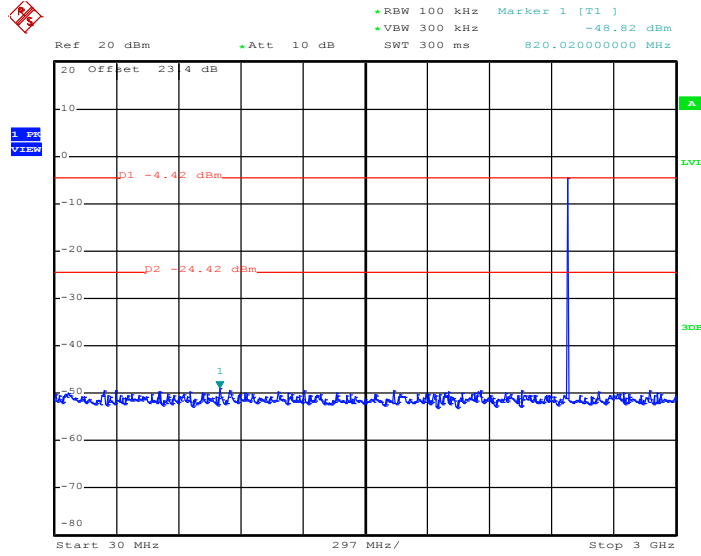

Date: 2.JUL.2016 14:36:32

3Mbps CSE Plot on Ch 78 between 2 GHz ~ 25 GHz

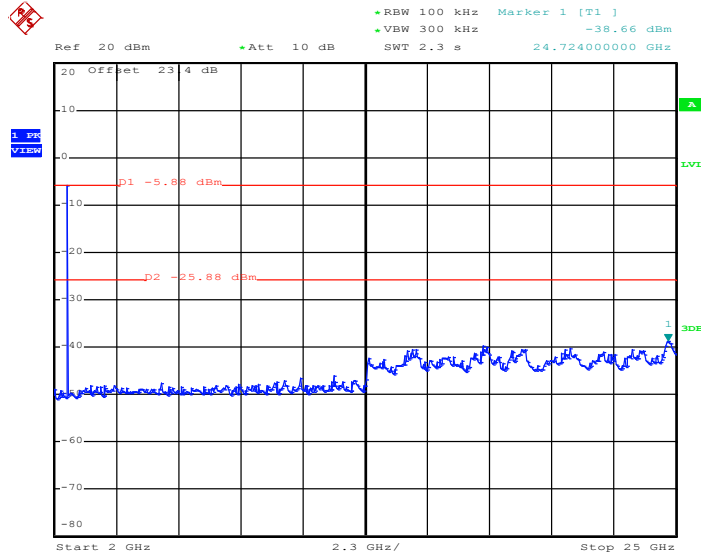

Date: 2.JUL.2016 14:36:54



### 3.8 Radiated Band Edges and Spurious Emission Measurement

#### 3.8.1 Limit of Radiated Band Edges and Spurious Emission

In any 100 kHz bandwidth outside the intentional radiator frequency band, all harmonics/spurious must be at least 20 dB below the highest emission level within the authorized band. In addition, radiated emissions which fall in the restricted bands must also comply with the FCC section 15.209 limits as below.

Frequency (MHz)	Field Strength (microvolts/meter)	Measurement Distance (meters)
0.009 – 0.490	2400/F(kHz)	300
0.490 – 1.705	24000/F(kHz)	30
1.705 – 30.0	30	30
30 – 88	100	3
88 – 216	150	3
216 - 960	200	3
Above 960	500	3

#### 3.8.2 Measuring Instruments

The measuring equipment is listed in the section 4 of this test report.





### 3.8.3 Test Procedures

1. The EUT was placed on a turntable with 0.8 meter for frequency below 1GHz and 1.5 meter for frequency above 1GHz respectively above ground.
2. The EUT was set 3 meters from the interference receiving antenna, which was mounted on the top of a variable height antenna tower.
3. For each suspected emission, the EUT was arranged and then tune the Antenna tower (from 1 m to 4 m) and turntable (from 0 degree to 360 degrees) to find the maximum reading. A pre-amp and a high pass filter are used for the test in order to get better signal level to comply with the guidelines.
4. Set to the maximum power setting and enable the EUT transmit continuously.
5. Use the following spectrum analyzer settings:
  - (1) Span shall wide enough to fully capture the emission being measured;
  - (2) Set RBW=100 kHz for  $f < 1 \text{ GHz}$ , RBW=1MHz for  $f > 1\text{GHz}$  ; VBW  $\geq$  RBW; Sweep = auto; Detector function = peak; Trace = max hold for peak
  - (3) For average measurement: use duty cycle correction factor method per 15.35(c).  
Duty cycle = On time/100 milliseconds  
On time =  $N_1 * L_1 + N_2 * L_2 + \dots + N_{n-1} * L_{n-1} + N_n * L_n$   
Where  $N_1$  is number of type 1 pulses,  $L_1$  is length of type 1 pulses, etc.  
Average Emission Level = Peak Emission Level +  $20 * \log(\text{Duty cycle})$
6. Corrected Reading: Antenna Factor + Cable Loss + Read Level - Preamp Factor = Level

Note: The average levels were calculated from the peak level corrected with duty cycle correction factor (24.79dB) derived from  $20 \log (\text{dwell time}/100\text{ms})$ . This correction is only for signals that hop with the fundamental signal, such as band-edge and harmonic. Other spurious signals that are independent of the hopping signal would not use this correction.

### 3.8.4 Test Setup

For radiated emissions below 30MHz

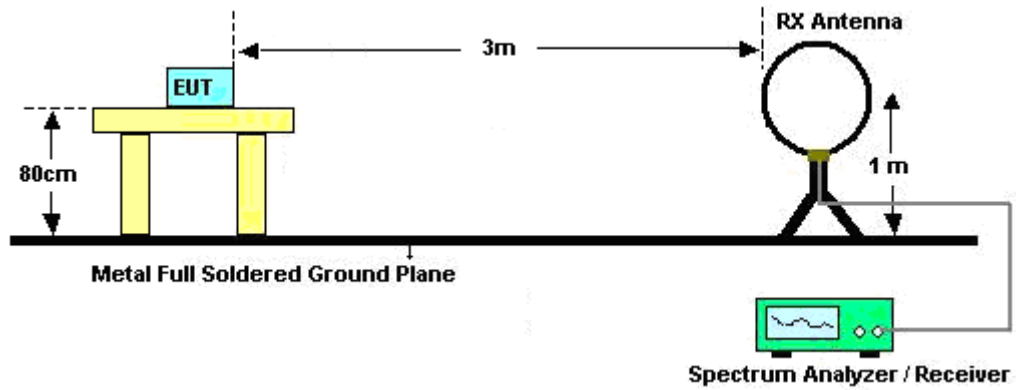

For radiated emissions from 30MHz to 1GHz

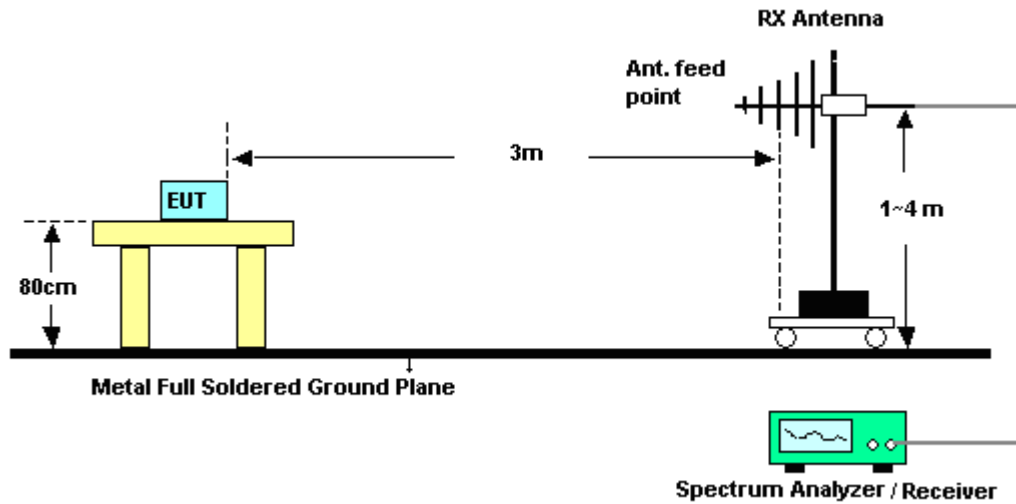

For radiated emissions above 1GHz

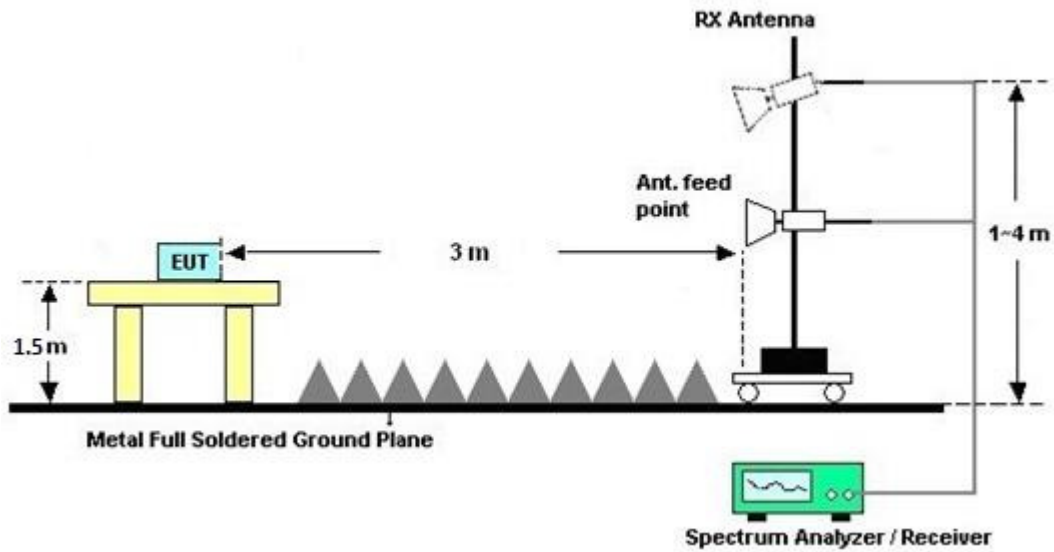

### 3.8.5 Test Results of Radiated Spurious Emissions (9 kHz ~ 30 MHz)

The low frequency, which started from 9 kHz to 30MHz, was pre-scanned and the result which was 20dB lower than the limit line per 15.31(o) was not reported.



### 3.8.6 Duty cycle correction factor for average measurement

DH5 on time (One Pulse) Plot on Channel 39

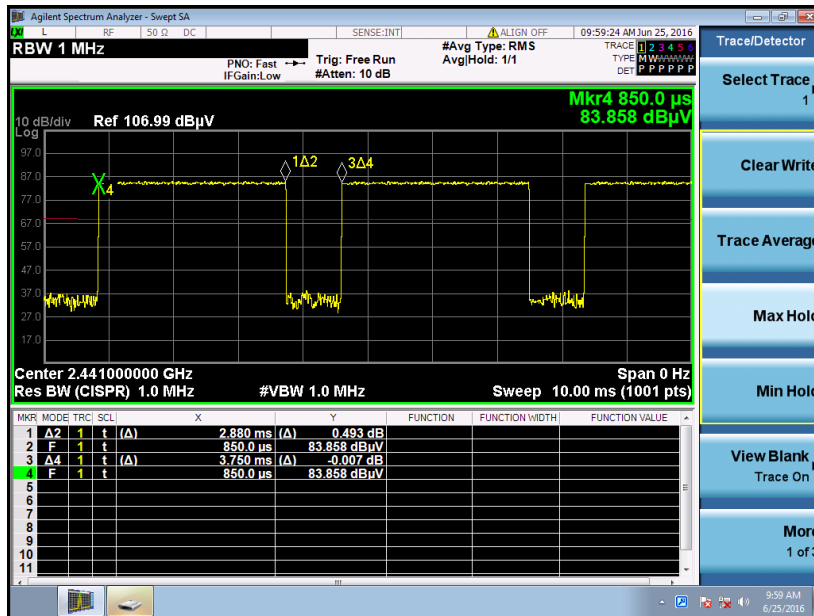

DH5 on time (Count Pulses) Plot on Channel 39

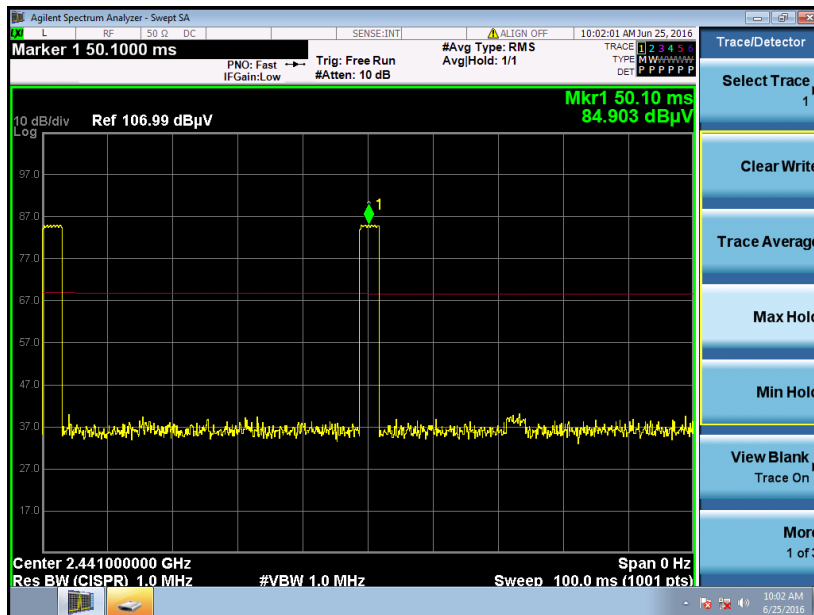

**Note:**

1. Duty cycle = on time/100 milliseconds = 2 \* 2.88 / 100 = 5.76 %
2. Duty cycle correction factor = 20\*log(Duty cycle) = -24.79 dB
3. DH5 has the highest duty cycle worst case and is reported.



**Duty Cycle Correction Factor Consideration for AFH mode:**

Bluetooth normal hopping rate is 1600Hz and reduced to 800Hz in AFH mode; due to the reduced number of hopping frequencies, with the same packet configuration the dwell time in each channel frequency within 100msec period is longer in AFH mode than normal mode.

In AFH mode, the minimum hopping frequencies are 20, to get the longest dwell time DH5 packet is observed; the period to have DH5 packet completing one hopping sequence is

$$2.88 \text{ ms} \times 20 \text{ channels} = 57.6 \text{ ms}$$

There cannot be 2 complete hopping sequences within 100ms period, considering the random hopping behavior, maximum 2 hops can be possibly observed within the period.  $[100\text{ms} / 57.6\text{ms}] = 2 \text{ hops}$

Thus, the maximum possible ON time:

$$2.88 \text{ ms} \times 2 = 5.76 \text{ ms}$$

Worst case Duty Cycle Correction factor, which is derived from the maximum possible ON time,

$$20 \times \log(5.76 \text{ ms}/100\text{ms}) = -24.79 \text{ dB}$$

**3.8.7 Test Result of Radiated Spurious at Band Edges**

Please refer to Appendix A and B.

**3.8.8 Test Result of Radiated Spurious Emission (30MHz ~ 10<sup>th</sup> Harmonic)**

Please refer to Appendix A and B.



### 3.9 AC Conducted Emission Measurement

#### 3.9.1 Limit of AC Conducted Emission

For equipment that is designed to be connected to the public utility (AC) power line, the radio frequency voltage that is conducted back onto the AC power line on any frequency or frequencies within the band 150 kHz to 30 MHz shall not exceed the limits in the following table.

Frequency of emission (MHz)	Conducted limit (dBµV)	
	Quasi-peak	Average
0.15-0.5	66 to 56*	56 to 46*
0.5-5	56	46
5-30	60	50

\*Decreases with the logarithm of the frequency.

For terminal test result, the testing follows FCC KDB 174176.

#### 3.9.2 Measuring Instruments

The measuring equipment is listed in the section 4 of this test report.

#### 3.9.3 Test Procedures

1. The EUT was placed 0.4 meter from the conducting wall of the shielding room was kept at least 80 centimeters from any other grounded conducting surface.
2. Connect EUT to the power mains through a line impedance stabilization network (LISN).
3. All the support units are connecting to the other LISN.
4. The LISN provides 50 ohm coupling impedance for the measuring instrument.
5. The FCC states that a 50 ohm, 50 microhenry LISN should be used.
6. Both sides of AC line were checked for maximum conducted interference.
7. The frequency range from 150 kHz to 30 MHz was searched.
8. Set the test-receiver system to Peak Detect Function and specified bandwidth (IF Bandwidth = 9kHz) with Maximum Hold Mode. Then measurement is also conducted by Average Detector and Quasi-Peak Detector Function respectively.

### 3.9.4 Test Setup

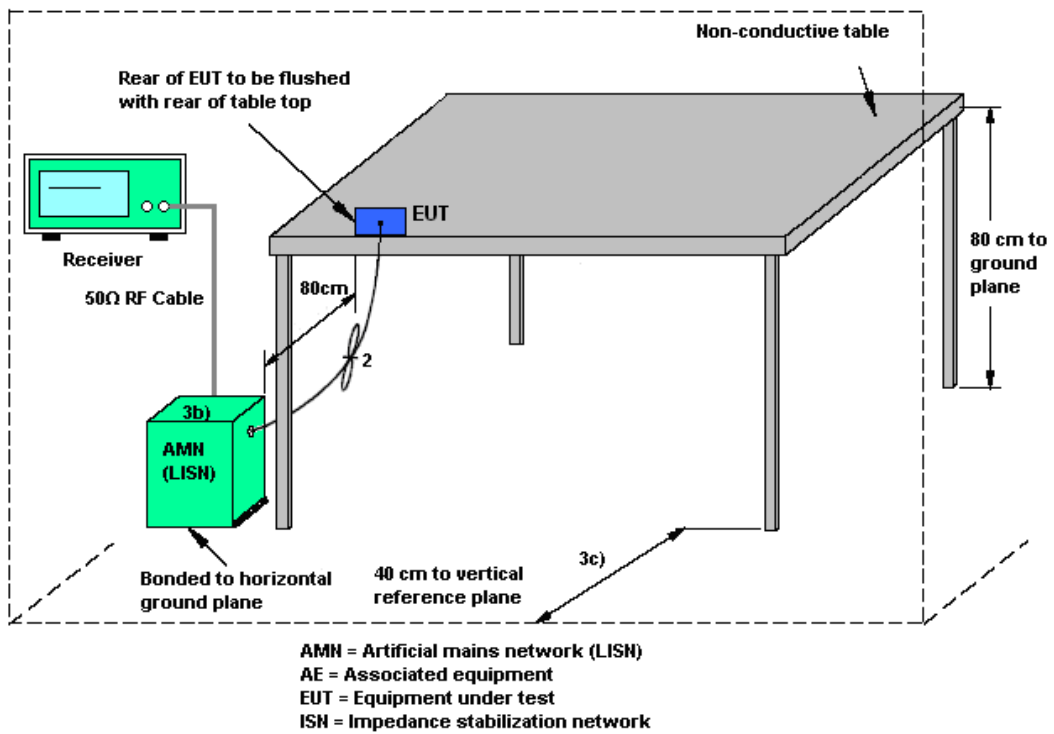

### 3.9.5 Test Result of AC Conducted Emission

<Original Test Result>

Test Mode :	Mode 1	Temperature :	23~24°C
Test Engineer :	Arthur Hsieh	Relative Humidity :	51~52%
Test Voltage :	120Vac / 60Hz	Phase :	Line
Function Type :	WLAN (2.4GHz) Link + Bluetooth Link + NFC Link + Earphone 1 with Audio Adapter connect to EDA + Charging Only Cable + AC Adapter		

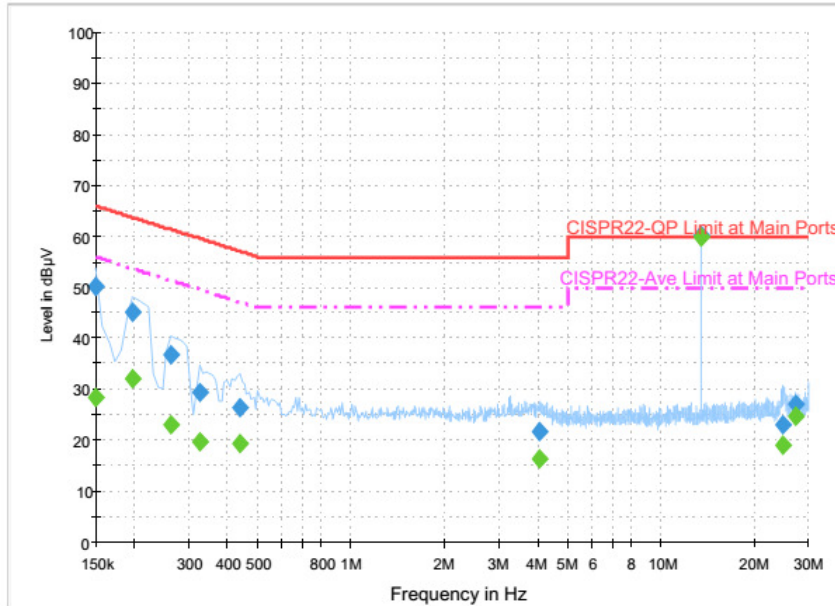

**Final Result : Quasi-Peak**

Frequency (MHz)	Quasi-Peak (dBµV)	Filter	Line	Corr. (dB)	Margin (dB)	Limit (dBµV)
0.150000	50.1	Off	L1	19.6	15.9	66.0
0.198000	45.1	Off	L1	19.6	18.6	63.7
0.262000	36.7	Off	L1	19.6	24.7	61.4
0.326000	29.4	Off	L1	19.6	30.2	59.6
0.438000	26.6	Off	L1	19.6	30.5	57.1
4.054000	21.7	Off	L1	19.7	34.3	56.0
13.558000	60.3	Off	L1	19.8	-0.3	60.0
24.942000	23.0	Off	L1	19.9	37.0	60.0
27.118000	27.3	Off	L1	19.9	32.7	60.0

**Final Result : Average**

Frequency (MHz)	Average (dBµV)	Filter	Line	Corr. (dB)	Margin (dB)	Limit (dBµV)
0.150000	28.4	Off	L1	19.6	27.6	56.0
0.198000	32.2	Off	L1	19.6	21.5	53.7
0.262000	23.0	Off	L1	19.6	28.4	51.4
0.326000	19.8	Off	L1	19.6	29.8	49.6
0.438000	19.2	Off	L1	19.6	27.9	47.1
4.054000	16.4	Off	L1	19.7	29.6	46.0
13.558000	60.0	Off	L1	19.8	-10.0	50.0
24.942000	18.9	Off	L1	19.9	31.1	50.0
27.118000	24.7	Off	L1	19.9	25.3	50.0





Test Mode :	Mode 1	Temperature :	23~24°C
Test Engineer :	Arthur Hsieh	Relative Humidity :	51~52%
Test Voltage :	120Vac / 60Hz	Phase :	Neutral
Function Type :	WLAN (2.4GHz) Link + Bluetooth Link + NFC Link + Earphone 1 with Audio Adapter connect to EDA + Charging Only Cable + AC Adapter		

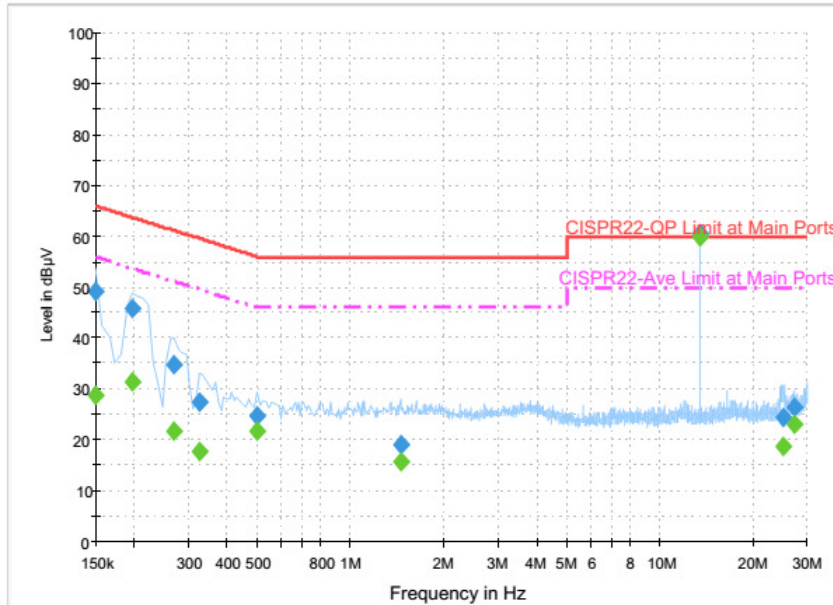

**Final Result : Quasi-Peak**

Frequency (MHz)	Quasi-Peak (dBµV)	Filter	Line	Corr. (dB)	Margin (dB)	Limit (dBµV)
0.150000	49.1	Off	N	19.6	16.9	66.0
0.198000	45.8	Off	N	19.6	17.9	63.7
0.270000	34.7	Off	N	19.6	26.4	61.1
0.326000	27.4	Off	N	19.6	32.2	59.6
0.502000	24.6	Off	N	19.6	31.4	56.0
1.454000	18.9	Off	N	19.6	37.1	56.0
13.558000	60.5	Off	N	19.8	-0.5	60.0
25.078000	24.4	Off	N	20.0	35.6	60.0
27.118000	26.6	Off	N	20.1	33.4	60.0

**Final Result : Average**

Frequency (MHz)	Average (dBµV)	Filter	Line	Corr. (dB)	Margin (dB)	Limit (dBµV)
0.150000	28.6	Off	N	19.6	27.4	56.0
0.198000	31.3	Off	N	19.6	22.4	53.7
0.270000	21.8	Off	N	19.6	29.3	51.1
0.326000	17.6	Off	N	19.6	32.0	49.6
0.502000	21.7	Off	N	19.6	24.3	46.0
1.454000	15.8	Off	N	19.6	30.2	46.0
13.558000	59.8	Off	N	19.8	-9.8	50.0
25.078000	18.6	Off	N	20.0	31.4	50.0
27.118000	23.2	Off	N	20.1	26.8	50.0



<Terminal Test Result>

Test Mode :	Mode 1	Temperature :	23~24°C
Test Engineer :	Arthur Hsieh	Relative Humidity :	51~52%
Test Voltage :	120Vac / 60Hz	Phase :	Line
Function Type :	WLAN (2.4GHz) Link + Bluetooth Link + NFC Link + Earphone 1 with Audio Adapter connect to EDA + Charging Only Cable + AC Adapter		

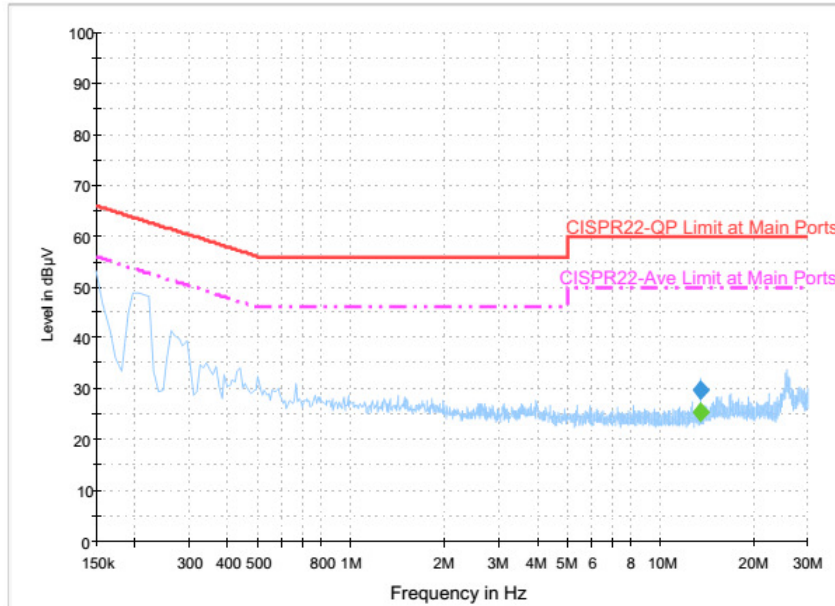

Final Result : Quasi-Peak

Frequency (MHz)	Quasi-Peak (dBµV)	Filter	Line	Corr. (dB)	Margin (dB)	Limit (dBµV)
13.558000	29.8	Off	L1	19.8	30.2	60.0

Final Result : Average

Frequency (MHz)	Average (dBµV)	Filter	Line	Corr. (dB)	Margin (dB)	Limit (dBµV)
13.558000	25.5	Off	L1	19.8	24.5	50.0



Test Mode :	Mode 1	Temperature :	23~24°C
Test Engineer :	Arthur Hsieh	Relative Humidity :	51~52%
Test Voltage :	120Vac / 60Hz	Phase :	Neutral
Function Type :	WLAN (2.4GHz) Link + Bluetooth Link + NFC Link + Earphone 1 with Audio Adapter connect to EDA + Charging Only Cable + AC Adapter		

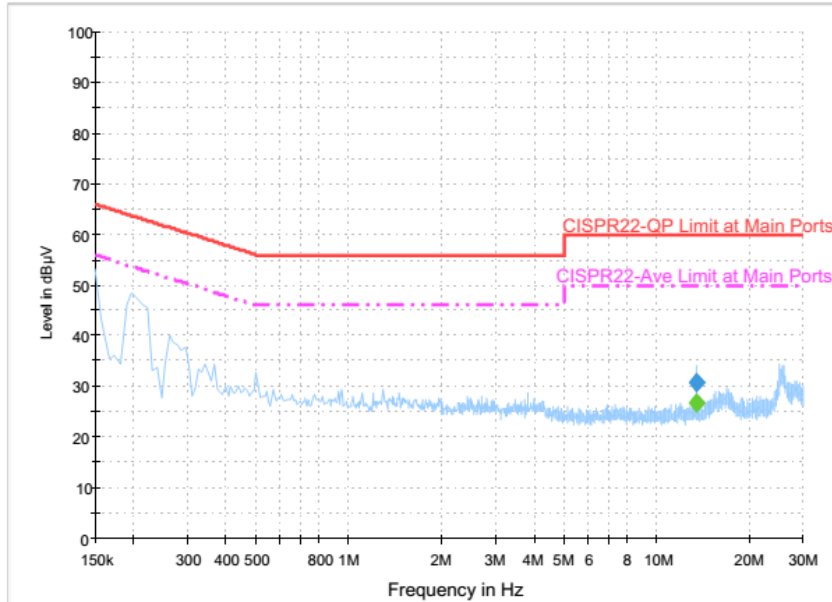

**Final Result : Quasi-Peak**

Frequency (MHz)	Quasi-Peak (dBµV)	Filter	Line	Corr. (dB)	Margin (dB)	Limit (dBµV)
13.558000	30.9	Off	N	19.8	29.1	60.0

**Final Result : Average**

Frequency (MHz)	Average (dBµV)	Filter	Line	Corr. (dB)	Margin (dB)	Limit (dBµV)
13.558000	26.9	Off	N	19.8	23.1	50.0



<Original Test Result>

Test Mode :	Mode 2	Temperature :	23~24°C
Test Engineer :	Arthur Hsieh	Relative Humidity :	51~52%
Test Voltage :	120Vac / 60Hz	Phase :	Line
Function Type :	WLAN (2.4GHz) Link + Bluetooth Link + NFC Link + Snap on USB Cable Data link with Notebook + Copy Data from EDA (eMMC) to Notebook + AC Adapter		

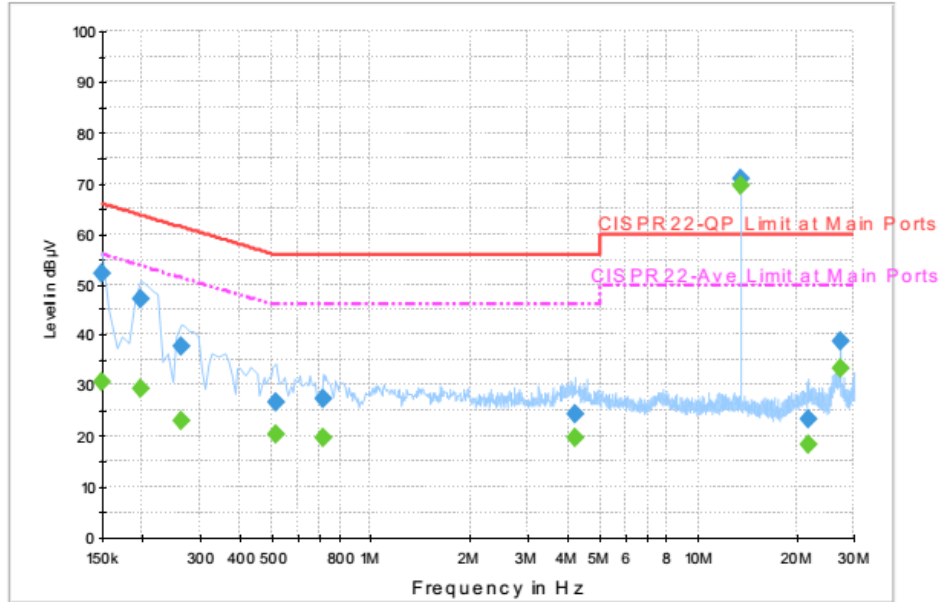

Final Result : Quasi-Peak

Frequency (MHz)	Quasi-Peak (dBµV)	Filter	Line	Corr. (dB)	Margin (dB)	Limit (dBµV)
0.150000	52.3	Off	L1	19.6	13.7	66.0
0.198000	47.0	Off	L1	19.6	16.7	63.7
0.262000	37.8	Off	L1	19.6	23.6	61.4
0.510000	26.6	Off	L1	19.6	29.4	56.0
0.710000	27.4	Off	L1	19.6	28.6	56.0
4.198000	24.3	Off	L1	19.7	31.7	56.0
13.558000	71.0	Off	L1	19.8	-11.0	60.0
21.718000	23.4	Off	L1	19.8	36.6	60.0
27.118000	38.8	Off	L1	19.9	21.2	60.0

Final Result : Average

Frequency (MHz)	Average (dBµV)	Filter	Line	Corr. (dB)	Margin (dB)	Limit (dBµV)
0.150000	30.6	Off	L1	19.6	25.4	56.0
0.198000	29.4	Off	L1	19.6	24.3	53.7
0.262000	23.1	Off	L1	19.6	28.3	51.4
0.510000	20.4	Off	L1	19.6	25.6	46.0
0.710000	19.6	Off	L1	19.6	26.4	46.0
4.198000	19.7	Off	L1	19.7	26.3	46.0
13.558000	69.5	Off	L1	19.8	-19.5	50.0
21.718000	18.4	Off	L1	19.8	31.6	50.0
27.118000	33.6	Off	L1	19.9	16.4	50.0



Test Mode :	Mode 2	Temperature :	23~24°C
Test Engineer :	Arthur Hsieh	Relative Humidity :	51~52%
Test Voltage :	120Vac / 60Hz	Phase :	Neutral
Function Type :	WLAN (2.4GHz) Link + Bluetooth Link + NFC Link + Snap on USB Cable Data link with Notebook + Copy Data from EDA (eMMC) to Notebook + AC Adapter		

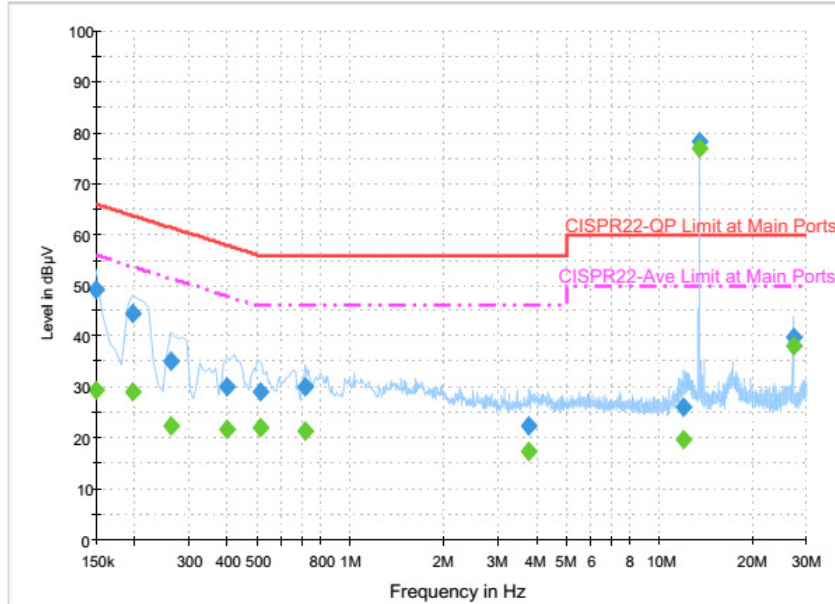

**Final Result : Quasi-Peak**

Frequency (MHz)	Quasi-Peak (dBµV)	Filter	Line	Corr. (dB)	Margin (dB)	Limit (dBµV)
0.150000	49.0	Off	N	19.6	17.0	66.0
0.198000	44.5	Off	N	19.6	19.2	63.7
0.262000	35.3	Off	N	19.6	26.1	61.4
0.398000	29.9	Off	N	19.6	28.0	57.9
0.510000	29.3	Off	N	19.6	26.7	56.0
0.710000	30.1	Off	N	19.6	25.9	56.0
3.790000	22.4	Off	N	19.6	33.6	56.0
11.966000	26.2	Off	N	19.8	33.8	60.0
13.558000	78.1	Off	N	19.8	-18.1	60.0
27.118000	39.9	Off	N	20.1	20.1	60.0

**Final Result : Average**

Frequency (MHz)	Average (dBµV)	Filter	Line	Corr. (dB)	Margin (dB)	Limit (dBµV)
0.150000	29.3	Off	N	19.6	26.7	56.0
0.198000	29.2	Off	N	19.6	24.5	53.7
0.262000	22.6	Off	N	19.6	28.8	51.4
0.398000	21.9	Off	N	19.6	26.0	47.9
0.510000	22.1	Off	N	19.6	23.9	46.0
0.710000	21.6	Off	N	19.6	24.4	46.0
3.790000	17.5	Off	N	19.6	28.5	46.0
11.966000	19.8	Off	N	19.8	30.2	50.0
13.558000	77.0	Off	N	19.8	-27.0	50.0
27.118000	38.0	Off	N	20.1	12.0	50.0



<Terminal Test Result>

Test Mode :	Mode 2	Temperature :	23~24°C
Test Engineer :	Arthur Hsieh	Relative Humidity :	51~52%
Test Voltage :	120Vac / 60Hz	Phase :	Line
Function Type :	WLAN (2.4GHz) Link + Bluetooth Link + NFC Link + Snap on USB Cable Data link with Notebook + Copy Data from EDA (eMMC) to Notebook + AC Adapter		

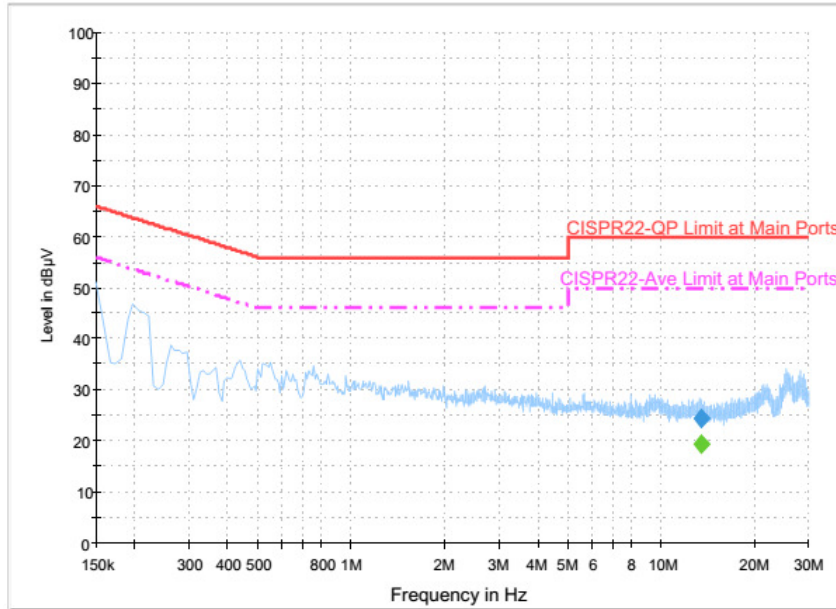

Final Result : Quasi-Peak

Frequency (MHz)	Quasi-Peak (dBµV)	Filter	Line	Corr. (dB)	Margin (dB)	Limit (dBµV)
13.558000	24.3	Off	L1	19.8	35.7	60.0

Final Result : Average

Frequency (MHz)	Average (dBµV)	Filter	Line	Corr. (dB)	Margin (dB)	Limit (dBµV)
13.558000	19.4	Off	L1	19.8	30.6	50.0



Test Mode :	Mode 2	Temperature :	23~24°C
Test Engineer :	Arthur Hsieh	Relative Humidity :	51~52%
Test Voltage :	120Vac / 60Hz	Phase :	Neutral
Function Type :	WLAN (2.4GHz) Link + Bluetooth Link + NFC Link + Snap on USB Cable Data link with Notebook + Copy Data from EDA (eMMC) to Notebook + AC Adapter		

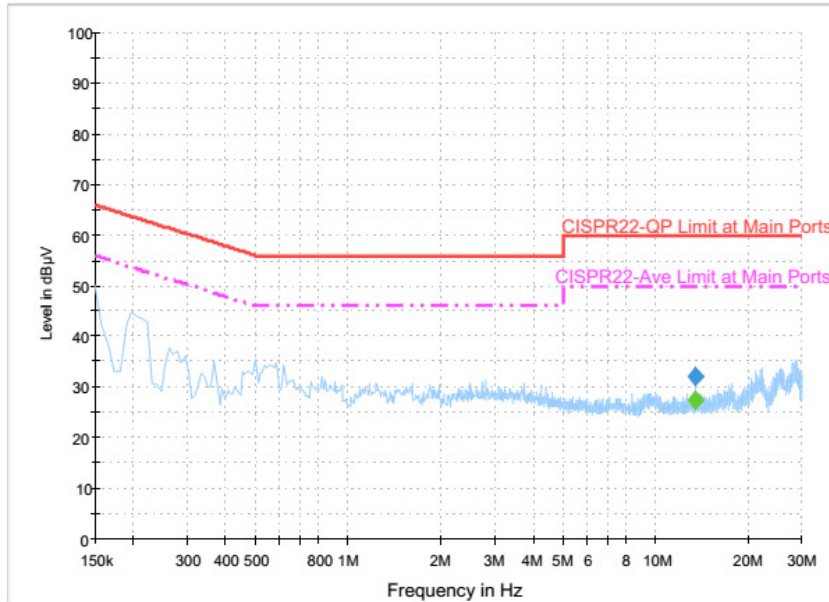

**Final Result : Quasi-Peak**

Frequency (MHz)	Quasi-Peak (dBµV)	Filter	Line	Corr. (dB)	Margin (dB)	Limit (dBµV)
13.558000	32.2	Off	N	19.8	27.8	60.0

**Final Result : Average**

Frequency (MHz)	Average (dBµV)	Filter	Line	Corr. (dB)	Margin (dB)	Limit (dBµV)
13.558000	27.4	Off	N	19.8	22.6	50.0





<Original Test Result>

Test Mode :	Mode 3	Temperature :	23~24°C
Test Engineer :	Arthur Hsieh	Relative Humidity :	51~52%
Test Voltage :	120Vac / 60Hz	Phase :	Line
Function Type :	WLAN (2.4GHz) Link + Bluetooth Link + NFC Link + Earphone 2 with Audio Adapter connect to EDA + Charging Only Cable + AC Adapter		

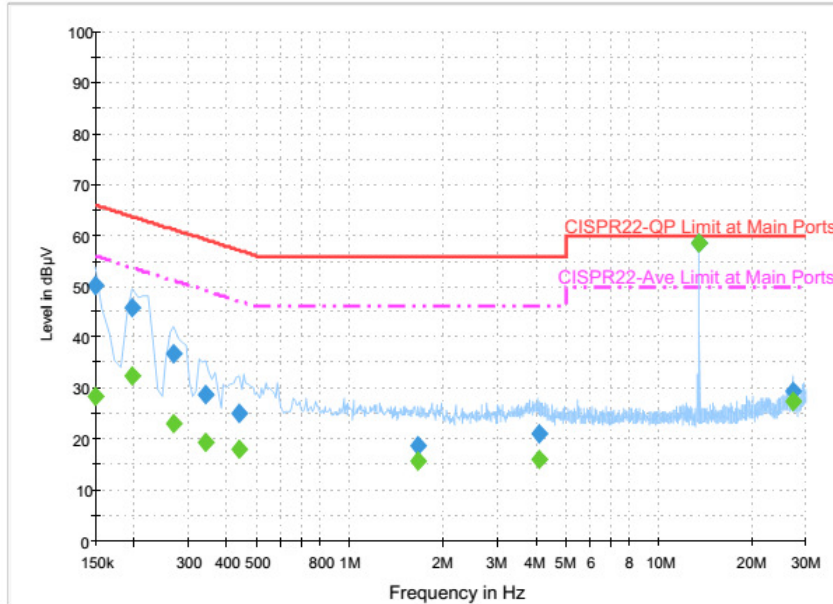

Final Result : Quasi-Peak

Frequency (MHz)	Quasi-Peak (dBµV)	Filter	Line	Corr. (dB)	Margin (dB)	Limit (dBµV)
0.150000	50.1	Off	L1	19.6	15.9	66.0
0.198000	46.0	Off	L1	19.6	17.7	63.7
0.270000	36.8	Off	L1	19.6	24.3	61.1
0.342000	28.9	Off	L1	19.6	30.3	59.2
0.438000	25.2	Off	L1	19.6	31.9	57.1
1.670000	18.9	Off	L1	19.6	37.1	56.0
4.102000	20.9	Off	L1	19.7	35.1	56.0
13.558000	58.6	Off	L1	19.8	1.4	60.0
27.118000	29.5	Off	L1	19.9	30.5	60.0

Final Result : Average

Frequency (MHz)	Average (dBµV)	Filter	Line	Corr. (dB)	Margin (dB)	Limit (dBµV)
0.150000	28.3	Off	L1	19.6	27.7	56.0
0.198000	32.6	Off	L1	19.6	21.1	53.7
0.270000	23.1	Off	L1	19.6	28.0	51.1
0.342000	19.4	Off	L1	19.6	29.8	49.2
0.438000	18.1	Off	L1	19.6	29.0	47.1
1.670000	15.7	Off	L1	19.6	30.3	46.0
4.102000	16.2	Off	L1	19.7	29.8	46.0
13.558000	58.4	Off	L1	19.8	-8.4	50.0
27.118000	27.4	Off	L1	19.9	22.6	50.0





Test Mode :	Mode 3	Temperature :	23~24°C
Test Engineer :	Arthur Hsieh	Relative Humidity :	51~52%
Test Voltage :	120Vac / 60Hz	Phase :	Neutral
Function Type :	WLAN (2.4GHz) Link + Bluetooth Link + NFC Link + Earphone 2 with Audio Adapter connect to EDA + Charging Only Cable + AC Adapter		

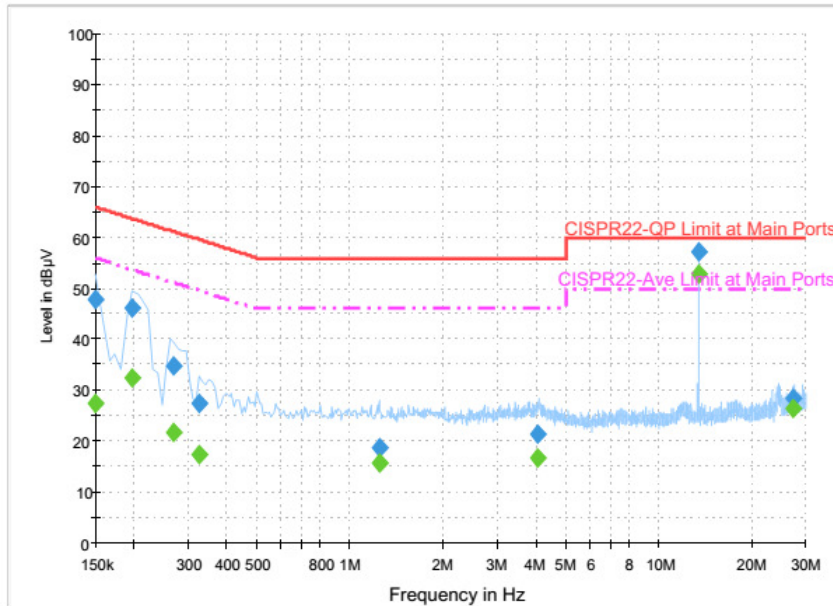

**Final Result : Quasi-Peak**

Frequency (MHz)	Quasi-Peak (dBµV)	Filter	Line	Corr. (dB)	Margin (dB)	Limit (dBµV)
0.150000	47.9	Off	N	19.6	18.1	66.0
0.198000	46.1	Off	N	19.6	17.6	63.7
0.270000	34.9	Off	N	19.6	26.2	61.1
0.326000	27.5	Off	N	19.6	32.1	59.6
1.246000	18.6	Off	N	19.6	37.4	56.0
4.062000	21.4	Off	N	19.6	34.6	56.0
13.558000	57.2	Off	N	19.8	2.8	60.0
27.118000	28.5	Off	N	20.1	31.5	60.0

**Final Result : Average**

Frequency (MHz)	Average (dBµV)	Filter	Line	Corr. (dB)	Margin (dB)	Limit (dBµV)
0.150000	27.5	Off	N	19.6	28.5	56.0
0.198000	32.5	Off	N	19.6	21.2	53.7
0.270000	21.8	Off	N	19.6	29.3	51.1
0.326000	17.5	Off	N	19.6	32.1	49.6
1.246000	15.7	Off	N	19.6	30.3	46.0
4.062000	16.8	Off	N	19.6	29.2	46.0
13.558000	53.0	Off	N	19.8	-3.0	50.0
27.118000	26.3	Off	N	20.1	23.7	50.0



<Terminal Test Result>

Test Mode :	Mode 3	Temperature :	23~24°C
Test Engineer :	Arthur Hsieh	Relative Humidity :	51~52%
Test Voltage :	120Vac / 60Hz	Phase :	Line
Function Type :	WLAN (2.4GHz) Link + Bluetooth Link + NFC Link + Earphone 2 with Audio Adapter connect to EDA + Charging Only Cable + AC Adapter		

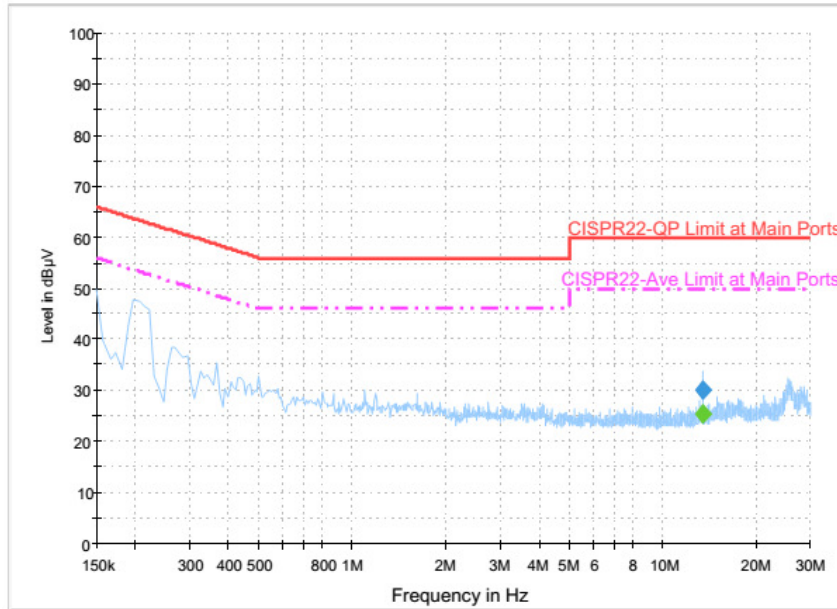

Final Result : Quasi-Peak

Frequency (MHz)	Quasi-Peak (dBµV)	Filter	Line	Corr. (dB)	Margin (dB)	Limit (dBµV)
13.558000	30.1	Off	L1	19.8	29.9	60.0

Final Result : Average

Frequency (MHz)	Average (dBµV)	Filter	Line	Corr. (dB)	Margin (dB)	Limit (dBµV)
13.558000	25.5	Off	L1	19.8	24.5	50.0



Test Mode :	Mode 3	Temperature :	23~24°C
Test Engineer :	Arthur Hsieh	Relative Humidity :	51~52%
Test Voltage :	120Vac / 60Hz	Phase :	Neutral
Function Type :	WLAN (2.4GHz) Link + Bluetooth Link + NFC Link + Earphone 2 with Audio Adapter connect to EDA + Charging Only Cable + AC Adapter		

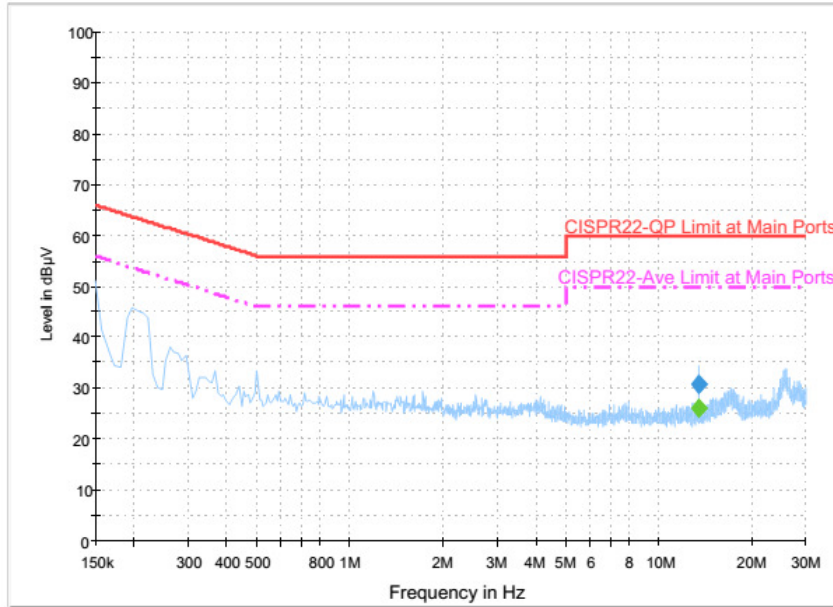

**Final Result : Quasi-Peak**

Frequency (MHz)	Quasi-Peak (dBµV)	Filter	Line	Corr. (dB)	Margin (dB)	Limit (dBµV)
13.558000	30.7	Off	N	19.8	29.3	60.0

**Final Result : Average**

Frequency (MHz)	Average (dBµV)	Filter	Line	Corr. (dB)	Margin (dB)	Limit (dBµV)
13.558000	26.1	Off	N	19.8	23.9	50.0



## **3.10 Antenna Requirements**

### **3.10.1 Standard Applicable**

If directional gain of transmitting antennas is greater than 6dBi, the power shall be reduced by the same level in dB comparing to gain minus 6dBi. The use of a permanently attached antenna or of an antenna that uses a unique coupling to the intentional radiator shall be considered sufficient to comply with the FCC rule.

### **3.10.2 Antenna Anti-Replacement Construction**

An embedded-in antenna design is used.

### **3.10.3 Antenna Gain**

The antenna peak gain of EUT is less than 6 dBi. Therefore, it is not necessary to reduce maximum peak output power limit.



## 4 List of Measuring Equipment

Instrument	Manufacturer	Model No.	Serial No.	Characteristics	Calibration Date	Test Date	Due Date	Remark
Power Meter	Agilent	E4416A	GB412923 44	300MHz~40GHz	Jan. 08, 2016	Jul. 02, 2016	Jan. 07, 2017	Conducted (TH02-HY)
Power Sensor	Agilent	E9327A	US404415 48	300MHz~40GHz	Jan. 07, 2016	Jul. 02, 2016	Jan. 06, 2017	Conducted (TH02-HY)
Spectrum Analyzer	Rohde & Schwarz	FSP40	100055	9kHz~40GHz	Jun. 17, 2016	Jul. 02, 2016	Jun. 16, 2017	Conducted (TH02-HY)
BT Base Station (Measure)	Rohde & Schwarz	CBT32	100519	N/A	Jun. 03, 2016	Jul. 02, 2016	Jun. 02, 2017	Conducted (TH02-HY)
Bilog Antenna	TESEQ	CBL 6111D	35419	30MHz to 1GHz	Jan. 13, 2016	Jun. 24, 2016 ~ Jun. 29, 2016	Jan. 12, 2017	Radiation (03CH07-HY)
Double Ridge Horn Antenna	ESCO	3117	00075962	1GHz ~ 18GHz	Aug. 21, 2015	Jun. 24, 2016 ~ Jun. 29, 2016	Aug. 20, 2016	Radiation (03CH07-HY)
EMI Test Receiver	Keysight	N9038A(MXE )	MY541300 85	20Hz ~ 8.4GHz	Nov. 04, 2015	Jun. 24, 2016 ~ Jun. 29, 2016	Nov. 03, 2016	Radiation (03CH07-HY)
Loop Antenna	Rohde & Schwarz	HFH2-Z2	100315	9 kHz~30 MHz	Sep. 02, 2015	Jun. 24, 2016 ~ Jun. 29, 2016	Sep. 01, 2016	Radiation (03CH07-HY)
Preamplifier	MITEQ	AMF-7D-0010 1800-30-10P	1590075	1GHz ~ 18GHz	Apr. 15, 2016	Jun. 24, 2016 ~ Jun. 29, 2016	Apr. 14, 2017	Radiation (03CH07-HY)
Preamplifier	COM-POWER	PA-103A	161241	10MHz-1GHz	Mar. 18, 2016	Jun. 24, 2016 ~ Jun. 29, 2016	Mar. 17, 2017	Radiation (03CH07-HY)
Preamplifier	Agilent	8449B	3008A023 62	1GHz~ 26.5GHz	Oct. 19, 2015	Jun. 24, 2016 ~ Jun. 29, 2016	Oct. 18, 2016	Radiation (03CH07-HY)
Spectrum Analyzer	Agilent	N9010A	MY534701 18	10Hz~44GHz	Feb. 27, 2016	Jun. 24, 2016 ~ Jun. 29, 2016	Feb. 26, 2017	Radiation (03CH07-HY)
Antenna Mast	Max-Full	MFA520BS	N/A	1m~4m	N/A	Jun. 24, 2016 ~ Jun. 29, 2016	N/A	Radiation (03CH07-HY)
Turn Table	ChainTek	Chaintek 3000	N/A	0~360 Degree	N/A	Jun. 24, 2016 ~ Jun. 29, 2016	N/A	Radiation (03CH07-HY)
Loop Cable	Rohde & Schwarz	N/A	N/A	9KHz~30MHz	Dec. 03, 2015	Jun. 24, 2016 ~ Jun. 29, 2016	Dec. 02, 2016	Radiation (03CH07-HY)
Preamplifier	MITEQ	JS44-180040 00-33-8P	1840917	18GHz ~ 40GHz	Jun. 14, 2016	Jun. 24, 2016 ~ Jun. 29, 2016	Jun. 13, 2017	Radiation (03CH07-HY)
SHF-EHF Horn Antenna	SCHWARZBECK	BBHA 9170	BBHA9170 584	18GHz- 40GHz	Nov. 02, 2015	Jun. 24, 2016 ~ Jun. 29, 2016	Nov. 01, 2016	Radiation (03CH07-HY)
AC Power Source	ChainTek	APC-1000W	N/A	N/A	N/A	Jun. 27, 2016 ~ Jul. 11, 2016	N/A	Conduction (CO05-HY)
EMI Test Receiver	Rohde & Schwarz	ESCI 7	100724	9kHz~7GHz	Aug. 26, 2015	Jun. 27, 2016 ~ Jul. 11, 2016	Aug. 25, 2016	Conduction (CO05-HY)
LISN	Rohde & Schwarz	ENV216	100080	9kHz~30MHz	Dec. 02, 2015	Jun. 27, 2016 ~ Jul. 11, 2016	Dec. 01, 2016	Conduction (CO05-HY)
LISN	Rohde & Schwarz	ENV216	100081	9kHz~30MHz	Dec. 14, 2015	Jun. 27, 2016 ~ Jul. 11, 2016	Dec. 13, 2016	Conduction (CO05-HY)



## 5 Uncertainty of Evaluation

### Uncertainty of Conducted Emission Measurement (150 kHz ~ 30 MHz)

Measuring Uncertainty for a Level of Confidence of 95% ( $U = 2Uc(y)$ )	2.26
---	------

### Uncertainty of Radiated Emission Measurement (30 MHz ~ 1000 MHz)

Measuring Uncertainty for a Level of Confidence of 95% ( $U = 2Uc(y)$ )	5.6
---	-----