



FCC RF Test Report

APPLICANT : Zebra Technologies Corporation
EQUIPMENT : Touch computer
BRAND NAME : Zebra
MODEL NAME : TC700J
FCC ID : UZ7TC700J
STANDARD : FCC Part 15 Subpart C §15.247
CLASSIFICATION : (DTS) Digital Transmission System

The product was received on Jun. 18, 2016 and testing was completed on Jul. 19, 2016. We, SPORTON INTERNATIONAL INC., would like to declare that the tested sample has been evaluated in accordance with the test procedures and has been in compliance with the applicable technical standards.

The test results in this report apply exclusively to the tested model / sample. Without written approval of SPORTON INTERNATIONAL INC., the test report shall not be reproduced except in full.

Reviewed by: Joseph Lin / Supervisor

Approved by: Jones Tsai / Manager



SPORTON INTERNATIONAL INC.

No. 52, Hwa Ya 1st Rd., Hwa Ya Technology Park, Kwei-Shan District, Tao Yuan City, Taiwan, R.O.C.



TABLE OF CONTENTS

Revision History 3

Summary of Test RESULT 4

1 General Description 5

 1.1 Applicant 5

 1.2 Manufacturer 5

 1.3 Product Feature of Equipment Under Test 5

 1.4 Product Specification of Equipment Under Test 6

 1.5 Modification of EUT 7

 1.6 Testing Location 8

 1.7 Applicable Standards 8

2 Test Configuration of Equipment Under Test 9

 2.1 Carrier Frequency and Channel 9

 2.2 Pre-Scanned RF Power 10

 2.3 Test Mode 16

 2.4 Connection Diagram of Test System 17

 2.5 Support Unit used in test configuration and system 18

 2.6 EUT Operation Test Setup 19

 2.7 Measurement Results Explanation Example 19

3 Test Result 20

 3.1 6dB and 99% Bandwidth Measurement 20

 3.2 Peak Output Power Measurement 22

 3.3 Power Spectral Density Measurement 23

 3.4 Conducted Band Edges and Spurious Emission Measurement 26

 3.5 Radiated Band Edges and Spurious Emission Measurement 51

 3.6 AC Conducted Emission Measurement 55

 3.7 Antenna Requirements 69

4 List of Measuring Equipment 70

5 Uncertainty of Evaluation 71

APPENDIX A. CONDUCTED TEST RESULTS

APPENDIX B. RADIATED SPURIOUS EMISSION

APPENDIX C. RADIATED SPURIOUS EMISSION PLOTS

APPENDIX D. DUTY CYCLE PLOTS

APPENDIX E. SETUP PHOTOGRAPHS



SUMMARY OF TEST RESULT

Report Section	FCC Rule	Description	Limit	Result	Remark
3.1	15.247(a)(2)	6dB Bandwidth	$\geq 0.5\text{MHz}$	Pass	-
3.1	-	99% Bandwidth	-	Pass	-
3.2	15.247(b)	Power Output Measurement	$\leq 30\text{dBm}$	Pass	-
3.3	15.247(e)	Power Spectral Density	$\leq 8\text{dBm}/3\text{kHz}$	Pass	-
3.4	15.247(d)	Conducted Band Edges	$\leq 20\text{dBc}$	Pass	-
		Conducted Spurious Emission		Pass	-
3.5	15.247(d)	Radiated Band Edges and Radiated Spurious Emission	15.209(a) & 15.247(d)	Pass	Under limit 1.05 dB at 2389.695 MHz
3.6	15.207	AC Conducted Emission	15.207(a)	Pass	Under limit 12.00 dB at 27.118 MHz
3.7	15.203 & 15.247(b)	Antenna Requirement	N/A	Pass	-



1 General Description

1.1 Applicant

Zebra Technologies Corporation
1 Zebra Plaza, Holtsville, NY 11742

1.2 Manufacturer

Wistron Corporation
21F, No. 88, Sec. 1, Hsin Tai Wu Rd., Hsichih Dist, New Taipei City 221, Taiwan R.O.C.

1.3 Product Feature of Equipment Under Test

Product Feature	
Equipment	Touch computer
Brand Name	Zebra
Model Name	TC700J
FCC ID	UZ7TC700J
EUT supports Radios application	NFC WLAN 11a/b/g/n HT20/HT40 WLAN 11ac VHT20/VHT40/VHT80 Bluetooth v4.1 EDR/LE
HW Version	DV1
SW Version	10.0.10586.242
FW Version	01078.00161.09001.07002
MFD	04JUN16
EUT Stage	Engineering sample

Remark: The above EUT's information was declared by manufacturer. Please refer to the specifications or user's manual for more detailed description.



1.4 Product Specification of Equipment Under Test

Standards-related Product Specification										
Tx/Rx Channel Frequency Range	802.11b/g/n : 2412 MHz ~ 2462 MHz									
Maximum (Peak) Output Power to antenna	<p><SISO Ant. 1> 802.11b : 22.86 dBm (0.1932 W) 802.11g : 24.03 dBm (0.2529 W) 802.11n HT20 : 24.42 dBm (0.2767 W) 802.11n HT40 : 22.32 dBm (0.1706 W)</p> <p><SISO Ant. 2> 802.11b : 22.27 dBm (0.1687 W) 802.11g : 23.13 dBm (0.2056 W) 802.11n HT20 : 23.57 dBm (0.2275 W) 802.11n HT40 : 21.59 dBm (0.1442 W)</p> <p><MIMO Ant. 1+2> 802.11b : 25.51 dBm (0.3556 W) 802.11g : 26.70 dBm (0.4677 W) 802.11n HT20 : 27.12 dBm (0.5152 W) 802.11n HT40 : 25.18 dBm (0.3296 W)</p>									
99% Occupied Bandwidth	802.11b : 14.80MHz 802.11g : 17.60MHz 802.11n HT20 : 18.70MHz 802.11n HT40 : 36.50MHz									
Antenna Type	<p><Ant 1> 802.11b/g/n : PIFA Antenna type with gain 2.26 dBi</p> <p><Ant 2> 802.11b/g/n : Monopole Antenna type with gain 0.79 dBi</p>									
Type of Modulation	802.11b : DSSS (DBPSK / DQPSK / CCK) 802.11g/n : OFDM (BPSK / QPSK / 16QAM / 64QAM)									
Antenna Function for Transmitter	<table border="1"> <thead> <tr> <th></th> <th>Ant. 1</th> <th>Ant. 2</th> </tr> </thead> <tbody> <tr> <td>802.11 b/g/n SISO</td> <td>V</td> <td>V</td> </tr> <tr> <td>802.11 b/g/n MIMO</td> <td>V</td> <td>V</td> </tr> </tbody> </table>		Ant. 1	Ant. 2	802.11 b/g/n SISO	V	V	802.11 b/g/n MIMO	V	V
	Ant. 1	Ant. 2								
802.11 b/g/n SISO	V	V								
802.11 b/g/n MIMO	V	V								



Specification of Accessories				
AC Adapter	Brand Name	Symbol	Part Number	PWRS-14000-249R
	Power Cord	1.75 meter, non-shielded cable, without ferrite core		
Snap-On USB/Charge Cable	Brand Name	Symbol	Part Number	CBL-TC7X-USB1-01
	Signal Line	0.15 meter, non-shielded cable, with w/o ferrite core		
Snap-On Charging Cable Cup	Brand Name	Symbol	Part Number	CHG-TC7X-CBL1-01
	Signal Line	1.85 meter, non-shielded cable, with w/o ferrite core		
Battery	Brand Name	Symbol	Part Number	82-171249-02
Earphone 1 (3.5mm Headset for PTT + VoIP)	Brand Name	Zebra	Part Number	HDST-35MM-PTVP-01
Earphone 2	Brand Name	Zebra	Part Number	RCH51
3.5mm to QD Audio Cable Adapter	Brand Name	Zebra	Part Number	ADP-35M-QDCBL1-01
Snap-on 3.5MM Audio Nugget	Brand Name	Symbol	Part Number	ADP-TC7X-AUD35-01

1.5 Modification of EUT

No modifications are made to the EUT during all test items.



1.6 Testing Location

Sporton Lab is accredited to ISO 17025 by Taiwan Accreditation Foundation (TAF code : 1190) and the FCC designation No. TW1022 under the FCC 2.948(e) by Mutual Recognition Agreement (MRA) in FCC Test.

Test Site	SPORTON INTERNATIONAL INC.		
Test Site Location	No. 52, Hwa Ya 1 st Rd., Hwa Ya Technology Park, Kwei-Shan District, Tao Yuan City, Taiwan, R.O.C. TEL: +886-3-327-3456 FAX: +886-3-328-4978		
Test Site No.	Sporton Site No.		
	TH05-HY	CO05-HY	03CH07-HY

Note: The test site complies with ANSI C63.4 2014 requirement.

1.7 Applicable Standards

According to the specifications of the manufacturer, the EUT must comply with the requirements of the following standards:

- ♦ FCC Part 15 Subpart C §15.247
- ♦ FCC KDB Publication No. 558074 D01 DTS Meas. Guidance v03r05
- ♦ FCC KDB 662911 D01 Multiple Transmitter Output v02r01.
- ♦ ANSI C63.10-2013

Remark: All test items were verified and recorded according to the standards and without any deviation during the test.



2 Test Configuration of Equipment Under Test

The EUT has been associated with peripherals and configuration operated in a manner tended to maximize its emission characteristics in a typical application. Frequency range investigated: conducted emission (150 kHz to 30 MHz) and radiated emission (9 kHz to the 10th harmonic of the highest fundamental frequency or to 40 GHz, whichever is lower). For radiated measurement, pre-scanned in three orthogonal panels, X, Y, Z. The worst cases (Y plane) were recorded in this report.

2.1 Carrier Frequency and Channel

Frequency Band	Channel	Freq. (MHz)	Channel	Freq. (MHz)
2400-2483.5 MHz	1	2412	7	2442
	2	2417	8	2447
	3	2422	9	2452
	4	2427	10	2457
	5	2432	11	2462
	6	2437		



2.2 Pre-Scanned RF Power

Preliminary tests were performed in different data rate and data rate associated with the highest power were chosen for full test shown in the following tables.

SISO <Ant. 1>

Channel	Frequency	2.4GHz 802.11b RF Average Power (dBm)			
		DSSS Data Rate			
		1 Mbps	2 Mbps	5.5 Mbps	11 Mbps
CH 06	2437MHz	20.26	20.08	19.89	19.68

Channel	Frequency	2.4GHz 802.11b RF Peak Power (dBm)			
		DSSS Data Rate			
		1 Mbps	2 Mbps	5.5 Mbps	11 Mbps
CH 06	2437MHz	22.86	22.82	22.84	22.84

Channel	Frequency	2.4GHz 802.11g RF Average Power (dBm)							
		OFDM Data Rate							
		6Mbps	9Mbps	12Mbps	18Mbps	24Mbps	36Mbps	48Mbps	54Mbps
CH 06	2437MHz	19.04	19.00	18.97	18.85	14.58	14.54	14.59	14.59

Channel	Frequency	2.4GHz 802.11g RF Peak Power (dBm)							
		OFDM Data Rate							
		6Mbps	9Mbps	12Mbps	18Mbps	24Mbps	36Mbps	48Mbps	54Mbps
CH 06	2437MHz	24.03	23.89	23.95	23.88	23.62	24.00	23.51	23.29



Channel	Frequency	2.4GHz 802.11n HT20 RF Average Power (dBm)							
		OFDM Data Rate							
		MCS0	MCS1	MCS2	MCS3	MCS4	MCS5	MCS6	MCS7
CH 06	2437MHz	19.38	19.19	19.34	15.46	15.34	15.51	14.67	14.63

Channel	Frequency	2.4GHz 802.11n HT20 RF Peak Power (dBm)							
		OFDM Data Rate							
		MCS0	MCS1	MCS2	MCS3	MCS4	MCS5	MCS6	MCS7
CH 06	2437MHz	24.42	24.40	24.35	24.29	24.22	24.28	23.37	24.09

Channel	Frequency	2.4GHz 802.11n HT40 RF Average Power (dBm)							
		OFDM Data Rate							
		MCS0	MCS1	MCS2	MCS3	MCS4	MCS5	MCS6	MCS7
CH 06	2437MHz	16.44	16.39	16.36	12.25	12.54	12.36	12.35	12.23

Channel	Frequency	2.4GHz 802.11n HT40 RF Peak Power (dBm)							
		OFDM Data Rate							
		MCS0	MCS1	MCS2	MCS3	MCS4	MCS5	MCS6	MCS7
CH 06	2437MHz	22.32	22.23	22.10	21.89	21.27	21.61	21.64	20.90



SISO <Ant. 2>

Channel	Frequency	2.4GHz 802.11b RF Average Power (dBm)			
		DSSS Data Rate			
		1 Mbps	2 Mbps	5.5 Mbps	11 Mbps
CH 11	2462MHz	19.95	19.60	19.62	19.52

Channel	Frequency	2.4GHz 802.11b RF Peak Power (dBm)			
		DSSS Data Rate			
		1 Mbps	2 Mbps	5.5 Mbps	11 Mbps
CH 11	2462MHz	22.27	22.22	22.24	22.22

Channel	Frequency	2.4GHz 802.11g RF Average Power (dBm)							
		OFDM Data Rate							
		6Mbps	9Mbps	12Mbps	18Mbps	24Mbps	36Mbps	48Mbps	54Mbps
CH 06	2437MHz	17.96	17.98	17.98	17.65	13.36	13.43	13.39	13.42

Channel	Frequency	2.4GHz 802.11g RF Peak Power (dBm)							
		OFDM Data Rate							
		6Mbps	9Mbps	12Mbps	18Mbps	24Mbps	36Mbps	48Mbps	54Mbps
CH 06	2437MHz	23.13	23.12	23.05	23.00	22.95	23.06	22.90	22.93



Channel	Frequency	2.4GHz 802.11n HT20 RF Average Power (dBm)							
		OFDM Data Rate							
		MCS0	MCS1	MCS2	MCS3	MCS4	MCS5	MCS6	MCS7
CH 06	2437MHz	18.34	18.26	18.33	14.38	14.33	14.32	13.43	13.36

Channel	Frequency	2.4GHz 802.11n HT20 RF Peak Power (dBm)							
		OFDM Data Rate							
		MCS0	MCS1	MCS2	MCS3	MCS4	MCS5	MCS6	MCS7
CH 06	2437MHz	23.57	23.39	23.46	22.77	23.08	22.85	23.18	22.91

Channel	Frequency	2.4GHz 802.11n HT40 RF Average Power (dBm)							
		OFDM Data Rate							
		MCS0	MCS1	MCS2	MCS3	MCS4	MCS5	MCS6	MCS7
CH 06	2437MHz	15.39	15.38	15.34	11.03	11.18	11.18	11.09	10.99

Channel	Frequency	2.4GHz 802.11n HT40 RF Peak Power (dBm)							
		OFDM Data Rate							
		MCS0	MCS1	MCS2	MCS3	MCS4	MCS5	MCS6	MCS7
CH 06	2437MHz	21.59	21.31	21.41	20.59	19.96	20.32	20.31	19.59



MIMO <Ant. 1+2>

Channel	Frequency	2.4GHz 802.11b RF Average Power (dBm)			
		DSSS Data Rate			
		1 Mbps	2 Mbps	5.5 Mbps	11 Mbps
CH 06	2437MHz	22.97	22.78	22.68	22.42

Channel	Frequency	2.4GHz 802.11b RF Peak Power (dBm)			
		DSSS Data Rate			
		1 Mbps	2 Mbps	5.5 Mbps	11 Mbps
CH 06	2437MHz	25.51	25.48	25.50	25.49

Channel	Frequency	2.4GHz 802.11g RF Average Power (dBm)							
		OFDM Data Rate							
		6Mbps	9Mbps	12Mbps	18Mbps	24Mbps	36Mbps	48Mbps	54Mbps
CH 06	2437MHz	21.73	21.70	21.68	21.46	17.19	17.23	17.21	17.17

Channel	Frequency	2.4GHz 802.11g RF Peak Power (dBm)							
		OFDM Data Rate							
		6Mbps	9Mbps	12Mbps	18Mbps	24Mbps	36Mbps	48Mbps	54Mbps
CH 06	2437MHz	26.70	26.64	26.68	26.68	26.50	26.70	26.37	26.21



Channel	Frequency	2.4GHz 802.11n HT20 RF Average Power (dBm)							
		OFDM Data Rate							
		MCS0	MCS1	MCS2	MCS3	MCS4	MCS5	MCS6	MCS7
CH 06	2437MHz	22.08	21.94	22.13	18.14	18.07	18.09	17.27	17.24

Channel	Frequency	2.4GHz 802.11n HT20 RF Peak Power (dBm)							
		OFDM Data Rate							
		MCS0	MCS1	MCS2	MCS3	MCS4	MCS5	MCS6	MCS7
CH 06	2437MHz	27.12	27.10	27.09	26.82	26.93	26.85	26.43	26.64

Channel	Frequency	2.4GHz 802.11n HT40 RF Average Power (dBm)							
		OFDM Data Rate							
		MCS0	MCS1	MCS2	MCS3	MCS4	MCS5	MCS6	MCS7
CH 06	2437MHz	19.14	19.13	19.06	14.92	14.96	15.01	14.89	14.98

Channel	Frequency	2.4GHz 802.11n HT40 RF Peak Power (dBm)							
		OFDM Data Rate							
		MCS0	MCS1	MCS2	MCS3	MCS4	MCS5	MCS6	MCS7
CH 06	2437MHz	25.18	25.06	24.96	24.47	23.92	24.31	24.25	23.51

Note: MIMO Ant. 1+2 is a calculated result from sum of the power MIMO Ant. 1 and MIMO Ant. 2.



2.3 Test Mode

Final test mode of conducted test items and radiated spurious emissions are considering the modulation and worse data rates from the power table described in section 2.2.

Single Antenna

Modulation	Data Rate
802.11b	1 Mbps
802.11g	6 Mbps
802.11n HT20	MCS0
802.11n HT40	MCS0

MIMO Antenna

Modulation	Data Rate
802.11b	1 Mbps
802.11g	6 Mbps
802.11n HT20	MCS0
802.11n HT40	MCS0

Test Cases	
AC Conducted Emission	<p>Mode 1 :WLAN (2.4GHz) Link + Bluetooth Link + NFC Link + Earphone 1 with Audio Adapter connect to EUT + Charging Only Cable + Adapter</p> <p>Mode 2 :WLAN (2.4GHz) Link + Bluetooth Link + NFC Link + Snap on USB Cable Data link with Notebook + Copy Data from EDA (eMMC) to Notebook + Adapter</p> <p>Mode 3 :WLAN (2.4GHz) Link + Bluetooth Link + NFC Link + Earphone 2 with Audio Adapter connect to EUT + Charging Only Cable + Adapter</p>
<p>Remark: For Radiated Test Cases, tests were performance with earphone 1 with audio adapter connect to EUT, charging only cable, and adapter.</p>	

2.4 Connection Diagram of Test System

<WLAN Tx Mode>

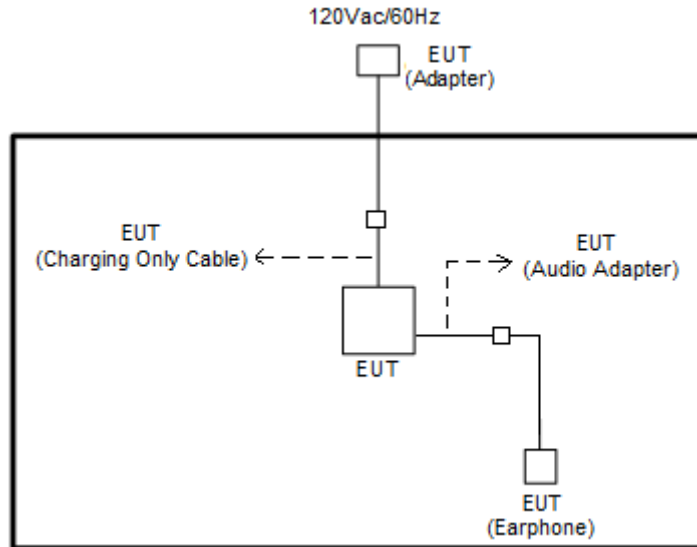

<AC Conducted Emission for charging mode>

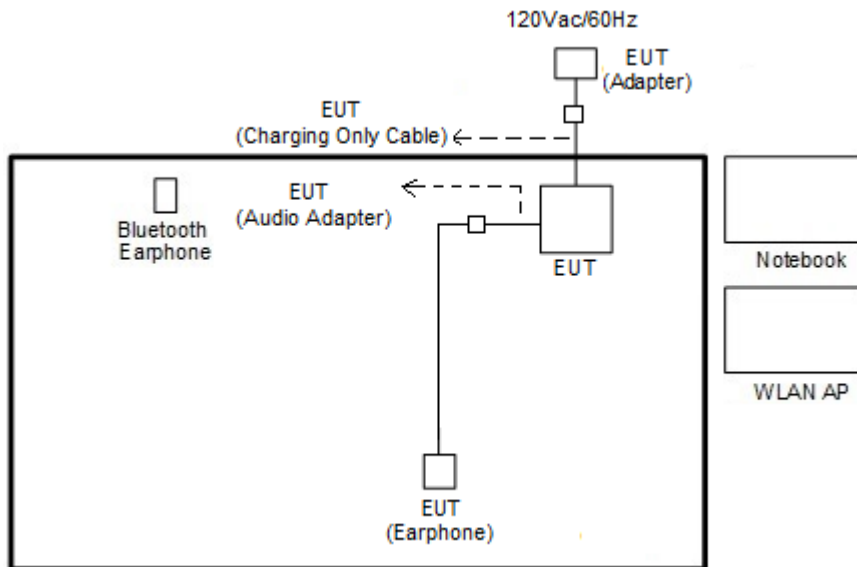

<AC Conducted Emission for data link mode>

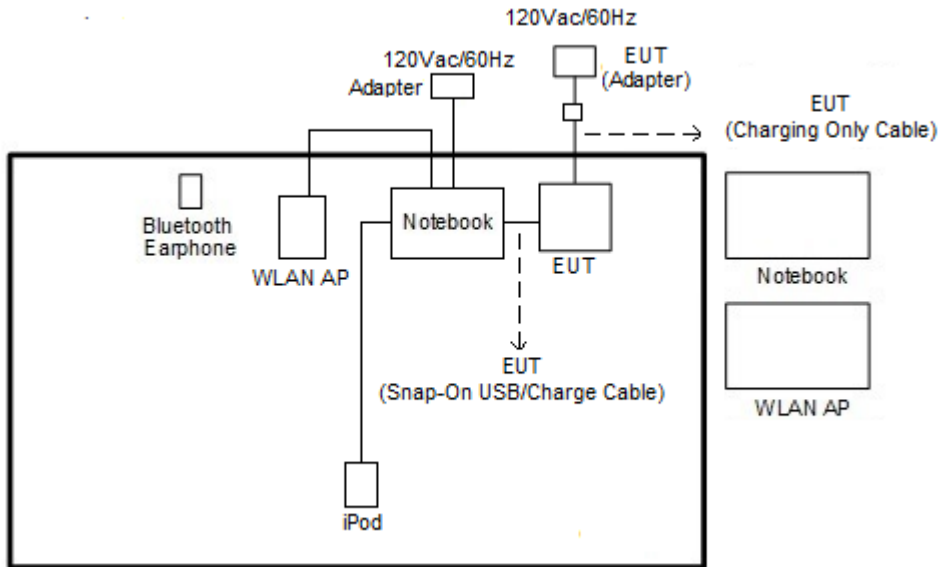

2.5 Support Unit used in test configuration and system

Item	Equipment	Trade Name	Model Name	FCC ID	Data Cable	Power Cord
1.	WLAN AP	D-Link	DIR-628	KA2DIR628A2	N/A	Unshielded, 1.8 m
2.	Notebook	DELL	Latitude E6320	FCC DoC/ Contains FCC ID: QDS-BRCM1054	N/A	AC I/P: Unshielded, 1.2 m DC O/P: Shielded, 1.8 m
3.	Bluetooth Earphone	Sony Ericsson	MW600	PY7DDA-2029	N/A	N/A
4.	iPod	Apple	A1285	FCC DoC	Shielded, 1.0 m	N/A
5.	SD Card	SanDisk	MicroSD HC	FCC DoC	N/A	N/A
6.	NFC Card	Metro Taipei	Easy Card	N/A	N/A	N/A



2.6 EUT Operation Test Setup

For WLAN function, programmed RF utility, "QRCT" installed in the notebook make the EUT provide functions like channel selection and power level for continuous transmitting and receiving signals.

2.7 Measurement Results Explanation Example

For all conducted test items:

The offset level is set in the spectrum analyzer to compensate the RF cable loss and attenuator factor between EUT conducted output port and spectrum analyzer. With the offset compensation, the spectrum analyzer reading level is exactly the EUT RF output level.

Example:

The spectrum analyzer offset is derived from RF cable loss and attenuator factor.

Offset = RF cable loss + attenuator factor.

Following shows an offset computation example with cable loss 4.2 dB and 10dB attenuator.

$$\begin{aligned} \text{Offset(dB)} &= \text{RF cable loss(dB)} + \text{attenuator factor(dB)}. \\ &= 4.2 + 10 = 14.2 \text{ (dB)} \end{aligned}$$

3 Test Result

3.1 6dB and 99% Bandwidth Measurement

3.1.1 Limit of 6dB and 99% Bandwidth

The minimum 6 dB bandwidth shall be at least 500 kHz.

3.1.2 Measuring Instruments

The measuring equipment is listed in the section 4 of this test report.

3.1.3 Test Procedures

1. The testing follows FCC KDB Publication No. 558074 DTS D01 Meas. Guidance v03r05.
2. The RF output of EUT was connected to the spectrum analyzer by RF cable and attenuator. The path loss was compensated to the results for each measurement.
3. Set to the maximum power setting and enable the EUT transmit continuously.
4. Make the measurement with the spectrum analyzer's resolution bandwidth (RBW) = 100 kHz. Set the Video bandwidth (VBW) = 300 kHz. In order to make an accurate measurement. The 6 dB bandwidth must be greater than 500 kHz.
5. For 99% Bandwidth Measurement, the spectrum analyzer's resolution bandwidth (RBW) = 1MHz and set the Video bandwidth (VBW) = 3MHz.
6. Measure and record the results in the test report.

3.1.4 Test Setup





3.1.5 Test Result of 6dB and 99% Occupied Bandwidth

Please refer to Appendix A.

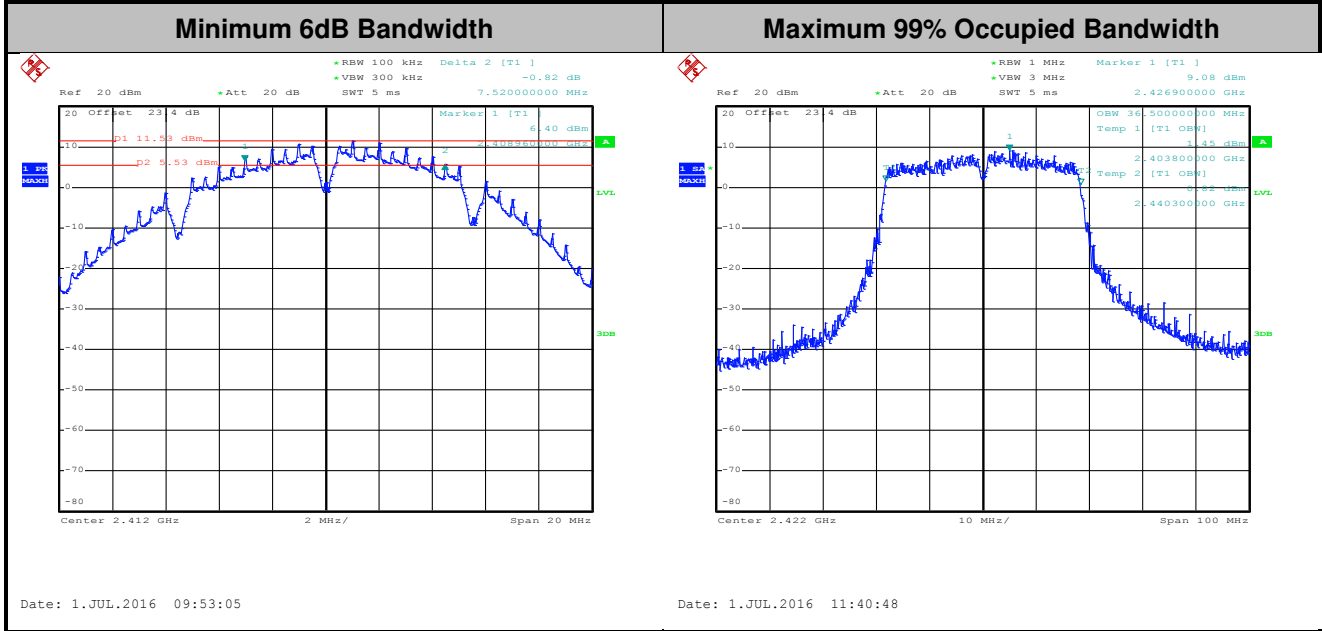

Note : The occupied channel bandwidth is maintained within the band of operation for all of the modulations.

3.2 Peak Output Power Measurement

3.2.1 Limit of Peak Output Power

For systems using digital modulation in the 2400-2483.5MHz, the limit for peak output power is 30dBm. If transmitting antenna with directional gain greater than 6dBi is used, the peak output power from the intentional radiator shall be reduced below the above stated value by the amount in dB that the directional gain of the antenna exceeds 6 dBi. In case of point-to-point operation, the limit has to be reduced by 1dB for every 3dB that the directional gain of the antenna exceeds 6dBi.

3.2.2 Measuring Instruments

The measuring equipment is listed in the section 4 of this test report.

3.2.3 Test Procedures

1. The testing follows the Measurement Procedure of FCC KDB No. 558074 DTS D01 Meas. Guidance v03r05 section 9.1.2 PKPM1 Peak power meter method.
2. The RF output of EUT was connected to the power meter by RF cable and attenuator. The path loss was compensated to the results for each measurement.
3. Set to the maximum power setting and enable the EUT transmit continuously.
4. Measure the conducted output power and record the results in the test report.
5. For MIMO mode, calculation method follows FCC KDB 662911 D01 Multiple Transmitter Output v02r01.

3.2.4 Test Setup

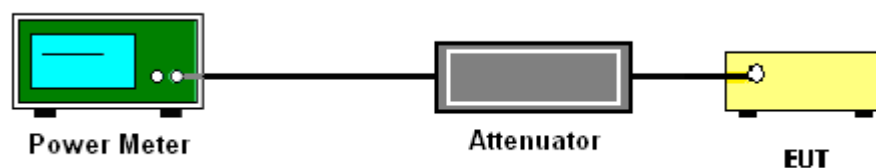

3.2.5 Test Result of Peak Output Power

Please refer to Appendix A of this test report.

3.2.6 Test Result of Average output Power (Reporting Only)

Please refer to Appendix A



3.3 Power Spectral Density Measurement

3.3.1 Limit of Power Spectral Density

The peak power spectral density shall not be greater than 8dBm in any 3kHz band at any time interval of continuous transmission.

3.3.2 Measuring Instruments

The measuring equipment is listed in the section 4 of this test report.

3.3.3 Test Procedures

1. The testing follows Measurement Procedure 10.2 Method PKPSD of FCC KDB Publication No. 558074 D01 DTS Meas. Guidance v03r05.
2. The RF output of EUT was connected to the spectrum analyzer by RF cable and attenuator. The path loss was compensated to the results for each measurement.
3. Set to the maximum power setting and enable the EUT transmit continuously.
4. Make the measurement with the spectrum analyzer's resolution bandwidth (RBW) = 3 kHz. Video bandwidth VBW = 10 kHz In order to make an accurate measurement, set the span to 1.5 times DTS Channel Bandwidth. (6dB BW)
5. Detector = peak, Sweep time = auto couple, Trace mode = max hold, Allow trace to fully stabilize. Use the peak marker function to determine the maximum power level.
6. Measure and record the results in the test report.
7. For MIMO mode, calculation method follows FCC KDB 662911 D01 Multiple Transmitter Output v02r01.

If measurements performed using method (2) plus $10 \log(N)$ exceeds the emission limit, the test should choose method (1) before declaring that the device fails the emission limit.

Method (1): Measure and sum the spectra across the outputs.

The total final Power Spectral Density is from a device with 2 transmitter outputs. The spectrum measurements of the individual outputs are all performed with the same span and number of points, the spectrum value in the first spectral bin of output 1 is summed with that in the first spectral bin of output 2 to obtain the value for the first frequency bin of the summed spectrum.

Method (2): Measure and add $10 \log(N)$ dB, where N is the number of outputs. (N=2)

3.3.4 Test Setup

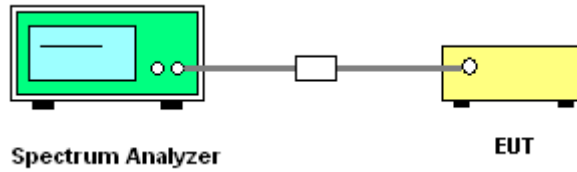

3.3.5 Test Result of Power Spectral Density

Please refer to Appendix A.

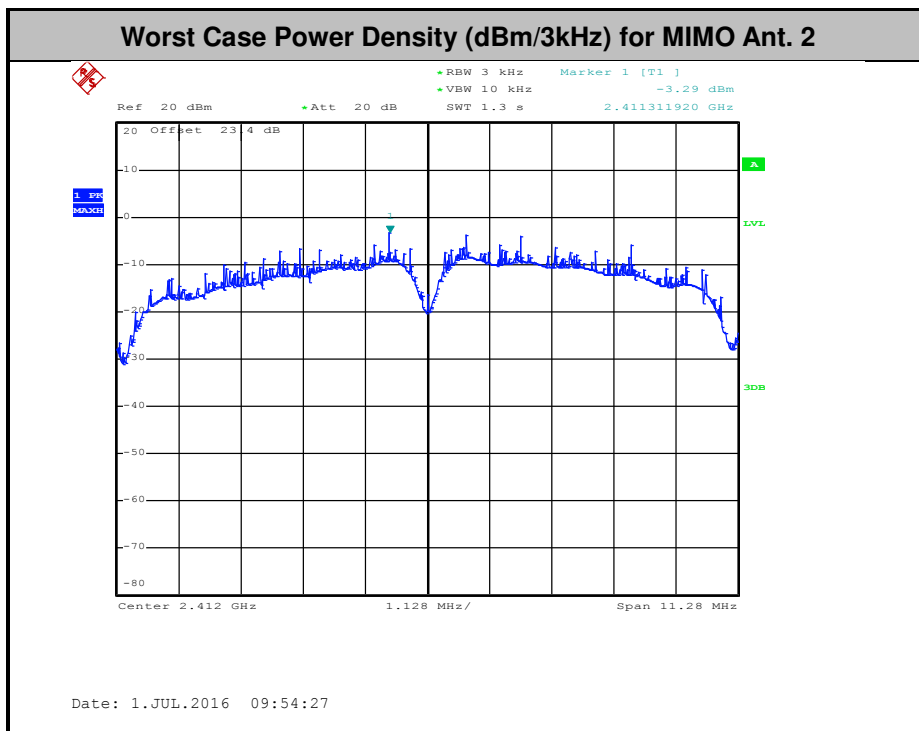
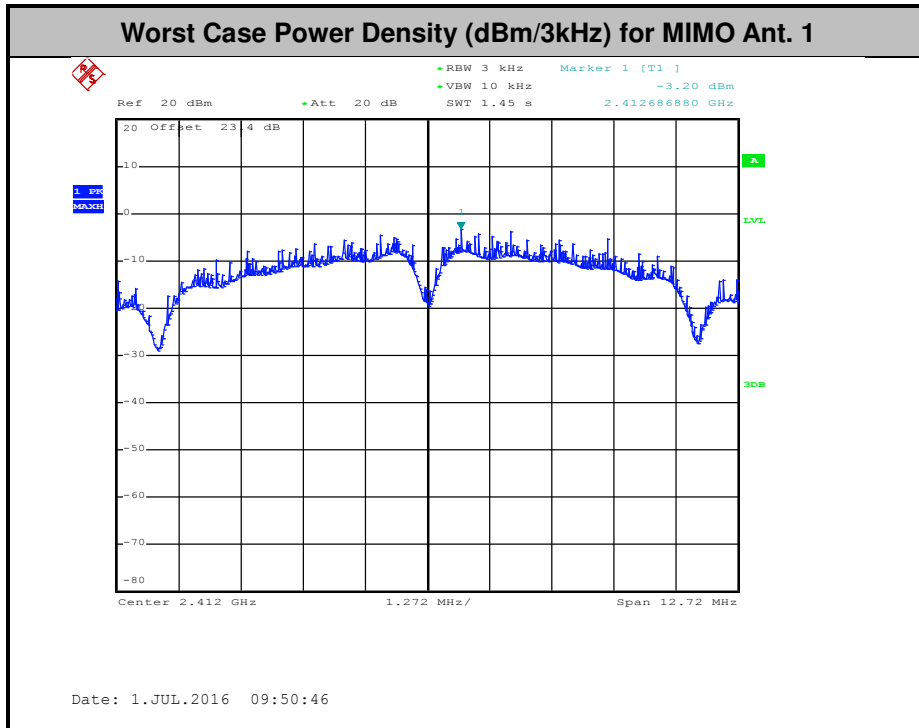

3.4 Conducted Band Edges and Spurious Emission Measurement

3.4.1 Limit of Conducted Band Edges and Spurious Emission Measurement

In any 100 kHz bandwidth outside of the authorized frequency band, the emissions which fall in the non-restricted bands shall be attenuated at least 20 dB / 30dB relative to the maximum PSD level in 100 kHz by RF conducted measurement and radiated emissions which fall in the restricted bands, as defined in Section 15.205(a), must also comply with the radiated emission limits specified in Section 15.209(a).

3.4.2 Measuring Instruments

The measuring equipment is listed in the section 4 of this test report.

3.4.3 Test Procedures

1. The testing follows FCC KDB Publication No. 558074 D01 DTS Meas. Guidance v03r05.
2. The RF output of EUT was connected to the spectrum analyzer by RF cable and attenuator. The path loss was compensated to the results for each measurement.
3. Set to the maximum power setting and enable the EUT transmit continuously.
4. Set RBW = 100 kHz, VBW=300 kHz, Peak Detector. Unwanted Emissions measured in any 100 kHz bandwidth outside of the authorized frequency band shall be attenuated by at least 20 dB relative to the maximum in-band peak PSD level in 100 kHz when maximum peak conducted output power procedure is used. If the transmitter complies with the conducted power limits based on the use of RMS averaging over a time interval, the attenuation required under this paragraph shall be 30 dB instead of 20 dB per 15.247(d).
5. Measure and record the results in the test report.
6. The RF fundamental frequency should be excluded against the limit line in the operating frequency band.

3.4.4 Test Setup

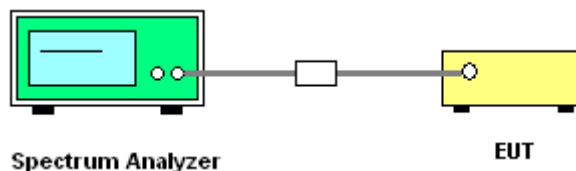



3.4.5 Test Result of Conducted Band Edges and Spurious Emission

Number of TX = 2, Ant. 1 (Measured)

Number of TX :	2	Ant. :	1
Test Mode :	802.11b	Temperature :	21~25°C
Test Band :	2.4GHz Low	Relative Humidity :	51~54%
Test Channel :	01	Test Engineer :	AC Chang

WLAN 802.11b Channel 01

100kHz PSD reference Level

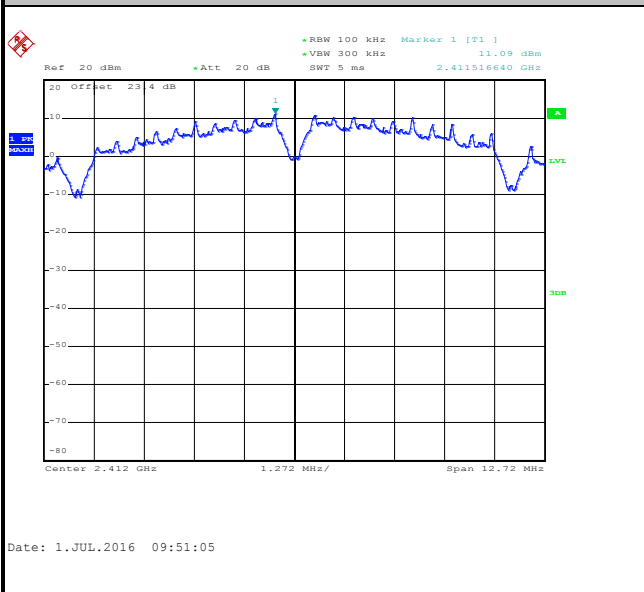

Low Channel Plot

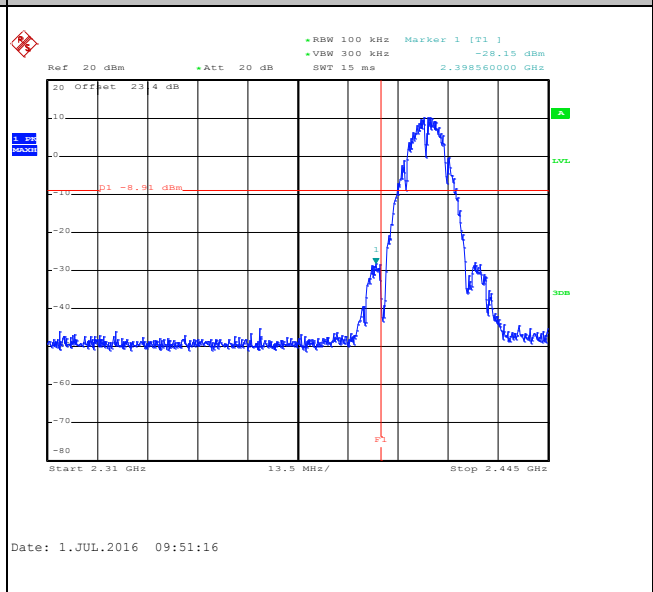

Spurious Emission 30MHz~3GHz

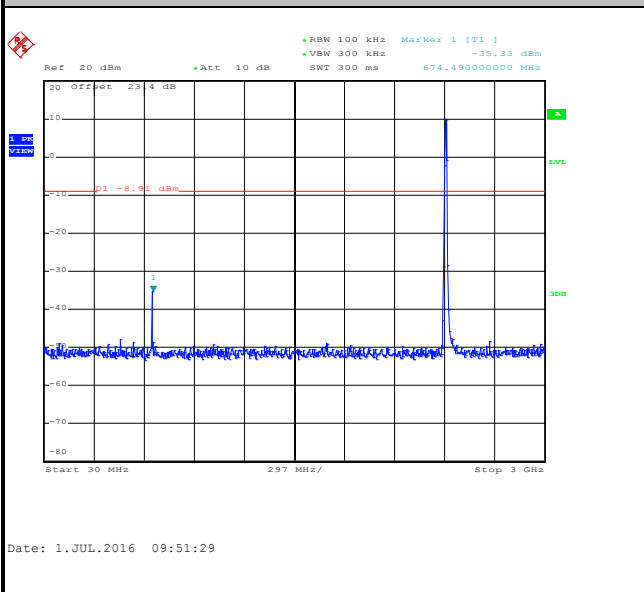

Spurious Emission 2GHz~25GHz

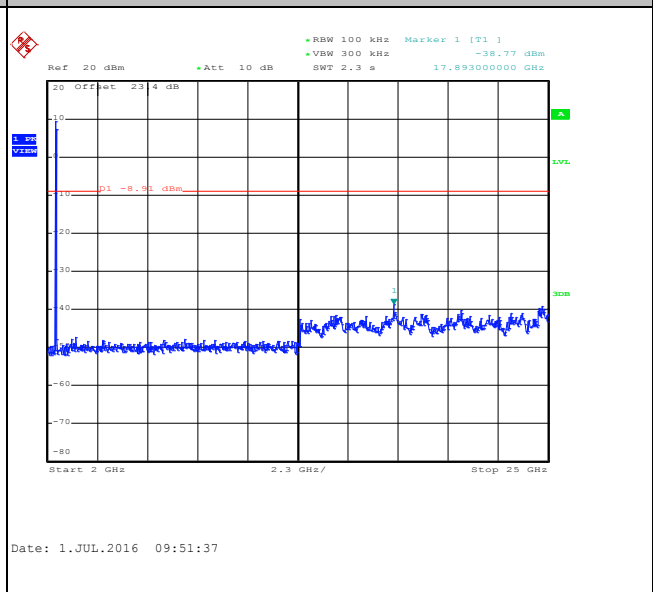



Number of TX :	2	Ant. :	1
Test Mode :	802.11b	Temperature :	21~25°C
Test Band :	2.4GHz Mid	Relative Humidity :	51~54%
Test Channel :	06	Test Engineer :	AC Chang

WLAN 802.11b Channel 06

100kHz PSD reference Level

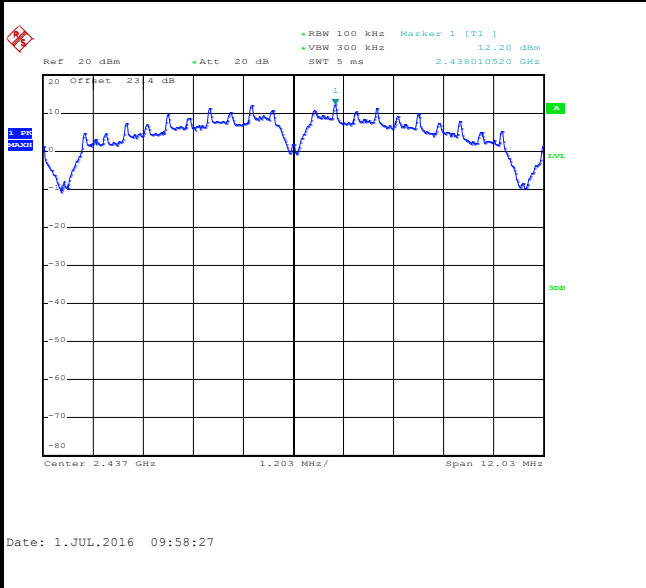

Spurious Emission 30MHz~3GHz

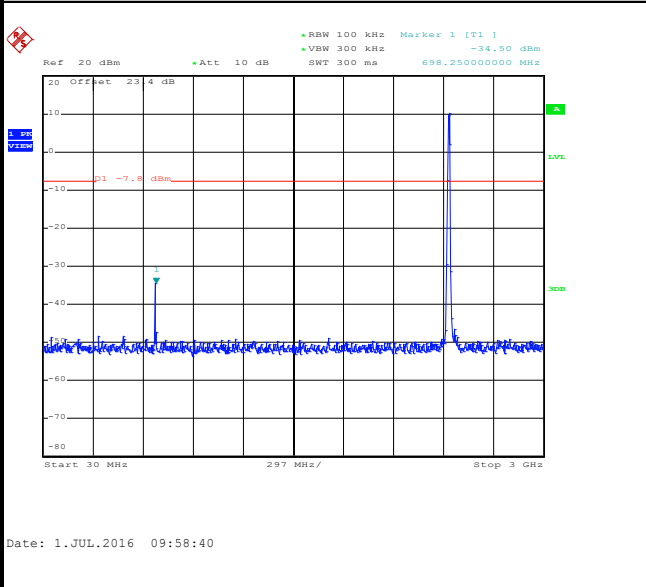

Spurious Emission 2GHz~25GHz

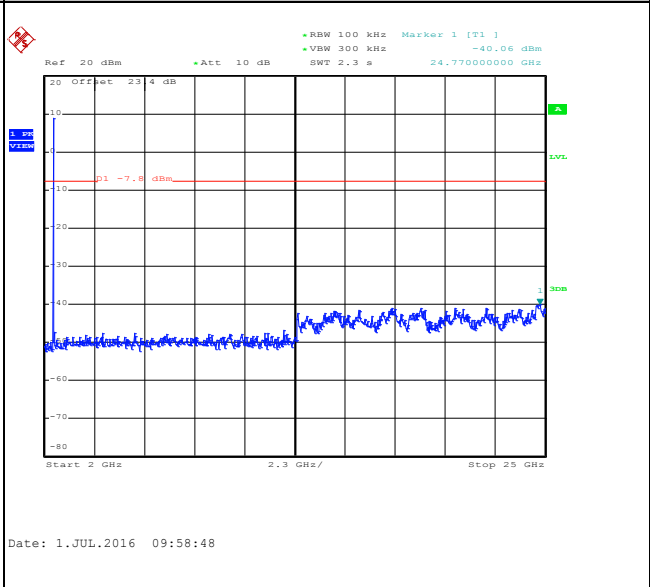



Number of TX :	2	Ant. :	1
Test Mode :	802.11b	Temperature :	21~25°C
Test Band :	2.4GHz High	Relative Humidity :	51~54%
Test Channel :	11	Test Engineer :	AC Chang

WLAN 802.11b Channel 11

100kHz PSD reference Level

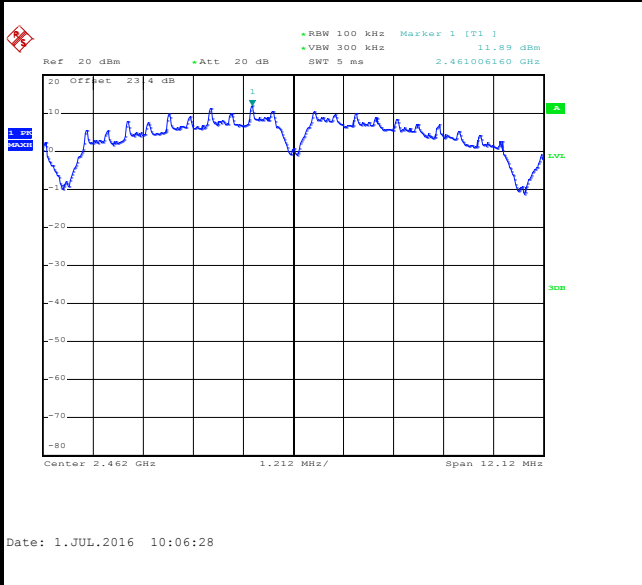

High Channel Plot

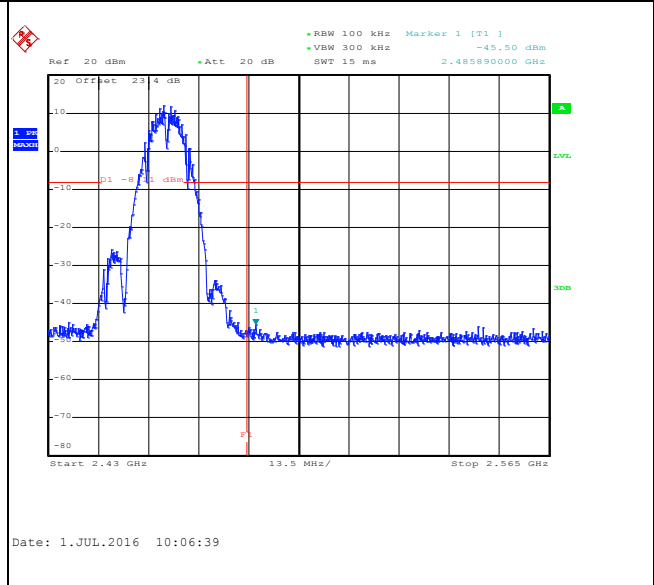

Spurious Emission 30MHz~3GHz

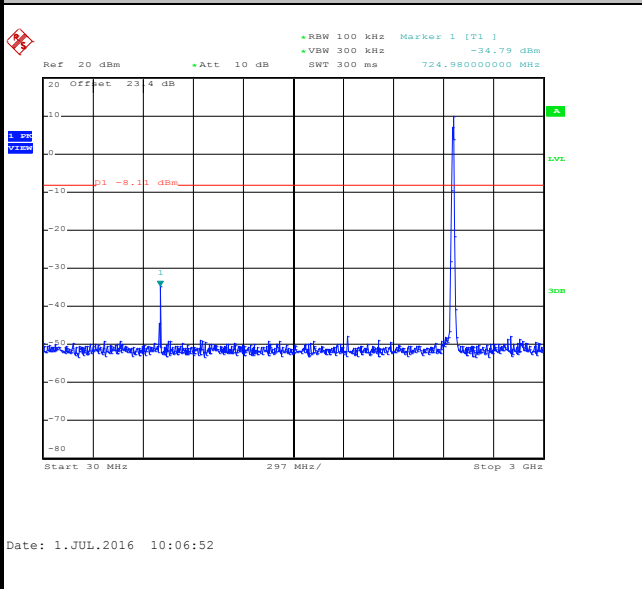

Spurious Emission 2GHz~25GHz

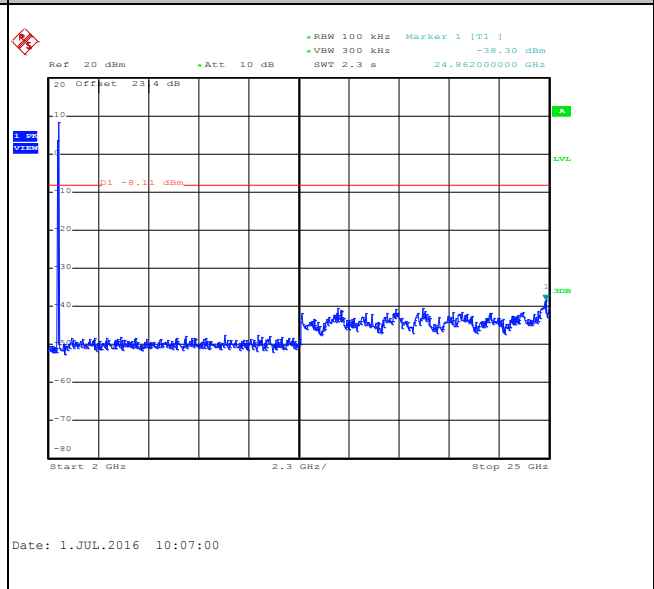



Number of TX :	2	Ant. :	1
Test Mode :	802.11g	Temperature :	21~25°C
Test Band :	2.4GHz Low	Relative Humidity :	51~54%
Test Channel :	01	Test Engineer :	AC Chang

WLAN 802.11g Channel 01

100kHz PSD reference Level

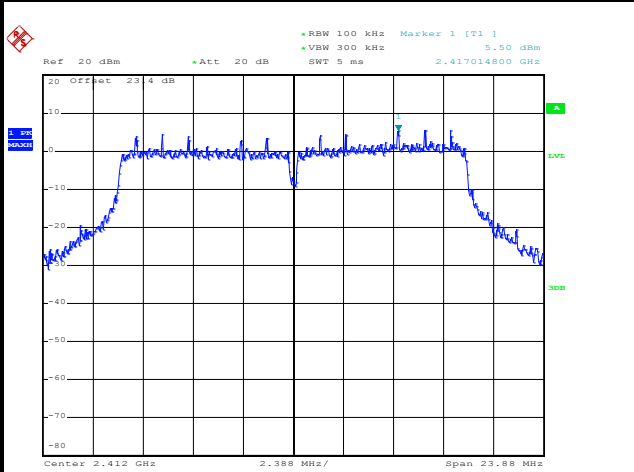

Date: 1.JUL.2016 10:19:25

Low Channel Plot

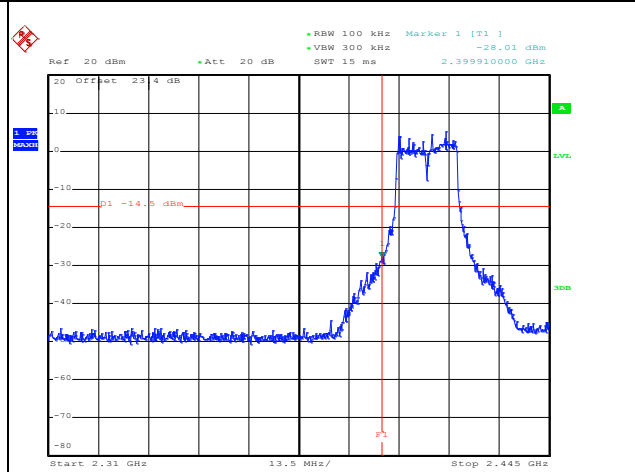

Date: 1.JUL.2016 10:19:41

Spurious Emission 30MHz~3GHz

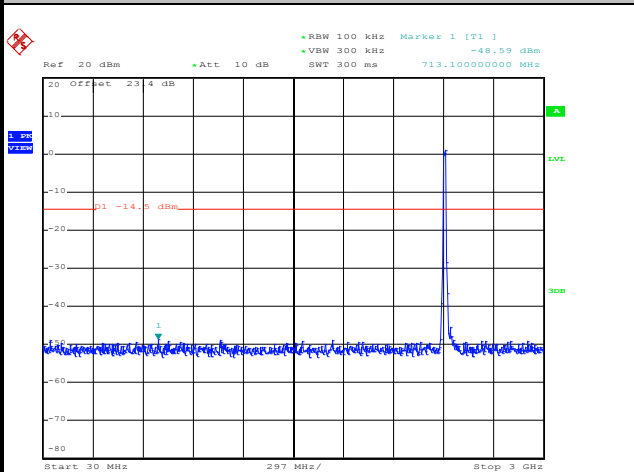

Date: 1.JUL.2016 10:20:00

Spurious Emission 2GHz~25GHz

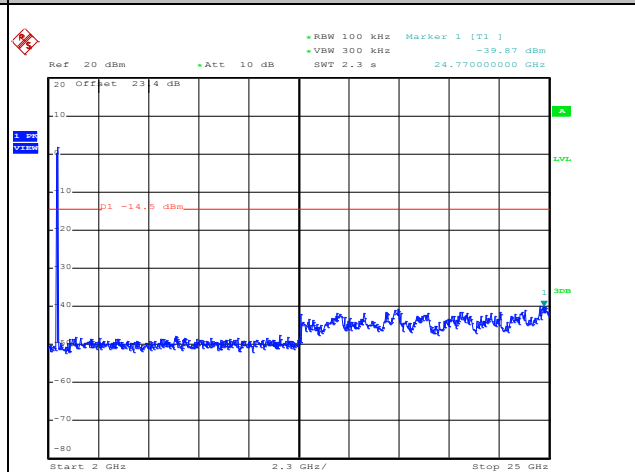

Date: 1.JUL.2016 10:20:08



Number of TX :	2	Ant. :	1
Test Mode :	802.11g	Temperature :	21~25°C
Test Band :	2.4GHz Mid	Relative Humidity :	51~54%
Test Channel :	06	Test Engineer :	AC Chang

WLAN 802.11g Channel 06

100kHz PSD reference Level

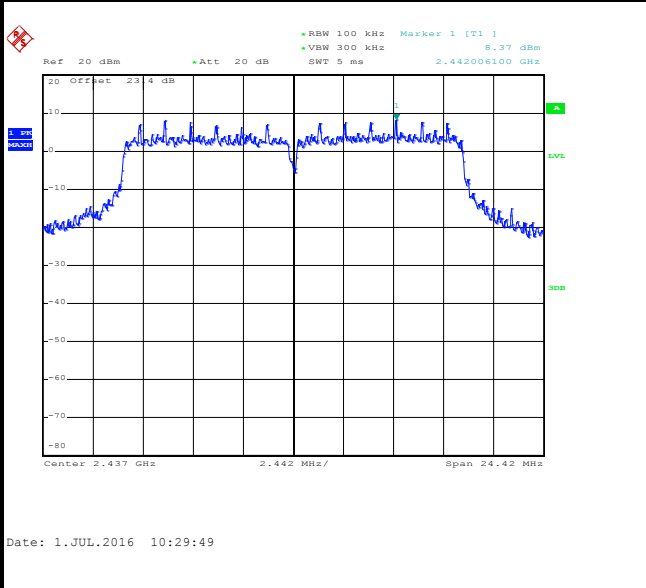

Spurious Emission 30MHz~3GHz

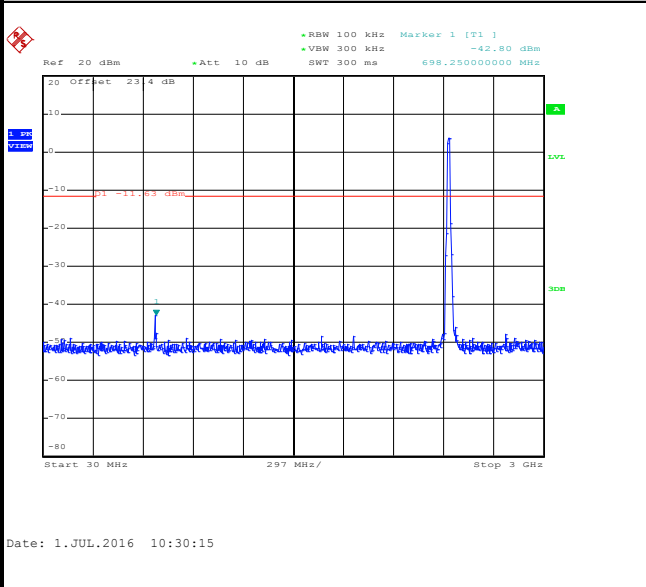

Spurious Emission 2GHz~25GHz

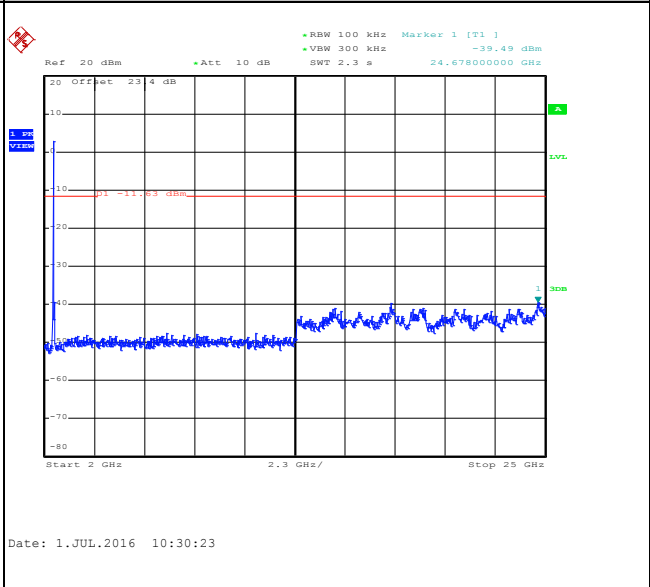



Number of TX :	2	Ant. :	1
Test Mode :	802.11g	Temperature :	21~25°C
Test Band :	2.4GHz High	Relative Humidity :	51~54%
Test Channel :	11	Test Engineer :	AC Chang

WLAN 802.11g Channel 11

100kHz PSD reference Level

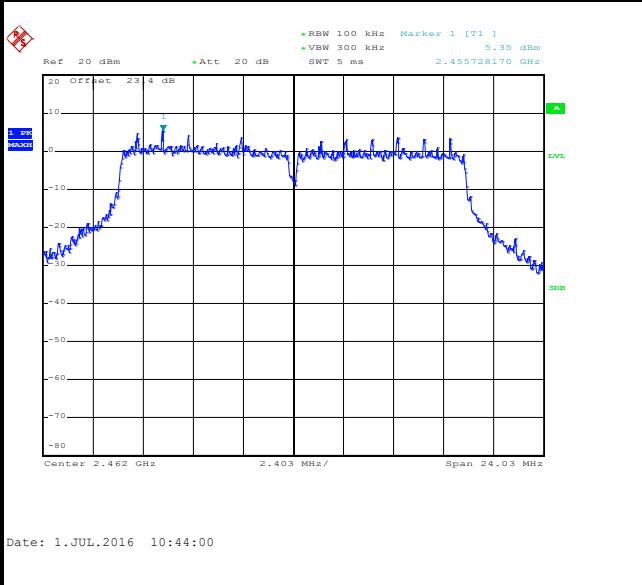

High Channel Plot

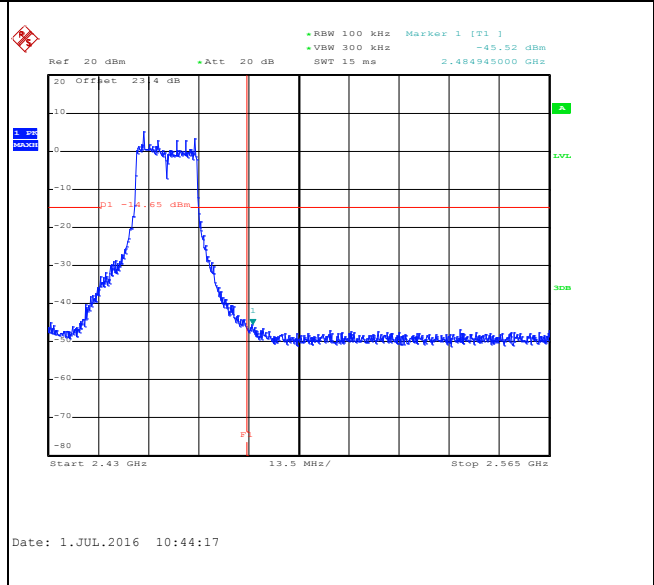

Spurious Emission 30MHz~3GHz

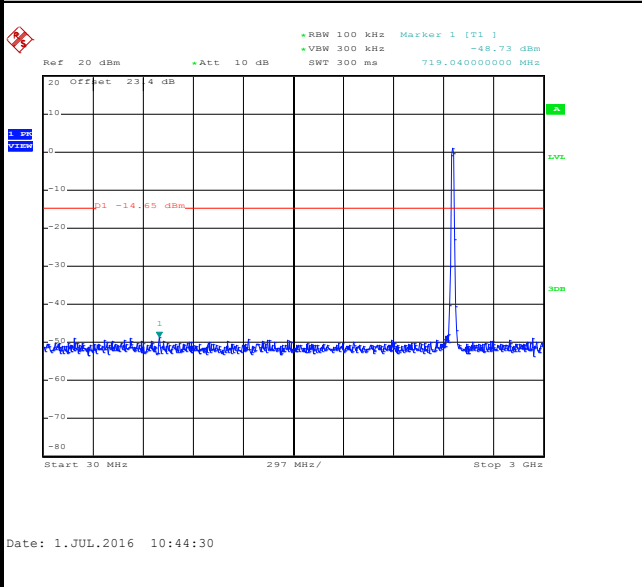

Spurious Emission 2GHz~25GHz

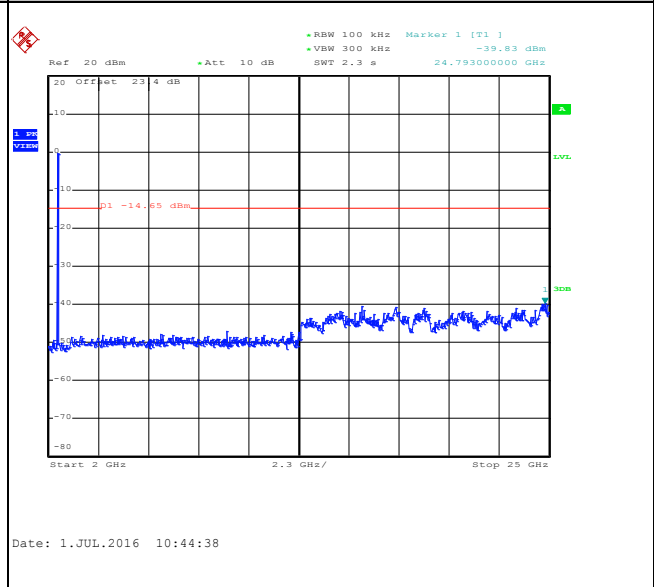



Number of TX :	2	Ant. :	1
Test Mode :	802.11n HT20	Temperature :	21~25°C
Test Band :	2.4GHz Low	Relative Humidity :	51~54%
Test Channel :	01	Test Engineer :	AC Chang

WLAN 802.11n HT20 Channel 01

100kHz PSD reference Level

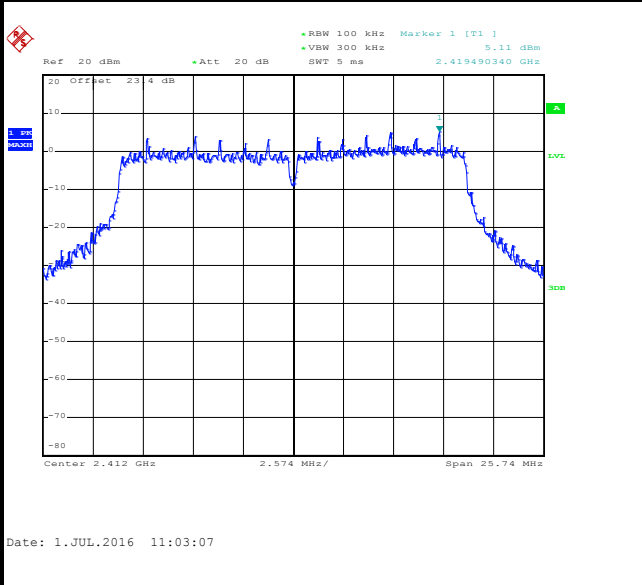

Low Channel Plot

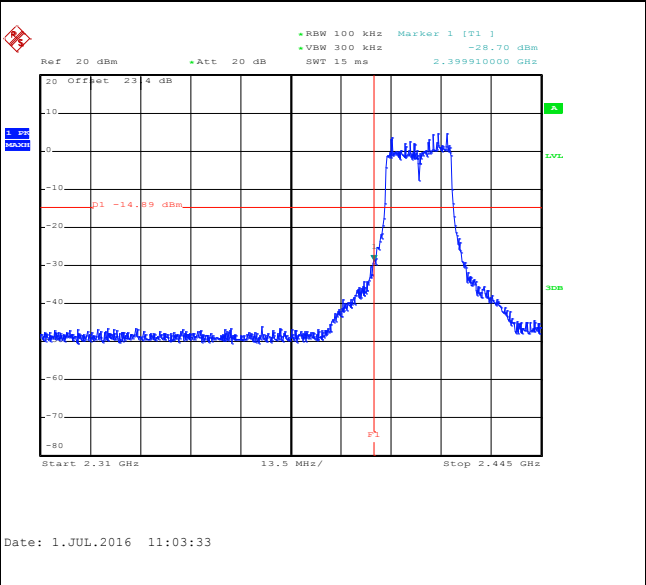

Spurious Emission 30MHz~3GHz

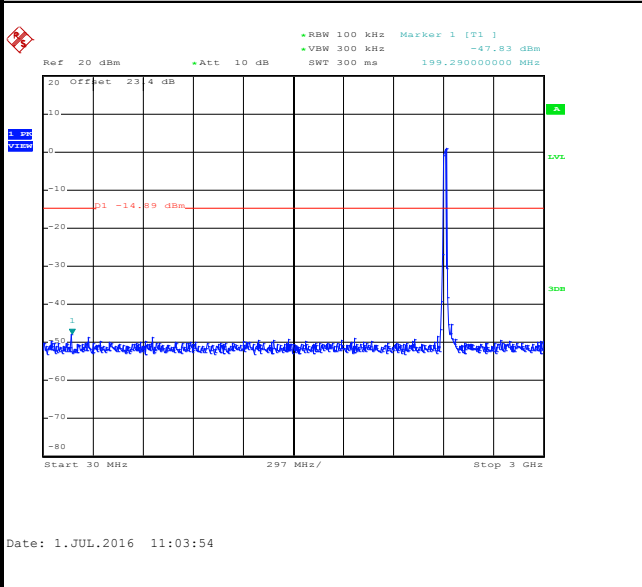

Spurious Emission 2GHz~25GHz

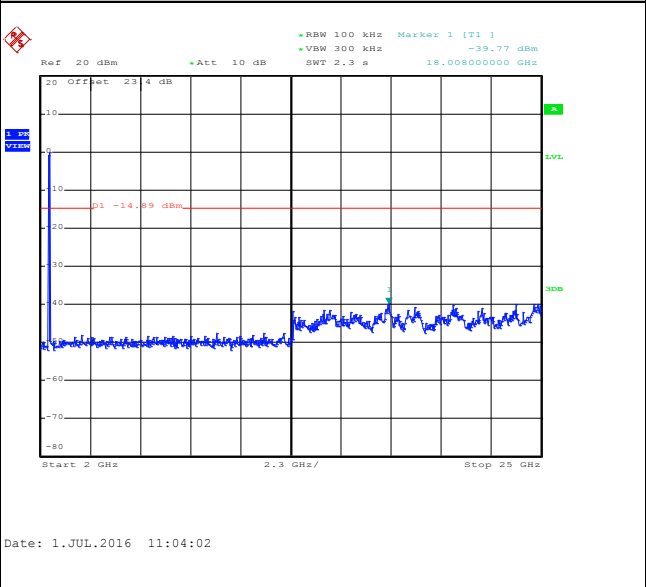



Number of TX :	2	Ant. :	1
Test Mode :	802.11n HT20	Temperature :	21~25°C
Test Band :	2.4GHz Mid	Relative Humidity :	51~54%
Test Channel :	06	Test Engineer :	AC Chang

WLAN 802.11n HT20 Channel 06

100kHz PSD reference Level

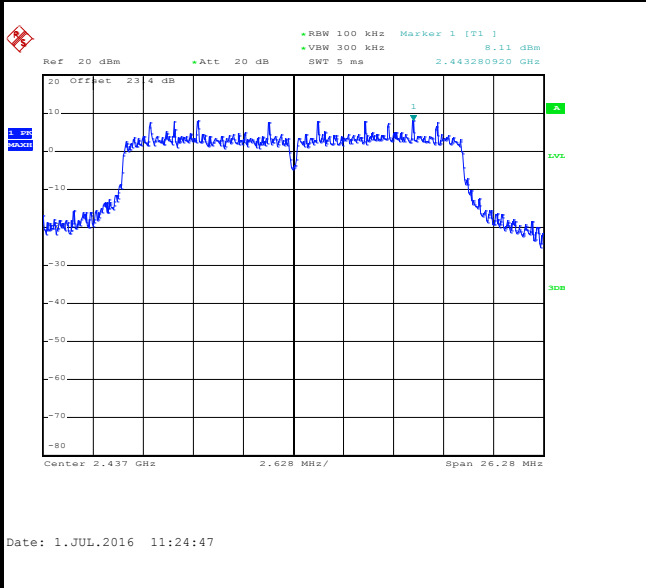

Spurious Emission 30MHz~3GHz

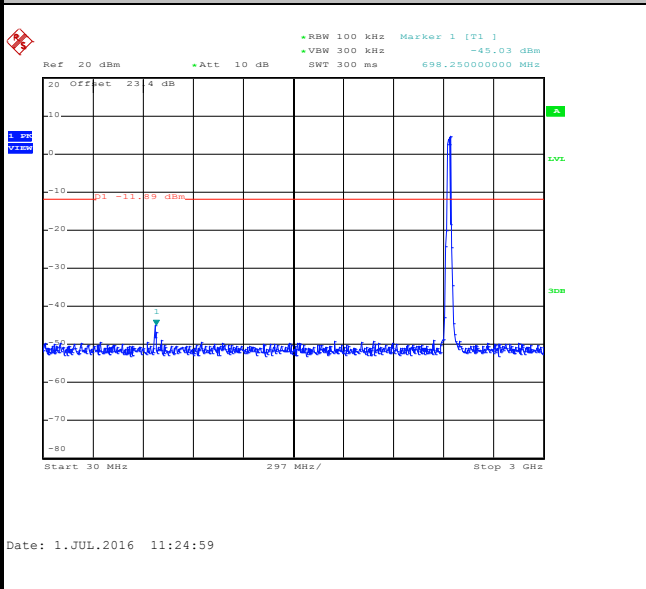

Spurious Emission 2GHz~25GHz

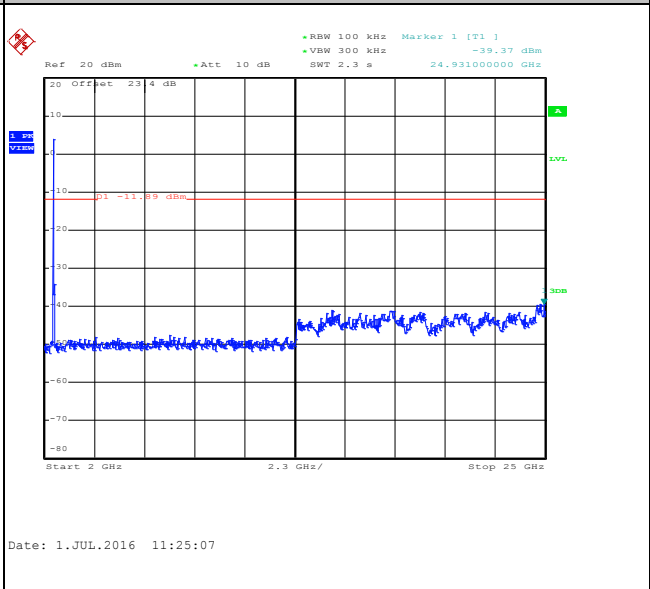



Number of TX :	2	Ant. :	1
Test Mode :	802.11n HT20	Temperature :	21~25°C
Test Band :	2.4GHz High	Relative Humidity :	51~54%
Test Channel :	11	Test Engineer :	AC Chang

WLAN 802.11n HT20 Channel 11

100kHz PSD reference Level

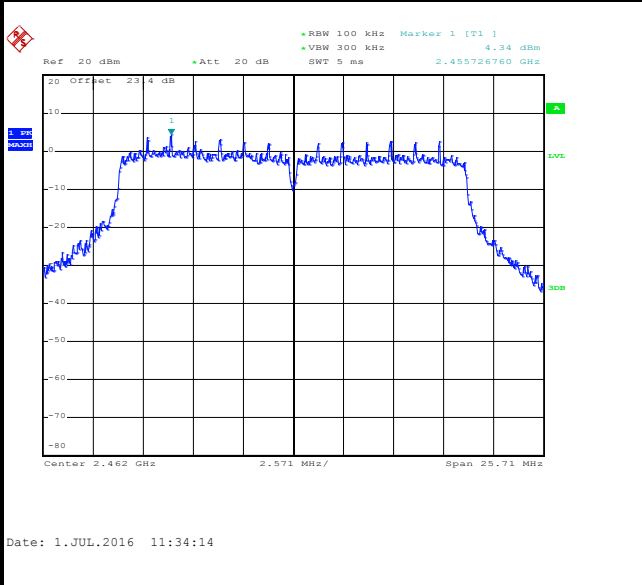

High Channel Plot

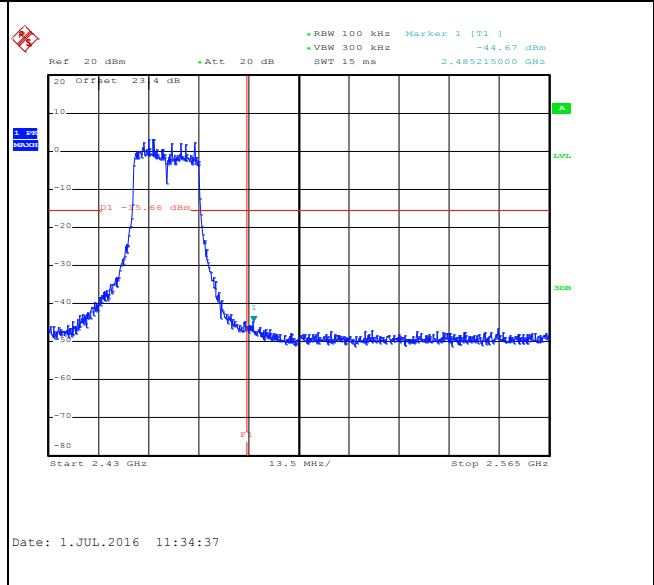

Spurious Emission 30MHz~3GHz

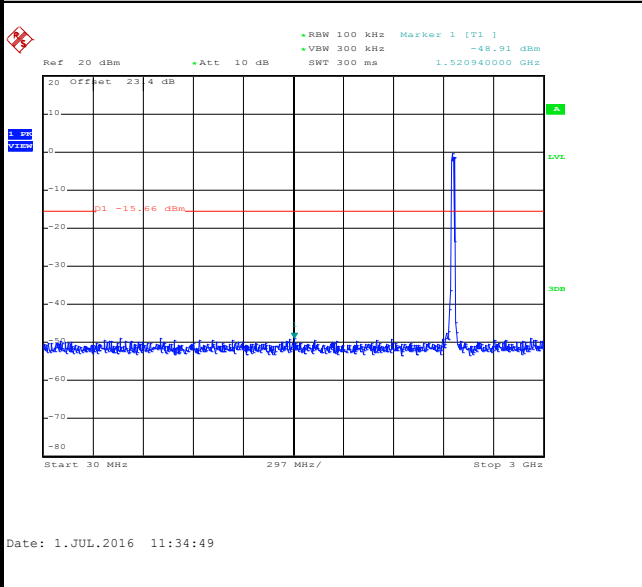

Spurious Emission 2GHz~25GHz

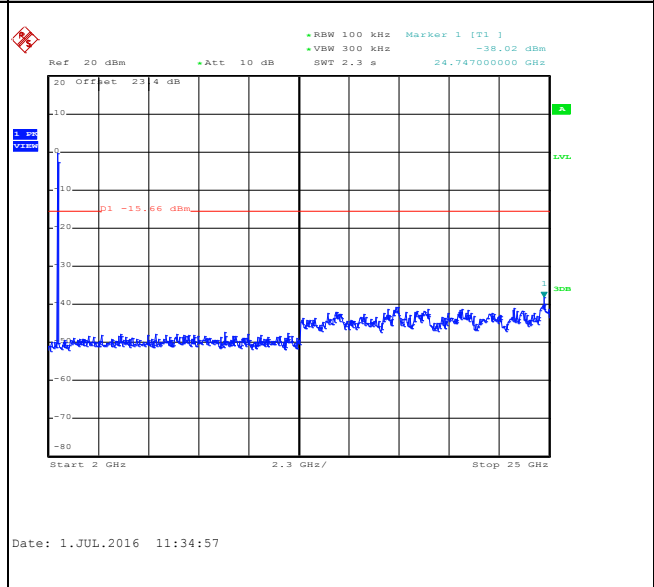



Number of TX :	2	Ant. :	1
Test Mode :	802.11n HT40	Temperature :	21~25°C
Test Band :	2.4GHz Low	Relative Humidity :	51~54%
Test Channel :	03	Test Engineer :	AC Chang

WLAN 802.11n HT40 Channel 03

100kHz PSD reference Level

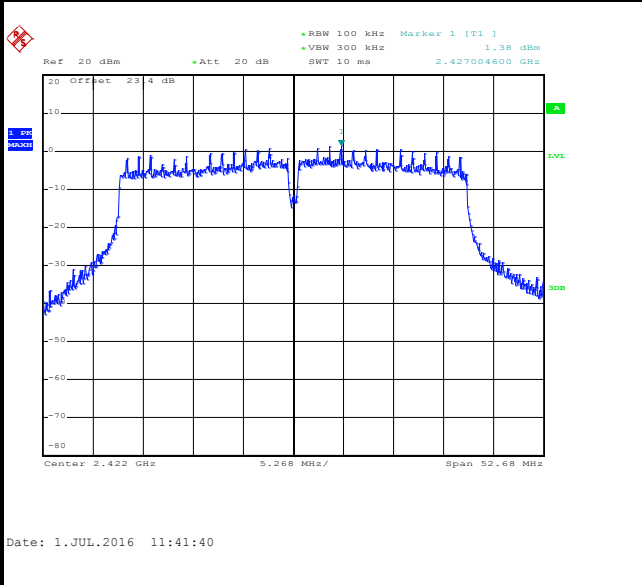

Low Channel Plot

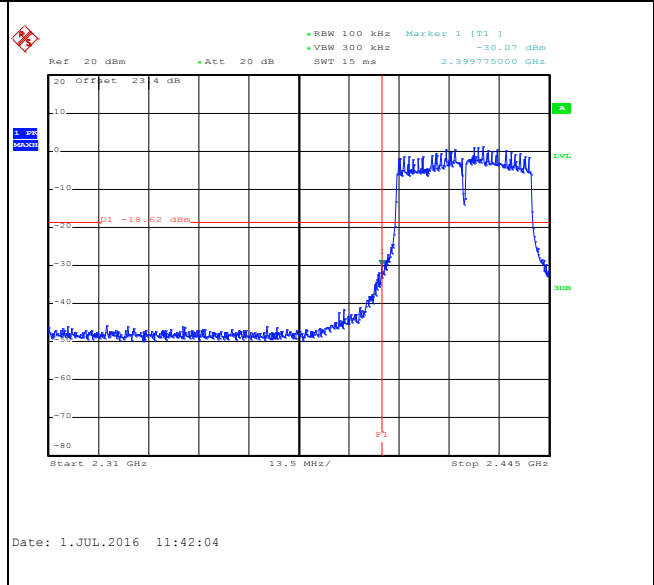

Spurious Emission 30MHz~3GHz

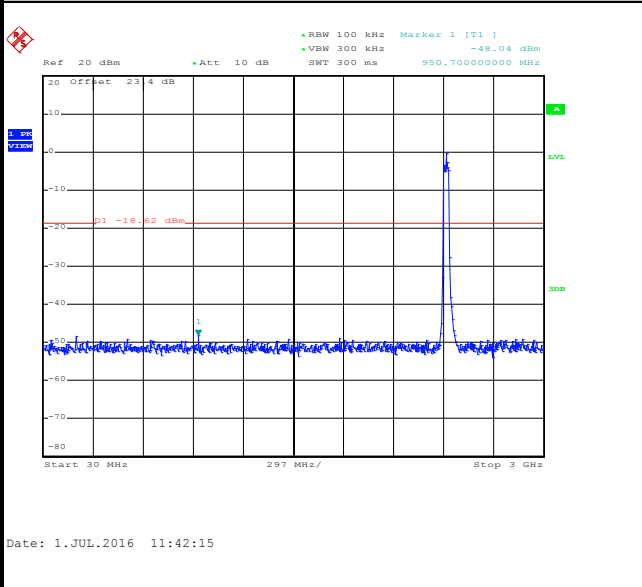

Spurious Emission 2GHz~25GHz

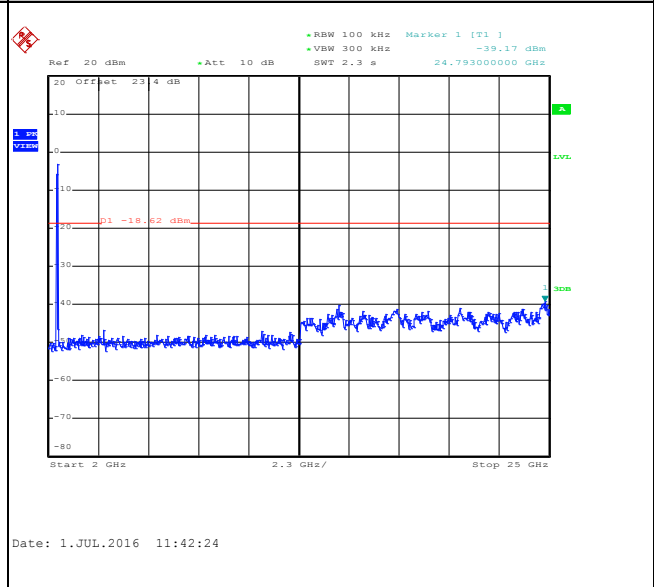



Number of TX :	2	Ant. :	1
Test Mode :	802.11n HT40	Temperature :	21~25°C
Test Band :	2.4GHz Mid	Relative Humidity :	51~54%
Test Channel :	06	Test Engineer :	AC Chang

WLAN 802.11n HT40 Channel 06

100kHz PSD reference Level

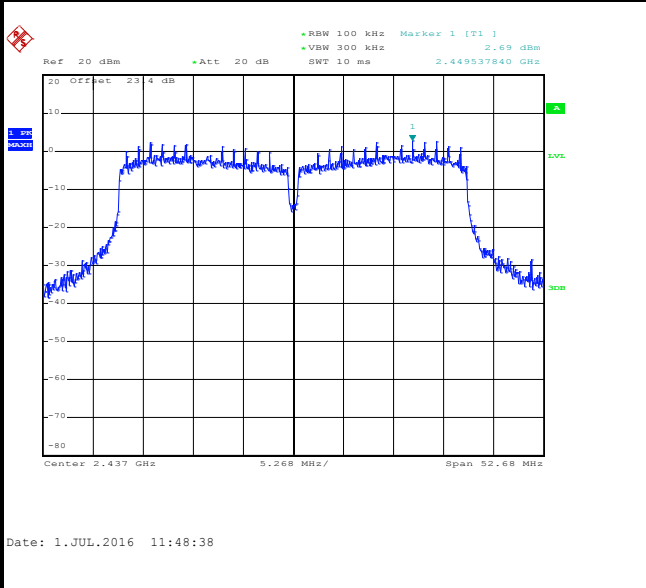

Spurious Emission 30MHz~3GHz

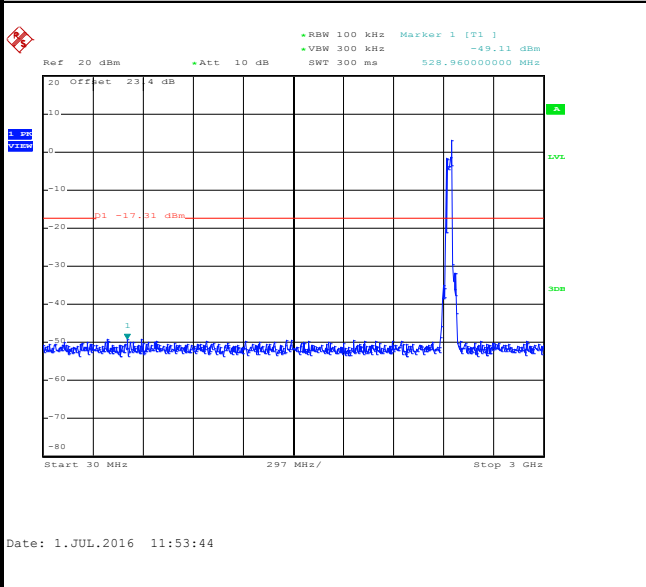

Spurious Emission 2GHz~25GHz

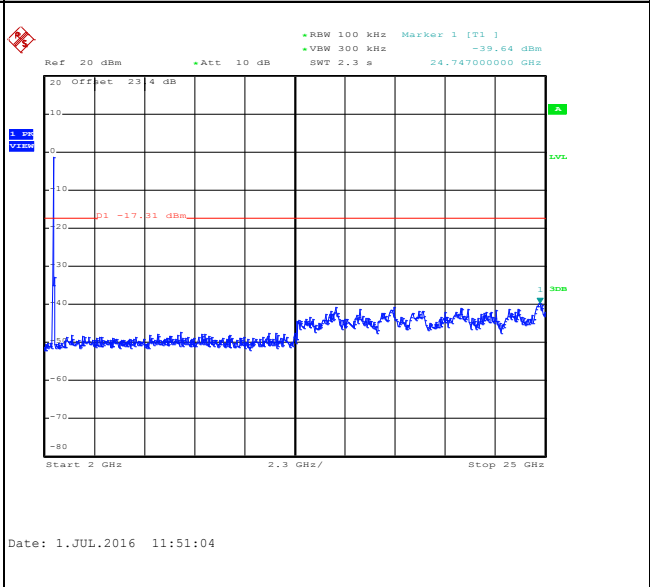



Number of TX :	2	Ant. :	1
Test Mode :	802.11n HT40	Temperature :	21~25°C
Test Band :	2.4GHz High	Relative Humidity :	51~54%
Test Channel :	09	Test Engineer :	AC Chang

WLAN 802.11n HT40 Channel 09

100kHz PSD reference Level

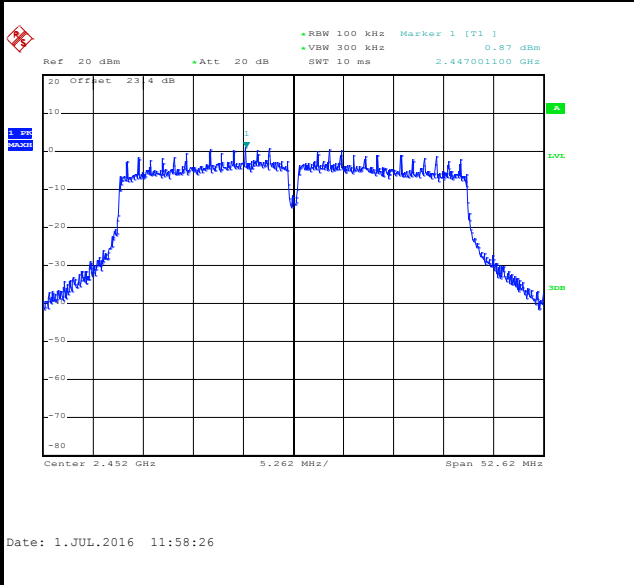

High Channel Plot

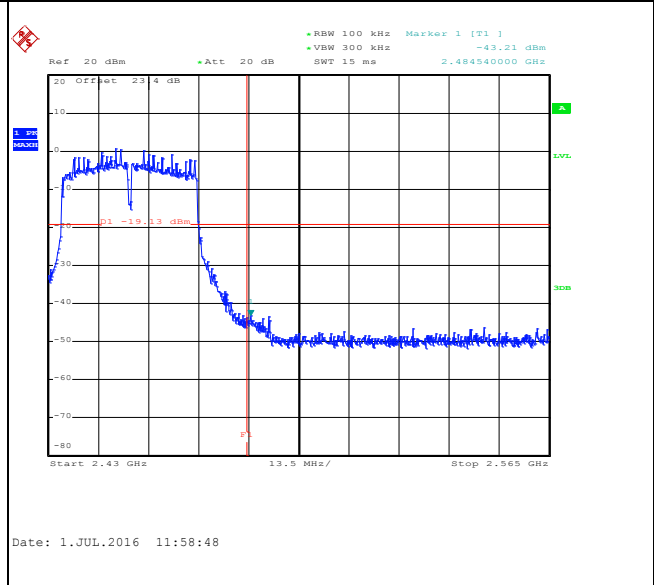

Spurious Emission 30MHz~3GHz

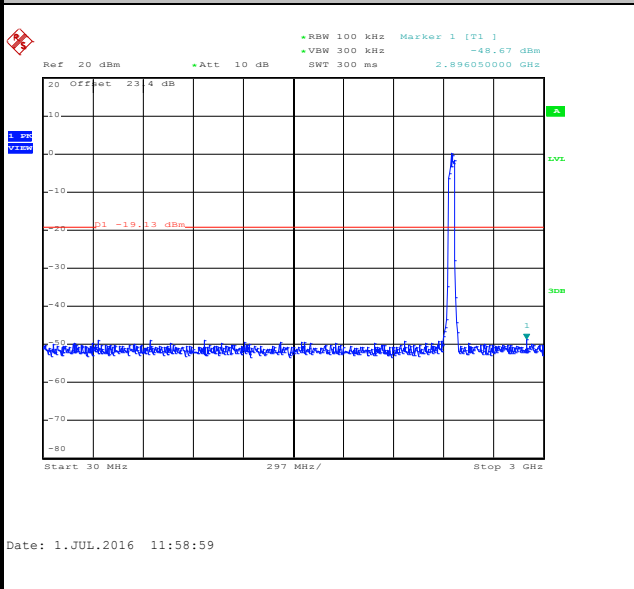

Spurious Emission 2GHz~25GHz

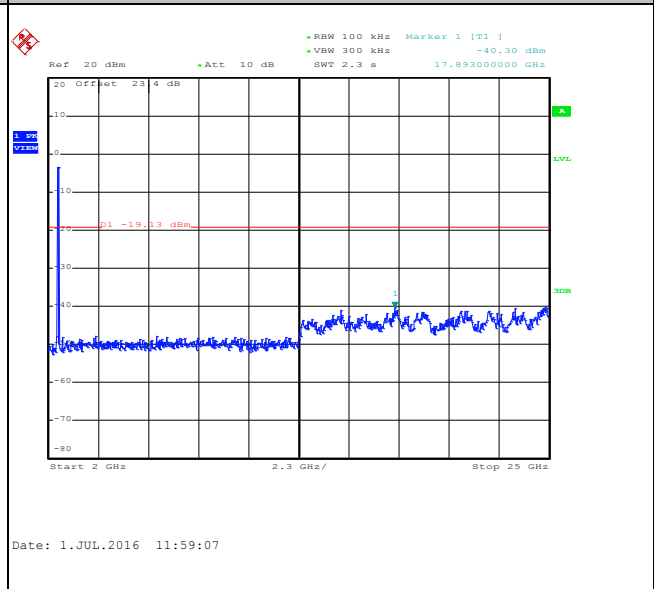



Number of TX = 2, Ant. 2 (Measured)

Number of TX :	2	Ant. :	2
Test Mode :	802.11b	Temperature :	21~25°C
Test Band :	2.4GHz Low	Relative Humidity :	51~54%
Test Channel :	01	Test Engineer :	AC Chang

WLAN 802.11b Channel 01

100kHz PSD reference Level

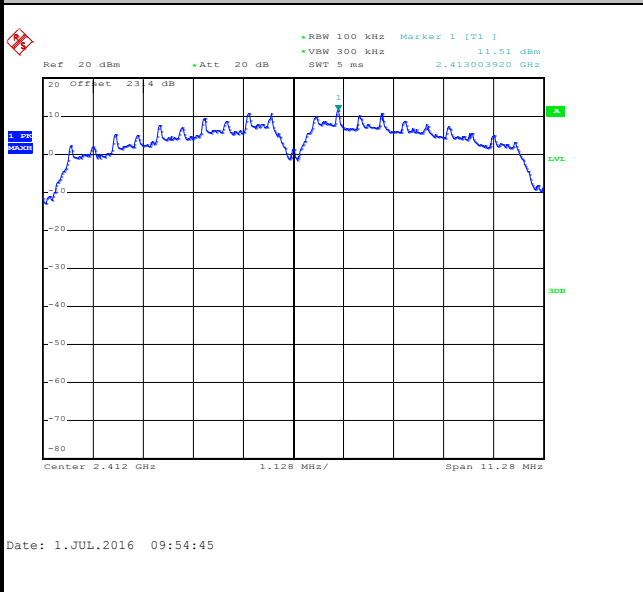

Low Channel Plot

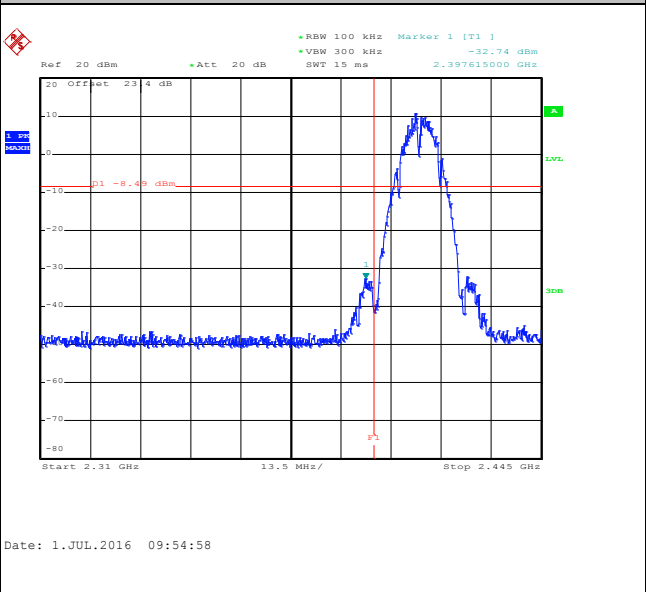

Spurious Emission 30MHz~3GHz

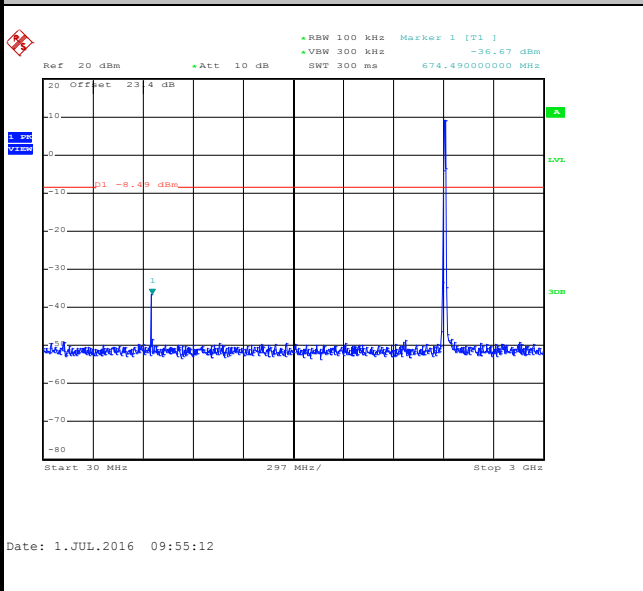

Spurious Emission 2GHz~25GHz

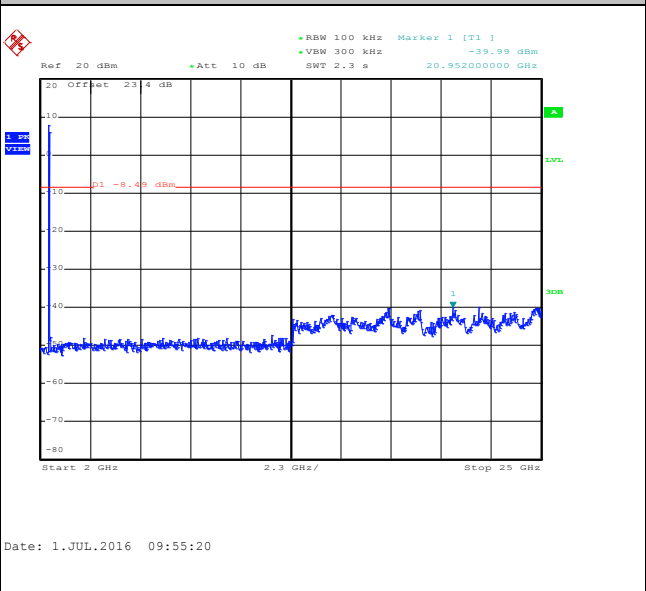



Number of TX :	2	Ant. :	2
Test Mode :	802.11b	Temperature :	21~25°C
Test Band :	2.4GHz Mid	Relative Humidity :	51~54%
Test Channel :	06	Test Engineer :	AC Chang

WLAN 802.11b Channel 06

100kHz PSD reference Level

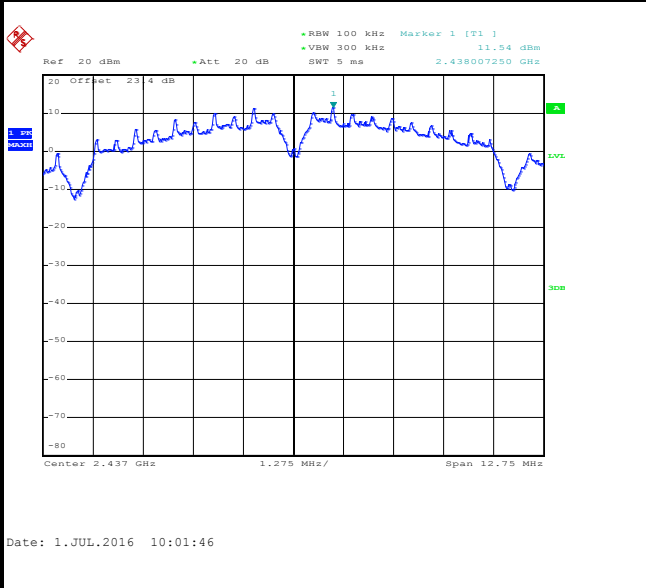

Spurious Emission 30MHz~3GHz

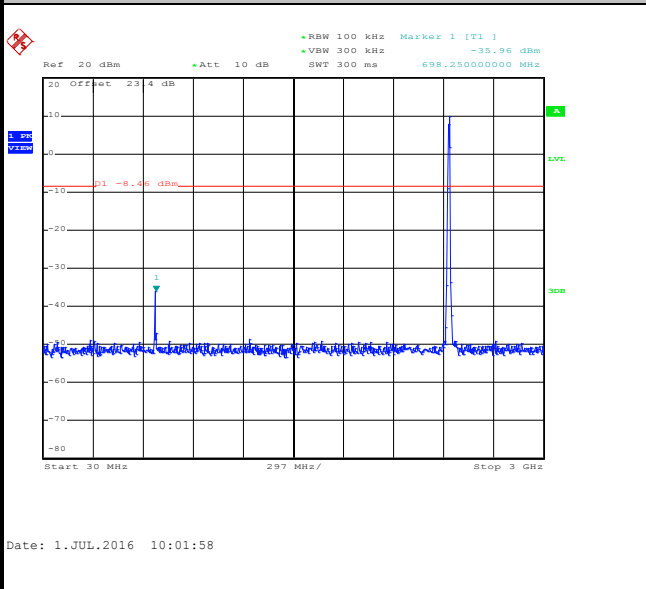

Spurious Emission 2GHz~25GHz

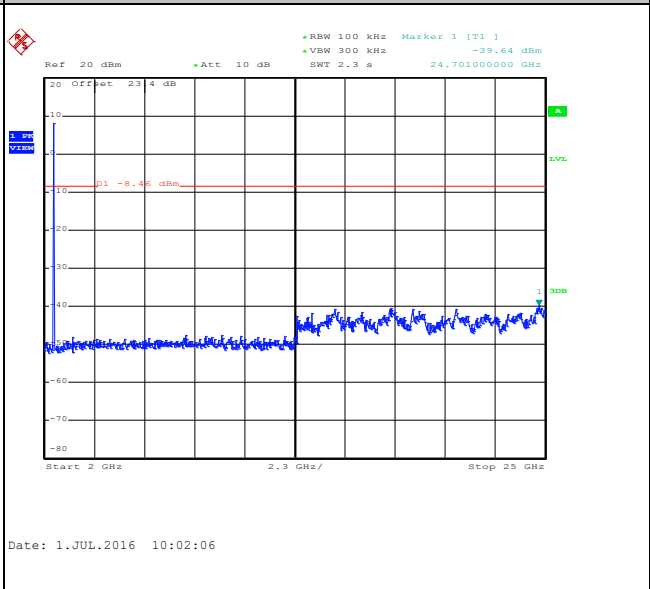



Number of TX :	2	Ant. :	2
Test Mode :	802.11b	Temperature :	21~25°C
Test Band :	2.4GHz High	Relative Humidity :	51~54%
Test Channel :	11	Test Engineer :	AC Chang

WLAN 802.11b Channel 11

100kHz PSD reference Level

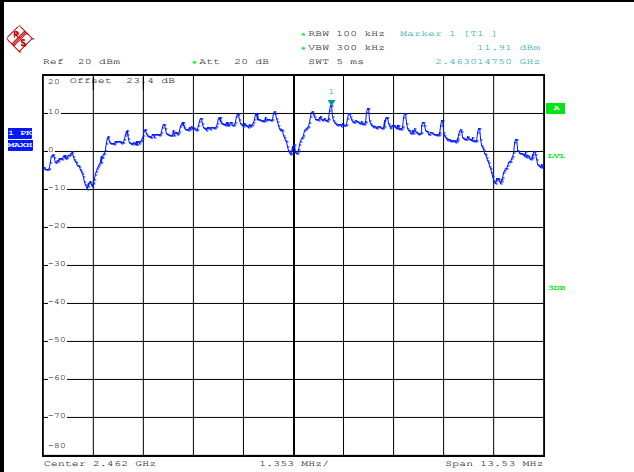

Date: 1.JUL.2016 10:10:59

High Channel Plot

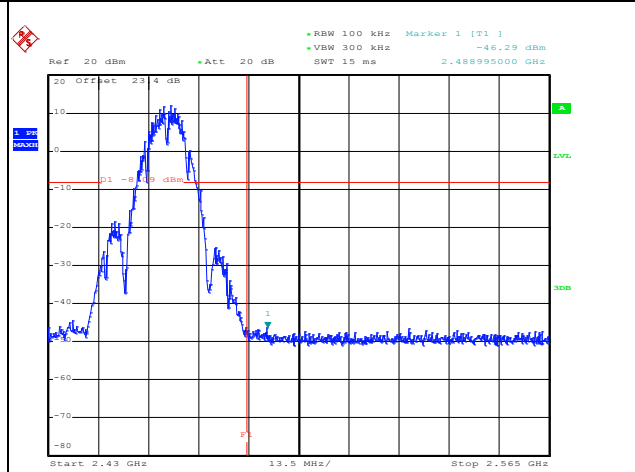

Date: 1.JUL.2016 10:11:11

Spurious Emission 30MHz~3GHz

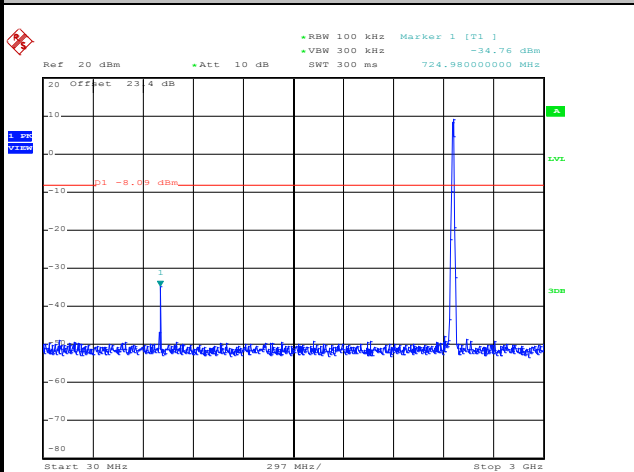

Date: 1.JUL.2016 10:11:26

Spurious Emission 2GHz~25GHz

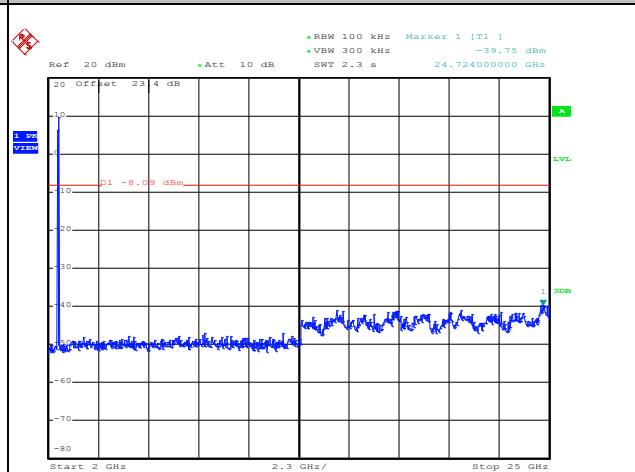

Date: 1.JUL.2016 10:11:35



Number of TX :	2	Ant. :	2
Test Mode :	802.11g	Temperature :	21~25°C
Test Band :	2.4GHz Low	Relative Humidity :	51~54%
Test Channel :	01	Test Engineer :	AC Chang

WLAN 802.11g Channel 01

100kHz PSD reference Level

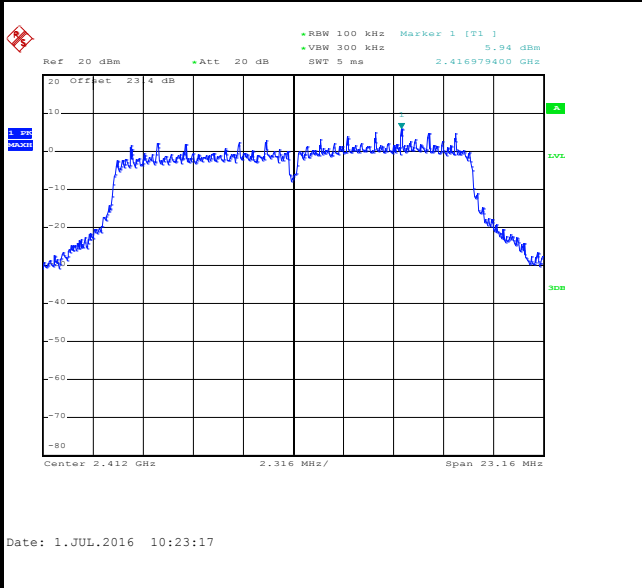

Low Channel Plot

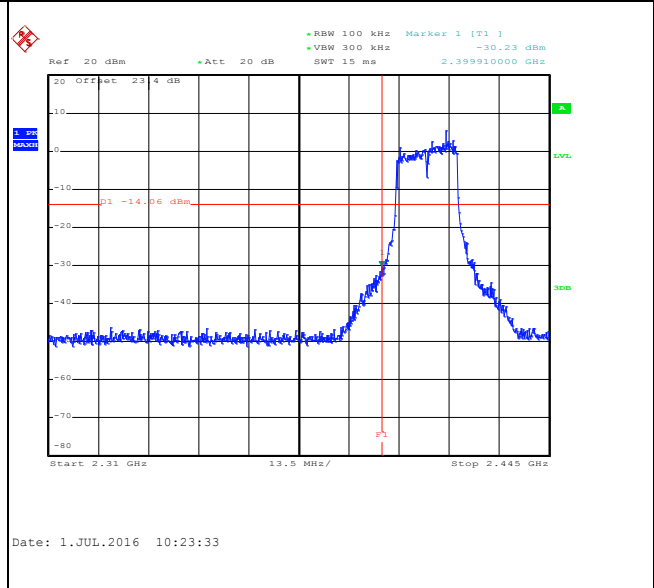

Spurious Emission 30MHz~3GHz

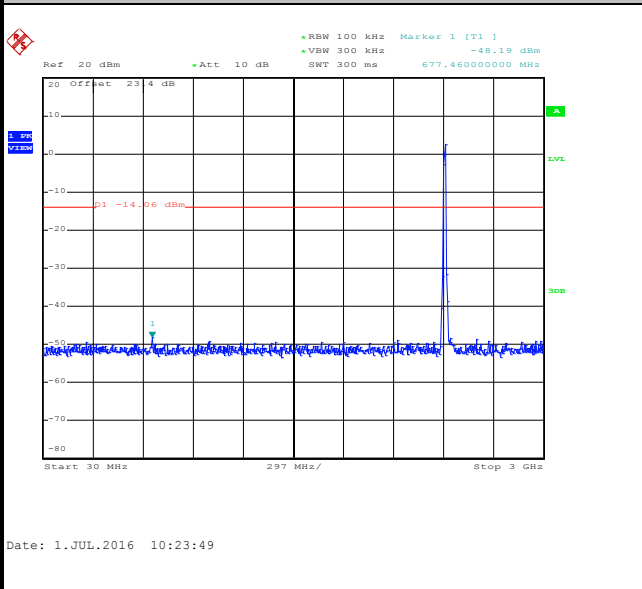

Spurious Emission 2GHz~25GHz

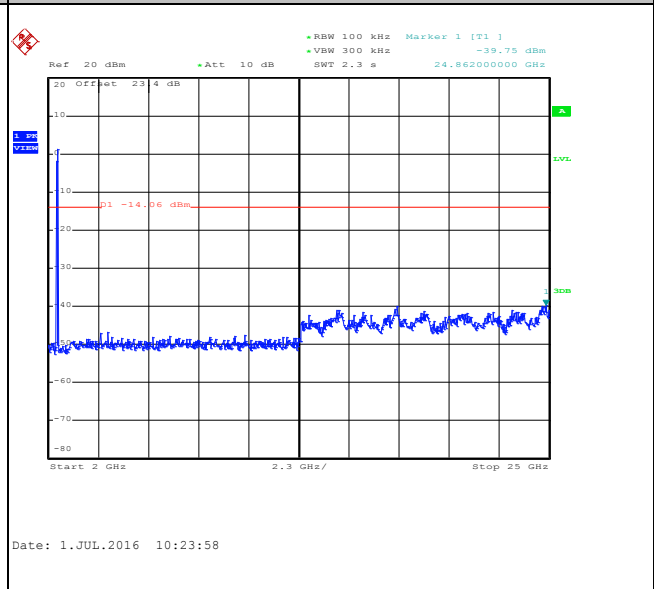



Number of TX :	2	Ant. :	2
Test Mode :	802.11g	Temperature :	21~25°C
Test Band :	2.4GHz Mid	Relative Humidity :	51~54%
Test Channel :	06	Test Engineer :	AC Chang

WLAN 802.11g Channel 06

100kHz PSD reference Level

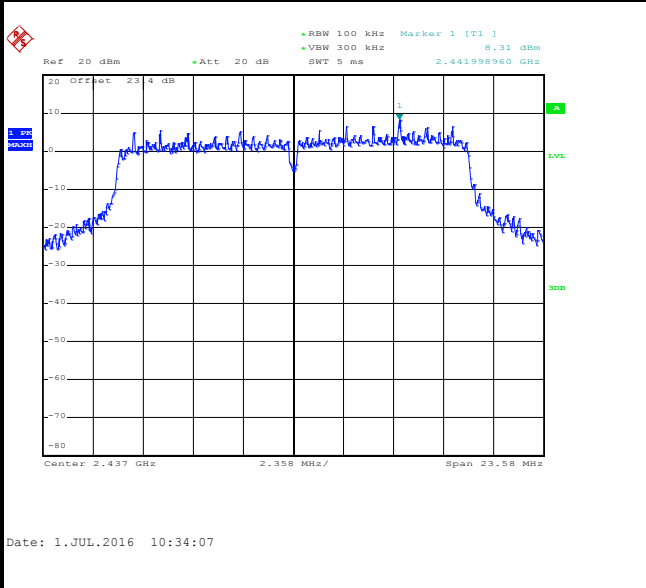

Spurious Emission 30MHz~3GHz

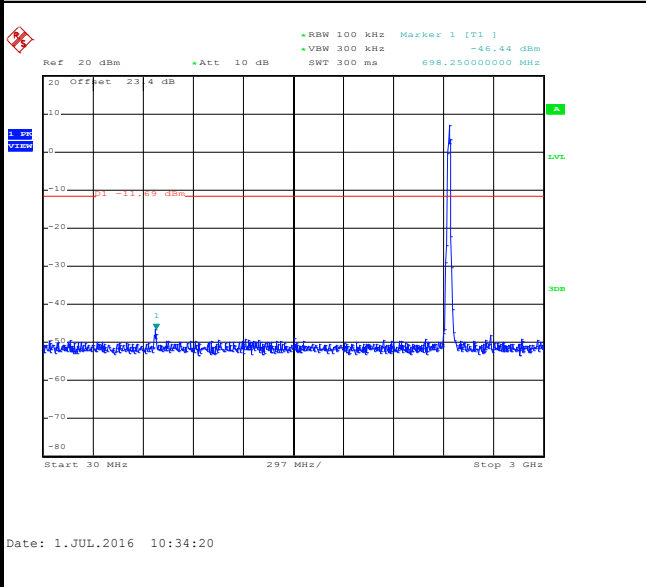

Spurious Emission 2GHz~25GHz

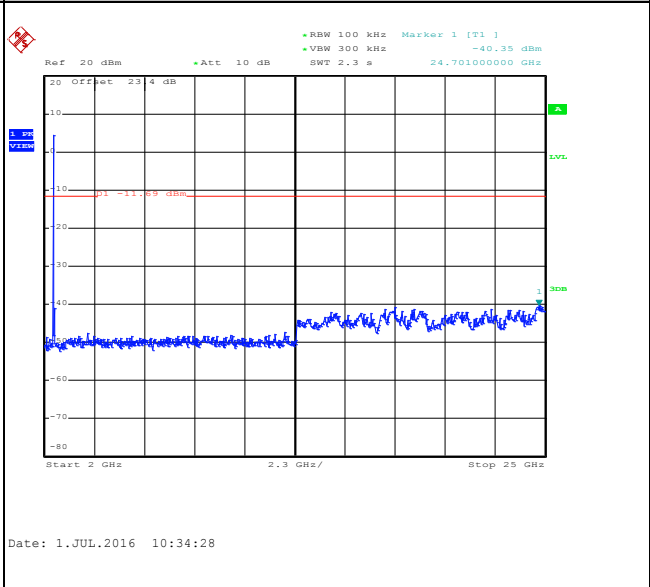



Number of TX :	2	Ant. :	2
Test Mode :	802.11g	Temperature :	21~25°C
Test Band :	2.4GHz High	Relative Humidity :	51~54%
Test Channel :	11	Test Engineer :	AC Chang

WLAN 802.11g Channel 11

100kHz PSD reference Level

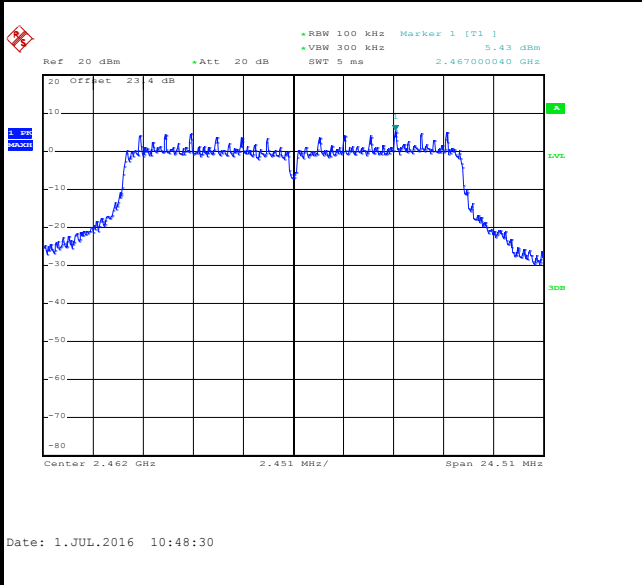

High Channel Plot

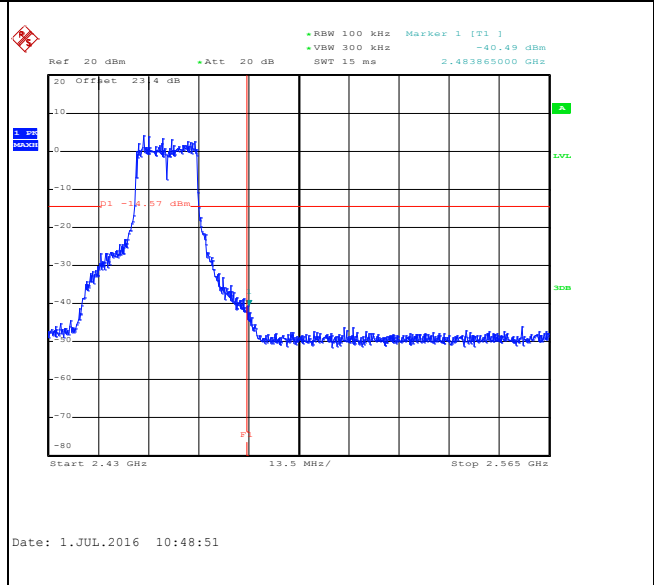

Spurious Emission 30MHz~3GHz

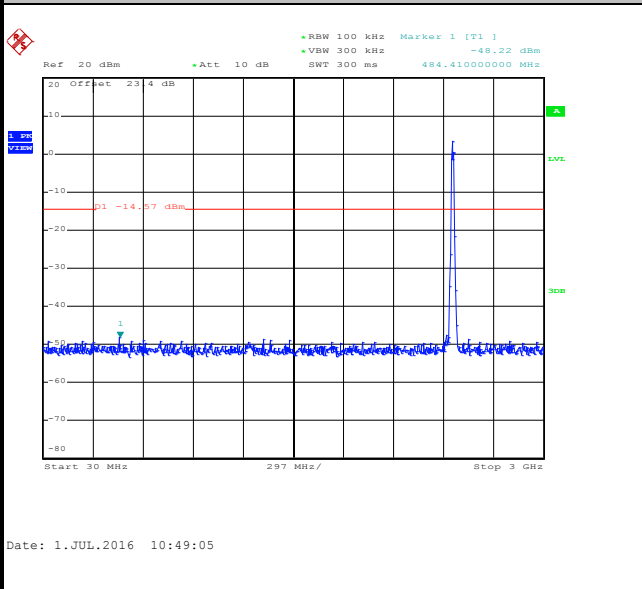

Spurious Emission 2GHz~25GHz

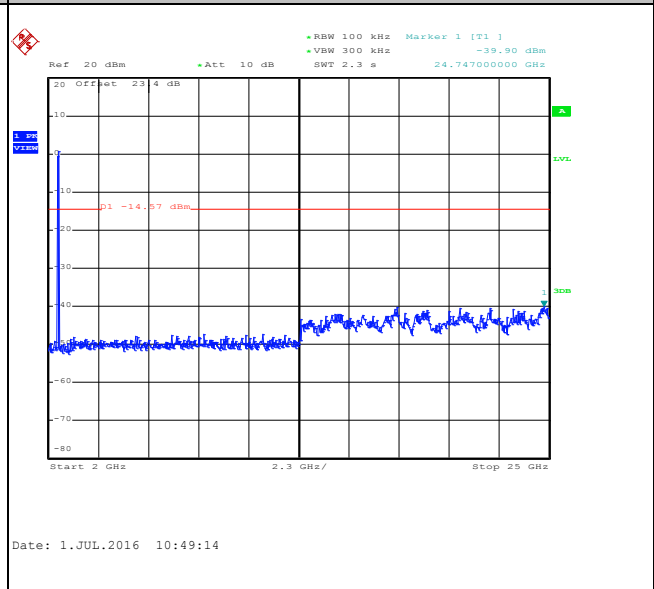



Number of TX :	2	Ant. :	2
Test Mode :	802.11n HT20	Temperature :	21~25°C
Test Band :	2.4GHz Low	Relative Humidity :	51~54%
Test Channel :	01	Test Engineer :	AC Chang

WLAN 802.11n HT20 Channel 01

100kHz PSD reference Level

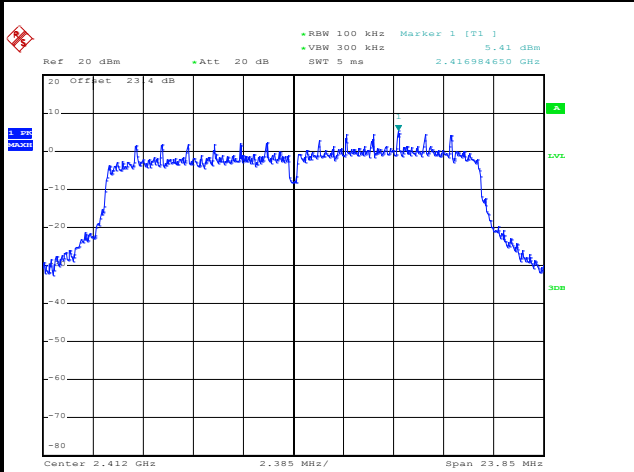

Date: 1.JUL.2016 11:09:27

Low Channel Plot

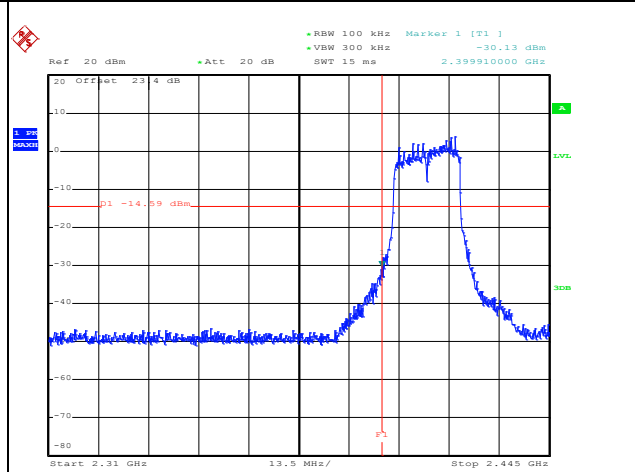

Date: 1.JUL.2016 11:09:42

Spurious Emission 30MHz~3GHz

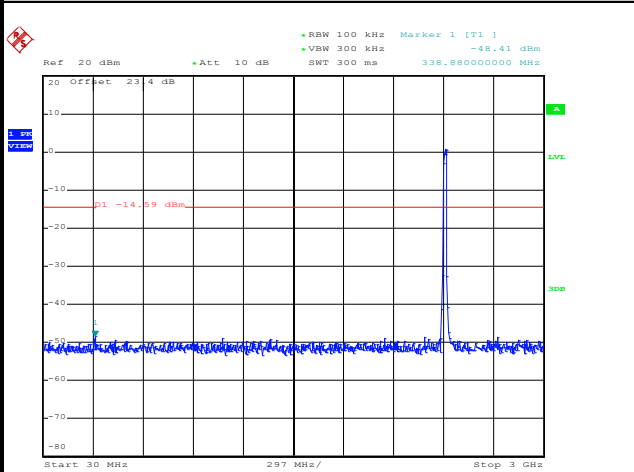

Date: 1.JUL.2016 11:10:04

Spurious Emission 2GHz~25GHz

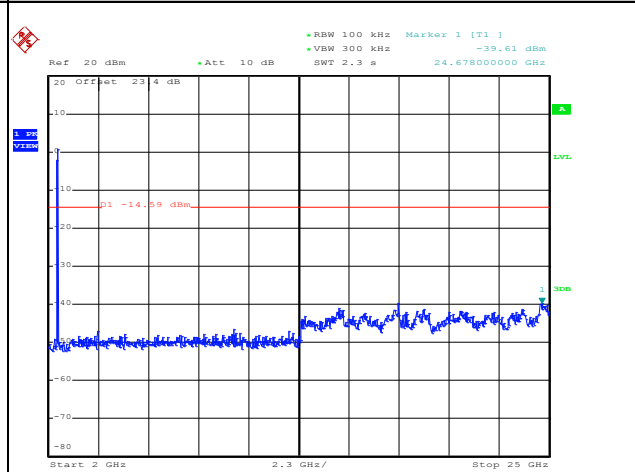

Date: 1.JUL.2016 11:10:12



Number of TX :	2	Ant. :	2
Test Mode :	802.11n HT20	Temperature :	21~25°C
Test Band :	2.4GHz Mid	Relative Humidity :	51~54%
Test Channel :	06	Test Engineer :	AC Chang

WLAN 802.11n HT20 Channel 06

100kHz PSD reference Level

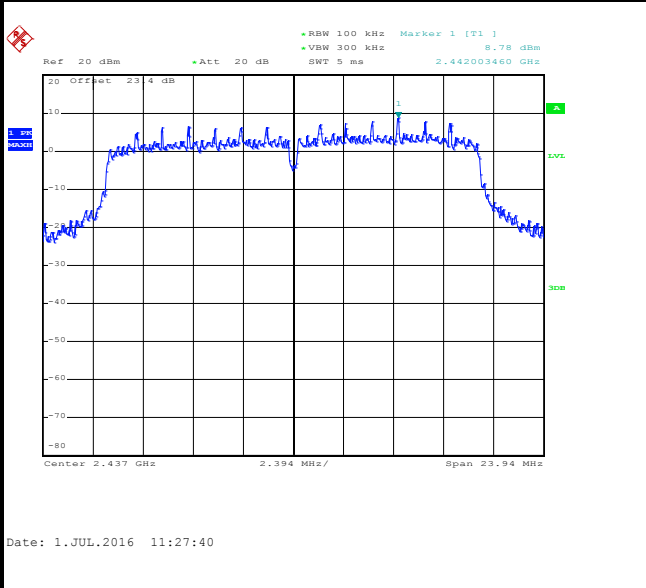

Spurious Emission 30MHz~3GHz

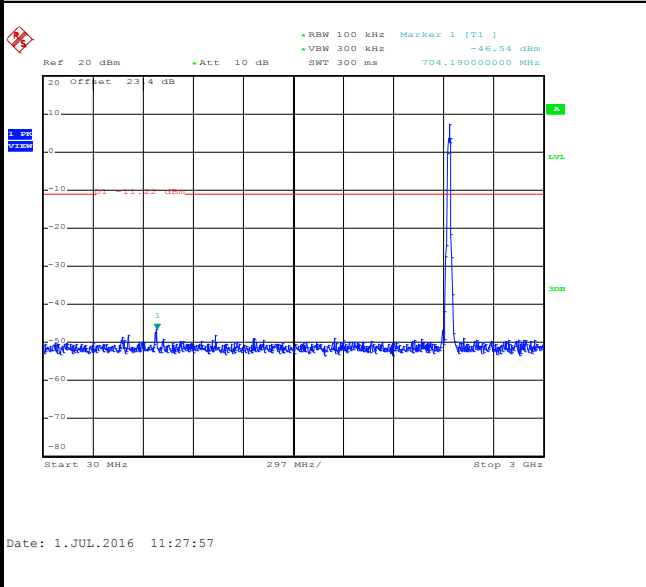

Spurious Emission 2GHz~25GHz

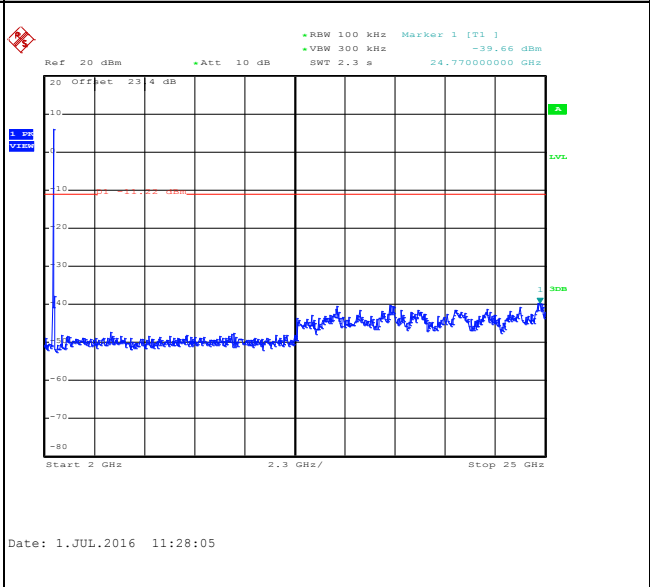



Number of TX :	2	Ant. :	2
Test Mode :	802.11n HT20	Temperature :	21~25°C
Test Band :	2.4GHz High	Relative Humidity :	51~54%
Test Channel :	11	Test Engineer :	AC Chang

WLAN 802.11n HT20 Channel 11

100kHz PSD reference Level

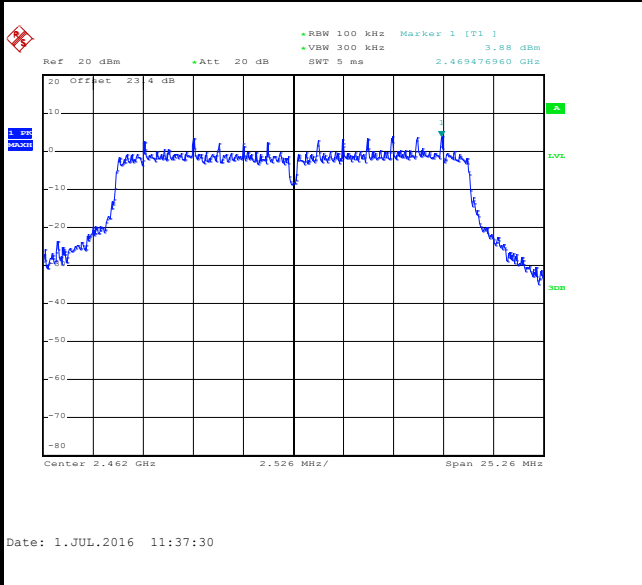

High Channel Plot

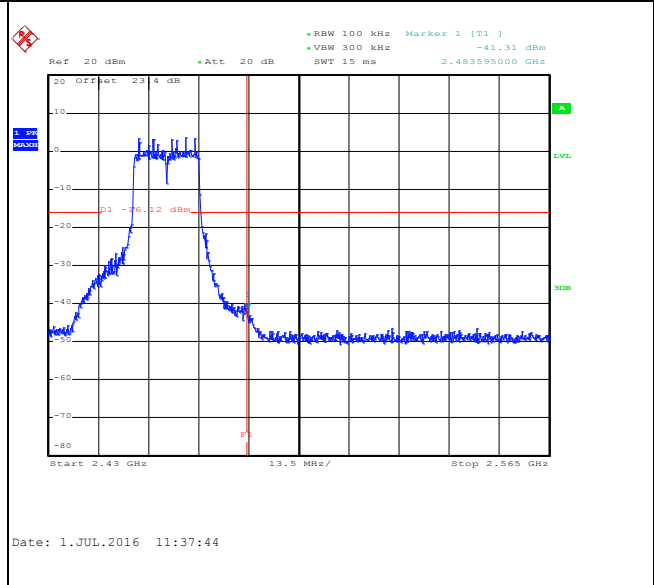

Spurious Emission 30MHz~3GHz

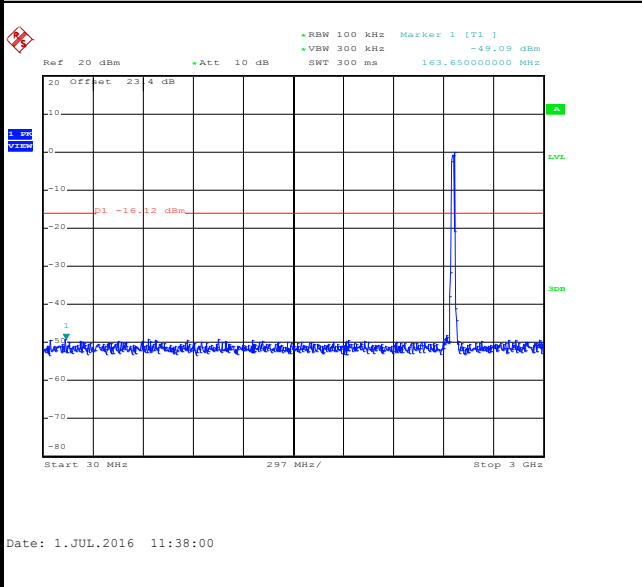

Spurious Emission 2GHz~25GHz

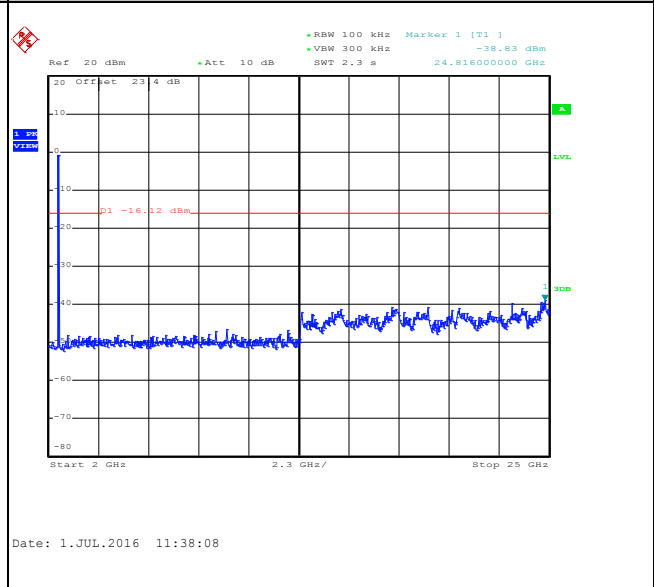



Number of TX :	2	Ant. :	2
Test Mode :	802.11n HT40	Temperature :	21~25°C
Test Band :	2.4GHz Low	Relative Humidity :	51~54%
Test Channel :	03	Test Engineer :	AC Chang

WLAN 802.11n HT40 Channel 03

100kHz PSD reference Level

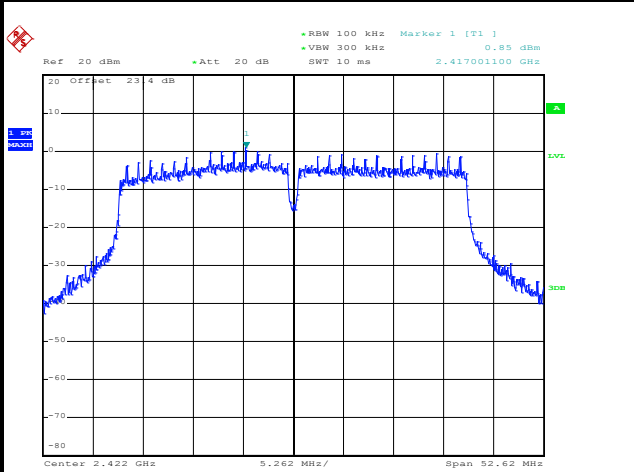

Date: 1.JUL.2016 11:44:56

Low Channel Plot

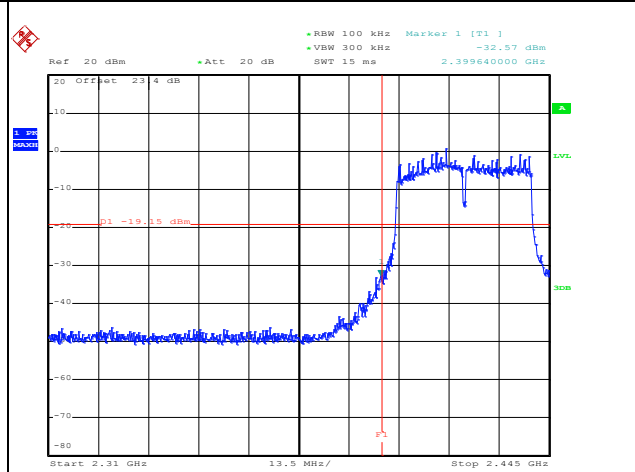

Date: 1.JUL.2016 11:45:08

Spurious Emission 30MHz~3GHz

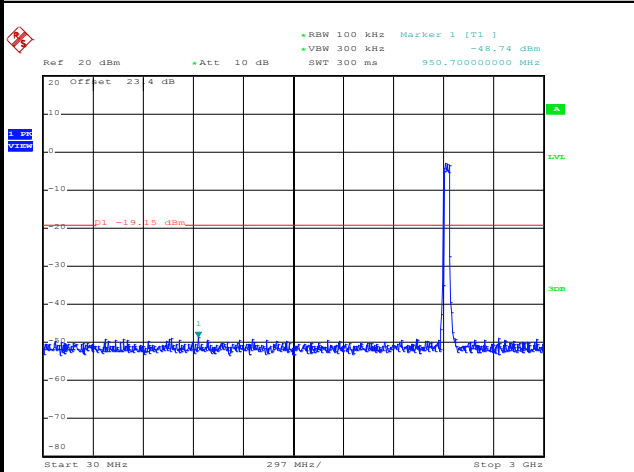

Date: 1.JUL.2016 11:45:20

Spurious Emission 2GHz~25GHz

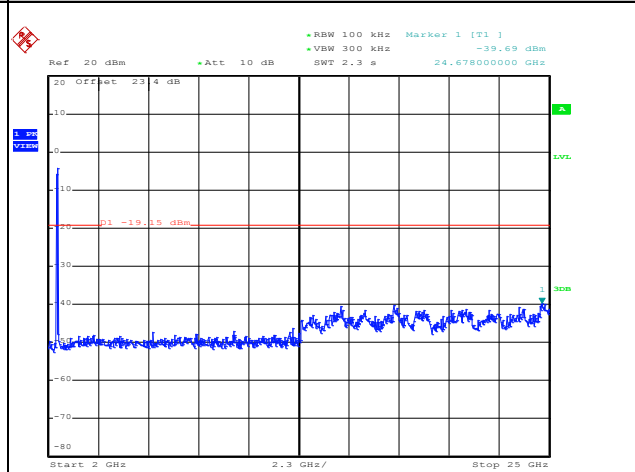

Date: 1.JUL.2016 11:45:29



Number of TX :	2	Ant. :	2
Test Mode :	802.11n HT40	Temperature :	21~25°C
Test Band :	2.4GHz Mid	Relative Humidity :	51~54%
Test Channel :	06	Test Engineer :	AC Chang

WLAN 802.11n HT40 Channel 06

100kHz PSD reference Level

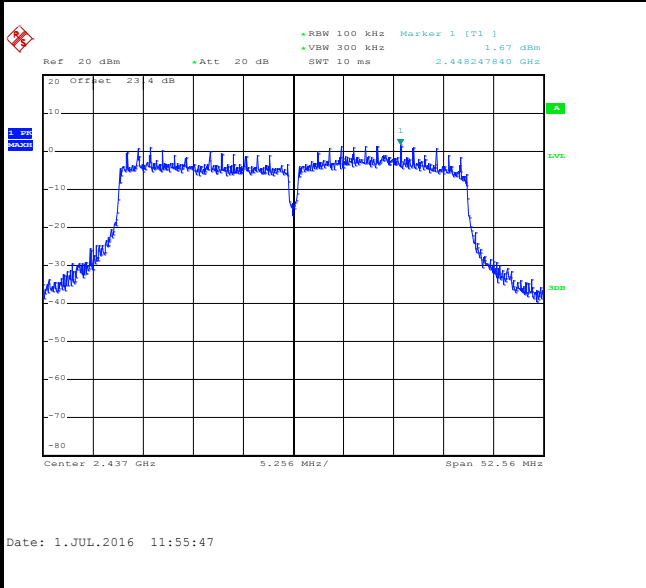

Spurious Emission 30MHz~3GHz

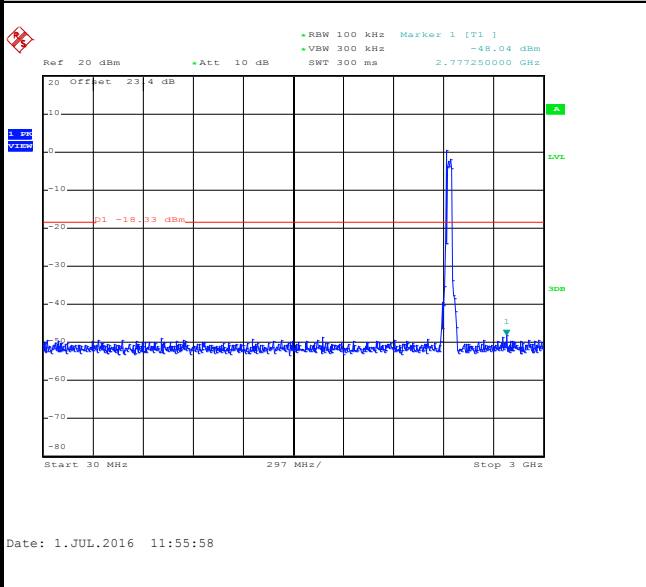

Spurious Emission 2GHz~25GHz

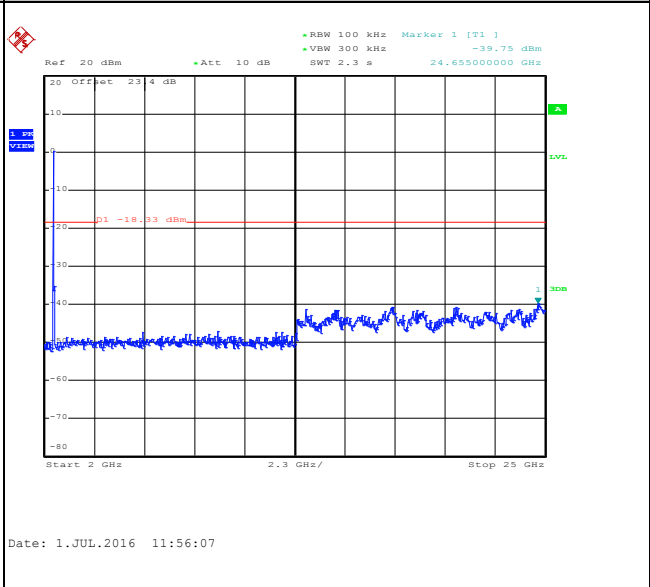



Number of TX :	2	Ant. :	2
Test Mode :	802.11n HT40	Temperature :	21~25°C
Test Band :	2.4GHz High	Relative Humidity :	51~54%
Test Channel :	09	Test Engineer :	AC Chang

WLAN 802.11n HT40 Channel 09

100kHz PSD reference Level

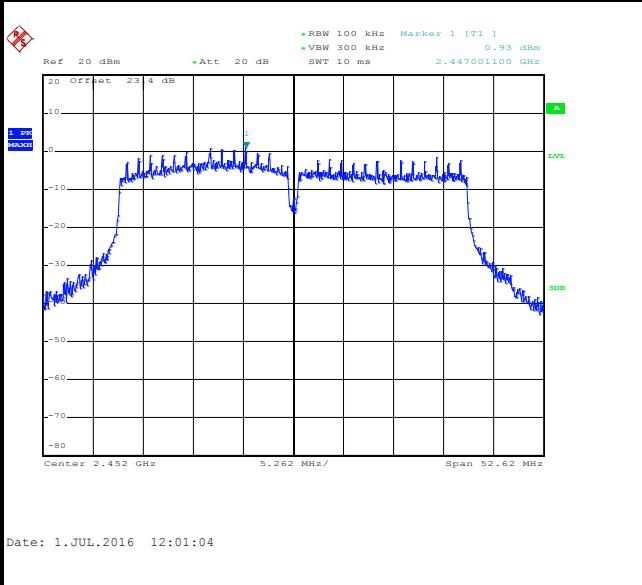

High Channel Plot

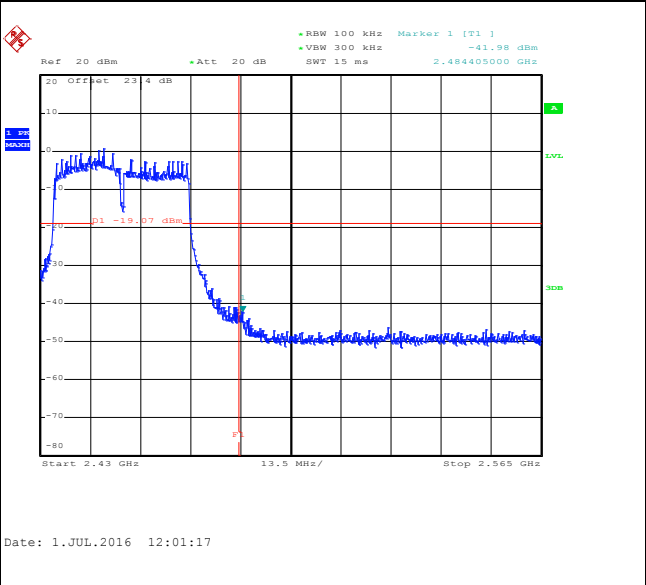

Spurious Emission 30MHz~3GHz

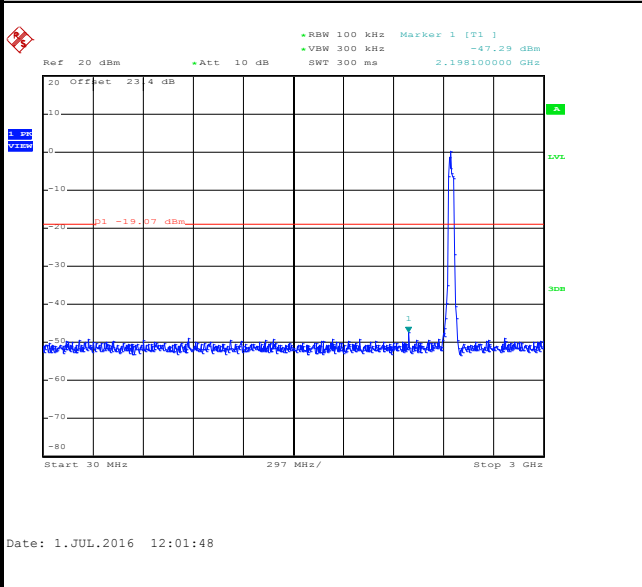

Spurious Emission 2GHz~25GHz

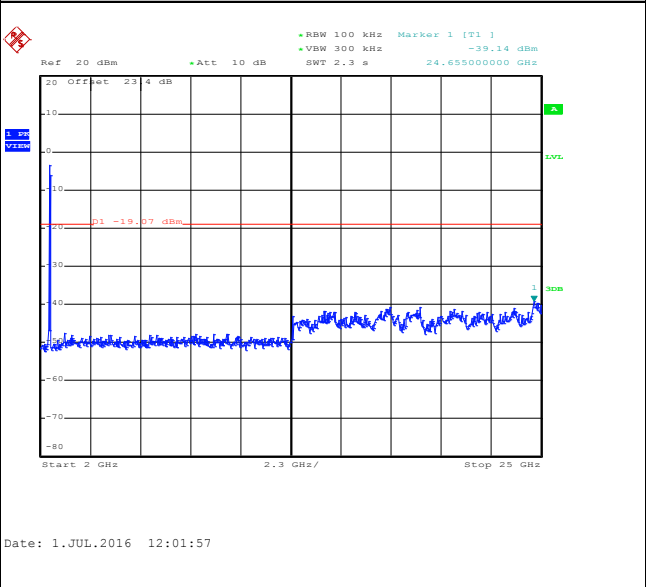



3.5 Radiated Band Edges and Spurious Emission Measurement

3.5.1 Limit of Radiated band edge and Spurious Emission Measurement

In any 100 kHz bandwidth outside the intentional radiator frequency band, all harmonics/spurious must be at least 20 dB below the highest emission level within the authorized band. If the output power of this device was measured by spectrum analyzer, the attenuation under this paragraph shall be 30 dB instead of 20 dB. In addition, radiated emissions which fall in the restricted bands must also comply with the FCC section 15.209 limits as below.

Frequency (MHz)	Field Strength (microvolts/meter)	Measurement Distance (meters)
0.009 – 0.490	2400/F(kHz)	300
0.490 – 1.705	24000/F(kHz)	30
1.705 – 30.0	30	30
30 – 88	100	3
88 – 216	150	3
216 - 960	200	3
Above 960	500	3

3.5.2 Measuring Instruments

The measuring equipment is listed in the section 4 of this test report.



3.5.3 Test Procedure

1. The testing follows FCC KDB Publication No. 558074 D01 DTS Meas. Guidance v03r05.
2. The EUT was arranged to its worst case and then tune the antenna tower (from 1 m to 4 m) and turntable (from 0 degree to 360 degrees) to find the maximum reading. A pre-amp and a high pass filter are used for the test in order to get better signal level.
3. The EUT was placed on a turntable with 0.8 meter for frequency below 1GHz and 1.5 meter for frequency above 1GHz respectively above ground.
4. The EUT was set 3 meters from the interference receiving antenna, which was mounted on the top of a variable height antenna tower.
5. Corrected Reading: Antenna Factor + Cable Loss + Read Level - Preamp Factor = Level
6. For measurement below 1GHz, If the emission level of the EUT measured by the peak detector is 3 dB lower than the applicable limit, the peak emission level will be reported. Otherwise, the emission measurement will be repeated using the quasi-peak detector and reported.
7. Use the following spectrum analyzer settings:
 - (1) Span shall wide enough to fully capture the emission being measured;
 - (2) Set RBW=100 kHz for $f < 1$ GHz; VBW \geq RBW; Sweep = auto; Detector function = peak; Trace = max hold;
 - (3) Set RBW = 1 MHz, VBW= 3MHz for $f \geq 1$ GHz for peak measurement.
For average measurement:
 - VBW = 10 Hz, when duty cycle is no less than 98 percent.
 - VBW $\geq 1/T$, when duty cycle is less than 98 percent where T is the minimum transmission duration over which the transmitter is on and is transmitting at its maximum power control level for the tested mode of operation.

3.5.4 Test Setup

For radiated emissions below 30MHz



For radiated emissions from 30MHz to 1GHz

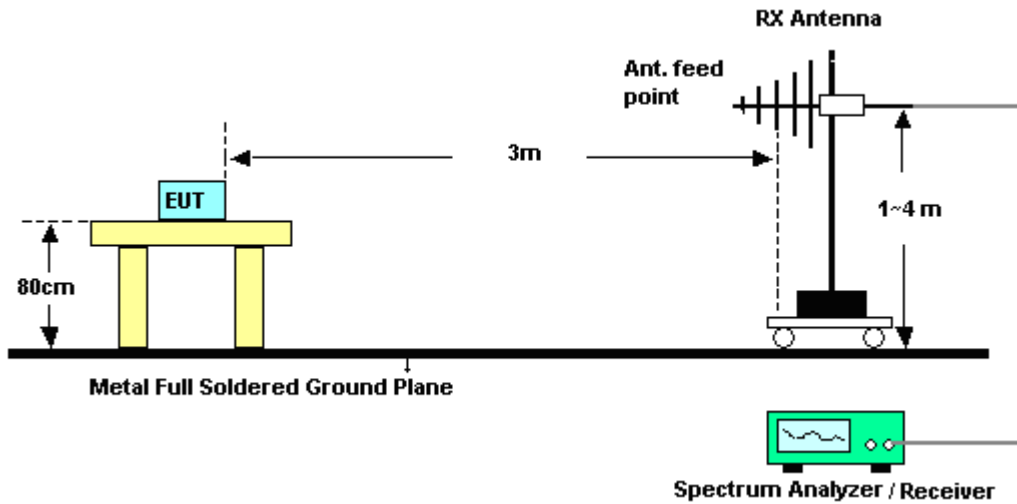

For radiated emissions above 1GHz

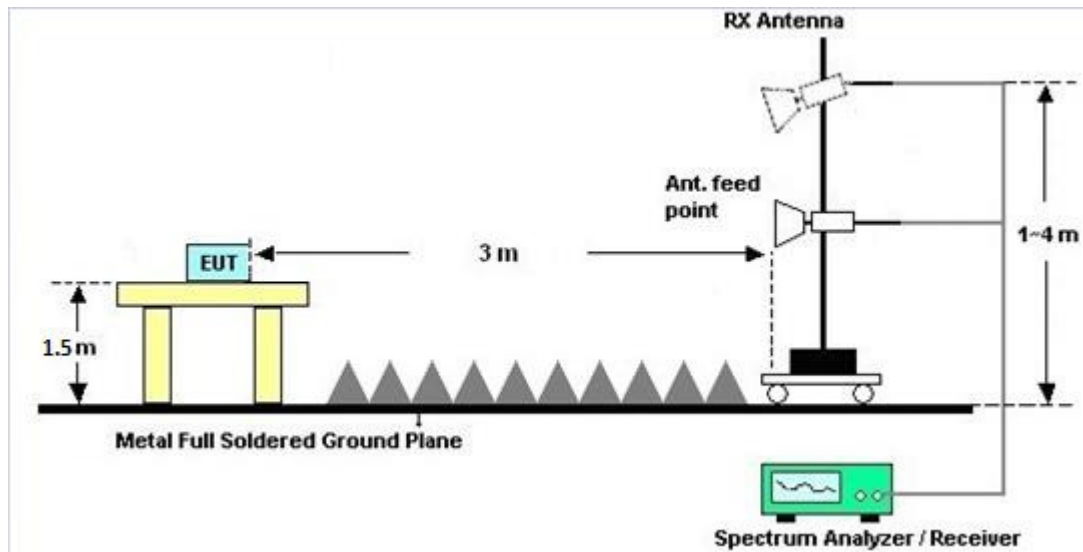

3.5.5 Test Results of Radiated Emissions (9kHz ~ 30MHz)

The low frequency, which started from 9 kHz to 30MHz, was pre-scanned and the result which was 20dB lower than the limit line per 15.31(o) was not reported.

3.5.6 Test Result of Radiated Spurious at Band Edges

Please refer to Appendix B and C of this test report.

3.5.7 Duty Cycle

Please refer to Appendix D.

3.5.8 Test Result of Radiated Spurious Emission (30MHz ~ 10th Harmonic)

Please refer to Appendix B and C.



3.6 AC Conducted Emission Measurement

3.6.1 Limit of AC Conducted Emission

For equipment that is designed to be connected to the public utility (AC) power line, the radio frequency voltage that is conducted back onto the AC power line on any frequency or frequencies within the band 150 kHz to 30 MHz shall not exceed the limits in the following table.

Frequency of Emission (MHz)	Conducted Limit (dBµV)	
	Quasi-Peak	Average
0.15-0.5	66 to 56*	56 to 46*
0.5-5	56	46
5-30	60	50

*Decreases with the logarithm of the frequency.

For terminal test result, the testing follows FCC KDB 174176.

3.6.2 Measuring Instruments

The measuring equipment is listed in the section 4 of this test report.

3.6.3 Test Procedures

1. The EUT was placed 0.4 meter from the conducting wall of the shielding room, and it was kept at least 80 centimeters from any other grounded conducting surface.
2. Connect EUT to the power mains through a line impedance stabilization network (LISN).
3. All the support units are connecting to the other LISN.
4. The LISN provides 50 ohm coupling impedance for the measuring instrument.
5. The FCC states that a 50 ohm, 50 microhenry LISN should be used.
6. Both sides of AC line were checked for maximum conducted interference.
7. The frequency range from 150 kHz to 30 MHz was searched.
8. Set the test-receiver system to Peak Detect Function and specified bandwidth (IF bandwidth = 9kHz) with Maximum Hold Mode.

3.6.4 Test Setup

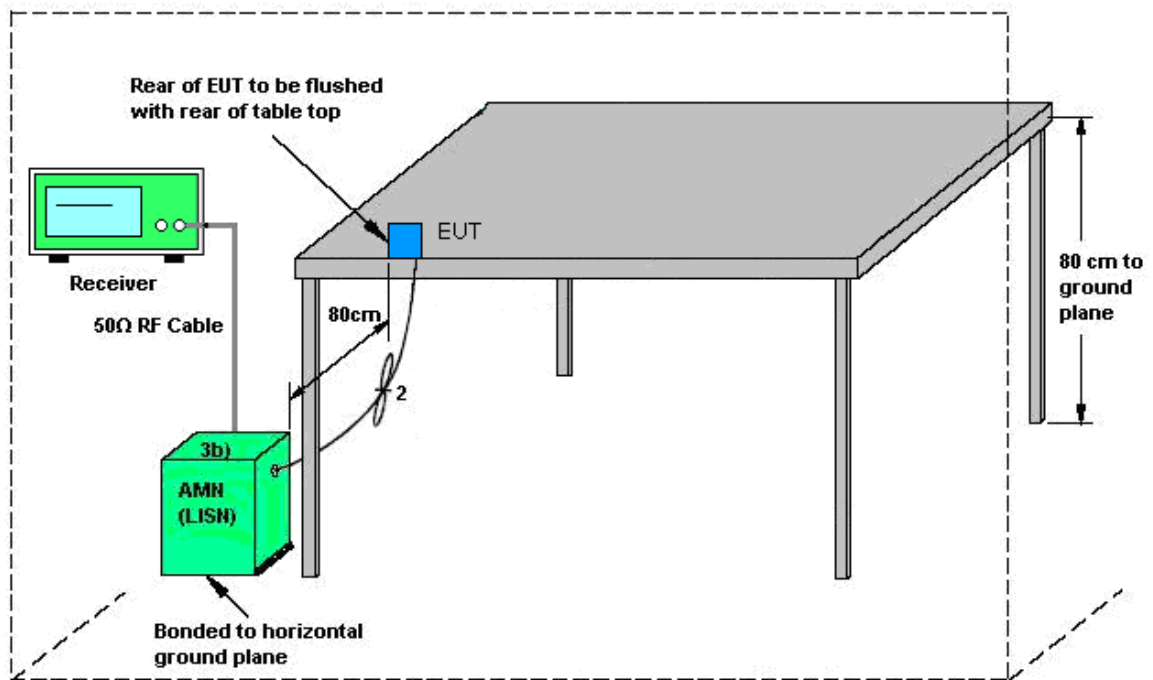

AMN = Artificial mains network (LISN)
AE = Associated equipment
EUT = Equipment under test
ISN = Impedance stabilization network



3.6.5 Test Result of AC Conducted Emission

<Original Test Result>

Test Mode :	Mode 1	Temperature :	23~24°C
Test Engineer :	Arthur Hsieh	Relative Humidity :	51~52%
Test Voltage :	120Vac / 60Hz	Phase :	Line
Function Type :	WLAN (2.4GHz) Link + Bluetooth Link + NFC Link + Earphone 1 with Audio Adapter connect to EUT + Charging Only Cable + Adapter		

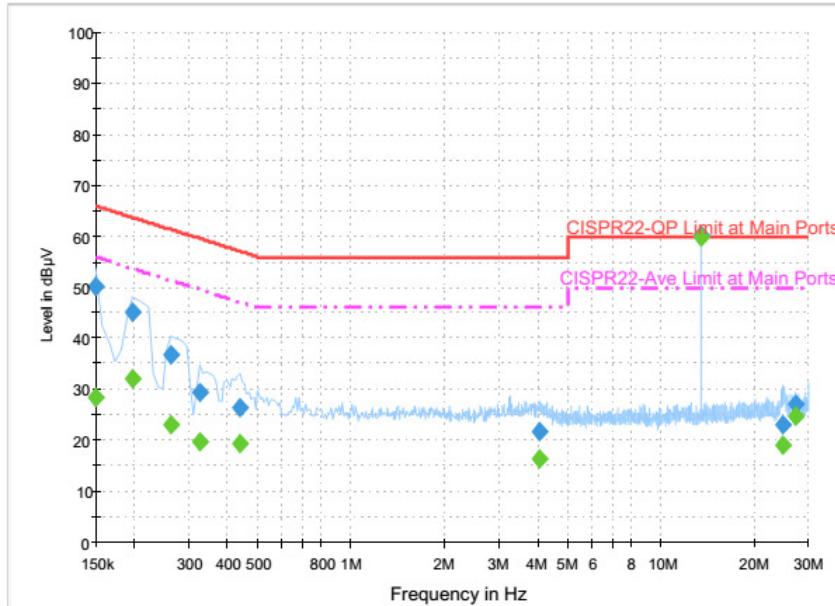

Final Result : Quasi-Peak

Frequency (MHz)	Quasi-Peak (dBµV)	Filter	Line	Corr. (dB)	Margin (dB)	Limit (dBµV)
0.150000	50.1	Off	L1	19.6	15.9	66.0
0.198000	45.1	Off	L1	19.6	18.6	63.7
0.262000	36.7	Off	L1	19.6	24.7	61.4
0.326000	29.4	Off	L1	19.6	30.2	59.6
0.438000	26.6	Off	L1	19.6	30.5	57.1
4.054000	21.7	Off	L1	19.7	34.3	56.0
13.558000	60.3	Off	L1	19.8	-0.3	60.0
24.942000	23.0	Off	L1	19.9	37.0	60.0
27.118000	27.3	Off	L1	19.9	32.7	60.0

Final Result : Average

Frequency (MHz)	Average (dBµV)	Filter	Line	Corr. (dB)	Margin (dB)	Limit (dBµV)
0.150000	28.4	Off	L1	19.6	27.6	56.0
0.198000	32.2	Off	L1	19.6	21.5	53.7
0.262000	23.0	Off	L1	19.6	28.4	51.4
0.326000	19.8	Off	L1	19.6	29.8	49.6
0.438000	19.2	Off	L1	19.6	27.9	47.1
4.054000	16.4	Off	L1	19.7	29.6	46.0
13.558000	60.0	Off	L1	19.8	-10.0	50.0
24.942000	18.9	Off	L1	19.9	31.1	50.0
27.118000	24.7	Off	L1	19.9	25.3	50.0



Test Mode :	Mode 1	Temperature :	23~24°C
Test Engineer :	Arthur Hsieh	Relative Humidity :	51~52%
Test Voltage :	120Vac / 60Hz	Phase :	Neutral
Function Type :	WLAN (2.4GHz) Link + Bluetooth Link + NFC Link + Earphone 1 with Audio Adapter connect to EUT + Charging Only Cable + Adapter		

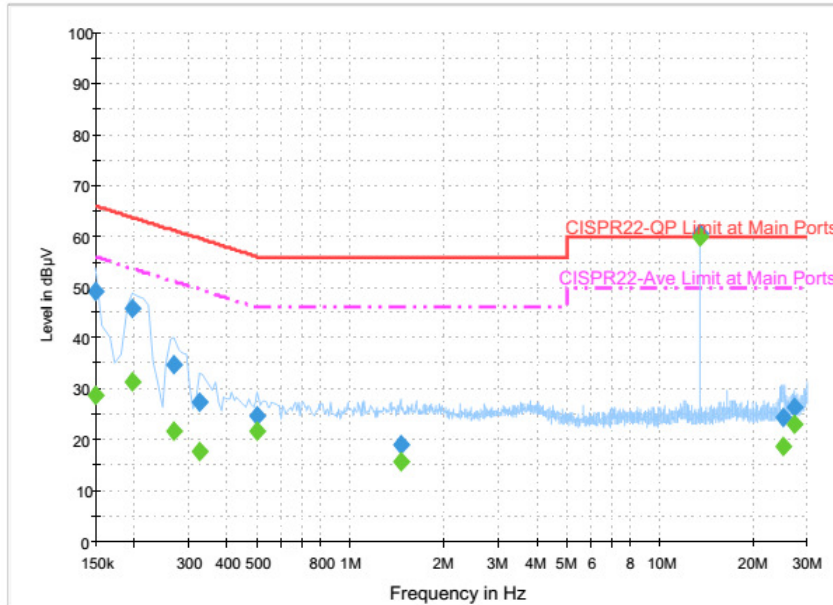

Final Result : Quasi-Peak

Frequency (MHz)	Quasi-Peak (dBµV)	Filter	Line	Corr. (dB)	Margin (dB)	Limit (dBµV)
0.150000	49.1	Off	N	19.6	16.9	66.0
0.198000	45.8	Off	N	19.6	17.9	63.7
0.270000	34.7	Off	N	19.6	26.4	61.1
0.326000	27.4	Off	N	19.6	32.2	59.6
0.502000	24.6	Off	N	19.6	31.4	56.0
1.454000	18.9	Off	N	19.6	37.1	56.0
13.558000	60.5	Off	N	19.8	-0.5	60.0
25.078000	24.4	Off	N	20.0	35.6	60.0
27.118000	26.6	Off	N	20.1	33.4	60.0

Final Result : Average

Frequency (MHz)	Average (dBµV)	Filter	Line	Corr. (dB)	Margin (dB)	Limit (dBµV)
0.150000	28.6	Off	N	19.6	27.4	56.0
0.198000	31.3	Off	N	19.6	22.4	53.7
0.270000	21.8	Off	N	19.6	29.3	51.1
0.326000	17.6	Off	N	19.6	32.0	49.6
0.502000	21.7	Off	N	19.6	24.3	46.0
1.454000	15.8	Off	N	19.6	30.2	46.0
13.558000	59.8	Off	N	19.8	-9.8	50.0
25.078000	18.6	Off	N	20.0	31.4	50.0
27.118000	23.2	Off	N	20.1	26.8	50.0



<Terminal Test Result>

Test Mode :	Mode 1	Temperature :	23~24°C
Test Engineer :	Arthur Hsieh	Relative Humidity :	51~52%
Test Voltage :	120Vac / 60Hz	Phase :	Line
Function Type :	WLAN (2.4GHz) Link + Bluetooth Link + NFC Link + Earphone 1 with Audio Adapter connect to EUT + Charging Only Cable + Adapter		

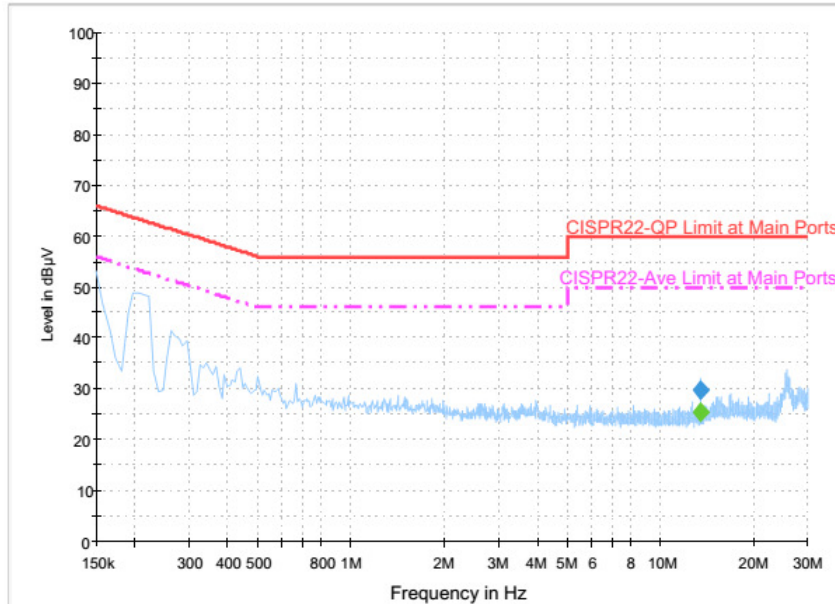

Final Result : Quasi-Peak

Frequency (MHz)	Quasi-Peak (dBµV)	Filter	Line	Corr. (dB)	Margin (dB)	Limit (dBµV)
13.558000	29.8	Off	L1	19.8	30.2	60.0

Final Result : Average

Frequency (MHz)	Average (dBµV)	Filter	Line	Corr. (dB)	Margin (dB)	Limit (dBµV)
13.558000	25.5	Off	L1	19.8	24.5	50.0



Test Mode :	Mode 1	Temperature :	23~24°C
Test Engineer :	Arthur Hsieh	Relative Humidity :	51~52%
Test Voltage :	120Vac / 60Hz	Phase :	Neutral
Function Type :	WLAN (2.4GHz) Link + Bluetooth Link + NFC Link + Earphone 1 with Audio Adapter connect to EUT + Charging Only Cable + Adapter		

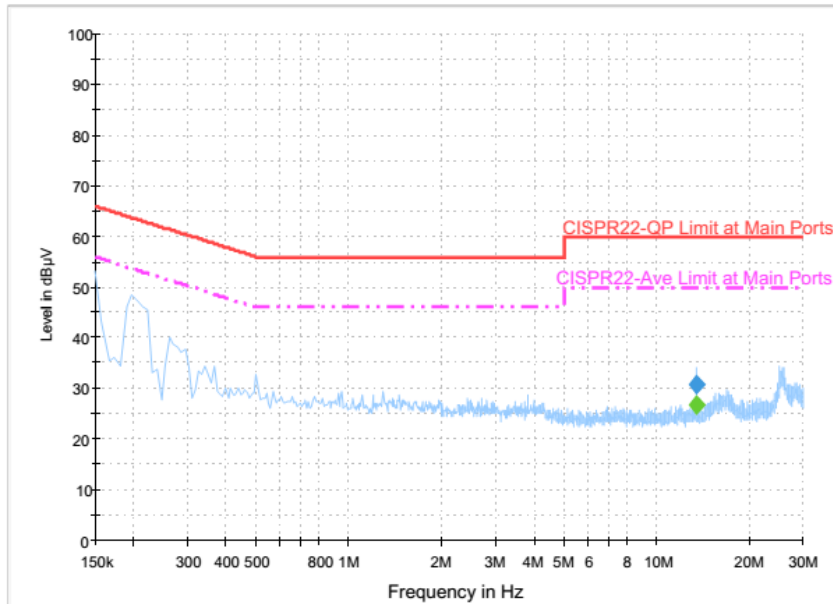

Final Result : Quasi-Peak

Frequency (MHz)	Quasi-Peak (dBµV)	Filter	Line	Corr. (dB)	Margin (dB)	Limit (dBµV)
13.558000	30.9	Off	N	19.8	29.1	60.0

Final Result : Average

Frequency (MHz)	Average (dBµV)	Filter	Line	Corr. (dB)	Margin (dB)	Limit (dBµV)
13.558000	26.9	Off	N	19.8	23.1	50.0



<Original Test Result>

Test Mode :	Mode 2	Temperature :	23~24°C
Test Engineer :	Arthur Hsieh	Relative Humidity :	51~52%
Test Voltage :	120Vac / 60Hz	Phase :	Line
Function Type :	WLAN (2.4GHz) Link + Bluetooth Link + NFC Link + Snap on USB Cable Data link with Notebook + Copy Data from EDA (eMMC) to Notebook + Adapter		

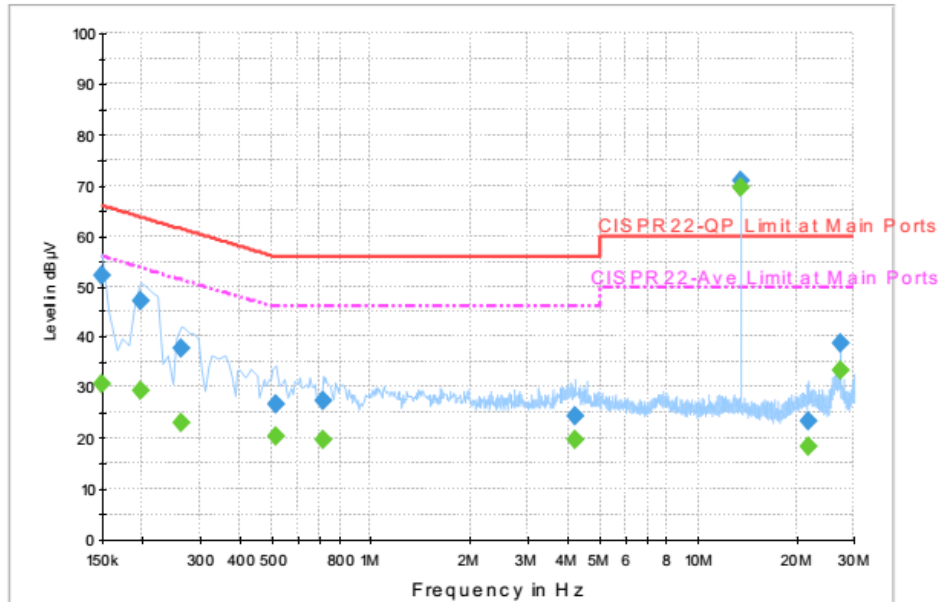

Final Result : Quasi-Peak

Frequency (MHz)	Quasi-Peak (dBµV)	Filter	Line	Corr. (dB)	Margin (dB)	Limit (dBµV)
0.150000	52.3	Off	L1	19.6	13.7	66.0
0.198000	47.0	Off	L1	19.6	16.7	63.7
0.262000	37.8	Off	L1	19.6	23.6	61.4
0.510000	26.6	Off	L1	19.6	29.4	56.0
0.710000	27.4	Off	L1	19.6	28.6	56.0
4.198000	24.3	Off	L1	19.7	31.7	56.0
13.558000	71.0	Off	L1	19.8	-11.0	60.0
21.718000	23.4	Off	L1	19.8	36.6	60.0
27.118000	38.8	Off	L1	19.9	21.2	60.0

Final Result : Average

Frequency (MHz)	Average (dBµV)	Filter	Line	Corr. (dB)	Margin (dB)	Limit (dBµV)
0.150000	30.6	Off	L1	19.6	25.4	56.0
0.198000	29.4	Off	L1	19.6	24.3	53.7
0.262000	23.1	Off	L1	19.6	28.3	51.4
0.510000	20.4	Off	L1	19.6	25.6	46.0
0.710000	19.6	Off	L1	19.6	26.4	46.0
4.198000	19.7	Off	L1	19.7	26.3	46.0
13.558000	69.5	Off	L1	19.8	-19.5	50.0
21.718000	18.4	Off	L1	19.8	31.6	50.0
27.118000	33.6	Off	L1	19.9	16.4	50.0



Test Mode :	Mode 2	Temperature :	23~24°C
Test Engineer :	Arthur Hsieh	Relative Humidity :	51~52%
Test Voltage :	120Vac / 60Hz	Phase :	Neutral
Function Type :	WLAN (2.4GHz) Link + Bluetooth Link + NFC Link + Snap on USB Cable Data link with Notebook + Copy Data from EDA (eMMC) to Notebook + Adapter		

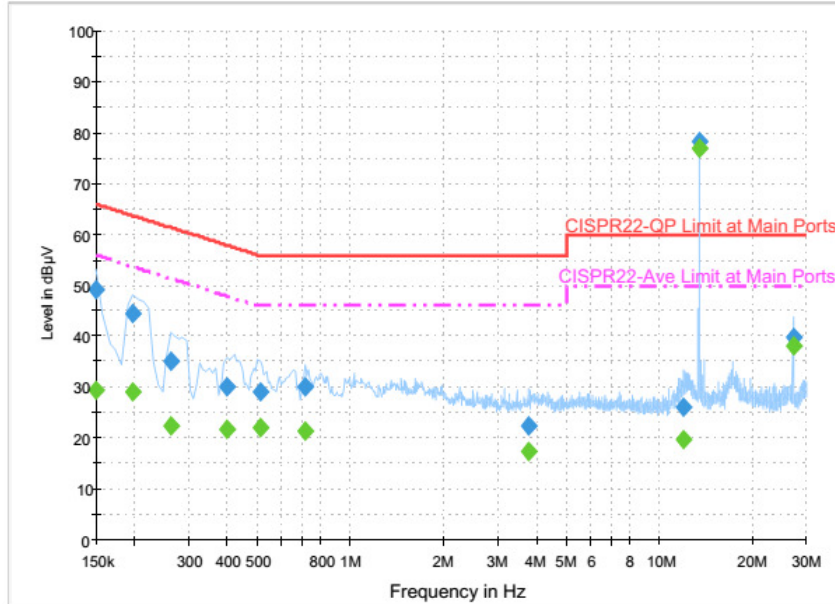

Final Result : Quasi-Peak

Frequency (MHz)	Quasi-Peak (dBµV)	Filter	Line	Corr. (dB)	Margin (dB)	Limit (dBµV)
0.150000	49.0	Off	N	19.6	17.0	66.0
0.198000	44.5	Off	N	19.6	19.2	63.7
0.262000	35.3	Off	N	19.6	26.1	61.4
0.398000	29.9	Off	N	19.6	28.0	57.9
0.510000	29.3	Off	N	19.6	26.7	56.0
0.710000	30.1	Off	N	19.6	25.9	56.0
3.790000	22.4	Off	N	19.6	33.6	56.0
11.966000	26.2	Off	N	19.8	33.8	60.0
13.558000	78.1	Off	N	19.8	-18.1	60.0
27.118000	39.9	Off	N	20.1	20.1	60.0

Final Result : Average

Frequency (MHz)	Average (dBµV)	Filter	Line	Corr. (dB)	Margin (dB)	Limit (dBµV)
0.150000	29.3	Off	N	19.6	26.7	56.0
0.198000	29.2	Off	N	19.6	24.5	53.7
0.262000	22.6	Off	N	19.6	28.8	51.4
0.398000	21.9	Off	N	19.6	26.0	47.9
0.510000	22.1	Off	N	19.6	23.9	46.0
0.710000	21.6	Off	N	19.6	24.4	46.0
3.790000	17.5	Off	N	19.6	28.5	46.0
11.966000	19.8	Off	N	19.8	30.2	50.0
13.558000	77.0	Off	N	19.8	-27.0	50.0
27.118000	38.0	Off	N	20.1	12.0	50.0



<Terminal Test Result>

Test Mode :	Mode 2	Temperature :	23~24°C
Test Engineer :	Arthur Hsieh	Relative Humidity :	51~52%
Test Voltage :	120Vac / 60Hz	Phase :	Line
Function Type :	WLAN (2.4GHz) Link + Bluetooth Link + NFC Link + Snap on USB Cable Data link with Notebook + Copy Data from EDA (eMMC) to Notebook + Adapter		

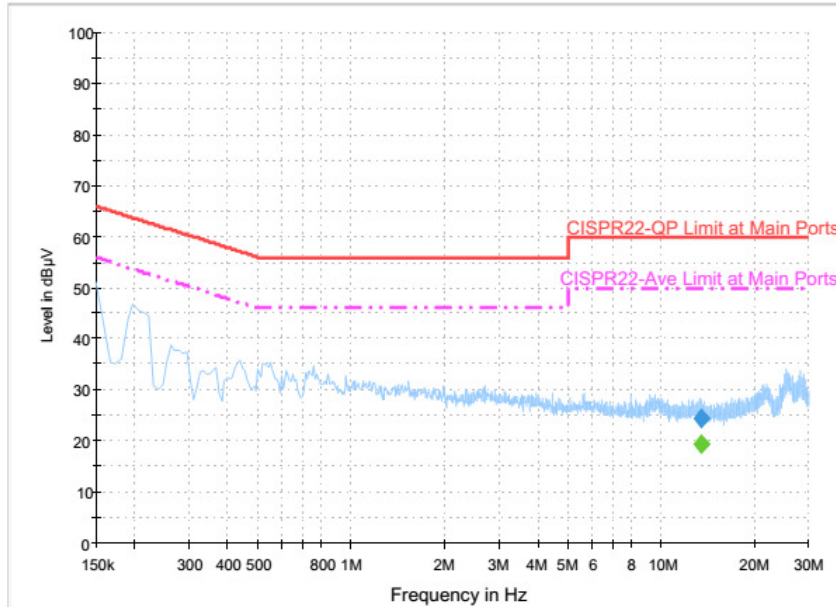

Final Result : Quasi-Peak

Frequency (MHz)	Quasi-Peak (dBµV)	Filter	Line	Corr. (dB)	Margin (dB)	Limit (dBµV)
13.558000	24.3	Off	L1	19.8	35.7	60.0

Final Result : Average

Frequency (MHz)	Average (dBµV)	Filter	Line	Corr. (dB)	Margin (dB)	Limit (dBµV)
13.558000	19.4	Off	L1	19.8	30.6	50.0



Test Mode :	Mode 2	Temperature :	23~24°C
Test Engineer :	Arthur Hsieh	Relative Humidity :	51~52%
Test Voltage :	120Vac / 60Hz	Phase :	Neutral
Function Type :	WLAN (2.4GHz) Link + Bluetooth Link + NFC Link + Snap on USB Cable Data link with Notebook + Copy Data from EDA (eMMC) to Notebook + Adapter		

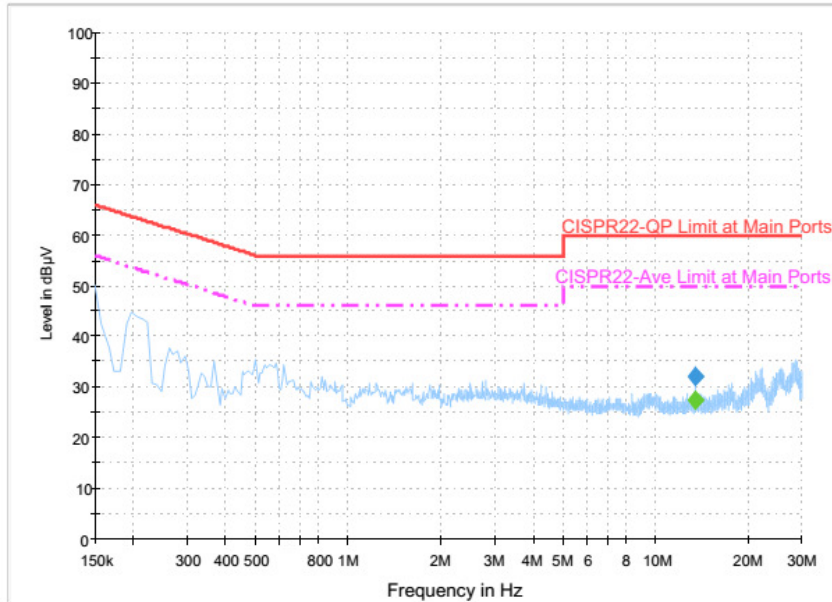

Final Result : Quasi-Peak

Frequency (MHz)	Quasi-Peak (dBµV)	Filter	Line	Corr. (dB)	Margin (dB)	Limit (dBµV)
13.558000	32.2	Off	N	19.8	27.8	60.0

Final Result : Average

Frequency (MHz)	Average (dBµV)	Filter	Line	Corr. (dB)	Margin (dB)	Limit (dBµV)
13.558000	27.4	Off	N	19.8	22.6	50.0



<Original Test Result>

Test Mode :	Mode 3	Temperature :	23~24°C
Test Engineer :	Arthur Hsieh	Relative Humidity :	51~52%
Test Voltage :	120Vac / 60Hz	Phase :	Line
Function Type :	WLAN (2.4GHz) Link + Bluetooth Link + NFC Link + Earphone 2 with Audio Adapter connect to EUT + Charging Only Cable + Adapter		

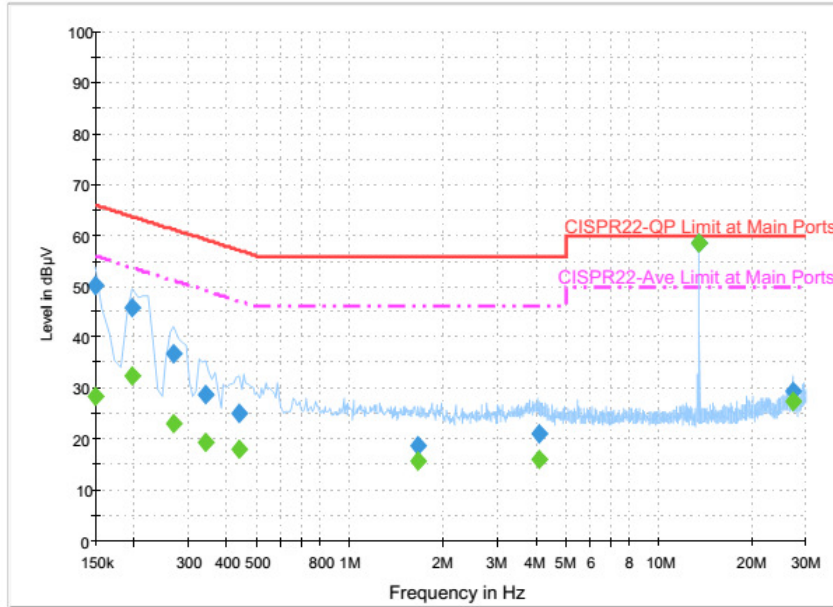

Final Result : Quasi-Peak

Frequency (MHz)	Quasi-Peak (dBµV)	Filter	Line	Corr. (dB)	Margin (dB)	Limit (dBµV)
0.150000	50.1	Off	L1	19.6	15.9	66.0
0.198000	46.0	Off	L1	19.6	17.7	63.7
0.270000	36.8	Off	L1	19.6	24.3	61.1
0.342000	28.9	Off	L1	19.6	30.3	59.2
0.438000	25.2	Off	L1	19.6	31.9	57.1
1.670000	18.9	Off	L1	19.6	37.1	56.0
4.102000	20.9	Off	L1	19.7	35.1	56.0
13.558000	58.6	Off	L1	19.8	1.4	60.0
27.118000	29.5	Off	L1	19.9	30.5	60.0

Final Result : Average

Frequency (MHz)	Average (dBµV)	Filter	Line	Corr. (dB)	Margin (dB)	Limit (dBµV)
0.150000	28.3	Off	L1	19.6	27.7	56.0
0.198000	32.6	Off	L1	19.6	21.1	53.7
0.270000	23.1	Off	L1	19.6	28.0	51.1
0.342000	19.4	Off	L1	19.6	29.8	49.2
0.438000	18.1	Off	L1	19.6	29.0	47.1
1.670000	15.7	Off	L1	19.6	30.3	46.0
4.102000	16.2	Off	L1	19.7	29.8	46.0
13.558000	58.4	Off	L1	19.8	-8.4	50.0
27.118000	27.4	Off	L1	19.9	22.6	50.0



Test Mode :	Mode 3	Temperature :	23~24°C
Test Engineer :	Arthur Hsieh	Relative Humidity :	51~52%
Test Voltage :	120Vac / 60Hz	Phase :	Neutral
Function Type :	WLAN (2.4GHz) Link + Bluetooth Link + NFC Link + Earphone 2 with Audio Adapter connect to EUT + Charging Only Cable + Adapter		

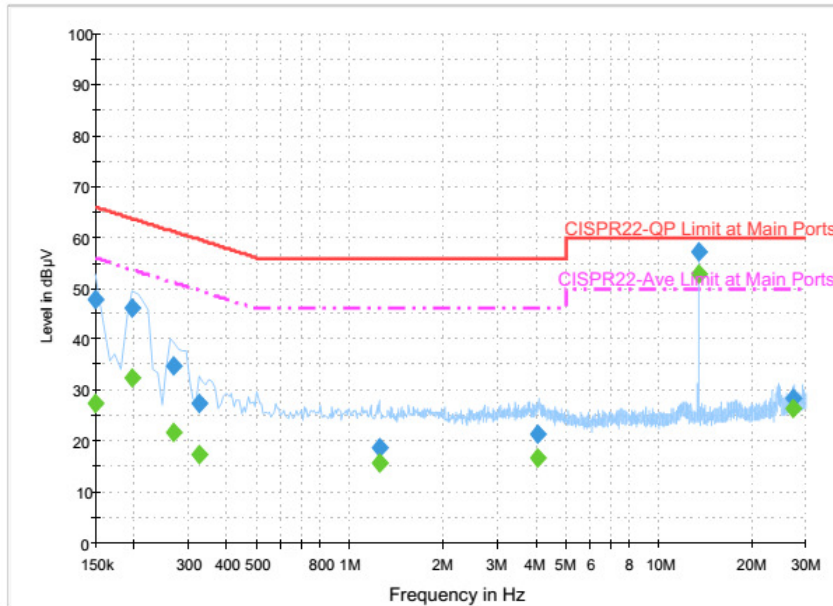

Final Result : Quasi-Peak

Frequency (MHz)	Quasi-Peak (dBµV)	Filter	Line	Corr. (dB)	Margin (dB)	Limit (dBµV)
0.150000	47.9	Off	N	19.6	18.1	66.0
0.198000	46.1	Off	N	19.6	17.6	63.7
0.270000	34.9	Off	N	19.6	26.2	61.1
0.326000	27.5	Off	N	19.6	32.1	59.6
1.246000	18.6	Off	N	19.6	37.4	56.0
4.062000	21.4	Off	N	19.6	34.6	56.0
13.558000	57.2	Off	N	19.8	2.8	60.0
27.118000	28.5	Off	N	20.1	31.5	60.0

Final Result : Average

Frequency (MHz)	Average (dBµV)	Filter	Line	Corr. (dB)	Margin (dB)	Limit (dBµV)
0.150000	27.5	Off	N	19.6	28.5	56.0
0.198000	32.5	Off	N	19.6	21.2	53.7
0.270000	21.8	Off	N	19.6	29.3	51.1
0.326000	17.5	Off	N	19.6	32.1	49.6
1.246000	15.7	Off	N	19.6	30.3	46.0
4.062000	16.8	Off	N	19.6	29.2	46.0
13.558000	53.0	Off	N	19.8	-3.0	50.0
27.118000	26.3	Off	N	20.1	23.7	50.0



<Terminal Test Result>

Test Mode :	Mode 3	Temperature :	23~24°C
Test Engineer :	Arthur Hsieh	Relative Humidity :	51~52%
Test Voltage :	120Vac / 60Hz	Phase :	Line
Function Type :	WLAN (2.4GHz) Link + Bluetooth Link + NFC Link + Earphone 2 with Audio Adapter connect to EUT + Charging Only Cable + Adapter		

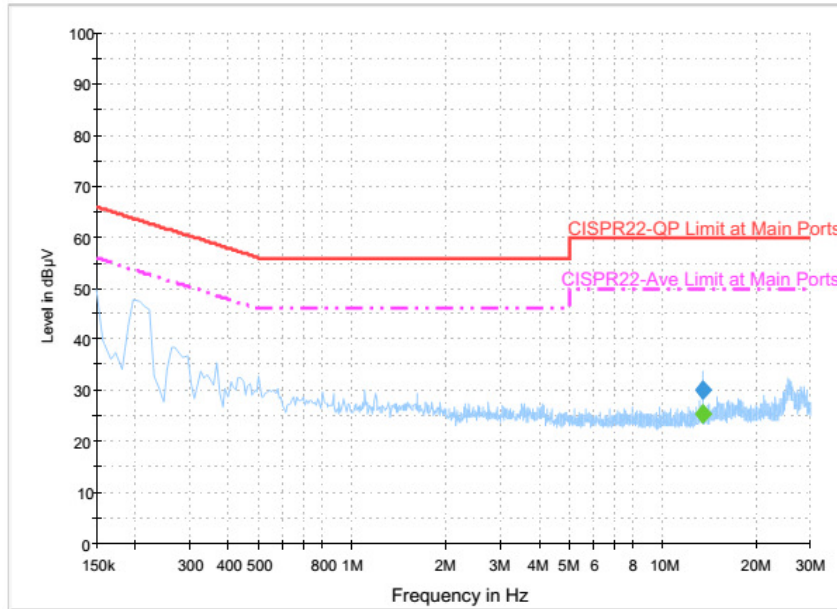

Final Result : Quasi-Peak

Frequency (MHz)	Quasi-Peak (dBµV)	Filter	Line	Corr. (dB)	Margin (dB)	Limit (dBµV)
13.558000	30.1	Off	L1	19.8	29.9	60.0

Final Result : Average

Frequency (MHz)	Average (dBµV)	Filter	Line	Corr. (dB)	Margin (dB)	Limit (dBµV)
13.558000	25.5	Off	L1	19.8	24.5	50.0



Test Mode :	Mode 3	Temperature :	23~24°C
Test Engineer :	Arthur Hsieh	Relative Humidity :	51~52%
Test Voltage :	120Vac / 60Hz	Phase :	Neutral
Function Type :	WLAN (2.4GHz) Link + Bluetooth Link + NFC Link + Earphone 2 with Audio Adapter connect to EUT + Charging Only Cable + Adapter		

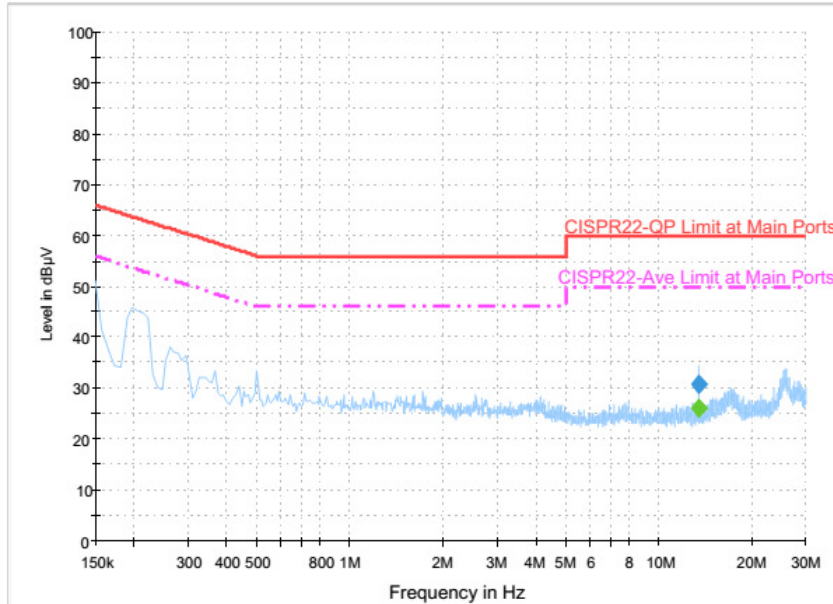

Final Result : Quasi-Peak

Frequency (MHz)	Quasi-Peak (dBµV)	Filter	Line	Corr. (dB)	Margin (dB)	Limit (dBµV)
13.558000	30.7	Off	N	19.8	29.3	60.0

Final Result : Average

Frequency (MHz)	Average (dBµV)	Filter	Line	Corr. (dB)	Margin (dB)	Limit (dBµV)
13.558000	26.1	Off	N	19.8	23.9	50.0



3.7 Antenna Requirements

3.7.1 Standard Applicable

If directional gain of transmitting Antennas is greater than 6dBi, the power shall be reduced by the same level in dB comparing to gain minus 6dBi. For the fixed point-to-point operation, the power shall be reduced by one dB for every 3 dB that the directional gain of the Antenna exceeds 6 dBi. The use of a permanently attached Antenna or of an Antenna that uses a unique coupling to the intentional radiator shall be considered sufficient to comply with the FCC rule.

3.7.2 Antenna Anti-Replacement Construction

An embedded-in antenna design is used.

3.7.3 Antenna Gain

FCC KDB 662911 D01 Multiple Transmitter Output v02r01.

For CDD transmissions, directional gain is calculated as

Directional gain = $G_{ANT} + \text{Array Gain}$, where Array Gain is as follows.

For power spectral density (PSD) measurements on all devices,

Array Gain = $10 \log(N_{ANT}/N_{SS}=1)$ dB.

For power measurements on IEEE 802.11 devices,

Array Gain = 0 dB (i.e., no array gain) for $N_{ANT} \leq 4$.

Directional gain may be calculated by using the formulas applicable to equal gain antennas with G_{ANT} set equal to the gain of the antenna having the highest gain;

The EUT supports CDD mode.

The power and PSD limit should be modified if the directional gain of EUT is over 6 dBi,

The directional gain "DG" is calculated as following table.

			DG	DG	Power	PSD
			for	for	Limit	Limit
	Ant. 1	Ant. 2	Power	PSD	Reduction	Reduction
	(dBi)	(dBi)	(dBi)	(dBi)	(dB)	(dB)
2.4 GHz	1.96	0.79	1.96	4.40	0.00	0.00

Power Limit Reduction = $DG(\text{Power}) - 6\text{dBi}$, (min = 0)

PSD Limit Reduction = $DG(\text{PSD}) - 6\text{dBi}$, (min = 0)



4 List of Measuring Equipment

Instrument	Manufacturer	Model No.	Serial No.	Characteristics	Calibration Date	Test Date	Due Date	Remark
Power Meter	Anritsu	ML2495A	1132003	300MHz~40GHz	Aug. 12, 2015	Jun. 28, 2016 ~ Jul. 19, 2016	Aug. 11, 2016	Conducted (TH05-HY)
Power Sensor	Anritsu	MA2411B	1126017	300MHz~40GHz	Aug. 12, 2015	Jun. 28, 2016 ~ Jul. 19, 2016	Aug. 11, 2016	Conducted (TH05-HY)
Spectrum Analyzer	Rohde & Schwarz	FSP40	100057	9kHz-40GHz	Nov. 23, 2015	Jun. 28, 2016 ~ Jul. 19, 2016	Nov. 22, 2016	Conducted (TH05-HY)
AC Power Source	ChainTek	APC-1000W	N/A	N/A	N/A	Jun. 27, 2016 ~ Jul. 11, 2016	N/A	Conduction (CO05-HY)
EMI Test Receiver	Rohde & Schwarz	ESCI 7	100724	9kHz~7GHz	Aug. 26, 2015	Jun. 27, 2016 ~ Jul. 11, 2016	Aug. 25, 2016	Conduction (CO05-HY)
LISN	Rohde & Schwarz	ENV216	100080	9kHz~30MHz	Dec. 02, 2015	Jun. 27, 2016 ~ Jul. 11, 2016	Dec. 01, 2016	Conduction (CO05-HY)
LISN	Rohde & Schwarz	ENV216	100081	9kHz~30MHz	Dec. 14, 2015	Jun. 27, 2016 ~ Jul. 11, 2016	Dec. 13, 2016	Conduction (CO05-HY)
Bilog Antenna	TESEQ	CBL 6111D	35419	30MHz to 1GHz	Jan. 13, 2016	Jun. 24, 2016 ~ Jul. 19, 2016	Jan. 12, 2017	Radiation (03CH07-HY)
Double Ridge Horn Antenna	ESCO	3117	00075962	1GHz ~ 18GHz	Aug. 21, 2015	Jun. 24, 2016 ~ Jul. 19, 2016	Aug. 20, 2016	Radiation (03CH07-HY)
EMI Test Receiver	Keysight	N9038A(MXE)	MY54130085	20Hz ~ 8.4GHz	Nov. 04, 2015	Jun. 24, 2016 ~ Jul. 19, 2016	Nov. 03, 2016	Radiation (03CH07-HY)
Loop Antenna	Rohde & Schwarz	HFH2-Z2	100315	9 kHz~30 MHz	Sep. 02, 2015	Jun. 24, 2016 ~ Jul. 19, 2016	Sep. 01, 2016	Radiation (03CH07-HY)
Preamplifier	MITEQ	AMF-7D-00101800-30-10P	1590075	1GHz ~ 18GHz	Apr. 15, 2016	Jun. 24, 2016 ~ Jul. 19, 2016	Apr. 14, 2017	Radiation (03CH07-HY)
Preamplifier	COM-POWER	PA-103A	161241	10MHz-1GHz	Mar. 18, 2016	Jun. 24, 2016 ~ Jul. 19, 2016	Mar. 17, 2017	Radiation (03CH07-HY)
Preamplifier	Agilent	8449B	3008A02362	1GHz~ 26.5GHz	Oct. 19, 2015	Jun. 24, 2016 ~ Jul. 19, 2016	Oct. 18, 2016	Radiation (03CH07-HY)
Spectrum Analyzer	Agilent	N9010A	MY53470118	10Hz~44GHz	Feb. 27, 2016	Jun. 24, 2016 ~ Jul. 19, 2016	Feb. 26, 2017	Radiation (03CH07-HY)
Antenna Mast	Max-Full	MFA520BS	N/A	1m~4m	N/A	Jun. 24, 2016 ~ Jul. 19, 2016	N/A	Radiation (03CH07-HY)
Turn Table	ChainTek	Chaintek 3000	N/A	0~360 Degree	N/A	Jun. 24, 2016 ~ Jul. 19, 2016	N/A	Radiation (03CH07-HY)
Preamplifier	MITEQ	JS44-18004000-33-8P	1840917	18GHz ~ 40GHz	Jun. 14, 2016	Jun. 24, 2016 ~ Jul. 19, 2016	Jun. 13, 2017	Radiation (03CH07-HY)
SHF-EHF Horn Antenna	SCHWARZBECK	BBHA 9170	BBHA9170584	18GHz- 40GHz	Nov. 02, 2015	Jun. 24, 2016 ~ Jul. 19, 2016	Nov. 01, 2016	Radiation (03CH07-HY)



5 Uncertainty of Evaluation

Uncertainty of Conducted Emission Measurement (150kHz ~ 30MHz)

Measuring Uncertainty for a Level of Confidence of 95% ($U = 2Uc(y)$)	2.26
---	------

Uncertainty of Radiated Emission Measurement (30 MHz ~ 1000 MHz)

Measuring Uncertainty for a Level of Confidence of 95% ($U = 2Uc(y)$)	4.50
---	------



Appendix A. Conducted Test Results