



# FCC RADIO TEST REPORT

**FCC ID** : UZ7TC58BE  
**Equipment** : Touch Computer  
**Brand Name** : Zebra  
**Model Name** : TC58BE  
**Applicant** : Zebra Technologies Corporation  
1 Zebra Plaza, Holtsville, NY 11742  
**Manufacturer** : Zebra Technologies Corporation  
1 Zebra Plaza, Holtsville, NY 11742  
**Standard** : FCC Part 15 Subpart E §15.407

The product was received on Jan. 10, 2024 and testing was performed from Jan. 26, 2024 to Apr. 24, 2024. We, Sporton International Inc. Wensan Laboratory, would like to declare that the tested sample has been evaluated in accordance with the test procedures and has been in compliance with the applicable technical standards.

The test results in this report apply exclusively to the tested model / sample. Without written approval from Sporton International Inc. Wensan Laboratory, the test report shall not be reproduced except in full.

Approved by: Louis Wu

**Sporton International Inc. Wensan Laboratory**

No.58, Aly. 75, Ln. 564, Wenhua 3rd, Rd., Guishan Dist., Taoyuan City 333010, Taiwan (R.O.C.)



# Table of Contents

**History of this test report..... 3**

**Summary of Test Result..... 4**

**1 General Description ..... 5**

    1.1 Product Feature ..... 5

    1.2 EUT Information (Referenced Model)..... 5

    1.3 Product Specification of Equipment Under Test..... 7

    1.4 Modification of EUT ..... 12

    1.5 Testing Location ..... 12

    1.6 Applicable Standards..... 12

**2 Test Configuration of Equipment Under Test ..... 13**

    2.1 Carrier Frequency and Channel ..... 13

    2.2 Test Mode ..... 15

    2.3 Connection Diagram of Test System..... 17

    2.4 Support Unit used in test configuration and system ..... 19

    2.5 EUT Operation Test Setup ..... 19

    2.6 Measurement Results Explanation Example..... 19

**3 Test Result ..... 20**

    3.1 26dB & 99% Occupied Bandwidth Measurement ..... 20

    3.2 Maximum Conducted Output Power Measurement..... 21

    3.3 Power Spectral Density Measurement ..... 23

    3.4 Unwanted Emissions Measurement ..... 25

    3.5 AC Conducted Emission Measurement..... 30

    3.6 Antenna Requirements ..... 32

**4 List of Measuring Equipment..... 33**

**5 Measurement Uncertainty ..... 35**

**Appendix A. Conducted Test Results**

**Appendix B. AC Conducted Emission Test Result**

**Appendix C. Radiated Spurious Emission**

**Appendix D. Radiated Spurious Emission Plots**

**Appendix E. Duty Cycle Plots**

**Appendix F. Setup Photographs**

**Appendix G. Spot Check Evaluation on TC58BE**





### Summary of Test Result

Report Clause	Ref Std. Clause	Test Items	Result (PASS/FAIL)	Remark
3.1	15.403(i)	26dB Bandwidth	Pass	-
3.1	2.1049	99% Occupied Bandwidth	Reporting only	-
3.2	15.407(a)	Maximum Conducted Output Power	Pass	-
3.3	15.407(a)	Power Spectral Density	Pass	-
3.4	15.407(b)	Unwanted Emissions	Pass	1.21 dB under the limit at 5464.96 MHz
3.5	15.207	AC Conducted Emission	Pass	18.52 dB under the limit at 0.16 MHz
3.6	15.203	Antenna Requirement	Pass	-

**Conformity Assessment Condition:**

- ECR inquiry for data referencing from UZ7TC58AE has been approved by FCC. The ECR inquiry and the associated document are submitted in the confidential exhibit.
- UZ7TC58BE is different from FCC ID: UZ7TC58AE (Reference model), in the following:
  - The only difference between UZ7TC58AE and UZ7TC58BE are the WWAN support bands, which is controlled by software.
- All the test results are referenced from UZ7TC58AE (Sporton Test Report FR411111E), and spot check results to justify data referencing is presented in the Appendix G.
- The test results (PASS/FAIL) with all measurement uncertainty excluded are presented against the regulation limits or in accordance with the requirements stipulated by the applicant/manufacture who shall bear all the risks of non-compliance that may potentially occur if measurement uncertainty is taken into account.
- The measurement uncertainty please refer to each test result in the section "Measurement Uncertainty".

**Disclaimer:**

The product specifications of the EUT presented in the test report that may affect the test assessments are declared by the manufacturer who shall take full responsibility for the authenticity.

**Reviewed by: Wei Chen**  
**Report Producer: Michelle Chen**



# 1 General Description

## 1.1 Product Feature

Product Feature	
Equipment	Touch Computer
Brand Name	Zebra
Model Name	TC58BE
FCC ID	UZ7TC58BE
Supported Radio application	WCDMA/HSPA/LTE/5G NR/NFC/GNSS WLAN 11a/b/g/n HT20/HT40 WLAN 11ac VHT20/VHT40/VHT80/VHT160 WLAN 11ax HE20/HE40/HE80/HE160 Bluetooth BR/EDR/LE

## 1.2 EUT Information (Referenced Model)

Product Feature	
FCC ID	UZ7TC58AE
Sample 1	SE55 + 8GB   128G (Samsung/SK Hynix)
Sample 2	SE4720 + 6GB   64G (SK Hynix/WD)
Sample 3	SE4770 + 6GB   64G (SK Hynix/WD)
EUT supports Radios application	WCDMA/HSPA/LTE/5G NR/NFC/GNSS WLAN 11a/b/g/n HT20/HT40 WLAN 11ac VHT20/VHT40/VHT80/VHT160 WLAN 11ax HE20/HE40/HE80/HE160 Bluetooth BR/EDR/LE
HW Version	DV1-2
SW Version	nemesis_A13_userdebug_GMS_RelKey_2023-12-12-0451_main_SE
FW Version	FUSION_QA_6_1.1.0.004_T
MFD	06DEC23
EUT Stage	Identical Prototype

Remark: The EUT's information above is declared by manufacturer.



<b>Specification of Accessories</b>				
<b>Adapter</b>	<b>Brand Name</b>	Zebra	<b>Part Number</b>	PWR-WUA5V12W0US
<b>Battery 1 (1x)</b>	<b>Brand Name</b>	Zebra	<b>Part Number</b>	BT-000442-0020
<b>Battery 2 (1.5x)</b>	<b>Brand Name</b>	Zebra	<b>Part Number</b>	BT-000442-0820
<b>Battery 3 (BLE battery)</b>	<b>Brand Name</b>	Zebra	<b>Part Number</b>	BT-000442-002B
<b>Battery 4 (Wireless Battery)</b>	<b>Brand Name</b>	Zebra	<b>Part Number</b>	BT-000442-002A
<b>Battery 5 (1x)</b>	<b>Brand Name</b>	Zebra	<b>Part Number</b>	BT-000442-1020
<b>USB TYPE A to TYPE C cable</b>	<b>Brand Name</b>	Zebra	<b>Part Number</b>	CBL-TC5X-USBC2A-01
<b>USB TYPE C to 3.5mm audio connector</b>	<b>Brand Name</b>	Zebra	<b>Part Number</b>	ADP-USBC-35MM1-01
<b>3.5mm Earphone</b>	<b>Brand Name</b>	Zebra	<b>Part Number</b>	HDST-35MM-PTT1-01
<b>Rugged Headset</b>	<b>Brand Name</b>	Zebra	<b>Part Number</b>	HS2100-OTH
<b>USB TYPE C Earphone</b>	<b>Brand Name</b>	Zebra	<b>Part Number</b>	HPST-USBC-PTT1-01
<b>Trigger Handle</b>	<b>Brand Name</b>	Zebra	<b>Part Number</b>	TRG-NGTC5-ELEC-01
<b>Soft Holster</b>	<b>Brand Name</b>	Zebra	<b>Part Number</b>	SG-NGTC5TC7-HLSTR-01
<b>TC53/TC58 RUGGED BOOT</b>	<b>Brand Name</b>	Zebra	<b>Part Number</b>	SG-NGTC5EXO1-01
<b>3.5mm to 3.5mm audio connector</b>	<b>Brand Name</b>	Zebra	<b>Part Number</b>	CBL-HS2100-3MS1-01



### 1.3 Product Specification of Equipment Under Test

Product Specification is subject to this standard	
<b>Tx/Rx Frequency Range</b>	5180 MHz ~ 5240 MHz 5260 MHz ~ 5320 MHz 5500 MHz ~ 5720 MHz
<b>Maximum Output Power</b>	<p><b>&lt;5180 MHz ~ 5240 MHz&gt;</b>  <b>MIMO &lt;Ant. 6+7&gt;</b>  802.11a: 21.11 dBm / 0.1291 W  802.11n HT20: 21.36 dBm / 0.1368 W  802.11n HT40: 21.21 dBm / 0.1321 W  802.11ac VHT20: 21.46 dBm / 0.1400 W  802.11ac VHT40: 21.31 dBm / 0.1352 W  802.11ac VHT80: 18.86 dBm / 0.0769 W  802.11ac VHT160: 17.81 dBm / 0.0604 W  802.11ax HE20: 21.56 dBm / 0.1432 W  802.11ax HE40: 21.41 dBm / 0.1384 W  802.11ax HE80: 18.96 dBm / 0.0787 W  802.11ax HE160: 17.91 dBm / 0.0618 W</p> <p><b>&lt;5260 MHz ~ 5320 MHz&gt;</b>  <b>MIMO &lt;Ant. 6+7&gt;</b>  802.11a: 21.06 dBm / 0.1276 W  802.11n HT20: 21.52 dBm / 0.1419 W  802.11n HT40: 21.11 dBm / 0.1291 W  802.11ac VHT20: 21.62 dBm / 0.1452 W  802.11ac VHT40: 21.21 dBm / 0.1321 W  802.11ac VHT80: 18.71 dBm / 0.0743 W  802.11ax HE20: 21.72 dBm / 0.1486 W  802.11ax HE40: 21.31 dBm / 0.1352 W  802.11ax HE80: 18.81 dBm / 0.0760 W  802.11ax HE160: 17.91 dBm / 0.0618 W</p> <p><b>&lt;5500 MHz ~ 5720 MHz&gt;</b>  <b>MIMO &lt;Ant. 6+7&gt;</b>  802.11a: 21.36 dBm / 0.1368 W  802.11n HT20: 21.21 dBm / 0.1321 W  802.11n HT40: 21.46 dBm / 0.1400 W  802.11ac VHT20: 21.31 dBm / 0.1352 W  802.11ac VHT40: 21.56 dBm / 0.1432 W  802.11ac VHT80: 20.51 dBm / 0.1125 W  802.11ac VHT160: 17.76 dBm / 0.0597 W  802.11ax HE20: 21.41 dBm / 0.1384 W  802.11ax HE40: 21.66 dBm / 0.1466 W  802.11ax HE80: 20.61 dBm / 0.1151 W  802.11ax HE160: 17.86 dBm / 0.0611 W</p>



Product Specification is subject to this standard	
99% Occupied Bandwidth	<p><b>MIMO &lt;Ant. 6&gt;</b>  802.11a: 16.33 MHz  802.11ac VHT20: 17.63 MHz  802.11ac VHT40: 36.26 MHz  802.11ac VHT80: 75.40 MHz  802.11ac VHT160: 154.89 MHz  802.11ax HE20: 18.98 MHz  802.11ax HE40: 37.96 MHz  802.11ax HE80: 77.08 MHz  802.11ax HE160: 156.56 MHz</p> <p><b>MIMO &lt;Ant. 7&gt;</b>  802.11a: 16.33 MHz  802.11ac VHT20: 17.63 MHz  802.11ac VHT40: 36.26 MHz  802.11ac VHT80: 75.40 MHz  802.11ac VHT160: 154.89 MHz  802.11ax HE20: 18.93 MHz  802.11ax HE40: 37.96 MHz  802.11ax HE80: 77.20 MHz  802.11ax HE160: 156.56 MHz</p>
Antenna Type	<p><b>&lt;5180 MHz ~ 5240 MHz&gt;</b>  &lt;Ant. 6&gt;: PIFA Antenna  &lt;Ant. 7&gt;: PIFA Antenna</p> <p><b>&lt;5260 MHz ~ 5320 MHz&gt;</b>  &lt;Ant. 6&gt;: PIFA Antenna  &lt;Ant. 7&gt;: PIFA Antenna</p> <p><b>&lt;5500 MHz ~ 5720 MHz&gt;</b>  &lt;Ant. 6&gt;: PIFA Antenna  &lt;Ant. 7&gt;: PIFA Antenna</p>





Product Specification is subject to this standard			
<b>Antenna Gain</b>	<5180 MHz ~ 5240 MHz> <Ant. 6>: 3.51 dBi <Ant. 7>: 1.77 dBi <5260 MHz ~ 5320 MHz> <Ant. 6>: 3.86 dBi <Ant. 7>: 1.74 dBi <5500 MHz ~ 5720 MHz> <Ant. 6>: 3.95 dBi <Ant. 7>: 2.24 dBi		
<b>Type of Modulation</b>	802.11a/n : OFDM (BPSK / QPSK / 16QAM / 64QAM) 802.11ac : OFDM (BPSK / QPSK / 16QAM / 64QAM / 256QAM) 802.11ax : OFDMA (BPSK / QPSK / 16QAM / 64QAM / 256QAM / 1024QAM)		
<b>Antenna Function Description</b>		Ant. 6	Ant. 7
	802.11 a/n/ac/ax MIMO	V	V
	802.11ax TXBF	V	V

**Remark:**

1. MIMO Ant. 6+7 Directional Gain is a calculated result from MIMO Ant. 6 and MIMO Ant. 7. The formula used in calculation is documented in section 1.2.1.
2. Power of MIMO Ant. 6 + Ant. 7 is a calculated result from sum of the power MIMO Ant. 6 and MIMO Ant. 7.
3. 802.11ax Support Tx Beamforming mode, and the manufacturer declares that Tx Beamforming power/EIRP is less than CDD mode 3dbm, so CDD mode cover Tx Beamforming mode.
4. The EUT's information above is declared by manufacturer. Please refer to Disclaimer in report summary

### 1.3.1 Antenna Directional Gain

**<For CDD Mode>**

Follows FCC KDB 662911 D01 Multiple Transmitter Output v02r01 F)2)f)ii)

Directional gain =  $G_{ANT}$  + Array Gain, where Array Gain is as follows:

For power measurements on IEEE 802.11 devices,

Array Gain = 0 dB (i.e., no array gain) for  $N_{ANT} \leq 4$ .

$G_{ANT}$  is set equal to the gain of the antenna having the highest gain.

For PSD measurements, the directional gain calculation.

$$DirectionalGain = 10 \cdot \log \left[ \frac{\sum_{j=1}^{N_{SS}} \left\{ \sum_{k=1}^{N_{ANT}} g_{j,k} \right\}^2}{N_{ANT}} \right]$$

where

Each antenna is driven by no more than one spatial stream;

$N_{SS}$  = the number of independent spatial streams of data;

$N_{ANT}$  = the total number of antennas

$g_{j,k} = 10^{G_k/20}$  if the  $k$ th antenna is being fed by spatial stream  $j$ , or zero if it is not;  
 $G_k$  is the gain in dBi of the  $k$ th antenna.

As minimum  $N_{SS}=1$  is supported by EUT, the formula can be simplified as:

Directional gain =  $10 \cdot \log[(10^{G_1/20} + 10^{G_2/20} + \dots + 10^{G_N/20})^2 / N_{ANT}]$  dBi

Where  $G_1, G_2, \dots, G_N$  denote single antenna gain.

The directional gain "DG" is calculated as following table.

			<b>DG</b>	<b>DG</b>	<b>Power</b>	<b>PSD</b>
			<b>for</b>	<b>for</b>	<b>Limit</b>	<b>Limit</b>
	<b>Ant 6</b>	<b>Ant 7</b>	<b>Power</b>	<b>PSD</b>	<b>Reduction</b>	<b>Reduction</b>
	<b>(dBi)</b>	<b>(dBi)</b>	<b>(dBi)</b>	<b>(dBi)</b>	<b>(dB)</b>	<b>(dB)</b>
<b>Band I</b>	3.51	1.77	3.51	5.69	0.00	0.00
<b>Band II</b>	3.86	1.74	3.86	5.87	0.00	0.00
<b>Band III</b>	3.95	2.24	3.95	6.15	0.00	0.15

Calculation example:

If a device has two antenna,  $G_{ANT6}= 3.51$ dBi;  $G_{ANT7}=1.77$ dBi

Directional gain of power measurement =  $\max(3.51, 1.77) + 0 = 3.51$  dBi

Directional gain of PSD derived from formula which is

$$10 \times \log \left\{ \left[ 10^{(3.51 \text{ dBi} / 20)} + 10^{(1.77 \text{ dBi} / 20)} \right]^2 / 2 \right\}$$

= 5.69 dBi

Power and PSD limit reduction = Composite gain – 6dBi, ( min = 0 )

**<For TXBF Modes>**

The EUT supports beamforming modes , then

Follows FCC KDB 662911 D01 Multiple Transmitter Output v02r01 F)2)e)ii)

$$DirectionalGain = 10 \cdot \log \left[ \frac{\sum_{j=1}^{N_{SS}} \left\{ \sum_{k=1}^{N_{ANT}} g_{j,k} \right\}^2}{N_{ANT}} \right]$$

where

Each antenna is driven by no more than one spatial stream;

$N_{SS}$  = the number of independent spatial streams of data;

$N_{ANT}$  = the total number of antennas

$g_{j,k} = 10^{G_k / 20}$  if the  $k$ th antenna is being fed by spatial stream  $j$ , or zero if it is not;  
 $G_k$  is the gain in dBi of the  $k$ th antenna.

The directional gain “DG” is calculated as following table.

			DG	DG	Power	PSD
			for	for	Limit	Limit
	Ant 6	Ant 7	Power	PSD	Reduction	Reduction
	(dBi)	(dBi)	(dBi)	(dBi)	(dB)	(dB)
<b>Band I</b>	3.51	1.77	5.69	5.69	0.00	0.00
<b>Band II</b>	3.86	1.74	5.87	5.87	0.00	0.00
<b>Band III</b>	3.95	2.24	6.15	6.15	0.15	0.15

Calculation example:

Directional gain is derived from formula which is

$$10 \times \log \left\{ \left[ 10^{(3.51 \text{ dBi} / 20)} + 10^{(1.77 \text{ dBi} / 20)} \right]^2 / 2 \right\}$$

$$= 5.69 \text{ dBi}$$

Power and PSD limit reduction = Composite gain – 6dBi, ( min = 0 )



### 1.4 Modification of EUT

No modifications made to the EUT during the testing.

### 1.5 Testing Location

<b>Test Site</b>	Sporton International Inc. EMC & Wireless Communications Laboratory
<b>Test Site Location</b>	No.52, Huaya 1st Rd., Guishan Dist., Taoyuan City 333, Taiwan (R.O.C.) TEL: +886-3-327-3456 FAX: +886-3-328-4978
<b>Test Site No.</b>	<b>Sporton Site No.</b> CO05-HY (TAF Code: 1190)
<b>Remark</b>	The AC Conducted Emission test item subcontracted to Sporton International Inc. EMC & Wireless Communications Laboratory.

**Note:** The test site complies with ANSI C63.4 2014 requirement.

<b>Test Site</b>	Sporton International Inc. Wensan Laboratory
<b>Test Site Location</b>	No.58, Aly. 75, Ln. 564, Wenhua 3rd, Rd., Guishan Dist., Taoyuan City 333010, Taiwan (R.O.C.) TEL: +886-3-327-0868 FAX: +886-3-327-0855
<b>Test Site No.</b>	<b>Sporton Site No.</b> TH05-HY, 03CH13-HY

**Note:** The test site complies with ANSI C63.4 2014 requirement.

FCC designation No.: TW1190 and TW3786

### 1.6 Applicable Standards

According to the specifications declared by the manufacturer, the EUT must comply with the requirements of the following standards:

- ♦ FCC Part 15 Subpart E
- ♦ FCC KDB 789033 D02 General UNII Test Procedures New Rules v02r01.
- ♦ FCC KDB 414788 D01 Radiated Test Site v01r01.
- ♦ FCC KDB 662911 D01 Multiple Transmitter Output v02r01.
- ♦ ANSI C63.10-2013

**Remark:**

1. All the test items were validated and recorded in accordance with the standards without any modification during the testing.
2. The TAF code is not including all the FCC KDB listed without accreditation.
3. This EUT has also been tested and complied with the requirements of FCC Part 15, Subpart B, recorded in a separate test report.



## 2 Test Configuration of Equipment Under Test

- a. The EUT has been associated with peripherals and configuration operated in a manner tended to maximize its emission characteristics in a typical application. Frequency range investigated: conduction emission (150 kHz to 30 MHz), radiation emission (9 kHz to the 10th harmonic of the highest fundamental frequency or to 40 GHz, whichever is lower). For radiated measurement, the measured emission level of the EUT was maximized by rotating the EUT on a turntable, adjusting the orientation of the EUT and EUT antenna in three orthogonal axis (X: flat, Y: portrait, Z: landscape) and Accessory (Adapter or Earphone), and adjusting the measurement antenna orientation, following C63.10 exploratory test procedures and only the worst case emissions were reported in this report.
- b. AC power line Conducted Emission was tested under maximum output power.

### 2.1 Carrier Frequency and Channel

Frequency Band	Channel	Freq. (MHz)	Channel	Freq. (MHz)
5150-5250 MHz Band 1 (U-NII-1)	36	5180	44	5220
	38*	5190	46*	5230
	40	5200	48	5240
	42#	5210		

Frequency Band	Channel	Freq. (MHz)	Channel	Freq. (MHz)
5250-5350 MHz Band 2 (U-NII-2A)	52	5260	60	5300
	54*	5270	62*	5310
	56	5280	64	5320
	58#	5290		

Frequency Band	Channel	Freq. (MHz)	Channel	Freq. (MHz)
5470-5725 MHz Band 3 (U-NII-2C)	100	5500	112	5560
	102*	5510	116	5580
	104	5520	132	5660
	106#	5530	134*	5670
	108	5540	136	5680
	110*	5550	140	5700



Frequency Band	Channel	Freq. (MHz)
5150-5350 MHz	50@	5250
5470-5725 MHz	114@	5570

Frequency Band	Channel	Freq. (MHz)	Channel	Freq. (MHz)
TDWR Channel	118*	5590	124	5620
	120	5600	126*	5630
	122#	5610	128	5640

Frequency Band	Channel	Freq. (MHz)	Channel	Freq. (MHz)
Straddle Channel	138#	5690	144	5720
	142*	5710		

**Note:**

1. The above Frequency and Channel with "\*" are 802.11n HT40 and 802.11ac VHT40 and 802.11ax HE40.
2. The above Frequency and Channel with "#" are 802.11ac VHT80 and 802.11ax HE80.
3. The above Frequency and Channel with "@" are 802.11ac VHT160 and 802.11ax HE160.



## 2.2 Test Mode

This device support 26/52/106/242/484/996-tone RU but does not support 2x996-tone RU on 160MHz channel.

The PSD of partial RU is reduced to be smaller than full RU according to TCB workshop interim guidance Oct. 2022.

The 802.11ax mode is investigated among different tones, full resource units (RU), partial resource units. The partial RU has no higher power than full RU's, thus the full RU is chosen as main test configuration.

The 242-tone RU is covered by 20MHz channel, 484-tone RU is covered by 40MHz channel and 996-tone RU is covered by 80MHz channel.

The SISO mode conducted power is covered by MIMO mode per chain, so only the MIMO mode is tested.

The power for 802.11n mode is smaller than 802.11ac mode, so all other conducted test is covered by 802.11ac mode.

The final test modes include the worst data rates for each modulation shown in the table below.

### MIMO Mode

Modulation	Data Rate
802.11a	6 Mbps
802.11n HT20 (Covered by VHT20)	MCS0
802.11n HT40 (Covered by VHT40)	MCS0
802.11ac VHT20	MCS0
802.11ac VHT40	MCS0
802.11ac VHT80	MCS0
802.11ac VHT160	MCS0
802.11ax HE20	MCS0
802.11ax HE40	MCS0
802.11ax HE80	MCS0
802.11ax HE160	MCS0

**Remark:** The conducted power level of each chain in MIMO mode is equal or higher than SISO mode.



Test Cases	
<b>AC Conducted Emission</b>	Mode 1 : WLAN (5GHz) Link + Bluetooth Link + USB TYPE A to TYPE C cable (Charging from Adapter) + Battery 2 (1.5) for Sample 1
<b>Remark:</b> For Radiated Test Cases, the tests were performed with Battery 1 (1x) and Sample 1.	

Ch. #		Band I : 5150-5250 MHz	Band II : 5250-5350 MHz	Band III : 5470-5725MHz
		802.11a	802.11a	802.11a
L	Low	36	52	100
M	Middle	44	60	116
H	High	48	64	140
Straddle		-	-	144

Ch. #		Band I : 5150-5250 MHz	Band II : 5250-5350 MHz	Band III : 5470-5725MHz
		802.11ax HE20	802.11ax HE20	802.11ax HE20
L	Low	36	52	100
M	Middle	44	60	116
H	High	48	64	140
Straddle		-	-	144

Ch. #		Band I : 5150-5250 MHz	Band II : 5250-5350 MHz	Band III : 5470-5725MHz
		802.11ax HE40	802.11ax HE40	802.11ax HE40
L	Low	38	54	102
M	Middle	-	-	110
H	High	46	62	134
Straddle		-	-	142



Ch. #		Band I : 5150-5250 MHz	Band II : 5250-5350 MHz	Band III : 5470-5725MHz
		802.11ax HE80	802.11ax HE80	802.11ax HE80
L	Low	-	-	106
M	Middle	42	58	-
H	High	-	-	122
Straddle		-	-	138

BW160	5150-5350 MHz	5470-5725MHz
	802.11ax HE160	802.11ax HE160
Ch. #	50	114

**Remark:** For radiation spurious emission, the modulation and the data rate picked for testing are determined by the Max. RF conducted power.

### 2.3 Connection Diagram of Test System

<AC Conducted Emission Mode>

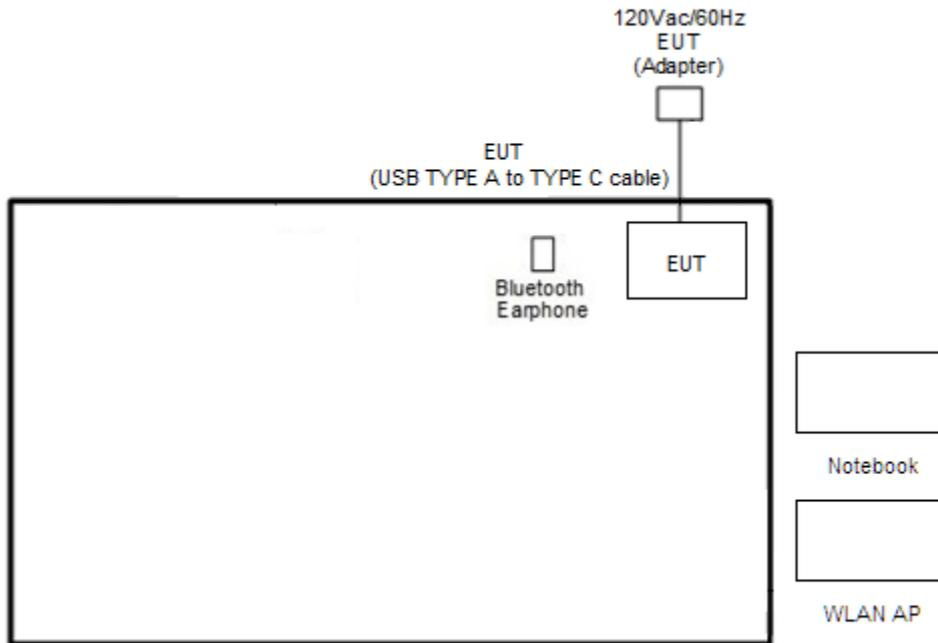

<WLAN Tx with Adapter Mode>

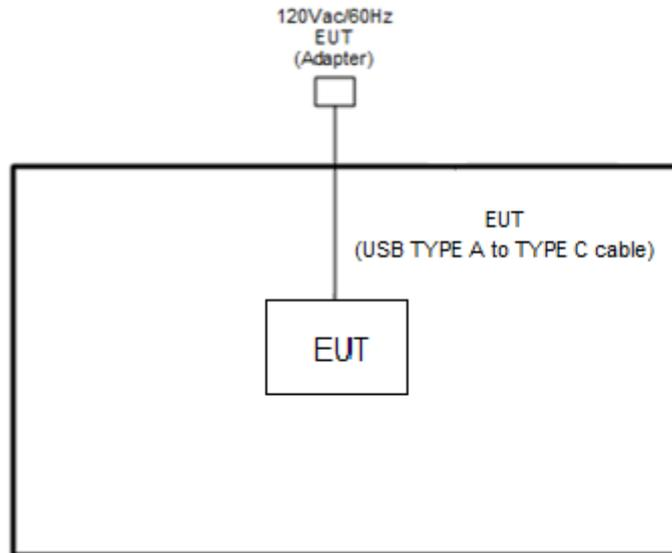

<WLAN Tx with Earphone Mode>

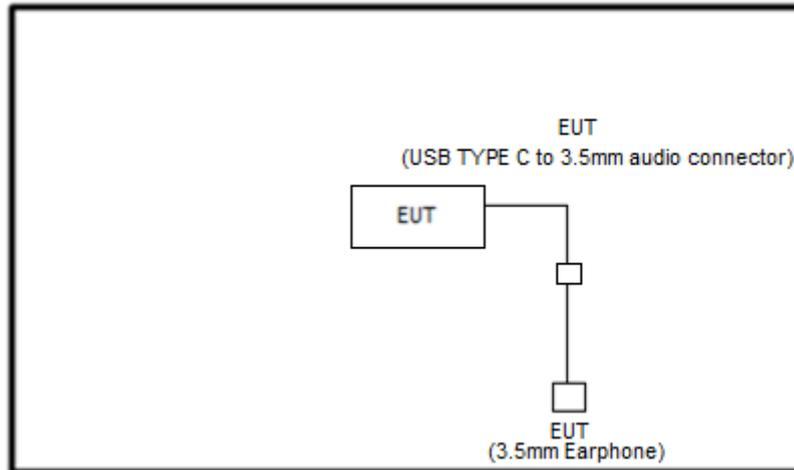



## 2.4 Support Unit used in test configuration and system

Item	Equipment	Brand Name	Model Name	FCC ID	Data Cable	Power Cord
1.	Bluetooth Earphone	Sony Ericsson	MW600	PY7DDA-2029	N/A	N/A
2.	WLAN AP	ASUS	RT-AC66U	MSQ-RTAC66U	N/A	Unshielded, 1.8 m
3.	Notebook	DELL	Latitude 3420	FCC DoC	N/A	AC I/P: Unshielded, 1.2 m DC O/P: Shielded, 1.8 m
4.	SD Card	SanDisk	MicroSD HC	FCC DoC	N/A	N/A

## 2.5 EUT Operation Test Setup

The RF test items, utility “QRCT Version 4.0.211.0” was installed in Notebook which was programmed in order to make the EUT get into the engineering modes to provide channel selection, power level, data rate and the application type and for continuous transmitting signals.

## 2.6 Measurement Results Explanation Example

**For all conducted test items:**

The offset level is set in the spectrum analyzer to compensate the RF cable loss and attenuator factor between EUT conducted output port and spectrum analyzer. With the offset compensation, the spectrum analyzer reading level is exactly the EUT RF output level.

Example :

The spectrum analyzer offset is derived from RF cable loss and attenuator factor.

*Offset = RF cable loss + attenuator factor.*

Following shows an offset computation example with cable loss 4.2 dB and 10 dB attenuator.

$$\begin{aligned} \text{Offset(dB)} &= \text{RF cable loss(dB)} + \text{attenuator factor(dB)}. \\ &= 4.2 + 10 = 14.2 \text{ (dB)} \end{aligned}$$

### 3 Test Result

#### 3.1 26dB & 99% Occupied Bandwidth Measurement

##### 3.1.1 Description of 26dB & 99% Occupied Bandwidth

This section is for reporting purpose only.

There is no restriction limits for bandwidth.

For Straddle Channel, according to KDB 789033 D02 General UNII Test Procedures New Rules v02r01, if the power and PSD of the devices are uniform and comply with the lower limits specified for the U-NII-2 bands, a single measurement over the entire emission bandwidth can be performed to show compliance.

##### 3.1.2 Measuring Instruments

Please refer to the measuring equipment list in this test report.

##### 3.1.3 Test Procedures

1. The testing follows FCC KDB 789033 D02 General UNII Test Procedures New Rules v02r01. Section C) Emission bandwidth
2. Set RBW = approximately 1% of the emission bandwidth.
3. Set the VBW > RBW.
4. Detector = Peak.
5. Trace mode = max hold
6. Measure the maximum width of the emission that is 26 dB down from the peak of the emission. Compare this with the RBW setting of the analyzer. Readjust RBW and repeat measurement as needed until the RBW/EBW ratio is approximately 1%.
7. For 99% Bandwidth Measurement, the spectrum analyzer's resolution bandwidth (RBW) is set 1-5% of the emission bandwidth and set the Video bandwidth (VBW)  $\geq 3 * RBW$ .
8. Measure and record the results in the test report.

##### 3.1.4 Test Setup

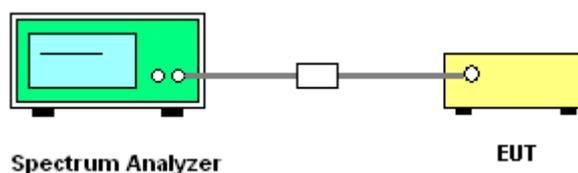

##### 3.1.5 Test Result of 26dB & 99% Occupied Bandwidth

Please refer to Appendix A.



## 3.2 Maximum Conducted Output Power Measurement

### 3.2.1 Limit of Maximum Conducted Output Power

<FCC 14-30 CFR 15.407>

**For the 5.15–5.25 GHz bands:**

■ For mobile and portable client devices in the 5.15–5.25 GHz band, the maximum conducted output power over the frequency band of operation shall not exceed 250 mW. For an indoor access point operating in the band 5.15-5.25 GHz, the maximum conducted output power over the frequency band of operation shall not exceed 1 W.

**For the 5.25–5.725 GHz bands:**

■ The maximum conducted output power over the frequency bands of operation shall not exceed the lesser of 250 mW or 11 dBm  $10 \log B$ , where B is the 26 dB emission bandwidth in megahertz.

For Straddle Channel, according to KDB 789033 D02 General UNII Test Procedures New Rules v02r01, if the power and PSD of the devices are uniform and comply with the lower limits specified for the U-NII-2 bands, a single measurement over the entire emission bandwidth can be performed to show compliance.

If transmitting antennas of directional gain greater than 6 dBi are used, the peak output power shall be reduced by the amount in dB that the directional gain of the antenna exceeds 6 dBi.

Note that U-NII-2 band, devices with a maximum e.i.r.p. greater than 500 mW shall implement TPC in order to have the capability to operate at least 6 dB below the maximum permitted e.i.r.p. of 1 W.

### 3.2.2 Measuring Instruments

Please refer to the measuring equipment list in this test report.

### 3.2.3 Test Procedures

The testing follows Method PM-G of FCC KDB 789033 D02 General UNII Test Procedures New Rules v02r01.

Method PM-G (Measurement using a gated RF average power meter):

1. Measurement is performed using a wideband RF power meter.
2. The EUT is configured to transmit at its maximum power control level.
3. Measure the average power of the transmitter.
4. Since the measurement is made only during the ON time of the transmitter, no duty cycle correction factor is required.
5. For MIMO mode, calculation method follows FCC KDB 662911 D01 Multiple Transmitter Output v02r01

For Straddle Channel, according to KDB 789033 D02 General UNII Test Procedures New Rules v02r01, if the power and PSD of the devices are uniform and comply with the lower limits specified for the U-NII-2 bands, a single measurement over the entire emission bandwidth can be performed to show compliance.

### 3.2.4 Test Setup

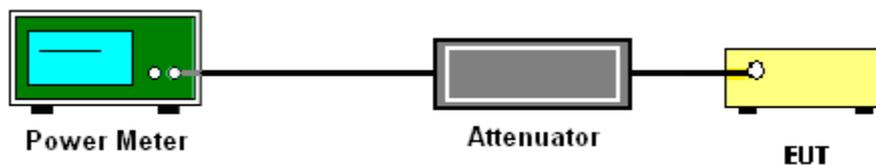

### 3.2.5 Test Result of Maximum Conducted Output Power

Please refer to Appendix A.



### 3.3 Power Spectral Density Measurement

#### 3.3.1 Limit of Power Spectral Density

<FCC 14-30 CFR 15.407>

**For the 5.15–5.25 GHz bands:**

For mobile and portable client devices in the 5.15–5.25 GHz band, the maximum power spectral density shall not exceed 11 dBm in any 1.0 MHz band. For an indoor access point operating in the band 5.15-5.25 GHz, the maximum power spectral density shall not exceed 17 dBm in any 1.0 MHz band.

**For the 5.25–5.725 GHz bands:**

The maximum power spectral density shall not exceed 11 dBm in any 1.0 MHz band.

For Straddle Channel, according to KDB 789033 D02 General UNII Test Procedures New Rules v02r01, if the power and PSD of the devices are uniform and comply with the lower limits specified for the U-NII-2 bands, a single measurement over the entire emission bandwidth can be performed to show compliance.

If transmitting antennas of directional gain greater than 6 dBi are used, the peak output power shall be reduced by the amount in dB that the directional gain of the antenna exceeds 6 dBi.

#### 3.3.2 Measuring Instruments

Please refer to the measuring equipment list in this test report.

### 3.3.3 Test Procedures

The testing follows FCC KDB 789033 D02 General UNII Test Procedures New Rules v02r01.  
Section F) Maximum power spectral density.

#### # Method SA-2 #

(trace averaging across on and off times of the EUT transmissions, followed by duty cycle correction).

- Measure the duty cycle.
  - Set span to encompass the entire emission bandwidth (EBW) of the signal.
  - Set RBW = 1 MHz.
  - Set VBW  $\geq$  3 MHz.
  - Number of points in sweep  $\geq$  2 Span / RBW.
  - Sweep time = auto.
  - Detector = RMS
  - Trace average at least 100 traces in power averaging mode.
  - Add  $10 \log(1/x)$ , where x is the duty cycle, to the measured power in order to compute the average power during the actual transmission times. For example, add  $10 \log(1/0.25) = 6$  dB if the duty cycle is 25 percent.
1. The RF output of EUT is connected to the spectrum analyzer by a low loss cable.
  2. Each plot has already offset with cable loss, and attenuator loss. Measure the PPSD and record it.
  3. For MIMO mode, calculation method follows FCC KDB 662911 D01 Multiple Transmitter Output v02r01.

Method (a): Measure and sum the spectra across the outputs.

The total final Power Spectral Density is from a device with 2 transmitter outputs. The spectrum measurements of the individual outputs are all performed with the same span and number of points; the spectrum value in the first spectral bin of output 1 is summed with that in the first spectral bin of output 2 to obtain the value for the first frequency bin of the summed spectrum.

### 3.3.4 Test Setup

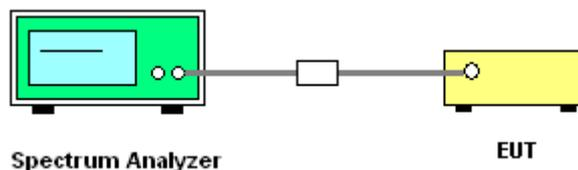

### 3.3.5 Test Result of Power Spectral Density

Please refer to Appendix A.





### 3.4 Unwanted Emissions Measurement

This section is to measure unwanted emissions through radiated measurement for band edge spurious emissions and out of band emissions measurement.

#### 3.4.1 Limit of Unwanted Emissions

(1) For transmitters operating in the 5150-5250 MHz band: all emissions outside of the 5150-5350 MHz band shall not exceed an EIRP of -27dBm/MHz.

For transmitters operating in the 5250-5350 MHz band: all emissions outside of the 5150-5350 MHz band shall not exceed an EIRP of -27 dBm/MHz. Devices operating in the 5250-5350 MHz band that generate emissions in the 5150-5250 MHz band must meet all applicable technical requirements for operation in the 5150-5250 MHz band (including indoor use) or alternatively meet an out-of-band emission EIRP limit of -27 dBm/MHz in the 5150-5250 MHz band.

For transmitters operating in the 5470-5600 MHz and 5650-5725MHz band: all emissions outside of the 5470-5600 MHz and 5650-5725MHz band shall not exceed an EIRP of -27 dBm/MHz.

(2) Unwanted spurious emissions falls in restricted bands shall comply with the general field strength limits as below table:

Frequency (MHz)	Field Strength (microvolts/meter)	Measurement Distance (meters)
0.009 – 0.490	2400/F(kHz)	300
0.490 – 1.705	24000/F(kHz)	30
1.705 – 30.0	30	30
30 – 88	100	3
88 – 216	150	3
216 - 960	200	3
Above 960	500	3

**Note:** The following formula is used to convert the EIRP to field strength.

$$E = \frac{1000000\sqrt{30P}}{3} \mu\text{V/m, where P is the eirp (Watts)}$$



EIRP (dBm)	Field Strength at 3m (dBμV/m)
- 27	68.3

(3) KDB789033 D02 v02r01 G)2)c)

(i) Sections 15.407(b)(1-3) specifies the unwanted emissions limit for the U-NII-1 and U-NII-2 bands. As specified, emissions above 1000 MHz that are outside of the restricted bands are subject to a peak emission limit of -27 dBm/MHz.

(ii) Section 15.407(b)(4) specifies the unwanted emissions limit for the U-NII-3 band. A band emissions mask is specified in Section 15.407(b)(4)(i). The emission limits are based on the use of a peak detector.

### 3.4.2 Measuring Instruments

Please refer to the measuring equipment list in this test report.

### 3.4.3 Test Procedures

1. The testing follows FCC KDB 789033 D02 General UNII Test Procedures New Rules v02r01. Section G) Unwanted emissions measurement.

(1) Procedure for Unwanted Emissions Measurements Below 1000 MHz

- RBW = 120 kHz
- VBW = 300 kHz
- Detector = Peak
- Trace mode = max hold

(2) Procedure for Peak Unwanted Emissions Measurements Above 1000 MHz

- RBW = 1 MHz
- VBW ≥ 3 MHz
- Detector = Peak
- Sweep time = auto
- Trace mode = max hold

(3) Procedures for Average Unwanted Emissions Measurements Above 1000 MHz

- RBW = 1 MHz
- VBW = 10 Hz, when duty cycle is no less than 98 percent.
- $VBW \geq 1/T$ , when duty cycle is less than 98 percent where T is the minimum transmission duration over which the transmitter is on and is transmitting at its maximum power control level for the tested mode of operation.

2. The EUT is placed on a turntable with 0.8 meter for frequency below 1 GHz and 1.5 meter for frequency above 1 GHz respectively above ground.
3. The EUT is set 3 meters away from the receiving antenna which is mounted on the top of a variable height antenna tower.
4. The antenna is a broadband antenna and its height is adjusted between one meter and four meters above ground to find the maximum value of the field strength for both horizontal polarization and vertical polarization of the antenna.
5. For each suspected emission, the EUT is arranged to its worst case and then adjust the antenna tower (from 1 m to 4 m) and turntable (from 0 degree to 360 degrees) to find the maximum reading.
6. Radiated testing below 1 GHz is performed by adjusting the antenna tower from 1 m to 4 m and by rotating the turn table from 0 degree to 360 degrees to find the peak maximum hold reading. When there is no suspected emission found and the emission level is with at least 6 dB margin against QP limit line, the position is marked as “-”.
7. Radiated testing above 1 GHz is performed by adjusting the antenna tower from 1 m to 4 m and by rotating the turn table from 0 degree to 360 degrees to find the peak maximum hold reading for scanning all frequencies. When there is no suspected emission found and the harmonic emission level is with at least 6 dB margin against average limit line, the position is marked as “-”.

### 3.4.4 Test Setup

For radiated emissions below 30MHz

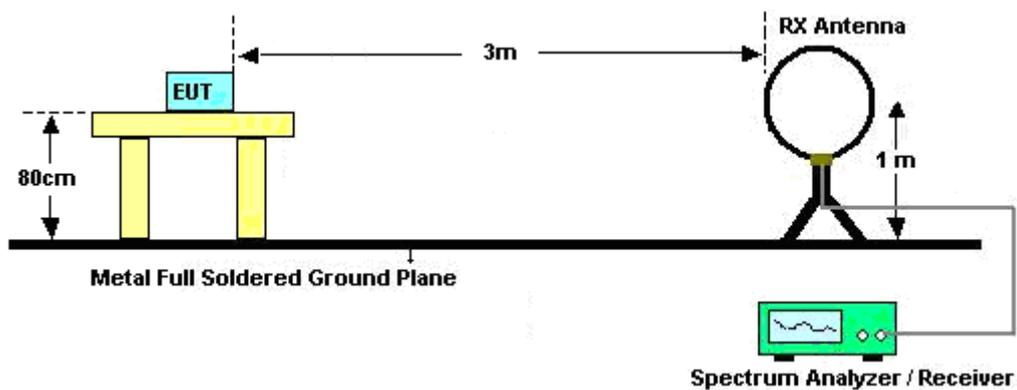

For radiated emissions from 30MHz to 1GHz

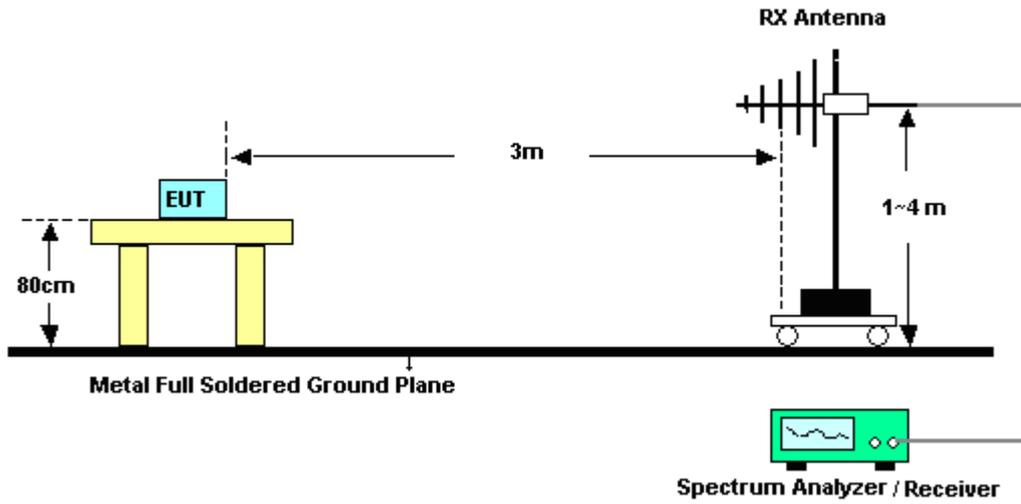

For radiated test from 1GHz to 18GHz

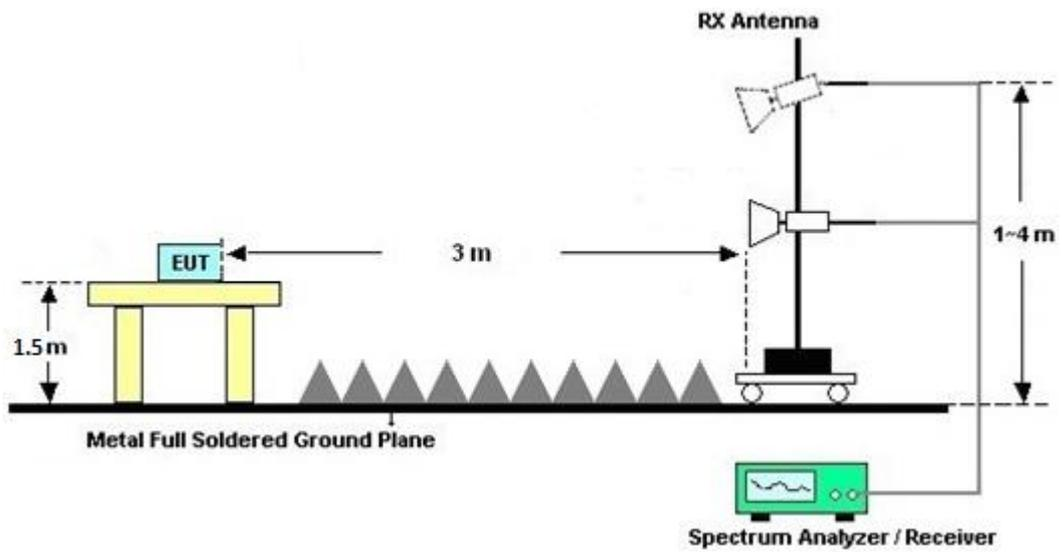

For radiated test above 18GHz

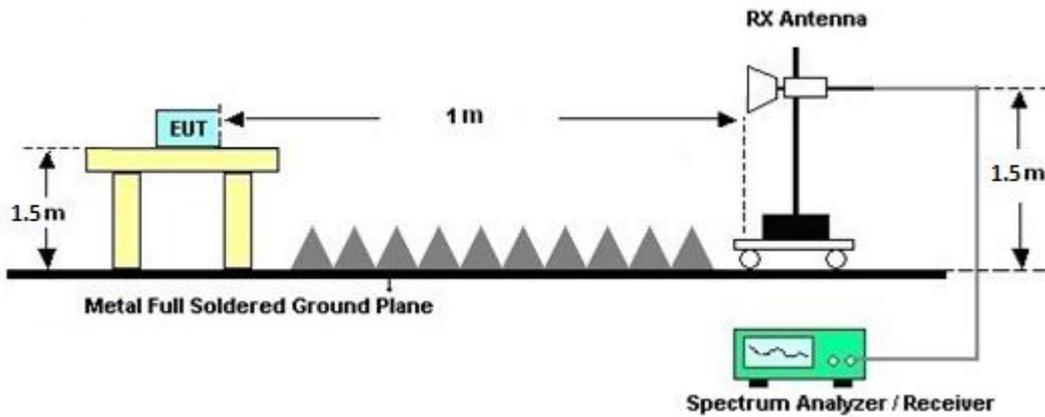

### 3.4.5 Test Results of Radiated Spurious Emissions (9 kHz ~ 30 MHz)

The low frequency, which starts from 9 kHz to 30 MHz, is pre-scanned and the result which is 20 dB lower than the limit line is not reported.

There is adequate comparison measurement of both open-field test site and alternative test site - semi-Anechoic chamber according to 414788 D01 Radiated Test Site v01r01, and the result came out very similar.

### 3.4.6 Test Result of Radiated Spurious at Band Edges

Please refer to Appendix C and D.

### 3.4.7 Duty Cycle

Please refer to Appendix E.

### 3.4.8 Test Result of Radiated Spurious Emissions (30MHz ~ 10th Harmonic)

Please refer to Appendix C and D.



### 3.5 AC Conducted Emission Measurement

#### 3.5.1 Limit of AC Conducted Emission

For equipment that is designed to be connected to the public utility (AC) power line, the radio frequency voltage that is conducted back onto the AC power line on any frequency or frequencies within the band 150 kHz to 30 MHz shall not exceed the limits in the following table.

Frequency of emission (MHz)	Conducted limit (dB $\mu$ V)	
	Quasi-peak	Average
0.15-0.5	66 to 56*	56 to 46*
0.5-5	56	46
5-30	60	50

\*Decreases with the logarithm of the frequency.

#### 3.5.2 Measuring Instruments

Please refer to the measuring equipment list in this test report.

#### 3.5.3 Test Procedures

1. The EUT is placed 0.4 meter away from the conducting wall of the shielding room, and is kept at least 80 centimeters from any other grounded conducting surface.
2. Connect EUT to the power mains through a line impedance stabilization network (LISN).
3. All the support units are connecting to the other LISN.
4. The LISN provides 50 ohm coupling impedance for the measuring instrument.
5. The FCC states that a 50 ohm, 50 microhenry LISN shall be used.
6. Both Line and Neutral shall be tested in order to find out the maximum conducted emission.
7. The frequency range from 150 kHz to 30 MHz is scanned.
8. Set the test-receiver system to Peak Detect Function and specified bandwidth with Maximum Hold Mode.

### 3.5.4 Test Setup

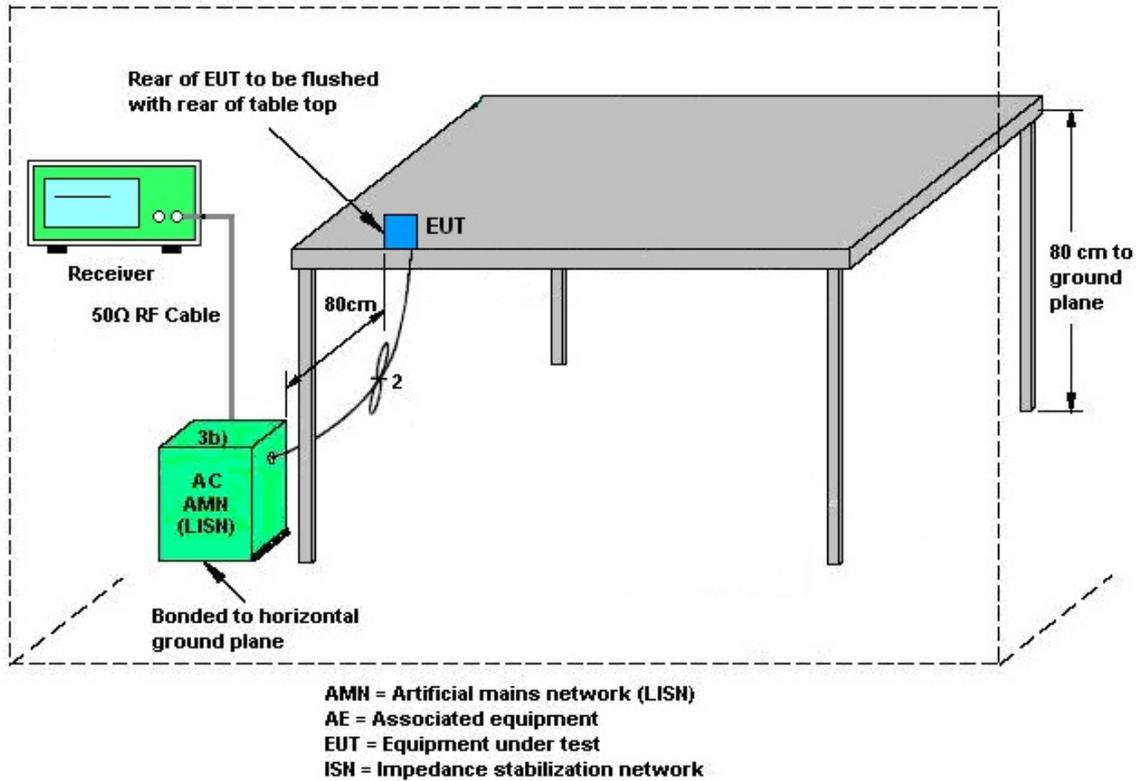

### 3.5.5 Test Result of AC Conducted Emission

Please refer to Appendix B.



## **3.6 Antenna Requirements**

### **3.6.1 Standard Applicable**

The use of a permanently attached antenna or of an antenna that uses a unique coupling to the intentional radiator shall be considered sufficient to comply with the rule.

### **3.6.2 Antenna Anti-Replacement Construction**

An embedded-in antenna design is used.





## 4 List of Measuring Equipment

Instrument	Brand Name	Model No.	Serial No.	Characteristics	Calibration Date	Test Date	Due Date	Remark
Loop Antenna	Rohde & Schwarz	HFH2-Z2	100488	9 kHz~30 MHz	Sep. 12, 2023	Feb. 15, 2024~ Apr. 17, 2024	Sep. 11, 2024	Radiation (03CH13-HY)
Amplifier	SONOMA	310N	187282	9kHz~1GHz	Dec. 13, 2023	Feb. 15, 2024~ Apr. 17, 2024	Dec. 12, 2024	Radiation (03CH13-HY)
Bilog Antenna	TESEQ	CBL 6111D & 00800N1D01N-06	40103 & 07	30MHz~1GHz	Apr. 23, 2023	Feb. 15, 2024~ Apr. 17, 2024	Apr. 22, 2024	Radiation (03CH13-HY)
EMI Test Receiver	Agilent	N9038A(MXE)	MY53290045	20MHz~8.4GHz	Apr. 25, 2023	Feb. 15, 2024~ Apr. 17, 2024	Apr. 24, 2024	Radiation (03CH13-HY)
Horn Antenna	SCHWARZBECK	BBHA 9120 D	9120D-1326	1GHz~18GHz	Aug. 17, 2023	Feb. 15, 2024~ Apr. 17, 2024	Aug. 16, 2024	Radiation (03CH13-HY)
Preamplifier	MITEQ	AMF-7D-0010180 0-30-10P	1590074	1GHz~18GHz	May 16, 2023	Feb. 15, 2024~ Apr. 17, 2024	May 15, 2024	Radiation (03CH13-HY)
Preamplifier	EM Electronics	EM01G18G	060803	1GHz~18GHz	Jan. 09, 2024	Feb. 15, 2024~ Apr. 17, 2024	Jan. 08, 2025	Radiation (03CH13-HY)
Preamplifier	EMEC	EM18G40G	060801	18GHz~40GHz	Jun. 27, 2023	Feb. 15, 2024~ Apr. 17, 2024	Jun. 26, 2024	Radiation (03CH13-HY)
SHF-EHF Horn Antenna	SCHWARZBECK	BBHA9170	1223	18GHz-40GHz	Jul. 10, 2023	Feb. 15, 2024~ Apr. 17, 2024	Jul. 09, 2024	Radiation (03CH13-HY)
Spectrum Analyzer	Keysight	N9010B	MY62170337	10Hz~44GHz	Aug. 17, 2023	Feb. 15, 2024~ Apr. 17, 2024	Aug. 16, 2024	Radiation (03CH13-HY)
Filter	Wainwright	WLK4-1000-1530 -8000-40SS	SN4	1.53GHz Low Pass Filter	Jun. 14, 2023	Feb. 15, 2024~ Apr. 17, 2024	Jun. 13, 2024	Radiation (03CH13-HY)
Filter	Wainwright	WHKX12-2700-30 00-18000-60SS	SN2	3GHz High Pass Filter	Jul. 10, 2023	Feb. 15, 2024~ Apr. 17, 2024	Jul. 09, 2024	Radiation (03CH13-HY)
Filter	Wainwright	WHKX8-5872.5-6 750-18000-40ST	SN5	6.75GHz High Pass Filter	Mar. 09, 2023	Feb. 15, 2024~ Mar. 07, 2024	Mar. 08, 2024	Radiation (03CH13-HY)
Filter	Wainwright	WHKX8-5872.5-6 750-18000-40ST	SN5	6.75GHz High Pass Filter	Mar. 08, 2024	Mar. 08, 2024~ Apr. 17, 2024	Mar. 07, 2025	Radiation (03CH13-HY)
Filter	Wainwright	WHKX6-7268-920 0-26500-40CD	SN4	9GHz High Pass Filter	May 23, 2023	Feb. 15, 2024~ Apr. 17, 2024	May 22, 2024	Radiation (03CH13-HY)
Notch Filter	Wainwright	WRCQV14-6025- 6425-7125-7525- 60SS	SN2	N/A	Jan. 05, 2024	Feb. 15, 2024~ Apr. 17, 2024	Jan. 04, 2025	Radiation (03CH13-HY)
RF Cable	HUBER + SUHNER	SUCOFLEX 102	804011/2, 804012/2	18GHz ~40GHz	Jan. 02, 2024	Feb. 15, 2024~ Apr. 17, 2024	Jan. 01, 2025	Radiation (03CH13-HY)
RF Cable	HUBER + SUHNER	SUCOFLEX 126E	0030/126E	30MHz~18GHz	Feb. 07, 2024	Feb. 15, 2024~ Apr. 17, 2024	Feb. 06, 2025	Radiation (03CH13-HY)
RF Cable	HUBER + SUHNER	SUCOFLEX 104	804793/4	30MHz~18GHz	Feb. 07, 2024	Feb. 15, 2024~ Apr. 17, 2024	Feb. 06, 2025	Radiation (03CH13-HY)
RF Cable	HUBER + SUHNER	SUCOFLEX 104	MY24961/4	30MHz~18GHz	Feb. 07, 2024	Feb. 15, 2024~ Apr. 17, 2024	Feb. 06, 2025	Radiation (03CH13-HY)
Hygrometer	TECPEL	DTM-303A	TP215159	N/A	Sep. 13, 2023	Feb. 15, 2024~ Apr. 17, 2024	Sep. 12, 2024	Radiation (03CH13-HY)
Controller	EMEC	EM1000	N/A	Control Turn table & Ant Mast	N/A	Feb. 15, 2024~ Apr. 17, 2024	N/A	Radiation (03CH13-HY)
Antenna Mast	EMEC	AM-BS-4500-B	N/A	1m~4m	N/A	Feb. 15, 2024~ Apr. 17, 2024	N/A	Radiation (03CH13-HY)
Turn Table	EMEC	TT2000	N/A	0~360 Degree	N/A	Feb. 15, 2024~ Apr. 17, 2024	N/A	Radiation (03CH13-HY)
Software	Audix	N/A	RK-001124	N/A	N/A	Feb. 15, 2024~ Apr. 17, 2024	N/A	Radiation (03CH13-HY)



Instrument	Brand Name	Model No.	Serial No.	Characteristics	Calibration Date	Test Date	Due Date	Remark
AC Power Source	ChainTek	APC-1000W	N/A	N/A	N/A	Feb. 02, 2024	N/A	Conduction (CO05-HY)
EMI Test Receiver	Rohde & Schwarz	ESR3	102388	9kHz~3.6GHz	Dec. 06, 2023	Feb. 02, 2024	Dec. 05, 2024	Conduction (CO05-HY)
Hygrometer	Testo	608-H1	34913912	N/A	Oct. 26, 2023	Feb. 02, 2024	Oct. 25, 2024	Conduction (CO05-HY)
LISN	Rohde & Schwarz	ENV216	100081	9kHz~30MHz	Nov. 22, 2023	Feb. 02, 2024	Nov. 21, 2024	Conduction (CO05-HY)
Software	Rohde & Schwarz	EMC32	N/A	N/A	N/A	Feb. 02, 2024	N/A	Conduction (CO05-HY)
ISN Cable	MVE	RG-400	200260	N/A	Dec. 28, 2023	Feb. 02, 2024	Dec. 27, 2024	Conduction (CO05-HY)
Pulse Limiter	SCHWARZBECK	VTSD 9561-FN	00691	9kHz-200MHz	Jul. 28, 2023	Feb. 02, 2024	Jul. 27, 2024	Conduction (CO05-HY)
LISN Cable	MVE	RG-400	260260	N/A	Dec. 28, 2023	Feb. 02, 2024	Dec. 27, 2024	Conduction (CO05-HY)
Hygrometer	TECPEL	DTM-303A	TP201996	N/A	Nov. 07, 2023	Jan. 26, 2024~ Apr. 22, 2024	Nov. 06, 2024	Conducted (TH05-HY)
Power Sensor	DARE	RPR3006W	17100015SNO36 (NO:35_原144)	10MHz~6GHz	Aug. 23, 2023	Jan. 26, 2024~ Apr. 22, 2024	Aug. 22, 2024	Conducted (TH05-HY)
Signal Analyzer	Rohde & Schwarz	FSV40	101564	10Hz ~ 40GHz	Sep. 12, 2023	Jan. 26, 2024~ Apr. 22, 2024	Sep. 11, 2024	Conducted (TH05-HY)



## 5 Measurement Uncertainty

### Uncertainty of Conducted Emission Measurement (150kHz ~ 30MHz)

Measuring Uncertainty for a Level of Confidence of 95% ( $U = 2Uc(y)$ )	3.5 dB
---	--------

### Uncertainty of Radiated Emission Measurement (30 MHz ~ 1000 MHz)

Measuring Uncertainty for a Level of Confidence of 95% ( $U = 2Uc(y)$ )	6.5 dB
---	--------

### Uncertainty of Radiated Emission Measurement (1000 MHz ~ 6000 MHz)

Measuring Uncertainty for a Level of Confidence of 95% ( $U = 2Uc(y)$ )	4.2 dB
---	--------

### Uncertainty of Radiated Emission Measurement (6000 MHz ~ 18000 MHz)

Measuring Uncertainty for a Level of Confidence of 95% ( $U = 2Uc(y)$ )	4.6 dB
---	--------

### Uncertainty of Radiated Emission Measurement (18000 MHz ~ 40000 MHz)

Measuring Uncertainty for a Level of Confidence of 95% ( $U = 2Uc(y)$ )	5.3 dB
---	--------

**Appendix A. Test Result of Conducted Test Items**

Test Engineer:	Sylvia Li	Temperature:	21~25	°C
Test Date:	2024/1/26~2024/04/22	Relative Humidity:	51~54	%

**TEST RESULTS DATA**  
**26dB and 99% OBW**

U-NII-1 MIMO													
Mod.	Data Rate	N <sub>TX</sub>	CH.	Freq. (MHz)	99% Bandwidth (MHz)		26 dB Bandwidth (MHz)		IC 99% Bandwidth Power Limit (dBm)		IC 99% Bandwidth EIRP Limit (dBm)		Note
					Ant 6	Ant 7	Ant 6	Ant 7	Ant 6	Ant 7	Ant 6	Ant 7	
11a	6Mbps	2	36	5180	16.33	16.33	19.68	19.43	-	-	22.13	-	
11a	6Mbps	2	44	5220	16.33	16.28	19.32	19.40	-	-	22.12	-	
11a	6Mbps	2	48	5240	16.28	16.28	19.21	19.21	-	-	22.12	-	
VHT20	MCS0	2	36	5180	17.63	17.63	20.84	21.31	-	-	22.46	-	
VHT20	MCS0	2	44	5220	17.48	17.48	20.54	20.72	-	-	22.43	-	
VHT20	MCS0	2	48	5240	17.48	17.53	20.58	20.30	-	-	22.43	-	
VHT40	MCS0	2	38	5190	36.06	36.06	40.66	40.42	-	-	23.01	-	
VHT40	MCS0	2	46	5230	36.06	36.06	40.56	40.80	-	-	23.01	-	
VHT80	MCS0	2	42	5210	75.40	75.40	82.88	82.11	-	-	23.01	-	
VHT160	MCS0	2	50	5250	154.89	154.89	167.95	166.70	-	-	23.01	-	

**TEST RESULTS DATA**  
**Average Power Table**

FCC U-NII-1 MIMO														
Mod.	Data Rate	N <sub>TX</sub>	CH.	Freq. (MHz)	Duty Factor (dB)		Average Conducted Power (dBm)			FCC Conducted Power Limit (dBm)		DG (dBi)		Pass/Fail
					Ant 6	Ant 7	Ant 6	Ant 7	SUM	Ant 6	Ant 7	Ant 6	Ant 7	
11a	6Mbps	2	36	5180	0.65	0.68	17.70	17.40	20.56	24.00		3.51	Pass	
11a	6Mbps	2	44	5220	0.65	0.68	18.20	18.00	21.11	24.00		3.51	Pass	
11a	6Mbps	2	48	5240	0.65	0.68	18.10	17.90	21.01	24.00		3.51	Pass	
HT20	MCS0	2	36	5180	0.65	0.66	17.40	16.50	19.98	24.00		3.51	Pass	
HT20	MCS0	2	44	5220	0.65	0.66	18.50	18.20	21.36	24.00		3.51	Pass	
HT20	MCS0	2	48	5240	0.65	0.66	18.20	17.70	20.97	24.00		3.51	Pass	
HT40	MCS0	2	38	5190	0.66	0.66	16.70	16.20	19.47	24.00		3.51	Pass	
HT40	MCS0	2	46	5230	0.66	0.66	18.30	18.10	21.21	24.00		3.51	Pass	
VHT20	MCS0	2	36	5180	0.66	0.65	17.50	16.60	20.08	24.00		3.51	Pass	
VHT20	MCS0	2	44	5220	0.66	0.65	18.60	18.30	21.46	24.00		3.51	Pass	
VHT20	MCS0	2	48	5240	0.66	0.65	18.30	17.80	21.07	24.00		3.51	Pass	
VHT40	MCS0	2	38	5190	0.66	0.66	16.80	16.30	19.57	24.00		3.51	Pass	
VHT40	MCS0	2	46	5230	0.66	0.66	18.40	18.20	21.31	24.00		3.51	Pass	
VHT80	MCS0	2	42	5210	0.65	0.69	16.00	15.70	18.86	24.00		3.51	Pass	
VHT160	MCS0	2	50	5250	0.66	0.66	14.90	14.70	17.81	24.00		3.51	Pass	

**TEST RESULTS DATA**  
**Power Spectral Density**

FCC U-NII-1 MIMO																	
Mod.	Data Rate	N <sub>rx</sub>	CH.	Freq. (MHz)	Duty Factor (dB)		Average Power Density with Duty Factor (dBm/MHz)			Average PSD Limit (dBm/MHz)		DG (dBi)		Pass /Fail			
					Ant 6	Ant 7	Ant 6	Ant 7	SUM	Ant 6	Ant 7	Ant 6	Ant 7				
11a	6Mbps	2	36	5180	0.65	0.68	-		-	-	-	-	-	10.32	11.00	5.69	Pass
11a	6Mbps	2	44	5220	0.65	0.68								10.80	11.00	5.69	Pass
11a	6Mbps	2	48	5240	0.65	0.68								10.89	11.00	5.69	Pass
VHT20	MCS0	2	36	5180	0.66	0.65								8.23	11.00	5.69	Pass
VHT20	MCS0	2	44	5220	0.66	0.65								10.46	11.00	5.69	Pass
VHT20	MCS0	2	48	5240	0.66	0.65								10.81	11.00	5.69	Pass
VHT40	MCS0	2	38	5190	0.66	0.66								6.56	11.00	5.69	Pass
VHT40	MCS0	2	46	5230	0.66	0.66								8.14	11.00	5.69	Pass
VHT80	MCS0	2	42	5210	0.65	0.69								0.92	11.00	5.69	Pass
VHT160	MCS0	2	50	5250	0.66	0.66								-2.90	11.00	5.69	Pass

**TEST RESULTS DATA**  
**26dB and 99% OBW**

U-NII-2A MIMO															
Mod.	Data Rate	N <sub>TX</sub>	CH.	Freq. (MHz)	99% Bandwidth (MHz)		26 dB Bandwidth (MHz)		IC 99% Bandwidth Power Limit (dBm)		IC 99% Bandwidth EIRP Limit (dBm)		FCC 26dB Bandwidth Power Limit (dBm)		Note
					Ant 6	Ant 7	Ant 6	Ant 7	Ant 6	Ant 7	Ant 6	Ant 7	Ant 6	Ant 7	
11a	6Mbps	2	52	5260	16.28	16.28	19.17	19.38	23.12		29.12		23.83		-
11a	6Mbps	2	60	5300	16.33	16.28	19.65	19.45	23.12		29.12		23.89		
11a	6Mbps	2	64	5320	16.33	16.28	19.29	19.37	23.12		29.12		23.85		
VHT20	MCS0	2	52	5260	17.48	17.53	20.62	20.98	23.43		29.43		23.98		
VHT20	MCS0	2	60	5300	17.53	17.53	20.43	20.24	23.44		29.44		23.98		
VHT20	MCS0	2	64	5320	17.48	17.53	20.59	20.34	23.43		29.43		23.98		
VHT40	MCS0	2	54	5270	36.06	36.06	40.64	40.56	23.98		30.00		23.98		
VHT40	MCS0	2	62	5310	36.26	36.26	41.26	41.23	23.98		30.00		23.98		
VHT80	MCS0	2	58	5290	75.40	75.40	83.01	81.98	23.98		30.00		23.98		



**TEST RESULTS DATA**  
**Average Power Table**

FCC U-NII-2A MIMO															
Mod.	Data Rate	N <sub>TX</sub>	CH.	Freq. (MHz)	Duty Factor (dB)		Average Conducted Power (dBm)			FCC Conducted Power Limit (dBm)		DG (dBi)		EIRP Power Limit (dBm)	Pass/Fail
					Ant 6	Ant 7	Ant 6	Ant 7	SUM	Ant 6	Ant 7	Ant 6	Ant 7		
11a	6Mbps	2	52	5260	0.65	0.68	17.90	17.80	20.86	23.83		3.86		30	Pass
11a	6Mbps	2	60	5300	0.65	0.68	18.20	17.90	21.06	23.89		3.86		30	Pass
11a	6Mbps	2	64	5320	0.65	0.68	18.10	17.90	21.01	23.85		3.86		30	Pass
HT20	MCS0	2	52	5260	0.65	0.66	17.90	17.60	20.76	23.98		3.86		30	Pass
HT20	MCS0	2	60	5300	0.65	0.66	18.80	18.20	21.52	23.98		3.86		30	Pass
HT20	MCS0	2	64	5320	0.65	0.66	18.10	17.70	20.91	23.98		3.86		30	Pass
HT40	MCS0	2	54	5270	0.66	0.66	18.10	18.10	21.11	23.98		3.86		30	Pass
HT40	MCS0	2	62	5310	0.66	0.66	15.40	15.00	18.21	23.98		3.86		30	Pass
VHT20	MCS0	2	52	5260	0.66	0.65	18.00	17.70	20.86	23.98		3.86		30	Pass
VHT20	MCS0	2	60	5300	0.66	0.65	18.90	18.30	21.62	23.98		3.86		30	Pass
VHT20	MCS0	2	64	5320	0.66	0.65	18.20	17.80	21.01	23.98		3.86		30	Pass
VHT40	MCS0	2	54	5270	0.66	0.66	18.20	18.20	21.21	23.98		3.86		30	Pass
VHT40	MCS0	2	62	5310	0.66	0.66	15.50	15.10	18.31	23.98		3.86		30	Pass
VHT80	MCS0	2	58	5290	0.65	0.69	15.90	15.50	18.71	23.98		3.86		30	Pass

**TEST RESULTS DATA**  
**Power Spectral Density**

U-NII-2A MIMO														
Mod.	Data Rate	N <sub>rx</sub>	CH.	Freq. (MHz)	Duty Factor (dB)		Average Power Density with Duty Factor (dBm/MHz)			Average PSD Limit (dBm/MHz)		DG (dBi)		Pass /Fail
					Ant 6	Ant 7	Ant 6	Ant 7	SUM	Ant 6	Ant 7	Ant 6	Ant 7	
11a	6Mbps	2	52	5260	0.65	0.68	-		SUM	10.74	11.00	5.87	-	Pass
11a	6Mbps	2	60	5300	0.65	0.68				10.68	11.00	5.87		Pass
11a	6Mbps	2	64	5320	0.65	0.68				10.79	11.00	5.87		Pass
VHT20	MCS0	2	52	5260	0.66	0.65				10.65	11.00	5.87		Pass
VHT20	MCS0	2	60	5300	0.66	0.65				10.89	11.00	5.87		Pass
VHT20	MCS0	2	64	5320	0.66	0.65				10.69	11.00	5.87		Pass
VHT40	MCS0	2	54	5270	0.66	0.66				7.94	11.00	5.87		Pass
VHT40	MCS0	2	62	5310	0.66	0.66				3.42	11.00	5.87		Pass
VHT80	MCS0	2	58	5290	0.65	0.69				1.03	11.00	5.87		Pass

**TEST RESULTS DATA**  
**26dB and 99% OBW**

U-NII-2C MIMO																
Mod.	Data Rate	N <sub>rx</sub>	CH.	Freq. (MHz)	99% Bandwidth In U-NII 2C (MHz)		26 dB Bandwidth In U-NII 2C (MHz)		IC 99% Bandwidth Power Limit (dBm)		IC 99% Bandwidth EIRP Limit (dBm)		FCC 26dB Bandwidth Power Limit (dBm)		6 dB Bandwidth for Straddle Channel (MHz)	
					Ant 6	Ant 7	Ant 6	Ant 7	Ant 6	Ant 7	Ant 6	Ant 7	Ant 6	Ant 7	Ant 6	Ant 7
11a	6Mbps	2	100	5500	16.33	16.33	19.39	19.42	23.13		29.13		23.88		----	----
11a	6Mbps	2	116	5580	16.28	16.33	19.49	19.51	23.12		29.12		23.90		----	----
11a	6Mbps	2	140	5700	16.33	16.33	19.60	19.15	23.13		29.13		23.82		----	----
VHT20	MCS0	2	100	5500	17.53	17.53	20.42	20.71	23.44		29.44		23.98		----	----
VHT20	MCS0	2	116	5580	17.43	17.53	20.47	20.82	23.41		29.41		23.98		----	----
VHT20	MCS0	2	140	5700	17.58	17.58	20.87	20.94	23.45		29.45		23.98		----	----
VHT40	MCS0	2	102	5510	36.26	36.26	41.14	40.74	23.98		30.00		23.98		----	----
VHT40	MCS0	2	110	5550	36.06	36.06	40.56	40.54	23.98		30.00		23.98		----	----
VHT40	MCS0	2	134	5670	36.06	36.06	40.48	40.48	23.98		30.00		23.98		----	----
VHT80	MCS0	2	106	5530	74.93	75.04	81.31	81.66	23.98		30.00		23.98		----	----
VHT80	MCS0	2	122	5610	75.04	75.04	81.63	81.44	23.98		30.00		23.98		----	----
VHT160	MCS0	2	114	5570	154.41	154.17	164.98	164.64	23.98		30.00		23.98		----	----

U-NII-2C straddle channel MIMO																
Mod.	Data Rate	N <sub>rx</sub>	CH.	Freq. (MHz)	99% Bandwidth In U-NII 2C (MHz)		26 dB Bandwidth In U-NII 2C (MHz)		IC 99% Bandwidth Power Limit (dBm)		IC 99% Bandwidth EIRP Limit (dBm)		FCC 26dB Bandwidth Power Limit (dBm)		6 dB Bandwidth for Straddle Channel (MHz)	
					Ant 6	Ant 7	Ant 6	Ant 7	Ant 6	Ant 7	Ant 6	Ant 7	Ant 6	Ant 7	Ant 6	Ant 7
11a	6Mbps	2	144	5720	13.19	13.19	14.81	14.62	22.20		28.20		22.65		2.525	2.555
VHT20	MCS0	2	144	5720	13.74	13.79	15.22	15.14	22.38		28.38		22.80		2.555	2.49
VHT40	MCS0	2	142	5710	32.98	33.08	35.26	35.18	23.98		30.00		23.98		2.523	2.523
VHT80	MCS0	2	138	5690	72.52	72.52	76.06	75.29	23.98		30.00		23.98		1.288	2.516
6dB Bandwidth Limit $\geq$ 500kHz															Pass	

**TEST RESULTS DATA**  
**Average Power Table**

FCC U-NII-2C MIMO															
Mod.	Data Rate	N <sub>TX</sub>	CH.	Freq. (MHz)	Duty Factor (dB)		Average Conducted Power (dBm)			FCC Conducted Power Limit (dBm)		DG (dBi)		EIRP Power Limit (dBm)	Pass/Fail
					Ant 6	Ant 7	Ant 6	Ant 7	SUM	Ant 6	Ant 7	Ant 6	Ant 7		
11a	6Mbps	2	100	5500	0.65	0.68	18.40	18.10	21.26	23.88		3.95		30	Pass
11a	6Mbps	2	116	5580	0.65	0.68	18.20	18.10	21.16	23.90		3.95		30	Pass
11a	6Mbps	2	140	5700	0.65	0.68	18.30	18.20	21.26	23.82		3.95		30	Pass
HT20	MCS0	2	100	5500	0.65	0.66	18.30	18.00	21.16	23.98		3.95		30	Pass
HT20	MCS0	2	116	5580	0.65	0.66	18.30	18.10	21.21	23.98		3.95		30	Pass
HT20	MCS0	2	140	5700	0.65	0.66	17.70	17.80	20.76	23.98		3.95		30	Pass
HT40	MCS0	2	102	5510	0.66	0.66	18.50	18.40	21.46	23.98		3.95		30	Pass
HT40	MCS0	2	110	5550	0.66	0.66	18.10	18.00	21.06	23.98		3.95		30	Pass
HT40	MCS0	2	134	5670	0.66	0.66	18.00	17.80	20.91	23.98		3.95		30	Pass
VHT20	MCS0	2	100	5500	0.66	0.65	18.40	18.10	21.26	23.98		3.95		30	Pass
VHT20	MCS0	2	116	5580	0.66	0.65	18.40	18.20	21.31	23.98		3.95		30	Pass
VHT20	MCS0	2	140	5700	0.66	0.65	17.80	17.90	20.86	23.98		3.95		30	Pass
VHT40	MCS0	2	102	5510	0.66	0.66	18.60	18.50	21.56	23.98		3.95		30	Pass
VHT40	MCS0	2	110	5550	0.66	0.66	18.20	18.10	21.16	23.98		3.95		30	Pass
VHT40	MCS0	2	134	5670	0.66	0.66	18.10	17.90	21.01	23.98		3.95		30	Pass
VHT80	MCS0	2	106	5530	0.65	0.69	17.40	17.30	20.36	23.98		3.95		30	Pass
VHT80	MCS0	2	122	5610	0.65	0.69	17.50	17.30	20.41	23.98		3.95		30	Pass
VHT160	MCS0	2	114	5570	0.66	0.66	14.90	14.60	17.76	23.98		3.95		30	Pass

FCC U-NII-2C straddle channel MIMO															
Mod.	Data Rate	N <sub>TX</sub>	CH.	Freq. (MHz)	Duty Factor (dB)		Average Conducted Power (dBm)			FCC Conducted Power Limit (dBm)		DG (dBi)		EIRP Power Limit (dBm)	Pass/Fail
					Ant 6	Ant 7	Ant 6	Ant 7	SUM	Ant 6	Ant 7	Ant 6	Ant 7		
11a	6Mbps	2	144	5720	0.65	0.68	18.50	18.20	21.36	22.65		3.95		30	Pass
HT20	MCS0	2	144	5720	0.65	0.66	18.10	17.70	20.91	23.98		3.95		30	Pass
HT40	MCS0	2	142	5710	0.66	0.66	18.30	18.20	21.26	23.98		3.95		30	Pass
VHT20	MCS0	2	144	5720	0.66	0.65	18.20	17.80	21.01	22.80		3.95		30	Pass
VHT40	MCS0	2	142	5710	0.66	0.66	18.40	18.30	21.36	23.98		3.95		30	Pass
VHT80	MCS0	2	138	5690	0.65	0.69	17.40	17.60	20.51	23.98		3.95		30	Pass

**TEST RESULTS DATA**  
**Power Spectral Density**

U-NII-2C MIMO														
Mod.	Data Rate	N <sub>TX</sub>	CH.	Freq. (MHz)	Duty Factor (dB)		Average Power Density with Duty Factor (dBm/MHz)			Average PSD Limit (dBm/MHz)		DG (dBi)		Pass /Fail
					Ant 6	Ant 7	Ant 6	Ant 7	SUM	Ant 6	Ant 7	Ant 6	Ant 7	
11a	6Mbps	2	100	5500	0.65	0.68	-	-	10.74	10.85	6.15	-	Pass	
11a	6Mbps	2	116	5580	0.65	0.68	-	-	10.79	10.85	6.15	-	Pass	
11a	6Mbps	2	140	5700	0.65	0.68	-	-	10.72	10.85	6.15	-	Pass	
VHT20	MCS0	2	100	5500	0.66	0.65	-	-	10.47	10.85	6.15	-	Pass	
VHT20	MCS0	2	116	5580	0.66	0.65	-	-	10.72	10.85	6.15	-	Pass	
VHT20	MCS0	2	140	5700	0.66	0.65	-	-	8.55	10.85	6.15	-	Pass	
VHT40	MCS0	2	102	5510	0.66	0.66	-	-	6.22	10.85	6.15	-	Pass	
VHT40	MCS0	2	110	5550	0.66	0.66	-	-	7.48	10.85	6.15	-	Pass	
VHT40	MCS0	2	134	5670	0.66	0.66	-	-	7.48	10.85	6.15	-	Pass	
VHT80	MCS0	2	106	5530	0.65	0.69	-	-	4.82	10.85	6.15	-	Pass	
VHT80	MCS0	2	122	5610	0.65	0.69	-	-	4.75	10.85	6.15	-	Pass	
VHT160	MCS0	2	114	5570	0.66	0.66	-	-	-1.30	10.85	6.15	-	Pass	

U-NII-2C straddle channel MIMO														
Mod.	Data Rate	N <sub>TX</sub>	CH.	Freq. (MHz)	Duty Factor (dB)		Average Power Density (dBm/MHz)			Average PSD Limit (dBm/MHz)		DG (dBi)		Pass /Fail
					Ant 6	Ant 7	Ant 6	Ant 7	SUM	Ant 6	Ant 7	Ant 6	Ant 7	
11a	6Mbps	2	144	5720	0.65	0.68	-	-	10.72	10.85	6.15	-	Pass	
VHT20	MCS0	2	144	5720	0.66	0.65	-	-	10.60	10.85	6.15	-	Pass	
VHT40	MCS0	2	142	5710	0.66	0.66	-	-	7.90	10.85	6.15	-	Pass	
VHT80	MCS0	2	138	5690	0.65	0.69	-	-	4.79	10.85	6.15	-	Pass	

**TEST RESULTS DATA**  
**26dB and 99% OBW**

U-NII-1 MIMO														
Mod.	Data Rate	N <sub>TX</sub>	CH.	Freq. (MHz)	RU Config	99% Bandwidth (MHz)		26 dB Bandwidth (MHz)		IC 99% Bandwidth Power Limit (dBm)		IC 99% Bandwidth EIRP Limit (dBm)		Note
						Ant 6	Ant 7	Ant 6	Ant 7	Ant 6	Ant 7	Ant 6	Ant 7	
HE20	MCS0	2	36	5180	Full	18.98	18.93	21.12	21.54	-	-	22.77	-	-
HE20	MCS0	2	44	5220	Full	18.88	18.88	20.90	21.21	-	-	22.76	-	-
HE20	MCS0	2	48	5240	Full	18.83	18.88	20.98	21.09	-	-	22.75	-	-
HE40	MCS0	2	38	5190	Full	37.76	37.76	41.39	41.22	-	-	23.01	-	-
HE40	MCS0	2	46	5230	Full	37.76	37.76	41.04	41.28	-	-	23.01	-	-
HE80	MCS0	2	42	5210	Full	77.08	77.20	83.26	82.66	-	-	23.01	-	-
HE160	MCS0	2	50	5250	Full	156.56	156.56	166.70	165.74	-	-	23.01	-	-

**TEST RESULTS DATA**  
**Average Power Table**

FCC U-NII-1 MIMO															
Mod.	Data Rate	N <sub>TX</sub>	CH.	Freq. (MHz)	RU Config	Duty Factor (dB)		Average Conducted Power (dBm)			FCC Conducted Power Limit (dBm)		DG (dBi)		Pass/Fail
						Ant 6	Ant 7	Ant 6	Ant 7	SUM	Ant 6	Ant 7	Ant 6	Ant 7	
HE20	MCS0	2	36	5180	Full	0.66	0.66	17.60	16.70	20.18	24.00	3.51		Pass	
HE20	MCS0	2	36	5180	26/0	0.64	0.64	8.30	7.90	11.11	24.00	3.51		Pass	
HE20	MCS0	2	36	5180	52/37	0.65	0.65	10.90	10.30	13.62	24.00	3.51		Pass	
HE20	MCS0	2	36	5180	106/53	0.67	0.69	13.60	13.60	16.61	24.00	3.51		Pass	
HE20	MCS0	2	44	5220	Full	0.66	0.66	18.70	18.40	21.56	24.00	3.51		Pass	
HE20	MCS0	2	44	5220	26/4	0.64	0.64	11.90	11.80	14.86	24.00	3.51		Pass	
HE20	MCS0	2	44	5220	52/38	0.65	0.65	14.00	13.90	16.96	24.00	3.51		Pass	
HE20	MCS0	2	44	5220	106/53	0.67	0.69	17.00	16.50	19.77	24.00	3.51		Pass	
HE20	MCS0	2	48	5240	Full	0.66	0.66	18.40	17.90	21.17	24.00	3.51		Pass	
HE20	MCS0	2	48	5240	26/8	0.64	0.64	10.00	10.20	13.11	24.00	3.51		Pass	
HE20	MCS0	2	48	5240	52/40	0.65	0.65	13.00	13.10	16.06	24.00	3.51		Pass	
HE20	MCS0	2	48	5240	106/54	0.67	0.69	16.70	16.20	19.47	24.00	3.51		Pass	
HE40	MCS0	2	38	5190	Full	0.67	0.65	16.90	16.40	19.67	24.00	3.51		Pass	
HE40	MCS0	2	38	5190	242/61	0.66	0.66	14.30	14.30	17.31	24.00	3.51		Pass	
HE40	MCS0	2	46	5230	Full	0.67	0.65	18.50	18.30	21.41	24.00	3.51		Pass	
HE40	MCS0	2	46	5230	242/62	0.66	0.66	18.00	17.20	20.63	24.00	3.51		Pass	
HE80	MCS0	2	42	5210	Full	0.69	0.69	16.10	15.80	18.96	24.00	3.51		Pass	
HE80	MCS0	2	42	5210	484/65	0.69	0.69	13.20	13.00	16.11	24.00	3.51		Pass	
HE160	MCS0	2	50	5250	Full	0.67	0.68	15.00	14.80	17.91	24.00	3.51		Pass	
HE160	MCS0	2	50	5250	996/67	0.66	0.68	12.30	12.00	15.16	24.00	3.51		Pass	

**TEST RESULTS DATA**  
**Power Spectral Density**

FCC U-NII-1 MIMO															
Mod.	Data Rate	N <sub>TX</sub>	CH.	Freq. (MHz)	RU Config	Duty Factor (dB)		Average Power Density with Duty Factor (dBm/MHz)			Average PSD Limit (dBm/MHz)		DG (dBi)		Pass /Fail
						Ant 6	Ant 7	Ant 6	Ant 7	SUM	Ant 6	Ant 7	Ant 6	Ant 7	
HE20	MCS0	2	36	5180	Full	0.66	0.66			7.92	11.00	5.69		Pass	
HE20	MCS0	2	36	5180	26/0	0.64	0.64			7.90	11.00	5.69		Pass	
HE20	MCS0	2	36	5180	52/37	0.65	0.65			7.44	11.00	5.69		Pass	
HE20	MCS0	2	36	5180	106/53	0.67	0.69			7.47	11.00	5.69		Pass	
HE20	MCS0	2	44	5220	Full	0.66	0.66			10.74	11.00	5.69		Pass	
HE20	MCS0	2	44	5220	26/4	0.64	0.64			10.66	11.00	5.69		Pass	
HE20	MCS0	2	44	5220	52/38	0.65	0.65			10.72	11.00	5.69		Pass	
HE20	MCS0	2	44	5220	106/53	0.67	0.69			10.64	11.00	5.69		Pass	
HE20	MCS0	2	48	5240	Full	0.66	0.66			10.66	11.00	5.69		Pass	
HE20	MCS0	2	48	5240	26/8	0.64	0.64			10.29	11.00	5.69		Pass	
HE20	MCS0	2	48	5240	52/40	0.65	0.65			10.27	11.00	5.69		Pass	
HE20	MCS0	2	48	5240	106/54	0.67	0.69			10.65	11.00	5.69		Pass	
HE40	MCS0	2	38	5190	Full	0.67	0.65			6.51	11.00	5.69		Pass	
HE40	MCS0	2	38	5190	242/61	0.66	0.66			4.38	11.00	5.69		Pass	
HE40	MCS0	2	46	5230	Full	0.67	0.65			8.43	11.00	5.69		Pass	
HE40	MCS0	2	46	5230	242/62	0.66	0.66			8.05	11.00	5.69		Pass	
HE80	MCS0	2	42	5210	Full	0.69	0.69			0.73	11.00	5.69		Pass	
HE80	MCS0	2	42	5210	484/65	0.69	0.69			0.43	11.00	5.69		Pass	
HE160	MCS0	2	50	5250	Full	0.67	0.68			-2.97	11.00	5.69		Pass	
HE160	MCS0	2	50	5250	996/67	0.66	0.68			-3.46	11.00	5.69		Pass	



**TEST RESULTS DATA**  
**26dB and 99% OBW**

U-NII-2A MIMO																
Mod.	Data Rate	N <sub>TX</sub>	CH.	Freq. (MHz)	RU Config	99% Bandwidth (MHz)		26 dB Bandwidth (MHz)		IC 99% Bandwidth Power Limit (dBm)		IC 99% Bandwidth EIRP Limit (dBm)		FCC 26dB Bandwidth Power Limit (dBm)		Note
						Ant 6	Ant 7	Ant 6	Ant 7	Ant 6	Ant 7	Ant 6	Ant 7	Ant 6	Ant 7	
HE20	MCS0	2	52	5260	Full	18.83	18.83	20.95	20.83	23.75		29.75		23.98		
HE20	MCS0	2	60	5300	Full	18.83	18.83	21.30	21.29	23.75		29.75		23.98		
HE20	MCS0	2	64	5320	Full	18.83	18.83	21.26	20.80	23.75		29.75		23.98		
HE40	MCS0	2	54	5270	Full	37.76	37.76	41.30	41.71	23.98		30.00		23.98		
HE40	MCS0	2	62	5310	Full	37.96	37.86	41.66	41.57	23.98		30.00		23.98		
HE80	MCS0	2	58	5290	Full	77.08	77.20	82.82	82.94	23.98		30.00		23.98		

**TEST RESULTS DATA**  
**Average Power Table**

FCC U-NII-2A MIMO																
Mod.	Data Rate	N <sub>TX</sub>	CH.	Freq. (MHz)	RU Config	Duty Factor (dB)		Average Conducted Power (dBm)			FCC Conducted Power Limit (dBm)		DG (dBi)		EIRP Power Limit (dBm)	Pass/Fail
						Ant 6	Ant 7	Ant 6	Ant 7	SUM	Ant 6	Ant 7	Ant 6	Ant 7		
HE20	MCS0	2	52	5260	Full	0.66	0.66	18.10	17.80	20.96	23.98	3.86	30	Pass		
HE20	MCS0	2	52	5260	26/0	0.64	0.64	10.00	10.00	13.01	23.98	3.86	30	Pass		
HE20	MCS0	2	52	5260	52/37	0.65	0.65	13.10	13.10	16.11	23.98	3.86	30	Pass		
HE20	MCS0	2	52	5260	106/53	0.67	0.69	16.00	15.80	18.91	23.98	3.86	30	Pass		
HE20	MCS0	2	60	5300	Full	0.66	0.66	19.00	18.40	21.72	23.98	3.86	30	Pass		
HE20	MCS0	2	60	5300	26/4	0.64	0.64	11.80	11.80	14.81	23.98	3.86	30	Pass		
HE20	MCS0	2	60	5300	52/38	0.65	0.65	14.00	13.80	16.91	23.98	3.86	30	Pass		
HE20	MCS0	2	60	5300	106/53	0.67	0.69	16.90	16.50	19.71	23.98	3.86	30	Pass		
HE20	MCS0	2	64	5320	Full	0.66	0.66	18.30	17.90	21.11	23.98	3.86	30	Pass		
HE20	MCS0	2	64	5320	26/8	0.64	0.64	10.40	10.60	13.51	23.98	3.86	30	Pass		
HE20	MCS0	2	64	5320	52/40	0.65	0.65	13.30	13.20	16.26	23.98	3.86	30	Pass		
HE20	MCS0	2	64	5320	106/54	0.67	0.69	15.00	14.70	17.86	23.98	3.86	30	Pass		
HE40	MCS0	2	54	5270	Full	0.67	0.65	18.30	18.30	21.31	23.98	3.86	30	Pass		
HE40	MCS0	2	54	5270	242/61	0.66	0.66	17.90	17.30	20.62	23.98	3.86	30	Pass		
HE40	MCS0	2	62	5310	Full	0.67	0.65	15.60	15.20	18.41	23.98	3.86	30	Pass		
HE40	MCS0	2	62	5310	242/62	0.66	0.66	12.40	12.30	15.36	23.98	3.86	30	Pass		
HE80	MCS0	2	58	5290	Full	0.69	0.69	16.00	15.60	18.81	23.98	3.86	30	Pass		
HE80	MCS0	2	58	5290	484/66	0.69	0.69	13.00	12.80	15.91	23.98	3.86	30	Pass		
HE160	MCS0	2	50	5250	Full	0.67	0.68	15.00	14.80	17.91	23.98	3.86	30	Pass		
HE160	MCS0	2	50	5250	996/S67	0.66	0.68	11.80	11.60	14.71	23.98	3.86	30	Pass		

**TEST RESULTS DATA**  
**Power Spectral Density**

U-NII-2A MIMO															
Mod.	Data Rate	N <sub>TX</sub>	CH.	Freq. (MHz)	RU Config	Duty Factor (dB)		Average Power Density with Duty Factor (dBm/MHz)			Average PSD Limit (dBm/MHz)		DG (dBi)		Pass /Fail
						Ant 6	Ant 7	Ant 6	Ant 7	SUM	Ant 6	Ant 7	Ant 6	Ant 7	
HE20	MCS0	2	52	5260	Full	0.66	0.66			10.56	11.00	5.87		Pass	
HE20	MCS0	2	52	5260	26/0	0.64	0.64			10.24	11.00	5.87		Pass	
HE20	MCS0	2	52	5260	52/37	0.65	0.65			10.20	11.00	5.87		Pass	
HE20	MCS0	2	52	5260	106/53	0.67	0.69			10.10	11.00	5.87		Pass	
HE20	MCS0	2	60	5300	Full	0.66	0.66			10.98	11.00	5.87		Pass	
HE20	MCS0	2	60	5300	26/4	0.64	0.64			10.58	11.00	5.87		Pass	
HE20	MCS0	2	60	5300	52/38	0.65	0.65			10.79	11.00	5.87		Pass	
HE20	MCS0	2	60	5300	106/53	0.67	0.69			10.55	11.00	5.87		Pass	
HE20	MCS0	2	64	5320	Full	0.66	0.66			10.67	11.00	5.87		Pass	
HE20	MCS0	2	64	5320	26/8	0.64	0.64			10.64	11.00	5.87		Pass	
HE20	MCS0	2	64	5320	52/40	0.65	0.65			10.47	11.00	5.87		Pass	
HE20	MCS0	2	64	5320	106/54	0.67	0.69			8.98	11.00	5.87		Pass	
HE40	MCS0	2	54	5270	Full	0.67	0.65			8.30	11.00	5.87		Pass	
HE40	MCS0	2	54	5270	242/61	0.66	0.66			8.15	11.00	5.87		Pass	
HE40	MCS0	2	62	5310	Full	0.67	0.65			3.18	11.00	5.87		Pass	
HE40	MCS0	2	62	5310	242/62	0.66	0.66			2.74	11.00	5.87		Pass	
HE80	MCS0	2	58	5290	Full	0.69	0.69			0.72	11.00	5.87		Pass	
HE80	MCS0	2	58	5290	484/66	0.69	0.69			0.45	11.00	5.87		Pass	
HE160	MCS0	2	50	5250	Full	0.67	0.68			-2.97	11.00	5.87		Pass	
HE160	MCS0	2	50	5250	996/S67	0.66	0.68			-3.29	11.00	5.87		Pass	

**TEST RESULTS DATA**  
**26dB and 99% OBW**

U-NII-2C MIMO																	
Mod.	Data Rate	N <sub>TX</sub>	CH.	Freq. (MHz)	RU Config	99% Bandwidth In U-NII 2C (MHz)		26 dB Bandwidth In U-NII 2C (MHz)		IC 99% Bandwidth Power Limit (dBm)		IC 99% Bandwidth EIRP Limit (dBm)		FCC 26dB Bandwidth Power Limit (dBm)		6 dB Bandwidth for Straddle Channel (MHz)	
						Ant 6	Ant 7	Ant 6	Ant 7	Ant 6	Ant 7	Ant 6	Ant 7	Ant 6	Ant 7	Ant 6	Ant 7
HE20	MCS0	2	100	5500	Full	18.83	18.83	21.06	21.32	23.75		29.75		23.98		----	----
HE20	MCS0	2	116	5580	Full	18.83	18.83	20.87	20.99	23.75		29.75		23.98		----	----
HE20	MCS0	2	140	5700	Full	18.93	18.93	21.62	21.40	23.77		29.77		23.98		----	----
HE40	MCS0	2	102	5510	Full	37.96	37.96	41.66	41.54	23.98		30.00		23.98		----	----
HE40	MCS0	2	110	5550	Full	37.76	37.76	41.20	41.41	23.98		30.00		23.98		----	----
HE40	MCS0	2	134	5670	Full	37.76	37.76	41.22	41.14	23.98		30.00		23.98		----	----
HE80	MCS0	2	106	5530	Full	76.84	76.72	81.38	81.44	23.98		30.00		23.98		----	----
HE80	MCS0	2	122	5610	Full	76.84	76.84	81.63	81.79	23.98		30.00		23.98		----	----
HE160	MCS0	2	114	5570	Full	155.84	155.60	164.88	165.46	23.98		30.00		23.98		----	----

U-NII-2C straddle channel MIMO																	
Mod.	Data Rate	N <sub>TX</sub>	CH.	Freq. (MHz)	RU Config	99% Bandwidth In U-NII 2C (MHz)		26 dB Bandwidth In U-NII 2C (MHz)		IC 99% Bandwidth Power Limit (dBm)		IC 99% Bandwidth EIRP Limit (dBm)		FCC 26dB Bandwidth Power Limit (dBm)		6 dB Bandwidth for Straddle Channel (MHz)	
						Ant 6	Ant 7	Ant 6	Ant 7	Ant 6	Ant 7	Ant 6	Ant 7	Ant 6	Ant 7	Ant 6	Ant 7
HE20	MCS0	2	144	5720	Full	14.44	14.44	15.83	15.60	22.60		28.60		22.93		1.265	2.425
HE40	MCS0	2	142	5710	Full	33.88	33.88	35.62	35.53	23.98		30.00		23.98		2.892	2.541
HE80	MCS0	2	138	5690	Full	73.48	73.36	75.93	75.86	23.98		30.00		23.98		2.536	2.504
6dB Bandwidth Limit $\geq$ 500kHz															Pass		

**TEST RESULTS DATA**  
**Average Power Table**

FCC U-NII-2C MIMO																
Mod.	Data Rate	N <sub>TX</sub>	CH.	Freq. (MHz)	RU Config	Duty Factor (dB)		Average Conducted Power (dBm)			FCC Conducted Power Limit (dBm)		DG (dBi)		EIRP Power Limit (dBm)	Pass/Fail
						Ant 6	Ant 7	Ant 6	Ant 7	SUM	Ant 6	Ant 7	Ant 6	Ant 7		
HE20	MCS0	2	100	5500	Full	0.66	0.66	18.50	18.20	21.36	23.98	23.98	3.95	30	Pass	
HE20	MCS0	2	100	5500	26/0	0.64	0.64	10.80	11.00	13.91	23.98	23.98	3.95	30	Pass	
HE20	MCS0	2	100	5500	52/37	0.65	0.65	13.80	13.90	16.86	23.98	23.98	3.95	30	Pass	
HE20	MCS0	2	100	5500	106/53	0.67	0.69	14.70	14.90	17.81	23.98	23.98	3.95	30	Pass	
HE20	MCS0	2	116	5580	Full	0.66	0.66	18.50	18.30	21.41	23.98	23.98	3.95	30	Pass	
HE20	MCS0	2	116	5580	26/4	0.64	0.64	12.00	11.90	14.96	23.98	23.98	3.95	30	Pass	
HE20	MCS0	2	116	5580	52/38	0.65	0.65	14.00	13.60	16.81	23.98	23.98	3.95	30	Pass	
HE20	MCS0	2	116	5580	106/53	0.67	0.69	16.80	16.40	19.61	23.98	23.98	3.95	30	Pass	
HE20	MCS0	2	140	5700	Full	0.66	0.66	17.90	18.00	20.96	23.98	23.98	3.95	30	Pass	
HE20	MCS0	2	140	5700	26/8	0.64	0.64	8.70	8.60	11.66	23.98	23.98	3.95	30	Pass	
HE20	MCS0	2	140	5700	52/40	0.65	0.65	11.60	11.60	14.61	23.98	23.98	3.95	30	Pass	
HE20	MCS0	2	140	5700	106/54	0.67	0.69	14.40	14.20	17.31	23.98	23.98	3.95	30	Pass	
HE40	MCS0	2	102	5510	Full	0.67	0.65	18.70	18.60	21.66	23.98	23.98	3.95	30	Pass	
HE40	MCS0	2	102	5510	242/61	0.66	0.66	15.60	15.50	18.56	23.98	23.98	3.95	30	Pass	
HE40	MCS0	2	110	5550	Full	0.67	0.65	18.30	18.20	21.26	23.98	23.98	3.95	30	Pass	
HE40	MCS0	2	110	5550	242/61	0.66	0.66	18.00	17.40	20.72	23.98	23.98	3.95	30	Pass	
HE40	MCS0	2	134	5670	Full	0.67	0.65	18.20	18.00	21.11	23.98	23.98	3.95	30	Pass	
HE40	MCS0	2	134	5670	242/62	0.66	0.66	13.70	13.30	16.51	23.98	23.98	3.95	30	Pass	
HE80	MCS0	2	106	5530	Full	0.69	0.69	17.50	17.40	20.46	23.98	23.98	3.95	30	Pass	
HE80	MCS0	2	106	5530	484/65	0.69	0.69	13.60	13.50	16.56	23.98	23.98	3.95	30	Pass	
HE80	MCS0	2	122	5610	Full	0.69	0.69	17.60	17.40	20.51	23.98	23.98	3.95	30	Pass	
HE80	MCS0	2	122	5610	484/66	0.69	0.69	14.00	13.40	16.72	23.98	23.98	3.95	30	Pass	
HE160	MCS0	2	114	5570	Full	0.67	0.68	15.00	14.70	17.86	23.98	23.98	3.95	30	Pass	
HE160	MCS0	2	114	5570	996/67	0.66	0.68	12.40	12.10	15.26	23.98	23.98	3.95	30	Pass	
HE160	MCS0	2	114	5570	996/S67	0.66	0.68	14.40	13.90	17.17	23.98	23.98	3.95	30	Pass	

FCC U-NII-2C straddle channel MIMO																
Mod.	Data Rate	N <sub>TX</sub>	CH.	Freq. (MHz)	RU Config	Duty Factor (dB)		Average Conducted Power (dBm)			FCC Conducted Power Limit (dBm)		DG (dBi)		EIRP Power Limit (dBm)	Pass/Fail
						Ant 6	Ant 7	Ant 6	Ant 7	SUM	Ant 6	Ant 7	Ant 6	Ant 7		
HE20	MCS0	2	144	5720	Full	0.66	0.66	18.30	17.90	21.11	22.93	22.93	3.95	30	Pass	
HE20	MCS0	2	144	5720	26/8	0.64	0.64	10.60	10.30	13.46	22.93	22.93	3.95	30	Pass	
HE20	MCS0	2	144	5720	52/40	0.65	0.65	14.20	13.80	17.01	22.93	22.93	3.95	30	Pass	
HE20	MCS0	2	144	5720	106/54	0.67	0.69	16.80	16.40	19.61	22.93	22.93	3.95	30	Pass	
HE40	MCS0	2	142	5710	Full	0.67	0.65	18.50	18.40	21.46	23.98	23.98	3.95	30	Pass	
HE40	MCS0	2	142	5710	242/62	0.66	0.66	17.40	17.30	20.36	23.98	23.98	3.95	30	Pass	
HE80	MCS0	2	138	5690	Full	0.67	0.68	17.50	17.70	20.61	23.98	23.98	3.95	30	Pass	
HE80	MCS0	2	138	5690	484/66	0.67	0.68	17.40	17.00	20.21	23.98	23.98	3.95	30	Pass	

**TEST RESULTS DATA**  
**Power Spectral Density**

U-NII-2C MIMO															
Mod.	Data Rate	N <sub>TX</sub>	CH.	Freq. (MHz)	RU Config	Duty Factor (dB)		Average Power Density with Duty Factor (dBm/MHz)			Average PSD Limit (dBm/MHz)		DG (dBi)		Pass /Fail
						Ant 6	Ant 7	Ant 6	Ant 7	SUM	Ant 6	Ant 7	Ant 6	Ant 7	
HE20	MCS0	2	100	5500	Full	0.66	0.66	-	-	10.54	10.85	6.15	-	Pass	
HE20	MCS0	2	100	5500	26/0	0.64	0.64	-	-	10.46	10.85	6.15	-	Pass	
HE20	MCS0	2	100	5500	52/37	0.65	0.65	-	-	10.48	10.85	6.15	-	Pass	
HE20	MCS0	2	100	5500	106/53	0.67	0.69	-	-	8.53	10.85	6.15	-	Pass	
HE20	MCS0	2	116	5580	Full	0.66	0.66	-	-	10.70	10.85	6.15	-	Pass	
HE20	MCS0	2	116	5580	26/4	0.64	0.64	-	-	10.66	10.85	6.15	-	Pass	
HE20	MCS0	2	116	5580	52/38	0.65	0.65	-	-	10.66	10.85	6.15	-	Pass	
HE20	MCS0	2	116	5580	106/53	0.67	0.69	-	-	10.47	10.85	6.15	-	Pass	
HE20	MCS0	2	140	5700	Full	0.66	0.66	-	-	8.35	10.85	6.15	-	Pass	
HE20	MCS0	2	140	5700	26/8	0.64	0.64	-	-	8.31	10.85	6.15	-	Pass	
HE20	MCS0	2	140	5700	52/40	0.65	0.65	-	-	8.30	10.85	6.15	-	Pass	
HE20	MCS0	2	140	5700	106/54	0.67	0.69	-	-	8.08	10.85	6.15	-	Pass	
HE40	MCS0	2	102	5510	Full	0.67	0.65	-	-	5.97	10.85	6.15	-	Pass	
HE40	MCS0	2	102	5510	242/61	0.66	0.66	-	-	5.71	10.85	6.15	-	Pass	
HE40	MCS0	2	110	5550	Full	0.67	0.65	-	-	7.81	10.85	6.15	-	Pass	
HE40	MCS0	2	110	5550	242/61	0.66	0.66	-	-	7.74	10.85	6.15	-	Pass	
HE40	MCS0	2	134	5670	Full	0.67	0.65	-	-	7.80	10.85	6.15	-	Pass	
HE40	MCS0	2	134	5670	242/62	0.66	0.66	-	-	4.10	10.85	6.15	-	Pass	
HE80	MCS0	2	106	5530	Full	0.69	0.69	-	-	4.89	10.85	6.15	-	Pass	
HE80	MCS0	2	106	5530	484/65	0.69	0.69	-	-	0.74	10.85	6.15	-	Pass	
HE80	MCS0	2	122	5610	Full	0.69	0.69	-	-	4.64	10.85	6.15	-	Pass	
HE80	MCS0	2	122	5610	484/66	0.69	0.69	-	-	1.16	10.85	6.15	-	Pass	
HE160	MCS0	2	114	5570	Full	0.67	0.68	-	-	-1.22	10.85	6.15	-	Pass	
HE160	MCS0	2	114	5570	996/67	0.66	0.68	-	-	-3.61	10.85	6.15	-	Pass	
HE160	MCS0	2	114	5570	996/S67	0.66	0.68	-	-	-1.65	10.85	6.15	-	Pass	

U-NII-2C straddle channel MIMO															
Mod.	Data Rate	N <sub>TX</sub>	CH.	Freq. (MHz)	RU Config	Duty Factor (dB)		Average Power Density (dBm/MHz)			Average PSD Limit (dBm/MHz)		DG (dBi)		Pass /Fail
						Ant 6	Ant 7	Ant 6	Ant 7	SUM	Ant 6	Ant 7	Ant 6	Ant 7	
HE20	MCS0	2	144	5720	Full	0.66	0.66	-	-	10.78	10.85	6.15	-	Pass	
HE20	MCS0	2	144	5720	26/8	0.64	0.64	-	-	10.16	10.85	6.15	-	Pass	
HE20	MCS0	2	144	5720	52/40	0.65	0.65	-	-	10.74	10.85	6.15	-	Pass	
HE20	MCS0	2	144	5720	106/54	0.67	0.69	-	-	10.40	10.85	6.15	-	Pass	
HE40	MCS0	2	142	5710	Full	0.67	0.65	-	-	8.05	10.85	6.15	-	Pass	
HE40	MCS0	2	142	5710	242/62	0.66	0.66	-	-	7.71	10.85	6.15	-	Pass	
HE80	MCS0	2	138	5690	Full	0.69	0.69	-	-	4.88	10.85	6.15	-	Pass	
HE80	MCS0	2	138	5690	484/66	0.69	0.69	-	-	4.69	10.85	6.15	-	Pass	



Test Result of 26dB & 99% Occupied Bandwidth

MIMO <Ant. 6+7>

<802.11a>

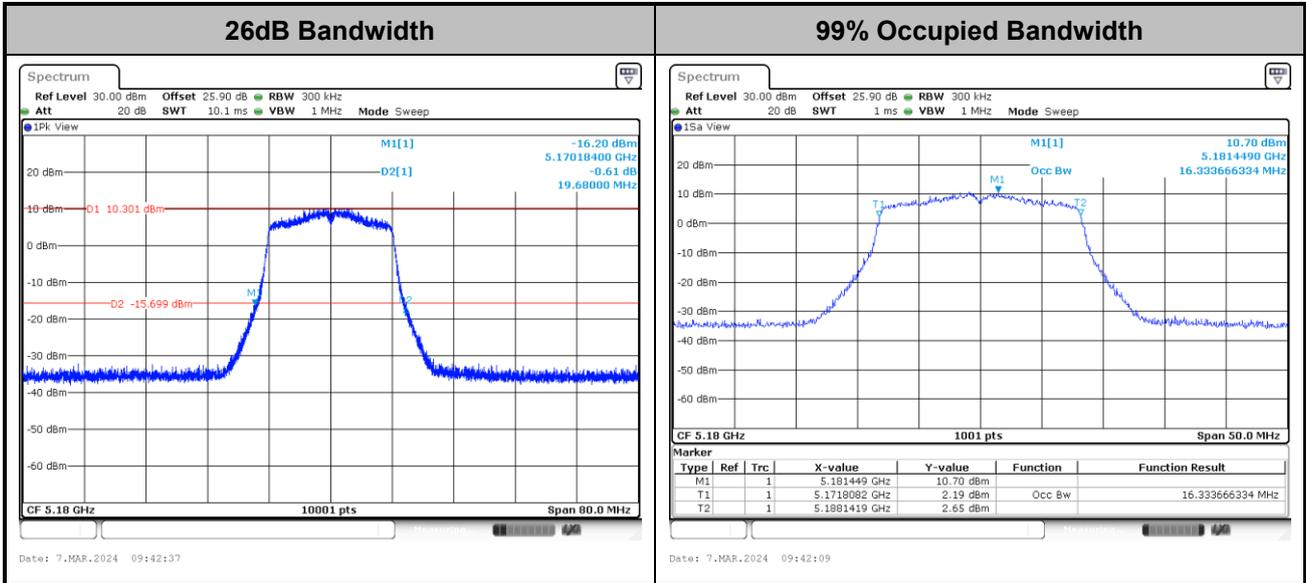

Note: The occupied channel bandwidth is maintained within the band of operation for all of the modulations.

<802.11ac VHT20>

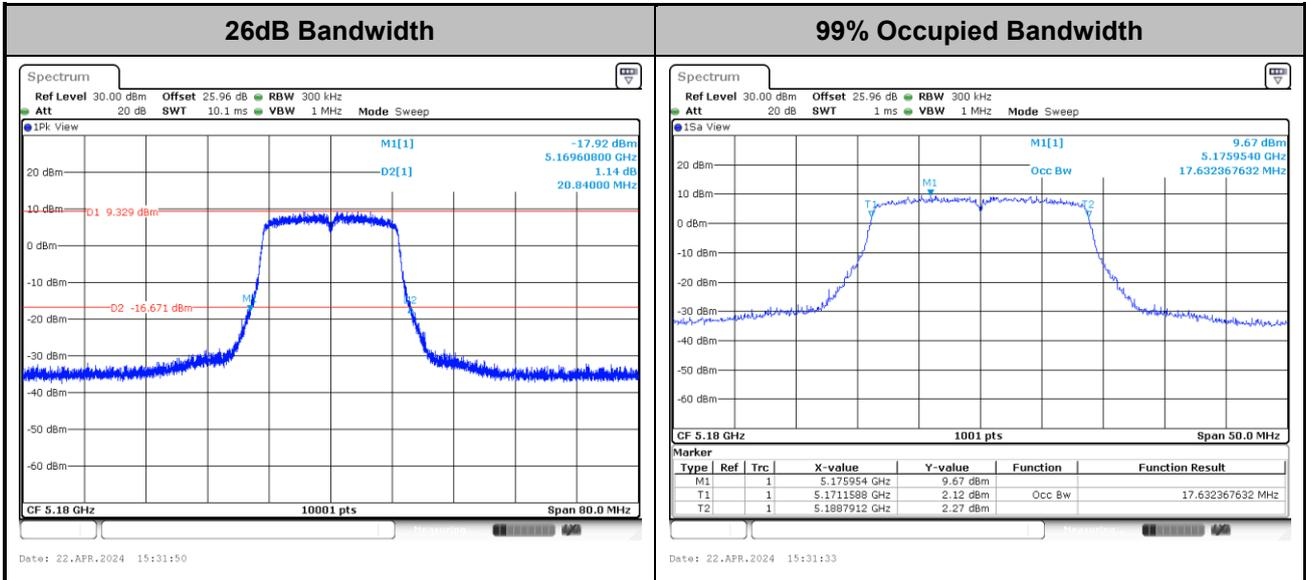

Note: The occupied channel bandwidth is maintained within the band of operation for all of the modulations.



<802.11ac VHT40>

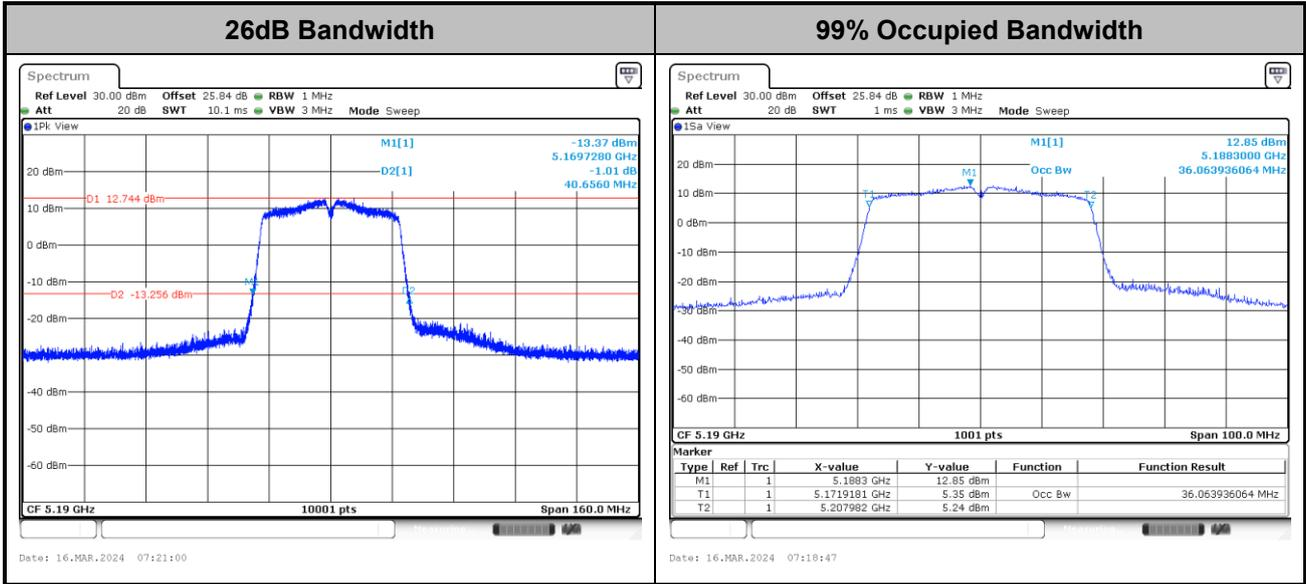

Note: The occupied channel bandwidth is maintained within the band of operation for all of the modulations.

<802.11ac VHT80>

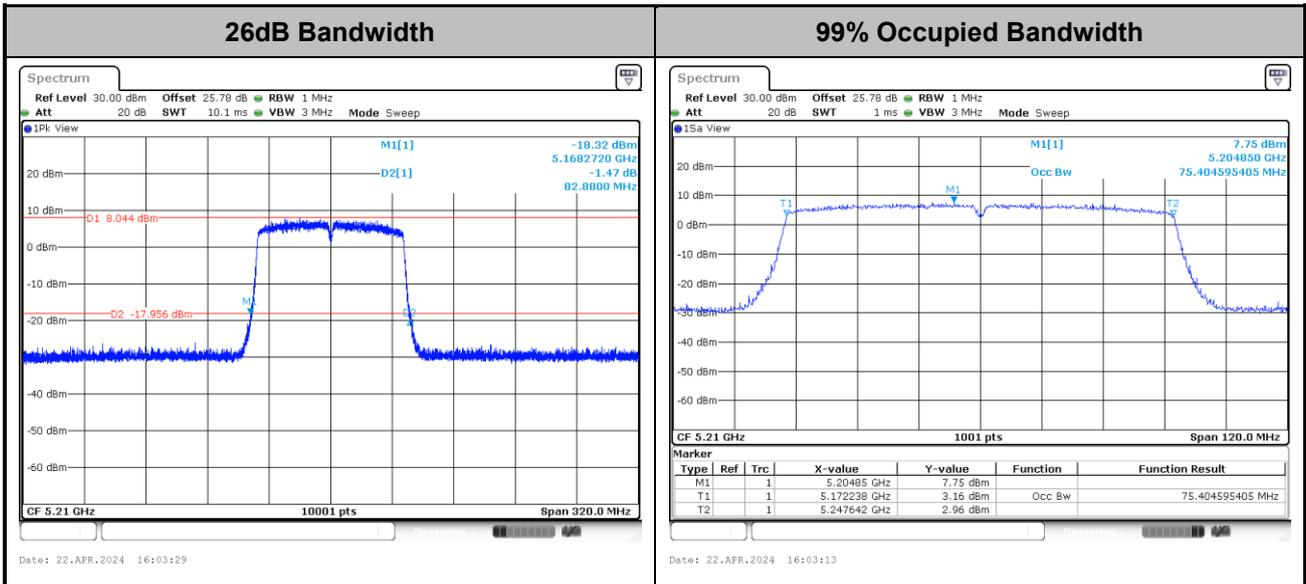

Note: The occupied channel bandwidth is maintained within the band of operation for all of the modulations.





<802.11ac VHT160>

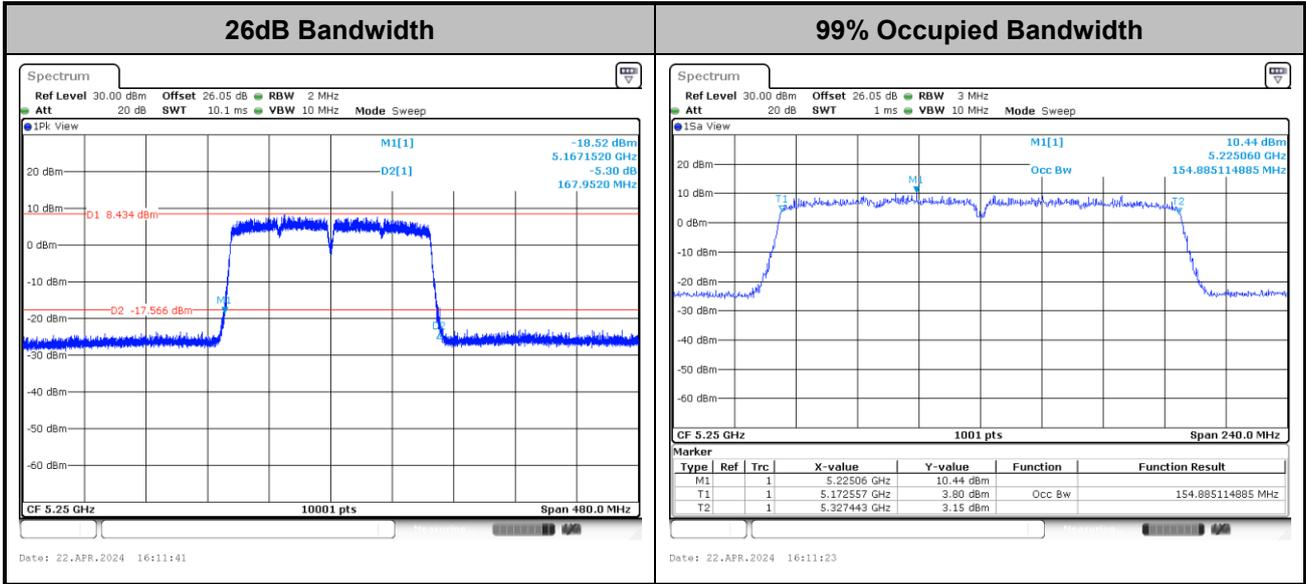

Note: The occupied channel bandwidth is maintained within the band of operation for all of the modulations.

<802.11ax HE20>

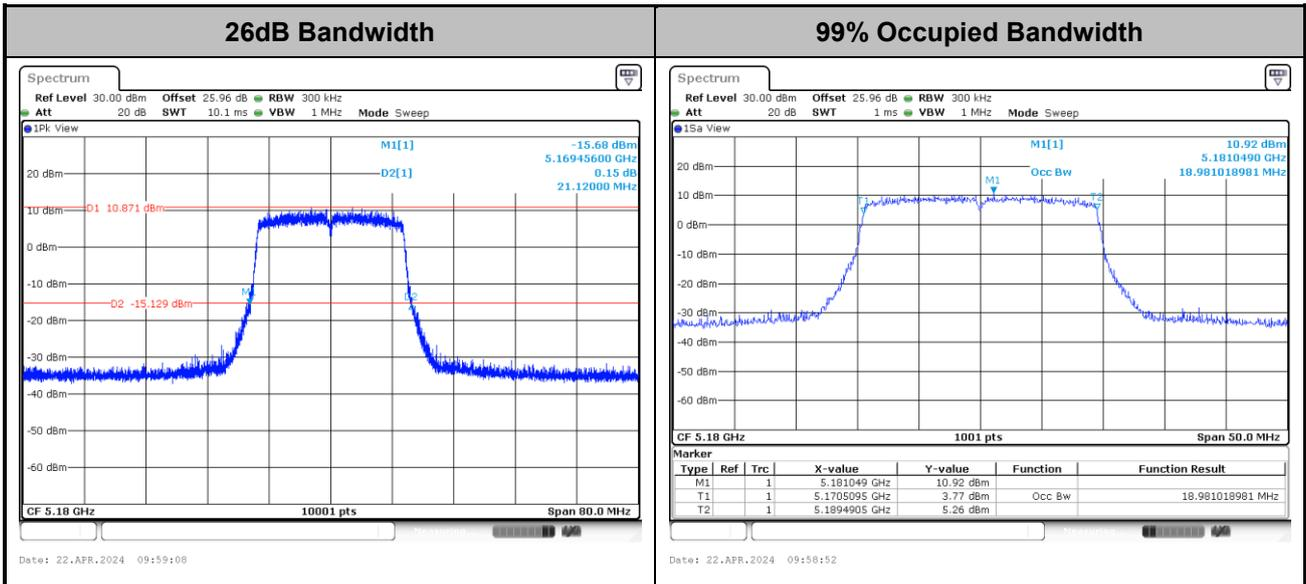

Note: The occupied channel bandwidth is maintained within the band of operation for all of the modulations.



<802.11ax HE40>

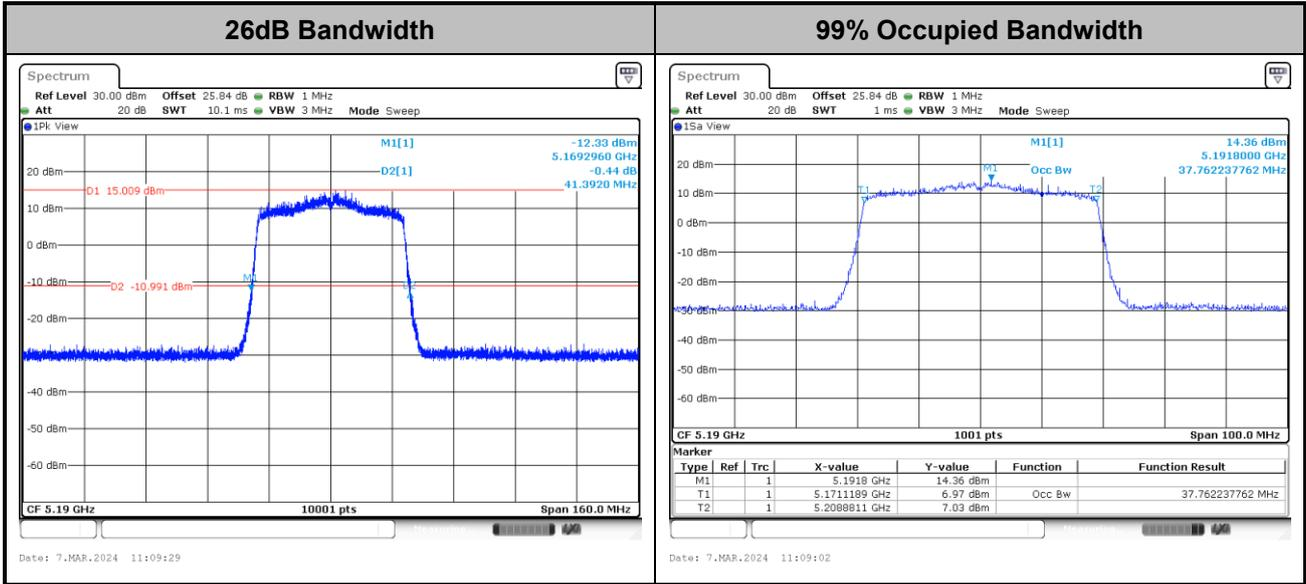

Note: The occupied channel bandwidth is maintained within the band of operation for all of the modulations.

<802.11ax HE80>

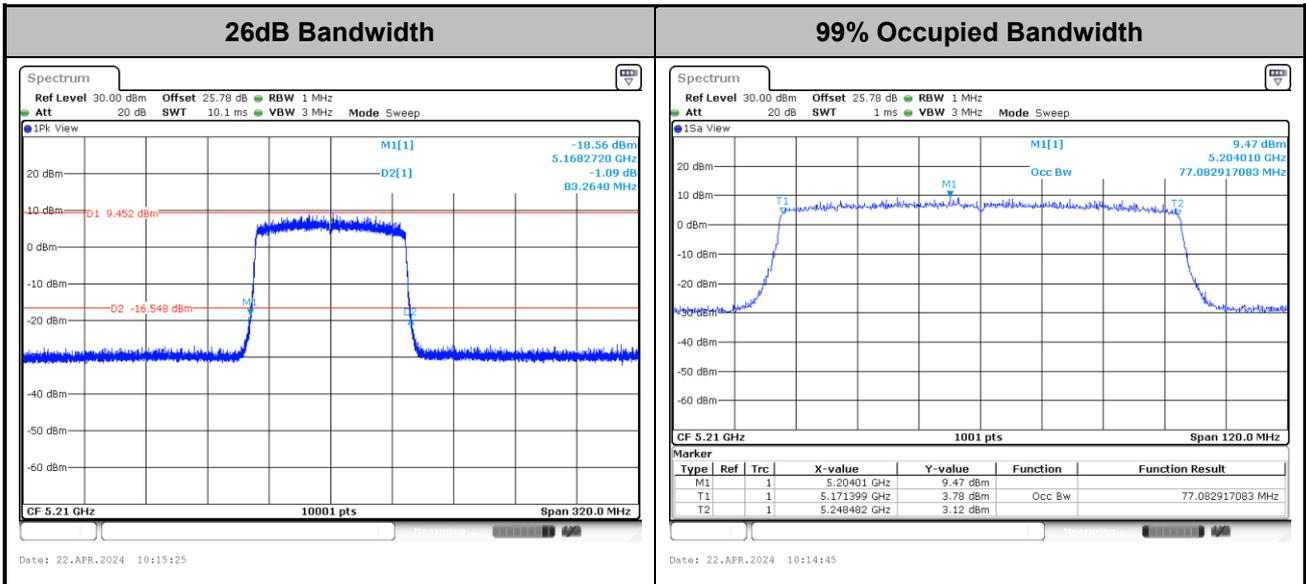

Note: The occupied channel bandwidth is maintained within the band of operation for all of the modulations.



<802.11ax HE160>

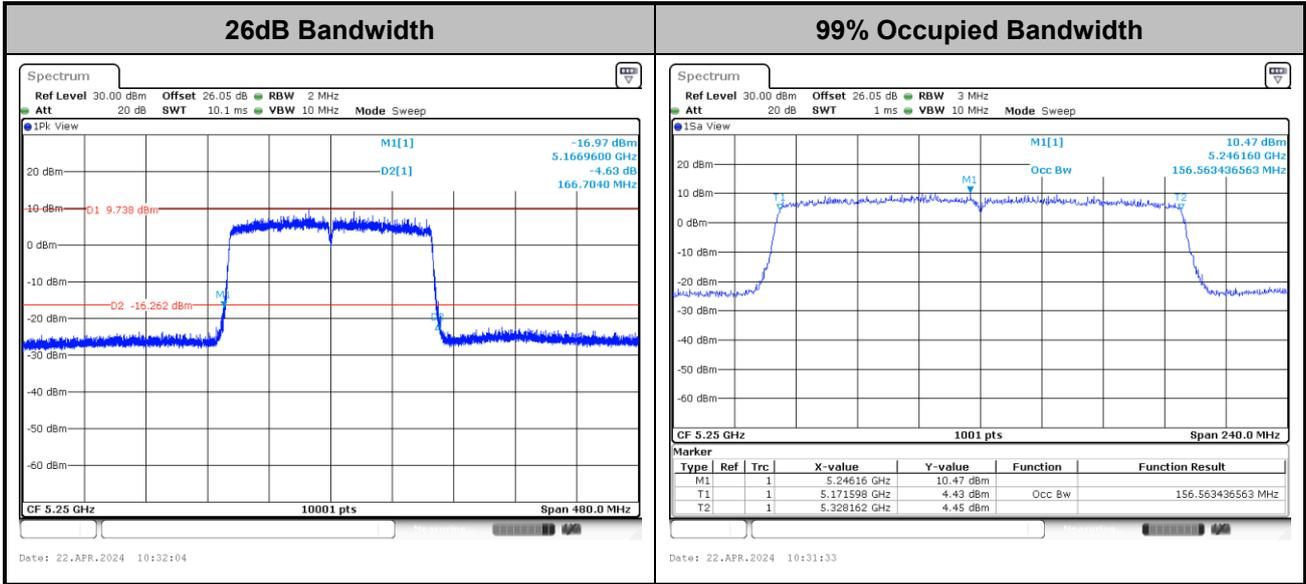

Note: The occupied channel bandwidth is maintained within the band of operation for all of the modulations.



**Result of Power Spectral Density**

<802.11a>

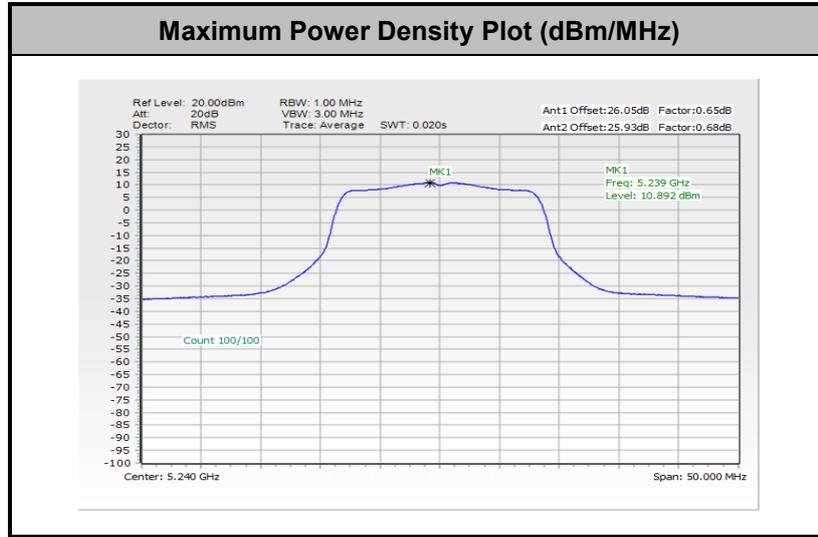

Remark: The test plot is showing a bin by bin combined result mathematically adds two traces.

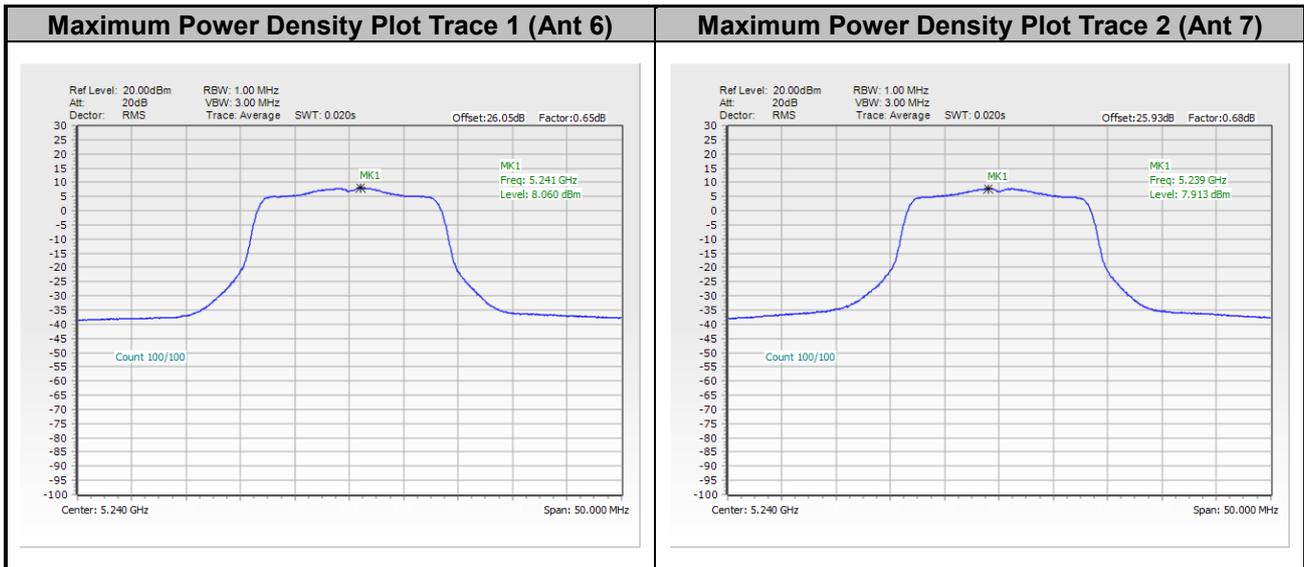



<802.11ac VHT20>

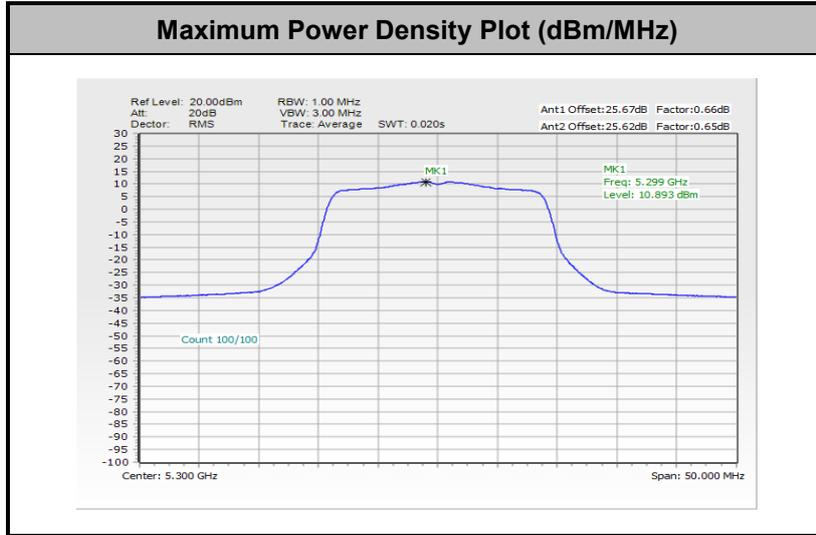

Remark: The test plot is showing a bin by bin combined result mathematically adds two traces.

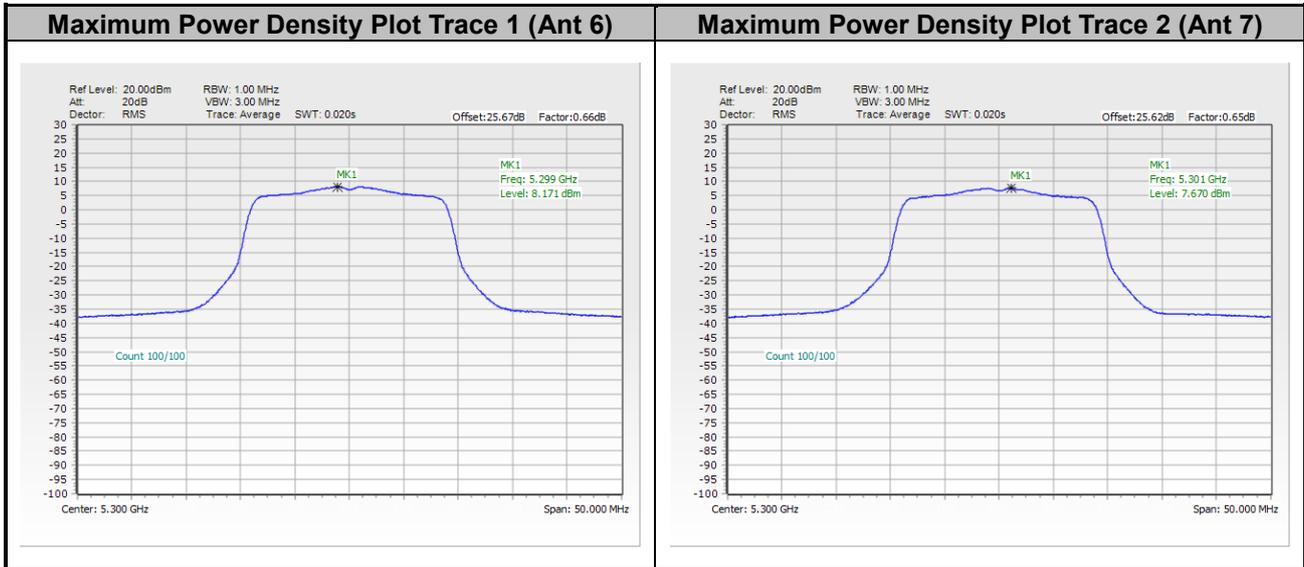



<802.11ac VHT40>

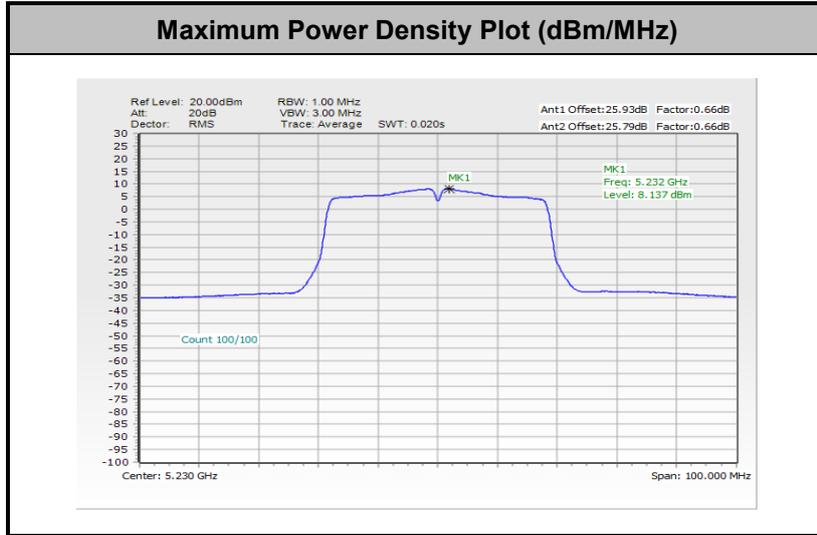

Remark: The test plot is showing a bin by bin combined result mathematically adds two traces.

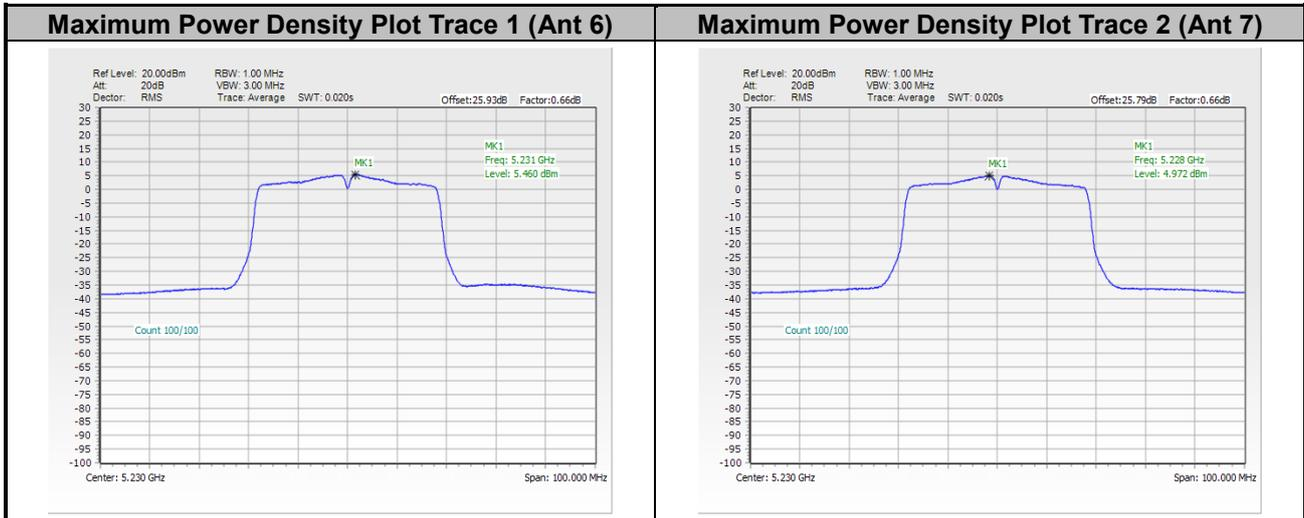



<802.11ac VHT80>

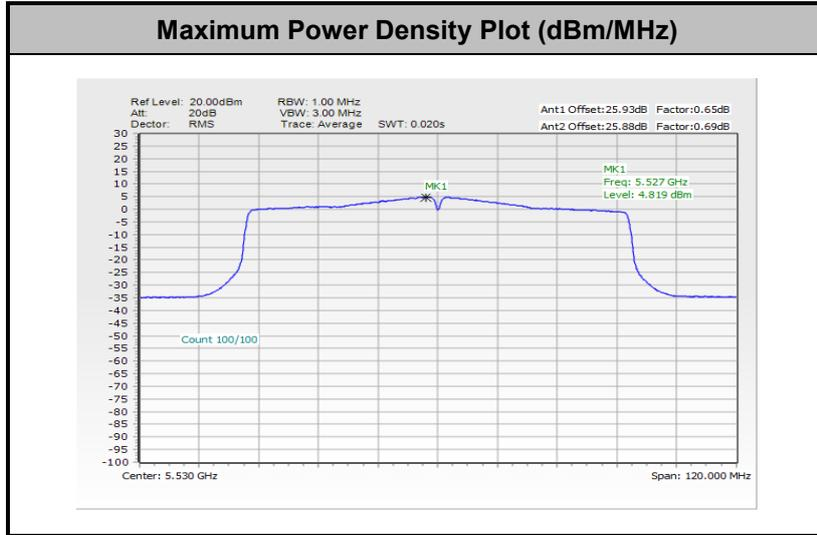

Remark: The test plot is showing a bin by bin combined result mathematically adds two traces.

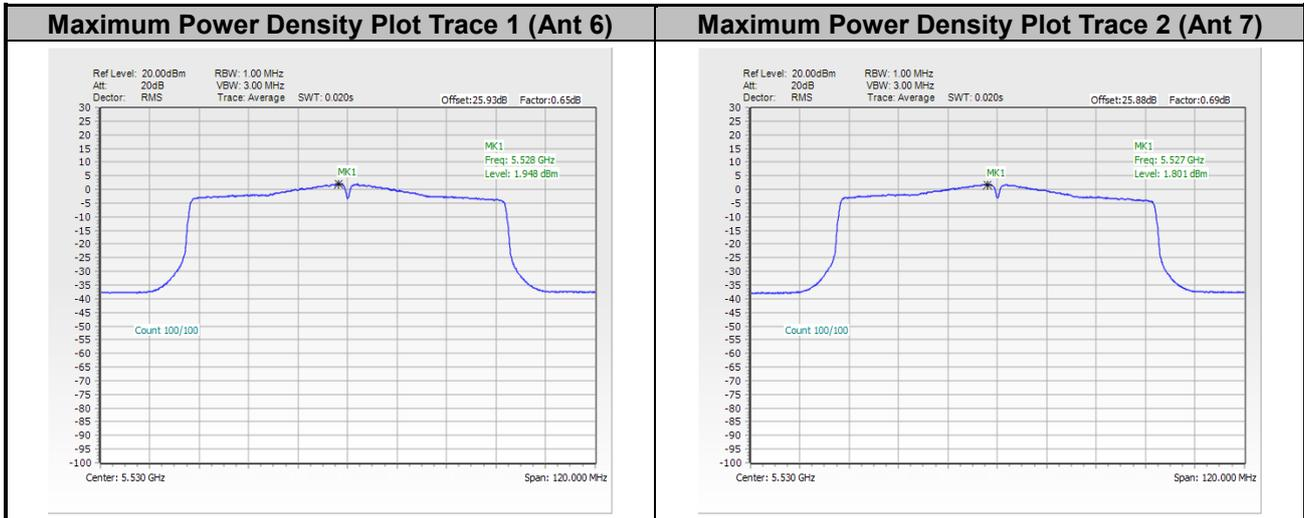



<802.11ac VHT160>

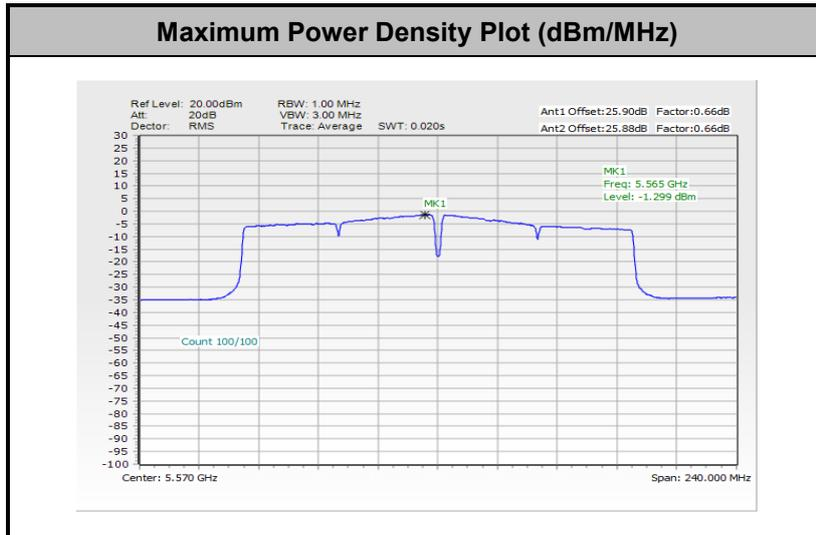

Remark: The test plot is showing a bin by bin combined result mathematically adds two traces.

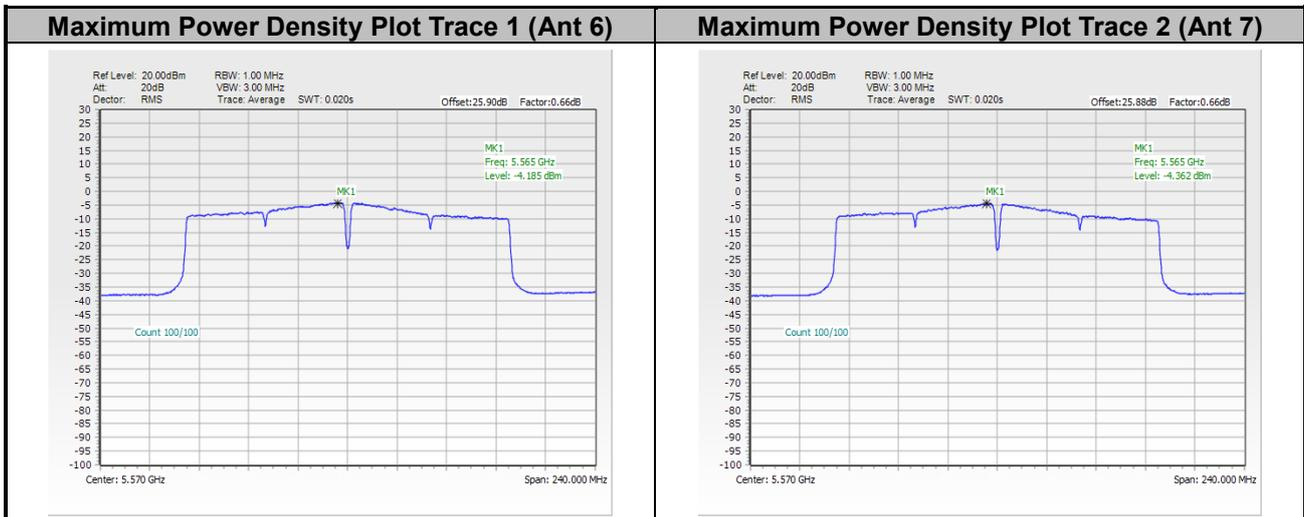





<802.11ax HE20>

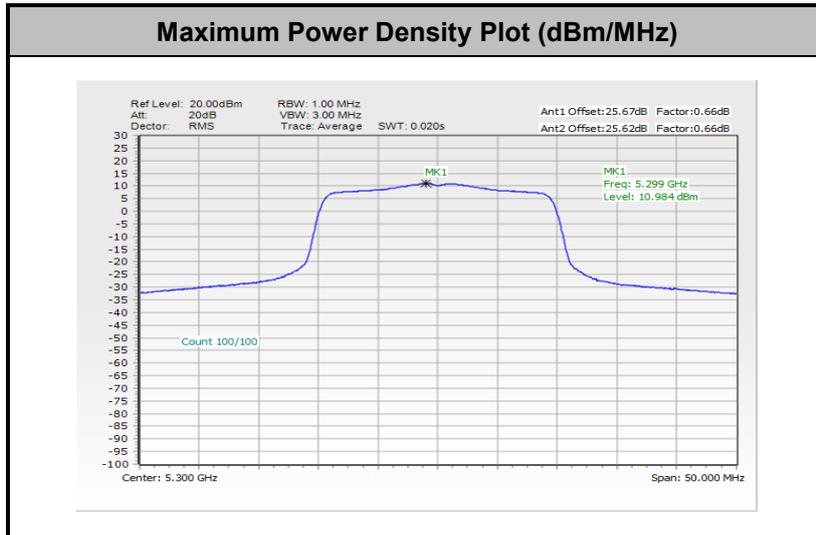

Remark: The test plot is showing a bin by bin combined result mathematically adds two traces.

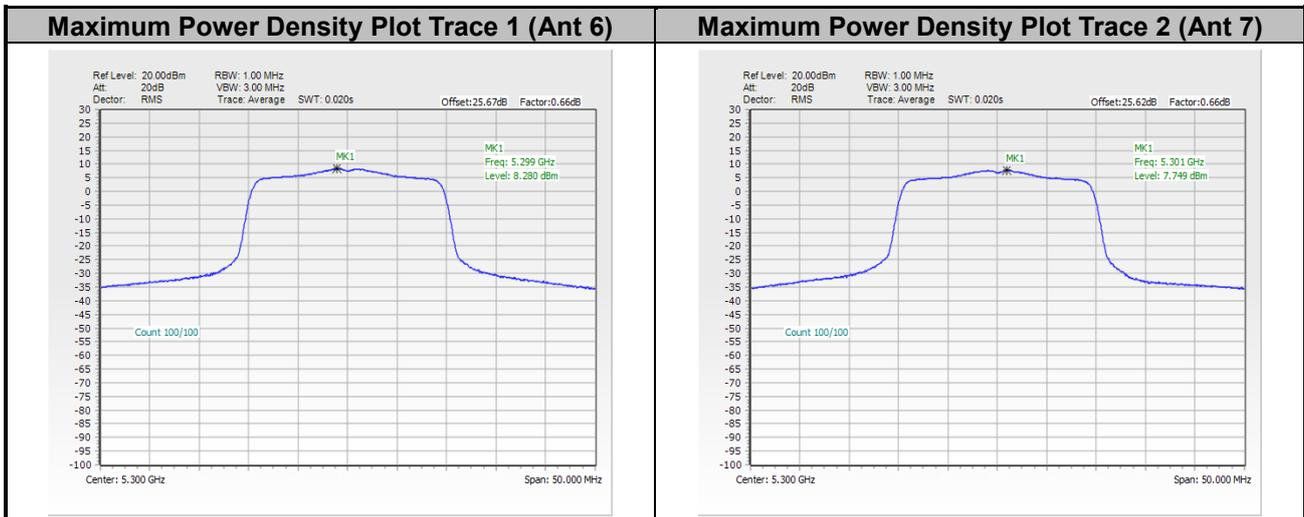



<802.11ax HE40>

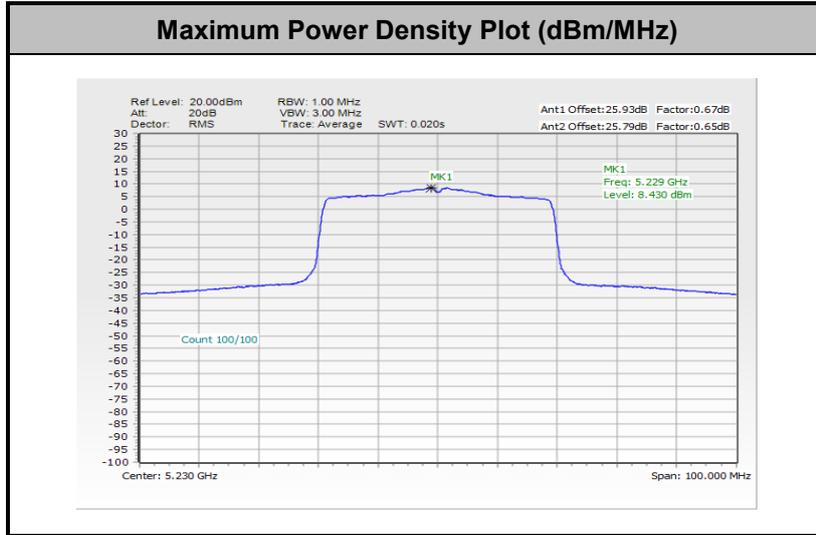

Remark: The test plot is showing a bin by bin combined result mathematically adds two traces.

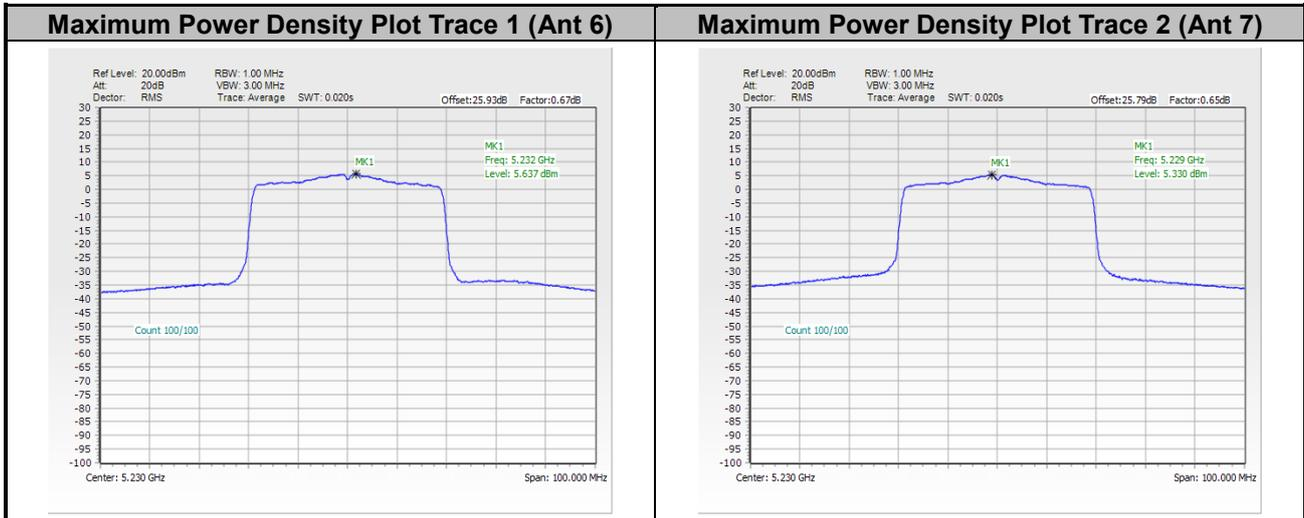



<802.11ax HE80>

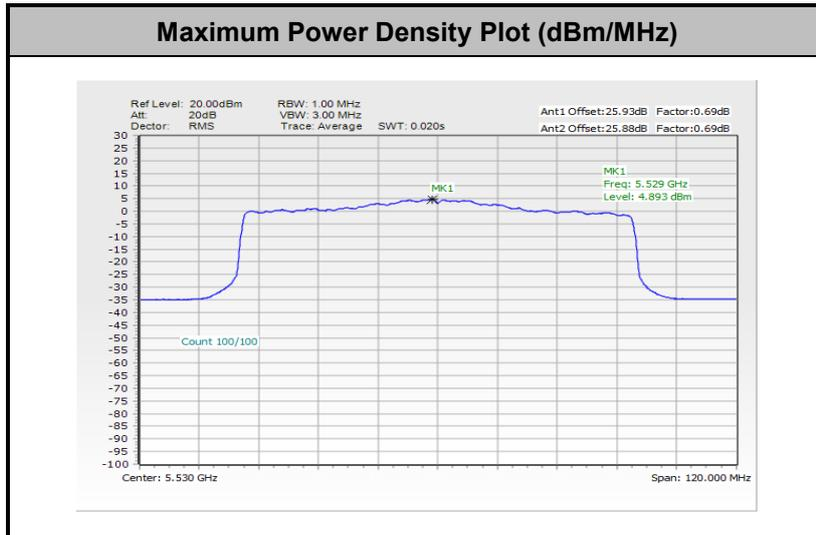

Remark: The test plot is showing a bin by bin combined result mathematically adds two traces.

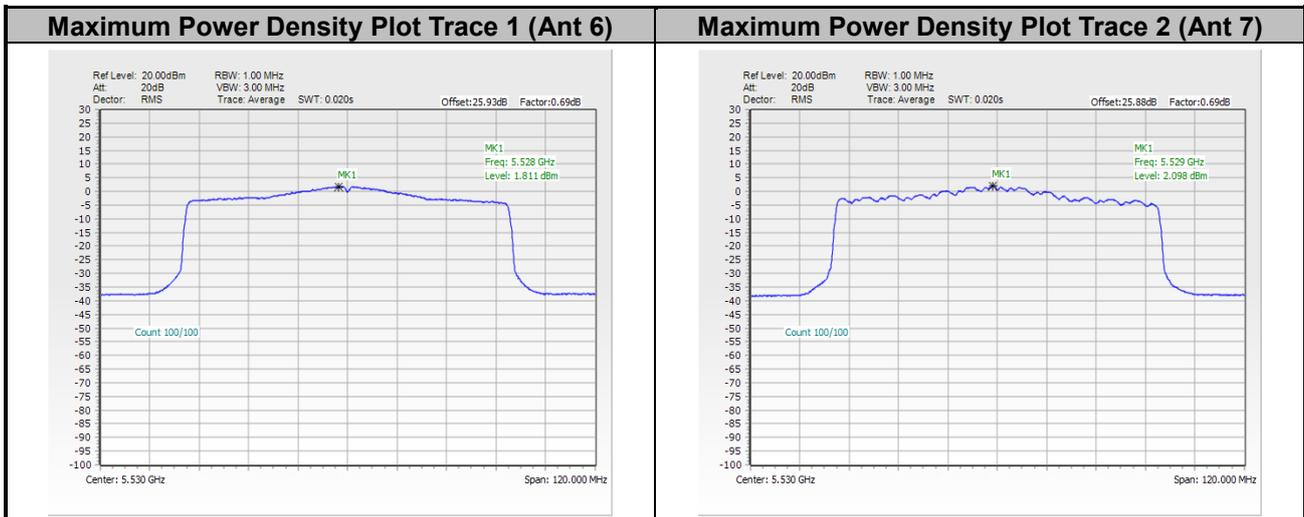



<802.11ax HE160>

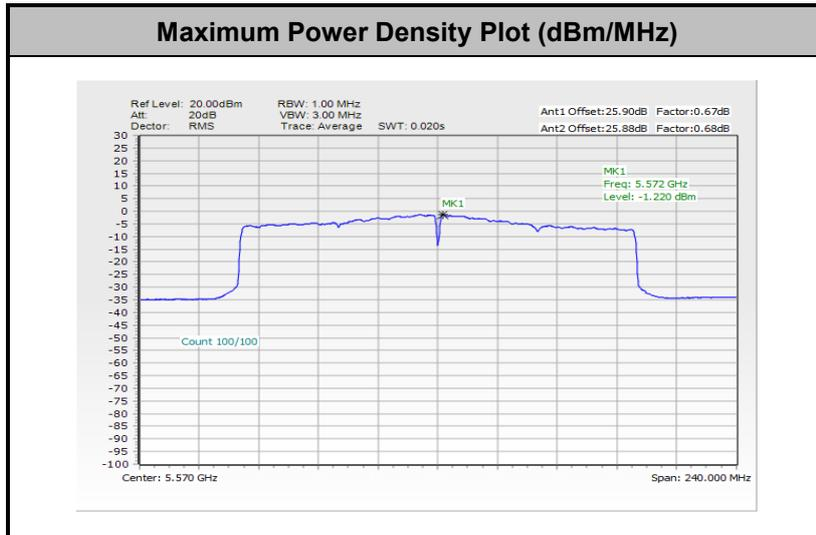

Remark: The test plot is showing a bin by bin combined result mathematically adds two traces.

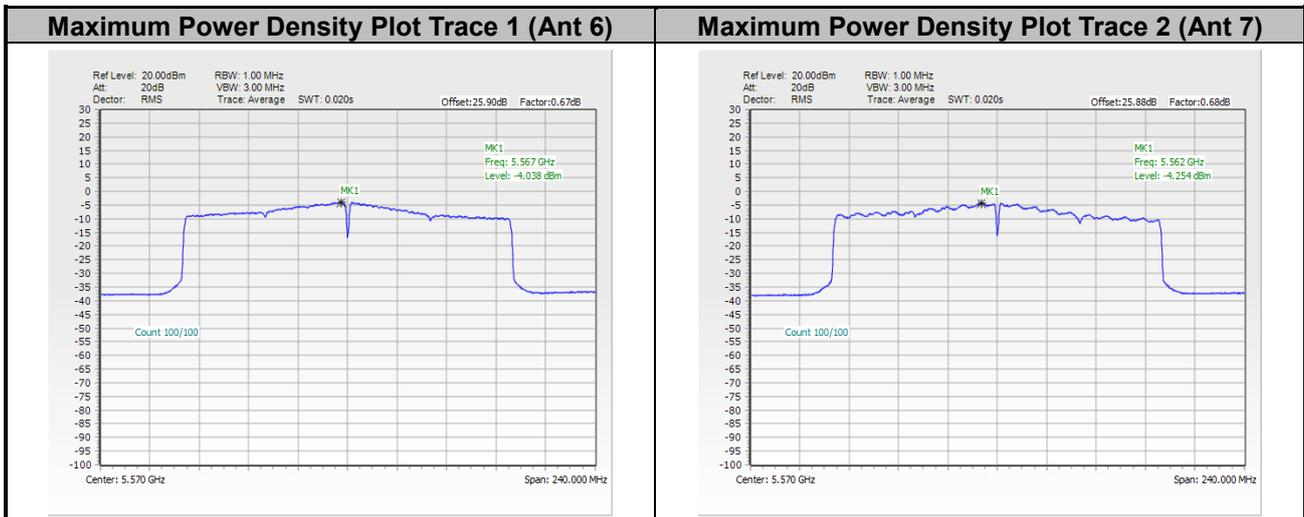



## Appendix B. AC Conducted Emission Test Results

Test Engineer :	Calvin Wang	Temperature :	23~26°C
		Relative Humidity :	45~55%

# EUT Information

Test Mode : Mode 1  
 Test Voltage : 120Vac/60Hz  
 Phase : Line

Full Spectrum

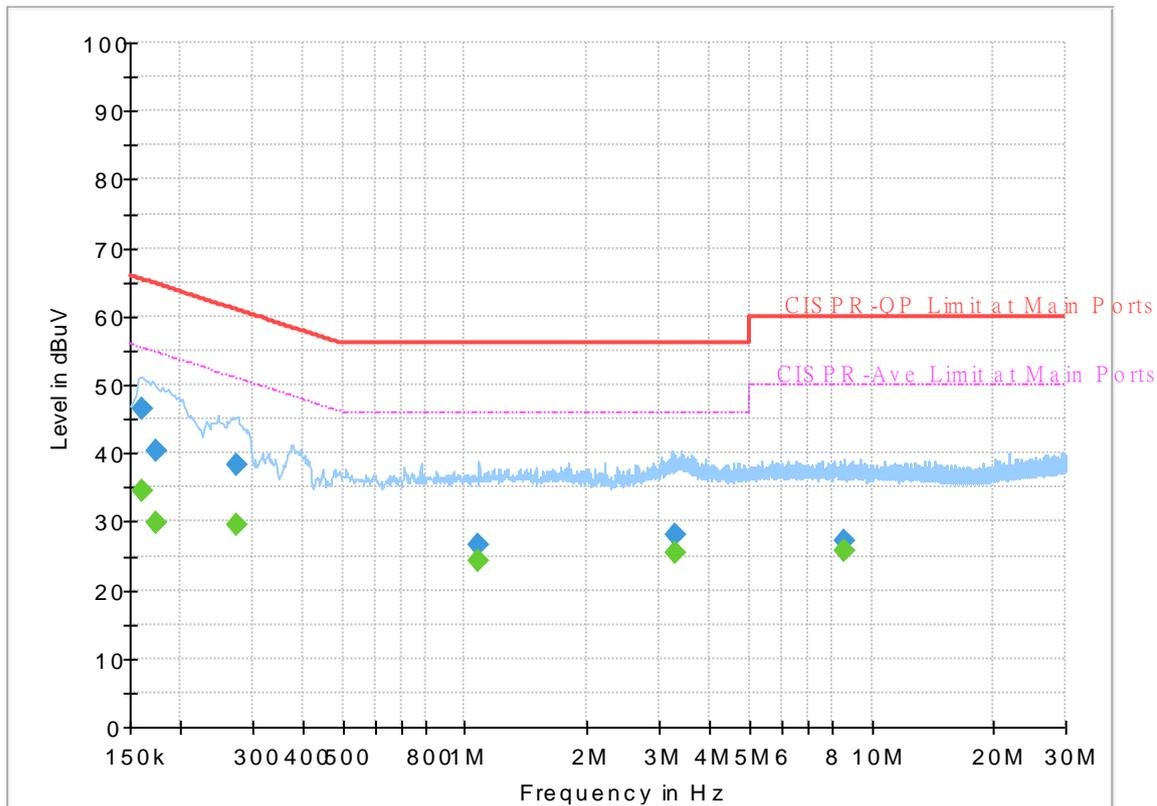

## Final\_Result

Frequency (MHz)	QuasiPeak (dBuV)	CAverage (dBuV)	Limit (dBuV)	Margin (dB)	Line	Filter	Corr. (dB)
0.161250	---	34.39	55.40	21.01	L1	OFF	19.8
0.161250	46.62	---	65.40	18.78	L1	OFF	19.8
0.174750	---	29.88	54.73	24.85	L1	OFF	19.8
0.174750	40.27	---	64.73	24.46	L1	OFF	19.8
0.273750	---	29.48	51.00	21.52	L1	OFF	19.8
0.273750	38.21	---	61.00	22.79	L1	OFF	19.8
1.081500	---	24.27	46.00	21.73	L1	OFF	19.8
1.081500	26.72	---	56.00	29.28	L1	OFF	19.8
3.293250	---	25.33	46.00	20.67	L1	OFF	19.9
3.293250	28.15	---	56.00	27.85	L1	OFF	19.9
8.596500	---	25.73	50.00	24.27	L1	OFF	20.1
8.596500	27.06	---	60.00	32.94	L1	OFF	20.1

# EUT Information

Test Mode : Mode 1  
 Test Voltage : 120Vac/60Hz  
 Phase : Neutral

Full Spectrum

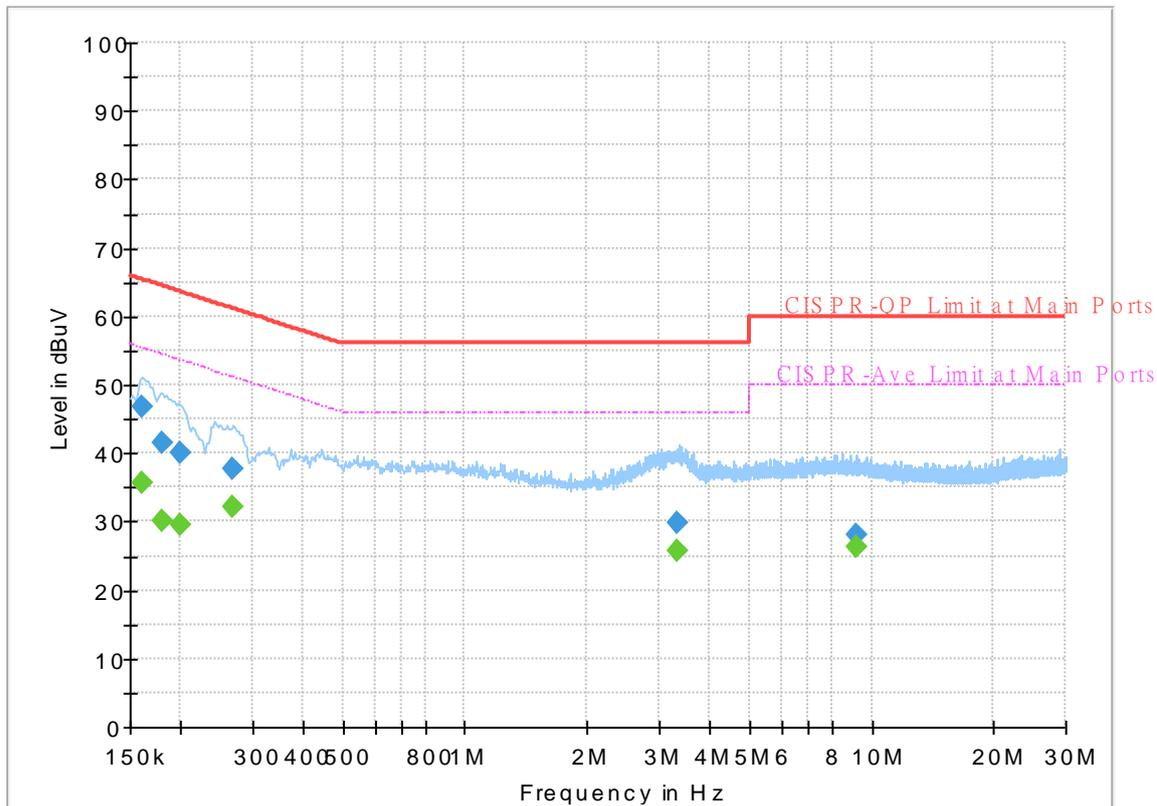

## Final\_Result

Frequency (MHz)	QuasiPeak (dBuV)	CAverage (dBuV)	Limit (dBuV)	Margin (dB)	Line	Filter	Corr. (dB)
0.161250	---	35.66	55.40	19.74	N	OFF	19.8
0.161250	46.88	---	65.40	18.52	N	OFF	19.8
0.179250	---	30.26	54.52	24.26	N	OFF	19.8
0.179250	41.47	---	64.52	23.05	N	OFF	19.8
0.199500	---	29.62	53.63	24.01	N	OFF	19.8
0.199500	40.11	---	63.63	23.52	N	OFF	19.8
0.269250	---	32.29	51.14	18.85	N	OFF	19.8
0.269250	37.82	---	61.14	23.32	N	OFF	19.8
3.309000	---	25.67	46.00	20.33	N	OFF	19.9
3.309000	29.86	---	56.00	26.14	N	OFF	19.9
9.154500	---	26.27	50.00	23.73	N	OFF	20.2
9.154500	27.93	---	60.00	32.07	N	OFF	20.2



## Appendix C. Radiated Spurious Emission

<b>Test Engineer :</b>	Jacky Hung, Mancy Chou and Rain Lee	<b>Temperature :</b>	20~26°C
		<b>Relative Humidity :</b>	40~65%





**Band 1 - 5150~5250MHz**  
**WIFI 802.11a (Band Edge @ 3m)**

WIFI	Note	Frequency	Level	Margin	Limit	Read	Antenna	Path	Preamp	Ant	Table	Peak	Pol.	
Ant.					Line	Level	Factor	Loss	Factor	Pos	Pos	Avg.		
6+7		( MHz )	( dBμV/m )	( dB )	( dBμV/m )	( dBμV )	( dB/m )	( dB )	( dB )	( cm )	( deg )	( P/A )	( H/V )	
802.11a CH 36 5180MHz		5147.16	56.57	-17.43	74	53.44	33.19	7	37.06	105	259	P	H	
		5149.76	49.53	-4.47	54	46.39	33.2	7	37.06	105	259	A	H	
	*	5180	115.88	-	-	112.67	33.2	7.05	37.04	105	259	P	H	
	*	5180	109.71	-	-	106.5	33.2	7.05	37.04	105	259	A	H	
													H	
														H
			5149.5	53.72	-20.28	74	50.58	33.2	7	37.06	106	152	P	V
			5147.16	47.24	-6.76	54	44.11	33.19	7	37.06	106	152	A	V
	*		5180	113.89	-	-	110.68	33.2	7.05	37.04	106	152	P	V
	*		5180	106.85	-	-	103.64	33.2	7.05	37.04	106	152	A	V
														V
														V
802.11a CH 44 5220MHz		5140.4	49.67	-24.33	74	46.56	33.18	6.99	37.06	100	255	P	H	
		5149.24	41.88	-12.12	54	38.74	33.2	7	37.06	100	255	A	H	
	*	5220	113.48	-	-	110.22	33.2	7.07	37.01	100	255	P	H	
	*	5220	108.7	-	-	105.44	33.2	7.07	37.01	100	255	A	H	
			5410.44	46.64	-27.36	74	43.49	33.02	7.01	36.88	100	255	P	H
			5350.52	37.67	-16.33	54	34.56	33	7.03	36.92	100	255	A	H
			5131.04	50.18	-23.82	74	47.12	33.16	6.97	37.07	100	289	P	V
			5149.76	40.7	-13.3	54	37.56	33.2	7	37.06	100	289	A	V
	*		5220	112.23	-	-	108.97	33.2	7.07	37.01	100	289	P	V
	*		5220	107.47	-	-	104.21	33.2	7.07	37.01	100	289	A	V
			5413.24	46.23	-27.77	74	43.07	33.03	7.01	36.88	100	289	P	V
			5371.52	37.21	-16.79	54	34.1	33	7.02	36.91	100	289	A	V



<b>802.11a CH 48 5240MHz</b>		5145.86	49.09	-24.91	74	45.96	33.19	7	37.06	100	256	P	H
		5147.68	40.76	-13.24	54	37.62	33.2	7	37.06	100	256	A	H
	*	5240	113.56	-	-	110.29	33.2	7.07	37	100	256	P	H
	*	5240	108.6	-	-	105.33	33.2	7.07	37	100	256	A	H
		5352.2	47.53	-26.47	74	44.42	33	7.03	36.92	100	256	P	H
		5350.52	38.39	-15.61	54	35.28	33	7.03	36.92	100	256	A	H
		5148.2	49.95	-24.05	74	46.81	33.2	7	37.06	100	146	P	V
		5148.46	39.68	-14.32	54	36.54	33.2	7	37.06	100	146	A	V
	*	5240	112.52	-	-	109.25	33.2	7.07	37	100	146	P	V
	*	5240	107.63	-	-	104.36	33.2	7.07	37	100	146	A	V
		5379.36	46.91	-27.09	74	43.79	33	7.02	36.9	100	146	P	V
		5350.24	37.28	-16.72	54	34.17	33	7.03	36.92	100	146	A	V
Remark	1. No other spurious found. 2. All results are PASS against Peak and Average limit line.												



Band 1 5150~5250MHz

WIFI 802.11a (Harmonic @ 3m)

WIFI Ant. 6+7	Note	Frequency ( MHz )	Level ( dBμV/m )	Margin ( dB )	Limit Line ( dBμV/m )	Read Level (dBμV)	Antenna Factor ( dB/m )	Path Loss ( dB )	Preamp Factor ( dB )	Ant Pos ( cm )	Table Pos ( deg )	Peak Avg. (P/A)	Pol. (H/V)	
802.11a CH 36 5180MHz		6906	62.04	-6.16	68.2	72.54	35.89	9.84	56.23	101	42	P	H	
		10360	48.85	-19.35	68.2	54.76	38.92	11.53	56.36	-	-	P	H	
		15540	45.67	-28.33	74	49.69	38.22	13.5	55.74	-	-	P	H	
													H	
													H	
													H	
													H	
													H	
													H	
													H	
													H	
													H	
													H	
													H	
													H	
													H	
			6906	61.66	-6.54	68.2	72.16	35.89	9.84	56.23	229	77	P	V
			10360	48.68	-19.52	68.2	54.59	38.92	11.53	56.36	-	-	P	V
		15540	46.48	-27.52	74	50.5	38.22	13.5	55.74	-	-	P	V	
													V	
													V	
													V	
													V	
													V	
													V	
													V	
													V	
													V	
													V	



WIFI Ant. 6+7	Note	Frequency ( MHz )	Level ( dBμV/m )	Margin ( dB )	Limit Line ( dBμV/m )	Read Level (dBμV)	Antenna Factor ( dB/m )	Path Loss ( dB )	Preamp Factor ( dB )	Ant Pos ( cm )	Table Pos ( deg )	Peak Avg. (P/A)	Pol. (H/V)	
802.11a CH 44 5220MHz		6959	60.3	-7.9	68.2	70.92	35.82	9.82	56.26	100	15	P	H	
		10440	47.14	-21.06	68.2	52.83	39	11.57	56.26	-	-	P	H	
		15660	45.87	-28.13	74	50.25	37.7	13.56	55.64	-	-	P	H	
													H	
													H	
													H	
													H	
													H	
													H	
													H	
													H	
													H	
													H	
													H	
													H	
													H	
													H	
			6959	60.5	-7.7	68.2	71.12	35.82	9.82	56.26	266	80	P	V
			10440	48.43	-19.77	68.2	54.12	39	11.57	56.26	-	-	P	V
		15660	45.92	-28.08	74	50.3	37.7	13.56	55.64	-	-	P	V	
													V	
													V	
													V	
													V	
													V	
													V	
													V	
													V	
													V	
													V	



WIFI Ant. 6+7	Note	Frequency ( MHz )	Level ( dBμV/m )	Margin ( dB )	Limit Line ( dBμV/m )	Read Level (dBμV)	Antenna Factor ( dB/m )	Path Loss ( dB )	Preamp Factor ( dB )	Ant Pos ( cm )	Table Pos ( deg )	Peak Avg. (P/A)	Pol. (H/V)	
802.11a CH 48 5240MHz		6986	60.66	-7.54	68.2	71.25	35.87	9.81	56.27	105	296	P	H	
		10480	48.05	-20.15	68.2	53.73	38.94	11.59	56.21	-	-	P	H	
		15720	46.5	-27.5	74	50.8	37.7	13.59	55.59	-	-	P	H	
													H	
													H	
													H	
													H	
													H	
													H	
													H	
													H	
													H	
			6986	61.42	-6.78	68.2	72.01	35.87	9.81	56.27	239	110	P	V
			10480	49.19	-19.01	68.2	54.87	38.94	11.59	56.21	-	-	P	V
			15720	45.79	-28.21	74	50.09	37.7	13.59	55.59	-	-	P	V
														V
														V
														V
													V	
													V	
													V	
													V	
<b>Remark</b>	<ol style="list-style-type: none"> <li>No other spurious found.</li> <li>All results are PASS against Peak and Average limit line.</li> <li>The emission position marked as "-" means no suspected emission found with sufficient margin against limit line or noise floor only.</li> </ol>													



**Band 1 5150~5250MHz**  
**WIFI 802.11ax HE20 Full (Band Edge @ 3m)**

WIFI Ant. 6+7	Note	Frequency ( MHz )	Level ( dBμV/m )	Margin ( dB )	Limit Line ( dBμV/m )	Read Level (dBμV)	Antenna Factor ( dB/m )	Path Loss ( dB )	Preamp Factor ( dB )	Ant Pos ( cm )	Table Pos ( deg )	Peak Avg. (P/A)	Pol. (H/V)	
802.11ax HE20 Full CH 36 5180MHz		5145.86	61.24	-12.76	74	58.11	33.19	7	37.06	110	260	P	H	
		5150	50.52	-3.48	54	47.38	33.2	7	37.06	110	260	A	H	
	*	5180	116.37	-	-	113.16	33.2	7.05	37.04	110	260	P	H	
	*	5180	108.46	-	-	105.25	33.2	7.05	37.04	110	260	A	H	
													H	
														H
			5149.76	57.48	-16.52	74	54.34	33.2	7	37.06	111	153	P	V
			5150	48.56	-5.44	54	45.42	33.2	7	37.06	111	153	A	V
		*	5180	112.53	-	-	109.32	33.2	7.05	37.04	111	153	P	V
		*	5180	105.74	-	-	102.53	33.2	7.05	37.04	111	153	A	V
													V	
													V	
802.11ax HE20 Full CH 44 5220MHz		5146.38	55.81	-18.19	74	52.68	33.19	7	37.06	100	262	P	H	
		5149.76	45.17	-8.83	54	42.03	33.2	7	37.06	100	262	A	H	
		* 5220	113.66	-	-	110.4	33.2	7.07	37.01	100	262	P	H	
		* 5220	108.78	-	-	105.52	33.2	7.07	37.01	100	262	A	H	
			5365.08	47.18	-26.82	74	44.07	33	7.02	36.91	100	262	P	H
			5351.64	38.35	-15.65	54	35.24	33	7.03	36.92	100	262	A	H
			5145.08	54.5	-19.5	74	51.38	33.19	6.99	37.06	100	144	P	V
			5149.24	43.76	-10.24	54	40.62	33.2	7	37.06	100	144	A	V
		*	5220	113.29	-	-	110.03	33.2	7.07	37.01	100	144	P	V
		*	5220	108.24	-	-	104.98	33.2	7.07	37.01	100	144	A	V
		5358.08	46.28	-27.72	74	43.18	33	7.02	36.92	100	144	P	V	
		5349.96	37.95	-112.05	150	34.84	33	7.03	36.92	100	144	A	V	



<b>802.11ax</b> <b>HE20 Full</b> <b>CH 48</b> <b>5240MHz</b>		5148.2	53	-21	74	49.86	33.2	7	37.06	100	259	P	H
		5149.5	42.46	-11.54	54	39.32	33.2	7	37.06	100	259	A	H
	*	5240	114.3	-	-	111.03	33.2	7.07	37	100	259	P	H
	*	5240	108.16	-	-	104.89	33.2	7.07	37	100	259	A	H
		5354.44	49.7	-24.3	74	46.59	33	7.03	36.92	100	259	P	H
		5368.72	41.89	-12.11	54	38.78	33	7.02	36.91	100	259	A	H
		5149.76	55.06	-18.94	74	51.92	33.2	7	37.06	119	142	P	V
		5148.46	44.3	-9.7	54	41.16	33.2	7	37.06	119	142	A	V
	*	5240	112.4	-	-	109.13	33.2	7.07	37	119	142	P	V
	*	5240	107.11	-	-	103.84	33.2	7.07	37	119	142	A	V
	5354.44	49.71	-24.29	74	46.6	33	7.03	36.92	119	142	P	V	
	5350.52	39.96	-14.04	54	36.85	33	7.03	36.92	119	142	A	V	
Remark	1. No other spurious found. 2. All results are PASS against Peak and Average limit line.												



Band 1 5150~5250MHz

WIFI 802.11ax HE20 Full (Harmonic @ 3m)

WIFI Ant. 6+7	Note	Frequency ( MHz )	Level ( dBμV/m )	Margin ( dB )	Limit Line ( dBμV/m )	Read Level (dBμV)	Antenna Factor ( dB/m )	Path Loss ( dB )	Preamp Factor ( dB )	Ant Pos ( cm )	Table Pos ( deg )	Peak Avg. (P/A)	Pol. (H/V)
802.11ax HE20 Full		6906	62.16	-6.04	68.2	72.66	35.89	9.84	56.23	114	41	P	H
		10360	47.84	-20.36	68.2	53.75	38.92	11.53	56.36	-	-	P	H
		15540	46.17	-27.83	74	50.19	38.22	13.5	55.74	-	-	P	H
													H
													H
													H
													H
													H
													H
													H
CH 36 5180MHz		6906	61.09	-7.11	68.2	71.59	35.89	9.84	56.23	236	75	P	V
		10360	47.6	-20.6	68.2	53.51	38.92	11.53	56.36	-	-	P	V
		15540	46	-28	74	50.02	38.22	13.5	55.74	-	-	P	V
													V
													V
													V
													V
													V
													V
													V





WIFI Ant. 6+7	Note	Frequency ( MHz )	Level ( dBμV/m )	Margin ( dB )	Limit Line ( dBμV/m )	Read Level (dBμV)	Antenna Factor ( dB/m )	Path Loss ( dB )	Preamp Factor ( dB )	Ant Pos ( cm )	Table Pos ( deg )	Peak Avg. (P/A)	Pol. (H/V)
802.11ax HE20 Full CH 44 5220MHz		6959	60.89	-7.31	68.2	71.51	35.82	9.82	56.26	100	42	P	H
		10440	47.92	-20.28	68.2	53.61	39	11.57	56.26	-	-	P	H
		15660	45.93	-28.07	74	50.31	37.7	13.56	55.64	-	-	P	H
													H
													H
													H
													H
													H
													H
													H
		6959	60.9	-7.3	68.2	71.52	35.82	9.82	56.26	263	81	P	V
		10440	48.96	-19.24	68.2	54.65	39	11.57	56.26	-	-	P	V
		15660	46.5	-27.5	74	50.88	37.7	13.56	55.64	-	-	P	V
													V
													V
													V
													V
													V
													V
													V
													V





**Band 1 5150~5250MHz**  
**WIFI 802.11ax HE20 Partial 106 (Band Edge @ 3m)**

WIFI Ant. 6+7	Note	Frequency ( MHz )	Level ( dBμV/m )	Margin ( dB )	Limit Line ( dBμV/m )	Read Level (dBμV)	Antenna Factor ( dB/m )	Path Loss ( dB )	Preamp Factor ( dB )	Ant Pos ( cm )	Table Pos ( deg )	Peak Avg. (P/A)	Pol. (H/V)	
802.11ax HE20 Partial 106/53 CH 36 5180MHz		5149.76	72.62	-1.38	74	69.48	33.2	7	37.06	100	261	P	H	
		5150	50.95	-3.05	54	47.81	33.2	7	37.06	100	261	A	H	
	*	5180	112.85	-	-	109.64	33.2	7.05	37.04	100	261	P	H	
	*	5180	107.32	-	-	104.11	33.2	7.05	37.04	100	261	A	H	
													H	
														H
			5150	70.84	-3.16	74	67.7	33.2	7	37.06	100	283	P	V
			5146.64	47.94	-6.06	54	44.81	33.19	7	37.06	100	283	A	V
	*		5180	111.42	-	-	108.21	33.2	7.05	37.04	100	283	P	V
	*		5180	105.33	-	-	102.12	33.2	7.05	37.04	100	283	A	V
													V	
													V	
<b>Remark</b>	1. No other spurious found. 2. All results are PASS against Peak and Average limit line.													



**Band 1 5150~5250MHz**  
**WIFI 802.11ax HE40 Full (Band Edge @ 3m)**

WIFI Ant. 6+7	Note	Frequency ( MHz )	Level ( dBμV/m )	Margin ( dB )	Limit Line ( dBμV/m )	Read Level (dBμV)	Antenna Factor ( dB/m )	Path Loss ( dB )	Preamp Factor ( dB )	Ant Pos ( cm )	Table Pos ( deg )	Peak Avg. (P/A)	Pol. (H/V)
802.11ax HE40 Full CH 38 5190MHz		5144.3	63.69	-10.31	74	60.57	33.19	6.99	37.06	102	260	P	H
		5150	52.16	-1.84	54	49.02	33.2	7	37.06	102	260	A	H
	*	5190	111.71	-	-	108.48	33.2	7.06	37.03	102	260	P	H
	*	5190	105.69	-	-	102.46	33.2	7.06	37.03	102	260	A	H
		5356.68	47.92	-26.08	74	44.81	33	7.03	36.92	102	260	P	H
		5350.24	38.88	-15.12	54	35.77	33	7.03	36.92	102	260	A	H
		5137.02	59	-15	74	55.92	33.17	6.98	37.07	100	152	P	V
		5148.72	48.52	-5.48	54	45.38	33.2	7	37.06	100	152	A	V
	*	5190	110.02	-	-	106.79	33.2	7.06	37.03	100	152	P	V
	*	5190	103.28	-	-	100.05	33.2	7.06	37.03	100	152	A	V
		5353.88	45.67	-28.33	74	42.56	33	7.03	36.92	100	152	P	V
		5350.24	36.63	-17.37	54	33.52	33	7.03	36.92	100	152	A	V
802.11ax HE40 Full CH 46 5230MHz		5148.46	65.24	-8.76	74	58.68	33.2	7	33.64	100	257	P	H
		5150	51.76	-2.24	54	45.2	33.2	7	33.64	100	257	A	H
	*	5230	113.83	-	-	107.18	33.2	7.07	33.62	100	257	P	H
	*	5230	107.81	-	-	101.16	33.2	7.07	33.62	100	257	A	H
		5372.92	54.7	-19.3	74	48.27	33	7.02	33.59	100	257	P	H
		5350.24	44.75	-9.25	54	38.32	33	7.03	33.6	100	257	A	H
		5148.72	62.48	-11.52	74	55.92	33.2	7	33.64	100	148	P	V
		5147.16	51.37	-2.63	54	44.82	33.19	7	33.64	100	148	A	V
	*	5230	112.51	-	-	105.86	33.2	7.07	33.62	100	148	P	V
	*	5230	106.49	-	-	99.84	33.2	7.07	33.62	100	148	A	V
		5358.92	54.52	-19.48	74	48.09	33	7.02	33.59	100	148	P	V
		5350.52	43.5	-10.5	54	37.07	33	7.03	33.6	100	148	A	V
Remark	1. No other spurious found. 2. All results are PASS against Peak and Average limit line.												



Band 1 5150~5250MHz

WIFI 802.11ax HE40 Full (Harmonic @ 3m)

WIFI Ant. 6+7	Note	Frequency ( MHz )	Level ( dBμV/m )	Margin ( dB )	Limit Line ( dBμV/m )	Read Level (dBμV)	Antenna Factor ( dB/m )	Path Loss ( dB )	Preamp Factor ( dB )	Ant Pos ( cm )	Table Pos ( deg )	Peak Avg. (P/A)	Pol. (H/V)
802.11ax HE40 Full		6920	61.74	-6.46	68.2	72.27	35.86	9.84	56.23	107	40	P	H
		10380	47.41	-20.79	68.2	53.25	38.96	11.54	56.34	-	-	P	H
		15570	43.8	-30.2	74	47.84	38.16	13.52	55.72	-	-	P	H
													H
													H
													H
													H
													H
													H
													H
CH 38 5190MHz		6920	61.41	-6.79	68.2	71.94	35.86	9.84	56.23	250	76	P	V
		10380	47.47	-20.73	68.2	53.31	38.96	11.54	56.34	-	-	P	V
		15570	44.73	-29.27	74	48.77	38.16	13.52	55.72	-	-	P	V
													V
													V
													V
													V
													V
													V
													V





**Band 1 5150~5250MHz**  
**WIFI 802.11ax HE40 Partial 242 (Band Edge @ 3m)**

WIFI Ant. 6+7	Note	Frequency ( MHz )	Level ( dBμV/m )	Margin ( dB )	Limit Line ( dBμV/m )	Read Level (dBμV)	Antenna Factor ( dB/m )	Path Loss ( dB )	Preamp Factor ( dB )	Ant Pos ( cm )	Table Pos ( deg )	Peak Avg. (P/A)	Pol. (H/V)
<b>802.11ax HE40 Partial 242/61 CH 38 5190MHz</b>		5147.68	67.7	-6.3	74	64.56	33.2	7	37.06	100	261	P	H
		5145.6	50.07	-3.93	54	46.94	33.19	7	37.06	100	261	A	H
	*	5190	113.25	-	-	110.02	33.2	7.06	37.03	100	261	P	H
	*	5190	104.81	-	-	101.58	33.2	7.06	37.03	100	261	A	H
		5350	49.36	-24.64	74	46.25	33	7.03	36.92	100	261	P	H
		5350	35.99	-18.01	54	32.88	33	7.03	36.92	100	261	A	H
		5138.84	65.5	-8.5	74	62.4	33.18	6.99	37.07	108	148	P	V
		5148.46	47.77	-6.23	54	44.63	33.2	7	37.06	108	148	A	V
	*	5190	109.37	-	-	106.14	33.2	7.06	37.03	108	148	P	V
	*	5190	102.35	-	-	99.12	33.2	7.06	37.03	108	148	A	V
		5353.88	48.7	-25.3	74	45.59	33	7.03	36.92	108	148	P	V
		5350	35.56	-18.44	54	32.45	33	7.03	36.92	108	148	A	V
<b>Remark</b>	1. No other spurious found. 2. All results are PASS against Peak and Average limit line.												



**Band 1 5150~5250MHz**  
**WIFI 802.11ax HE80 Full (Band Edge @ 3m)**

WIFI Ant. 6+7	Note	Frequency ( MHz )	Level ( dBμV/m )	Margin ( dB )	Limit Line ( dBμV/m )	Read Level (dBμV)	Antenna Factor ( dB/m )	Path Loss ( dB )	Preamp Factor ( dB )	Ant Pos ( cm )	Table Pos ( deg )	Peak Avg. (P/A)	Pol. (H/V)
<b>802.11ax HE80 Full CH 42 5210MHz</b>		5148.72	58.44	-15.56	74	55.3	33.2	7	37.06	100	259	P	H
		5149.76	50.66	-3.34	54	47.52	33.2	7	37.06	100	259	A	H
	*	5210	108.18	-	-	104.92	33.2	7.08	37.02	100	259	P	H
	*	5210	102.36	-	-	99.1	33.2	7.08	37.02	100	259	A	H
		5351.92	54.34	-19.66	74	51.23	33	7.03	36.92	100	259	P	H
		5351.64	44.28	-9.72	54	41.17	33	7.03	36.92	100	259	A	H
		5148.72	58.55	-15.45	74	55.41	33.2	7	37.06	108	145	P	V
		5148.2	47.55	-6.45	54	44.41	33.2	7	37.06	108	145	A	V
	*	5210	105.83	-	-	102.57	33.2	7.08	37.02	108	145	P	V
	*	5210	99.43	-	-	96.17	33.2	7.08	37.02	108	145	A	V
		5390	47.23	-26.77	74	44.11	33	7.01	36.89	108	145	P	V
		5350	39.23	-14.77	54	36.12	33	7.03	36.92	108	145	A	V
<b>Remark</b>	1. No other spurious found. 2. All results are PASS against Peak and Average limit line.												







**Band 1 5150~5250MHz**  
**WIFI 802.11ax HE80 Partial 484 (Band Edge @ 3m)**

WIFI Ant. 6+7	Note	Frequency ( MHz )	Level ( dBμV/m )	Margin ( dB )	Limit Line ( dBμV/m )	Read Level (dBμV)	Antenna Factor ( dB/m )	Path Loss ( dB )	Preamp Factor ( dB )	Ant Pos ( cm )	Table Pos ( deg )	Peak Avg. (P/A)	Pol. (H/V)
<b>802.11ax HE80 Partial 484/65 CH 42 5210MHz</b>		5145.34	70.27	-3.73	74	67.14	33.19	7	37.06	100	262	P	H
		5149.76	51.05	-2.95	54	47.91	33.2	7	37.06	100	262	A	H
	*	5210	107.44	-	-	104.18	33.2	7.08	37.02	100	262	P	H
	*	5210	99.84	-	-	96.58	33.2	7.08	37.02	100	262	A	H
		5361.16	59.66	-14.34	74	56.55	33	7.02	36.91	100	262	P	H
		5351.08	38.48	-15.52	54	35.37	33	7.03	36.92	100	262	A	H
		5143.52	71.16	-2.84	74	68.04	33.19	6.99	37.06	101	293	P	V
		5148.46	50.45	-3.55	54	47.31	33.2	7	37.06	101	293	A	V
	*	5210	107.17	-	-	103.91	33.2	7.08	37.02	101	293	P	V
	*	5210	98.77	-	-	95.51	33.2	7.08	37.02	101	293	A	V
		5358.36	57.38	-16.62	74	54.28	33	7.02	36.92	101	293	P	V
		5353.6	37.55	-16.45	54	34.44	33	7.03	36.92	101	293	A	V
<b>Remark</b>	1. No other spurious found. 2. All results are PASS against Peak and Average limit line.												



Band 1 5150~5250MHz

WIFI 802.11ax HE160 Full (Band Edge @ 3m)

WIFI Ant. 6+7	Note	Frequency ( MHz )	Level ( dBμV/m )	Margin ( dB )	Limit Line ( dBμV/m )	Read Level (dBμV)	Antenna Factor ( dB/m )	Path Loss ( dB )	Preamp Factor ( dB )	Ant Pos ( cm )	Table Pos ( deg )	Peak Avg. (P/A)	Pol. (H/V)
802.11ax HE160 Full CH 50 5250MHz		5102.18	55.81	-18.19	74	52.87	33.1	6.93	37.09	108	256	P	H
		5117.52	47.67	-6.33	54	44.66	33.14	6.95	37.08	108	256	A	H
	*	5250	105.22	-	-	101.95	33.2	7.06	36.99	108	256	P	H
	*	5250	97.8	-	-	94.53	33.2	7.06	36.99	108	256	A	H
		5394.2	61.74	-12.26	74	58.62	33	7.01	36.89	108	256	P	H
		5378.8	51.44	-2.56	54	48.32	33	7.02	36.9	108	256	A	H
		5110.76	53.96	-20.04	74	50.98	33.12	6.94	37.08	100	141	P	V
		5090.22	45.53	-8.47	54	42.6	33.12	6.91	37.1	100	141	A	V
	*	5250	102.86	-	-	99.59	33.2	7.06	36.99	100	141	P	V
	*	5250	94.8	-	-	91.53	33.2	7.06	36.99	100	141	A	V
		5397	59.02	-14.98	74	55.9	33	7.01	36.89	100	141	P	V
		5372.36	50.91	-3.09	54	47.8	33	7.02	36.91	100	141	A	V
Remark	<ol style="list-style-type: none"> <li>No other spurious found.</li> <li>All results are PASS against Peak and Average limit line.</li> </ol>												





**Band 1 5150~5250MHz**  
**WIFI 802.11ax HE160 Partial 996 (Band Edge @ 3m)**

WIFI Ant. 6+7	Note	Frequency ( MHz )	Level ( dBμV/m )	Margin ( dB )	Limit Line ( dBμV/m )	Read Level (dBμV)	Antenna Factor ( dB/m )	Path Loss ( dB )	Preamp Factor ( dB )	Ant Pos ( cm )	Table Pos ( deg )	Peak Avg. (P/A)	Pol. (H/V)
802.11ax HE160 Partial 996/67 CH 50 5250MHz		5136.24	71.76	-2.24	74	68.68	33.17	6.98	37.07	100	258	P	H
		5143.52	49.34	-4.66	54	46.22	33.19	6.99	37.06	100	258	A	H
	*	5250	104.88	-	-	101.61	33.2	7.06	36.99	100	258	P	H
	*	5250	96.56	-	-	93.29	33.2	7.06	36.99	100	258	A	H
		5389.72	69.71	-4.29	74	66.59	33	7.01	36.89	100	258	P	H
		5404.28	48.12	-5.88	54	44.99	33.01	7.01	36.89	100	258	A	H
		5148.72	67.06	-6.94	74	63.92	33.2	7	37.06	100	290	P	V
		5148.46	46.54	-7.46	54	43.4	33.2	7	37.06	100	290	A	V
	*	5250	103.23	-	-	99.96	33.2	7.06	36.99	100	290	P	V
	*	5250	94.94	-	-	91.67	33.2	7.06	36.99	100	290	A	V
		5402.6	68.5	-5.5	74	65.37	33.01	7.01	36.89	100	290	P	V
		5392.24	47.16	-6.84	54	44.04	33	7.01	36.89	100	290	A	V
802.11ax HE160 Partial 996/68 CH 50 5250MHz		5134.94	72.15	-1.85	74	69.07	33.17	6.98	37.07	100	267	P	H
		5130.52	51.21	-2.79	54	48.15	33.16	6.97	37.07	100	267	A	H
	*	5250	103.39	-	-	100.12	33.2	7.06	36.99	100	267	P	H
	*	5250	94.54	-	-	91.27	33.2	7.06	36.99	100	267	A	H
		5392.24	71.74	-2.26	74	68.62	33	7.01	36.89	100	267	P	H
		5393.64	50.06	-3.94	54	46.94	33	7.01	36.89	100	267	A	H
		5125.58	66.14	-7.86	74	63.1	33.15	6.96	37.07	100	147	P	V
		5129.22	45.21	-8.79	54	42.15	33.16	6.97	37.07	100	147	A	V
	*	5250	102.9	-	-	99.63	33.2	7.06	36.99	100	147	P	V
	*	5250	93.25	-	-	89.98	33.2	7.06	36.99	100	147	A	V
		5393.92	67.77	-6.23	74	64.65	33	7.01	36.89	100	147	P	V
		5398.96	47.32	-6.68	54	44.2	33	7.01	36.89	100	147	A	V
Remark	1. No other spurious found. 2. All results are PASS against Peak and Average limit line.												



**Band 2 - 5250~5350MHz**  
**WIFI 802.11a (Band Edge @ 3m)**

WIFI Ant. 6+7	Note	Frequency ( MHz )	Level ( dBμV/m )	Margin ( dB )	Limit Line ( dBμV/m )	Read Level (dBμV)	Antenna Factor ( dB/m )	Path Loss ( dB )	Preamp Factor ( dB )	Ant Pos ( cm )	Table Pos ( deg )	Peak Avg. (P/A)	Pol. (H/V)	
802.11a CH 52 5260MHz		5147.56	48.83	-25.17	74	45.69	33.2	7	37.06	101	270	P	H	
		5136.68	40.07	-13.93	54	36.99	33.17	6.98	37.07	101	270	A	H	
	*	5260	113.87	-	-	110.61	33.18	7.06	36.98	101	270	P	H	
	*	5260	108.07	-	-	104.81	33.18	7.06	36.98	101	270	A	H	
		5357.52	48.49	-25.51	74	45.39	33	7.02	36.92	101	270	P	H	
		5354.64	39.8	-14.2	54	36.69	33	7.03	36.92	101	270	A	H	
		5137.02	47.29	-26.71	74	44.21	33.17	6.98	37.07	101	120	P	V	
		5146.88	38.7	-15.3	54	35.57	33.19	7	37.06	101	120	A	V	
	*	5260	113.65	-	-	110.39	33.18	7.06	36.98	101	120	P	V	
	*	5260	107.51	-	-	104.25	33.18	7.06	36.98	101	120	A	V	
		5368.8	48.01	-25.99	74	44.9	33	7.02	36.91	101	120	P	V	
		5350.56	39.29	-14.71	54	36.18	33	7.03	36.92	101	120	A	V	
	802.11a CH 60 5300MHz		5144.5	46.97	-27.03	74	43.85	33.19	6.99	37.06	105	254	P	H
			5146.88	38.69	-15.31	54	35.56	33.19	7	37.06	105	254	A	H
*		5300	113.8	-	-	110.61	33.1	7.05	36.96	105	254	P	H	
*		5300	107.97	-	-	104.78	33.1	7.05	36.96	105	254	A	H	
		5351.28	50.92	-23.08	74	47.81	33	7.03	36.92	105	254	P	H	
		5351.52	43.77	-10.23	54	40.66	33	7.03	36.92	105	254	A	H	
		5095.54	47.63	-26.37	74	44.7	33.11	6.92	37.1	116	293	P	V	
		5145.52	38.19	-15.81	54	35.06	33.19	7	37.06	116	293	A	V	
*		5300	111.36	-	-	108.17	33.1	7.05	36.96	116	293	P	V	
*		5300	106.23	-	-	103.04	33.1	7.05	36.96	116	293	A	V	
		5358	50.02	-23.98	74	46.92	33	7.02	36.92	116	293	P	V	
		5353.44	41.89	-12.11	54	38.78	33	7.03	36.92	116	293	A	V	



<b>802.11a</b> <b>CH 64</b> <b>5320MHz</b>	*	5320	113.59	-	-	110.43	33.06	7.04	36.94	100	253	P	H
	*	5320	107.82	-	-	104.66	33.06	7.04	36.94	100	253	A	H
		5350.72	58.43	-15.57	74	55.32	33	7.03	36.92	100	253	P	H
		5350.4	49.38	-4.62	54	46.27	33	7.03	36.92	100	253	A	H
													H
													H
	*	5320	112.25	-	-	109.09	33.06	7.04	36.94	108	294	P	V
	*	5320	106.24	-	-	103.08	33.06	7.04	36.94	108	294	A	V
		5351.84	55.71	-18.29	74	52.6	33	7.03	36.92	108	294	P	V
		5352.16	46.43	-7.57	54	43.32	33	7.03	36.92	108	294	A	V
													V
													V
<b>Remark</b>	1. No other spurious found. 2. All results are PASS against Peak and Average limit line.												



Band 2 5250~5350MHz

WIFI 802.11a (Harmonic @ 3m)

WIFI Ant. 6+7	Note	Frequency ( MHz )	Level ( dBμV/m )	Margin ( dB )	Limit Line ( dBμV/m )	Read Level (dBμV)	Antenna Factor ( dB/m )	Path Loss ( dB )	Preamp Factor ( dB )	Ant Pos ( cm )	Table Pos ( deg )	Peak Avg. (P/A)	Pol. (H/V)	
802.11a CH 52 5260MHz		7011	63.54	-4.66	68.2	74.05	35.97	9.82	56.3	100	38	P	H	
		10520	46.79	-21.41	68.2	52.42	38.94	11.62	56.19	-	-	P	H	
		15780	46.15	-27.85	74	50.42	37.64	13.62	55.53	-	-	P	H	
													H	
													H	
													H	
													H	
													H	
													H	
													H	
													H	
													H	
													H	
													H	
													H	
													H	
			7013	64.41	-3.79	68.2	74.91	35.98	9.82	56.3	309	83	P	V
			10520	46.74	-21.46	68.2	52.37	38.94	11.62	56.19	-	-	P	V
		15780	46.68	-27.32	74	50.95	37.64	13.62	55.53	-	-	P	V	
													V	
													V	
													V	
													V	
													V	
													V	
													V	
													V	
													V	





WIFI Ant. 6+7	Note	Frequency ( MHz )	Level ( dBμV/m )	Margin ( dB )	Limit Line ( dBμV/m )	Read Level (dBμV)	Antenna Factor ( dB/m )	Path Loss ( dB )	Preamp Factor ( dB )	Ant Pos ( cm )	Table Pos ( deg )	Peak Avg. (P/A)	Pol. (H/V)	
802.11a CH 60 5300MHz		7066	62.74	-5.46	68.2	73	36.26	9.88	56.4	100	296	P	H	
		10600	47	-27	74	52.22	39.3	11.66	56.18	-	-	P	H	
		15900	45.24	-28.76	74	49.19	37.8	13.68	55.43	-	-	P	H	
													H	
													H	
													H	
													H	
													H	
													H	
													H	
													H	
													H	
													H	
													H	
													H	
													H	
			7066	62.51	-5.69	68.2	72.77	36.26	9.88	56.4	252	80	P	V
			10600	46.75	-27.25	74	51.97	39.3	11.66	56.18	-	-	P	V
		15900	45.6	-28.4	74	49.55	37.8	13.68	55.43	-	-	P	V	
													V	
													V	
													V	
													V	
													V	
													V	
													V	
													V	
													V	



WIFI Ant. 6+7	Note	Frequency ( MHz )	Level ( dBμV/m )	Margin ( dB )	Limit Line ( dBμV/m )	Read Level (dBμV)	Antenna Factor ( dB/m )	Path Loss ( dB )	Preamp Factor ( dB )	Ant Pos ( cm )	Table Pos ( deg )	Peak Avg. (P/A)	Pol. (H/V)
802.11a CH 64 5320MHz		7093	62.13	-6.07	68.2	72.29	36.37	9.91	56.44	100	145	P	H
		10640	48.85	-25.15	74	53.89	39.46	11.68	56.18	-	-	P	H
		15960	45.47	-28.53	74	49.66	37.48	13.71	55.38	-	-	P	H
													H
													H
													H
													H
													H
													H
													H
													H
													H
													H
													H
													H
													H
													H
			7093	63.39	-4.81	68.2	73.55	36.37	9.91	56.44	252	78	P
		10640	47.65	-26.35	74	52.69	39.46	11.68	56.18	-	-	P	V
		15960	45.46	-28.54	74	49.65	37.48	13.71	55.38	-	-	P	V
													V
													V
													V
													V
													V
													V
													V
													V
													V
													V
													V
													V
													V
<b>Remark</b>	<ol style="list-style-type: none"> <li>No other spurious found.</li> <li>All results are PASS against Peak and Average limit line.</li> <li>The emission position marked as "-" means no suspected emission found with sufficient margin against limit line or noise floor only.</li> </ol>												



**Band 2 5250~5350MHz**  
**WIFI 802.11ax HE20 Full (Band Edge @ 3m)**

WIFI Ant. 6+7	Note	Frequency ( MHz )	Level ( dBμV/m )	Margin ( dB )	Limit Line ( dBμV/m )	Read Level (dBμV)	Antenna Factor ( dB/m )	Path Loss ( dB )	Preamp Factor ( dB )	Ant Pos ( cm )	Table Pos ( deg )	Peak Avg. (P/A)	Pol. (H/V)
802.11ax HE20 Full CH 52 5260MHz		5149.94	49.31	-24.69	74	46.17	33.2	7	37.06	100	268	P	H
		5149.6	39.61	-14.39	54	36.47	33.2	7	37.06	100	268	A	H
	*	5260	114.39	-	-	111.13	33.18	7.06	36.98	100	268	P	H
	*	5260	108.01	-	-	104.75	33.18	7.06	36.98	100	268	A	H
		5352.72	49.03	-24.97	74	45.92	33	7.03	36.92	100	268	P	H
		5363.52	39.51	-14.49	54	36.4	33	7.02	36.91	100	268	A	H
		5149.94	48.33	-25.67	74	45.19	33.2	7	37.06	105	143	P	V
		5098.6	39.02	-14.98	54	36.09	33.1	6.92	37.09	105	143	A	V
	*	5260	114.16	-	-	110.9	33.18	7.06	36.98	105	143	P	V
	*	5260	107.26	-	-	104	33.18	7.06	36.98	105	143	A	V
		5355.36	48.28	-25.72	74	45.17	33	7.03	36.92	105	143	P	V
		5353.68	39	-15	54	35.89	33	7.03	36.92	105	143	A	V
802.11ax HE20 Full CH 60 5300MHz		5092.82	47.92	-26.08	74	45	33.11	6.91	37.1	100	268	P	H
		5142.46	39.04	-14.96	54	35.93	33.18	6.99	37.06	100	268	A	H
	*	5300	114.24	-	-	111.05	33.1	7.05	36.96	100	268	P	H
	*	5300	107.99	-	-	104.8	33.1	7.05	36.96	100	268	A	H
		5350.08	59.3	-14.7	74	56.19	33	7.03	36.92	100	268	P	H
		5350.08	45.74	-8.26	54	42.63	33	7.03	36.92	100	268	A	H
		5115.94	48.71	-25.29	74	45.71	33.13	6.95	37.08	114	143	P	V
		5146.54	38.85	-15.15	54	35.72	33.19	7	37.06	114	143	A	V
	*	5300	112.72	-	-	109.53	33.1	7.05	36.96	114	143	P	V
	*	5300	106.92	-	-	103.73	33.1	7.05	36.96	114	143	A	V
		5358.24	57.85	-16.15	74	54.75	33	7.02	36.92	114	143	P	V
		5350.08	45.18	-8.82	54	42.07	33	7.03	36.92	114	143	A	V



<b>802.11ax HE20 Full CH 64 5320MHz</b>	*	5320	113.99	-	-	110.83	33.06	7.04	36.94	100	260	P	H
	*	5320	107.27	-	-	104.11	33.06	7.04	36.94	100	260	A	H
		5350.08	63.75	-10.25	74	60.64	33	7.03	36.92	100	260	P	H
		5350.08	51.38	-2.62	54	48.27	33	7.03	36.92	100	260	A	H
													H
													H
	*	5320	113.98	-	-	110.82	33.06	7.04	36.94	100	119	P	V
	*	5320	106.35	-	-	103.19	33.06	7.04	36.94	100	119	A	V
		5351.52	62.98	-11.02	74	59.87	33	7.03	36.92	100	119	P	V
		5351.68	48.73	-5.27	54	45.62	33	7.03	36.92	100	119	A	V
												V	
												V	
<b>Remark</b>	<ol style="list-style-type: none"> <li>1. No other spurious found.</li> <li>2. All results are PASS against Peak and Average limit line.</li> </ol>												



Band 2 5250~5350MHz

WIFI 802.11ax HE20 Full (Harmonic @ 3m)

WIFI Ant. 6+7	Note	Frequency ( MHz )	Level ( dBμV/m )	Margin ( dB )	Limit Line ( dBμV/m )	Read Level (dBμV)	Antenna Factor ( dB/m )	Path Loss ( dB )	Preamp Factor ( dB )	Ant Pos ( cm )	Table Pos ( deg )	Peak Avg. (P/A)	Pol. (H/V)
802.11ax HE20 Full CH 52 5260MHz		7013	64.01	-4.19	68.2	74.51	35.98	9.82	56.3	100	15	P	H
		10520	47.21	-20.99	68.2	52.84	38.94	11.62	56.19	-	-	P	H
		15780	47.28	-26.72	74	51.55	37.64	13.62	55.53	-	-	P	H
													H
													H
													H
													H
													H
													H
													H
		7013	64.27	-3.93	68.2	74.77	35.98	9.82	56.3	240	79	P	V
		10520	47.97	-20.23	68.2	53.6	38.94	11.62	56.19	-	-	P	V
		15780	46.58	-27.42	74	50.85	37.64	13.62	55.53	-	-	P	V
													V
													V
													V
													V
													V
													V
													V
													V



WIFI Ant. 6+7	Note	Frequency ( MHz )	Level ( dBμV/m )	Margin ( dB )	Limit Line ( dBμV/m )	Read Level (dBμV)	Antenna Factor ( dB/m )	Path Loss ( dB )	Preamp Factor ( dB )	Ant Pos ( cm )	Table Pos ( deg )	Peak Avg. (P/A)	Pol. (H/V)
		7066	63.2	-5	68.2	73.46	36.26	9.88	56.4	101	292	P	H
		10600	47.47	-26.53	74	52.69	39.3	11.66	56.18	-	-	P	H
		15900	44.24	-29.76	74	48.19	37.8	13.68	55.43	-	-	P	H
													H
													H
													H
													H
													H
													H
													H
802.11ax													H
HE20 Full													H
CH 60		7066	63.26	-4.94	68.2	73.52	36.26	9.88	56.4	247	80	P	V
5300MHz		10600	46.79	-27.21	74	52.01	39.3	11.66	56.18	-	-	P	V
		15900	45.25	-28.75	74	49.2	37.8	13.68	55.43	-	-	P	V
													V
													V
													V
													V
													V
													V
													V
													V
													V
													V





**Band 2 5250~5350MHz**  
**WIFI 802.11ax HE20 Partial 106 (Band Edge @ 3m)**

WIFI Ant. 6+7	Note	Frequency ( MHz )	Level ( dBμV/m )	Margin ( dB )	Limit Line ( dBμV/m )	Read Level (dBμV)	Antenna Factor ( dB/m )	Path Loss ( dB )	Preamp Factor ( dB )	Ant Pos ( cm )	Table Pos ( deg )	Peak Avg. (P/A)	Pol. (H/V)
802.11ax HE20 Partial 106/54 CH 64 5320MHz	*	5320	111.22	-	-	108.06	33.06	7.04	36.94	100	258	P	H
	*	5320	104.9	-	-	101.74	33.06	7.04	36.94	100	258	A	H
		5350.4	71.27	-2.73	74	68.16	33	7.03	36.92	100	258	P	H
		5351.2	49.4	-4.6	54	46.29	33	7.03	36.92	100	258	A	H
													H
													H
	*	5320	111.5	-	-	108.34	33.06	7.04	36.94	101	297	P	V
	*	5320	104.93	-	-	101.77	33.06	7.04	36.94	101	297	A	V
		5352.64	70.06	-3.94	74	66.95	33	7.03	36.92	101	297	P	V
		5350.24	49.42	-4.58	54	46.31	33	7.03	36.92	101	297	A	V
												V	
												V	
<b>Remark</b>	1. No other spurious found. 2. All results are PASS against Peak and Average limit line.												





**Band 2 5250~5350MHz**  
**WIFI 802.11ax HE40 Full (Band Edge @ 3m)**

WIFI Ant. 6+7	Note	Frequency ( MHz )	Level ( dBμV/m )	Margin ( dB )	Limit Line ( dBμV/m )	Read Level (dBμV)	Antenna Factor ( dB/m )	Path Loss ( dB )	Preamp Factor ( dB )	Ant Pos ( cm )	Table Pos ( deg )	Peak Avg. (P/A)	Pol. (H/V)
802.11ax HE40 Full CH 54 5270MHz		5131.92	57.58	-16.42	74	51.1	33.16	6.97	33.65	100	256	P	H
		5149.94	45.77	-8.23	54	39.21	33.2	7	33.64	100	256	A	H
	*	5270	113.81	-	-	107.21	33.16	7.06	33.62	100	256	P	H
	*	5270	106.89	-	-	100.29	33.16	7.06	33.62	100	256	A	H
		5351.76	62.6	-11.4	74	56.17	33	7.03	33.6	100	256	P	H
		5351.04	50.25	-3.75	54	43.82	33	7.03	33.6	100	256	A	H
		5137.36	53.89	-20.11	74	47.39	33.17	6.98	33.65	100	147	P	V
		5146.88	44.58	-9.42	54	38.03	33.19	7	33.64	100	147	A	V
	*	5270	112.75	-	-	106.15	33.16	7.06	33.62	100	147	P	V
	*	5270	105.72	-	-	99.12	33.16	7.06	33.62	100	147	A	V
		5352.48	57.73	-16.27	74	51.3	33	7.03	33.6	100	147	P	V
		5357.76	47.44	-6.56	54	41.01	33	7.02	33.59	100	147	A	V
802.11ax HE40 Full CH 62 5310MHz		5149.94	47.88	-26.12	74	44.74	33.2	7	37.06	105	263	P	H
		5148.58	38.67	-15.33	54	35.53	33.2	7	37.06	105	263	A	H
	*	5310	112.57	-	-	109.4	33.08	7.04	36.95	105	263	P	H
	*	5310	103.47	-	-	100.3	33.08	7.04	36.95	105	263	A	H
		5350.56	59.54	-14.46	74	56.43	33	7.03	36.92	105	263	P	H
		5350.08	51.02	-2.98	54	47.91	33	7.03	36.92	105	263	A	H
		5136.34	47.48	-26.52	74	44.4	33.17	6.98	37.07	100	301	P	V
		5145.86	38.01	-15.99	54	34.88	33.19	7	37.06	100	301	A	V
	*	5310	109.49	-	-	106.32	33.08	7.04	36.95	100	301	P	V
	*	5310	101.14	-	-	97.97	33.08	7.04	36.95	100	301	A	V
		5354.16	56.15	-17.85	74	53.04	33	7.03	36.92	100	301	P	V
		5354.64	46.78	-7.22	54	43.67	33	7.03	36.92	100	301	A	V
Remark	1. No other spurious found. 2. All results are PASS against Peak and Average limit line.												



Band 2 5250~5350MHz

WIFI 802.11ax HE40 Full (Harmonic @ 3m)

WIFI Ant. 6+7	Note	Frequency ( MHz )	Level ( dBμV/m )	Margin ( dB )	Limit Line ( dBμV/m )	Read Level (dBμV)	Antenna Factor ( dB/m )	Path Loss ( dB )	Preamp Factor ( dB )	Ant Pos ( cm )	Table Pos ( deg )	Peak Avg. (P/A)	Pol. (H/V)
802.11ax HE40 Full		7026	63.75	-4.45	68.2	74.19	36.06	9.83	56.33	107	41	P	H
		10540	47.54	-20.66	68.2	53.12	38.98	11.63	56.19	-	-	P	H
		15810	43.41	-30.59	74	47.69	37.6	13.63	55.51	-	-	P	H
													H
													H
													H
													H
													H
													H
													H
CH 54 5270MHz		7026	64.25	-3.95	68.2	74.69	36.06	9.83	56.33	244	80	P	V
		10540	47.24	-20.96	68.2	52.82	38.98	11.63	56.19	-	-	P	V
		15810	43.5	-30.5	74	47.78	37.6	13.63	55.51	-	-	P	V
													V
													V
													V
													V
													V
													V
													V





**Band 2 5250~5350MHz**  
**WIFI 802.11ax HE40 Partial 242 (Band Edge @ 3m)**

WIFI Ant. 6+7	Note	Frequency ( MHz )	Level ( dBμV/m )	Margin ( dB )	Limit Line ( dBμV/m )	Read Level (dBμV)	Antenna Factor ( dB/m )	Path Loss ( dB )	Preamp Factor ( dB )	Ant Pos ( cm )	Table Pos ( deg )	Peak Avg. (P/A)	Pol. (H/V)
<b>802.11ax HE40 Partial 242/62 CH 62 5310MHz</b>		5044.2	53.74	-20.26	74	50.82	33.21	6.84	37.13	101	265	P	H
		5057.46	42.92	-11.08	54	39.99	33.19	6.86	37.12	101	265	A	H
	*	5310	111.56	-	-	108.39	33.08	7.04	36.95	101	265	P	H
	*	5310	103.03	-	-	99.86	33.08	7.04	36.95	101	265	A	H
		5360.16	70.28	-3.72	74	67.18	33	7.02	36.92	101	265	P	H
		5358.96	47.9	-6.1	54	44.8	33	7.02	36.92	101	265	A	H
		5015.3	53.21	-20.79	74	50.3	33.27	6.79	37.15	103	150	P	V
		5054.4	42.9	-11.1	54	39.98	33.19	6.85	37.12	103	150	A	V
	*	5310	110.83	-	-	107.66	33.08	7.04	36.95	103	150	P	V
	*	5310	101.94	-	-	98.77	33.08	7.04	36.95	103	150	A	V
		5359.2	68.84	-5.16	74	65.74	33	7.02	36.92	103	150	P	V
		5357.04	47.91	-6.09	54	44.8	33	7.03	36.92	103	150	A	V
<b>Remark</b>	1. No other spurious found. 2. All results are PASS against Peak and Average limit line.												



**Band 2 5250~5350MHz**  
**WIFI 802.11ax HE80 Full (Band Edge @ 3m)**

WIFI Ant. 6+7	Note	Frequency ( MHz )	Level ( dBμV/m )	Margin ( dB )	Limit Line ( dBμV/m )	Read Level (dBμV)	Antenna Factor ( dB/m )	Path Loss ( dB )	Preamp Factor ( dB )	Ant Pos ( cm )	Table Pos ( deg )	Peak Avg. (P/A)	Pol. (H/V)
<b>802.11ax HE80 Full CH 58 5290MHz</b>		5148.92	51.61	-22.39	74	48.47	33.2	7	37.06	100	261	P	H
		5149.94	43.34	-10.66	54	40.2	33.2	7	37.06	100	261	A	H
	*	5290	108.14	-	-	104.93	33.12	7.05	36.96	100	261	P	H
	*	5290	102.14	-	-	98.93	33.12	7.05	36.96	100	261	A	H
		5351.04	60.2	-13.8	74	57.09	33	7.03	36.92	100	261	P	H
		5359.68	50.8	-3.2	54	47.7	33	7.02	36.92	100	261	A	H
		5145.18	50.02	-23.98	74	46.89	33.19	7	37.06	100	297	P	V
		5145.18	41.19	-12.81	54	38.06	33.19	7	37.06	100	297	A	V
	*	5290	109.18	-	-	105.97	33.12	7.05	36.96	100	297	P	V
	*	5290	99.5	-	-	96.29	33.12	7.05	36.96	100	297	A	V
		5353.2	57.81	-16.19	74	54.7	33	7.03	36.92	100	297	P	V
		5355.6	48.98	-5.02	54	45.87	33	7.03	36.92	100	297	A	V
<b>Remark</b>	1. No other spurious found. 2. All results are PASS against Peak and Average limit line.												



Band 2 5250~5350MHz

WIFI 802.11ax HE80 Full (Harmonic @ 3m)

WIFI Ant. 6+7	Note	Frequency ( MHz )	Level ( dBμV/m )	Margin ( dB )	Limit Line ( dBμV/m )	Read Level (dBμV)	Antenna Factor ( dB/m )	Path Loss ( dB )	Preamp Factor ( dB )	Ant Pos ( cm )	Table Pos ( deg )	Peak Avg. (P/A)	Pol. (H/V)
802.11ax HE80 Full CH 58 5290MHz		7053	63.6	-4.6	68.2	73.89	36.21	9.87	56.37	100	42	P	H
		10580	46.76	-21.44	68.2	52.11	39.18	11.65	56.18	-	-	P	H
		15870	43.66	-30.34	74	47.76	37.68	13.67	55.45	-	-	P	H
													H
													H
													H
													H
													H
													H
													H
													H
													H
													H
													H
			7053	63.61	-4.59	68.2	73.9	36.21	9.87	56.37	233	79	P
		10580	46.79	-21.41	68.2	52.14	39.18	11.65	56.18	-	-	P	V
		15870	42.87	-31.13	74	46.97	37.68	13.67	55.45	-	-	P	V
													V
													V
													V
													V
													V
													V
													V
													V
													V
													V
													V
<b>Remark</b>	<ol style="list-style-type: none"> <li>No other spurious found.</li> <li>All results are PASS against Peak and Average limit line.</li> <li>The emission position marked as "-" means no suspected emission found with sufficient margin against limit line or noise floor only.</li> </ol>												



**Band 2 5250~5350MHz**  
**WIFI 802.11ax HE80 Partial 484 (Band Edge @ 3m)**

WIFI Ant. 6+7	Note	Frequency ( MHz )	Level ( dBμV/m )	Margin ( dB )	Limit Line ( dBμV/m )	Read Level (dBμV)	Antenna Factor ( dB/m )	Path Loss ( dB )	Preamp Factor ( dB )	Ant Pos ( cm )	Table Pos ( deg )	Peak Avg. (P/A)	Pol. (H/V)
802.11ax HE80 Partial 484/66 CH 58 5290MHz		5143.14	59.1	-14.9	74	55.98	33.19	6.99	37.06	100	267	P	H
		5149.6	43.62	-10.38	54	40.48	33.2	7	37.06	100	267	A	H
	*	5290	107.03	-	-	103.82	33.12	7.05	36.96	100	267	P	H
	*	5290	98.45	-	-	95.24	33.12	7.05	36.96	100	267	A	H
		5380.32	70.44	-3.56	74	67.32	33	7.02	36.9	100	267	P	H
		5369.76	48.07	-5.93	54	44.96	33	7.02	36.91	100	267	A	H
		5133.28	59.29	-14.71	74	56.21	33.17	6.98	37.07	100	292	P	V
		5061.54	43.19	-10.81	54	40.26	33.18	6.87	37.12	100	292	A	V
	*	5290	107.52	-	-	104.31	33.12	7.05	36.96	100	292	P	V
	*	5290	97.42	-	-	94.21	33.12	7.05	36.96	100	292	A	V
		5358	70.31	-3.69	74	67.21	33	7.02	36.92	100	292	P	V
		5368.56	49.84	-4.16	54	46.73	33	7.02	36.91	100	292	A	V
<b>Remark</b>	1. No other spurious found. 2. All results are PASS against Peak and Average limit line.												



**Band 3 - 5470~5725MHz**  
**WIFI 802.11a (Band Edge @ 3m)**

WIFI Ant. 6+7	Note	Frequency ( MHz )	Level ( dBμV/m )	Margin ( dB )	Limit Line ( dBμV/m )	Read Level (dBμV)	Antenna Factor ( dB/m )	Path Loss ( dB )	Preamp Factor ( dB )	Ant Pos ( cm )	Table Pos ( deg )	Peak Avg. (P/A)	Pol. (H/V)	
802.11a CH 100 5500MHz		5455.44	53.17	-20.83	74	49.91	33.1	7.01	36.85	100	257	P	H	
		5469.84	56.46	-11.74	68.2	53.19	33.1	7.01	36.84	100	257	P	H	
		5460	46.07	-7.93	54	42.81	33.1	7.01	36.85	100	257	A	H	
	*	5500	112.25	-	-	108.96	33.1	7.01	36.82	100	257	P	H	
	*	5500	107.5	-	-	104.21	33.1	7.01	36.82	100	257	A	H	
														H
			5456.08	53.33	-20.67	74	50.07	33.1	7.01	36.85	100	297	P	V
			5465.04	57.29	-10.91	68.2	54.02	33.1	7.01	36.84	100	297	P	V
			5458.48	44.72	-9.28	54	41.46	33.1	7.01	36.85	100	297	A	V
	*		5500	112.74	-	-	109.45	33.1	7.01	36.82	100	297	P	V
	*		5500	106.66	-	-	103.37	33.1	7.01	36.82	100	297	A	V
														V
802.11a CH 116 5580MHz		5447.44	47	-27	74	43.76	33.09	7.01	36.86	105	253	P	H	
		5470	47.1	-21.1	68.2	43.83	33.1	7.01	36.84	105	253	P	H	
		5456.08	38.12	-15.88	54	34.86	33.1	7.01	36.85	105	253	A	H	
	*	5580	113.76	-	-	110.54	33.06	7	36.84	105	253	P	H	
	*	5580	106.14	-	-	102.92	33.06	7	36.84	105	253	A	H	
			5740.43	47.52	-20.68	68.2	43.59	33.74	7.07	36.88	105	253	P	H
			5451.04	46.47	-27.53	74	43.21	33.1	7.01	36.85	100	297	P	V
			5463.52	46.86	-21.34	68.2	43.59	33.1	7.01	36.84	100	297	P	V
			5458.72	38.08	-15.92	54	34.82	33.1	7.01	36.85	100	297	A	V
	*		5580	111.94	-	-	108.72	33.06	7	36.84	100	297	P	V
	*		5580	105.46	-	-	102.24	33.06	7	36.84	100	297	A	V
			5731.925	46.87	-21.33	68.2	42.99	33.69	7.07	36.88	100	297	P	V





<b>802.11a</b> <b>CH 140</b> <b>5700MHz</b>	*	5700	113.15	-	-	109.47	33.5	7.05	36.87	101	247	P	H
	*	5700	105.89	-	-	102.21	33.5	7.05	36.87	101	247	A	H
		5726.36	59.03	-9.17	68.2	55.18	33.66	7.06	36.87	101	247	P	H
													H
													H
													H
	*	5700	110.93	-	-	107.25	33.5	7.05	36.87	100	304	P	V
	*	5700	104.15	-	-	100.47	33.5	7.05	36.87	100	304	A	V
		5726.6	56.92	-11.28	68.2	53.07	33.66	7.06	36.87	100	304	P	V
													V
													V
													V
<b>Remark</b>	1. No other spurious found. 2. All results are PASS against Peak and Average limit line.												



**Band 3 - 5470~5725MHz**  
**WIFI 802.11a (Harmonic @ 3m)**

WIFI Ant. 6+7	Note	Frequency ( MHz )	Level ( dBμV/m )	Margin ( dB )	Limit Line ( dBμV/m )	Read Level (dBμV)	Antenna Factor ( dB/m )	Path Loss ( dB )	Preamp Factor ( dB )	Ant Pos ( cm )	Table Pos ( deg )	Peak Avg. (P/A)	Pol. (H/V)	
802.11a CH 100 5500MHz		11000	47.96	-26.04	74	53.34	38.9	11.87	56.15	-	-	P	H	
		16500	46.33	-21.87	68.2	49.54	38.2	13.9	55.31	-	-	P	H	
													H	
													H	
													H	
													H	
													H	
													H	
													H	
													H	
													H	
													H	
													H	
													H	
													H	
													H	
			11000	46.73	-27.27	74	52.11	38.9	11.87	56.15	-	-	P	V
			16500	46.42	-21.78	68.2	49.63	38.2	13.9	55.31	-	-	P	V
													V	
													V	
													V	
													V	
													V	
													V	
													V	
													V	
													V	
													V	
													V	
													V	



WIFI Ant. 6+7	Note	Frequency ( MHz )	Level ( dBμV/m )	Margin ( dB )	Limit Line ( dBμV/m )	Read Level (dBμV)	Antenna Factor ( dB/m )	Path Loss ( dB )	Preamp Factor ( dB )	Ant Pos ( cm )	Table Pos ( deg )	Peak Avg. (P/A)	Pol. (H/V)
802.11a CH 116 5580MHz		11160	46.6	-27.4	74	51.89	38.9	11.9	56.09	-	-	P	H
		16740	46.56	-21.64	68.2	50.12	38.04	14	55.6	-	-	P	H
													H
													H
													H
													H
													H
													H
													H
													H
													H
													H
													H
													H
													H
													H
													H
													H
													H
			11160	46.22	-27.78	74	51.51	38.9	11.9	56.09	-	-	P
		16740	46.02	-22.18	68.2	49.58	38.04	14	55.6	-	-	P	V
													V
													V
													V
													V
													V
													V
													V
													V
													V
													V
													V
													V
													V
													V
													V



WIFI Ant. 6+7	Note	Frequency ( MHz )	Level ( dBμV/m )	Margin ( dB )	Limit Line ( dBμV/m )	Read Level (dBμV)	Antenna Factor ( dB/m )	Path Loss ( dB )	Preamp Factor ( dB )	Ant Pos ( cm )	Table Pos ( deg )	Peak Avg. (P/A)	Pol. (H/V)	
802.11a CH 140 5700MHz		11400	46.46	-27.54	74	51.53	39	11.94	56.01	-	-	P	H	
		17100	46.96	-21.24	68.2	50.77	38.1	14.16	56.07	-	-	P	H	
													H	
													H	
													H	
													H	
													H	
													H	
													H	
													H	
													H	
													H	
													H	
													H	
													H	
													H	
													H	
													H	
			11400	46.49	-27.51	74	51.56	39	11.94	56.01	-	-	P	V
			17100	46.64	-21.56	68.2	50.45	38.1	14.16	56.07	-	-	P	V
													V	
													V	
													V	
													V	
													V	
													V	
													V	
													V	
													V	
													V	
													V	
													V	
Remark	1. No other spurious found.													
	2. All results are PASS against Peak and Average limit line.													
	3. The emission position marked as "-" means no suspected emission found with sufficient margin against limit line or noise floor only.													



**Band 3 - 5470~5725MHz**  
**WIFI 802.11ax HE20 Full (Band Edge @ 3m)**

WIFI Ant. 6+7	Note	Frequency ( MHz )	Level ( dBμV/m )	Margin ( dB )	Limit Line ( dBμV/m )	Read Level (dBμV)	Antenna Factor ( dB/m )	Path Loss ( dB )	Preamp Factor ( dB )	Ant Pos ( cm )	Table Pos ( deg )	Peak Avg. (P/A)	Pol. (H/V)	
802.11ax HE20 Full CH 100 5500MHz		5460.08	56.44	-11.76	68.2	53.18	33.1	7.01	36.85	100	262	P	H	
		5469.84	60.51	-7.69	68.2	57.24	33.1	7.01	36.84	100	262	P	H	
		5460	47.7	-6.3	54	44.44	33.1	7.01	36.85	100	262	A	H	
	*	5500	114.91	-	-	111.62	33.1	7.01	36.82	100	262	P	H	
	*	5500	107.56	-	-	104.27	33.1	7.01	36.82	100	262	A	H	
		5457.84	56.76	-17.24	74	53.5	33.1	7.01	36.85	100	294	P	V	
		5468.88	58.65	-9.55	68.2	55.38	33.1	7.01	36.84	100	294	P	V	
		5456.08	46.34	-7.66	54	43.08	33.1	7.01	36.85	100	294	A	V	
	*	5500	112.88	-	-	109.59	33.1	7.01	36.82	100	294	P	V	
	*	5500	104.73	-	-	101.44	33.1	7.01	36.82	100	294	A	V	
														V
														V
802.11ax HE20 Full CH 116 5580MHz		5421.52	48.06	-25.94	74	44.88	33.04	7.01	36.87	100	259	P	H	
		5465.2	49.26	-18.94	68.2	45.99	33.1	7.01	36.84	100	259	P	H	
		5452.72	41.49	-12.51	54	38.23	33.1	7.01	36.85	100	259	A	H	
	*	5580	113.9	-	-	110.68	33.06	7	36.84	100	259	P	H	
	*	5580	107.18	-	-	103.96	33.06	7	36.84	100	259	A	H	
		5743.265	48.62	-19.58	68.2	44.67	33.76	7.07	36.88	100	259	P	H	
		5456.08	46.67	-27.33	74	43.41	33.1	7.01	36.85	100	200	P	V	
		5461.36	47.97	-20.23	68.2	44.71	33.1	7.01	36.85	100	200	P	V	
		5452.48	38.46	-15.54	54	35.2	33.1	7.01	36.85	100	200	A	V	
	*	5580	113.58	-	-	110.36	33.06	7	36.84	100	200	P	V	
	*	5580	106.1	-	-	102.88	33.06	7	36.84	100	200	A	V	
		5765	46.36	-21.84	68.2	42.3	33.86	7.08	36.88	100	200	P	V	



<b>802.11ax</b> <b>HE20 Full</b> <b>CH 140</b> <b>5700MHz</b>	*	5700	114.53	-	-	110.85	33.5	7.05	36.87	100	189	P	H
	*	5700	107.21	-	-	103.53	33.5	7.05	36.87	100	189	A	H
		5727.4	62.41	-5.79	68.2	58.56	33.66	7.06	36.87	100	189	P	H
													H
													H
													H
	*	5700	112.45	-	-	108.77	33.5	7.05	36.87	100	199	P	V
	*	5700	105.02	-	-	101.34	33.5	7.05	36.87	100	199	A	V
		5729.64	56.66	-11.54	68.2	52.8	33.68	7.06	36.88	100	199	P	V
													V
												V	
												V	
<b>Remark</b>	1. No other spurious found. 2. All results are PASS against Peak and Average limit line.												









WIFI Ant. 6+7	Note	Frequency ( MHz )	Level ( dBμV/m )	Margin ( dB )	Limit Line ( dBμV/m )	Read Level ( dBμV )	Antenna Factor ( dB/m )	Path Loss ( dB )	Preamp Factor ( dB )	Ant Pos ( cm )	Table Pos ( deg )	Peak Avg. ( P/A )	Pol. ( H/V )	
802.11ax HE20 Full CH 140 5700MHz		11400	45.84	-28.16	74	50.91	39	11.94	56.01	-	-	P	H	
		17100	46.57	-21.63	68.2	50.38	38.1	14.16	56.07	-	-	P	H	
													H	
													H	
													H	
													H	
													H	
													H	
													H	
													H	
													H	
													H	
													H	
													H	
													H	
													H	
													H	
													H	
			11400	45.75	-28.25	74	50.82	39	11.94	56.01	-	-	P	V
			17100	46.47	-21.73	68.2	50.28	38.1	14.16	56.07	-	-	P	V
													V	
													V	
													V	
													V	
													V	
													V	
													V	
													V	
													V	
													V	
													V	
													V	
<b>Remark</b>	<ol style="list-style-type: none"> <li>No other spurious found.</li> <li>All results are PASS against Peak and Average limit line.</li> <li>The emission position marked as "-" means no suspected emission found with sufficient margin against limit line or noise floor only.</li> </ol>													



Band 3 5470~5725MHz

WIFI 802.11ax HE20 Partial 106 (Band Edge @ 3m)

WIFI Ant. 6+7	Note	Frequency ( MHz )	Level ( dBμV/m )	Margin ( dB )	Limit Line ( dBμV/m )	Read Level (dBμV)	Antenna Factor ( dB/m )	Path Loss ( dB )	Preamp Factor ( dB )	Ant Pos ( cm )	Table Pos ( deg )	Peak Avg. (P/A)	Pol. (H/V)	
802.11ax HE20 Partial 106/53 CH 100 5500MHz		5459.28	59.45	-14.55	74	56.19	33.1	7.01	36.85	108	258	P	H	
		5466.32	65.16	-3.04	68.2	61.89	33.1	7.01	36.84	108	258	P	H	
		5459.92	40.56	-13.44	54	37.3	33.1	7.01	36.85	108	258	A	H	
		5500	112.85	44.65	68.2	109.56	33.1	7.01	36.82	108	258	P	H	
		5500	105.92	51.92	54	102.63	33.1	7.01	36.82	108	258	A	H	
														H
			5453.04	58.08	-15.92	74	54.82	33.1	7.01	36.85	102	296	P	V
			5464.88	65.6	-2.6	68.2	62.33	33.1	7.01	36.84	102	296	P	V
			5459.44	41.33	-12.67	54	38.07	33.1	7.01	36.85	102	296	A	V
			5500	112.16	43.96	68.2	108.87	33.1	7.01	36.82	102	296	P	V
			5500	105.09	51.09	54	101.8	33.1	7.01	36.82	102	296	A	V
														V
802.11ax HE20 Partial 106/54 CH 140 5700MHz		5700	111.33	43.13	68.2	107.65	33.5	7.05	36.87	200	182	P	H	
		5700	103.52	49.52	54	99.84	33.5	7.05	36.87	200	182	A	H	
		5728.6	64.65	-3.55	68.2	60.79	33.67	7.06	36.87	200	182	P	H	
													H	
													H	
													H	
			5700	111.38	43.18	68.2	107.7	33.5	7.05	36.87	300	126	P	V
			5700	102.75	48.75	54	99.07	33.5	7.05	36.87	300	126	A	V
			5727.88	61.26	-6.94	68.2	57.4	33.67	7.06	36.87	300	126	P	V
														V
													V	
													V	
Remark	1. No other spurious found. 2. All results are PASS against Peak and Average limit line.													



**Band 3 5470~5725MHz**  
**WIFI 802.11ax HE40 Full (Band Edge @ 3m)**

WIFI Ant. 6+7	Note	Frequency ( MHz )	Level ( dBμV/m )	Margin ( dB )	Limit Line ( dBμV/m )	Read Level ( dBμV )	Antenna Factor ( dB/m )	Path Loss ( dB )	Preamp Factor ( dB )	Ant Pos ( cm )	Table Pos ( deg )	Peak Avg. (P/A)	Pol. (H/V)
802.11ax HE40 Full CH 102 5510MHz		5455.84	64.12	-9.88	74	60.86	33.1	7.01	36.85	101	240	P	H
		5464.72	65.84	-2.36	68.2	62.57	33.1	7.01	36.84	101	240	P	H
		5457.52	51.64	-2.36	54	48.38	33.1	7.01	36.85	101	240	A	H
	*	5510	111.14	-	-	107.88	33.08	7	36.82	101	240	P	H
	*	5510	104.09	-	-	100.83	33.08	7	36.82	101	240	A	H
		5740.745	52.31	-15.89	68.2	48.38	33.74	7.07	36.88	101	240	P	H
		5454.16	63.08	-10.92	74	59.82	33.1	7.01	36.85	100	326	P	V
		5467.84	65.31	-2.89	68.2	62.04	33.1	7.01	36.84	100	326	P	V
		5456.08	51.05	-2.95	54	47.79	33.1	7.01	36.85	100	326	A	V
	*	5510	111.99	-	-	108.73	33.08	7	36.82	100	326	P	V
	*	5510	104.14	-	-	100.88	33.08	7	36.82	100	326	A	V
		5737.595	51.91	-16.29	68.2	47.99	33.73	7.07	36.88	100	326	P	V
802.11ax HE40 Full CH 110 5550MHz		5459.2	61.84	-12.16	74	55.3	33.1	7.01	33.57	100	256	P	H
		5462.08	61.23	-6.97	68.2	54.69	33.1	7.01	33.57	100	256	P	H
		5459.92	48.19	-5.81	54	41.65	33.1	7.01	33.57	100	256	A	H
	*	5550	112.99	-	-	106.56	33	7	33.57	100	256	P	H
	*	5550	105.74	-	-	99.31	33	7	33.57	100	256	A	H
		5730.35	49.88	-18.32	68.2	42.72	33.68	7.07	33.59	100	256	P	H
		5458.24	54.82	-19.18	74	48.28	33.1	7.01	33.57	100	202	P	V
		5466.88	58.21	-9.99	68.2	51.67	33.1	7.01	33.57	100	202	P	V
		5459.92	45.39	-8.61	54	38.85	33.1	7.01	33.57	100	202	A	V
	*	5550	110.19	-	-	103.76	33	7	33.57	100	202	P	V
	*	5550	103.29	-	-	96.86	33	7	33.57	100	202	A	V
		5748.62	49.74	-18.46	68.2	42.47	33.79	7.07	33.59	100	202	P	V



<b>802.11ax</b> <b>HE40 Full</b> <b>CH 134</b> <b>5670MHz</b>		5396.9	48.39	-25.61	74	41.96	33	7.01	33.58	100	190	P	H
		5469.35	48.27	-19.93	68.2	41.73	33.1	7.01	33.57	100	190	P	H
		5435.4	39.4	-14.6	54	32.9	33.07	7.01	33.58	100	190	A	H
	*	5670	111.25	-	-	104.48	33.32	7.03	33.58	100	190	P	H
	*	5670	104.26	-	-	97.49	33.32	7.03	33.58	100	190	A	H
		5725.94	62.66	-5.54	68.2	55.53	33.66	7.06	33.59	100	190	P	H
		5434	48.94	-25.06	74	42.44	33.07	7.01	33.58	100	199	P	V
		5469	47.6	-20.6	68.2	41.06	33.1	7.01	33.57	100	199	P	V
		5449.05	39.24	-14.76	54	32.7	33.1	7.01	33.57	100	199	A	V
	*	5670	111.53	-	-	104.76	33.32	7.03	33.58	100	199	P	V
	*	5670	104.33	-	-	97.56	33.32	7.03	33.58	100	199	A	V
		5729.405	60.55	-7.65	68.2	53.4	33.68	7.06	33.59	100	199	P	V
<b>Remark</b>	1. No other spurious found. 2. All results are PASS against Peak and Average limit line.												





WIFI Ant. 6+7	Note	Frequency ( MHz )	Level ( dBμV/m )	Margin ( dB )	Limit Line ( dBμV/m )	Read Level ( dBμV )	Antenna Factor ( dB/m )	Path Loss ( dB )	Preamp Factor ( dB )	Ant Pos ( cm )	Table Pos ( deg )	Peak Avg. ( P/A )	Pol. ( H/V )
802.11ax HE40 Full CH 110 5550MHz		11100	46.16	-27.84	74	51.58	38.8	11.89	56.11	-	-	P	H
		16650	46.47	-21.73	68.2	49.7	38.3	13.96	55.49	-	-	P	H
													H
													H
													H
													H
													H
													H
													H
													H
													H
													H
													H
													H
													H
													H
													H
													H
													H
			11100	46.54	-27.46	74	51.96	38.8	11.89	56.11	-	-	P
		16650	45.73	-22.47	68.2	48.96	38.3	13.96	55.49	-	-	P	V
													V
													V
													V
													V
													V
													V
													V
													V
													V
													V
													V
													V
													V
													V
													V



WIFI Ant. 6+7	Note	Frequency ( MHz )	Level ( dBμV/m )	Margin ( dB )	Limit Line ( dBμV/m )	Read Level ( dBμV )	Antenna Factor ( dB/m )	Path Loss ( dB )	Preamp Factor ( dB )	Ant Pos ( cm )	Table Pos ( deg )	Peak Avg. ( P/A )	Pol. ( H/V )	
802.11ax HE40 Full CH 134 5670MHz		11340	46.51	-27.49	74	51.61	39	11.93	56.03	-	-	P	H	
		17010	45.74	-22.46	68.2	49.42	38.16	14.1	55.94	-	-	P	H	
													H	
													H	
													H	
													H	
													H	
													H	
													H	
													H	
													H	
													H	
													H	
													H	
													H	
													H	
													H	
													H	
			11340	46.13	-27.87	74	51.23	39	11.93	56.03	-	-	P	V
			17010	46.07	-22.13	68.2	49.75	38.16	14.1	55.94	-	-	P	V
													V	
													V	
													V	
													V	
													V	
													V	
													V	
													V	
													V	
													V	
													V	
													V	
Remark	<ol style="list-style-type: none"> <li>No other spurious found.</li> <li>All results are PASS against Peak and Average limit line.</li> <li>The emission position marked as "-" means no suspected emission found with sufficient margin against limit line or noise floor only.</li> </ol>													



**Band 3 5470~5725MHz**  
**WIFI 802.11ax HE40 Partial 242 (Band Edge @ 3m)**

WIFI Ant. 6+7	Note	Frequency ( MHz )	Level ( dBμV/m )	Margin ( dB )	Limit Line ( dBμV/m )	Read Level (dBμV)	Antenna Factor ( dB/m )	Path Loss ( dB )	Preamp Factor ( dB )	Ant Pos ( cm )	Table Pos ( deg )	Peak Avg. (P/A)	Pol. (H/V)
802.11ax HE40 Partial 242/61 CH 102 5510MHz		5451.04	55.68	-18.32	74	52.42	33.1	7.01	36.85	100	256	P	H
		5470	54.95	-13.25	68.2	51.68	33.1	7.01	36.84	100	256	P	H
		5459.92	39.71	-14.29	54	36.45	33.1	7.01	36.85	100	256	A	H
	*	5510	109.25	-	-	105.99	33.08	7	36.82	100	256	P	H
	*	5510	101.48	-	-	98.22	33.08	7	36.82	100	256	A	H
		5761.535	47.44	-20.76	68.2	43.39	33.85	7.08	36.88	100	256	P	H
		5457.04	59.54	-14.46	74	56.28	33.1	7.01	36.85	104	299	P	V
		5465.92	58.69	-9.51	68.2	55.42	33.1	7.01	36.84	104	299	P	V
		5459.92	39.36	-14.64	54	36.1	33.1	7.01	36.85	104	299	A	V
	*	5510	109.44	-	-	106.18	33.08	7	36.82	104	299	P	V
	*	5510	101.04	-	-	97.78	33.08	7	36.82	104	299	A	V
		5742.32	47.54	-20.66	68.2	43.6	33.75	7.07	36.88	104	299	P	V
802.11ax HE40 Partial 242/62 CH 134 5670MHz		5421.05	50.02	-23.98	74	46.84	33.04	7.01	36.87	100	186	P	H
		5463.75	49.18	-19.02	68.2	45.91	33.1	7.01	36.84	100	186	P	H
		5459.9	41.39	-12.61	54	38.13	33.1	7.01	36.85	100	186	A	H
	*	5670	107.93	-	-	104.44	33.32	7.03	36.86	100	186	P	H
	*	5670	101.05	-	-	97.56	33.32	7.03	36.86	100	186	A	H
		5733.815	64.03	-4.17	68.2	60.14	33.7	7.07	36.88	100	186	P	H
		5444.85	50.43	-23.57	74	47.19	33.09	7.01	36.86	100	224	P	V
		5461.3	49.45	-18.75	68.2	46.19	33.1	7.01	36.85	100	224	P	V
		5459.9	41.3	-12.7	54	38.04	33.1	7.01	36.85	100	224	A	V
	*	5670	106.46	-	-	102.97	33.32	7.03	36.86	100	224	P	V
	*	5670	99.28	-	-	95.79	33.32	7.03	36.86	100	224	A	V
		5726.885	66.31	-1.89	68.2	62.46	33.66	7.06	36.87	100	224	P	V
Remark	1. No other spurious found. 2. All results are PASS against Peak and Average limit line.												





**Band 3 5470~5725MHz**  
**WIFI 802.11ax HE80 Full (Band Edge @ 3m)**

WIFI Ant. 6+7	Note	Frequency ( MHz )	Level ( dBμV/m )	Margin ( dB )	Limit Line ( dBμV/m )	Read Level (dBμV)	Antenna Factor ( dB/m )	Path Loss ( dB )	Preamp Factor ( dB )	Ant Pos ( cm )	Table Pos ( deg )	Peak Avg. (P/A)	Pol. (H/V)
802.11ax HE80 Full CH 106 5530MHz		5441.44	61.54	-12.46	74	55.02	33.08	7.01	33.57	113	258	P	H
		5470	63.92	-4.28	68.2	57.38	33.1	7.01	33.57	113	258	P	H
		5459.68	51.93	-2.07	54	45.39	33.1	7.01	33.57	113	258	A	H
	*	5530	109.25	-	-	102.77	33.04	7	33.56	113	258	P	H
	*	5530	102.21	-	-	95.73	33.04	7	33.56	113	258	A	H
		5753.03	49.62	-18.58	68.2	42.32	33.81	7.08	33.59	113	258	P	H
		5454.88	61.37	-12.63	74	54.83	33.1	7.01	33.57	100	297	P	V
		5465.44	62.75	-5.45	68.2	56.21	33.1	7.01	33.57	100	297	P	V
		5455.6	52.64	-1.36	54	46.1	33.1	7.01	33.57	100	297	A	V
	*	5530	107.84	-	-	101.36	33.04	7	33.56	100	297	P	V
	*	5530	100.86	-	-	94.38	33.04	7	33.56	100	297	A	V
		5759.96	50.05	-18.15	68.2	42.72	33.84	7.08	33.59	100	297	P	V
802.11ax HE80 Full CH 122 5610MHz		5457.1	52.69	-21.31	74	46.15	33.1	7.01	33.57	100	258	P	H
		5469.7	53.03	-15.17	68.2	46.49	33.1	7.01	33.57	100	258	P	H
		5459.9	43.64	-10.36	54	37.1	33.1	7.01	33.57	100	258	A	H
	*	5610	108.94	-	-	102.38	33.12	7.01	33.57	100	258	P	H
	*	5610	101.2	-	-	94.64	33.12	7.01	33.57	100	258	A	H
		5739.8	52.47	-15.73	68.2	45.25	33.74	7.07	33.59	100	258	P	H
		5446.6	50.12	-23.88	74	43.59	33.09	7.01	33.57	100	205	P	V
		5462.7	49.48	-18.72	68.2	42.94	33.1	7.01	33.57	100	205	P	V
		5458.5	41.27	-12.73	54	34.73	33.1	7.01	33.57	100	205	A	V
	*	5610	108.61	-	-	102.05	33.12	7.01	33.57	100	205	P	V
	*	5610	100.89	-	-	94.33	33.12	7.01	33.57	100	205	A	V
		5732.87	52.96	-15.24	68.2	45.78	33.7	7.07	33.59	100	205	P	V
Remark	1. No other spurious found. 2. All results are PASS against Peak and Average limit line.												



Band 3 5470~5725MHz

WIFI 802.11ax HE80 Full (Harmonic @ 3m)

WIFI Ant. 6+7	Note	Frequency ( MHz )	Level ( dBμV/m )	Margin ( dB )	Limit Line ( dBμV/m )	Read Level (dBμV)	Antenna Factor ( dB/m )	Path Loss ( dB )	Preamp Factor ( dB )	Ant Pos ( cm )	Table Pos ( deg )	Peak Avg. (P/A)	Pol. (H/V)	
802.11ax HE80 Full CH 106 5530MHz		11060	46.29	-27.71	74	51.74	38.8	11.88	56.13	-	-	P	H	
		16590	45.68	-22.52	68.2	49.16	38	13.94	55.42	-	-	P	H	
													H	
													H	
													H	
													H	
													H	
													H	
													H	
													H	
													H	
													H	
													H	
													H	
													H	
													H	
			11060	46.79	-27.21	74	52.24	38.8	11.88	56.13	-	-	P	V
			16590	45.17	-23.03	68.2	48.65	38	13.94	55.42	-	-	P	V
													V	
													V	
													V	
													V	
													V	
													V	
													V	
													V	
													V	
													V	
													V	
													V	



WIFI Ant. 6+7	Note	Frequency ( MHz )	Level ( dBμV/m )	Margin ( dB )	Limit Line ( dBμV/m )	Read Level ( dBμV )	Antenna Factor ( dB/m )	Path Loss ( dB )	Preamp Factor ( dB )	Ant Pos ( cm )	Table Pos ( deg )	Peak Avg. ( P/A )	Pol. ( H/V )
802.11ax HE80 Full CH 122 5610MHz		11220	46.8	-27.2	74	52.02	38.94	11.91	56.07	-	-	P	H
		16830	46.3	-21.9	68.2	49.82	38.16	14.03	55.71	-	-	P	H
													H
													H
													H
													H
													H
													H
													H
													H
													H
													H
													H
													H
													H
													H
													H
													H
													H
			11220	46.74	-27.26	74	51.96	38.94	11.91	56.07	-	-	P
		16830	45.16	-23.04	68.2	48.68	38.16	14.03	55.71	-	-	P	V
													V
													V
													V
													V
													V
													V
													V
													V
													V
													V
													V
													V
													V
<b>Remark</b>	<ol style="list-style-type: none"> <li>No other spurious found.</li> <li>All results are PASS against Peak and Average limit line.</li> <li>The emission position marked as "-" means no suspected emission found with sufficient margin against limit line or noise floor only.</li> </ol>												



**Band 3 5470~5725MHz**  
**WIFI 802.11ax HE80 Partial 484 (Band Edge @ 3m)**

WIFI Ant. 6+7	Note	Frequency ( MHz )	Level ( dBμV/m )	Margin ( dB )	Limit Line ( dBμV/m )	Read Level (dBμV)	Antenna Factor ( dB/m )	Path Loss ( dB )	Preamp Factor ( dB )	Ant Pos ( cm )	Table Pos ( deg )	Peak Avg. (P/A)	Pol. (H/V)
802.11ax HE80 Partial 484/65 CH 106 5530MHz		5424.16	62.9	-11.1	74	59.71	33.05	7.01	36.87	100	260	P	H
		5469.52	66.54	-1.66	68.2	63.27	33.1	7.01	36.84	100	260	P	H
		5459.92	44.03	-9.97	54	40.77	33.1	7.01	36.85	100	260	A	H
	*	5530	106.28	-	-	103.07	33.04	7	36.83	100	260	P	H
	*	5530	97.84	-	-	94.63	33.04	7	36.83	100	260	A	H
		5744.21	52.41	-15.79	68.2	48.45	33.77	7.07	36.88	100	260	P	H
		5421.28	62.49	-11.51	74	59.31	33.04	7.01	36.87	100	299	P	V
		5465.68	63.99	-4.21	68.2	60.72	33.1	7.01	36.84	100	299	P	V
		5459.92	43.62	-10.38	54	40.36	33.1	7.01	36.85	100	299	A	V
	*	5530	107.26	-	-	104.05	33.04	7	36.83	100	299	P	V
	*	5530	98.13	-	-	94.92	33.04	7	36.83	100	299	A	V
		5739.8	53.55	-14.65	68.2	49.62	33.74	7.07	36.88	100	299	P	V
802.11ax HE80 Partial 484/66 CH 122 5610MHz		5449.4	62.05	-11.95	74	58.79	33.1	7.01	36.85	100	259	P	H
		5469.35	48.63	-19.57	68.2	45.36	33.1	7.01	36.84	100	259	P	H
		5455	39.62	-14.38	54	36.36	33.1	7.01	36.85	100	259	A	H
	*	5610	106.5	-	-	103.22	33.12	7.01	36.85	100	259	P	H
	*	5610	97.17	-	-	93.89	33.12	7.01	36.85	100	259	A	H
		5741.375	64.91	-3.29	68.2	60.97	33.75	7.07	36.88	100	259	P	H
		5450.45	62.45	-11.55	74	59.19	33.1	7.01	36.85	100	303	P	V
		5461.65	48.86	-19.34	68.2	45.6	33.1	7.01	36.85	100	303	P	V
		5451.15	40.02	-13.98	54	36.76	33.1	7.01	36.85	100	303	A	V
	*	5610	103.01	-	-	99.73	33.12	7.01	36.85	100	303	P	V
	*	5610	95.67	-	-	92.39	33.12	7.01	36.85	100	303	A	V
		5729.72	63.46	-4.74	68.2	59.6	33.68	7.06	36.88	100	303	P	V
Remark	1. No other spurious found. 2. All results are PASS against Peak and Average limit line.												



Band 3 5470~5725MHz

WIFI 802.11ax HE160 Full (Band Edge @ 3m)

WIFI Ant. 6+7	Note	Frequency ( MHz )	Level ( dBμV/m )	Margin ( dB )	Limit Line ( dBμV/m )	Read Level (dBμV)	Antenna Factor ( dB/m )	Path Loss ( dB )	Preamp Factor ( dB )	Ant Pos ( cm )	Table Pos ( deg )	Peak Avg. (P/A)	Pol. (H/V)
802.11ax HE160 Full CH 114 5570MHz		5443.84	59.49	-14.51	74	56.25	33.09	7.01	36.86	101	261	P	H
		5467.36	58.47	-9.73	68.2	55.2	33.1	7.01	36.84	101	261	P	H
		5459.92	51.35	-2.65	54	48.09	33.1	7.01	36.85	101	261	A	H
	*	5570	103.42	-	-	100.22	33.04	7	36.84	101	261	P	H
	*	5570	95.7	-	-	92.5	33.04	7	36.84	101	261	A	H
		5731.61	59.3	-8.9	68.2	55.42	33.69	7.07	36.88	101	261	P	H
		5443.6	56.1	-17.9	74	52.86	33.09	7.01	36.86	100	261	P	V
		5462.8	54.09	-14.11	68.2	50.83	33.1	7.01	36.85	100	261	P	V
		5454.64	46.67	-7.33	54	43.41	33.1	7.01	36.85	100	261	A	V
	*	5570	98.45	-	-	95.25	33.04	7	36.84	100	261	P	V
	*	5570	90.47	-	-	87.27	33.04	7	36.84	100	261	A	V
		5727.83	54.55	-13.65	68.2	50.69	33.67	7.06	36.87	100	261	P	V
Remark	1. No other spurious found. 2. All results are PASS against Peak and Average limit line.												



Band 3 5470~5725MHz

WIFI 802.11ax HE160 Full (Harmonic @ 3m)

WIFI Ant. 6+7	Note	Frequency ( MHz )	Level ( dBμV/m )	Margin ( dB )	Limit Line ( dBμV/m )	Read Level (dBμV)	Antenna Factor ( dB/m )	Path Loss ( dB )	Preamp Factor ( dB )	Ant Pos ( cm )	Table Pos ( deg )	Peak Avg. (P/A)	Pol. (H/V)
802.11ax HE160 Full CH 114 5570MHz		11140	46.39	-27.61	74	51.72	38.88	11.89	56.1	-	-	P	H
		16710	46.09	-22.11	68.2	49.52	38.16	13.98	55.57	-	-	P	H
													H
													H
													H
													H
													H
													H
													H
													H
													H
													H
													H
													H
													H
													H
													H
													H
													H
			11140	46.18	-27.82	74	51.51	38.88	11.89	56.1	-	-	P
		16710	44.77	-23.43	68.2	48.2	38.16	13.98	55.57	-	-	P	V
													V
													V
													V
													V
													V
													V
													V
													V
													V
													V
													V
													V
													V
Remark	1. No other spurious found.												
	2. All results are PASS against Peak and Average limit line.												
	3. The emission position marked as "-" means no suspected emission found with sufficient margin against limit line or noise floor only.												



**Band 3 5470~5725MHz**  
**WIFI 802.11ax HE160 Partial 996 (Band Edge @ 3m)**

WIFI Ant. 6+7	Note	Frequency ( MHz )	Level ( dBμV/m )	Margin ( dB )	Limit Line ( dBμV/m )	Read Level (dBμV)	Antenna Factor ( dB/m )	Path Loss ( dB )	Preamp Factor ( dB )	Ant Pos ( cm )	Table Pos ( deg )	Peak Avg. (P/A)	Pol. (H/V)
802.11ax HE160 Partial 996/67 CH 114 5570MHz		5451.04	69	-5	74	65.74	33.1	7.01	36.85	100	256	P	H
		5464	66.19	-2.01	68.2	62.92	33.1	7.01	36.84	100	256	P	H
		5452.24	48.31	-5.69	54	45.05	33.1	7.01	36.85	100	256	A	H
	*	5570	101.08	-	-	97.88	33.04	7	36.84	100	256	P	H
	*	5570	94.05	-	-	90.85	33.04	7	36.84	100	256	A	H
		5725.94	59.04	-9.16	68.2	55.19	33.66	7.06	36.87	100	256	P	H
		5452.48	68	-6	74	64.74	33.1	7.01	36.85	100	302	P	V
		5464.96	66.99	-1.21	68.2	63.72	33.1	7.01	36.84	100	302	P	V
		5457.52	49.15	-4.85	54	45.89	33.1	7.01	36.85	100	302	A	V
	*	5570	101.07	-	-	97.87	33.04	7	36.84	100	302	P	V
	*	5570	93.81	-	-	90.61	33.04	7	36.84	100	302	A	V
		5727.515	57.73	-10.47	68.2	53.87	33.67	7.06	36.87	100	302	P	V
Remark	1. No other spurious found. 2. All results are PASS against Peak and Average limit line.												



**Band 3 - Straddle Channel**  
**WIFI 802.11a (Band Edge @ 3m)**

WIFI	Note	Frequency	Level	Margin	Limit	Read	Antenna	Path	Preamp	Ant	Table	Peak	Pol.
Ant.					Line	Level	Factor	Loss	Factor	Pos	Pos	Avg.	
6+7		( MHz )	( dBµV/m )	( dB )	( dBµV/m )	( dBµV )	( dB/m )	( dB )	( dB )	( cm )	( deg )	( P/A )	( H/V )
<b>802.11a</b> <b>CH 144</b> <b>5720MHz</b>		5385.1	44.75	-29.25	74	41.63	33	7.02	36.9	109	298	P	H
		5467	44.58	-23.62	68.2	41.31	33.1	7.01	36.84	109	298	P	H
		5431.9	36.85	-17.15	54	33.65	33.06	7.01	36.87	109	298	A	H
	*	5720	111.72	-	-	107.91	33.62	7.06	36.87	109	298	P	H
	*	5720	105.67	-	-	101.86	33.62	7.06	36.87	109	298	A	H
		5927.25	47.18	-21.02	68.2	42.46	34.5	7.14	36.92	109	298	P	H
		5445.16	45.49	-28.51	74	42.25	33.09	7.01	36.86	100	202	P	V
		5466.22	44.79	-23.41	68.2	41.52	33.1	7.01	36.84	100	202	P	V
		5419.03	36.77	-17.23	54	33.6	33.04	7.01	36.88	100	202	A	V
	*	5720	112.74	-	-	108.93	33.62	7.06	36.87	100	202	P	V
	*	5720	107.39	-	-	103.58	33.62	7.06	36.87	100	202	A	V
		5906.25	47.66	-20.54	68.2	42.95	34.5	7.13	36.92	100	202	P	V
<b>Remark</b>	1. No other spurious found. 2. All results are PASS against Peak and Average limit line.												





**Band 3 - Straddle Channel**  
**WIFI 802.11a (Harmonic @ 3m)**

WIFI Ant. 6+7	Note	Frequency ( MHz )	Level ( dBμV/m )	Margin ( dB )	Limit Line ( dBμV/m )	Read Level (dBμV)	Antenna Factor ( dB/m )	Path Loss ( dB )	Preamp Factor ( dB )	Ant Pos ( cm )	Table Pos ( deg )	Peak Avg. (P/A)	Pol. (H/V)	
802.11a CH 144 5720MHz		11440	47.17	-26.83	74	52.3	38.92	11.94	55.99	-	-	P	H	
		17160	47.32	-20.88	68.2	51.02	38.26	14.2	56.16	-	-	P	H	
													H	
													H	
													H	
													H	
													H	
													H	
													H	
													H	
													H	
													H	
													H	
													H	
													H	
													H	
													H	
													H	
			11440	46.58	-27.42	74	51.71	38.92	11.94	55.99	-	-	P	V
			17160	46.81	-21.39	68.2	50.51	38.26	14.2	56.16	-	-	P	V
													V	
													V	
													V	
													V	
													V	
													V	
													V	
													V	
													V	
													V	
													V	
													V	
<b>Remark</b>	1. No other spurious found. 2. All results are PASS against Peak and Average limit line. 3. The emission position marked as "-" means no suspected emission found with sufficient margin against limit line or noise floor only.													



**Band 3 - Straddle Channel**  
**WIFI 802.11ax HE20 Full (Band Edge @ 3m)**

WIFI Ant. 6+7	Note	Frequency ( MHz )	Level ( dBμV/m )	Margin ( dB )	Limit Line ( dBμV/m )	Read Level (dBμV)	Antenna Factor ( dB/m )	Path Loss ( dB )	Preamp Factor ( dB )	Ant Pos ( cm )	Table Pos ( deg )	Peak Avg. (P/A)	Pol. (H/V)
802.11ax HE20 Full CH 144 5720MHz		5378.08	45.62	-28.38	74	42.5	33	7.02	36.9	105	210	P	H
		5467.39	45.57	-22.63	68.2	42.3	33.1	7.01	36.84	105	210	P	H
		5459.98	36.62	-17.38	54	33.36	33.1	7.01	36.85	105	210	A	H
	*	5720	112.32	-	-	108.51	33.62	7.06	36.87	105	210	P	H
	*	5720	104.04	-	-	100.23	33.62	7.06	36.87	105	210	A	H
		5893.75	48.26	-19.94	68.2	43.58	34.46	7.13	36.91	105	210	P	H
		5374.96	46.63	-27.37	74	43.52	33	7.02	36.91	100	201	P	V
		5466.61	43.95	-24.25	68.2	40.68	33.1	7.01	36.84	100	201	P	V
		5459.2	36.37	-17.63	54	33.11	33.1	7.01	36.85	100	201	A	V
	*	5720	115.08	-	-	111.27	33.62	7.06	36.87	100	201	P	V
	*	5720	107.72	-	-	103.91	33.62	7.06	36.87	100	201	A	V
		5864.25	48.25	-19.95	68.2	43.75	34.29	7.12	36.91	100	201	P	V
<b>Remark</b>	1. No other spurious found. 2. All results are PASS against Peak and Average limit line.												



**Band 3 - Straddle Channel**  
**WIFI 802.11ax HE20 Full (Harmonic @ 3m)**

WIFI Ant. 6+7	Note	Frequency ( MHz )	Level ( dBμV/m )	Margin ( dB )	Limit Line ( dBμV/m )	Read Level (dBμV)	Antenna Factor ( dB/m )	Path Loss ( dB )	Preamp Factor ( dB )	Ant Pos ( cm )	Table Pos ( deg )	Peak Avg. (P/A)	Pol. (H/V)	
802.11ax HE20 Full CH 144 5720MHz		11440	46	-28	74	51.13	38.92	11.94	55.99	-	-	P	H	
		17160	47.05	-21.15	68.2	50.75	38.26	14.2	56.16	-	-	P	H	
													H	
													H	
													H	
													H	
													H	
													H	
													H	
													H	
													H	
													H	
													H	
													H	
													H	
													H	
													H	
													H	
			11440	45.7	-28.3	74	50.83	38.92	11.94	55.99	-	-	P	V
			17160	46.54	-21.66	68.2	50.24	38.26	14.2	56.16	-	-	P	V
													V	
													V	
													V	
													V	
													V	
													V	
													V	
													V	
													V	
													V	
													V	
													V	
<b>Remark</b>	1. No other spurious found. 2. All results are PASS against Peak and Average limit line. 3. The emission position marked as "-" means no suspected emission found with sufficient margin against limit line or noise floor only.													



**Band 3 - Straddle Channel**  
**WIFI 802.11ax HE40 Full (Band Edge @ 3m)**

WIFI Ant. 6+7	Note	Frequency ( MHz )	Level ( dBμV/m )	Margin ( dB )	Limit Line ( dBμV/m )	Read Level ( dBμV )	Antenna Factor ( dB/m )	Path Loss ( dB )	Preamp Factor ( dB )	Ant Pos ( cm )	Table Pos ( deg )	Peak Avg. (P/A)	Pol. (H/V)
802.11ax HE40 Full CH 142 5710MHz		5397.19	48.13	-25.87	74	41.7	33	7.01	33.58	177	187	P	H
		5467	48.64	-19.56	68.2	42.1	33.1	7.01	33.57	177	187	P	H
		5438.14	39.25	-14.75	54	32.73	33.08	7.01	33.57	177	187	A	H
	*	5710	111.2	-	-	104.18	33.56	7.05	33.59	177	187	P	H
	*	5710	105.4	-	-	98.38	33.56	7.05	33.59	177	187	A	H
		5855.25	51.89	-16.31	68.2	44.14	34.23	7.12	33.6	177	187	P	H
		5376.52	48.52	-25.48	74	42.09	33	7.02	33.59	100	237	P	V
		5469.73	48.2	-20	68.2	41.66	33.1	7.01	33.57	100	237	P	V
		5444.38	39.13	-14.87	54	32.6	33.09	7.01	33.57	100	237	A	V
	*	5710	110.27	-	-	103.25	33.56	7.05	33.59	100	237	P	V
	*	5710	102.78	-	-	95.76	33.56	7.05	33.59	100	237	A	V
	5877	51.32	-16.88	68.2	43.45	34.36	7.12	33.61	100	237	P	V	
Remark	1. No other spurious found. 2. All results are PASS against Peak and Average limit line.												



**Band 3 - Straddle Channel**  
**WIFI 802.11ax HE40 Full (Harmonic @ 3m)**

WIFI Ant. 6+7	Note	Frequency ( MHz )	Level ( dBμV/m )	Margin ( dB )	Limit Line ( dBμV/m )	Read Level ( dBμV )	Antenna Factor ( dB/m )	Path Loss ( dB )	Preamp Factor ( dB )	Ant Pos ( cm )	Table Pos ( deg )	Peak Avg. ( P/A )	Pol. ( H/V )	
802.11ax HE40 Full CH 142 5710MHz		11420	46.44	-27.56	74	51.54	38.96	11.94	56	-	-	P	H	
		17130	46.08	-22.12	68.2	49.86	38.16	14.18	56.12	-	-	P	H	
													H	
													H	
													H	
													H	
													H	
													H	
													H	
													H	
													H	
													H	
													H	
													H	
													H	
													H	
													H	
													H	
			11420	46.47	-27.53	74	51.57	38.96	11.94	56	-	-	P	V
			17130	46.51	-21.69	68.2	50.29	38.16	14.18	56.12	-	-	P	V
													V	
													V	
													V	
													V	
													V	
													V	
													V	
													V	
													V	
													V	
													V	
													V	
<b>Remark</b>	1. No other spurious found. 2. All results are PASS against Peak and Average limit line. 3. The emission position marked as "-" means no suspected emission found with sufficient margin against limit line or noise floor only.													



**Band 3 Straddle Channel  
WIFI 802.11ax HE80 Full (Band Edge @ 3m)**

WIFI Ant. 6+7	Note	Frequency ( MHz )	Level ( dBμV/m )	Margin ( dB )	Limit Line ( dBμV/m )	Read Level (dBμV)	Antenna Factor ( dB/m )	Path Loss ( dB )	Preamp Factor ( dB )	Ant Pos ( cm )	Table Pos ( deg )	Peak Avg. (P/A)	Pol. (H/V)
802.11ax HE80 Full CH 138 5690MHz		5457.25	49.12	-24.88	74	42.58	33.1	7.01	33.57	181	185	P	H
		5465.05	49.06	-19.14	68.2	42.52	33.1	7.01	33.57	181	185	P	H
		5456.47	39.88	-14.12	54	33.34	33.1	7.01	33.57	181	185	A	H
	*	5690	108.97	-	-	102.06	33.44	7.05	33.58	181	185	P	H
	*	5690	101.91	-	-	95	33.44	7.05	33.58	181	185	A	H
		5850.1	52.54	-15.66	68.2	44.82	34.2	7.12	33.6	181	185	P	H
		5417.47	48.2	-25.8	74	41.74	33.03	7.01	33.58	100	195	P	V
		5469.73	48.54	-19.66	68.2	42	33.1	7.01	33.57	100	195	P	V
		5457.25	39.29	-14.71	54	32.75	33.1	7.01	33.57	100	195	A	V
	*	5690	108.04	-	-	101.13	33.44	7.05	33.58	100	195	P	V
	*	5690	100.45	-	-	93.54	33.44	7.05	33.58	100	195	A	V
		5871.4	52.77	-15.43	68.2	44.92	34.33	7.12	33.6	100	195	P	V
<b>Remark</b>	1. No other spurious found. 2. All results are PASS against Peak and Average limit line.												



**Band 3 - Straddle Channel**  
**WIFI 802.11ax HE80 Full (Harmonic @ 3m)**

WIFI Ant. 6+7	Note	Frequency ( MHz )	Level ( dBμV/m )	Margin ( dB )	Limit Line ( dBμV/m )	Read Level (dBμV)	Antenna Factor ( dB/m )	Path Loss ( dB )	Preamp Factor ( dB )	Ant Pos ( cm )	Table Pos ( deg )	Peak Avg. (P/A)	Pol. (H/V)	
802.11ax HE80 Full CH 138 5690MHz		11380	46.2	-27.8	74	51.28	39	11.93	56.01	-	-	P	H	
		17070	46.82	-21.38	68.2	50.44	38.28	14.13	56.03	-	-	P	H	
													H	
													H	
													H	
													H	
													H	
													H	
													H	
													H	
													H	
													H	
													H	
													H	
													H	
													H	
													H	
													H	
			11380	45.88	-28.12	74	50.96	39	11.93	56.01	-	-	P	V
			17070	46.44	-21.76	68.2	50.06	38.28	14.13	56.03	-	-	P	V
													V	
													V	
													V	
													V	
													V	
													V	
													V	
													V	
													V	
													V	
													V	
<b>Remark</b>	1. No other spurious found. 2. All results are PASS against Peak and Average limit line. 3. The emission position marked as "-" means no suspected emission found with sufficient margin against limit line or noise floor only.													







Emission below 1GHz  
WIFI 802.11ax HE80 (LF @ 3m)

WIFI	Note	Frequency	Level	Margin	Limit	Read	Antenna	Path	Preamp	Ant	Table	Peak	Pol.	
Ant.					Line	Level	Factor	Loss	Factor	Pos	Pos	Avg.		
6+7		( MHz )	( dBμV/m )	( dB )	( dBμV/m )	( dBμV )	( dB/m )	( dB )	( dB )	( cm )	( deg )	( P/A )	( H/V )	
802.11ax HE80 LF		35.4	31.61	-8.39	40	40.85	21.97	1.17	32.38	-	-	P	H	
		96.15	26.48	-17.02	43.5	41.79	15.49	1.48	32.28	-	-	P	H	
		134.22	22	-21.5	43.5	35.05	17.59	1.6	32.24	-	-	P	H	
		470.8	29.42	-16.58	46	35.69	23.45	2.45	32.17	-	-	P	H	
		718.6	37.86	-8.14	46	39.99	27.06	2.92	32.11	-	-	P	H	
		899.2	34.58	-11.42	46	33.79	29	3.23	31.44	-	-	P	H	
														H
														H
														H
														H
														H
														H
														H
			33.78	32.82	-7.18	40	41.34	22.69	1.15	32.36	-	-	P	V
			64.02	30.99	-9.01	40	50.07	11.8	1.37	32.25	-	-	P	V
			159.87	22.93	-20.57	43.5	36.82	16.55	1.75	32.19	-	-	P	V
			470.8	28.87	-17.13	46	35.14	23.45	2.45	32.17	-	-	P	V
			714.4	31.66	-14.34	46	33.99	26.86	2.92	32.11	-	-	P	V
			949.6	33.84	-12.16	46	30.77	30.75	3.31	30.99	-	-	P	V
														V
													V	
													V	
													V	
													V	
													V	
Remark	<ol style="list-style-type: none"> <li>No other spurious found.</li> <li>All results are PASS against limit line.</li> <li>The emission position marked as "-" means no suspected emission found and emission level has at least 6dB margin against limit or emission is noise floor only.</li> </ol>													



**Note symbol**

*	<b>Fundamental Frequency</b> which can be ignored. However, the level of any unwanted emissions shall not exceed the level of the fundamental frequency.
!	Test result is <b>Margin</b> line.
P/A	<b>Peak</b> or <b>Average</b>
H/V	<b>Horizontal</b> or <b>Vertical</b>



A calculation example for radiated spurious emission is shown as below:

WIFI	Note	Frequency	Level	Margin	Limit	Read	Antenna	Path	Preamp	Ant	Table	Peak	Pol.
Ant.					Line	Level	Factor	Loss	Factor	Pos	Pos	Avg.	
6+7		( MHz )	( dBμV/m )	( dB )	( dBμV/m )	( dBμV )	( dB/m )	( dB )	( dB )	( cm )	( deg )	(P/A)	(H/V)
802.11a		5150	55.45	-18.55	74	54.51	32.22	4.58	35.86	103	308	P	H
CH 36		5150	43.54	-10.46	54	42.6	32.22	4.58	35.86	103	308	A	H
5180MHz													

1. Path Loss(dB) = Cable loss(dB) + Filter loss(dB) + Attenuator loss(dB)
2. Level(dBμV/m) = Antenna Factor(dB/m) + Path Loss(dB) + Read Level(dBμV) - Preamp Factor(dB)
3. Margin (dB) = Level(dBμV/m) – Limit Line(dBμV/m)
- 4.

**For Peak Limit @ 5150MHz:**

1. Level(dBμV/m)  
= Antenna Factor(dB/m) + Path Loss(dB) + Read Level(dBμV) - Preamp Factor(dB)  
= 32.22(dB/m) + 4.58(dB) + 54.51(dBμV) – 35.86 (dB)  
= 55.45 (dBμV/m)
2. Margin (dB)  
= Leve(dBμV/m) – Limit Line(dBμV/m)  
= 55.45(dBμV/m) – 74(dBμV/m)  
= -18.55(dB)

**For Average Limit @ 5150MHz:**

1. Level(dBμV/m)  
= Antenna Factor(dB/m) + Path Loss(dB) + Read Level(dBμV) - Preamp Factor(dB)  
= 32.22(dB/m) + 4.58(dB) + 42.6(dBμV) – 35.86 (dB)  
= 43.54 (dBμV/m)
2. Margin (dB)  
= Level(dBμV/m) – Limit Line(dBμV/m)  
= 43.54 (dBμV/m) – 54(dBμV/m)  
= -10.46(dB)

**Both peak and average measured complies with the limit line, so test result is “PASS”.**



## Appendix D. Radiated Spurious Emission Plots

Test Engineer :	Jacky Hung, Mancy Chou and Rain Lee	Temperature :	20~26°C
		Relative Humidity :	40~65%

### Note symbol

-L	Low channel location
-R	High channel location

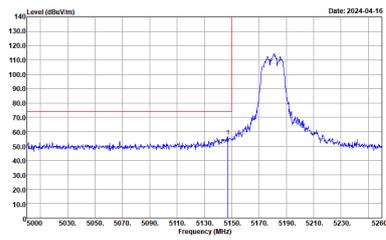
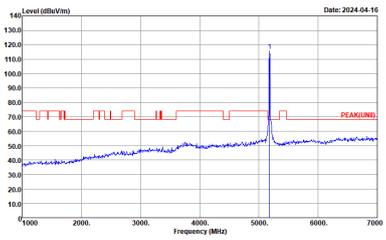
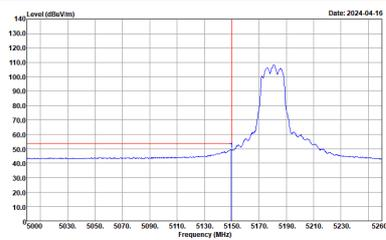
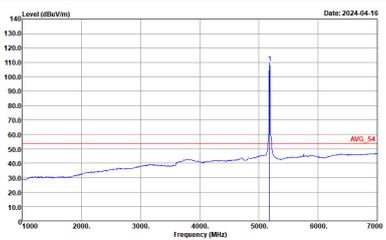

**Band 1 - 5150~5250MHz**  
**WIFI 802.11a (Band Edge @ 3m)**

WIFI	Band 1 5150~5250MHz Band Edge @ 3m	
ANT	802.11a CH36 5180MHz	
6+7	Horizontal	Fundamental
<b>Peak</b>	 <p>Site : 03CH13-HY            Condition : PEAK_BE_74 3m HORN_9120D_1326 HORIZONTAL            : RBW:1000.000kHz VBW:3000.000kHz SWT:Auto</p>	 <p>Site : 03CH13-HY            Condition : PEAK(UNII) 3m HORN_9120D_1326 HORIZONTAL            : RBW:1000.000kHz VBW:3000.000kHz SWT:Auto</p>
<b>Avg.</b>	 <p>Site : 03CH13-HY            Condition : AVG_BE_54 3m HORN_9120D_1326 HORIZONTAL            : RBW:1000.000kHz VBW:1000kHz SWT:Auto</p>	 <p>Site : 03CH13-HY            Condition : AVG_54 3m HORN_9120D_1326 HORIZONTAL            : RBW:1000.000kHz VBW:1000kHz SWT:Auto</p>

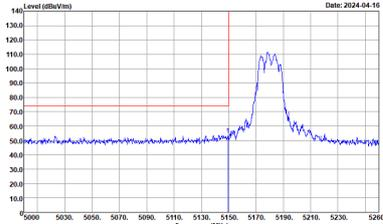
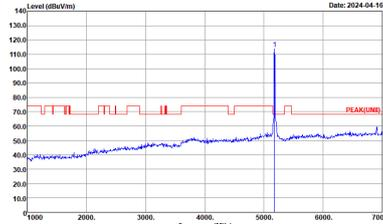
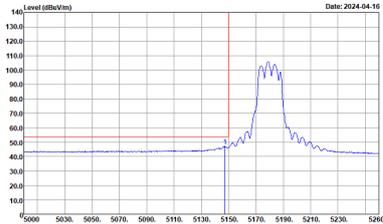
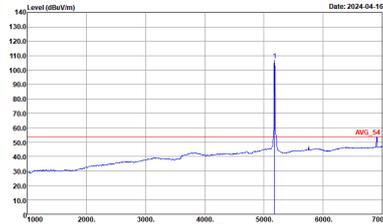

WIFI	Band 1 5150~5250MHz Band Edge @ 3m	
ANT	802.11a CH36 5180MHz	
6+7	Vertical	Fundamental
Peak	 <p>Date: 2024-04-16</p> <p>Site : 03CH13-HY Condition : PEAK_BE_74 3m HORN_9120D_1326 VERTICAL : RBW:1000.000KHz VBW:3000.000KHz SWT:Auto</p>	 <p>Date: 2024-04-16</p> <p>Site : 03CH13-HY Condition : PEAK(UNII) 3m HORN_9120D_1326 VERTICAL : RBW:1000.000KHz VBW:3000.000KHz SWT:Auto</p>
Avg.	 <p>Date: 2024-04-16</p> <p>Site : 03CH13-HY Condition : AVG_BE_54 3m HORN_9120D_1326 VERTICAL : RBW:1000.000KHz VBW:1000KHz SWT:Auto</p>	 <p>Date: 2024-04-16</p> <p>Site : 03CH13-HY Condition : AVG_54 3m HORN_9120D_1326 VERTICAL : RBW:1000.000KHz VBW:1000KHz SWT:Auto</p>

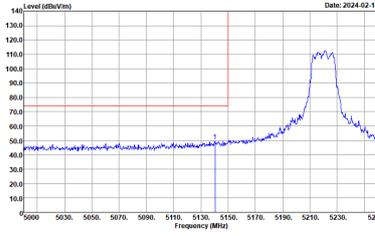
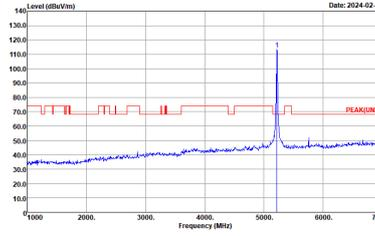
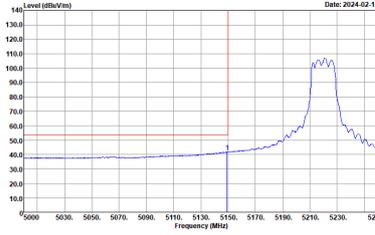
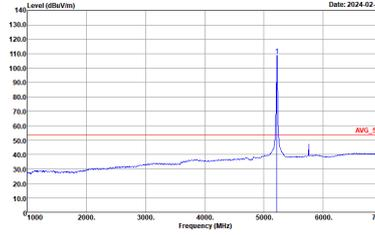

WIFI	Band 1 5150~5250MHz Band Edge @ 3m	
ANT	802.11a CH44 5220MHz - L	
6+7	Horizontal	Fundamental
Peak	 <p>Site : 03CH13-HY Condition : PEAK_BE_74 3m HORN_9120D_1326 HORIZONTAL : RBW:1000.000KHz VBW:3000.000KHz SWT:Auto</p>	 <p>Site : 03CH13-HY Condition : PEAK(UNII) 3m HORN_9120D_1326 HORIZONTAL : RBW:1000.000KHz VBW:3000.000KHz SWT:Auto</p>
Avg.	 <p>Site : 03CH13-HY Condition : AVG_BE_54 3m HORN_9120D_1326 HORIZONTAL : RBW:1000.000KHz VBW:1.000KHz SWT:Auto</p>	 <p>Site : 03CH13-HY Condition : AVG_54 3m HORN_9120D_1326 HORIZONTAL : RBW:1000.000KHz VBW:1.000KHz SWT:Auto</p>



WIFI	Band 1 5150~5250MHz Band Edge @ 3m	
ANT	802.11a CH44 5220MHz - R	
6+7	Horizontal	Fundamental
Peak	<p>Site : 03CH13-HY Condition : PEAK_BE_74 3m HORN_9120D_1326 HORIZONTAL : RBW:1000.000KHz VBW:3000.000KHz SWT:Auto</p>	Left blank
Avg.	<p>Site : 03CH13-HY Condition : AVG_BE_54 3m HORN_9120D_1326 HORIZONTAL : RBW:1000.000KHz VBW:1.000KHz SWT:Auto</p>	Left blank



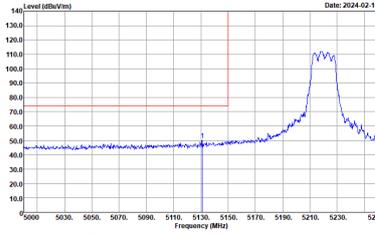
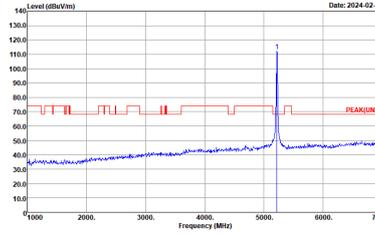
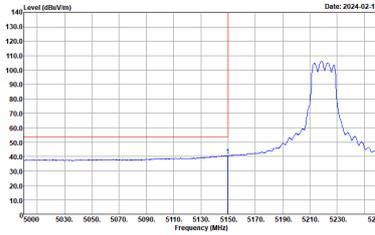
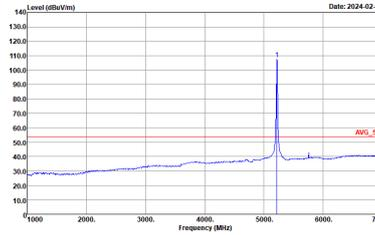

WIFI	Band 1 5150~5250MHz Band Edge @ 3m	
ANT	802.11a CH44 5220MHz - L	
6+7	Vertical	Fundamental
Peak	 <p>Date: 2024-02-16</p> <p>Site : 03CH13-HY Condition : PEAK_BE_74 3m HORN_91200_1326 VERTICAL : RBW:1000.000KHz VBW:3000.000KHz SWT:Auto</p>	 <p>Date: 2024-02-16</p> <p>Site : 03CH13-HY Condition : PEAK(UNII) 3m HORN_91200_1326 VERTICAL : RBW:1000.000KHz VBW:3000.000KHz SWT:Auto</p>
Avg.	 <p>Date: 2024-02-16</p> <p>Site : 03CH13-HY Condition : AVG_BE_54 3m HORN_91200_1326 VERTICAL : RBW:1000.000KHz VBW:1.000KHz SWT:Auto</p>	 <p>Date: 2024-02-16</p> <p>Site : 03CH13-HY Condition : AVG_54 3m HORN_91200_1326 VERTICAL : RBW:1000.000KHz VBW:1.000KHz SWT:Auto</p>

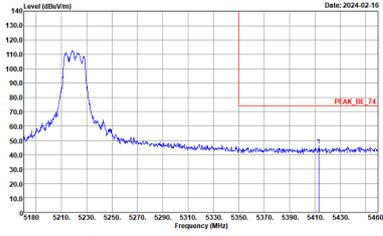
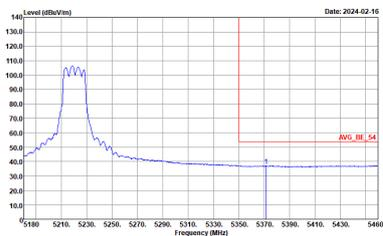

WIFI	Band 1 5150~5250MHz Band Edge @ 3m	
ANT	802.11a CH44 5220MHz - R	
6+7	Vertical	Fundamental
Peak	 <p>Site : 03CH13-HY Condition : PEAK_BE_74 3m HORN_9120D_1326 VERTICAL : RBW:1000.000KHz VBW:3000.000KHz SWT:Auto</p>	Left blank
Avg.	 <p>Site : 03CH13-HY Condition : AVG_BE_54 3m HORN_9120D_1326 VERTICAL : RBW:1000.000KHz VBW:1.000KHz SWT:Auto</p>	Left blank

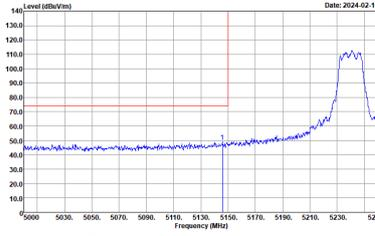
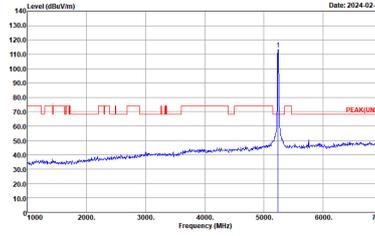
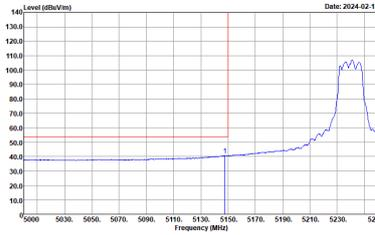
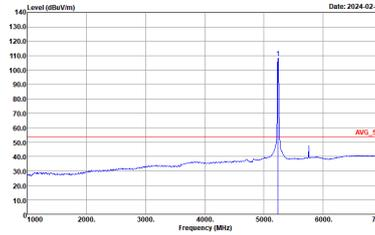

WIFI	Band 1 5150~5250MHz Band Edge @ 3m	
ANT	802.11a CH48 5240MHz - L	
6+7	Horizontal	Fundamental
Peak	 <p>Site : 03CH13-HY Condition : PEAK_BE_74 3m HORN_9120D_1326 HORIZONTAL : RBW:1000.000KHz VBW:3000.000KHz SWT:Auto</p>	 <p>Site : 03CH13-HY Condition : PEAK(UNII) 3m HORN_9120D_1326 HORIZONTAL : RBW:1000.000KHz VBW:3000.000KHz SWT:Auto</p>
Avg.	 <p>Site : 03CH13-HY Condition : AVG_BE_54 3m HORN_9120D_1326 HORIZONTAL : RBW:1000.000KHz VBW:1.000KHz SWT:Auto</p>	 <p>Site : 03CH13-HY Condition : AVG_54 3m HORN_9120D_1326 HORIZONTAL : RBW:1000.000KHz VBW:1.000KHz SWT:Auto</p>

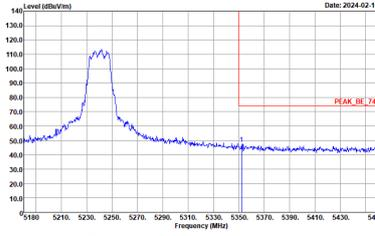
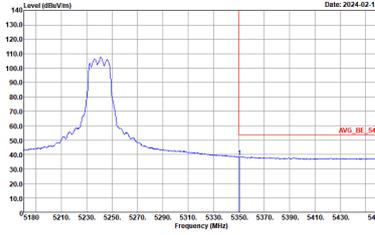

WIFI	Band 1 5150~5250MHz Band Edge @ 3m	
ANT	802.11a CH48 5240MHz - R	
6+7	Horizontal	Fundamental
Peak	 <p>Site : 03CH13-HY Condition : PEAK_BE_74 3m HORN_9120D_1326 HORIZONTAL : RBW:1000.000KHz VBW:3000.000KHz SWT:Auto</p>	Left blank
Avg.	 <p>Site : 03CH13-HY Condition : AVG_BE_54 3m HORN_9120D_1326 HORIZONTAL : RBW:1000.000KHz VBW:1.000KHz SWT:Auto</p>	Left blank

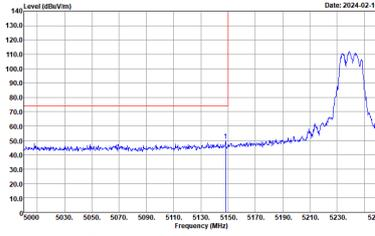
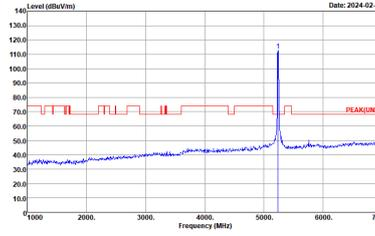
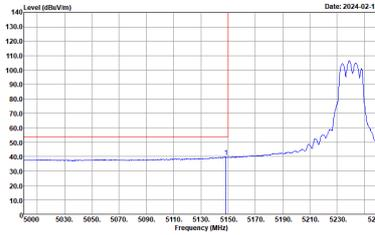
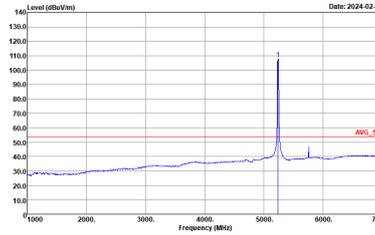

WIFI	Band 1 5150~5250MHz Band Edge @ 3m	
ANT	802.11a CH48 5240MHz - L	
6+7	Vertical	Fundamental
Peak	 <p>Site : 03CH13-HY Condition : PEAK_BE_74 3m HORN_9120D_1326 VERTICAL : RBW:1000.000KHz VBW:3000.000KHz SWT:Auto</p>	 <p>Site : 03CH13-HY Condition : PEAK(UNII) 3m HORN_9120D_1326 VERTICAL : RBW:1000.000KHz VBW:3000.000KHz SWT:Auto</p>
Avg.	 <p>Site : 03CH13-HY Condition : AVG_BE_54 3m HORN_9120D_1326 VERTICAL : RBW:1000.000KHz VBW:1.000KHz SWT:Auto</p>	 <p>Site : 03CH13-HY Condition : AVG_54 3m HORN_9120D_1326 VERTICAL : RBW:1000.000KHz VBW:1.000KHz SWT:Auto</p>

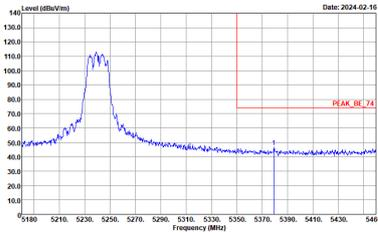
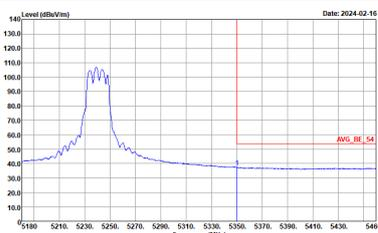

WIFI	Band 1 5150~5250MHz Band Edge @ 3m	
ANT	802.11a CH48 5240MHz - R	
6+7	Vertical	Fundamental
Peak	 <p>Site : 03CH13-HY Condition : PEAK_BE_74 3m HORN_91200_1326 VERTICAL : RBW:1000.000KHz VBW:3000.000KHz SWT:Auto</p>	Left blank
Avg.	 <p>Site : 03CH13-HY Condition : AVG_BE_54 3m HORN_91200_1326 VERTICAL : RBW:1000.000KHz VBW:1.000KHz SWT:Auto</p>	Left blank

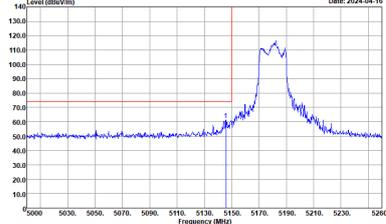
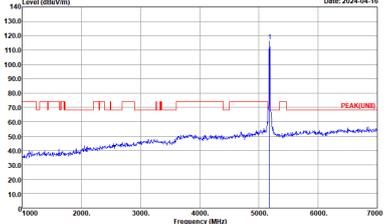
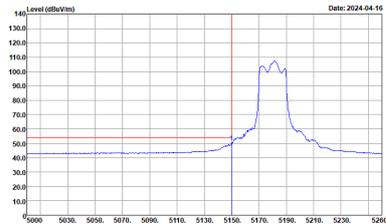
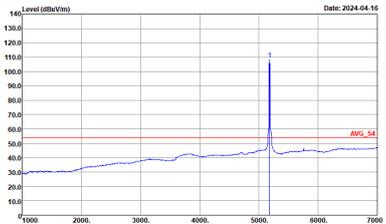

**Band 1 5150~5250MHz**  
**WIFI 802.11ax HE20 Full (Band Edge @ 3m)**

WIFI	Band 1 5150~5250MHz Band Edge @ 3m	
ANT	802.11ax HE20 Full CH36 5180MHz	
6+7	Horizontal	Fundamental
<b>Peak</b>	 <p>Site : 03CH13-HY            Condition : PEAK_BE_74 3m HORN_91200_1326 HORIZONTAL            : RBW:1000.000kHz VBW:3000.000kHz SWT:Auto</p>	 <p>Site : 03CH13-HY            Condition : PEAK(FUNDF) 3m HORN_91200_1326 HORIZONTAL            : RBW:1000.000kHz VBW:3000.000kHz SWT:Auto</p>
<b>Avg.</b>	 <p>Site : 03CH13-HY            Condition : AV6_BE_54 3m HORN_91200_1326 HORIZONTAL            : RBW:1000.000kHz VBW:0.300kHz SWT:Auto</p>	 <p>Site : 03CH13-HY            Condition : AV6_54 3m HORN_91200_1326 HORIZONTAL            : RBW:1000.000kHz VBW:0.300kHz SWT:Auto</p>

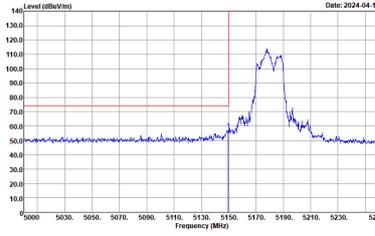
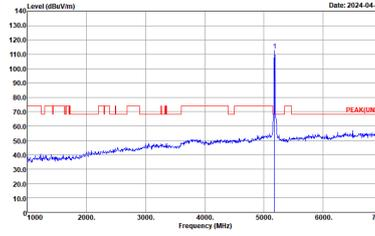
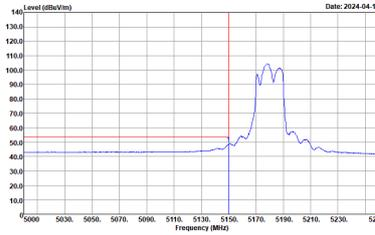
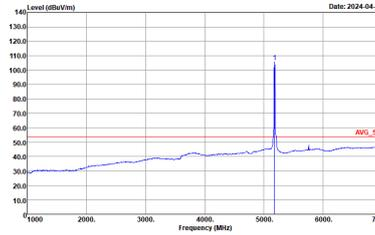

WIFI	Band 1 5150~5250MHz Band Edge @ 3m	
ANT	802.11ax HE20 Full CH36 5180MHz	
6+7	Vertical	Fundamental
Peak	 <p>Date: 2024-04-16</p> <p>Site : 03CH13-HY Condition : PEAK_BE_74 3m HORN_91200_1326 VERTICAL : RBW:1000.000KHz VBW:3000.000KHz SWT:Auto</p>	 <p>Date: 2024-04-16</p> <p>Site : 03CH13-HY Condition : PEAK(UNII) 3m HORN_91200_1326 VERTICAL : RBW:1000.000KHz VBW:3000.000KHz SWT:Auto</p>
Avg.	 <p>Date: 2024-04-16</p> <p>Site : 03CH13-HY Condition : AVG_BE_54 3m HORN_91200_1326 VERTICAL : RBW:1000.000KHz VBW:0.300KHz SWT:Auto</p>	 <p>Date: 2024-04-16</p> <p>Site : 03CH13-HY Condition : AVG_54 3m HORN_91200_1326 VERTICAL : RBW:1000.000KHz VBW:0.300KHz SWT:Auto</p>



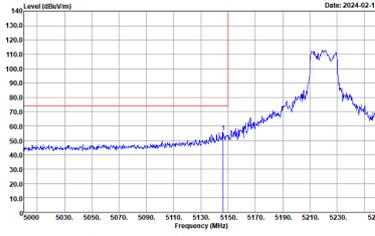
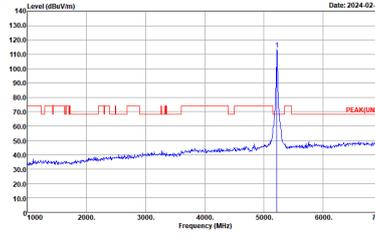
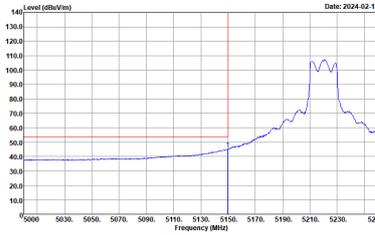
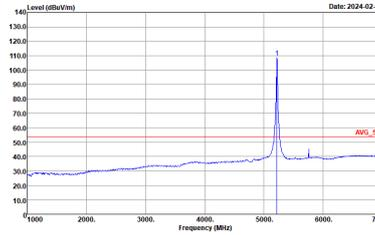

WIFI	Band 1 5150~5250MHz Band Edge @ 3m	
ANT	802.11ax HE20 Full CH44 5220MHz - L	
6+7	Horizontal	Fundamental
Peak	 <p>Site : 03CH13-HY Condition : PEAK_BE_74 3m HORN_91200_1326 HORIZONTAL : RBW:1000.000KHz VBW:3000.000KHz SWT:Auto</p>	 <p>Site : 03CH13-HY Condition : PEAK(UNII) 3m HORN_91200_1326 HORIZONTAL : RBW:1000.000KHz VBW:3000.000KHz SWT:Auto</p>
Avg.	 <p>Site : 03CH13-HY Condition : AVG_BE_54 3m HORN_91200_1326 HORIZONTAL : RBW:1000.000KHz VBW:0.300KHz SWT:Auto</p>	 <p>Site : 03CH13-HY Condition : AVG_54 3m HORN_91200_1326 HORIZONTAL : RBW:1000.000KHz VBW:0.300KHz SWT:Auto</p>

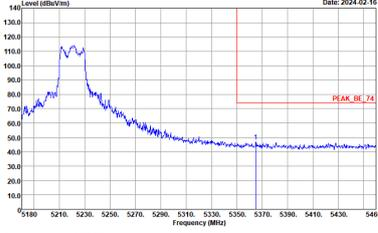
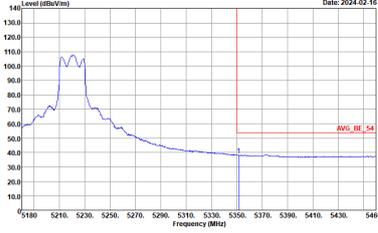

WIFI	Band 1 5150~5250MHz Band Edge @ 3m	
ANT	802.11ax HE20 Full CH44 5220MHz - R	
6+7	Horizontal	Fundamental
Peak	 <p>Site : 03CH13-HY Condition : PEAK_BE_74 3m HORN_9120D_1326 HORIZONTAL : RBW:1000.000KHz VBW:3000.000KHz SWT:Auto</p>	Left blank
Avg.	 <p>Site : 03CH13-HY Condition : AVG_BE_54 3m HORN_9120D_1326 HORIZONTAL : RBW:1000.000KHz VBW:0.300KHz SWT:Auto</p>	Left blank

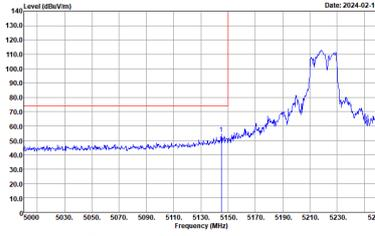
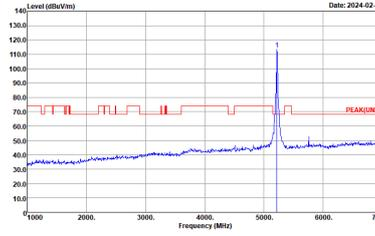
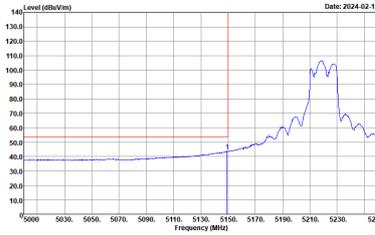
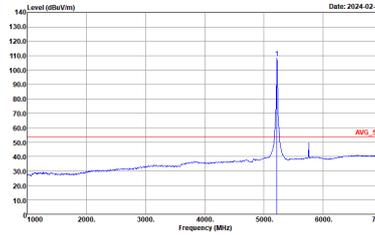

WIFI	Band 1 5150~5250MHz Band Edge @ 3m	
ANT	802.11ax HE20 Full CH44 5220MHz - L	
6+7	Vertical	Fundamental
Peak	 <p>Site : 03CH13-HY Condition : PEAK_BE_74 3m HORN_91200_1326 VERTICAL : RBW:1000.000KHz VBW:3000.000KHz SWT:Auto</p>	 <p>Site : 03CH13-HY Condition : PEAK(UNII) 3m HORN_91200_1326 VERTICAL : RBW:1000.000KHz VBW:3000.000KHz SWT:Auto</p>
Avg.	 <p>Site : 03CH13-HY Condition : AVG_BE_54 3m HORN_91200_1326 VERTICAL : RBW:1000.000KHz VBW:0.300KHz SWT:Auto</p>	 <p>Site : 03CH13-HY Condition : AVG_54 3m HORN_91200_1326 VERTICAL : RBW:1000.000KHz VBW:0.300KHz SWT:Auto</p>

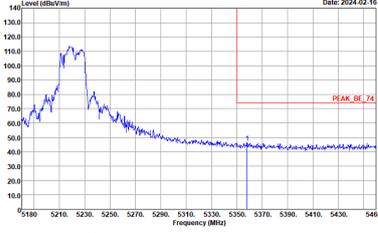
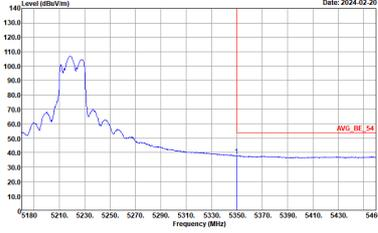

WIFI	Band 1 5150~5250MHz Band Edge @ 3m	
ANT	802.11ax HE20 Full CH44 5220MHz - R	
6+7	Vertical	Fundamental
Peak	 <p>Date: 2024-02-16</p> <p>Site : 03CH13-HY Condition : PEAK_BE_74 3m HORN_9120D_1326 VERTICAL : RBW:1000.000KHz VBW:3000.000KHz SWT:Auto</p>	Left blank
Avg.	 <p>Date: 2024-02-20</p> <p>Site : 03CH13-HY Condition : AVG_BE_54 3m HORN_9120D_1326 VERTICAL : RBW:1000.000KHz VBW:0.300KHz SWT:Auto</p>	Left blank

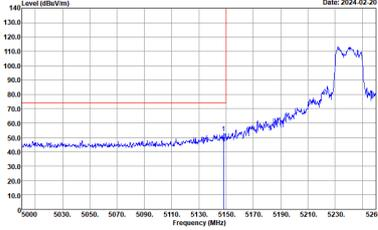
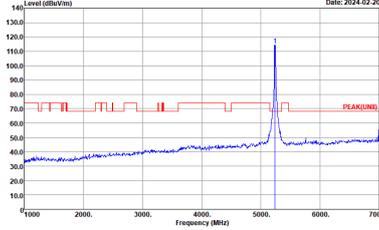
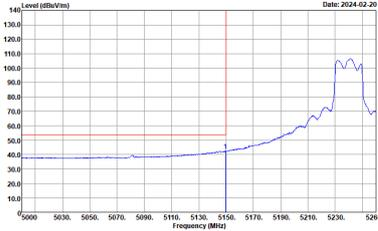
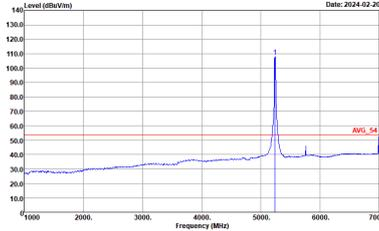

WIFI	Band 1 5150~5250MHz Band Edge @ 3m	
ANT	802.11ax HE20 Full CH48 5240MHz - L	
6+7	Horizontal	Fundamental
Peak	 <p>Site : 03CH13-HY Condition : PEAK_BE_74 3m HORN_91200_1326 HORIZONTAL : RBW:1000.000KHz VBW:3000.000KHz SWT:Auto</p>	 <p>Site : 03CH13-HY Condition : PEAK(UNII) 3m HORN_91200_1326 HORIZONTAL : RBW:1000.000KHz VBW:3000.000KHz SWT:Auto</p>
Avg.	 <p>Site : 03CH13-HY Condition : AVG_BE_54 3m HORN_91200_1326 HORIZONTAL : RBW:1000.000KHz VBW:0.300KHz SWT:Auto</p>	 <p>Site : 03CH13-HY Condition : AVG_54 3m HORN_91200_1326 HORIZONTAL : RBW:1000.000KHz VBW:0.300KHz SWT:Auto</p>



WIFI	Band 1 5150~5250MHz Band Edge @ 3m	
ANT	802.11ax HE20 Full CH48 5240MHz - R	
6+7	Horizontal	Fundamental
Peak	<p>Site : 03CH13-HY Condition : PEAK_BE_74 3m HORN_91200_1326 HORIZONTAL : RBW:1000.000KHz VBW:3000.000KHz SWT:Auto</p>	Left blank
Avg.	<p>Site : 03CH13-HY Condition : AVG_BE_54 3m HORN_91200_1326 HORIZONTAL : RBW:1000.000KHz VBW:0.300KHz SWT:Auto</p>	Left blank

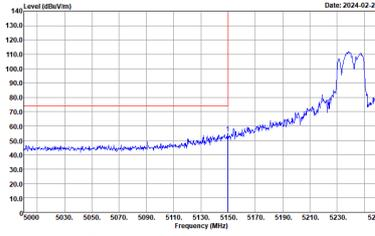
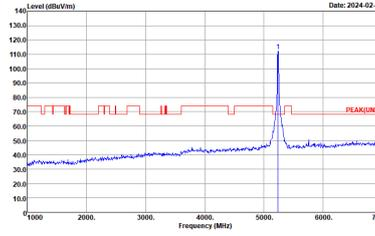
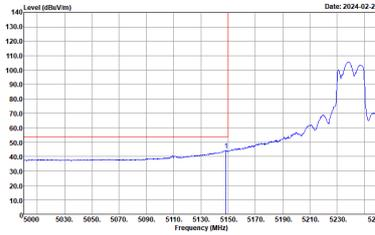
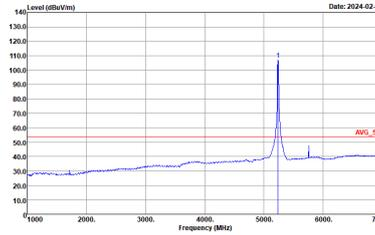

WIFI	Band 1 5150~5250MHz Band Edge @ 3m	
ANT	802.11ax HE20 Full CH48 5240MHz - L	
6+7	Vertical	Fundamental
Peak	 <p>Date: 2024-02-20</p> <p>Site : 03CH13-HY Condition : PEAK_BE_74 3m HORN_91200_1326 VERTICAL : RBW:1000.000KHz VBW:3000.000KHz SWT:Auto</p>	 <p>Date: 2024-02-20</p> <p>Site : 03CH13-HY Condition : PEAK(UNII) 3m HORN_91200_1326 VERTICAL : RBW:1000.000KHz VBW:3000.000KHz SWT:Auto</p>
Avg.	 <p>Date: 2024-02-20</p> <p>Site : 03CH13-HY Condition : AVG_BE_54 3m HORN_91200_1326 VERTICAL : RBW:1000.000KHz VBW:0.300KHz SWT:Auto</p>	 <p>Date: 2024-02-20</p> <p>Site : 03CH13-HY Condition : AVG_54 3m HORN_91200_1326 VERTICAL : RBW:1000.000KHz VBW:0.300KHz SWT:Auto</p>



WIFI	Band 1 5150~5250MHz Band Edge @ 3m	
ANT	802.11ax HE20 Full CH48 5240MHz - R	
6+7	Vertical	Fundamental
Peak	<p>Site : 03CH13-HY Condition : PEAK_BE_74 3m HORN_91200_1326 VERTICAL : RBW:1000.000KHz VBW:3000.000KHz SWT:Auto</p>	Left blank
Avg.	<p>Site : 03CH13-HY Condition : AVG_BE_54 3m HORN_91200_1326 VERTICAL : RBW:1000.000KHz VBW:0.300KHz SWT:Auto</p>	Left blank



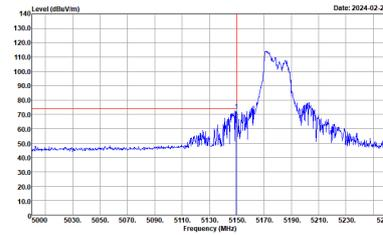
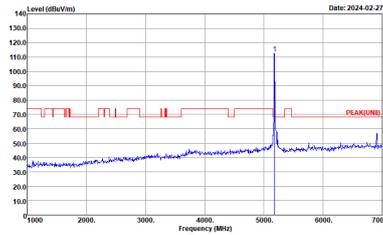
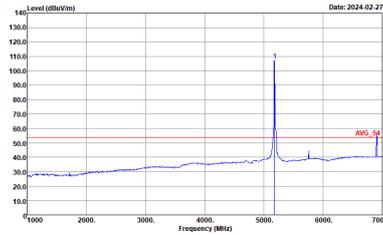

**Band 1 5150~5250MHz**  
**WIFI 802.11ax HE20 Partial 106 (Band Edge @ 3m)**

WIFI	Band 1 5150~5250MHz Band Edge @ 3m	
ANT	802.11ax HE20 Partial 106/53 CH36 5180MHz	
6+7	Horizontal	Fundamental
Peak	 <p>Site : 03CH13-HY            Condition : PEAK_BE_74 3m HORN_91200_1326 HORIZONTAL            : RBW:1000.000KHz VBW:3000.000KHz SWT:Auto</p>	 <p>Site : 03CH13-HY            Condition : PEAK(FUNDE) 3m HORN_91200_1326 HORIZONTAL            : RBW:1000.000KHz VBW:3000.000KHz SWT:Auto</p>
Avg.	 <p>Site : 03CH13-HY            Condition : AV6_BE_54 3m HORN_91200_1326 HORIZONTAL            : RBW:1000.000KHz VBW:0.300KHz SWT:Auto</p>	 <p>Site : 03CH13-HY            Condition : AV6_54 3m HORN_91200_1326 HORIZONTAL            : RBW:1000.000KHz VBW:0.300KHz SWT:Auto</p>

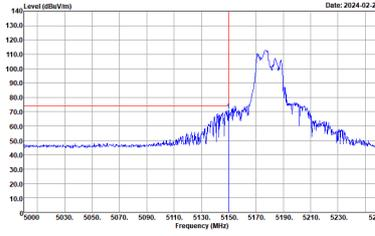
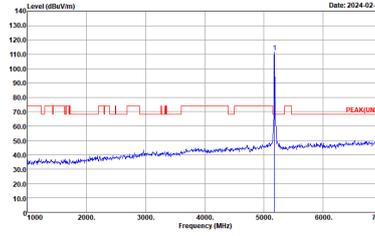
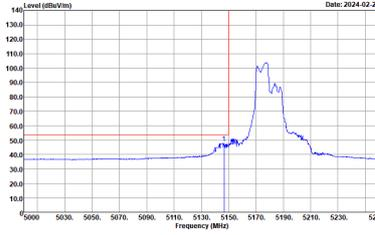
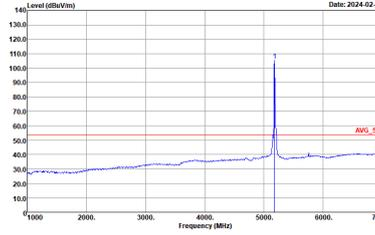

WIFI	Band 1 5150~5250MHz Band Edge @ 3m	
ANT	802.11ax HE20 Partial 106/53 CH36 5180MHz	
6+7	Vertical	Fundamental
Peak	 <p>Date: 2024-02-27</p> <p>Site : 03CH13-HY Condition : PEAK_BE_74 3m HORN_91200_1326 VERTICAL : RBW:1000.000KHz VBW:3000.000KHz SWT:Auto</p>	 <p>Date: 2024-02-27</p> <p>Site : 03CH13-HY Condition : PEAK(UNII) 3m HORN_91200_1326 VERTICAL : RBW:1000.000KHz VBW:3000.000KHz SWT:Auto</p>
Avg.	 <p>Date: 2024-02-27</p> <p>Site : 03CH13-HY Condition : AVG_BE_54 3m HORN_91200_1326 VERTICAL : RBW:1000.000KHz VBW:3000.000KHz SWT:Auto</p>	 <p>Date: 2024-02-27</p> <p>Site : 03CH13-HY Condition : AVG_54 3m HORN_91200_1326 VERTICAL : RBW:1000.000KHz VBW:3000.000KHz SWT:Auto</p>



**Band 1 5150~5250MHz**  
**WIFI 802.11ax HE40 Full (Band Edge @ 3m)**

<b>WIFI</b>	<b>Band 1 5150~5250MHz Band Edge @ 3m</b>	
<b>ANT</b>	<b>802.11ax HE40 Full CH38 5190MHz - L</b>	
<b>6+7</b>	<b>Horizontal</b>	<b>Fundamental</b>
<b>Peak</b>	<p>Site : 03CH13-HY          Condition : PEAK_SE_74 3m HORN_9120_1326 HORIZONTAL          : RBW:1000.000KHz VBW:3000.000KHz SWT:Auto</p>	<p>Site : 03CH13-HY          Condition : PEAK(LINE) 3m HORN_9120_1326 HORIZONTAL          : RBW:1000.000KHz VBW:3000.000KHz SWT:Auto</p>

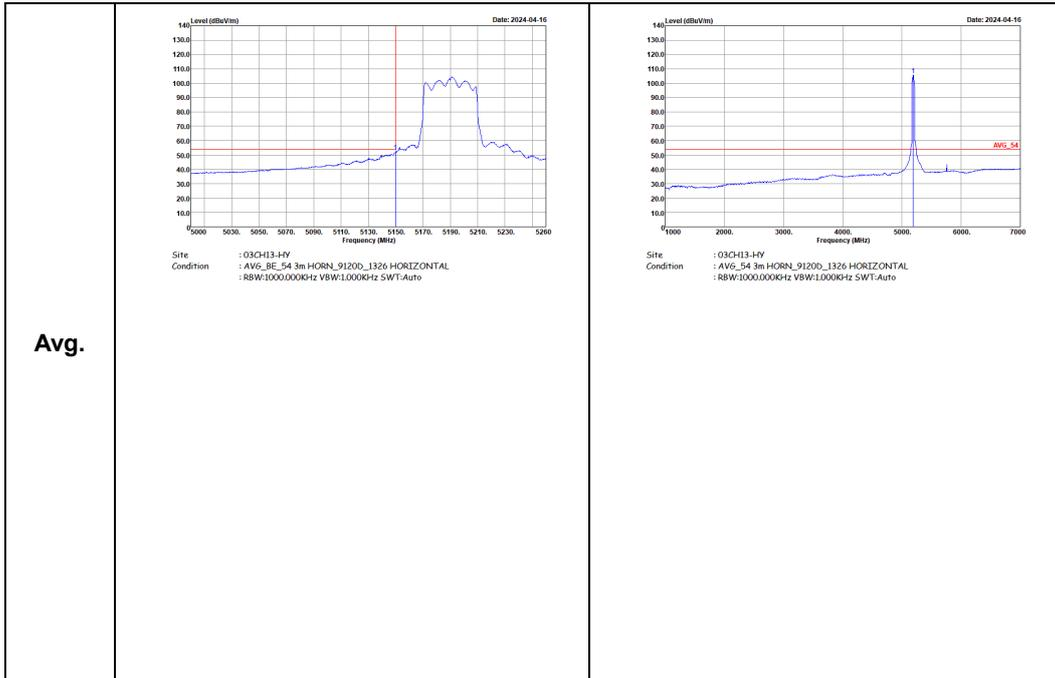

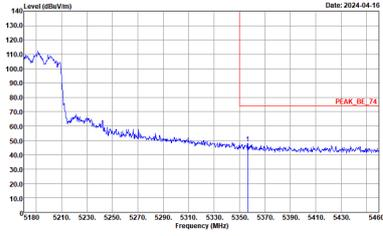
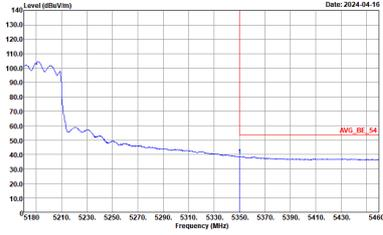

WIFI	Band 1 5150~5250MHz Band Edge @ 3m	
ANT	802.11ax HE40 Full CH38 5190MHz - R	
6+7	Horizontal	Fundamental
<p><b>Peak</b></p>	 <p>Site : 03CH13-HY Condition : PEAK_BE_74 3m HORN_91200_1326 HORIZONTAL : RBW:1000.000KHz VBW:3000.000KHz SWT:Auto</p>	<p>Left blank</p>
<p><b>Avg.</b></p>	 <p>Site : 03CH13-HY Condition : AVG_BE_54 3m HORN_91200_1326 HORIZONTAL : RBW:1000.000KHz VBW:1000KHz SWT:Auto</p>	<p>Left blank</p>

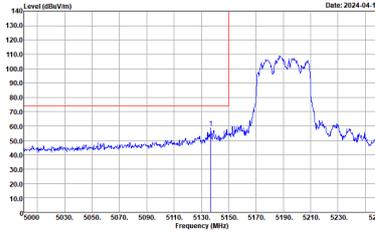
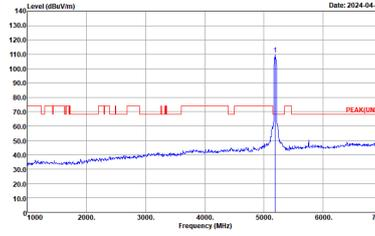
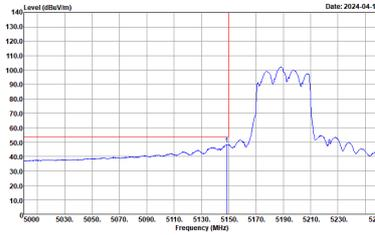
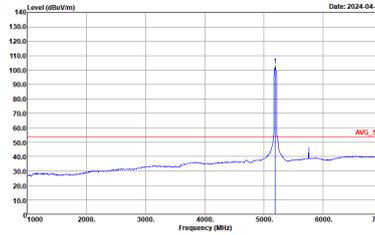

WIFI	Band 1 5150~5250MHz Band Edge @ 3m	
ANT	802.11ax HE40 Full CH38 5190MHz - L	
6+7	Vertical	Fundamental
Peak	 <p>Date: 2024-04-16</p> <p>Site : 03CH13-HY Condition : PEAK_BE_74 3m HORN_91200_1326 VERTICAL : RBW:1000.000KHz VBW:3000.000KHz SWT:Auto</p>	 <p>Date: 2024-04-16</p> <p>Site : 03CH13-HY Condition : PEAK(UNII) 3m HORN_91200_1326 VERTICAL : RBW:1000.000KHz VBW:3000.000KHz SWT:Auto</p>
Avg.	 <p>Date: 2024-04-16</p> <p>Site : 03CH13-HY Condition : AVG_BE_54 3m HORN_91200_1326 VERTICAL : RBW:1000.000KHz VBW:1000KHz SWT:Auto</p>	 <p>Date: 2024-04-16</p> <p>Site : 03CH13-HY Condition : AVG_54 3m HORN_91200_1326 VERTICAL : RBW:1000.000KHz VBW:1000KHz SWT:Auto</p>

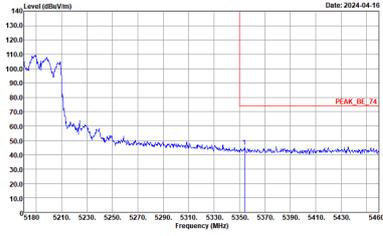
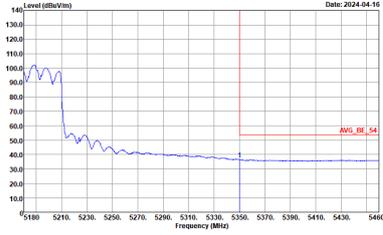

WIFI	Band 1 5150~5250MHz Band Edge @ 3m	
ANT	802.11ax HE40 Full CH38 5190MHz - R	
6+7	Vertical	Fundamental
<p><b>Peak</b></p>	 <p>Site : 03CH13-HY Condition : PEAK_BE_74 3m HORN_9120D_1326 VERTICAL : RBW:1000.000KHz VBW:3000.000KHz SWT:Auto</p>	<p>Left blank</p>
<p><b>Avg.</b></p>	 <p>Site : 03CH13-HY Condition : AVG_BE_54 3m HORN_9120D_1326 VERTICAL : RBW:1000.000KHz VBW:1000KHz SWT:Auto</p>	<p>Left blank</p>

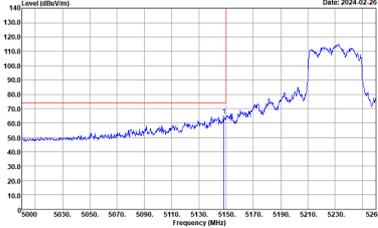
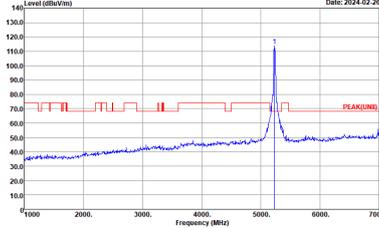
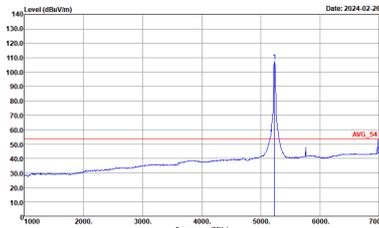

WIFI	Band 1 5150~5250MHz Band Edge @ 3m	
ANT	802.11ax HE40 Full CH46 5230MHz - L	
6+7	Horizontal	Fundamental
Peak	 <p>Site : 03CH13-HY Condition : PEAK_BE_74 3m HORN_91200_1326 HORIZONTAL : RBW:1000.000KHz VBW:3000.000KHz SWT:Auto</p>	 <p>Site : 03CH13-HY Condition : PEAK(UNII) 3m HORN_91200_1326 HORIZONTAL : RBW:1000.000KHz VBW:3000.000KHz SWT:Auto</p>
Avg.	 <p>Site : 03CH13-HY Condition : AVG_BE_54 3m HORN_91200_1326 HORIZONTAL : RBW:1000.000KHz VBW:1.000KHz SWT:Auto</p>	 <p>Site : 03CH13-HY Condition : AVG_54 3m HORN_91200_1326 HORIZONTAL : RBW:1000.000KHz VBW:1.000KHz SWT:Auto</p>





WIFI	Band 1 5150~5250MHz Band Edge @ 3m	
ANT	802.11ax HE40 Full CH46 5230MHz - R	
6+7	Horizontal	Fundamental
<p><b>Peak</b></p>	<p>Site : 03CH13-HY Condition : PEAK_BE_74 3m HORN_9120D_1326 HORIZONTAL : RBW:1000.000KHz VBW:3000.000KHz SWT:Auto</p>	<p>Left blank</p>
<p><b>Avg.</b></p>	<p>Site : 03CH13-HY Condition : AVG_BE_54 3m HORN_9120D_1326 HORIZONTAL : RBW:1000.000KHz VBW:1.000KHz SWT:Auto</p>	<p>Left blank</p>

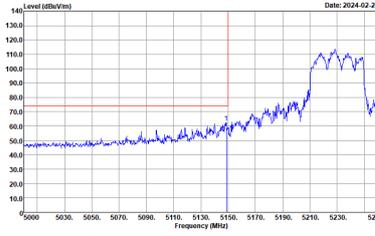
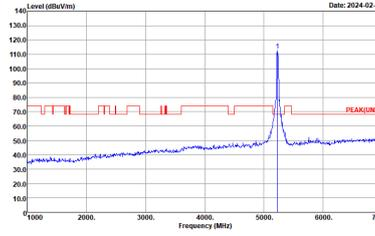
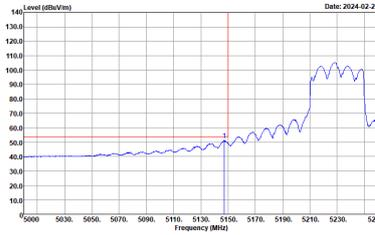
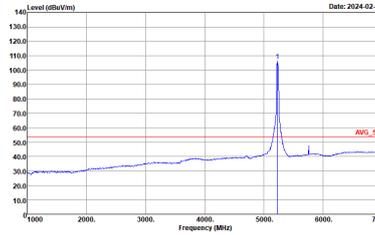

WIFI	Band 1 5150~5250MHz Band Edge @ 3m	
ANT	802.11ax HE40 Full CH46 5230MHz - L	
6+7	Vertical	Fundamental
Peak	 <p>Site : 03CH13-HY Condition : PEAK_BE_74 3m HORN_91200_1326 VERTICAL : RBW:1000.000KHz VBW:3000.000KHz SWT:Auto</p>	 <p>Site : 03CH13-HY Condition : PEAK(UNII) 3m HORN_91200_1326 VERTICAL : RBW:1000.000KHz VBW:3000.000KHz SWT:Auto</p>
Avg.	 <p>Site : 03CH13-HY Condition : AVG_BE_54 3m HORN_91200_1326 VERTICAL : RBW:1000.000KHz VBW:1.000KHz SWT:Auto</p>	 <p>Site : 03CH13-HY Condition : AVG_54 3m HORN_91200_1326 VERTICAL : RBW:1000.000KHz VBW:1.000KHz SWT:Auto</p>



WIFI	Band 1 5150~5250MHz Band Edge @ 3m	
ANT	802.11ax HE40 Full CH46 5230MHz - R	
6+7	Vertical	Fundamental
Peak	<p>Site : 03CH13-HY Condition : PEAK_BE_74 3m HORN_91200_1326 VERTICAL : RBW:1000.000KHz VBW:3000.000KHz SWT:Auto</p>	Left blank
Avg.	<p>Site : 03CH13-HY Condition : AVG_BE_54 3m HORN_91200_1326 VERTICAL : RBW:1000.000KHz VBW:1.000KHz SWT:Auto</p>	Left blank



Band 1 5150~5250MHz
WIFI 802.11ax HE40 Partial 242 (Band Edge @ 3m)

Table with 4 columns: WIFI, ANT, 6+7, and two sub-columns for Horizontal and Fundamental plots. Rows are labeled 'Peak' and 'Avg.' containing spectral analysis graphs and site/condition details.

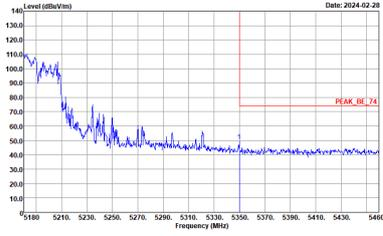
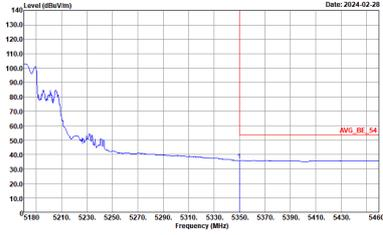

WIFI	Band 1 5150~5250MHz Band Edge @ 3m	
ANT	802.11ax HE40 Partial 242/61 CH38 5190MHz - R	
6+7	Horizontal	Fundamental
Peak	 <p>Site : 03CH13-HY Condition : PEAK_BE_74 3m HORN_9120D_1326 HORIZONTAL : RBW:1000.000KHz VBW:3000.000KHz SWT:Auto</p>	Left blank
Avg.	 <p>Site : 03CH13-HY Condition : AVG_BE_54 3m HORN_9120D_1326 HORIZONTAL : RBW:1000.000KHz VBW:0.010KHz SWT:Auto</p>	Left blank

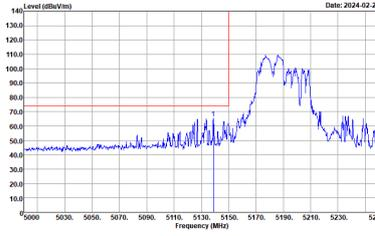
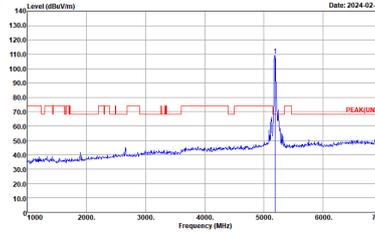
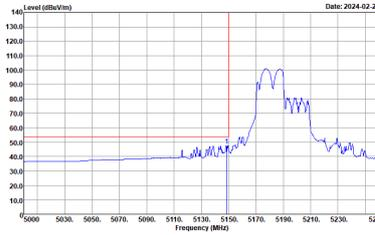
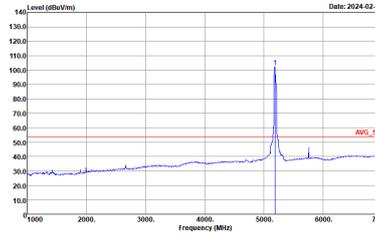

WIFI	Band 1 5150~5250MHz Band Edge @ 3m	
ANT	802.11ax HE40 Partial 242/61 CH38 5190MHz - L	
6+7	Vertical	Fundamental
Peak	 <p>Date: 2024-02-28</p> <p>Site : 03CH13-HY Condition : PEAK_BE_74 3m HORN_91200_1326 VERTICAL : RBW:1000.000KHz VBW:3000.000KHz SWT:Auto</p>	 <p>Date: 2024-02-28</p> <p>Site : 03CH13-HY Condition : PEAK(UNII) 3m HORN_91200_1326 VERTICAL : RBW:1000.000KHz VBW:3000.000KHz SWT:Auto</p>
Avg.	 <p>Date: 2024-02-28</p> <p>Site : 03CH13-HY Condition : AVG_BE_54 3m HORN_91200_1326 VERTICAL : RBW:1000.000KHz VBW:0.010KHz SWT:Auto</p>	 <p>Date: 2024-02-28</p> <p>Site : 03CH13-HY Condition : AVG_54 3m HORN_91200_1326 VERTICAL : RBW:1000.000KHz VBW:0.010KHz SWT:Auto</p>



WIFI	Band 1 5150~5250MHz Band Edge @ 3m	
ANT	802.11ax HE40 Partial 242/61 CH38 5190MHz - R	
6+7	Vertical	Fundamental
Peak	<p>Site : 03CH13-HY Condition : PEAK_BE_74 3m HORN_91200_1326 VERTICAL : RBW:1000.000KHz VBW:3000.000KHz SWT:Auto</p>	Left blank
Avg.	<p>Site : 03CH13-HY Condition : AVG_BE_54 3m HORN_91200_1326 VERTICAL : RBW:1000.000KHz VBW:0.010KHz SWT:Auto</p>	Left blank

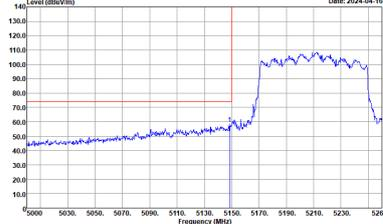
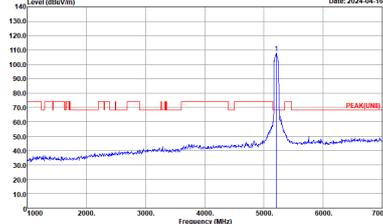
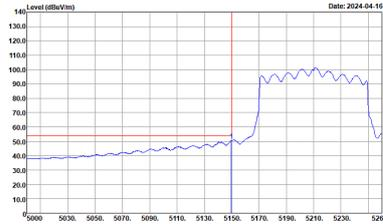
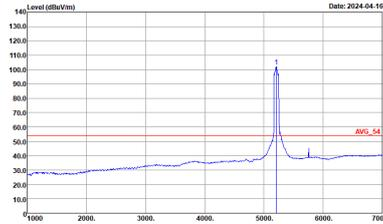

**Band 1 5150~5250MHz**  
**WIFI 802.11ax HE80 Full (Band Edge @ 3m)**

WIFI	Band 1 5150~5250MHz Band Edge @ 3m	
ANT	802.11ax HE80 Full CH42 5210MHz - L	
6+7	Horizontal	Fundamental
Peak	 <p>Site : 03CH13-HY            Condition : PEAK_BE_74 3m HORN_91200_1326 HORIZONTAL            : RBW:1000.000KHz VBW:3000.000KHz SWT:Auto</p>	 <p>Site : 03CH13-HY            Condition : PEAK(FUNDF) 3m HORN_91200_1326 HORIZONTAL            : RBW:1000.000KHz VBW:3000.000KHz SWT:Auto</p>
Avg.	 <p>Site : 03CH13-HY            Condition : AV6_BE_54 3m HORN_91200_1326 HORIZONTAL            : RBW:1000.000KHz VBW:1000KHz SWT:Auto</p>	 <p>Site : 03CH13-HY            Condition : AV6_54 3m HORN_91200_1326 HORIZONTAL            : RBW:1000.000KHz VBW:1000KHz SWT:Auto</p>



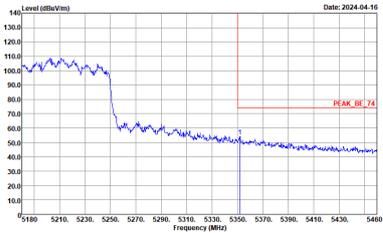
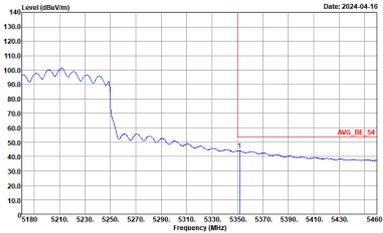

WIFI	Band 1 5150~5250MHz Band Edge @ 3m	
ANT	802.11ax HE80 Full CH42 5210MHz - R	
6+7	Horizontal	Fundamental
<p><b>Peak</b></p>	 <p>Site : 03CH13-HY Condition : PEAK_BE_74 3m HORN_9120D_1326 HORIZONTAL : RBW:1000.000KHz VBW:3000.000KHz SWT:Auto</p>	<p>Left blank</p>
<p><b>Avg.</b></p>	 <p>Site : 03CH13-HY Condition : AVG_BE_54 3m HORN_9120D_1326 HORIZONTAL : RBW:1000.000KHz VBW:1000KHz SWT:Auto</p>	<p>Left blank</p>

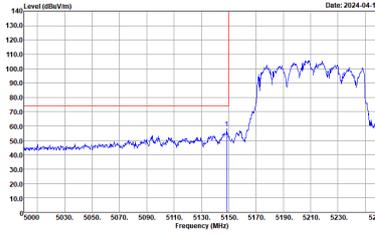
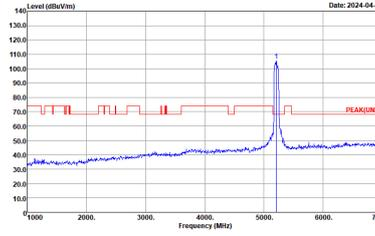
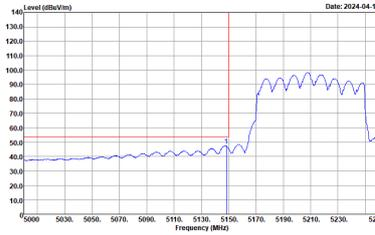
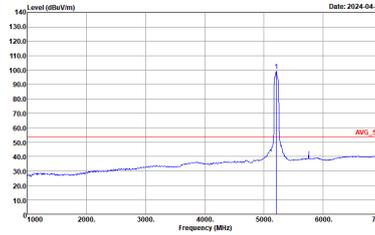

WIFI	Band 1 5150~5250MHz Band Edge @ 3m	
ANT	802.11ax HE80 Full CH42 5210MHz - L	
6+7	Vertical	Fundamental
Peak	 <p>Date: 2024-04-16</p> <p>Site : 03CH13-HY Condition : PEAK_BE_74 3m HORN_91200_1326 VERTICAL : RBW:1000.000KHz VBW:3000.000KHz SWT:Auto</p>	 <p>Date: 2024-04-16</p> <p>Site : 03CH13-HY Condition : PEAK(UNII) 3m HORN_91200_1326 VERTICAL : RBW:1000.000KHz VBW:3000.000KHz SWT:Auto</p>
Avg.	 <p>Date: 2024-04-16</p> <p>Site : 03CH13-HY Condition : AVG_BE_54 3m HORN_91200_1326 VERTICAL : RBW:1000.000KHz VBW:1000KHz SWT:Auto</p>	 <p>Date: 2024-04-16</p> <p>Site : 03CH13-HY Condition : AVG_54 3m HORN_91200_1326 VERTICAL : RBW:1000.000KHz VBW:1000KHz SWT:Auto</p>

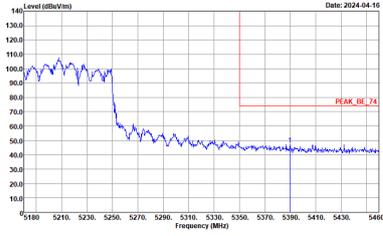
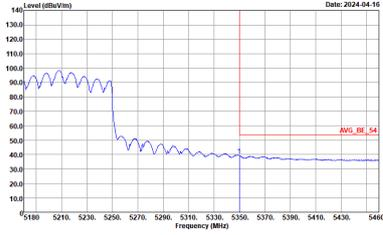

WIFI	Band 1 5150~5250MHz Band Edge @ 3m	
ANT	802.11ax HE80 Full CH42 5210MHz - R	
6+7	Vertical	Fundamental
<p><b>Peak</b></p>	 <p>Site : 03CH13-HY Condition : PEAK_BE_74 3m HORN_9120D_1326 VERTICAL : RBW:1000.000KHz VBW:3000.000KHz SWT:Auto</p>	<p>Left blank</p>
<p><b>Avg.</b></p>	 <p>Site : 03CH13-HY Condition : AVG_BE_54 3m HORN_9120D_1326 VERTICAL : RBW:1000.000KHz VBW:1000KHz SWT:Auto</p>	<p>Left blank</p>

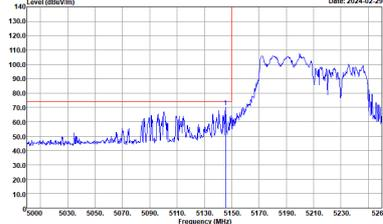
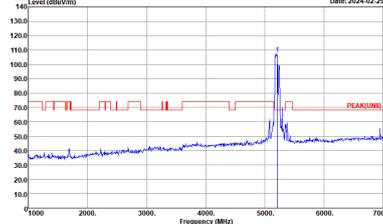
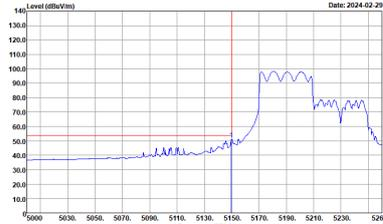
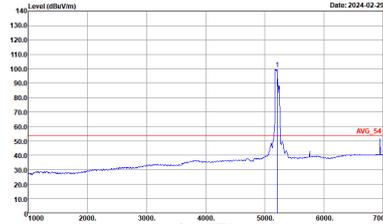

**Band 1 5150~5250MHz**  
**WIFI 802.11ax HE80 Partial 484 (Band Edge @ 3m)**

WIFI	Band 1 5150~5250MHz Band Edge @ 3m	
ANT	802.11ax HE80 Partial 484/65 CH42 5210MHz - L	
6+7	Horizontal	Fundamental
Peak	 <p>Site : 03CH13-HY            Condition : PEAK_BE_74 3m HORN_91200_1326 HORIZONTAL            : RBW:1000.000KHz VBW:3000.000KHz SWT:Auto</p>	 <p>Site : 03CH13-HY            Condition : PEAK(FUNDE) 3m HORN_91200_1326 HORIZONTAL            : RBW:1000.000KHz VBW:3000.000KHz SWT:Auto</p>
Avg.	 <p>Site : 03CH13-HY            Condition : AV6_BE_54 3m HORN_91200_1326 HORIZONTAL            : RBW:1000.000KHz VBW:0.010KHz SWT:Auto</p>	 <p>Site : 03CH13-HY            Condition : AV6_54 3m HORN_91200_1326 HORIZONTAL            : RBW:1000.000KHz VBW:0.010KHz SWT:Auto</p>

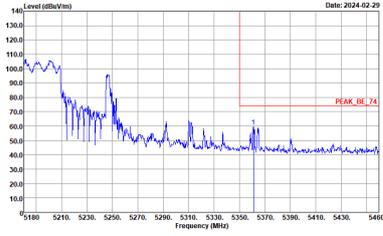
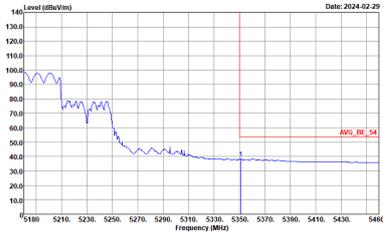

WIFI	Band 1 5150~5250MHz Band Edge @ 3m	
ANT	802.11ax HE80 Partial 484/65 CH42 5210MHz - R	
6+7	Horizontal	Fundamental
<p><b>Peak</b></p>	 <p>Site : 03CH13-HY Condition : PEAK_BE_74 3m HORN_9120D_1326 HORIZONTAL : RBW:1000.000KHz VBW:3000.000KHz SWT:Auto</p>	<p>Left blank</p>
<p><b>Avg.</b></p>	 <p>Site : 03CH13-HY Condition : AVG_BE_54 3m HORN_9120D_1326 HORIZONTAL : RBW:1000.000KHz VBW:0.010KHz SWT:Auto</p>	<p>Left blank</p>

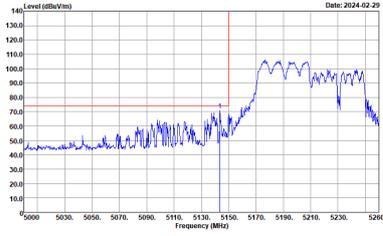
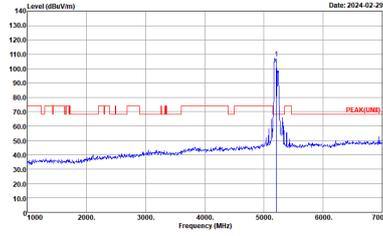
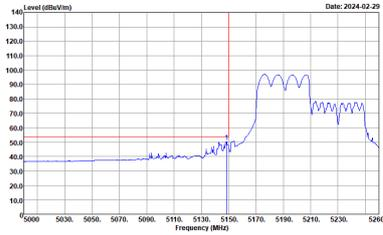
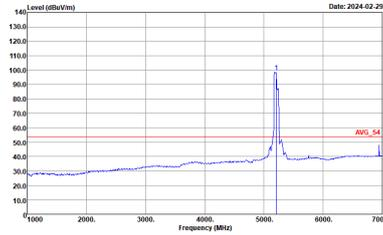

WIFI	Band 1 5150~5250MHz Band Edge @ 3m	
ANT	802.11ax HE80 Partial 484/65 CH42 5210MHz - L	
6+7	Vertical	Fundamental
Peak	 <p>Date: 2024-02-29</p> <p>Site : 03CH13-HY Condition : PEAK_BE_74 3m HORN_9120D_1326 VERTICAL : RBW:1000.000KHz VBW:3000.000KHz SWT:Auto</p>	 <p>Date: 2024-02-29</p> <p>Site : 03CH13-HY Condition : PEAK(UNII) 3m HORN_9120D_1326 VERTICAL : RBW:1000.000KHz VBW:3000.000KHz SWT:Auto</p>
Avg.	 <p>Date: 2024-02-29</p> <p>Site : 03CH13-HY Condition : AVG_BE_54 3m HORN_9120D_1326 VERTICAL : RBW:1000.000KHz VBW:0.010KHz SWT:Auto</p>	 <p>Date: 2024-02-29</p> <p>Site : 03CH13-HY Condition : AVG_54 3m HORN_9120D_1326 VERTICAL : RBW:1000.000KHz VBW:0.010KHz SWT:Auto</p>

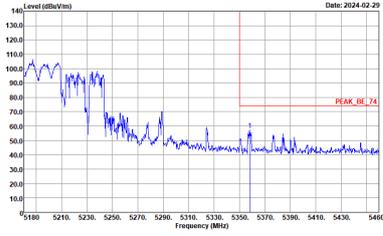
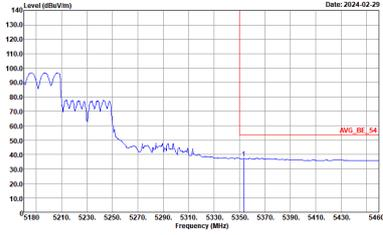

WIFI	Band 1 5150~5250MHz Band Edge @ 3m	
ANT	802.11ax HE80 Partial 484/65 CH42 5210MHz - R	
6+7	Vertical	Fundamental
Peak	 <p>Site : 03CH13-HY Condition : PEAK_BE_74 3m HORN_9120D_1326 VERTICAL : RBW:1000.000KHz VBW:3000.000KHz SWT:Auto</p>	Left blank
Avg.	 <p>Site : 03CH13-HY Condition : AVG_BE_54 3m HORN_9120D_1326 VERTICAL : RBW:1000.000KHz VBW:0.010KHz SWT:Auto</p>	Left blank

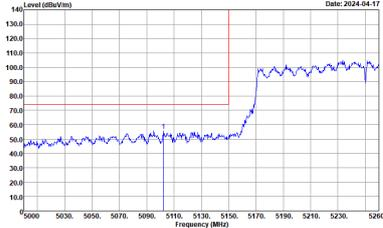
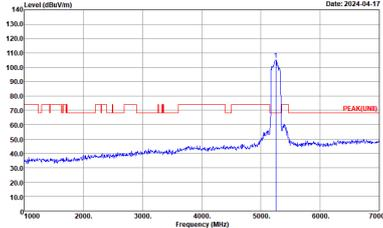
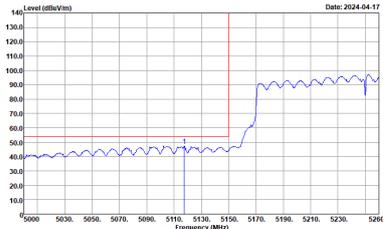
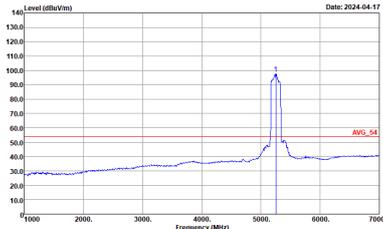

**Band 1 5150~5250MHz**  
**WIFI 802.11ax HE160 Full (Band Edge @ 3m)**

WIFI	Band 1 5150~5250MHz Band Edge @ 3m	
ANT	802.11ax HE160 Full CH50 5250MHz - L	
6+7	Horizontal	Fundamental
Peak	 <p>Site : 03CH13-HY            Condition : PEAK_BE_74 3m HORN_91200_1326 HORIZONTAL            : RBW:1000.000kHz VBW:3000.000kHz SWT:Auto</p>	 <p>Site : 03CH13-HY            Condition : PEAK(FUNDF) 3m HORN_91200_1326 HORIZONTAL            : RBW:1000.000kHz VBW:3000.000kHz SWT:Auto</p>
	 <p>Site : 03CH13-HY            Condition : AVG_BE_54 3m HORN_91200_1326 HORIZONTAL            : RBW:1000.000kHz VBW:3.000kHz SWT:Auto</p>	 <p>Site : 03CH13-HY            Condition : AVG_54 3m HORN_91200_1326 HORIZONTAL            : RBW:1000.000kHz VBW:3.000kHz SWT:Auto</p>
Avg.		



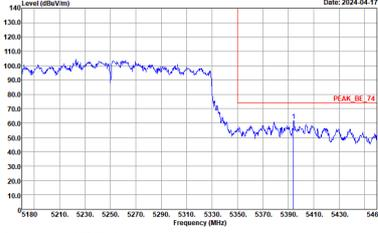
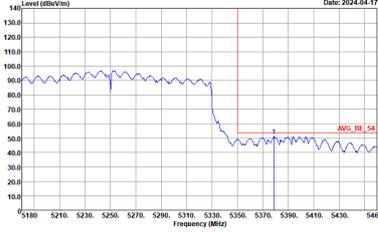

WIFI	Band 1 5150~5250MHz Band Edge @ 3m	
ANT	802.11ax HE160 Full CH50 5250MHz - R	
6+7	Horizontal	Fundamental
<p><b>Peak</b></p>	 <p>Date: 2024-04-17</p> <p>Site : 03CH13-HY Condition : PEAK_BE_74 3m HORN_9120D_1326 HORIZONTAL : RBW:1000.000KHz VBW:3000.000KHz SWT:Auto</p>	<p>Left blank</p>
<p><b>Avg.</b></p>	 <p>Date: 2024-04-17</p> <p>Site : 03CH13-HY Condition : AVG_BE_54 3m HORN_9120D_1326 HORIZONTAL : RBW:1000.000KHz VBW:3.000KHz SWT:Auto</p>	<p>Left blank</p>



WIFI	Band 1 5150~5250MHz Band Edge @ 3m	
ANT	802.11ax HE160 Full CH50 5250MHz - L	
6+7	Vertical	Fundamental
Peak	<p>Date: 2024-04-17</p> <p>Site : 03CH13-HY Condition : PEAK_BE_74 3m HORN_91200_1326 VERTICAL : RBW:1000.000KHz VBW:3000.000KHz SWT:Auto</p>	<p>Date: 2024-04-17</p> <p>Site : 03CH13-HY Condition : PEAK(UNII) 3m HORN_91200_1326 VERTICAL : RBW:1000.000KHz VBW:3000.000KHz SWT:Auto</p>
Avg.	<p>Date: 2024-04-17</p> <p>Site : 03CH13-HY Condition : AVG_BE_54 3m HORN_91200_1326 VERTICAL : RBW:1000.000KHz VBW:3.000KHz SWT:Auto</p>	<p>Date: 2024-04-17</p> <p>Site : 03CH13-HY Condition : AVG_54 3m HORN_91200_1326 VERTICAL : RBW:1000.000KHz VBW:3.000KHz SWT:Auto</p>

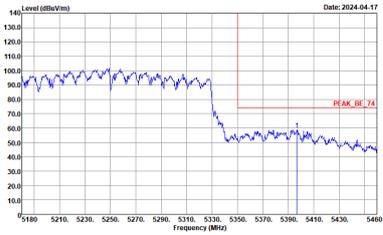
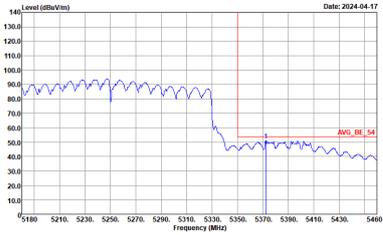

WIFI	Band 1 5150~5250MHz Band Edge @ 3m	
ANT	802.11ax HE160 Full CH50 5250MHz - R	
6+7	Vertical	Fundamental
<p><b>Peak</b></p>		<p>Left blank</p>
<p><b>Avg.</b></p>		<p>Left blank</p>



Band 1 5150~5250MHz
WIFI 802.11ax HE160 Partial 996 (Band Edge @ 3m)

Table with 4 columns: WIFI, ANT, 6+7, and two measurement plots (Horizontal and Fundamental) for Peak and Avg. conditions. Each plot shows Level (dBm/Vm) vs Frequency (MHz) with specific test parameters.