



FCC RADIO TEST REPORT

FCC ID : UZ7TC58BE
Equipment : Touch Computer
Brand Name : Zebra
Model Name : TC58BE
Applicant : Zebra Technologies Corporation
1 Zebra Plaza, Holtsville, NY 11742
Manufacturer : Zebra Technologies Corporation
1 Zebra Plaza, Holtsville, NY 11742
Standard : FCC Part 15 Subpart C §15.247

The product was received on Jan. 10, 2024 and testing was performed from Jan. 26, 2024 to May 06, 2024. We, Sporton International Inc. Wensan Laboratory, would like to declare that the tested sample has been evaluated in accordance with the test procedures and has been in compliance with the applicable technical standards.

The test results in this report apply exclusively to the tested model / sample. Without written approval from Sporton International Inc. Wensan Laboratory, the test report shall not be reproduced except in full.

Louis Wu

Approved by: Louis Wu

Sporton International Inc. Wensan Laboratory

No.58, Aly. 75, Ln. 564, Wenhua 3rd, Rd., Guishan Dist., Taoyuan City 333010, Taiwan (R.O.C.)



Table of Contents

History of this test report..... 3

Summary of Test Result..... 4

1 General Description 5

 1.1 Product Feature of Equipment Under Test..... 5

 1.2 EUT Information (Referenced Model)..... 5

 1.3 Product Specification of Equipment Under Test..... 7

 1.4 Modification of EUT 10

 1.5 Testing Location 10

 1.6 Applicable Standards..... 10

2 Test Configuration of Equipment Under Test 11

 2.1 Carrier Frequency and Channel 11

 2.2 Test Mode..... 12

 2.3 Connection Diagram of Test System..... 13

 2.4 Support Unit used in test configuration and system 14

 2.5 EUT Operation Test Setup 14

 2.6 Measurement Results Explanation Example..... 15

3 Test Result 16

 3.1 6dB and 99% Bandwidth Measurement 16

 3.2 Output Power Measurement..... 17

 3.3 Power Spectral Density Measurement 18

 3.4 Conducted Band Edges and Spurious Emission Measurement 19

 3.5 Radiated Band Edges and Spurious Emission Measurement 20

 3.6 AC Conducted Emission Measurement..... 24

 3.7 Antenna Requirements 26

4 List of Measuring Equipment..... 27

5 Measurement Uncertainty 28

Appendix A. Conducted Test Results

Appendix B. AC Conducted Emission Test Result

Appendix C. Radiated Spurious Emission

Appendix D. Radiated Spurious Emission Plots

Appendix E. Duty Cycle Plots

Appendix F. Setup Photographs

Appendix G. Spot Check Evaluation on TC58BE



Summary of Test Result

Report Clause	Ref Std. Clause	Test Items	Result (PASS/FAIL)	Remark
3.1	15.247(a)(2)	6dB Bandwidth	Pass	-
3.1	2.1049	99% Occupied Bandwidth	Reporting only	-
3.2	15.247(b)	Power Output Measurement	Pass	-
3.3	15.247(e)	Power Spectral Density	Pass	-
3.4	15.247(d)	Conducted Band Edges	Pass	-
		Conducted Spurious Emission	Pass	-
3.5	15.247(d)	Radiated Band Edges and Radiated Spurious Emission	Pass	1.11 dB under the limit at 2483.52 MHz
3.6	15.207	AC Conducted Emission	Pass	17.48 dB under the limit at 0.17 MHz
3.7	15.203	Antenna Requirement	Pass	-

Conformity Assessment Condition:

1. ECR inquiry for data referencing from UZ7TC58AE has been approved by FCC. The ECR inquiry and the associated document are submitted in the confidential exhibit.
2. UZ7TC58BE is different from FCC ID: UZ7TC58AE (Reference model), in the following:
 - The only difference between UZ7TC58AE and UZ7TC58BE are the WWAN support bands, which is controlled by software.
3. All the test results are referenced from UZ7TC58AE (Sporton Test Report FR411111C), and spot check results to justify data referencing is presented in the Appendix G.
4. The test results (PASS/FAIL) with all measurement uncertainty excluded are presented against the regulation limits or in accordance with the requirements stipulated by the applicant/manufacture who shall bear all the risks of non-compliance that may potentially occur if measurement uncertainty is taken into account.
5. The measurement uncertainty please refer to each test result in the section "Measurement Uncertainty".

Disclaimer:

The product specifications of the EUT presented in the test report that may affect the test assessments are declared by the manufacturer who shall take full responsibility for the authenticity.

Reviewed by: Wei Chen

Report Producer: Mila Chen



1 General Description

1.1 Product Feature of Equipment Under Test

Product Feature	
Equipment	Touch Computer
Brand Name	Zebra
Model Name	TC58BE
FCC ID	UZ7TC58BE
Supported Radio application	WCDMA/HSPA/LTE/5G NR/NFC/GNSS WLAN 11a/b/g/n HT20/HT40 WLAN 11ac VHT20/VHT40/VHT80/VHT160 WLAN 11ax HE20/HE40/HE80/HE160 Bluetooth BR/EDR/LE

Remark: The EUT's information above is declared by manufacturer.

1.2 EUT Information (Referenced Model)

Product Feature	
FCC ID	UZ7TC58AE
Sample 1	SE55 + 8GB 128G (Samsung/SK Hynix)
Sample 2	SE4720 + 6GB 64G (SK Hynix/WD)
Sample 3	SE4770 + 6GB 64G (SK Hynix/WD)
EUT supports Radios application	WCDMA/HSPA/LTE/5G NR/NFC/GNSS WLAN 11a/b/g/n HT20/HT40 WLAN 11ac VHT20/VHT40/VHT80/VHT160 WLAN 11ax HE20/HE40/HE80/HE160 Bluetooth BR/EDR/LE
HW Version	DV1-2
SW Version	nemesis_A13_userdebug_GMS_RelKey_2023-12-12-0451_main_SE
FW Version	FUSION_QA_6_1.1.0.004_T
MFD	06DEC23
EUT Stage	Identical Prototype

Remark: The EUT's information above is declared by manufacturer.



Specification of Accessories				
Adapter	Brand Name	Zebra	Part Number	PWR-WUA5V12W0US
Battery 1 (1x)	Brand Name	Zebra	Part Number	BT-000442-0020
Battery 2 (1.5x)	Brand Name	Zebra	Part Number	BT-000442-0820
Battery 3 (BLE battery)	Brand Name	Zebra	Part Number	BT-000442-002B
Battery 4 (Wireless Battery)	Brand Name	Zebra	Part Number	BT-000442-002A
Battery 5 (1x)	Brand Name	Zebra	Part Number	BT-000442-1020
USB TYPE A to TYPE C cable	Brand Name	Zebra	Part Number	CBL-TC5X-USBC2A-01
USB TYPE C to 3.5mm audio connector	Brand Name	Zebra	Part Number	ADP-USBC-35MM1-01
3.5mm Earphone	Brand Name	Zebra	Part Number	HDST-35MM-PTT1-01
Rugged Headset	Brand Name	Zebra	Part Number	HS2100-OTH
USB TYPE C Earphone	Brand Name	Zebra	Part Number	HPST-USBC-PTT1-01
Trigger Handle	Brand Name	Zebra	Part Number	TRG-NGTC5-ELEC-01
Soft Holster	Brand Name	Zebra	Part Number	SG-NGTC5TC7-HLSTR-01
TC53/TC58 RUGGED BOOT	Brand Name	Zebra	Part Number	SG-NGTC5EXO1-01
3.5mm to 3.5mm audio connector	Brand Name	Zebra	Part Number	CBL-HS2100-3MS1-01



1.3 Product Specification of Equipment Under Test

Product Specification is subject to this standard	
Tx/Rx Frequency Range	2402 MHz ~ 2480 MHz
Maximum Output Power to Antenna	MIMO <Ant. 6+7> 802.11b : 23.41 dBm / 0.2193 W 802.11g : 23.56 dBm / 0.2270 W 802.11n HT20 : 23.16 dBm / 0.2070 W 802.11n HT40 : 21.86 dBm / 0.1535 W 802.11ac VHT20 : 23.26 dBm / 0.2118 W 802.11ac VHT40 : 21.96 dBm / 0.1570 W 802.11ax HE20 : 23.36 dBm / 0.2168 W 802.11ax HE40 : 22.06 dBm / 0.1607 W
99% Occupied Bandwidth	MIMO <Ant. 6> 802.11b: 13.14 MHz 802.11g: 16.43 MHz 802.11ac VHT20 : 17.68 MHz 802.11ac VHT40 : 36.06 MHz 802.11ax HE20: 18.93 MHz 802.11ax HE40: 37.86 MHz MIMO <Ant. 7> 802.11b: 13.59 MHz 802.11g: 16.33 MHz 802.11ac VHT20 : 17.53 MHz 802.11ac VHT40 : 36.16 MHz 802.11ax HE20: 18.93 MHz 802.11ax HE40: 37.86 MHz
Antenna Type / Gain	<Ant. 6> : PIFA Antenna with gain 2.32 dBi <Ant. 7> : PIFA Antenna with gain 0.14 dBi
Type of Modulation	802.11b : DSSS (DBPSK / DQPSK / CCK) 802.11g/n : OFDM (BPSK / QPSK / 16QAM / 64QAM) 802.11ac : OFDM (BPSK / QPSK / 16QAM / 64QAM / 256QAM) 802.11ax : OFDMA (BPSK / QPSK / 16QAM / 64QAM / 256QAM / 1024QAM)



Product Specification is subject to this standard			
Antenna Function Description		Ant. 6	Ant. 7
	802.11 b/g/n/ac/ax MIMO	V	V
	802.11ax TXBF	V	V

Remark:

1. MIMO Ant. 6+7 Directional Gain is a calculated result from MIMO Ant. 6 and MIMO Ant. 7. The formula used in calculation is documented in section 1.2.1.
2. Power of MIMO Ant. 6 + Ant. 7 is a calculated result from sum of the power MIMO Ant. 6 and MIMO Ant. 7.
3. 802.11ax Support Tx Beamforming mode, and the manufacturer declares that Tx Beamforming power/EIRP is less than CDD mode 3dbm, so CDD mode cover Tx Beamforming mode.
4. The EUT's information above is declared by manufacturer. Please refer to Disclaimer in report summary.

1.3.1 Antenna Directional Gain

Follows FCC KDB 662911 D01 Multiple Transmitter Output v02r01 F)2)f)ii)

Directional gain = G_{ANT} + Array Gain, where Array Gain is as follows:

For power measurements on IEEE 802.11 devices,

Array Gain = 0 dB (i.e., no array gain) for $N_{ANT} \leq 4$.

G_{ANT} is set equal to the gain of the antenna having the highest gain.

For PSD measurements, the directional gain calculation.

$$DirectionalGain = 10 \cdot \log \left[\frac{\sum_{j=1}^{N_{SS}} \left\{ \sum_{k=1}^{N_{ANT}} g_{j,k} \right\}^2}{N_{ANT}} \right]$$

where

Each antenna is driven by no more than one spatial stream;

N_{SS} = the number of independent spatial streams of data;

N_{ANT} = the total number of antennas

$g_{j,k} = 10^{G_k/20}$ if the k th antenna is being fed by spatial stream j , or zero if it is not;
 G_k is the gain in dBi of the k th antenna.

As minimum $N_{SS}=1$ is supported by EUT, the formula can be simplified as:

Directional gain = $10 \cdot \log[(10^{G_1/20} + 10^{G_2/20} + \dots + 10^{G_N/20})^2 / N_{ANT}]$ dBi

Where G_1, G_2, \dots, G_N denote single antenna gain.

The directional gain "DG" is calculated as following table.

			DG for Power (dBi)	DG for PSD (dBi)	Power Limit Reduction (dB)	PSD Limit Reduction (dB)
	Ant 6 (dBi)	Ant 7 (dBi)				
2.4GHz	2.32	0.14	2.32	4.31	0.00	0.00

Calculation example:

If a device has two antenna, $G_{ANT6}= 2.32$ dBi; $G_{ANT7}=0.14$ dBi

Directional gain of power measurement = $\max(2.32, 0.14) + 0 = 2.32$ dBi

Directional gain of PSD derived from formula which is

$$10 \times \log \left\{ \left[10^{(2.32 \text{ dBi} / 20)} + 10^{(0.14 \text{ dBi} / 20)} \right]^2 / 2 \right\}$$

$$= 4.31 \text{ dBi}$$

Power and PSD limit reduction = Composite gain – 6dBi, (min = 0)



1.4 Modification of EUT

No modifications made to the EUT during the testing.

1.5 Testing Location

Test Site	Sporton International Inc. EMC & Wireless Communications Laboratory
Test Site Location	No.52, Huaya 1st Rd., Guishan Dist., Taoyuan City 333, Taiwan (R.O.C.) TEL: +886-3-327-3456 FAX: +886-3-328-4978
Test Site No.	Sporton Site No. CO05-HY (TAF Code: 1190)
Remark	The AC Conducted Emission test items subcontracted to Sporton International Inc. EMC & Wireless Communications Laboratory.

Note: The test site complies with ANSI C63.4 2014 requirement.

Test Site	Sporton International Inc. Wensan Laboratory
Test Site Location	No.58, Aly. 75, Ln. 564, Wenhua 3rd, Rd., Guishan Dist., Taoyuan City 333010, Taiwan (R.O.C.) TEL: +886-3-327-0868 FAX: +886-3-327-0855
Test Site No.	Sporton Site No. TH05-HY, 03CH20-HY

Note: The test site complies with ANSI C63.4 2014 requirement.

FCC designation No.: TW1190 and TW3786

1.6 Applicable Standards

According to the specifications declared by the manufacturer, the EUT must comply with the requirements of the following standards:

- ♦ FCC Part 15 Subpart C §15.247
- ♦ FCC KDB Publication No. 558074 D01 15.247 Meas Guidance v05r02
- ♦ FCC KDB 414788 D01 Radiated Test Site v01r01.
- ♦ FCC KDB 662911 D01 Multiple Transmitter Output v02r01.
- ♦ ANSI C63.10-2013

Remark:

1. All the test items were validated and recorded in accordance with the standards without any modification during the testing.
2. The TAF code is not including all the FCC KDB listed without accreditation.
3. This EUT has also been tested and complied with the requirements of FCC Part 15, Subpart B, recorded in a separate test report.



2 Test Configuration of Equipment Under Test

- a. The EUT has been associated with peripherals and configuration operated in a manner tended to maximize its emission characteristics in a typical application. Frequency range investigated: conduction emission (150 kHz to 30 MHz), radiation emission (9 kHz to the 10th harmonic of the highest fundamental frequency or to 40 GHz, whichever is lower). For radiated measurement, the measured emission level of the EUT was maximized by rotating the EUT on a turntable, adjusting the orientation of the EUT and EUT antenna in three orthogonal axis (X: flat, Y: portrait, Z: landscape) and Accessory (Adapter or Earphone), and adjusting the measurement antenna orientation, following C63.10 exploratory test procedures and only the worst case emissions were reported in this report.

- b. AC power line Conducted Emission was tested under maximum output power.

2.1 Carrier Frequency and Channel

Frequency Band	Channel	Freq. (MHz)	Channel	Freq. (MHz)
2400-2483.5 MHz	1	2412	7	2442
	2	2417	8	2447
	3	2422	9	2452
	4	2427	10	2457
	5	2432	11	2462
	6	2437		



2.2 Test Mode

This device support 26/52/106/242/484-tone RU.

The PSD of partial RU is reduced to be smaller than full RU according to TCB workshop interim guidance Oct. 2022.

The 802.11ax mode is investigated among different tones, full resource units (RU), partial resource units. The partial RU has no higher power than full RU's, thus the full RU is chosen as main test configuration.

The 242-tone RU is covered by 20MHz channel, 484-tone RU is covered by 40MHz channel.

The SISO mode conducted power is covered by MIMO mode per chain, so only the MIMO mode is tested.

The power for 802.11n mode is smaller than 802.11ac mode, so all other conducted test is covered by 802.11ac mode.

The power for 802.11n and 802.11 ac mode is smaller than 802.11ax mode, so all other radiated test is covered by 802.11ax mode.

The final test modes include the worst data rates for each modulation shown in the table below.

MIMO Antenna

Modulation	Data Rate
802.11b	1 Mbps
802.11g	6 Mbps
802.11n HT20 (Covered by VHT20)	MCS0
802.11n HT40 (Covered by VHT40)	MCS0
802.11ac VHT20	MCS0
802.11ac VHT40	MCS0
802.11ax HE20	MCS0
802.11ax HE40	MCS0

Test Cases	
AC Conducted Emission	Mode 1 Mode 1: Bluetooth Link + WLAN (2.4GHz) Link + USB TYPE-A to TYPE-C cable (Charging with Adapter) + Battery 2 (1.5x) for Sample 1
Remark: For Radiated Test Cases, the tests were performed with Battery 1 (1x), and Sample 1.	

Ch. #	2400-2483.5 MHz			
	802.11b	802.11g	802.11ax HE20	802.11ax HE40
Low	01	01	01	03
Middle	06	06	06	06
High	11	11	11	09

Remark: For radiation spurious emission, the modulation and the data rate picked for testing are determined by the Max. RF conducted power.

2.3 Connection Diagram of Test System

<AC Conducted Emission Mode>

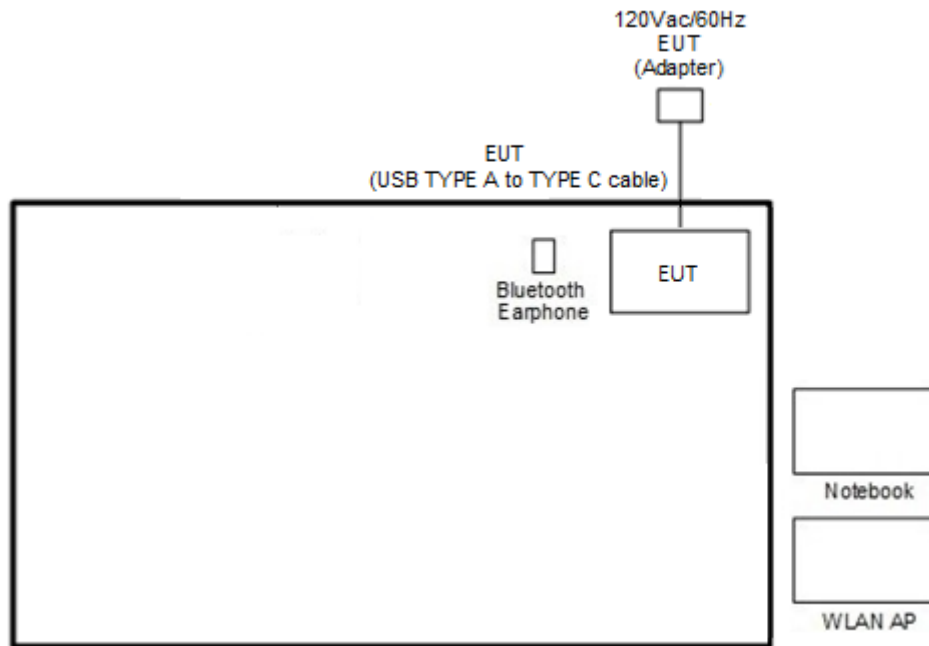

<WLAN Tx with Adapter Mode >

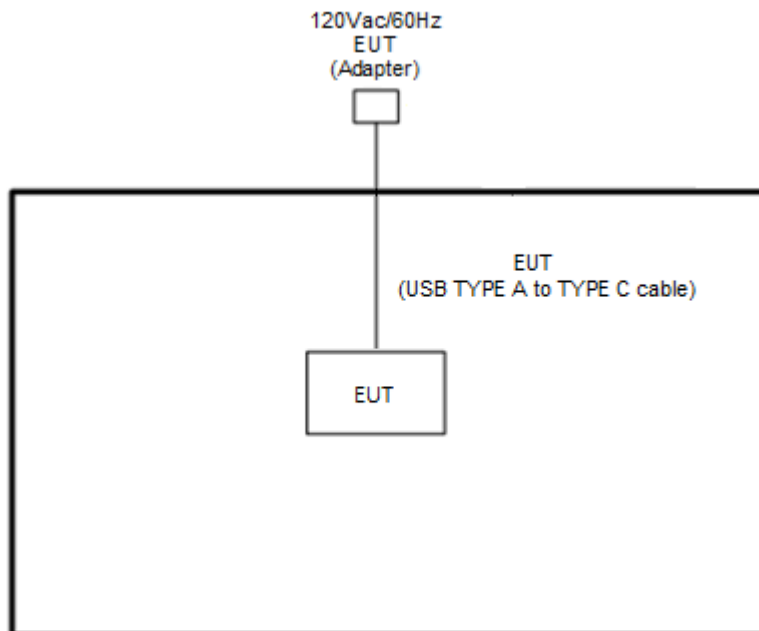

<WLAN Tx with Earphone Mode>

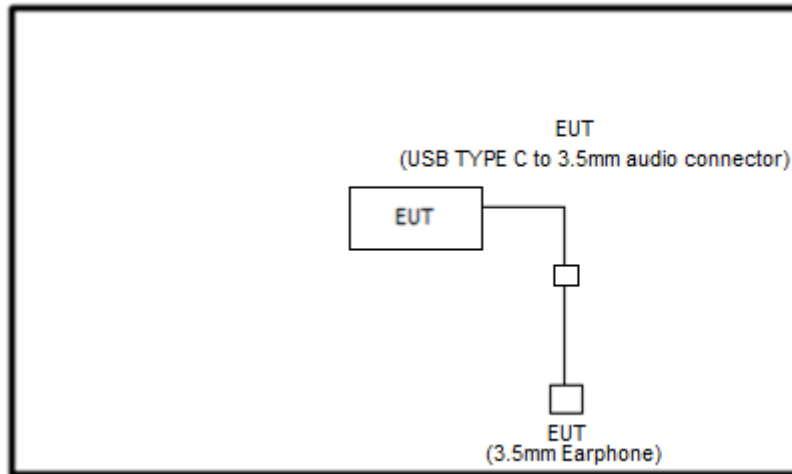

2.4 Support Unit used in test configuration and system

Item	Equipment	Brand Name	Model Name	FCC ID	Data Cable	Power Cord
1.	Bluetooth Earphone	Sony Ericsson	MW600	PY700A2029	N/A	N/A
2.	WLAN AP	ASUS	RT-AC66U	MSQ-RTAC66U	N/A	Unshielded, 1.8m
3.	Notebook	DELL	Latitude 3420	FCC DoC	N/A	AC I/P: Unshielded, 1.2 m DC O/P: Shielded, 1.8 m
4.	SD Card	SanDisk	MicroSD HC	FCC DoC	N/A	N/A

2.5 EUT Operation Test Setup

The RF test items, utility "QRCT Version 4.0.211.0" was installed in Notebook which was programmed in order to make the EUT get into the engineering modes to provide channel selection, power level, data rate and the application type and for continuous transmitting signals.



2.6 Measurement Results Explanation Example

For all conducted test items:

The offset level is set in the spectrum analyzer to compensate the RF cable loss and attenuator factor between EUT conducted output port and spectrum analyzer. With the offset compensation, the spectrum analyzer reading level is exactly the EUT RF output level.

Example:

The spectrum analyzer offset is derived from RF cable loss and attenuator factor.

Offset = RF cable loss + attenuator factor.

Following shows an offset computation example with cable loss 4.2 dB and 10 dB attenuator.

$$\begin{aligned} \text{Offset(dB)} &= \text{RF cable loss(dB)} + \text{attenuator factor(dB)}. \\ &= 4.2 + 10 = 14.2 \text{ (dB)} \end{aligned}$$

3 Test Result

3.1 6dB and 99% Bandwidth Measurement

3.1.1 Limit of 6dB and 99% Bandwidth

The minimum 6 dB bandwidth shall be at least 500 kHz.

3.1.2 Measuring Instruments

Please refer to the measuring equipment list in this test report.

3.1.3 Test Procedures

1. The testing follows the ANSI C63.10 Section 6.9.3 (OBW) and 11.8.1 (6dB BW).
2. The RF output of EUT is connected to the spectrum analyzer by RF cable and attenuator. The path loss is compensated to the results for each measurement.
3. Set the maximum power setting and enable the EUT to transmit continuously.
4. Make the measurement with the spectrum analyzer's resolution bandwidth (RBW) = 100 kHz. Set the Video bandwidth (VBW) = 300 kHz. In order to make an accurate measurement. The 6 dB bandwidth must be greater than 500 kHz.
5. For 99% Bandwidth Measurement, the spectrum analyzer's resolution bandwidth (RBW) is set 1-5% of the emission bandwidth and set the Video bandwidth (VBW) $\geq 3 * RBW$.
6. Measure and record the results in the test report.

3.1.4 Test Setup

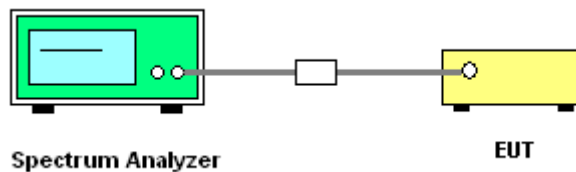

3.1.5 Test Result of 6dB and 99% Occupied Bandwidth

Please refer to Appendix A.

3.2 Output Power Measurement

3.2.1 Limit of Output Power

For systems using digital modulation in the 2400-2483.5 MHz, the limit for output power is 30 dBm. If transmitting antenna with directional gain greater than 6 dBi is used, the peak output power from the intentional radiator shall be reduced below the above stated value by the amount in dB that the directional gain of the antenna exceeds 6 dBi. In case of point-to-point operation, the limit has to be reduced by 1 dB for every 3 dB that the directional gain of the antenna exceeds 6 dBi.

3.2.2 Measuring Instruments

Please refer to the measuring equipment list in this test report.

3.2.3 Test Procedures

1. For Average Power, the testing follows ANSI C63.10 Section 11.9.2.3.2 Method AVGPM-G
2. The RF output of EUT is connected to the power meter by RF cable and attenuator. The path loss is compensated to the results for each measurement.
3. Set the maximum power setting and enable the EUT to transmit continuously.
4. Measure the conducted output power and record the results in the test report.
5. For MIMO mode, calculation method follows FCC KDB 662911 D01 Multiple Transmitter Output v02r01.

3.2.4 Test Setup

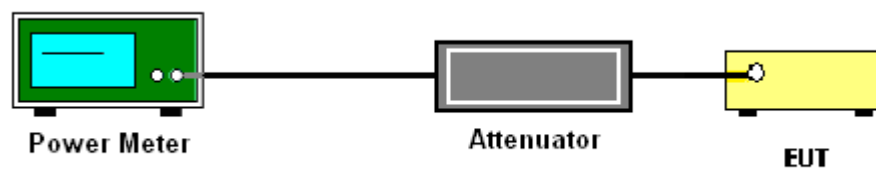

3.2.5 Test Result of Average Output Power

Please refer to Appendix A.

3.3 Power Spectral Density Measurement

3.3.1 Limit of Power Spectral Density

The peak power spectral density shall not be greater than 8 dBm in any 3 kHz band at any time interval of continuous transmission.

3.3.2 Measuring Instruments

Please refer to the measuring equipment list in this test report.

3.3.3 Test Procedures

1. The testing follows the ANSI C63.10 Section 11.10.2 Method PKPSD.
2. The RF output of EUT is connected to the spectrum analyzer by RF cable and attenuator. The path loss is compensated to the results for each measurement.
3. Set the maximum power setting and enable the EUT to transmit continuously.
4. Make the measurement with the spectrum analyzer's resolution bandwidth (RBW) = 3 kHz. Video bandwidth VBW = 10 kHz In order to make an accurate measurement, set the span to 1.5 times DTS Channel Bandwidth. (6dB BW)
5. Detector = peak, Sweep time = auto couple, Trace mode = max hold, Allow trace to fully stabilize. Use the peak marker function to determine the maximum power level.
6. Measure and record the results in the test report.
7. For MIMO mode, calculation method follows FCC KDB 662911 D01 Multiple Transmitter Output v02r01.

Method (c): Measure and add $10 \log(N_{ANT})$ dB.

With this technique, spectrum measurements are performed at each output of the device, but rather than summing the spectra or the spectral peaks across the outputs, the quantity $10 \log(N_{ANT})$ dB is added to each spectrum value before comparing to the emission limit. The addition of $10 \log(N_{ANT})$ dB serves to apportion the emission limit among the N_{ANT} outputs so that each output is permitted to contribute no more than $1/N_{ANT}^{th}$ of the PSD limit .

3.3.4 Test Setup

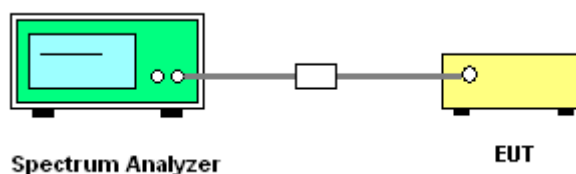

3.3.5 Test Result of Power Spectral Density

Please refer to Appendix A.

3.4 Conducted Band Edges and Spurious Emission Measurement

3.4.1 Limit of Conducted Band Edges and Spurious Emission Measurement

In any 100 kHz bandwidth outside of the authorized frequency band, the emissions which fall in the non-restricted bands shall be attenuated at least 20 dB / 30dB relative to the maximum PSD level in 100 kHz by RF conducted measurement.

3.4.2 Measuring Instruments

Please refer to the measuring equipment list in this test report.

3.4.3 Test Procedures

1. The testing follows the ANSI C63.10 Section 11.11.3 Emission level measurement.
2. The RF output of EUT is connected to the spectrum analyzer by RF cable and attenuator. The path loss is compensated to the results for each measurement.
3. Set the maximum power setting and enable the EUT to transmit continuously.
4. Set RBW = 100 kHz, VBW=300 kHz, Peak Detector. Unwanted Emissions measured in any 100 kHz bandwidth outside of the authorized frequency band shall be attenuated by at least 20 dB relative to the maximum in-band peak PSD level in 100 kHz when maximum peak conducted output power procedure is used. If the transmitter complies with the conducted power limits based on the use of RMS averaging over a time interval, the attenuation required under this paragraph shall be 30 dB instead of 20 dB per 15.247(d).
5. Measure and record the results in the test report.
6. The RF fundamental frequency should be excluded against the limit line in the operating frequency band.

3.4.4 Test Setup

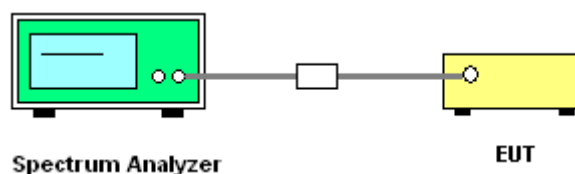

3.4.5 Test Result of Conducted Band Edges and Spurious Emission

Please refer to Appendix A.



3.5 Radiated Band Edges and Spurious Emission Measurement

3.5.1 Limit of Radiated band edge and Spurious Emission Measurement

In any 100 kHz bandwidth outside the intentional radiator frequency band, all harmonics/spurious must be at least 20 dB below the highest emission level within the authorized band. If the output power of this device is measured by spectrum analyzer, the attenuation under this paragraph shall be 30 dB instead of 20 dB. In addition, radiated emissions which fall in the restricted bands must also comply with the limits as below.

Frequency (MHz)	Field Strength (microvolts/meter)	Measurement Distance (meters)
0.009 – 0.490	2400/F(kHz)	300
0.490 – 1.705	24000/F(kHz)	30
1.705 – 30.0	30	30
30 – 88	100	3
88 – 216	150	3
216 - 960	200	3
Above 960	500	3

3.5.2 Measuring Instruments

Please refer to the measuring equipment list in this test report.

3.5.3 Test Procedures

1. The testing follows the ANSI C63.10 Section 11.12.1 Radiated emission measurements.
2. The EUT is arranged to its worst case and then tune the antenna tower (from 1 m to 4 m) and turntable (from 0 degree to 360 degrees) to find the maximum reading. A pre-amp and a high pass filter are used for the test in order to get better signal level.
3. The EUT is placed on a turntable with 0.8 meter for frequency below 1 GHz and 1.5 meter for frequency above 1 GHz respectively above ground.
4. The EUT is set 3 meters away from the receiving antenna, which is mounted on the top of a variable height antenna tower.
5. Corrected Reading: Antenna Factor + Cable Loss + Read Level - Preamp Factor = Level
6. Radiated testing below 1 GHz is performed by adjusting the antenna tower from 1 m to 4 m and by rotating the turn table from 0 degree to 360 degrees to find the peak maximum hold reading. When there is no suspected emission found and the emission level is with at least 6 dB margin against QP limit line, the position is marked as “-“.

7. Radiated testing above 1 GHz is performed by adjusting the antenna tower from 1 m to 4 m and by rotating the turn table from 0 degree to 360 degrees to find the peak maximum hold reading for scanning all frequencies. When there is no suspected emission found and the harmonic emission level is with at least 6 dB margin against average limit line, the position is marked as “-“.
8. Use the following spectrum analyzer settings:
 - (1) Span shall wide enough to fully capture the emission being measured;
 - (2) Set RBW = 100 kHz for $f < 1$ GHz; VBW \geq RBW; Sweep = auto; Detector function = peak; Trace = max hold;
 - (3) Set RBW = 1 MHz, VBW = 3 MHz for $f \geq 1$ GHz for peak measurement.For average measurement:
 - VBW = 10 Hz, when duty cycle is no less than 98 percent.
 - VBW $\geq 1/T$, when duty cycle is less than 98 percent where T is the minimum transmission duration over which the transmitter is on and is transmitting at its maximum power control level for the tested mode of operation.

3.5.4 Test Setup

For radiated emissions below 30MHz

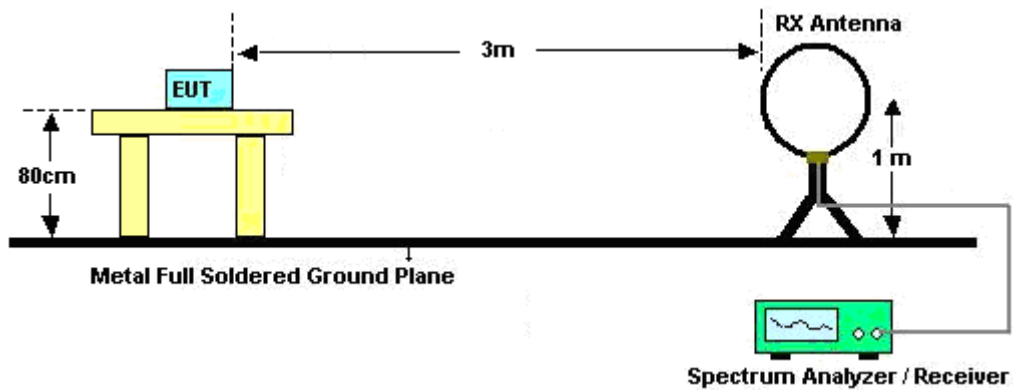

For radiated emissions from 30MHz to 1GHz

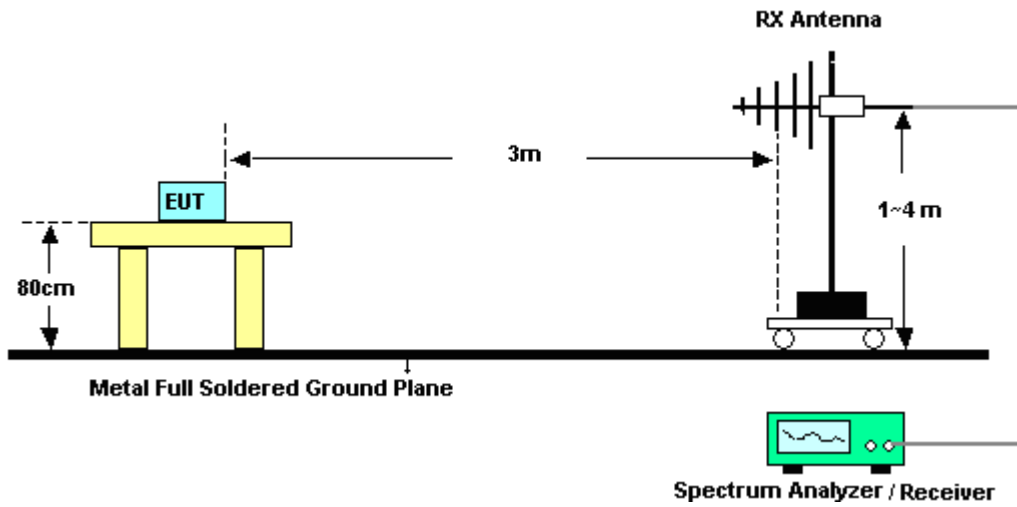

For radiated test from 1GHz to 18GHz

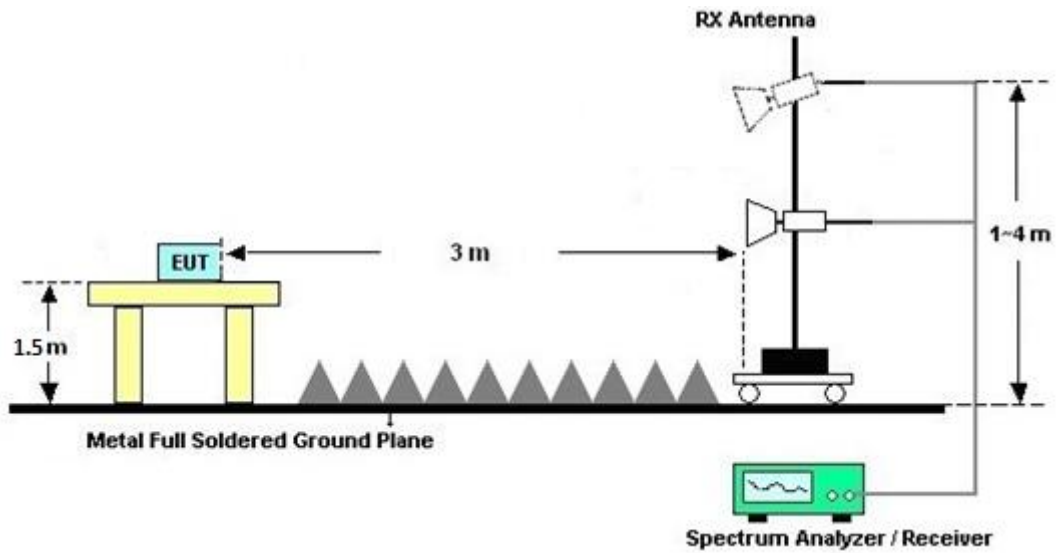

For radiated test above 18GHz

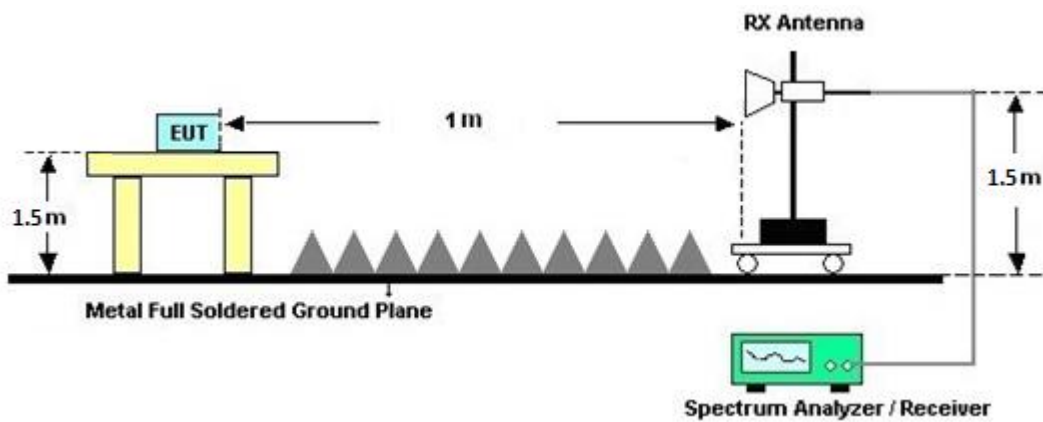



3.5.5 Test Results of Radiated Spurious Emissions (9kHz ~ 30MHz)

The low frequency, which starts from 9 kHz to 30 MHz, is pre-scanned and the result which is 20 dB lower than the limit line is not reported.

There is adequate comparison measurement of both open-field test site and alternative test site - semi-Anechoic chamber according to 414788 D01 Radiated Test Site v01r01, and the result comes out very similar.

3.5.6 Test Result of Radiated Spurious at Band Edges

Please refer to Appendix C and D.

3.5.7 Duty Cycle

Please refer to Appendix E.

3.5.8 Test Result of Radiated Spurious Emission (30MHz ~ 10th Harmonic)

Please refer to Appendix C and D.



3.6 AC Conducted Emission Measurement

3.6.1 Limit of AC Conducted Emission

For equipment that is designed to be connected to the public utility (AC) power line, the radio frequency voltage that is conducted back onto the AC power line on any frequency or frequencies within the band 150 kHz to 30 MHz shall not exceed the limits in the following table.

Frequency of Emission (MHz)	Conducted Limit (dB μ V)	
	Quasi-Peak	Average
0.15-0.5	66 to 56*	56 to 46*
0.5-5	56	46
5-30	60	50

*Decreases with the logarithm of the frequency.

3.6.2 Measuring Instruments

Please refer to the measuring equipment list in this test report.

3.6.3 Test Procedures

1. The EUT is placed 0.4 meter away from the conducting wall of the shielding room, and is kept at least 80 centimeters from any other grounded conducting surface.
2. Connect EUT to the power mains through a line impedance stabilization network (LISN).
3. All the support units are connecting to the other LISN.
4. The LISN provides 50 ohm coupling impedance for the measuring instrument.
5. The FCC states that a 50 ohm, 50 microhenry LISN shall be used.
6. Both Line and Neutral shall be tested in order to find out the maximum conducted emission.
7. The frequency range from 150 kHz to 30 MHz is scanned.
8. Set the test-receiver system to Peak Detect Function and specified bandwidth (IF bandwidth = 9kHz) with Maximum Hold Mode.

3.6.4 Test Setup

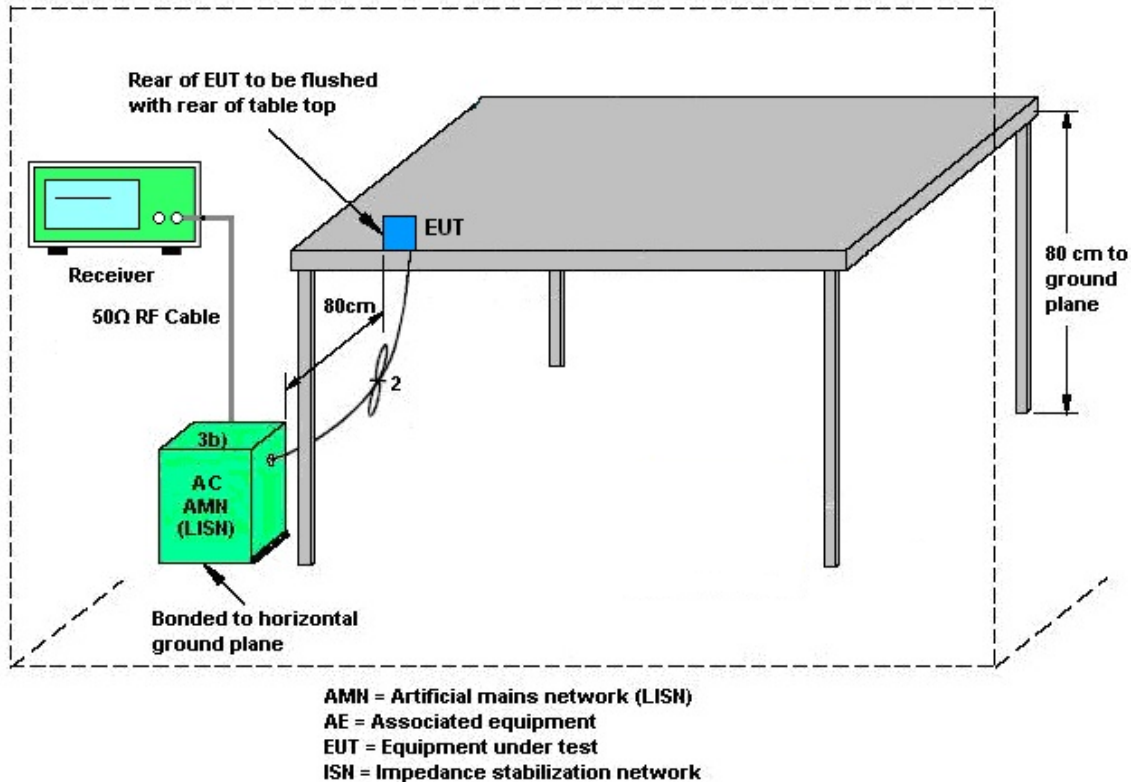

3.6.5 Test Result of AC Conducted Emission

Please refer to Appendix B.



3.7 Antenna Requirements

3.7.1 Standard Applicable

The use of a permanently attached antenna or of an antenna that uses a unique coupling to the intentional radiator shall be considered sufficient to comply with the rule.

3.7.2 Antenna Anti-Replacement Construction

An embedded-in antenna design is used.



4 List of Measuring Equipment

Instrument	Brand Name	Model No.	Serial No.	Characteristics	Calibration Date	Test Date	Due Date	Remark
AC Power Source	ChainTek	APC-1000W	N/A	N/A	N/A	Feb. 02, 2024	N/A	Conduction (CO05-HY)
EMI Test Receiver	Rohde & Schwarz	ESR3	102388	9kHz~3.6GHz	Dec. 06, 2023	Feb. 02, 2024	Dec. 05, 2024	Conduction (CO05-HY)
Hygrometer	Testo	608-H1	34913912	N/A	Oct. 26, 2023	Feb. 02, 2024	Oct. 25, 2024	Conduction (CO05-HY)
LISN	Rohde & Schwarz	ENV216	100081	9kHz~30MHz	Nov. 22, 2023	Feb. 02, 2024	Nov. 21, 2024	Conduction (CO05-HY)
Software	Rohde & Schwarz	EMC32	N/A	N/A	N/A	Feb. 02, 2024	N/A	Conduction (CO05-HY)
ISN Cable	MVE	RG-400	200260	N/A	Dec. 28, 2023	Feb. 02, 2024	Dec. 27, 2024	Conduction (CO05-HY)
Pulse Limiter	SCHWARZBECK	VTSD 9561-F N	00691	9kHz-200MHz	Jul. 28, 2023	Feb. 02, 2024	Jul. 27, 2024	Conduction (CO05-HY)
LISN Cable	MVE	RG-400	260260	N/A	Dec. 28, 2023	Feb. 02, 2024	Dec. 27, 2024	Conduction (CO05-HY)
EMI Test Receiver	Keysight	N9038A(MXE)	MY54130085	N/A	Oct. 06, 2023	Feb. 11, 2024~ Apr. 16, 2024	Oct. 05, 2024	Radiation (03CH20-HY)
Loop Antenna	Rohde & Schwarz	HFH2-Z2	100488	9 kHz~30 MHz	Sep. 12, 2023	Feb. 11, 2024~ Apr. 16, 2024	Sep. 11, 2024	Radiation (03CH20-HY)
Preamplifier	EMEC	EM18G40G	060801	18GHz~40GHz	Jun. 27, 2023	Feb. 11, 2024~ Apr. 16, 2024	Jun. 26, 2024	Radiation (03CH20-HY)
Controller	ChainTek	3000-1	N/A	Control Turn table & Ant Mast	N/A	Feb. 11, 2024~ Apr. 16, 2024	N/A	Radiation (03CH20-HY)
Antenna Mast	ChainTek	MBS-520-1	N/A	1m~4m	N/A	Feb. 11, 2024~ Apr. 16, 2024	N/A	Radiation (03CH20-HY)
Turn Table	ChainTek	T-200-S-1	N/A	0~360 Degree	N/A	Feb. 11, 2024~ Apr. 16, 2024	N/A	Radiation (03CH20-HY)
Signal Analyzer	Keysight	N9010B	MY60240520	N/A	Dec. 12, 2023	Feb. 11, 2024~ Apr. 16, 2024	Dec. 11, 2024	Radiation (03CH20-HY)
Bilog Antenna	TESEQ	CBL 6111D&00802N 1D01N-06	55606 & 08	30MHz~1GHz	Oct. 20, 2023	Feb. 11, 2024~ Apr. 16, 2024	Oct. 19, 2024	Radiation (03CH20-HY)
Horn Antenna	SCHWARZBECK	BBHA 9120 D	02360	1GHz-18GHz	Oct. 30, 2023	Feb. 11, 2024~ Apr. 16, 2024	Oct. 29, 2024	Radiation (03CH20-HY)
SHF-EHF Horn Antenna	SCHWARZBECK	BBHA 9170	1224	18GHz-40GHz	Jul. 10, 2023	Feb. 11, 2024~ Apr. 16, 2024	Jul. 09, 2024	Radiation (03CH20-HY)
Preamplifier	COM-POWER	PAM-103	18020201	1MHz-1000MHz	Jan. 01, 2024	Feb. 11, 2024~ Apr. 16, 2024	Dec. 31, 2024	Radiation (03CH20-HY)
Amplifier	EMCI	EMC118A45SE	980792	N/A	Nov. 13, 2023	Feb. 11, 2024~ Apr. 16, 2024	Nov. 12, 2024	Radiation (03CH20-HY)
RF Cable	HUBER + SUHNER	SUCOFLEX 102	519229/2,804 015/2,804027 /2	N/A	Jan. 17, 2024	Feb. 11, 2024~ Apr. 16, 2024	Jan. 16, 2025	Radiation (03CH20-HY)
Hygrometer	TECPEL	DTM-303B	TP200728	N/A	Mar. 28, 2023	Feb. 11, 2024~ Mar. 26, 2024	Mar. 27, 2024	Radiation (03CH20-HY)
Hygrometer	TECPEL	DTM-303A	TP211382	N/A	Mar. 27, 2024	Mar. 27, 2024~ Apr. 16, 2024	Mar. 26, 2025	Radiation (03CH20-HY)
Software	Audix	N/A	RK-002156	N/A	N/A	Feb. 11, 2024~ Apr. 16, 2024	N/A	Radiation (03CH20-HY)
Hygrometer	TECPEL	DTM-303A	TP201996	N/A	Nov. 07, 2023	Jan. 26, 2024~ Apr. 22, 2024	Nov. 06, 2024	Conducted (TH05-HY)
Power Sensor	DARE	RPR3006W	15100041SNO 10 (NO:248)	10MHz~6GHz	Jun. 05, 2023	Jan. 26, 2024~ Apr. 22, 2024	Jun. 04, 2024	Conducted (TH05-HY)
Signal Analyzer	Rohde & Schwarz	FSV40	101566	10Hz~40GHz	Aug. 23, 2023	Jan. 26, 2024~ Apr. 22, 2024	Aug. 22, 2024	Conducted (TH05-HY)



5 Measurement Uncertainty

Uncertainty of Conducted Emission Measurement (150kHz ~ 30MHz)

Measuring Uncertainty for a Level of Confidence of 95% ($U = 2Uc(y)$)	3.5 dB
---	--------

Uncertainty of Radiated Emission Measurement (30 MHz ~ 1000 MHz)

Measuring Uncertainty for a Level of Confidence of 95% ($U = 2Uc(y)$)	6.4 dB
---	--------

Uncertainty of Radiated Emission Measurement (1000 MHz ~ 6000 MHz)

Measuring Uncertainty for a Level of Confidence of 95% ($U = 2Uc(y)$)	4.5 dB
---	--------

Uncertainty of Radiated Emission Measurement (6000 MHz ~ 18000 MHz)

Measuring Uncertainty for a Level of Confidence of 95% ($U = 2Uc(y)$)	4.6 dB
---	--------

Uncertainty of Radiated Emission Measurement (18000 MHz ~ 40000 MHz)

Measuring Uncertainty for a Level of Confidence of 95% ($U = 2Uc(y)$)	5.4 dB
---	--------

Appendix A. Test Result of Conducted Test Items

Test Engineer:	Sylvia Li	Temperature:	21~25	°C
Test Date:	2024/1/26~2024/04/22	Relative Humidity:	51~54	%

TEST RESULTS DATA
6dB and 99% Occupied Bandwidth

2.4GHz Band MIMO										
Mod.	Data Rate	NTX	CH.	Freq. (MHz)	99% Occupied BW (MHz)		6dB BW (MHz)		6dB BW Limit (MHz)	Pass/Fail
					Ant6	Ant7	Ant6	Ant7		
11b	1Mbps	2	1	2412	13.14	13.59	8.05	9.03	0.50	Pass
11b	1Mbps	2	6	2437	13.14	12.89	8.05	8.03	0.50	Pass
11b	1Mbps	2	11	2462	13.09	13.04	8.05	8.03	0.50	Pass
11g	6Mbps	2	1	2412	16.28	16.33	15.33	15.72	0.50	Pass
11g	6Mbps	2	6	2437	16.43	16.28	15.67	15.10	0.50	Pass
11g	6Mbps	2	11	2462	16.33	16.28	15.30	15.11	0.50	Pass
VHT20	MCS0	2	1	2412	17.43	17.48	15.91	16.31	0.50	Pass
VHT20	MCS0	2	6	2437	17.53	17.43	15.04	15.02	0.50	Pass
VHT20	MCS0	2	11	2462	17.68	17.53	17.53	16.89	0.50	Pass
VHT40	MCS0	2	3	2422	35.96	35.86	35.26	33.83	0.50	Pass
VHT40	MCS0	2	6	2437	36.06	36.16	35.08	33.78	0.50	Pass
VHT40	MCS0	2	9	2452	35.86	36.16	33.84	34.98	0.50	Pass

TEST RESULTS DATA
Average Output Power

2.4GHz Band MIMO																
Mod.	Data Rate	NTX	CH.	Freq. (MHz)	Average Conducted Power (dBm)			Conducted Power Limit (dBm)		DG (dBi)		EIRP Power (dBm)		EIRP Power Limit (dBm)		Pass /Fail
					Ant6	Ant7	SUM	Ant6	Ant7	Ant6	Ant7	Ant6	Ant7	Ant6	Ant7	
11b	1Mbps	2	1	2412	20.20	20.60	23.41	30.00		2.32		25.73		36.00	Pass	
11b	1Mbps	2	6	2437	19.30	19.60	22.46	30.00		2.32		24.78		36.00	Pass	
11b	1Mbps	2	11	2462	19.60	19.90	22.76	30.00		2.32		25.08		36.00	Pass	
11g	6Mbps	2	1	2412	18.80	18.60	21.71	30.00		2.32		24.03		36.00	Pass	
11g	6Mbps	2	6	2437	20.40	20.70	23.56	30.00		2.32		25.88		36.00	Pass	
11g	6Mbps	2	11	2462	17.20	17.50	20.36	30.00		2.32		22.68		36.00	Pass	
HT20	MCS0	2	1	2412	16.80	16.90	19.86	30.00		2.32		22.18		36.00	Pass	
HT20	MCS0	2	6	2437	20.00	20.30	23.16	30.00		2.32		25.48		36.00	Pass	
HT20	MCS0	2	11	2462	14.60	14.80	17.71	30.00		2.32		20.03		36.00	Pass	
HT40	MCS0	2	3	2422	12.80	12.80	15.81	30.00		2.32		18.13		36.00	Pass	
HT40	MCS0	2	6	2437	18.90	18.80	21.86	30.00		2.32		24.18		36.00	Pass	
HT40	MCS0	2	9	2452	10.10	9.70	12.91	30.00		2.32		15.23		36.00	Pass	
VHT20	MCS0	2	1	2412	16.90	17.00	19.96	30.00		2.32		22.28		36.00	Pass	
VHT20	MCS0	2	6	2437	20.10	20.40	23.26	30.00		2.32		25.58		36.00	Pass	
VHT20	MCS0	2	11	2462	14.70	14.90	17.81	30.00		2.32		20.13		36.00	Pass	
VHT40	MCS0	2	3	2422	12.90	12.90	15.91	30.00		2.32		18.23		36.00	Pass	
VHT40	MCS0	2	6	2437	19.00	18.90	21.96	30.00		2.32		24.28		36.00	Pass	
VHT40	MCS0	2	9	2452	10.20	9.80	13.01	30.00		2.32		15.33		36.00	Pass	

Note: Measured power (dBm) has offset with cable loss.

TEST RESULTS DATA
Peak Power Spectral Density

2.4GHz Band MIMO												
Mod.	Data Rate	NTX	CH.	Freq. (MHz)	Peak PSD (dBm/3kHz)			DG (dBi)		Peak PSD Limit (dBm/3kHz)		Pass/Fail
					Ant6	Ant7	Worse + 3.01	Ant6	Ant7	Ant6	Ant7	
11b	1Mbps	2	1	2412	-1.70	-1.23	1.78	4.31		8.00		Pass
11b	1Mbps	2	6	2437	-2.23	-1.93	1.08	4.31		8.00		Pass
11b	1Mbps	2	11	2462	-2.30	-2.01	1.00	4.31		8.00		Pass
11g	6Mbps	2	1	2412	-5.75	-5.80	-2.74	4.31		8.00		Pass
11g	6Mbps	2	6	2437	-3.90	-3.79	-0.78	4.31		8.00		Pass
11g	6Mbps	2	11	2462	-7.35	-6.52	-3.51	4.31		8.00		Pass
VHT20	MCS0	2	1	2412	-7.67	-7.96	-4.66	4.31		8.00		Pass
VHT20	MCS0	2	6	2437	-5.21	-4.80	-1.79	4.31		8.00		Pass
VHT20	MCS0	2	11	2462	-10.49	-10.48	-7.47	4.31		8.00		Pass
VHT40	MCS0	2	3	2422	-14.33	-14.37	-11.32	4.31		8.00		Pass
VHT40	MCS0	2	6	2437	-8.39	-8.09	-5.08	4.31		8.00		Pass
VHT40	MCS0	2	9	2452	-17.11	-17.47	-14.10	4.31		8.00		Pass

Measured power density (dBm) has offset with cable loss.

TEST RESULTS DATA
6dB and 99% Occupied Bandwidth

2.4GHz Band MIMO											
Mod.	Data Rate	NTX	CH.	Freq. (MHz)	RU Config	99% Occupied BW (MHz)		6dB BW (MHz)		6dB BW Limit (MHz)	Pass/Fail
						Ant6	Ant7	Ant6	Ant7		
HE20	MCS0	2	1	2412	Full	18.78	18.83	16.87	16.92	0.50	Pass
HE20	MCS0	2	6	2437	Full	18.88	18.83	16.32	15.06	0.50	Pass
HE20	MCS0	2	11	2462	Full	18.93	18.93	18.73	18.26	0.50	Pass
HE40	MCS0	2	3	2422	Full	37.66	37.56	34.91	35.00	0.50	Pass
HE40	MCS0	2	6	2437	Full	37.86	37.86	35.36	35.29	0.50	Pass
HE40	MCS0	2	9	2452	Full	37.56	37.76	35.04	36.27	0.50	Pass

TEST RESULTS DATA
Average Output Power

2.4GHz Band MIMO																	
Mod.	Data Rate	NTX	CH.	Freq. (MHz)	RU Config	Average Conducted Power (dBm)			Conducted Power Limit (dBm)		DG (dBi)		EIRP Power (dBm)		EIRP Power Limit (dBm)		Pass /Fail
						Ant6	Ant7	SUM	Ant6	Ant7	Ant6	Ant7	Ant6	Ant7	Ant6	Ant7	
HE20	MCS0	2	1	2412	Full	17.00	17.10	20.06	30.00		2.32		22.38		36.00	Pass	
HE20	MCS0	2	1	2412	26/0	9.60	9.50	12.56	30.00		2.32		14.88		36.00	Pass	
HE20	MCS0	2	1	2412	52/37	11.30	11.90	14.62	30.00		2.32		16.94		36.00	Pass	
HE20	MCS0	2	1	2412	106/53	14.40	14.40	17.41	30.00		2.32		19.73		36.00	Pass	
HE20	MCS0	2	6	2437	Full	20.20	20.50	23.36	30.00		2.32		25.68		36.00	Pass	
HE20	MCS0	2	6	2437	26/4	11.90	12.80	15.38	30.00		2.32		17.70		36.00	Pass	
HE20	MCS0	2	6	2437	52/38	14.20	15.20	17.74	30.00		2.32		20.06		36.00	Pass	
HE20	MCS0	2	6	2437	106/53	17.10	18.10	20.64	30.00		2.32		22.96		36.00	Pass	
HE20	MCS0	2	11	2462	Full	14.80	15.00	17.91	30.00		2.32		20.23		36.00	Pass	
HE20	MCS0	2	11	2462	26/8	7.30	7.40	10.36	30.00		2.32		12.68		36.00	Pass	
HE20	MCS0	2	11	2462	52/40	9.40	8.70	12.07	30.00		2.32		14.39		36.00	Pass	
HE20	MCS0	2	11	2462	106/54	12.10	12.20	15.16	30.00		2.32		17.48		36.00	Pass	
HE40	MCS0	2	3	2422	Full	13.00	13.00	16.01	30.00		2.32		18.33		36.00	Pass	
HE40	MCS0	2	3	2422	242/61	11.50	11.30	14.41	30.00		2.32		16.73		36.00	Pass	
HE40	MCS0	2	6	2437	Full	19.10	19.00	22.06	30.00		2.32		24.38		36.00	Pass	
HE40	MCS0	2	6	2437	242/61	17.00	17.70	20.37	30.00		2.32		22.69		36.00	Pass	
HE40	MCS0	2	9	2452	Full	10.30	9.90	13.11	30.00		2.32		15.43		36.00	Pass	
HE40	MCS0	2	9	2452	242/62	6.80	7.50	10.17	30.00		2.32		12.49		36.00	Pass	

Note: Measured power (dBm) has offset with cable loss.

TEST RESULTS DATA
Peak Power Spectral Density

2.4GHz Band MIMO													
Mod.	Data Rate	NTx	CH.	Freq. (MHz)	RU Config	Peak PSD (dBm/3kHz)			DG (dBi)		Peak PSD Limit (dBm/3kHz)		Pass/Fail
						Ant6	Ant7	Worse + 3.01	Ant6	Ant7	Ant6	Ant7	
HE20	MCS0	2	1	2412	Full	-8.21	-8.35	-5.20	4.31		8.00		Pass
HE20	MCS0	2	1	2412	26/0	-8.69	-8.42	-5.41	4.31		8.00		Pass
HE20	MCS0	2	1	2412	52/37	-9.13	-8.74	-5.73	4.31		8.00		Pass
HE20	MCS0	2	1	2412	106/53	-8.89	-8.81	-5.80	4.31		8.00		Pass
HE20	MCS0	2	6	2437	Full	-5.08	-4.73	-1.72	4.31		8.00		Pass
HE20	MCS0	2	6	2437	26/4	-5.80	-4.94	-1.93	4.31		8.00		Pass
HE20	MCS0	2	6	2437	52/38	-5.85	-5.17	-2.16	4.31		8.00		Pass
HE20	MCS0	2	6	2437	106/53	-6.18	-5.16	-2.15	4.31		8.00		Pass
HE20	MCS0	2	11	2462	Full	-10.15	-10.06	-7.05	4.31		8.00		Pass
HE20	MCS0	2	11	2462	26/8	-10.46	-10.65	-7.45	4.31		8.00		Pass
HE20	MCS0	2	11	2462	52/40	-10.26	-10.75	-7.25	4.31		8.00		Pass
HE20	MCS0	2	11	2462	106/54	-10.24	-10.39	-7.23	4.31		8.00		Pass
HE40	MCS0	2	3	2422	Full	-15.00	-15.09	-11.99	4.31		8.00		Pass
HE40	MCS0	2	3	2422	242/61	-15.32	-15.47	-12.31	4.31		8.00		Pass
HE40	MCS0	2	6	2437	Full	-9.42	-9.37	-6.36	4.31		8.00		Pass
HE40	MCS0	2	6	2437	242/61	-9.95	-9.53	-6.52	4.31		8.00		Pass
HE40	MCS0	2	9	2452	Full	-18.39	-18.82	-15.38	4.31		8.00		Pass
HE40	MCS0	2	9	2452	242/62	-19.54	-18.94	-15.93	4.31		8.00		Pass

Measured power density (dBm) has offset with cable loss.



6dB and 99% Occupied Bandwidth

MIMO <Ant. 6+7>

<802.11b>

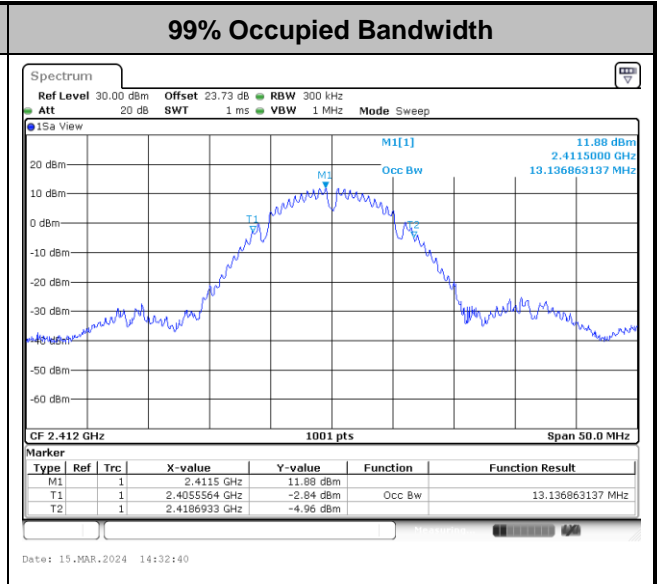
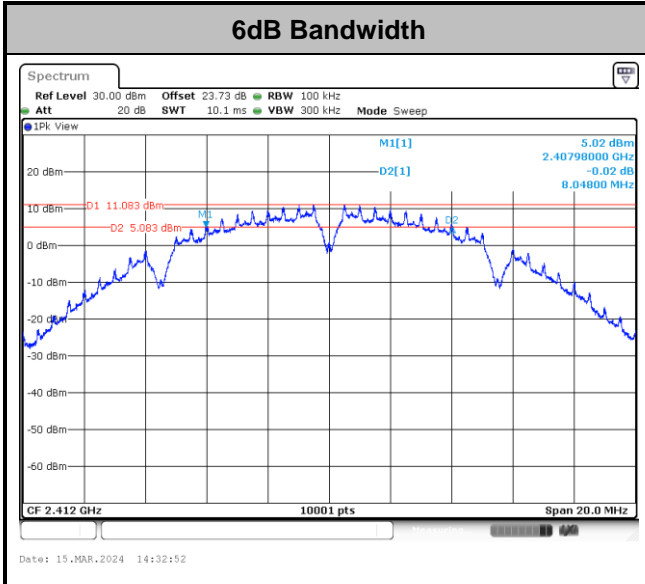

Note: The occupied channel bandwidth is maintained within the band of operation for all of the modulations.

<802.11g>

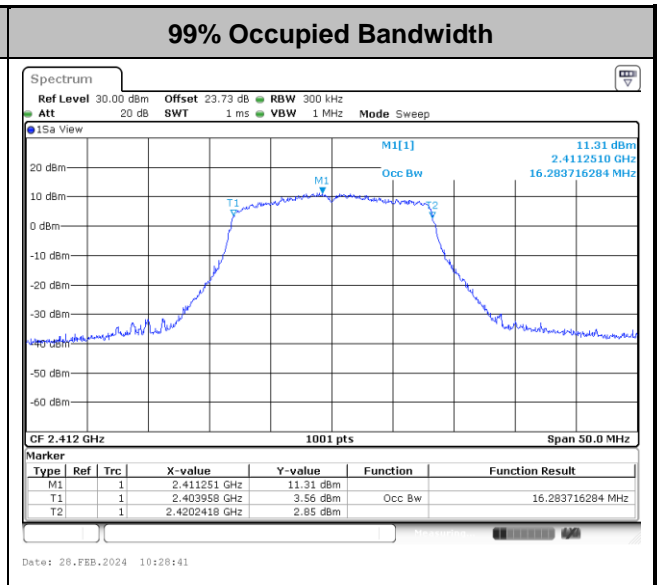
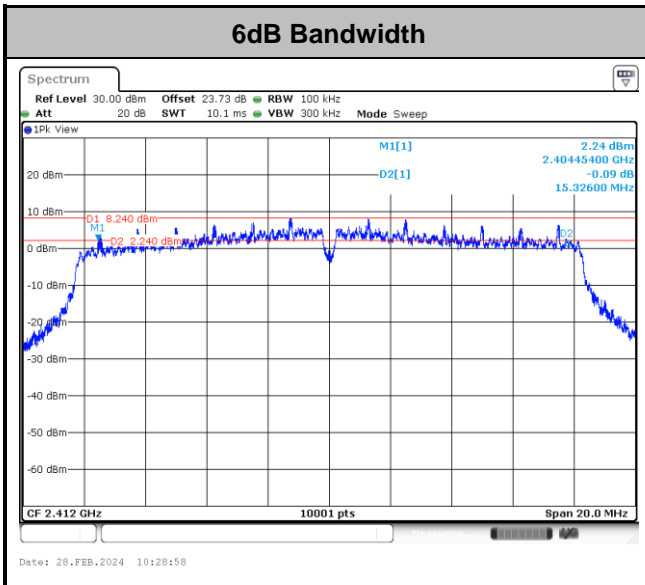

Note: The occupied channel bandwidth is maintained within the band of operation for all of the modulations.



<802.11ac VHT20>

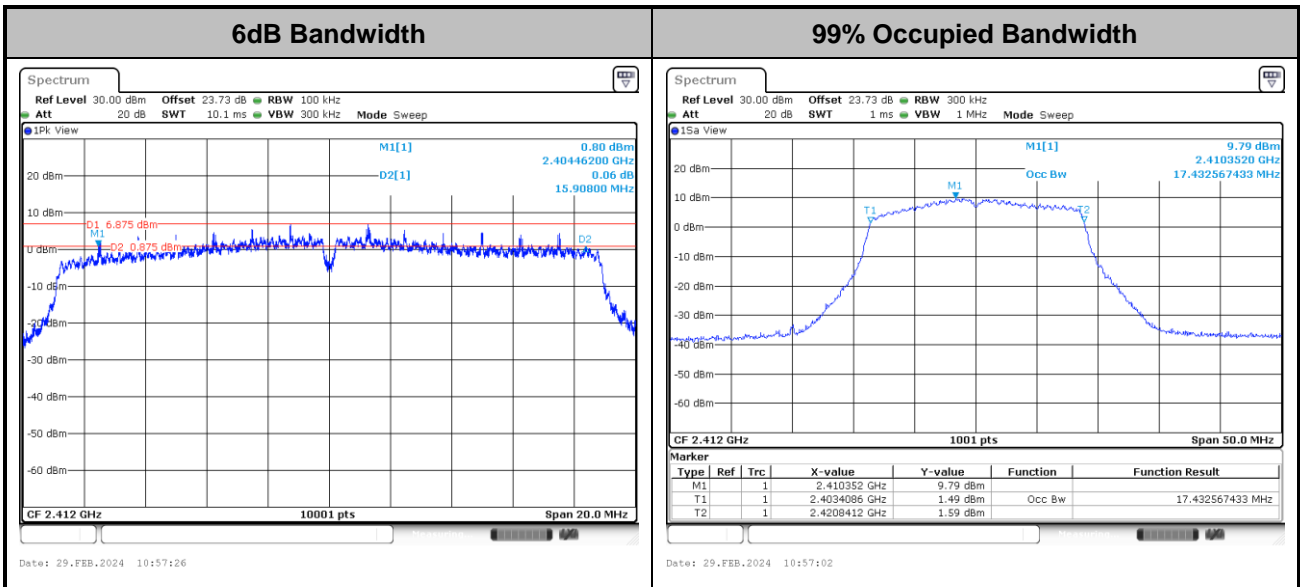

Note: The occupied channel bandwidth is maintained within the band of operation for all of the modulations.

<802.11ac VHT40>

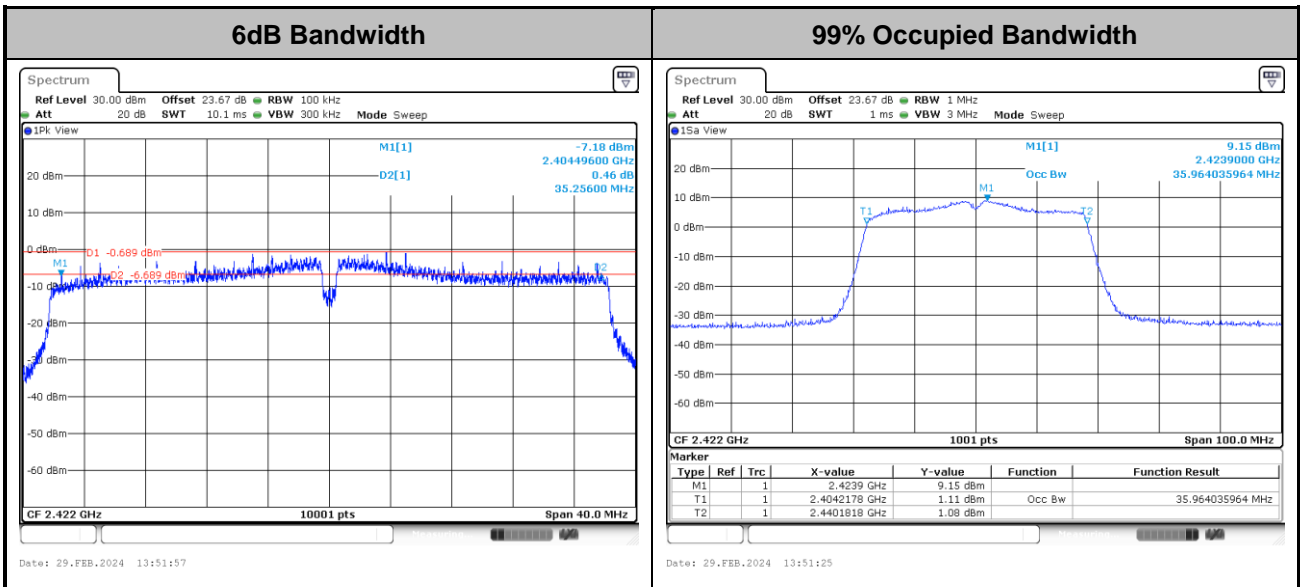

Note: The occupied channel bandwidth is maintained within the band of operation for all of the modulations.



<802.11ax HE20>

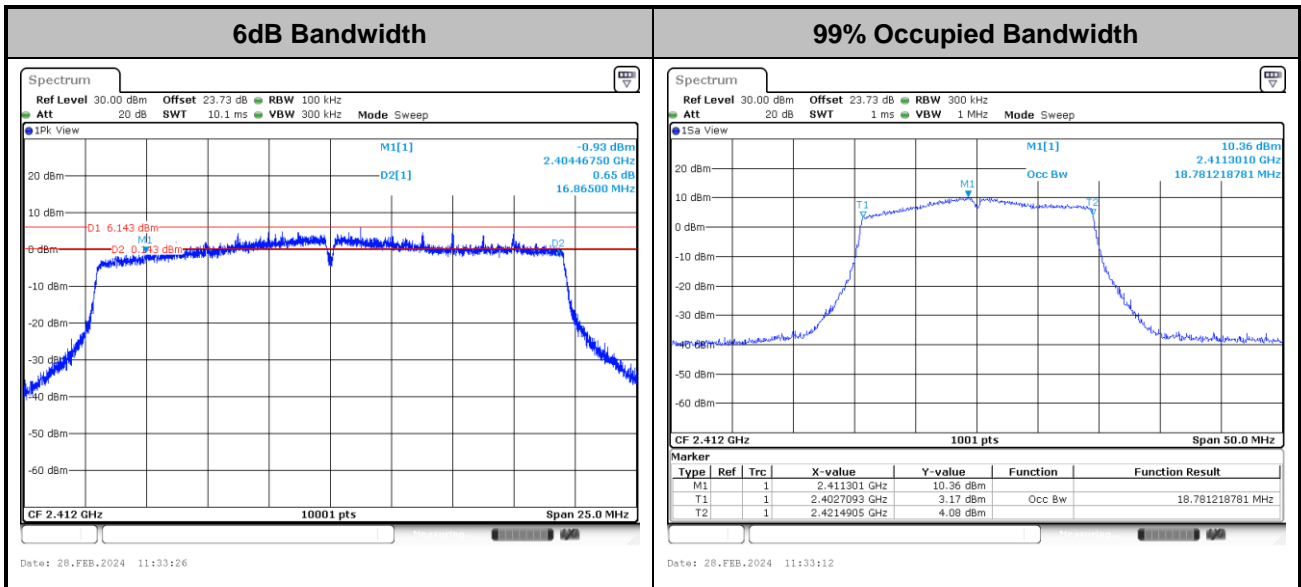

Note: The occupied channel bandwidth is maintained within the band of operation for all of the modulations.

<802.11ax HE40>

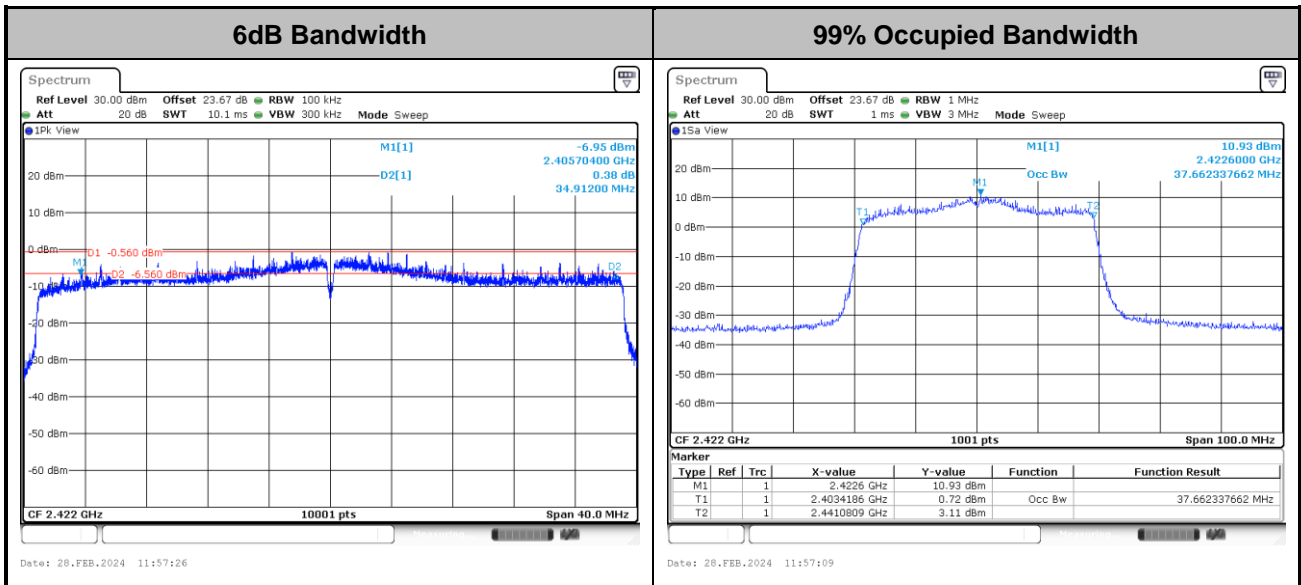

Note: The occupied channel bandwidth is maintained within the band of operation for all of the modulations.



Power Spectral Density(dBm/3kHz)

<802.11b>

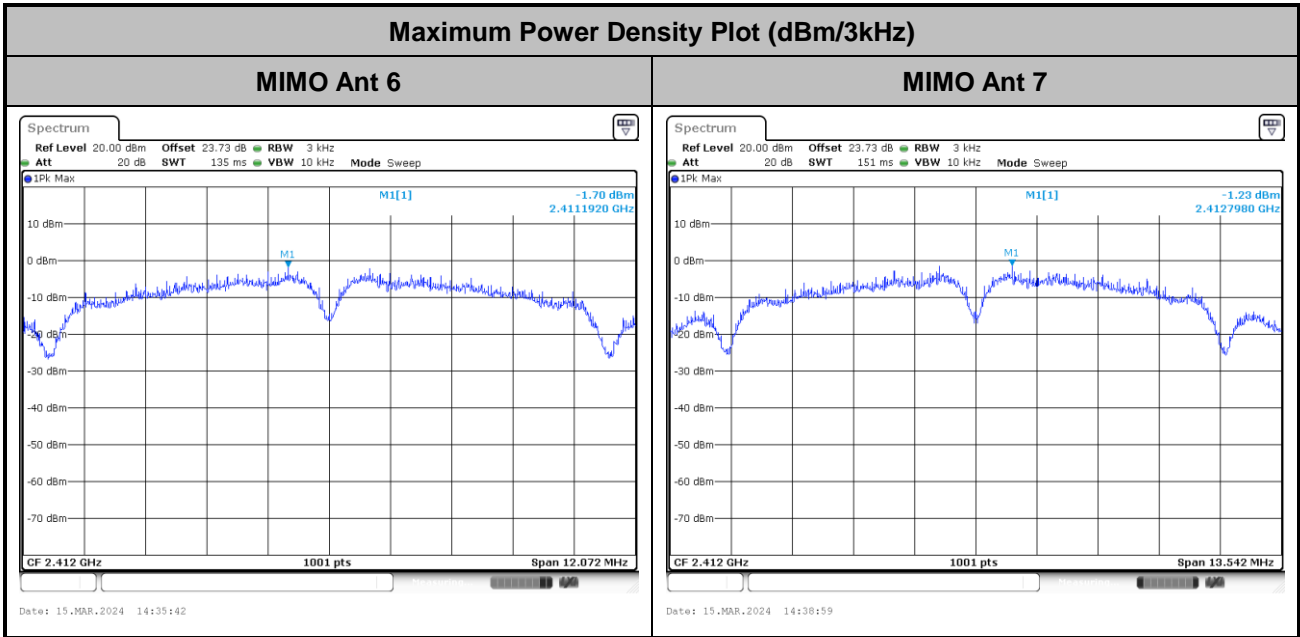

<802.11g>

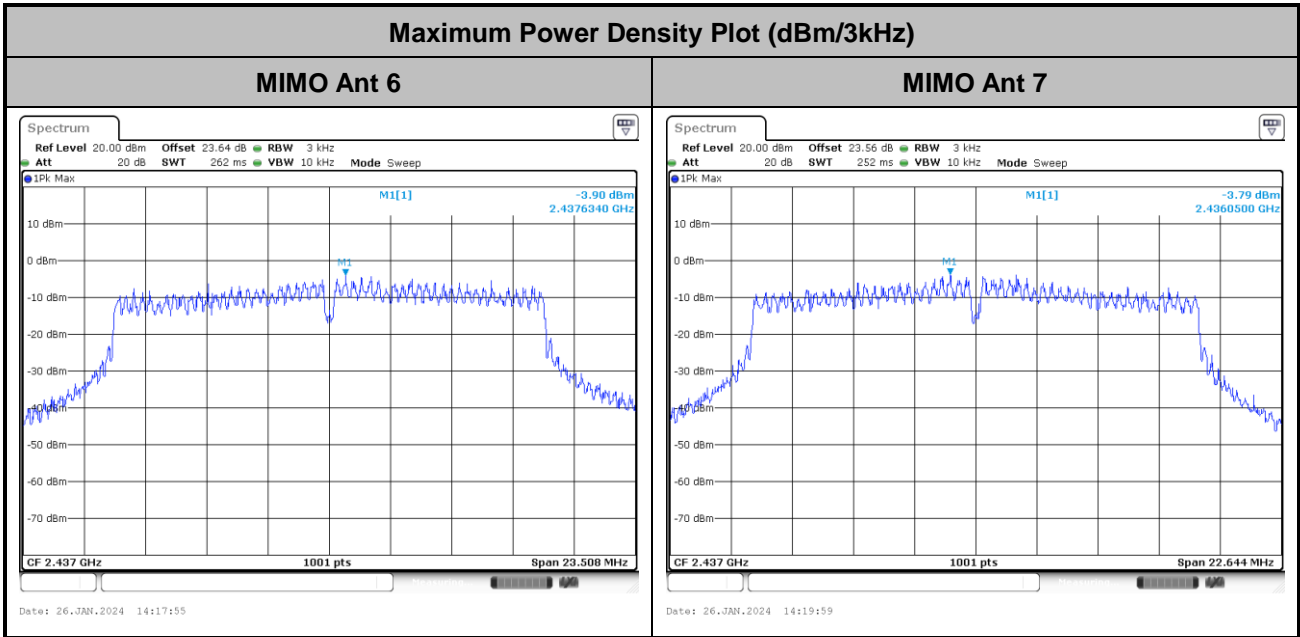



<802.11ac VHT20>

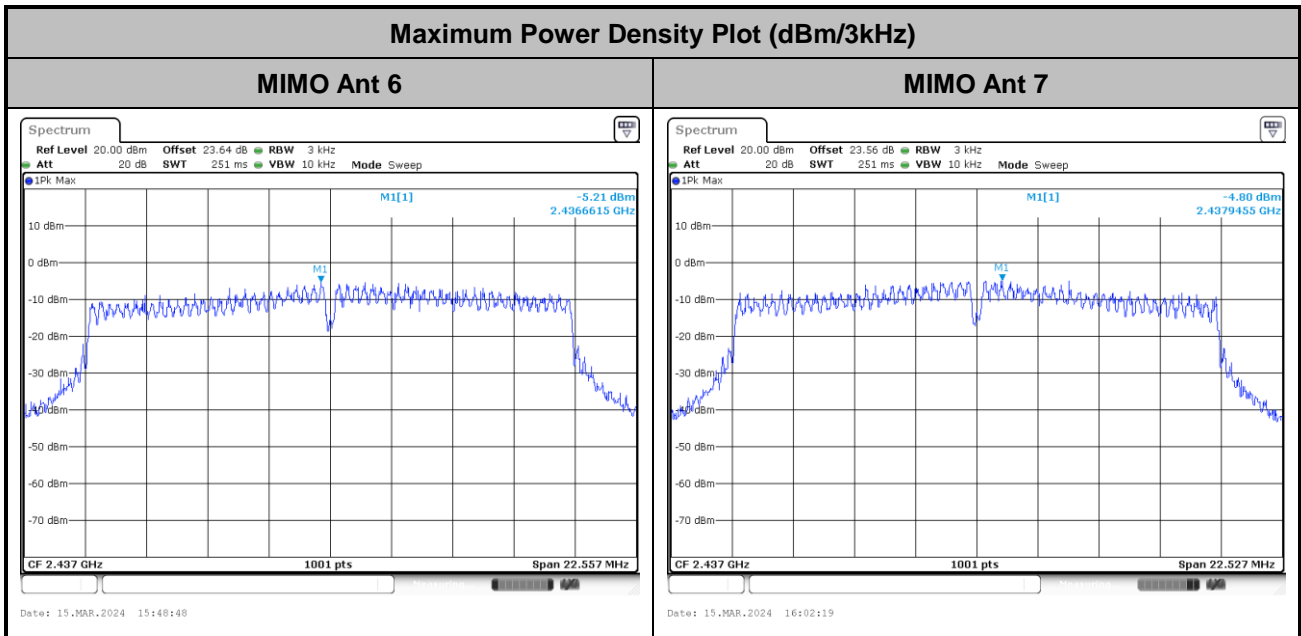

<802.11ac VHT40>

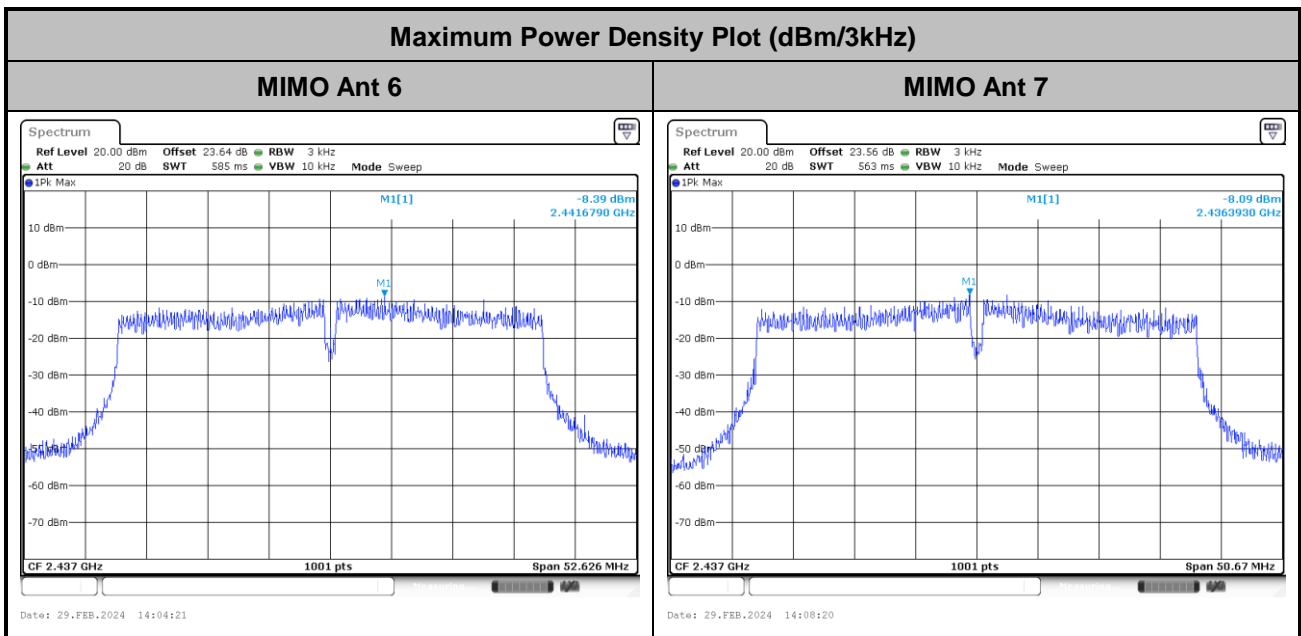



<802.11ax HE20>

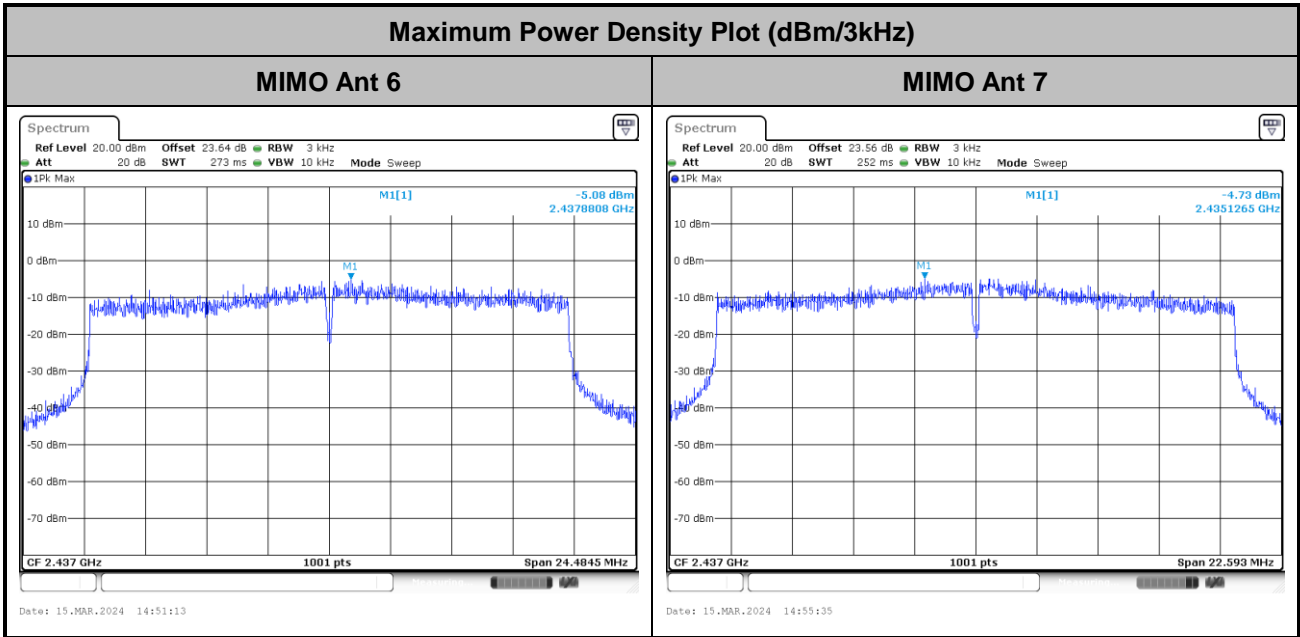

<802.11ax HE40>

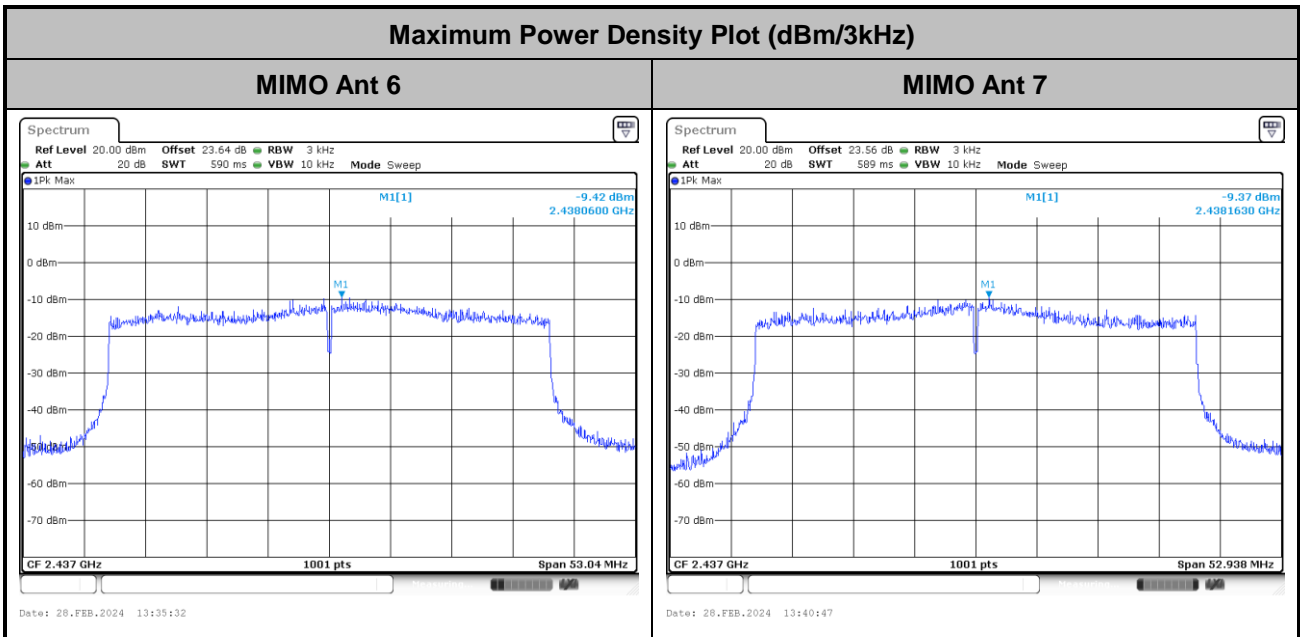



Band Edges and Spurious Emission

Number of TX = 2, Ant. 6 (Measured)

Test Mode :	802.11b	Test Channel :	01
-------------	---------	----------------	----

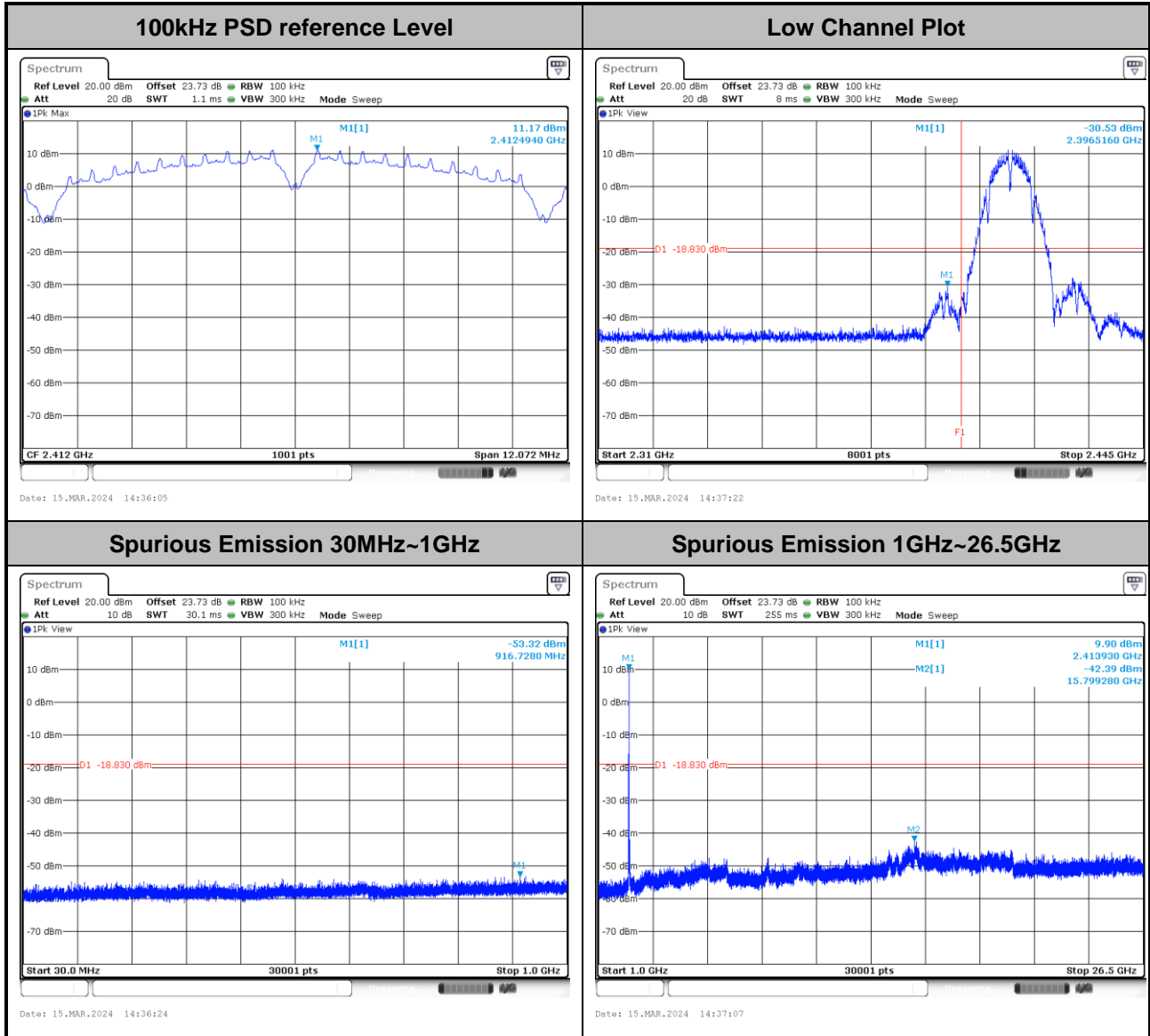



Test Mode :	802.11b	Test Channel :	06
-------------	---------	----------------	----

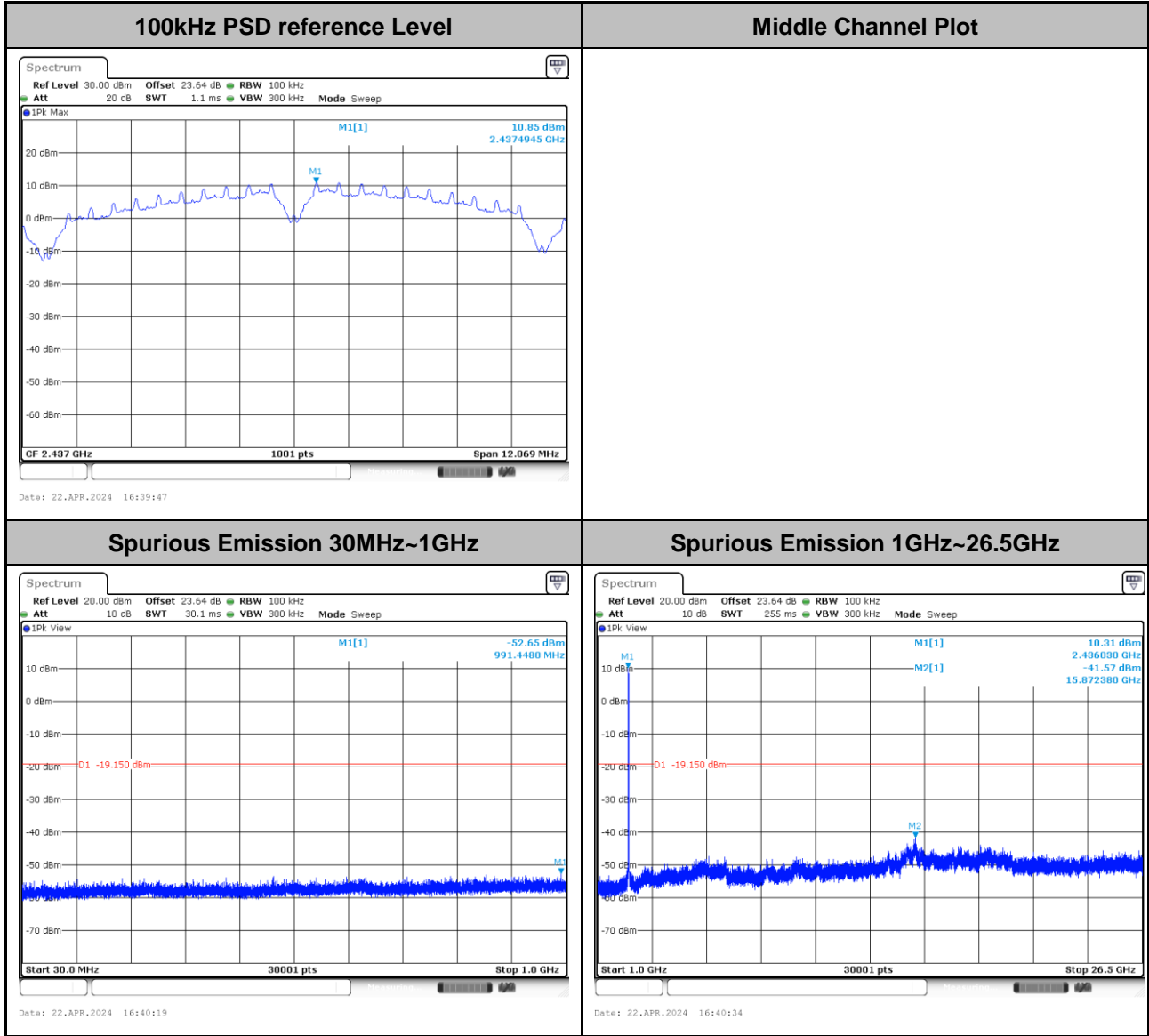



Test Mode :	802.11b	Test Channel :	11
-------------	---------	----------------	----

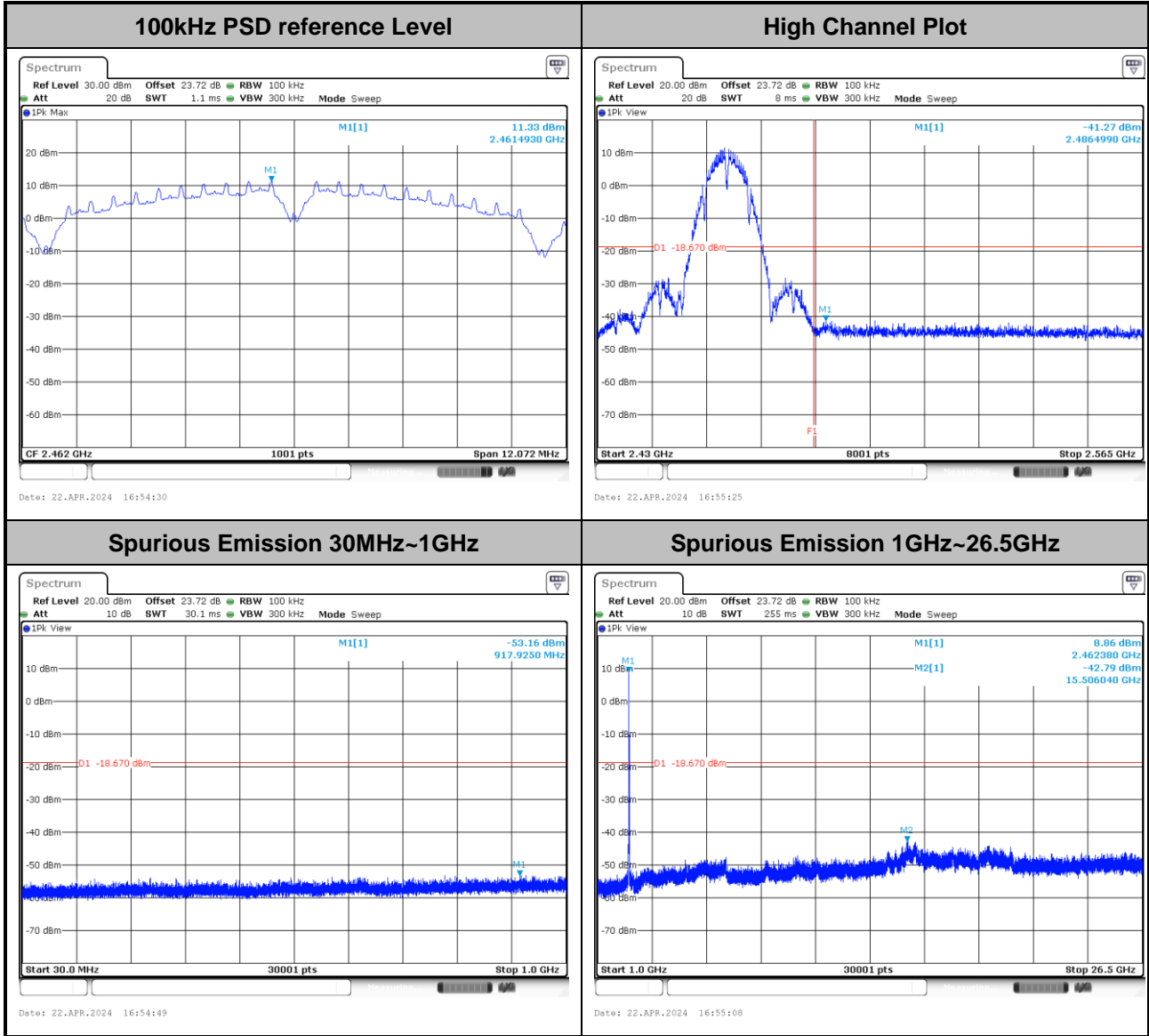



Test Mode :	802.11g	Test Channel :	01
-------------	---------	----------------	----

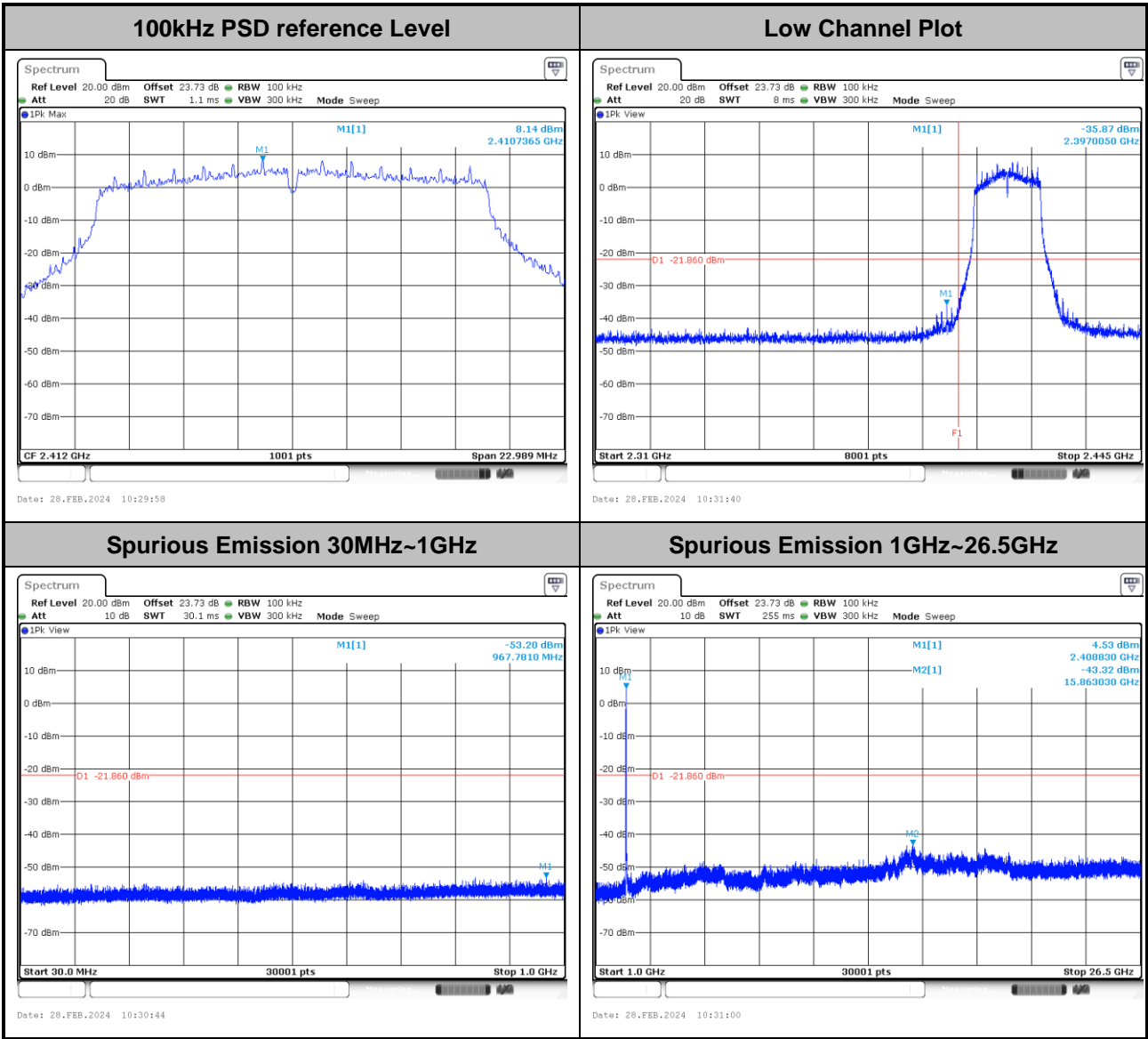



Test Mode :	802.11g	Test Channel :	06
-------------	---------	----------------	----

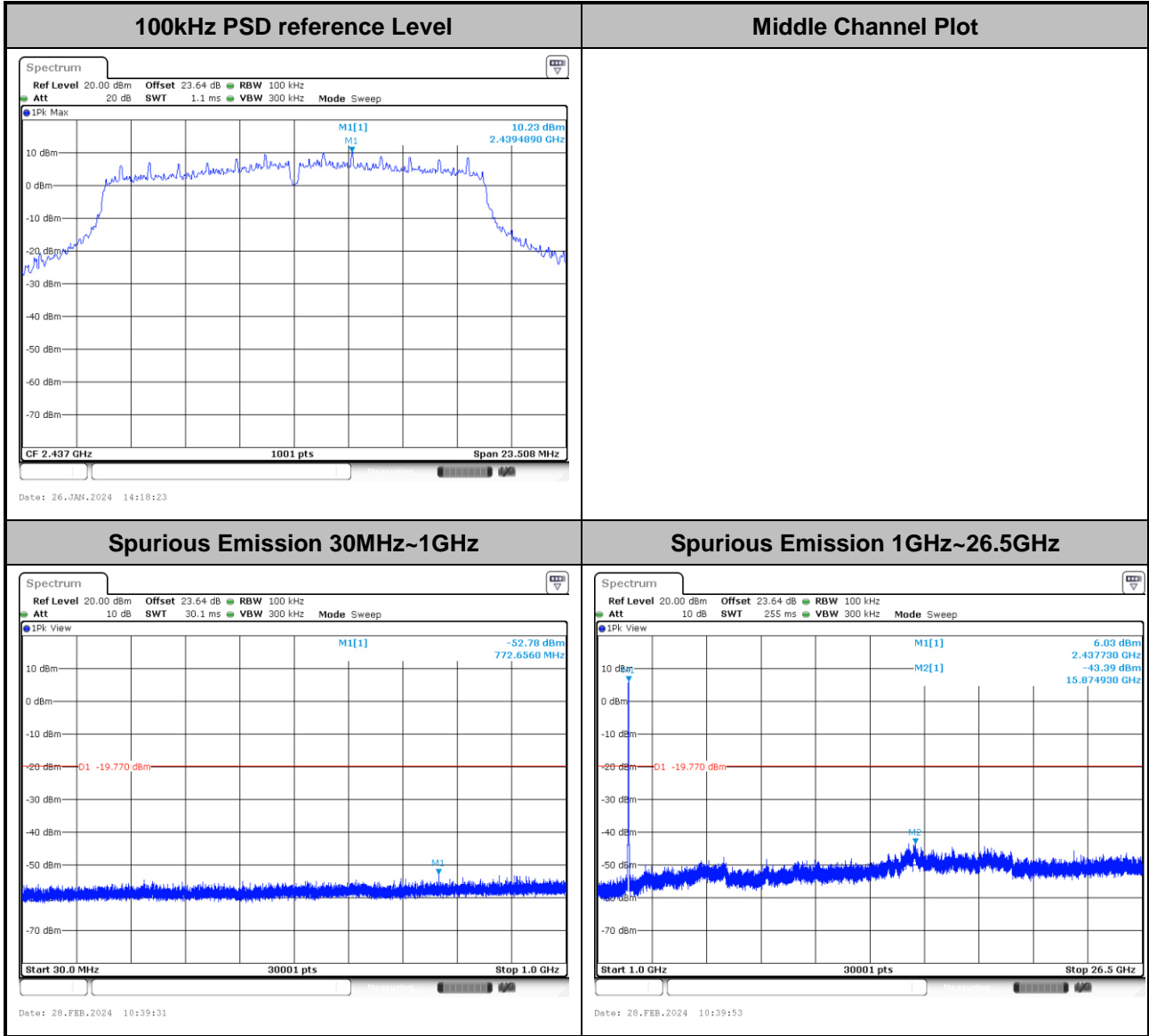



Test Mode :	802.11g	Test Channel :	11
-------------	---------	----------------	----

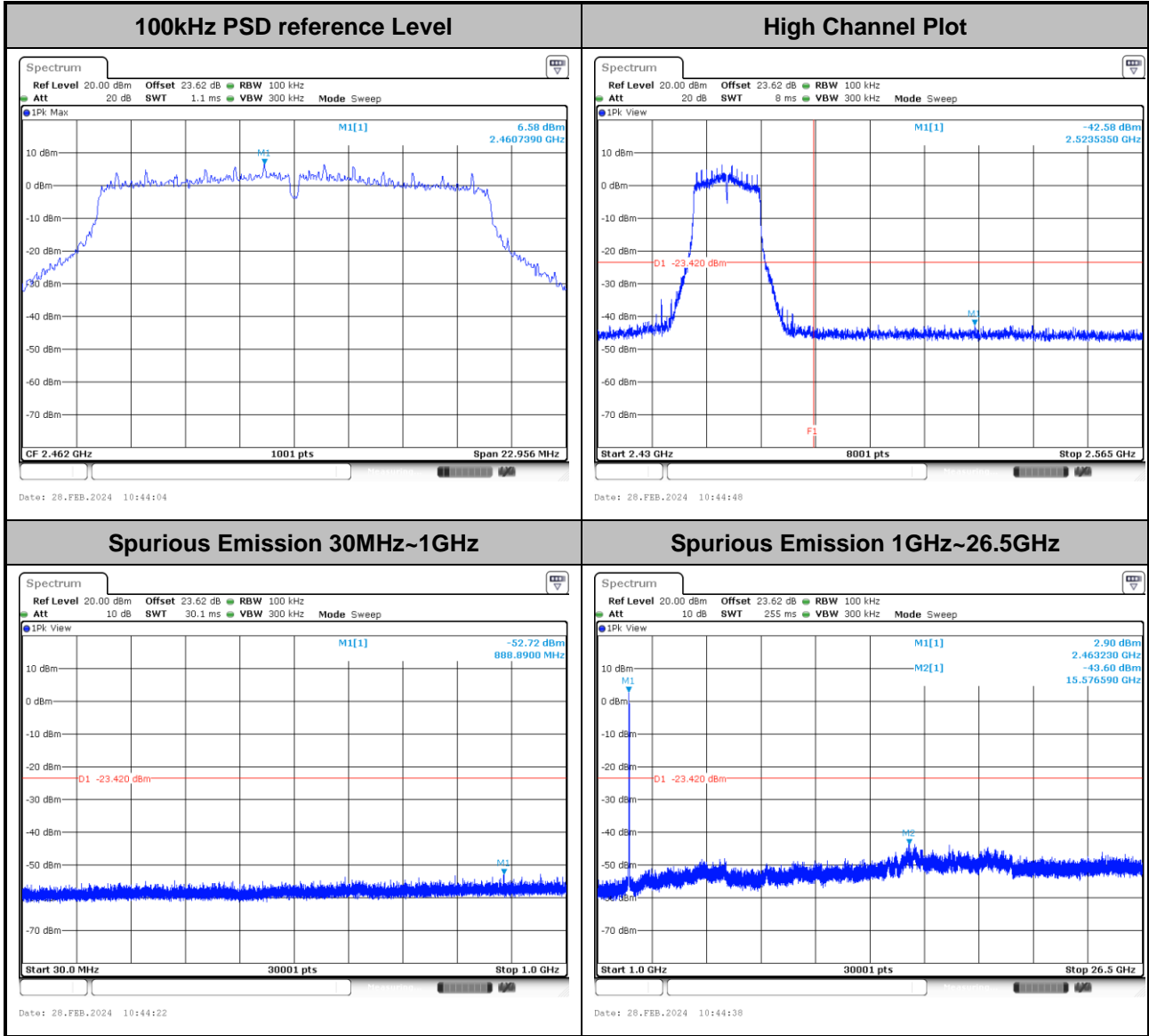



Test Mode :	802.11ac VHT20	Test Channel :	01
-------------	----------------	----------------	----

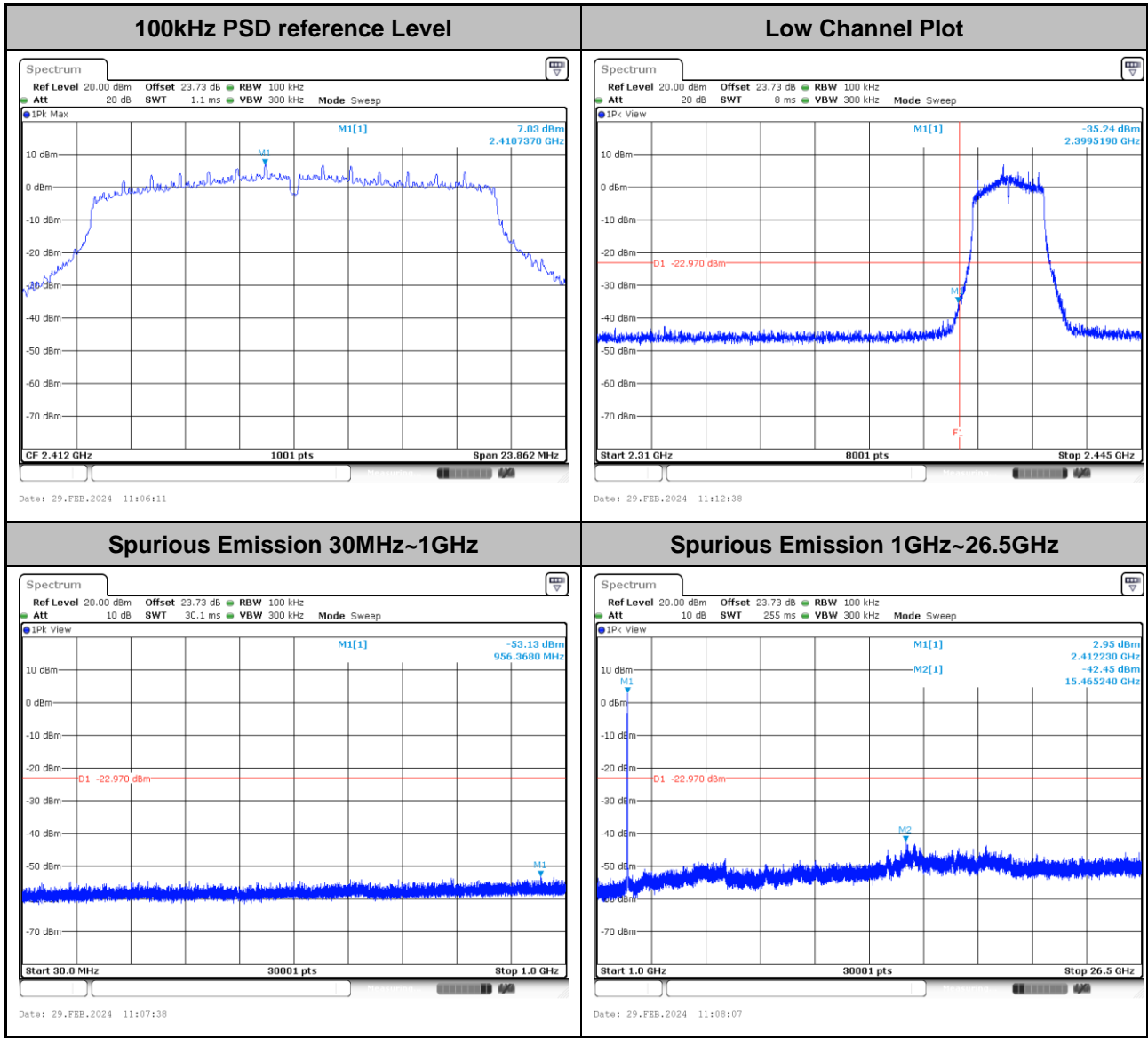



Test Mode :	802.11ac VHT20	Test Channel :	06
-------------	----------------	----------------	----

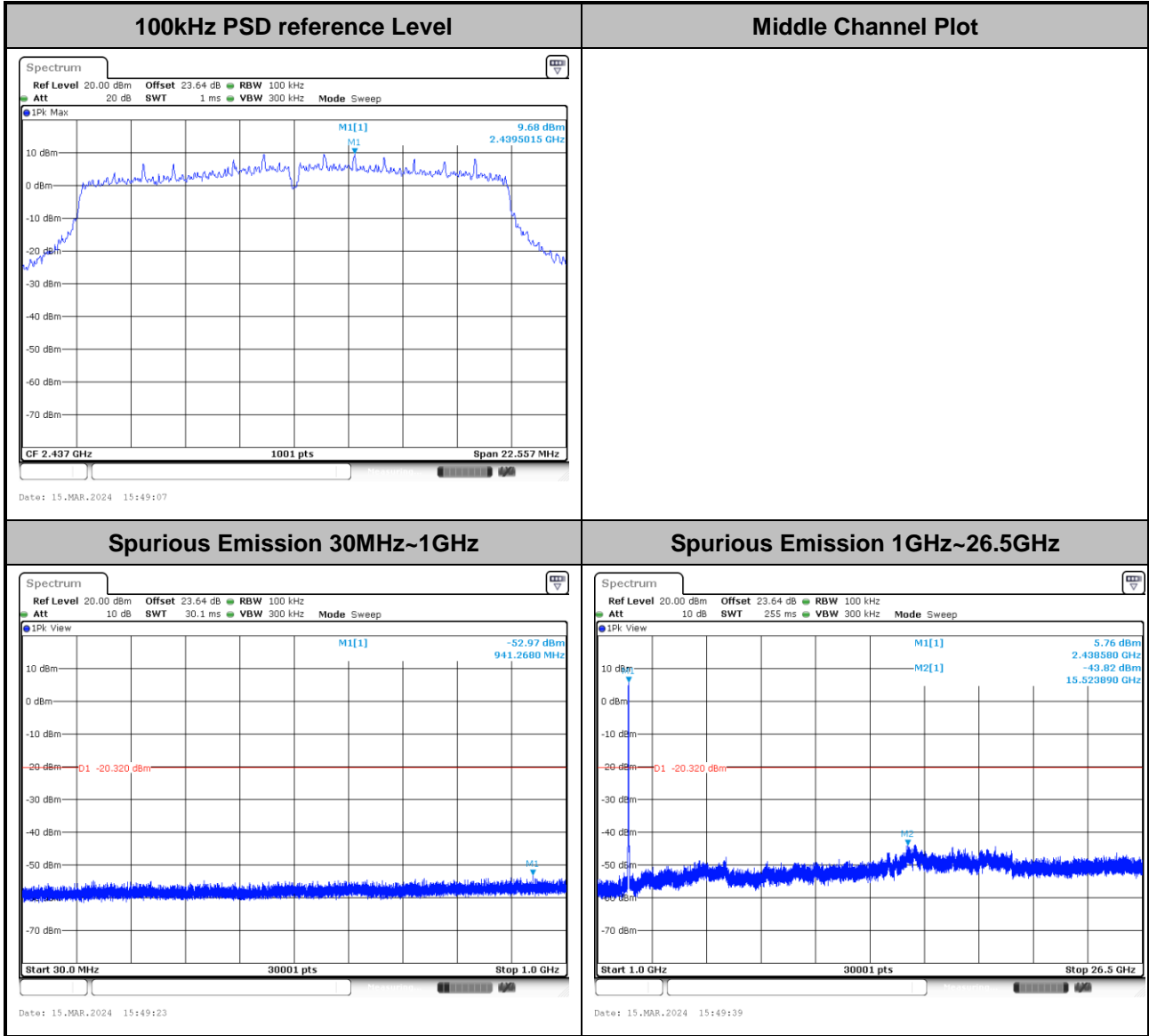



Test Mode :	802.11ac VHT20	Test Channel :	11
-------------	----------------	----------------	----

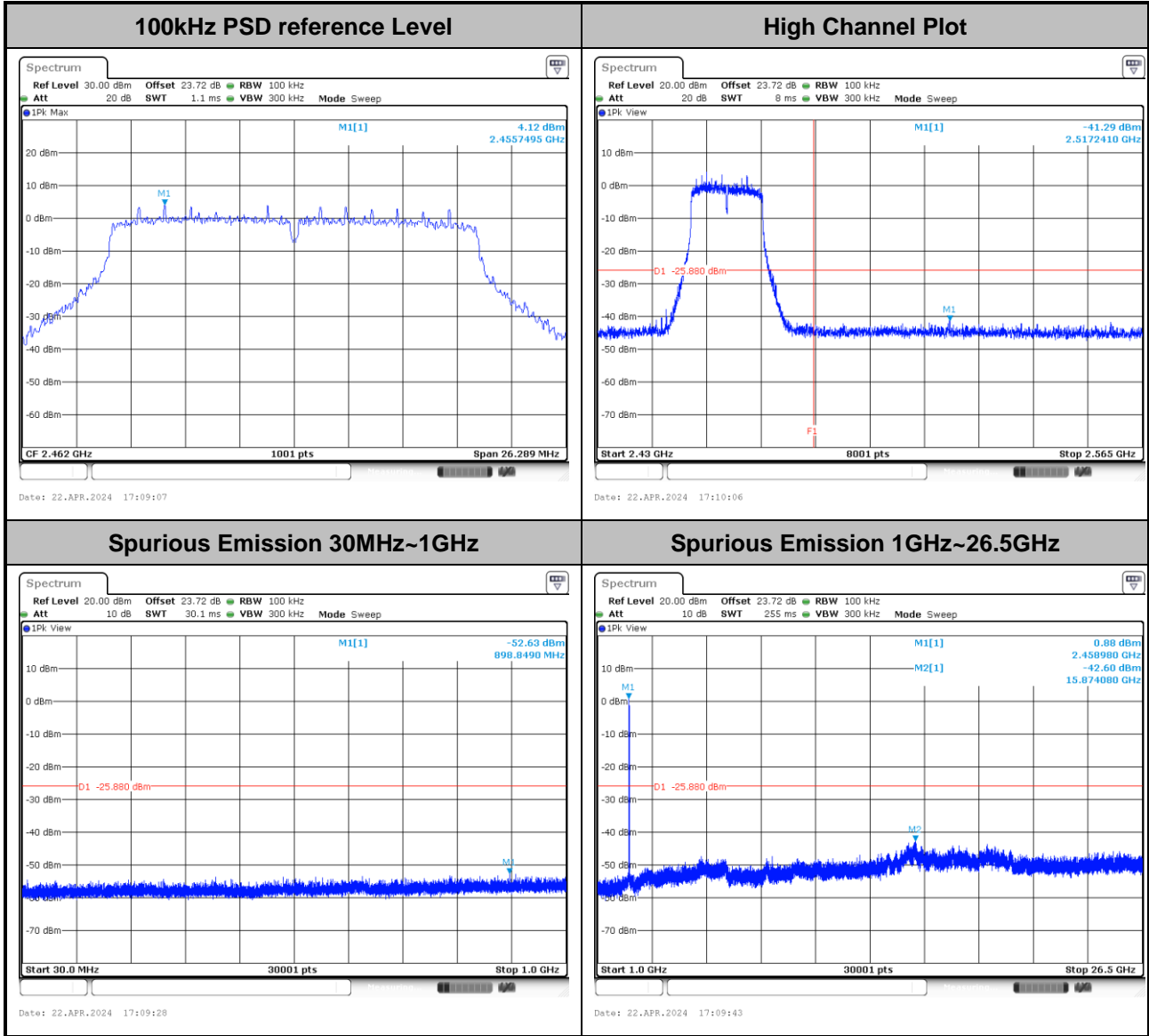



Test Mode :	802.11ac VHT40	Test Channel :	03
-------------	----------------	----------------	----

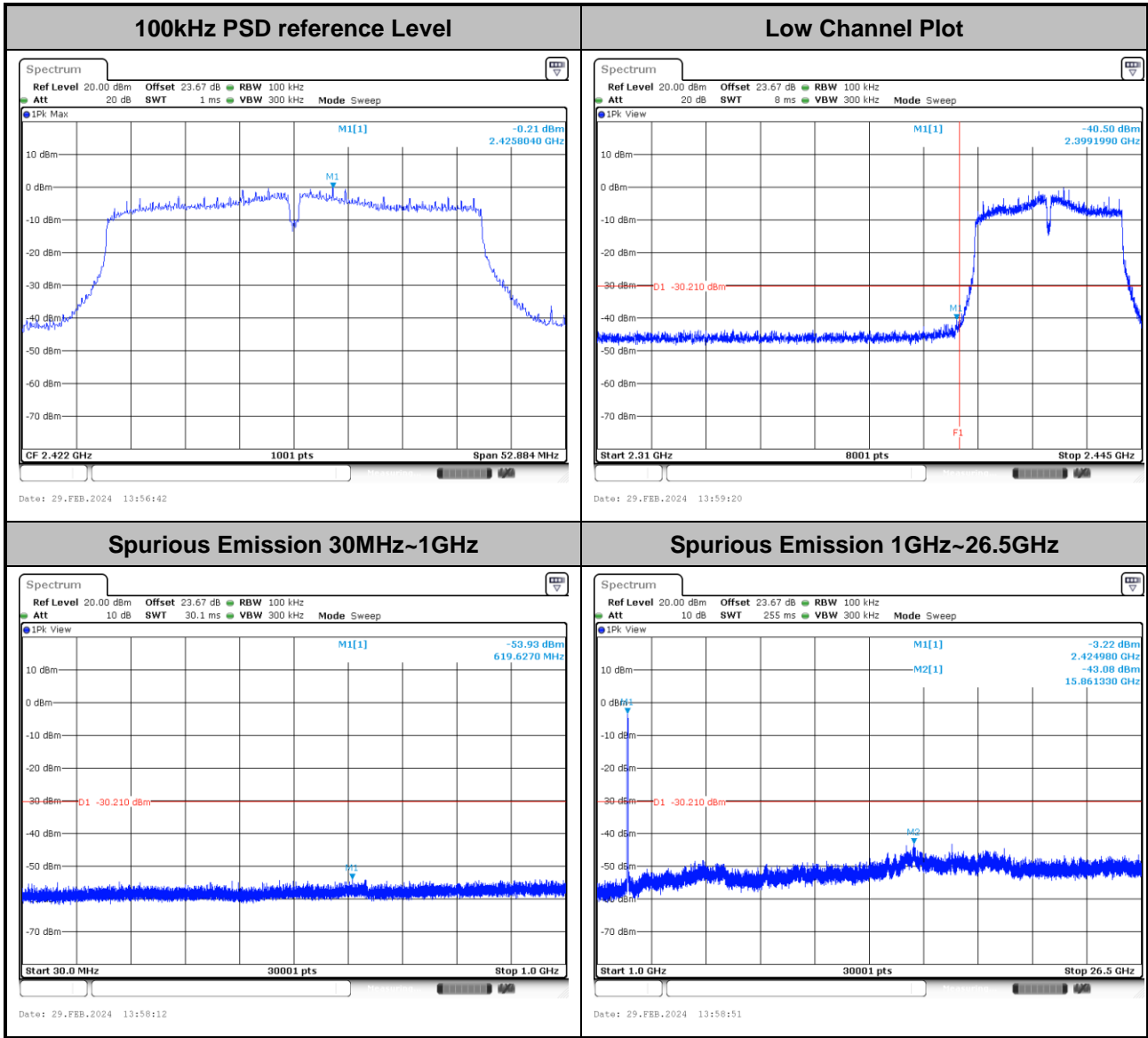



Test Mode :	802.11ac VHT40	Test Channel :	06
-------------	----------------	----------------	----

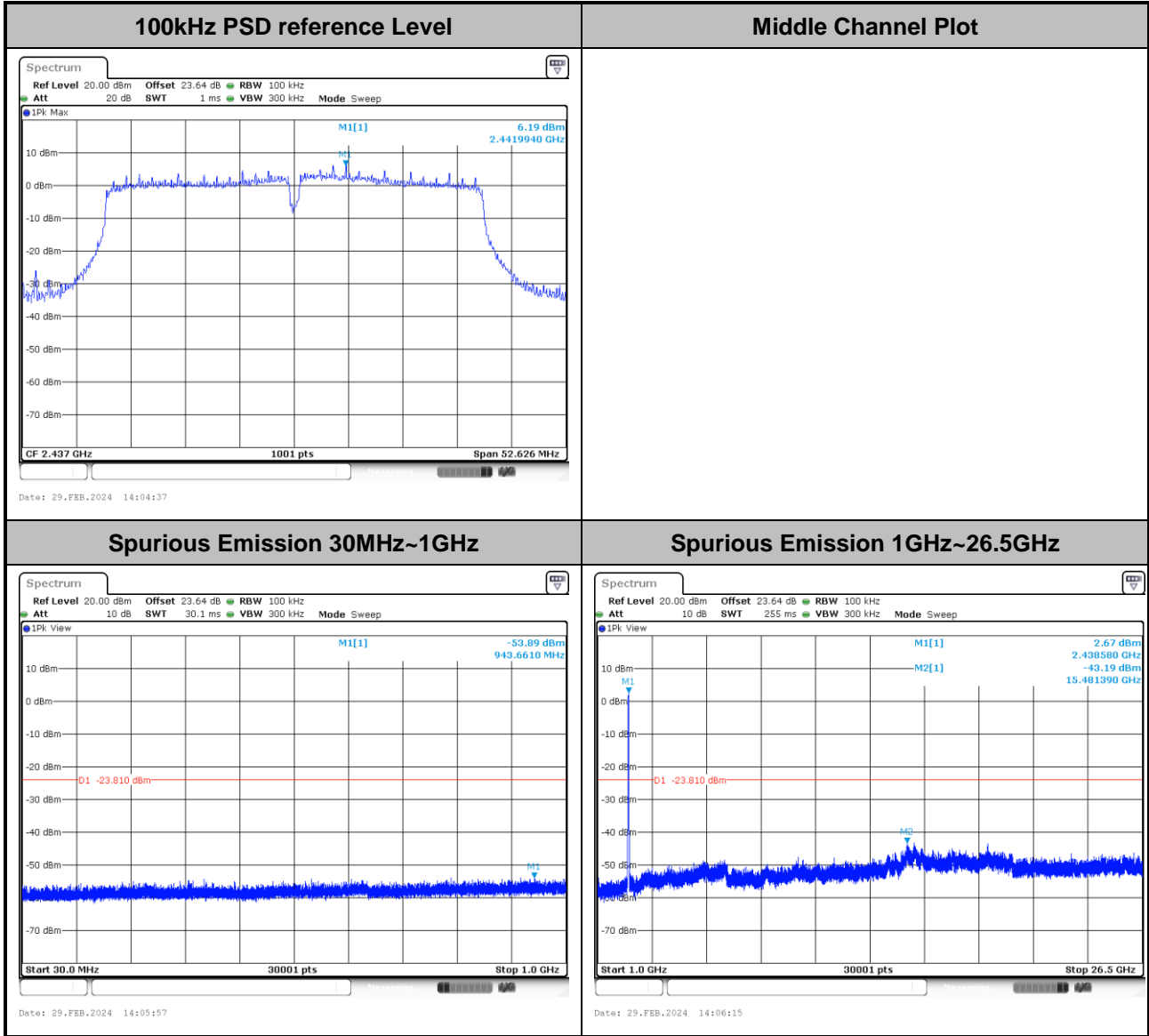



Test Mode :	802.11ac VHT40	Test Channel :	09
-------------	----------------	----------------	----

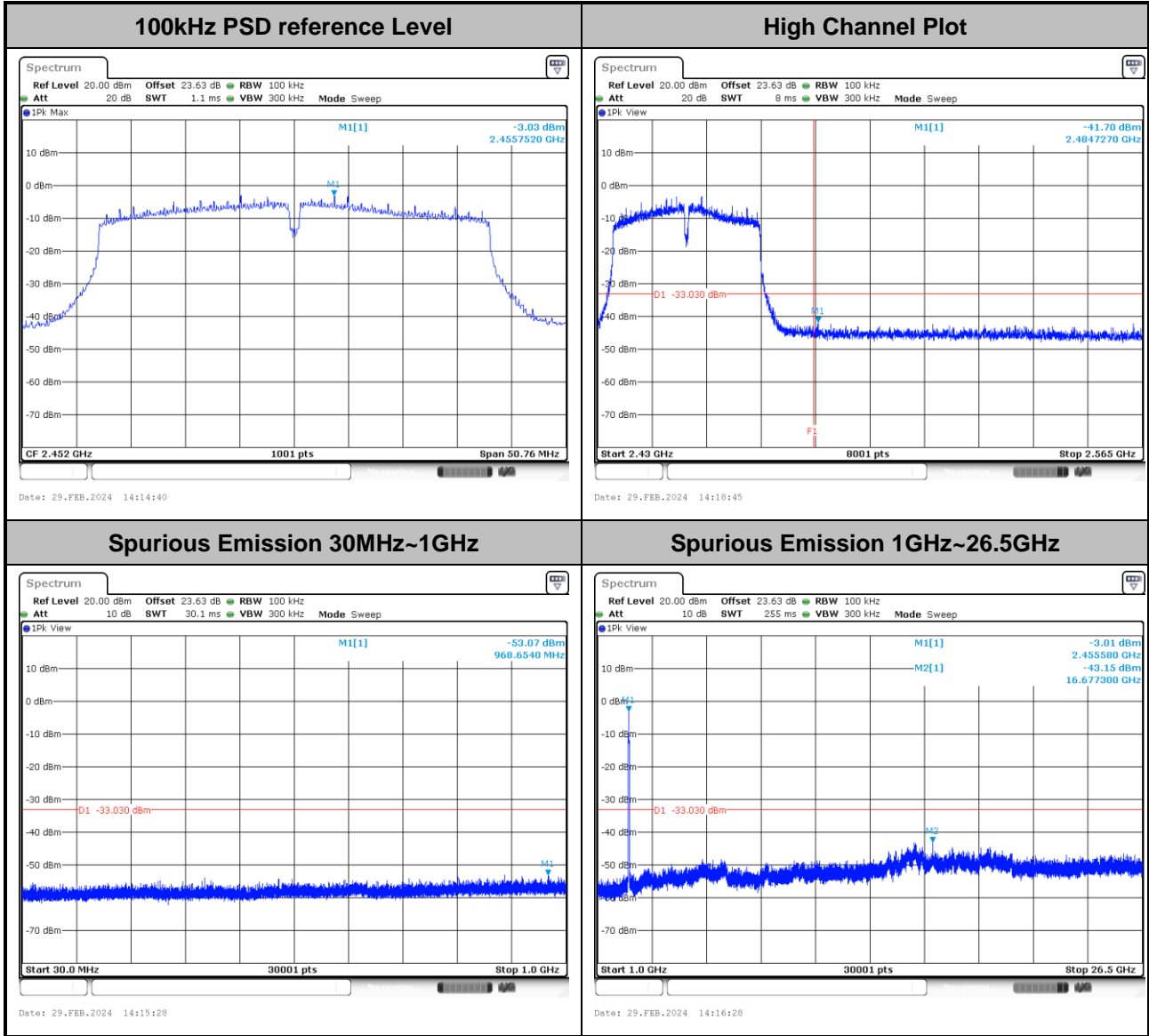



Test Mode :	802.11ax HE20_Full RU	Test Channel :	01
-------------	-----------------------	----------------	----

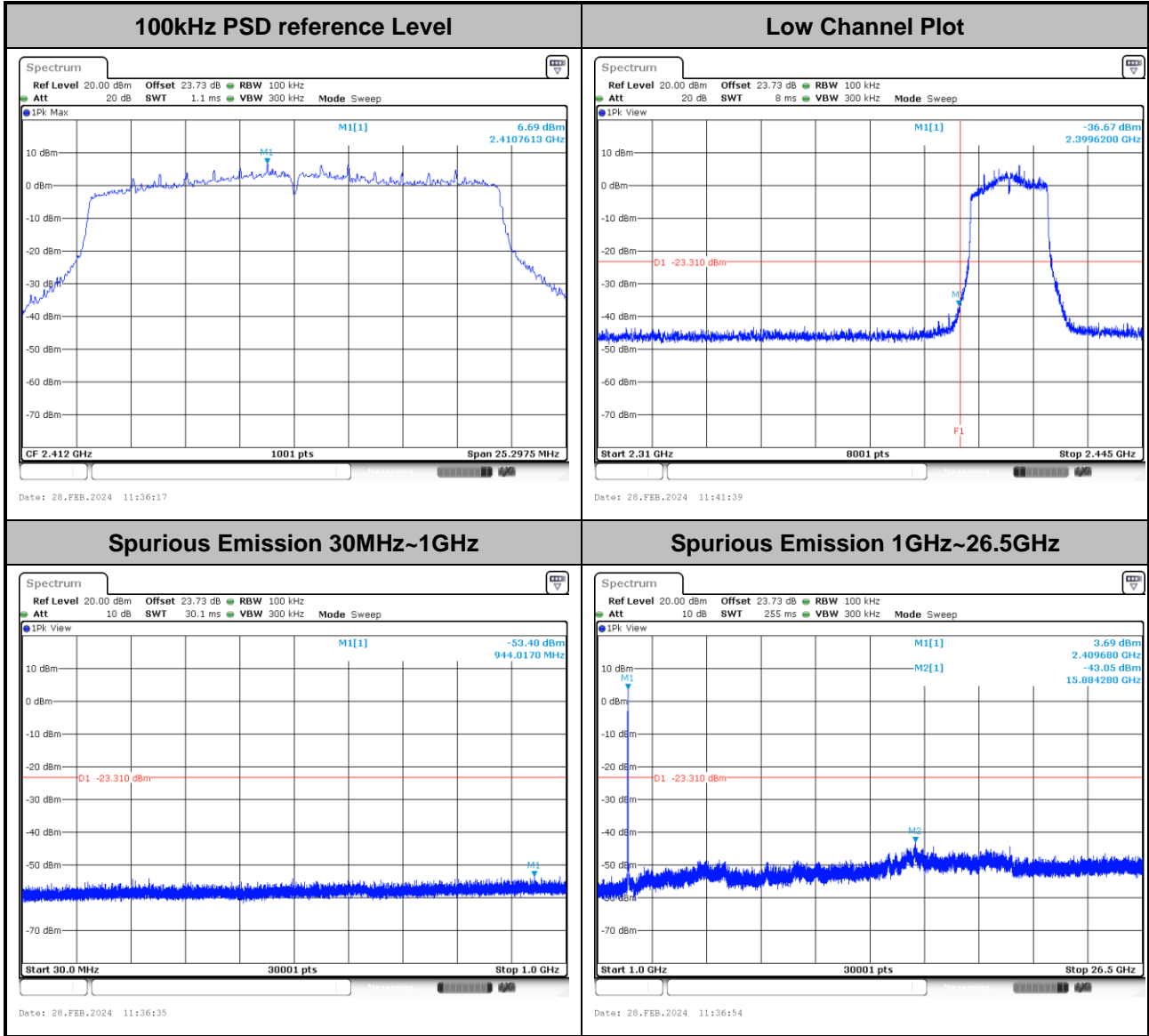



Test Mode :	802.11ax HE20_Full RU	Test Channel :	06
-------------	-----------------------	----------------	----

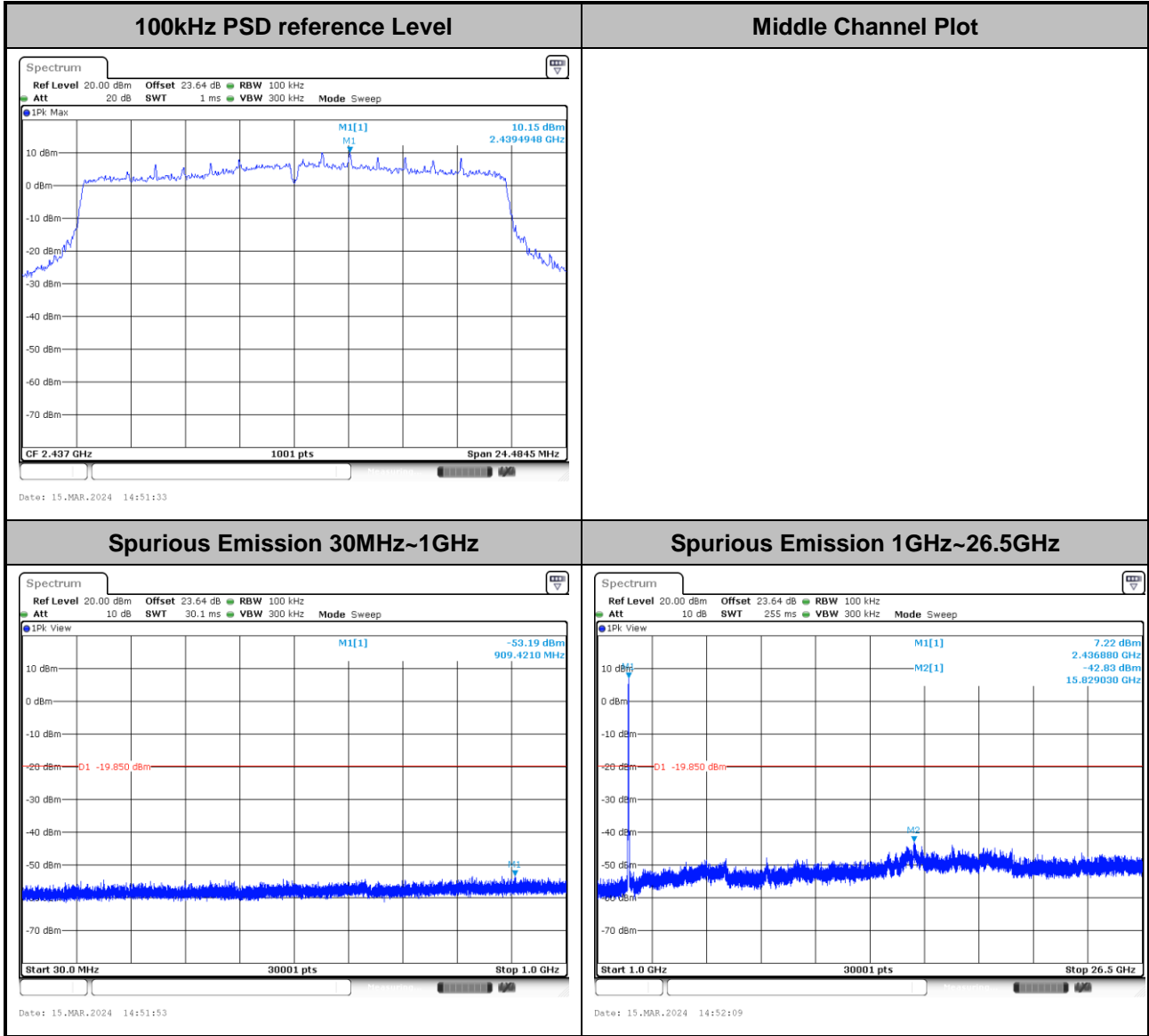



Test Mode :	802.11ax HE20_Full RU	Test Channel :	11
-------------	-----------------------	----------------	----

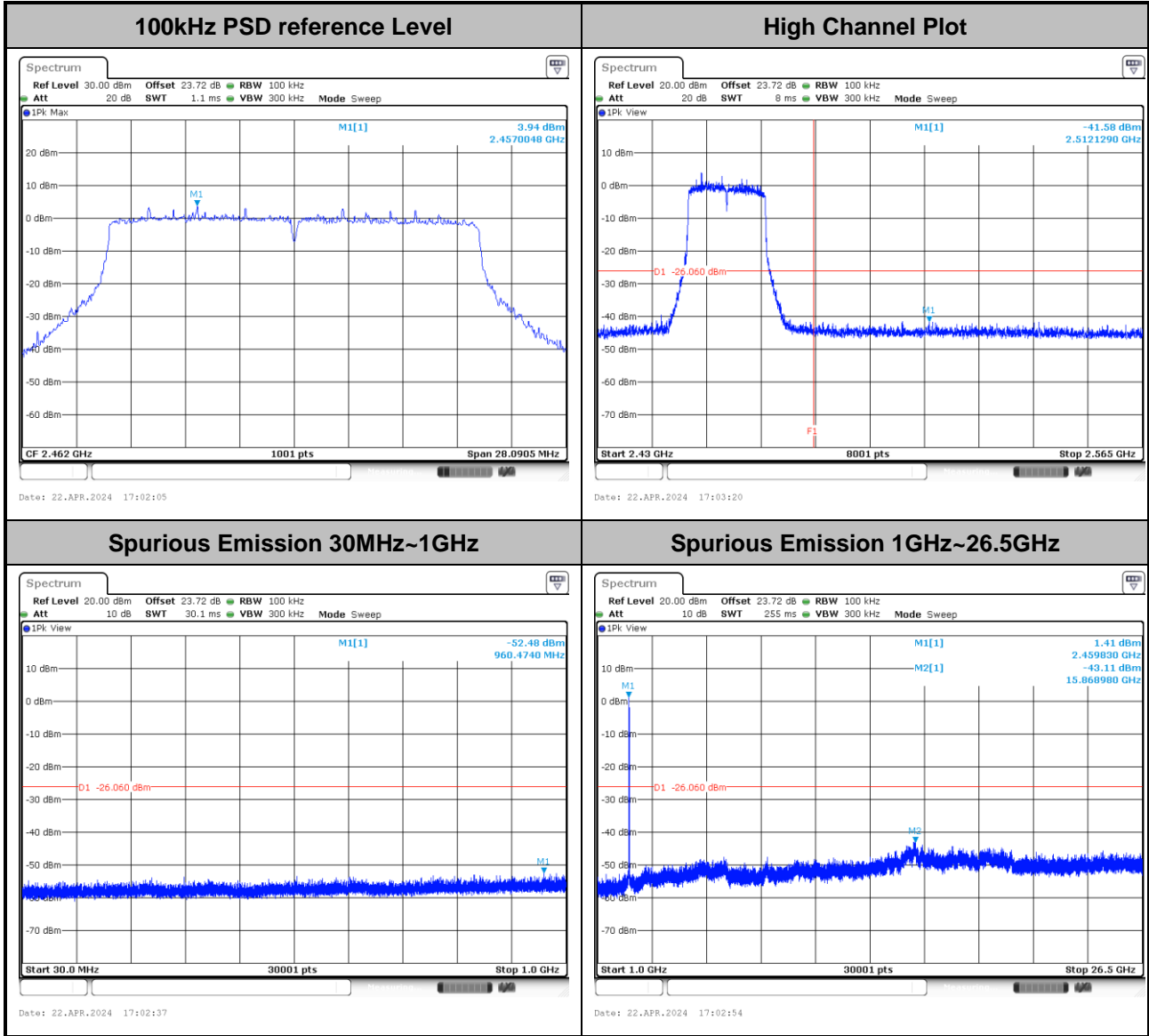



Test Mode :	802.11ax HE40_Full RU	Test Channel :	03
-------------	-----------------------	----------------	----

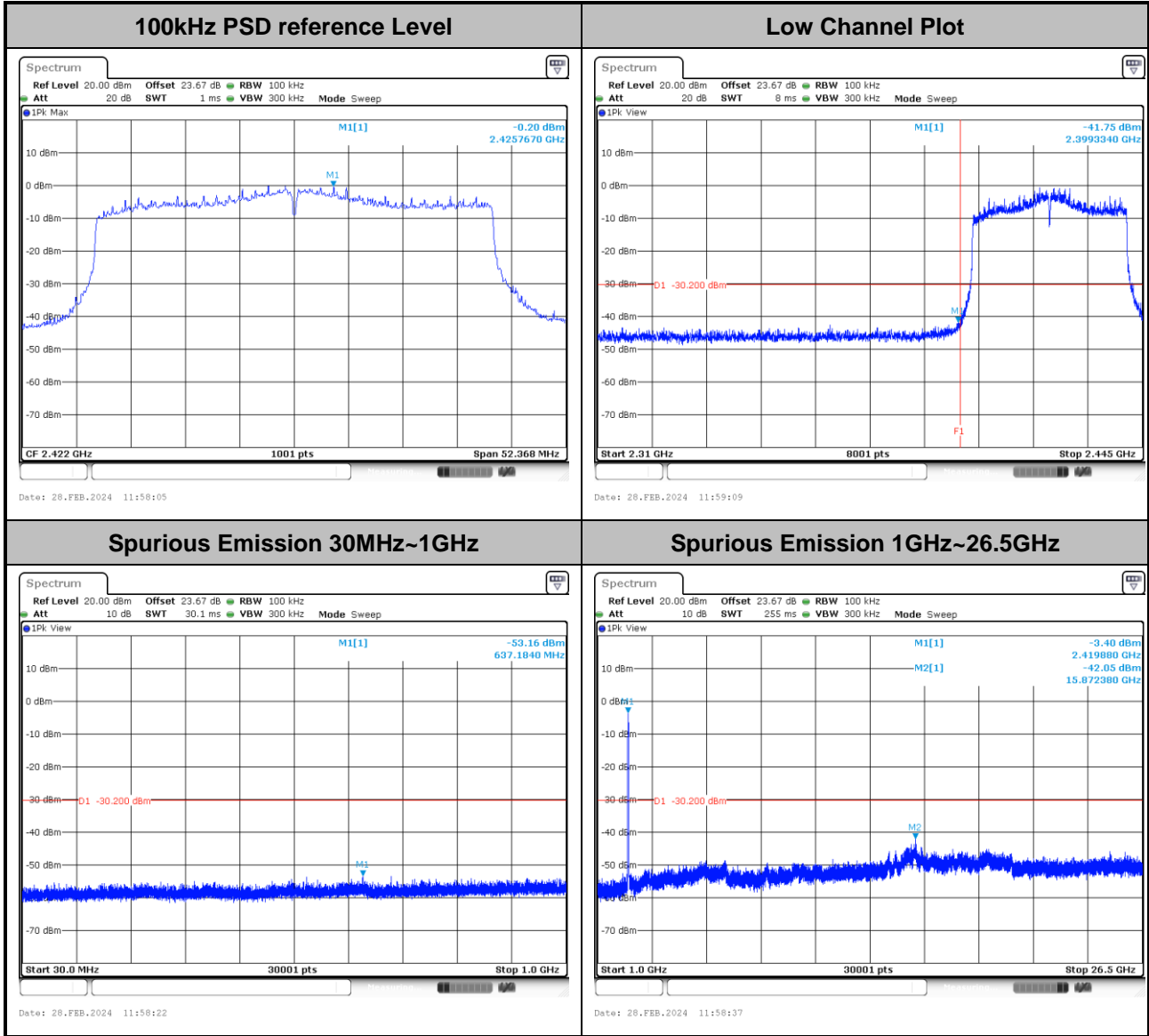



Test Mode :	802.11ax HE40_Full RU	Test Channel :	06
-------------	-----------------------	----------------	----

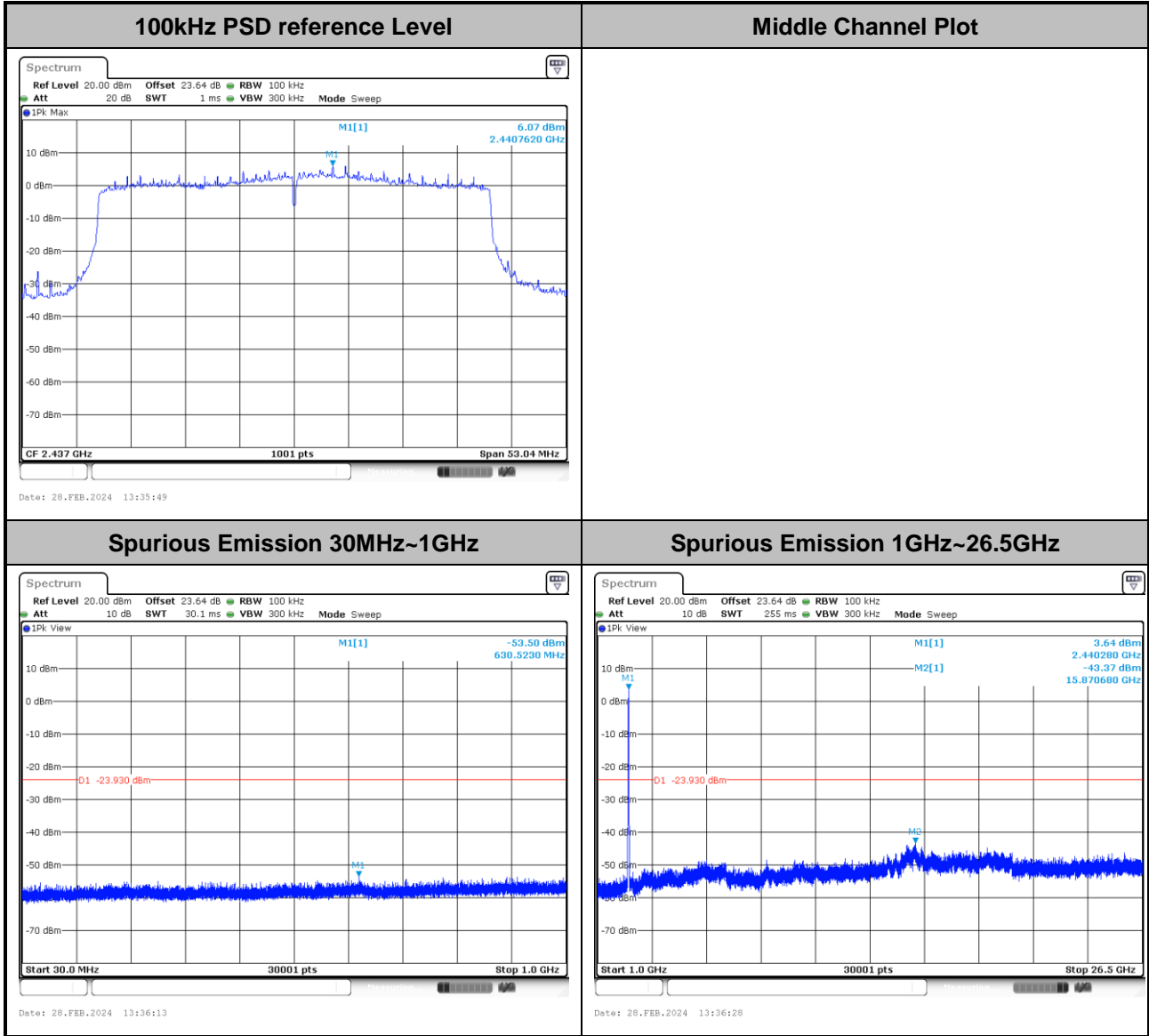



Test Mode :	802.11ax HE40_Full RU	Test Channel :	09
-------------	-----------------------	----------------	----

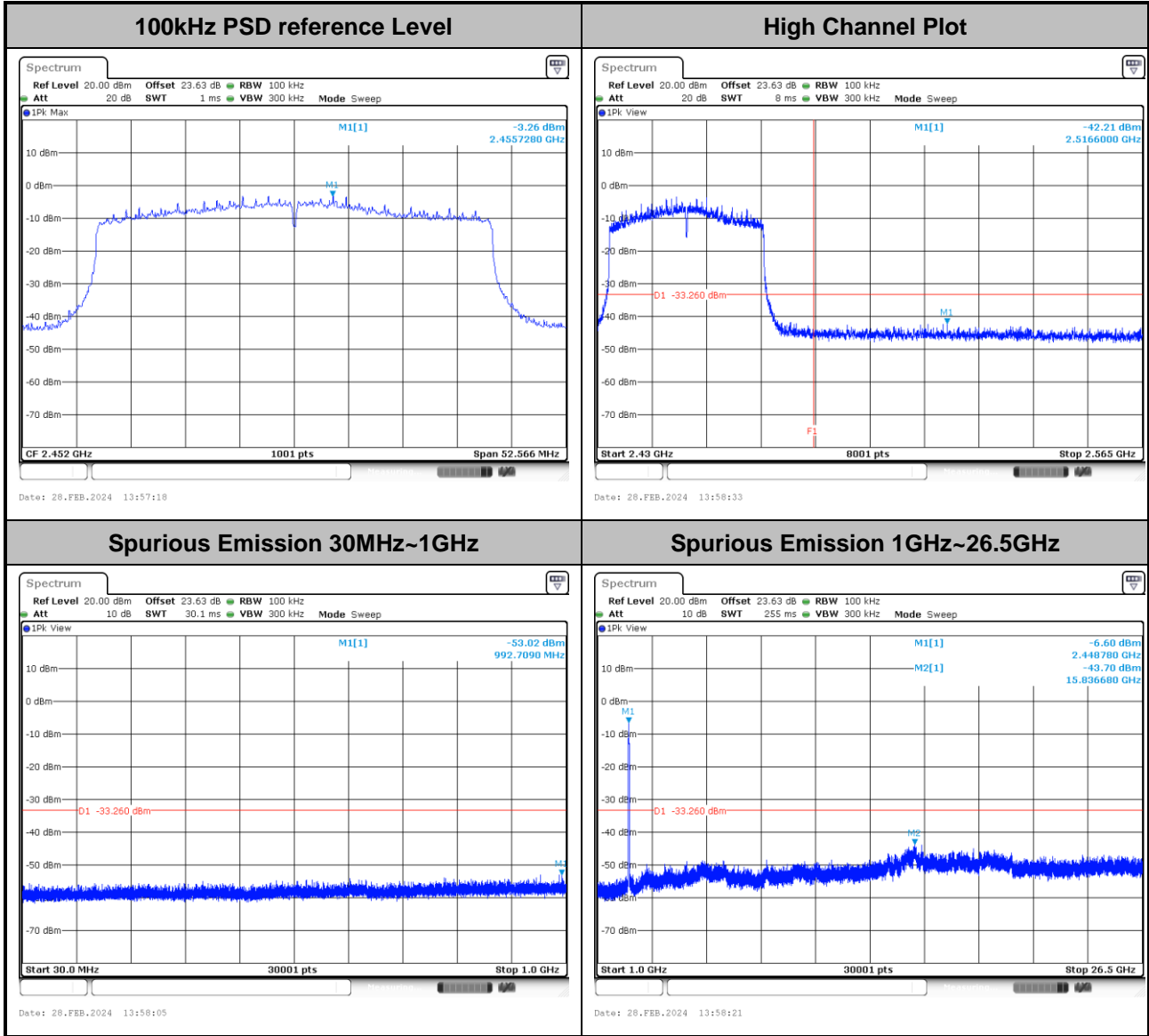



Number of TX = 2, Ant. 7 (Measured)

Test Mode :	802.11b	Test Channel :	01
-------------	---------	----------------	----

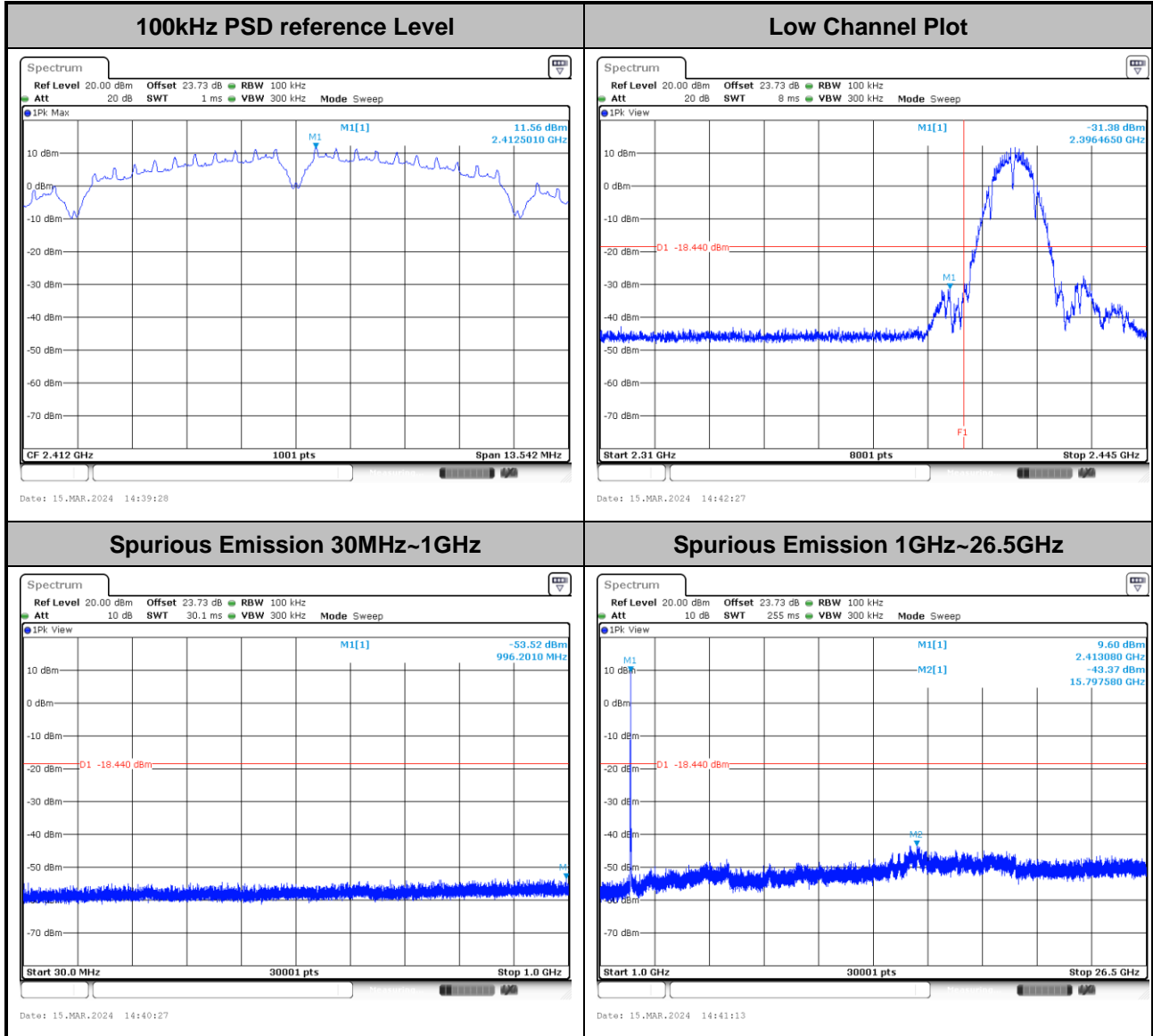



Test Mode :	802.11b	Test Channel :	06
-------------	---------	----------------	----

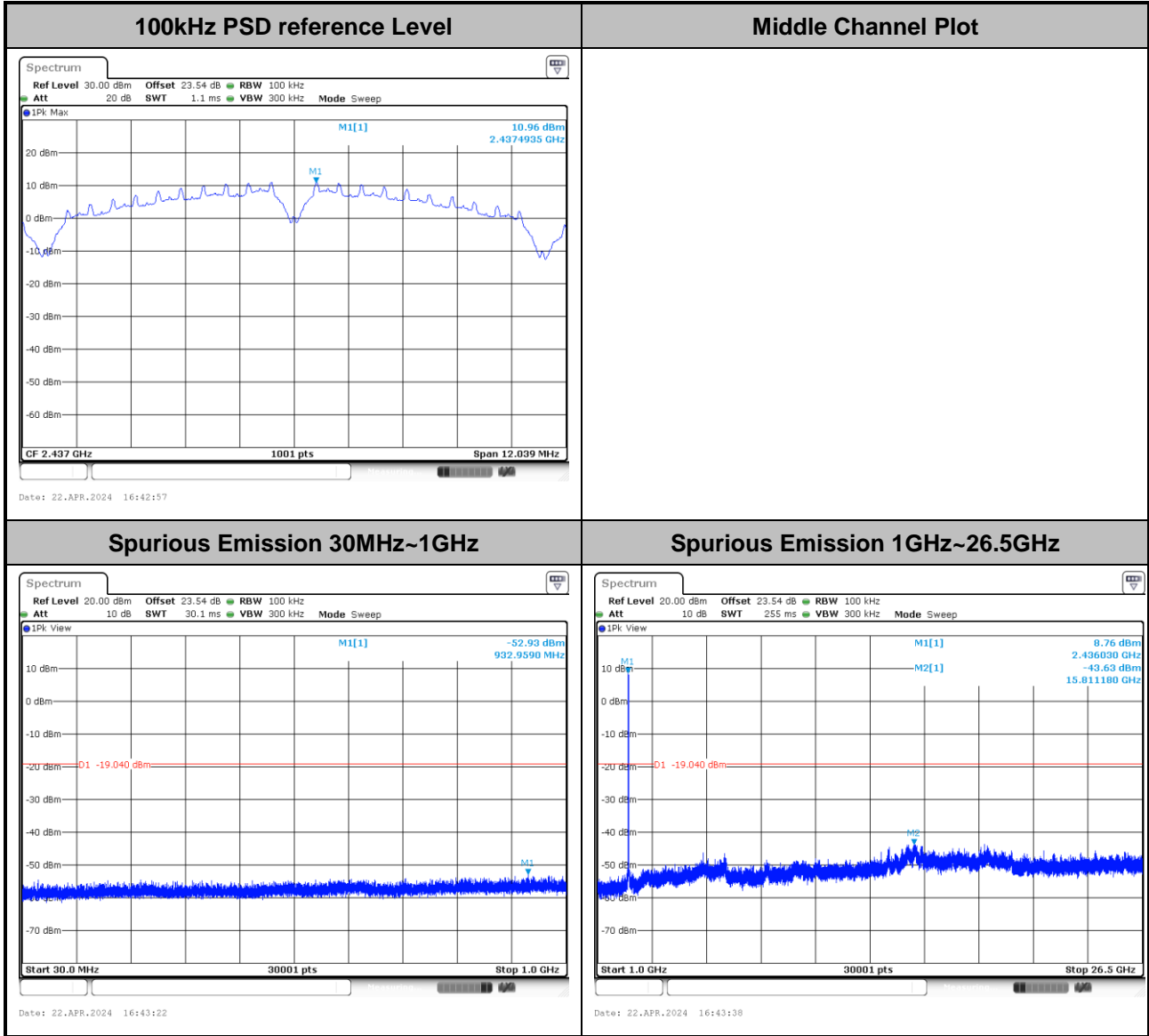



Test Mode :	802.11b	Test Channel :	11
-------------	---------	----------------	----

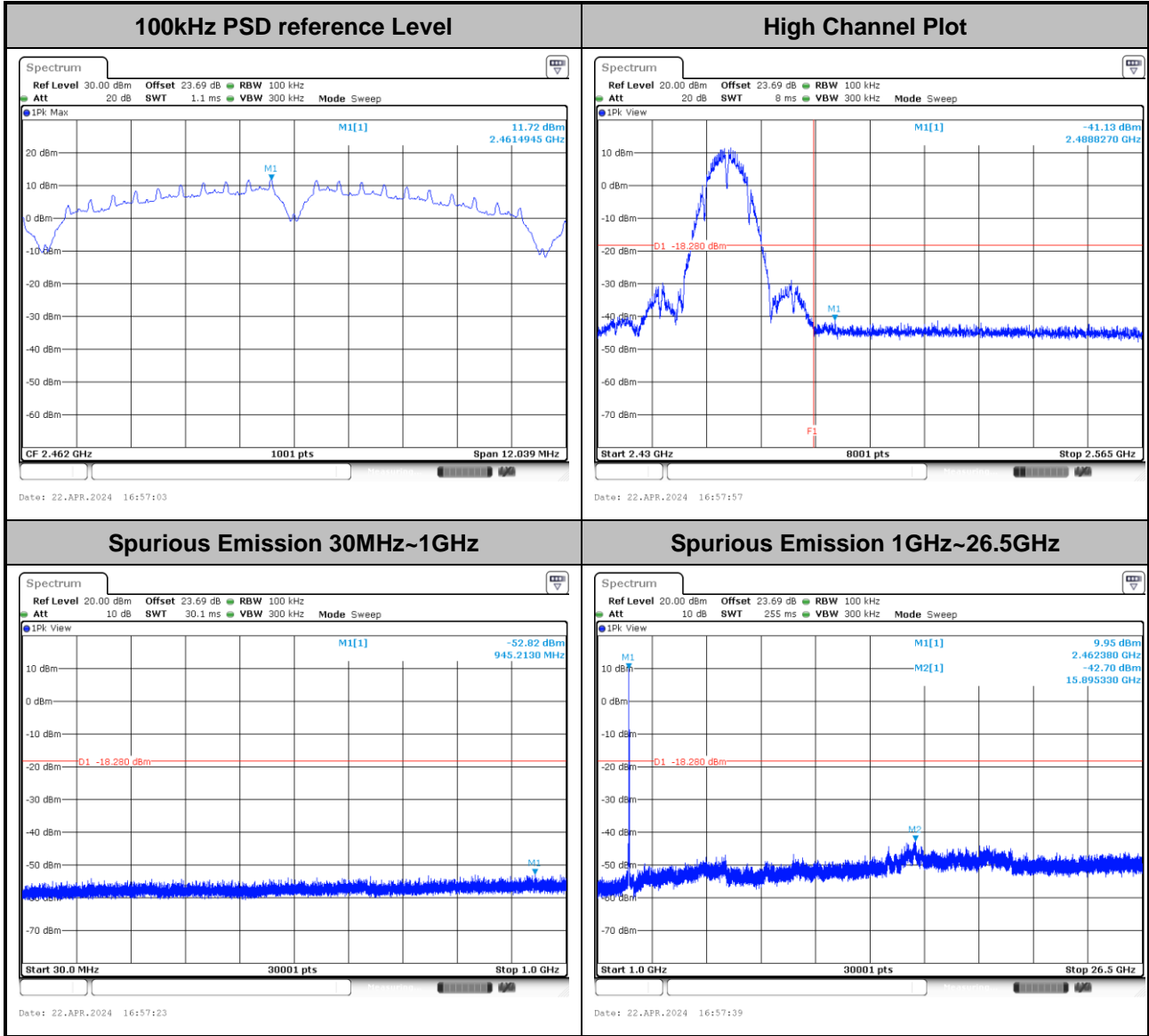



Test Mode :	802.11g	Test Channel :	01
-------------	---------	----------------	----

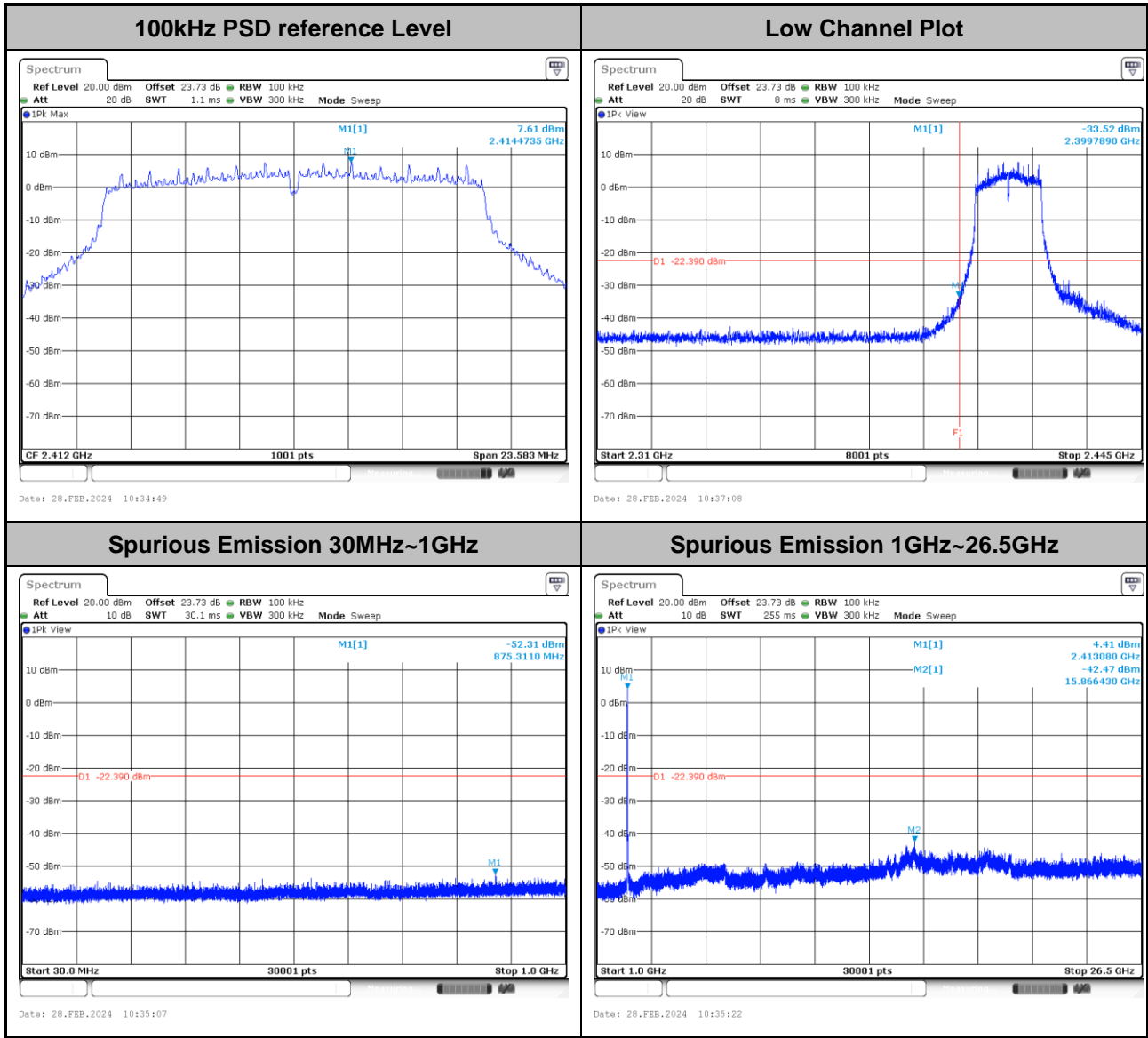



Test Mode :	802.11g	Test Channel :	06
-------------	---------	----------------	----

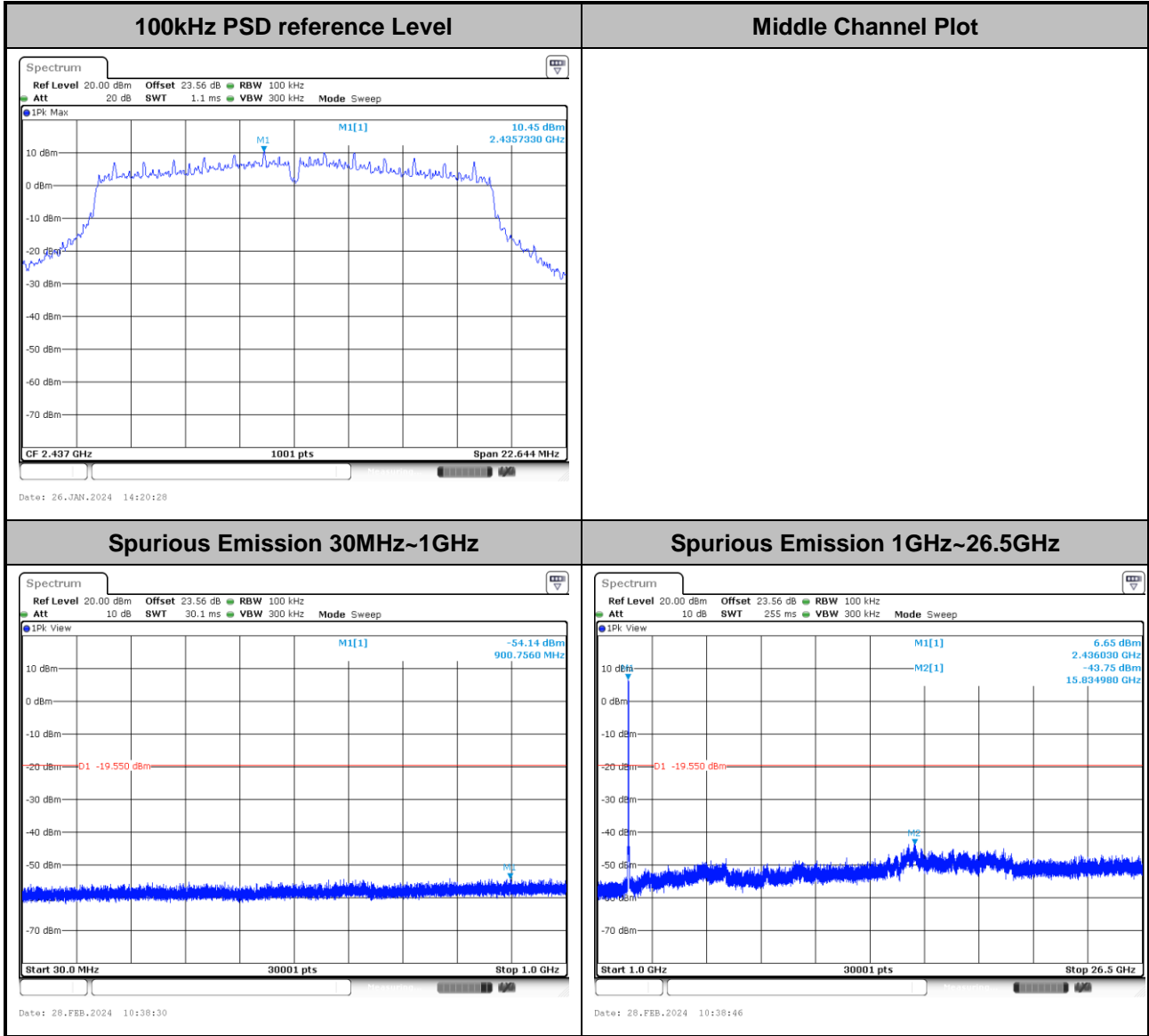



Test Mode :	802.11g	Test Channel :	11
-------------	---------	----------------	----

