



FCC RADIO TEST REPORT

FCC ID : UZ7TC58A1
Equipment : Touch Computer
Brand Name : Zebra
Model Name : TC58A1
Applicant : Zebra Technologies Corporation
1 Zebra Plaza, Holtsville, NY 11742
Manufacturer : Zebra Technologies Corporation
1 Zebra Plaza, Holtsville, NY 11742
Standard : FCC Part 15 Subpart C §15.247

The product was received on Feb. 21, 2022 and testing was performed from Feb. 24, 2022 to Apr. 12, 2022. We, Sporton International Inc. Wensan Laboratory, would like to declare that the tested sample has been evaluated in accordance with the test procedures and has been in compliance with the applicable technical standards.

The test results in this report apply exclusively to the tested model / sample. Without written approval from Sporton International Inc. Wensan Laboratory, the test report shall not be reproduced except in full.

Approved by: Louis Wu

Sporton International Inc. Wensan Laboratory

No.58, Aly. 75, Ln. 564, Wenhua 3rd, Rd., Guishan Dist., Taoyuan City 333010, Taiwan (R.O.C.)



Table of Contents

History of this test report.....	3
Summary of Test Result.....	4
1 General Description.....	5
1.1 Product Feature of Equipment Under Test.....	5
1.2 Product Specification of Equipment Under Test.....	6
1.3 Modification of EUT	6
1.4 Testing Location	7
1.5 Applicable Standards.....	7
2 Test Configuration of Equipment Under Test.....	8
2.1 Carrier Frequency Channel	8
2.2 Test Mode.....	9
2.3 Connection Diagram of Test System.....	11
2.4 Support Unit used in test configuration and system	12
2.5 EUT Operation Test Setup	12
2.6 Measurement Results Explanation Example.....	12
3 Test Result.....	13
3.1 6dB and 99% Bandwidth Measurement	13
3.2 Output Power Measurement.....	20
3.3 Power Spectral Density Measurement	22
3.4 Conducted Band Edges and Spurious Emission Measurement	28
3.5 Radiated Band Edges and Spurious Emission Measurement	34
3.6 AC Conducted Emission Measurement.....	38
3.7 Antenna Requirements.....	40
4 List of Measuring Equipment	41
5 Uncertainty of Evaluation.....	42
Appendix A. AC Conducted Emission Test Result	
Appendix B. Radiated Spurious Emission	
Appendix C. Radiated Spurious Emission Plots	
Appendix D. Duty Cycle Plots	
Appendix E. Setup Photographs	



History of this test report

Report No.	Version	Description	Issue Date
FR222202B	01	Initial issue of report	Jun. 17, 2022



Summary of Test Result

Report Clause	Ref Std. Clause	Test Items	Result (PASS/FAIL)	Remark
3.1	15.247(a)(2)	6dB Bandwidth	Pass	-
3.1	2.1049	99% Occupied Bandwidth	Reporting only	-
3.2	15.247(b)(3)	Output Power	Pass	-
3.3	15.247(e)	Power Spectral Density	Pass	-
3.4	15.247(d)	Conducted Band Edges and Spurious Emission	Pass	-
3.5	15.247(d)	Radiated Band Edges and Spurious Emission	Pass	4.69 dB under the limit at 2487.000 MHz
3.6	15.207	AC Conducted Emission	Pass	17.47 dB under the limit at 0.240 MHz
3.7	15.203 & 15.247(b)	Antenna Requirement	Pass	-

Declaration of Conformity:

1. The test results (PASS/FAIL) with all measurement uncertainty excluded are presented in accordance with the regulation limits or requirements declared by manufacturers. It's means measurement values may risk exceeding the limit of regulation standards, if measurement uncertainty is include in test results.
2. The measurement uncertainty please refer to this report "Uncertainty of Evaluation".

Comments and Explanations:

The product specifications of the EUT presented in the report are declared by the manufacturer who shall take full responsibility for the authenticity.

Reviewed by: Wei Chen**Report Producer: Kaye Yang**



1 General Description

1.1 Product Feature of Equipment Under Test

Product Feature	
Equipment	Touch Computer
Brand Name	Zebra
Model Name	TC58A1
FCC ID	UZ7TC58A1
Sample 1	Lowell + Premium config
Sample 2	SE4720 + Base config
Sample 3	Lowell + Base config
EUT supports Radios application	GSM/EGPRS/WCDMA/HSPA/LTE/5G NR/NFC/GNSS WLAN 11a/b/g/n HT20/HT40 WLAN 11ac VHT20/VHT40/VHT80/VHT160 WLAN 11ax HE20/HE40/HE80/HE160 Bluetooth BR/EDR/LE
HW Version	EV3
SW Version	athena_A11_userdebug_GMS_RelKey_2022-02-22-21 45_product_SE
FW Version	FUSION_QA_4_1.0.0.013_R
MFD	19FEB22
EUT Stage	Identical Prototype

Remark: The above EUT's information was declared by manufacturer.

Specification of Accessories			
Adapter	Brand Name	Zebra	Part Number PWR-WUA5V12W0US
Battery 1X	Brand Name	Zebra	Part Number BT-000442-0020
Battery 1.5X	Brand Name	Zebra	Part Number BT-000442-0820
USB TYPE A to TYPE C cable	Brand Name	Zebra	Part Number CBL-TC5X-USBC2A-01
USB TYPE C to 3.5mm audio connector	Brand Name	Zebra	Part Number ADP-USBC-35MM1-01
3.5mm Earphone	Brand Name	Zebra	Part Number HDST-35MM-PTVP-01
USB TYPE C Earphone	Brand Name	Zebra	Part Number HPST-USBC-PTT1-01
Headset Jumper	Brand Name	Zebra	Part Number CBL-TC51-HDST35-01
Trigger Handle	Brand Name	Zebra	Part Number TRG-NGTC5-ELEC-01
Soft Holster	Brand Name	Zebra	Part Number SG-NGTC5TC7-HLSTR-01
TC53/TC58 RUGGED BOOT	Brand Name	Zebra	Part Number SG-NGTC5EXO1-01



1.2 Product Specification of Equipment Under Test

Product Specification is subject to this standard	
Tx/Rx Frequency Range	2402 MHz ~ 2480 MHz
Number of Channels	40
Carrier Frequency of Each Channel	40 Channel (37 hopping + 3 advertising channel)
Maximum Output Power to Antenna	Bluetooth – LE (1Mbps): 3.80 dBm / 0.0024 W Bluetooth – LE (2Mbps): 3.80 dBm / 0.0024 W
99% Occupied Bandwidth	1.017 MHz for 1Mbps 2.002 MHz for 2Mbps
Antenna Type / Gain	PIFA Antenna type with gain 2.40 dBi
Type of Modulation	Bluetooth LE : GFSK

Remark: The EUT's information above is declared by manufacturer. Please refer to Comments and Explanations in report summary.

1.3 Modification of EUT

No modifications made to the EUT during the testing.



1.4 Testing Location

Test Site	Sporton International Inc. EMC & Wireless Communications Laboratory
Test Site Location	No.52, Huaya 1st Rd., Guishan Dist., Taoyuan City 333, Taiwan (R.O.C.) TEL: +886-3-327-3456 FAX: +886-3-328-4978
Test Site No.	Sporton Site No. CO05-HY (TAF Code: 1190)
Remark	The Conducted Emission test item subcontracted to Sporton International Inc. EMC & Wireless Communications Laboratory.

Note: The test site complies with ANSI C63.4 2014 requirement.

Test Site	Sporton International Inc. Wensan Laboratory
Test Site Location	No.58, Aly. 75, Ln. 564, Wenhua 3rd, Rd., Guishan Dist., Taoyuan City 333010, Taiwan (R.O.C.) TEL: +886-3-327-0868 FAX: +886-3-327-0855
Test Site No.	Sporton Site No. TH05-HY, 03CH16-HY

Note: The test site complies with ANSI C63.4 2014 requirement.

FCC designation No.: TW1190 and TW3786

1.5 Applicable Standards

According to the specifications declared by the manufacturer, the EUT must comply with the requirements of the following standards:

- ♦ FCC Part 15 Subpart C §15.247
- ♦ FCC KDB Publication No. 558074 D01 DTS Meas. Guidance v05r02
- ♦ FCC KDB 414788 D01 Radiated Test Site v01r01
- ♦ ANSI C63.10-2013

Remark:

1. All the test items were validated and recorded in accordance with the standards without any modification during the testing.
2. The TAF code is not including all the FCC KDB listed without accreditation.
3. This EUT has also been tested and complied with the requirements of FCC Part 15, Subpart B, recorded in a separate test report.



2 Test Configuration of Equipment Under Test

2.1 Carrier Frequency Channel

Frequency Band	Channel	Freq. (MHz)	Channel	Freq. (MHz)
2400-2483.5 MHz	0	2402	21	2444
	1	2404	22	2446
	2	2406	23	2448
	3	2408	24	2450
	4	2410	25	2452
	5	2412	26	2454
	6	2414	27	2456
	7	2416	28	2458
	8	2418	29	2460
	9	2420	30	2462
	10	2422	31	2464
	11	2424	32	2466
	12	2426	33	2468
	13	2428	34	2470
	14	2430	35	2472
	15	2432	36	2474
	16	2434	37	2476
	17	2436	38	2478
	18	2438	39	2480
	19	2440	-	-
20	2442	-	-	

2.2 Test Mode

Channel	Frequency	Bluetooth – LE RF Average Output Power	
		Data Rate / Modulation	
		GFSK	
		1Mbps	
Ch00	2402MHz	3.80 dBm	
Ch19	2440MHz	3.70 dBm	
Ch39	2480MHz	3.60 dBm	

Channel	Frequency	Bluetooth – LE RF Average Output Power	
		Data Rate / Modulation	
		GFSK	
		2Mbps	
Ch00	2402MHz	3.80 dBm	
Ch19	2440MHz	3.70 dBm	
Ch39	2480MHz	3.60 dBm	

- a. The EUT has been associated with peripherals and configuration operated in a manner tended to maximize its emission characteristics in a typical application. Frequency range investigated: conduction emission (150 kHz to 30 MHz), radiation emission (9 kHz to the 10th harmonic of the highest fundamental frequency or to 40 GHz, whichever is lower). For radiated measurement, the measured emission level of the EUT was maximized by rotating the EUT on a turntable, adjusting the orientation of the EUT and EUT antenna in three orthogonal axis (X: flat, Y: portrait, Z: landscape), and adjusting the measurement antenna orientation, following C63.10 exploratory test procedures and find Y plane as worst plane.
- b. AC power line Conducted Emission was tested under maximum output power.



The following summary table is showing all test modes to demonstrate in compliance with the standard.

Summary table of Test Cases	
Test Item	Data Rate / Modulation
Conducted Test Cases	Bluetooth – LE / GFSK
	Mode 1: Bluetooth Tx CH00_2402 MHz_1Mbps
	Mode 2: Bluetooth Tx CH19_2440 MHz_1Mbps
	Mode 3: Bluetooth Tx CH39_2480 MHz_1Mbps
	Mode 4: Bluetooth Tx CH00_2402 MHz_2Mbps
	Mode 5: Bluetooth Tx CH19_2440 MHz_2Mbps
	Mode 6: Bluetooth Tx CH39_2480 MHz_2Mbps
Radiated Test Cases	Mode 1: Bluetooth Tx CH00_2402 MHz_1Mbps
	Mode 2: Bluetooth Tx CH19_2440 MHz_1Mbps
	Mode 3: Bluetooth Tx CH39_2480 MHz_1Mbps
	Mode 4: Bluetooth Tx CH00_2402 MHz_2Mbps
	Mode 5: Bluetooth Tx CH19_2440 MHz_2Mbps
	Mode 6: Bluetooth Tx CH39_2480 MHz_2Mbps
AC Conducted Emission	Mode 1: WCDMA Band V Link + WLAN (2.4GHz) Link + Bluetooth Link + NFC on + USB TYPE A to TYPE C cable (Charging with Adapter) + Battery 1X for Sample 2
Remark: For Radiated Test Cases, the tests were performed with Battery 1X and Sample 2.	

2.3 Connection Diagram of Test System

<AC Conducted Emission Mode>

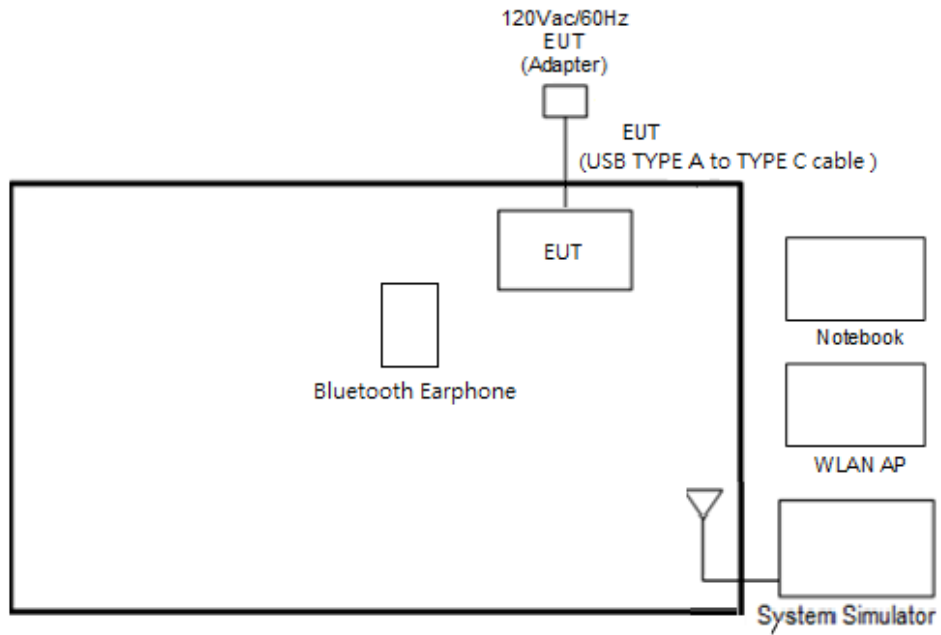

<Bluetooth – LE Tx Mode>

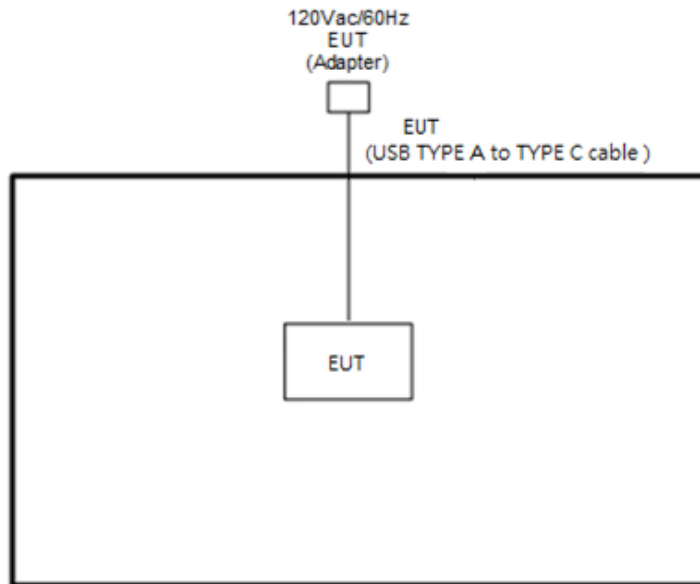



2.4 Support Unit used in test configuration and system

Item	Equipment	Brand Name	Model Name	FCC ID	Data Cable	Power Cord
1.	System Simulator	Anritsu	MT8820C	N/A	N/A	Unshielded, 1.8m
2.	Bluetooth Earphone	Sony Ericsson	MW600	PY700A2029	N/A	N/A
3.	WLAN AP	ASUS	RT-AC66U	MSQ-RTAC66U	N/A	N/A
4.	Notebook	DELL	Latitude 3400	FCC DoC	N/A	AC I/P: Unshielded, 1.2 m DC O/P: Shielded, 1.8 m
5.	SD Card	SanDisk	MicroSD HC	FCC DoC	N/A	N/A

2.5 EUT Operation Test Setup

The RF test items, utility “QRCT Ver.4.0.00197.0” was installed in Notebook which was programmed in order to make the EUT get into the engineering modes to provide channel selection, power level, data rate and the application type and for continuous transmitting signals.

2.6 Measurement Results Explanation Example

For all conducted test items:

The offset level is set in the spectrum analyzer to compensate the RF cable loss and attenuator factor between EUT conducted output port and spectrum analyzer. With the offset compensation, the spectrum analyzer reading level is exactly the EUT RF output level.

Example :

The spectrum analyzer offset is derived from RF cable loss and attenuator factor.

Offset = RF cable loss + attenuator factor.

Following shows an offset computation example with cable loss 4.2 dB and 10 dB attenuator.

$$\begin{aligned} \text{Offset(dB)} &= \text{RF cable loss(dB)} + \text{attenuator factor(dB)}. \\ &= 4.2 + 10 = 14.2 \text{ (dB)} \end{aligned}$$

3 Test Result

3.1 6dB and 99% Bandwidth Measurement

3.1.1 Limit of 6dB and 99% Bandwidth

The minimum 6 dB bandwidth shall be at least 500 kHz.

3.1.2 Measuring Instruments

Please refer to the measuring equipment list in this test report.

3.1.3 Test Procedures

1. The testing follows the ANSI C63.10 Section 6.9.3 (OBW) and 11.8.1 (6dB BW).
2. The RF output of EUT is connected to the spectrum analyzer by RF cable and attenuator. The path loss is compensated to the results for each measurement.
3. Set the maximum power setting and enable the EUT to transmit continuously.
4. Make the measurement with the spectrum analyzer's resolution bandwidth (RBW) = 100 kHz. Set the Video bandwidth (VBW) = 300 kHz. In order to make an accurate measurement. The 6dB bandwidth must be greater than 500 kHz.
5. For 99% Bandwidth Measurement, the spectrum analyzer's resolution bandwidth (RBW) is set 1-5% of the emission bandwidth and set the Video bandwidth (VBW) $\geq 3 * RBW$.
6. Measure and record the results in the test report.

3.1.4 Test Setup





3.1.5 Test Result of 6dB Bandwidth

Test Engineer :	Junyu Jhou	Temperature :	16.9~23.3°C
		Relative Humidity :	54.5~65.2%

Mod.	Data Rate	NTX	CH.	Freq. (MHz)	6dB BW (MHz)	6dB BW Limit (MHz)	Pass/Fail
BLE	1Mbps	1	0	2402	0.674	0.50	Pass
BLE	1Mbps	1	19	2440	0.676	0.50	Pass
BLE	1Mbps	1	39	2480	0.678	0.50	Pass

Mod.	Data Rate	NTX	CH.	Freq. (MHz)	6dB BW (MHz)	6dB BW Limit (MHz)	Pass/Fail
BLE	2Mbps	1	0	2402	1.160	0.50	Pass
BLE	2Mbps	1	19	2440	1.160	0.50	Pass
BLE	2Mbps	1	39	2480	1.168	0.50	Pass



<1Mbps>

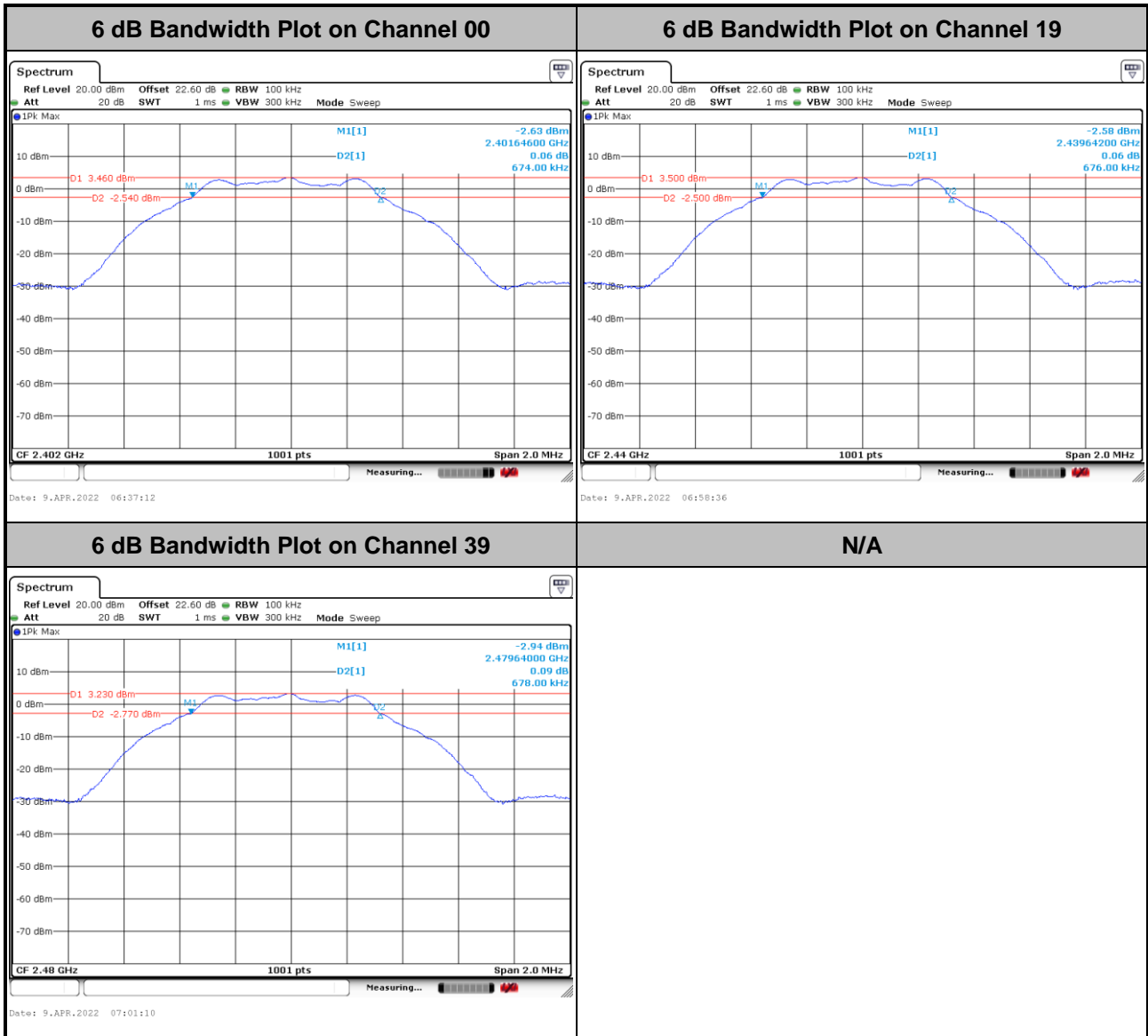



<2Mbps>

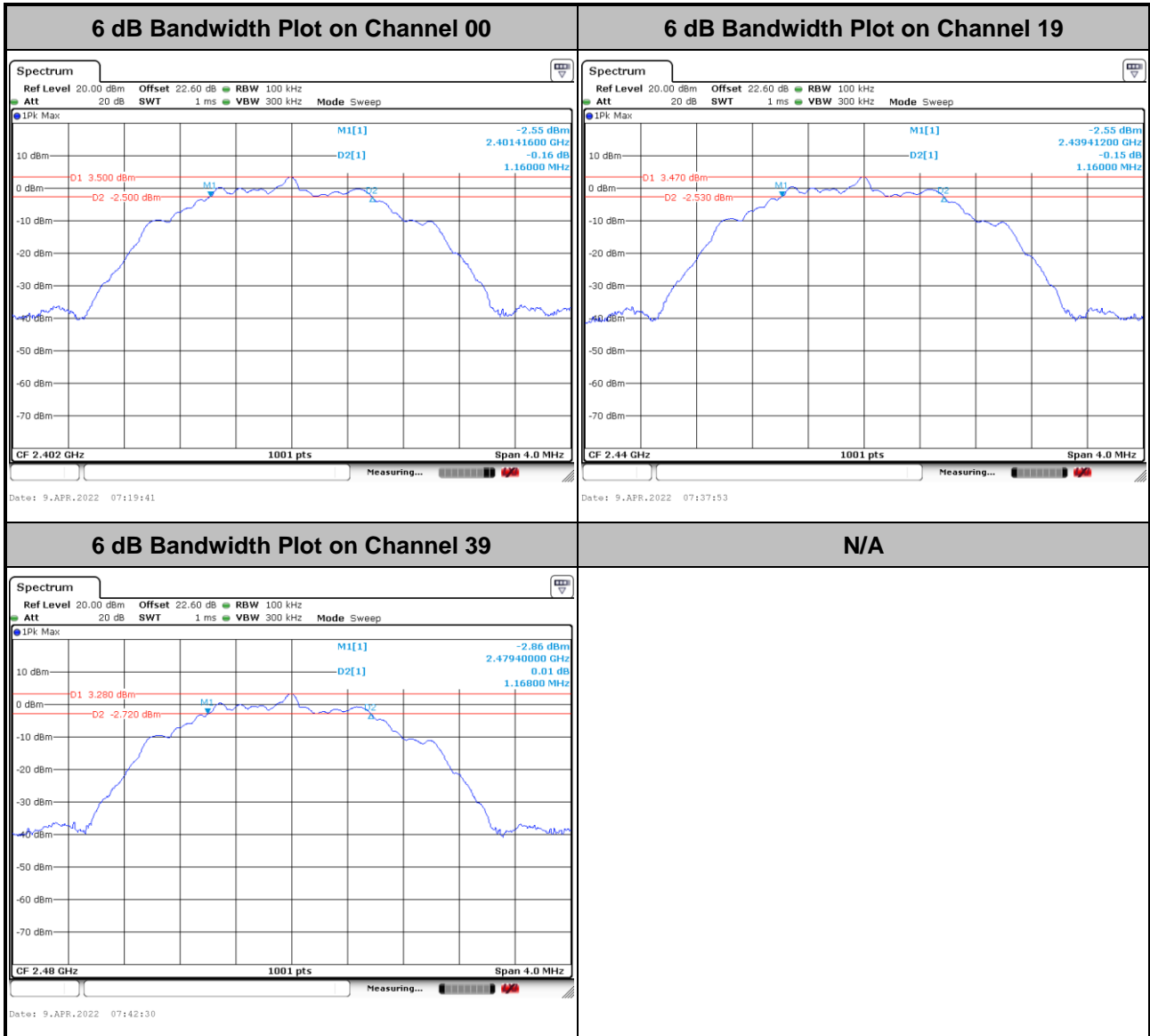



3.1.6 Test Result of 99% Occupied Bandwidth

Test Engineer :	Junyu Jhou	Temperature :	16.9~23.3°C
		Relative Humidity :	54.5~65.2%

Mod.	Data Rate	NTX	CH.	Freq. (MHz)	99% Occupied BW (MHz)	Pass/Fail
BLE	1Mbps	1	0	2402	1.015	Pass
BLE	1Mbps	1	19	2440	1.017	Pass
BLE	1Mbps	1	39	2480	1.015	Pass

Mod.	Data Rate	NTX	CH.	Freq. (MHz)	99% Occupied BW (MHz)	Pass/Fail
BLE	2Mbps	1	0	2402	2.002	Pass
BLE	2Mbps	1	19	2440	1.998	Pass
BLE	2Mbps	1	39	2480	1.944	Pass



<1Mbps>

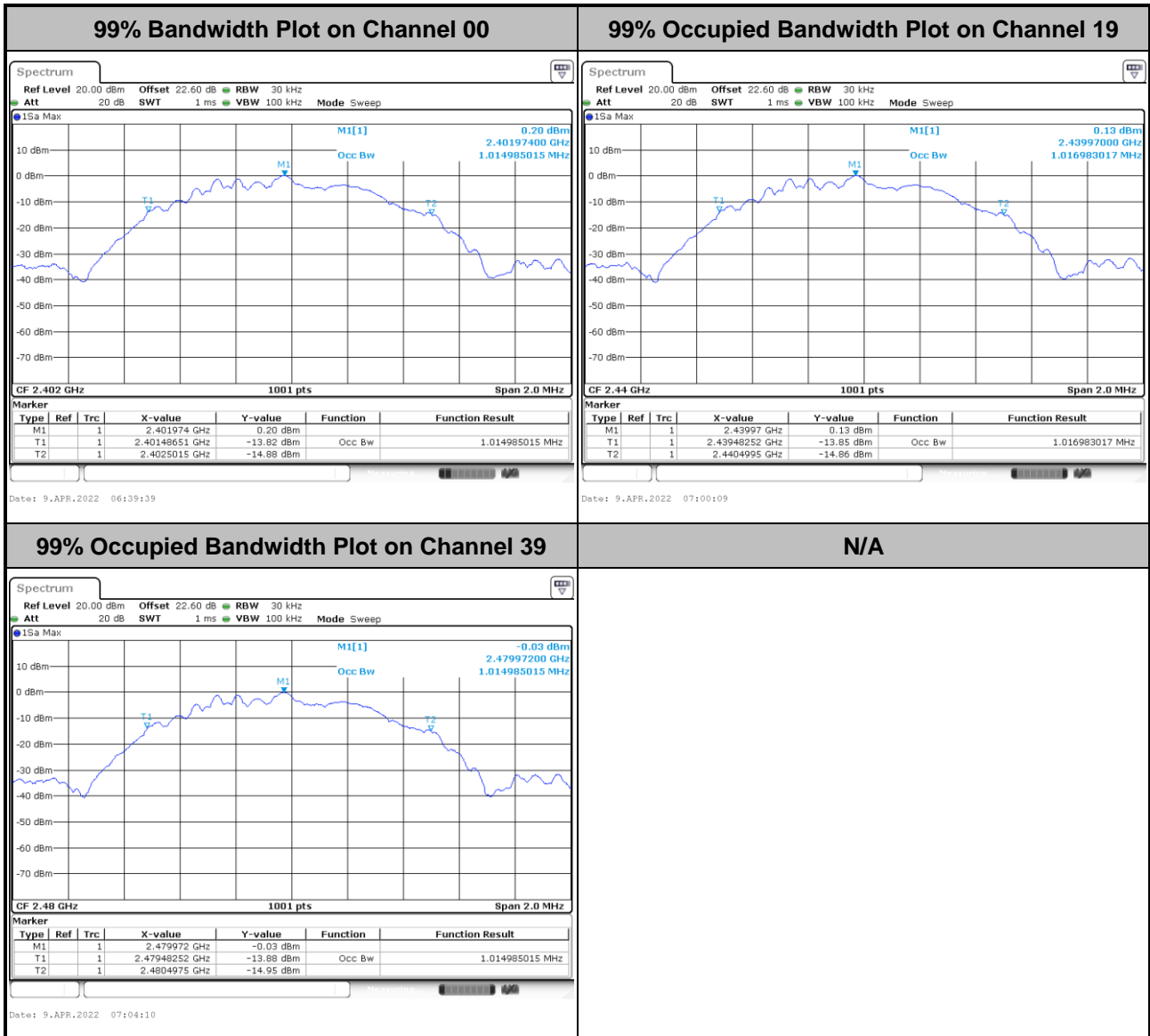

Note: The occupied channel bandwidth is maintained within the band of operation for all of the modulations.



<2Mbps>

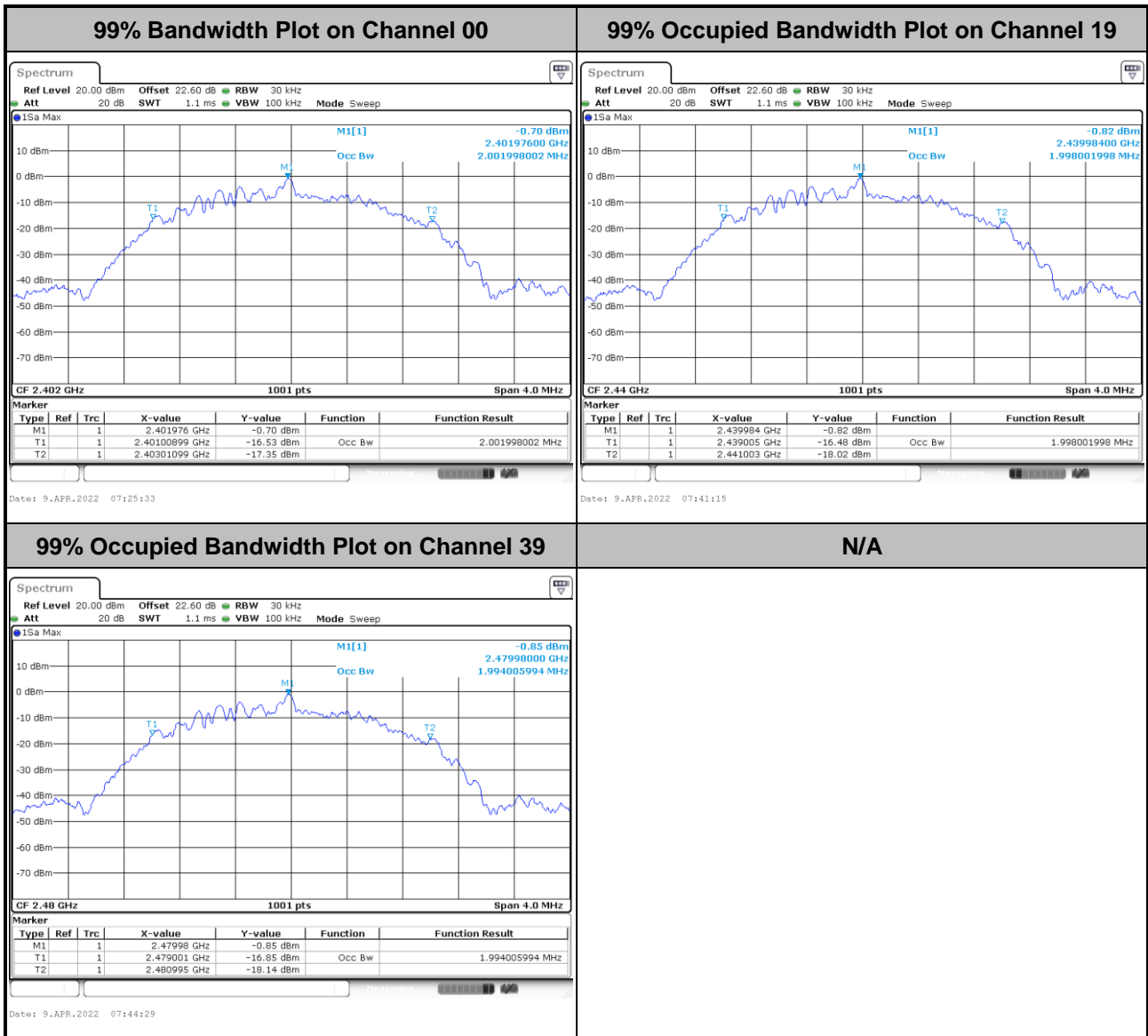

Note: The occupied channel bandwidth is maintained within the band of operation for all of the modulations.

3.2 Output Power Measurement

3.2.1 Limit of Output Power

For systems using digital modulation in the 2400-2483.5 MHz, the limit for output power is 30 dBm. If transmitting antenna of directional gain greater than 6 dBi is used, the peak output power from the intentional radiator shall be reduced below the above stated value by the amount in dB that the directional gain of the antenna exceeds 6 dBi. In case of point-to-point operation, the limit has to be reduced by 1 dB for every 3 dB that the directional gain of the antenna exceeds 6 dBi.

3.2.2 Measuring Instruments

Please refer to the measuring equipment list in this test report.

3.2.3 Test Procedures

1. For Average Power, the testing follows ANSI C63.10 Section 11.9.2.3.2 Method AVGPM-G
2. The RF output of EUT is connected to the power meter by RF cable and attenuator.
3. The path loss is compensated to the results for each measurement.
4. Set the maximum power setting and enable the EUT to transmit continuously.
5. Measure the conducted output power and record the results in the test report.

3.2.4 Test Setup

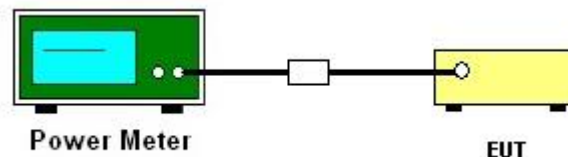



3.2.5 Test Result of Average Output Power

Test Engineer :	Junyu Jhou	Temperature :	16.9~23.3°C
		Relative Humidity :	54.5~65.2%

Mod.	Data Rate	N _{TX}	CH.	Freq. (MHz)	Average Conducted Power (dBm)	Conducted Power Limit (dBm)	DG (dBi)	EIRP Power (dBm)	EIRP Power Limit (dBm)	Pass /Fail
BLE	1Mbps	1	0	2402	3.80	30.00	2.50	6.30	36.00	Pass
BLE	1Mbps	1	19	2440	3.70	30.00	2.50	6.20	36.00	Pass
BLE	1Mbps	1	39	2480	3.60	30.00	2.50	6.10	36.00	Pass

Mod.	Data Rate	N _{TX}	CH.	Freq. (MHz)	Average Conducted Power (dBm)	Conducted Power Limit (dBm)	DG (dBi)	EIRP Power (dBm)	EIRP Power Limit (dBm)	Pass /Fail
BLE	2Mbps	1	0	2402	3.80	30.00	2.50	6.30	36.00	Pass
BLE	2Mbps	1	19	2440	3.70	30.00	2.50	6.20	36.00	Pass
BLE	2Mbps	1	39	2480	3.60	30.00	2.50	6.10	36.00	Pass

3.3 Power Spectral Density Measurement

3.3.1 Limit of Power Spectral Density

The peak power spectral density shall not be greater than 8 dBm in any 3 kHz band at any time interval of continuous transmission.

3.3.2 Measuring Instruments

Please refer to the measuring equipment list in this test report.

3.3.3 Test Procedures

1. The testing follows the ANSI C63.10 Section 11.10.2 Method PKPSD.
2. The RF output of EUT is connected to the spectrum analyzer by RF cable and attenuator. The path loss is compensated to the results for each measurement.
3. Set the maximum power setting and enable the EUT to transmit continuously.
4. Make the measurement with the spectrum analyzer's resolution bandwidth (RBW) = 3 kHz. Video bandwidth (VBW) = 10 kHz. In order to make an accurate measurement, set the span to 1.5 times DTS Channel Bandwidth. (6 dB BW)
5. Detector = peak, Sweep time = auto couple, Trace mode = max hold, Allow trace to fully stabilize. Use the peak marker function to determine the maximum power level.
6. Measure and record the results in the test report.
7. The Measured power density (dBm)/ 100 kHz is a reference level and is used as 20 dBc down limit line for Conducted Band Edges and Conducted Spurious Emission.

3.3.4 Test Setup





3.3.5 Test Result of Power Spectral Density

Test Engineer :	Junyu Zhou	Temperature :	16.9~23.3°C
		Relative Humidity :	54.5~65.2%

Mod.	Data Rate	N _{TX}	CH.	Freq. (MHz)	Peak PSD (dBm /100kHz)	Peak PSD (dBm /3kHz)	DG (dBi)	Peak PSD Limit (dBm /3kHz)	Pass/Fail
BLE	1Mbps	1	0	2402	3.45	-10.91	2.50	8.00	Pass
BLE	1Mbps	1	19	2440	3.43	-10.92	2.50	8.00	Pass
BLE	1Mbps	1	39	2480	3.27	-11.06	2.50	8.00	Pass

Mod.	Data Rate	N _{TX}	CH.	Freq. (MHz)	Peak PSD (dBm /100kHz)	Peak PSD (dBm /3kHz)	DG (dBi)	Peak PSD Limit (dBm /3kHz)	Pass/Fail
BLE	2Mbps	1	0	2402	3.43	-13.96	2.50	8.00	Pass
BLE	2Mbps	1	19	2440	3.36	-13.94	2.50	8.00	Pass
BLE	2Mbps	1	39	2480	3.27	-14.02	2.50	8.00	Pass



3.3.6 Test Result of Power Spectral Density Plots (100kHz)

<1Mbps>

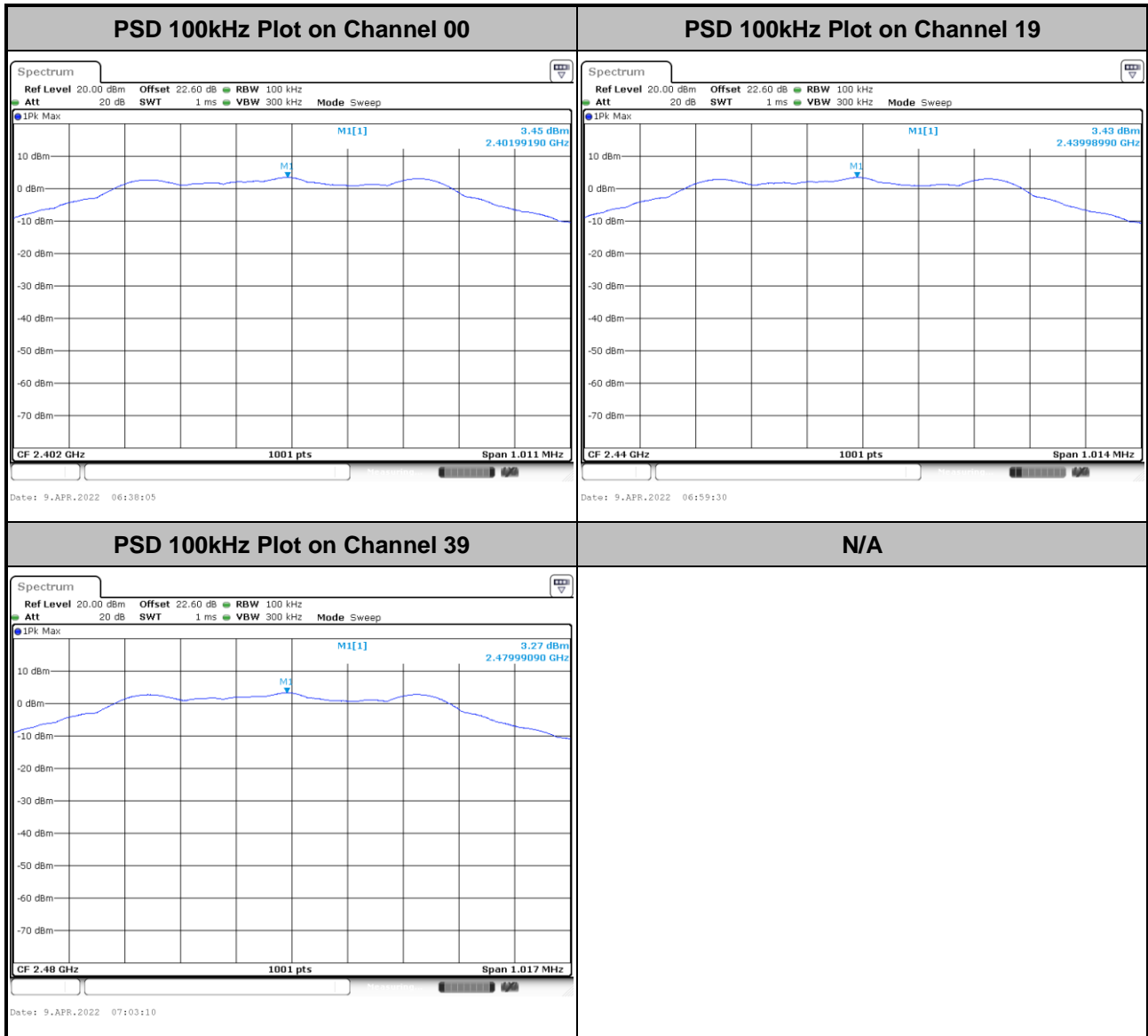



<2Mbps>

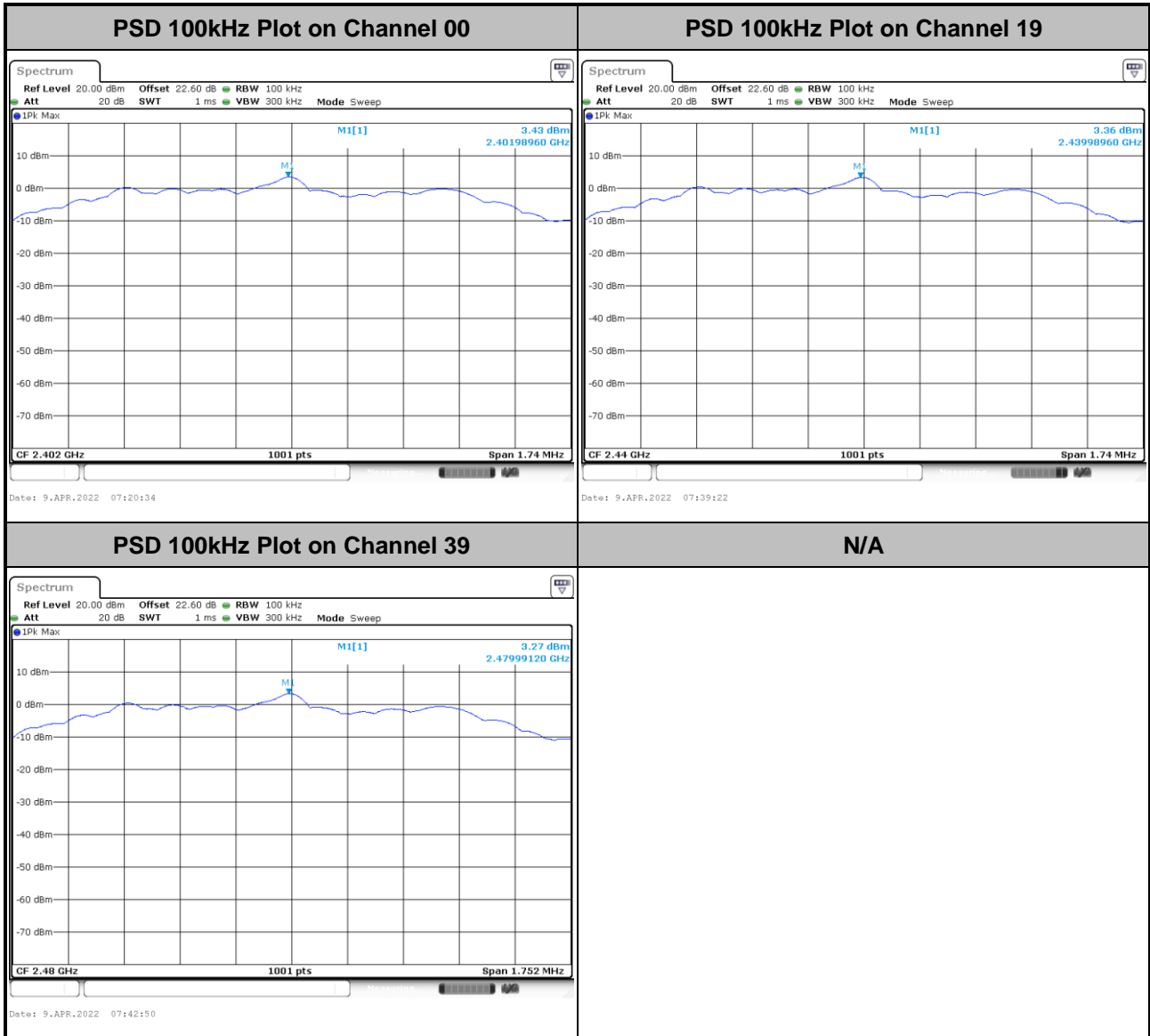



3.3.7 Test Result of Power Spectral Density Plots (3kHz)

<1Mbps>

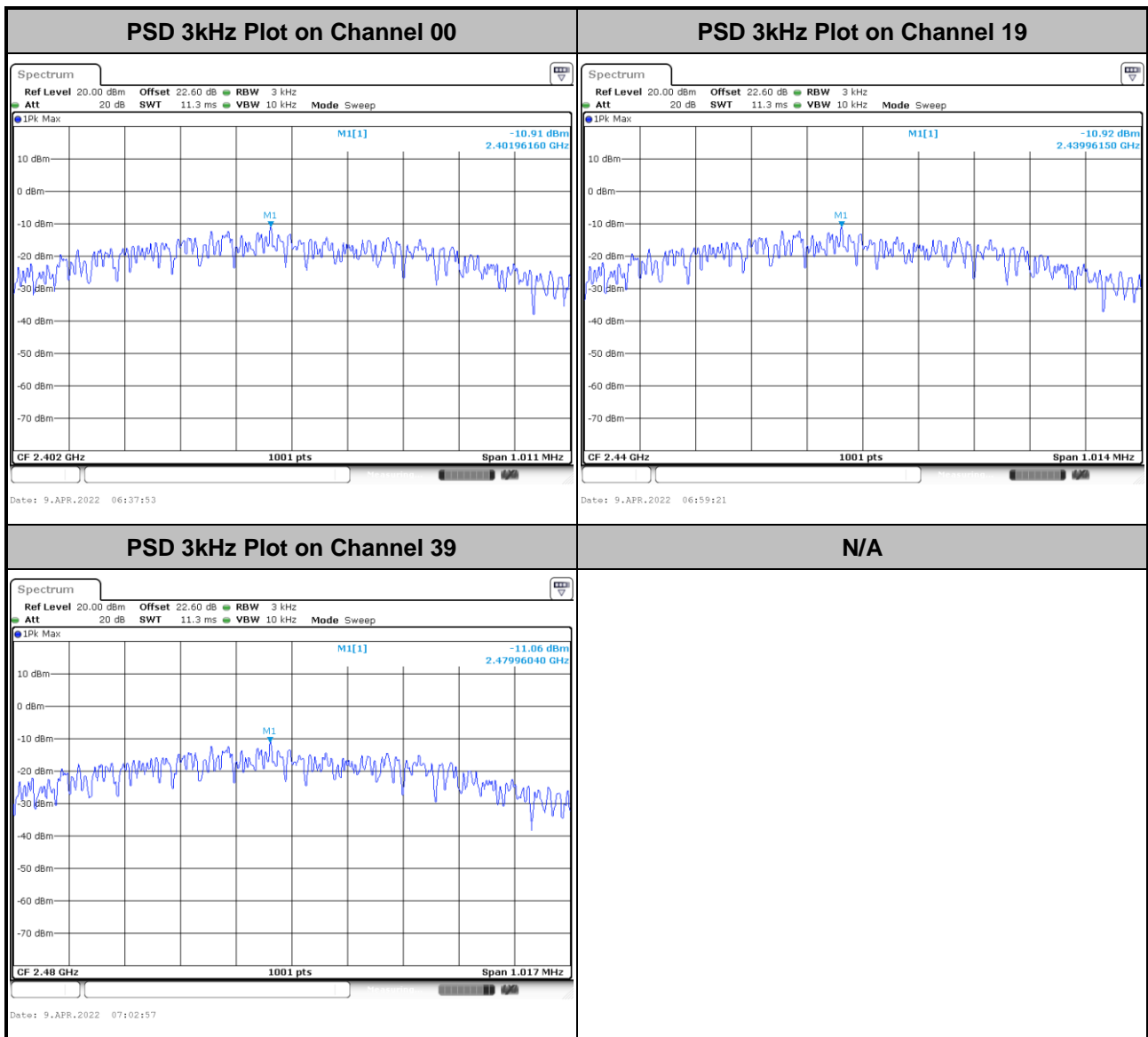



<2Mbps>

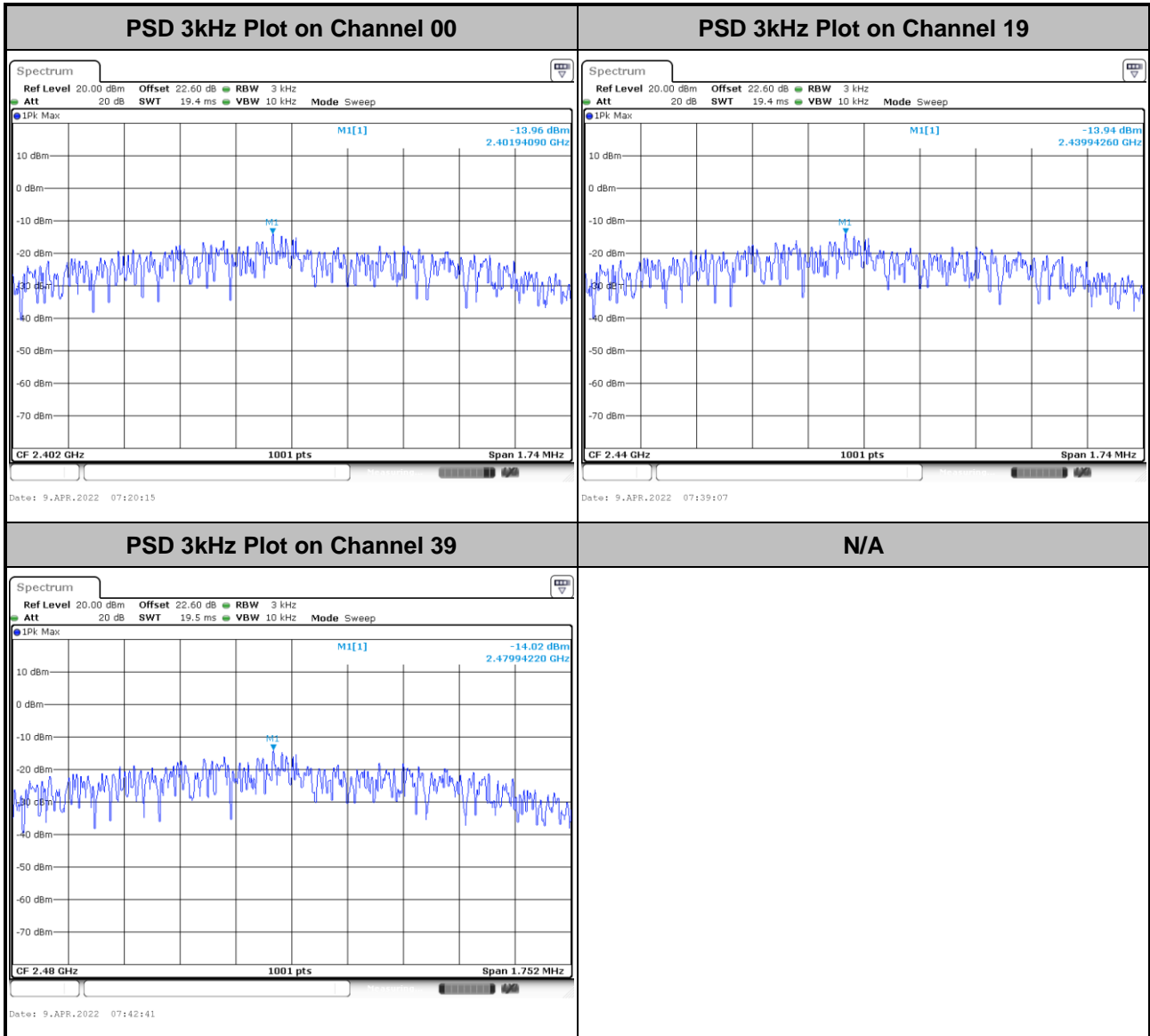

3.4 Conducted Band Edges and Spurious Emission Measurement

3.4.1 Limit of Conducted Band Edges and Spurious Emission

All harmonics/spurious must be at least 20 dB down from the highest emission level within the authorized band.

3.4.2 Measuring Instruments

Please refer to the measuring equipment list in this test report.

3.4.3 Test Procedure

1. The testing follows the ANSI C63.10 Section 11.11.3 Emission level measurement.
2. The RF output of EUT is connected to the spectrum analyzer by RF cable and attenuator. The path loss is compensated to the results for each measurement.
3. Set the maximum power setting and enable the EUT to transmit continuously.
4. Set RBW = 100 kHz, VBW = 300 kHz, Peak Detector. Unwanted Emissions measured in any 100 kHz bandwidth outside of the authorized frequency band shall be attenuated by at least 20 dB relative to the maximum in-band peak PSD level in 100 kHz when maximum peak conducted output power procedure is used. If the transmitter complies with the conducted power limits based on the use of RMS averaging over a time interval, the attenuation required under this paragraph shall be 30 dB instead of 20 dB.
5. Measure and record the results in the test report.
6. The RF fundamental frequency should be excluded against the limit line in the operating frequency band.

3.4.4 Test Setup





3.4.5 Test Result of Conducted Band Edges Plots

Test Engineer : Junyu Zhou	Temperature :	16.9~23.3°C
	Relative Humidity :	54.5~65.2%

<1Mbps>

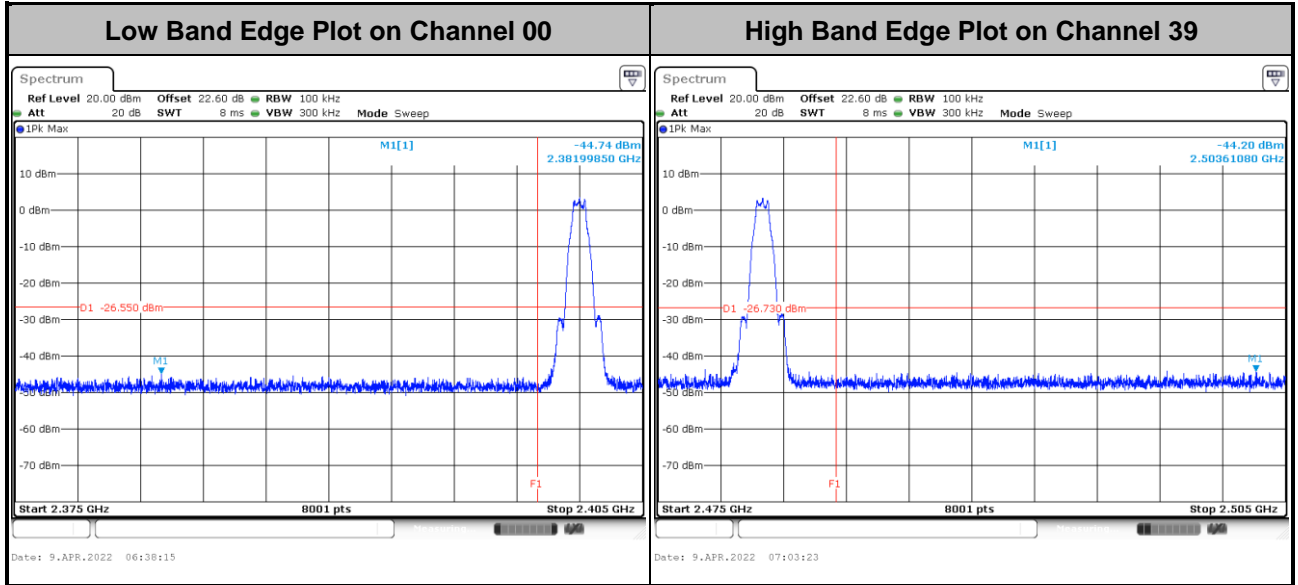

<2Mbps>

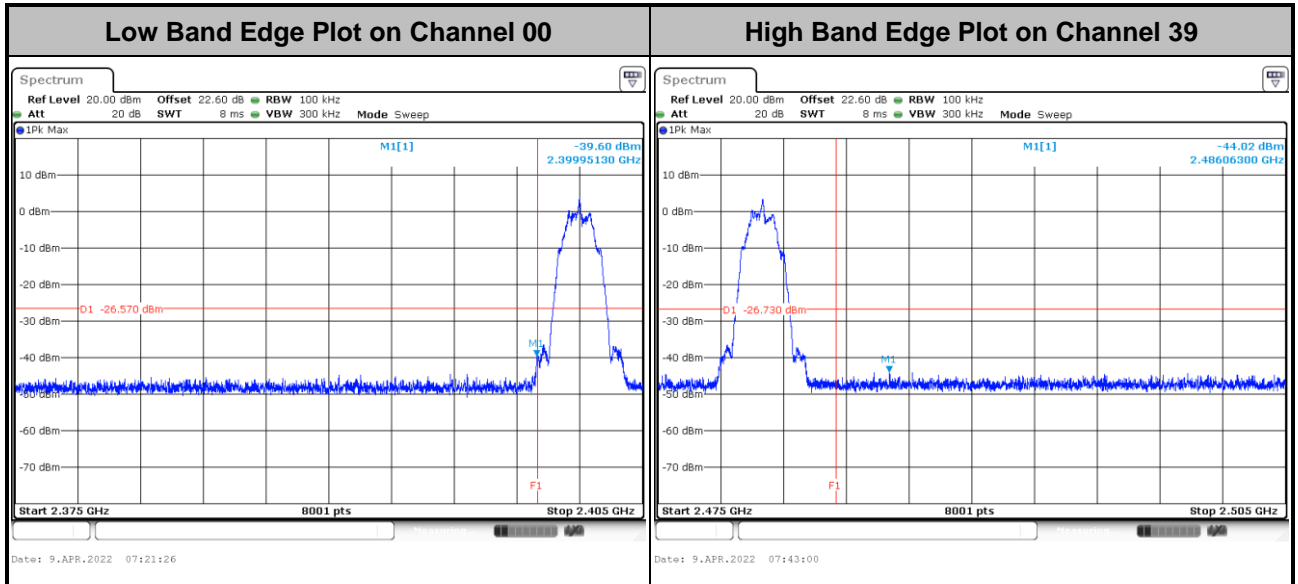



3.4.6 Test Result of Conducted Spurious Emission Plots

Test Engineer :	Junyu Zhou	Temperature :	16.9~23.3°C
		Relative Humidity :	54.5~65.2%

<1Mbps>

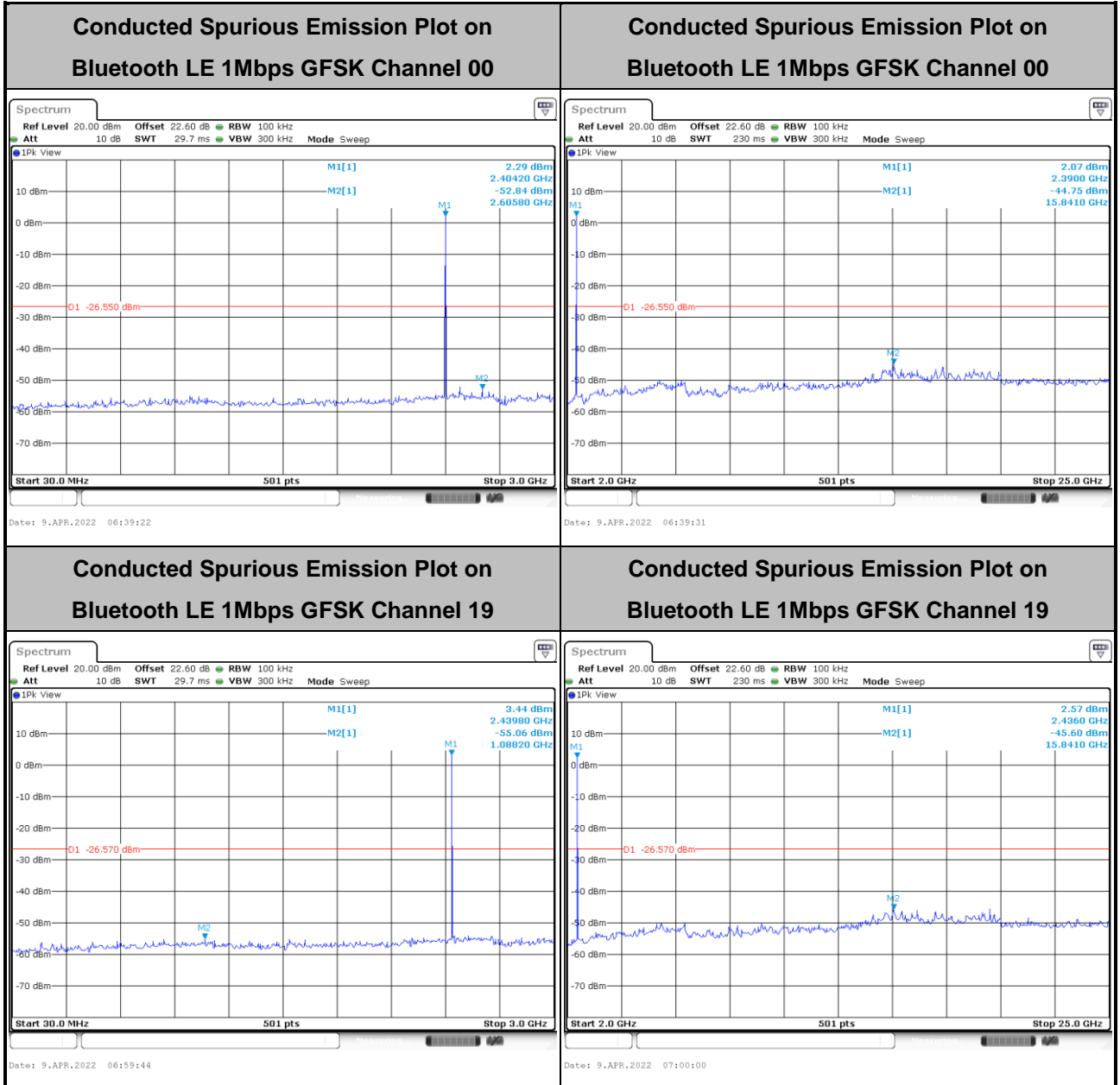

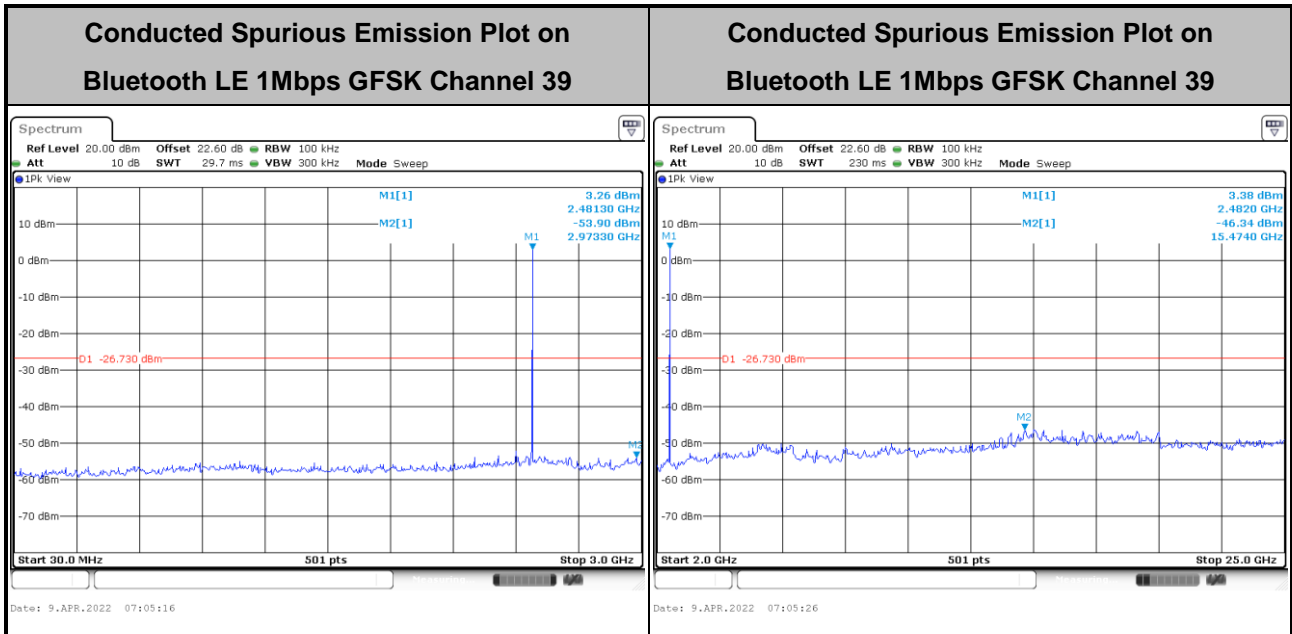



<2Mbps>

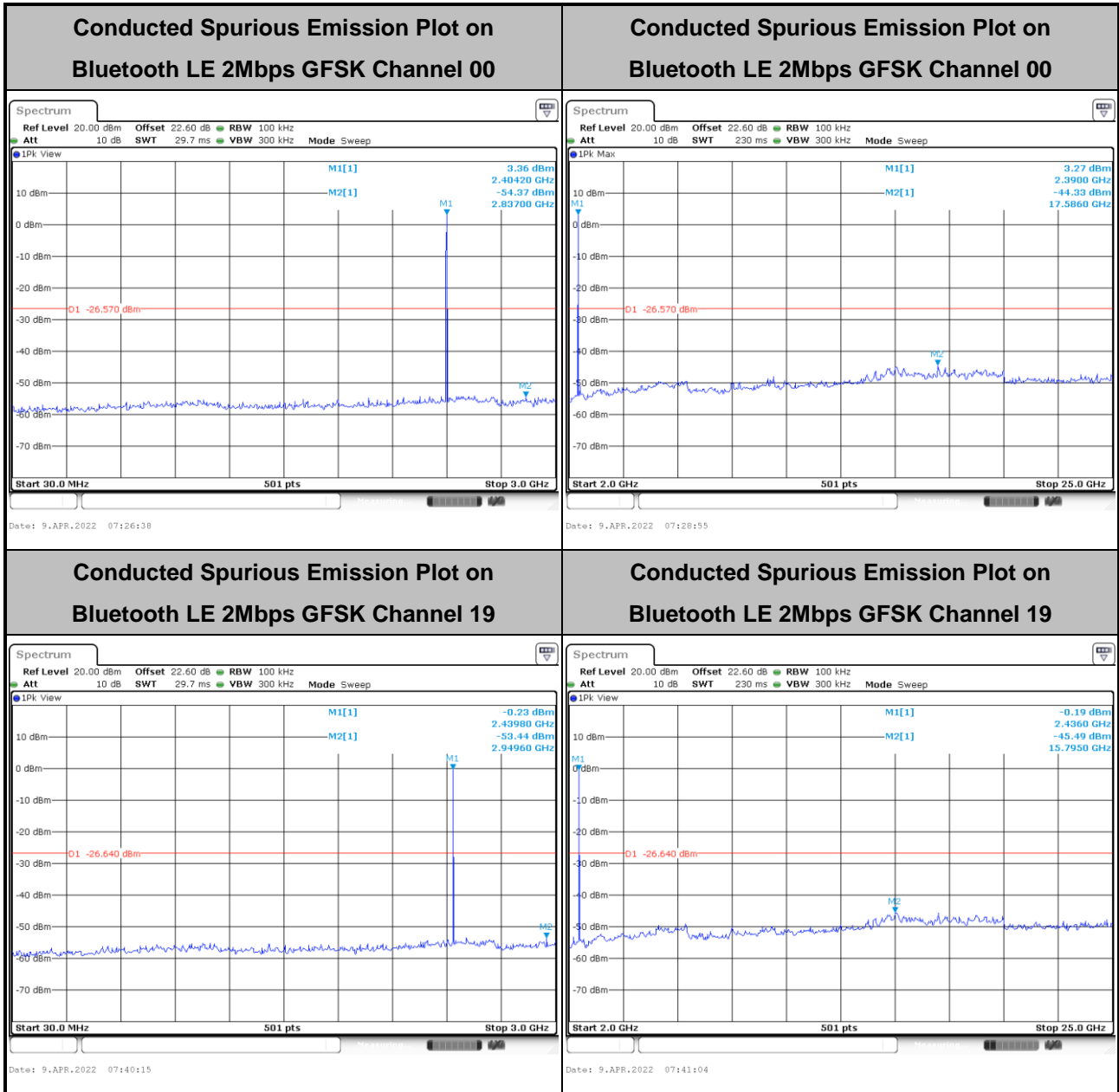

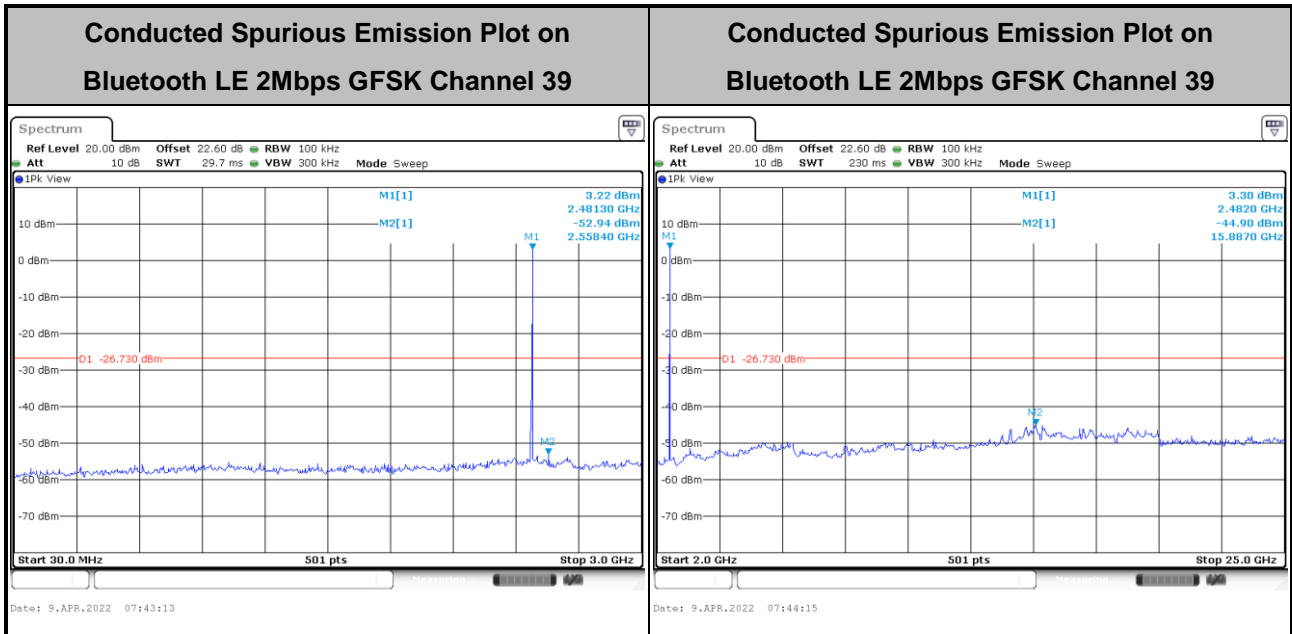



3.5 Radiated Band Edges and Spurious Emission Measurement

3.5.1 Limit of Radiated Band Edges and Spurious Emission

In any 100 kHz bandwidth outside the intentional radiator frequency band, all harmonics/spurious must be at least 20 dB below the highest emission level within the authorized band. If the output power of this device is measured by spectrum analyzer, the attenuation under this paragraph shall be 30 dB instead of 20 dB. In addition, radiated emissions which fall in the restricted bands must also comply with the limits as below.

Frequency (MHz)	Field Strength (microvolts/meter)	Measurement Distance (meters)
0.009 – 0.490	2400/F(kHz)	300
0.490 – 1.705	24000/F(kHz)	30
1.705 – 30.0	30	30
30 – 88	100	3
88 – 216	150	3
216 - 960	200	3
Above 960	500	3

3.5.2 Measuring Instruments

Please refer to the measuring equipment list in this test report.

**3.5.3 Test Procedures**

1. The testing follows the ANSI C63.10 Section 11.12.1 Radiated emission measurements.
2. The EUT is arranged to its worst case and then tune the antenna tower (from 1 m to 4 m) and turntable (from 0 degree to 360 degrees) to find the maximum reading. A pre-amp and a high pass filter are used for the test in order to get better signal level.
3. The EUT is placed on a turntable with 0.8 meter for frequency below 1 GHz and 1.5 meter for frequency above 1 GHz respectively above ground.
4. The EUT is set 3 meters away from the receiving antenna, which is mounted on the top of a variable height antenna tower.
5. Corrected Reading: Antenna Factor + Cable Loss + Read Level - Preamp Factor = Level
6. Radiated testing below 1 GHz is performed by adjusting the antenna tower from 1 m to 4 m and by rotating the turn table from 0 degree to 360 degrees to find the peak maximum hold reading. When there is no suspected emission found and the emission level is with at least 6 dB margin against QP limit line, the position is marked as “-“.
7. Radiated testing above 1 GHz is performed by adjusting the antenna tower from 1 m to 4 m and by rotating the turn table from 0 degree to 360 degrees to find the peak maximum hold reading for scanning all frequencies. When there is no suspected emission found and the harmonic emission level is with at least 6 dB margin against average limit line, the position is marked as “-“.
8. Use the following spectrum analyzer settings:
 - (1) Span shall wide enough to fully capture the emission being measured;
 - (2) Set RBW = 100 kHz for $f < 1$ GHz; VBW \geq RBW; Sweep = auto; Detector function = peak; Trace = max hold;
 - (3) Set RBW = 1 MHz, VBW = 3 MHz for $f \geq 1$ GHz for peak measurement.
For average measurement:
 - VBW = 10 Hz, when duty cycle is no less than 98 percent.
 - VBW $\geq 1/T$, when duty cycle is less than 98 percent where T is the minimum transmission duration over which the transmitter is on and is transmitting at its maximum power control level for the tested mode of operation.

3.5.4 Test Setup

For radiated test below 30MHz

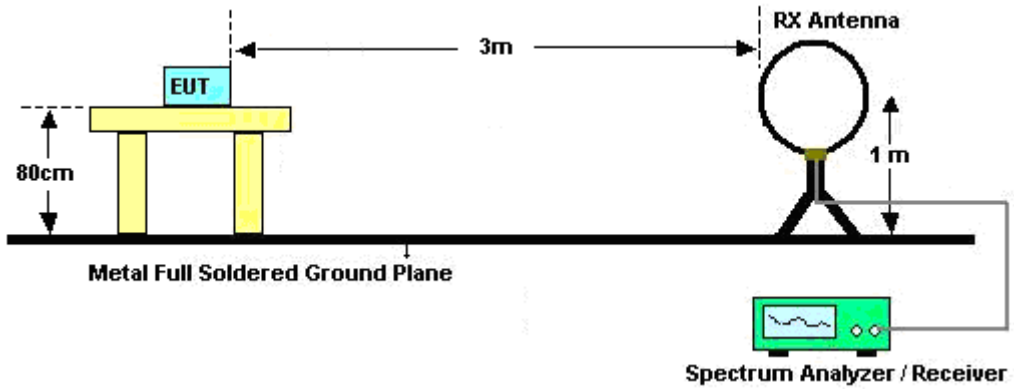

For radiated test from 30MHz to 1GHz

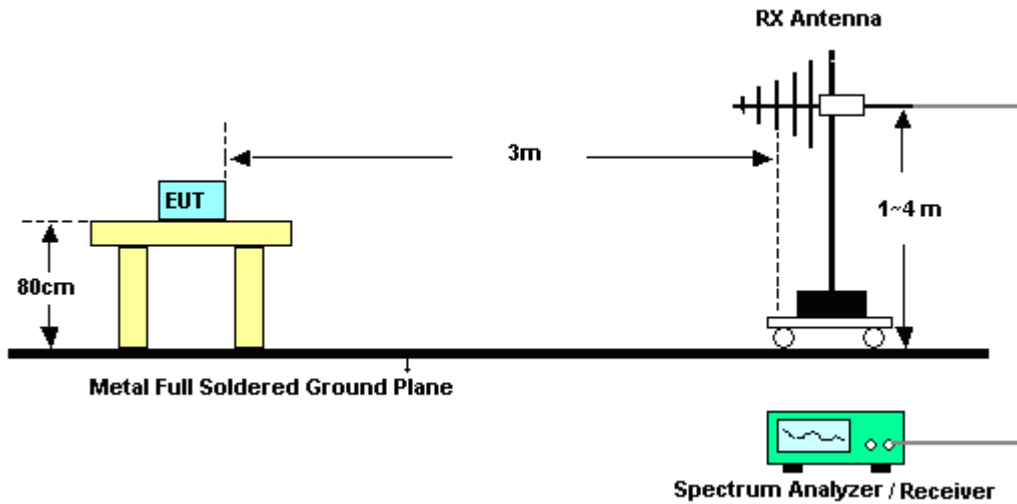

For radiated test from 1GHz to 18GHz

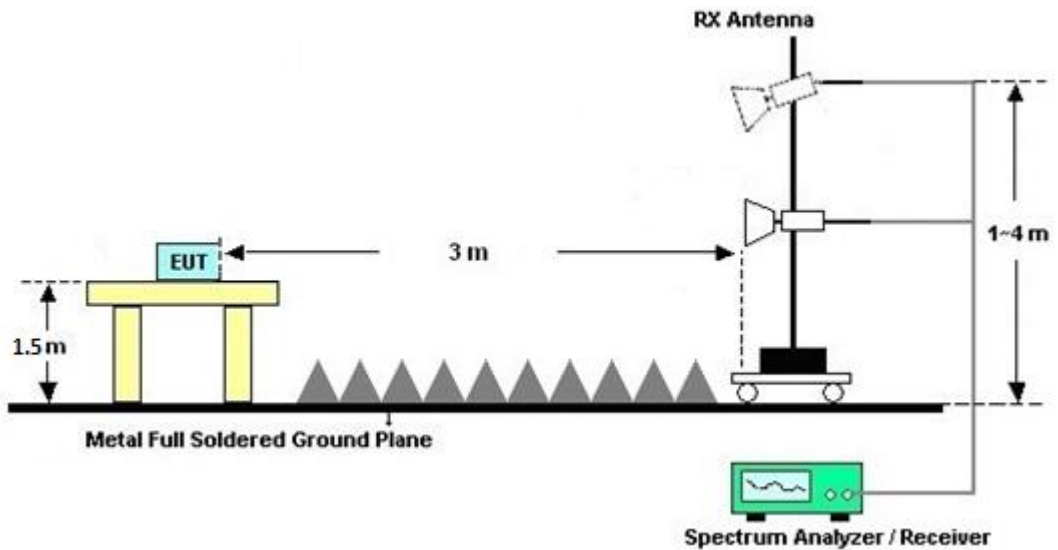

For radiated test above 18GHz

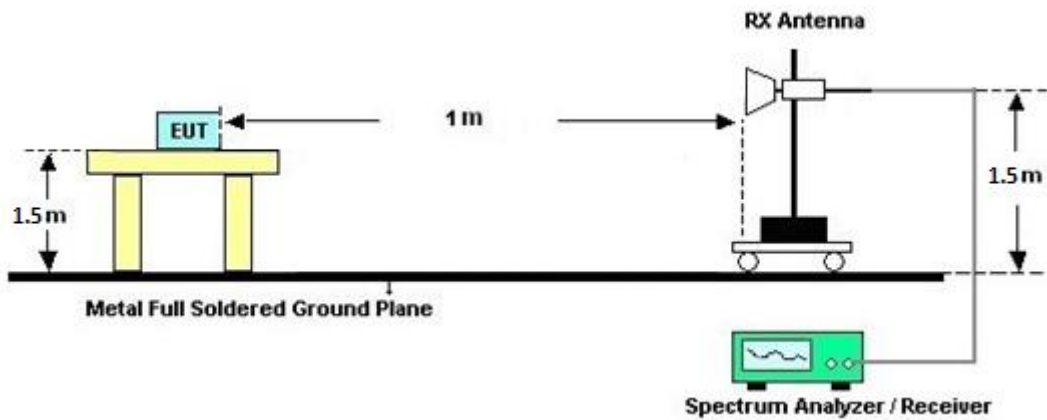

3.5.5 Test Results of Radiated Spurious Emissions (9 kHz ~ 30 MHz)

The low frequency, which starts from 9 kHz to 30 MHz, is pre-scanned and the result which is 20 dB lower than the limit line is not reported.

There is adequate comparison measurement of both open-field test site and alternative test site - semi-Anechoic chamber according to 414788 D01 Radiated Test Site v01r01, and the result comes out very similar.

3.5.6 Test Result of Radiated Spurious at Band Edges

Please refer to Appendix B and C.

3.5.7 Duty Cycle

Please refer to Appendix D.

3.5.8 Test Result of Radiated Spurious Emission (30 MHz ~ 10th Harmonic)

Please refer to Appendix B and C.



3.6 AC Conducted Emission Measurement

3.6.1 Limit of AC Conducted Emission

For equipment that is designed to be connected to the public utility (AC) power line, the radio frequency voltage that is conducted back onto the AC power line on any frequency or frequencies within the band 150 kHz to 30 MHz shall not exceed the limits in the following table.

Frequency of emission (MHz)	Conducted limit (dB μ V)	
	Quasi-peak	Average
0.15-0.5	66 to 56*	56 to 46*
0.5-5	56	46
5-30	60	50

*Decreases with the logarithm of the frequency.

3.6.2 Measuring Instruments

Please refer to the measuring equipment list in this test report.

3.6.3 Test Procedures

1. The EUT is placed 0.4 meter away from the conducting wall of the shielding room, and is kept at least 80 centimeters from any other grounded conducting surface.
2. Connect EUT to the power mains through a line impedance stabilization network (LISN).
3. All the support units are connecting to the other LISN.
4. The LISN provides 50 ohm coupling impedance for the measuring instrument.
5. The FCC states that a 50 ohm, 50 microhenry LISN shall be used.
6. Both Line and Neutral shall be tested in order to find out the maximum conducted emission.
7. The frequency range from 150 kHz to 30 MHz is scanned.
8. Set the test-receiver system to Peak Detect Function and specified bandwidth (IF Bandwidth = 9 kHz) with Maximum Hold Mode. Then measurement is also conducted by Average Detector and Quasi-Peak Detector Function respectively.

3.6.4 Test Setup

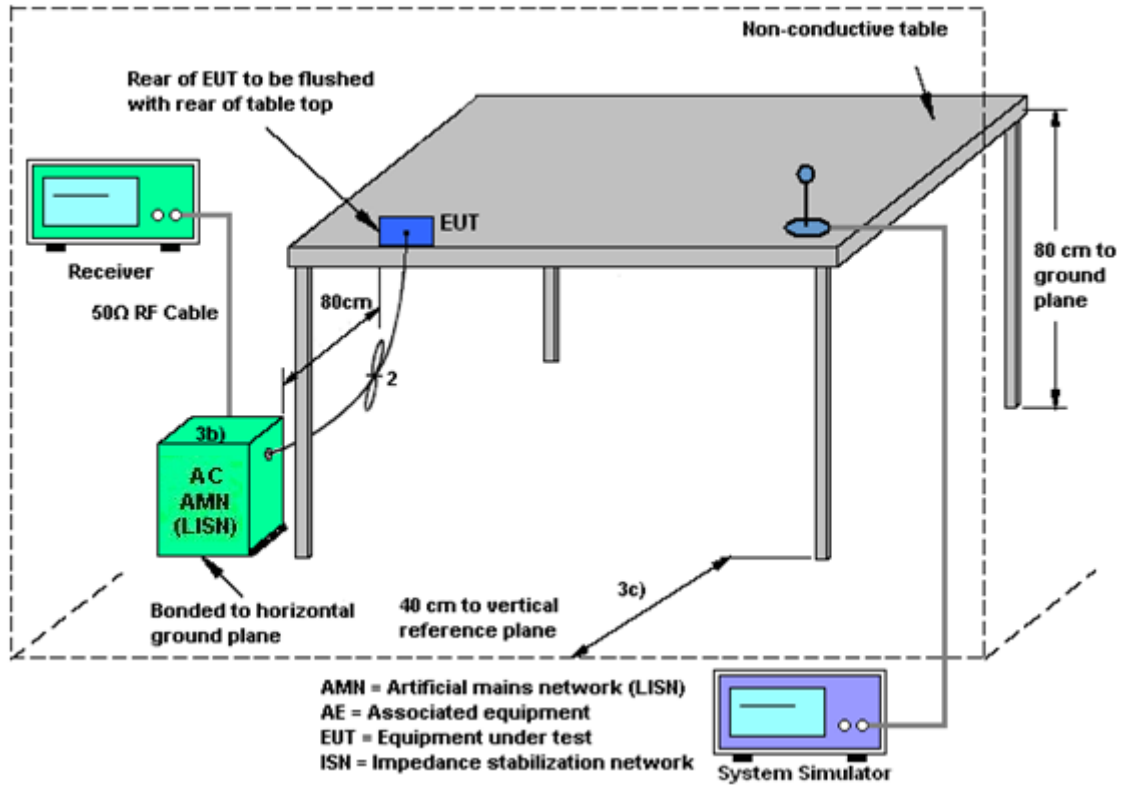

3.6.5 Test Result of AC Conducted Emission

Please refer to Appendix A.



3.7 Antenna Requirements

3.7.1 Standard Applicable

If directional gain of transmitting antennas is greater than 6 dBi, the power shall be reduced by the same level in dB comparing to gain minus 6 dBi. The use of a permanently attached antenna or of an antenna that uses a unique coupling to the intentional radiator shall be considered sufficient to comply with the rule.

3.7.2 Antenna Anti-Replacement Construction

An embedded-in antenna design is used.

3.7.3 Antenna Gain

The antenna peak gain of EUT is less than 6 dBi. Therefore, it is not necessary to reduce maximum peak output power limit.



4 List of Measuring Equipment

Instrument	Brand Name	Model No.	Serial No.	Characteristics	Calibration Date	Test Date	Due Date	Remark
Hygrometer	TECPEL	DTM-303A	TP201996	N/A	Nov. 16, 2021	Feb. 24, 2022~ Apr. 09, 2022	Nov. 15, 2022	Conducted (TH05-HY)
Power Sensor	DARE	RPR3006W	16I00054SNO 12 (NO:113)	10MHz~6GHz	Dec. 16, 2021	Feb. 24, 2022~ Apr. 09, 2022	Dec. 15, 2022	Conducted (TH05-HY)
Signal Analyzer	Rohde & Schwarz	FSV40	101566	10Hz~40GHz	Aug. 30, 2021	Feb. 24, 2022~ Apr. 09, 2022	Aug. 29, 2022	Conducted (TH05-HY)
Switch Control Mainframe	E-IUSTRUMENT	ETF-1405-0	EC1900067 (BOX7)	N/A	Aug. 12, 2021	Feb. 24, 2022~ Apr. 09, 2022	Aug. 11, 2022	Conducted (TH05-HY)
Loop Antenna	Rohde & Schwarz	HFH2-Z2	100488	9 kHz~30 MHz	Sep. 07, 2021	Mar. 06, 2022~ Mar. 12, 2022	Sep. 06, 2022	Radiation (03CH16-HY)
Bilog Antenna	TESEQ	CBL 6111D & 00802N1D01N- 06	47020 & 06	30MHz to 1GHz	Oct. 09, 2021	Mar. 06, 2022~ Mar. 12, 2022	Oct. 08, 2022	Radiation (03CH16-HY)
Horn Antenna	SCHWARZBECK	BBHA 9120 D	9120D-02114	1G~18GHz	Aug. 04, 2021	Mar. 06, 2022~ Mar. 12, 2022	Aug. 03, 2022	Radiation (03CH16-HY)
SHF-EHF Horn Antenna	SCHWARZBECK	BBHA 9170	00993	18GHz ~40GHz	Nov. 30, 2021	Mar. 06, 2022~ Mar. 12, 2022	Nov. 29, 2022	Radiation (03CH16-HY)
Amplifier	SONOMA	310N	371607	9kHz~1G	Jul. 05, 2021	Mar. 06, 2022~ Mar. 12, 2022	Jul. 04, 2022	Radiation (03CH16-HY)
Amplifier	EMCI	EMC051845SE	980729	1-18GHz	Jul. 09, 2021	Mar. 06, 2022~ Mar. 12, 2022	Jul. 08, 2022	Radiation (03CH16-HY)
Preamplifier	EMEC	EM18G40G	060801	18GHz~40GHz	Jun. 22, 2021	Mar. 06, 2022~ Mar. 12, 2022	Jun. 21, 2022	Radiation (03CH16-HY)
Preamplifier	Keysight	83017A	MY53270264	1GHz~26.5GHz	Dec. 09, 2021	Mar. 06, 2022~ Mar. 12, 2022	Dec. 08, 2022	Radiation (03CH16-HY)
EMI Test Receiver	Keysight	N9038A(MXE)	MY57290111	3Hz~26.5GHz	Dec. 15, 2021	Mar. 06, 2022~ Mar. 12, 2022	Dec. 14, 2022	Radiation (03CH16-HY)
RF Cable	HUBER + SUHNER	SUCOFLEX 104	MY11680/4PE	NA	Aug. 28, 2021	Mar. 06, 2022~ Mar. 12, 2022	Aug. 27, 2022	Radiation (03CH16-HY)
RF Cable	HUBER + SUHNER	SUCOFLEX 104	MY11688/4PE	NA	Aug. 28, 2021	Mar. 06, 2022~ Mar. 12, 2022	Aug. 27, 2022	Radiation (03CH16-HY)
RF Cable	HUBER + SUHNER	SUCOFLEX 102	EC-A5-300-57 57	NA	Aug. 28, 2021	Mar. 06, 2022~ Mar. 12, 2022	Aug. 27, 2022	Radiation (03CH16-HY)
Software	Audix	E3 6.2009-8-24	RK-001136	N/A	N/A	Mar. 06, 2022~ Mar. 12, 2022	N/A	Radiation (03CH16-HY)
Controller	ChainTek	3000-1	N/A	Control Turn table & Ant Mast	N/A	Mar. 06, 2022~ Mar. 12, 2022	N/A	Radiation (03CH16-HY)
Antenna Mast	ChainTek	MBS-520-1	N/A	1m~4m	N/A	Mar. 06, 2022~ Mar. 12, 2022	N/A	Radiation (03CH16-HY)
Turn Table	ChainTek	T-200-S-1	N/A	0~360 Degree	N/A	Mar. 06, 2022~ Mar. 12, 2022	N/A	Radiation (03CH16-HY)
AC Power Source	ChainTek	APC-1000W	N/A	N/A	N/A	Apr. 12, 2022	N/A	Conduction (CO05-HY)
EMI Test Receiver	Rohde & Schwarz	ESR3	102388	9kHz~3.6GHz	Dec. 01, 2021	Apr. 12, 2022	Nov. 30, 2022	Conduction (CO05-HY)
Hygrometer	Testo	608-H1	34913912	N/A	Nov. 17, 2021	Apr. 12, 2022	Nov. 16, 2022	Conduction (CO05-HY)
LISN	Rohde & Schwarz	ENV216	100080	9kHz~30MHz	Dec. 03, 2021	Apr. 12, 2022	Dec. 02, 2022	Conduction (CO05-HY)
Software	Rohde & Schwarz	EMC32	N/A	N/A	N/A	Apr. 12, 2022	N/A	Conduction (CO05-HY)
Pulse Limiter	SCHWARZBECK	VTSD 9561-F N	00691	N/A	Jul. 28, 2021	Apr. 12, 2022	Jul. 27, 2022	Conduction (CO05-HY)
LISN Cable	MVE	RG-400	260260	N/A	Dec. 30, 2021	Apr. 12, 2022	Dec. 29, 2022	Conduction (CO05-HY)



5 Uncertainty of Evaluation

Uncertainty of Conducted Emission Measurement (150 kHz ~ 30 MHz)

Measuring Uncertainty for a Level of Confidence of 95% ($U = 2Uc(y)$)	3.1 dB
---	--------

Uncertainty of Radiated Emission Measurement (30 MHz ~ 1000 MHz)

Measuring Uncertainty for a Level of Confidence of 95% ($U = 2Uc(y)$)	5.8 dB
---	--------

Uncertainty of Radiated Emission Measurement (1000 MHz ~ 18000 MHz)

Measuring Uncertainty for a Level of Confidence of 95% ($U = 2Uc(y)$)	5.2 dB
---	--------

Uncertainty of Radiated Emission Measurement (18000 MHz ~ 40000 MHz)

Measuring Uncertainty for a Level of Confidence of 95% ($U = 2Uc(y)$)	5.8 dB
---	--------



Appendix A. AC Conducted Emission Test Results

Test Engineer :	Calvin Wang	Temperature :	23~26°C
		Relative Humidity :	40~50%

EUT Information

Report NO : 222202
 Test Mode : Mode 1
 Test Voltage : 120Vac/60Hz
 Phase : Line

Full Spectrum

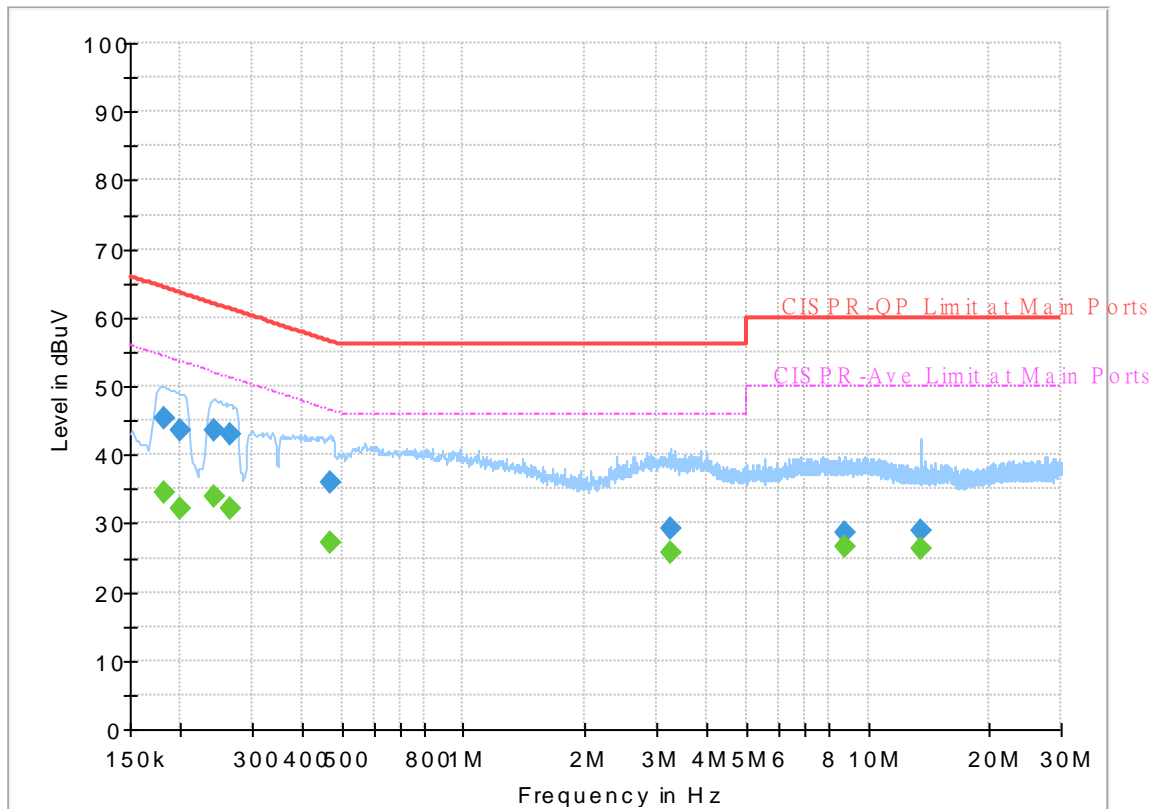

Final_Result

Frequency (MHz)	QuasiPeak (dBuV)	CAverage (dBuV)	Limit (dBuV)	Margin (dB)	Line	Filter	Corr. (dB)
0.181500	45.40	---	64.42	19.02	L1	OFF	19.6
0.181500	---	34.52	54.42	19.90	L1	OFF	19.6
0.199500	43.58	---	63.63	20.05	L1	OFF	19.6
0.199500	---	32.26	53.63	21.37	L1	OFF	19.6
0.242250	43.68	---	62.02	18.34	L1	OFF	19.6
0.242250	---	33.88	52.02	18.14	L1	OFF	19.6
0.264750	42.90	---	61.28	18.38	L1	OFF	19.6
0.264750	---	32.17	51.28	19.11	L1	OFF	19.6
0.469500	36.07	---	56.52	20.45	L1	OFF	19.6
0.469500	---	27.21	46.52	19.31	L1	OFF	19.6
3.261750	29.33	---	56.00	26.67	L1	OFF	19.8
3.261750	---	25.80	46.00	20.20	L1	OFF	19.8
8.794500	28.57	---	60.00	31.43	L1	OFF	20.0
8.794500	---	26.51	50.00	23.49	L1	OFF	20.0
13.560000	29.01	---	60.00	30.99	L1	OFF	20.2
13.560000	---	26.41	50.00	23.59	L1	OFF	20.2

EUT Information

Report NO : 222202
 Test Mode : Mode 1
 Test Voltage : 120Vac/60Hz
 Phase : Neutral

Full Spectrum

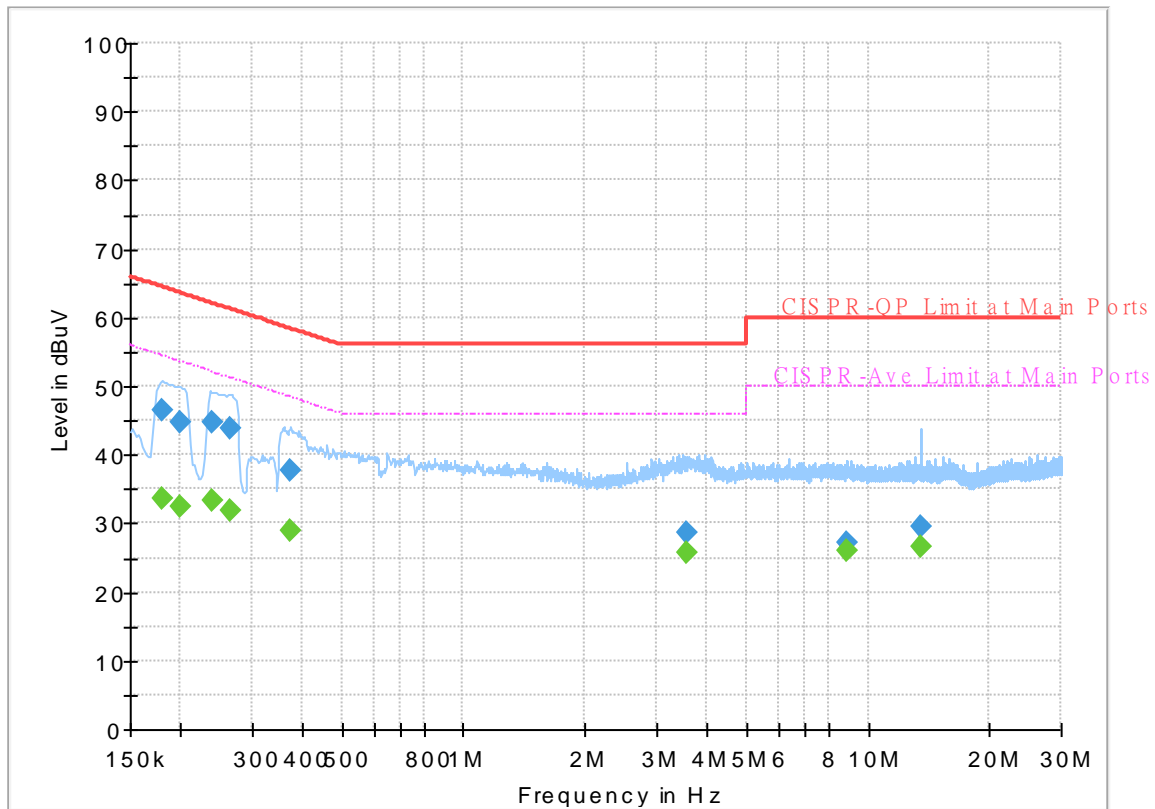

Final Result

Frequency (MHz)	QuasiPeak (dBuV)	CAverage (dBuV)	Limit (dBuV)	Margin (dB)	Line	Filter	Corr. (dB)
0.179250	---	33.50	54.52	21.02	N	OFF	19.6
0.179250	46.35	---	64.52	18.17	N	OFF	19.6
0.199500	---	32.50	53.63	21.13	N	OFF	19.6
0.199500	44.62	---	63.63	19.01	N	OFF	19.6
0.240000	---	33.22	52.10	18.88	N	OFF	19.6
0.240000	44.63	---	62.10	17.47	N	OFF	19.6
0.264750	---	31.95	51.28	19.33	N	OFF	19.6
0.264750	43.71	---	61.28	17.57	N	OFF	19.6
0.375000	---	28.88	48.39	19.51	N	OFF	19.6
0.375000	37.74	---	58.39	20.65	N	OFF	19.6
3.552000	---	25.61	46.00	20.39	N	OFF	19.8
3.552000	28.71	---	56.00	27.29	N	OFF	19.8
8.839500	---	25.95	50.00	24.05	N	OFF	20.0
8.839500	27.34	---	60.00	32.66	N	OFF	20.0
13.560000	---	26.73	50.00	23.27	N	OFF	20.2
13.560000	29.46	---	60.00	30.54	N	OFF	20.2



Appendix B. Radiated Spurious Emission

Test Engineer :	Andy Yang, Karl Hou, Wilson Wu	Temperature :	20~25°C
		Relative Humidity :	50~60%



<1Mbps>

2.4GHz 2400~2483.5MHz

BLE (Band Edge @ 3m)

BLE	Note	Frequency	Level	Over Limit	Limit Line	Read Level	Antenna Factor	Path Loss	Preamp Factor	Ant Pos	Table Pos	Peak Avg.	Pol.	
		(MHz)	(dBμV/m)	(dB)	(dBμV/m)	(dBμV)	(dB/m)	(dB)	(dB)	(cm)	(deg)	(P/A)	(H/V)	
BLE CH 00 2402MHz		2385.705	55.78	-18.22	74	40.3	27.34	18.21	30.07	200	324	P	H	
		2373.105	45.86	-8.14	54	30.46	27.29	18.19	30.08	200	324	A	H	
	*	2402	97.47	-	-	81.89	27.41	18.24	30.07	200	324	P	H	
	*	2402	96.84	-	-	81.26	27.41	18.24	30.07	200	324	A	H	
													H	
													H	
			2369.01	56.16	-17.84	74	40.78	27.28	18.18	30.08	192	51	P	V
			2383.29	45.7	-8.3	54	30.24	27.33	18.21	30.08	192	51	A	V
	*		2402	98.64	-	-	83.06	27.41	18.24	30.07	192	51	P	V
	*		2402	97.86	-	-	82.28	27.41	18.24	30.07	192	51	A	V
													V	
												V		
BLE CH 19 2440MHz		2317.84	55.73	-18.27	74	40.6	27.14	18.08	30.09	219	328	P	H	
		2386.44	45.64	-8.36	54	30.15	27.35	18.21	30.07	219	328	A	H	
	*	2440	98.94	-	-	83.13	27.56	18.31	30.06	219	328	P	H	
	*	2440	98.36	-	-	82.55	27.56	18.31	30.06	219	328	A	H	
			2494.4	56.84	-17.16	74	40.6	27.87	18.41	30.04	219	328	P	H
			2490.62	46.87	-7.13	54	30.67	27.84	18.4	30.04	219	328	A	H
			2380.98	55.52	-18.48	74	40.08	27.32	18.2	30.08	172	34	P	V
			2387.42	45.77	-8.23	54	30.28	27.35	18.21	30.07	172	34	A	V
	*		2440	99.73	-	-	83.92	27.56	18.31	30.06	172	34	P	V
	*		2440	99.02	-	-	83.21	27.56	18.31	30.06	172	34	A	V
			2489.64	56.3	-17.7	74	40.1	27.84	18.4	30.04	172	34	P	V
		2494.82	46.83	-7.17	54	30.59	27.87	18.41	30.04	172	34	A	V	



BLE CH 39 2480MHz	*	2480	99.07	-	-	82.96	27.78	18.38	30.05	190	328	P	H
	*	2480	98.41	-	-	82.3	27.78	18.38	30.05	190	328	A	H
		2489.56	57.09	-16.91	74	40.89	27.84	18.4	30.04	190	328	P	H
		2485.24	46.59	-7.41	54	30.43	27.81	18.39	30.04	190	328	A	H
													H
													H
	*	2480	99.5	-	-	83.39	27.78	18.38	30.05	186	78	P	V
	*	2480	99.02	-	-	82.91	27.78	18.38	30.05	186	78	A	V
		2492.16	56.33	-17.67	74	40.11	27.85	18.41	30.04	186	78	P	V
		2492.4	46.94	-7.06	54	30.72	27.85	18.41	30.04	186	78	A	V
													V
													V
Remark	1. No other spurious found. 2. All results are PASS against Peak and Average limit line.												



2.4GHz 2400~2483.5MHz
BLE (Harmonic @ 3m)

BLE	Note	Frequency (MHz)	Level (dBµV/m)	Over Limit (dB)	Limit Line (dBµV/m)	Read Level (dBµV)	Antenna Factor (dB/m)	Path Loss (dB)	Preamp Factor (dB)	Ant Pos (cm)	Table Pos (deg)	Peak Avg. (P/A)	Pol. (H/V)
BLE CH 00 2402MHz		4804	40.12	-33.88	74	50.6	32.41	12.35	55.24	-	-	P	H
													H
													H
													H
													H
													H
													H
													H
													H
													H
													H
													H
													H
													H
													H
													H
													H
													H
													H
			4804	40.12	-33.88	74	50.6	32.41	12.35	55.24	-	-	P
													V
													V
													V
													V
													V
													V
													V
													V
													V
													V
													V
													V
													V
													V



BLE	Note	Frequency (MHz)	Level (dBμV/m)	Over Limit (dB)	Limit Line (dBμV/m)	Read Level (dBμV)	Antenna Factor (dB/m)	Path Loss (dB)	Preamp Factor (dB)	Ant Pos (cm)	Table Pos (deg)	Peak Avg. (P/A)	Pol. (H/V)	
BLE CH 19 2440MHz		4880	40.81	-33.19	74	51.21	32.62	12.32	55.34	-	-	P	H	
		7320	45.68	-28.32	74	48.69	36.76	15.88	55.65	-	-	P	H	
													H	
													H	
													H	
													H	
													H	
													H	
													H	
													H	
													H	
													H	
			4880	39.66	-34.34	74	50.06	32.62	12.32	55.34	-	-	P	V
			7320	45.26	-28.74	74	48.27	36.76	15.88	55.65	-	-	P	V
														V
														V
														V
														V
														V
														V
													V	
													V	



BLE	Note	Frequency (MHz)	Level (dBμV/m)	Over Limit (dB)	Limit Line (dBμV/m)	Read Level (dBμV)	Antenna Factor (dB/m)	Path Loss (dB)	Preamp Factor (dB)	Ant Pos (cm)	Table Pos (deg)	Peak Avg. (P/A)	Pol. (H/V)
BLE CH 39 2480MHz		4960	40.37	-33.63	74	50.51	33.02	12.28	55.44	-	-	P	H
		7440	45.97	-28.03	74	49.22	36.22	16.2	55.67	-	-	P	H
													H
													H
													H
													H
													H
													H
													H
													H
													H
													H
													H
													H
													H
													H
													H
													H
													H
			4960	39.77	-34.23	74	49.91	33.02	12.28	55.44	-	-	P
		7440	46.1	-27.9	74	49.35	36.22	16.2	55.67	-	-	P	V
													V
													V
													V
													V
													V
													V
													V
													V
													V
													V
													V
													V
													V
Remark	<ol style="list-style-type: none"> No other spurious found. All results are PASS against Peak and Average limit line. The emission position marked as "-" means no suspected emission found with sufficient margin against limit line or noise floor only. 												



<2Mbps>

2.4GHz 2400~2483.5MHz

BLE (Band Edge @ 3m)

BLE	Note	Frequency	Level	Over Limit	Limit Line	Read Level	Antenna Factor	Path Loss	Preamp Factor	Ant Pos	Table Pos	Peak Avg.	Pol.	
		(MHz)	(dBμV/m)	(dB)	(dBμV/m)	(dBμV)	(dB/m)	(dB)	(dB)	(cm)	(deg)	(P/A)	(H/V)	
BLE CH 00 2402MHz		2364.915	57.07	-16.93	74	41.72	27.26	18.17	30.08	199	326	P	H	
		2365.44	48.28	-5.72	54	32.93	27.26	18.17	30.08	199	326	A	H	
	*	2402	97.21	-	-	81.63	27.41	18.24	30.07	199	326	P	H	
	*	2402	95.95	-	-	80.37	27.41	18.24	30.07	199	326	A	H	
													H	
													H	
			2385.39	55.81	-18.19	74	40.33	27.34	18.21	30.07	191	55	P	V
			2340.975	48.08	-5.92	54	32.87	27.18	18.12	30.09	191	55	A	V
	*		2402	98.59	-	-	83.01	27.41	18.24	30.07	191	55	P	V
	*		2402	97.21	-	-	81.63	27.41	18.24	30.07	191	55	A	V
													V	
												V		
BLE CH 19 2440MHz		2350.88	55.43	-18.57	74	40.17	27.2	18.14	30.08	201	332	P	H	
		2384.2	47.96	-6.04	54	32.48	27.34	18.21	30.07	201	332	A	H	
	*	2440	98.33	-	-	82.52	27.56	18.31	30.06	201	332	P	H	
	*	2440	96.98	-	-	81.17	27.56	18.31	30.06	201	332	A	H	
			2499.58	56.8	-17.2	74	40.52	27.9	18.42	30.04	201	332	P	H
			2486.42	48.78	-5.22	54	32.6	27.82	18.4	30.04	201	332	A	H
			2375.66	55.68	-18.32	74	40.27	27.3	18.19	30.08	170	58	P	V
			2318.26	47.87	-6.13	54	32.74	27.14	18.08	30.09	170	58	A	V
	*		2440	99.78	-	-	83.97	27.56	18.31	30.06	170	58	P	V
	*		2440	98.54	-	-	82.73	27.56	18.31	30.06	170	58	A	V
			2496.15	57.05	-16.95	74	40.8	27.88	18.41	30.04	170	58	P	V
		2496.78	48.88	-5.12	54	32.63	27.88	18.41	30.04	170	58	A	V	



BLE CH 39 2480MHz	*	2480	99.7	-	-	83.59	27.78	18.38	30.05	188	327	P	H
	*	2480	98.38	-	-	82.27	27.78	18.38	30.05	188	327	A	H
		2496.32	56.84	-17.16	74	40.59	27.88	18.41	30.04	188	327	P	H
		2487	49.31	-4.69	54	33.13	27.82	18.4	30.04	188	327	A	H
													H
													H
	*	2480	100.25	-	-	84.14	27.78	18.38	30.05	225	66	P	V
	*	2480	98.9	-	-	82.79	27.78	18.38	30.05	225	66	A	V
		2491.08	56.95	-17.05	74	40.74	27.85	18.4	30.04	225	66	P	V
		2499.24	48.91	-5.09	54	32.63	27.9	18.42	30.04	225	66	A	V
													V
													V
Remark	<ol style="list-style-type: none"> 1. No other spurious found. 2. All results are PASS against Peak and Average limit line. 												



2.4GHz 2400~2483.5MHz
BLE (Harmonic @ 3m)

BLE	Note	Frequency (MHz)	Level (dBµV/m)	Over Limit (dB)	Limit Line (dBµV/m)	Read Level (dBµV)	Antenna Factor (dB/m)	Path Loss (dB)	Preamp Factor (dB)	Ant Pos (cm)	Table Pos (deg)	Peak Avg. (P/A)	Pol. (H/V)
BLE CH 00 2402MHz		4804	39.71	-34.29	74	50.19	32.41	12.35	55.24	-	-	P	H
													H
													H
													H
													H
													H
													H
													H
													H
													H
													H
													H
													H
													H
													H
													H
													H
													H
													H
			4804	39.61	-34.39	74	50.09	32.41	12.35	55.24	-	-	P
													V
													V
													V
													V
													V
													V
													V
													V
													V
													V
													V
													V
													V
													V
													V



BLE	Note	Frequency (MHz)	Level (dBµV/m)	Over Limit (dB)	Limit Line (dBµV/m)	Read Level (dBµV)	Antenna Factor (dB/m)	Path Loss (dB)	Preamp Factor (dB)	Ant Pos (cm)	Table Pos (deg)	Peak Avg. (P/A)	Pol. (H/V)
BLE CH 19 2440MHz		4880	39.58	-34.42	74	49.98	32.62	12.32	55.34	-	-	P	H
		7320	45.84	-28.16	74	48.85	36.76	15.88	55.65	-	-	P	H
													H
													H
													H
													H
													H
													H
													H
													H
													H
													H
													H
													H
													H
													H
													H
													H
													H
			4880	39.36	-34.64	74	49.76	32.62	12.32	55.34	-	-	P
		7320	46.24	-27.76	74	49.25	36.76	15.88	55.65	-	-	P	V
													V
													V
													V
													V
													V
													V
													V
													V
													V
													V
													V
													V
													V
													V
													V



BLE	Note	Frequency (MHz)	Level (dBμV/m)	Over Limit (dB)	Limit Line (dBμV/m)	Read Level (dBμV)	Antenna Factor (dB/m)	Path Loss (dB)	Preamp Factor (dB)	Ant Pos (cm)	Table Pos (deg)	Peak Avg. (P/A)	Pol. (H/V)
BLE CH 39 2480MHz		4960	39.66	-34.34	74	49.8	33.02	12.28	55.44	-	-	P	H
		7440	46.67	-27.33	74	49.92	36.22	16.2	55.67	-	-	P	H
													H
													H
													H
													H
													H
													H
													H
													H
													H
													H
													H
													H
													H
													H
													H
													H
													H
			4960	40.27	-33.73	74	50.41	33.02	12.28	55.44	-	-	P
		7440	45.86	-28.14	74	49.11	36.22	16.2	55.67	-	-	P	V
													V
													V
													V
													V
													V
													V
													V
													V
													V
													V
													V
													V
													V
Remark	<ol style="list-style-type: none"> No other spurious found. All results are PASS against Peak and Average limit line. The emission position marked as "-" means no suspected emission found with sufficient margin against limit line or noise floor only. 												



Emission below 1GHz

2.4GHz BLE (LF)

BLE	Note	Frequency	Level	Over	Limit	Read	Antenna	Path	Preamp	Ant	Table	Peak	Pol.	
		(MHz)	(dBμV/m)	(dB)	(dBμV/m)	(dBμV)	(dB/m)	(dB)	(dB)	(cm)	(deg)	(P/A)	(H/V)	
2.4GHz BLE LF		92.08	32.09	-11.41	43.5	47.83	14.82	1.74	32.3	-	-	P	H	
		133.79	36.1	-7.4	43.5	48.72	17.57	2.08	32.27	-	-	P	H	
		180.35	32.24	-11.26	43.5	46.98	15.05	2.43	32.22	-	-	P	H	
		471.35	30	-16	46	34.96	23.6	3.84	32.4	-	-	P	H	
		903	38.83	-7.17	46	36	29.06	5.29	31.52	-	-	P	H	
		954.41	34.75	-11.25	46	29.77	30.67	5.47	31.16	-	-	P	H	
														H
														H
														H
														H
														H
														H
			38.73	32.08	-7.92	40	43.21	20.15	1.02	32.3	-	-	P	V
			50.37	31.07	-8.93	40	47.98	14.14	1.25	32.3	-	-	P	V
			72.68	29.04	-10.96	40	47.28	12.53	1.54	32.31	-	-	P	V
			471.35	31.77	-14.23	46	36.73	23.6	3.84	32.4	-	-	P	V
			898.15	38.75	-7.25	46	36.06	28.97	5.28	31.56	-	-	P	V
			956.35	34.75	-11.25	46	29.68	30.74	5.47	31.14	-	-	P	V
													V	
													V	
													V	
													V	
													V	
													V	

Remark

- No other spurious found.
- All results are PASS against limit line.
- The emission position marked as "-" means no suspected emission found and emission level has at least 6dB margin against limit or emission is noise floor only.



Note symbol

*	Fundamental Frequency which can be ignored. However, the level of any unwanted emissions shall not exceed the level of the fundamental frequency.
!	Test result is over limit line.
P/A	Peak or Average
H/V	Horizontal or Vertical



A calculation example for radiated spurious emission is shown as below:

BLE	Note	Frequency	Level	Over	Limit	Read	Antenna	Path	Preamp	Ant	Table	Peak	Pol.
		(MHz)	(dBμV/m)	(dB)	(dBμV/m)	(dBμV)	(dB/m)	(dB)	(dB)	(cm)	(deg)	(P/A)	(H/V)
BLE CH 00 2402MHz		2390	55.45	-18.55	74	54.51	32.22	4.58	35.86	103	308	P	H
		2390	43.54	-10.46	54	42.6	32.22	4.58	35.86	103	308	A	H

1. Path Loss(dB) = Cable loss(dB) + Filter loss(dB) + Attenuator loss(dB)
2. Level(dBμV/m) =
Antenna Factor(dB/m) + Path Loss(dB) + Read Level(dBμV) - Preamp Factor(dB)
3. Over Limit(dB) = Level(dBμV/m) – Limit Line(dBμV/m)

For Peak Limit @ 2390MHz:

1. Level(dBμV/m)
= Antenna Factor(dB/m) + Path Loss(dB) + Read Level(dBμV) - Preamp Factor(dB)
= 32.22(dB/m) + 4.58(dB) + 54.51(dBμV) – 35.86 (dB)
= 55.45 (dBμV/m)
2. Over Limit(dB)
= Level(dBμV/m) – Limit Line(dBμV/m)
= 55.45(dBμV/m) – 74(dBμV/m)
= -18.55(dB)

For Average Limit @ 2390MHz:

1. Level(dBμV/m)
= Antenna Factor(dB/m) + Path Loss(dB) + Read Level(dBμV) - Preamp Factor(dB)
= 32.22(dB/m) + 4.58(dB) + 42.6(dBμV) – 35.86 (dB)
= 43.54 (dBμV/m)
2. Over Limit(dB)
= Level(dBμV/m) – Limit Line(dBμV/m)
= 43.54(dBμV/m) – 54(dBμV/m)
= -10.46(dB)

Both peak and average measured complies with the limit line, so test result is “PASS”.



Appendix C. Radiated Spurious Emission Plots

Test Engineer :	Andy Yang, Karl Hou, Wilson Wu	Temperature :	20~25°C
		Relative Humidity :	50~60%

Note symbol

-L	Low channel location
-R	High channel location



<1Mbps>

2.4GHz 2400~2483.5MHz

BLE (Band Edge @ 3m)

BLE	2.4GHz 2400~2483.5MHz Band Edge @ 3m	
BLE CH00 2402MHz		
	Horizontal	Fundamental
Peak	<p>Date: 2022-03-07</p> <p>Site : 03CH16-HY Condition : PEAK_BE_74 3m 91200_02114_210804 HORIZONTAL : RBW:1000.000KHz VBW:3000.000KHz SWT:Auto</p>	<p>Date: 2022-03-07</p> <p>Site : 03CH16-HY Condition : PEAK_74 3m 91200_02114_210804 HORIZONTAL : RBW:1000.000KHz VBW:3000.000KHz SWT:Auto</p>
Avg.	<p>Date: 2022-03-07</p> <p>Site : 03CH16-HY Condition : AVG_BE_54 3m 91200_02114_210804 HORIZONTAL : RBW:1000.000KHz VBW:3000.000KHz SWT:Auto</p>	<p>Date: 2022-03-07</p> <p>Site : 03CH16-HY Condition : AVG_54 3m 91200_02114_210804 HORIZONTAL : RBW:1000.000KHz VBW:3000.000KHz SWT:Auto</p>



BLE	2.4GHz 2400~2483.5MHz Band Edge @ 3m	
	BLE CH00 2402MHz	
	Vertical	Fundamental
Peak	<p>Site : 03CH16-HY Condition : PEAK_BE_74 3m 91200_02114_210804 VERTICAL : RBW:1000.000KHz VBW:3000.000KHz SWT:Auto</p>	<p>Site : 03CH16-HY Condition : PEAK_74 3m 91200_02114_210804 VERTICAL : RBW:1000.000KHz VBW:3000.000KHz SWT:Auto</p>
Avg	<p>Site : 03CH16-HY Condition : AVG_BE_54 3m 91200_02114_210804 VERTICAL : RBW:1000.000KHz VBW:3000.000KHz SWT:Auto</p>	<p>Site : 03CH16-HY Condition : AVG_54 3m 91200_02114_210804 VERTICAL : RBW:1000.000KHz VBW:3000.000KHz SWT:Auto</p>



BLE	2.4GHz 2400~2483.5MHz Band Edge @ 3m	
	BLE CH19 2440MHz - L	
	Horizontal	Fundamental
Peak	<p>Site : 03CH16-HY Condition : PEAK_BE_74 3m 9120D_02114_210804 HORIZONTAL : RBW:1000.000kHz VBW:3000.000kHz SWT:Auto</p>	<p>Site : 03CH16-HY Condition : PEAK_74 3m 9120D_02114_210804 HORIZONTAL : RBW:1000.000kHz VBW:3000.000kHz SWT:Auto</p>
Avg.	<p>Site : 03CH16-HY Condition : AVG_BE_54 3m 9120D_02114_210804 HORIZONTAL : RBW:1000.000kHz VBW:3.000kHz SWT:Auto</p>	<p>Site : 03CH16-HY Condition : AVG_54 3m 9120D_02114_210804 HORIZONTAL : RBW:1000.000kHz VBW:3.000kHz SWT:Auto</p>



BLE	2.4GHz 2400~2483.5MHz Band Edge @ 3m	
BLE CH19 2440MHz - R		
	Horizontal	Fundamental
<p>Peak</p>		<p>Left blank</p>
<p>Avg.</p>		<p>Left blank</p>

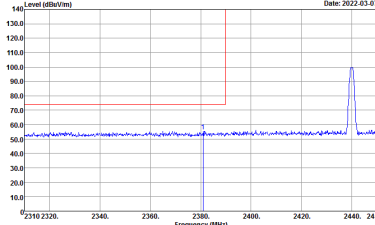
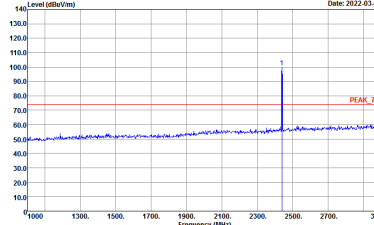
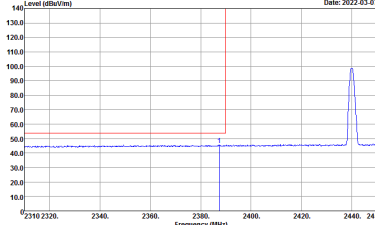
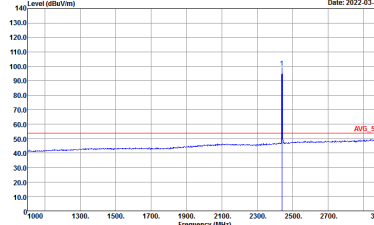

BLE	2.4GHz 2400~2483.5MHz Band Edge @ 3m	
BLE CH19 2440MHz - L		
	Vertical	Fundamental
Peak	 <p>Site : 03CH16-HY Condition : PEAK_BE_74 3m 91200_02114_210804 VERTICAL : RBW:1000.000KHz VBW:3000.000KHz SWT:Auto</p>	 <p>Site : 03CH16-HY Condition : PEAK_74 3m 91200_02114_210804 VERTICAL : RBW:1000.000KHz VBW:3000.000KHz SWT:Auto</p>
Avg.	 <p>Site : 03CH16-HY Condition : AVG_BE_54 3m 91200_02114_210804 VERTICAL : RBW:1000.000KHz VBW:3.000KHz SWT:Auto</p>	 <p>Site : 03CH16-HY Condition : AVG_54 3m 91200_02114_210804 VERTICAL : RBW:1000.000KHz VBW:3.000KHz SWT:Auto</p>



BLE	2.4GHz 2400~2483.5MHz Band Edge @ 3m	
	BLE CH19 2440MHz - R	
	Vertical	Fundamental
Peak	<p>Site : 03CH16-HY Condition : PEAK_BE_74 3m 91200_02114_210804 VERTICAL : RBW:1000.000KHz VBW:3000.000KHz SWF:Auto</p>	Left blank
Avg.	<p>Site : 03CH16-HY Condition : AVG_BE_54 3m 91200_02114_210804 VERTICAL : RBW:1000.000KHz VBW:3000.000KHz SWF:Auto</p>	Left blank



BLE	2.4GHz 2400~2483.5MHz Band Edge @ 3m	
BLE CH39 2480MHz		
	Horizontal	Fundamental
Peak	<p>Site : 03CH16-HY Condition : PEAK_BE_74 3m 91200_02114_210804 HORIZONTAL : RBW:1000.000KHz VBW:3000.000KHz SWT:Auto</p>	<p>Site : 03CH16-HY Condition : PEAK_74 3m 91200_02114_210804 HORIZONTAL : RBW:1000.000KHz VBW:3000.000KHz SWT:Auto</p>
Avg.	<p>Site : 03CH16-HY Condition : AVG_BE_54 3m 91200_02114_210804 HORIZONTAL : RBW:1000.000KHz VBW:3000.000KHz SWT:Auto</p>	<p>Site : 03CH16-HY Condition : AVG_54 3m 91200_02114_210804 HORIZONTAL : RBW:1000.000KHz VBW:3000.000KHz SWT:Auto</p>

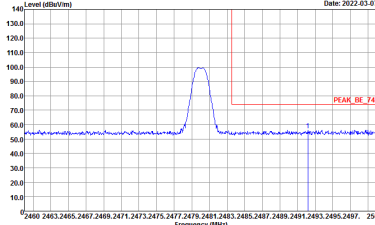
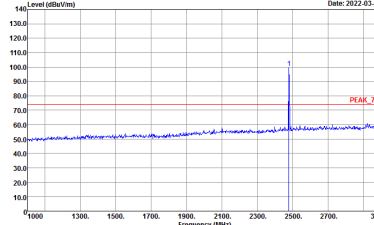
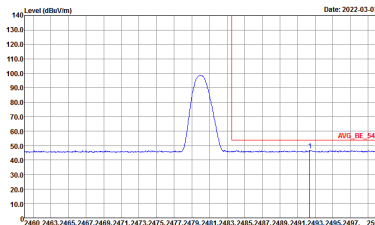
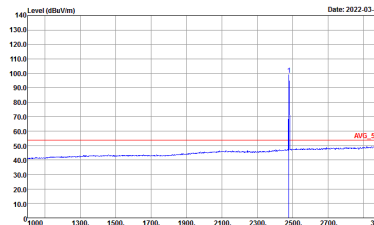

BLE	2.4GHz 2400~2483.5MHz Band Edge @ 3m	
BLE CH39 2480MHz		
	Vertical	Fundamental
Peak	 <p>Site : 03CH16-HY Condition : PEAK_BE_74 3m 91200_02114_210804 VERTICAL : RBW:1000.000KHz VBW:3000.000KHz SWT:Auto</p>	 <p>Site : 03CH16-HY Condition : PEAK_74 3m 91200_02114_210804 VERTICAL : RBW:1000.000KHz VBW:3000.000KHz SWT:Auto</p>
Avg.	 <p>Site : 03CH16-HY Condition : AVG_BE_54 3m 91200_02114_210804 VERTICAL : RBW:1000.000KHz VBW:3000.000KHz SWT:Auto</p>	 <p>Site : 03CH16-HY Condition : AVG_54 3m 91200_02114_210804 VERTICAL : RBW:1000.000KHz VBW:3000.000KHz SWT:Auto</p>



2.4GHz 2400~2483.5MHz

BLE (Harmonic @ 3m)

BLE	2.4GHz 2400~2483.5MHz Harmonic @ 3m	
	BLE CH00 2402MHz	
	Horizontal	Vertical
Peak Avg.	<p>Site : 03CH16-HY Condition : PEAK_74 3m 9120D_02114_210804 HORIZONTAL</p>	<p>Site : 03CH16-HY Condition : PEAK_74 3m 9120D_02114_210804 VERTICAL</p>



BLE	2.4GHz 2400~2483.5MHz Harmonic @ 3m	
	BLE CH19 2440MHz	
	Horizontal	Vertical
Peak Avg.	<p>Site : 03CH16-HY Condition : PEAK_74 3m 9120D_02114_210804 HORIZONTAL</p>	<p>Site : 03CH16-HY Condition : PEAK_74 3m 9120D_02114_210804 VERTICAL</p>



BLE	2.4GHz 2400~2483.5MHz Harmonic @ 3m	
	BLE CH39 2480MHz	
	Horizontal	Vertical
Peak	<p>Site : 03CH16-HY Condition : PEAK_74 3m 91200_02114_210804 HORIZONTAL</p>	<p>Site : 03CH16-HY Condition : PEAK_74 3m 91200_02114_210804 VERTICAL</p>



<2Mbps>

2.4GHz 2400~2483.5MHz

BLE (Band Edge @ 3m)

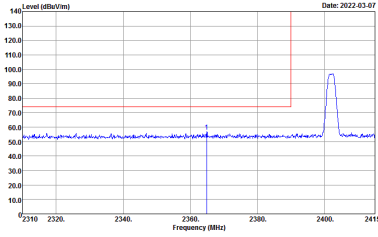
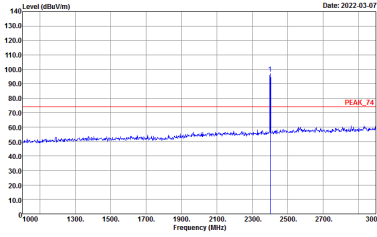
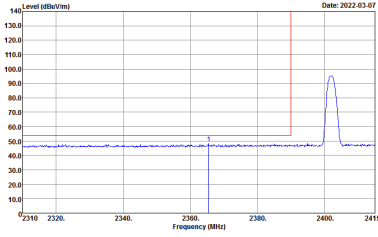
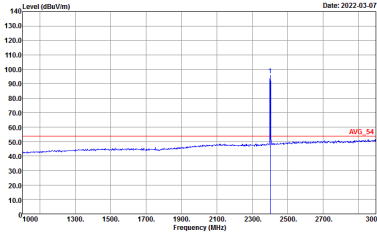
BLE	2.4GHz 2400~2483.5MHz Band Edge @ 3m	
BLE CH00 2402MHz		
Horizontal		Fundamental
Peak	 <p>Site : 03CH16-HY Condition : PEAK_BE_74 3m 91200_02114_210804 HORIZONTAL : RBW:1000.000KHz VBW:3000.000KHz SWT:Auto</p>	 <p>Site : 03CH16-HY Condition : PEAK_74 3m 91200_02114_210804 HORIZONTAL : RBW:1000.000KHz VBW:3000.000KHz SWT:Auto</p>
Avg.	 <p>Site : 03CH16-HY Condition : AVG_BE_54 3m 91200_02114_210804 HORIZONTAL : RBW:1000.000KHz VBW:30.000KHz SWT:Auto</p>	 <p>Site : 03CH16-HY Condition : AVG_54 3m 91200_02114_210804 HORIZONTAL : RBW:1000.000KHz VBW:30.000KHz SWT:Auto</p>



BLE	2.4GHz 2400~2483.5MHz Band Edge @ 3m	
BLE CH00 2402MHz		
	Vertical	Fundamental
Peak	<p>Site : 03CH16-HY Condition : PEAK_BE_74 3m 91200_02114_210804 VERTICAL : RBW:1000.000KHz VBW:3000.000KHz SWT:Auto</p>	<p>Site : 03CH16-HY Condition : PEAK_74 3m 91200_02114_210804 VERTICAL : RBW:1000.000KHz VBW:3000.000KHz SWT:Auto</p>
Avg	<p>Site : 03CH16-HY Condition : AVG_BE_54 3m 91200_02114_210804 VERTICAL : RBW:1000.000KHz VBW:30.000KHz SWT:Auto</p>	<p>Site : 03CH16-HY Condition : AVG_54 3m 91200_02114_210804 VERTICAL : RBW:1000.000KHz VBW:30.000KHz SWT:Auto</p>

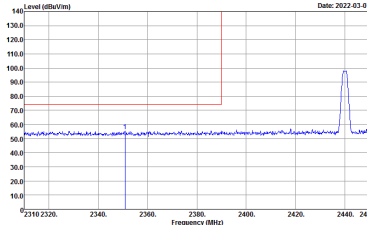
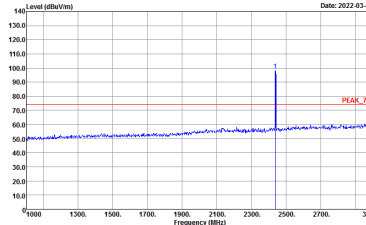
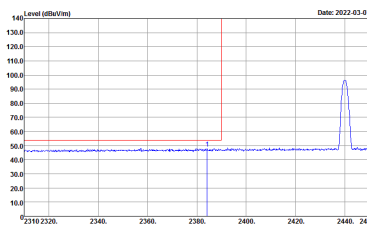
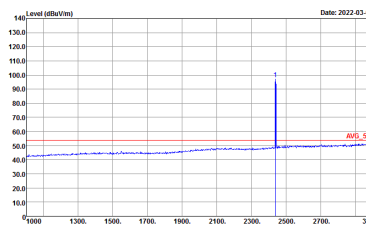

BLE	2.4GHz 2400~2483.5MHz Band Edge @ 3m	
BLE CH19 2440MHz - L		
	Horizontal	Fundamental
Peak	 <p>Site : 03CH16-HY Condition : PEAK_BE_74 3m 9120D_02114_210804 HORIZONTAL : RBW:1000.000KHz VBW:3000.000KHz SWT:Auto</p>	 <p>Site : 03CH16-HY Condition : PEAK_74 3m 9120D_02114_210804 HORIZONTAL : RBW:1000.000KHz VBW:3000.000KHz SWT:Auto</p>
Avg.	 <p>Site : 03CH16-HY Condition : AVG_BE_54 3m 9120D_02114_210804 HORIZONTAL : RBW:1000.000KHz VBW:10.000KHz SWT:Auto</p>	 <p>Site : 03CH16-HY Condition : AVG_54 3m 9120D_02114_210804 HORIZONTAL : RBW:1000.000KHz VBW:10.000KHz SWT:Auto</p>

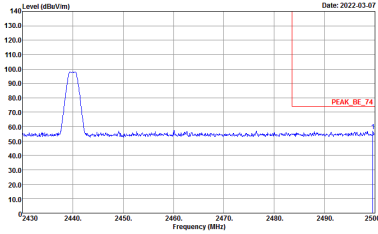
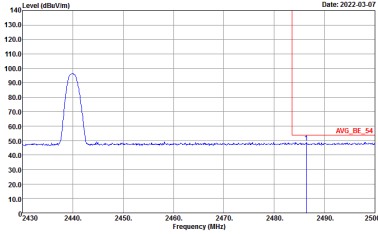

BLE	2.4GHz 2400~2483.5MHz Band Edge @ 3m	
BLE CH19 2440MHz - R		
	Horizontal	Fundamental
<p>Peak</p>	 <p>Site : 03CH16-HY Condition : PEAK_BE_74 3m 91200_02114_210804 HORIZONTAL : RBW:1000.000KHz VBW:3000.000KHz SWT:Auto</p>	<p>Left blank</p>
<p>Avg.</p>	 <p>Site : 03CH16-HY Condition : AVG_BE_54 3m 91200_02114_210804 HORIZONTAL : RBW:1000.000KHz VBW:30.000KHz SWT:Auto</p>	<p>Left blank</p>

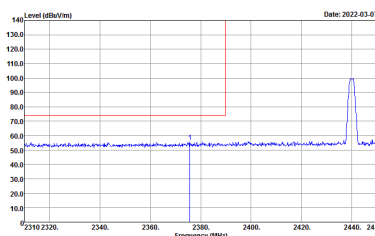
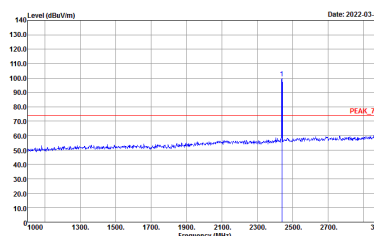
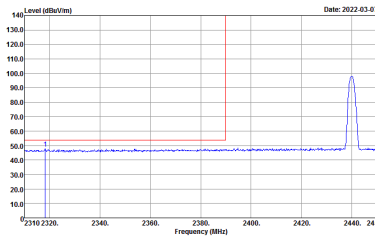
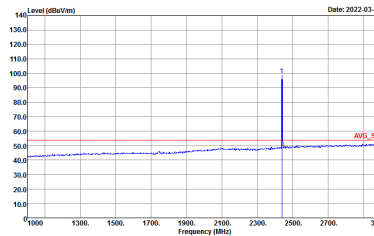

BLE	2.4GHz 2400~2483.5MHz Band Edge @ 3m	
BLE CH19 2440MHz - L		
	Vertical	Fundamental
Peak	 <p>Site : 03CH16-HY Condition : PEAK_BE_74 3m 91200_02114_210804 VERTICAL : RBW:1000.000KHz VBW:3000.000KHz SWT:Auto</p>	 <p>Site : 03CH16-HY Condition : PEAK_74 3m 91200_02114_210804 VERTICAL : RBW:1000.000KHz VBW:3000.000KHz SWT:Auto</p>
Avg.	 <p>Site : 03CH16-HY Condition : AVG_BE_54 3m 91200_02114_210804 VERTICAL : RBW:1000.000KHz VBW:30.000KHz SWT:Auto</p>	 <p>Site : 03CH16-HY Condition : AVG_54 3m 91200_02114_210804 VERTICAL : RBW:1000.000KHz VBW:30.000KHz SWT:Auto</p>



BLE	2.4GHz 2400~2483.5MHz Band Edge @ 3m	
	BLE CH19 2440MHz - R	
	Vertical	Fundamental
Peak	<p>Site : 03CH16-HY Condition : PEAK_BE_74 3m 91200_02114_210804 VERTICAL : RBW:1000.000KHz VBW:3000.000KHz SWT:Auto</p>	Left blank
Avg.	<p>Site : 03CH16-HY Condition : AVG_BE_54 3m 91200_02114_210804 VERTICAL : RBW:1000.000KHz VBW:30.000KHz SWT:Auto</p>	Left blank

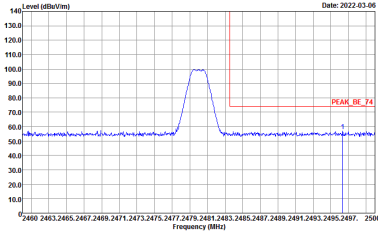
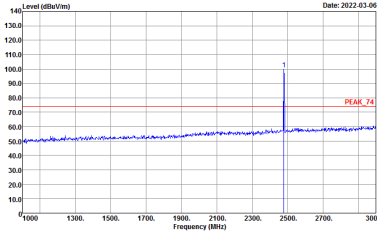
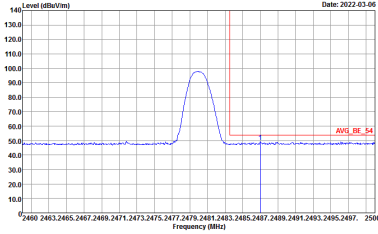
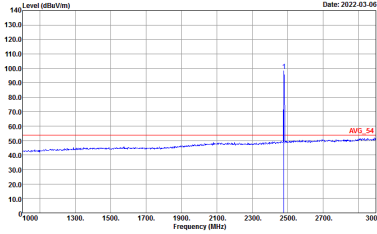

BLE	2.4GHz 2400~2483.5MHz Band Edge @ 3m	
BLE CH39 2480MHz		
	Horizontal	Fundamental
Peak	 <p>Site : 03CH16-HY Condition : PEAK_BE_74 3m 91200_02114_210804 HORIZONTAL : RBW:1000.000KHz VBW:3000.000KHz SWT:Auto</p>	 <p>Site : 03CH16-HY Condition : PEAK_74 3m 91200_02114_210804 HORIZONTAL : RBW:1000.000KHz VBW:3000.000KHz SWT:Auto</p>
Avg.	 <p>Site : 03CH16-HY Condition : AVG_BE_54 3m 91200_02114_210804 HORIZONTAL : RBW:1000.000KHz VBW:30.000KHz SWT:Auto</p>	 <p>Site : 03CH16-HY Condition : AVG_54 3m 91200_02114_210804 HORIZONTAL : RBW:1000.000KHz VBW:30.000KHz SWT:Auto</p>

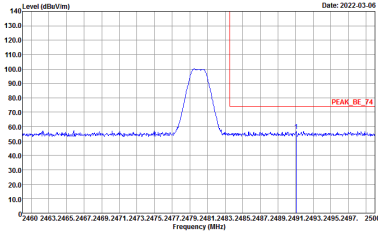
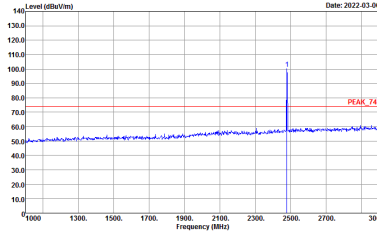
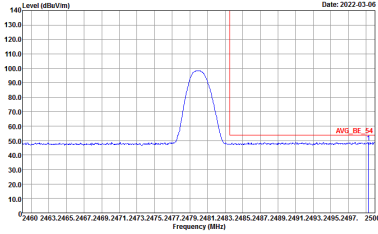
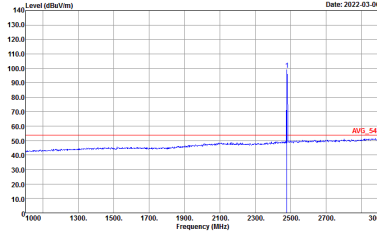

BLE	2.4GHz 2400~2483.5MHz Band Edge @ 3m	
BLE CH39 2480MHz		
	Vertical	Fundamental
Peak	 <p>Site : 03CH16-HY Condition : PEAK_BE_74 3m 91200_02114_210804 VERTICAL : RBW:1000.000KHz VBW:3000.000KHz SWT:Auto</p>	 <p>Site : 03CH16-HY Condition : PEAK_74 3m 91200_02114_210804 VERTICAL : RBW:1000.000KHz VBW:3000.000KHz SWT:Auto</p>
Avg.	 <p>Site : 03CH16-HY Condition : AVG_BE_54 3m 91200_02114_210804 VERTICAL : RBW:1000.000KHz VBW:30.000KHz SWT:Auto</p>	 <p>Site : 03CH16-HY Condition : AVG_54 3m 91200_02114_210804 VERTICAL : RBW:1000.000KHz VBW:30.000KHz SWT:Auto</p>



2.4GHz 2400~2483.5MHz

BLE (Harmonic @ 3m)

BLE	2.4GHz 2400~2483.5MHz Harmonic @ 3m	
	BLE CH00 2402MHz	
	Horizontal	Vertical
Peak Avg.	<p>Site : 03CH16-HY Condition : PEAK_74 3m 9120D_02114_210804 HORIZONTAL</p>	<p>Site : 03CH16-HY Condition : PEAK_74 3m 9120D_02114_210804 VERTICAL</p>



BLE	2.4GHz 2400~2483.5MHz Harmonic @ 3m	
	BLE CH19 2440MHz	
	Horizontal	Vertical
Peak Avg.	<p>Site : 03CH16-HY Condition : PEAK_74 3m 91200_02114_210804 HORIZONTAL</p>	<p>Site : 03CH16-HY Condition : PEAK_74 3m 91200_02114_210804 VERTICAL</p>



BLE	2.4GHz 2400~2483.5MHz Harmonic @ 3m	
	BLE CH39 2480MHz	
	Horizontal	Vertical
Peak	<p>Site : 03CH16-HY Condition : PEAK_74 3m 9120D_02114_210804 HORIZONTAL</p>	<p>Site : 03CH16-HY Condition : PEAK_74 3m 9120D_02114_210804 VERTICAL</p>



Emission below 1GHz
2.4GHz BLE (LF)

Table with 2 columns: Horizontal and Vertical. Each column contains a graph of Level (dBuV/m) vs Frequency (MHz) for the 2.4GHz BLE (LF) test. The graphs show a blue signal line and a red QP limit line. The horizontal graph is labeled 'Horizontal' and the vertical graph is labeled 'Vertical'. Both graphs include site and condition information: Site: 03CH16-HY, Condition: QP 3m BIL06_47020_211009.

QP / Peak



Appendix D. Duty Cycle Plots

Band	Duty Cycle(%)	T(us)	1/T(kHz)	VBW Setting
Bluetooth - LE for 1Mbps	62.38	388	2.58	3kHz
Bluetooth - LE for 2Mbps	32.59	204	4.90	10kHz

