



FCC RF Test Report

APPLICANT : Zebra Technologies Corporation
EQUIPMENT : Touch computer
BRAND NAME : Zebra
MODEL NAME : TC56CJ
FCC ID : UZ7TC56CJ
STANDARD : FCC Part 15 Subpart C §15.247
CLASSIFICATION : (DTS) Digital Transmission System

The product was received on Oct. 13, 2016 and testing was completed on Nov. 23, 2016. We, SPORTON INTERNATIONAL INC., would like to declare that the tested sample has been evaluated in accordance with the test procedures and has been in compliance with the applicable technical standards.

The test results in this report apply exclusively to the tested model / sample. Without written approval of SPORTON INTERNATIONAL INC., the test report shall not be reproduced except in full.

Reviewed by: Joseph Lin / Supervisor

Approved by: Jones Tsai / Manager



SPORTON INTERNATIONAL INC.

No. 52, Hwa Ya 1st Rd., Hwa Ya Technology Park, Kwei-Shan District, Tao Yuan City, Taiwan, R.O.C.



TABLE OF CONTENTS

REVISION HISTORY 3

SUMMARY OF TEST RESULT 4

1 GENERAL DESCRIPTION 5

 1.1 Applicant 5

 1.2 Manufacturer 5

 1.3 Product Feature of Equipment Under Test 5

 1.4 Product Specification of Equipment Under Test 6

 1.5 Modification of EUT 6

 1.6 Testing Location 7

 1.7 Applicable Standards 7

2 TEST CONFIGURATION OF EQUIPMENT UNDER TEST 8

 2.1 Carrier Frequency and Channel 8

 2.2 Pre-Scanned RF Power 9

 2.3 Test Mode 13

 2.4 Connection Diagram of Test System 14

 2.5 Support Unit used in test configuration and system 15

 2.6 EUT Operation Test Setup 15

 2.7 Measurement Results Explanation Example 15

3 TEST RESULT 16

 3.1 6dB and 99% Bandwidth Measurement 16

 3.2 Output Power Measurement 18

 3.3 Power Spectral Density Measurement 21

 3.4 Conducted Band Edges and Spurious Emission Measurement 23

 3.5 Radiated Band Edges and Spurious Emission Measurement 36

 3.6 AC Conducted Emission Measurement 40

 3.7 Antenna Requirements 44

4 LIST OF MEASURING EQUIPMENT 45

5 UNCERTAINTY OF EVALUATION 46

APPENDIX A. RADIATED SPURIOUS EMISSION

APPENDIX B. RADIATED SPURIOUS EMISSION PLOTS

APPENDIX C. DUTY CYCLE PLOTS

APPENDIX D. SETUP PHOTOGRAPHS



SUMMARY OF TEST RESULT

Report Section	FCC Rule	Description	Limit	Result	Remark
3.1	15.247(a)(2)	6dB Bandwidth	$\geq 0.5\text{MHz}$	Pass	-
3.1	-	99% Bandwidth	-	Pass	-
3.2	15.247(b)	Power Output Measurement	$\leq 30\text{dBm}$	Pass	-
3.3	15.247(e)	Power Spectral Density	$\leq 8\text{dBm}/3\text{kHz}$	Pass	-
3.4	15.247(d)	Conducted Band Edges	$\leq 20\text{dBc}$	Pass	-
		Conducted Spurious Emission		Pass	-
3.5	15.247(d)	Radiated Band Edges and Radiated Spurious Emission	15.209(a) & 15.247(d)	Pass	Under limit 1.04 dB at 2389.940 MHz
3.6	15.207	AC Conducted Emission	15.207(a)	Pass	Under limit 14.80 dB at 0.286 MHz
3.7	15.203 & 15.247(b)	Antenna Requirement	N/A	Pass	-



1 General Description

1.1 Applicant

Zebra Technologies Corporation
1 Zebra Plaza Holtsville, NY 11742

1.2 Manufacturer

Wistron Corporation
21F, No. 88, Sec. 1, Hsin Tai Wu Rd., Hsichih Dist, New Taipei City 221, Taiwan R.O.C.

1.3 Product Feature of Equipment Under Test

Product Feature	
Equipment	Touch computer
Brand Name	Zebra
Model Name	TC56CJ
FCC ID	UZ7TC56CJ
EUT supports Radios application	CDMA/EV-DO/GSM/EGPRS/WCDMA/HSPA/LTE/NFC WLAN 11a/b/g/n HT20/HT40 WLAN 11ac VHT20/VHT40/VHT80 Bluetooth BR/EDR/LE
HW Version	DV1
SW Version	91-12-04.4-MG-00
FW Version	FUSION_BA_2_00.0.0.022
MFD	17OCT16
EUT Stage	Engineering sample

Remark: The above EUT's information was declared by manufacturer. Please refer to the specifications or user's manual for more detailed description.

Specification of Accessories				
Adapter (5V/2.5A)	Brand Name	Zebra	Model Number	SAWA-65-20005A
Headset Jumper 1	Brand Name	Zebra	Part Number	CBL-TC51-HDST25-01
Headset Jumper 2	Brand Name	Zebra	Part Number	CBL-TC51-HDST35-01
Battery	Brand Name	Zebra	Model Number	BT-000314
2.5mm Earphone	Brand Name	Zebra	Part Number	HDST-25MM-PTVP-01
3.5mm Earphone	Brand Name	Zebra	Part Number	HDST-35MM-PTVP-01
Trigger Handle	Brand Name	Zebra	Part Number	TRG-TC51-SNP1-01
Rugged Charge/USB cable	Brand Name	Zebra	Part Number	CBL-TC51-USB1-01
Soft Holster	Brand Name	Zebra	Part Number	SG-TC51-HLSTR1-01
Exoskeleton	Brand Name	Zebra	Part Number	SG-TC51-EX01-01
Hand strap	Brand Name	Zebra	Part Number	SG-TC51-BHDSTP1-03



1.4 Product Specification of Equipment Under Test

Standards-related Product Specification	
Tx/Rx Channel Frequency Range	2412 MHz ~ 2462 MHz
Maximum (Peak) Output Power to antenna	802.11b : 21.85 dBm (0.1531 W) 802.11g : 23.45 dBm (0.2213 W) 802.11n HT20 : 23.51 dBm (0.2244 W) 802.11n HT40 : 22.94 dBm (0.1968 W) 802.11ac VHT20 : 23.60 dBm (0.2291 W) 802.11ac VHT40 : 22.95 dBm (0.1972 W)
99% Occupied Bandwidth	802.11b : 11.95MHz 802.11g : 18.70MHz 802.11ac VHT20 : 19.45MHz 802.11ac VHT40 : 36.90MHz
Antenna Type / Gain	Loop Antenna with gain 1.40 dBi
Type of Modulation	802.11b : DSSS (DBPSK / DQPSK / CCK) 802.11g/n : OFDM (BPSK / QPSK / 16QAM / 64QAM) 802.11ac : OFDM (BPSK / QPSK / 16QAM / 64QAM / 256QAM)

1.5 Modification of EUT

No modifications are made to the EUT during all test items.



1.6 Testing Location

Sporton Lab is accredited to ISO 17025 by Taiwan Accreditation Foundation (TAF code : 1190) and the FCC designation No. TW1022 under the FCC 2.948(e) by Mutual Recognition Agreement (MRA) in FCC Test.

Test Site	SPORTON INTERNATIONAL INC.	
Test Site Location	No. 52, Hwa Ya 1 st Rd., Hwa Ya Technology Park, Kwei-Shan District, Tao Yuan City, Taiwan, R.O.C. TEL: +886-3-327-3456 FAX: +886-3-328-4978	
Test Site No.	Sporton Site No.	
	TH05-HY	CO05-HY

Note: The test site complies with ANSI C63.4 2014 requirement.

Test Site	SPORTON INTERNATIONAL INC.	
Test Site Location	No.58, Aly. 75, Ln. 564, Wenhua 3rd Rd. Guishan Dist, Taoyuan City, Taiwan (R.O.C.) TEL: +886-3-327-0868 FAX: +886-3-327-0855	
Test Site No.	Sporton Site No.	
	03CH12-HY	

Note: The test site complies with ANSI C63.4 2014 requirement.

1.7 Applicable Standards

According to the specifications of the manufacturer, the EUT must comply with the requirements of the following standards:

- ♦ FCC Part 15 Subpart C §15.247
- ♦ FCC KDB Publication No. 558074 D01 DTS Meas. Guidance v03r05
- ♦ FCC KDB 644545 D03 Guidance for IEEE 802 11ac New Rules v01
- ♦ ANSI C63.10-2013

Remark:

1. All test items were verified and recorded according to the standards and without any deviation during the test.
2. This EUT has also been tested and complied with the requirements of FCC Part 15, Subpart B, recorded in a separate test report.



2 Test Configuration of Equipment Under Test

The EUT has been associated with peripherals and configuration operated in a manner tended to maximize its emission characteristics in a typical application. Frequency range investigated: conducted emission (150 kHz to 30 MHz) and radiated emission (9 kHz to the 10th harmonic of the highest fundamental frequency or to 40 GHz, whichever is lower). For radiated measurement, pre-scanned in three orthogonal panels, X, Y, Z. The worst cases (X plane) were recorded in this report.

2.1 Carrier Frequency and Channel

Frequency Band	Channel	Freq. (MHz)	Channel	Freq. (MHz)
2400-2483.5 MHz	1	2412	7	2442
	2	2417	8	2447
	3	2422	9	2452
	4	2427	10	2457
	5	2432	11	2462
	6	2437	-	-



2.2 Pre-Scanned RF Power

Preliminary tests were performed in different data rate and data rate associated with the highest power were chosen for full test shown in the following tables.

<Peak Power>

802.11b mode						
Power vs. Channel			Power vs. Data Rate			
Channel	Frequency (MHz)	Data Rate (bps)	Channel	Data Rate (bps)		
		1M		2M	5.5M	11M
CH 01	2412	21.85	CH 01	21.75	21.53	21.50
CH 02	2417	21.73				
CH 06	2437	21.64				
CH 10	2457	21.75				
CH 11	2462	21.82				

802.11g mode										
Power vs. Channel			Power vs. Data Rate							
Channel	Frequency (MHz)	Data Rate (bps)	Channel	Data Rate (bps)						
		6M		9M	12M	18M	24M	36M	48M	54M
CH 01	2412	21.65	CH 06	23.44	23.40	23.42	23.40	23.44	23.41	23.43
CH 02	2417	23.30								
CH 06	2437	23.45								
CH 10	2457	23.30								
CH 11	2462	22.58								

802.11n HT20 mode										
Power vs. Channel			Power vs. Data Rate							
Channel	Frequency (MHz)	MCS Index	Channel	MCS Index						
		MCS0		MCS1	MCS2	MCS3	MCS4	MCS5	MCS6	MCS7
CH 01	2412	21.77	CH 06	23.50	23.50	23.48	23.50	23.49	23.50	23.49
CH 02	2417	23.30								
CH 06	2437	23.51								
CH 10	2457	23.14								
CH 11	2462	22.71								



802.11n HT40 mode										
Power vs. Channel			Power vs. Data Rate							
Channel	Frequency (MHz)	MCS Index	Channel	MCS Index						
		MCS0		MCS1	MCS2	MCS3	MCS4	MCS5	MCS6	MCS7
CH 03	2422	21.81	CH 06	22.85	22.80	22.90	22.90	22.88	22.85	22.80
CH 04	2427	22.60								
CH 06	2437	22.94								
CH 08	2447	21.51								
CH 09	2452	22.03								

802.11ac VHT20 mode											
Power vs. Channel			Power vs. Data Rate								
Channel	Frequency (MHz)	MCS Index	Channel	MCS Index							
		MCS0		MCS1	MCS2	MCS3	MCS4	MCS5	MCS6	MCS7	MCS8
CH 01	2412	21.83	CH 06	23.43	23.35	23.55	23.58	23.59	23.59	23.58	23.59
CH 02	2417	23.34									
CH 06	2437	23.60									
CH 10	2457	23.15									
CH 11	2462	22.73									

802.11ac VHT40 mode												
Power vs. Channel			Power vs. Data Rate									
Channel	Frequency (MHz)	MCS Index	Channel	MCS Index								
		MCS0		MCS1	MCS2	MCS3	MCS4	MCS5	MCS6	MCS7	MCS8	MCS9
CH 03	2422	21.84	CH 06	22.92	22.93	22.94	22.93	22.92	22.93	22.93	22.94	22.94
CH 04	2427	22.62										
CH 06	2437	22.95										
CH 08	2447	21.52										
CH 09	2452	22.13										



<Average Power>

802.11b mode						
Power vs. Channel			Power vs. Data Rate			
Channel	Frequency (MHz)	Data Rate (bps)	Channel	Data Rate (bps)		
		1M		2M	5.5M	11M
CH 01	2412	18.76	CH 01	18.71	18.62	18.60
CH 02	2417	18.75				
CH 06	2437	18.60				
CH 10	2457	18.71				
CH 11	2462	18.71				

802.11g mode										
Power vs. Channel			Power vs. Data Rate							
Channel	Frequency (MHz)	Data Rate (bps)	Channel	Data Rate (bps)						
		6M		9M	12M	18M	24M	36M	48M	54M
CH 01	2412	15.14	CH 06	17.74	17.70	17.73	17.76	17.75	17.75	17.74
CH 02	2417	17.70								
CH 06	2437	17.77								
CH 10	2457	17.74								
CH 11	2462	16.68								

802.11n HT20 mode										
Power vs. Channel			Power vs. Data Rate							
Channel	Frequency (MHz)	MCS Index	Channel	MCS Index						
		MCS0		MCS1	MCS2	MCS3	MCS4	MCS5	MCS6	MCS7
CH 01	2412	15.14	CH 06	17.67	17.69	17.62	17.65	17.69	17.65	17.67
CH 02	2417	17.65								
CH 06	2437	17.70								
CH 10	2457	17.55								
CH 11	2462	16.59								



802.11n HT40 mode										
Power vs. Channel			Power vs. Data Rate							
Channel	Frequency (MHz)	MCS Index	Channel	MCS Index						
		MCS0		MCS1	MCS2	MCS3	MCS4	MCS5	MCS6	MCS7
CH 03	2422	14.29	CH 06	15.89	15.88	15.83	15.92	15.86	15.90	15.91
CH 04	2427	15.34								
CH 06	2437	15.93								
CH 08	2447	13.86								
CH 09	2452	14.21								

802.11ac VHT20 mode											
Power vs. Channel			Power vs. Data Rate								
Channel	Frequency (MHz)	MCS Index	Channel	MCS Index							
		MCS0		MCS1	MCS2	MCS3	MCS4	MCS5	MCS6	MCS7	MCS8
CH 01	2412	15.22	CH 06	17.72	17.68	17.75	17.76	17.76	17.76	17.75	17.76
CH 02	2417	17.72									
CH 06	2437	17.77									
CH 10	2457	17.59									
CH 11	2462	16.68									

802.11ac VHT40 mode												
Power vs. Channel			Power vs. Data Rate									
Channel	Frequency (MHz)	MCS Index	Channel	MCS Index								
		MCS0		MCS1	MCS2	MCS3	MCS4	MCS5	MCS6	MCS7	MCS8	MCS9
CH 03	2422	14.32	CH 06	15.94	15.94	15.93	15.94	15.94	15.93	15.91	15.94	
CH 04	2427	15.37										
CH 06	2437	15.96										
CH 08	2447	13.87										
CH 09	2452	14.24										



2.3 Test Mode

Final test mode of conducted test items and radiated spurious emissions are considering the modulation and worse data rates as below table.

Modulation	Data Rate
802.11b	1 Mbps
802.11g	6 Mbps
802.11n HT20	MCS0
802.11n HT40	MCS0
802.11ac VHT20	MCS0
802.11ac VHT40	MCS0

Test Cases	
AC Conducted Emission	Mode 1 : GSM850 Idle + WLAN (2.4GHz) Link + Bluetooth Link + NFC active + Battery + Scanner + without Exoskeleton + Rugged Charge/USB cable + Adapter (SAWA-65-20005A (5V/2.5A)) + Headset Jumper (CBL-TC51-HDST25-01) + Earphone (HDST-25MM-PTVP-01)

2.4 Connection Diagram of Test System

<WLAN Tx Mode>

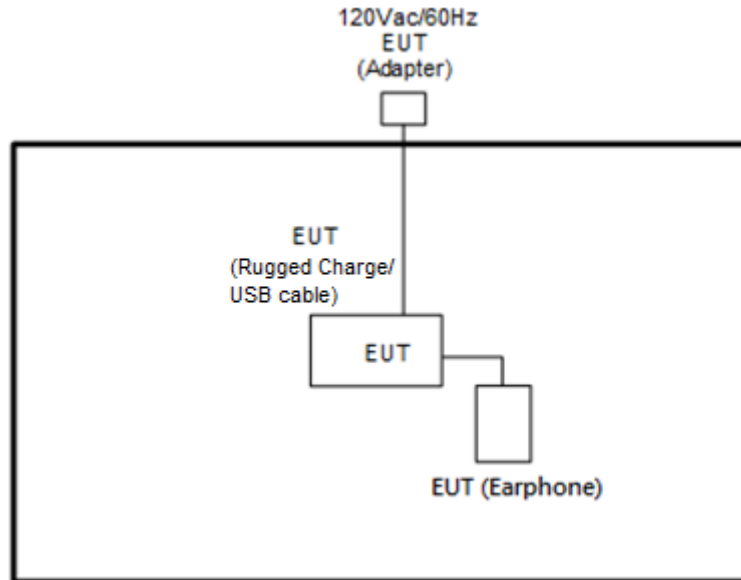

<AC Conducted Emission Mode>

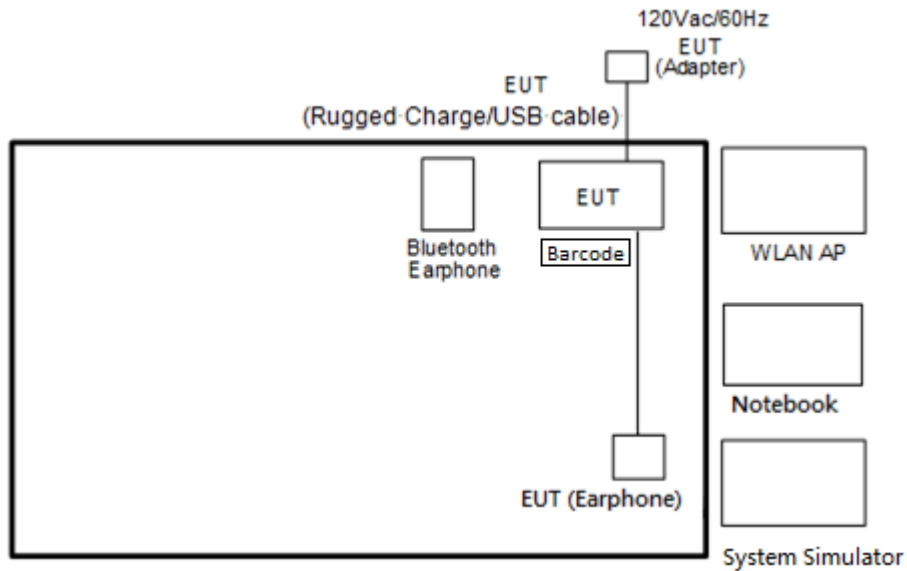



2.5 Support Unit used in test configuration and system

Item	Equipment	Trade Name	Model Name	FCC ID	Data Cable	Power Cord
1.	System Simulator	Anritsu	MT8820C	N/A	N/A	Unshielded, 1.8 m
2.	Bluetooth Earphone	Sony Ericsson	MW600	PY7DDA-2029	N/A	N/A
3.	WLAN AP	ASUS	RT-AC66U	MSQ-RTAC66U	N/A	Unshielded, 1.8 m
4.	Notebook	DELL	Latitude E6320	FCC DoC/ Contains FCC ID: QDS-BRCM1054	N/A	AC I/P: Unshielded, 1.2 m DC O/P: Shielded, 1.8 m
5.	SD Card	SanDisk	MicroSD HC	FCC DoC	N/A	N/A
6.	Barcode	N/A	N/A	N/A	N/A	N/A

2.6 EUT Operation Test Setup

For WLAN function, programmed RF utility, “ADB” installed in the notebook make the EUT provide functions like channel selection and power level for continuous transmitting and receiving signals.

2.7 Measurement Results Explanation Example

For all conducted test items:

The offset level is set in the spectrum analyzer to compensate the RF cable loss and attenuator factor between EUT conducted output port and spectrum analyzer. With the offset compensation, the spectrum analyzer reading level is exactly the EUT RF output level.

Example :

The spectrum analyzer offset is derived from RF cable loss and attenuator factor.

Offset = RF cable loss + attenuator factor.

Following shows an offset computation example with cable loss 4.2 dB and 10dB attenuator.

$$\begin{aligned} \text{Offset(dB)} &= \text{RF cable loss(dB)} + \text{attenuator factor(dB)}. \\ &= 4.2 + 10 = 14.2 \text{ (dB)} \end{aligned}$$

3 Test Result

3.1 6dB and 99% Bandwidth Measurement

3.1.1 Limit of 6dB and 99% Bandwidth

The minimum 6 dB bandwidth shall be at least 500 kHz.

3.1.2 Measuring Instruments

The measuring equipment is listed in the section 4 of this test report.

3.1.3 Test Procedures

1. The testing follows FCC KDB Publication No. 558074 DTS D01 Meas. Guidance v03r05.
2. The RF output of EUT was connected to the spectrum analyzer by RF cable and attenuator. The path loss was compensated to the results for each measurement.
3. Set to the maximum power setting and enable the EUT transmit continuously.
4. Make the measurement with the spectrum analyzer's resolution bandwidth (RBW) = 100 kHz. Set the Video bandwidth (VBW) = 300 kHz. In order to make an accurate measurement. The 6 dB bandwidth must be greater than 500 kHz.
5. For 99% Bandwidth Measurement, the spectrum analyzer's resolution bandwidth (RBW) = 1MHz and set the Video bandwidth (VBW) = 3MHz.
6. Measure and record the results in the test report.

3.1.4 Test Setup

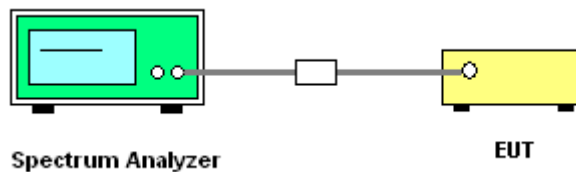



3.1.5 Test Result of 6dB and 99% Occupied Bandwidth

2.4GHz Band								
Mod.	Data Rate	NTX	CH.	Freq. (MHz)	99% Occupied BW (MHz)	6dB BW (MHz)	6dB BW Limit (MHz)	Pass/Fail
11b	1Mbps	1	1	2412	11.95	9.04	0.50	Pass
11b	1Mbps	1	6	2437	11.85	8.52	0.50	Pass
11b	1Mbps	1	11	2462	11.75	8.52	0.50	Pass
11g	6Mbps	1	1	2412	18.40	16.32	0.50	Pass
11g	6Mbps	1	6	2437	18.70	16.08	0.50	Pass
11g	6Mbps	1	11	2462	18.05	16.04	0.50	Pass
VHT20	MCS0	1	1	2412	19.30	17.60	0.50	Pass
VHT20	MCS0	1	6	2437	19.45	17.28	0.50	Pass
VHT20	MCS0	1	11	2462	19.00	16.36	0.50	Pass
VHT40	MCS0	1	3	2422	36.50	35.68	0.50	Pass
VHT40	MCS0	1	6	2437	36.90	36.24	0.50	Pass
VHT40	MCS0	1	9	2452	36.50	35.76	0.50	Pass

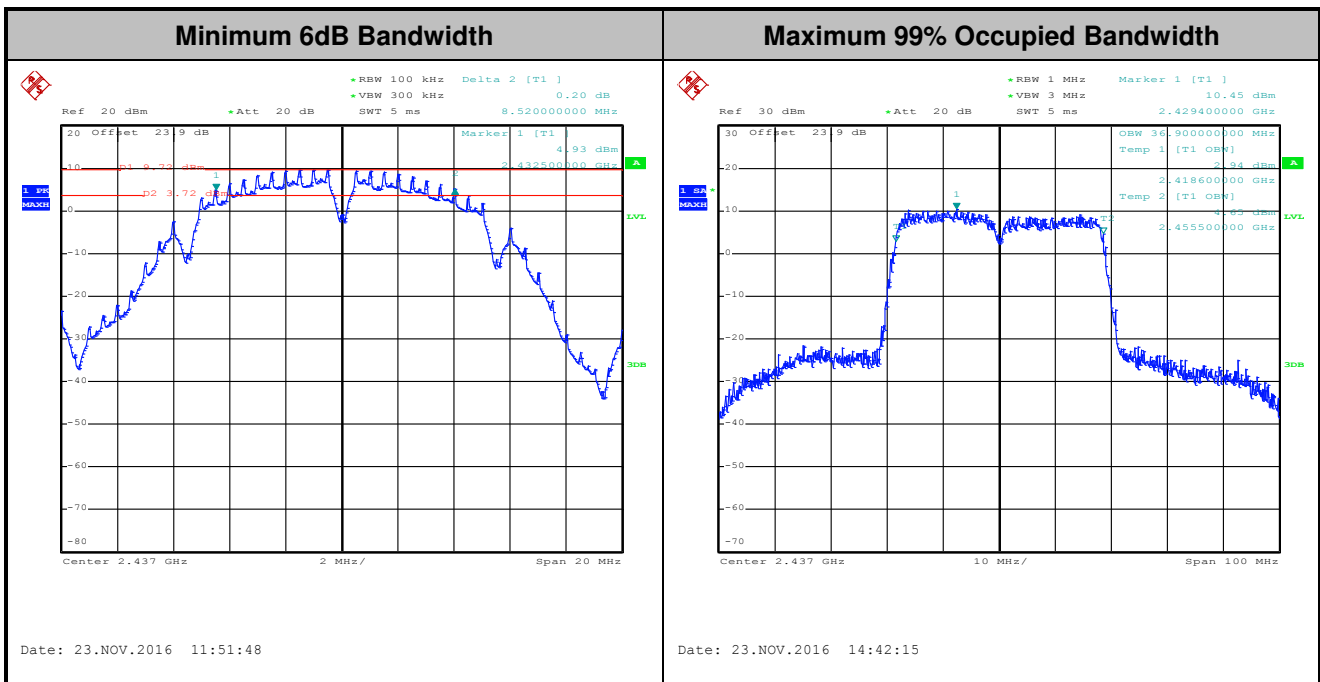

Note : The occupied channel bandwidth is maintained within the band of operation for all of the modulations.

3.2 Output Power Measurement

3.2.1 Limit of Output Power

For systems using digital modulation in the 2400-2483.5MHz, the limit for peak output power is 30dBm. If transmitting antenna of directional gain greater than 6dBi are used the peak output power from the intentional radiator shall be reduced below the above stated value by the amount in dB that the directional gain of the antenna exceeds 6 dBi. In case of point-to-point operation, the limit has to be reduced by 1dB for every 3dB that the directional gain of the antenna exceeds 6dBi.

3.2.2 Measuring Instruments

The measuring equipment is listed in the section 4 of this test report.

3.2.3 Test Procedures

1. The testing follows the Measurement Procedure of FCC KDB No. 558074 DTS D01 Meas. Guidance v03r05 section 9.1.2 PKPM1 Peak power meter method.
2. The RF output of EUT was connected to the power meter by RF cable and attenuator. The path loss was compensated to the results for each measurement.
3. Set to the maximum power setting and enable the EUT transmit continuously.
4. Measure the conducted output power and record the results in the test report.

3.2.4 Test Setup

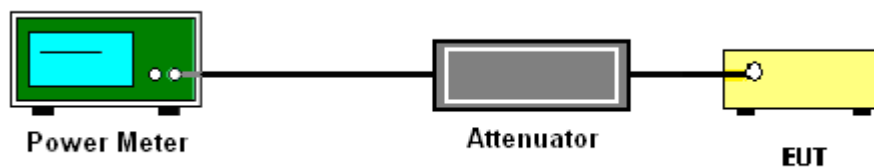



3.2.5 Test Result of Peak Output Power

2.4GHz Band										
Mod.	Data Rate	NTX	CH.	Freq. (MHz)	Peak Conducted Power (dBm)	Conducted Power Limit (dBm)	DG (dBi)	EIRP Power (dBm)	EIRP Power Limit (dBm)	Pass /Fail
11b	1Mbps	1	1	2412	21.85	30.00	1.40	23.25	36.00	Pass
11b	1Mbps	1	2	2417	21.73	30.00	1.40	23.13	36.00	Pass
11b	1Mbps	1	6	2437	21.64	30.00	1.40	23.04	36.00	Pass
11b	1Mbps	1	10	2457	21.75	30.00	1.40	23.15	36.00	Pass
11b	1Mbps	1	11	2462	21.82	30.00	1.40	23.22	36.00	Pass
11g	6Mbps	1	1	2412	21.65	30.00	1.40	23.05	36.00	Pass
11g	6Mbps	1	2	2417	23.30	30.00	1.40	24.70	36.00	Pass
11g	6Mbps	1	6	2437	23.45	30.00	1.40	24.85	36.00	Pass
11g	6Mbps	1	10	2457	23.30	30.00	1.40	24.70	36.00	Pass
11g	6Mbps	1	11	2462	22.58	30.00	1.40	23.98	36.00	Pass
HT20	MCS0	1	1	2412	21.77	30.00	1.40	23.17	36.00	Pass
HT20	MCS0	1	2	2417	23.30	30.00	1.40	24.70	36.00	Pass
HT20	MCS0	1	6	2437	23.51	30.00	1.40	24.91	36.00	Pass
HT20	MCS0	1	10	2457	23.14	30.00	1.40	24.54	36.00	Pass
HT20	MCS0	1	11	2462	22.71	30.00	1.40	24.11	36.00	Pass
HT40	MCS0	1	3	2422	21.81	30.00	1.40	23.21	36.00	Pass
HT40	MCS0	1	4	2427	22.60	30.00	1.40	24.00	36.00	Pass
HT40	MCS0	1	6	2437	22.94	30.00	1.40	24.34	36.00	Pass
HT40	MCS0	1	8	2447	21.51	30.00	1.40	22.91	36.00	Pass
HT40	MCS0	1	9	2452	22.03	30.00	1.40	23.43	36.00	Pass
VHT20	MCS0	1	1	2412	21.83	30.00	1.40	23.23	36.00	Pass
VHT20	MCS0	1	2	2417	23.34	30.00	1.40	24.74	36.00	Pass
VHT20	MCS0	1	6	2437	23.60	30.00	1.40	25.00	36.00	Pass
VHT20	MCS0	1	10	2457	23.15	30.00	1.40	24.55	36.00	Pass
VHT20	MCS0	1	11	2462	22.73	30.00	1.40	24.13	36.00	Pass
VHT40	MCS0	1	3	2422	21.84	30.00	1.40	23.24	36.00	Pass
VHT40	MCS0	1	4	2427	22.62	30.00	1.40	24.02	36.00	Pass
VHT40	MCS0	1	6	2437	22.95	30.00	1.40	24.35	36.00	Pass
VHT40	MCS0	1	8	2447	21.52	30.00	1.40	22.92	36.00	Pass
VHT40	MCS0	1	9	2452	22.13	30.00	1.40	23.53	36.00	Pass



3.2.6 Test Result of Average output Power (Reporting Only)

2.4GHz Band						
Mod.	Data Rate	NTX	CH.	Freq.(MHz)	Duty Factor (dB)	Average Conducted Power (dBm)
11b	1Mbps	1	1	2412	0.06	18.76
11b	1Mbps	1	2	2417	0.06	18.75
11b	1Mbps	1	6	2437	0.06	18.60
11b	1Mbps	1	10	2457	0.06	18.71
11b	1Mbps	1	11	2462	0.06	18.71
11g	6Mbps	1	1	2412	0.32	15.14
11g	6Mbps	1	2	2417	0.32	17.70
11g	6Mbps	1	6	2437	0.32	17.77
11g	6Mbps	1	10	2457	0.32	17.74
11g	6Mbps	1	11	2462	0.32	16.68
HT20	MCS0	1	1	2412	0.34	15.14
HT20	MCS0	1	2	2417	0.34	17.65
HT20	MCS0	1	6	2437	0.34	17.70
HT20	MCS0	1	10	2457	0.34	17.55
HT20	MCS0	1	11	2462	0.34	16.59
HT40	MCS0	1	3	2422	0.06	14.29
HT40	MCS0	1	4	2427	0.06	15.34
HT40	MCS0	1	6	2437	0.06	15.93
HT40	MCS0	1	8	2447	0.06	13.86
HT40	MCS0	1	9	2452	0.06	14.21
VHT20	MCS0	1	1	2412	0.37	15.22
VHT20	MCS0	1	2	2417	0.37	17.72
VHT20	MCS0	1	6	2437	0.37	17.77
VHT20	MCS0	1	10	2457	0.37	17.59
VHT20	MCS0	1	11	2462	0.37	16.68
VHT40	MCS0	1	3	2422	0.11	14.32
VHT40	MCS0	1	4	2427	0.11	15.37
VHT40	MCS0	1	6	2437	0.11	15.96
VHT40	MCS0	1	8	2447	0.11	13.87
VHT40	MCS0	1	9	2452	0.11	14.24

3.3 Power Spectral Density Measurement

3.3.1 Limit of Power Spectral Density

The peak power spectral density shall not be greater than 8dBm in any 3kHz band at any time interval of continuous transmission.

3.3.2 Measuring Instruments

The measuring equipment is listed in the section 4 of this test report.

3.3.3 Test Procedures

1. The testing follows Measurement Procedure 10.2 Method PKPSD of FCC KDB Publication No. 558074 D01 DTS Meas. Guidance v03r05
2. The RF output of EUT was connected to the spectrum analyzer by RF cable and attenuator. The path loss was compensated to the results for each measurement.
3. Set to the maximum power setting and enable the EUT transmit continuously.
4. Make the measurement with the spectrum analyzer's resolution bandwidth (RBW) = 3 kHz. Video bandwidth VBW = 10 kHz In order to make an accurate measurement, set the span to 1.5 times DTS Channel Bandwidth. (6dB BW)
5. Detector = peak, Sweep time = auto couple, Trace mode = max hold, Allow trace to fully stabilize. Use the peak marker function to determine the maximum power level.
6. Measure and record the results in the test report.

3.3.4 Test Setup





3.3.5 Test Result of Power Spectral Density

2.4GHz Band								
Mod.	Data Rate	NTX	CH.	Freq. (MHz)	Peak PSD (dBm/3kHz)	DG (dBi)	Peak PSD Limit (dBm/3kHz)	Pass/Fail
11b	1Mbps	1	1	2412	-4.58	1.40	8.00	Pass
11b	1Mbps	1	6	2437	-4.58	1.40	8.00	Pass
11b	1Mbps	1	11	2462	-4.49	1.40	8.00	Pass
11g	6Mbps	1	1	2412	-9.12	1.40	8.00	Pass
11g	6Mbps	1	6	2437	-7.00	1.40	8.00	Pass
11g	6Mbps	1	11	2462	-7.71	1.40	8.00	Pass
VHT20	MCS0	1	1	2412	-10.71	1.40	8.00	Pass
VHT20	MCS0	1	6	2437	-7.06	1.40	8.00	Pass
VHT20	MCS0	1	11	2462	-9.35	1.40	8.00	Pass
VHT40	MCS0	1	3	2422	-14.29	1.40	8.00	Pass
VHT40	MCS0	1	6	2437	-13.02	1.40	8.00	Pass
VHT40	MCS0	1	9	2452	-13.95	1.40	8.00	Pass

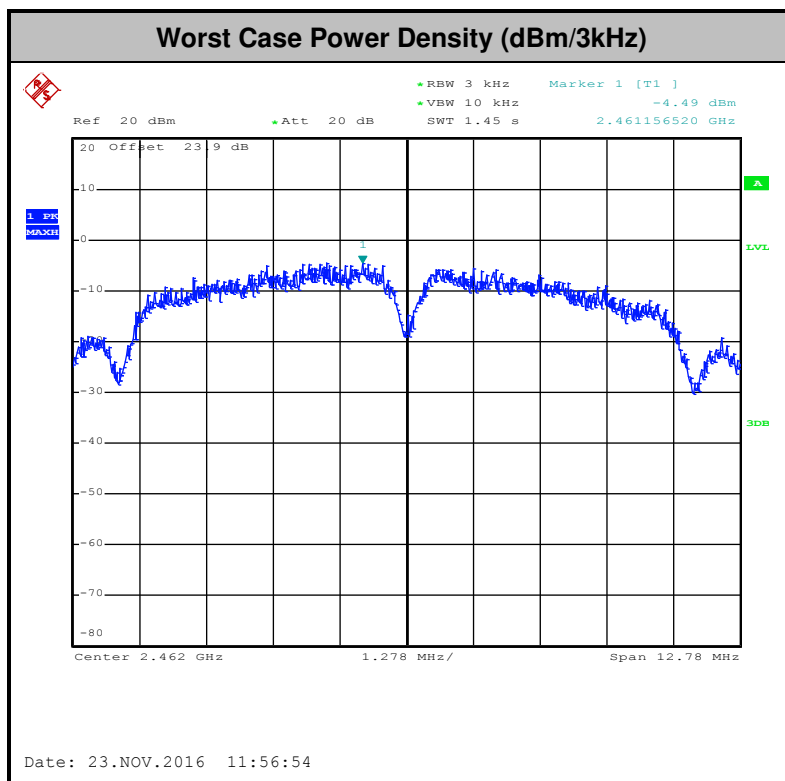

3.4 Conducted Band Edges and Spurious Emission Measurement

3.4.1 Limit of Conducted Band Edges and Spurious Emission Measurement

In any 100 kHz bandwidth outside of the authorized frequency band, the emissions which fall in the non-restricted bands shall be attenuated at least 20 dB / 30dB relative to the maximum PSD level in 100 kHz by RF conducted measurement and radiated emissions which fall in the restricted bands, as defined in Section 15.205(a), must also comply with the radiated emission limits specified in Section 15.209(a).

3.4.2 Measuring Instruments

The measuring equipment is listed in the section 4 of this test report.

3.4.3 Test Procedures

1. The testing follows FCC KDB Publication No. 558074 D01 DTS Meas. Guidance v03r05.
2. The RF output of EUT was connected to the spectrum analyzer by RF cable and attenuator. The path loss was compensated to the results for each measurement.
3. Set to the maximum power setting and enable the EUT transmit continuously.
4. Set RBW = 100 kHz, VBW=300 kHz, Peak Detector. Unwanted Emissions measured in any 100 kHz bandwidth outside of the authorized frequency band shall be attenuated by at least 20 dB relative to the maximum in-band peak PSD level in 100 kHz when maximum peak conducted output power procedure is used. If the transmitter complies with the conducted power limits based on the use of RMS averaging over a time interval, the attenuation required under this paragraph shall be 30 dB instead of 20 dB per 15.247(d).
5. Measure and record the results in the test report.
6. The RF fundamental frequency should be excluded against the limit line in the operating frequency band.

3.4.4 Test Setup

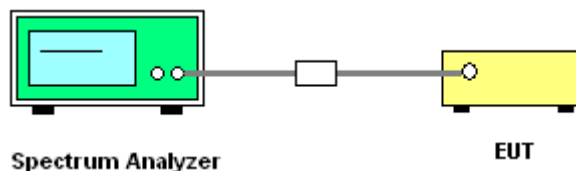



3.4.5 Test Result of Conducted Band Edges and Spurious Emission

Test Mode :	802.11b	Temperature :	21~25°C
Test Band :	2.4GHz Low	Relative Humidity :	51~54%
Test Channel :	01	Test Engineer :	Luffy Lin and Tommy Lee

WLAN 802.11b Channel 01

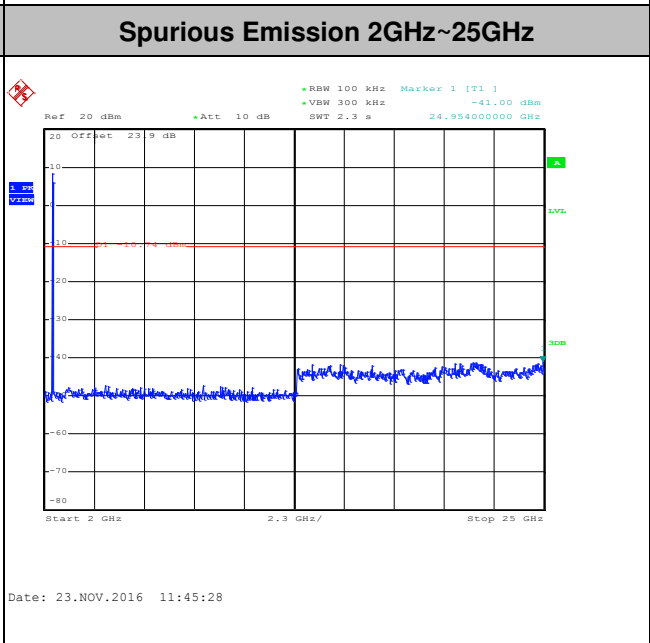
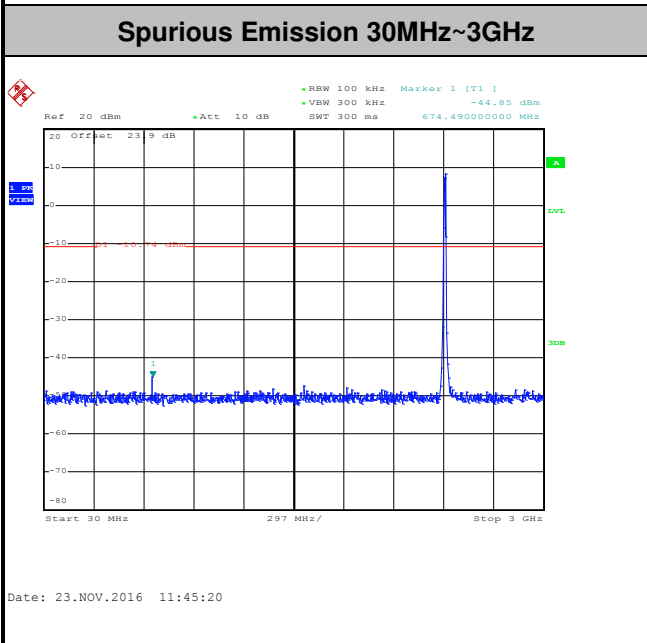
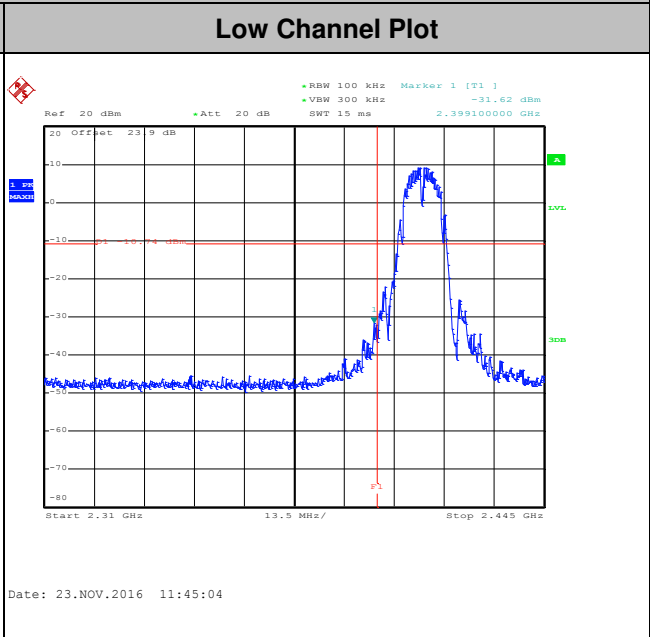
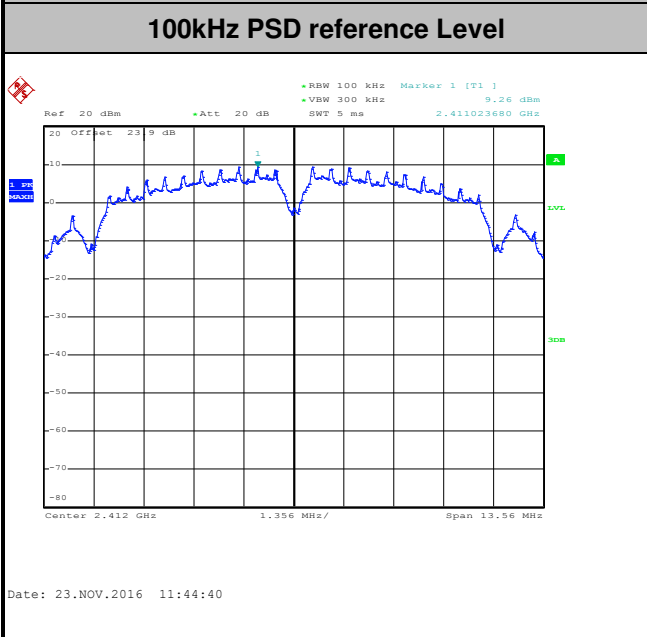



Test Mode :	802.11b	Temperature :	21~25°C
Test Band :	2.4GHz Mid	Relative Humidity :	51~54%
Test Channel :	06	Test Engineer :	Luffy Lin and Tommy Lee

WLAN 802.11b Channel 06

100kHz PSD reference Level

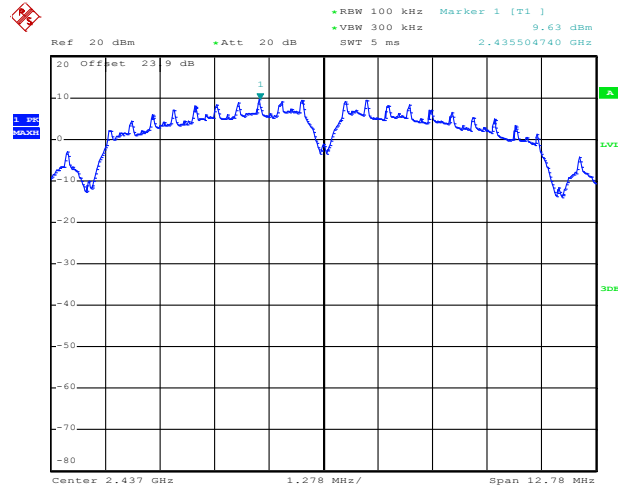

Date: 23.NOV.2016 11:52:37

Spurious Emission 30MHz~3GHz

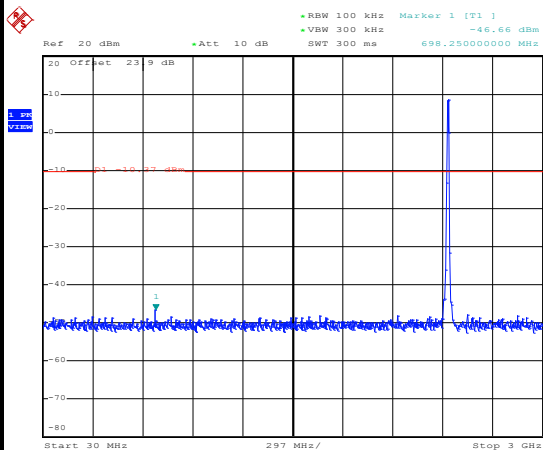

Date: 23.NOV.2016 11:52:57

Spurious Emission 2GHz~25GHz

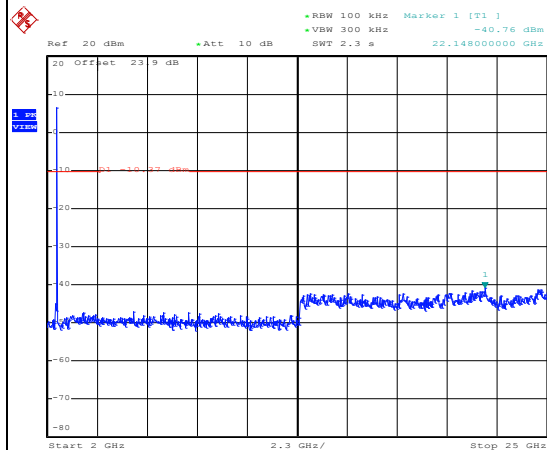

Date: 23.NOV.2016 11:53:05



Test Mode :	802.11b	Temperature :	21~25°C
Test Band :	2.4GHz High	Relative Humidity :	51~54%
Test Channel :	11	Test Engineer :	Luffy Lin and Tommy Lee

WLAN 802.11b Channel 11

100kHz PSD reference Level

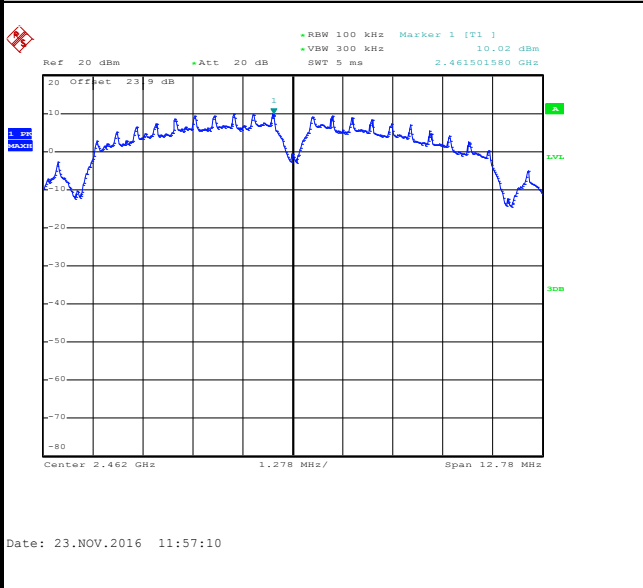

High Channel Plot

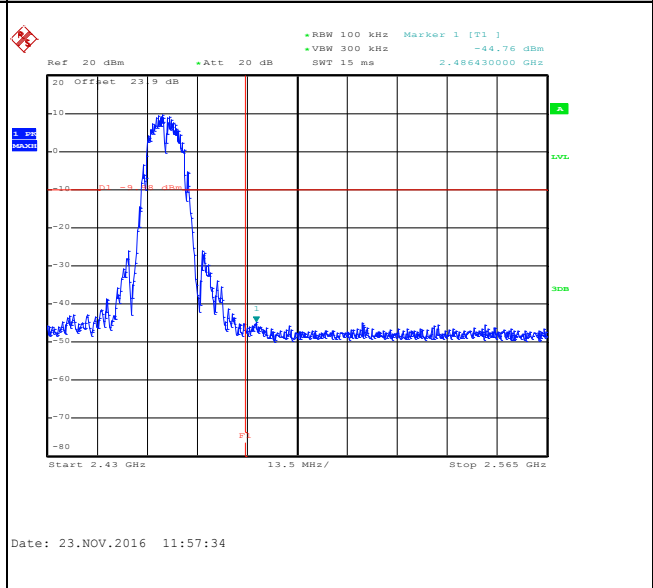

Spurious Emission 30MHz~3GHz

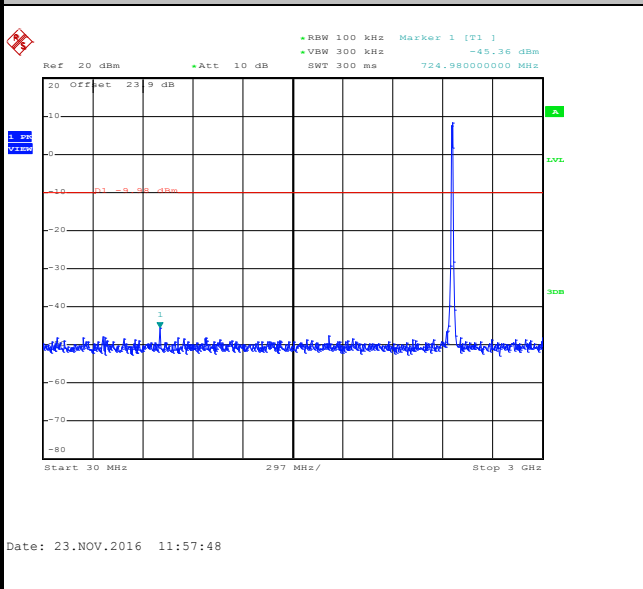

Spurious Emission 2GHz~25GHz

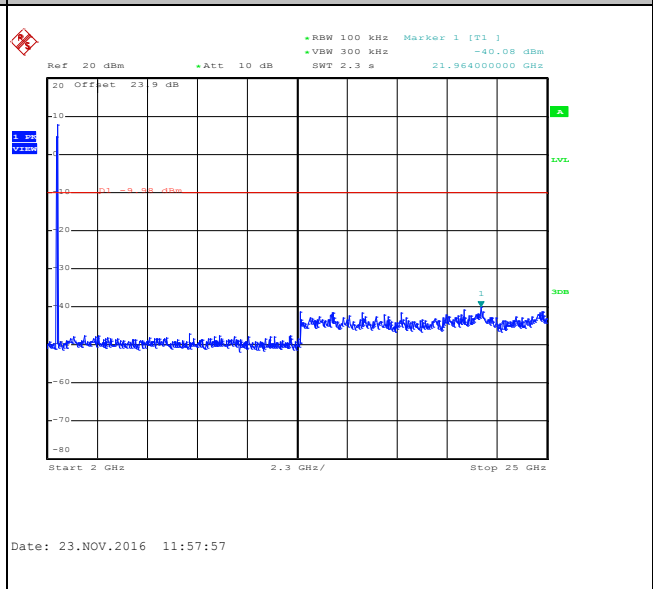



Test Mode :	802.11g	Temperature :	21~25°C
Test Band :	2.4GHz Low	Relative Humidity :	51~54%
Test Channel :	01	Test Engineer :	Luffy Lin and Tommy Lee

WLAN 802.11g Channel 01

100kHz PSD reference Level

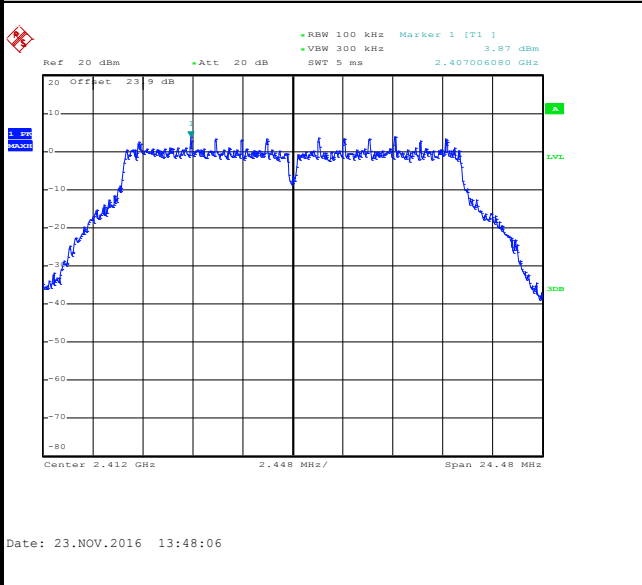

Low Channel Plot

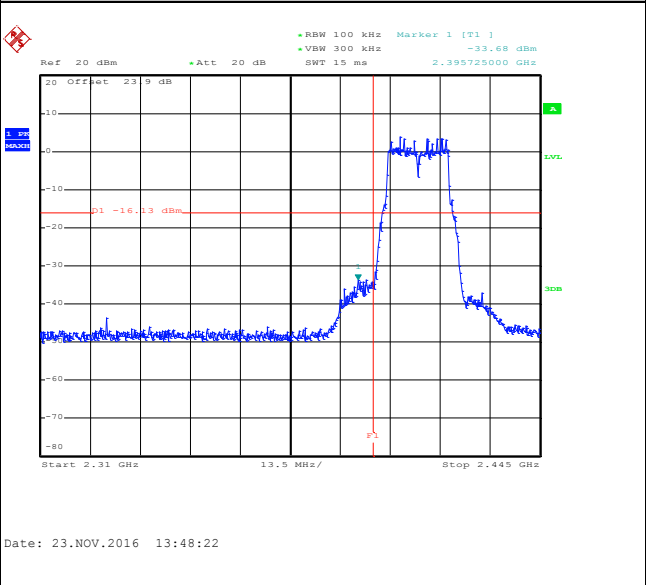

Spurious Emission 30MHz~3GHz

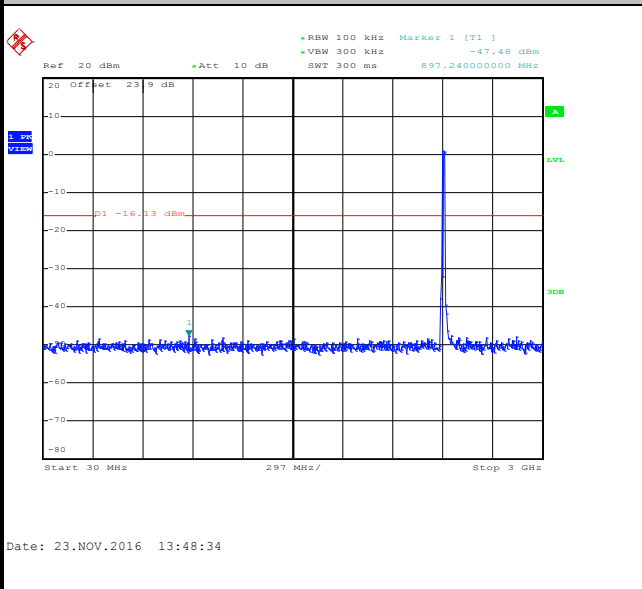

Spurious Emission 2GHz~25GHz

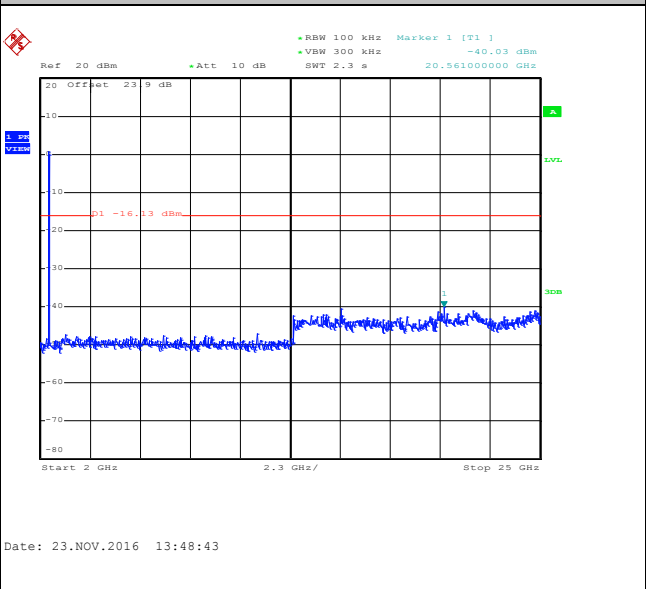



Test Mode :	802.11g	Temperature :	21~25°C
Test Band :	2.4GHz Mid	Relative Humidity :	51~54%
Test Channel :	06	Test Engineer :	Luffy Lin and Tommy Lee

WLAN 802.11g Channel 06

100kHz PSD reference Level

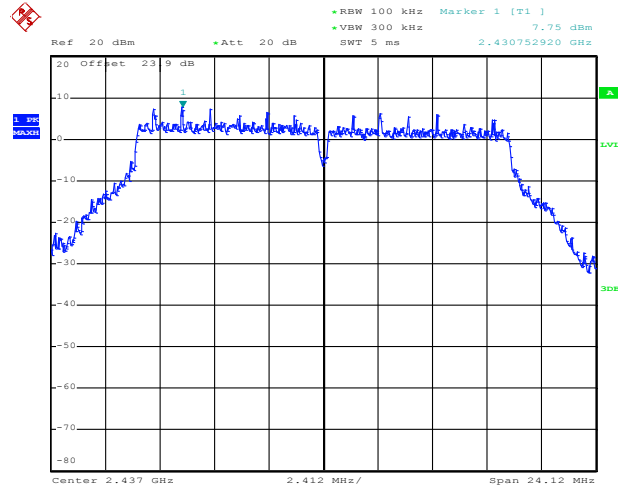

Date: 23.NOV.2016 13:51:52

Spurious Emission 30MHz~3GHz

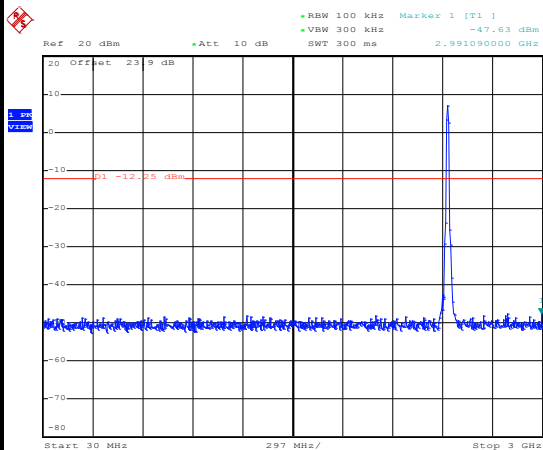

Date: 23.NOV.2016 13:52:07

Spurious Emission 2GHz~25GHz

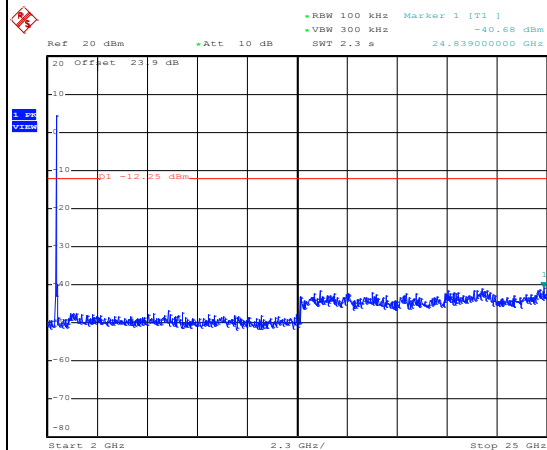

Date: 23.NOV.2016 13:52:15



Test Mode :	802.11g	Temperature :	21~25°C
Test Band :	2.4GHz High	Relative Humidity :	51~54%
Test Channel :	11	Test Engineer :	Luffy Lin and Tommy Lee

WLAN 802.11g Channel 11

100kHz PSD reference Level

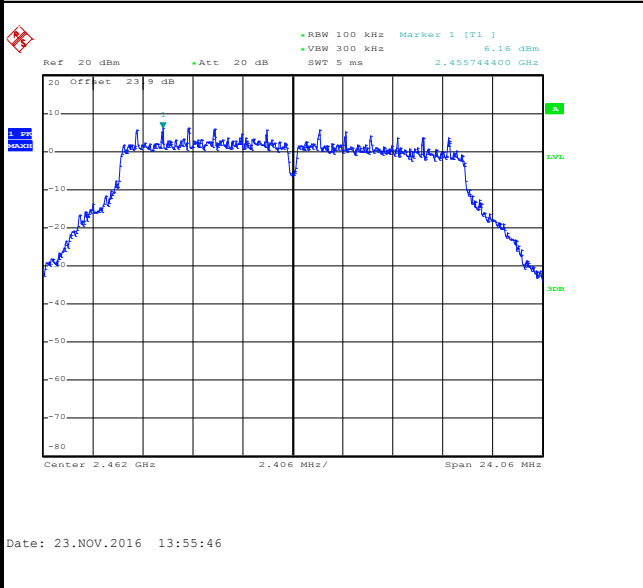

High Channel Plot

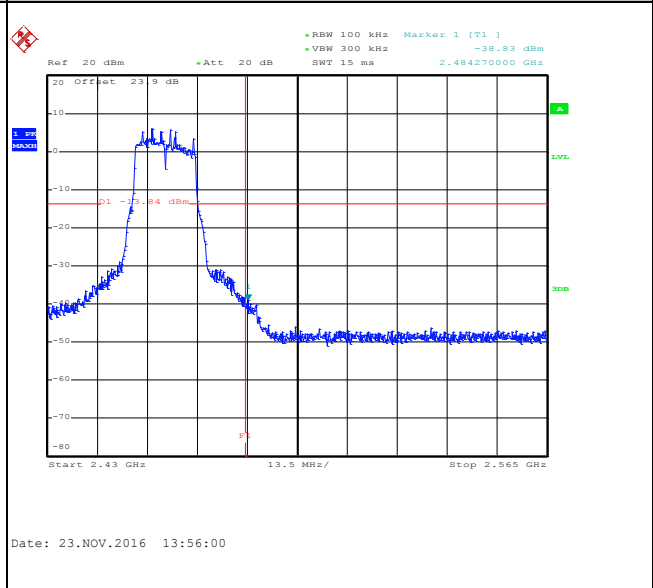

Spurious Emission 30MHz~3GHz

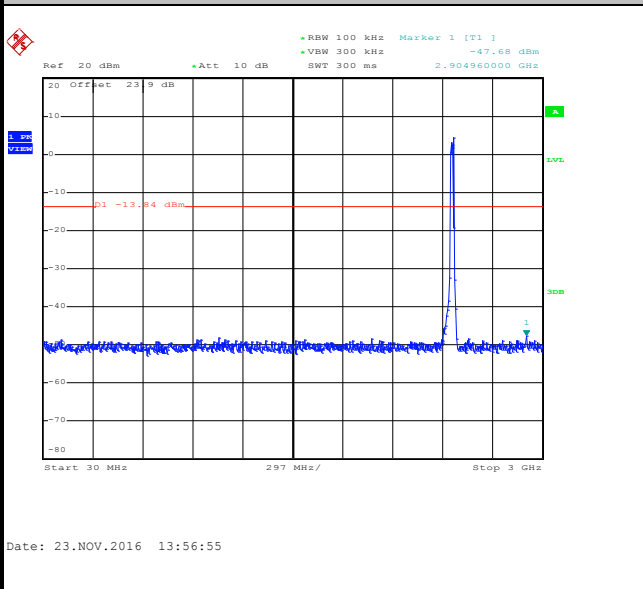

Spurious Emission 2GHz~25GHz

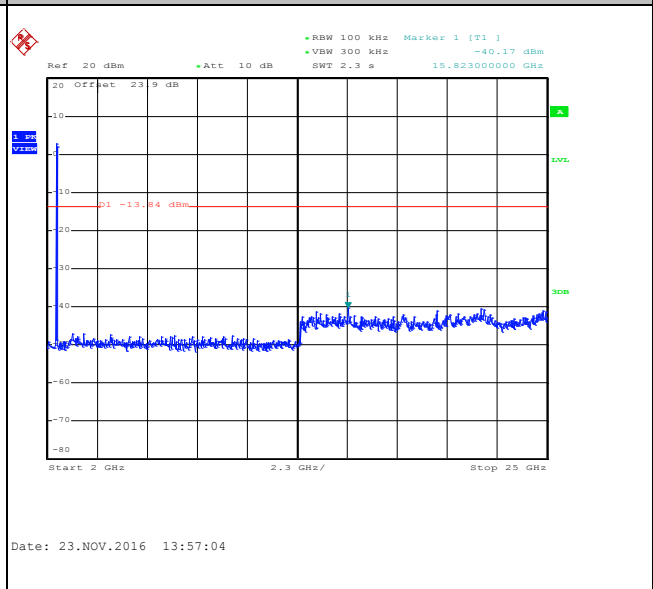



Test Mode :	802.11ac VHT20	Temperature :	21~25°C
Test Band :	2.4GHz Low	Relative Humidity :	51~54%
Test Channel :	01	Test Engineer :	Luffy Lin and Tommy Lee

WLAN 802.11ac VHT20 Channel 01

100kHz PSD reference Level

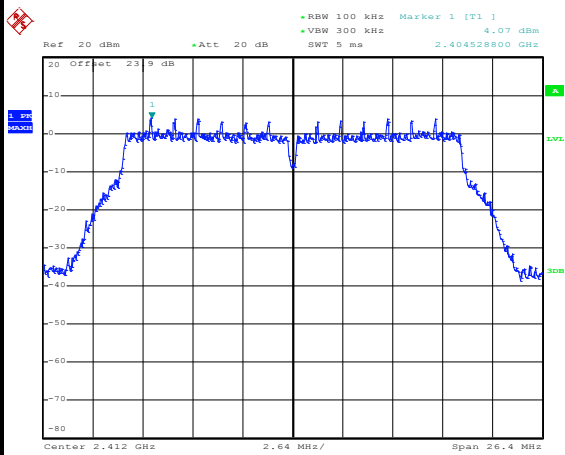

Date: 23.NOV.2016 14:06:21

Low Channel Plot

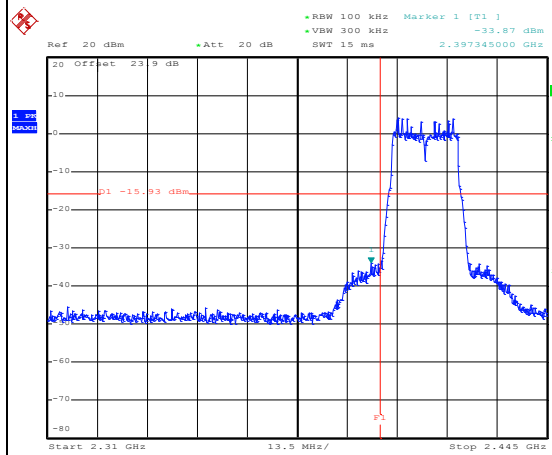

Date: 23.NOV.2016 14:06:36

Spurious Emission 30MHz~3GHz

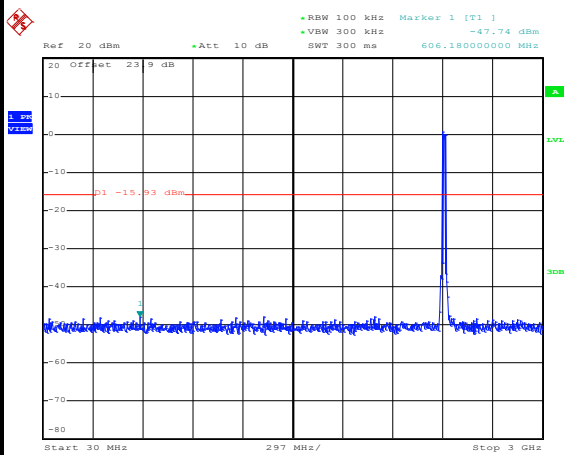

Date: 23.NOV.2016 14:06:50

Spurious Emission 2GHz~25GHz

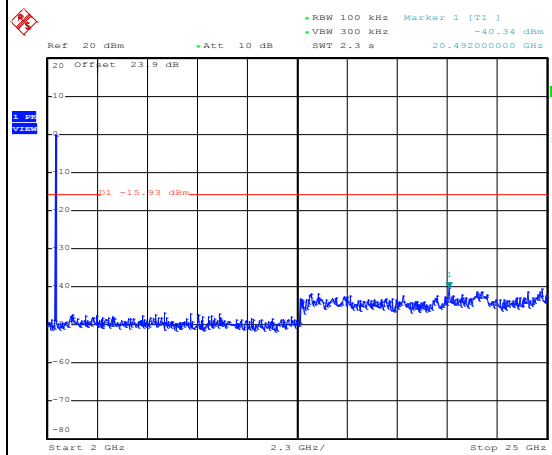

Date: 23.NOV.2016 14:06:58



Test Mode :	802.11ac VHT20	Temperature :	21~25°C
Test Band :	2.4GHz Mid	Relative Humidity :	51~54%
Test Channel :	06	Test Engineer :	Luffy Lin and Tommy Lee

WLAN 802.11ac VHT20 Channel 06

100kHz PSD reference Level

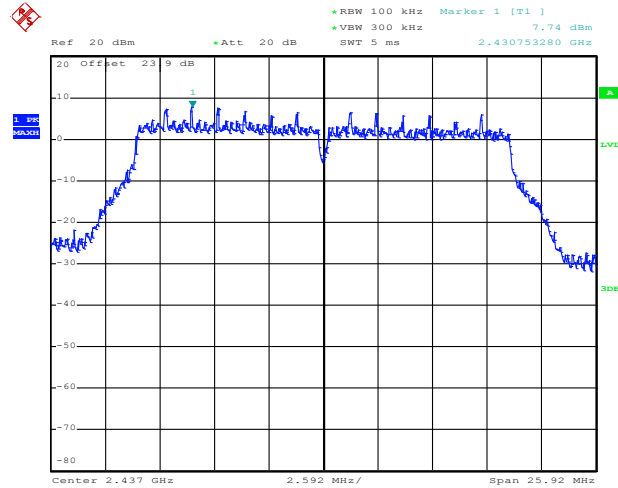

Date: 23.NOV.2016 14:11:49

Spurious Emission 30MHz~3GHz

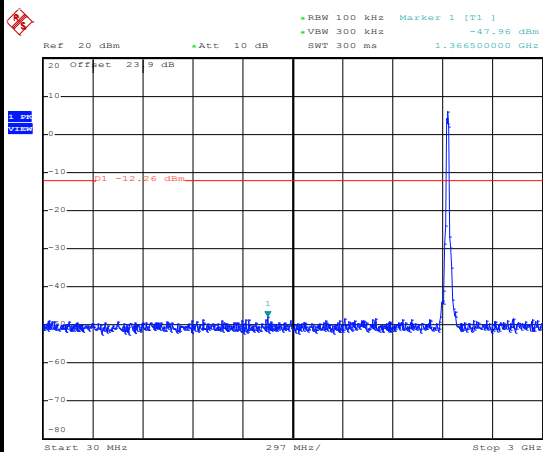

Date: 23.NOV.2016 14:12:09

Spurious Emission 2GHz~25GHz

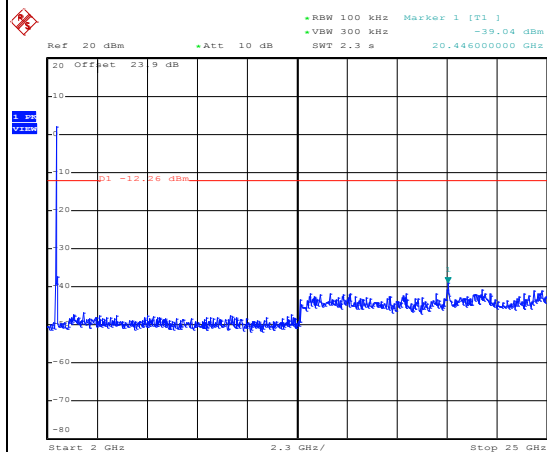

Date: 23.NOV.2016 14:12:18



Test Mode :	802.11ac VHT20	Temperature :	21~25°C
Test Band :	2.4GHz High	Relative Humidity :	51~54%
Test Channel :	11	Test Engineer :	Luffy Lin and Tommy Lee

WLAN 802.11ac VHT20 Channel 11

100kHz PSD reference Level

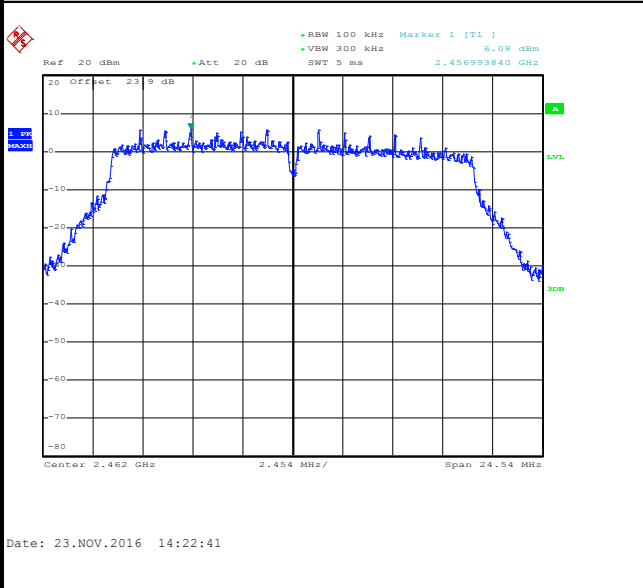

High Channel Plot

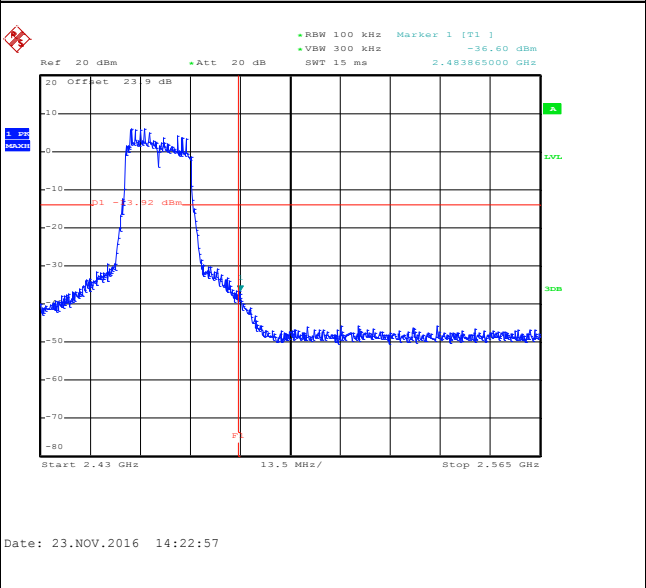

Spurious Emission 30MHz~3GHz

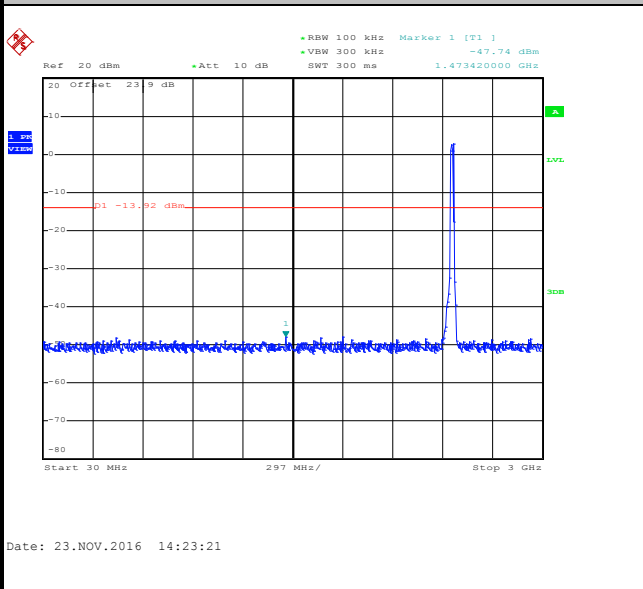

Spurious Emission 2GHz~25GHz

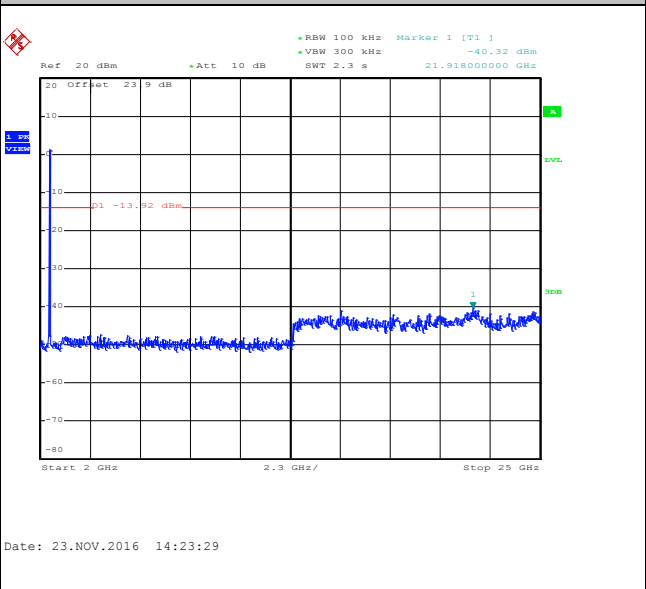



Test Mode :	802.11ac VHT40	Temperature :	21~25°C
Test Band :	2.4GHz Low	Relative Humidity :	51~54%
Test Channel :	03	Test Engineer :	Luffy Lin and Tommy Lee

WLAN 802.11ac VHT40 Channel 03

100kHz PSD reference Level

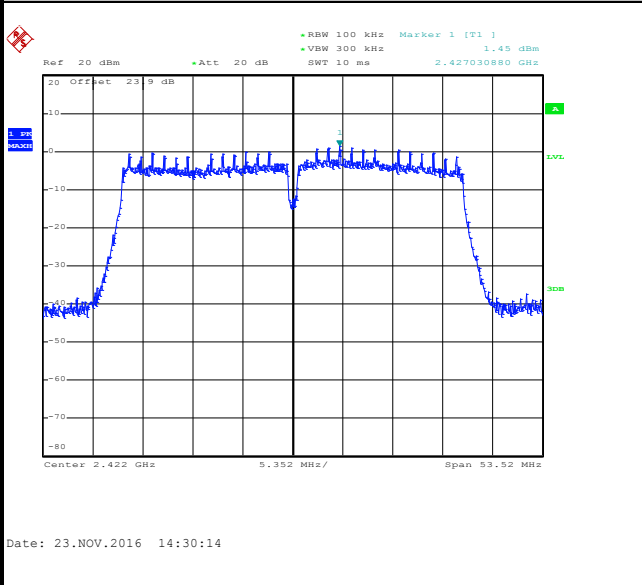

Low Channel Plot

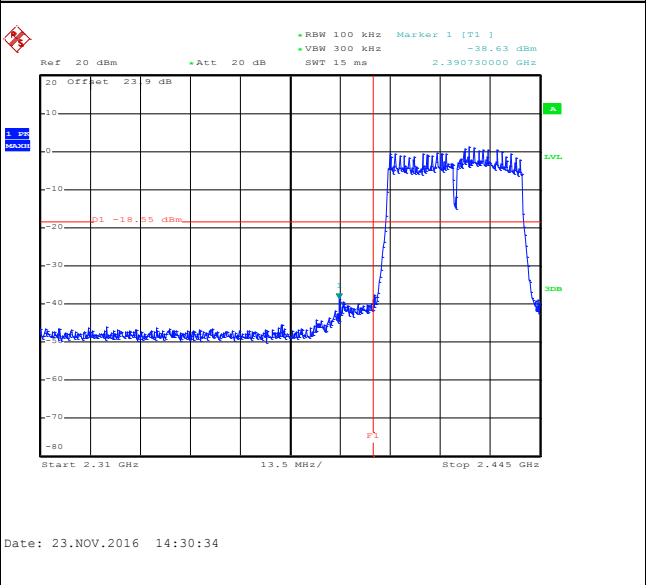

Spurious Emission 30MHz~3GHz

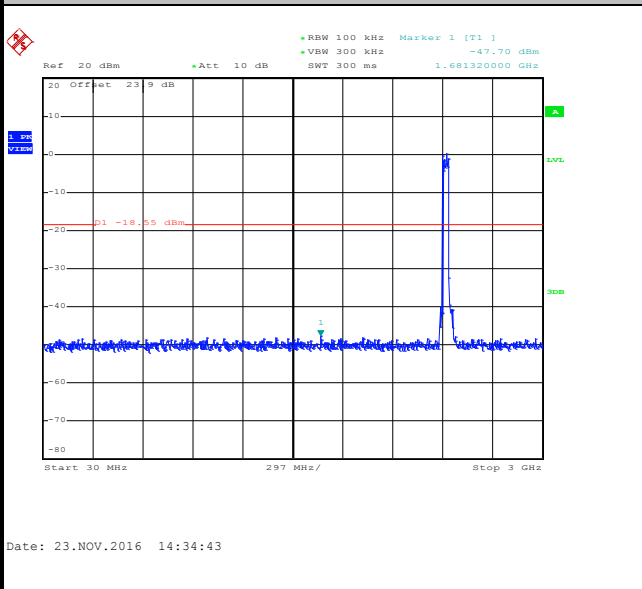

Spurious Emission 2GHz~25GHz

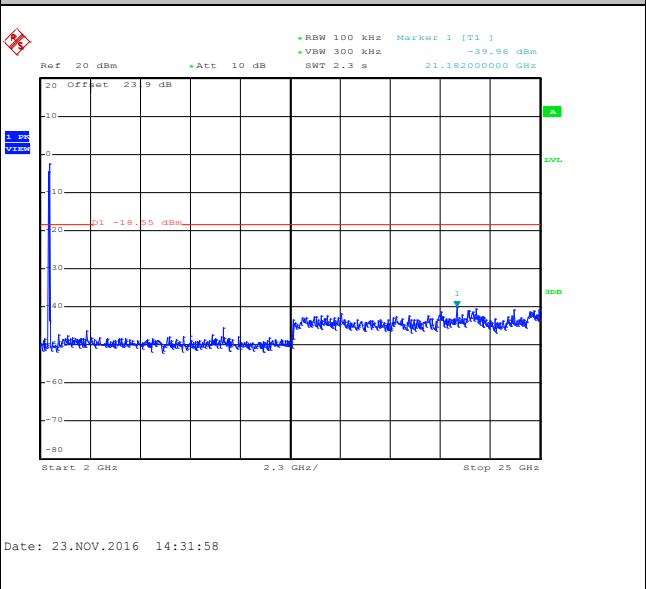



Test Mode :	802.11ac VHT40	Temperature :	21~25°C
Test Band :	2.4GHz Mid	Relative Humidity :	51~54%
Test Channel :	06	Test Engineer :	Luffy Lin and Tommy Lee

WLAN 802.11ac VHT40 Channel 06

100kHz PSD reference Level

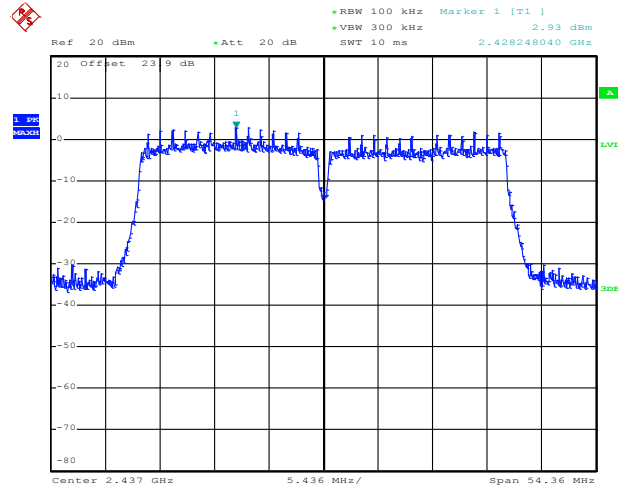

Date: 23.NOV.2016 14:41:03

Spurious Emission 30MHz~3GHz

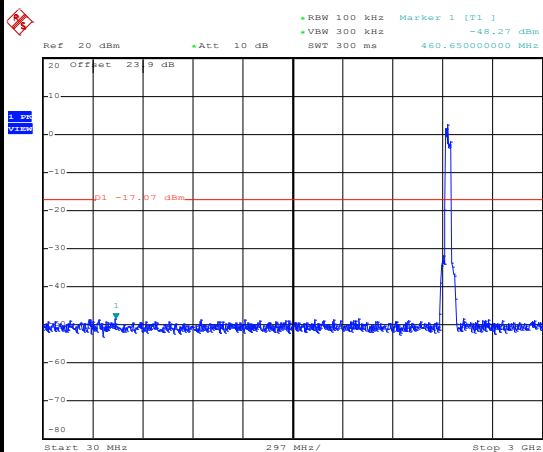

Date: 23.NOV.2016 14:41:18

Spurious Emission 2GHz~25GHz

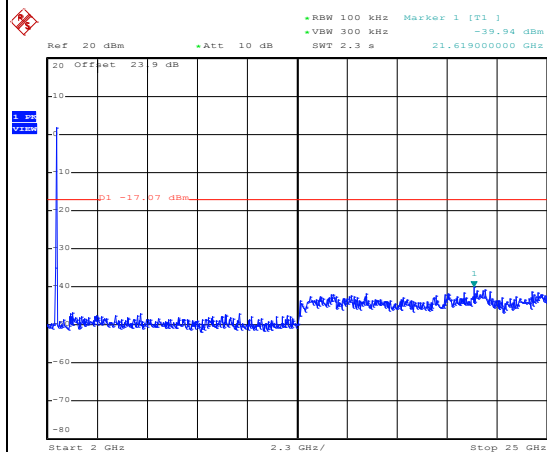

Date: 23.NOV.2016 14:41:26



Test Mode :	802.11ac VHT40	Temperature :	21~25°C
Test Band :	2.4GHz High	Relative Humidity :	51~54%
Test Channel :	09	Test Engineer :	Luffy Lin and Tommy Lee

WLAN 802.11ac VHT40 Channel 09

100kHz PSD reference Level

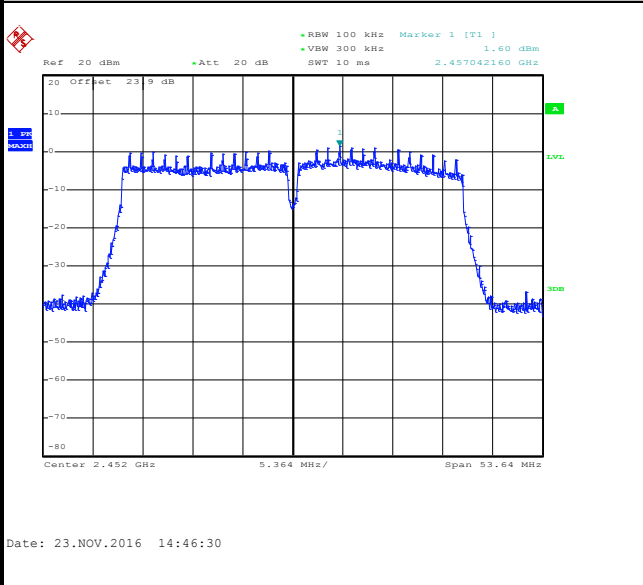

High Channel Plot

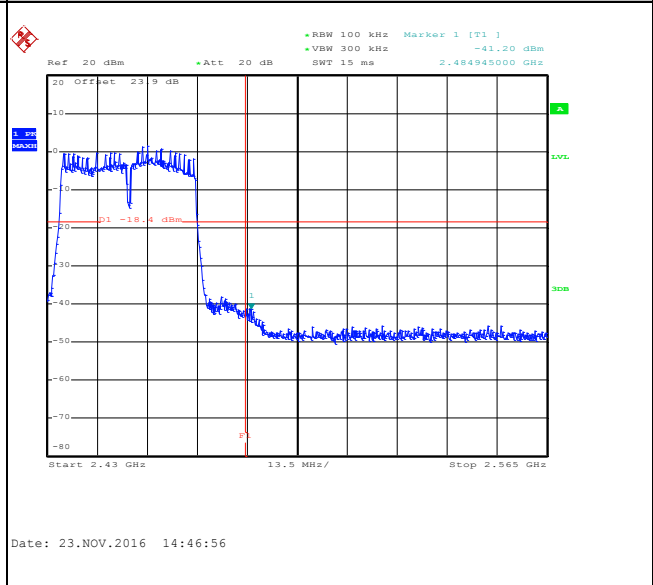

Spurious Emission 30MHz~3GHz

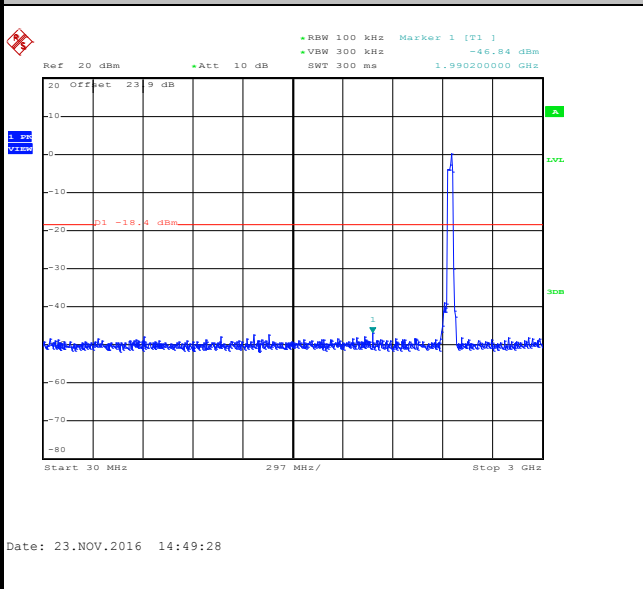

Spurious Emission 2GHz~25GHz

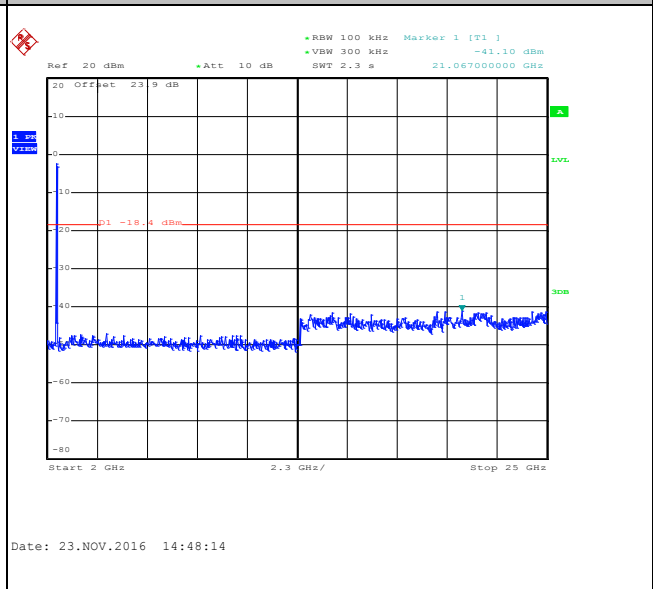



3.5 Radiated Band Edges and Spurious Emission Measurement

3.5.1 Limit of Radiated band edge and Spurious Emission Measurement

In any 100 kHz bandwidth outside the intentional radiator frequency band, all harmonics/spurious must be at least 20 dB below the highest emission level within the authorized band. If the output power of this device was measured by spectrum analyzer, the attenuation under this paragraph shall be 30 dB instead of 20 dB. In addition, radiated emissions which fall in the restricted bands must also comply with the FCC section 15.209 limits as below.

Frequency (MHz)	Field Strength (microvolts/meter)	Measurement Distance (meters)
0.009 – 0.490	2400/F(kHz)	300
0.490 – 1.705	24000/F(kHz)	30
1.705 – 30.0	30	30
30 – 88	100	3
88 – 216	150	3
216 - 960	200	3
Above 960	500	3

3.5.2 Measuring Instruments

The measuring equipment is listed in the section 4 of this test report.



3.5.3 Test Procedures

1. The testing follows FCC KDB Publication No. 558074 D01 DTS Meas. Guidance v03r05.
2. The EUT was arranged to its worst case and then tune the antenna tower (from 1 m to 4 m) and turntable (from 0 degree to 360 degrees) to find the maximum reading. A pre-amp and a high pass filter are used for the test in order to get better signal level.
3. The EUT was placed on a turntable with 0.8 meter for frequency below 1GHz and 1.5 meter for frequency above 1GHz respectively above ground.
4. The EUT was set 3 meters from the interference receiving antenna, which was mounted on the top of a variable height antenna tower.
5. Corrected Reading: Antenna Factor + Cable Loss + Read Level - Preamp Factor = Level
6. For measurement below 1GHz, If the emission level of the EUT measured by the peak detector is 3 dB lower than the applicable limit, the peak emission level will be reported. Otherwise, the emission measurement will be repeated using the quasi-peak detector and reported.
7. Use the following spectrum analyzer settings:
 - (1) Span shall wide enough to fully capture the emission being measured;
 - (2) Set RBW=100 kHz for $f < 1$ GHz; VBW \geq RBW; Sweep = auto; Detector function = peak; Trace = max hold;
 - (3) Set RBW = 1 MHz, VBW= 3MHz for $f \geq 1$ GHz for peak measurement.
For average measurement:
 - VBW = 10 Hz, when duty cycle is no less than 98 percent.
 - VBW $\geq 1/T$, when duty cycle is less than 98 percent where T is the minimum transmission duration over which the transmitter is on and is transmitting at its maximum power control level for the tested mode of operation.

3.5.4 Test Setup

For radiated emissions below 30MHz

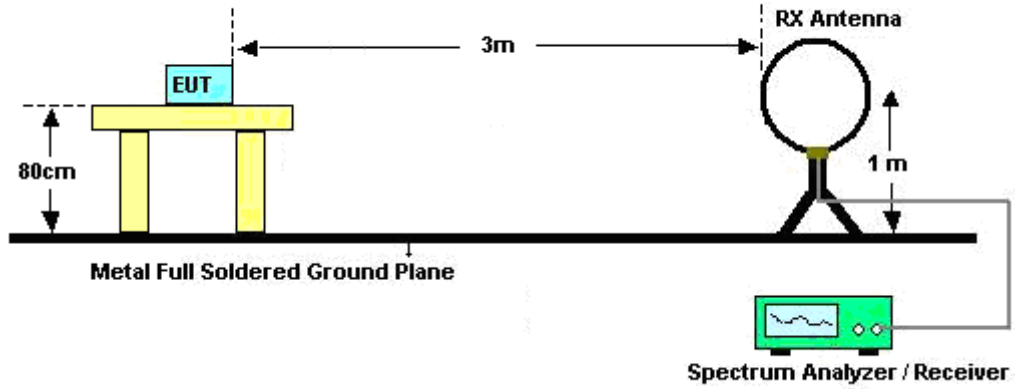

For radiated emissions from 30MHz to 1GHz

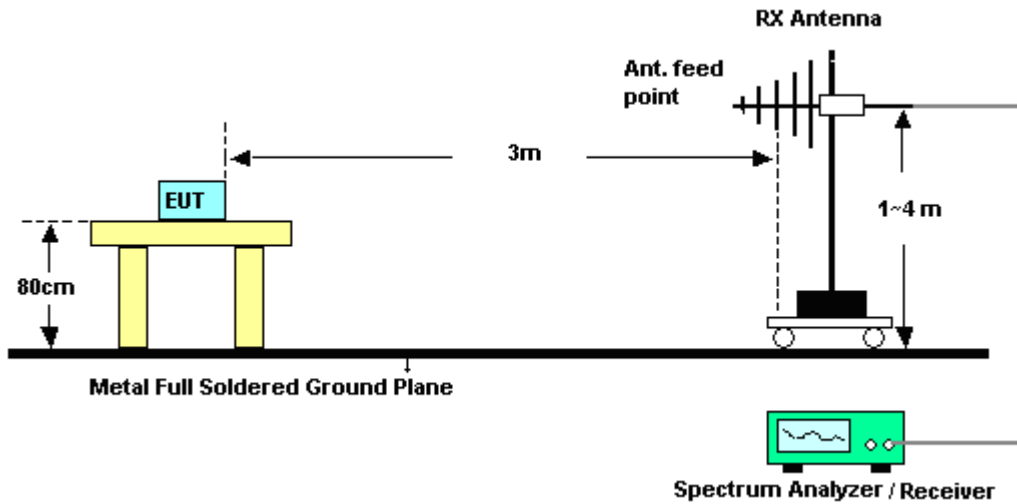

For radiated emissions above 1GHz

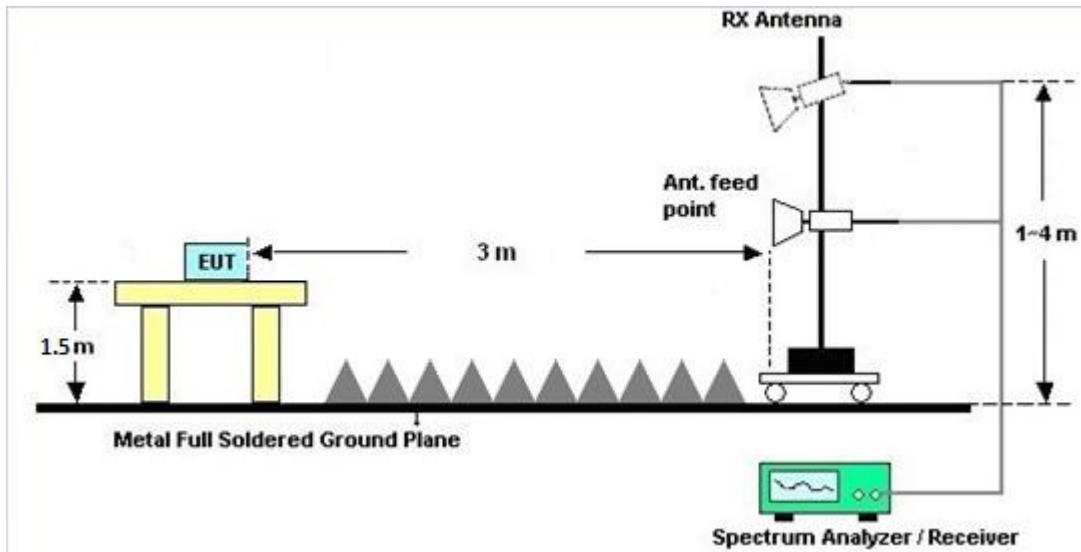

3.5.5 Test Results of Radiated Spurious Emissions (9kHz ~ 30MHz)

The low frequency, which started from 9 kHz to 30MHz, was pre-scanned and the result which was 20dB lower than the limit line per 15.31(o) was not reported.

3.5.6 Test Result of Radiated Spurious at Band Edges

Please refer to Appendix A and B.

3.5.7 Duty Cycle

Please refer to Appendix C.

3.5.8 Test Result of Radiated Spurious Emission (30MHz ~ 10th Harmonic)

Please refer to Appendix A and B.



3.6 AC Conducted Emission Measurement

3.6.1 Limit of AC Conducted Emission

For equipment that is designed to be connected to the public utility (AC) power line, the radio frequency voltage that is conducted back onto the AC power line on any frequency or frequencies within the band 150 kHz to 30 MHz shall not exceed the limits in the following table.

Frequency of Emission (MHz)	Conducted Limit (dBµV)	
	Quasi-Peak	Average
0.15-0.5	66 to 56*	56 to 46*
0.5-5	56	46
5-30	60	50

*Decreases with the logarithm of the frequency.

3.6.2 Measuring Instruments

The measuring equipment is listed in the section 4 of this test report.

3.6.3 Test Procedures

1. The EUT was placed 0.4 meter from the conducting wall of the shielding room, and it was kept at least 80 centimeters from any other grounded conducting surface.
2. Connect EUT to the power mains through a line impedance stabilization network (LISN).
3. All the support units are connecting to the other LISN.
4. The LISN provides 50 ohm coupling impedance for the measuring instrument.
5. The FCC states that a 50 ohm, 50 microhenry LISN should be used.
6. Both sides of AC line were checked for maximum conducted interference.
7. The frequency range from 150 kHz to 30 MHz was searched.
8. Set the test-receiver system to Peak Detect Function and specified bandwidth (IF bandwidth = 9kHz) with Maximum Hold Mode.

3.6.4 Test Setup

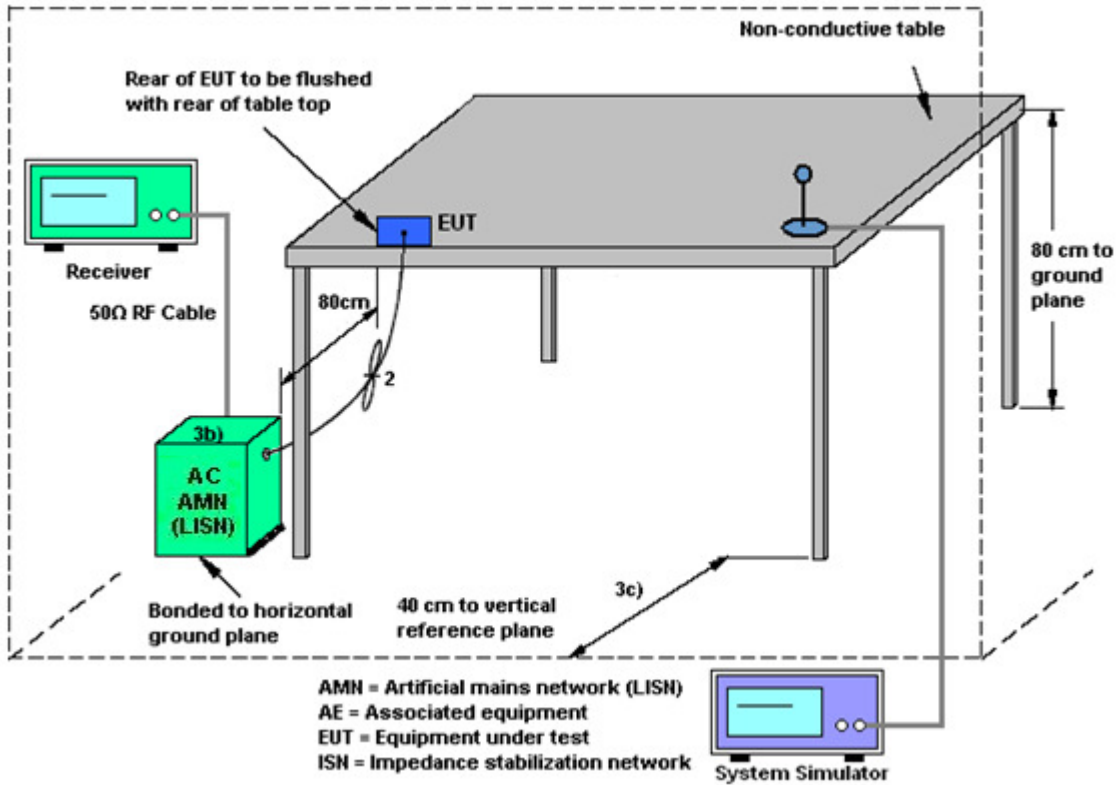

3.6.5 Test Result of AC Conducted Emission

Test Mode :	Mode 1	Temperature :	23~24°C
Test Engineer :	Arthur Hsieh	Relative Humidity :	51~52%
Test Voltage :	120Vac / 60Hz	Phase :	Line
Function Type :	GSM850 Idle + WLAN (2.4GHz) Link + Bluetooth Link + NFC active + Battery + Scanner + without Exoskeleton + Rugged Charge/USB cable + Adapter (SAWA-65-20005A (5V/2.5A)) + Headset Jumper (CBL-TC51-HDST25-01) + Earphone (HDST-25MM-PTVP-01)		

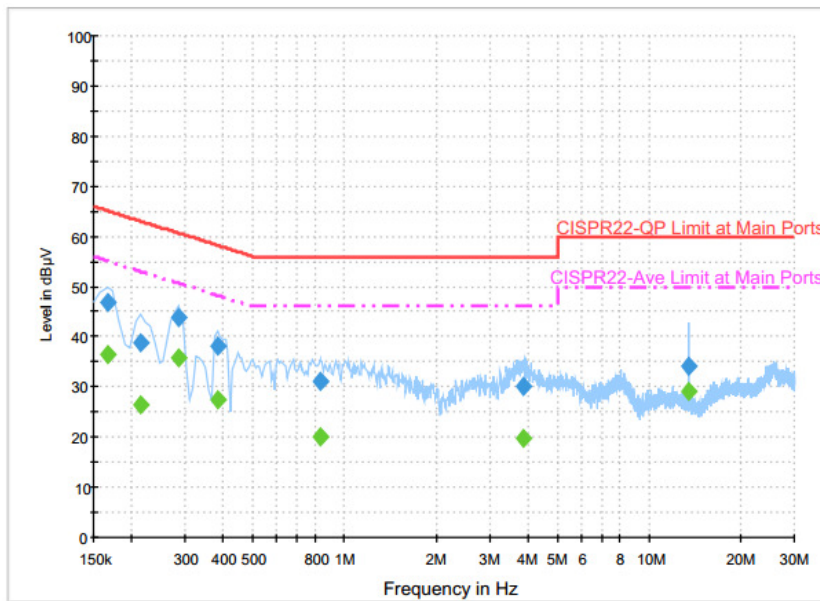

Final Result : Quasi-Peak

Frequency (MHz)	Quasi-Peak (dBµV)	Filter	Line	Corr. (dB)	Margin (dB)	Limit (dBµV)
0.166000	46.7	Off	L1	19.6	18.5	65.2
0.214000	38.9	Off	L1	19.6	24.1	63.0
0.286000	43.8	Off	L1	19.6	16.8	60.6
0.382000	38.0	Off	L1	19.6	20.2	58.2
0.830000	31.0	Off	L1	19.6	25.0	56.0
3.854000	30.1	Off	L1	19.8	25.9	56.0
13.558000	34.1	Off	L1	20.3	25.9	60.0

Final Result : Average

Frequency (MHz)	Average (dBµV)	Filter	Line	Corr. (dB)	Margin (dB)	Limit (dBµV)
0.166000	36.5	Off	L1	19.6	18.7	55.2
0.214000	26.6	Off	L1	19.6	26.4	53.0
0.286000	35.8	Off	L1	19.6	14.8	50.6
0.382000	27.3	Off	L1	19.6	20.9	48.2
0.830000	20.2	Off	L1	19.6	25.8	46.0
3.854000	19.8	Off	L1	19.8	26.2	46.0
13.558000	29.1	Off	L1	20.3	20.9	50.0



Test Mode :	Mode 1	Temperature :	23~24°C
Test Engineer :	Arthur Hsieh	Relative Humidity :	51~52%
Test Voltage :	120Vac / 60Hz	Phase :	Neutral
Function Type :	GSM850 Idle + WLAN (2.4GHz) Link + Bluetooth Link + NFC active + Battery + Scanner + without Exoskeleton + Rugged Charge/USB cable + Adapter (SAWA-65-20005A (5V/2.5A)) + Headset Jumper (CBL-TC51-HDST25-01) + Earphone (HDST-25MM-PTVP-01)		

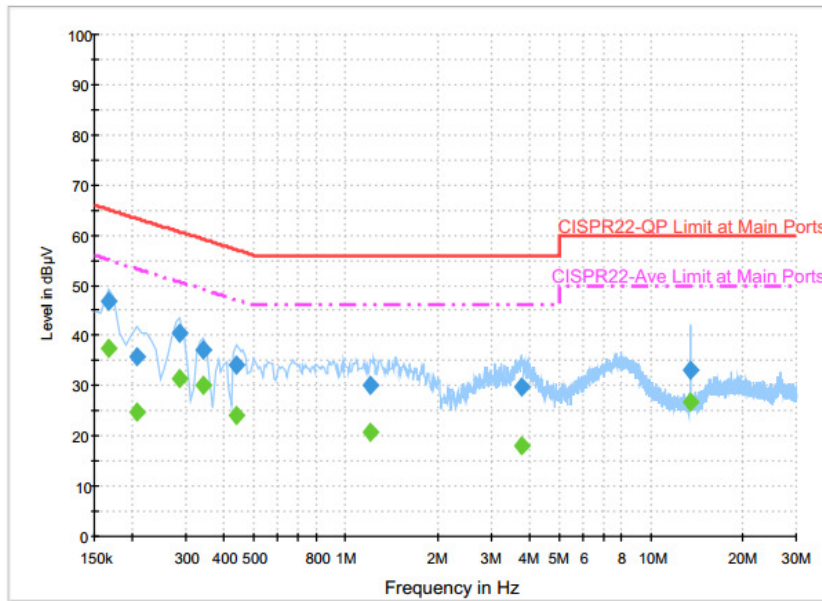

Final Result : Quasi-Peak

Frequency (MHz)	Quasi-Peak (dBµV)	Filter	Line	Corr. (dB)	Margin (dB)	Limit (dBµV)
0.166000	46.8	Off	N	19.6	18.4	65.2
0.206000	35.7	Off	N	19.6	27.7	63.4
0.286000	40.3	Off	N	19.6	20.3	60.6
0.342000	37.0	Off	N	19.6	22.2	59.2
0.438000	34.1	Off	N	19.6	23.0	57.1
1.206000	29.9	Off	N	19.6	26.1	56.0
3.774000	29.9	Off	N	19.7	26.1	56.0
13.558000	33.0	Off	N	20.4	27.0	60.0

Final Result : Average

Frequency (MHz)	Average (dBµV)	Filter	Line	Corr. (dB)	Margin (dB)	Limit (dBµV)
0.166000	37.5	Off	N	19.6	17.7	55.2
0.206000	24.7	Off	N	19.6	28.7	53.4
0.286000	31.3	Off	N	19.6	19.3	50.6
0.342000	30.0	Off	N	19.6	19.2	49.2
0.438000	24.1	Off	N	19.6	23.0	47.1
1.206000	20.9	Off	N	19.6	25.1	46.0
3.774000	18.0	Off	N	19.7	28.0	46.0
13.558000	26.9	Off	N	20.4	23.1	50.0



3.7 Antenna Requirements

3.7.1 Standard Applicable

If directional gain of transmitting Antennas is greater than 6dBi, the power shall be reduced by the same level in dB comparing to gain minus 6dBi. For the fixed point-to-point operation, the power shall be reduced by one dB for every 3 dB that the directional gain of the Antenna exceeds 6 dBi. The use of a permanently attached Antenna or of an Antenna that uses a unique coupling to the intentional radiator shall be considered sufficient to comply with the FCC rule.

3.7.2 Antenna Anti-Replacement Construction

An embedded-in antenna design is used.

3.7.3 Antenna Gain

The antenna peak gain of EUT is less than 6 dBi. Therefore, it is not necessary to reduce maximum peak output power limit.



4 List of Measuring Equipment

Instrument	Manufacturer	Model No.	Serial No.	Characteristics	Calibration Date	Test Date	Due Date	Remark
Power Meter	Agilent	E4416A	GB412923 44	300MHz~40GHz	Jan. 08, 2016	Nov. 08, 2016 ~ Nov. 23, 2016	Jan. 07, 2017	Conducted (TH05-HY)
Power Sensor	Agilent	E9327A	US404415 48	300MHz~40GHz	Jan. 07, 2016	Nov. 08, 2016 ~ Nov. 23, 2016	Jan. 06, 2017	Conducted (TH05-HY)
Spectrum Analyzer	Rohde & Schwarz	FSP40	100055	9kHz~40GHz	Jun. 17, 2016	Nov. 08, 2016 ~ Nov. 23, 2016	Jun. 16, 2017	Conducted (TH05-HY)
AC Power Source	ChainTek	APC-1000W	N/A	N/A	N/A	Oct. 22, 2016	N/A	Conduction (CO05-HY)
EMI Test Receiver	Rohde & Schwarz	ESCI 7	100724	9kHz~7GHz	Aug. 30, 2016	Oct. 22, 2016	Aug. 29, 2017	Conduction (CO05-HY)
LISN	Rohde & Schwarz	ENV216	100080	9kHz~30MHz	Dec. 02, 2015	Oct. 22, 2016	Dec. 01, 2016	Conduction (CO05-HY)
Loop Antenna	Rohde & Schwarz	HFH2-Z2	100315	9 kHz~30 MHz	Sep. 02, 2015	Nov. 13, 2016 ~ Nov. 20, 2016	Sep. 01, 2017	Radiation (03CH12-HY)
Amplifier	SONOMA	310N	187312	9kHz~1GHz	Nov. 10, 2016	Nov. 13, 2016 ~ Nov. 20, 2016	Nov. 09, 2017	Radiation (03CH12-HY)
Spectrum Analyzer	Keysight	N9010A	MY542004 86	10Hz ~ 44GHz	Oct. 12, 2016	Nov. 13, 2016 ~ Nov. 20, 2016	Oct. 11, 2017	Radiation (03CH12-HY)
Bilog Antenna	TESEQ	CBL 6111D&00800 N1D01N-06	37059&01	30MHz~1GHz	Oct. 15, 2016	Nov. 13, 2016 ~ Nov. 20, 2016	Oct. 14, 2017	Radiation (03CH12-HY)
EMI Test Receiver	Rohde & Schwarz	ESU26	100390	20Hz~26.5GHz	Dec. 21, 2015	Nov. 13, 2016 ~ Nov. 20, 2016	Dec. 20, 2016	Radiation (03CH12-HY)
Preamplifier	MITEQ	TTA0204	1872107	2GHz~40GHz	Feb. 15, 2016	Nov. 13, 2016 ~ Nov. 20, 2016	Feb. 14, 2017	Radiation (03CH12-HY)
Horn Antenna	SCHWARZBE CK	BBHA 9120D	9120D-132 8	1GHz ~ 18GHz	Oct. 25, 2016	Nov. 13, 2016 ~ Nov. 20, 2016	Oct. 24, 2017	Radiation (03CH12-HY)
Preamplifier	MITEQ	AMF-7D-0010 1800-30-10P	1815698	1GHz~18GHz	Dec. 14, 2015	Nov. 13, 2016 ~ Nov. 20, 2016	Dec. 13, 2016	Radiation (03CH12-HY)
Preamplifier	Keysight	83017A	MY532701 48	1GHz~26.5GHz	Jan. 30, 2016	Nov. 13, 2016 ~ Nov. 20, 2016	Jan. 29, 2017	Radiation (03CH12-HY)
Antenna Mast	EMEC	AM-BS-4500- B	N/A	1m~4m	N/A	Nov. 13, 2016 ~ Nov. 20, 2016	N/A	Radiation (03CH12-HY)
Turn Table	EMEC	TT2000	N/A	0~360 Degree	N/A	Nov. 13, 2016 ~ Nov. 20, 2016	N/A	Radiation (03CH12-HY)
Preamplifier	MITEQ	TTA0204	1872107	2GHz~40GHz	Feb. 15, 2016	Nov. 13, 2016 ~ Nov. 20, 2016	Feb. 14, 2017	Radiation (03CH12-HY)
SHF-EHF Horn Antenna	SCHWARZBE CK	BBHA 9170	BBHA9170 576	18GHz ~ 40GHz	Apr. 15, 2016	Nov. 13, 2016 ~ Nov. 20, 2016	Apr. 14, 2017	Radiation (03CH12-HY)



5 Uncertainty of Evaluation

Uncertainty of Conducted Emission Measurement (150kHz ~ 30MHz)

Measuring Uncertainty for a Level of Confidence of 95% ($U = 2Uc(y)$)	2.7
---	-----

Uncertainty of Radiated Emission Measurement (30 MHz ~ 1000 MHz)

Measuring Uncertainty for a Level of Confidence of 95% ($U = 2Uc(y)$)	5.1
---	-----

Uncertainty of Radiated Emission Measurement (1000 MHz ~ 18000 MHz)

Measuring Uncertainty for a Level of Confidence of 95% ($U = 2Uc(y)$)	5.2
---	-----

Uncertainty of Radiated Emission Measurement (18000 MHz ~ 40000 MHz)

Measuring Uncertainty for a Level of Confidence of 95% ($U = 2Uc(y)$)	4.7
---	-----



Appendix A. Radiated Spurious Emission

Test Engineer :	Peter Chiu, Karl Hou, Nick Yu, and Citta Ke	Temperature :	23~24°C
		Relative Humidity :	51~54%

2.4GHz 2400~2483.5MHz

WIFI 802.11b (Band Edge @ 3m)

WIFI Ant. 1	Note	Frequency (MHz)	Level (dBμV/m)	Over Limit (dB)	Limit Line (dBμV/m)	Read Level (dBμV)	Antenna Factor (dB/m)	Cable Loss (dB)	Preamp Factor (dB)	Ant Pos (cm)	Table Pos (deg)	Peak Avg. (P/A)	Pol. (H/V)	
802.11b CH 01 2412MHz		2388.12	59.02	-14.98	74	56.01	27.05	7.45	31.49	147	135	P	H	
		2387.28	50.71	-3.29	54	47.7	27.05	7.45	31.49	147	135	A	H	
	*	2412	110.71	-	-	107.66	27.09	7.45	31.49	147	135	P	H	
	*	2412	106.24	-	-	103.19	27.09	7.45	31.49	147	135	A	H	
													H	
														H
			2389.38	57.18	-16.82	74	54.17	27.05	7.45	31.49	385	55	P	V
			2387.39	46.4	-7.6	54	43.39	27.05	7.45	31.49	385	55	A	V
	*		2412	106.89	-	-	103.84	27.09	7.45	31.49	385	55	P	V
	*		2412	102.35	-	-	99.3	27.09	7.45	31.49	385	55	A	V
														V
														V
802.11b CH 02 2417MHz		2389.66	57.64	-16.36	74	54.63	27.05	7.45	31.49	174	144	P	H	
		2389.94	48.4	-5.6	54	45.39	27.05	7.45	31.49	174	144	A	H	
	*	2417	110.67	-	-	107.61	27.09	7.45	31.48	174	144	P	H	
	*	2417	106.22	-	-	103.16	27.09	7.45	31.48	174	144	A	H	
														H
														H
			2388.26	56.64	-17.36	74	53.63	27.05	7.45	31.49	387	54	P	V
			2389.94	47.24	-6.76	54	44.23	27.05	7.45	31.49	387	54	A	V
	*		2417	109.18	-	-	106.12	27.09	7.45	31.48	387	54	P	V
	*		2417	104.65	-	-	101.59	27.09	7.45	31.48	387	54	A	V
														V
														V



802.11b CH 06 2437MHz		2350.32	55.52	-18.48	74	52.72	26.93	7.37	31.5	114	135	P	H
		2389.8	44.32	-9.68	54	41.31	27.05	7.45	31.49	114	135	A	H
	*	2437	110.62	-	-	107.4	27.21	7.49	31.48	114	135	P	H
	*	2437	105.95	-	-	102.73	27.21	7.49	31.48	114	135	A	H
		2496.01	56.28	-17.72	74	52.91	27.3	7.53	31.46	114	135	P	H
		2483.69	44.44	-9.56	54	41.12	27.26	7.53	31.47	114	135	A	H
		2377.48	55.49	-18.51	74	52.6	27.01	7.37	31.49	381	52	P	V
		2389.52	43.8	-10.2	54	40.79	27.05	7.45	31.49	381	52	A	V
	*	2437	106.08	-	-	102.86	27.21	7.49	31.48	381	52	P	V
	*	2437	101.52	-	-	98.3	27.21	7.49	31.48	381	52	A	V
		2485.02	56.33	-17.67	74	53.01	27.26	7.53	31.47	381	52	P	V
		2484.04	44.07	-9.93	54	40.75	27.26	7.53	31.47	381	52	A	V
	802.11b CH 10 2457MHz	*	2457	110.9	-	-	107.66	27.22	7.49	31.47	160	141	P
*		2457	106.45	-	-	103.21	27.22	7.49	31.47	160	141	A	H
		2483.56	58.3	-15.7	74	54.98	27.26	7.53	31.47	160	141	P	H
		2483.5	48.31	-5.69	54	44.99	27.26	7.53	31.47	160	141	A	H
													H
													H
*		2457	108.21	-	-	104.97	27.22	7.49	31.47	380	53	P	V
*		2457	103.85	-	-	100.61	27.22	7.49	31.47	380	53	A	V
		2483.5	56.59	-17.41	74	53.27	27.26	7.53	31.47	380	53	P	V
		2483.5	45.77	-8.23	54	42.45	27.26	7.53	31.47	380	53	A	V
												V	
												V	



802.11b CH 11 2462MHz	*	2462	111.47	-	-	108.19	27.22	7.53	31.47	160	144	P	H
	*	2462	106.76	-	-	103.48	27.22	7.53	31.47	160	144	A	H
		2483.52	58.98	-15.02	74	55.66	27.26	7.53	31.47	160	144	P	H
		2483.52	47.32	-6.68	54	44	27.26	7.53	31.47	160	144	A	H
													H
													H
	*	2462	107.3	-	-	104.02	27.22	7.53	31.47	373	54	P	V
	*	2462	102.83	-	-	99.55	27.22	7.53	31.47	373	54	A	V
		2483.56	56.18	-17.82	74	52.86	27.26	7.53	31.47	373	54	P	V
		2483.52	45.41	-8.59	54	42.09	27.26	7.53	31.47	373	54	A	V
													V
													V
Remark	1. No other spurious found. 2. All results are PASS against Peak and Average limit line.												



2.4GHz 2400~2483.5MHz

WIFI 802.11b (Harmonic @ 3m)

WIFI Ant. 1	Note	Frequency (MHz)	Level (dBμV/m)	Over Limit (dB)	Limit Line (dBμV/m)	Read Level (dBμV)	Antenna Factor (dB/m)	Cable Loss (dB)	Preamp Factor (dB)	Ant Pos (cm)	Table Pos (deg)	Peak Avg. (P/A)	Pol. (H/V)	
802.11b CH 01 2412MHz		4824	45.47	-28.53	74	60.69	32.18	10.74	58.14	100	0	P	H	
													H	
													H	
													H	
			4824	45.41	-28.59	74	60.63	32.18	10.74	58.14	100	0	P	V
														V
														V
802.11b CH 06 2437MHz		4874	41.02	-32.98	74	55.96	32.27	10.89	58.1	100	0	P	H	
		7311	42.74	-31.26	74	51.58	36.07	14.18	59.09	100	0	P	H	
													H	
													H	
			4874	40.87	-33.13	74	55.81	32.27	10.89	58.1	100	0	P	V
			7311	42.72	-31.28	74	50.66	36.97	14.18	59.09	100	0	P	V
														V
802.11b CH 11 2462MHz		4924	41.77	-32.23	74	56.43	32.36	11.04	58.06	100	0	P	H	
		7386	44.27	-29.73	74	51.96	37.18	14.27	59.14	100	0	P	H	
													H	
													H	
			4924	43.51	-30.49	74	58.17	32.36	11.04	58.06	100	0	P	V
			7386	44.17	-29.83	74	51.86	37.18	14.27	59.14	100	0	P	V
														V
Remark	1. No other spurious found.													
	2. All results are PASS against Peak and Average limit line.													



2.4GHz 2400~2483.5MHz

WIFI 802.11g (Band Edge @ 3m)

WIFI Ant. 1	Note	Frequency (MHz)	Level (dBμV/m)	Over Limit (dB)	Limit Line (dBμV/m)	Read Level (dBμV)	Antenna Factor (dB/m)	Cable Loss (dB)	Preamp Factor (dB)	Ant Pos (cm)	Table Pos (deg)	Peak Avg. (P/A)	Pol. (H/V)	
802.11g CH 01 2412MHz		2389.49	65.65	-8.35	74	62.64	27.05	7.45	31.49	151	135	P	H	
		2390	52.57	-1.43	54	49.56	27.05	7.45	31.49	151	135	A	H	
	*	2412	108.91	-	-	105.86	27.09	7.45	31.49	151	135	P	H	
	*	2412	98.78	-	-	95.73	27.09	7.45	31.49	151	135	A	H	
													H	
														H
			2389.695	59.87	-14.13	74	56.86	27.05	7.45	31.49	394	50	P	V
			2390	49.23	-4.77	54	46.22	27.05	7.45	31.49	394	50	A	V
	*		2412	104.86	-	-	101.81	27.09	7.45	31.49	394	50	P	V
	*		2412	94.94	-	-	91.89	27.09	7.45	31.49	394	50	A	V
														V
														V
802.11g CH 02 2417MHz		2388.96	60.46	-13.54	74	57.45	27.05	7.45	31.49	143	142	P	H	
		2389.94	49.78	-4.22	54	46.77	27.05	7.45	31.49	143	142	A	H	
	*	2417	109.95	-	-	106.89	27.09	7.45	31.48	143	142	P	H	
	*	2417	100.82	-	-	97.76	27.09	7.45	31.48	143	142	A	H	
														H
														H
			2389.52	58.35	-15.65	74	55.34	27.05	7.45	31.49	386	54	P	V
			2389.94	47.76	-6.24	54	44.75	27.05	7.45	31.49	386	54	A	V
	*		2417	108.95	-	-	105.89	27.09	7.45	31.48	386	54	P	V
	*		2417	98.88	-	-	95.82	27.09	7.45	31.48	386	54	A	V
														V
														V



802.11g CH 06 2437MHz		2389.66	57.76	-16.24	74	54.75	27.05	7.45	31.49	233	137	P	H
		2389.94	46.84	-7.16	54	43.83	27.05	7.45	31.49	233	137	A	H
	*	2437	111.26	-	-	108.07	27.18	7.49	31.48	233	137	P	H
	*	2437	100.99	-	-	97.8	27.18	7.49	31.48	233	137	A	H
		2489.15	56.42	-17.58	74	53.06	27.3	7.53	31.47	233	137	P	H
		2484.39	45.88	-8.12	54	42.56	27.26	7.53	31.47	233	137	A	H
		2347.24	56.56	-17.44	74	53.76	26.93	7.37	31.5	383	55	P	V
		2389.94	45.28	-8.72	54	42.27	27.05	7.45	31.49	383	55	A	V
	*	2437	107.03	-	-	103.84	27.18	7.49	31.48	383	55	P	V
	*	2437	97.5	-	-	94.31	27.18	7.49	31.48	383	55	A	V
		2491.88	56.12	-17.88	74	52.75	27.3	7.53	31.46	383	55	P	V
		2485.58	45.06	-8.94	54	41.74	27.26	7.53	31.47	383	55	A	V
802.11g CH 10 2457MHz	*	2457	111.11	-	-	107.87	27.22	7.49	31.47	162	142	P	H
	*	2457	100.97	-	-	97.73	27.22	7.49	31.47	162	142	A	H
		2483.5	64.32	-9.68	74	61	27.26	7.53	31.47	162	142	P	H
		2483.56	52.38	-1.62	54	49.06	27.26	7.53	31.47	162	142	A	H
													H
													H
	*	2457	108.73	-	-	105.49	27.22	7.49	31.47	379	54	P	V
	*	2457	98.4	-	-	95.16	27.22	7.49	31.47	379	54	A	V
		2483.8	61.09	-12.91	74	57.77	27.26	7.53	31.47	379	54	P	V
		2483.5	48.79	-5.21	54	45.47	27.26	7.53	31.47	379	54	A	V
												V	
												V	



802.11g CH 11 2462MHz	*	2462	109.84	-	-	106.56	27.22	7.53	31.47	153	138	P	H
	*	2462	100.48	-	-	97.2	27.22	7.53	31.47	153	138	A	H
		2483.76	66.19	-7.81	74	62.87	27.26	7.53	31.47	153	138	P	H
		2483.52	51.05	-2.95	54	47.73	27.26	7.53	31.47	153	138	A	H
													H
													H
	*	2462	106.05	-	-	102.7	27.29	7.53	31.47	368	57	P	V
	*	2462	96.45	-	-	93.1	27.29	7.53	31.47	368	57	A	V
		2483.96	61.59	-12.41	74	58.27	27.26	7.53	31.47	368	57	P	V
		2483.52	48.41	-5.59	54	45.09	27.26	7.53	31.47	368	57	A	V
													V
													V
Remark	1. No other spurious found. 2. All results are PASS against Peak and Average limit line.												



2.4GHz 2400~2483.5MHz

WIFI 802.11g (Harmonic @ 3m)

WIFI Ant. 1	Note	Frequency (MHz)	Level (dBμV/m)	Over Limit (dB)	Limit Line (dBμV/m)	Read Level (dBμV)	Antenna Factor (dB/m)	Cable Loss (dB)	Preamp Factor (dB)	Ant Pos (cm)	Table Pos (deg)	Peak Avg. (P/A)	Pol. (H/V)	
802.11g CH 01 2412MHz		4824	39.09	-34.91	74	54.31	32.18	10.74	58.14	100	0	P	H	
													H	
													H	
													H	
			4824	39.07	-34.93	74	54.29	32.18	10.74	58.14	100	0	P	V
														V
														V
802.11g CH 06 2437MHz		4874	38.02	-35.98	74	52.96	32.27	10.89	58.1	100	0	P	H	
		7311	42	-32	74	50.84	36.07	14.18	59.09	100	0	P	H	
													H	
													H	
			4874	38.11	-35.89	74	53.99	31.33	10.89	58.1	100	0	P	V
			7311	42.59	-31.41	74	50.53	36.97	14.18	59.09	100	0	P	V
														V
802.11g CH 11 2462MHz		4924	38.81	-35.19	74	53.47	32.36	11.04	58.06	100	0	P	H	
		7386	43.51	-30.49	74	51.2	37.18	14.27	59.14	100	0	P	H	
													H	
													H	
			4924	38.83	-35.17	74	53.49	32.36	11.04	58.06	100	0	P	V
			7386	43.69	-30.31	74	51.38	37.18	14.27	59.14	100	0	P	V
														V
Remark	1. No other spurious found.													
	2. All results are PASS against Peak and Average limit line.													



2.4GHz 2400~2483.5MHz

WIFI 802.11ac VHT20 (Band Edge @ 3m)

WIFI Ant. 1	Note	Frequency (MHz)	Level (dBμV/m)	Over Limit (dB)	Limit Line (dBμV/m)	Read Level (dBμV)	Antenna Factor (dB/m)	Cable Loss (dB)	Preamp Factor (dB)	Ant Pos (cm)	Table Pos (deg)	Peak Avg. (P/A)	Pol. (H/V)	
802.11ac VHT20 CH 01 2412MHz		2389.07	63.98	-10.02	74	60.97	27.05	7.45	31.49	169	135	P	H	
		2389.91	52.53	-1.47	54	49.52	27.05	7.45	31.49	169	135	A	H	
	*	2412	107.17	-	-	104.12	27.09	7.45	31.49	169	135	P	H	
	*	2412	97.46	-	-	94.41	27.09	7.45	31.49	169	135	A	H	
													H	
														H
			2389.49	62.86	-11.14	74	59.85	27.05	7.45	31.49	393	52	P	V
			2390	50.07	-3.93	54	47.06	27.05	7.45	31.49	393	52	A	V
		*	2412	103.82	-	-	100.77	27.09	7.45	31.49	393	52	P	V
		*	2412	94.21	-	-	91.16	27.09	7.45	31.49	393	52	A	V
802.11ac VHT20 CH 02 2417MHz		2389.24	58.71	-15.29	74	55.7	27.05	7.45	31.49	174	143	P	H	
		2389.94	49.04	-4.96	54	46.03	27.05	7.45	31.49	174	143	A	H	
	*	2417	109.85	-	-	106.79	27.09	7.45	31.48	174	143	P	H	
	*	2417	100.29	-	-	97.23	27.09	7.45	31.48	174	143	A	H	
													H	
														H
			2389.66	58.54	-15.46	74	55.53	27.05	7.45	31.49	386	56	P	V
			2389.94	48.1	-5.9	54	45.09	27.05	7.45	31.49	386	56	A	V
		*	2417	108.83	-	-	105.77	27.09	7.45	31.48	386	56	P	V
		*	2417	98.79	-	-	95.73	27.09	7.45	31.48	386	56	A	V
													V	
													V	



802.11ac VHT20 CH 06 2437MHz		2389.66	56.22	-17.78	74	53.21	27.05	7.45	31.49	169	143	P	H
		2389.94	46.19	-7.81	54	43.18	27.05	7.45	31.49	169	143	A	H
	*	2437	110.15	-	-	106.96	27.18	7.49	31.48	169	143	P	H
	*	2437	100.05	-	-	96.86	27.18	7.49	31.48	169	143	A	H
		2484.04	56.76	-17.24	74	53.44	27.26	7.53	31.47	169	143	P	H
		2483.76	46.31	-7.69	54	42.99	27.26	7.53	31.47	169	143	A	H
		2381.54	55.54	-18.46	74	52.57	27.01	7.45	31.49	382	57	P	V
		2389.8	45.66	-8.34	54	42.65	27.05	7.45	31.49	382	57	A	V
	*	2437	107.73	-	-	104.54	27.18	7.49	31.48	382	57	P	V
	*	2437	98.15	-	-	94.96	27.18	7.49	31.48	382	57	A	V
		2484.95	56.93	-17.07	74	53.61	27.26	7.53	31.47	382	57	P	V
		2483.83	45.23	-8.77	54	41.91	27.26	7.53	31.47	382	57	A	V
802.11ac VHT20 CH 10 2457MHz	*	2457	110.32	-	-	107.08	27.22	7.49	31.47	159	142	P	H
	*	2457	100.41	-	-	97.17	27.22	7.49	31.47	159	142	A	H
		2483.8	63.53	-10.47	74	60.21	27.26	7.53	31.47	159	142	P	H
		2483.5	52.39	-1.61	54	49.07	27.26	7.53	31.47	159	142	A	H
													H
													H
	*	2457	106.69	-	-	103.45	27.22	7.49	31.47	379	55	P	V
	*	2457	97.74	-	-	94.5	27.22	7.49	31.47	379	55	A	V
		2483.92	59.9	-14.1	74	56.58	27.26	7.53	31.47	379	55	P	V
		2483.5	48.29	-5.71	54	44.97	27.26	7.53	31.47	379	55	A	V
												V	
												V	



802.11ac VHT20 CH 11 2462MHz	*	2462	110.29	-	-	107.01	27.22	7.53	31.47	164	141	P	H
	*	2462	99.96	-	-	96.68	27.22	7.53	31.47	164	141	A	H
		2483.88	66.7	-7.3	74	63.38	27.26	7.53	31.47	164	141	P	H
		2483.52	51.85	-2.15	54	48.53	27.26	7.53	31.47	164	141	A	H
													H
													H
	*	2462	105.57	-	-	102.29	27.22	7.53	31.47	373	55	P	V
	*	2462	96.3	-	-	93.02	27.22	7.53	31.47	373	55	A	V
		2484.4	61.13	-12.87	74	57.81	27.26	7.53	31.47	373	55	P	V
		2483.52	47.9	-6.1	54	44.58	27.26	7.53	31.47	373	55	A	V
													V
												V	
Remark	1. No other spurious found. 2. All results are PASS against Peak and Average limit line.												



2.4GHz 2400~2483.5MHz

WIFI 802.11ac VHT20 (Harmonic @ 3m)

WIFI Ant. 1	Note	Frequency (MHz)	Level (dBμV/m)	Over Limit (dB)	Limit Line (dBμV/m)	Read Level (dBμV)	Antenna Factor (dB/m)	Cable Loss (dB)	Preamp Factor (dB)	Ant Pos (cm)	Table Pos (deg)	Peak Avg. (P/A)	Pol. (H/V)	
802.11ac VHT20 CH 01 2412MHz		4824	39.48	-34.52	74	54.7	32.18	10.74	58.14	100	0	P	H	
													H	
													H	
													H	
			4824	38.79	-35.21	74	54.01	32.18	10.74	58.14	100	0	P	V
														V
														V
802.11ac VHT20 CH 06 2437MHz		4874	39.57	-34.43	74	54.51	32.27	10.89	58.1	100	0	P	H	
		7311	43.74	-30.26	74	51.68	36.97	14.18	59.09	100	0	P	H	
													H	
													H	
			4874	40.57	-33.43	74	55.51	32.27	10.89	58.1	100	0	P	V
			7311	44.95	-29.05	74	52.89	36.97	14.18	59.09	100	0	P	V
														V
802.11ac VHT20 CH 11 2462MHz		4924	38.91	-35.09	74	53.57	32.36	11.04	58.06	100	0	P	H	
		7386	43.92	-30.08	74	51.61	37.18	14.27	59.14	100	0	P	H	
													H	
													H	
			4924	38.88	-35.12	74	53.54	32.36	11.04	58.06	100	0	P	V
			7386	43.46	-30.54	74	51.15	37.18	14.27	59.14	100	0	P	V
														V
Remark	1. No other spurious found.													
	2. All results are PASS against Peak and Average limit line.													



2.4GHz 2400~2483.5MHz

WIFI 802.11ac VHT40 (Band Edge @ 3m)

WIFI Ant. 1	Note	Frequency (MHz)	Level (dBμV/m)	Over Limit (dB)	Limit Line (dBμV/m)	Read Level (dBμV)	Antenna Factor (dB/m)	Cable Loss (dB)	Preamp Factor (dB)	Ant Pos (cm)	Table Pos (deg)	Peak Avg. (P/A)	Pol. (H/V)
802.11ac VHT40 CH 03 2422MHz		2389.8	64.48	-9.52	74	61.47	27.05	7.45	31.49	233	135	P	H
		2389.94	52.96	-1.04	54	49.95	27.05	7.45	31.49	233	135	A	H
	*	2422	104.33	-	-	101.19	27.13	7.49	31.48	233	135	P	H
	*	2422	95.3	-	-	92.16	27.13	7.49	31.48	233	135	A	H
		2486.35	56.04	-17.96	74	52.72	27.26	7.53	31.47	233	135	P	H
		2484.04	45.74	-8.26	54	42.42	27.26	7.53	31.47	233	135	A	H
		2388.26	59.03	-14.97	74	56.02	27.05	7.45	31.49	383	56	P	V
		2389.94	48.82	-5.18	54	45.81	27.05	7.45	31.49	383	56	A	V
	*	2422	100.85	-	-	97.71	27.13	7.49	31.48	383	56	P	V
	*	2422	91.58	-	-	88.44	27.13	7.49	31.48	383	56	A	V
		2498.32	55.62	-18.38	74	52.25	27.3	7.53	31.46	383	56	P	V
		2498.39	45.92	-8.08	54	42.55	27.3	7.53	31.46	383	56	A	V
802.11ac VHT40 CH 04 2427MHz		2389.38	62.46	-11.54	74	59.45	27.05	7.45	31.49	166	143	P	H
		2389.94	52.78	-1.22	54	49.77	27.05	7.45	31.49	166	143	A	H
	*	2427	105.69	-	-	102.55	27.13	7.49	31.48	166	143	P	H
	*	2427	95.77	-	-	92.63	27.13	7.49	31.48	166	143	A	H
		2485.16	56.7	-17.3	74	53.38	27.26	7.53	31.47	166	143	P	H
		2484.11	46.38	-7.62	54	43.06	27.26	7.53	31.47	166	143	A	H
		2389.94	62.58	-11.42	74	59.57	27.05	7.45	31.49	385	55	P	V
		2389.38	51.19	-2.81	54	48.18	27.05	7.45	31.49	385	55	A	V
	*	2427	103.28	-	-	100.14	27.13	7.49	31.48	385	55	P	V
	*	2427	93.73	-	-	90.59	27.13	7.49	31.48	385	55	A	V
		2493.91	56.19	-17.81	74	52.82	27.3	7.53	31.46	385	55	P	V
		2483.5	45.56	-8.44	54	42.24	27.26	7.53	31.47	385	55	A	V



802.11ac VHT40 CH 06 2437MHz		2389.8	61.25	-12.75	74	58.24	27.05	7.45	31.49	164	143	P	H
		2389.8	50.4	-3.6	54	47.39	27.05	7.45	31.49	164	143	A	H
	*	2437	106.73	-	-	103.54	27.18	7.49	31.48	164	143	P	H
	*	2437	96.27	-	-	93.08	27.18	7.49	31.48	164	143	A	H
		2484.88	63.96	-10.04	74	60.64	27.26	7.53	31.47	164	143	P	H
		2483.5	52.72	-1.28	54	49.4	27.26	7.53	31.47	164	143	A	H
		2389.94	59.43	-14.57	74	56.42	27.05	7.45	31.49	384	55	P	V
		2389.66	49.45	-4.55	54	46.44	27.05	7.45	31.49	384	55	A	V
	*	2437	103.98	-	-	100.79	27.18	7.49	31.48	384	55	P	V
	*	2437	94.37	-	-	91.18	27.18	7.49	31.48	384	55	A	V
		2484.11	60.65	-13.35	74	57.33	27.26	7.53	31.47	384	55	P	V
		2483.69	48.48	-5.52	54	45.16	27.26	7.53	31.47	384	55	A	V
802.11ac VHT40 CH 08 2447MHz		2360.4	55.88	-18.12	74	53.04	26.97	7.37	31.5	172	142	P	H
		2388.96	46.28	-7.72	54	43.27	27.05	7.45	31.49	172	142	A	H
	*	2447	103.45	-	-	100.25	27.18	7.49	31.47	172	142	P	H
	*	2447	93.69	-	-	90.49	27.18	7.49	31.47	172	142	A	H
		2484.6	64.1	-9.9	74	60.78	27.26	7.53	31.47	172	142	P	H
		2483.62	52.71	-1.29	54	49.39	27.26	7.53	31.47	172	142	A	H
		2339.26	56.53	-17.47	74	53.8	26.93	7.3	31.5	383	56	P	V
		2389.52	45.44	-8.56	54	42.43	27.05	7.45	31.49	383	56	A	V
	*	2447	101.24	-	-	98.04	27.18	7.49	31.47	383	56	P	V
	*	2447	91.37	-	-	88.17	27.18	7.49	31.47	383	56	A	V
	2483.69	59.27	-14.73	74	55.95	27.26	7.53	31.47	383	56	P	V	
	2483.9	48.33	-5.67	54	45.01	27.26	7.53	31.47	383	56	A	V	



802.11ac VHT40 CH 09 2452MHz		2387.28	55.87	-18.13	74	52.86	27.05	7.45	31.49	171	143	P	H
		2389.94	46.38	-7.62	54	43.37	27.05	7.45	31.49	171	143	A	H
	*	2452	104.76	-	-	101.56	27.18	7.49	31.47	171	143	P	H
	*	2452	95.72	-	-	92.52	27.18	7.49	31.47	171	143	A	H
		2483.9	64.01	-9.99	74	60.69	27.26	7.53	31.47	171	143	P	H
		2483.62	52.94	-1.06	54	49.62	27.26	7.53	31.47	171	143	A	H
		2382.8	55.69	-18.31	74	52.72	27.01	7.45	31.49	376	53	P	V
		2382.66	45.4	-8.6	54	42.43	27.01	7.45	31.49	376	53	A	V
	*	2452	101.35	-	-	98.15	27.18	7.49	31.47	376	53	P	V
	*	2452	91.54	-	-	88.34	27.18	7.49	31.47	376	53	A	V
		2483.62	60.34	-13.66	74	57.02	27.26	7.53	31.47	376	53	P	V
		2483.62	48.64	-5.36	54	45.32	27.26	7.53	31.47	376	53	A	V
Remark	1. No other spurious found. 2. All results are PASS against Peak and Average limit line.												



2.4GHz 2400~2483.5MHz

WIFI 802.11ac VHT40 (Harmonic @ 3m)

WIFI Ant. 1	Note	Frequency (MHz)	Level (dBμV/m)	Over Limit (dB)	Limit Line (dBμV/m)	Read Level (dBμV)	Antenna Factor (dB/m)	Cable Loss (dB)	Preamp Factor (dB)	Ant Pos (cm)	Table Pos (deg)	Peak Avg. (P/A)	Pol. (H/V)
802.11ac VHT40 CH 03 2422MHz		4844	39.52	-34.48	74	54.68	32.22	10.74	58.12	100	0	P	H
		7266	43.74	-30.26	74	51.83	36.84	14.14	59.07	100	0	P	H
													H
													H
		4844	39	-35	74	54.16	32.22	10.74	58.12	100	0	P	V
		7266	43.48	-30.52	74	51.57	36.84	14.14	59.07	100	0	P	V
802.11ac VHT40 CH 06 2437MHz		4874	38.35	-35.65	74	53.29	32.27	10.89	58.1	100	0	P	H
		7311	43.67	-30.33	74	51.61	36.97	14.18	59.09	100	0	P	H
													H
													H
		4874	38.96	-35.04	74	53.9	32.27	10.89	58.1	100	0	P	V
		7311	43.98	-30.02	74	51.92	36.97	14.18	59.09	100	0	P	V
802.11ac VHT40 CH 09 2452MHz		4904	39.32	-34.68	74	54.02	32.33	11.04	58.07	100	0	P	H
		7356	43.39	-30.61	74	51.19	37.1	14.22	59.12	100	0	P	H
													H
													H
		4904	39.38	-34.62	74	54.08	32.33	11.04	58.07	100	0	P	V
		7356	43.13	-30.87	74	50.93	37.1	14.22	59.12	100	0	P	V
Remark	1. No other spurious found.												
	2. All results are PASS against Peak and Average limit line.												



Emission below 1GHz

2.4GHz WIFI 802.11ac VHT40 (LF)

WIFI	Note	Frequency	Level	Over	Limit	Read	Antenna	Cable	Preamp	Ant	Table	Peak	Pol.	
Ant.				Limit	Line	Level	Factor	Loss	Factor	Pos	Pos	Avg.		
1		(MHz)	(dBμV/m)	(dB)	(dBμV/m)	(dBμV)	(dB/m)	(dB)	(dB)	(cm)	(deg)	(P/A)	(H/V)	
2.4GHz 802.11ac VHT40 LF		37.02	29.52	-10.48	40	39.22	21.98	0.78	32.46	100	0	P	H	
		81.84	22.82	-17.18	40	40.39	13.81	1.06	32.44	-	-	P	H	
		115.59	29.36	-14.14	43.5	42.99	17.37	1.43	32.43	-	-	P	H	
		260.58	19.15	-26.85	46	29.74	19.46	2.25	32.3	-	-	P	H	
		362.3	24.87	-21.13	46	33.44	21.31	2.44	32.32	-	-	P	H	
		942.6	32.21	-13.79	46	28.54	30.11	4.75	31.19	-	-	P	H	
														H
														H
														H
														H
														H
														H
														H
														H
														H
														H
														H
														H
			34.86	35.32	-4.68	40	43.9	23.1	0.78	32.46	100	306	QP	V
			34.86	38.88	-	-	47.46	23.1	0.78	32.46	100	306	P	V
		36.75	36.34	-3.66	40	46.04	21.98	0.78	32.46	100	319	QP	V	
		36.75	39.85	-	-	49.55	21.98	0.78	32.46	100	319	P	V	
		63.75	26.94	-13.06	40	46.33	12	1.06	32.45	-	-	P	V	
		124.77	25.46	-18.04	43.5	38.65	17.8	1.43	32.42	-	-	P	V	
		592.6	25.97	-20.03	46	29.61	25.26	3.5	32.4	-	-	P	V	
		930.7	31.53	-14.47	46	28.45	29.78	4.6	31.3	-	-	P	V	
													V	
													V	
													V	
													V	
Remark	1. No other spurious found. 2. All results are PASS against limit line.													



Note symbol

*	Fundamental Frequency which can be ignored. However, the level of any unwanted emissions shall not exceed the level of the fundamental frequency.
!	Test result is over limit line.
P/A	Peak or Average
H/V	Horizontal or Vertical



A calculation example for radiated spurious emission is shown as below:

WIFI	Note	Frequency	Level	Over	Limit	Read	Antenna	Cable	Preamp	Ant	Table	Peak	Pol.
Ant.				Limit	Line	Level	Factor	Loss	Factor	Pos	Pos	Avg.	
1		(MHz)	(dBμV/m)	(dB)	(dBμV/m)	(dBμV)	(dB/m)	(dB)	(dB)	(cm)	(deg)	(P/A)	(H/V)
802.11b		2390	55.45	-18.55	74	54.51	32.22	4.58	35.86	103	308	P	H
CH 01													
2412MHz		2390	43.54	-10.46	54	42.6	32.22	4.58	35.86	103	308	A	H

- Level(dBμV/m) =
Antenna Factor(dB/m) + Cable Loss(dB) + Read Level(dBμV) - Preamp Factor(dB)
- Over Limit(dB) = Level(dBμV/m) – Limit Line(dBμV/m)

For Peak Limit @ 2390MHz:

- Level(dBμV/m)
= Antenna Factor(dB/m) + Cable Loss(dB) + Read Level(dBμV) - Preamp Factor(dB)
= 32.22(dB/m) + 4.58(dB) + 54.51(dBμV) – 35.86 (dB)
= 55.45 (dBμV/m)
- Over Limit(dB)
= Level(dBμV/m) – Limit Line(dBμV/m)
= 55.45(dBμV/m) – 74(dBμV/m)
= -18.55(dB)

For Average Limit @ 2390MHz:

- Level(dBμV/m)
= Antenna Factor(dB/m) + Cable Loss(dB) + Read Level(dBμV) - Preamp Factor(dB)
= 32.22(dB/m) + 4.58(dB) + 42.6(dBμV) – 35.86 (dB)
= 43.54 (dBμV/m)
- Over Limit(dB)
= Level(dBμV/m) – Limit Line(dBμV/m)
= 43.54(dBμV/m) – 54(dBμV/m)
= -10.46(dB)

Both peak and average measured complies with the limit line, so test result is “PASS”.



Appendix B. Radiated Spurious Emission Plots

Test Engineer :	Peter Chiu, Karl Hou, Nick Yu, and Citta Ke	Temperature :	23~24°C
		Relative Humidity :	51~54%

Note symbol

-L	Low channel location
-R	High channel location



2.4GHz 2400~2483.5MHz
WIFI 802.11b (Band Edge @ 3m)

WIFI	2.4GHz 2400~2483.5MHz Band Edge @ 3m	
ANT	802.11b CH01 2412MHz	
1	Horizontal	Fundamental
Peak	<p>Date: 2016-11-13 PEAK_BE_74</p> <p>Site : 03CH12-HY Condition : PEAK_BE_74 3m HORN_9120D_1328 HORIZONTAL : RBW:1000.000KHz VBW:3000.000KHz SWT:Auto Detector : Peak Project : 672014-10 Mode : 11</p>	<p>Date: 2016-11-13 PEAK_74</p> <p>Site : 03CH12-HY Condition : PEAK_74 3m HORN_9120D_1328 HORIZONTAL : RBW:1000.000KHz VBW:3000.000KHz SWT:Auto Detector : Peak Project : 672014-10 Mode : 11</p>
Avg.	<p>Date: 2016-11-13 AVG_BE_54</p> <p>Site : 03CH12-HY Condition : AVG_BE_54 3m HORN_9120D_1328 HORIZONTAL : RBW:1000.000KHz VBW:0.010KHz SWT:Auto Detector : Peak Project : 672014-10 Mode : 11</p>	<p>Date: 2016-11-13 AVG_54</p> <p>Site : 03CH12-HY Condition : AVG_54 3m HORN_9120D_1328 HORIZONTAL : RBW:1000.000KHz VBW:0.010KHz SWT:Auto Detector : Peak Project : 672014-10 Mode : 11</p>

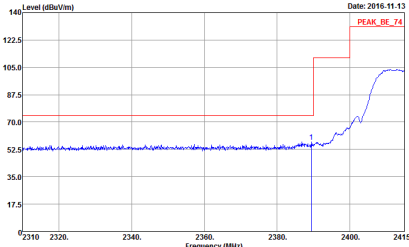
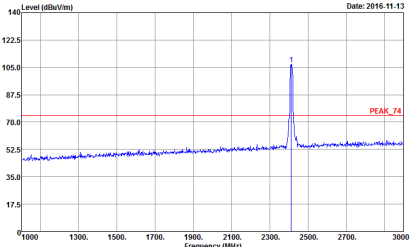
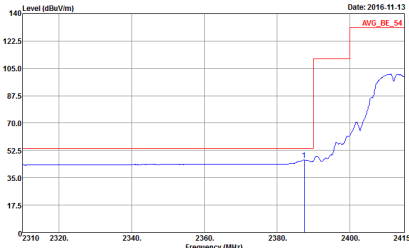
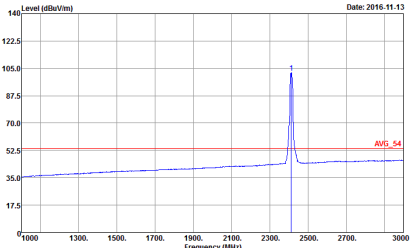

WIFI	2.4GHz 2400~2483.5MHz Band Edge @ 3m	
ANT	802.11b CH01 2412MHz	
1	Vertical	Fundamental
Peak	 <p>Date: 2016.11.13 PEAK_BE_74</p> <p>Site : 03CH12-HY Condition : PEAK_BE_74 3m HORN_9120D_1328 VERTICAL RBW:1000.000KHz VBW:3000.000KHz SWT:Auto Detector : Peak Project : 672014-10 Mode : 11</p>	 <p>Date: 2016.11.13 PEAK_74</p> <p>Site : 03CH12-HY Condition : PEAK_74 3m HORN_9120D_1328 VERTICAL RBW:1000.000KHz VBW:3000.000KHz SWT:Auto Detector : Peak Project : 672014-10 Mode : 11</p>
Avg.	 <p>Date: 2016.11.13 AVG_BE_54</p> <p>Site : 03CH12-HY Condition : AVG_BE_54 3m HORN_9120D_1328 VERTICAL RBW:1000.000KHz VBW:0.010KHz SWT:Auto Detector : Peak Project : 672014-10 Mode : 11</p>	 <p>Date: 2016.11.13 AVG_54</p> <p>Site : 03CH12-HY Condition : AVG_54 3m HORN_9120D_1328 VERTICAL RBW:1000.000KHz VBW:0.010KHz SWT:Auto Detector : Peak Project : 672014-10 Mode : 11</p>

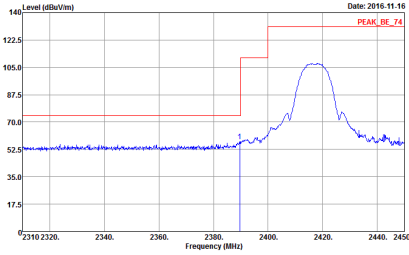
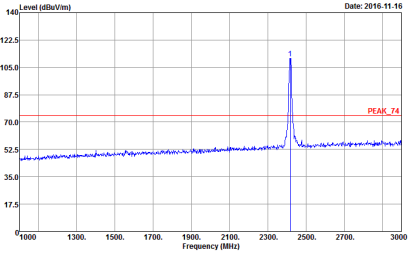
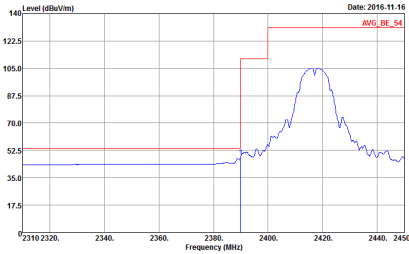
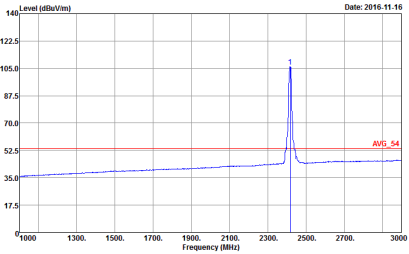

WIFI	2.4GHz 2400~2483.5MHz Band Edge @ 3m	
ANT	802.11b CH02 2417MHz	
1	Horizontal	Fundamental
Peak	 <p>Date: 2016.11.16 PEAK_BE_74</p> <p>Site : 03CH12-HY Condition : PEAK_BE_74 3m HORN_9120D_1328 HORIZONTAL RBW:1000.000KHz VBW:3000.000KHz SWT:Auto Detector : Peak Project : 672014-10 Mode : 12</p>	 <p>Date: 2016.11.16 PEAK_74</p> <p>Site : 03CH12-HY Condition : PEAK_74 3m HORN_9120D_1328 HORIZONTAL RBW:1000.000KHz VBW:3000.000KHz SWT:Auto Detector : Peak Project : 672014-10 Mode : 12</p>
Avg.	 <p>Date: 2016.11.16 AVG_BE_54</p> <p>Site : 03CH12-HY Condition : AVG_BE_54 3m HORN_9120D_1328 HORIZONTAL RBW:1000.000KHz VBW:0.010KHz SWT:Auto Detector : Peak Project : 672014-10 Mode : 12</p>	 <p>Date: 2016.11.16 AVG_54</p> <p>Site : 03CH12-HY Condition : AVG_54 3m HORN_9120D_1328 HORIZONTAL RBW:1000.000KHz VBW:0.010KHz SWT:Auto Detector : Peak Project : 672014-10 Mode : 12</p>

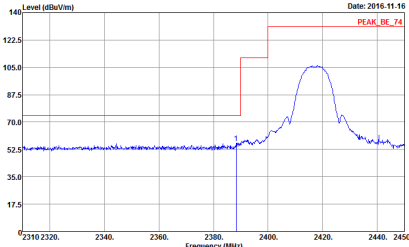
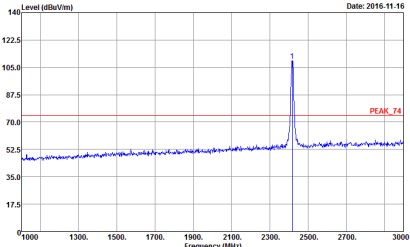
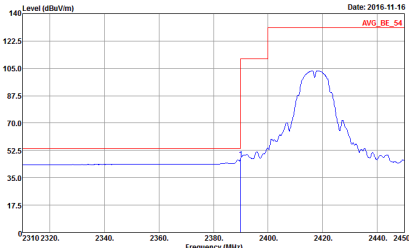
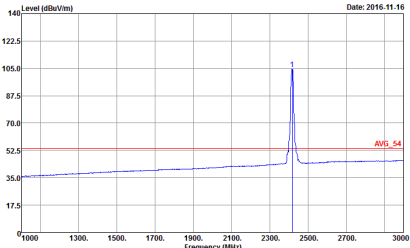

WIFI	2.4GHz 2400~2483.5MHz Band Edge @ 3m	
ANT	802.11b CH02 2417MHz	
1	Vertical	Fundamental
Peak	 <p>Date: 2016.11.16 PEAK_BE_74</p> <p>Site : 03CH12-HY Condition : PEAK_BE_74 3m HORN_9120D_1328 VERTICAL RBW:1000.000KHz VBW:3000.000KHz SWT:Auto Detector : Peak Project : 672014-10 Mode : 12</p>	 <p>Date: 2016.11.16 PEAK_74</p> <p>Site : 03CH12-HY Condition : PEAK_74 3m HORN_9120D_1328 VERTICAL RBW:1000.000KHz VBW:3000.000KHz SWT:Auto Detector : Peak Project : 672014-10 Mode : 12</p>
Avg.	 <p>Date: 2016.11.16 AVG_BE_54</p> <p>Site : 03CH12-HY Condition : AVG_BE_54 3m HORN_9120D_1328 VERTICAL RBW:1000.000KHz VBW:0.010KHz SWT:Auto Detector : Peak Project : 672014-10 Mode : 12</p>	 <p>Date: 2016.11.16 AVG_54</p> <p>Site : 03CH12-HY Condition : AVG_54 3m HORN_9120D_1328 VERTICAL RBW:1000.000KHz VBW:0.010KHz SWT:Auto Detector : Peak Project : 672014-10 Mode : 12</p>

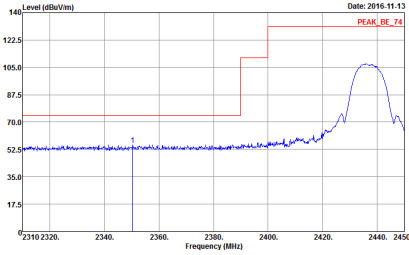
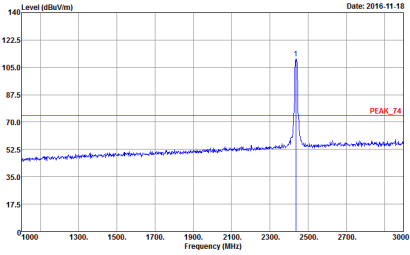
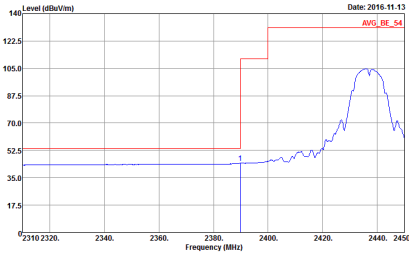
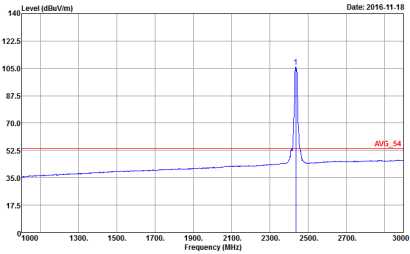

WIFI	2.4GHz 2400~2483.5MHz Band Edge @ 3m	
ANT	802.11b CH06 2437MHz - L	
1	Horizontal	Fundamental
Peak	 <p>Date: 2016.11.13 PEAK_BE_74</p> <p>Site : 03CH12-HY Condition : PEAK_BE_74 3m HORN_9120D_1328 HORIZONTAL RBW:1000.000KHz VBW:3000.000KHz SWT:Auto Detector : Peak Project : 672014-10 Mode : 13</p>	 <p>Date: 2016.11.18 PEAK_74</p> <p>Site : 03CH12-HY Condition : PEAK_74 3m HORN_9120D_1328 HORIZONTAL RBW:1000.000KHz VBW:3000.000KHz SWT:Auto Detector : Peak Project : 672014-10 Mode : 13</p>
Avg.	 <p>Date: 2016.11.13 AVG_BE_54</p> <p>Site : 03CH12-HY Condition : AVG_BE_54 3m HORN_9120D_1328 HORIZONTAL RBW:1000.000KHz VBW:0.010KHz SWT:Auto Detector : Peak Project : 672014-10 Mode : 13</p>	 <p>Date: 2016.11.18 AVG_54</p> <p>Site : 03CH12-HY Condition : AVG_54 3m HORN_9120D_1328 HORIZONTAL RBW:1000.000KHz VBW:0.010KHz SWT:Auto Detector : Peak Project : 672014-10 Mode : 13</p>

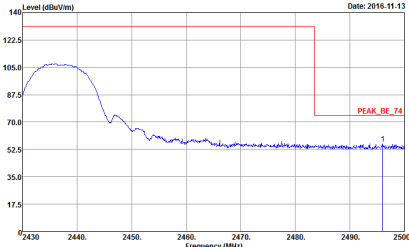
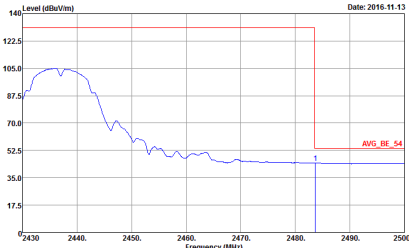

WIFI	2.4GHz 2400~2483.5MHz Band Edge @ 3m	
ANT	802.11b CH06 2437MHz - R	
1	Horizontal	Fundamental
Peak	 <p>Date: 2016.11.13</p> <p>Site : 03CH12-HY Condition : PEAK_BE_74 3m HORN_9120D_1378 HORIZONTAL : RBW:1000.000KHz VBW:3000.000KHz SWT:Auto Detector : Peak Project : 672014-10 Mode : 13</p>	Left blank
Avg.	 <p>Date: 2016.11.13</p> <p>Site : 03CH12-HY Condition : AVG_BE_54 3m HORN_9120D_1378 HORIZONTAL : RBW:1000.000KHz VBW:0.010KHz SWT:Auto Detector : Peak Project : 672014-10 Mode : 13</p>	Left blank

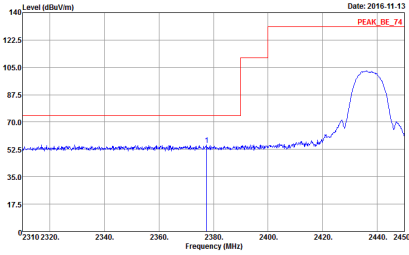
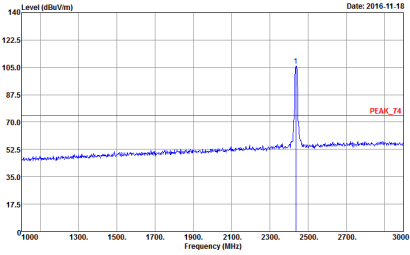
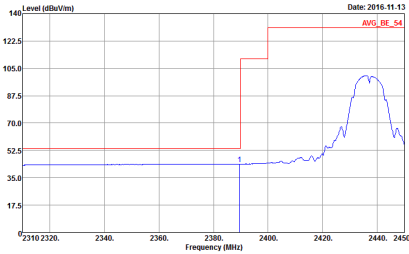
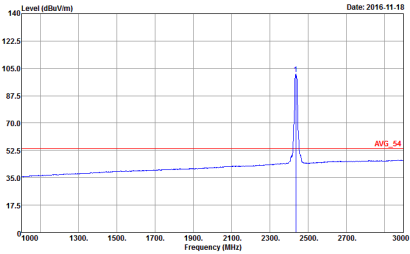

WIFI	2.4GHz 2400~2483.5MHz Band Edge @ 3m	
ANT	802.11b CH06 2437MHz - L	
1	Vertical	Fundamental
Peak	 <p>Date: 2016.11.13 PEAK_BE_74</p> <p>Site : 03CH12-HY Condition : PEAK_BE_74 3m HORN_9120D_1328 VERTICAL RBW:1000.000KHz VBW:3000.000KHz SWT:Auto Detector : Peak Project : 672014-10 Mode : 13</p>	 <p>Date: 2016.11.18 PEAK_74</p> <p>Site : 03CH12-HY Condition : PEAK_74 3m HORN_9120D_1328 VERTICAL RBW:1000.000KHz VBW:3000.000KHz SWT:Auto Detector : Peak Project : 672014-10 Mode : 13</p>
Avg.	 <p>Date: 2016.11.13 AVG_BE_54</p> <p>Site : 03CH12-HY Condition : AVG_BE_54 3m HORN_9120D_1328 VERTICAL RBW:1000.000KHz VBW:0.010KHz SWT:Auto Detector : Peak Project : 672014-10 Mode : 13</p>	 <p>Date: 2016.11.18 AVG_54</p> <p>Site : 03CH12-HY Condition : AVG_54 3m HORN_9120D_1328 VERTICAL RBW:1000.000KHz VBW:0.010KHz SWT:Auto Detector : Peak Project : 672014-10 Mode : 13</p>

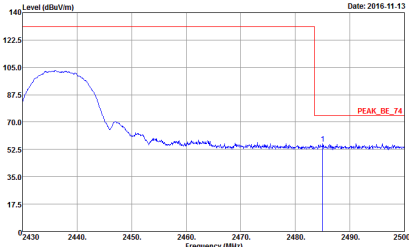
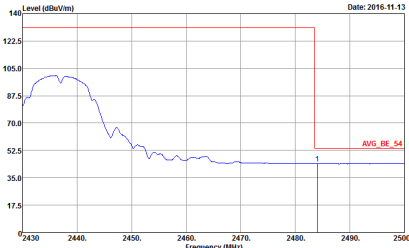

WIFI	2.4GHz 2400~2483.5MHz Band Edge @ 3m	
ANT	802.11b CH06 2437MHz - R	
1	Vertical	Fundamental
Peak	 <p>Date: 2016.11.13</p> <p>Site : 03CH12-HY Condition : PEAK_BE_74 3m HORN_9120D_1378 VERTICAL : RBW:1000.000KHz VBW:3000.000KHz SWT:Auto Detector : Peak Project : 672014-10 Mode : 13</p>	Left blank
Avg.	 <p>Date: 2016.11.13</p> <p>Site : 03CH12-HY Condition : AVG_BE_54 3m HORN_9120D_1378 VERTICAL : RBW:1000.000KHz VBW:0.010KHz SWT:Auto Detector : Peak Project : 672014-10 Mode : 13</p>	Left blank

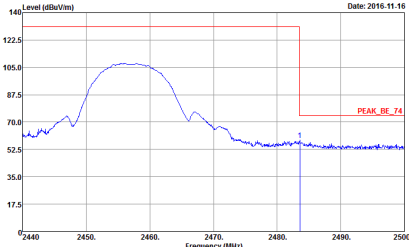
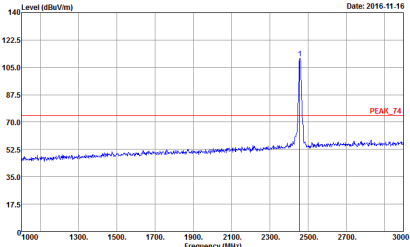
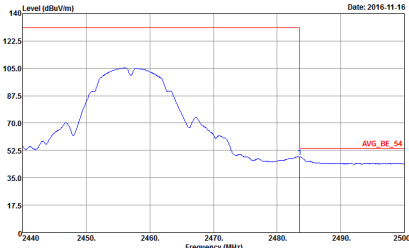
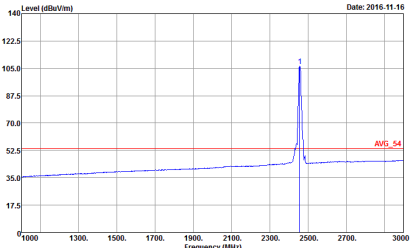

WIFI	2.4GHz 2400~2483.5MHz Band Edge @ 3m	
ANT	802.11b CH10 2457MHz	
1	Horizontal	Fundamental
Peak	 <p>Date: 2016.11.16</p> <p>Level (dBuV/m)</p> <p>Frequency (MHz)</p> <p>Site : 03CH12-HY Condition : PEAK_BE_74 3m HORN_9120D_1328 HORIZONTAL RBW:1000.000KHz VBW:3000.000KHz SWT:Auto Detector : Peak Project : 672014-10 Mode : 14</p>	 <p>Date: 2016.11.16</p> <p>Level (dBuV/m)</p> <p>Frequency (MHz)</p> <p>Site : 03CH12-HY Condition : PEAK_74 3m HORN_9120D_1328 HORIZONTAL RBW:1000.000KHz VBW:3000.000KHz SWT:Auto Detector : Peak Project : 672014-10 Mode : 14</p>
Avg.	 <p>Date: 2016.11.16</p> <p>Level (dBuV/m)</p> <p>Frequency (MHz)</p> <p>Site : 03CH12-HY Condition : AVG_BE_54 3m HORN_9120D_1328 HORIZONTAL RBW:1000.000KHz VBW:0.010KHz SWT:Auto Detector : Peak Project : 672014-10 Mode : 14</p>	 <p>Date: 2016.11.16</p> <p>Level (dBuV/m)</p> <p>Frequency (MHz)</p> <p>Site : 03CH12-HY Condition : AVG_54 3m HORN_9120D_1328 HORIZONTAL RBW:1000.000KHz VBW:0.010KHz SWT:Auto Detector : Peak Project : 672014-10 Mode : 14</p>

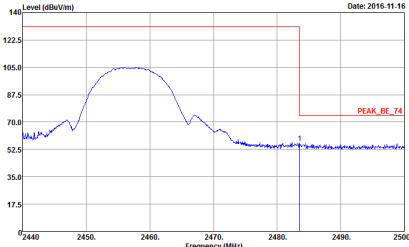
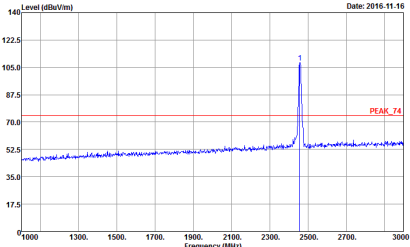
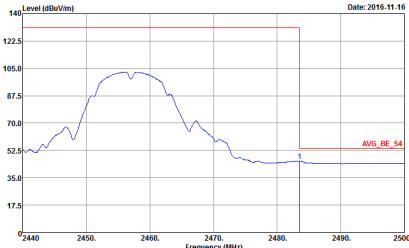
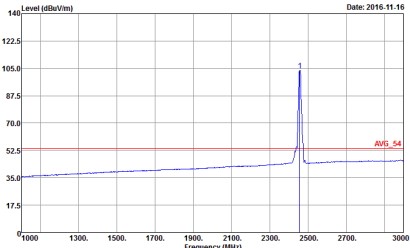

WIFI	2.4GHz 2400~2483.5MHz Band Edge @ 3m	
ANT	802.11b CH10 2457MHz	
1	Vertical	Fundamental
Peak	 <p>Level (dBuV/m) vs Frequency (MHz) plot showing a peak at approximately 2457 MHz. The y-axis ranges from 0 to 140 dBuV/m, and the x-axis ranges from 2440 to 2500 MHz. A red horizontal line indicates the peak level at approximately 105 dBuV/m, labeled 'PEAK_BE_74'.</p> <p>Site : 03CH12-HY Condition : PEAK_BE_74 3m HORN_9120D_1328 VERTICAL : RBW:1000.000KHz VBW:3000.000KHz SWT:Auto Detector : Peak Project : 672014-10 Mode : 14</p>	 <p>Level (dBuV/m) vs Frequency (MHz) plot showing a sharp peak at approximately 2457 MHz. The y-axis ranges from 0 to 140 dBuV/m, and the x-axis ranges from 1000 to 3000 MHz. A red horizontal line indicates the peak level at approximately 105 dBuV/m, labeled 'PEAK_74'.</p> <p>Site : 03CH12-HY Condition : PEAK_74 3m HORN_9120D_1328 VERTICAL : RBW:1000.000KHz VBW:3000.000KHz SWT:Auto Detector : Peak Project : 672014-10 Mode : 14</p>
Avg.	 <p>Level (dBuV/m) vs Frequency (MHz) plot showing the average spectrum. The y-axis ranges from 0 to 140 dBuV/m, and the x-axis ranges from 2440 to 2500 MHz. A red horizontal line indicates the average level at approximately 55 dBuV/m, labeled 'AVG_BE_54'.</p> <p>Site : 03CH12-HY Condition : AVG_BE_54 3m HORN_9120D_1328 VERTICAL : RBW:1000.000KHz VBW:0.010KHz SWT:Auto Detector : Peak Project : 672014-10 Mode : 14</p>	 <p>Level (dBuV/m) vs Frequency (MHz) plot showing the average spectrum. The y-axis ranges from 0 to 140 dBuV/m, and the x-axis ranges from 1000 to 3000 MHz. A red horizontal line indicates the average level at approximately 55 dBuV/m, labeled 'AVG_54'.</p> <p>Site : 03CH12-HY Condition : AVG_54 3m HORN_9120D_1328 VERTICAL : RBW:1000.000KHz VBW:0.010KHz SWT:Auto Detector : Peak Project : 672014-10 Mode : 14</p>

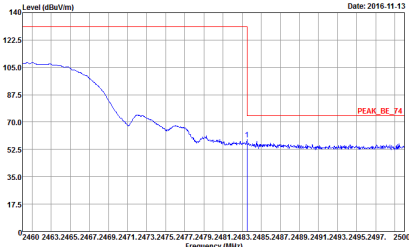
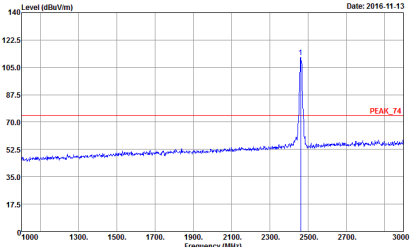
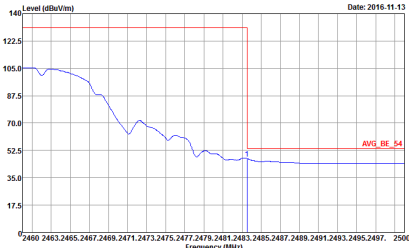
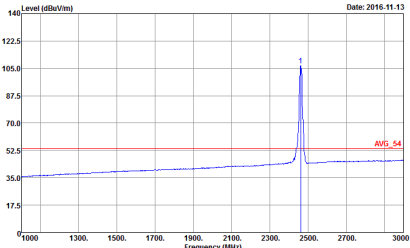

WIFI	2.4GHz 2400~2483.5MHz Band Edge @ 3m	
ANT	802.11b CH11 2462MHz	
1	Horizontal	Fundamental
Peak	 <p>Date: 2016.11.13</p> <p>Site : 03CH12-HY Condition : PEAK_BE_74 3m HORN_9120D_1328 HORIZONTAL RBW:1000.000KHz VBW:3000.000KHz SWT:Auto Detector : Peak Project : 672014-10 Mode : 15</p>	 <p>Date: 2016.11.13</p> <p>Site : 03CH12-HY Condition : PEAK_74 3m HORN_9120D_1328 HORIZONTAL RBW:1000.000KHz VBW:3000.000KHz SWT:Auto Detector : Peak Project : 672014-10 Mode : 15</p>
Avg.	 <p>Date: 2016.11.13</p> <p>Site : 03CH12-HY Condition : AVG_BE_54 3m HORN_9120D_1328 HORIZONTAL RBW:1000.000KHz VBW:0.010KHz SWT:Auto Detector : Peak Project : 672014-10 Mode : 15</p>	 <p>Date: 2016.11.13</p> <p>Site : 03CH12-HY Condition : AVG_54 3m HORN_9120D_1328 HORIZONTAL RBW:1000.000KHz VBW:0.010KHz SWT:Auto Detector : Peak Project : 672014-10 Mode : 15</p>

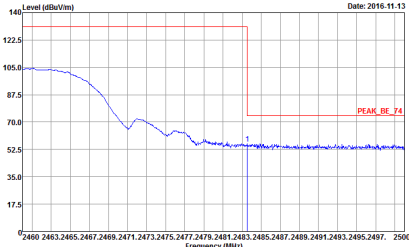
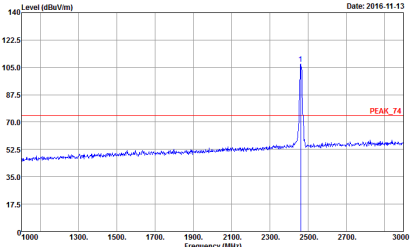
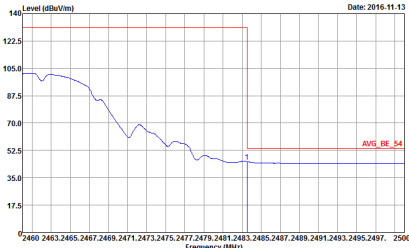
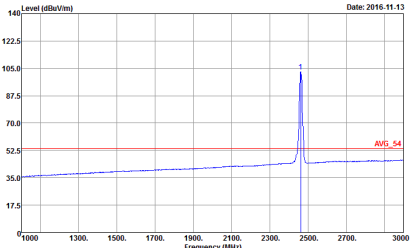

WIFI	2.4GHz 2400~2483.5MHz Band Edge @ 3m	
ANT	802.11b CH11 2462MHz	
1	Vertical	Fundamental
Peak	 <p>Date: 2016.11.13</p> <p>Level (dBuV/m)</p> <p>Frequency (MHz)</p> <p>PEAK_BE_74</p> <p>Site : 03CH12-HY Condition : PEAK_BE_74 3m HORN_9120D_1328 VERTICAL RBW:1000.000KHz VBW:3000.000KHz SWT:Auto Detector : Peak Project : 672014-10 Mode : 15</p>	 <p>Date: 2016.11.13</p> <p>Level (dBuV/m)</p> <p>Frequency (MHz)</p> <p>PEAK_74</p> <p>Site : 03CH12-HY Condition : PEAK_74 3m HORN_9120D_1328 VERTICAL RBW:1000.000KHz VBW:3000.000KHz SWT:Auto Detector : Peak Project : 672014-10 Mode : 15</p>
Avg.	 <p>Date: 2016.11.13</p> <p>Level (dBuV/m)</p> <p>Frequency (MHz)</p> <p>AVG_BE_54</p> <p>Site : 03CH12-HY Condition : AVG_BE_54 3m HORN_9120D_1328 VERTICAL RBW:1000.000KHz VBW:0.010KHz SWT:Auto Detector : Peak Project : 672014-10 Mode : 15</p>	 <p>Date: 2016.11.13</p> <p>Level (dBuV/m)</p> <p>Frequency (MHz)</p> <p>AVG_54</p> <p>Site : 03CH12-HY Condition : AVG_54 3m HORN_9120D_1328 VERTICAL RBW:1000.000KHz VBW:0.010KHz SWT:Auto Detector : Peak Project : 672014-10 Mode : 15</p>

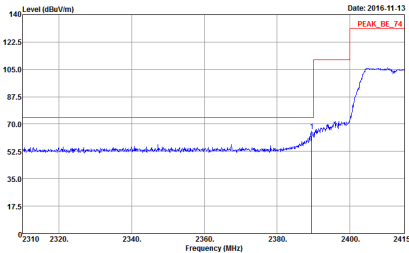
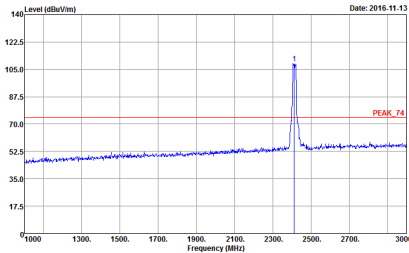
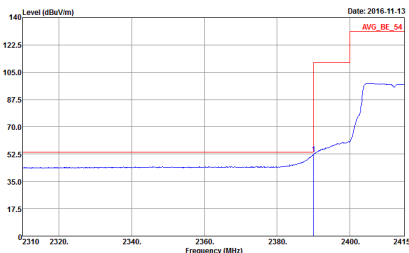
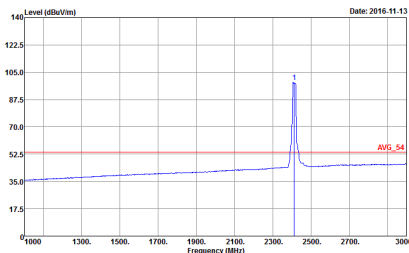

2.4GHz 2400~2483.5MHz
WIFI 802.11g (Band Edge @ 3m)

WIFI	2.4GHz 2400~2483.5MHz Band Edge @ 3m	
ANT	802.11g CH01 2412MHz	
1	Horizontal	Fundamental
Peak	 <p>Site Condition : 03CH12-HY : PEAK_BE_74 3m HORN_9120D_1328 HORIZONTAL : RBW:1000.000KHz VBW:3000.000KHz SWT:Auto Detector : Peak Project : 672014-10 Mode : 16 Setting : 67</p>	 <p>Site Condition : 03CH12-HY : PEAK_74 3m HORN_9120D_1328 HORIZONTAL : RBW:1000.000KHz VBW:3000.000KHz SWT:Auto Detector : Peak Project : 672014-10 Mode : 16 Setting : 67</p>
Avg.	 <p>Site Condition : 03CH12-HY : AVG_BE_54 3m HORN_9120D_1328 HORIZONTAL : RBW:1000.000KHz VBW:1.000KHz SWT:Auto Detector : Peak Project : 672014-10 Mode : 16 Setting : 67</p>	 <p>Site Condition : 03CH12-HY : AVG_54 3m HORN_9120D_1328 HORIZONTAL : RBW:1000.000KHz VBW:1.000KHz SWT:Auto Detector : Peak Project : 672014-10 Mode : 16 Setting : 67</p>

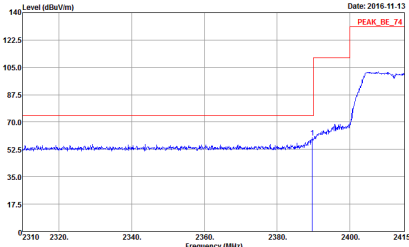
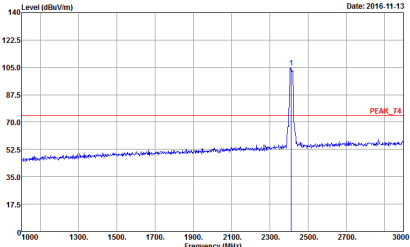
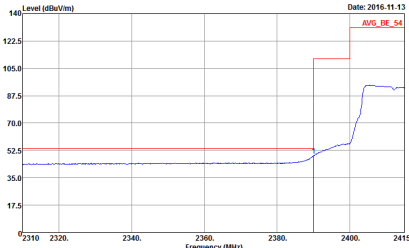
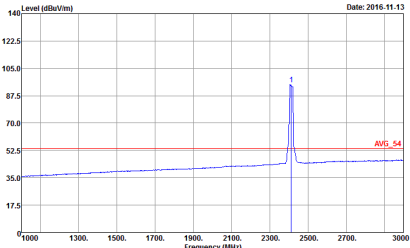

WIFI	2.4GHz 2400~2483.5MHz Band Edge @ 3m	
ANT	802.11g CH01 2412MHz	
1	Vertical	Fundamental
Peak	 <p>Date: 2016-11-13 PEAK_BE_74</p> <p>Site : 03CH12-HY Condition : PEAK_BE_74 3m HORN_9120D_1328 VERTICAL RBW:1000.000KHz VBW:3000.000KHz SWT:Auto Detector : Peak Project : 672014-10 Mode : 16 Setting : 67</p>	 <p>Date: 2016-11-13 PEAK_74</p> <p>Site : 03CH12-HY Condition : PEAK_74 3m HORN_9120D_1328 VERTICAL RBW:1000.000KHz VBW:3000.000KHz SWT:Auto Detector : Peak Project : 672014-10 Mode : 16 Setting : 67</p>
Avg.	 <p>Date: 2016-11-13 AVG_BE_54</p> <p>Site : 03CH12-HY Condition : AVG_BE_54 3m HORN_9120D_1328 VERTICAL RBW:1000.000KHz VBW:1.000KHz SWT:Auto Detector : Peak Project : 672014-10 Mode : 16 Setting : 67</p>	 <p>Date: 2016-11-13 AVG_54</p> <p>Site : 03CH12-HY Condition : AVG_54 3m HORN_9120D_1328 VERTICAL RBW:1000.000KHz VBW:1.000KHz SWT:Auto Detector : Peak Project : 672014-10 Mode : 16 Setting : 67</p>

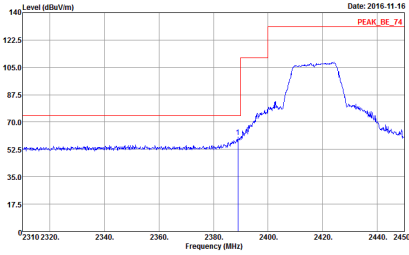
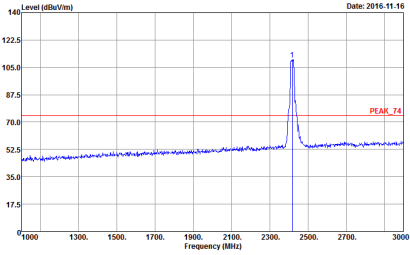
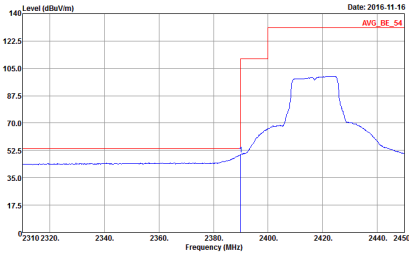
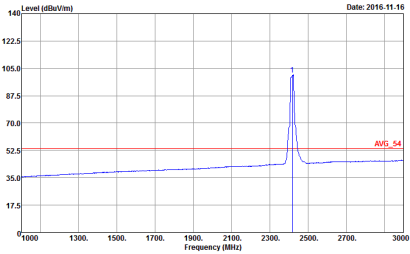

WIFI	2.4GHz 2400~2483.5MHz Band Edge @ 3m	
ANT	802.11g CH02 2417MHz	
1	Horizontal	Fundamental
Peak	 <p>Date: 2016.11.16 PEAK_BE_74</p> <p>Site : 03CH12-HY Condition : PEAK_BE_74 3m HORN_9120D_1328 HORIZONTAL RBW:1000.000KHz VBW:3000.000KHz SWT:Auto Detector : Peak Project : 672014-10 Mode : 17</p>	 <p>Date: 2016.11.16 PEAK_74</p> <p>Site : 03CH12-HY Condition : PEAK_74 3m HORN_9120D_1328 HORIZONTAL RBW:1000.000KHz VBW:3000.000KHz SWT:Auto Detector : Peak Project : 672014-10 Mode : 17</p>
Avg.	 <p>Date: 2016.11.16 AVG_BE_54</p> <p>Site : 03CH12-HY Condition : AVG_BE_54 3m HORN_9120D_1328 HORIZONTAL RBW:1000.000KHz VBW:1.000KHz SWT:Auto Detector : Peak Project : 672014-10 Mode : 17</p>	 <p>Date: 2016.11.16 AVG_54</p> <p>Site : 03CH12-HY Condition : AVG_54 3m HORN_9120D_1328 HORIZONTAL RBW:1000.000KHz VBW:1.000KHz SWT:Auto Detector : Peak Project : 672014-10 Mode : 17</p>

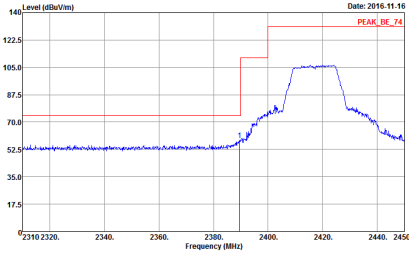
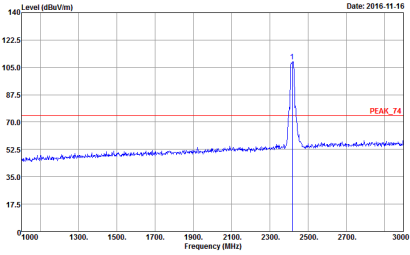
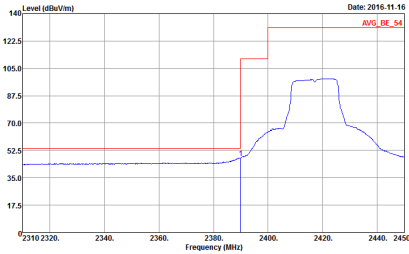
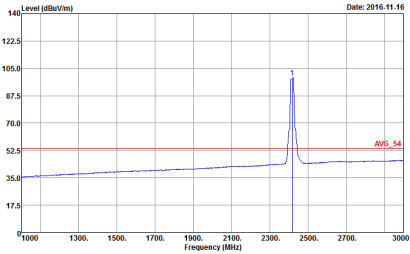

WIFI	2.4GHz 2400~2483.5MHz Band Edge @ 3m	
ANT	802.11g CH02 2417MHz	
1	Vertical	Fundamental
Peak	 <p>Date: 2016.11.16 PEAK_BE_74</p> <p>Site : 03CH12-HY Condition : PEAK_BE_74 3m HORN_9120D_1328 VERTICAL RBW:1000.000kHz VBW:3000.000kHz SWT:Auto Detector : Peak Project : 672014-10 Mode : 17</p>	 <p>Date: 2016.11.16 PEAK_74</p> <p>Site : 03CH12-HY Condition : PEAK_74 3m HORN_9120D_1328 VERTICAL RBW:1000.000kHz VBW:3000.000kHz SWT:Auto Detector : Peak Project : 672014-10 Mode : 17</p>
Avg.	 <p>Date: 2016.11.16 AVG_BE_54</p> <p>Site : 03CH12-HY Condition : AVG_BE_54 3m HORN_9120D_1328 VERTICAL RBW:1000.000kHz VBW:1.000kHz SWT:Auto Detector : Peak Project : 672014-10 Mode : 17</p>	 <p>Date: 2016.11.16 AVG_54</p> <p>Site : 03CH12-HY Condition : AVG_54 3m HORN_9120D_1328 VERTICAL RBW:1000.000kHz VBW:1.000kHz SWT:Auto Detector : Peak Project : 672014-10 Mode : 17</p>

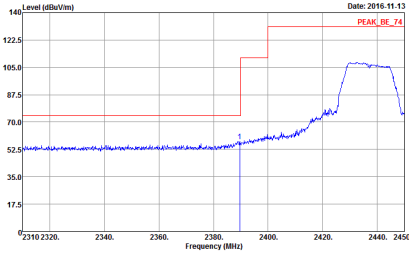
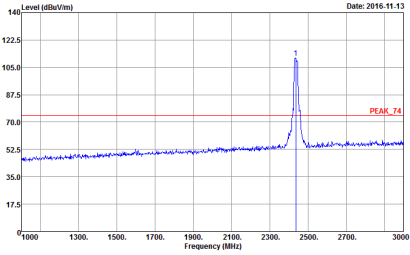
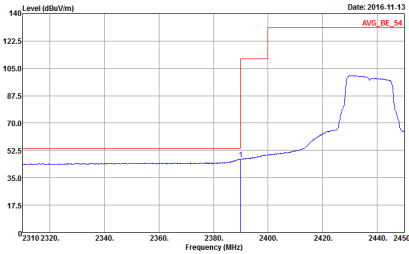
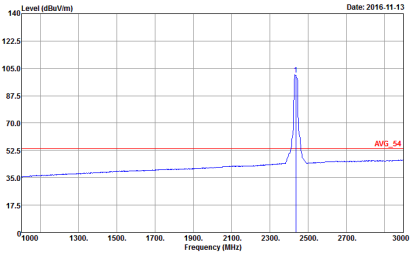

WIFI	2.4GHz 2400~2483.5MHz Band Edge @ 3m	
ANT	802.11g CH06 2437MHz - L	
1	Horizontal	Fundamental
Peak	 <p>Date: 2016.11.13 PEAK_BE_74</p> <p>Site : 03CH12-HY Condition : PEAK_BE_74 3m HORN_9120D_1328 HORIZONTAL RBW:1000.000KHz VBW:3000.000KHz SWT:Auto Detector : Peak Project : 672014-10 Mode : 18</p>	 <p>Date: 2016.11.13 PEAK_74</p> <p>Site : 03CH12-HY Condition : PEAK_74 3m HORN_9120D_1328 HORIZONTAL RBW:1000.000KHz VBW:3000.000KHz SWT:Auto Detector : Peak Project : 672014-10 Mode : 18</p>
Avg.	 <p>Date: 2016.11.13 AVG_BE_54</p> <p>Site : 03CH12-HY Condition : AVG_BE_54 3m HORN_9120D_1328 HORIZONTAL RBW:1000.000KHz VBW:1.000KHz SWT:Auto Detector : Peak Project : 672014-10 Mode : 18</p>	 <p>Date: 2016.11.13 AVG_54</p> <p>Site : 03CH12-HY Condition : AVG_54 3m HORN_9120D_1328 HORIZONTAL RBW:1000.000KHz VBW:1.000KHz SWT:Auto Detector : Peak Project : 672014-10 Mode : 18</p>

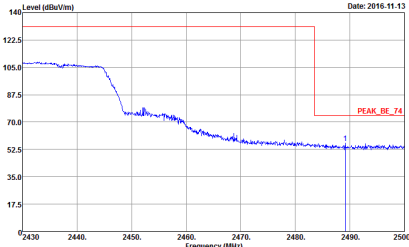
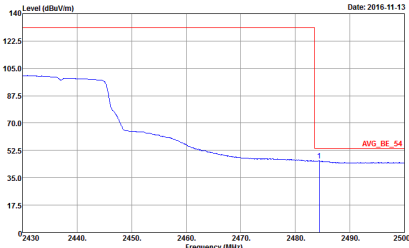

WIFI	2.4GHz 2400~2483.5MHz Band Edge @ 3m	
ANT	802.11g CH06 2437MHz - R	
1	Horizontal	Fundamental
Peak	 <p>Date: 2016.11.13</p> <p>Site : 03CH12-HY Condition : PEAK_BE_74 3m HORN_9120D_1378 HORIZONTAL : RBW:1000.000KHz VBW:3000.000KHz SWT:Auto Detector : Peak Project : 672014-10 Mode : 18</p>	Left blank
Avg.	 <p>Date: 2016.11.13</p> <p>Site : 03CH12-HY Condition : AVG_BE_54 3m HORN_9120D_1378 HORIZONTAL : RBW:1000.000KHz VBW:1.000KHz SWT:Auto Detector : Peak Project : 672014-10 Mode : 18</p>	Left blank

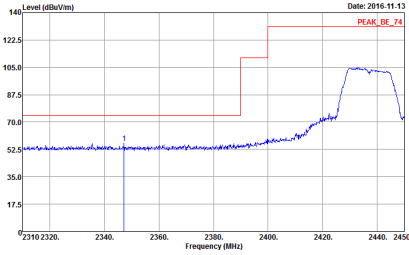
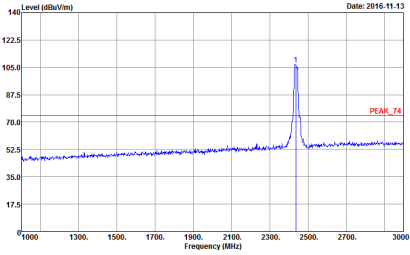
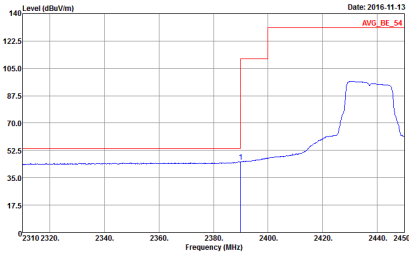
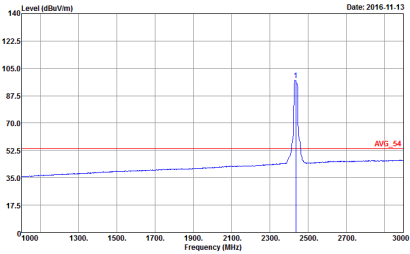

WIFI	2.4GHz 2400~2483.5MHz Band Edge @ 3m	
ANT	802.11g CH06 2437MHz - L	
1	Vertical	Fundamental
Peak	 <p>Date: 2016.11.13 PEAK_BE_74</p> <p>Site : 03CH12-HY Condition : PEAK_BE_74 3m HORN_9120D_1328 VERTICAL RBW:1000.000KHz VBW:3000.000KHz SWT:Auto Detector : Peak Project : 672014-10 Mode : 18</p>	 <p>Date: 2016.11.13 PEAK_74</p> <p>Site : 03CH12-HY Condition : PEAK_74 3m HORN_9120D_1328 VERTICAL RBW:1000.000KHz VBW:3000.000KHz SWT:Auto Detector : Peak Project : 672014-10 Mode : 18</p>
Avg.	 <p>Date: 2016.11.13 AVG_BE_54</p> <p>Site : 03CH12-HY Condition : AVG_BE_54 3m HORN_9120D_1328 VERTICAL RBW:1000.000KHz VBW:1.000KHz SWT:Auto Detector : Peak Project : 672014-10 Mode : 18</p>	 <p>Date: 2016.11.13 AVG_54</p> <p>Site : 03CH12-HY Condition : AVG_54 3m HORN_9120D_1328 VERTICAL RBW:1000.000KHz VBW:1.000KHz SWT:Auto Detector : Peak Project : 672014-10 Mode : 18</p>

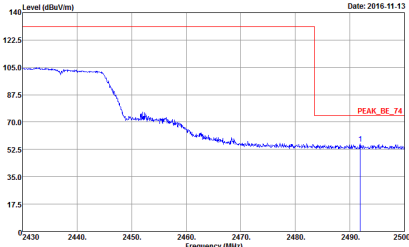
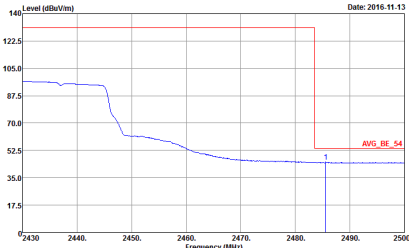

WIFI	2.4GHz 2400~2483.5MHz Band Edge @ 3m	
ANT	802.11g CH06 2437MHz - R	
1	Vertical	Fundamental
<p>Peak</p>	 <p>Date: 2016.11.13</p> <p>Site : 03CH12-HY Condition : PEAK_BE_74 3m HORN_9120D_1328 VERTICAL : RBW:1000.000KHz VBW:3000.000KHz SWT:Auto Detector : Peak Project : 672014-10 Mode : 18</p>	<p>Left Blank</p>
<p>Avg.</p>	 <p>Date: 2016.11.13</p> <p>Site : 03CH12-HY Condition : AVG_BE_54 3m HORN_9120D_1328 VERTICAL : RBW:1000.000KHz VBW:1.000KHz SWT:Auto Detector : Peak Project : 672014-10 Mode : 18</p>	<p>Left Blank</p>

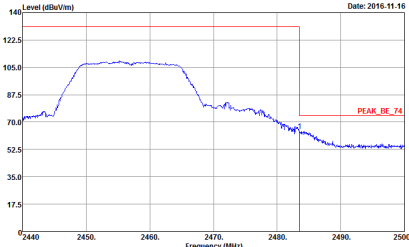
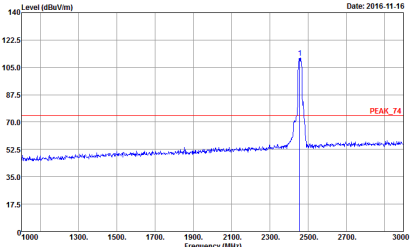
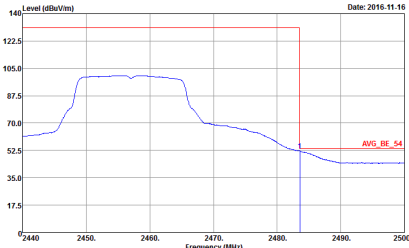
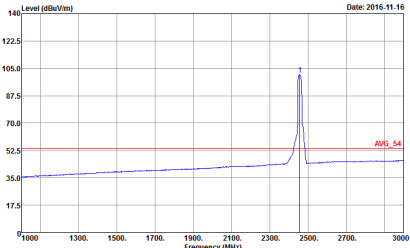

WIFI	2.4GHz 2400~2483.5MHz Band Edge @ 3m	
ANT	802.11g CH10 2457MHz	
1	Horizontal	Fundamental
Peak	 <p>Date: 2016.11.16</p> <p>Site : 03CH12-HY Condition : PEAK_BE_74 3m HORN_9120D_1328 HORIZONTAL : RBW:1000.000KHz VBW:3000.000KHz SWT:Auto Detector : Peak Project : 672014-10 Mode : 19</p>	 <p>Date: 2016.11.16</p> <p>Site : 03CH12-HY Condition : PEAK_74 3m HORN_9120D_1328 HORIZONTAL : RBW:1000.000KHz VBW:3000.000KHz SWT:Auto Detector : Peak Project : 672014-10 Mode : 19</p>
Avg.	 <p>Date: 2016.11.16</p> <p>Site : 03CH12-HY Condition : AVG_BE_54 3m HORN_9120D_1328 HORIZONTAL : RBW:1000.000KHz VBW:1.000KHz SWT:Auto Detector : Peak Project : 672014-10 Mode : 19</p>	 <p>Date: 2016.11.16</p> <p>Site : 03CH12-HY Condition : AVG_54 3m HORN_9120D_1328 HORIZONTAL : RBW:1000.000KHz VBW:1.000KHz SWT:Auto Detector : Peak Project : 672014-10 Mode : 19</p>

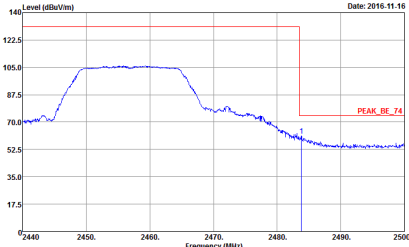
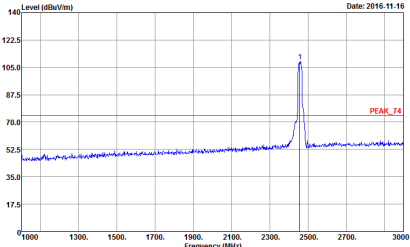
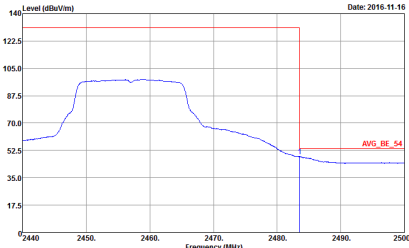
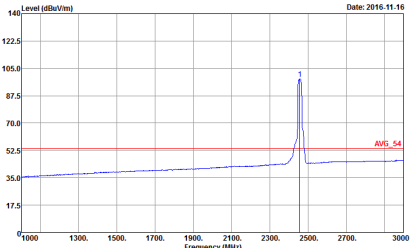

WIFI	2.4GHz 2400~2483.5MHz Band Edge @ 3m	
ANT	802.11g CH10 2457MHz	
1	Vertical	Fundamental
Peak	 <p>Date: 2016.11.16</p> <p>Site : 03CH12-HY Condition : PEAK_BE_74 3m HORN_9120D_1328 VERTICAL : RBW:1000.000KHz VBW:3000.000KHz SWT:Auto Detector : Peak Project : 672014-10 Mode : 19</p>	 <p>Date: 2016.11.16</p> <p>Site : 03CH12-HY Condition : PEAK_74 3m HORN_9120D_1328 VERTICAL : RBW:1000.000KHz VBW:3000.000KHz SWT:Auto Detector : Peak Project : 672014-10 Mode : 19</p>
Avg.	 <p>Date: 2016.11.16</p> <p>Site : 03CH12-HY Condition : AVG_BE_54 3m HORN_9120D_1328 VERTICAL : RBW:1000.000KHz VBW:1.000KHz SWT:Auto Detector : Peak Project : 672014-10 Mode : 19</p>	 <p>Date: 2016.11.16</p> <p>Site : 03CH12-HY Condition : AVG_54 3m HORN_9120D_1328 VERTICAL : RBW:1000.000KHz VBW:1.000KHz SWT:Auto Detector : Peak Project : 672014-10 Mode : 19</p>

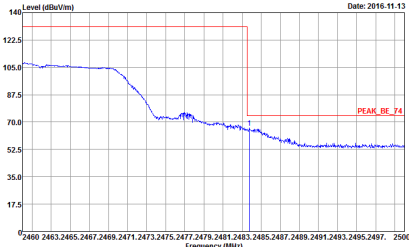
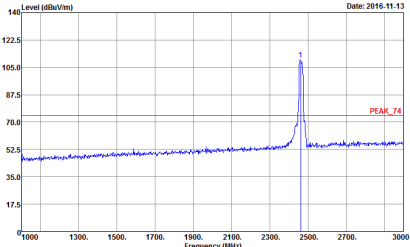
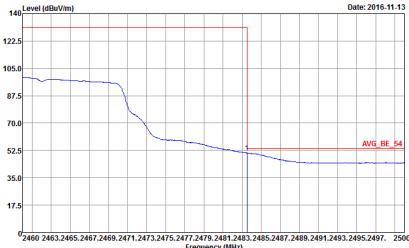
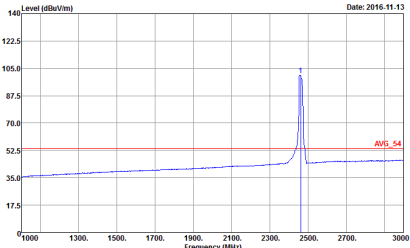

WIFI	2.4GHz 2400~2483.5MHz Band Edge @ 3m	
ANT	802.11g CH11 2462MHz	
1	Horizontal	Fundamental
Peak	 <p>Date: 2016-11-13</p> <p>Site : 03CH12-HY Condition : PEAK_BE_74 3m HORN_9120D_1328 HORIZONTAL : RBW:1000.000KHz VBW:3000.000KHz SWT:Auto Detector : Peak Project : 672014-10 Mode : 20 Setting : 71</p>	 <p>Date: 2016-11-13</p> <p>Site : 03CH12-HY Condition : PEAK_74 3m HORN_9120D_1328 HORIZONTAL : RBW:1000.000KHz VBW:3000.000KHz SWT:Auto Detector : Peak Project : 672014-10 Mode : 20 Setting : 71</p>
Avg.	 <p>Date: 2016-11-13</p> <p>Site : 03CH12-HY Condition : AVG_BE_54 3m HORN_9120D_1328 HORIZONTAL : RBW:1000.000KHz VBW:1.000KHz SWT:Auto Detector : Peak Project : 672014-10 Mode : 20 Setting : 71</p>	 <p>Date: 2016-11-13</p> <p>Site : 03CH12-HY Condition : AVG_54 3m HORN_9120D_1328 HORIZONTAL : RBW:1000.000KHz VBW:1.000KHz SWT:Auto Detector : Peak Project : 672014-10 Mode : 20 Setting : 71</p>

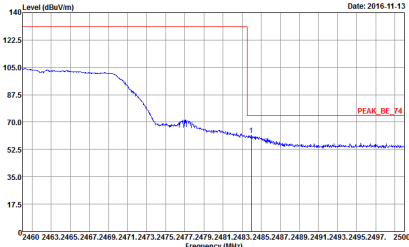
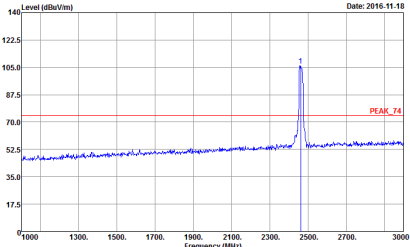
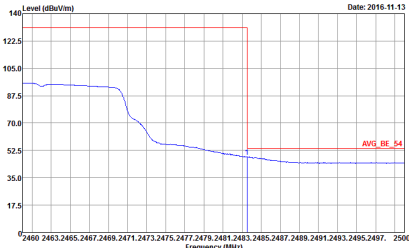
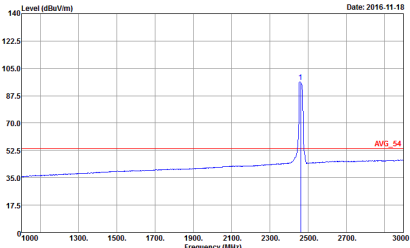

WIFI	2.4GHz 2400~2483.5MHz Band Edge @ 3m	
ANT	802.11g CH11 2462MHz	
1	Vertical	Fundamental
Peak	 <p>Date: 2016-11-13</p> <p>Site : 03CH12-HY Condition : PEAK_BE_74 3m HORN_9120D_1328 VERTICAL : RBW:1000.000KHz VBW:3000.000KHz SWT:Auto Detector : Peak Project : 672014-10 Mode : 20 Setting : 71</p>	 <p>Date: 2016-11-18</p> <p>Site : 03CH12-HY Condition : PEAK_74 3m HORN_9120D_1328 VERTICAL : RBW:1000.000KHz VBW:3000.000KHz SWT:Auto Detector : Peak Project : 672014-10 Mode : 20 Setting : 71</p>
Avg.	 <p>Date: 2016-11-13</p> <p>Site : 03CH12-HY Condition : AVG_BE_54 3m HORN_9120D_1328 VERTICAL : RBW:1000.000KHz VBW:1.000KHz SWT:Auto Detector : Peak Project : 672014-10 Mode : 20 Setting : 71</p>	 <p>Date: 2016-11-18</p> <p>Site : 03CH12-HY Condition : AVG_54 3m HORN_9120D_1328 VERTICAL : RBW:1000.000KHz VBW:1.000KHz SWT:Auto Detector : Peak Project : 672014-10 Mode : 20 Setting : 71</p>



2.4GHz 2400~2483.5MHz

WIFI 802.11ac VHT20 (Band Edge @ 3m)

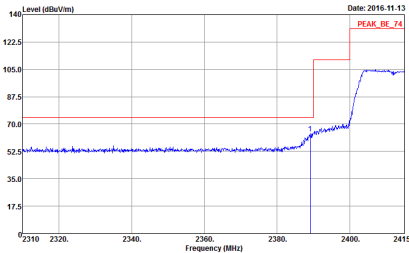
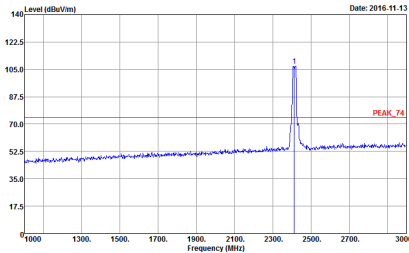
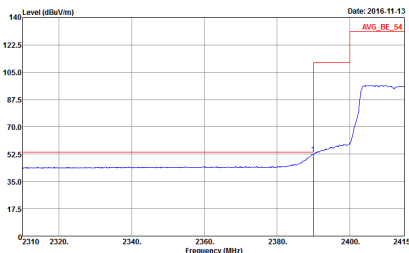
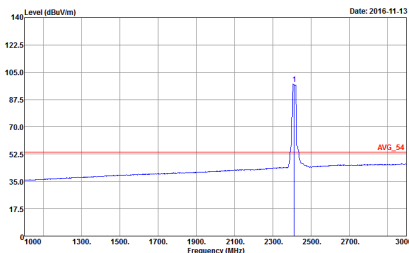
WIFI	2.4GHz 2400~2483.5MHz Band Edge @ 3m	
ANT	802.11ac VHT20 CH01 2412MHz	
1	Horizontal	Fundamental
Peak	 <p>Site Condition : 03CH12-HY : PEAK_BE_74 3m HORN_9120D_1328 HORIZONTAL : RBW:1000.000KHz VBW:3000.000KHz SWT:Auto Detector : Peak Project : 672014-10 Mode : 21 Setting : 66</p>	 <p>Site Condition : 03CH12-HY : PEAK_74 3m HORN_9120D_1328 HORIZONTAL : RBW:1000.000KHz VBW:3000.000KHz SWT:Auto Detector : Peak Project : 672014-10 Mode : 21 Setting : 66</p>
Avg.	 <p>Site Condition : 03CH12-HY : AVG_BE_54 3m HORN_9120D_1328 HORIZONTAL : RBW:1000.000KHz VBW:1.000KHz SWT:Auto Detector : Peak Project : 672014-10 Mode : 21 Setting : 66</p>	 <p>Site Condition : 03CH12-HY : AVG_54 3m HORN_9120D_1328 HORIZONTAL : RBW:1000.000KHz VBW:1.000KHz SWT:Auto Detector : Peak Project : 672014-10 Mode : 21 Setting : 66</p>

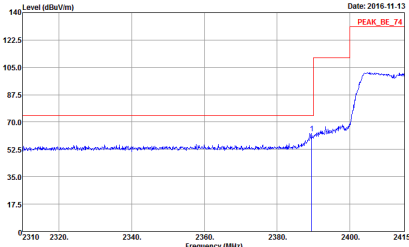
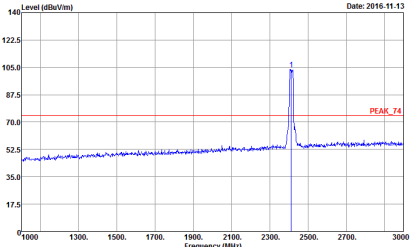
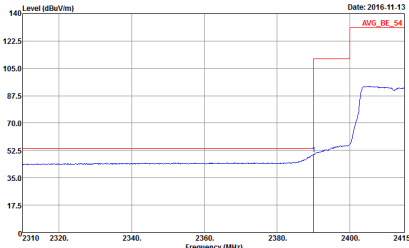
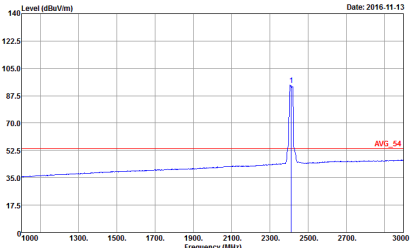

WIFI	2.4GHz 2400~2483.5MHz Band Edge @ 3m	
ANT	802.11ac VHT20 CH01 2412MHz	
1	Vertical	Fundamental
Peak	 <p>Date: 2016-11-13 PEAK_BE_74</p> <p>Site : 03CH12-HY Condition : PEAK_BE_74 3m HORN_9120D_1328 VERTICAL RBW:1000.000KHz VBW:3000.000KHz SWT:Auto Detector : Peak Project : 672014-10 Mode : 21 Setting : 66</p>	 <p>Date: 2016-11-13 PEAK_74</p> <p>Site : 03CH12-HY Condition : PEAK_74 3m HORN_9120D_1328 VERTICAL RBW:1000.000KHz VBW:3000.000KHz SWT:Auto Detector : Peak Project : 672014-10 Mode : 21 Setting : 66</p>
Avg.	 <p>Date: 2016-11-13 AVG_BE_54</p> <p>Site : 03CH12-HY Condition : AVG_BE_54 3m HORN_9120D_1328 VERTICAL RBW:1000.000KHz VBW:1.000KHz SWT:Auto Detector : Peak Project : 672014-10 Mode : 21 Setting : 66</p>	 <p>Date: 2016-11-13 AVG_54</p> <p>Site : 03CH12-HY Condition : AVG_54 3m HORN_9120D_1328 VERTICAL RBW:1000.000KHz VBW:1.000KHz SWT:Auto Detector : Peak Project : 672014-10 Mode : 21 Setting : 66</p>

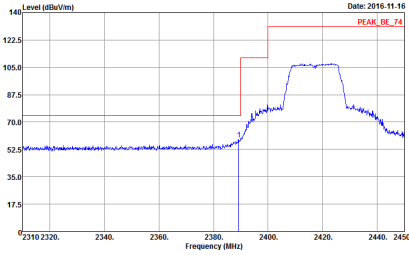
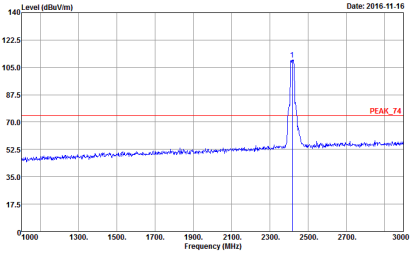
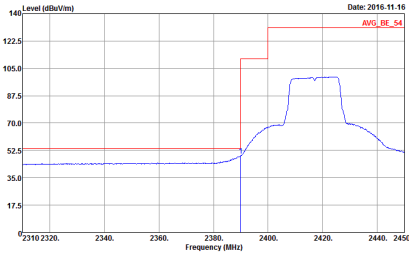
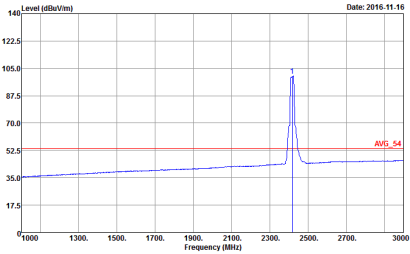

WIFI	2.4GHz 2400~2483.5MHz Band Edge @ 3m	
ANT	802.11ac VHT20 CH02 2417MHz	
1	Horizontal	Fundamental
Peak	 <p>Date: 2016.11.16 PEAK_BE_74</p> <p>Site : 03CH12-HY Condition : PEAK_BE_74 3m HORN_9120D_1328 HORIZONTAL RBW:1000.000KHz VBW:3000.000KHz SWT:Auto Detector : Peak Project : 672014-10 Mode : 22</p>	 <p>Date: 2016.11.16 PEAK_74</p> <p>Site : 03CH12-HY Condition : PEAK_74 3m HORN_9120D_1328 HORIZONTAL RBW:1000.000KHz VBW:3000.000KHz SWT:Auto Detector : Peak Project : 672014-10 Mode : 22</p>
Avg.	 <p>Date: 2016.11.16 AVG_BE_54</p> <p>Site : 03CH12-HY Condition : AVG_BE_54 3m HORN_9120D_1328 HORIZONTAL RBW:1000.000KHz VBW:1.000KHz SWT:Auto Detector : Peak Project : 672014-10 Mode : 22</p>	 <p>Date: 2016.11.16 AVG_54</p> <p>Site : 03CH12-HY Condition : AVG_54 3m HORN_9120D_1328 HORIZONTAL RBW:1000.000KHz VBW:1.000KHz SWT:Auto Detector : Peak Project : 672014-10 Mode : 22</p>

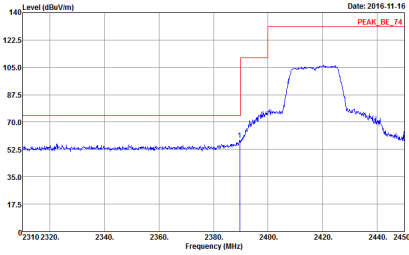
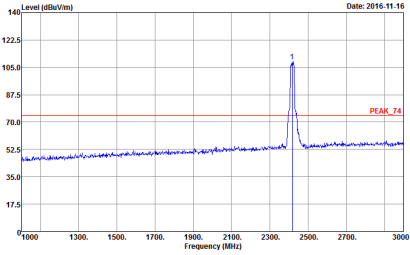
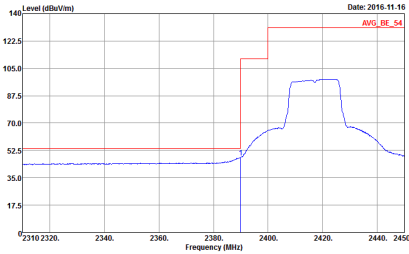
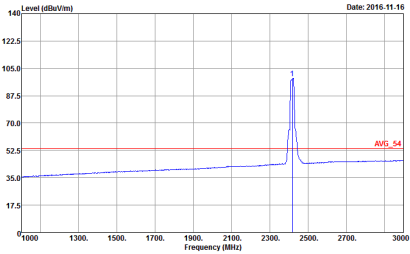

WIFI	2.4GHz 2400~2483.5MHz Band Edge @ 3m	
ANT	802.11ac VHT20 CH02 2417MHz	
1	Vertical	Fundamental
Peak	 <p>Date: 2016.11.16 PEAK_BE_74</p> <p>Site : 03CH12-HY Condition : PEAK_BE_74 3m HORN_9120D_1328 VERTICAL RBW:1000.000KHz VBW:3000.000KHz SWT:Auto Detector : Peak Project : 672014-10 Mode : 22</p>	 <p>Date: 2016.11.16 PEAK_74</p> <p>Site : 03CH12-HY Condition : PEAK_74 3m HORN_9120D_1328 VERTICAL RBW:1000.000KHz VBW:3000.000KHz SWT:Auto Detector : Peak Project : 672014-10 Mode : 22</p>
Avg.	 <p>Date: 2016.11.16 AVG_BE_54</p> <p>Site : 03CH12-HY Condition : AVG_BE_54 3m HORN_9120D_1328 VERTICAL RBW:1000.000KHz VBW:1.000KHz SWT:Auto Detector : Peak Project : 672014-10 Mode : 22</p>	 <p>Date: 2016.11.16 AVG_54</p> <p>Site : 03CH12-HY Condition : AVG_54 3m HORN_9120D_1328 VERTICAL RBW:1000.000KHz VBW:1.000KHz SWT:Auto Detector : Peak Project : 672014-10 Mode : 22</p>

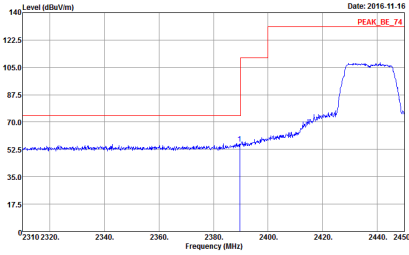
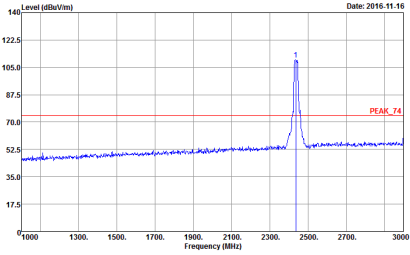
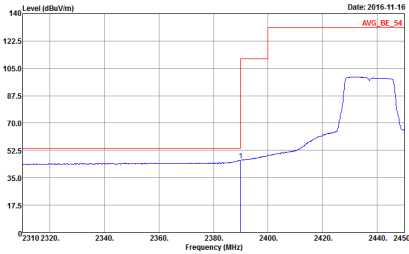
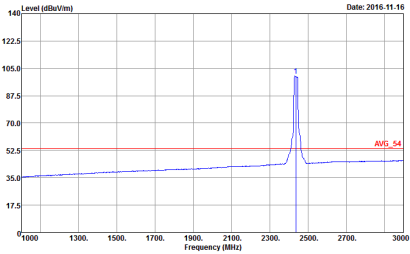

WIFI	2.4GHz 2400~2483.5MHz Band Edge @ 3m	
ANT	802.11ac VHT20 CH06 2437MHz - L	
1	Horizontal	Fundamental
Peak	 <p>Date: 2016.11.16 PEAK_BE_74</p> <p>Site : 03CH12-HY Condition : PEAK_BE_74 3m HORN_9120D_1328 HORIZONTAL RBW:1000.000KHz VBW:3000.000KHz SWT:Auto Detector : Peak Project : 672014-10 Mode : 23</p>	 <p>Date: 2016.11.16 PEAK_74</p> <p>Site : 03CH12-HY Condition : PEAK_74 3m HORN_9120D_1328 HORIZONTAL RBW:1000.000KHz VBW:3000.000KHz SWT:Auto Detector : Peak Project : 672014-10 Mode : 23</p>
Avg.	 <p>Date: 2016.11.16 AVG_BE_54</p> <p>Site : 03CH12-HY Condition : AVG_BE_54 3m HORN_9120D_1328 HORIZONTAL RBW:1000.000KHz VBW:1.000KHz SWT:Auto Detector : Peak Project : 672014-10 Mode : 23</p>	 <p>Date: 2016.11.16 AVG_54</p> <p>Site : 03CH12-HY Condition : AVG_54 3m HORN_9120D_1328 HORIZONTAL RBW:1000.000KHz VBW:1.000KHz SWT:Auto Detector : Peak Project : 672014-10 Mode : 23</p>

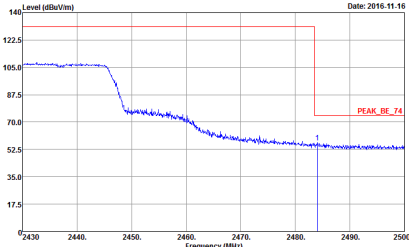
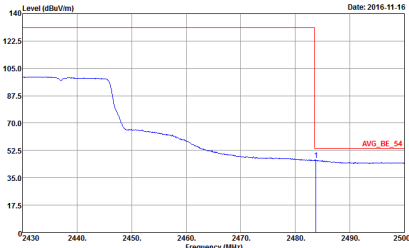

WIFI	2.4GHz 2400~2483.5MHz Band Edge @ 3m	
ANT	802.11ac VH20 CH06 2437MHz - R	
1	Horizontal	Fundamental
Peak	 <p> Date: 2016.11.16 Site : 03CH12-HY Condition : PEAK_BE_74 3m HORN_9120D_1378 HORIZONTAL : RBW:1000.000KHz VBW:3000.000KHz SWT:Auto Detector : Peak Project : 672014-10 Mode : 23 </p>	Left blank
Avg.	 <p> Date: 2016.11.16 Site : 03CH12-HY Condition : AVG_BE_54 3m HORN_9120D_1378 HORIZONTAL : RBW:1000.000KHz VBW:1.000KHz SWT:Auto Detector : Peak Project : 672014-10 Mode : 23 </p>	Left blank

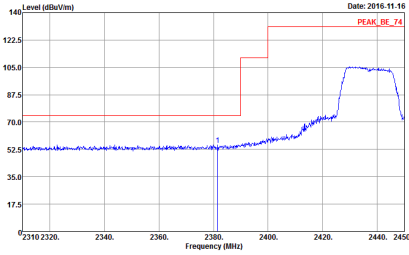
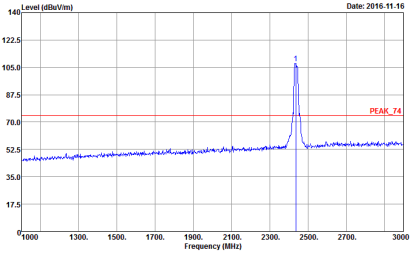
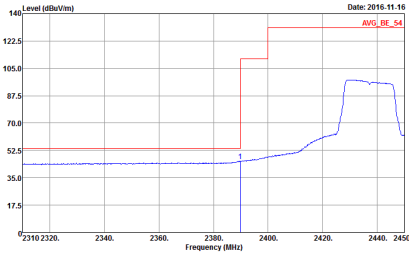
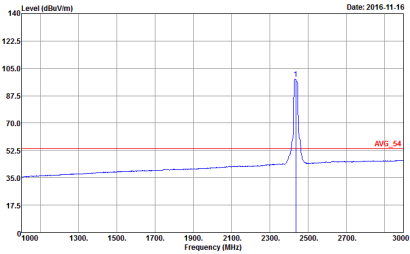

WIFI	2.4GHz 2400~2483.5MHz Band Edge @ 3m	
ANT	802.11ac VH20 CH06 2437MHz - L	
1	Vertical	Fundamental
Peak	 <p>Date: 2016.11.16 PEAK_BE_74</p> <p>Site : 03CH12-HY Condition : PEAK_BE_74 3m HORN_9120D_1328 VERTICAL : RBW:1000.000KHz VBW:3000.000KHz SWT:Auto Detector : Peak Project : 672014-10 Mode : 23</p>	 <p>Date: 2016.11.16 PEAK_74</p> <p>Site : 03CH12-HY Condition : PEAK_74 3m HORN_9120D_1328 VERTICAL : RBW:1000.000KHz VBW:3000.000KHz SWT:Auto Detector : Peak Project : 672014-10 Mode : 23</p>
Avg.	 <p>Date: 2016.11.16 AVG_BE_54</p> <p>Site : 03CH12-HY Condition : AVG_BE_54 3m HORN_9120D_1328 VERTICAL : RBW:1000.000KHz VBW:1.000KHz SWT:Auto Detector : Peak Project : 672014-10 Mode : 23</p>	 <p>Date: 2016.11.16 AVG_54</p> <p>Site : 03CH12-HY Condition : AVG_54 3m HORN_9120D_1328 VERTICAL : RBW:1000.000KHz VBW:1.000KHz SWT:Auto Detector : Peak Project : 672014-10 Mode : 23</p>

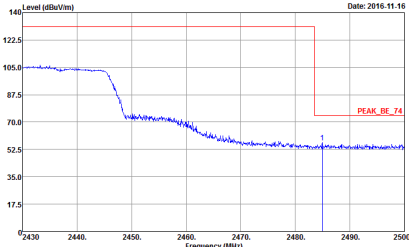
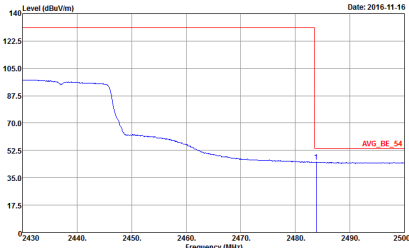

WIFI	2.4GHz 2400~2483.5MHz Band Edge @ 3m	
ANT	802.11ac VH20 CH06 2437MHz - R	
1	Vertical	Fundamental
Peak	 <p> Date: 2016.11.16 Site : 03CH12-HY Condition : PEAK_BE_74 3m HORN_9120D_1378 VERTICAL : RBW:1000.000KHz VBW:3000.000KHz SWT:Auto Detector : Peak Project : 672014-10 Mode : 23 </p>	Left blank
Avg.	 <p> Date: 2016.11.16 Site : 03CH12-HY Condition : AVG_BE_54 3m HORN_9120D_1378 VERTICAL : RBW:1000.000KHz VBW:1.000KHz SWT:Auto Detector : Peak Project : 672014-10 Mode : 23 </p>	Left blank

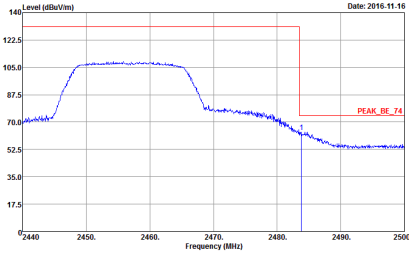
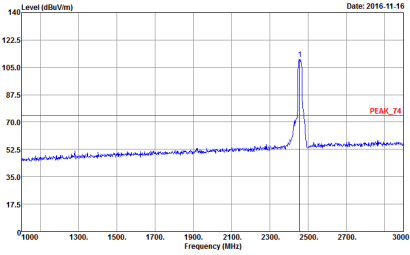
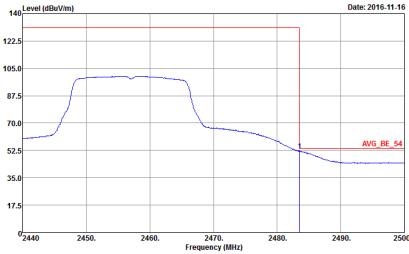
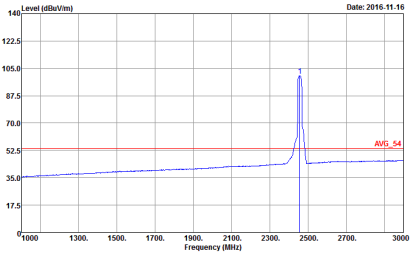

WIFI	2.4GHz 2400~2483.5MHz Band Edge @ 3m	
ANT	802.11ac VH20 CH10 2457MHz	
1	Horizontal	Fundamental
Peak	 <p>Date: 2016.11.16</p> <p>Site : 03CH12-HY Condition : PEAK_BE_74 3m HORN_9120D_1328 HORIZONTAL : RBW:1000.000KHz VBW:3000.000KHz SWT:Auto Detector : Peak Project : 672014-10 Mode : 24 Setting : 75</p>	 <p>Date: 2016.11.16</p> <p>Site : 03CH12-HY Condition : PEAK_74 3m HORN_9120D_1328 HORIZONTAL : RBW:1000.000KHz VBW:3000.000KHz SWT:Auto Detector : Peak Project : 672014-10 Mode : 24 Setting : 75</p>
Avg.	 <p>Date: 2016.11.16</p> <p>Site : 03CH12-HY Condition : AVG_BE_54 3m HORN_9120D_1328 HORIZONTAL : RBW:1000.000KHz VBW:1.000KHz SWT:Auto Detector : Peak Project : 672014-10 Mode : 24 Setting : 75</p>	 <p>Date: 2016.11.16</p> <p>Site : 03CH12-HY Condition : AVG_54 3m HORN_9120D_1328 HORIZONTAL : RBW:1000.000KHz VBW:1.000KHz SWT:Auto Detector : Peak Project : 672014-10 Mode : 24 Setting : 75</p>

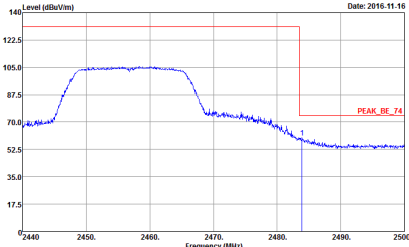
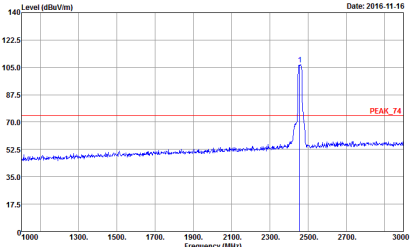
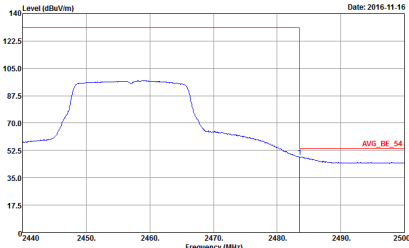
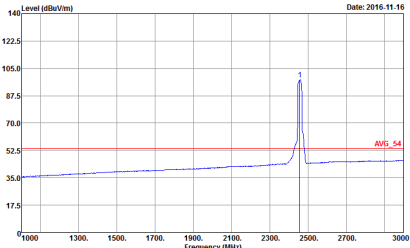

WIFI	2.4GHz 2400~2483.5MHz Band Edge @ 3m	
ANT	802.11ac VH20 CH10 2457MHz	
1	Vertical	Fundamental
Peak	 <p>Site : 03CH12-HY Condition : PEAK_BE_74 3m HORN_9120D_1328 VERTICAL : RBW:1000.000KHz VBW:3000.000KHz SWT:Auto Detector : Peak Project : 672014-10 Mode : 24 Setting : 75</p>	 <p>Site : 03CH12-HY Condition : PEAK_74 3m HORN_9120D_1328 VERTICAL : RBW:1000.000KHz VBW:3000.000KHz SWT:Auto Detector : Peak Project : 672014-10 Mode : 24 Setting : 75</p>
Avg.	 <p>Site : 03CH12-HY Condition : AVG_BE_54 3m HORN_9120D_1328 VERTICAL : RBW:1000.000KHz VBW:1.000KHz SWT:Auto Detector : Peak Project : 672014-10 Mode : 24 Setting : 75</p>	 <p>Site : 03CH12-HY Condition : AVG_54 3m HORN_9120D_1328 VERTICAL : RBW:1000.000KHz VBW:1.000KHz SWT:Auto Detector : Peak Project : 672014-10 Mode : 24 Setting : 75</p>

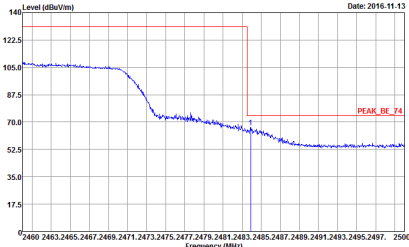
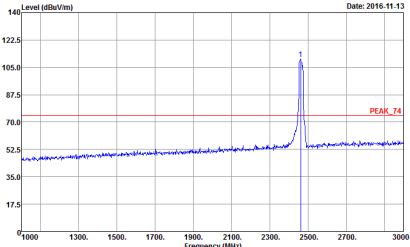
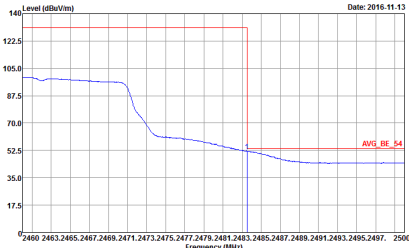
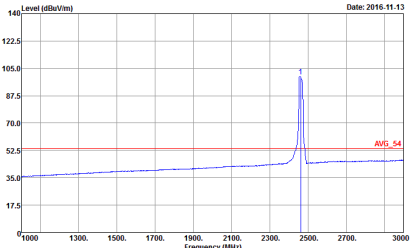

WIFI	2.4GHz 2400~2483.5MHz Band Edge @ 3m	
ANT	802.11ac VH20 CH11 2462MHz	
1	Horizontal	Fundamental
Peak	 <p>Level (dBuV/m) vs Frequency (MHz) plot showing a peak at 2462 MHz. The y-axis ranges from 0 to 140 dBuV/m, and the x-axis ranges from 2460 to 2500 MHz. A red horizontal line indicates the peak level at approximately 75 dBuV/m.</p> <pre> Site : 03CH12-HY Condition : PEAK_BE_74 3m HORN_9120D_1328 HORIZONTAL : RBW:1000.000KHz VBW:3000.000KHz SWT:Auto Detector : Peak Project : 672014-10 Mode : 25 Setting : 71 </pre>	 <p>Level (dBuV/m) vs Frequency (MHz) plot showing a sharp peak at 2462 MHz. The y-axis ranges from 0 to 140 dBuV/m, and the x-axis ranges from 1000 to 3000 MHz. A red horizontal line indicates the peak level at approximately 75 dBuV/m.</p> <pre> Site : 03CH12-HY Condition : PEAK_74 3m HORN_9120D_1328 HORIZONTAL : RBW:1000.000KHz VBW:3000.000KHz SWT:Auto Detector : Peak Project : 672014-10 Mode : 25 Setting : 71 </pre>
Avg.	 <p>Level (dBuV/m) vs Frequency (MHz) plot showing the average spectrum. The y-axis ranges from 0 to 140 dBuV/m, and the x-axis ranges from 2460 to 2500 MHz. A red horizontal line indicates the average level at approximately 55 dBuV/m.</p> <pre> Site : 03CH12-HY Condition : AVG_BE_54 3m HORN_9120D_1328 HORIZONTAL : RBW:1000.000KHz VBW:1.000KHz SWT:Auto Detector : Peak Project : 672014-10 Mode : 25 Setting : 71 </pre>	 <p>Level (dBuV/m) vs Frequency (MHz) plot showing the average spectrum. The y-axis ranges from 0 to 140 dBuV/m, and the x-axis ranges from 1000 to 3000 MHz. A red horizontal line indicates the average level at approximately 55 dBuV/m.</p> <pre> Site : 03CH12-HY Condition : AVG_54 3m HORN_9120D_1328 HORIZONTAL : RBW:1000.000KHz VBW:1.000KHz SWT:Auto Detector : Peak Project : 672014-10 Mode : 25 Setting : 71 </pre>

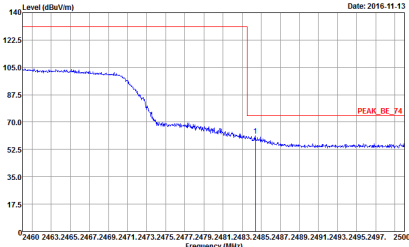
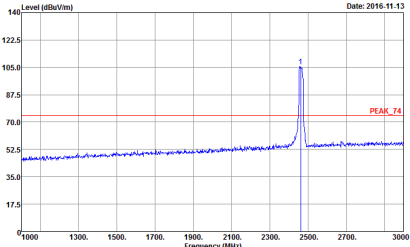
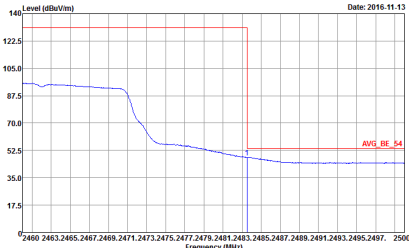
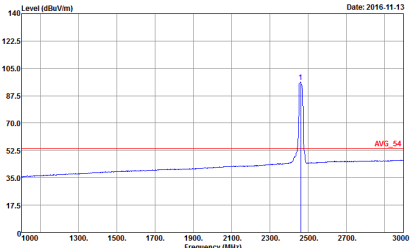

WIFI	2.4GHz 2400~2483.5MHz Band Edge @ 3m	
ANT	802.11ac VH20 CH11 2462MHz	
1	Vertical	Fundamental
Peak	 <p>Level (dBuV/m) vs Frequency (MHz) plot showing a peak at 2462 MHz. The y-axis ranges from 0 to 140 dBuV/m, and the x-axis ranges from 2460 to 2500 MHz. A red box highlights the peak area.</p> <p>Site : 03CH12-HY Condition : PEAK_BE_74 3m HORN_9120D_1328 VERTICAL : RBW:1000.000KHz VBW:3000.000KHz SWT:Auto Detector : Peak Project : 672014-10 Mode : 25 Setting : 71</p>	 <p>Level (dBuV/m) vs Frequency (MHz) plot showing a peak at 2462 MHz. The y-axis ranges from 0 to 140 dBuV/m, and the x-axis ranges from 1000 to 3000 MHz. A red box highlights the peak area.</p> <p>Site : 03CH12-HY Condition : PEAK_74 3m HORN_9120D_1328 VERTICAL : RBW:1000.000KHz VBW:3000.000KHz SWT:Auto Detector : Peak Project : 672014-10 Mode : 25 Setting : 71</p>
Avg.	 <p>Level (dBuV/m) vs Frequency (MHz) plot showing the average signal. The y-axis ranges from 0 to 140 dBuV/m, and the x-axis ranges from 2460 to 2500 MHz. A red box highlights the average level.</p> <p>Site : 03CH12-HY Condition : AVG_BE_54 3m HORN_9120D_1328 VERTICAL : RBW:1000.000KHz VBW:1.000KHz SWT:Auto Detector : Peak Project : 672014-10 Mode : 25 Setting : 71</p>	 <p>Level (dBuV/m) vs Frequency (MHz) plot showing the average signal. The y-axis ranges from 0 to 140 dBuV/m, and the x-axis ranges from 1000 to 3000 MHz. A red box highlights the average level.</p> <p>Site : 03CH12-HY Condition : AVG_54 3m HORN_9120D_1328 VERTICAL : RBW:1000.000KHz VBW:1.000KHz SWT:Auto Detector : Peak Project : 672014-10 Mode : 25 Setting : 71</p>



2.4GHz 2400~2483.5MHz

WIFI 802.11ac VHT40 (Band Edge @ 3m)

WIFI	2.4GHz 2400~2483.5MHz Band Edge @ 3m	
ANT	802.11ac VH40 CH03 2422MHz - L	
1	Horizontal	Fundamental
Peak	<p>Date: 2016-11-13</p> <p>Site : 03CH12-HY Condition : PEAK_BE_74 3m HORN_9120D_1328 HORIZONTAL RBW:1000.000KHz VBW:3000.000KHz SWT:Auto Detector : Peak Project : 672014-10 Mode : 26 Setting : 60</p>	<p>Date: 2016-11-13</p> <p>Site : 03CH12-HY Condition : PEAK_74 3m HORN_9120D_1328 HORIZONTAL RBW:1000.000KHz VBW:3000.000KHz SWT:Auto Detector : Peak Project : 672014-10 Mode : 26 Setting : 60</p>
Avg.	<p>Date: 2016-11-13</p> <p>Site : 03CH12-HY Condition : AVG_BE_54 3m HORN_9120D_1328 HORIZONTAL RBW:1000.000KHz VBW:3.000KHz SWT:Auto Detector : Peak Project : 672014-10 Mode : 26 Setting : 60</p>	<p>Date: 2016-11-13</p> <p>Site : 03CH12-HY Condition : AVG_54 3m HORN_9120D_1328 HORIZONTAL RBW:1000.000KHz VBW:3.000KHz SWT:Auto Detector : Peak Project : 672014-10 Mode : 26 Setting : 60</p>

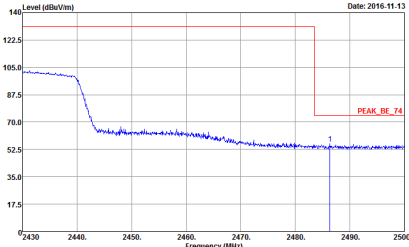
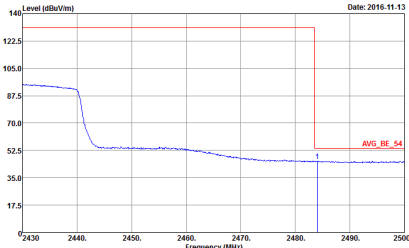

WIFI	2.4GHz 2400~2483.5MHz Band Edge @ 3m	
ANT	802.11ac VH40 CH03 2422MHz - R	
1	Horizontal	Fundamental
Peak	 <p>Date: 2016.11.13</p> <p>Site : 03CH12-HY Condition : PEAK_BE_74 3m HORN_9120D_1378 HORIZONTAL : RBW:1000.000KHz VBW:3000.000KHz SWT:Auto Detector : Peak Project : 672014-10 Mode : 26 Setting : 60</p>	Left blank
Avg.	 <p>Date: 2016.11.13</p> <p>Site : 03CH12-HY Condition : AVG_BE_54 3m HORN_9120D_1378 HORIZONTAL : RBW:1000.000KHz VBW:3.000KHz SWT:Auto Detector : Peak Project : 672014-10 Mode : 26 Setting : 60</p>	Left blank

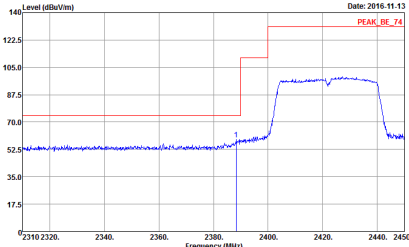
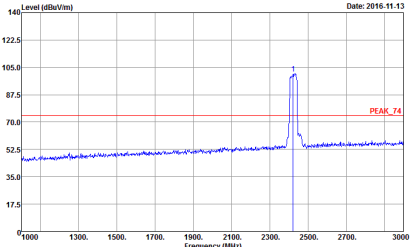
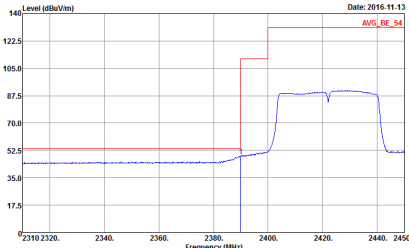
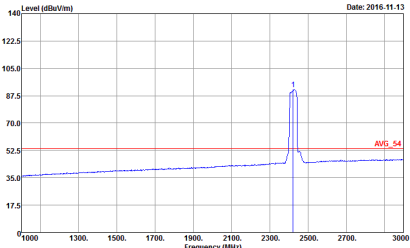

WIFI	2.4GHz 2400~2483.5MHz Band Edge @ 3m	
ANT	802.11ac VH40 CH03 2422MHz - L	
1	Vertical	Fundamental
Peak	 <p>Date: 2016.11.13</p> <p>Site : 03CH12-HY Condition : PEAK_BE_74 3m HORN_9120D_1328 VERTICAL : RBW:1000.000KHz VBW:3000.000KHz SWT:Auto Detector : Peak Project : 672014-10 Mode : 26 Setting : 60</p>	 <p>Date: 2016.11.13</p> <p>Site : 03CH12-HY Condition : PEAK_74 3m HORN_9120D_1328 VERTICAL : RBW:1000.000KHz VBW:3000.000KHz SWT:Auto Detector : Peak Project : 672014-10 Mode : 26 Setting : 60</p>
Avg.	 <p>Date: 2016.11.13</p> <p>Site : 03CH12-HY Condition : AVG_BE_54 3m HORN_9120D_1328 VERTICAL : RBW:1000.000KHz VBW:3.000KHz SWT:Auto Detector : Peak Project : 672014-10 Mode : 26 Setting : 60</p>	 <p>Date: 2016.11.13</p> <p>Site : 03CH12-HY Condition : AVG_54 3m HORN_9120D_1328 VERTICAL : RBW:1000.000KHz VBW:3.000KHz SWT:Auto Detector : Peak Project : 672014-10 Mode : 26 Setting : 60</p>

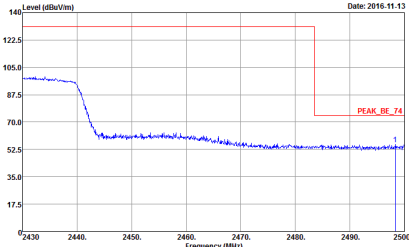
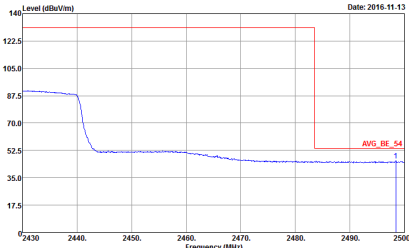

WIFI	2.4GHz 2400~2483.5MHz Band Edge @ 3m	
ANT	802.11ac VH40 CH03 2422MHz - R	
1	Vertical	Fundamental
Peak	 <p>Date: 2016.11.13</p> <p>Site : 03CH12-HY Condition : PEAK_BE_74 3m HORN_9120D_1378 VERTICAL : RBW:1000.000KHz VBW:3000.000KHz SWT:Auto Detector : Peak Project : 672014-10 Mode : 26 Setting : 60</p>	Left blank
Avg.	 <p>Date: 2016.11.13</p> <p>Site : 03CH12-HY Condition : AVG_BE_54 3m HORN_9120D_1378 VERTICAL : RBW:1000.000KHz VBW:3.000KHz SWT:Auto Detector : Peak Project : 672014-10 Mode : 26 Setting : 60</p>	Left blank

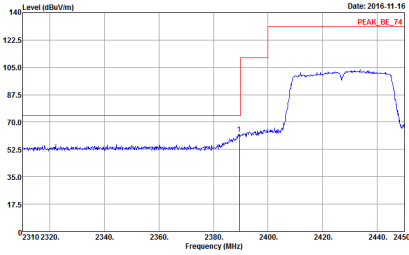
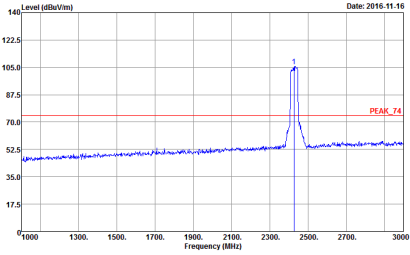
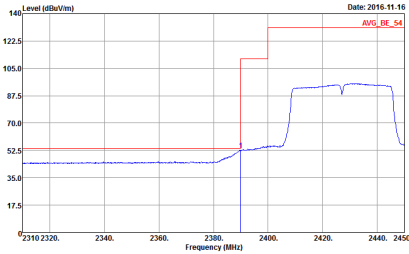
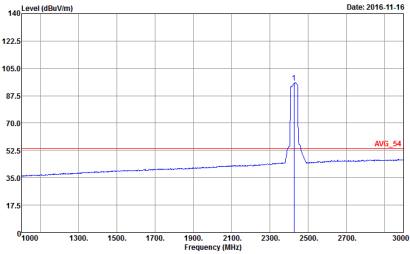

WIFI	2.4GHz 2400~2483.5MHz Band Edge @ 3m	
ANT	802.11ac VH40 CH04 2427MHz - L	
1	Horizontal	Fundamental
Peak	 <p>Date: 2016.11.16 PEAK_BE_74</p> <p>Site : 03CH12-HY Condition : PEAK_BE_74 3m HORN_9120D_1328 HORIZONTAL RBW:1000.000KHz VBW:3000.000KHz SWT:Auto Detector : Peak Project : 672014-10 Mode : 27 Setting : 64</p>	 <p>Date: 2016.11.16 PEAK_74</p> <p>Site : 03CH12-HY Condition : PEAK_74 3m HORN_9120D_1328 HORIZONTAL RBW:1000.000KHz VBW:3000.000KHz SWT:Auto Detector : Peak Project : 672014-10 Mode : 27 Setting : 64</p>
Avg.	 <p>Date: 2016.11.16 AVG_BE_54</p> <p>Site : 03CH12-HY Condition : AVG_BE_54 3m HORN_9120D_1328 HORIZONTAL RBW:1000.000KHz VBW:3.000KHz SWT:Auto Detector : Peak Project : 672014-10 Mode : 27 Setting : 64</p>	 <p>Date: 2016.11.16 AVG_54</p> <p>Site : 03CH12-HY Condition : AVG_54 3m HORN_9120D_1328 HORIZONTAL RBW:1000.000KHz VBW:3.000KHz SWT:Auto Detector : Peak Project : 672014-10 Mode : 27 Setting : 64</p>

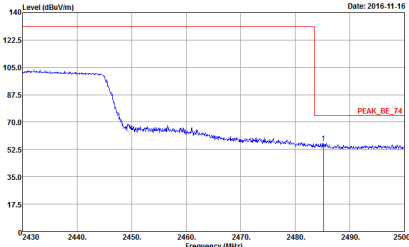
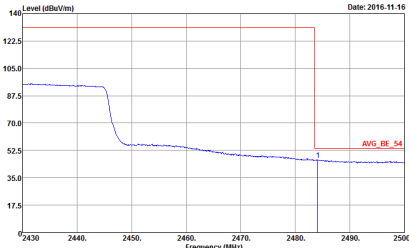

WIFI	2.4GHz 2400~2483.5MHz Band Edge @ 3m	
ANT	802.11ac VH40 CH04 2427MHz - R	
1	Horizontal	Fundamental
Peak	 <p>Date: 2016.11.16</p> <p>Site : 03CH12-HY Condition : PEAK_BE_74 3m HORN_9120D_1378 HORIZONTAL : RBW:1000.000KHz VBW:3000.000KHz SWT:Auto Detector : Peak Project : 672014-10 Mode : 27 Setting : 64</p>	Left blank
Avg.	 <p>Date: 2016.11.16</p> <p>Site : 03CH12-HY Condition : AVG_BE_54 3m HORN_9120D_1378 HORIZONTAL : RBW:1000.000KHz VBW:3.000KHz SWT:Auto Detector : Peak Project : 672014-10 Mode : 27 Setting : 64</p>	Left blank

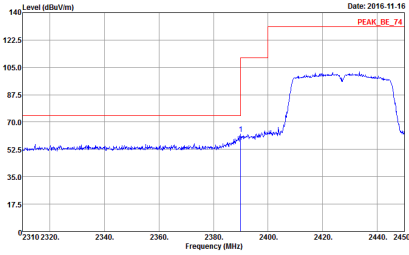
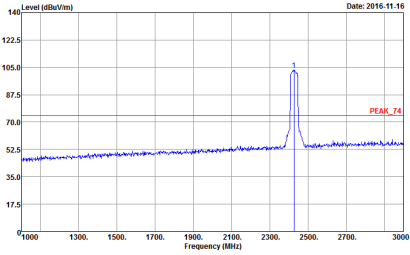
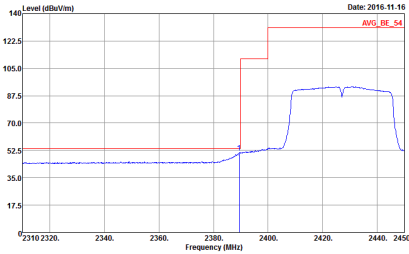
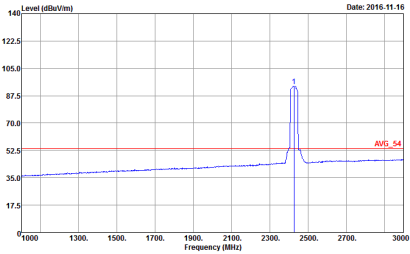

WIFI	2.4GHz 2400~2483.5MHz Band Edge @ 3m	
ANT	802.11ac VH40 CH04 2427MHz - L	
1	Vertical	Fundamental
Peak	 <p>Date: 2016.11.16 PEAK_BE_74</p> <p>Site : 03CH12-HY Condition : PEAK_BE_74 3m HORN_9120D_1328 VERTICAL RBW:1000.000KHz VBW:3000.000KHz SWT:Auto Detector : Peak Project : 672014-10 Mode : 27 Setting : 64</p>	 <p>Date: 2016.11.16 PEAK_74</p> <p>Site : 03CH12-HY Condition : PEAK_74 3m HORN_9120D_1328 VERTICAL RBW:1000.000KHz VBW:3000.000KHz SWT:Auto Detector : Peak Project : 672014-10 Mode : 27 Setting : 64</p>
Avg.	 <p>Date: 2016.11.16 AVG_BE_54</p> <p>Site : 03CH12-HY Condition : AVG_BE_54 3m HORN_9120D_1328 VERTICAL RBW:1000.000KHz VBW:3.000KHz SWT:Auto Detector : Peak Project : 672014-10 Mode : 27 Setting : 64</p>	 <p>Date: 2016.11.16 AVG_54</p> <p>Site : 03CH12-HY Condition : AVG_54 3m HORN_9120D_1328 VERTICAL RBW:1000.000KHz VBW:3.000KHz SWT:Auto Detector : Peak Project : 672014-10 Mode : 27 Setting : 64</p>

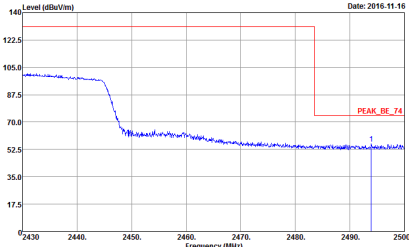
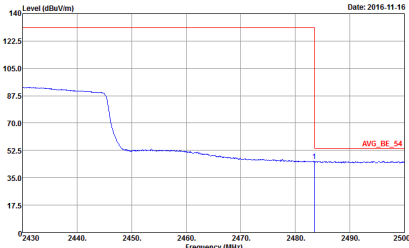

WIFI	2.4GHz 2400~2483.5MHz Band Edge @ 3m	
ANT	802.11ac VH40 CH04 2427MHz - R	
1	Vertical	Fundamental
Peak	 <p>Date: 2016.11.16</p> <p>Site : 03CH12-HY Condition : PEAK_BE_74 3m HORN_9120D_1328 VERTICAL : RBW:1000.000KHz VBW:3000.000KHz SWT:Auto Detector : Peak Project : 672014-10 Mode : 27 Setting : 64</p>	Left blank
Avg.	 <p>Date: 2016.11.16</p> <p>Site : 03CH12-HY Condition : AVG_BE_54 3m HORN_9120D_1328 VERTICAL : RBW:1000.000KHz VBW:3.000KHz SWT:Auto Detector : Peak Project : 672014-10 Mode : 27 Setting : 64</p>	Left blank

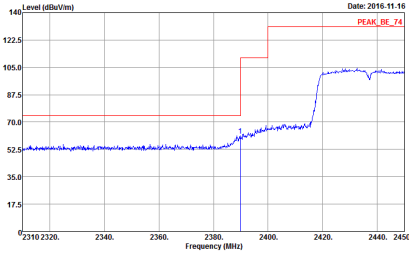
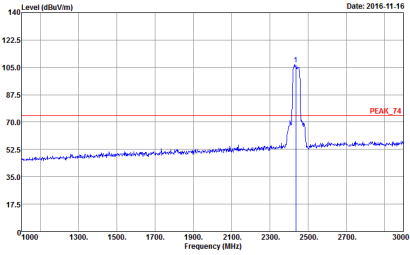
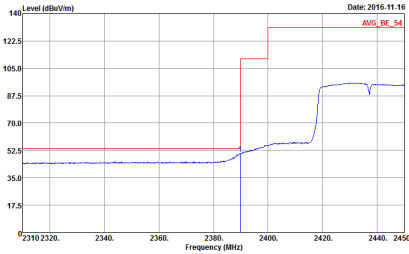
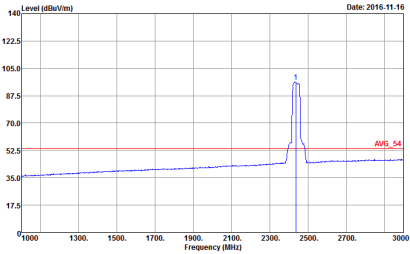

WIFI	2.4GHz 2400~2483.5MHz Band Edge @ 3m	
ANT	802.11ac VH40 CH06 2437MHz - L	
1	Horizontal	Fundamental
Peak	 <p>Date: 2016.11.16</p> <p>Site : 03CH12-HY Condition : PEAK_BE_74 3m HORN_9120D_1328 HORIZONTAL : RBW:1000.000KHz VBW:3000.000KHz SWT:Auto Detector : Peak Project : 672014-10 Mode : 28 Setting : 67</p>	 <p>Date: 2016.11.16</p> <p>Site : 03CH12-HY Condition : PEAK_74 3m HORN_9120D_1328 HORIZONTAL : RBW:1000.000KHz VBW:3000.000KHz SWT:Auto Detector : Peak Project : 672014-10 Mode : 28 Setting : 67</p>
Avg.	 <p>Date: 2016.11.16</p> <p>Site : 03CH12-HY Condition : AVG_BE_54 3m HORN_9120D_1328 HORIZONTAL : RBW:1000.000KHz VBW:3.000KHz SWT:Auto Detector : Peak Project : 672014-10 Mode : 28 Setting : 67</p>	 <p>Date: 2016.11.16</p> <p>Site : 03CH12-HY Condition : AVG_54 3m HORN_9120D_1328 HORIZONTAL : RBW:1000.000KHz VBW:3.000KHz SWT:Auto Detector : Peak Project : 672014-10 Mode : 28 Setting : 67</p>

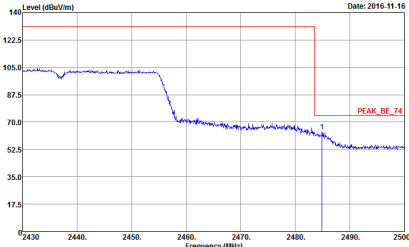
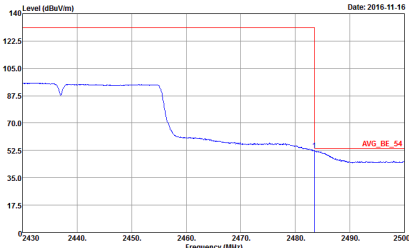

WIFI	2.4GHz 2400~2483.5MHz Band Edge @ 3m	
ANT	802.11ac VH40 CH06 2437MHz - R	
1	Horizontal	Fundamental
Peak	 <p>Date: 2016.11.16</p> <p>Site : 03CH12-HY Condition : PEAK_BE_74 3m HORN_9120D_1378 HORIZONTAL : RBW:1000.000KHz VBW:3000.000KHz SWT:Auto Detector : Peak Project : 672014-10 Mode : 28 Setting : 67</p>	Left blank
Avg.	 <p>Date: 2016.11.16</p> <p>Site : 03CH12-HY Condition : AVG_BE_54 3m HORN_9120D_1378 HORIZONTAL : RBW:1000.000KHz VBW:3.000KHz SWT:Auto Detector : Peak Project : 672014-10 Mode : 28 Setting : 67</p>	Left blank

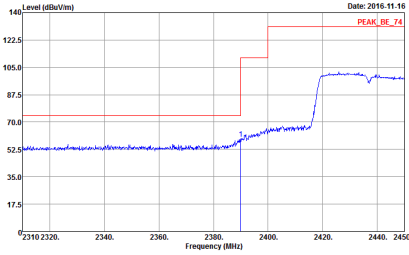
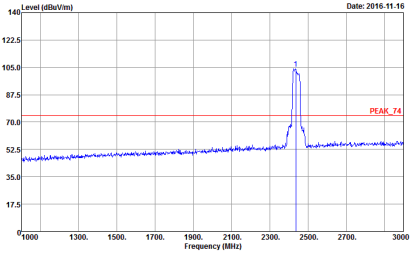
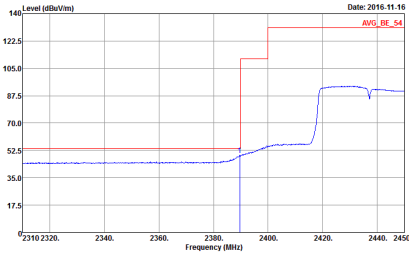
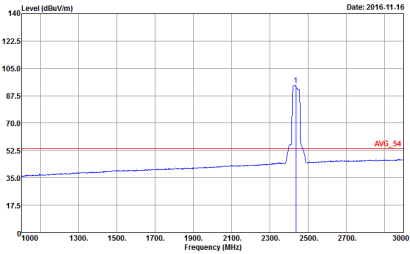

WIFI	2.4GHz 2400~2483.5MHz Band Edge @ 3m	
ANT	802.11ac VH40 CH06 2437MHz - L	
1	Vertical	Fundamental
Peak	 <p>Date: 2016.11.16 PEAK_BE_74</p> <p>Site : 03CH12-HY Condition : PEAK_BE_74 3m HORN_9120D_1328 VERTICAL RBW:1000.000KHz VBW:3000.000KHz SWT:Auto Detector : Peak Project : 672014-10 Mode : 28 Setting : 67</p>	 <p>Date: 2016.11.16 PEAK_74</p> <p>Site : 03CH12-HY Condition : PEAK_74 3m HORN_9120D_1328 VERTICAL RBW:1000.000KHz VBW:3000.000KHz SWT:Auto Detector : Peak Project : 672014-10 Mode : 28 Setting : 67</p>
Avg.	 <p>Date: 2016.11.16 AVG_BE_54</p> <p>Site : 03CH12-HY Condition : AVG_BE_54 3m HORN_9120D_1328 VERTICAL RBW:1000.000KHz VBW:3.000KHz SWT:Auto Detector : Peak Project : 672014-10 Mode : 28 Setting : 67</p>	 <p>Date: 2016.11.16 AVG_54</p> <p>Site : 03CH12-HY Condition : AVG_54 3m HORN_9120D_1328 VERTICAL RBW:1000.000KHz VBW:3.000KHz SWT:Auto Detector : Peak Project : 672014-10 Mode : 28 Setting : 67</p>

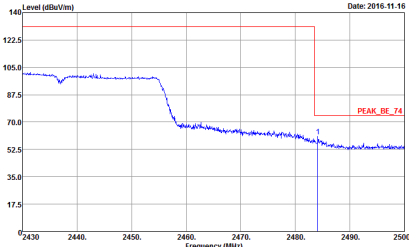
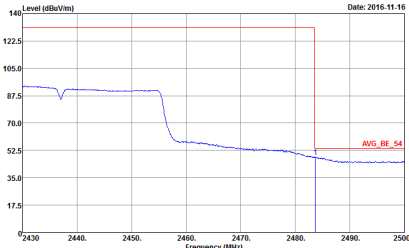

WIFI	2.4GHz 2400~2483.5MHz Band Edge @ 3m	
ANT	802.11ac VH40 CH06 2437MHz - R	
1	Vertical	Fundamental
Peak	 <p>Date: 2016.11.16</p> <p>Site : 03CH12-HY Condition : PEAK_BE_74 3m HORN_9120D_1328 VERTICAL : RBW:1000.000KHz VBW:3000.000KHz SWT:Auto Detector : Peak Project : 672014-10 Mode : 28 Setting : 67</p>	Left blank
Avg.	 <p>Date: 2016.11.16</p> <p>Site : 03CH12-HY Condition : AVG_BE_54 3m HORN_9120D_1328 VERTICAL : RBW:1000.000KHz VBW:3.000KHz SWT:Auto Detector : Peak Project : 672014-10 Mode : 28 Setting : 67</p>	Left blank

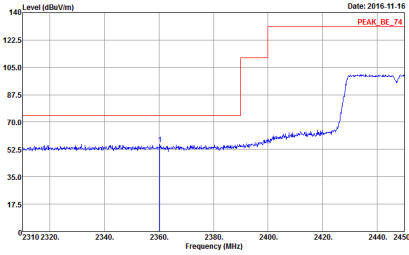
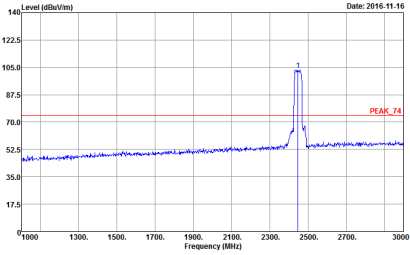
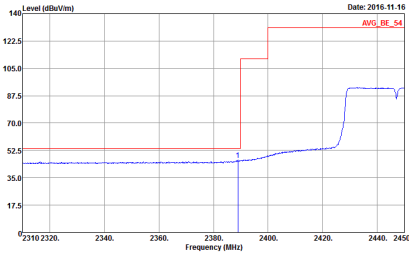
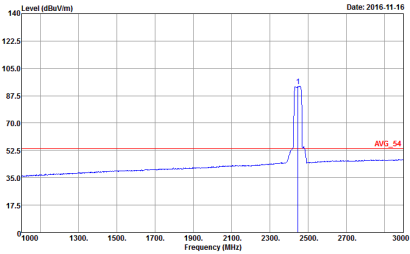

WIFI	2.4GHz 2400~2483.5MHz Band Edge @ 3m	
ANT	802.11ac VH40 CH08 2447MHz - L	
1	Horizontal	Fundamental
Peak	 <p>Date: 2016.11.16 PEAK_BE_74</p> <p>Site : 03CH12-HY Condition : PEAK_BE_74 3m HORN_9120D_1328 HORIZONTAL RBW:1000.000KHz VBW:3000.000KHz SWT:Auto Detector : Peak Project : 672014-10 Mode : 29 Setting : 59</p>	 <p>Date: 2016.11.16 PEAK_74</p> <p>Site : 03CH12-HY Condition : PEAK_74 3m HORN_9120D_1328 HORIZONTAL RBW:1000.000KHz VBW:3000.000KHz SWT:Auto Detector : Peak Project : 672014-10 Mode : 29 Setting : 59</p>
Avg.	 <p>Date: 2016.11.16 AVG_BE_54</p> <p>Site : 03CH12-HY Condition : AVG_BE_54 3m HORN_9120D_1328 HORIZONTAL RBW:1000.000KHz VBW:3.000KHz SWT:Auto Detector : Peak Project : 672014-10 Mode : 29 Setting : 59</p>	 <p>Date: 2016.11.16 AVG_54</p> <p>Site : 03CH12-HY Condition : AVG_54 3m HORN_9120D_1328 HORIZONTAL RBW:1000.000KHz VBW:3.000KHz SWT:Auto Detector : Peak Project : 672014-10 Mode : 29 Setting : 59</p>

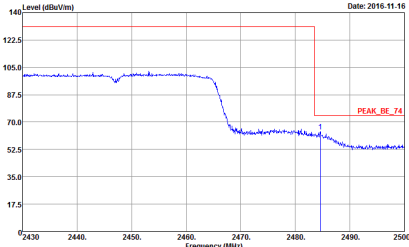
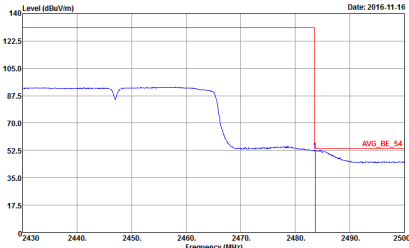

WIFI	2.4GHz 2400~2483.5MHz Band Edge @ 3m	
ANT	802.11ac VH40 CH08 2447MHz - R	
1	Horizontal	Fundamental
Peak	 <p>Date: 2016.11.16</p> <p>Site : 03CH12-HY Condition : PEAK_BE_74 3m HORN_9120D_1378 HORIZONTAL : RBW:1000.000KHz VBW:3000.000KHz SWT:Auto Detector : Peak Project : 672014-10 Mode : 29 Setting : 59</p>	Left blank
Avg.	 <p>Date: 2016.11.16</p> <p>Site : 03CH12-HY Condition : AVG_BE_54 3m HORN_9120D_1378 HORIZONTAL : RBW:1000.000KHz VBW:3.000KHz SWT:Auto Detector : Peak Project : 672014-10 Mode : 29 Setting : 59</p>	Left blank

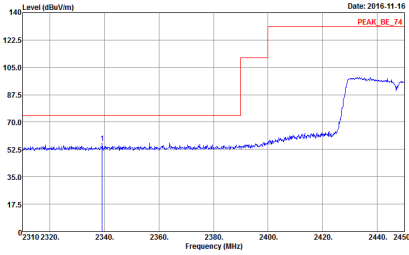
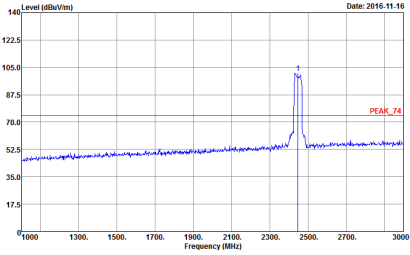
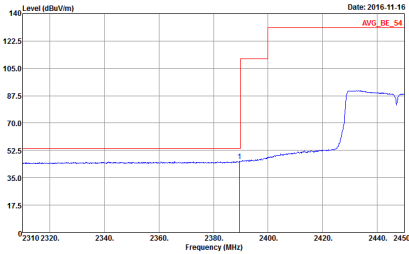
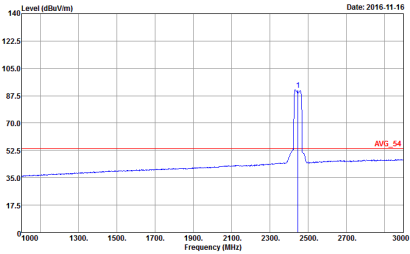

WIFI	2.4GHz 2400~2483.5MHz Band Edge @ 3m	
ANT	802.11ac VH40 CH08 2447MHz - L	
1	Vertical	Fundamental
Peak	 <p>Date: 2016.11.16 PEAK_BE_74</p> <p>Site : 03CH12-HY Condition : PEAK_BE_74 3m HORN_9120D_1328 VERTICAL RBW:1000.000KHz VBW:3000.000KHz SWT:Auto Detector : Peak Project : 672014-10 Mode : 29 Setting : 59</p>	 <p>Date: 2016.11.16 PEAK_74</p> <p>Site : 03CH12-HY Condition : PEAK_74 3m HORN_9120D_1328 VERTICAL RBW:1000.000KHz VBW:3000.000KHz SWT:Auto Detector : Peak Project : 672014-10 Mode : 29 Setting : 59</p>
Avg.	 <p>Date: 2016.11.16 AVG_BE_54</p> <p>Site : 03CH12-HY Condition : AVG_BE_54 3m HORN_9120D_1328 VERTICAL RBW:1000.000KHz VBW:3.000KHz SWT:Auto Detector : Peak Project : 672014-10 Mode : 29 Setting : 59</p>	 <p>Date: 2016.11.16 AVG_54</p> <p>Site : 03CH12-HY Condition : AVG_54 3m HORN_9120D_1328 VERTICAL RBW:1000.000KHz VBW:3.000KHz SWT:Auto Detector : Peak Project : 672014-10 Mode : 29 Setting : 59</p>

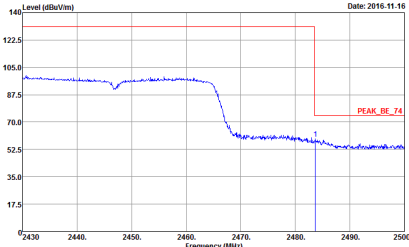
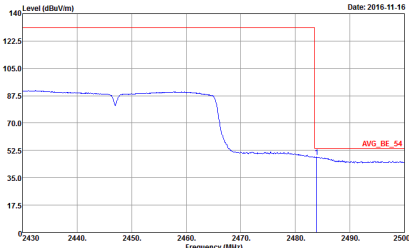

WIFI	2.4GHz 2400~2483.5MHz Band Edge @ 3m	
ANT	802.11ac VH40 CH08 2447MHz - R	
1	Vertical	Fundamental
Peak	 <p>Date: 2016.11.16</p> <p>Site : 03CH12-HY Condition : PEAK_BE_74 3m HORN_9120D_1378 VERTICAL : RBW:1000.000KHz VBW:3000.000KHz SWT:Auto Detector : Peak Project : 672014-10 Mode : 29 Setting : 59</p>	Left blank
Avg.	 <p>Date: 2016.11.16</p> <p>Site : 03CH12-HY Condition : AVG_BE_54 3m HORN_9120D_1378 VERTICAL : RBW:1000.000KHz VBW:3.000KHz SWT:Auto Detector : Peak Project : 672014-10 Mode : 29 Setting : 59</p>	Left blank

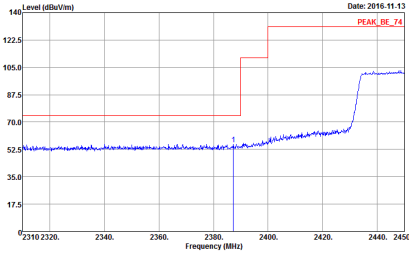
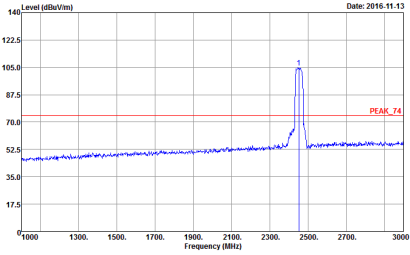
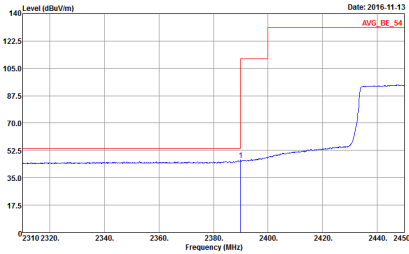
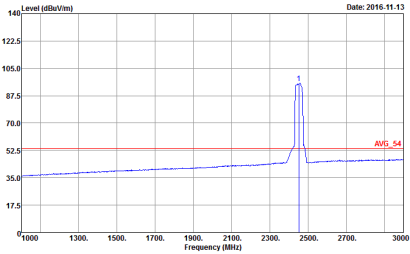

WIFI	2.4GHz 2400~2483.5MHz Band Edge @ 3m	
ANT	802.11ac VH40 CH09 2452MHz - L	
1	Horizontal	Fundamental
Peak	 <p>Date: 2016-11-13</p> <p>Site : 03CH12-HY Condition : PEAK_BE_74 3m HORN_9120D_1328 HORIZONTAL RBW: 1000.000KHz VBW: 3000.000KHz SWT: Auto Detector : Peak Project : 672014-10 Mode : 30 Setting : 60</p>	 <p>Date: 2016-11-13</p> <p>Site : 03CH12-HY Condition : PEAK_74 3m HORN_9120D_1328 HORIZONTAL RBW: 1000.000KHz VBW: 3000.000KHz SWT: Auto Detector : Peak Project : 672014-10 Mode : 30 Setting : 60</p>
Avg.	 <p>Date: 2016-11-13</p> <p>Site : 03CH12-HY Condition : AVG_BE_54 3m HORN_9120D_1328 HORIZONTAL RBW: 1000.000KHz VBW: 3.000KHz SWT: Auto Detector : Peak Project : 672014-10 Mode : 30 Setting : 60</p>	 <p>Date: 2016-11-13</p> <p>Site : 03CH12-HY Condition : AVG_54 3m HORN_9120D_1328 HORIZONTAL RBW: 1000.000KHz VBW: 3.000KHz SWT: Auto Detector : Peak Project : 672014-10 Mode : 30 Setting : 60</p>

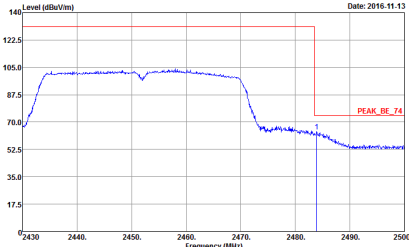
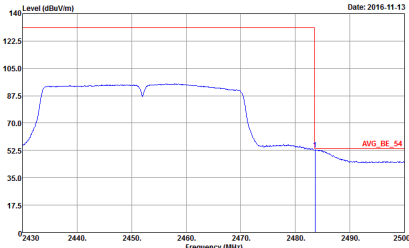

WIFI	2.4GHz 2400~2483.5MHz Band Edge @ 3m	
ANT	802.11ac VH40 CH09 2452MHz - R	
1	Horizontal	Fundamental
Peak	 <p>Date: 2016.11.13</p> <p>Site : 03CH12-HY Condition : PEAK_BE_74 3m HORN_9120D_1378 HORIZONTAL : RBW:1000.000KHz VBW:3000.000KHz SWT:Auto Detector : Peak Project : 672014-10 Mode : 30 Setting : 60</p>	Left blank
Avg.	 <p>Date: 2016.11.13</p> <p>Site : 03CH12-HY Condition : AVG_BE_54 3m HORN_9120D_1378 HORIZONTAL : RBW:1000.000KHz VBW:3.000KHz SWT:Auto Detector : Peak Project : 672014-10 Mode : 30 Setting : 60</p>	Left blank

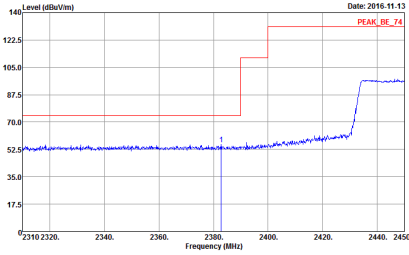
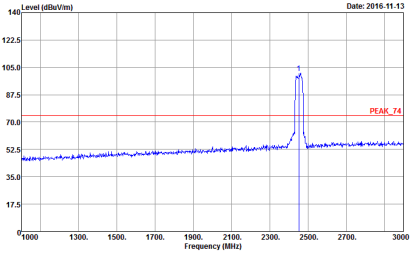
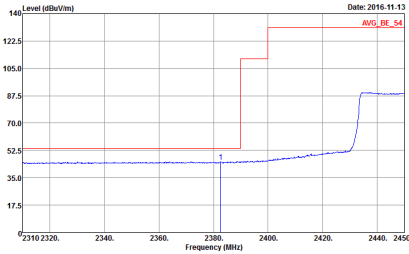
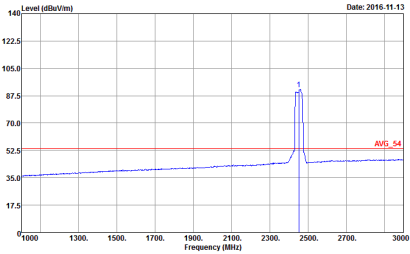

WIFI	2.4GHz 2400~2483.5MHz Band Edge @ 3m	
ANT	802.11ac VH40 CH09 2452MHz - L	
1	Vertical	Fundamental
Peak	 <p>Date: 2016.11.13</p> <p>Level (dBuV/m)</p> <p>Frequency (MHz)</p> <p>PEAK_BE_74</p> <p>Site : 03CH12-HY Condition : PEAK_BE_74 3m HORN_9120D_1328 VERTICAL RBW:1000.000KHz VBW:3000.000KHz SWT:Auto Detector : Peak Project : 672014-10 Mode : 30 Setting : 60</p>	 <p>Date: 2016.11.13</p> <p>Level (dBuV/m)</p> <p>Frequency (MHz)</p> <p>PEAK_74</p> <p>Site : 03CH12-HY Condition : PEAK_74 3m HORN_9120D_1328 VERTICAL RBW:1000.000KHz VBW:3000.000KHz SWT:Auto Detector : Peak Project : 672014-10 Mode : 30 Setting : 60</p>
Avg.	 <p>Date: 2016.11.13</p> <p>Level (dBuV/m)</p> <p>Frequency (MHz)</p> <p>AVG_BE_54</p> <p>Site : 03CH12-HY Condition : AVG_BE_54 3m HORN_9120D_1328 VERTICAL RBW:1000.000KHz VBW:3.000KHz SWT:Auto Detector : Peak Project : 672014-10 Mode : 30 Setting : 60</p>	 <p>Date: 2016.11.13</p> <p>Level (dBuV/m)</p> <p>Frequency (MHz)</p> <p>AVG_54</p> <p>Site : 03CH12-HY Condition : AVG_54 3m HORN_9120D_1328 VERTICAL RBW:1000.000KHz VBW:3.000KHz SWT:Auto Detector : Peak Project : 672014-10 Mode : 30 Setting : 60</p>

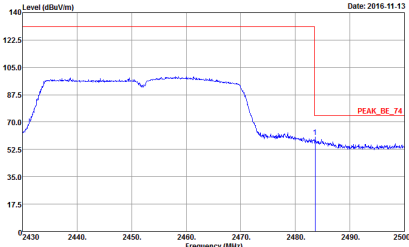
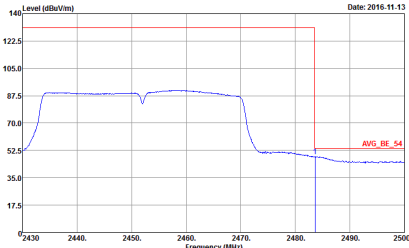

WIFI	2.4GHz 2400~2483.5MHz Band Edge @ 3m	
ANT	802.11ac VH40 CH09 2452MHz - R	
1	Vertical	Fundamental
Peak	 <p>Date: 2016.11.13</p> <p>Site : 03CH12-HY Condition : PEAK_BE_74 3m HORN_9120D_1378 VERTICAL : RBW:1000.000KHz VBW:3000.000KHz SWT:Auto Detector : Peak Project : 672014-10 Mode : 30 Setting : 60</p>	Left blank
Avg.	 <p>Date: 2016.11.13</p> <p>Site : 03CH12-HY Condition : AVG_BE_54 3m HORN_9120D_1378 VERTICAL : RBW:1000.000KHz VBW:3.000KHz SWT:Auto Detector : Peak Project : 672014-10 Mode : 30 Setting : 60</p>	Left blank



2.4GHz 2400~2483.5MHz
WIFI 802.11b (Harmonic @ 3m)

WIFI	2.4GHz 2400~2483.5MHz Harmonic @ 3m	
ANT	802.11b CH01 2412MHz	
1	Horizontal	Vertical
Peak Avg.	<p>Site : 03CH12-HY Condition : PEAK_74 3m HORN_9120D_1328 HORIZONTAL Project : 672014-10 Mode : 11</p>	<p>Site : 03CH12-HY Condition : PEAK_74 3m HORN_9120D_1328 VERTICAL Project : 672014-10 Mode : 11</p>

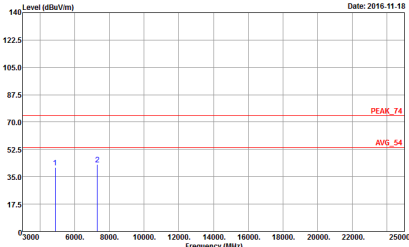
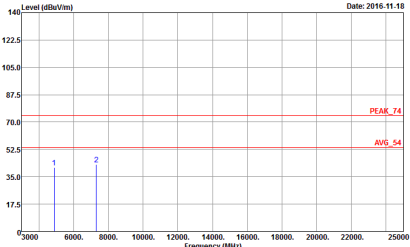

WIFI	2.4GHz 2400~2483.5MHz Harmonic @ 3m	
ANT	802.11b CH06 2437MHz	
1	Horizontal	Vertical
Peak Avg.	 <p>Site : 03CH12-HY Condition : PEAK_74 3m HORN_9120D_1328 HORIZONTAL Project : 672014-10 Mode : 13</p>	 <p>Site : 03CH12-HY Condition : PEAK_74 3m HORN_9120D_1328 VERTICAL Project : 672014-10 Mode : 13</p>

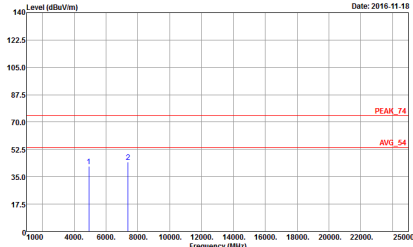
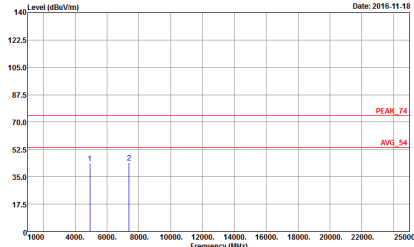

WIFI	2.4GHz 2400~2483.5MHz Harmonic @ 3m	
ANT	802.11b CH11 2462MHz	
1	Horizontal	Vertical
Peak Avg.	 <p>Site : 03CH12-HY Condition : PEAK_74 3m HORN_9120D_1328 HORIZONTAL Project : 672014-10 Mode : 15</p>	 <p>Site : 03CH12-HY Condition : PEAK_74 3m HORN_9120D_1328 VERTICAL Project : 672014-10 Mode : 15</p>



2.4GHz 2400~2483.5MHz
WIFI 802.11g (Harmonic @ 3m)

WIFI	2.4GHz 2400~2483.5MHz Harmonic @ 3m	
ANT	802.11g CH01 2412MHz	
1	Horizontal	Vertical
Peak Avg.	<p>Site : 03CH12-HY Condition : PEAK_74 3m HORN_9120D_1328 HORIZONTAL Project : 672014-10 Mode : 16</p>	<p>Site : 03CH12-HY Condition : PEAK_74 3m HORN_9120D_1328 VERTICAL Project : 672014-10 Mode : 16</p>

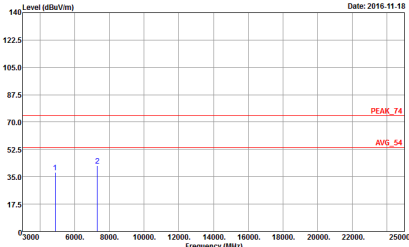
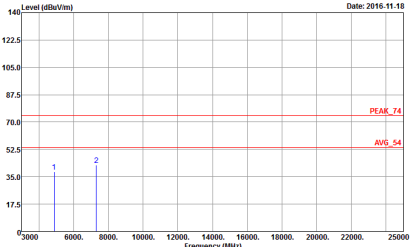

WIFI	2.4GHz 2400~2483.5MHz Harmonic @ 3m	
ANT	802.11g CH06 2437MHz	
1	Horizontal	Vertical
Peak Avg.	 <p>Site : 03CH12-HY Condition : PEAK_74 3m HORN_9120D_1328 HORIZONTAL Project : 672014-10 Mode : 18</p>	 <p>Site : 03CH12-HY Condition : PEAK_74 3m HORN_9120D_1328 VERTICAL Project : 672014-10 Mode : 18</p>

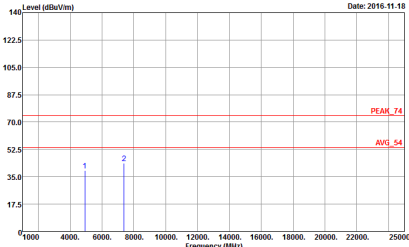
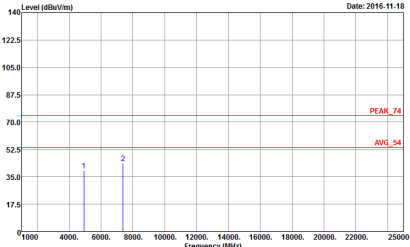

WIFI	2.4GHz 2400~2483.5MHz Harmonic @ 3m	
ANT	802.11g CH11 2462MHz	
1	Horizontal	Vertical
Peak Avg.	 <p>Site : 03CH12-HY Condition : PEAK_74 3m HORN_9120D_1328 HORIZONTAL Project : 672014-10 Mode : 20</p>	 <p>Site : 03CH12-HY Condition : PEAK_74 3m HORN_9120D_1328 VERTICAL Project : 672014-10 Mode : 20</p>



2.4GHz 2400~2483.5MHz

WIFI 802.11ac VHT20 (Harmonic @ 3m)

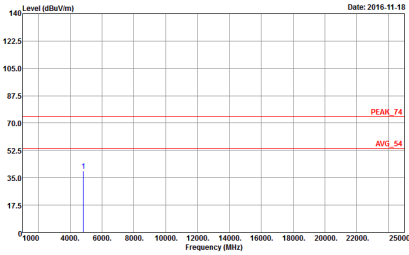
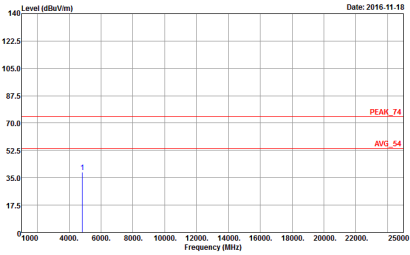
WIFI	2.4GHz 2400~2483.5MHz Harmonic @ 3m	
ANT	802.11ac VHT20 CH01 2412MHz	
1	Horizontal	Vertical
<p>Peak</p> <p>Avg.</p>	 <p>Site : 03CH12-HY Condition : PEAK_74 3m HORN_9120D_1328 HORIZONTAL Project : 672014-10 Mode : 21</p>	 <p>Site : 03CH12-HY Condition : PEAK_74 3m HORN_9120D_1328 VERTICAL Project : 672014-10 Mode : 21</p>

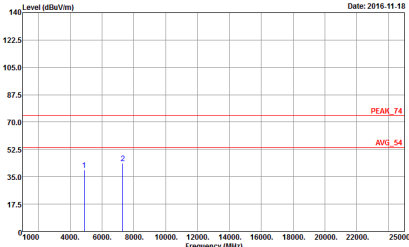
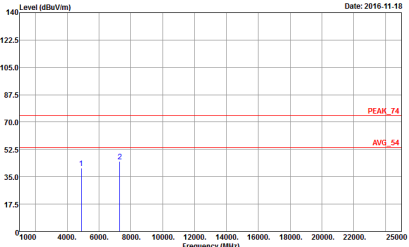

WIFI	2.4GHz 2400~2483.5MHz Harmonic @ 3m	
ANT	802.11ac VHT20 CH06 2437MHz	
1	Horizontal	Vertical
Peak Avg.	 <p>Date: 2016.11.18</p> <p>Site : 03CH12-HY Condition : PEAK_74 3m HORN_9120D_1328 HORIZONTAL Project : 672014-10 Mode : 23</p>	 <p>Date: 2016.11.18</p> <p>Site : 03CH12-HY Condition : PEAK_74 3m HORN_9120D_1328 VERTICAL Project : 672014-10 Mode : 23</p>

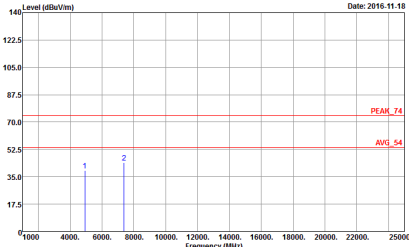
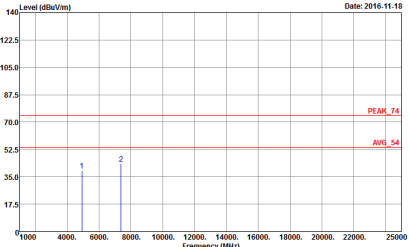

WIFI	2.4GHz 2400~2483.5MHz Harmonic @ 3m	
ANT	802.11ac VHT20 CH11 2462MHz	
1	Horizontal	Vertical
Peak Avg.	 <p>Site : 03CH12-HY Condition : PEAK_74 3m HORN_9120D_1328 HORIZONTAL Project : 672014-10 Mode : 25</p>	 <p>Site : 03CH12-HY Condition : PEAK_74 3m HORN_9120D_1328 VERTICAL Project : 672014-10 Mode : 25</p>



2.4GHz 2400~2483.5MHz

WIFI 802.11ac VHT40 (Harmonic @ 3m)

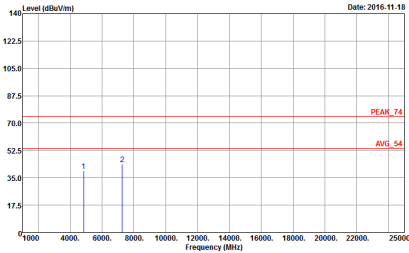
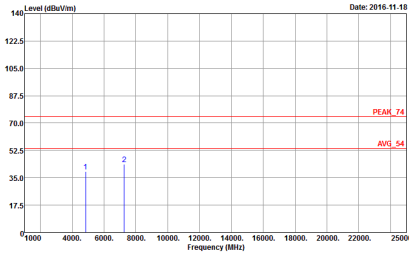
WIFI	2.4GHz 2400~2483.5MHz Harmonic @ 3m	
ANT	802.11ac VHT40 CH03 2422MHz	
1	Horizontal	Vertical
Peak Avg.	 <p>Site : 03CH12-HY Condition : PEAK_74 3m HORN_9120D_1328 HORIZONTAL Project : 672014-10 Mode : 25</p>	 <p>Site : 03CH12-HY Condition : PEAK_74 3m HORN_9120D_1328 VERTICAL Project : 672014-10 Mode : 25</p>

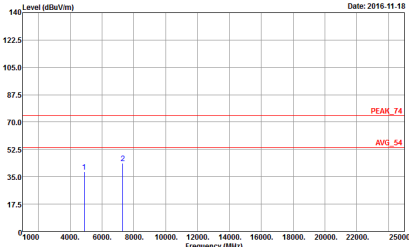
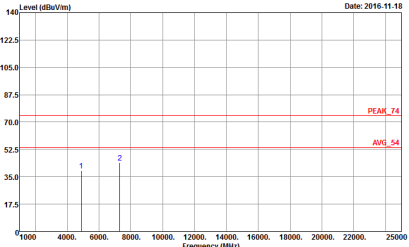

WIFI	2.4GHz 2400~2483.5MHz Harmonic @ 3m	
ANT	802.11ac VHT40 CH06 2437MHz	
1	Horizontal	Vertical
Peak Avg.	 <p>Date: 2016.11.18</p> <p>Site : 03CH12-HY Condition : PEAK_74 3m HORN_9120D_1328 HORIZONTAL Project : 672014-10 Mode : 28</p>	 <p>Date: 2016.11.18</p> <p>Site : 03CH12-HY Condition : PEAK_74 3m HORN_9120D_1328 VERTICAL Project : 672014-10 Mode : 28</p>



WIFI	2.4GHz 2400~2483.5MHz Harmonic @ 3m	
ANT	802.11ac VHT40 CH09 2452MHz	
1	Horizontal	Vertical
Peak Avg.	<p>Site : 03CH12-HY Condition : PEAK_74 3m HORN_9120D_1328 HORIZONTAL Project : 672014-10 Mode : 30</p>	<p>Site : 03CH12-HY Condition : PEAK_74 3m HORN_9120D_1328 VERTICAL Project : 672014-10 Mode : 30</p>



2.4GHz 2400~2483.5MHz

Emission below 1GHz

2.4GHz WIFI 802.11ac VHT40 (LF)

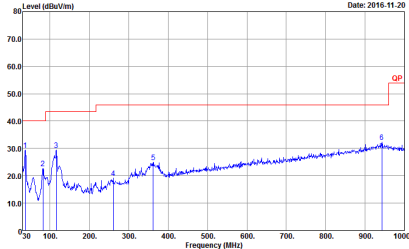
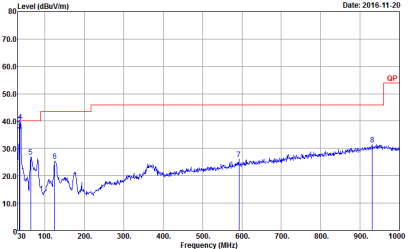
WIFI	2.4GHz 2400~2483.5MHz	
ANT	802.11ac VHT40 LF	
1	Horizontal	Vertical
<p>QP / Peak</p>	 <p>Site : 03CH12-HY Condition : QP 3m BILOG_6111D_37059 HORIZONTAL Detector : Peak Project : 672014-10 Mode : 31</p>	 <p>Site : 03CH12-HY Condition : QP 3m BILOG_6111D_37059 VERTICAL Detector : Peak Project : 672014-10 Mode : 31</p>



Appendix C. Duty Cycle Plots

Antenna	Band	Duty Cycle(%)	T(us)	1/T(kHz)	VBW Setting
1	802.11b	98.621	-	-	10Hz
1	802.11g	92.857	1430	0.70	1kHz
1	2.4GHz 802.11n HT20	92.414	1340	0.75	1kHz
1	2.4GHz 802.11n HT40	97.5	936	1.07	3kHz
1	2.4GHz 802.11ac VHT20	91.781	1340	0.75	1kHz
1	2.4GHz 802.11ac VHT40	97.531	948	1.05	3kHz



802.11b

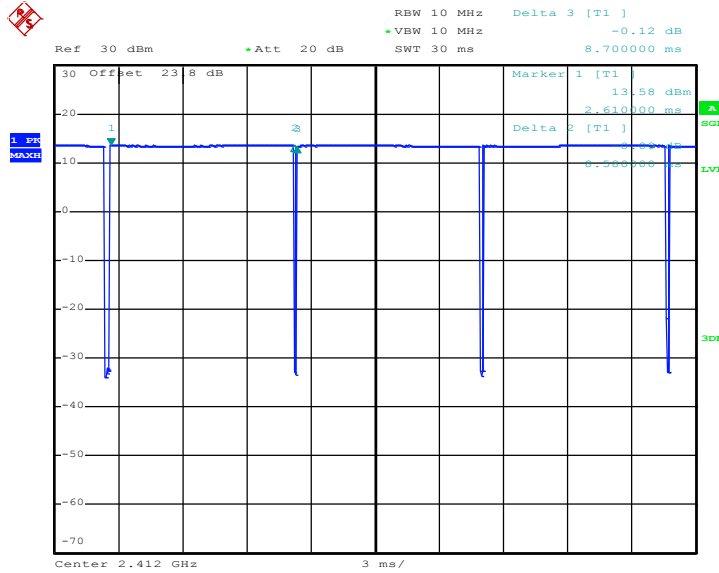

Date: 8.NOV.2016 19:59:02

802.11g

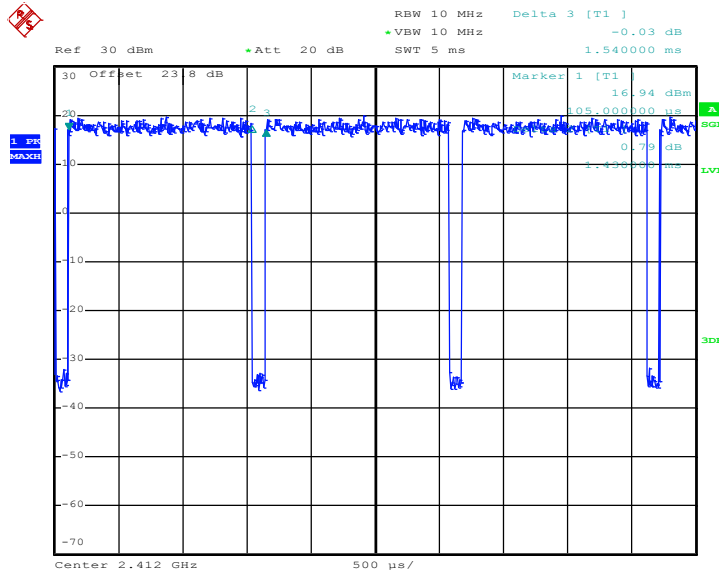

Date: 8.NOV.2016 20:08:13



802.11n HT20

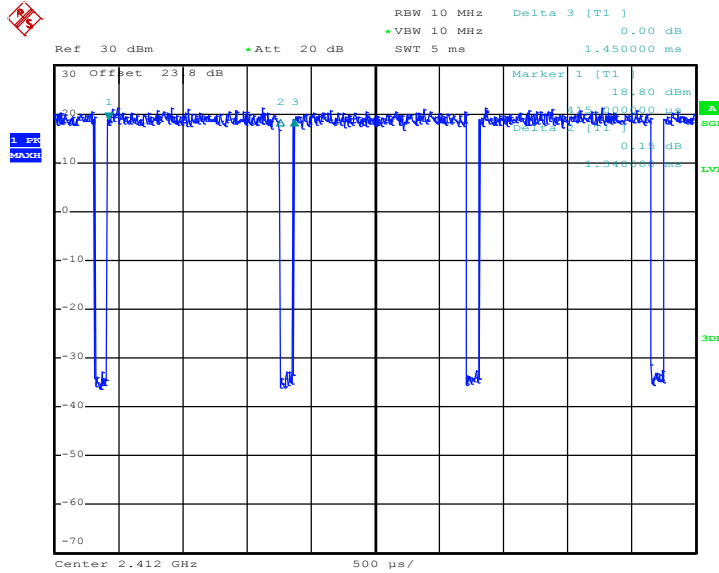

Date: 8.NOV.2016 20:13:46

802.11n HT40

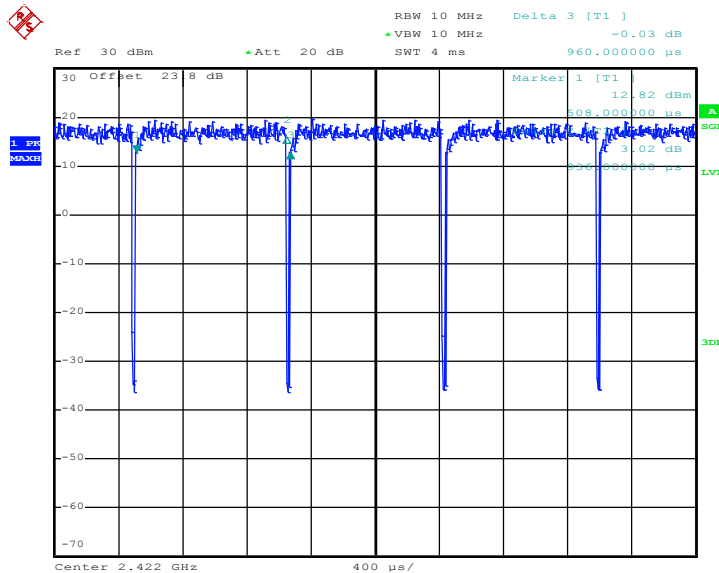

Date: 10.NOV.2016 20:39:55



802.11ac VHT20

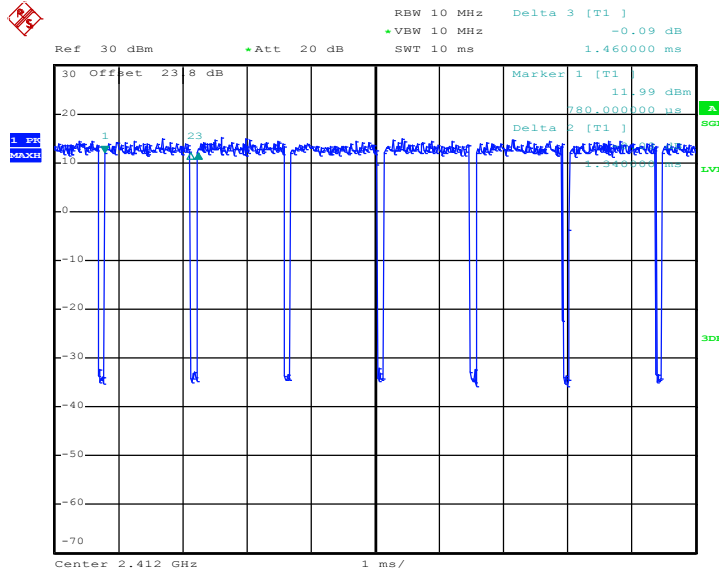

Date: 8.NOV.2016 20:33:13

802.11ac VHT40

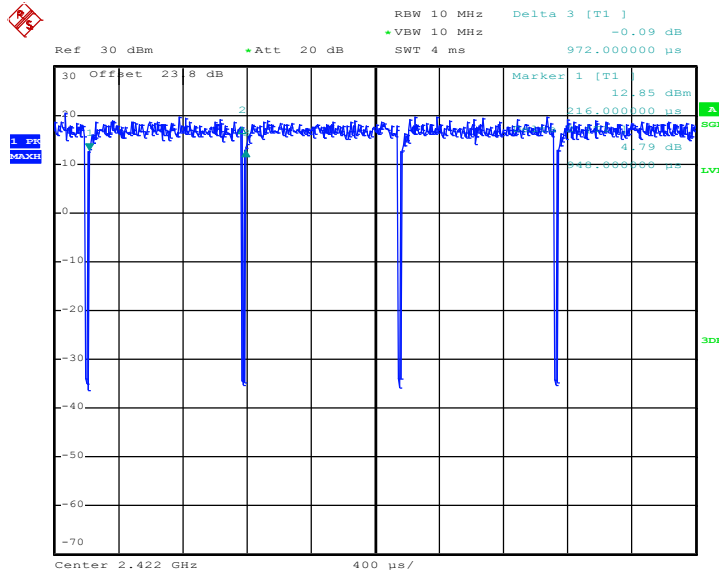

Date: 10.NOV.2016 20:27:12