



FCC RF Test Report

APPLICANT : Zebra Technologies Corporation
EQUIPMENT : Touch computer
BRAND NAME : Zebra
MODEL NAME : TC56CJ
FCC ID : UZ7TC56CJ
STANDARD : FCC Part 15 Subpart E §15.407
CLASSIFICATION : (NII) Unlicensed National Information Infrastructure

The product was received on Oct. 13, 2016 and testing was completed on Nov. 30, 2016. We, SPORTON INTERNATIONAL INC., would like to declare that the tested sample has been evaluated in accordance with the test procedures and has been in compliance with the applicable technical standards.

The test results in this report apply exclusively to the tested model / sample. Without written approval of SPORTON INTERNATIONAL INC., the test report shall not be reproduced except in full.

Reviewed by: Joseph Lin / Supervisor

Approved by: Jones Tsai / Manager



SPORTON INTERNATIONAL INC.

No. 52, Hwa Ya 1st Rd., Hwa Ya Technology Park, Kwei-Shan District, Tao Yuan City, Taiwan, R.O.C.

SPORTON INTERNATIONAL INC.

TEL : 886-3-327-3456

FAX : 886-3-328-4978

FCC ID : UZ7TC56CJ

Page Number : 1 of 35

Report Issued Date : Jan. 04, 2017

Report Version : Rev. 01

Report Template No.: BU5-FR15EWLB4 AC MA Version 1.5



TABLE OF CONTENTS

REVISION HISTORY..... 3

SUMMARY OF TEST RESULT 4

1 GENERAL DESCRIPTION 5

 1.1 Applicant 5

 1.2 Manufacturer 5

 1.3 Product Feature of Equipment Under Test 5

 1.4 Product Specification of Equipment Under Test 6

 1.5 Modification of EUT 6

 1.6 Testing Location 7

 1.7 Applicable Standards 7

2 TEST CONFIGURATION OF EQUIPMENT UNDER TEST 8

 2.1 Carrier Frequency and Channel 8

 2.2 Pre-Scanned RF Power 9

 2.3 Test Mode 11

 2.4 Connection Diagram of Test System 12

 2.5 Support Unit used in test configuration and system 13

 2.6 EUT Operation Test Setup 13

 2.7 Measurement Results Explanation Example 13

3 TEST RESULT 14

 3.1 6dB and 26dB and 99% Occupied Bandwidth Measurement 14

 3.2 Maximum Conducted Output Power Measurement 17

 3.3 Power Spectral Density Measurement 19

 3.4 Unwanted Emissions Measurement 22

 3.5 AC Conducted Emission Measurement 26

 3.6 Frequency Stability Measurement 30

 3.7 Automatically Discontinue Transmission 32

 3.8 Antenna Requirements 33

4 LIST OF MEASURING EQUIPMENT 34

5 UNCERTAINTY OF EVALUATION 35

APPENDIX A. RADIATED SPURIOUS EMISSION

APPENDIX B. RADIATED SPURIOUS EMISSION PLOTS

APPENDIX C. DUTY CYCLE PLOTS

APPENDIX D. SETUP PHOTOGRAPHS



REVISION HISTORY

REPORT NO.	VERSION	DESCRIPTION	ISSUED DATE
FR672014-10F	Rev. 01	Initial issue of report	Jan. 04, 2017



SUMMARY OF TEST RESULT

Report Section	FCC Rule	Description	Limit	Result	Remark
3.1	15.403(i)	6dB, 26dB and 99% Occupied Bandwidth	> 500kHz	Pass	-
3.2	15.407(a)	Maximum Conducted Output Power	≤ 30 dBm	Pass	-
3.3	15.407(a)	Power Spectral Density	≤ 30 dBm/500kHz	Pass	-
3.4	15.407(b)	Unwanted Emissions	15.407(b)(4)(i) & 15.209(a)	Pass	Under limit 3.07 dB at 36.210 MHz for Quasi-Peak
3.5	15.207	AC Conducted Emission	15.207(a)	Pass	Under limit 14.50 dB at 0.286 MHz
3.6	15.407(g)	Frequency Stability	Within Operation Band	Pass	-
3.7	15.407(c)	Automatically Discontinue Transmission	Discontinue Transmission	Pass	-
3.8	15.203 & 15.407(a)	Antenna Requirement	N/A	Pass	-



1 General Description

1.1 Applicant

Zebra Technologies Corporation
1 Zebra Plaza Holtsville, NY 11742

1.2 Manufacturer

Wistron Corporation
21F, No. 88, Sec. 1, Hsin Tai Wu Rd., Hsichih Dist, New Taipei City 221, Taiwan R.O.C.

1.3 Product Feature of Equipment Under Test

Product Feature	
Equipment	Touch computer
Brand Name	Zebra
Model Name	TC56CJ
FCC ID	UZ7TC56CJ
EUT supports Radios application	CDMA/EV-DO/GSM/EGPRS/WCDMA/HSPA/LTE/NFC WLAN 11a/b/g/n HT20/HT40 WLAN 11ac VHT20/VHT40/VHT80 Bluetooth BR/EDR/LE
HW Version	DV1
SW Version	91-12-04.4-MG-00
FW Version	FUSION_BA_2_00.0.0.022
MFD	17OCT16
EUT Stage	Engineering sample

Remark: The above EUT's information was declared by manufacturer. Please refer to the specifications or user's manual for more detailed description.

Specification of Accessories				
Adapter (5V/2.5A)	Brand Name	Zebra	Model Number	SAWA-65-20005A
Headset Jumper 1	Brand Name	Zebra	Part Number	CBL-TC51-HDST25-01
Headset Jumper 2	Brand Name	Zebra	Part Number	CBL-TC51-HDST35-01
Battery	Brand Name	Zebra	Model Number	BT-000314
2.5mm Earphone	Brand Name	Zebra	Part Number	HDST-25MM-PTVP-01
3.5mm Earphone	Brand Name	Zebra	Part Number	HDST-35MM-PTVP-01
Trigger Handle	Brand Name	Zebra	Part Number	TRG-TC51-SNP1-01
Rugged Charge/USB cable	Brand Name	Zebra	Part Number	CBL-TC51-USB1-01
Soft Holster	Brand Name	Zebra	Part Number	SG-TC51-HLSTR1-01
Exoskeleton	Brand Name	Zebra	Part Number	SG-TC51-EX01-01
Hand strap	Brand Name	Zebra	Part Number	SG-TC51-BHDSTP1-03



1.4 Product Specification of Equipment Under Test

Standards-related Product Specification	
Tx/Rx Channel Frequency Range	5745 MHz ~ 5825 MHz
Maximum Output Power	802.11a : 16.59 dBm / 0.0456 W 802.11n HT20 : 16.54 dBm / 0.0451 W 802.11n HT40 : 16.04 dBm / 0.0402 W 802.11ac VHT20: 16.59 dBm / 0.0456 W 802.11ac VHT40: 16.09 dBm / 0.0406 W 802.11ac VHT80: 14.93 dBm / 0.0311 W
99% Occupied Bandwidth	802.11a : 18.80 MHz 802.11ac VHT20 : 18.80 MHz 802.11ac VHT40 : 36.90 MHz 802.11ac VHT80 : 75.96 MHz
Type of Modulation	802.11a/n : OFDM (BPSK / QPSK / 16QAM / 64QAM) 802.11ac : OFDM (BPSK / QPSK / 16QAM / 64QAM / 256QAM)
Antenna Type / Gain	Loop Antenna with gain 3.30 dBi

1.5 Modification of EUT

No modifications are made to the EUT during all test items.



1.6 Testing Location

Sporton Lab is accredited to ISO 17025 by Taiwan Accreditation Foundation (TAF code : 1190) and the FCC designation No. TW1022 under the FCC 2.948(e) by Mutual Recognition Agreement (MRA) in FCC Test.

Test Site	SPORTON INTERNATIONAL INC.	
Test Site Location	No. 52, Hwa Ya 1 st Rd., Hwa Ya Technology Park, Kwei-Shan District, Tao Yuan City, Taiwan, R.O.C. TEL: +886-3-327-3456 FAX: +886-3-328-4978	
Test Site No.	Sporton Site No.	
	TH05-HY	CO05-HY

Note: The test site complies with ANSI C63.4 2014 requirement.

Test Site	SPORTON INTERNATIONAL INC.	
Test Site Location	No.58, Aly. 75, Ln. 564, Wenhua 3rd Rd. Guishan Dist, Taoyuan City, Taiwan (R.O.C.) TEL: +886-3-327-0868 FAX: +886-3-327-0855	
Test Site No.	Sporton Site No.	
	03CH12-HY	

Note: The test site complies with ANSI C63.4 2014 requirement.

1.7 Applicable Standards

According to the specifications of the manufacturer, the EUT must comply with the requirements of the following standards:

- ♦ FCC Part 15 Subpart E
- ♦ FCC KDB 789033 D02 General UNII Test Procedures New Rules v01r03
- ♦ FCC KDB 644545 D03 Guidance for IEEE 802 11ac New Rules v01
- ♦ ANSI C63.10-2013

Remark:

1. All test items were verified and recorded according to the standards and without any deviation during the test.
2. This EUT has also been tested and complied with the requirements of FCC Part 15, Subpart B, recorded in a separate test report.



2 Test Configuration of Equipment Under Test

The EUT has been associated with peripherals and configuration operated in a manner tended to maximize its emission characteristics in a typical application. Frequency range investigated: conducted emission (150 kHz to 30 MHz) and radiated emission (9 kHz to the 10th harmonic of the highest fundamental frequency or to 40 GHz, whichever is lower). For radiated measurement, pre-scanned in three orthogonal panels, X, Y, Z. The worst cases (X plane) were recorded in this report.

2.1 Carrier Frequency and Channel

Frequency Band	Channel	Freq. (MHz)	Channel	Freq. (MHz)
5725-5850 MHz Band 4 (U-NII-3)	149	5745	157	5785
	151*	5755	159*	5795
	153	5765	161	5805
	155#	5775	165	5825

Note:

1. The above Frequency and Channel in "*" were 802.11n HT40 and 802.11ac VHT40.
2. The above Frequency and Channel in "#n" were 802.11ac VHT80.



2.2 Pre-Scanned RF Power

Preliminary tests were performed in different data rate and data rate associated with the highest power were chosen for full test in the following tables. Final Output Power equals to Measured Output Power adds the duty factor.

802.11a mode										
Power vs. Channel			Power vs. Data Rate							
Channel	Frequency (MHz)	Data Rate (bps)	Channel	Data Rate (bps)						
		6M		9M	12M	18M	24M	36M	48M	54M
CH 149	5745 MHz	16.45	CH 157	16.58	16.53	16.56	16.52	16.56	16.58	16.55
CH 157	5785 MHz	16.59								
CH 165	5825 MHz	16.58								

802.11n HT20 mode										
Power vs. Channel			Power vs. Data Rate							
Channel	Frequency (MHz)	MCS Index	Channel	MCS Index						
		MCS0		MCS1	MCS2	MCS3	MCS4	MCS5	MCS6	MCS7
CH 149	5745 MHz	16.54	CH 149	16.48	16.37	16.39	16.42	16.48	16.50	16.45
CH 157	5785 MHz	16.52								
CH 165	5825 MHz	16.45								

802.11n HT40 mode										
Power vs. Channel			Power vs. Data Rate							
Channel	Frequency (MHz)	MCS Index	Channel	MCS Index						
		MCS0		MCS1	MCS2	MCS3	MCS4	MCS5	MCS6	MCS7
CH 151	5755 MHz	16.04	CH 151	15.80	15.78	15.75	15.87	15.83	15.86	15.96
CH 159	5795 MHz	16.01								

802.11ac VHT20 mode											
Power vs. Channel			Power vs. Data Rate								
Channel	Frequency (MHz)	MCS Index	Channel	MCS Index							
		MCS0		MCS1	MCS2	MCS3	MCS4	MCS5	MCS6	MCS7	MCS8
CH 149	5745 MHz	16.59	CH 149	16.58	16.50	16.55	16.57	16.54	16.55	16.51	16.58
CH 157	5785 MHz	16.54									
CH 165	5825 MHz	16.49									



802.11ac VHT40 mode												
Power vs. Channel			Power vs. Data Rate									
Channel	Frequency (MHz)	MCS Index	Channel	MCS Index								
		MCS0		MCS1	MCS2	MCS3	MCS4	MCS5	MCS6	MCS7	MCS8	MCS9
CH 151	5755 MHz	16.09	CH 151	15.93	15.98	15.82	15.95	16.00	16.07	16.06	16.02	16.02
CH 159	5795 MHz	16.03										

802.11ac VHT80 mode												
Power vs. Channel			Power vs. Data Rate									
Channel	Frequency (MHz)	MCS Index	Channel	MCS Index								
		MCS0		MCS1	MCS2	MCS3	MCS4	MCS5	MCS6	MCS7	MCS8	MCS9
CH 155	5775MHz	14.93	CH 155	14.62	14.73	14.87	14.93	14.85	14.88	14.84	14.87	14.90



2.3 Test Mode

Final test mode of conducted test items and radiated spurious emissions are considering the modulation and worse data rates from the power table described in section 2.2.

Modulation	Data Rate
802.11a	6 Mbps
802.11n HT20	MCS0
802.11n HT40	MCS0
802.11ac VHT20	MCS0
802.11ac VHT40	MCS0
802.11ac VHT80	MCS0

AC Conducted Emission	<p>Mode 1 : GSM850 Idle + WLAN (5GHz) Link + Bluetooth Link + NFC active + Battery + Scanner + without Exoskeleton + Rugged Charge/USB cable + Adapter (SAWA-65-20005A (5V/2.5A)) + Headset Jumper (CBL-TC51-HDST25-01) + Earphone (HDST-25MM-PTVP-01)</p>
------------------------------	--

Ch. #		Band IV : 5725-5850 MHz		
		802.11a	802.11n HT20	802.11n HT40
L	Low	149	149	151
M	Middle	157	157	-
H	High	165	165	159

Ch. #		Band IV : 5725-5850 MHz		
		802.11ac VHT20	802.11ac VHT40	802.11ac VHT80
L	Low	149	151	-
M	Middle	157	-	155
H	High	165	159	-

2.4 Connection Diagram of Test System

<WLAN Tx Mode>

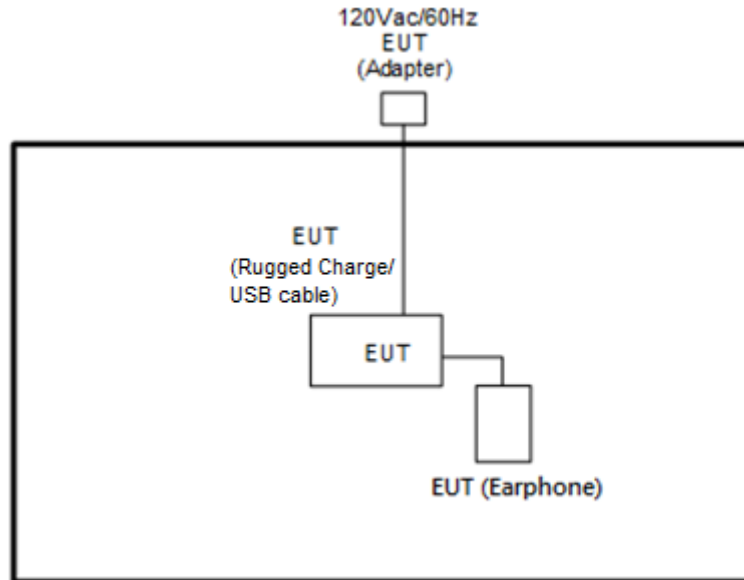

<AC Conducted Emission Mode>

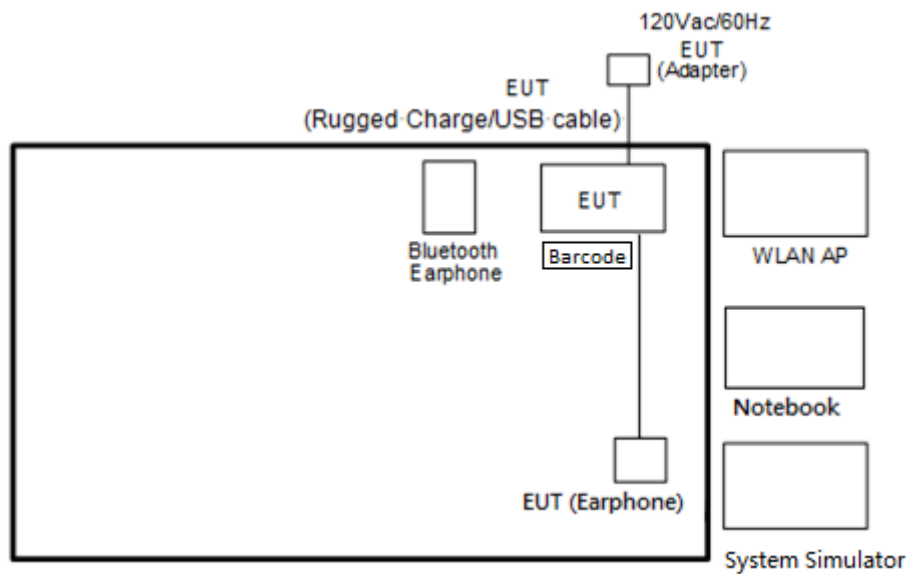



2.5 Support Unit used in test configuration and system

Item	Equipment	Trade Name	Model Name	FCC ID	Data Cable	Power Cord
1.	System Simulator	Anritsu	MT8820C	N/A	N/A	Unshielded, 1.8 m
2.	Bluetooth Earphone	Sony Ericsson	MW600	PY7DDA-2029	N/A	N/A
3.	WLAN AP	ASUS	RT-AC66U	MSQ-RTAC66U	N/A	Unshielded, 1.8 m
4.	Notebook	DELL	Latitude E6320	FCC DoC/ Contains FCC ID: QDS-BRCM1054	N/A	AC I/P: Unshielded, 1.2 m DC O/P: Shielded, 1.8 m
5.	SD Card	SanDisk	MicroSD HC	FCC DoC	N/A	N/A
6.	Barcode	N/A	N/A	N/A	N/A	N/A

2.6 EUT Operation Test Setup

For WLAN function, programmed RF utility, “ADB” installed in the notebook make the EUT provide functions like channel selection and power level for continuous transmitting and receiving signals.

2.7 Measurement Results Explanation Example

For all conducted test items:

The offset level is set in the spectrum analyzer to compensate the RF cable loss and attenuator factor between EUT conducted output port and spectrum analyzer. With the offset compensation, the spectrum analyzer reading level is exactly the EUT RF output level.

Example :

The spectrum analyzer offset is derived from RF cable loss and attenuator factor.

Offset = RF cable loss + attenuator factor.

Following shows an offset computation example with cable loss 4.2 dB and 10dB attenuator.

$$\begin{aligned}
 \text{Offset(dB)} &= \text{RF cable loss(dB)} + \text{attenuator factor(dB)}. \\
 &= 4.2 + 10 = 14.2 \text{ (dB)}
 \end{aligned}$$

3 Test Result

3.1 6dB and 26dB and 99% Occupied Bandwidth Measurement

3.1.1 Description of 6dB and 26dB and 99% Occupied Bandwidth

The minimum 6 dB bandwidth shall be at least 500 kHz.

26dB and 99% Occupied bandwidth are reporting only.

3.1.2 Measuring Instruments

The measuring equipment is listed in the section 4 of this test report.

3.1.3 Test Procedures

1. The testing follows FCC KDB 789033 D02 General UNII Test Procedures New Rules v01r03.
Section C) Emission bandwidth for the band 5.725-5.85GHz
2. Set RBW = 100kHz.
3. Set the VBW $\geq 3 \times$ RBW.
4. Detector = Peak.
5. Trace mode = max hold
6. Measure the maximum width of the emission that is 6 dB down from the peak of the emission.
7. Measure and record the results in the test report.

3.1.4 Test Setup

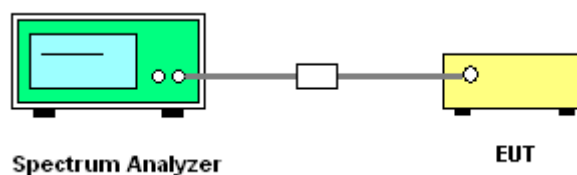



3.1.5 Test Result of 6dB Bandwidth

Band IV									
Mod.	Data Rate	NTX	CH.	Freq. (MHz)	99% Bandwidth (MHz)	26 dB Bandwidth (MHz)	6 dB Bandwidth (MHz)	6dB Bandwidth min. Limit (MHz)	Pass/Fail
11a	6M bps	1	149	5745	18.75	33.3	16.32	0.5	Pass
11a	6Mbps	1	157	5785	18.8	30.5	16.32	0.5	Pass
11a	6Mbps	1	165	5825	18.6	35.2	16.32	0.5	Pass
VHT20	MCS 0	1	149	5745	18.6	27.5	16.32	0.5	Pass
VHT20	MCS 0	1	157	5785	18.45	27.9	16.32	0.5	Pass
VHT20	MCS 0	1	165	5825	18.8	35.2	16.32	0.5	Pass
VHT40	MCS 0	1	151	5755	36.9	58.32	36.32	0.5	Pass
VHT40	MCS 0	1	159	5795	36.9	72.18	36.32	0.5	Pass
VHT80	MCS 0	1	155	5775	75.96	82.24	75.52	0.5	Pass

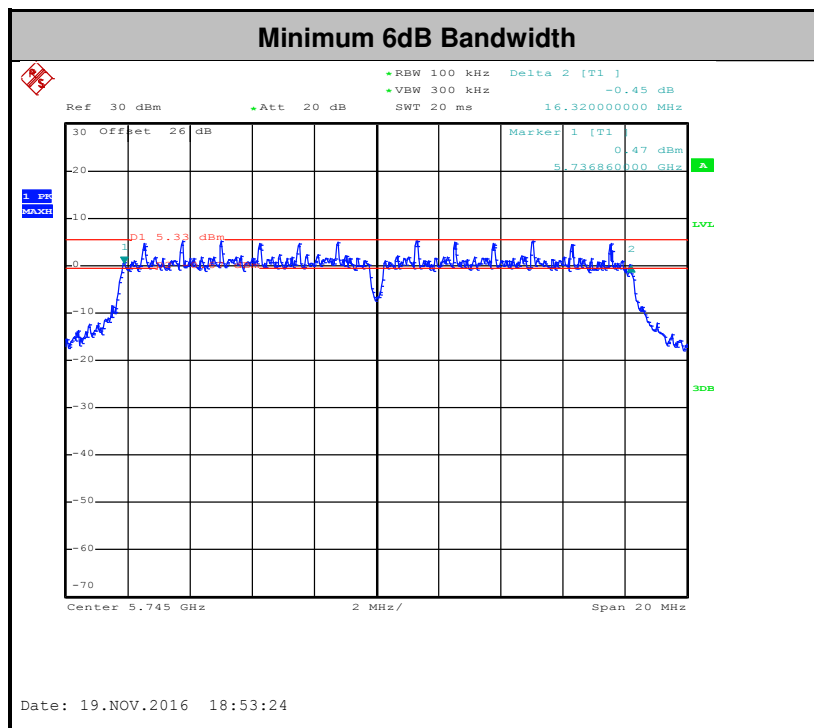

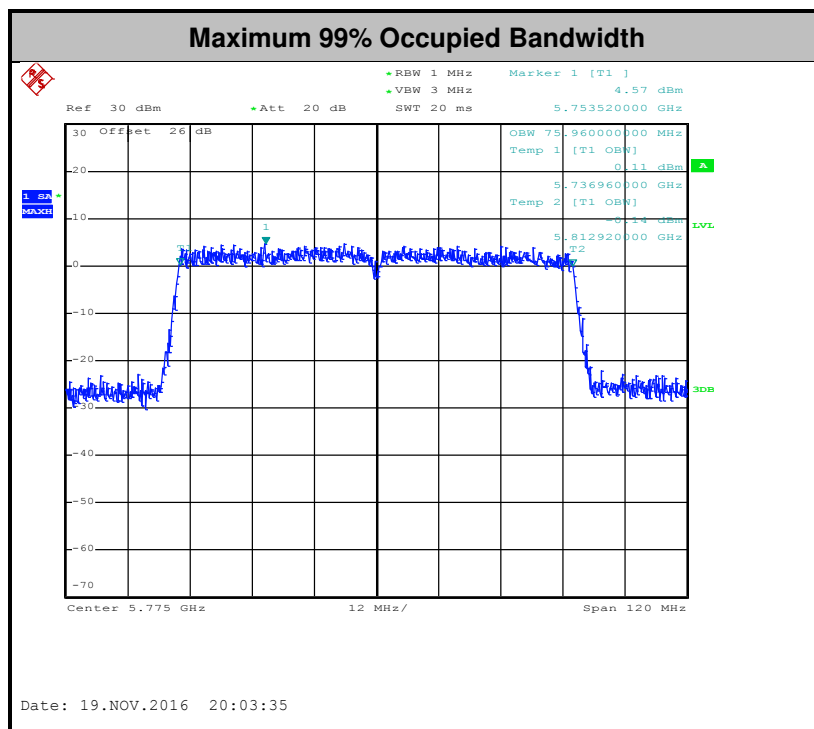
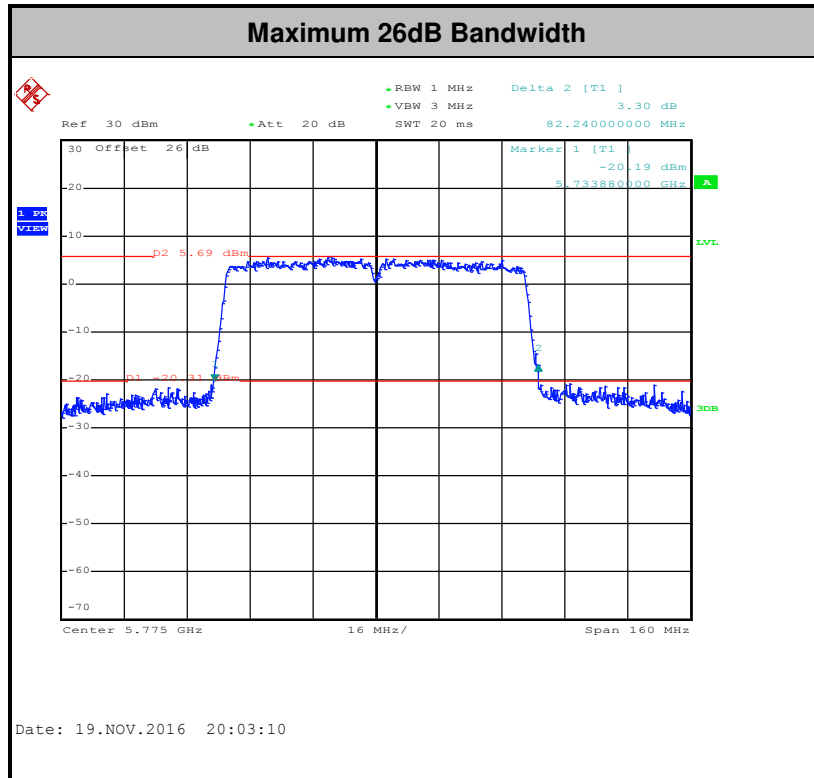

Note: The occupied channel bandwidth is maintained within the band of operation for all of the modulations.

3.2 Maximum Conducted Output Power Measurement

3.2.1 Limit of Maximum Conducted Output Power

For the band 5.725–5.85 GHz, the maximum conducted output power over the frequency band of operation shall not exceed 1 W.

If transmitting antennas of directional gain greater than 6 dBi are used, the peak output power shall be reduced by the amount in dB that the directional gain of the antenna exceeds 6 dBi.

3.2.2 Measuring Instruments

The measuring equipment is listed in the section 4 of this test report.

3.2.3 Test Procedures

The testing follows Method PM of FCC KDB 789033 D02 General UNII Test Procedures New Rules v01r03.

Method PM (Measurement using an RF average power meter):

1. Measurement is performed using a wideband RF power meter.
2. The EUT is configured to transmit continuously with a consistent duty cycle at its maximum power control level.
3. Measure the average power of the transmitter, and the average power is corrected with duty factor, $10 \log(1/x)$, where x is the duty cycle.

3.2.4 Test Setup

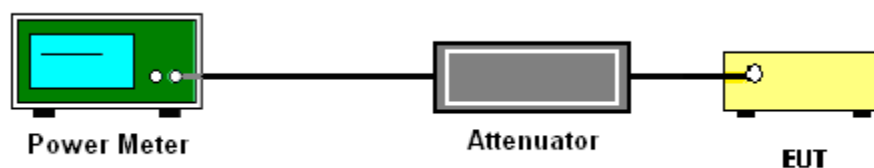



3.2.5 Test Result of Maximum Conducted Output Power

Band IV									
Mod.	Data Rate	NTX	CH.	Freq. (MHz)	Duty Factor (dB)	Average Conducted Power (dBm)	FCC Conducted Power Limit (dBm)	DG (dBi)	Pass/Fail
11a	6M bps	1	149	5745	0.29	16.45	30.00	3.30	Pass
11a	6Mbps	1	157	5785	0.29	16.59	30.00	3.30	Pass
11a	6Mbps	1	165	5825	0.29	16.58	30.00	3.30	Pass
HT20	MCS 0	1	149	5745	0.34	16.54	30.00	3.30	Pass
HT20	MCS 0	1	157	5785	0.34	16.52	30.00	3.30	Pass
HT20	MCS 0	1	165	5825	0.34	16.45	30.00	3.30	Pass
HT40	MCS 0	1	151	5755	0.14	16.04	30.00	3.30	Pass
HT40	MCS 0	1	159	5795	0.14	16.01	30.00	3.30	Pass
VHT20	MCS 0	1	149	5745	0.34	16.59	30.00	3.30	Pass
VHT20	MCS 0	1	157	5785	0.34	16.54	30.00	3.30	Pass
VHT20	MCS 0	1	165	5825	0.34	16.49	30.00	3.30	Pass
VHT40	MCS 0	1	151	5755	0.14	16.09	30.00	3.30	Pass
VHT40	MCS 0	1	159	5795	0.14	16.03	30.00	3.30	Pass
VHT80	MCS 0	1	155	5775	0.18	14.93	30.00	3.30	Pass



3.3 Power Spectral Density Measurement

3.3.1 Limit of Power Spectral Density

For the band 5.725–5.85 GHz, the maximum power spectral density shall not exceed 30 dBm in any 500-kHz band.

If transmitting antennas of directional gain greater than 6 dBi are used, the peak output power shall be reduced by the amount in dB that the directional gain of the antenna exceeds 6 dBi.

3.3.2 Measuring Instruments

The measuring equipment is listed in the section 4 of this test report.

3.3.3 Test Procedures

The testing follows FCC KDB 789033 D02 General UNII Test Procedures New Rules v01r03. Section F) Maximum power spectral density.

Method SA-2

(trace averaging across on and off times of the EUT transmissions, followed by duty cycle correction).

- Measure the duty cycle.
 - Set span to encompass the entire emission bandwidth (EBW) of the signal.
 - Set RBW = 300 kHz.
 - Set VBW \geq 1 MHz.
 - Number of points in sweep \geq 2 Span / RBW.
 - Sweep time = auto.
 - Detector = RMS
 - Trace average at least 100 traces in power averaging mode.
 - Add $10 \log(500\text{kHz}/\text{RBW})$ to the test result.
 - Add $10 \log(1/x)$, where x is the duty cycle, to the measured power in order to compute the average power during the actual transmission times. For example, add $10 \log(1/0.25) = 6$ dB if the duty cycle is 25 percent.
1. The RF output of EUT was connected to the spectrum analyzer by a low loss cable.
 2. Each plot has already offset with cable loss, and attenuator loss. Measure the PPSD and record it.

3.3.4 Test Setup

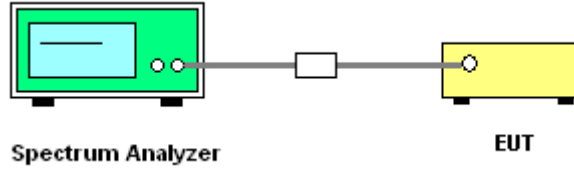

3.3.5 Test Result of Power Spectral Density

Band IV										
Mod.	Data Rate	NTX	CH.	Freq. (MHz)	Duty Factor (dB)	10log (500kHz /RBW) Factor (dB)	Average Power Density (dBm/500kHz)	Average PSD Limit (dBm/500kHz)	DG (dBi)	Pass/Fail
11a	6M bps	1	149	5745	0.29	2.22	2.16	30.00	3.30	Pass
11a	6Mbps	1	157	5785	0.29	2.22	1.57	30.00	3.30	Pass
11a	6Mbps	1	165	5825	0.29	2.22	1.69	30.00	3.30	Pass
VHT20	MCS 0	1	149	5745	0.34	2.22	1.95	30.00	3.30	Pass
VHT20	MCS 0	1	157	5785	0.34	2.22	1.71	30.00	3.30	Pass
VHT20	MCS 0	1	165	5825	0.34	2.22	1.92	30.00	3.30	Pass
VHT40	MCS 0	1	151	5755	0.14	2.22	-2.03	30.00	3.30	Pass
VHT40	MCS 0	1	159	5795	0.14	2.22	-2.08	30.00	3.30	Pass
VHT80	MCS 0	1	155	5775	0.18	2.22	-6.02	30.00	3.30	Pass

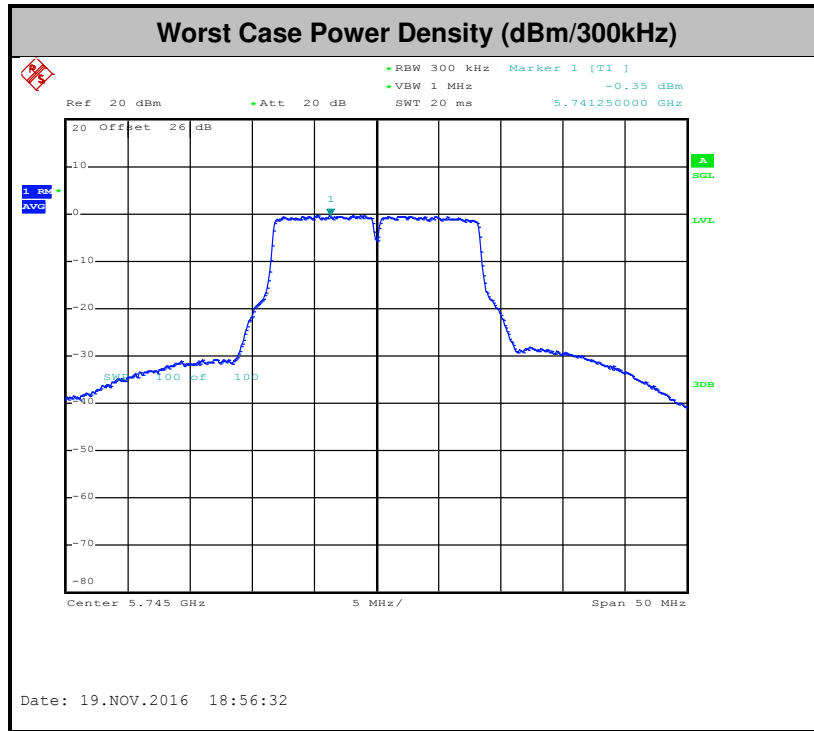



3.4 Unwanted Emissions Measurement

This section as specified in FCC Part 15.407(b) is to measure unwanted emissions through radiated measurement for band edge spurious emissions and out of band emissions measurement. The unwanted emissions shall comply with 15.407(b)(1) to (6), and restricted bands per FCC Part15.205.

3.4.1 Limit of Unwanted Emissions

(1) For transmitters operating in the 5.725-5.85 GHz band:

15.407(b)(4)(i) All emissions shall be limited to a level of -27 dBm/MHz at 75 MHz or more above or below the band edge increasing linearly to 10 dBm/MHz at 25 MHz above or below the band edge, and from 25 MHz above or below the band edge increasing linearly to a level of 15.6 dBm/MHz at 5 MHz above or below the band edge, and from 5 MHz above or below the band edge increasing linearly to a level of 27 dBm/MHz at the band edge.

(2) Unwanted spurious emissions fallen in restricted bands per FCC Part15.205 shall comply with the general field strength limits set forth in § 15.209 as below table,

Frequency (MHz)	Field Strength (microvolts/meter)	Measurement Distance (meters)
0.009 – 0.490	2400/F(kHz)	300
0.490 – 1.705	24000/F(kHz)	30
1.705 – 30.0	30	30
30 – 88	100	3
88 – 216	150	3
216 - 960	200	3
Above 960	500	3

Note: The following formula is used to convert the EIRP to field strength.

$$E = \frac{1000000\sqrt{30P}}{3} \text{ } \mu\text{V/m, where P is the eirp (Watts)}$$

EIRP (dBm)	Field Strength at 3m (dBμV/m)
-17	78.3
-27	68.3

(3) KDB 789033 D02 General UNII Test Procedures New Rules v01r03 G)2)c) As specified in 15.407(b), emissions above 1000 MHz that are outside of the restricted bands are subject to a peak emission limit of -27 dBm/MHz (or -17 dBm/MHz as specified in 15.407(b)(4)). However, an out-of-band emission that complies with both the average and peak limits of 15.209 is not required to satisfy the -27 dBm/MHz or -17 dBm/MHz peak emission limit.



3.4.2 Measuring Instruments

The measuring equipment is listed in the section 4 of this test report.

3.4.3 Test Procedures

1. The testing follows FCC KDB 789033 D02 General UNII Test Procedures New Rules v01r03. Section G) Unwanted emissions measurement.
 - (1) Procedure for Unwanted Emissions Measurements Below 1000MHz
 - RBW = 120 kHz
 - VBW = 300 kHz
 - Detector = Peak
 - Trace mode = max hold
 - (2) Procedure for Peak Unwanted Emissions Measurements Above 1000 MHz
 - RBW = 1 MHz
 - VBW \geq 3 MHz
 - Detector = Peak
 - Sweep time = auto
 - Trace mode = max hold
 - (3) Procedures for Average Unwanted Emissions Measurements Above 1000MHz
 - RBW = 1 MHz
 - VBW = 10 Hz, when duty cycle is no less than 98 percent.
 - VBW \geq 1/T, when duty cycle is less than 98 percent where T is the minimum transmission duration over which the transmitter is on and is transmitting at its maximum power control level for the tested mode of operation.
2. The EUT was placed on a turntable with 0.8 meter for frequency below 1GHz and 1.5 meter for frequency above 1GHz respectively above ground.
3. The EUT was set 3 meters from the interference receiving antenna which was mounted on the top of a variable height antenna tower.
4. The antenna is a broadband antenna and its height is adjusted between one meter and four meters above ground to find the maximum value of the field strength for both horizontal polarization and vertical polarization of the antenna.
5. For each suspected emission, the EUT was arranged to its worst case and then adjust the antenna tower (from 1 m to 4 m) and turntable (from 0 degree to 360 degrees) to find the maximum reading.
6. For testing below 1GHz, if the emission level of the EUT in peak mode was 3 dB lower than the limit specified, then peak values of EUT will be reported, otherwise, the emissions will be

repeated one by one using the CISPR quasi-peak method and reported.

- 7. For testing above 1GHz, the emission level of the EUT in peak mode was 20dB lower than average limit (that means the emission level in average mode also complies with the limit in average mode), then peak values of EUT will be reported, otherwise, the emissions will be measured in average mode again and reported.

3.4.4 Test Setup

For radiated emissions below 30MHz

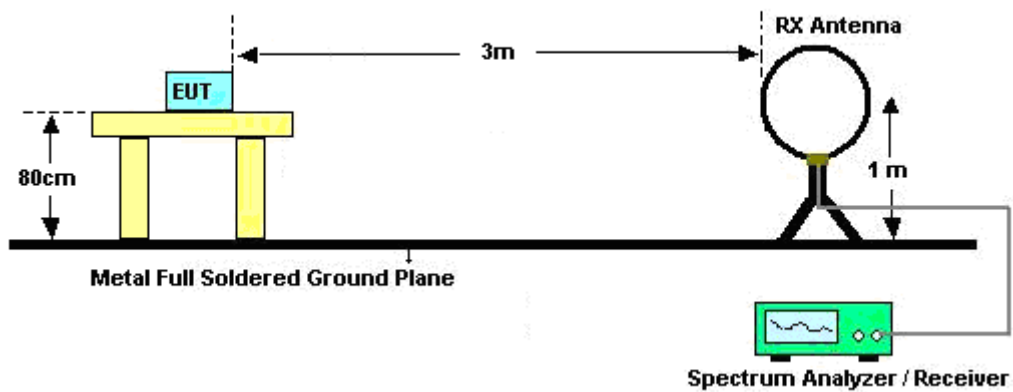

For radiated emissions from 30MHz to 1GHz

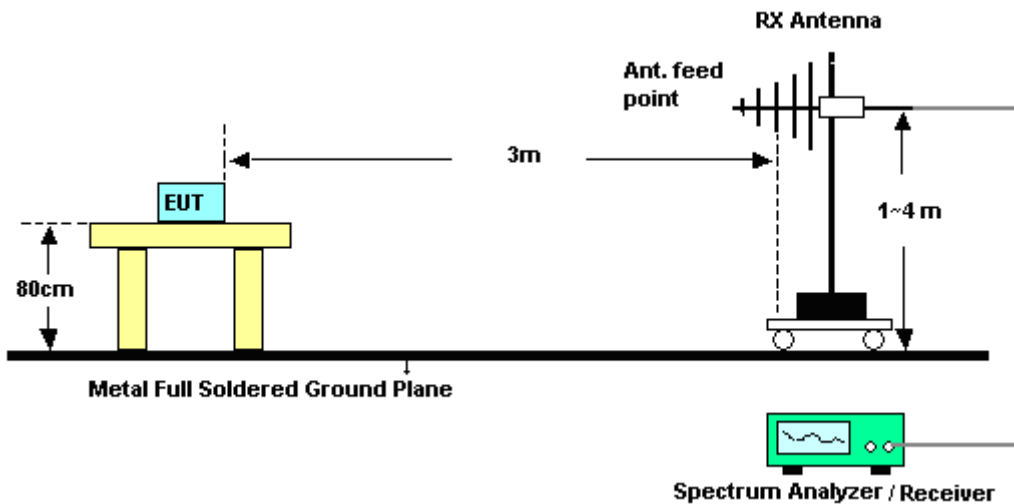

For radiated emissions above 1GHz

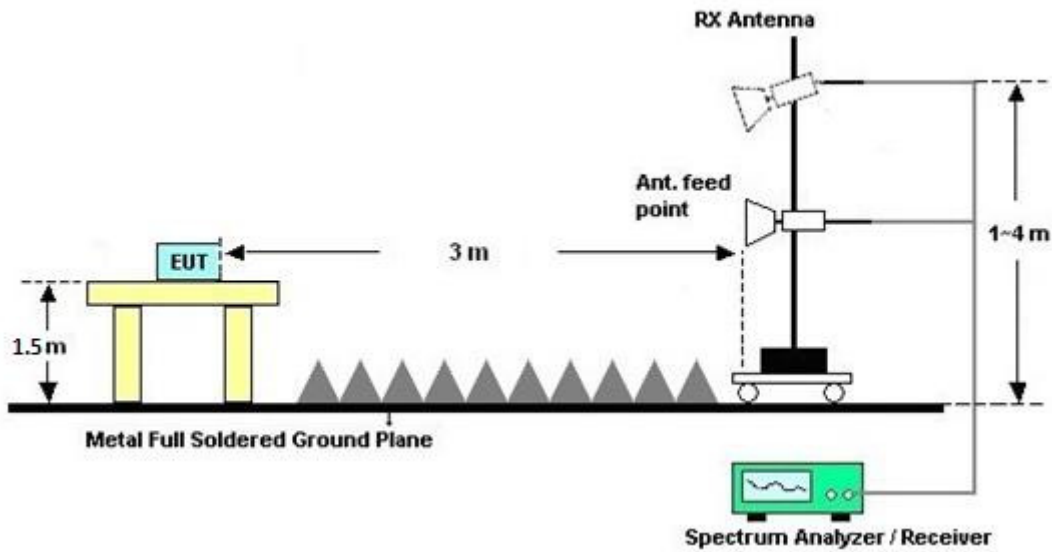

3.4.5 Test Results of Radiated Spurious Emissions (9 kHz ~ 30 MHz)

The low frequency, which started from 9 kHz to 30MHz, was pre-scanned and the result which was 20dB lower than the limit line per 15.31(o) was not reported.

3.4.6 Test Result of Radiated Spurious at Band Edges

Please refer to Appendix A and B.

3.4.7 Duty Cycle

Please refer to Appendix C.

3.4.8 Test Result of Radiated Spurious Emissions (30MHz ~ 10th Harmonic)

Please refer to Appendix A and B.



3.5 AC Conducted Emission Measurement

3.5.1 Limit of AC Conducted Emission

For equipment that is designed to be connected to the public utility (AC) power line, the radio frequency voltage that is conducted back onto the AC power line on any frequency or frequencies within the band 150 kHz to 30 MHz shall not exceed the limits in the following table.

Frequency of emission (MHz)	Conducted limit (dBµV)	
	Quasi-peak	Average
0.15-0.5	66 to 56*	56 to 46*
0.5-5	56	46
5-30	60	50

*Decreases with the logarithm of the frequency.

3.5.2 Measuring Instruments

The measuring equipment is listed in the section 4 of this test report.

3.5.3 Test Procedures

1. The EUT was placed 0.4 meter from the conducting wall of the shielding room was kept at least 80 centimeters from any other grounded conducting surface.
2. Connect EUT to the power mains through a line impedance stabilization network (LISN).
3. All the support units are connecting to the other LISN.
4. The LISN provides 50 ohm coupling impedance for the measuring instrument.
5. The FCC states that a 50 ohm, 50 microhenry LISN should be used.
6. Both sides of AC line were checked for maximum conducted interference.
7. The frequency range from 150 kHz to 30 MHz was searched.
8. Set the test-receiver system to Peak Detect Function and specified bandwidth with Maximum Hold Mode.

3.5.4 Test Setup

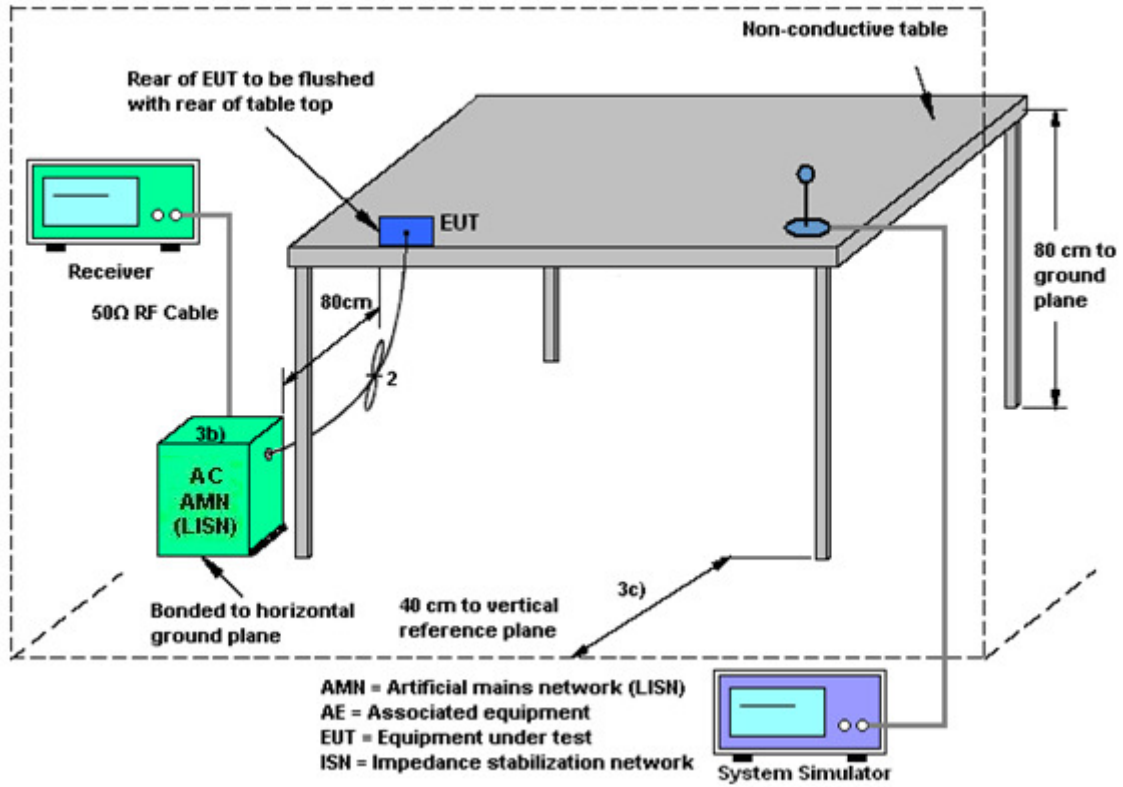

3.5.5 Test Result of AC Conducted Emission

Test Mode :	Mode 1	Temperature :	23~24°C
Test Engineer :	Arthur Hsieh	Relative Humidity :	51~52%
Test Voltage :	120Vac / 60Hz	Phase :	Line
Function Type :	GSM850 Idle + WLAN (5GHz) Link + Bluetooth Link + NFC active + Battery + Scanner + without Exoskeleton + Rugged Charge/USB cable + Adapter (SAWA-65-20005A (5V/2.5A)) + Headset Jumper (CBL-TC51-HDST25-01) + Earphone (HDST-25MM-PTVP-01)		

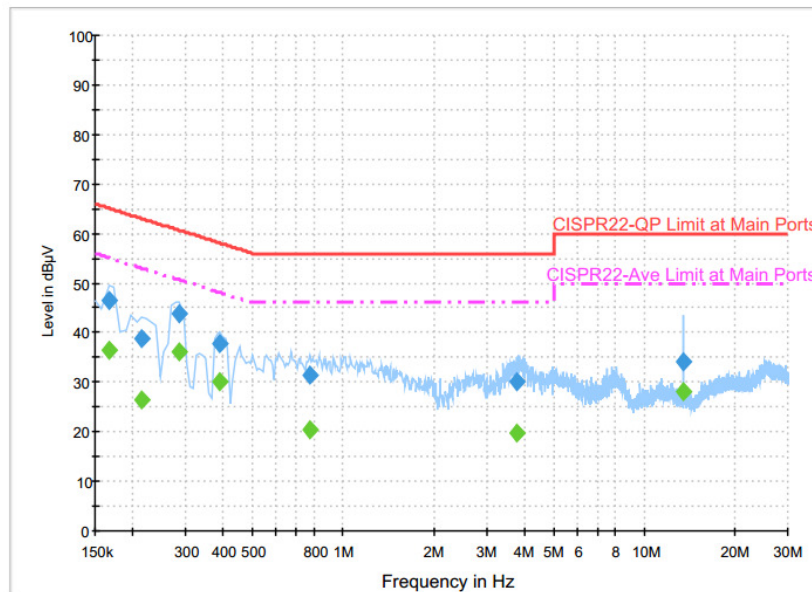

Final Result : QuasiPeak

Frequency (MHz)	QuasiPeak (dBµV)	Filter	Line	Corr. (dB)	Margin (dB)	Limit (dBµV)
0.166000	46.5	Off	L1	19.6	18.7	65.2
0.214000	38.8	Off	L1	19.6	24.2	63.0
0.286000	43.9	Off	L1	19.6	16.7	60.6
0.390000	37.9	Off	L1	19.6	20.2	58.1
0.774000	31.5	Off	L1	19.6	24.5	56.0
3.782000	30.1	Off	L1	19.8	25.9	56.0
13.558000	34.1	Off	L1	20.3	25.9	60.0

Final Result : Average

Frequency (MHz)	Average (dBµV)	Filter	Line	Corr. (dB)	Margin (dB)	Limit (dBµV)
0.166000	36.5	Off	L1	19.6	18.7	55.2
0.214000	26.5	Off	L1	19.6	26.5	53.0
0.286000	36.1	Off	L1	19.6	14.5	50.6
0.390000	30.2	Off	L1	19.6	17.9	48.1
0.774000	20.5	Off	L1	19.6	25.5	46.0
3.782000	19.7	Off	L1	19.8	26.3	46.0
13.558000	28.0	Off	L1	20.3	22.0	50.0



Test Mode :	Mode 1	Temperature :	23~24°C
Test Engineer :	Arthur Hsieh	Relative Humidity :	51~52%
Test Voltage :	120Vac / 60Hz	Phase :	Neutral
Function Type :	GSM850 Idle + WLAN (5GHz) Link + Bluetooth Link + NFC active + Battery + Scanner + without Exoskeleton + Rugged Charge/USB cable + Adapter (SAWA-65-20005A (5V/2.5A)) + Headset Jumper (CBL-TC51-HDST25-01) + Earphone (HDST-25MM-PTVP-01)		

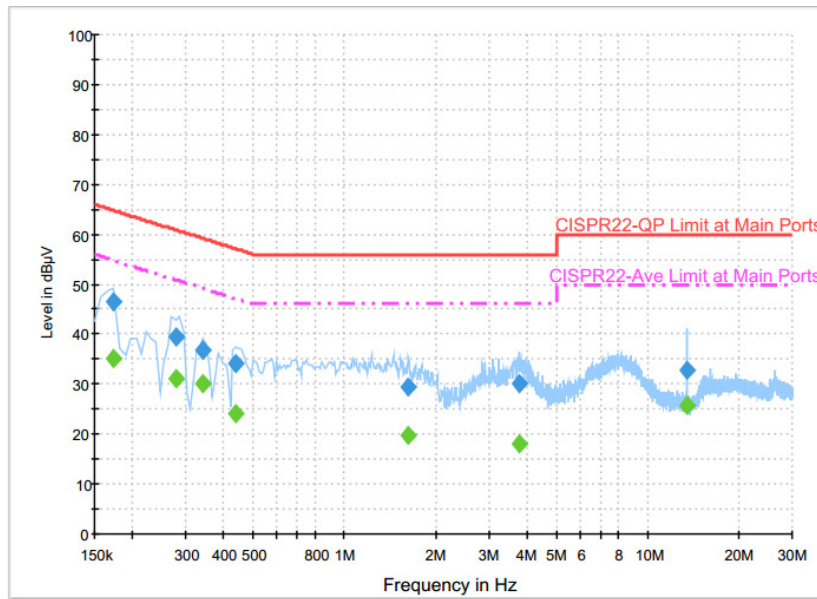

Final Result : QuasiPeak

Frequency (MHz)	QuasiPeak (dBµV)	Filter	Line	Corr. (dB)	Margin (dB)	Limit (dBµV)
0.174000	46.4	Off	N	19.6	18.4	64.8
0.278000	39.4	Off	N	19.6	21.5	60.9
0.342000	37.0	Off	N	19.6	22.2	59.2
0.438000	34.2	Off	N	19.6	22.9	57.1
1.630000	29.5	Off	N	19.7	26.5	56.0
3.774000	30.0	Off	N	19.7	26.0	56.0
13.558000	32.8	Off	N	20.4	27.2	60.0

Final Result : Average

Frequency (MHz)	Average (dBµV)	Filter	Line	Corr. (dB)	Margin (dB)	Limit (dBµV)
0.174000	35.2	Off	N	19.6	19.6	54.8
0.278000	31.1	Off	N	19.6	19.8	50.9
0.342000	30.1	Off	N	19.6	19.1	49.2
0.438000	24.1	Off	N	19.6	23.0	47.1
1.630000	19.8	Off	N	19.7	26.2	46.0
3.774000	17.9	Off	N	19.7	28.1	46.0
13.558000	25.9	Off	N	20.4	24.1	50.0

3.6 Frequency Stability Measurement

3.6.1 Limit of Frequency Stability

Manufacturers of U-NII devices are responsible for ensuring frequency stability such that an emission is maintained within the band of operation under all conditions of normal operation as specified in the user's manual.

3.6.2 Measuring Instruments

The measuring equipment is listed in the section 4 of this test report.

3.6.3 Test Procedures

1. To ensure emission at the band edge is maintained within the authorized band, those values shall be measured by radiation emissions at upper and lower frequency points, and finally compensated by frequency deviation as procedures below.
2. The EUT was operated at the maximum output power, and connected to the spectrum analyzer, which is set to maximum hold function and peak detector. The peak value of the power envelope was measured and noted. The upper and lower frequency points were respectively measured relatively 10dB lower than the measured peak value.
3. The frequency deviation was calculated by adding the upper frequency point and the lower frequency point divided by two. Those detailed values of frequency deviation are provided in table below.

3.6.4 Test Setup

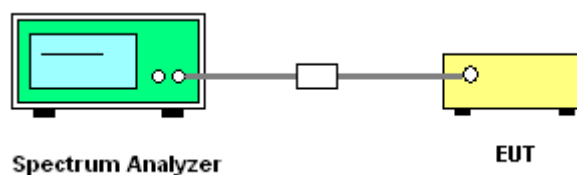



3.6.5 Test Result of Frequency Stability

Band IV									
Mod.	Data Rate	NTX	CH.	Freq. (MHz)	Center Frequency (MHz)	Frequency Deviation (MHz)	Frequency Stability (ppm)	Temperature (°C)	Voltage (V)
11a	6M bps	1	149	5745	5745.050	0.050	8.70	50	3.6
11a	6M bps	1	149	5745	5745.100	0.100	17.41	-30	3.6
11a	6M bps	1	149	5745	5745.050	0.050	8.70	20	4.2
11a	6M bps	1	149	5745	5745.050	0.050	8.70	20	3.45
11a	6M bps	1	149	5745	5745.050	0.050	8.70	20	3.6



3.7 Automatically Discontinue Transmission

3.7.1 Limit of Automatically Discontinue Transmission

The device shall automatically discontinue transmission in case of either absence of information to transmit or operational failure. These provisions are not intended to preclude the transmission of control or signaling information or the use of repetitive codes used by certain digital technologies to complete frame or burst intervals. Applicants shall include in their application for equipment authorization to describe how this requirement is met.

3.7.2 Measuring Instruments

The measuring equipment is listed in the section 4 of this test report.

3.7.3 Test Result of Automatically Discontinue Transmission

While the EUT is not transmitting any information, the EUT can automatically discontinue transmission and become standby mode for power saving. The EUT can detect the controlling signal of ACK message transmitting from remote device and verify whether it shall resend or discontinue transmission.



3.8 Antenna Requirements

3.8.1 Standard Applicable

According to FCC 47 CFR Section 15.407(a)(1)(2) ,if transmitting antenna directional gain is greater than 6 dBi, both the peak transmit power and the peak power spectral density shall be reduced by the amount in dB that the directional gain of the antenna exceeds 6 dBi.

3.8.2 Antenna Anti-Replacement Construction

An embedded-in antenna design is used.

3.8.3 Antenna Gain

The antenna gain is less than 6 dBi. Therefore, it is not necessary to reduce maximum peak output power limit.



4 List of Measuring Equipment

Instrument	Manufacturer	Model No.	Serial No.	Characteristics	Calibration Date	Test Date	Due Date	Remark
Power Meter	Agilent	E4416A	GB41292344	300MHz~40GHz	Jan. 08, 2016	Nov. 08, 2016 ~ Nov. 30, 2016	Jan. 07, 2017	Conducted (TH05-HY)
Power Sensor	Agilent	E9327A	US40441548	300MHz~40GHz	Jan. 07, 2016	Nov. 08, 2016 ~ Nov. 30, 2016	Jan. 06, 2017	Conducted (TH05-HY)
Spectrum Analyzer	Rohde & Schwarz	FSP40	100055	9kHz~40GHz	Jun. 17, 2016	Nov. 08, 2016 ~ Nov. 30, 2016	Jun. 16, 2017	Conducted (TH05-HY)
Temperature Chamber	ESPEC	SH-641	92013720	-40℃ ~90℃	Sep. 01, 2016	Nov. 08, 2016 ~ Nov. 30, 2016	Aug. 31, 2017	Conducted (TH05-HY)
Loop Antenna	Rohde & Schwarz	HFH2-Z2	100315	9 kHz~30 MHz	Sep. 02, 2015	Nov. 13, 2016 ~ Nov. 20, 2016	Sep. 01, 2017	Radiation (03CH12-HY)
Amplifier	SONOMA	310N	187312	9kHz~1GHz	Nov. 10, 2016	Nov. 13, 2016 ~ Nov. 20, 2016	Nov. 09, 2017	Radiation (03CH12-HY)
Spectrum Analyzer	Keysight	N9010A	MY54200486	10Hz ~ 44GHz	Oct. 12, 2016	Nov. 13, 2016 ~ Nov. 20, 2016	Oct. 11, 2017	Radiation (03CH12-HY)
Bilog Antenna	TESEQ	CBL 6111D&00800 N1D01N-06	37059&01	30MHz~1GHz	Oct. 15, 2016	Nov. 13, 2016 ~ Nov. 20, 2016	Oct. 14, 2017	Radiation (03CH12-HY)
EMI Test Receiver	Rohde & Schwarz	ESU26	100390	20Hz~26.5GHz	Dec. 21, 2015	Nov. 13, 2016 ~ Nov. 20, 2016	Dec. 20, 2016	Radiation (03CH12-HY)
Preamplifier	MITEQ	TTA0204	1872107	2GHz~40GHz	Feb. 15, 2016	Nov. 13, 2016 ~ Nov. 20, 2016	Feb. 14, 2017	Radiation (03CH12-HY)
Horn Antenna	SCHWARZBECK	BBHA 9120D	9120D-1328	1GHz ~ 18GHz	Oct. 25, 2016	Nov. 13, 2016 ~ Nov. 20, 2016	Oct. 24, 2017	Radiation (03CH12-HY)
Preamplifier	MITEQ	AMF-7D-0010 1800-30-10P	1815698	1GHz~18GHz	Dec. 14, 2015	Nov. 13, 2016 ~ Nov. 20, 2016	Dec. 13, 2016	Radiation (03CH12-HY)
Preamplifier	Keysight	83017A	MY53270148	1GHz~26.5GHz	Jan. 30, 2016	Nov. 13, 2016 ~ Nov. 20, 2016	Jan. 29, 2017	Radiation (03CH12-HY)
Antenna Mast	EMEC	AM-BS-4500-B	N/A	1m~4m	N/A	Nov. 13, 2016 ~ Nov. 20, 2016	N/A	Radiation (03CH12-HY)
Turn Table	EMEC	TT2000	N/A	0~360 Degree	N/A	Nov. 13, 2016 ~ Nov. 20, 2016	N/A	Radiation (03CH12-HY)
Preamplifier	MITEQ	TTA0204	1872107	2GHz~40GHz	Feb. 15, 2016	Nov. 13, 2016 ~ Nov. 20, 2016	Feb. 14, 2017	Radiation (03CH12-HY)
SHF-EHF Horn Antenna	SCHWARZBECK	BBHA 9170	BBHA917057 6	18GHz ~ 40GHz	Apr. 15, 2016	Nov. 13, 2016 ~ Nov. 20, 2016	Apr. 14, 2017	Radiation (03CH12-HY)
AC Power Source	ChainTek	APC-1000W	N/A	N/A	N/A	Oct. 22, 2016	N/A	Conduction (CO05-HY)
EMI Test Receiver	Rohde & Schwarz	ESCI 7	100724	9kHz~7GHz	Aug. 30, 2016	Oct. 22, 2016	Aug. 29, 2017	Conduction (CO05-HY)
LISN	Rohde & Schwarz	ENV216	100080	9kHz~30MHz	Dec. 02, 2015	Oct. 22, 2016	Dec. 01, 2016	Conduction (CO05-HY)



5 Uncertainty of Evaluation

Uncertainty of Conducted Emission Measurement (150kHz ~ 30MHz)

Measuring Uncertainty for a Level of Confidence of 95% ($U = 2Uc(y)$)	2.7
---	-----

Uncertainty of Radiated Emission Measurement (30 MHz ~ 1000 MHz)

Measuring Uncertainty for a Level of Confidence of 95% ($U = 2Uc(y)$)	5.1
---	-----

Uncertainty of Radiated Emission Measurement (1000 MHz ~ 18 GHz)

Measuring Uncertainty for a Level of Confidence of 95% ($U = 2Uc(y)$)	5.2
---	-----

Uncertainty of Radiated Emission Measurement (18 GHz ~ 40 GHz)

Measuring Uncertainty for a Level of Confidence of 95% ($U = 2Uc(y)$)	4.7
---	-----



Appendix A. Radiated Spurious Emission

Test Engineer :	Peter Chiu, Karl Hou, Nick Yu, and Citta Ke	Temperature :	23~24°C
		Relative Humidity :	51~54%

Band 4 - 5725~5850MHz

WIFI 802.11a (Band Edge @ 3m)

WIFI Ant. 1	Note	Frequency (MHz)	Level (dBμV/m)	Over Limit (dB)	Limit Line (dBμV/m)	Read Level (dBμV)	Antenna Factor (dB/m)	Cable Loss (dB)	Preamp Factor (dB)	Ant Pos (cm)	Table Pos (deg)	Peak Avg. (P/A)	Pol. (H/V)	
802.11a CH 149 5745MHz		5622.2	60.79	-7.41	68.2	47.82	32.17	11.79	30.99	105	157	P	H	
		5695.2	61.77	-39.89	101.66	48.69	32.27	11.82	31.01	105	157	P	H	
		5718.8	71.82	-38.64	110.46	58.69	32.31	11.84	31.02	105	157	P	H	
		5724.6	78.3	-42.99	121.29	65.17	32.31	11.84	31.02	105	157	P	H	
	*	5745	110.99	-	-	97.82	32.34	11.86	31.03	105	157	P	H	
	*	5745	100.09	-	-	86.92	32.34	11.86	31.03	105	157	A	H	
														H
														H
			5634.4	59.8	-8.4	68.2	46.82	32.19	11.79	31	122	154	P	V
			5700	60.78	-44.42	105.2	47.7	32.27	11.82	31.01	122	154	P	V
			5718.8	69.09	-41.37	110.46	55.96	32.31	11.84	31.02	122	154	P	V
			5724.4	76.18	-44.65	120.83	63.05	32.31	11.84	31.02	122	154	P	V
	*		5745	108.57	-	-	95.4	32.34	11.86	31.03	122	154	P	V
	*		5745	97.67	-	-	84.5	32.34	11.86	31.03	122	154	A	V
														V
													V	



WIFI Ant. 1	Note	Frequency (MHz)	Level (dBμV/m)	Over Limit (dB)	Limit Line (dBμV/m)	Read Level (dBμV)	Antenna Factor (dB/m)	Cable Loss (dB)	Preamp Factor (dB)	Ant Pos (cm)	Table Pos (deg)	Peak Avg. (P/A)	Pol. (H/V)
		5613.2	59.48	-8.72	68.2	46.56	32.14	11.77	30.99	100	157	P	H
		5679.2	60.03	-29.82	89.85	46.98	32.24	11.82	31.01	100	157	P	H
		5702.4	60.62	-45.25	105.87	47.5	32.29	11.84	31.01	100	157	P	H
		5725	59.98	-62.22	122.2	46.85	32.31	11.84	31.02	100	157	P	H
	*	5785	110.7	-	-	97.48	32.39	11.88	31.05	100	157	P	H
	*	5785	99.73	-	-	86.51	32.39	11.88	31.05	100	157	A	H
		5854.4	60.52	-51.65	112.17	47.04	32.51	12.03	31.06	100	157	P	H
		5858.8	61	-48.73	109.73	47.53	32.51	12.03	31.07	100	157	P	H
		5920.6	60.34	-11.1	71.44	46.54	32.58	12.31	31.09	100	157	P	H
		5942.6	60.14	-8.06	68.2	46.15	32.63	12.45	31.09	100	157	P	H
													H
													H
802.11a													
CH 157													
5785MHz		5630.2	60.12	-8.08	68.2	47.16	32.17	11.79	31	100	153	P	V
		5698	60.19	-43.54	103.73	47.11	32.27	11.82	31.01	100	153	P	V
		5712	60.1	-48.46	108.56	46.99	32.29	11.84	31.02	100	153	P	V
		5720	60.06	-50.74	110.8	46.93	32.31	11.84	31.02	100	153	P	V
	*	5785	108.23	-	-	95.01	32.39	11.88	31.05	100	153	P	V
	*	5785	97.31	-	-	84.09	32.39	11.88	31.05	100	153	A	V
		5852.4	59.84	-56.89	116.73	46.39	32.48	12.03	31.06	100	153	P	V
		5874.8	60.23	-45.03	105.26	46.6	32.53	12.17	31.07	100	153	P	V
		5905.2	61.29	-21.52	82.81	47.48	32.58	12.31	31.08	100	153	P	V
		5943.8	60.74	-7.46	68.2	46.75	32.63	12.45	31.09	100	153	P	V
													V
													V



WiFi Ant. 1	Note	Frequency (MHz)	Level (dBμV/m)	Over Limit (dB)	Limit Line (dBμV/m)	Read Level (dBμV)	Antenna Factor (dB/m)	Cable Loss (dB)	Preamp Factor (dB)	Ant Pos (cm)	Table Pos (deg)	Peak Avg. (P/A)	Pol. (H/V)	
802.11a CH 165 5825MHz	*	5825	112.26	-	-	98.82	32.46	12.03	31.05	100	158	P	H	
	*	5825	101.24	-	-	87.8	32.46	12.03	31.05	100	158	A	H	
		5851.6	72.83	-45.72	118.55	59.38	32.48	12.03	31.06	100	158	P	H	
		5855.8	69.28	-41.3	110.58	55.8	32.51	12.03	31.06	100	158	P	H	
		5875.4	63.05	-41.85	104.9	49.42	32.53	12.17	31.07	100	158	P	H	
		5931.4	60.65	-7.55	68.2	46.83	32.6	12.31	31.09	100	158	P	H	
														H
														H
	*	5825	109.86	-	-	95.57	33.31	12.03	31.05	100	154	154	P	V
	*	5825	99	-	-	84.71	33.31	12.03	31.05	100	154	154	A	V
		5851.8	69.16	-48.94	118.1	55.71	32.48	12.03	31.06	100	154	154	P	V
		5855.6	67.06	-43.57	110.63	53.58	32.51	12.03	31.06	100	154	154	P	V
		5902.6	61.29	-23.45	84.74	47.5	32.56	12.31	31.08	100	154	154	P	V
		5946.6	61.18	-7.02	68.2	47.19	32.63	12.45	31.09	100	154	154	P	V
														V
														V
														V
Remark	1. No other spurious found. 2. All results are PASS against Peak and Average limit line.													



Band 4 5725~5850MHz

WIFI 802.11a (Harmonic @ 3m)

WIFI Ant. 1	Note	Frequency (MHz)	Level (dBμV/m)	Over Limit (dB)	Limit Line (dBμV/m)	Read Level (dBμV)	Antenna Factor (dB/m)	Cable Loss (dB)	Preamp Factor (dB)	Ant Pos (cm)	Table Pos (deg)	Peak Avg. (P/A)	Pol. (H/V)	
802.11a CH 149 5745MHz		11490	47.39	-26.61	74	46.57	40.2	18.4	57.78	100	0	P	H	
		17235	49.92	-18.28	68.2	42	41.92	23.14	57.14	100	0	P	H	
													H	
													H	
			11490	46.79	-27.21	74	45.97	40.2	18.4	57.78	100	0	P	V
			17235	49.22	-18.98	68.2	41.3	41.92	23.14	57.14	100	0	P	V
														V
802.11a CH 157 5785MHz		11570	46.67	-27.33	74	46.03	39.95	18.49	57.8	100	0	P	H	
		17355	49.97	-18.23	68.2	42.26	42.02	23.25	57.56	100	0	P	H	
													H	
													H	
			11570	47.87	-26.13	74	47.23	39.95	18.49	57.8	100	0	P	V
			17355	49.86	-18.34	68.2	42.15	42.02	23.25	57.56	100	0	P	V
														V
802.11a CH 165 5825MHz		11650	47.06	-26.94	74	46.38	39.9	18.58	57.8	100	0	P	H	
		17475	48.55	-19.65	68.2	40.73	42.44	23.36	57.98	100	0	P	H	
													H	
													H	
			11650	47.25	-26.75	74	46.57	39.9	18.58	57.8	100	0	P	V
			17475	47.63	-20.57	68.2	39.81	42.44	23.36	57.98	100	0	P	V
														V
Remark	1. No other spurious found.													
	2. All results are PASS against Peak and Average limit line.													



Band 4 5725~5850MHz

WIFI 802.11ac VHT20 (Band Edge @ 3m)

WIFI Ant. 1	Note	Frequency (MHz)	Level (dBμV/m)	Over Limit (dB)	Limit Line (dBμV/m)	Read Level (dBμV)	Antenna Factor (dB/m)	Cable Loss (dB)	Preamp Factor (dB)	Ant Pos (cm)	Table Pos (deg)	Peak Avg. (P/A)	Pol. (H/V)	
802.11ac VHT20 CH 149 5745MHz		5638.4	60.14	-8.06	68.2	47.16	32.19	11.79	31	100	157	P	H	
		5696.2	62.14	-40.26	102.4	49.06	32.27	11.82	31.01	100	157	P	H	
		5719.6	71.69	-39	110.69	58.56	32.31	11.84	31.02	100	157	P	H	
		5724.4	79.24	-41.59	120.83	66.11	32.31	11.84	31.02	100	157	P	H	
	*	5745	110.43	-	-	96.51	33.09	11.86	31.03	100	157	P	H	
	*	5745	99.32	-	-	85.4	33.09	11.86	31.03	100	157	A	H	
														H
														H
			5624.8	59.65	-8.55	68.2	46.68	32.17	11.79	30.99	113	170	P	V
			5699.6	61.95	-42.96	104.91	48.87	32.27	11.82	31.01	113	170	P	V
			5719.8	71.18	-39.56	110.74	58.05	32.31	11.84	31.02	113	170	P	V
			5724.8	77.96	-43.78	121.74	64.83	32.31	11.84	31.02	113	170	P	V
	*		5745	108.87	-	-	95.7	32.34	11.86	31.03	113	170	P	V
	*		5745	97.9	-	-	84.73	32.34	11.86	31.03	113	170	A	V
														V
														V



WIFI Ant. 1	Note	Frequency (MHz)	Level (dBμV/m)	Over Limit (dB)	Limit Line (dBμV/m)	Read Level (dBμV)	Antenna Factor (dB/m)	Cable Loss (dB)	Preamp Factor (dB)	Ant Pos (cm)	Table Pos (deg)	Peak Avg. (P/A)	Pol. (H/V)
		5612.8	59.51	-8.69	68.2	46.59	32.14	11.77	30.99	100	157	P	H
		5694.6	60.06	-41.16	101.22	46.98	32.27	11.82	31.01	100	157	P	H
		5719.6	60.96	-49.73	110.69	47.83	32.31	11.84	31.02	100	157	P	H
		5720.2	60.16	-51.1	111.26	47.03	32.31	11.84	31.02	100	157	P	H
	*	5785	110.99	-	-	97.77	32.39	11.88	31.05	100	157	P	H
	*	5785	99.87	-	-	86.65	32.39	11.88	31.05	100	157	A	H
		5850	60.65	-61.55	122.2	47.2	32.48	12.03	31.06	100	157	P	H
		5855.4	60	-50.69	110.69	46.52	32.51	12.03	31.06	100	157	P	H
		5899.6	60.5	-26.46	86.96	46.85	32.56	12.17	31.08	100	157	P	H
		5938.2	61.61	-6.59	68.2	47.79	32.6	12.31	31.09	100	157	P	H
802.11ac													H
VHT20													H
CH 157		5635	59.51	-8.69	68.2	46.53	32.19	11.79	31	100	153	P	V
5785MHz		5669.6	59.78	-22.96	82.74	46.73	32.24	11.82	31.01	100	153	P	V
		5706.8	60.16	-46.95	107.11	47.05	32.29	11.84	31.02	100	153	P	V
		5722	59.96	-55.4	115.36	46.83	32.31	11.84	31.02	100	153	P	V
	*	5785	108.89	-	-	95.67	32.39	11.88	31.05	100	153	P	V
	*	5785	97.54	-	-	84.32	32.39	11.88	31.05	100	153	A	V
		5854.2	60.7	-51.92	112.62	47.22	32.51	12.03	31.06	100	153	P	V
		5855.2	59.67	-51.07	110.74	46.19	32.51	12.03	31.06	100	153	P	V
		5911.6	60.67	-17.42	78.09	46.87	32.58	12.31	31.09	100	153	P	V
		5946.2	60.73	-7.47	68.2	46.74	32.63	12.45	31.09	100	153	P	V
													V
													V



WIFI Ant. 1	Note	Frequency (MHz)	Level (dBμV/m)	Over Limit (dB)	Limit Line (dBμV/m)	Read Level (dBμV)	Antenna Factor (dB/m)	Cable Loss (dB)	Preamp Factor (dB)	Ant Pos (cm)	Table Pos (deg)	Peak Avg. (P/A)	Pol. (H/V)	
802.11ac VHT20 CH 165 5825MHz	*	5825	111.86	-	-	97.57	33.31	12.03	31.05	100	156	P	H	
	*	5825	100.67	-	-	86.38	33.31	12.03	31.05	100	156	A	H	
		5850.2	77.42	-44.32	121.74	63.97	32.48	12.03	31.06	100	156	P	H	
		5855.8	68.55	-42.03	110.58	55.07	32.51	12.03	31.06	100	156	P	H	
		5875.2	62.01	-43.04	105.05	48.38	32.53	12.17	31.07	100	156	P	H	
		5948.8	61.19	-7.01	68.2	47.2	32.63	12.45	31.09	100	156	P	H	
														H
														H
	*	5825	109.02	-	-	94.73	33.31	12.03	31.05	100	170	P	V	
	*	5825	97.9	-	-	83.61	33.31	12.03	31.05	100	170	A	V	
		5850	73.29	-48.91	122.2	59.84	32.48	12.03	31.06	100	170	P	V	
		5857.6	65.12	-44.95	110.07	51.64	32.51	12.03	31.06	100	170	P	V	
		5884	61.62	-36.9	98.52	48	32.53	12.17	31.08	100	170	P	V	
		5934	60.87	-7.33	68.2	47.05	32.6	12.31	31.09	100	170	P	V	
														V
														V
Remark	1. No other spurious found. 2. All results are PASS against Peak and Average limit line.													



Band 4 5725~5850MHz

WIFI 802.11ac VHT20 (Harmonic @ 3m)

WIFI Ant. 1	Note	Frequency (MHz)	Level (dBμV/m)	Over Limit (dB)	Limit Line (dBμV/m)	Read Level (dBμV)	Antenna Factor (dB/m)	Cable Loss (dB)	Preamp Factor (dB)	Ant Pos (cm)	Table Pos (deg)	Peak Avg. (P/A)	Pol. (H/V)	
802.11ac VHT20 CH 149 5745MHz		11490	46.97	-27.03	74	46.15	40.2	18.4	57.78	100	0	P	H	
		17235	50.39	-17.81	68.2	42.47	41.92	23.14	57.14	100	0	P	H	
													H	
													H	
			11490	47.01	-26.99	74	46.19	40.2	18.4	57.78	100	0	P	V
			17235	51	-17.2	68.2	43.08	41.92	23.14	57.14	100	0	P	V
														V
802.11ac VHT20 CH 157 5785MHz		11570	46.58	-27.42	74	45.83	40.06	18.49	57.8	100	0	P	H	
		17355	49.79	-18.41	68.2	41.92	42.18	23.25	57.56	100	0	P	H	
													H	
													H	
			11570	47.07	-26.93	74	46.32	40.06	18.49	57.8	100	0	P	V
			17355	48.96	-19.24	68.2	41.09	42.18	23.25	57.56	100	0	P	V
														V
802.11ac VHT20 CH 165 5825MHz		11650	47.61	-26.39	74	46.93	39.9	18.58	57.8	100	0	P	H	
		17475	48.97	-19.23	68.2	41.15	42.44	23.36	57.98	100	0	P	H	
													H	
													H	
			11650	47.59	-26.41	74	46.91	39.9	18.58	57.8	100	0	P	V
			17475	47.75	-20.45	68.2	39.93	42.44	23.36	57.98	100	0	P	V
														V
Remark	1. No other spurious found.													
	2. All results are PASS against Peak and Average limit line.													



Band 4 5725~5850MHz

WIFI 802.11ac VHT40 (Band Edge @ 3m)

WIFI Ant. 1	Note	Frequency (MHz)	Level (dBμV/m)	Over Limit (dB)	Limit Line (dBμV/m)	Read Level (dBμV)	Antenna Factor (dB/m)	Cable Loss (dB)	Preamp Factor (dB)	Ant Pos (cm)	Table Pos (deg)	Peak Avg. (P/A)	Pol. (H/V)
		5639.8	60.67	-7.53	68.2	47.69	32.19	11.79	31	100	157	P	H
		5697.8	67.64	-35.94	103.58	54.56	32.27	11.82	31.01	100	157	P	H
		5717.6	77.87	-32.26	110.13	64.74	32.31	11.84	31.02	100	157	P	H
		5722.6	77.81	-38.92	116.73	64.68	32.31	11.84	31.02	100	157	P	H
	*	5755	107.51	-	-	94.32	32.36	11.86	31.03	100	157	P	H
	*	5755	96.77	-	-	83.58	32.36	11.86	31.03	100	157	A	H
		5852.4	60.26	-56.47	116.73	46.81	32.48	12.03	31.06	100	157	P	H
		5862.8	61.99	-46.62	108.61	48.38	32.51	12.17	31.07	100	157	P	H
		5919.6	60.96	-11.22	72.18	47.16	32.58	12.31	31.09	100	157	P	H
		5941.2	60.2	-8	68.2	46.21	32.63	12.45	31.09	100	157	P	H
													H
													H
802.11ac VHT40 CH 151 5755MHz		5646	60.77	-7.43	68.2	47.79	32.19	11.79	31	100	155	P	V
		5694.6	66.24	-34.98	101.22	53.16	32.27	11.82	31.01	100	155	P	V
		5717.4	76.2	-33.87	110.07	63.09	32.29	11.84	31.02	100	155	P	V
		5722.2	76.81	-39.01	115.82	63.68	32.31	11.84	31.02	100	155	P	V
	*	5755	105.48	-	-	92.29	32.36	11.86	31.03	100	155	P	V
	*	5755	94.35	-	-	81.16	32.36	11.86	31.03	100	155	A	V
		5853.4	60.56	-53.89	114.45	47.11	32.48	12.03	31.06	100	155	P	V
		5864.4	60.46	-47.71	108.17	46.85	32.51	12.17	31.07	100	155	P	V
		5902.2	60.85	-24.18	85.03	47.06	32.56	12.31	31.08	100	155	P	V
		5945	60.69	-7.51	68.2	46.7	32.63	12.45	31.09	100	155	P	V
													V
													V



WIFI Ant. 1	Note	Frequency (MHz)	Level (dBμV/m)	Over Limit (dB)	Limit Line (dBμV/m)	Read Level (dBμV)	Antenna Factor (dB/m)	Cable Loss (dB)	Preamp Factor (dB)	Ant Pos (cm)	Table Pos (deg)	Peak Avg. (P/A)	Pol. (H/V)
		5615.4	59.45	-8.75	68.2	46.53	32.14	11.77	30.99	100	159	P	H
		5690.4	60.85	-37.27	98.12	47.77	32.27	11.82	31.01	100	159	P	H
		5712.6	62.61	-46.12	108.73	49.5	32.29	11.84	31.02	100	159	P	H
		5721.6	64.23	-50.22	114.45	51.1	32.31	11.84	31.02	100	159	P	H
	*	5795	108.25	-	-	95.01	32.41	11.88	31.05	100	159	P	H
	*	5795	96.61	-	-	83.37	32.41	11.88	31.05	100	159	A	H
		5852.6	65.22	-51.05	116.27	51.77	32.48	12.03	31.06	100	159	P	H
		5859.2	64.08	-45.54	109.62	50.61	32.51	12.03	31.07	100	159	P	H
		5885	62.2	-35.57	97.77	48.58	32.53	12.17	31.08	100	159	P	H
		5937.2	60.22	-7.98	68.2	46.4	32.6	12.31	31.09	100	159	P	H
802.11ac													H
VHT40													H
CH 159		5631.2	60.37	-7.83	68.2	47.41	32.17	11.79	31	100	170	P	V
5795MHz		5696.4	59.93	-42.62	102.55	46.85	32.27	11.82	31.01	100	170	P	V
		5717.4	62.02	-48.05	110.07	48.91	32.29	11.84	31.02	100	170	P	V
		5720.2	62.64	-48.62	111.26	49.51	32.31	11.84	31.02	100	170	P	V
	*	5795	105.65	-	-	92.41	32.41	11.88	31.05	100	170	P	V
	*	5795	94.51	-	-	81.27	32.41	11.88	31.05	100	170	A	V
		5852.4	63.2	-53.53	116.73	49.75	32.48	12.03	31.06	100	170	P	V
		5866.2	62.38	-45.28	107.66	48.77	32.51	12.17	31.07	100	170	P	V
		5904.4	61	-22.41	83.41	47.21	32.56	12.31	31.08	100	170	P	V
		5942.6	60.12	-8.08	68.2	46.13	32.63	12.45	31.09	100	170	P	V
													V
													V
Remark	1. No other spurious found. 2. All results are PASS against Peak and Average limit line.												



Band 4 5725~5850MHz

WIFI 802.11ac VHT40 (Harmonic @ 3m)

WIFI Ant. 1	Note	Frequency (MHz)	Level (dBμV/m)	Over Limit (dB)	Limit Line (dBμV/m)	Read Level (dBμV)	Antenna Factor (dB/m)	Cable Loss (dB)	Preamp Factor (dB)	Ant Pos (cm)	Table Pos (deg)	Peak Avg. (P/A)	Pol. (H/V)	
802.11ac VHT40 CH 151 5755MHz		11510	46.68	-27.32	74	45.85	40.18	18.45	57.8	100	0	P	H	
		17265	48.28	-19.92	68.2	40.39	41.98	23.17	57.26	100	0	P	H	
													H	
													H	
			11510	46.92	-27.08	74	46.09	40.18	18.45	57.8	100	0	P	V
			17265	48.36	-19.84	68.2	40.47	41.98	23.17	57.26	100	0	P	V
														V
802.11ac VHT40 CH 159 5795MHz		11590	46.67	-27.33	74	45.91	40.02	18.54	57.8	100	0	P	H	
		17385	48.84	-19.36	68.2	40.98	42.25	23.29	57.68	100	0	P	H	
													H	
													H	
			11590	46.13	-27.87	74	45.37	40.02	18.54	57.8	100	0	P	V
			17385	49.01	-19.19	68.2	41.15	42.25	23.29	57.68	100	0	P	V
														V
Remark	1. No other spurious found.													
	2. All results are PASS against Peak and Average limit line.													



Band 4 5725~5850MHz

WIFI 802.11ac VHT80 (Band Edge @ 3m)

WIFI Ant. 1	Note	Frequency (MHz)	Level (dBμV/m)	Over Limit (dB)	Limit Line (dBμV/m)	Read Level (dBμV)	Antenna Factor (dB/m)	Cable Loss (dB)	Preamp Factor (dB)	Ant Pos (cm)	Table Pos (deg)	Peak Avg. (P/A)	Pol. (H/V)
		5649.6	62.08	-6.12	68.2	49.07	32.22	11.79	31	100	158	P	H
		5698.8	71.98	-32.34	104.32	58.9	32.27	11.82	31.01	100	158	P	H
		5719.8	73.42	-37.32	110.74	60.29	32.31	11.84	31.02	100	158	P	H
		5723	73.33	-44.31	117.64	60.2	32.31	11.84	31.02	100	158	P	H
	*	5775	104.41	-	-	91.2	32.39	11.86	31.04	100	158	P	H
	*	5775	93.41	-	-	80.2	32.39	11.86	31.04	100	158	A	H
		5851.8	72.13	-45.97	118.1	58.68	32.48	12.03	31.06	100	158	P	H
		5860.2	70.79	-38.55	109.34	57.18	32.51	12.17	31.07	100	158	P	H
		5876.2	67.13	-37.18	104.31	53.5	32.53	12.17	31.07	100	158	P	H
		5927.4	60.39	-7.81	68.2	46.57	32.6	12.31	31.09	100	158	P	H
													H
													H
802.11ac VHT80 CH 155 5775MHz		5640.2	61.64	-6.56	68.2	48.66	32.19	11.79	31	100	186	P	V
		5698.8	70.03	-34.29	104.32	56.95	32.27	11.82	31.01	100	186	P	V
		5712.4	71.86	-36.81	108.67	58.75	32.29	11.84	31.02	100	186	P	V
		5720	71.57	-39.23	110.8	58.44	32.31	11.84	31.02	100	186	P	V
	*	5775	101.46	-	-	88.25	32.39	11.86	31.04	100	186	P	V
	*	5775	90.75	-	-	77.54	32.39	11.86	31.04	100	186	A	V
		5850.6	70.58	-50.25	120.83	57.13	32.48	12.03	31.06	100	186	P	V
		5860.4	69.46	-39.83	109.29	55.85	32.51	12.17	31.07	100	186	P	V
		5875.6	64.75	-40	104.75	51.12	32.53	12.17	31.07	100	186	P	V
		5930.2	60.58	-7.62	68.2	46.76	32.6	12.31	31.09	100	186	P	V
													V
													V
Remark	1. No other spurious found. 2. All results are PASS against Peak and Average limit line.												



Band 4 5725~5850MHz

WIFI 802.11ac VHT80 (Harmonic @ 3m)

WIFI Ant. 1	Note	Frequency (MHz)	Level (dBμV/m)	Over Limit (dB)	Limit Line (dBμV/m)	Read Level (dBμV)	Antenna Factor (dB/m)	Cable Loss (dB)	Preamp Factor (dB)	Ant Pos (cm)	Table Pos (deg)	Peak Avg. (P/A)	Pol. (H/V)	
802.11ac VHT80 CH 155 5775MHz		11550	46.5	-27.5	74	45.71	40.1	18.49	57.8	100	0	P	H	
		17325	49.54	-18.66	68.2	41.65	42.12	23.21	57.44	100	0	P	H	
													H	
													H	
			11550	46.3	-27.7	74	45.51	40.1	18.49	57.8	100	0	P	V
			17325	49.12	-19.08	68.2	41.23	42.12	23.21	57.44	100	0	P	V
														V
Remark	1. No other spurious found. 2. All results are PASS against Peak and Average limit line.													



Emission below 1GHz

5GHz WIFI 802.11ac VHT80 (LF @ 3m)

WIFI	Note	Frequency	Level	Over	Limit	Read	Antenna	Cable	Preamp	Ant	Table	Peak	Pol.	
Ant.				Limit	Line	Level	Factor	Loss	Factor	Pos	Pos	Avg.		
1		(MHz)	(dBμV/m)	(dB)	(dBμV/m)	(dBμV)	(dB/m)	(dB)	(dB)	(cm)	(deg)	(P/A)	(H/V)	
5GHz 802.11ac VHT80 LF		36.21	29.23	-10.77	40	38.37	22.54	0.78	32.46	-	-	P	H	
		79.95	22.76	-17.24	40	40.57	13.57	1.06	32.44	-	-	P	H	
		106.95	32.81	-10.69	43.5	47.04	16.77	1.43	32.43	100	0	P	H	
		229.8	23.92	-22.08	46	37.75	16.7	1.83	32.36	-	-	P	H	
		337.1	27.44	-18.56	46	36.76	20.62	2.34	32.28	-	-	P	H	
		946.8	31.49	-14.51	46	27.68	30.22	4.75	31.16	-	-	P	H	
														H
														H
														H
														H
														H
														H
														H
			34.32	35.36	-4.64	40	43.4	23.64	0.78	32.46	100	243	QP	V
			34.32	38.8	-	-	46.84	23.64	0.78	32.46	100	243	P	V
			36.21	36.93	-3.07	40	46.07	22.54	0.78	32.46	100	294	QP	V
			36.21	40.65	-	-	49.79	22.54	0.78	32.46	100	294	P	V
			59.97	27.67	-12.33	40	47.54	11.8	0.78	32.45	-	-	P	V
			107.76	30.55	-12.95	43.5	44.67	16.88	1.43	32.43	-	-	P	V
		339.2	28.17	-17.83	46	37.43	20.68	2.34	32.28	-	-	P	V	
		954.5	32.78	-13.22	46	28.88	30.24	4.75	31.09	-	-	P	V	
													V	
													V	
													V	
													V	
Remark	1. No other spurious found. 2. All results are PASS against limit line.													



Note symbol

*	Fundamental Frequency which can be ignored. However, the level of any unwanted emissions shall not exceed the level of the fundamental frequency.
!	Test result is over limit line.
P/A	Peak or Average
H/V	Horizontal or Vertical



A calculation example for radiated spurious emission is shown as below:

WIFI	Note	Frequency	Level	Over	Limit	Read	Antenna	Cable	Preamp	Ant	Table	Peak	Pol.
Ant.				Limit	Line	Level	Factor	Loss	Factor	Pos	Pos	Avg.	
1		(MHz)	(dBμV/m)	(dB)	(dBμV/m)	(dBμV)	(dB/m)	(dB)	(dB)	(cm)	(deg)	(P/A)	(H/V)
802.11b		2390	55.45	-18.55	74	54.51	32.22	4.58	35.86	103	308	P	H
CH 01													
2412MHz		2390	43.54	-10.46	54	42.6	32.22	4.58	35.86	103	308	A	H

- Level(dBμV/m) =
Antenna Factor(dB/m) + Cable Loss(dB) + Read Level(dBμV) - Preamp Factor(dB)
- Over Limit(dB) = Level(dBμV/m) – Limit Line(dBμV/m)

For Peak Limit @ 2390MHz:

- Level(dBμV/m)
= Antenna Factor(dB/m) + Cable Loss(dB) + Read Level(dBμV) - Preamp Factor(dB)
= 32.22(dB/m) + 4.58(dB) + 54.51(dBμV) – 35.86 (dB)
= 55.45 (dBμV/m)
- Over Limit(dB)
= Level(dBμV/m) – Limit Line(dBμV/m)
= 55.45(dBμV/m) – 74(dBμV/m)
= -18.55(dB)

For Average Limit @ 2390MHz:

- Level(dBμV/m)
= Antenna Factor(dB/m) + Cable Loss(dB) + Read Level(dBμV) - Preamp Factor(dB)
= 32.22(dB/m) + 4.58(dB) + 42.6(dBμV) – 35.86 (dB)
= 43.54 (dBμV/m)
- Over Limit(dB)
= Level(dBμV/m) – Limit Line(dBμV/m)
= 43.54(dBμV/m) – 54(dBμV/m)
= -10.46(dB)

Both peak and average measured complies with the limit line, so test result is “PASS”.



Appendix B. Radiated Spurious Emission Plots

Test Engineer :	Peter Chiu, Karl Hou, Nick Yu, and Citta Ke	Temperature :	23~24°C
		Relative Humidity :	51~54%

Band 4 - 5725~5850MHz
WIFI 802.11a (Band Edge @ 3m)

WIFI	Band 4 5725~5850MHz Band Edge @ 3m	
ANT	802.11a CH149 5745MHz	
1	Horizontal	Fundamental
Peak	<p>Date: 2016-11-15 PEAK_BE(B4)_19-24</p> <p>Site : 03CH12-HY Condition : PEAK_BE(B4)_16-24 3m HORN_9120D_1328 HORIZONTAL RBW:1000.000KHz VBW:3000.000KHz SWT:Auto Detector : Peak Project : 672014-10 Mode : 36</p>	<p>Date: 2016-11-15 PEAK(UMB)</p> <p>Site : 03CH12-HY Condition : PEAK(UMI) 3m HORN_9120D_1328 HORIZONTAL RBW:1000.000KHz VBW:3000.000KHz SWT:Auto Detector : Peak Project : 672014-10 Mode : 36</p>



WIFI	Band 4 5725~5850MHz Band Edge @ 3m	
ANT	802.11a CH149 5745MHz	
1	Vertical	Fundamental
Peak	<p>Site : 03CH12-HY Condition : PEAK_BE(B4)_16-24 3m HORN_9120D_1328 VERTICAL Detector : Peak Project : 672014-10 Mode : 36</p>	<p>Site : 03CH12-HY Condition : PEAK(UMI) 3m HORN_9120D_1328 VERTICAL Detector : Peak Project : 672014-10 Mode : 36</p>

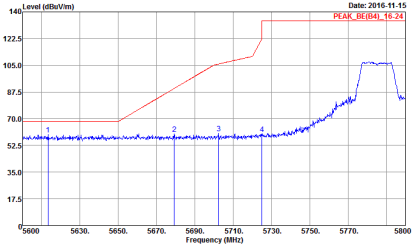
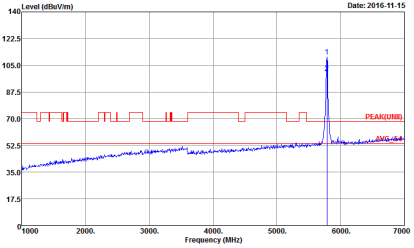
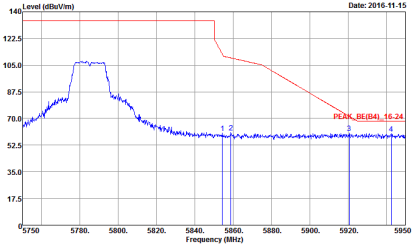

WIFI	Band 4 5725~5850MHz Band Edge @ 3m	
ANT	802.11a CH157 5785MHz	
1	Horizontal	Fundamental
Peak	 <p>Date: 2016-11-15 PEAK_BE(B4)_16-24</p> <p>Site : 03CH12-HY Condition : PEAK_BE(B4)_16-24 3m HORN_9120D_1328 HORIZONTAL Detector : Peak Project : 672014-10 Mode : 37</p>	 <p>Date: 2016-11-15 PEAK(UM)</p> <p>Site : 03CH12-HY Condition : PEAK(UM) 3m HORN_9120D_1328 HORIZONTAL Detector : Peak Project : 672014-10 Mode : 37</p>
Peak	 <p>Date: 2016-11-15 PEAK_BE(B4)_16-24</p> <p>Site : 03CH12-HY Condition : PEAK_BE(B4)_16-24 3m HORN_9120D_1328 HORIZONTAL Detector : Peak Project : 672014-10 Mode : 37</p>	Left blank

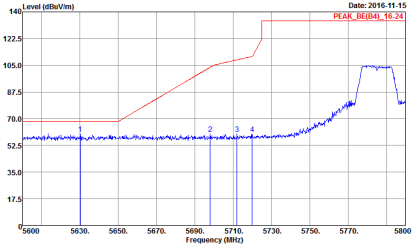
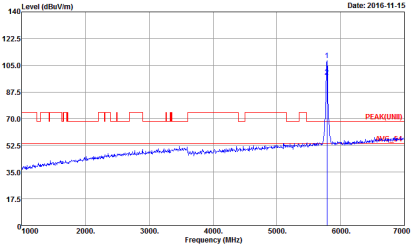
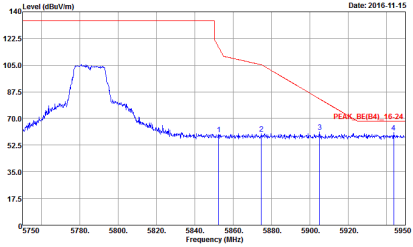

WIFI	Band 4 5725~5850MHz Band Edge @ 3m	
ANT	802.11a CH157 5785MHz	
1	Vertical	Fundamental
<p>Peak</p>	 <p>Date: 2016-11-15 PEAK_BE(B4)_16-24</p> <p>Site : 03CH12-HY Condition : PEAK_BE(B4)_16-24 3m HORN_9120D_1328 VERTICAL Detector : Peak Project : 672014-10 Mode : 37</p>	 <p>Date: 2016-11-15 PEAK(UM)</p> <p>Site : 03CH12-HY Condition : PEAK(UM) 3m HORN_9120D_1328 VERTICAL Detector : Peak Project : 672014-10 Mode : 37</p>
<p>Peak</p>	 <p>Date: 2016-11-15 PEAK_BE(B4)_16-24</p> <p>Site : 03CH12-HY Condition : PEAK_BE(B4)_16-24 3m HORN_9120D_1328 VERTICAL Detector : Peak Project : 672014-10 Mode : 37</p>	<p>Left blank</p>

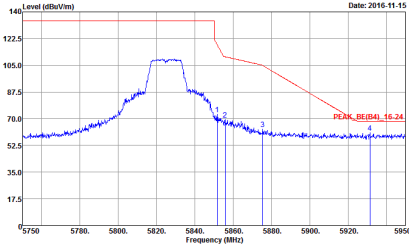
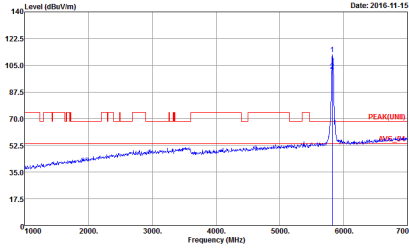

WIFI	Band 4 5725~5850MHz Band Edge @ 3m	
ANT	802.11a CH165 5825MHZ	
1	Horizontal	Fundamental
Peak	 <p>Site : 03CH12-HY Condition : PEAK_BE(B4)_16-24 3m HORN_9120D_1328 HORIZONTAL RBW:1000.000KHz VBW:3000.000KHz SWT:Auto Detector : Peak Project : 672014-10 Mode : 38</p>	 <p>Site : 03CH12-HY Condition : PEAK(UNI) 3m HORN_9120D_1328 HORIZONTAL RBW:1000.000KHz VBW:3000.000KHz SWT:Auto Detector : Peak Project : 672014-10 Mode : 38</p>

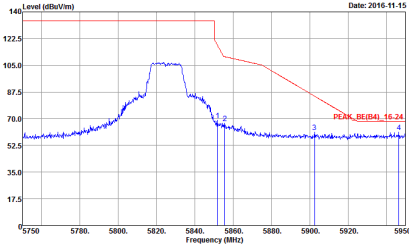
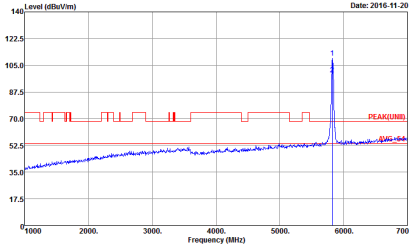

WIFI	Band 4 5725~5850MHz Band Edge @ 3m	
ANT	802.11a CH165 5825MHz	
1	Vertical	Fundamental
Peak	 <p>Date: 2016-11-15</p> <p>Site : 03CH12-HY Condition : PEAK_BE(B4)_16-24 3m HORN_9120D_1328 VERTICAL : RBW:1000.000KHz VBW:3000.000KHz SWT:Auto Detector : Peak Project : 672014-10 Mode : 38</p>	 <p>Date: 2016-11-20</p> <p>Site : 03CH12-HY Condition : PEAK(UWB) 3m HORN_9120D_1328 VERTICAL : RBW:1000.000KHz VBW:3000.000KHz SWT:Auto Detector : Peak Project : 672014-10 Mode : 38</p>

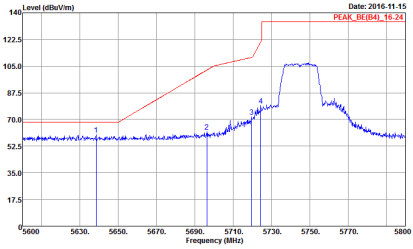
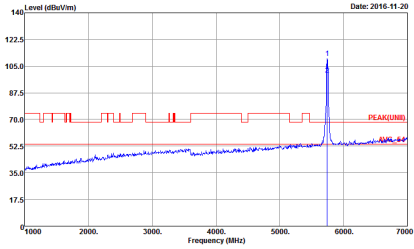

Band 4 5725~5850MHz
WIFI 802.11ac VHT20 (Band Edge @ 3m)

WIFI	Band 4 5725~5850MHz Band Edge @ 3m	
ANT	802.11ac VHT20 CH149 5745MHz	
1	Horizontal	Fundamental
<p>Peak</p>	 <p>Date: 2016-11-15</p> <p>Site : 03CH12-HY Condition : PEAK_DB[84]_16-24 3m HORN_9120D_132S HORIZONTAL Detector : Peak Project : 672014-10 Mode : 39</p>	 <p>Date: 2016-11-20</p> <p>Site : 03CH12-HY Condition : PEAK[UM] 3m HORN_9120D_132S HORIZONTAL Detector : Peak Project : 672014-10 Mode : 39</p>

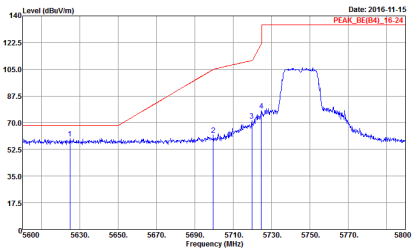
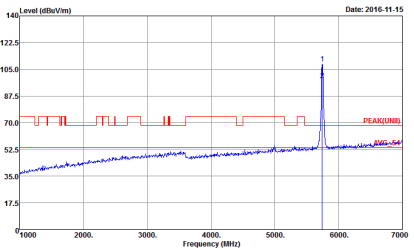

WIFI	Band 4 5725~5850MHz Band Edge @ 3m	
ANT	802.11ac VHT20 CH149 5745MHz	
1	Vertical	Fundamental
Peak Avg.	 <p>Date: 2016-11-15 PEAK_BE(B4)_16-24</p> <p>Site : 03CH12-HY Condition : PEAK_BE(B4)_16-24 3m HORN_9120D_1328 VERTICAL Detector : RBW:1000.000KHz VBW:3000.000KHz SWT:Auto Project : Peak Mode : 672014-10 : 39</p>	 <p>Date: 2016-11-15 PEAK(UNI)</p> <p>Site : 03CH12-HY Condition : PEAK(UNI) 3m HORN_9120D_1328 VERTICAL Detector : RBW:1000.000KHz VBW:3000.000KHz SWT:Auto Project : Peak Mode : 672014-10 : 39</p>

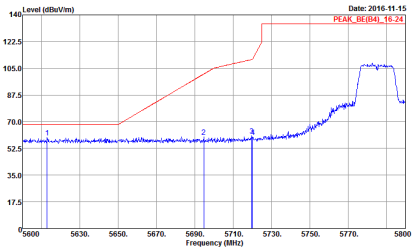
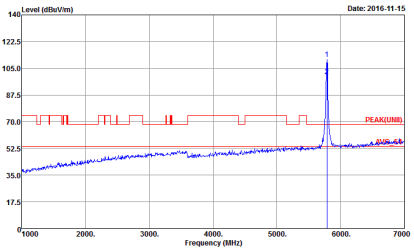
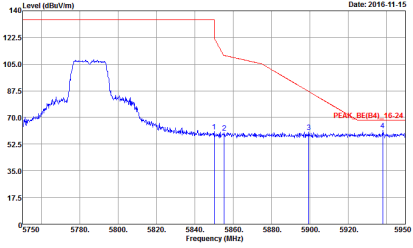

WIFI	Band 4 5725~5850MHz Band Edge @ 3m	
ANT	802.11ac VHT20 CH157 5785MHz	
1	<p style="text-align: center;">Horizontal</p>  <p>Site : 03CH12-HY Condition : PEAK_BE(B4)_16-24 3m HORN_9120D_1328 HORIZONTAL Detector : RBW:1000.000KHz VBW:3000.000KHz SWT:Auto Project : Peak Mode : 672014-10 : 40</p>	<p style="text-align: center;">Fundamental</p>  <p>Site : 03CH12-HY Condition : PEAK(UNI) 3m HORN_9120D_1328 HORIZONTAL Detector : RBW:1000.000KHz VBW:3000.000KHz SWT:Auto Project : Peak Mode : 672014-10 : 40</p>
Peak	 <p>Site : 03CH12-HY Condition : PEAK_BE(B4)_16-24 3m HORN_9120D_1328 HORIZONTAL Detector : RBW:1000.000KHz VBW:3000.000KHz SWT:Auto Project : Peak Mode : 672014-10 : 40</p>	<p style="text-align: center;">Left blank</p>

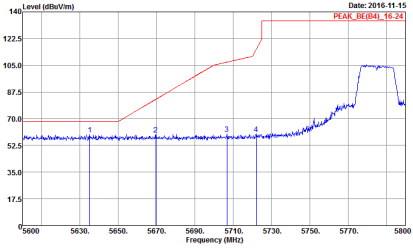
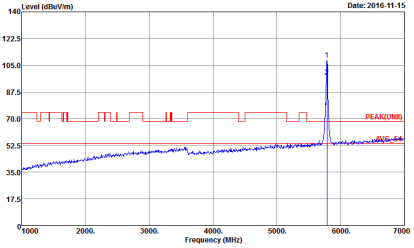
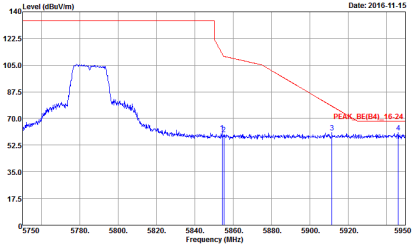

WIFI	Band 4 5725~5850MHz Band Edge @ 3m	
ANT	802.11ac VHT20 CH157 5785MHz	
1	Vertical	Fundamental
Peak	 <p>Date: 2016-11-15 PEAK_BE(B4)_16-24</p> <p>Site : 03CH12-HY Condition : PEAK_BE(B4)_16-24 3m HORN_9120D_1328 VERTICAL : RBW:1000.000KHz VBW:3000.000KHz SWT:Auto Detector : Peak Project : 672014-10 Mode : 40</p>	 <p>Date: 2016-11-15 PEAK(UM)</p> <p>Site : 03CH12-HY Condition : PEAK(UM) 3m HORN_9120D_1328 VERTICAL : RBW:1000.000KHz VBW:3000.000KHz SWT:Auto Detector : Peak Project : 672014-10 Mode : 40</p>
Peak	 <p>Date: 2016-11-15 PEAK_BE(B4)_16-24</p> <p>Site : 03CH12-HY Condition : PEAK_BE(B4)_16-24 3m HORN_9120D_1328 VERTICAL : RBW:1000.000KHz VBW:3000.000KHz SWT:Auto Detector : Peak Project : 672014-10 Mode : 40</p>	Left blank

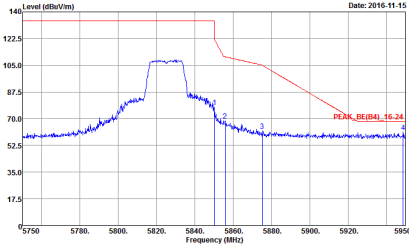
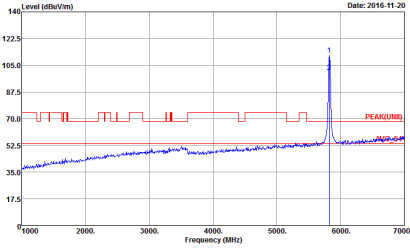

WIFI	Band 4 5725~5850MHz Band Edge @ 3m	
ANT	802.11ac VHT20 CH165 5825MHz	
1	Horizontal	Fundamental
Peak	 <p>Date: 2016-11-15</p> <p>Site : 03CH12-HY Condition : PEAK_BE(B4)_16-24 3m HORN_9120D_1328 HORIZONTAL : RBW:1000.000KHz VBW:3000.000KHz SWT:Auto Detector : Peak Project : 672014-10 Mode : 41</p>	 <p>Date: 2016-11-20</p> <p>Site : 03CH12-HY Condition : PEAK(UNI) 3m HORN_9120D_1328 HORIZONTAL : RBW:1000.000KHz VBW:3000.000KHz SWT:Auto Detector : Peak Project : 672014-10 Mode : 41</p>

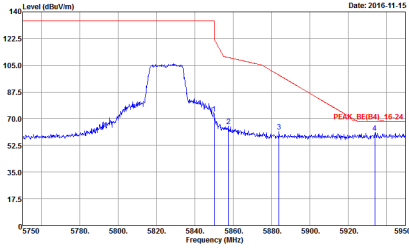
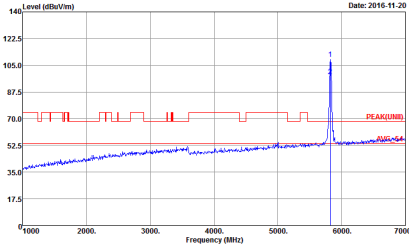

WIFI	Band 4 5725~5850MHz Band Edge @ 3m	
ANT	802.11ac VHT20 CH165 5825MHz	
1	Vertical	Fundamental
Peak Avg.	 <p>Date: 2016-11-15</p> <p>Site : 03CH12-HY Condition : PEAK_BE(B4)_16-24 3m HORN_9120D_1328 VERTICAL Detector : RBW:1000.000KHz VBW:3000.000KHz SWT:Auto Project : Peak Mode : 672014-10 : 41</p>	 <p>Date: 2016-11-20</p> <p>Site : 03CH12-HY Condition : PEAK(UMB) 3m HORN_9120D_1328 VERTICAL Detector : RBW:1000.000KHz VBW:3000.000KHz SWT:Auto Project : Peak Mode : 672014-10 : 41</p>



Band 4 5725~5850MHz
WIFI 802.11ac VHT40 (Band Edge @ 3m)

WIFI	Band 4 5725~5850MHz Band Edge @ 3m	
ANT	802.11ac VHT40 CH151 5755MHz	
1	Horizontal	Fundamental
Peak	<p>Date: 2016-11-15</p> <p>Site : 03CH12-HY Condition : PEAK_BE(B4)_16-24 3m HORN_9120D_1328 HORIZONTAL RBW:1000.000KHz VBW:3000.000KHz SWT:Auto Detector : Peak Project : 672014-10 Mode : 42</p>	<p>Date: 2016-11-15</p> <p>Site : 03CH12-HY Condition : PEAK(UWB) 3m HORN_9120D_1328 HORIZONTAL RBW:1000.000KHz VBW:3000.000KHz SWT:Auto Detector : Peak Project : 672014-10 Mode : 42</p>
Peak	<p>Date: 2016-11-15</p> <p>Site : 03CH12-HY Condition : PEAK_BE(B4)_16-24 3m HORN_9120D_1328 HORIZONTAL RBW:1000.000KHz VBW:3000.000KHz SWT:Auto Detector : Peak Project : 672014-10 Mode : 42</p>	Left blank

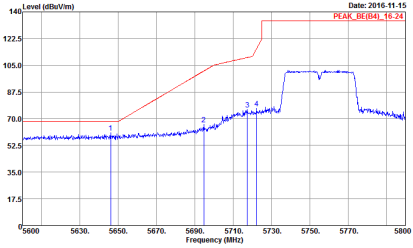
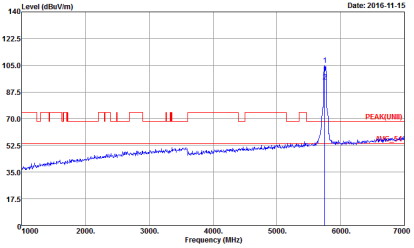
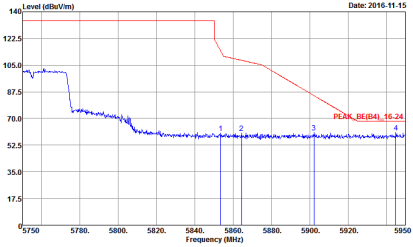

WIFI	Band 4 5725~5850MHz Band Edge @ 3m	
ANT	802.11ac VHT40 CH151 5755MHz	
1	Vertical	Fundamental
Peak	 <p>Date: 2016-11-15 PEAK_BE(B4)_16-24</p> <p>Site : 03CH12-HY Condition : PEAK_BE(B4)_16-24 3m HORN_9120D_1328 VERTICAL : RBW:1000.000KHz VBW:3000.000KHz SWT:Auto Detector : Peak Project : 672014-10 Mode : 42</p>	 <p>Date: 2016-11-15 PEAK(UM)</p> <p>Site : 03CH12-HY Condition : PEAK(UM) 3m HORN_9120D_1328 VERTICAL : RBW:1000.000KHz VBW:3000.000KHz SWT:Auto Detector : Peak Project : 672014-10 Mode : 42</p>
Peak	 <p>Date: 2016-11-15 PEAK_BE(B4)_16-24</p> <p>Site : 03CH12-HY Condition : PEAK_BE(B4)_16-24 3m HORN_9120D_1328 VERTICAL : RBW:1000.000KHz VBW:3000.000KHz SWT:Auto Detector : Peak Project : 672014-10 Mode : 42</p>	Left blank

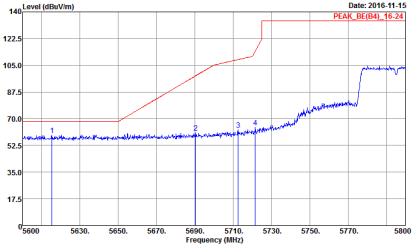
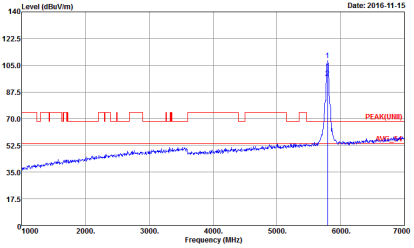
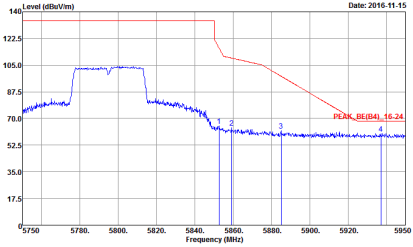

WIFI	Band 4 5725~5850MHz Band Edge @ 3m	
ANT	802.11ac VHT40 CH159 5795MHz	
1	Horizontal	Fundamental
Peak	 <p>Date: 2016-11-15 PEAK_BE(B4)_16-24</p> <p>Site : 03CH12-HY Condition : PEAK_BE(B4)_16-24 3m HORN_9120D_1328 HORIZONTAL Detector : Peak Project : 672014-10 Mode : 43</p>	 <p>Date: 2016-11-15 PEAK(UM)</p> <p>Site : 03CH12-HY Condition : PEAK(UM) 3m HORN_9120D_1328 HORIZONTAL Detector : Peak Project : 672014-10 Mode : 43</p>
Peak	 <p>Date: 2016-11-15 PEAK_BE(B4)_16-24</p> <p>Site : 03CH12-HY Condition : PEAK_BE(B4)_16-24 3m HORN_9120D_1328 HORIZONTAL Detector : Peak Project : 672014-10 Mode : 43</p>	Left blank

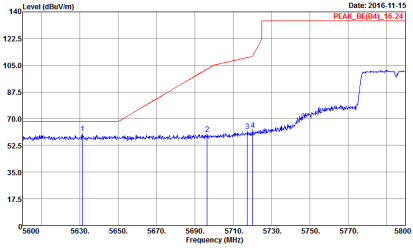
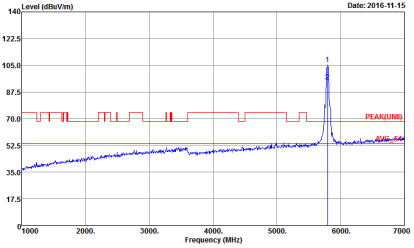
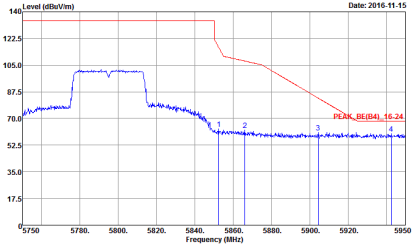

WIFI	Band 4 5725~5850MHz Band Edge @ 3m	
ANT	802.11ac VHT40 CH159 5795MHz	
1	Vertical	Fundamental
<p>Peak</p>	 <p>Date: 2016-11-15 PEAK_BE(B4)_16-24</p> <p>Site : 03CH12-HY Condition : PEAK_BE(B4)_16-24 3m HORN_9120D_1328 VERTICAL : RBW:1000.000KHz VBW:3000.000KHz SWT:Auto Detector : Peak Project : 672014-10 Mode : 43</p>	 <p>Date: 2016-11-15 PEAK(UWB)</p> <p>Site : 03CH12-HY Condition : PEAK(UWB) 3m HORN_9120D_1328 VERTICAL : RBW:1000.000KHz VBW:3000.000KHz SWT:Auto Detector : Peak Project : 672014-10 Mode : 43</p>
<p>Peak</p>	 <p>Date: 2016-11-15 PEAK_BE(B4)_16-24</p> <p>Site : 03CH12-HY Condition : PEAK_BE(B4)_16-24 3m HORN_9120D_1328 VERTICAL : RBW:1000.000KHz VBW:3000.000KHz SWT:Auto Detector : Peak Project : 672014-10 Mode : 43</p>	<p>Left blank</p>



Band 4 5725~5850MHz
WIFI 802.11ac VHT80 (Band Edge @ 3m)

Table with 2 columns (WIFI, ANT) and 2 rows (Peak, Peak). Contains spectral plots for 'Horizontal' and 'Fundamental' views, and a 'Left blank' view. Includes technical details like Site, Condition, Detector, Project, and Mode.

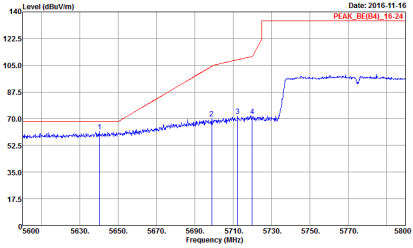
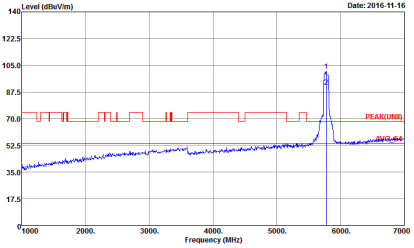
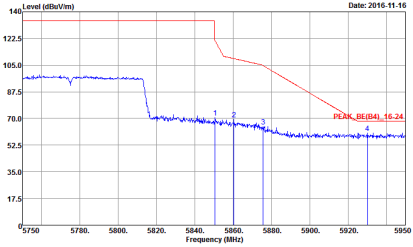

WIFI	Band 4 5725~5850MHz Band Edge @ 3m	
ANT	802.11ac VHT80 CH155 5775MHz	
1	Vertical	Fundamental
Peak	 <p>Date: 2016-11-16 PEAK_BE(B4)_16-24</p> <p>Site : 03CH12-HY Condition : PEAK_BE(B4)_16-24 3m HORN_9120D_1328 VERTICAL : RBW:1000.000KHz VBW:3000.000KHz SWT:Auto Detector : Peak Project : 672014-10 Mode : 44</p>	 <p>Date: 2016-11-16 PEAK(UNI)</p> <p>Site : 03CH12-HY Condition : PEAK(UNI) 3m HORN_9120D_1328 VERTICAL : RBW:1000.000KHz VBW:3000.000KHz SWT:Auto Detector : Peak Project : 672014-10 Mode : 44</p>
Peak	 <p>Date: 2016-11-16 PEAK_BE(B4)_16-24</p> <p>Site : 03CH12-HY Condition : PEAK_BE(B4)_16-24 3m HORN_9120D_1328 VERTICAL : RBW:1000.000KHz VBW:3000.000KHz SWT:Auto Detector : Peak Project : 672014-10 Mode : 44</p>	Left blank



Band 4 - 5725~5850MHz
WIFI 802.11a (Harmonic @ 3m)

WIFI	Band 4 5725~5850MHz Harmonic @ 3m	
ANT	802.11a CH149 5745MHz	
1	Horizontal	Vertical
<p>Peak</p> <p>Avg.</p>	<p>Site : 03CH12-HY Condition : PEAK(UNI) 3m HORN_9120D_1328 HORIZONTAL Project : 672014-10 Mode : 36</p>	<p>Site : 03CH12-HY Condition : PEAK(UNI) 3m HORN_9120D_1328 VERTICAL Project : 672014-10 Mode : 36</p>



WIFI	Band 4 5725~5850MHz Harmonic @ 3m	
ANT	802.11a CH157 5785MHz	
1	Horizontal	Vertical
Peak Avg.	<p>Site : 03CH12-HY Condition : PEAK(UNI) 3m HORN_9120D_1328 HORIZONTAL Project : 672014-10 Mode : 37</p>	<p>Site : 03CH12-HY Condition : PEAK(UNI) 3m HORN_9120D_1328 VERTICAL Project : 672014-10 Mode : 37</p>

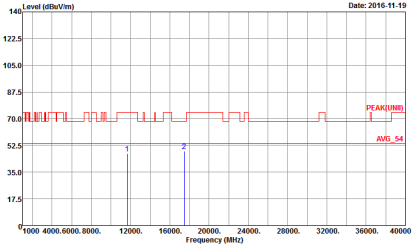
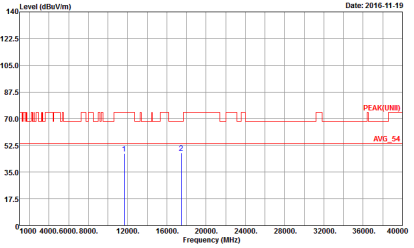

WIFI	Band 4 5725~5850MHz Harmonic @ 3m	
ANT	802.11a CH165 5825MHz	
1	Horizontal	Vertical
Peak Avg.	 <p>Site : 03CH12-HY Condition : PEAK(UNI) 3m HORN_9120D_1328 HORIZONTAL Project : 672014-10 Mode : 38</p>	 <p>Site : 03CH12-HY Condition : PEAK(UNI) 3m HORN_9120D_1328 VERTICAL Project : 672014-10 Mode : 38</p>



Band 4 5725~5850MHz
WIFI 802.11ac VHT20 (Harmonic @ 3m)

Table with 2 columns: Horizontal and Vertical. It contains two spectral plots showing Level (dBm/m) vs Frequency (MHz) for Peak and Avg. measurements. Includes metadata like Site, Condition, Detector, Project, and Mode.



WIFI	Band 4 5725~5850MHz Harmonic @ 3m	
ANT	802.11ac VHT20 CH157 5785MHz	
1	Horizontal	Vertical
Peak Avg.	<p>Site : 03CH12-HY Condition : PEAK(UNI) 3m HORN_9120D_1328 HORIZONTAL Detector : Peak Project : 672014-10 Mode : 40</p>	<p>Site : 03CH12-HY Condition : PEAK(UNI) 3m HORN_9120D_1328 VERTICAL Detector : Peak Project : 672014-10 Mode : 40</p>



WIFI	Band 4 5725~5850MHz Harmonic @ 3m	
ANT	802.11ac VHT20 CH165 5825MHz	
1	Horizontal	Vertical
Peak Avg.	<p>Site : 03CH12-HY Condition : PEAK(UNI) 3m HORN_9120D_1328 HORIZONTAL Detector : Peak Project : 672014-10 Mode : 41</p>	<p>Site : 03CH12-HY Condition : PEAK(UNI) 3m HORN_9120D_1328 VERTICAL Detector : Peak Project : 672014-10 Mode : 41</p>



Band 4 5725~5850MHz
WIFI 802.11ac VHT40 (Harmonic @ 3m)

WIFI	Band 4 5725~5850MHz Harmonic @ 3m	
ANT	802.11ac VHT40 CH151 5755MHz	
1	Horizontal	Vertical
<p>Peak</p> <p>Avg.</p>	<p>Site : 03CH12-HY Condition : PEAK(UMI) 3m HORN_9120D_1328 HORIZONTAL Detector : Peak Project : 672014-10 Mode : 42</p>	<p>Site : 03CH12-HY Condition : PEAK(UMI) 3m HORN_9120D_1328 VERTICAL Detector : Peak Project : 672014-10 Mode : 42</p>

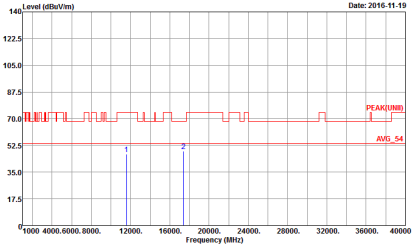
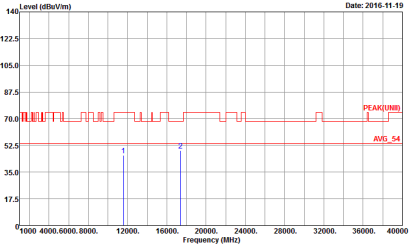

WIFI	Band 4 5725~5850MHz Harmonic @ 3m	
ANT	802.11ac VHT40 CH159 5795MHz	
1	Horizontal	Vertical
Peak Avg.	 <p>Site : 03CH12-HY Condition : PEAK(UNI) 3m HORN_9120D_1328 HORIZONTAL Detector : Peak Project : 672014-10 Mode : 43</p>	 <p>Site : 03CH12-HY Condition : PEAK(UNI) 3m HORN_9120D_1328 VERTICAL Detector : Peak Project : 672014-10 Mode : 43</p>



Band 4 5725~5850MHz
WIFI 802.11ac VHT80 (Harmonic @ 3m)

Table with 2 columns: Horizontal and Vertical. It contains two graphs showing Level (dBu/m) vs Frequency (MHz) for Peak and Avg. measurements. Includes metadata like Site, Condition, Detector, Project, and Mode.

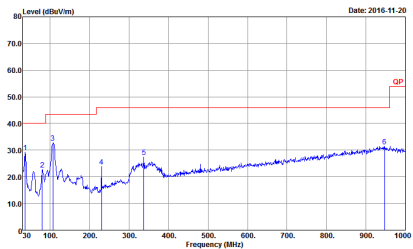
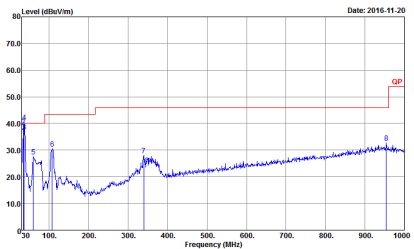

Emission below 1GHz
5GHz WIFI 802.11ac VHT80 (LF)

WIFI	5GHz 5725~5850MHz	
ANT	802.11ac VHT80 LF	
1	Horizontal	Vertical
QP / Peak	 <p data-bbox="347 873 606 929"> Site : 03CH12-HY Condition : QP 3m BILLOG_6111D_37059 HORIZONTAL Detector : Peak Project : 672014-10 Mode : 45 </p>	 <p data-bbox="944 873 1203 929"> Site : 03CH12-HY Condition : QP 3m BILLOG_6111D_37059 VERTICAL Detector : Peak Project : 672014-10 Mode : 45 </p>



Appendix C. Duty Cycle Plots

Antenna	Band	Duty Cycle(%)	T(us)	1/T(kHz)	VBW Setting
1	802.11a	93.46	1430.00	0.70	1kHz
1	5GHz 802.11ac VHT20	92.47	1350.00	0.74	1kHz
1	5GHz 802.11ac VHT40	96.94	950.00	1.05	3kHz
1	5GHz 802.11ac VHT80	95.83	460.00	2.17	3kHz



802.11a

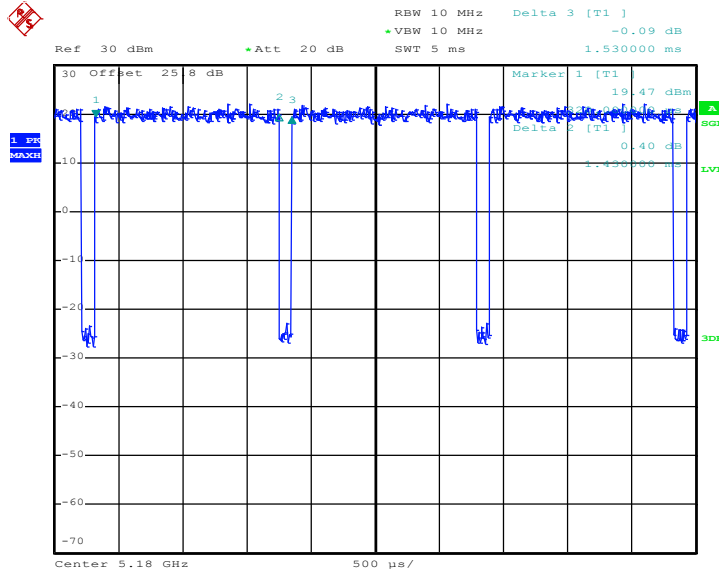

Date: 8.NOV.2016 20:53:54

802.11ac VHT20

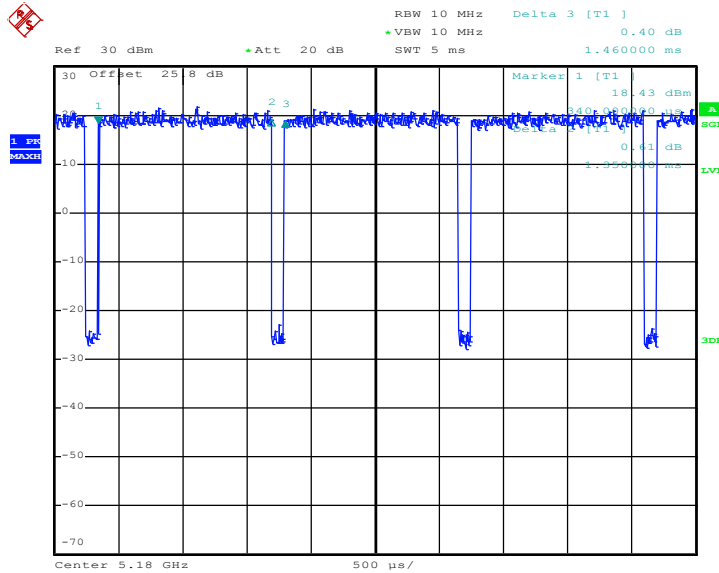

Date: 8.NOV.2016 22:53:42



802.11ac VHT40

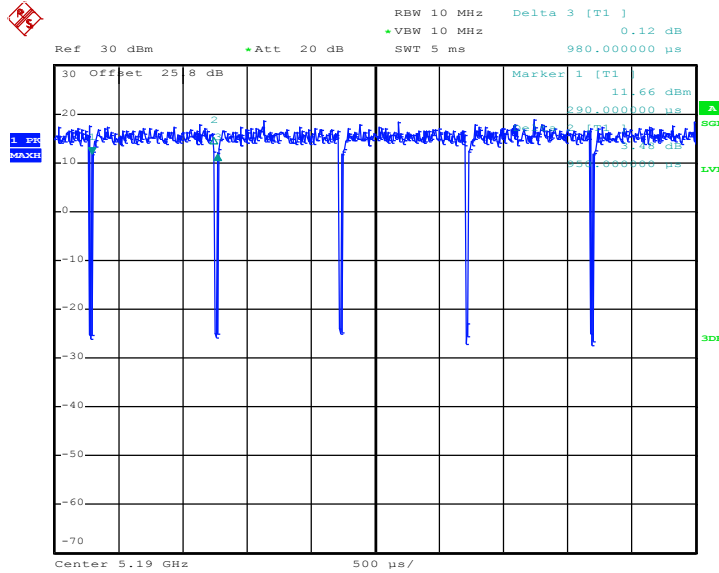

Date: 8.NOV.2016 22:58:56

802.11ac VHT80

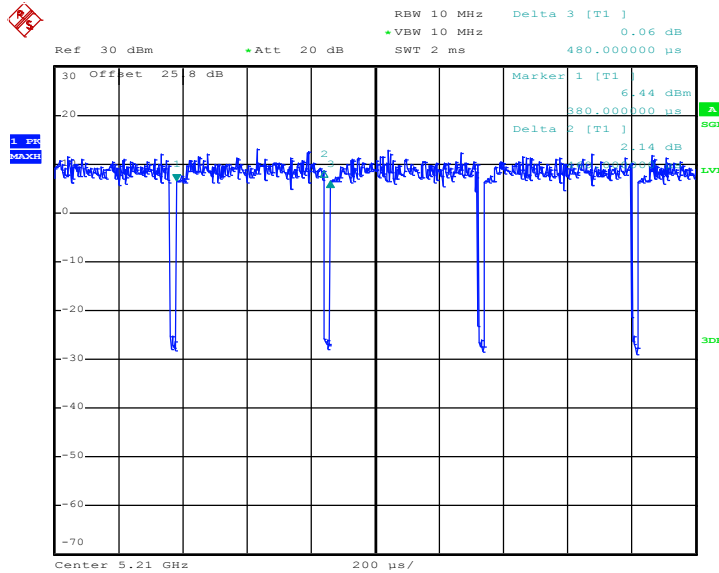

Date: 8.NOV.2016 23:39:29