



FCC RADIO TEST REPORT

FCC ID : UZ7TC530E
Equipment : Touch Computer
Brand Name : Zebra
Model Name : TC530E
Applicant : Zebra Technologies Corporation
1 Zebra Plaza, Holtsville, NY 11742
Manufacturer : Zebra Technologies Corporation
1 Zebra Plaza, Holtsville, NY 11742
Standard : FCC Part 15 Subpart C §15.247

The product was received on Dec. 05, 2023 and testing was performed from Dec. 11, 2023 to Jan. 26, 2024. We, Sporton International Inc. Wensan Laboratory, would like to declare that the tested sample has been evaluated in accordance with the test procedures and has been in compliance with the applicable technical standards.

The test results in this report apply exclusively to the tested model / sample. Without written approval from Sporton International Inc. Wensan Laboratory, the test report shall not be reproduced except in full.

Approved by: Louis Wu

Sporton International Inc. Wensan Laboratory

No.58, Aly. 75, Ln. 564, Wenhua 3rd, Rd., Guishan Dist., Taoyuan City 333010, Taiwan (R.O.C.)



Table of Contents

History of this test report.....	3
Summary of Test Result.....	4
1 General Description.....	5
1.1 Product Feature of Equipment Under Test.....	5
1.2 Product Specification of Equipment Under Test.....	6
1.3 Modification of EUT	6
1.4 Testing Location	7
1.5 Applicable Standards.....	7
2 Test Configuration of Equipment Under Test	8
2.1 Carrier Frequency Channel	8
2.2 Test Mode.....	9
2.3 Connection Diagram of Test System.....	11
2.4 Support Unit used in test configuration and system	12
2.5 EUT Operation Test Setup	13
2.6 Measurement Results Explanation Example.....	13
3 Test Result.....	14
3.1 6dB and 99% Bandwidth Measurement	14
3.2 Output Power Measurement.....	15
3.3 Power Spectral Density Measurement	16
3.4 Conducted Band Edges and Spurious Emission Measurement	17
3.5 Radiated Band Edges and Spurious Emission Measurement	18
3.6 AC Conducted Emission Measurement.....	22
3.7 Antenna Requirements	24
4 List of Measuring Equipment	25
5 Measurement Uncertainty	27
Appendix A. Conducted Test Results	
Appendix B. AC Conducted Emission Test Result	
Appendix C. Radiated Spurious Emission	
Appendix D. Radiated Spurious Emission Plots	
Appendix E. Duty Cycle Plots	
Appendix F. Setup Photographs	



History of this test report

Report No.	Version	Description	Issue Date
FR3D0601B	01	Initial issue of report	Feb. 07, 2024



Summary of Test Result

Report Clause	Ref Std. Clause	Test Items	Result (PASS/FAIL)	Remark
3.1	15.247(a)(2)	6dB Bandwidth	Pass	-
3.1	2.1049	99% Occupied Bandwidth	Reporting only	-
3.2	15.247(b)(3) 15.247(b)(4)	Output Power	Pass	-
3.3	15.247(e)	Power Spectral Density	Pass	-
3.4	15.247(d)	Conducted Band Edges and Spurious Emission	Pass	-
3.5	15.247(d)	Radiated Band Edges and Spurious Emission	Pass	11.23 dB under the limit at 45.64 MHz
3.6	15.207	AC Conducted Emission	Pass	16.92 dB under the limit at 0.18 MHz
3.7	15.203	Antenna Requirement	Pass	-

Conformity Assessment Condition:

1. The test results (PASS/FAIL) with all measurement uncertainty excluded are presented against the regulation limits or in accordance with the requirements stipulated by the applicant/manufacturer who shall bear all the risks of non-compliance that may potentially occur if measurement uncertainty is taken into account.
2. The measurement uncertainty please refer to each test result in the section "Measurement Uncertainty".

Disclaimer:

The product specifications of the EUT presented in the test report that may affect the test assessments are declared by the manufacturer who shall take full responsibility for the authenticity.

Reviewed by: Wei Chen

Report Producer: Mila Chen



1 General Description

1.1 Product Feature of Equipment Under Test

Product Feature	
Equipment	Touch Computer
Brand Name	Zebra
Model Name	TC530E
FCC ID	UZ7TC530E
Sample 1	SE55 + 8GB (Samsung) 128GB (SK Hynix)
Sample 2	SE55 + 6GB (SK Hynix) 64GB (WD)
Sample 3	SE4720 + 6GB (SK Hynix) 64GB (WD)
EUT supports Radios application	NFC WLAN 11a/b/g/n HT20/HT40 WLAN 11ac VHT20/VHT40/VHT80/VHT160 WLAN 11ax HE20/HE40/HE80/HE160 Bluetooth BR/EDR/LE
HW Version	DV1-1
SW Version	13-11-28.00-TN-U00-PRD-NEM-04
FW Version	PN7160_AR_11.02.00
MFD	13NOV23
EUT Stage	Identical Prototype

Remark: The EUT's information above is declared by manufacturer.

Specification of Accessories				
Adapter	Brand Name	Zebra	Part Number	PWR-WUA5V12W0US
Battery 1 (1x)	Brand Name	Zebra	Part Number	BT-000442-0020
Battery 2 (1.5x)	Brand Name	Zebra	Part Number	BT-000442-0820
Battery 3 (Wireless Battery)	Brand Name	Zebra	Part Number	BT-000442-002B
Battery 4 (1x)	Brand Name	Zebra	Part Number	BT-000442-1020
USB TYPE A to TYPE C cable	Brand Name	Zebra	Part Number	CBL-TC5X-USBC2A-01
USB TYPE C to 3.5mm audio connector	Brand Name	Zebra	Part Number	ADP-USBC-35MM1-01
3.5mm Earphone	Brand Name	Zebra	Part Number	HDST-35MM-PTT1-01
Rugged Headset	Brand Name	Zebra	Part Number	HS2100-OTH
USB TYPE C Earphone	Brand Name	Zebra	Part Number	HPST-USBC-PTT1-01
Trigger Handle	Brand Name	Zebra	Part Number	TRG-NGTC5-ELEC-01
Soft Holster	Brand Name	Zebra	Part Number	SG-NGTC5TC7-HLSTR-01
TC53/TC58 RUGGED BOOT	Brand Name	Zebra	Part Number	SG-NGTC5EXO1-01
3.5mm to 3.5mm audio connector	Brand Name	Zebra	Part Number	CBL-HS2100-3MS1-01



1.2 Product Specification of Equipment Under Test

Product Specification is subject to this standard	
Tx/Rx Frequency Range	2402 MHz ~ 2480 MHz
Number of Channels	79
Carrier Frequency of Each Channel	2402+n*1 MHz; n=0~78
Maximum Output Power to Antenna	<p><Class 1> <Ant. 6> Bluetooth-LE (1Mbps): 6.50 dBm (0.0045 W) Bluetooth-LE (2Mbps): 6.50 dBm (0.0045 W) <Ant. 7> Bluetooth-LE (1Mbps): 5.40 dBm (0.0035 W) Bluetooth-LE (2Mbps): 5.40 dBm (0.0035 W)</p> <p><Class 2> <Ant. 6> Bluetooth-LE (1Mbps): 2.70 dBm (0.0019 W) Bluetooth-LE (2Mbps): 2.70 dBm (0.0019 W) <Ant. 7> Bluetooth-LE (1Mbps): 1.30 dBm (0.0013 W) Bluetooth-LE (2Mbps): 1.30 dBm (0.0013 W)</p>
99% Occupied Bandwidth	<p><Class 1> <Ant. 6> Bluetooth-LE (1Mbps): 1.017 MHz Bluetooth-LE (2Mbps): 1.998 MHz <Ant. 7> Bluetooth-LE (1Mbps): 1.019 MHz Bluetooth-LE (2Mbps): 2.002 MHz</p>
Antenna Type / Gain	<p><Ant. 6>: PIFA Antenna with gain 0.67 dBi <Ant. 7>: PIFA Antenna with gain 0.53 dBi</p>
Type of Modulation	Bluetooth LE: GFSK

Remark: The above EUT's information was declared by manufacturer. Please refer to Disclaimer in report summary.

1.3 Modification of EUT

No modifications made to the EUT during the testing.



1.4 Testing Location

Test Site	Sporton International Inc. EMC & Wireless Communications Laboratory
Test Site Location	No.52, Huaya 1st Rd., Guishan Dist., Taoyuan City 333, Taiwan (R.O.C.) TEL: +886-3-327-3456 FAX: +886-3-328-4978
Test Site No.	Sporton Site No. CO05-HY (TAF Code: 1190)
Remark	The AC Conducted Emission test item subcontracted to Sporton International Inc. EMC & Wireless Communications Laboratory.

Note: The test site complies with ANSI C63.4 2014 requirement.

Test Site	Sporton International Inc. Wensan Laboratory
Test Site Location	No.58, Aly. 75, Ln. 564, Wenhua 3rd, Rd., Guishan Dist., Taoyuan City 333010, Taiwan (R.O.C.) TEL: +886-3-327-0868 FAX: +886-3-327-0855
Test Site No.	Sporton Site No. TH05-HY, 03CH20-HY

Note: The test site complies with ANSI C63.4 2014 requirement.

FCC designation No.: TW1190 and TW3786

1.5 Applicable Standards

According to the specifications declared by the manufacturer, the EUT must comply with the requirements of the following standards:

- ♦ FCC Part 15 Subpart C §15.247
- ♦ FCC KDB Publication No. 558074 D01 15.247 Meas Guidance v05r02
- ♦ FCC KDB 414788 D01 Radiated Test Site v01r01
- ♦ ANSI C63.10-2013

Remark:

1. All the test items were validated and recorded in accordance with the standards without any modification during the testing.
2. The TAF code is not including all the FCC KDB listed without accreditation.
3. This EUT has also been tested and complied with the requirements of FCC Part 15, Subpart B, recorded in a separate test report.



2 Test Configuration of Equipment Under Test

2.1 Carrier Frequency Channel

Frequency Band	Channel	Freq. (MHz)	Channel	Freq. (MHz)
2400-2483.5 MHz	0	2402	21	2444
	1	2404	22	2446
	2	2406	23	2448
	3	2408	24	2450
	4	2410	25	2452
	5	2412	26	2454
	6	2414	27	2456
	7	2416	28	2458
	8	2418	29	2460
	9	2420	30	2462
	10	2422	31	2464
	11	2424	32	2466
	12	2426	33	2468
	13	2428	34	2470
	14	2430	35	2472
	15	2432	36	2474
	16	2434	37	2476
	17	2436	38	2478
	18	2438	39	2480
	19	2440	-	-
20	2442	-	-	



2.2 Test Mode

- a. The EUT has been associated with peripherals and configuration operated in a manner tended to maximize its emission characteristics in a typical application. Frequency range investigated: conduction emission (150 kHz to 30 MHz), radiation emission (9 kHz to the 10th harmonic of the highest fundamental frequency or to 40 GHz, whichever is lower). For radiated measurement, the measured emission level of the EUT was maximized by rotating the EUT on a turntable, adjusting the orientation of the EUT and EUT antenna in three orthogonal axis (X: flat, Y: portrait, Z: landscape) accessory (Adapter or Earphone), and adjusting the measurement antenna orientation, following C63.10 exploratory test procedures and only the worst case emissions were reported in this report.
- b. AC power line Conducted Emission was tested under maximum output power.

The following summary table is showing all test modes to demonstrate in compliance with the standard.

Summary table of Test Cases	
Test Item	Data Rate / Modulation
Conducted Test Cases	Bluetooth – LE / GFSK
	Mode 1: Bluetooth Tx CH00_2402 MHz_1Mbps
	Mode 2: Bluetooth Tx CH19_2440 MHz_1Mbps
	Mode 3: Bluetooth Tx CH39_2480 MHz_1Mbps
	Mode 4: Bluetooth Tx CH00_2402 MHz_2Mbps
	Mode 5: Bluetooth Tx CH19_2440 MHz_2Mbps
	Mode 6: Bluetooth Tx CH39_2480 MHz_2Mbps



Test Item	Data Rate / Modulation
Radiated Test Cases	<p><Ant.6></p> <p>Mode 1: Bluetooth Tx CH00_2402 MHz_1Mbps Mode 2: Bluetooth Tx CH19_2440 MHz_1Mbps Mode 3: Bluetooth Tx CH39_2480 MHz_1Mbps Mode 4: Bluetooth Tx CH00_2402 MHz_2Mbps Mode 5: Bluetooth Tx CH19_2440 MHz_2Mbps Mode 6: Bluetooth Tx CH39_2480 MHz_2Mbps</p> <p><Ant.7></p> <p>Mode 1: Bluetooth Tx CH00_2402 MHz_1Mbps Mode 2: Bluetooth Tx CH19_2440 MHz_1Mbps Mode 3: Bluetooth Tx CH39_2480 MHz_1Mbps Mode 4: Bluetooth Tx CH00_2402 MHz_2Mbps Mode 5: Bluetooth Tx CH19_2440 MHz_2Mbps Mode 6: Bluetooth Tx CH39_2480 MHz_2Mbps</p>
AC Conducted Emission	Mode 1: WLAN (2.4GHz) + Bluetooth Link + Battery 2 (1.5x) + USB Type A to Type C Cable (Charging from Adapter) for Sample 1
Remark:	<ol style="list-style-type: none">For Radiated Test Cases, the tests were performed with Battery 1, and Sample 1For radiation spurious emission, the modulation and the data rate picked for testing are determined by the Max. RF conducted power.

2.3 Connection Diagram of Test System

<AC Conducted Emission Mode>

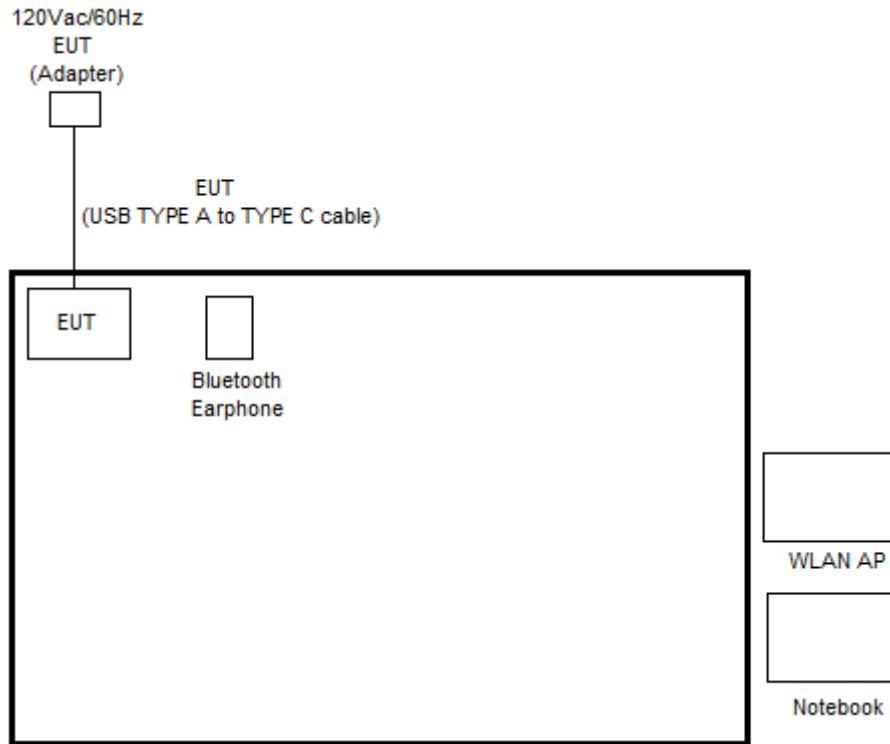

<Bluetooth-LE Tx Mode>

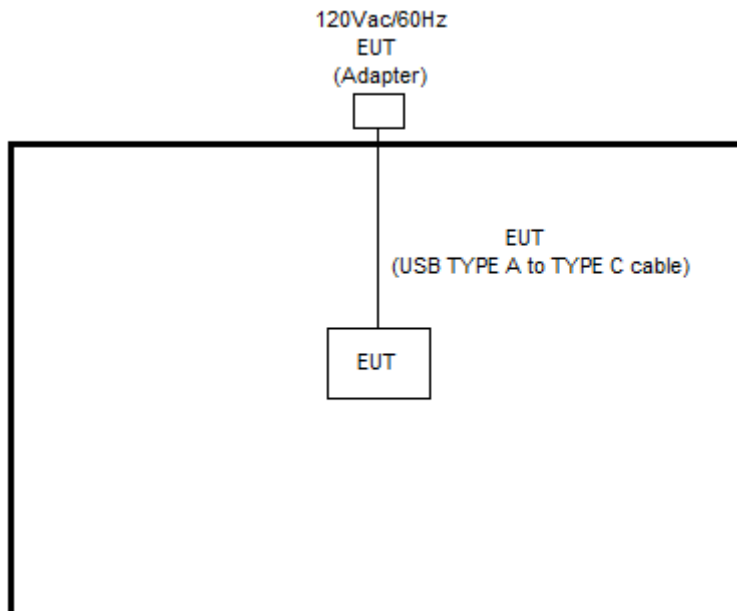

< Bluetooth-LE Tx with Earphone Mode >

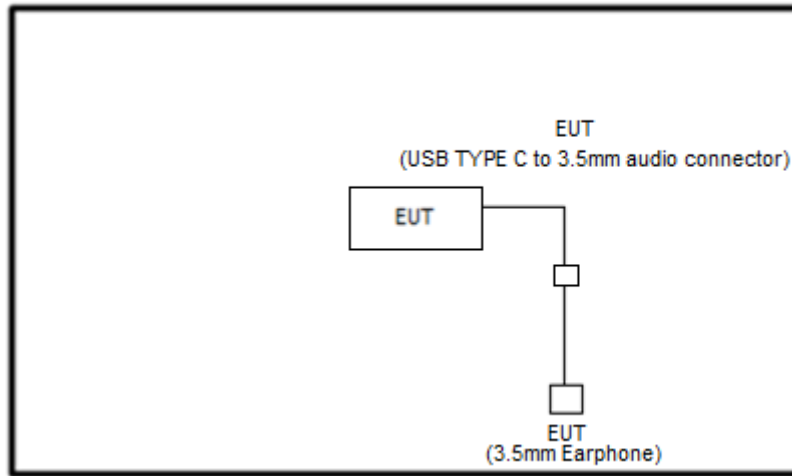

2.4 Support Unit used in test configuration and system

Item	Equipment	Brand Name	Model Name	FCC ID	Data Cable	Power Cord
1.	Bluetooth Earphone	Sony Ericsson	MW600	PY700A2029	N/A	N/A
2.	WLAN AP	ASUS	RT-AC66U	MSQ-RTAC66U	N/A	Unshielded, 1.8m
3.	Notebook	DELL	Latitude 3420	FCC DoC	N/A	AC I/P: Unshielded, 1.2 m DC O/P: Shielded, 1.8 m
4.	Notebook	DELL	Latitude 5310	N/A	N/A	unshielded, 1.8m
5.	SD Card	SanDisk	MicroSD HC	FCC DoC	N/A	N/A



2.5 EUT Operation Test Setup

The RF test items, utility “QRCT Version 4.0.00206.0” was installed in Notebook which was programmed in order to make the EUT get into the engineering modes to provide channel selection, power level, data rate and the application type and for continuous transmitting signals.

2.6 Measurement Results Explanation Example

For all conducted test items:

The offset level is set in the spectrum analyzer to compensate the RF cable loss and attenuator factor between EUT conducted output port and spectrum analyzer. With the offset compensation, the spectrum analyzer reading level is exactly the EUT RF output level.

Example :

The spectrum analyzer offset is derived from RF cable loss and attenuator factor.

Offset = RF cable loss + attenuator factor.

Following shows an offset computation example with cable loss 4.2 dB and 10 dB attenuator.

$$\begin{aligned} \text{Offset(dB)} &= \text{RF cable loss(dB)} + \text{attenuator factor(dB)}. \\ &= 4.2 + 10 = 14.2 \text{ (dB)} \end{aligned}$$

3 Test Result

3.1 6dB and 99% Bandwidth Measurement

3.1.1 Limit of 6dB and 99% Bandwidth

The minimum 6 dB bandwidth shall be at least 500 kHz.

3.1.2 Measuring Instruments

Please refer to the measuring equipment list in this test report.

3.1.3 Test Procedures

1. The testing follows the ANSI C63.10 Section 6.9.3 (OBW) and 11.8.1 (6dB BW).
2. The RF output of EUT is connected to the spectrum analyzer by RF cable and attenuator. The path loss is compensated to the results for each measurement.
3. Set the maximum power setting and enable the EUT to transmit continuously.
4. Make the measurement with the spectrum analyzer's resolution bandwidth (RBW) = 100 kHz. Set the Video bandwidth (VBW) = 300 kHz. In order to make an accurate measurement. The 6dB bandwidth must be greater than 500 kHz.
5. For 99% Bandwidth Measurement, the spectrum analyzer's resolution bandwidth (RBW) is set 1-5% of the emission bandwidth and set the Video bandwidth (VBW) $\geq 3 * RBW$.
6. Measure and record the results in the test report.

3.1.4 Test Setup



3.1.5 Test Result of 6dB Bandwidth

Please refer to Appendix A.

3.1.6 Test Result of 99% Occupied Bandwidth

Please refer to Appendix A.

3.2 Output Power Measurement

3.2.1 Limit of Output Power

For systems using digital modulation in the 2400-2483.5 MHz, the limit for output power is 30 dBm. If transmitting antenna of directional gain greater than 6 dBi is used, the peak output power from the intentional radiator shall be reduced below the above stated value by the amount in dB that the directional gain of the antenna exceeds 6 dBi. In case of point-to-point operation, the limit has to be reduced by 1 dB for every 3 dB that the directional gain of the antenna exceeds 6 dBi.

3.2.2 Measuring Instruments

Please refer to the measuring equipment list in this test report.

3.2.3 Test Procedures

1. For Average Power, the testing follows ANSI C63.10 Section 11.9.2.3.2 Method AVGP-M-G
2. The RF output of EUT is connected to the power meter by RF cable and attenuator.
3. The path loss is compensated to the results for each measurement.
4. Set the maximum power setting and enable the EUT to transmit continuously.
5. Measure the conducted output power and record the results in the test report.

3.2.4 Test Setup

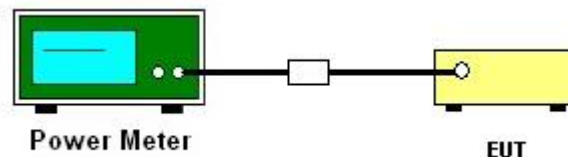

3.2.5 Test Result of Average Output Power

Please refer to Appendix A.

3.3 Power Spectral Density Measurement

3.3.1 Limit of Power Spectral Density

The peak power spectral density shall not be greater than 8 dBm in any 3 kHz band at any time interval of continuous transmission.

3.3.2 Measuring Instruments

Please refer to the measuring equipment list in this test report.

3.3.3 Test Procedures

1. The testing follows the ANSI C63.10 Section 11.10.2 Method PKPSD.
2. The RF output of EUT is connected to the spectrum analyzer by RF cable and attenuator. The path loss is compensated to the results for each measurement.
3. Set the maximum power setting and enable the EUT to transmit continuously.
4. Make the measurement with the spectrum analyzer's resolution bandwidth (RBW) = 3 kHz. Video bandwidth (VBW) = 10 kHz. In order to make an accurate measurement, set the span to 1.5 times DTS Channel Bandwidth. (6 dB BW)
5. Detector = peak, Sweep time = auto couple, Trace mode = max hold, Allow trace to fully stabilize. Use the peak marker function to determine the maximum power level.
6. Measure and record the results in the test report.
7. The Measured power density (dBm)/ 100 kHz is a reference level and is used as 20 dBc down limit line for Conducted Band Edges and Conducted Spurious Emission.

3.3.4 Test Setup



3.3.5 Test Result of Power Spectral Density

Please refer to Appendix A.

3.4 Conducted Band Edges and Spurious Emission Measurement

3.4.1 Limit of Conducted Band Edges and Spurious Emission

All harmonics/spurious must be at least 30 dB down from the highest emission level within the authorized band.

3.4.2 Measuring Instruments

Please refer to the measuring equipment list in this test report.

3.4.3 Test Procedure

1. The testing follows the ANSI C63.10 Section 11.11.3 Emission level measurement.
2. The RF output of EUT is connected to the spectrum analyzer by RF cable and attenuator. The path loss is compensated to the results for each measurement.
3. Set the maximum power setting and enable the EUT to transmit continuously.
4. Set RBW = 100 kHz, VBW = 300 kHz, Peak Detector. Unwanted Emissions measured in any 100 kHz bandwidth outside of the authorized frequency band shall be attenuated by at least 20 dB relative to the maximum in-band peak PSD level in 100 kHz when maximum peak conducted output power procedure is used. If the transmitter complies with the conducted power limits based on the use of RMS averaging over a time interval, the attenuation required under this paragraph shall be 30 dB instead of 20 dB.
5. Measure and record the results in the test report.
6. The RF fundamental frequency should be excluded against the limit line in the operating frequency band.

3.4.4 Test Setup

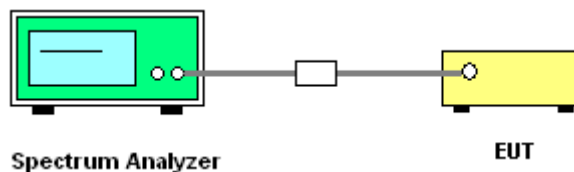

3.4.5 Test Result of Conducted Band Edges Plots

Please refer to Appendix A.

3.4.6 Test Result of Conducted Spurious Emission Plots

Please refer to Appendix A.



3.5 Radiated Band Edges and Spurious Emission Measurement

3.5.1 Limit of Radiated Band Edges and Spurious Emission

In any 100 kHz bandwidth outside the intentional radiator frequency band, all harmonics/spurious must be at least 20 dB below the highest emission level within the authorized band. If the output power of this device is measured by spectrum analyzer, the attenuation under this paragraph shall be 30 dB instead of 20 dB. In addition, radiated emissions which fall in the restricted bands must also comply with the limits as below.

Frequency (MHz)	Field Strength (microvolts/meter)	Measurement Distance (meters)
0.009 – 0.490	2400/F(kHz)	300
0.490 – 1.705	24000/F(kHz)	30
1.705 – 30.0	30	30
30 – 88	100	3
88 – 216	150	3
216 - 960	200	3
Above 960	500	3

3.5.2 Measuring Instruments

Please refer to the measuring equipment list in this test report.

**3.5.3 Test Procedures**

1. The testing follows the ANSI C63.10 Section 11.12.1 Radiated emission measurements.
2. The EUT is arranged to its worst case and then tune the antenna tower (from 1 m to 4 m) and turntable (from 0 degree to 360 degrees) to find the maximum reading. A pre-amp and a high pass filter are used for the test in order to get better signal level.
3. The EUT is placed on a turntable with 0.8 meter for frequency below 1 GHz and 1.5 meter for frequency above 1 GHz respectively above ground.
4. The EUT is set 3 meters away from the receiving antenna, which is mounted on the top of a variable height antenna tower.
5. Corrected Reading: Antenna Factor + Cable Loss + Read Level - Preamp Factor = Level
6. Radiated testing below 1 GHz is performed by adjusting the antenna tower from 1 m to 4 m and by rotating the turn table from 0 degree to 360 degrees to find the peak maximum hold reading. When there is no suspected emission found and the emission level is with at least 6 dB margin against QP limit line, the position is marked as “-”.
7. Radiated testing above 1 GHz is performed by adjusting the antenna tower from 1 m to 4 m and by rotating the turn table from 0 degree to 360 degrees to find the peak maximum hold reading for scanning all frequencies. When there is no suspected emission found and the harmonic emission level is with at least 6 dB margin against average limit line, the position is marked as “-”.
8. Use the following spectrum analyzer settings:
 - (1) Span shall wide enough to fully capture the emission being measured;
 - (2) Set RBW = 100 kHz for $f < 1$ GHz; VBW \geq RBW; Sweep = auto; Detector function = peak; Trace = max hold;
 - (3) Set RBW = 1 MHz, VBW = 3 MHz for $f \geq 1$ GHz for peak measurement.
For average measurement:
 - VBW = 10 Hz, when duty cycle is no less than 98 percent.
 - VBW $\geq 1/T$, when duty cycle is less than 98 percent where T is the minimum transmission duration over which the transmitter is on and is transmitting at its maximum power control level for the tested mode of operation.

3.5.4 Test Setup

For radiated test below 30MHz

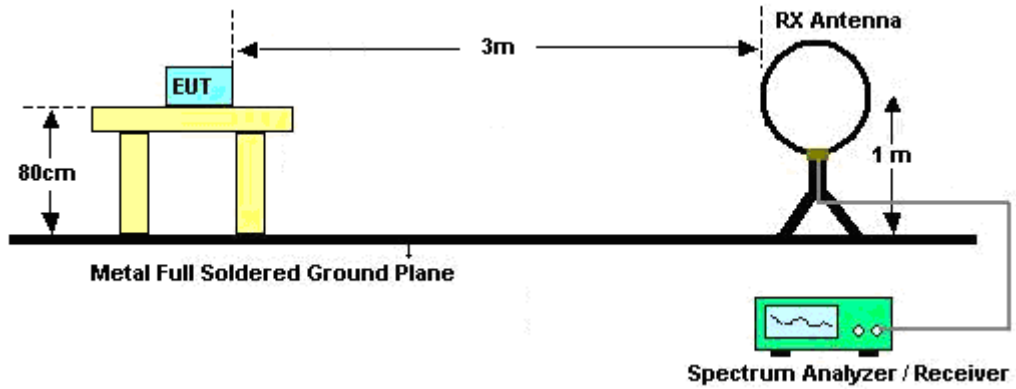

For radiated test from 30MHz to 1GHz

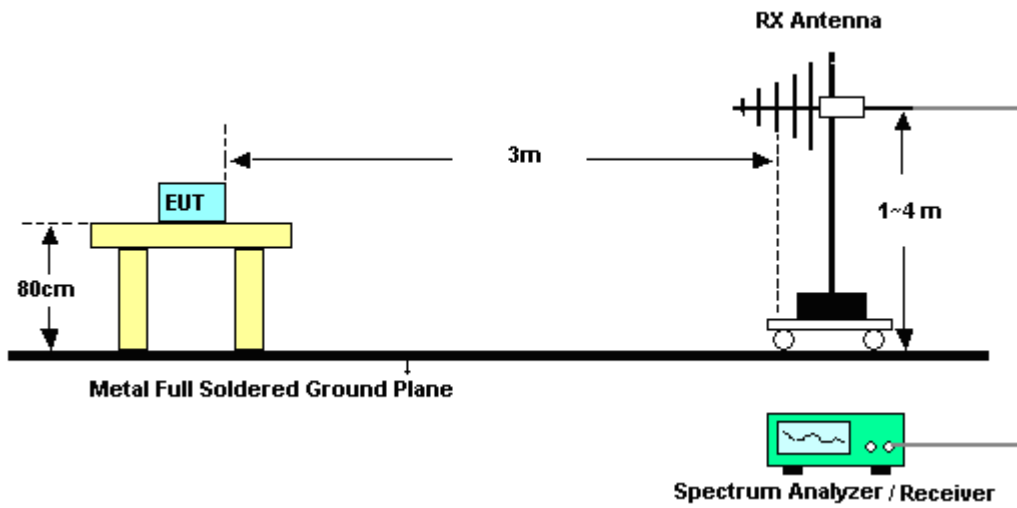

For radiated test from 1GHz to 18GHz

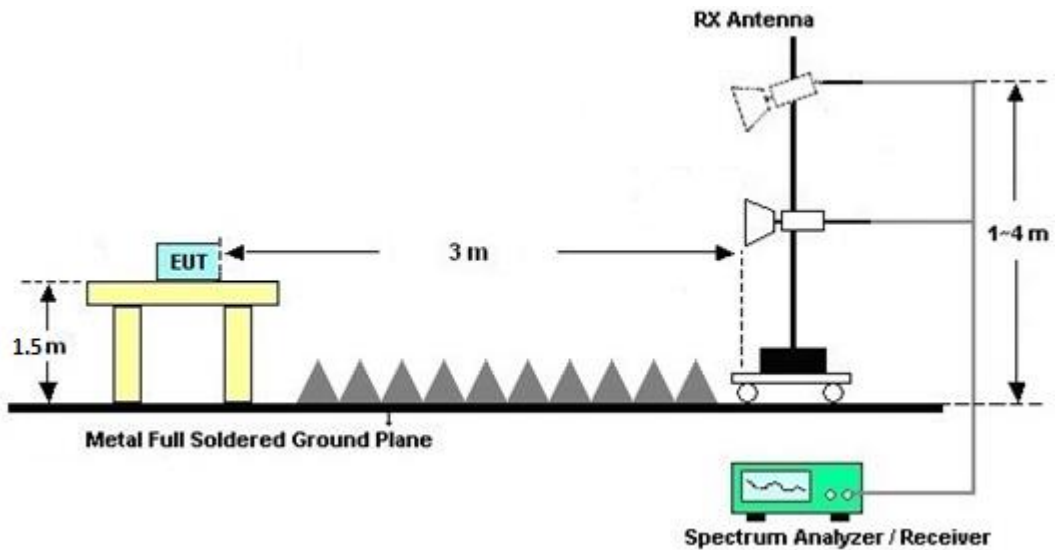

For radiated test above 18GHz

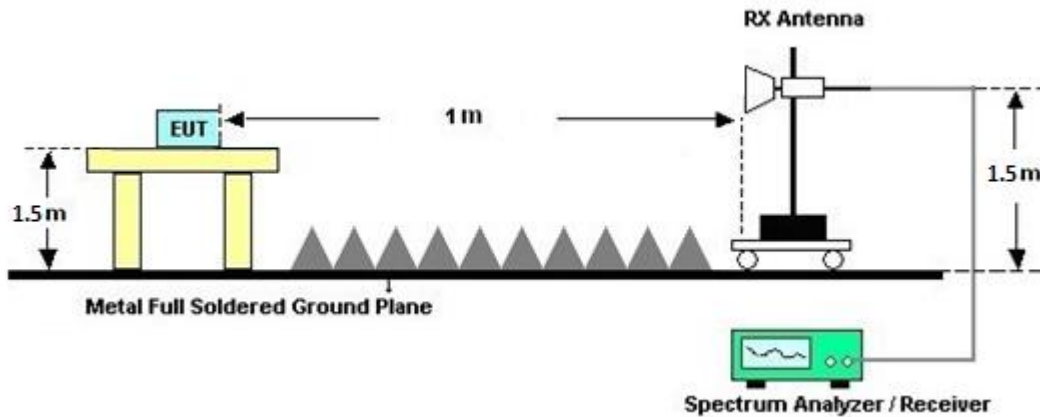

3.5.5 Test Results of Radiated Spurious Emissions (9 kHz ~ 30 MHz)

The low frequency, which starts from 9 kHz to 30 MHz, is pre-scanned and the result which is 20 dB lower than the limit line is not reported.

There is adequate comparison measurement of both open-field test site and alternative test site - semi-Anechoic chamber according to 414788 D01 Radiated Test Site v01r01, and the result comes out very similar.

3.5.6 Test Result of Radiated Spurious at Band Edges

Please refer to Appendix C and D.

3.5.7 Duty Cycle

Please refer to Appendix E.

3.5.8 Test Result of Radiated Spurious Emission (30 MHz ~ 10th Harmonic)

Please refer to Appendix C and D.



3.6 AC Conducted Emission Measurement

3.6.1 Limit of AC Conducted Emission

For equipment that is designed to be connected to the public utility (AC) power line, the radio frequency voltage that is conducted back onto the AC power line on any frequency or frequencies within the band 150 kHz to 30 MHz shall not exceed the limits in the following table.

Frequency of emission (MHz)	Conducted limit (dB μ V)	
	Quasi-peak	Average
0.15-0.5	66 to 56*	56 to 46*
0.5-5	56	46
5-30	60	50

*Decreases with the logarithm of the frequency.

3.6.2 Measuring Instruments

Please refer to the measuring equipment list in this test report.

3.6.3 Test Procedures

1. The EUT is placed 0.4 meter away from the conducting wall of the shielding room, and is kept at least 80 centimeters from any other grounded conducting surface.
2. Connect EUT to the power mains through a line impedance stabilization network (LISN).
3. All the support units are connecting to the other LISN.
4. The LISN provides 50 ohm coupling impedance for the measuring instrument.
5. The FCC states that a 50 ohm, 50 microhenry LISN shall be used.
6. Both Line and Neutral shall be tested in order to find out the maximum conducted emission.
7. The frequency range from 150 kHz to 30 MHz is scanned.
8. Set the test-receiver system to Peak Detect Function and specified bandwidth (IF Bandwidth = 9 kHz) with Maximum Hold Mode. Then measurement is also conducted by Average Detector and Quasi-Peak Detector Function respectively.

3.6.4 Test Setup

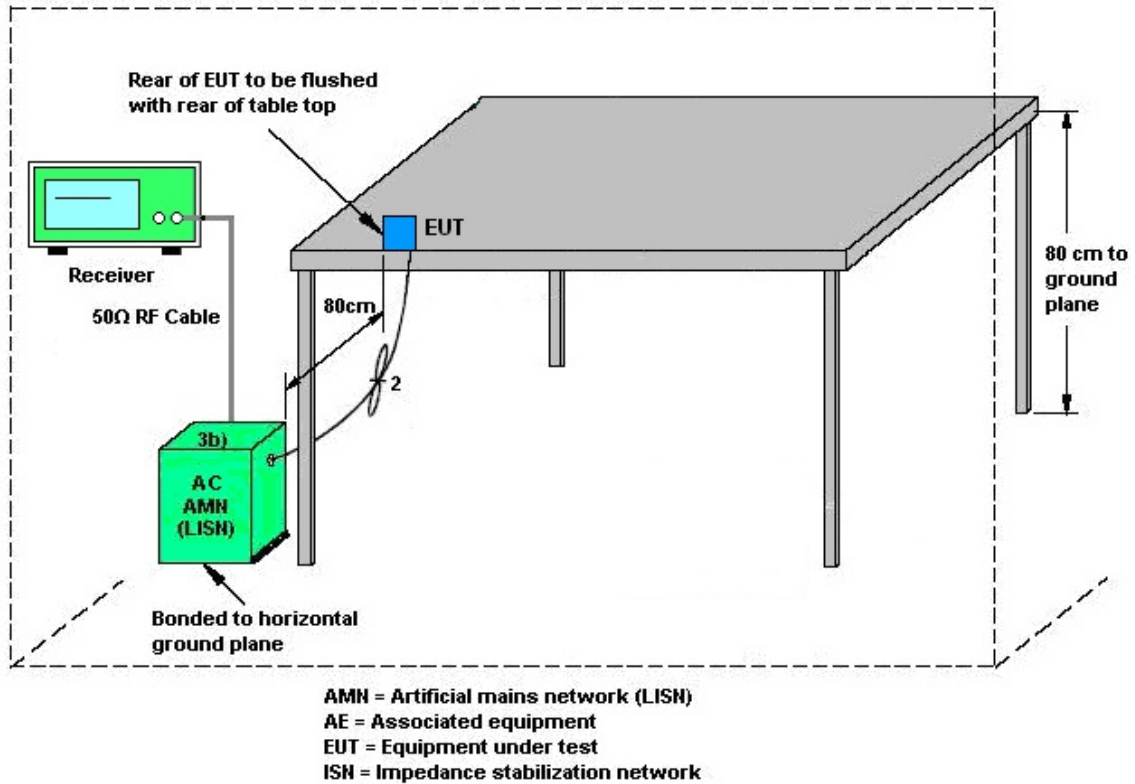

3.6.5 Test Result of AC Conducted Emission

Please refer to Appendix B.



3.7 Antenna Requirements

3.7.1 Standard Applicable

The use of a permanently attached antenna or of an antenna that uses a unique coupling to the intentional radiator shall be considered sufficient to comply with the rule.

3.7.2 Antenna Anti-Replacement Construction

An embedded-in antenna design is used.



4 List of Measuring Equipment

Instrument	Brand Name	Model No.	Serial No.	Characteristics	Calibration Date	Test Date	Due Date	Remark
AC Power Source	ChainTek	APC-1000W	N/A	N/A	N/A	Dec. 28, 2023	N/A	Conduction (CO05-HY)
EMI Test Receiver	Rohde & Schwarz	ESR3	102388	9kHz~3.6GHz	Dec. 06, 2023	Dec. 28, 2023	Dec. 05, 2024	Conduction (CO05-HY)
Hygrometer	Testo	608-H1	34913912	N/A	Oct. 26, 2023	Dec. 28, 2023	Oct. 25, 2024	Conduction (CO05-HY)
LISN	Rohde & Schwarz	ENV216	100081	9kHz~30MHz	Nov. 22, 2023	Dec. 28, 2023	Nov. 21, 2024	Conduction (CO05-HY)
Software	Rohde & Schwarz	EMC32	N/A	N/A	N/A	Dec. 28, 2023	N/A	Conduction (CO05-HY)
ISN Cable	MVE	RG-400	200260	N/A	Dec. 28, 2023	Dec. 28, 2023	Dec. 27, 2024	Conduction (CO05-HY)
Pulse Limiter	SCHWARZBECK	VTSD 9561-FN	00691	9kHz-200MHz	Jul. 28, 2023	Dec. 28, 2023	Jul. 27, 2024	Conduction (CO05-HY)
LISN Cable	MVE	RG-400	260260	N/A	Dec. 28, 2023	Dec. 28, 2023	Dec. 27, 2024	Conduction (CO05-HY)
Hygrometer	TECPEL	DTM-303A	TP201996	N/A	Nov. 07, 2023	Dec. 11, 2023~Jan. 09, 2024	Nov. 06, 2024	Conducted (TH05-HY)
Power Sensor	DARE	RPR3006W	15I00041SNO10 (NO:248)	10MHz~6GHz	Jan. 05, 2023	Dec. 11, 2023~Dec. 29, 2023	Jan. 04, 2024	Conducted (TH05-HY)
Power Sensor	DARE	RPR3006W	16I00054SNO12 (NO:113)	10MHz~6GHz	Dec. 12, 2023	Jan. 02, 2024~Jan. 09, 2024	Dec. 11, 2024	Conducted (TH05-HY)
Signal Analyzer	Rohde & Schwarz	FSV40	101566	10Hz~40GHz	Aug. 23, 2023	Dec. 11, 2023~Jan. 09, 2024	Aug. 22, 2024	Conducted (TH05-HY)
EMI Test Receiver	Keysight	N9038A(MXE)	MY54130085	N/A	Oct. 06, 2023	Dec. 27, 2023~Jan. 26, 2024	Oct. 05, 2024	Radiation (03CH20-HY)
Loop Antenna	Rohde & Schwarz	HFH2-Z2	100488	9 kHz~30 MHz	Sep. 12, 2023	Dec. 27, 2023~Jan. 26, 2024	Sep. 11, 2024	Radiation (03CH20-HY)
Preamplifier	EMEC	EM18G40G	060873	18GHz~40GHz	Sep. 06, 2023	Dec. 27, 2023~Jan. 26, 2024	Sep. 05, 2024	Radiation (03CH20-HY)
Controller	ChainTek	3000-1	N/A	Control Turn table & Ant Mast	N/A	Dec. 27, 2023~Jan. 26, 2024	N/A	Radiation (03CH20-HY)
Antenna Mast	ChainTek	MBS-520-1	N/A	1m~4m	N/A	Dec. 27, 2023~Jan. 26, 2024	N/A	Radiation (03CH20-HY)
Turn Table	ChainTek	T-200-S-1	N/A	0~360 Degree	N/A	Dec. 27, 2023~Jan. 26, 2024	N/A	Radiation (03CH20-HY)
Signal Analyzer	Keysight	N9010B	MY60240520	N/A	Dec. 12, 2023	Dec. 27, 2023~Jan. 26, 2024	Dec. 11, 2024	Radiation (03CH20-HY)



Instrument	Brand Name	Model No.	Serial No.	Characteristics	Calibration Date	Test Date	Due Date	Remark
Bilog Antenna	TESEQ	CBL 6111D&00802 N1D01N-06	55606 & 08	30MHz~1GHz	Oct. 20, 2023	Dec. 27, 2023~ Jan. 26, 2024	Oct. 19, 2024	Radiation (03CH20-HY)
Horn Antenna	SCHWARZBE CK	BBHA 9120 D	02360	1GHz-18GHz	Oct. 30, 2023	Dec. 27, 2023~ Jan. 26, 2024	Oct. 29, 2024	Radiation (03CH20-HY)
SHF-EHF Horn Antenna	SCHWARZBE CK	BBHA 9170	1224	18GHz-40GHz	Jul. 10, 2023	Dec. 27, 2023~ Jan. 26, 2024	Jul. 09, 2024	Radiation (03CH20-HY)
Preamplifier	COM-POWER	PAM-103	18020201	1MHz-1000MHz	Jan. 02, 2023	Dec. 27, 2023~ Dec. 31, 2023	Jan. 01, 2024	Radiation (03CH20-HY)
Preamplifier	COM-POWER	PAM-103	18020201	1MHz-1000MHz	Jan. 01, 2024	Jan. 01, 2024~ Jan. 26, 2024	Dec. 31, 2024	Radiation (03CH20-HY)
Amplifier	EMCI	EMC118A45S E	980792	N/A	Nov. 13, 2023	Dec. 27, 2023~ Jan. 26, 2024	Nov. 12, 2024	Radiation (03CH20-HY)
RF Cable	HUBER + SUHNER	SUCOFLEX 102	519229/2,804 015/2,804027 /2	N/A	Jan. 18, 2023	Dec. 27, 2023~ Jan. 16, 2024	Jan. 17, 2024	Radiation (03CH20-HY)
RF Cable	HUBER + SUHNER	SUCOFLEX 102	519229/2,804 015/2,804027 /2	N/A	Jan. 17, 2024	Jan. 17, 2024~ Jan. 26, 2024	Jan. 16, 2025	Radiation (03CH20-HY)
Hygrometer	TECPEL	DTM-303B	TP200728	N/A	Mar. 28, 2023	Dec. 27, 2023~ Jan. 26, 2024	Mar. 27, 2024	Radiation (03CH20-HY)
Software	Audix	N/A	RK-002156	N/A	N/A	Dec. 27, 2023~ Jan. 26, 2024	N/A	Radiation (03CH20-HY)



5 Measurement Uncertainty

Uncertainty of Conducted Emission Measurement (150 kHz ~ 30 MHz)

Measuring Uncertainty for a Level of Confidence of 95% ($U = 2Uc(y)$)	3.5 dB
---	--------

Uncertainty of Radiated Emission Measurement (30 MHz ~ 1000 MHz)

Measuring Uncertainty for a Level of Confidence of 95% ($U = 2Uc(y)$)	6.4 dB
---	--------

Uncertainty of Radiated Emission Measurement (1000 MHz ~ 6000 MHz)

Measuring Uncertainty for a Level of Confidence of 95% ($U = 2Uc(y)$)	4.5 dB
---	--------

Uncertainty of Radiated Emission Measurement (6000 MHz ~ 18000 MHz)

Measuring Uncertainty for a Level of Confidence of 95% ($U = 2Uc(y)$)	4.6 dB
---	--------

Uncertainty of Radiated Emission Measurement (18000 MHz ~ 40000 MHz)

Measuring Uncertainty for a Level of Confidence of 95% ($U = 2Uc(y)$)	5.4 dB
---	--------

Appendix A. Test Result of Conducted Test Items

Test Engineer:	Sylvia Li	Temperature:	21~25	°C
Test Date:	2023/12/11~2024/01/09	Relative Humidity:	51~54	%

<Class 1> <Ant.6>

TEST RESULTS DATA
6dB and 99% Occupied Bandwidth

Mod.	Data Rate	NTX	CH.	Freq. (MHz)	99% Occupied BW (MHz)	6dB BW (MHz)	6dB BW Limit (MHz)	Pass/Fail
BLE	1Mbps	1	0	2402	1.015	0.670	0.50	Pass
BLE	1Mbps	1	19	2440	1.017	0.674	0.50	Pass
BLE	1Mbps	1	39	2480	1.017	0.674	0.50	Pass

TEST RESULTS DATA
Average Power Table

Mod.	Data Rate	NTX	CH.	Freq. (MHz)	Average Conducted Power (dBm)	Conducted Power Limit (dBm)	DG (dBi)	EIRP Power (dBm)	EIRP Power Limit (dBm)	Pass /Fail
BLE	1Mbps	1	0	2402	6.20	30.00	0.67	6.87	36.00	Pass
BLE	1Mbps	1	19	2440	6.30	30.00	0.67	6.97	36.00	Pass
BLE	1Mbps	1	39	2480	6.50	30.00	0.67	7.17	36.00	Pass

TEST RESULTS DATA
Peak Power Density

Mod.	Data Rate	NTX	CH.	Freq. (MHz)	Peak PSD (dBm /100kHz)	Peak PSD (dBm /3kHz)	DG (dBi)	Peak PSD Limit (dBm /3kHz)	Pass/Fail
BLE	1Mbps	1	0	2402	5.87	-8.51	0.67	8.00	Pass
BLE	1Mbps	1	19	2440	5.88	-8.50	0.67	8.00	Pass
BLE	1Mbps	1	39	2480	6.21	-8.18	0.67	8.00	Pass

Note: PSD (dBm/ 100kHz) is a reference level used for Conducted Band Edges and Conducted Spurious Emission 30dBc limit.

TEST RESULTS DATA
6dB and 99% Occupied Bandwidth

Mod.	Data Rate	NTx	CH.	Freq. (MHz)	99% Occupied BW (MHz)	6dB BW (MHz)	6dB BW Limit (MHz)	Pass/Fail
BLE	2Mbps	1	0	2402	1.998	1.160	0.50	Pass
BLE	2Mbps	1	19	2440	1.990	1.160	0.50	Pass
BLE	2Mbps	1	39	2480	1.994	1.164	0.50	Pass

TEST RESULTS DATA
Average Power Table

Mod.	Data Rate	NTx	CH.	Freq. (MHz)	Average Conducted Power (dBm)	Conducted Power Limit (dBm)	DG (dBi)	EIRP Power (dBm)	EIRP Power Limit (dBm)	Pass /Fail
BLE	2Mbps	1	0	2402	6.20	30.00	0.67	6.87	36.00	Pass
BLE	2Mbps	1	19	2440	6.30	30.00	0.67	6.97	36.00	Pass
BLE	2Mbps	1	39	2480	6.50	30.00	0.67	7.17	36.00	Pass

TEST RESULTS DATA
Peak Power Density

Mod.	Data Rate	NTx	CH.	Freq. (MHz)	Peak PSD (dBm /100kHz)	Peak PSD (dBm /3kHz)	DG (dBi)	Peak PSD Limit (dBm /3kHz)	Pass/Fail
BLE	2Mbps	1	0	2402	5.83	-11.57	0.67	8.00	Pass
BLE	2Mbps	1	19	2440	5.81	-11.55	0.67	8.00	Pass
BLE	2Mbps	1	39	2480	6.16	-11.17	0.67	8.00	Pass

Note: PSD (dBm/ 100kHz) is a reference level used for Conducted Band Edges and Conducted Spurious Emission 30dBc limit.

<Class 1> <Ant.7>

TEST RESULTS DATA
6dB and 99% Occupied Bandwidth

Mod.	Data Rate	NTx	CH.	Freq. (MHz)	99% Occupied BW (MHz)	6dB BW (MHz)	6dB BW Limit (MHz)	Pass/Fail
BLE	1Mbps	1	0	2402	1.013	0.672	0.50	Pass
BLE	1Mbps	1	19	2440	1.017	0.676	0.50	Pass
BLE	1Mbps	1	39	2480	1.019	0.676	0.50	Pass

TEST RESULTS DATA
Average Power Table

Mod.	Data Rate	NTx	CH.	Freq. (MHz)	Average Conducted Power (dBm)	Conducted Power Limit (dBm)	DG (dBi)	EIRP Power (dBm)	EIRP Power Limit (dBm)	Pass /Fail
BLE	1Mbps	1	0	2402	4.50	30.00	0.53	5.03	36.00	Pass
BLE	1Mbps	1	19	2440	5.30	30.00	0.53	5.83	36.00	Pass
BLE	1Mbps	1	39	2480	5.40	30.00	0.53	5.93	36.00	Pass

TEST RESULTS DATA
Peak Power Density

Mod.	Data Rate	NTx	CH.	Freq. (MHz)	Peak PSD (dBm /100kHz)	Peak PSD (dBm /3kHz)	DG (dBi)	Peak PSD Limit (dBm /3kHz)	Pass/Fail
BLE	1Mbps	1	0	2402	5.27	-9.14	0.53	8.00	Pass
BLE	1Mbps	1	19	2440	6.27	-8.17	0.53	8.00	Pass
BLE	1Mbps	1	39	2480	6.59	-7.80	0.53	8.00	Pass

Note: PSD (dBm/ 100kHz) is a reference level used for Conducted Band Edges and Conducted Spurious Emission 30dBc limit.

TEST RESULTS DATA
6dB and 99% Occupied Bandwidth

Mod.	Data Rate	NTx	CH.	Freq. (MHz)	99% Occupied BW (MHz)	6dB BW (MHz)	6dB BW Limit (MHz)	Pass/Fail
BLE	2Mbps	1	0	2402	2.002	1.160	0.50	Pass
BLE	2Mbps	1	19	2440	1.990	1.164	0.50	Pass
BLE	2Mbps	1	39	2480	1.994	1.168	0.50	Pass

TEST RESULTS DATA
Average Power Table

Mod.	Data Rate	NTx	CH.	Freq. (MHz)	Average Conducted Power (dBm)	Conducted Power Limit (dBm)	DG (dBi)	EIRP Power (dBm)	EIRP Power Limit (dBm)	Pass /Fail
BLE	2Mbps	1	0	2402	4.40	30.00	0.53	4.93	36.00	Pass
BLE	2Mbps	1	19	2440	5.30	30.00	0.53	5.83	36.00	Pass
BLE	2Mbps	1	39	2480	5.40	30.00	0.53	5.93	36.00	Pass

TEST RESULTS DATA
Peak Power Density

Mod.	Data Rate	NTx	CH.	Freq. (MHz)	Peak PSD (dBm /100kHz)	Peak PSD (dBm /3kHz)	DG (dBi)	Peak PSD Limit (dBm /3kHz)	Pass/Fail
BLE	2Mbps	1	0	2402	5.34	-12.03	0.53	8.00	Pass
BLE	2Mbps	1	19	2440	6.30	-11.07	0.53	8.00	Pass
BLE	2Mbps	1	39	2480	6.63	-10.70	0.53	8.00	Pass

Note: PSD (dBm/ 100kHz) is a reference level used for Conducted Band Edges and Conducted Spurious Emission 30dBc limit.

<Class 2> <Ant.6>

TEST RESULTS DATA
Average Power Table

Mod.	Data Rate	NTX	CH.	Freq. (MHz)	Average Conducted Power (dBm)	Conducted Power Limit (dBm)	DG (dBi)	EIRP Power (dBm)	EIRP Power Limit (dBm)	Pass /Fail
BLE	1Mbps	1	0	2402	2.10	30.00	0.67	2.77	36.00	Pass
BLE	1Mbps	1	19	2440	2.30	30.00	0.67	2.97	36.00	Pass
BLE	1Mbps	1	39	2480	2.70	30.00	0.67	3.37	36.00	Pass

TEST RESULTS DATA
Average Power Table

Mod.	Data Rate	N _{Tx}	CH.	Freq. (MHz)	Average Conducted Power (dBm)	Conducted Power Limit (dBm)	DG (dBi)	EIRP Power (dBm)	EIRP Power Limit (dBm)	Pass /Fail
BLE	2Mbps	1	0	2402	2.10	30.00	0.67	2.77	36.00	Pass
BLE	2Mbps	1	19	2440	2.30	30.00	0.67	2.97	36.00	Pass
BLE	2Mbps	1	39	2480	2.70	30.00	0.67	3.37	36.00	Pass

<Class 2> <Ant.7>

TEST RESULTS DATA
Average Power Table

Mod.	Data Rate	NTX	CH.	Freq. (MHz)	Average Conducted Power (dBm)	Conducted Power Limit (dBm)	DG (dBi)	EIRP Power (dBm)	EIRP Power Limit (dBm)	Pass /Fail
BLE	1Mbps	1	0	2402	-0.10	30.00	0.53	0.43	36.00	Pass
BLE	1Mbps	1	19	2440	1.20	30.00	0.53	1.73	36.00	Pass
BLE	1Mbps	1	39	2480	1.30	30.00	0.53	1.83	36.00	Pass

TEST RESULTS DATA
Average Power Table

Mod.	Data Rate	N _{Tx}	CH.	Freq. (MHz)	Average Conducted Power (dBm)	Conducted Power Limit (dBm)	DG (dBi)	EIRP Power (dBm)	EIRP Power Limit (dBm)	Pass /Fail
BLE	2Mbps	1	0	2402	-0.10	30.00	0.53	0.43	36.00	Pass
BLE	2Mbps	1	19	2440	1.20	30.00	0.53	1.73	36.00	Pass
BLE	2Mbps	1	39	2480	1.30	30.00	0.53	1.83	36.00	Pass



<Class 1>

<Ant. 6>

6dB Bandwidth

<1Mbps>

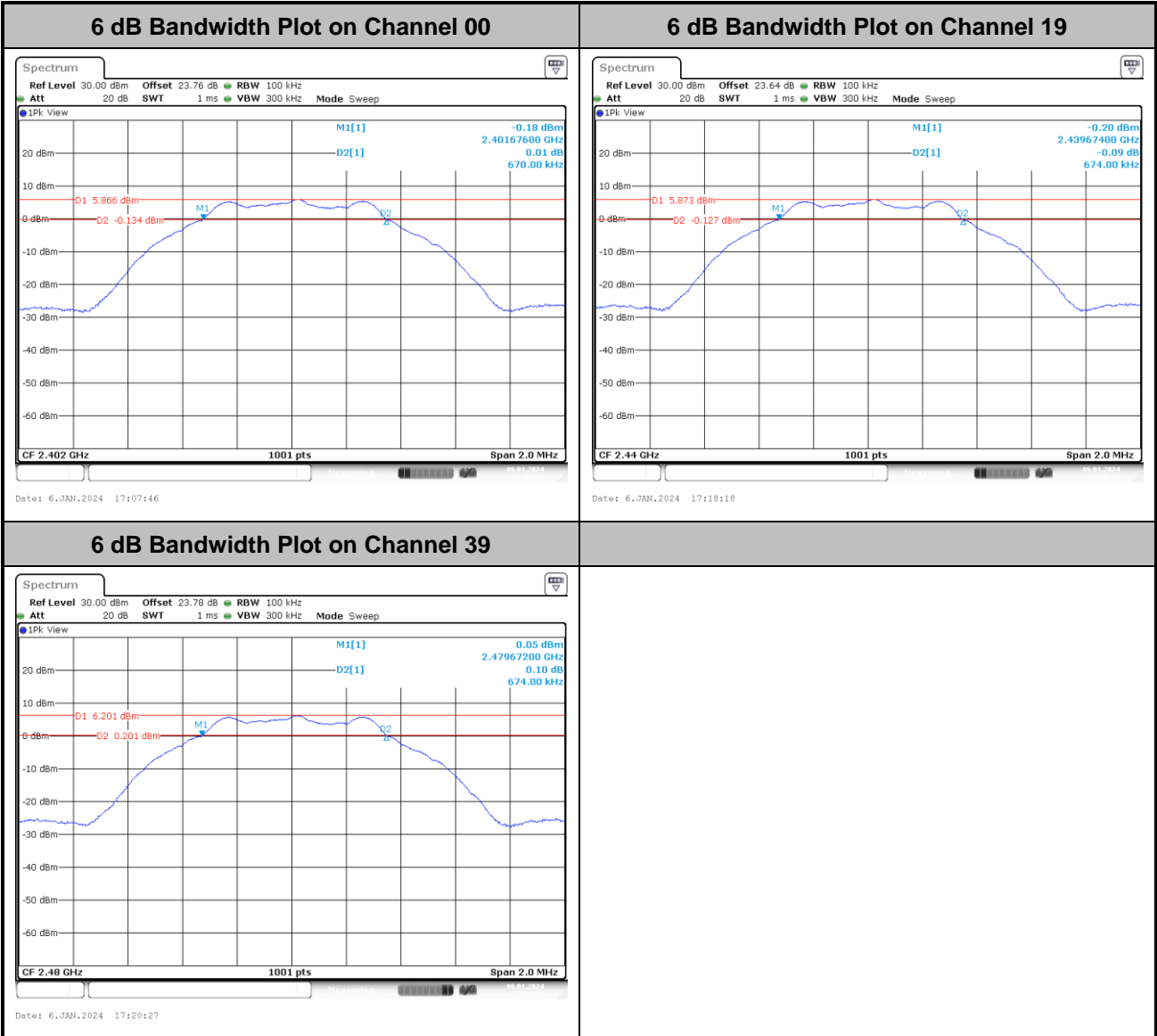



<2Mbps>

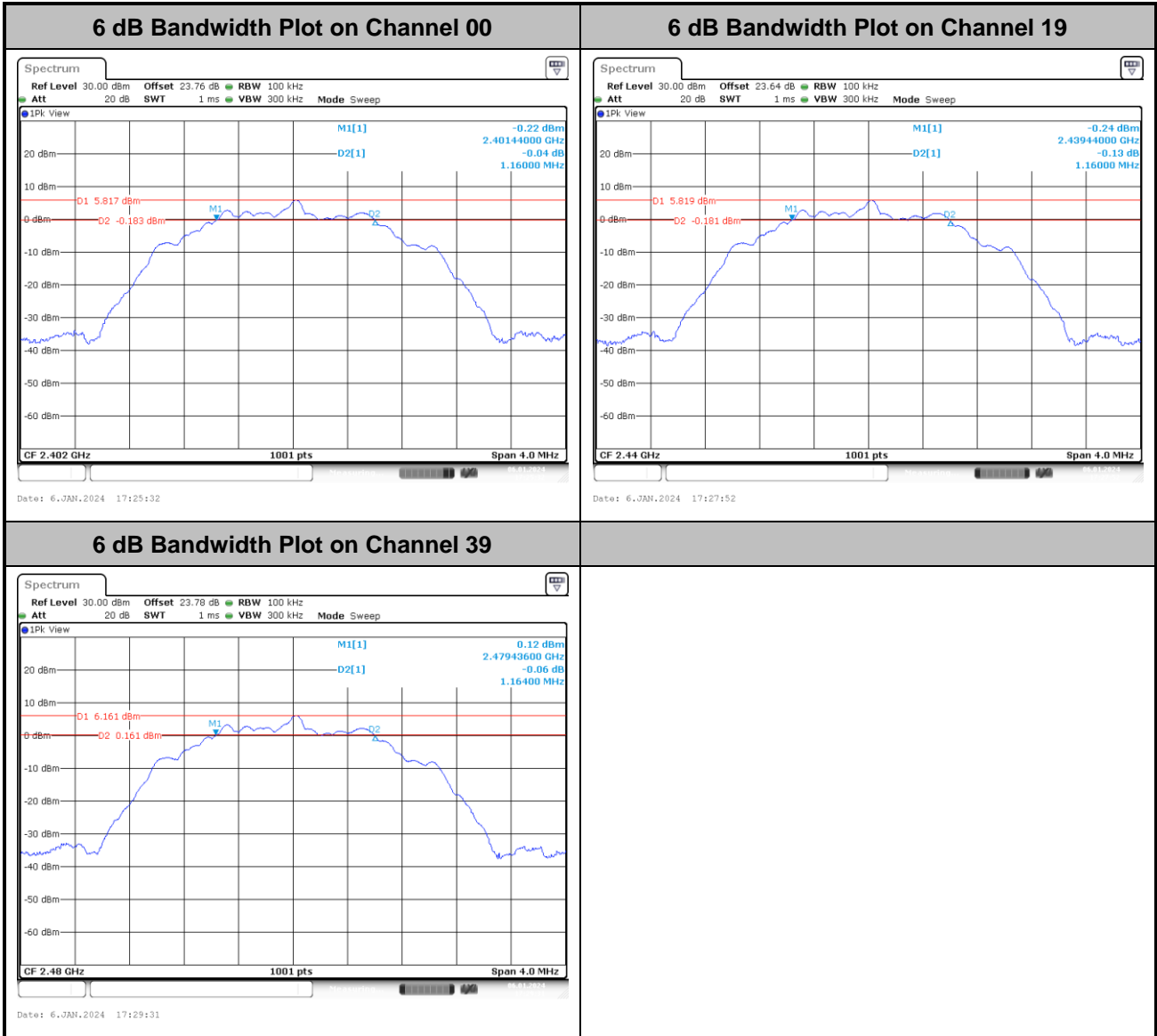



99% Occupied Bandwidth

<1Mbps>

99% Occupied Bandwidth Plot on Channel 00

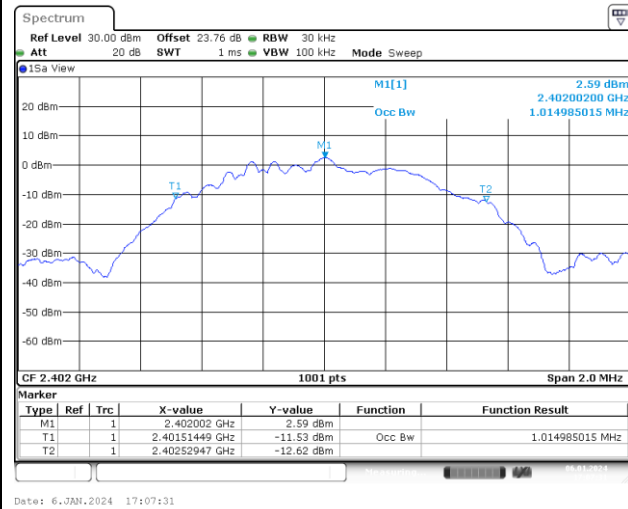

99% Occupied Bandwidth Plot on Channel 19

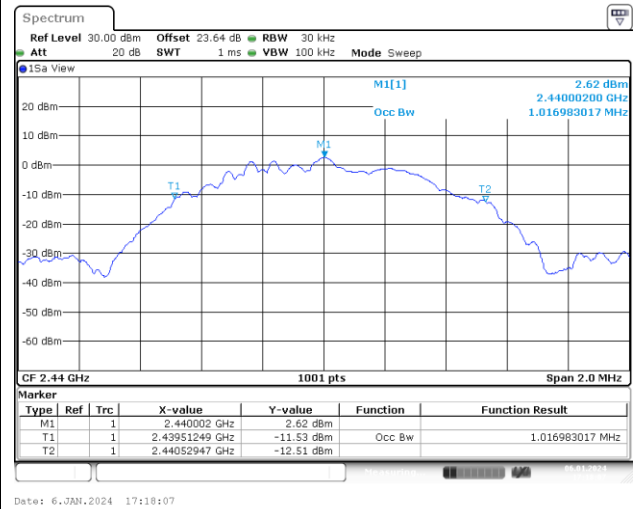

99% Occupied Bandwidth Plot on Channel 39

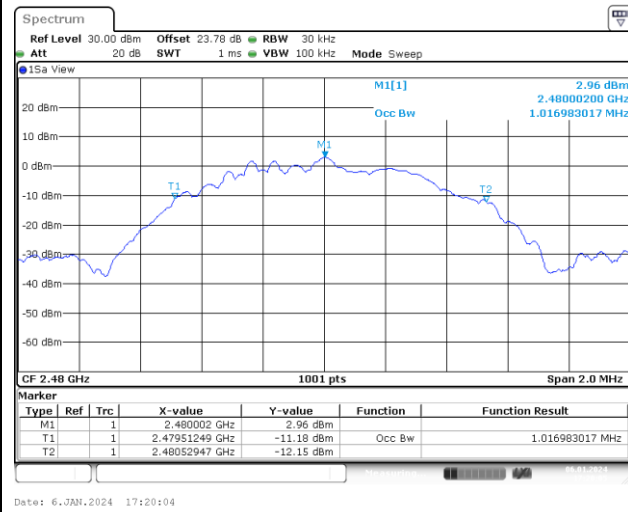



<2Mbps>

99% Occupied Bandwidth Plot on Channel 00

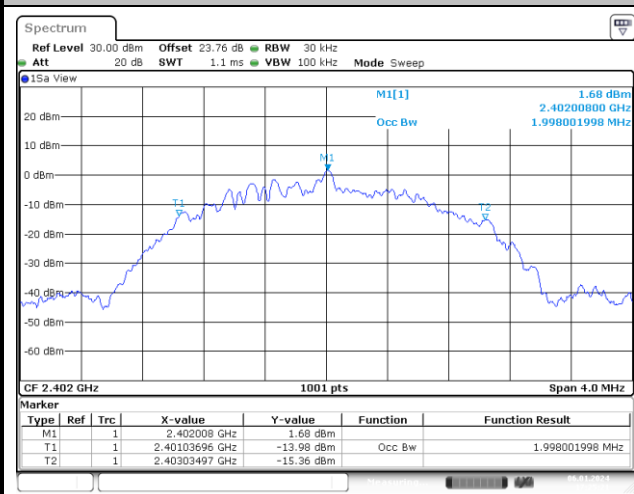

99% Occupied Bandwidth Plot on Channel 19

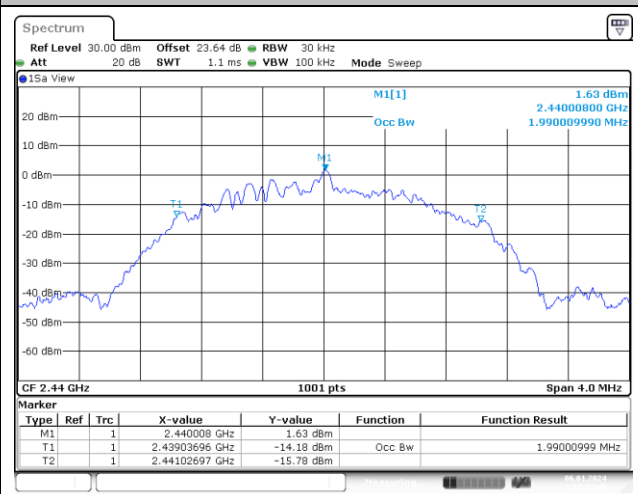

99% Occupied Bandwidth Plot on Channel 39

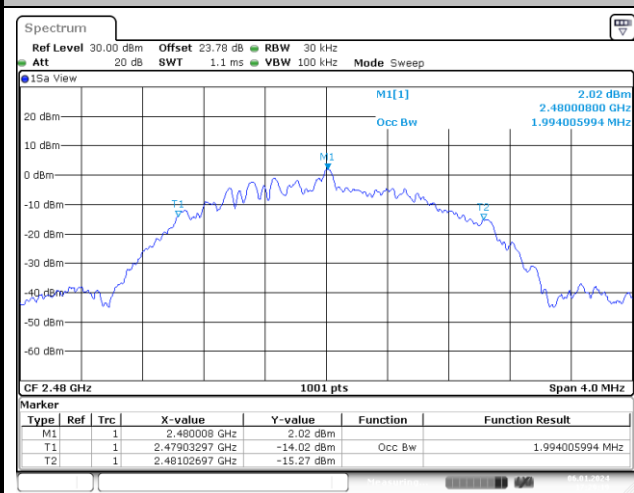



Power Spectral Density (dBm/3kHz)

<1Mbps>

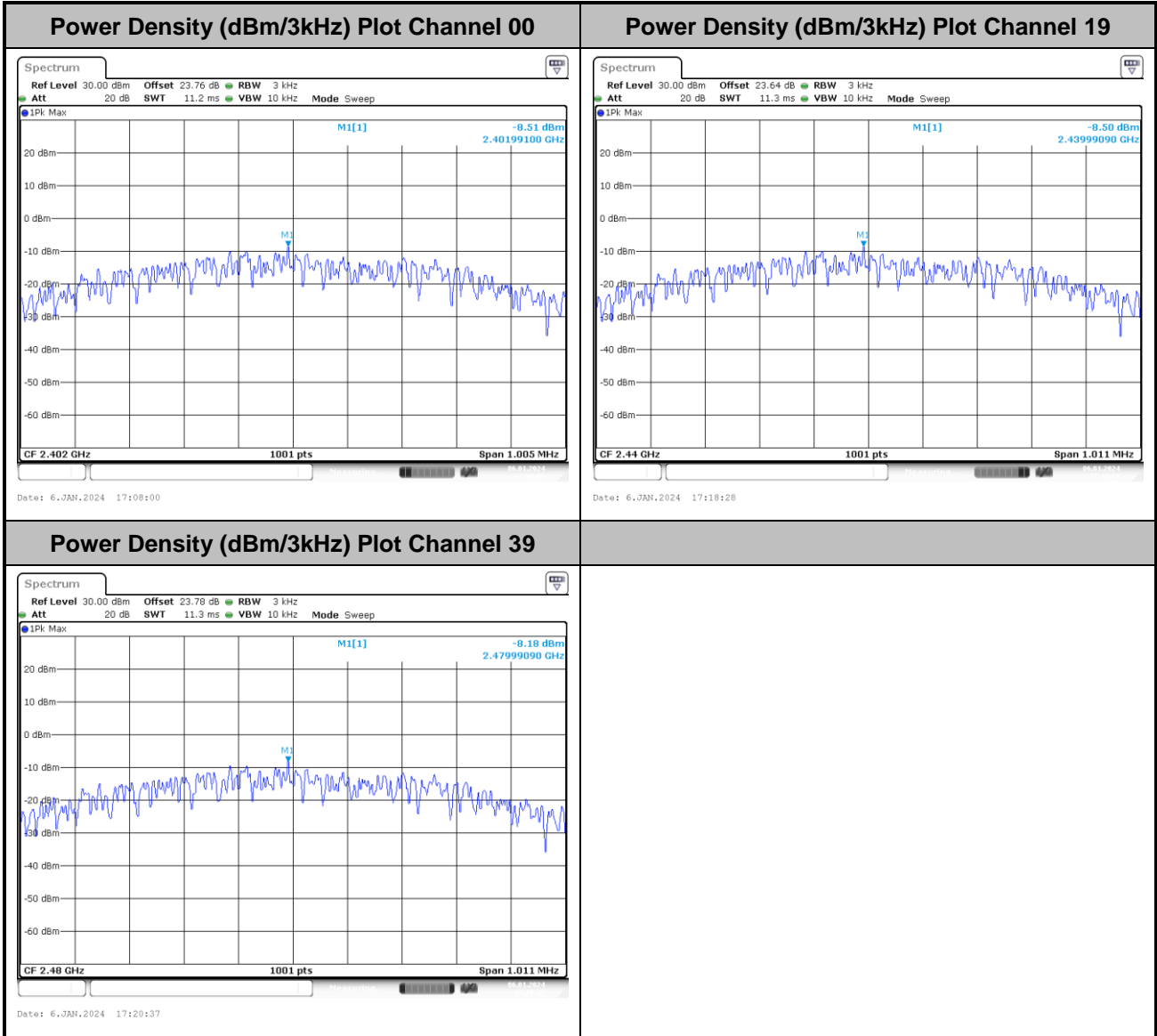



<2Mbps>

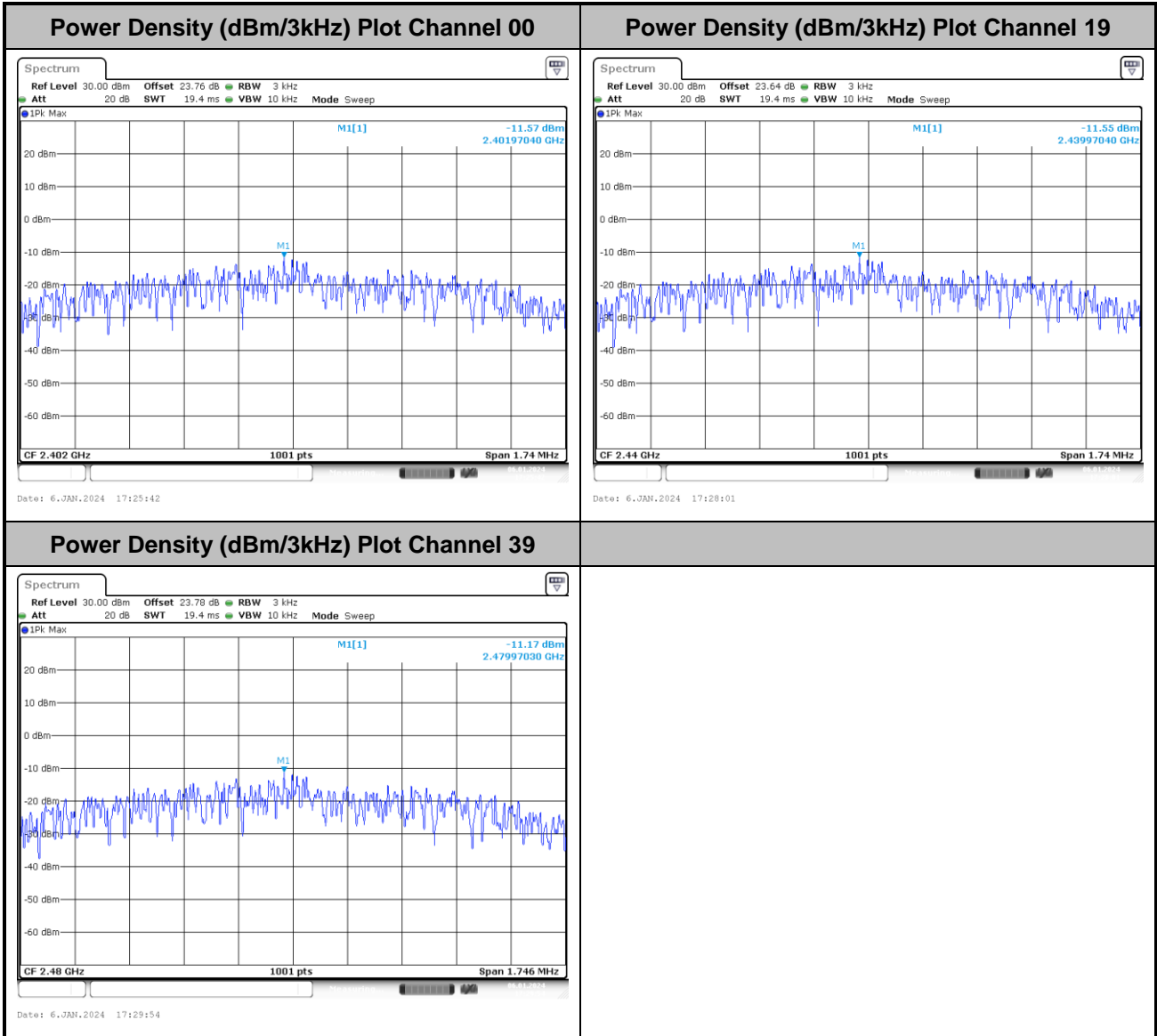



Band Edge and Conducted Spurious Emission

<1Mbps>

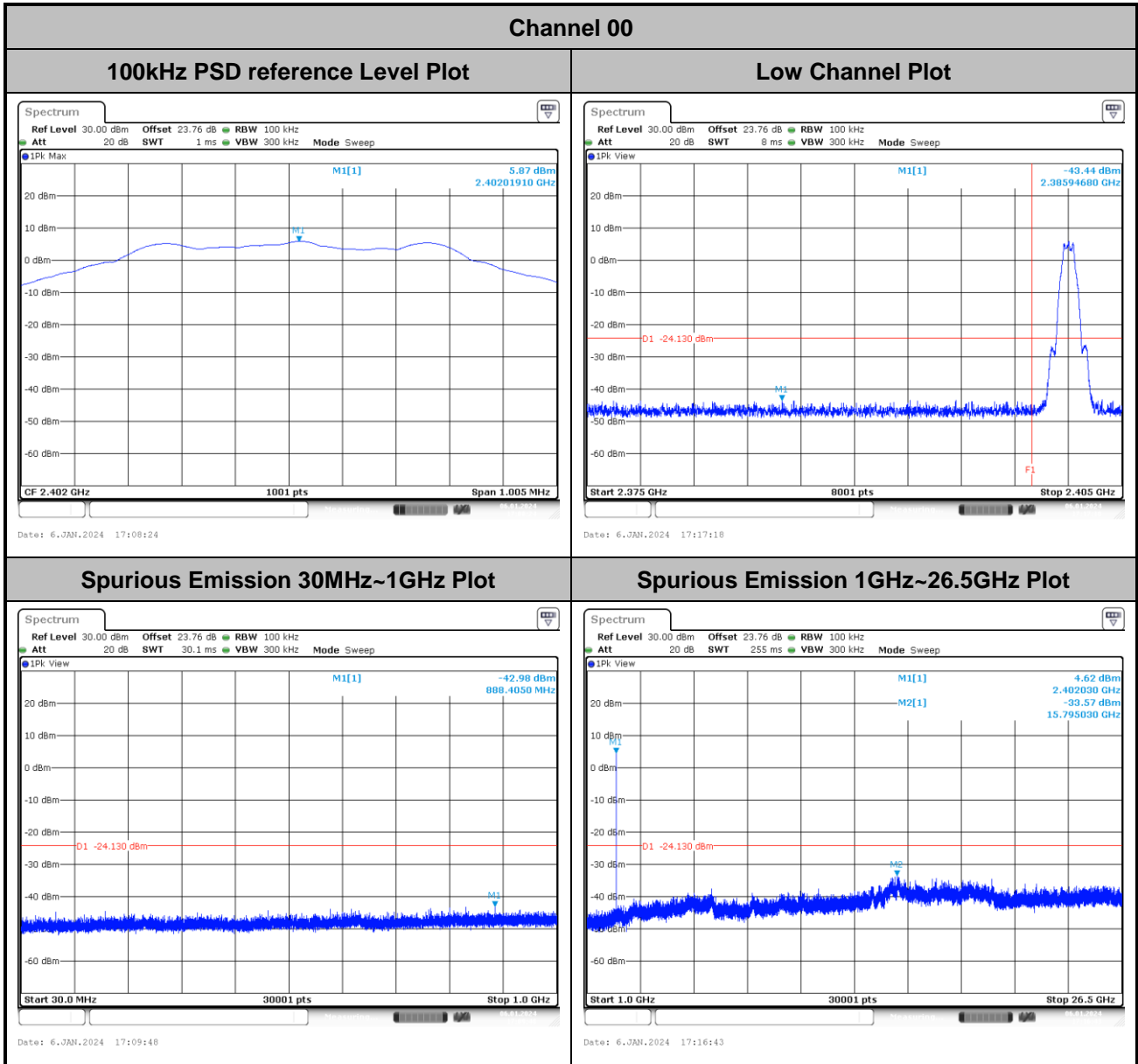



Channel 19

100kHz PSD reference Level Plot

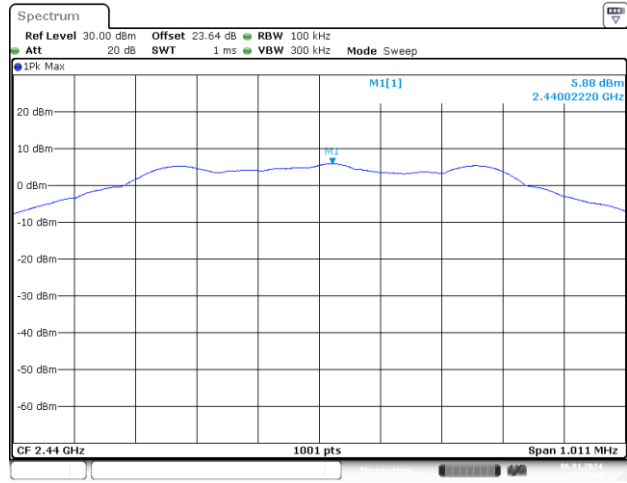

Mid Channel Plot

Spurious Emission 30MHz~1GHz Plot

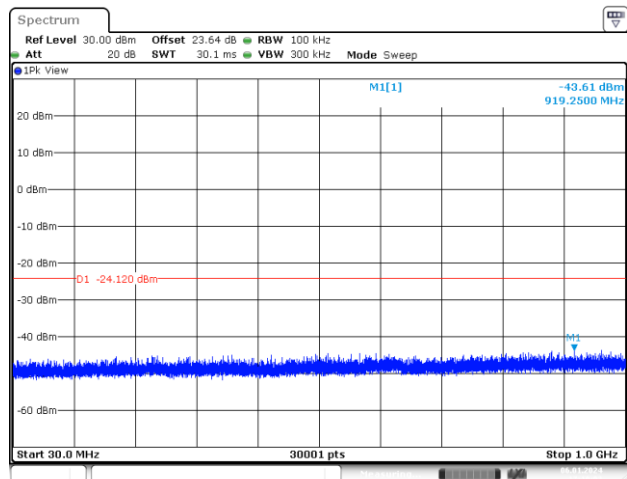

Spurious Emission 1GHz~26.5GHz Plot

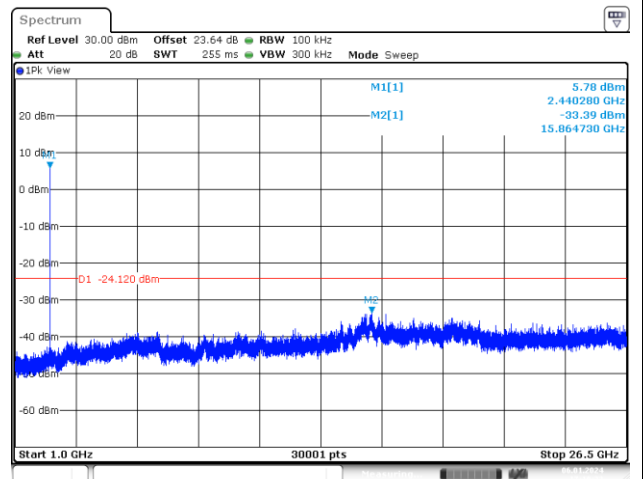



Channel 39

100kHz PSD reference Level Plot

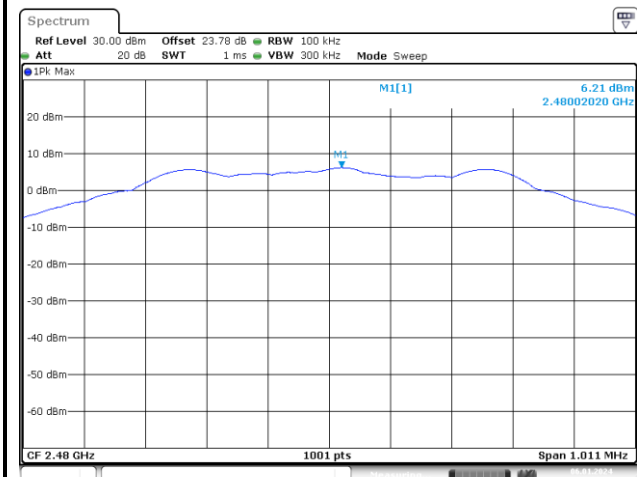

Date: 6.JAN.2024 17:20:59

High Channel Plot

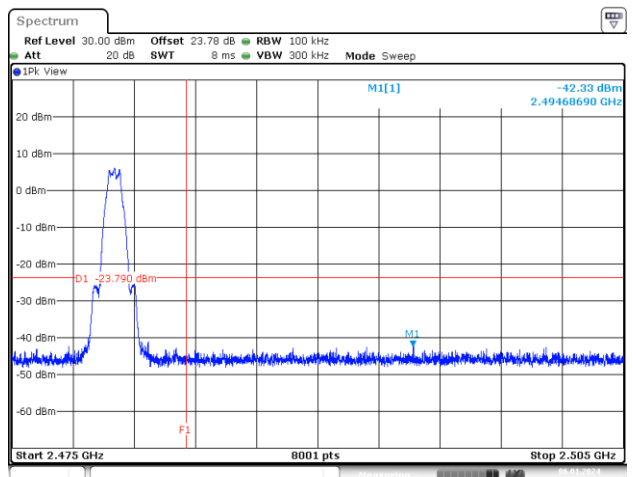

Date: 6.JAN.2024 17:22:41

Spurious Emission 30MHz~1GHz Plot

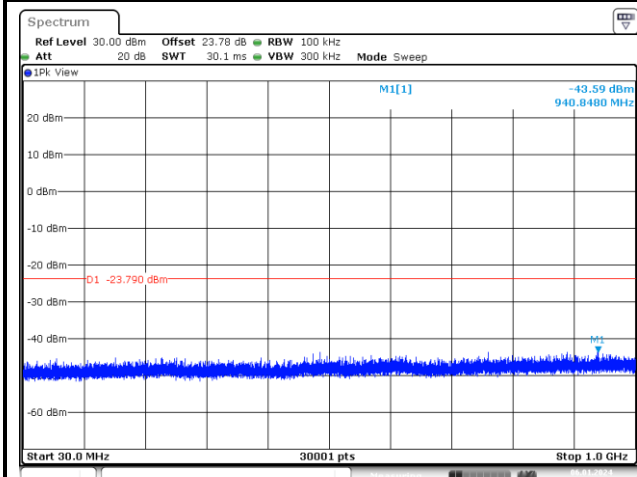

Date: 6.JAN.2024 17:21:43

Spurious Emission 1GHz~26.5GHz Plot

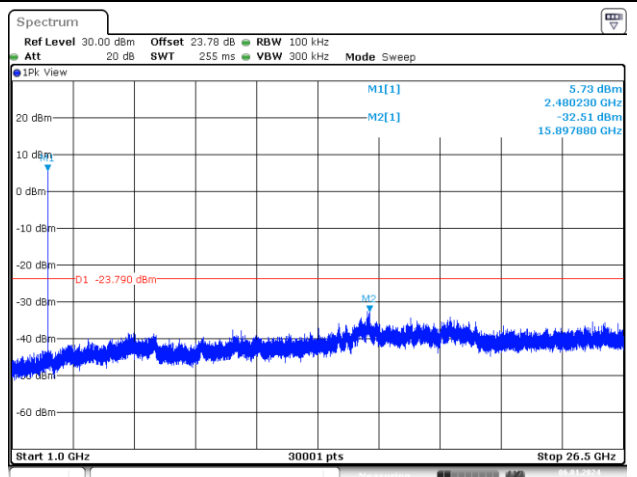

Date: 6.JAN.2024 17:22:06



<2Mbps>

Channel 00

100kHz PSD reference Level Plot

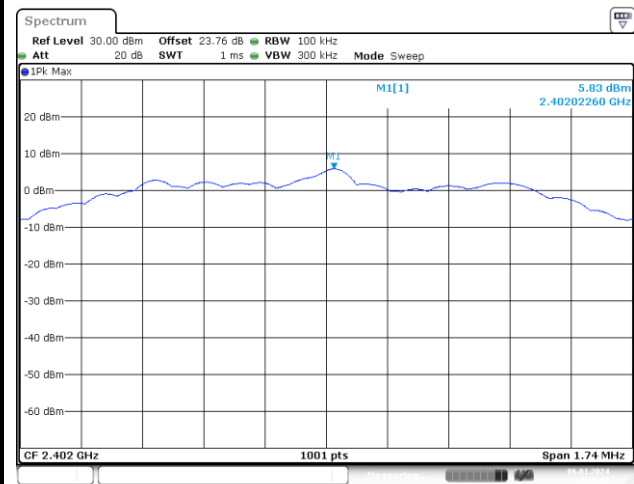

Date: 6.JAN.2024 17:26:00

Low Channel Plot

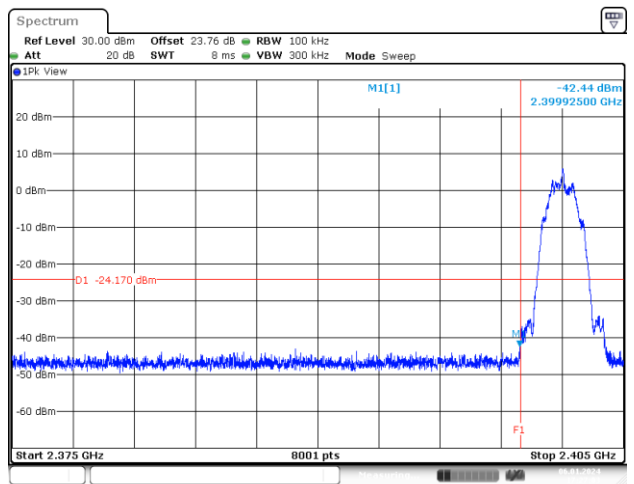

Date: 6.JAN.2024 17:27:03

Spurious Emission 30MHz~1GHz Plot

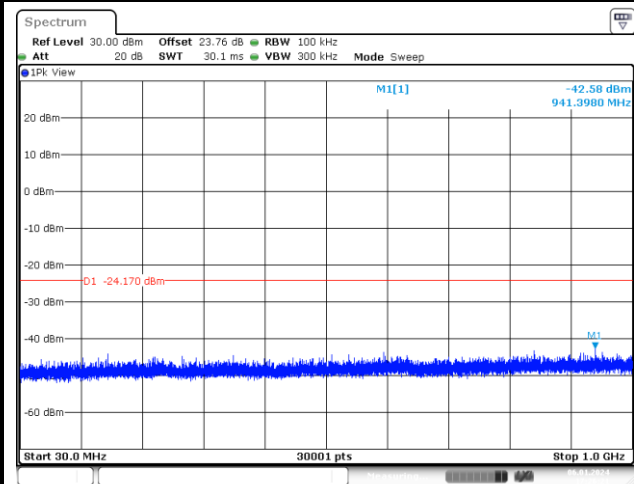

Date: 6.JAN.2024 17:26:20

Spurious Emission 1GHz~26.5GHz Plot

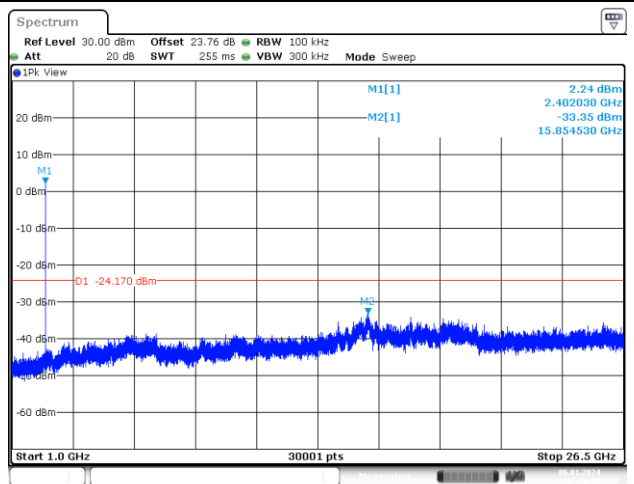

Date: 6.JAN.2024 17:26:37



Channel 19

100kHz PSD reference Level Plot

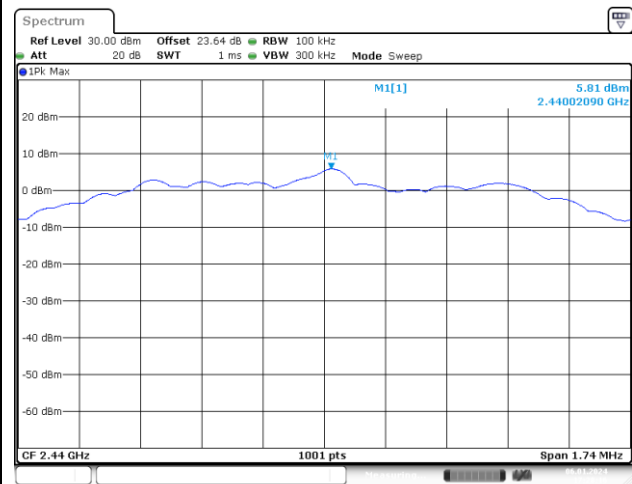

Mid Channel Plot

Spurious Emission 30MHz~1GHz Plot

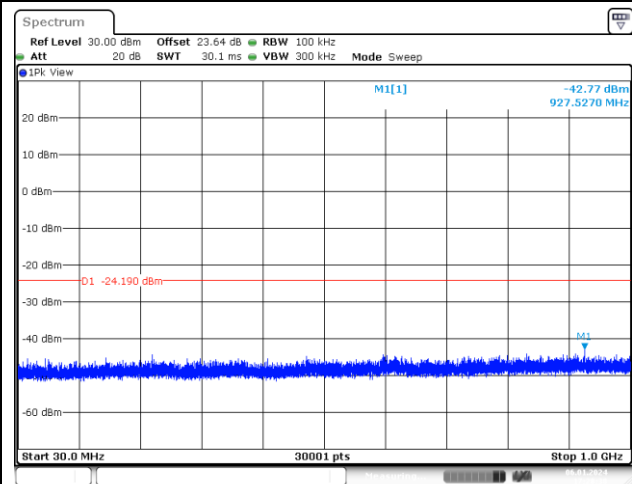

Spurious Emission 1GHz~26.5GHz Plot

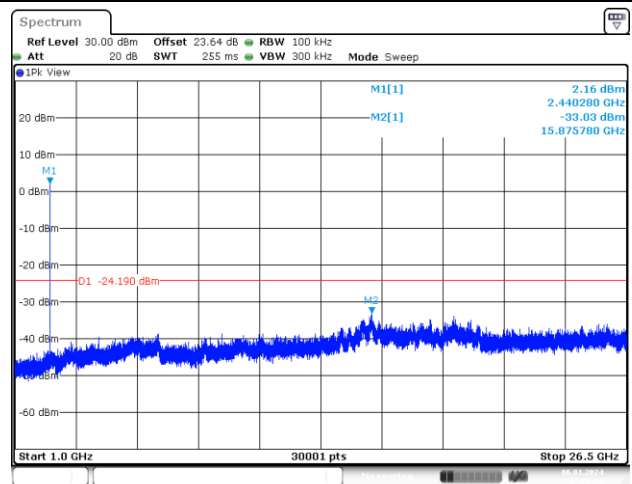



Channel 39

100kHz PSD reference Level Plot

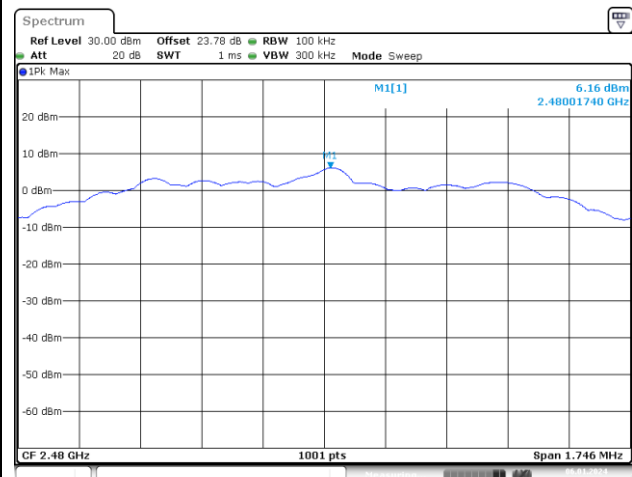

Date: 6.JAN.2024 17:30:10

High Channel Plot

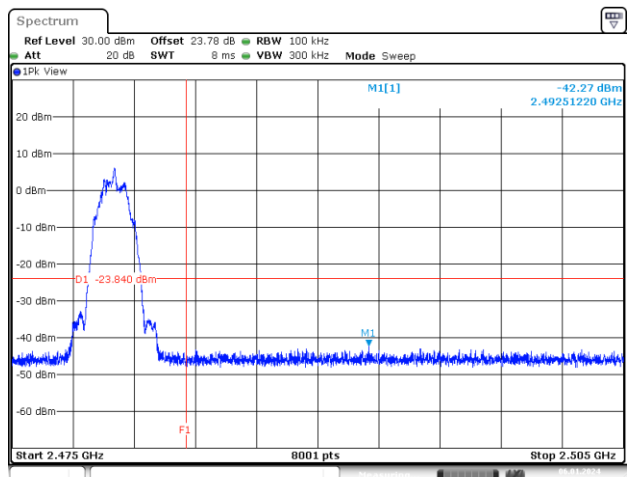

Date: 6.JAN.2024 17:30:55

Spurious Emission 30MHz~1GHz Plot

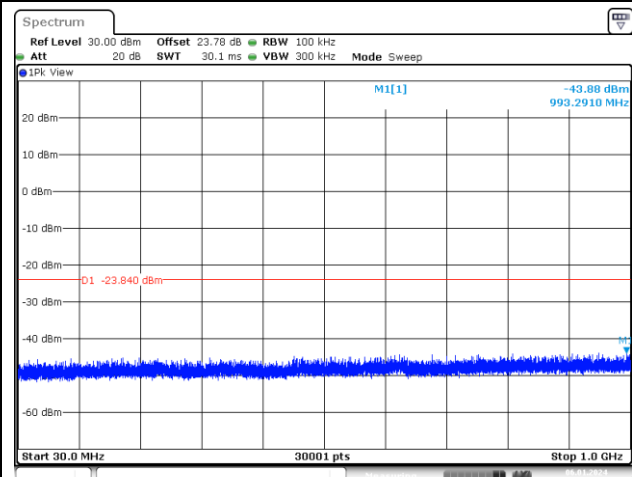

Date: 6.JAN.2024 17:30:28

Spurious Emission 1GHz~26.5GHz Plot

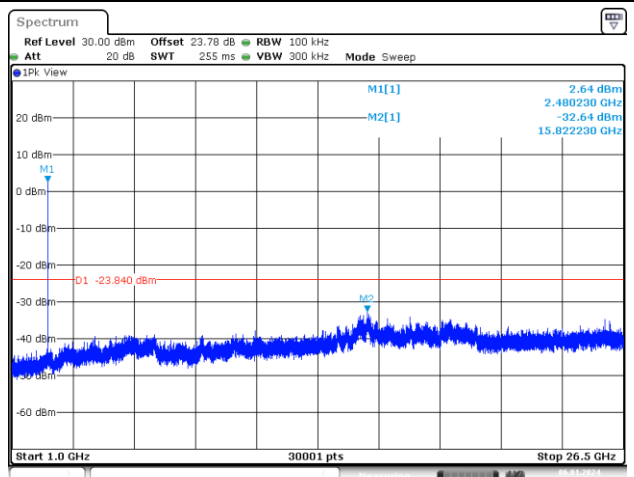

Date: 6.JAN.2024 17:30:44



<Ant. 7>

6dB Bandwidth

<1Mbps>

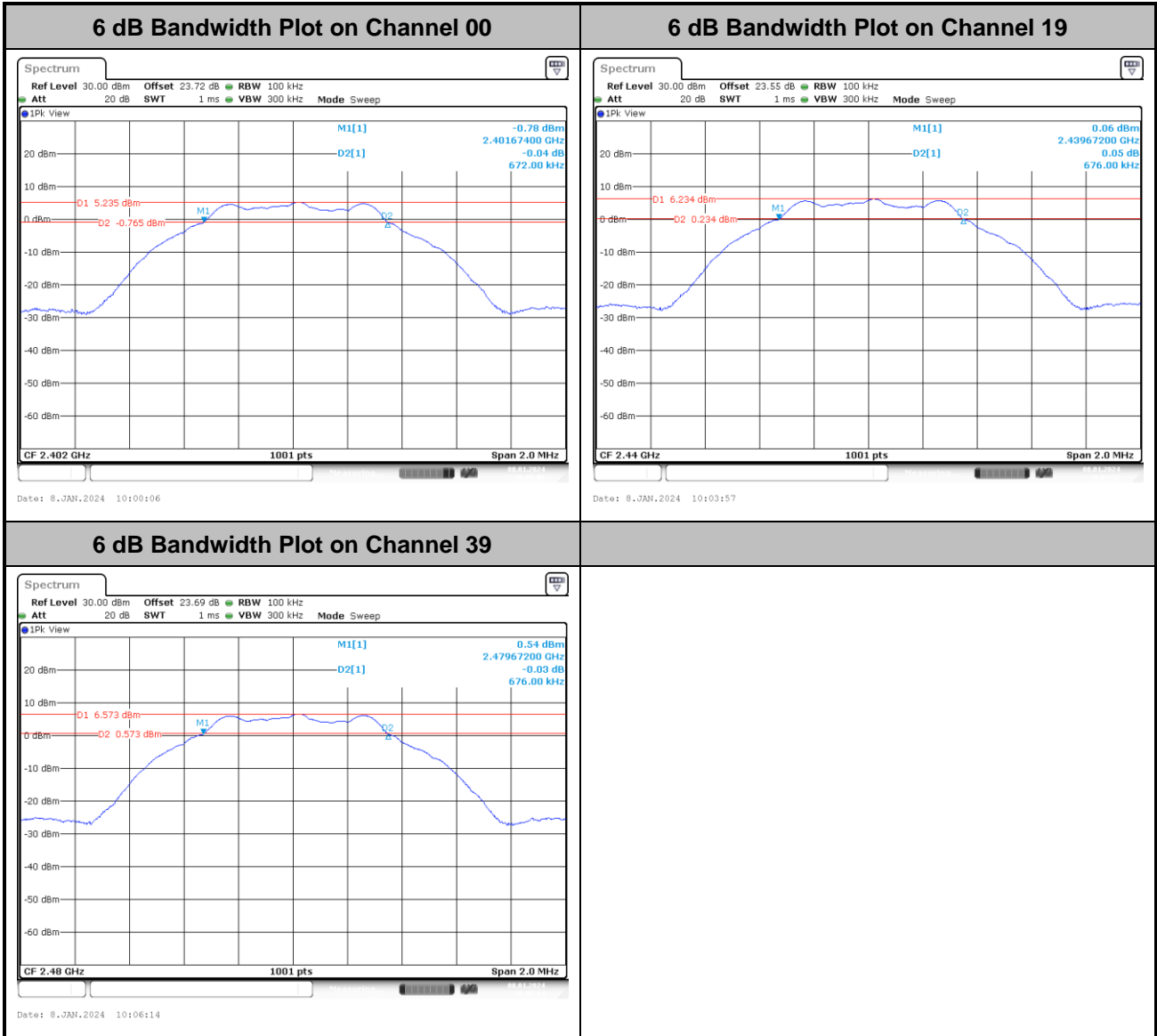



<2Mbps>

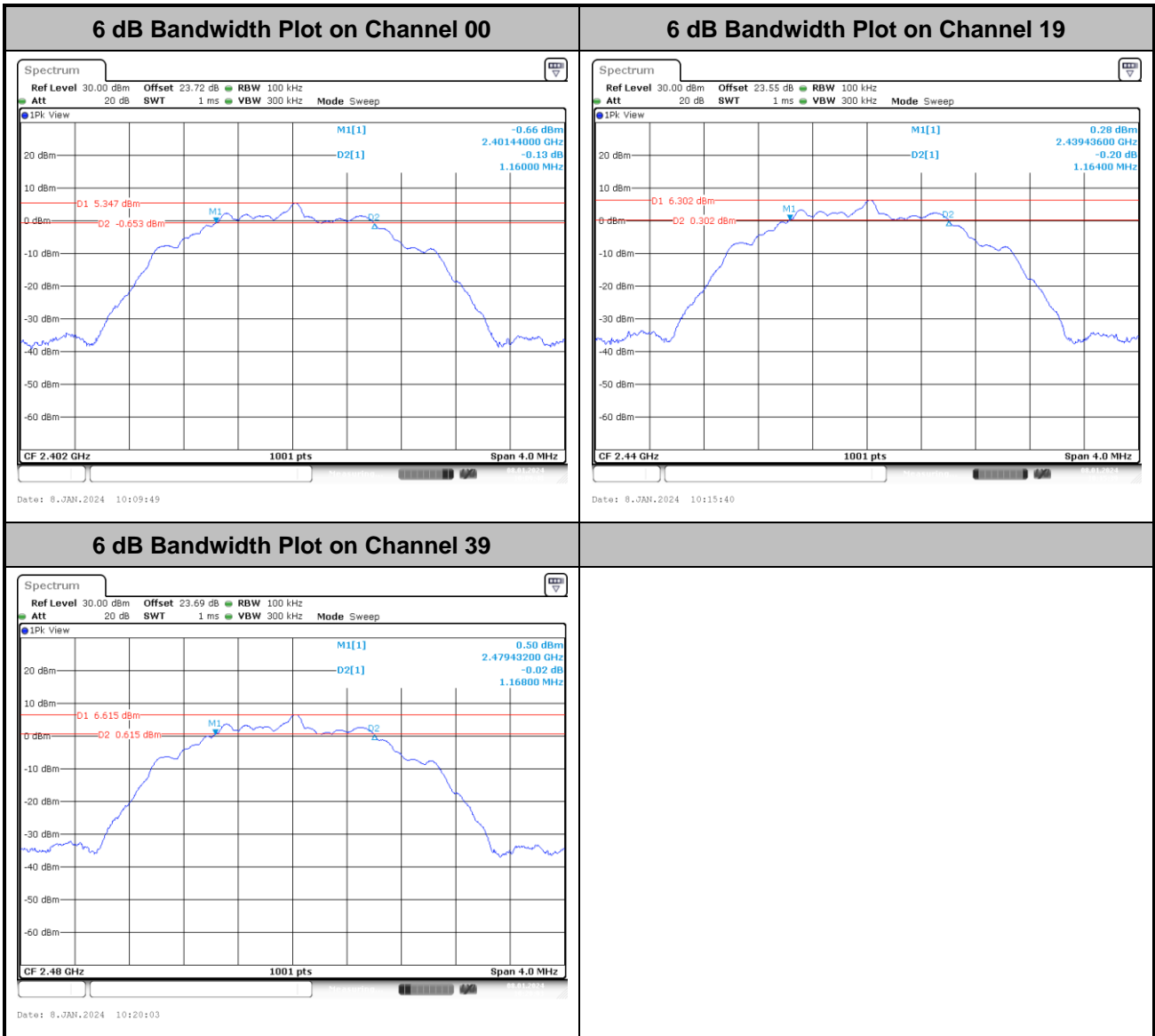



99% Occupied Bandwidth

<1Mbps>

99% Occupied Bandwidth Plot on Channel 00

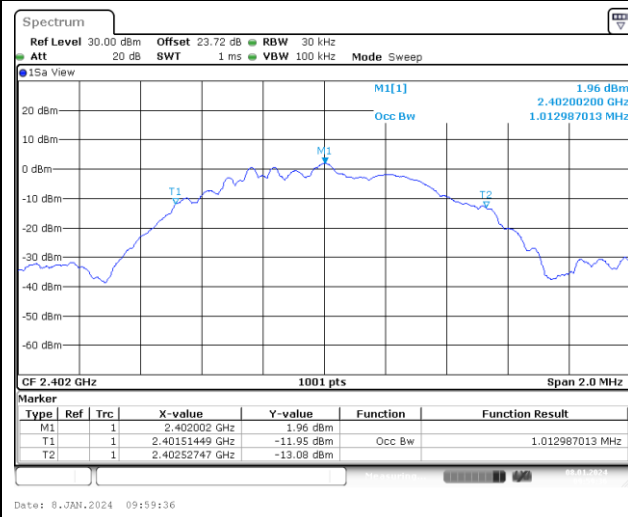

99% Occupied Bandwidth Plot on Channel 19

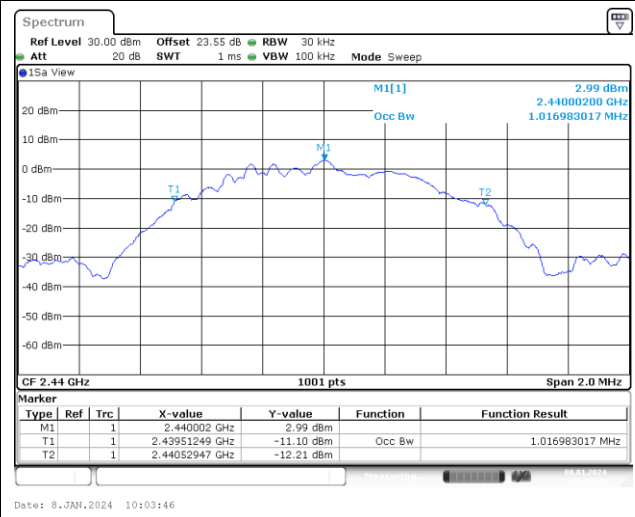

99% Occupied Bandwidth Plot on Channel 39

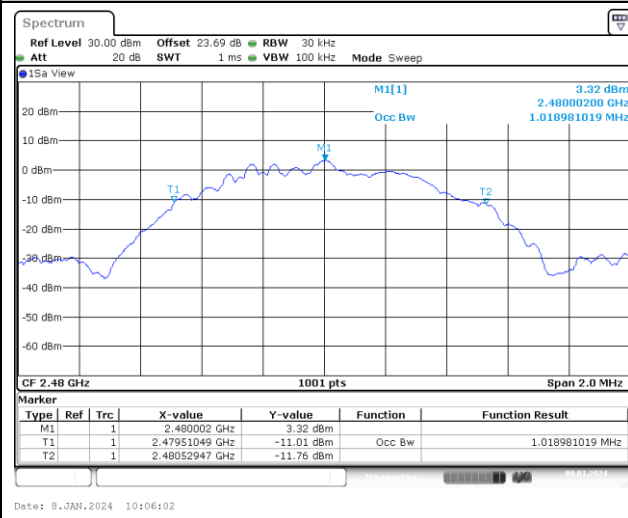



<2Mbps>

99% Occupied Bandwidth Plot on Channel 00

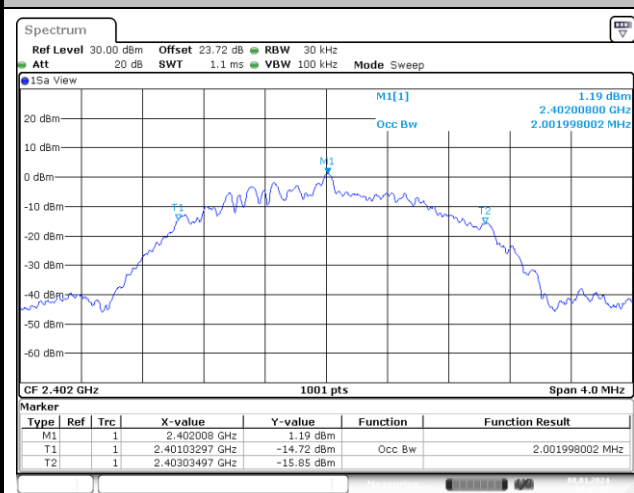

99% Occupied Bandwidth Plot on Channel 19

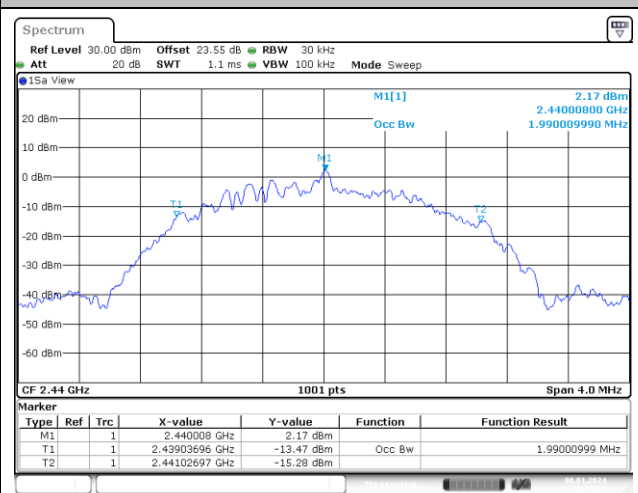

99% Occupied Bandwidth Plot on Channel 39

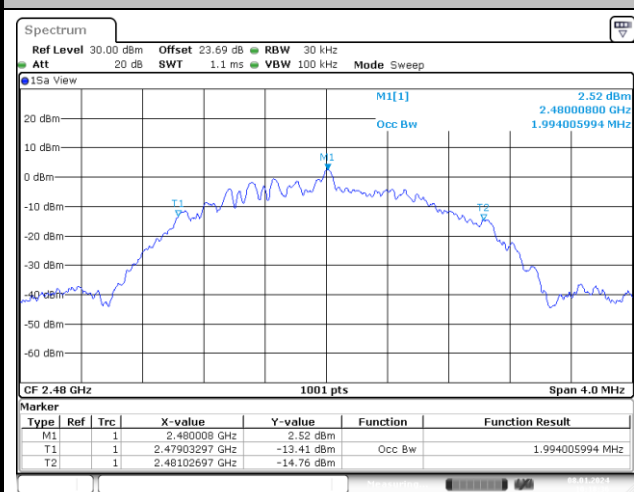



Power Spectral Density (dBm/3kHz)

<1Mbps>

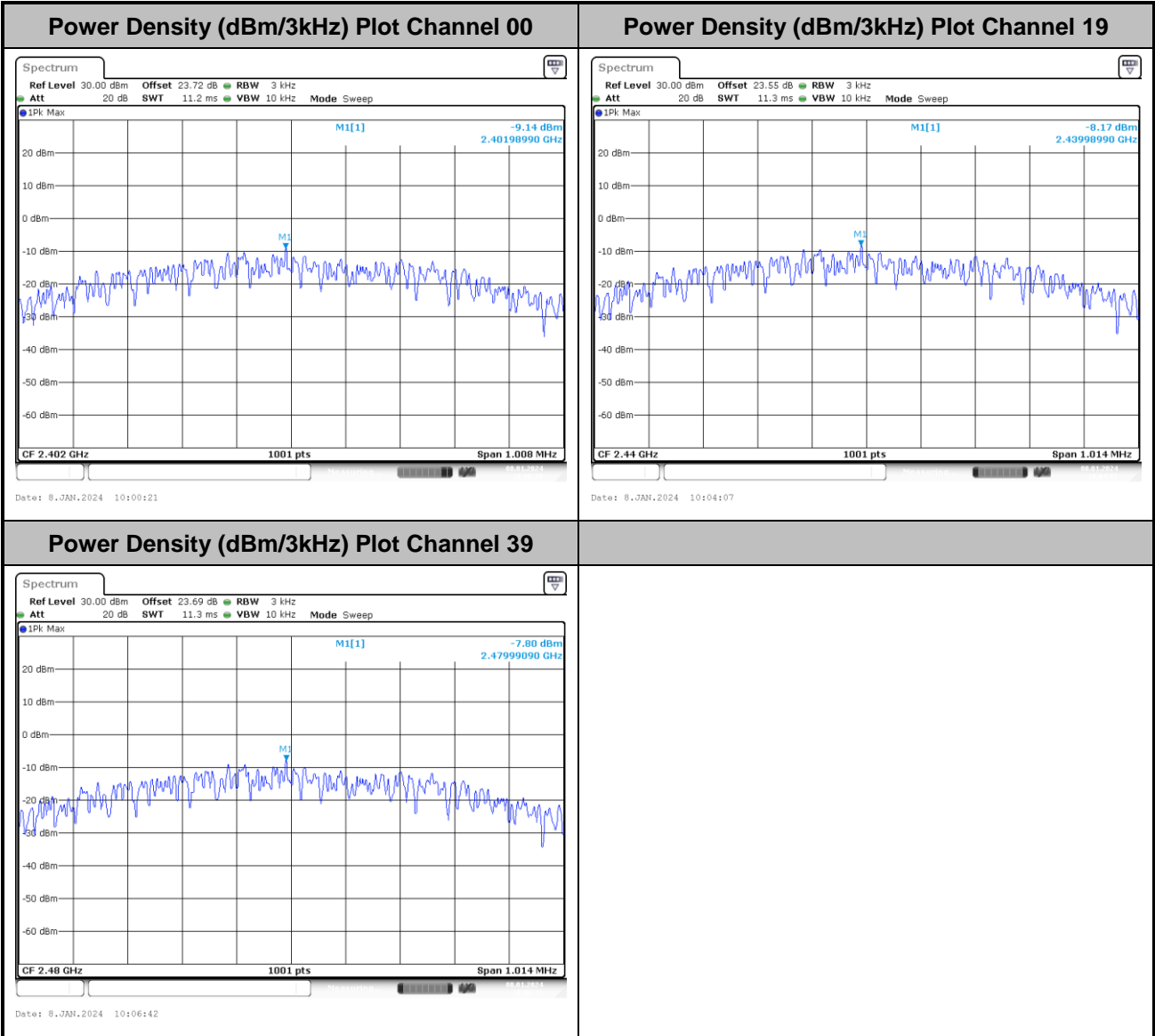



<2Mbps>

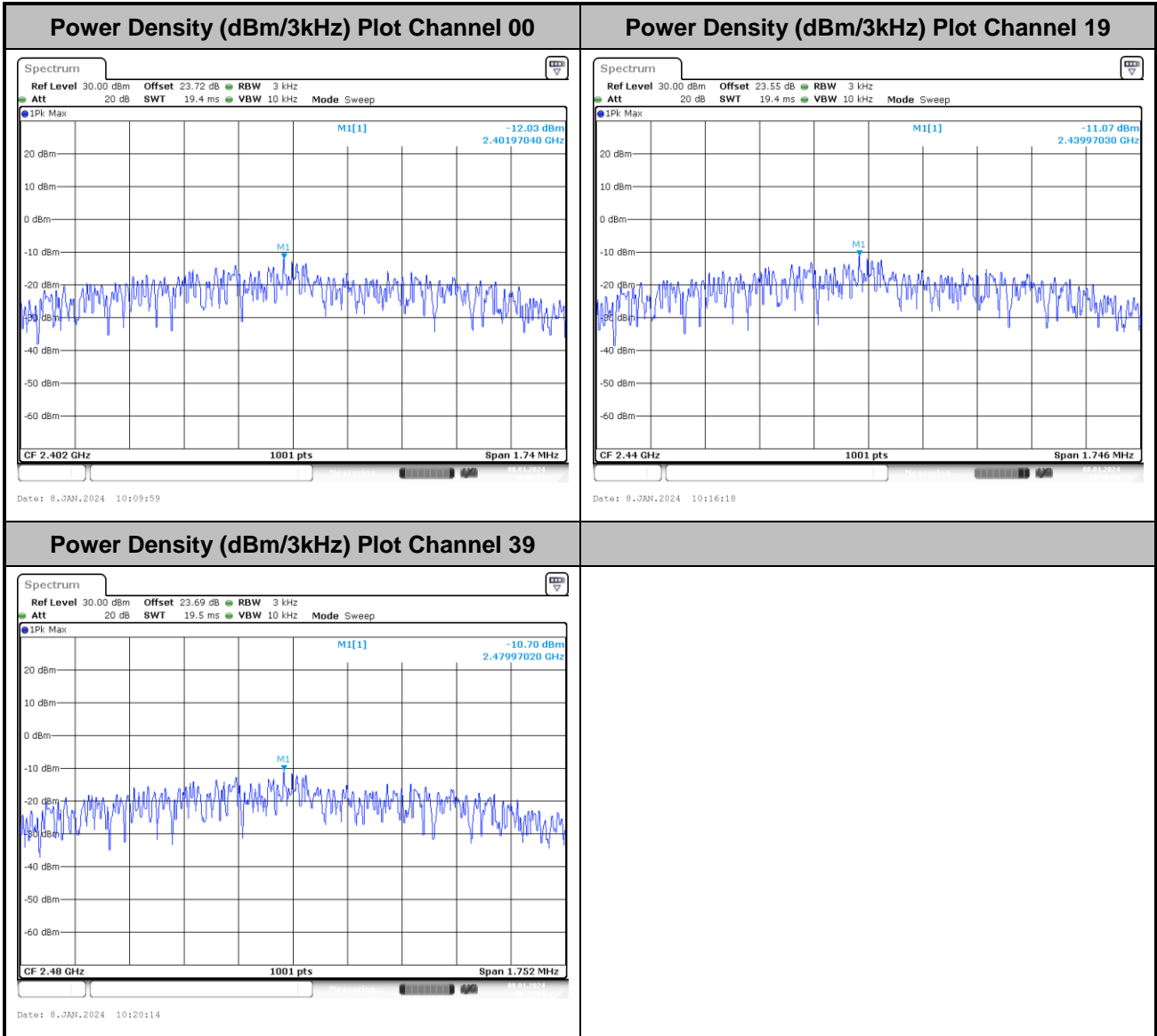



Band Edge and Conducted Spurious Emission

<1Mbps>

Channel 00

100kHz PSD reference Level Plot

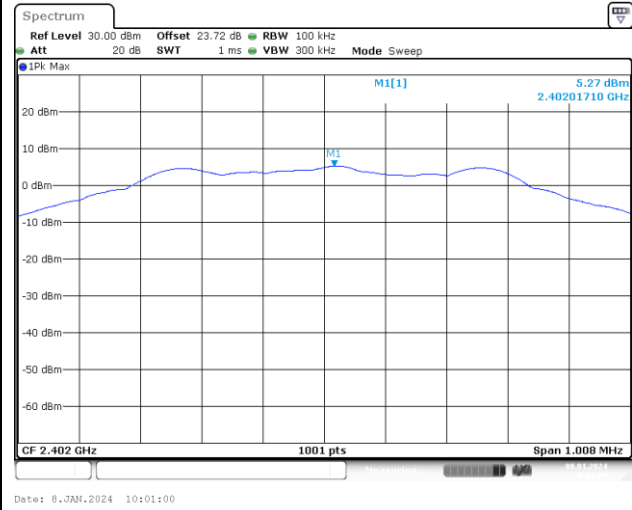

Low Channel Plot

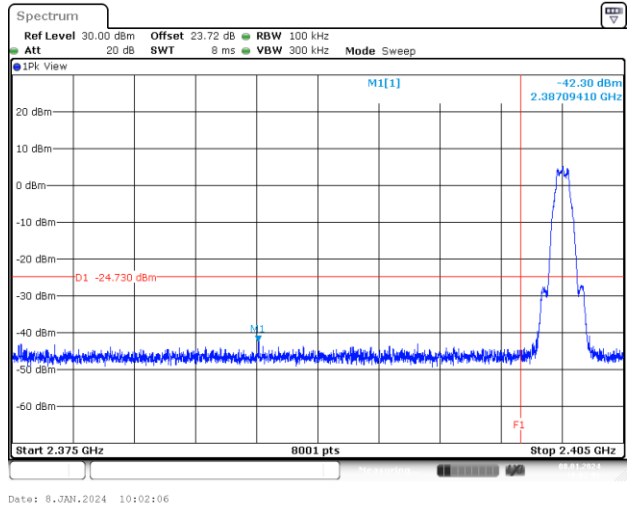

Spurious Emission 30MHz~1GHz Plot

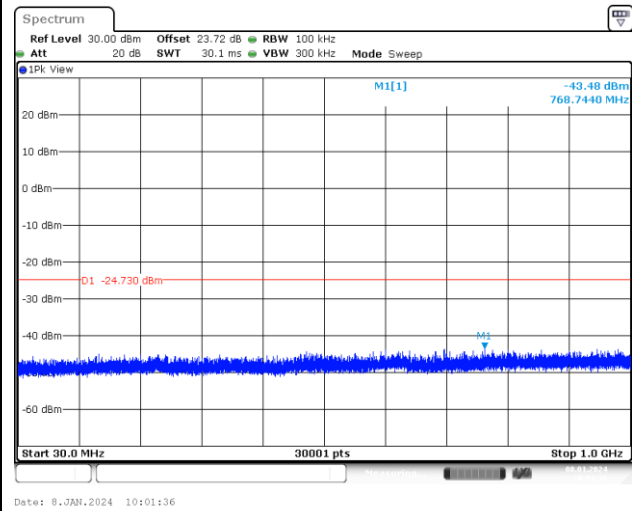

Spurious Emission 1GHz~26.5GHz Plot

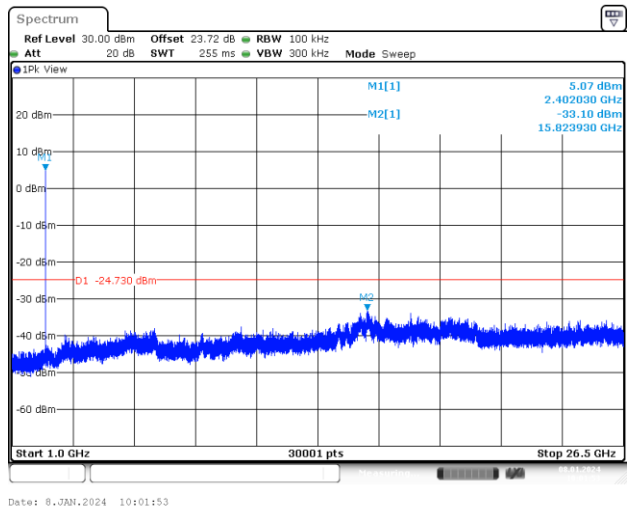



Channel 19

100kHz PSD reference Level Plot

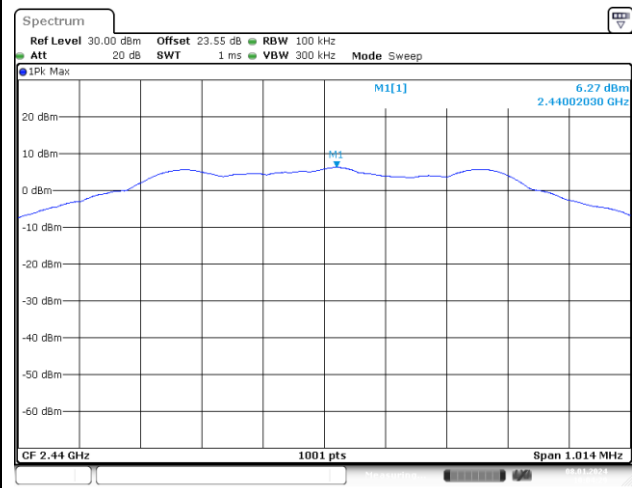

Date: 8.JAN.2024 10:04:29

Mid Channel Plot

Spurious Emission 30MHz~1GHz Plot

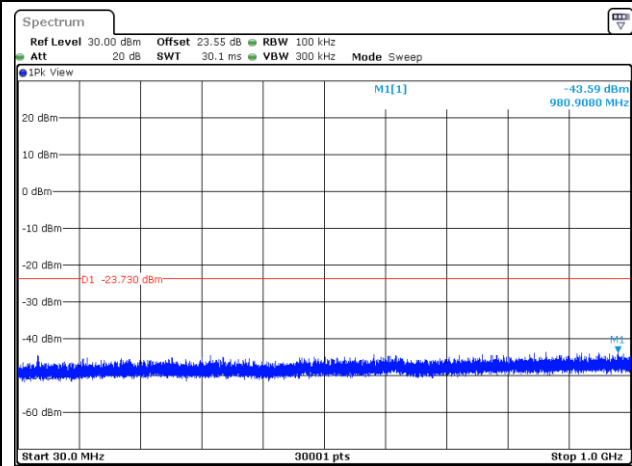

Date: 8.JAN.2024 10:04:47

Spurious Emission 1GHz~26.5GHz Plot

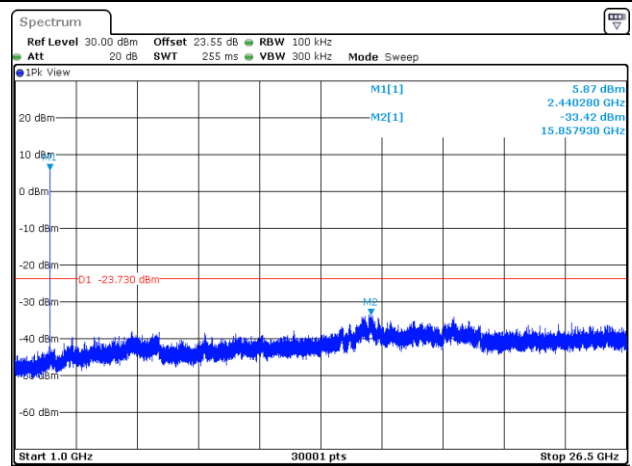

Date: 8.JAN.2024 10:05:09



Channel 39

100kHz PSD reference Level Plot

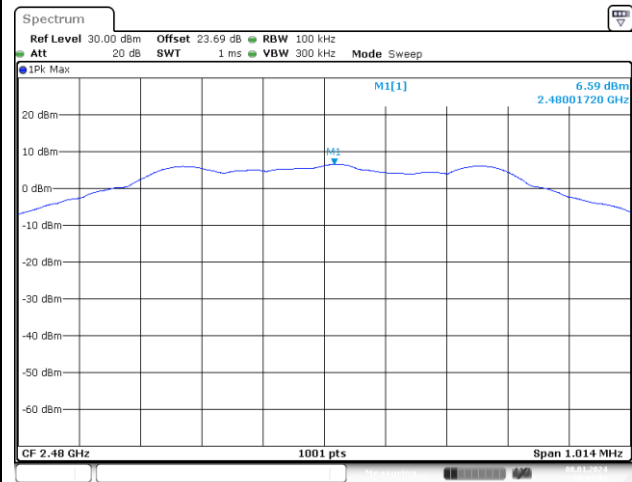

Date: 8.JAN.2024 10:07:02

High Channel Plot

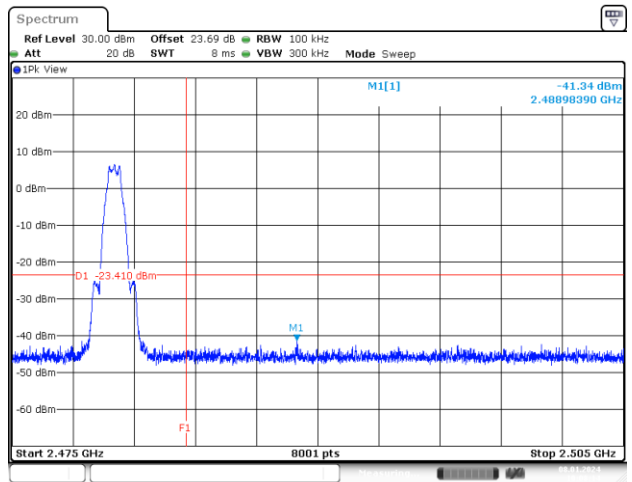

Date: 8.JAN.2024 10:08:14

Spurious Emission 30MHz~1GHz Plot

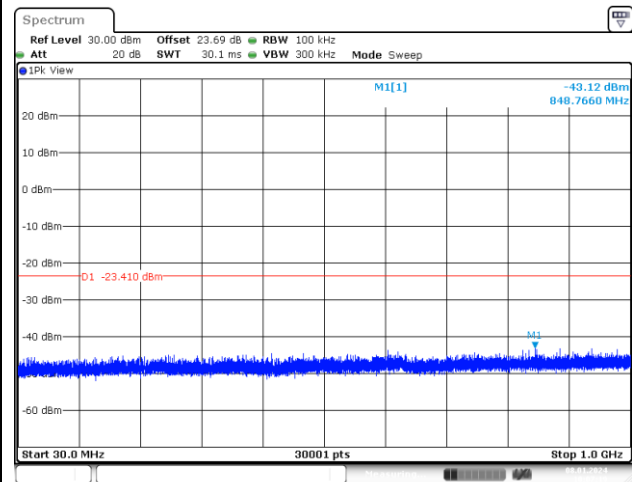

Date: 8.JAN.2024 10:07:20

Spurious Emission 1GHz~26.5GHz Plot

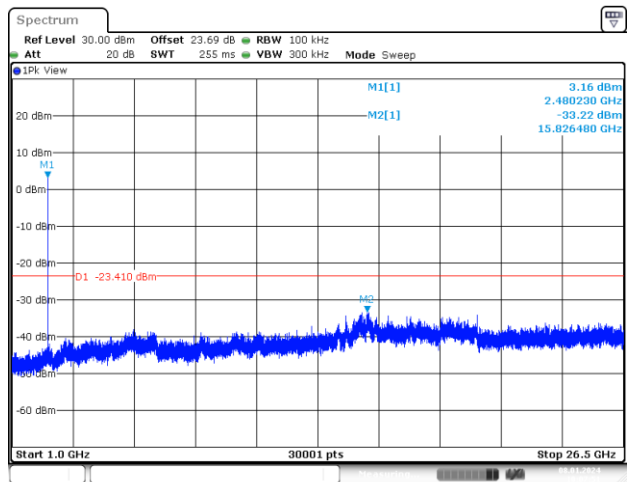

Date: 8.JAN.2024 10:07:51



<2Mbps>

Channel 00

100kHz PSD reference Level Plot

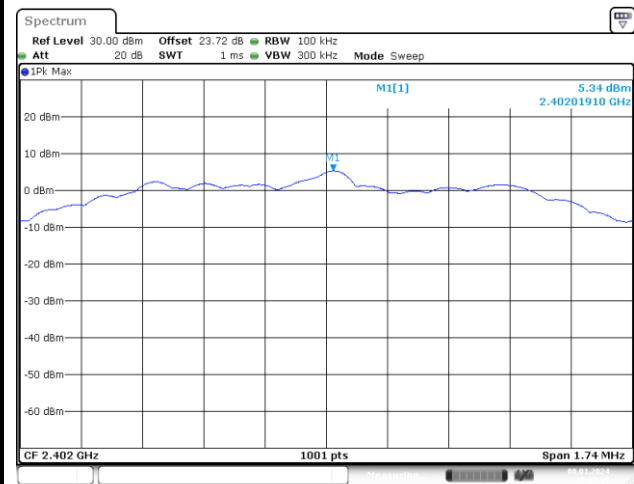

Date: 8.JAN.2024 10:10:15

Low Channel Plot

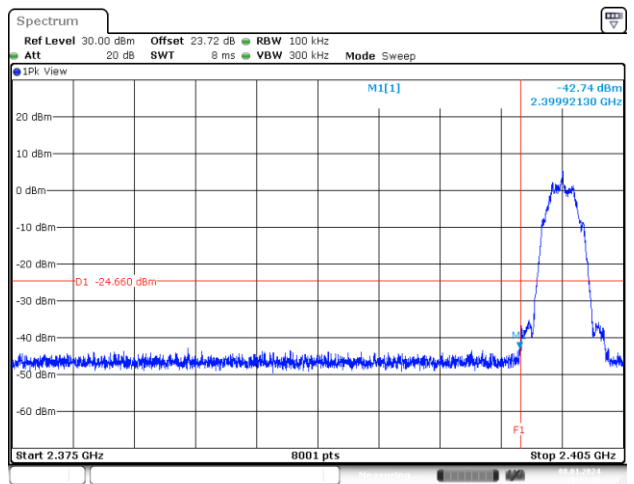

Date: 8.JAN.2024 10:13:18

Spurious Emission 30MHz~1GHz Plot

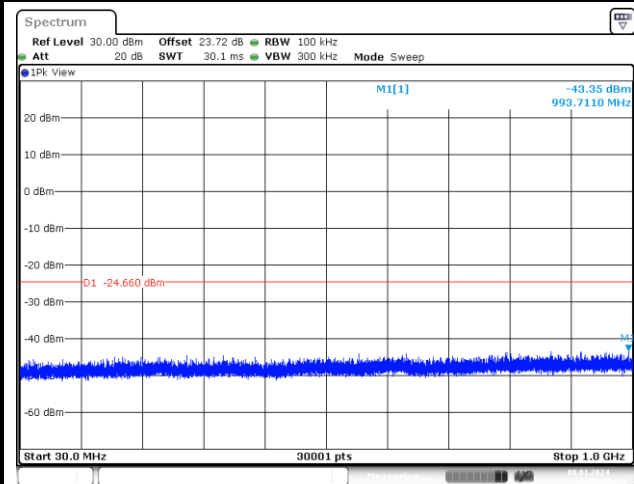

Date: 8.JAN.2024 10:10:34

Spurious Emission 1GHz~26.5GHz Plot

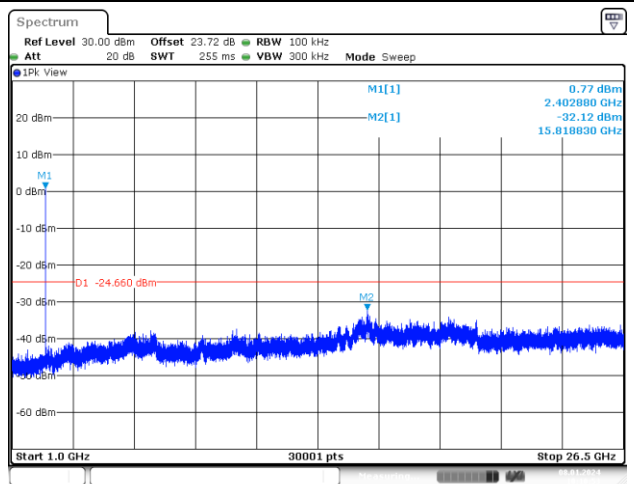

Date: 8.JAN.2024 10:10:54



Channel 19

100kHz PSD reference Level Plot

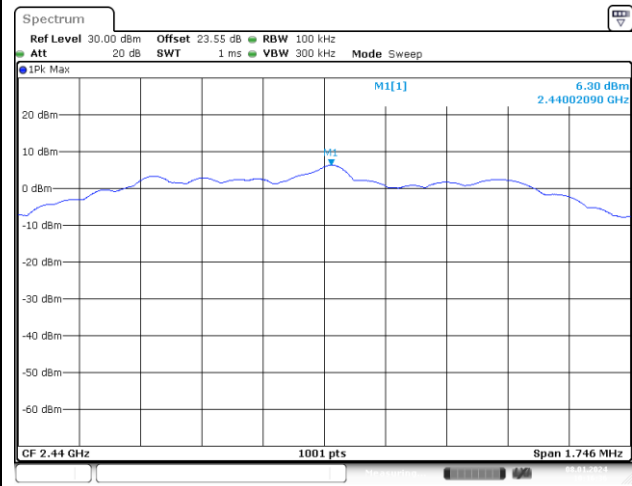

Mid Channel Plot

Spurious Emission 30MHz~1GHz Plot

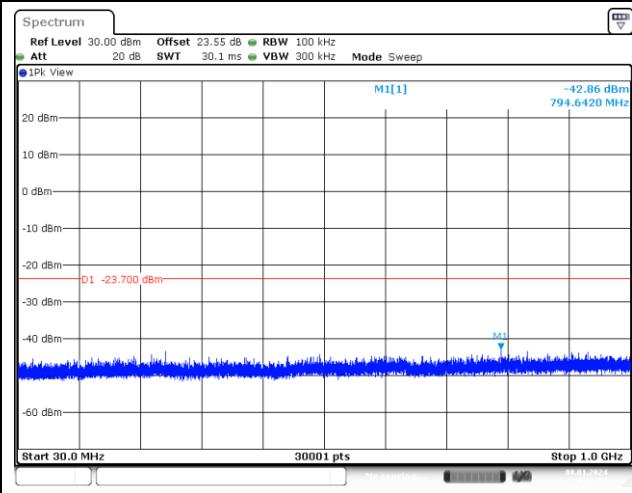

Spurious Emission 1GHz~26.5GHz Plot

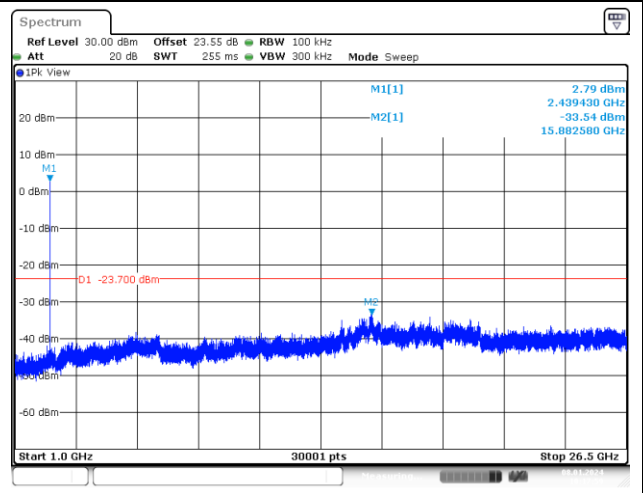



Channel 39

100kHz PSD reference Level Plot

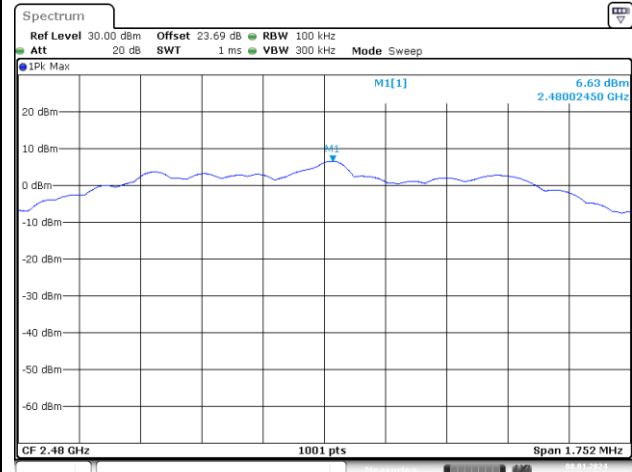

Date: 8.JAN.2024 10:20:30

High Channel Plot

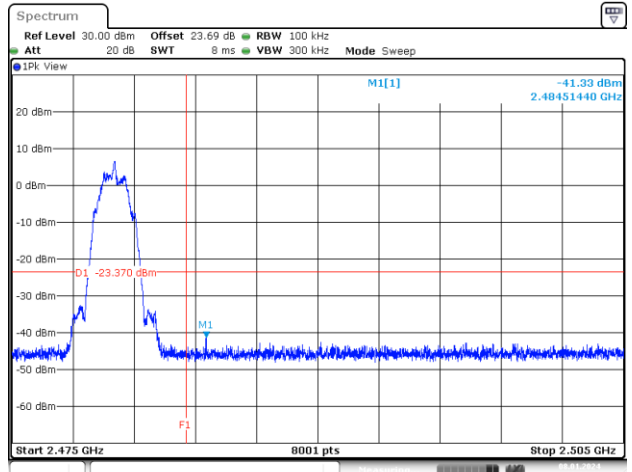

Date: 8.JAN.2024 10:21:41

Spurious Emission 30MHz~1GHz Plot

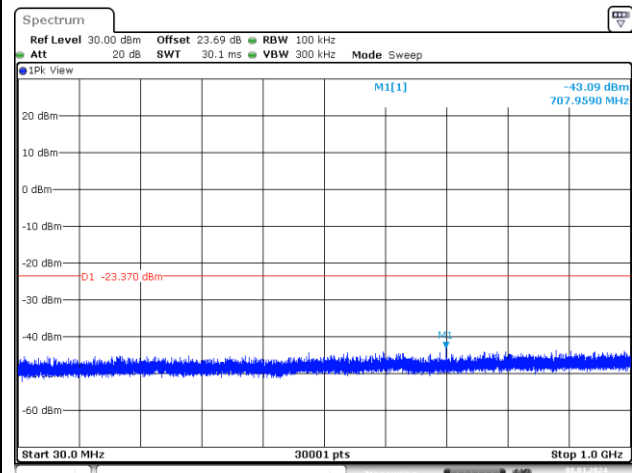

Date: 8.JAN.2024 10:20:49

Spurious Emission 1GHz~26.5GHz Plot

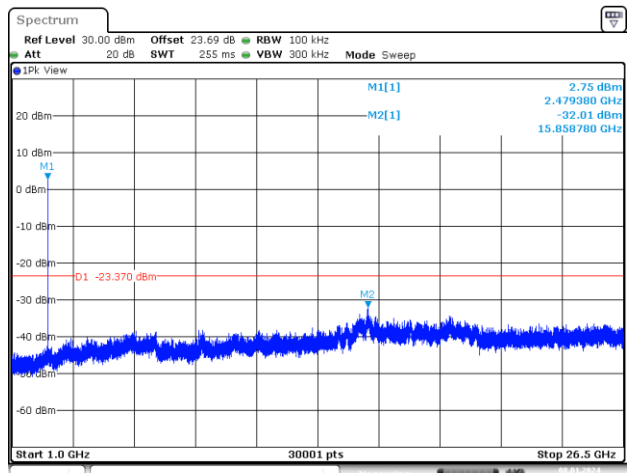

Date: 8.JAN.2024 10:21:18



Appendix B. AC Conducted Emission Test Results

Test Engineer :	Calvin Wang	Temperature :	23~26°C
		Relative Humidity :	45~55%

EUT Information

Report NO : 3D0601
 Test Mode : Mode 1
 Test Voltage : 120Vac/60Hz
 Phase : Line

Full Spectrum

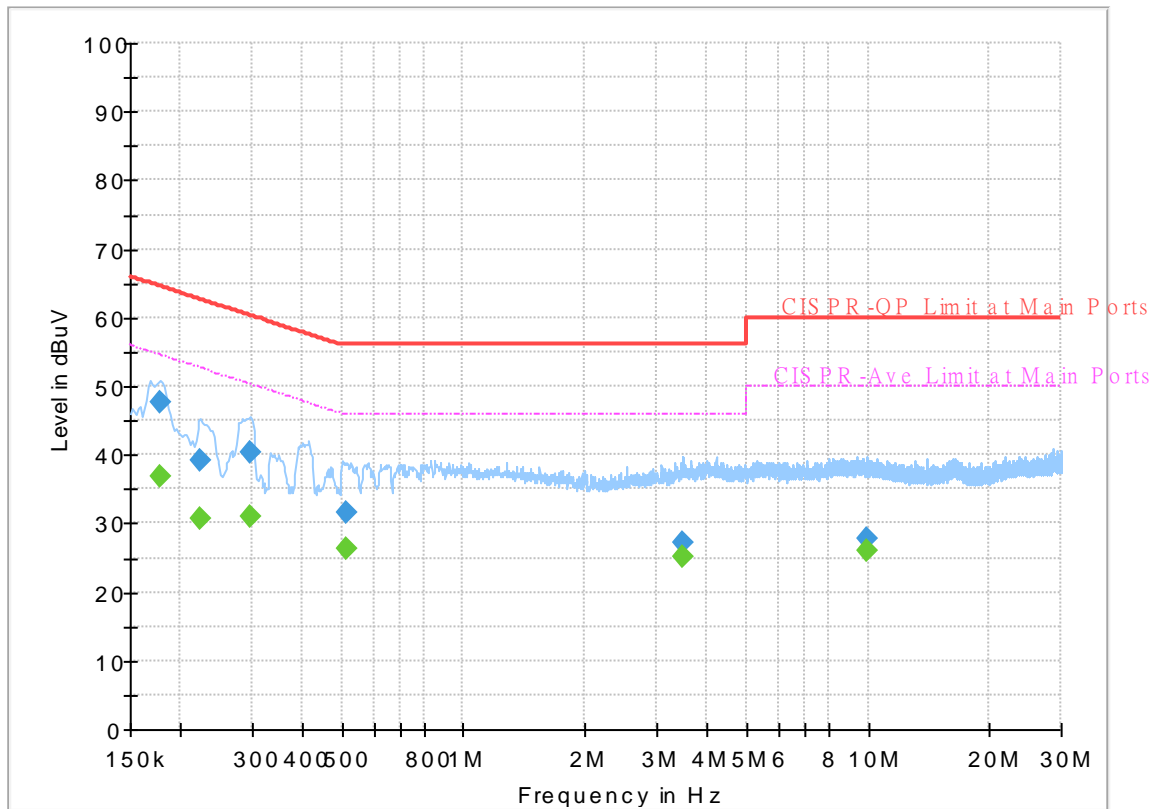

Final_Result

Frequency (MHz)	QuasiPeak (dBuV)	CAverage (dBuV)	Limit (dBuV)	Margin (dB)	Line	Filter	Corr. (dB)
0.177000	---	36.92	54.63	17.71	L1	OFF	19.9
0.177000	47.71	---	64.63	16.92	L1	OFF	19.9
0.224250	---	30.70	52.66	21.96	L1	OFF	19.9
0.224250	39.25	---	62.66	23.41	L1	OFF	19.9
0.298500	---	31.00	50.28	19.28	L1	OFF	19.9
0.298500	40.22	---	60.28	20.06	L1	OFF	19.9
0.514500	---	26.26	46.00	19.74	L1	OFF	19.9
0.514500	31.65	---	56.00	24.35	L1	OFF	19.9
3.482250	---	25.11	46.00	20.89	L1	OFF	20.0
3.482250	27.14	---	56.00	28.86	L1	OFF	20.0
9.912750	---	26.14	50.00	23.86	L1	OFF	20.2
9.912750	27.89	---	60.00	32.11	L1	OFF	20.2

EUT Information

Report NO : 3D0601
 Test Mode : Mode 1
 Test Voltage : 120Vac/60Hz
 Phase : Neutral

Full Spectrum

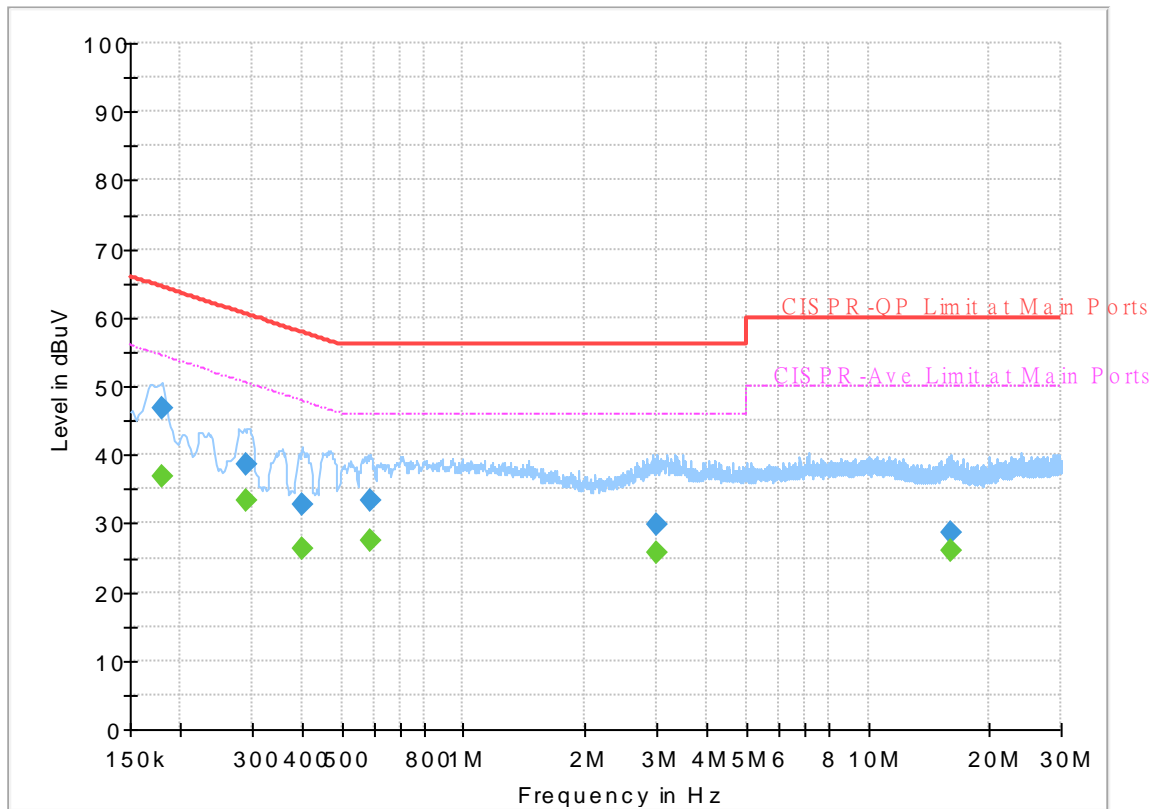

Final_Result

Frequency (MHz)	QuasiPeak (dBuV)	CAverage (dBuV)	Limit (dBuV)	Margin (dB)	Line	Filter	Corr. (dB)
0.179250	---	36.73	54.52	17.79	N	OFF	19.9
0.179250	46.71	---	64.52	17.81	N	OFF	19.9
0.291750	---	33.20	50.47	17.27	N	OFF	19.9
0.291750	38.63	---	60.47	21.84	N	OFF	19.9
0.397500	---	26.39	47.91	21.52	N	OFF	19.9
0.397500	32.84	---	57.91	25.07	N	OFF	19.9
0.591000	---	27.52	46.00	18.48	N	OFF	19.9
0.591000	33.33	---	56.00	22.67	N	OFF	19.9
3.007500	---	25.71	46.00	20.29	N	OFF	20.0
3.007500	29.92	---	56.00	26.08	N	OFF	20.0
16.026000	---	26.08	50.00	23.92	N	OFF	20.4
16.026000	28.62	---	60.00	31.38	N	OFF	20.4



Appendix C. Radiated Spurious Emission

Test Engineer :	John Chuang, David Dai, and Howard Huang	Temperature :	19.3~23.4°C
		Relative Humidity :	65.9~70.3%

<Ant.6> <1Mbps>

2.4GHz 2400~2483.5MHz

BLE (Band Edge @ 3m)

BLE	Note	Frequency	Level	Margin	Limit	Read	Antenna	Path	Preamp	Ant	Table	Peak	Pol.	
		(MHz)	(dBμV/m)	(dB)	Line	Level	Factor	Loss	Factor	Pos	Pos	Avg.		
					(dBμV/m)	(dBμV)	(dB/m)	(dB)	(dB)	(cm)	(deg)	(P/A)	(H/V)	
BLE CH 00 2402MHz		2357.25	49.97	-24.03	74	40.5	27.13	18.57	36.23	123	357	P	H	
		2385.18	40.24	-13.76	54	30.62	27.24	18.62	36.24	123	357	A	H	
	*	2402	102.83	-	-	93.12	27.31	18.65	36.25	123	357	P	H	
	*	2402	102.2	-	-	92.49	27.31	18.65	36.25	123	357	A	H	
													H	
														H
			2355.465	50.13	-23.87	74	40.68	27.12	18.56	36.23	100	309	P	V
			2388.645	40.3	-13.7	54	30.66	27.25	18.63	36.24	100	309	A	V
	*		2402	101.03	-	-	91.32	27.31	18.65	36.25	100	309	P	V
	*		2402	100.4	-	-	90.69	27.31	18.65	36.25	100	309	A	V
													V	
													V	
BLE CH 19 2440MHz		2339.76	50.04	-23.96	74	40.64	27.1	18.53	36.23	301	54	P	H	
		2375.28	40.12	-13.88	54	30.56	27.2	18.6	36.24	301	54	A	H	
	*	2440	103.05	-	-	93.12	27.46	18.73	36.26	301	54	P	H	
	*	2440	102.4	-	-	92.47	27.46	18.73	36.26	301	54	A	H	
			2496.56	49.98	-24.02	74	39.73	27.69	18.84	36.28	301	54	P	H
			2485.68	40.7	-13.3	54	30.52	27.64	18.82	36.28	301	54	A	H
			2360.88	50.7	-23.3	74	41.22	27.14	18.57	36.23	100	280	P	V
			2387.76	40.34	-13.66	54	30.7	27.25	18.63	36.24	100	280	A	V
	*		2440	100.46	-	-	90.53	27.46	18.73	36.26	100	280	P	V
	*		2440	99.83	-	-	89.9	27.46	18.73	36.26	100	280	A	V
			2490.8	49.84	-24.16	74	39.63	27.66	18.83	36.28	100	280	P	V
		2494.72	40.69	-13.31	54	30.45	27.68	18.84	36.28	100	280	A	V	



BLE CH 39 2480MHz	*	2480	104.02	-	-	93.86	27.62	18.81	36.27	297	51	P	H
	*	2480	103.45	-	-	93.29	27.62	18.81	36.27	297	51	A	H
		2483.56	51.48	-22.52	74	41.3	27.63	18.82	36.27	297	51	P	H
		2485.52	40.72	-13.28	54	30.54	27.64	18.82	36.28	297	51	A	H
													H
													H
	*	2480	102.59	-	-	92.43	27.62	18.81	36.27	126	92	P	V
	*	2480	101.98	-	-	91.82	27.62	18.81	36.27	126	92	A	V
		2484	50.89	-23.11	74	40.7	27.64	18.82	36.27	126	92	P	V
		2485.12	40.83	-13.17	54	30.64	27.64	18.82	36.27	126	92	A	V
													V
													V
Remark	1. No other spurious found. 2. All results are PASS against Peak and Average limit line.												



2.4GHz 2400~2483.5MHz
BLE (Harmonic @ 3m)

BLE	Note	Frequency	Level	Margin	Limit	Read	Antenna	Path	Preamp	Ant	Table	Peak	Pol.
		(MHz)	(dBμV/m)	(dB)	(dBμV/m)	(dBμV)	(dB/m)	(dB)	(dB)	(cm)	(deg)	(P/A)	(H/V)
BLE CH 00 2402MHz		4804	42.43	-31.57	74	34.64	32.4	12.89	37.5	-	-	P	H
													H
													H
													H
													H
													H
													H
													H
													H
													H
													H
													H
													H
													H
													H
													H
													H
													H
													H
			4804	42.66	-31.34	74	34.87	32.4	12.89	37.5	-	-	P
													V
													V
													V
													V
													V
													V
													V
													V
													V
													V
													V
													V
													V
													V



BLE	Note	Frequency (MHz)	Level (dBμV/m)	Margin (dB)	Limit Line (dBμV/m)	Read Level (dBμV)	Antenna Factor (dB/m)	Path Loss (dB)	Preamp Factor (dB)	Ant Pos (cm)	Table Pos (deg)	Peak Avg. (P/A)	Pol. (H/V)
BLE CH 19 2440MHz		4880	43.01	-30.99	74	34.94	32.52	13.11	37.56	-	-	P	H
		7320	47.94	-26.06	74	33.76	36.9	15.89	38.61	-	-	P	H
													H
													H
													H
													H
													H
													H
													H
													H
													H
													H
													H
													H
													H
													H
													H
													H
													H
			4880	43.73	-30.27	74	35.66	32.52	13.11	37.56	-	-	P
		7320	47.97	-26.03	74	33.79	36.9	15.89	38.61	-	-	P	V
													V
													V
													V
													V
													V
													V
													V
													V
													V
													V
													V
													V
													V
													V
													V



BLE	Note	Frequency	Level	Margin	Limit	Read	Antenna	Path	Preamp	Ant	Table	Peak	Pol.
		(MHz)	(dBμV/m)	(dB)	(dBμV/m)	(dBμV)	(dB/m)	(dB)	(dB)	(cm)	(deg)	(P/A)	(H/V)
BLE CH 39 2480MHz		4960	44.87	-29.13	74	36.22	32.94	13.34	37.63	-	-	P	H
		7440	47.87	-26.13	74	34.05	36.52	16.01	38.71	-	-	P	H
													H
													H
													H
													H
													H
													H
													H
													H
													H
													H
													H
													H
													H
													H
													H
													H
													H
			4960	44.07	-29.93	74	35.42	32.94	13.34	37.63	-	-	P
		7440	46.98	-27.02	74	33.16	36.52	16.01	38.71	-	-	P	V
													V
													V
													V
													V
													V
													V
													V
													V
													V
													V
													V
													V
													V
Remark	1. No other spurious found. 2. All results are PASS against Peak and Average limit line. 3. The emission position marked as "-" means no suspected emission found with sufficient margin against limit line or noise floor only.												



<Ant.6> <2Mbps>

2.4GHz 2400~2483.5MHz

BLE (Band Edge @ 3m)

BLE	Note	Frequency	Level	Margin	Limit	Read	Antenna	Path	Preamp	Ant	Table	Peak	Pol.	
		(MHz)	(dBμV/m)	(dB)	Line (dBμV/m)	Level (dBμV)	Factor (dB/m)	Loss (dB)	Factor (dB)	Pos (cm)	Pos (deg)	Avg. (P/A)	(H/V)	
BLE CH 00 2402MHz		2371.425	50.52	-23.48	74	40.98	27.19	18.59	36.24	166	360	P	H	
		2368.38	41.01	-12.99	54	31.49	27.17	18.59	36.24	166	360	A	H	
	*	2402	102.24	-	-	92.53	27.31	18.65	36.25	166	360	P	H	
	*	2402	100.83	-	-	91.12	27.31	18.65	36.25	166	360	A	H	
													H	
														H
			2383.185	49.64	-24.36	74	40.03	27.23	18.62	36.24	200	42	P	V
			2377.305	40.81	-13.19	54	31.23	27.21	18.61	36.24	200	42	A	V
	*		2402	92.68	-	-	82.97	27.31	18.65	36.25	200	42	P	V
	*		2402	91.23	-	-	81.52	27.31	18.65	36.25	200	42	A	V
														V
													V	
BLE CH 19 2440MHz		2339.28	49.59	-24.41	74	40.19	27.1	18.53	36.23	265	0	P	H	
		2383.28	40.85	-13.15	54	31.24	27.23	18.62	36.24	265	0	A	H	
	*	2440	103.37	-	-	93.44	27.46	18.73	36.26	265	0	P	H	
	*	2440	101.9	-	-	91.97	27.46	18.73	36.26	265	0	A	H	
			2486.72	50.24	-23.76	74	40.05	27.65	18.82	36.28	265	0	P	H
			2485.84	41.31	-12.69	54	31.13	27.64	18.82	36.28	265	0	A	H
			2334.96	50.15	-23.85	74	40.75	27.1	18.52	36.22	100	277	P	V
			2368.56	40.67	-13.33	54	31.15	27.17	18.59	36.24	100	277	A	V
	*		2440	100	-	-	90.07	27.46	18.73	36.26	100	277	P	V
	*		2440	98.6	-	-	88.67	27.46	18.73	36.26	100	277	A	V
			2492.08	50.39	-23.61	74	40.17	27.67	18.83	36.28	100	277	P	V
		2490.32	41.41	-12.59	54	31.2	27.66	18.83	36.28	100	277	A	V	
BLE CH 39 2480MHz	*	2480	104.63	-	-	94.47	27.62	18.81	36.27	297	0	P	H	
	*	2480	103.2	-	-	93.04	27.62	18.81	36.27	297	0	A	H	
			2483.64	51.67	-22.33	74	41.49	27.63	18.82	36.27	297	0	P	H
			2483.52	41.68	-12.32	54	31.5	27.63	18.82	36.27	297	0	A	H
													H	
													H	
	*		2480	100.08	-	-	89.92	27.62	18.81	36.27	100	253	P	V
	*		2480	98.57	-	-	88.41	27.62	18.81	36.27	100	253	A	V
			2483.52	50.03	-23.97	74	39.85	27.63	18.82	36.27	100	253	P	V
			2493.64	41.48	-12.52	54	31.25	27.67	18.84	36.28	100	253	A	V
													V	
													V	
Remark	1. No other spurious found. 2. All results are PASS against Peak and Average limit line.													



2.4GHz 2400~2483.5MHz

BLE (Harmonic @ 3m)

BLE	Note	Frequency	Level	Margin	Limit	Read	Antenna	Path	Preamp	Ant	Table	Peak	Pol.
		(MHz)	(dBμV/m)	(dB)	(dBμV/m)	(dBμV)	(dB/m)	(dB)	(dB)	(cm)	(deg)	(P/A)	(H/V)
BLE CH 00 2402MHz		4804	42.81	-31.19	74	35.02	32.4	12.89	37.5	-	-	P	H
													H
													H
													H
													H
													H
													H
													H
													H
													H
													H
													H
													H
													H
													H
													H
													H
													H
													H
			4804	42.59	-31.41	74	34.8	32.4	12.89	37.5	-	-	P
													V
													V
													V
													V
													V
													V
													V
													V
													V
													V
													V
													V
													V
													V



BLE	Note	Frequency (MHz)	Level (dBμV/m)	Margin (dB)	Limit Line (dBμV/m)	Read Level (dBμV)	Antenna Factor (dB/m)	Path Loss (dB)	Preamp Factor (dB)	Ant Pos (cm)	Table Pos (deg)	Peak Avg. (P/A)	Pol. (H/V)	
BLE CH 19 2440MHz		4880	42.72	-31.28	74	34.65	32.52	13.11	37.56	-	-	P	H	
		7320	47.74	-26.26	74	33.56	36.9	15.89	38.61	-	-	P	H	
													H	
													H	
													H	
													H	
													H	
													H	
													H	
													H	
													H	
			7320	48.05	-25.95	74	33.87	36.9	15.89	38.61	-	-	P	V
			7320	47.98	-26.02	74	33.8	36.9	15.89	38.61	-	-	P	V
														V
														V
														V
														V
														V
													V	



BLE	Note	Frequency (MHz)	Level (dBμV/m)	Margin (dB)	Limit Line (dBμV/m)	Read Level (dBμV)	Antenna Factor (dB/m)	Path Loss (dB)	Preamp Factor (dB)	Ant Pos (cm)	Table Pos (deg)	Peak Avg. (P/A)	Pol. (H/V)
BLE CH 39 2480MHz		4960	44.66	-29.34	74	36.01	32.94	13.34	37.63	-	-	P	H
		7440	47.23	-26.77	74	33.41	36.52	16.01	38.71	-	-	P	H
													H
													H
													H
													H
													H
													H
													H
													H
													H
													H
													H
													H
													H
													H
													H
													H
													H
			4960	44.36	-29.64	74	35.71	32.94	13.34	37.63	-	-	P
		7440	47.69	-26.31	74	33.87	36.52	16.01	38.71	-	-	P	V
													V
													V
													V
													V
													V
													V
													V
													V
													V
													V
													V
													V
													V
Remark	<ol style="list-style-type: none"> No other spurious found. All results are PASS against Peak and Average limit line. The emission position marked as "-" means no suspected emission found with sufficient margin against limit line or noise floor only. 												



Emission above 18GHz

2.4GHz BLE (SHF)

BT	Note	Frequency	Level	Margin	Limit	Read	Antenna	Path	Preamp	Ant	Table	Peak	Pol.
		(MHz)	(dBμV/m)	(dB)	(dBμV/m)	(dBμV)	(dB/m)	(dB)	(dB)	(cm)	(deg)	(P/A)	(H/V)
2.4GHz BLE SHF		24552	42.26	-31.74	74	37.03	39.4	19.31	53.48	-	-	P	H
													H
													H
													H
													H
													H
													H
													H
													H
													H
													H
													H
													H
													H
													H
													H
													H
	2.4GHz BLE SHF		24874	43.44	-30.56	74	37.65	39.66	19.48	53.35	-	-	P
													V
													V
													V
													V
													V
													V
													V
													V
													V
													V
													V
													V
													V
													V
													V
													V
Remark		1. No other spurious found. 2. All results are PASS against limit line. 3. The emission position marked as "-" means no suspected emission found with sufficient margin against limit line or noise floor only.											



Emission below 1GHz

2.4GHz BLE (LF)

BLE	Note	Frequency	Level	Margin	Limit	Read	Antenna	Path	Preamp	Ant	Table	Peak	Pol.	
		(MHz)	(dBµV/m)	(dB)	(dBµV/m)	(dBµV)	(dB/m)	(dB)	(dB)	(cm)	(deg)	(P/A)	(H/V)	
2.4GHz BLE LF		32.38	24.18	-15.82	40	34.62	23.88	1.27	35.59	-	-	P	H	
		91.37	30.92	-12.58	43.5	49.65	14.92	1.87	35.52	-	-	P	H	
		138.63	25.34	-18.16	43.5	40.65	17.82	2.32	35.45	-	-	P	H	
		270.4	28.19	-17.81	46	41.09	19.18	3.1	35.18	-	-	P	H	
		688.8	30.12	-15.88	46	32.69	26.53	4.89	33.99	-	-	P	H	
		952.8	35.49	-10.51	46	31.81	30.87	5.78	32.97	-	-	P	H	
														H
														H
														H
														H
														H
														H
			45.64	28.77	-11.23	40	46.23	16.72	1.4	35.58	100	89	Q	V
			89.67	30.94	-12.56	43.5	49.87	14.74	1.86	35.53	-	-	P	V
			151.38	22.13	-21.37	43.5	37.87	17.28	2.4	35.42	-	-	P	V
			277.6	22.1	-23.9	46	35.25	18.87	3.15	35.17	-	-	P	V
			564	29.36	-16.64	46	32.87	26.35	4.49	34.35	-	-	P	V
			932.8	34.51	-11.49	46	31.97	29.88	5.71	33.05	-	-	P	V
													V	
													V	
													V	
													V	
													V	
Remark	1. No other spurious found. 2. All results are PASS against limit line. 3. The emission position marked as "-" means no suspected emission found and emission level has at least 6dB margin against limit or emission is noise floor only.													



<Ant.7> <1Mbps>

2.4GHz 2400~2483.5MHz

BLE (Band Edge @ 3m)

BLE	Note	Frequency	Level	Margin	Limit Line	Read Level	Antenna Factor	Path Loss	Preamp Factor	Ant Pos	Table Pos	Peak Avg.	Pol.	
		(MHz)	(dBμV/m)	(dB)	(dBμV/m)	(dBμV)	(dB/m)	(dB)	(dB)	(cm)	(deg)	(P/A)	(H/V)	
BLE CH 00 2402MHz		2371.53	50.26	-23.74	74	40.72	27.19	18.59	36.24	208	343	P	H	
		2385.18	39.97	-14.03	54	30.35	27.24	18.62	36.24	208	343	A	H	
	*	2402	102.1	-	-	92.39	27.31	18.65	36.25	208	343	P	H	
	*	2402	101.46	-	-	91.75	27.31	18.65	36.25	208	343	A	H	
													H	
														H
			2335.2	49.71	-24.29	74	40.31	27.1	18.52	36.22	100	341	P	V
			2352.945	39.88	-14.12	54	30.44	27.11	18.56	36.23	100	341	A	V
	*		2402	99.82	-	-	90.11	27.31	18.65	36.25	100	341	P	V
	*		2402	99.24	-	-	89.53	27.31	18.65	36.25	100	341	A	V
														V
													V	
BLE CH 19 2440MHz		2318	49.74	-24.26	74	40.37	27.1	18.49	36.22	237	343	P	H	
		2383.12	39.83	-14.17	54	30.22	27.23	18.62	36.24	237	343	A	H	
	*	2440	102.49	-	-	92.56	27.46	18.73	36.26	237	343	P	H	
	*	2440	101.9	-	-	91.97	27.46	18.73	36.26	237	343	A	H	
			2498.32	50.07	-23.93	74	39.81	27.69	18.85	36.28	237	343	P	H
			2486.8	40.49	-13.51	54	30.3	27.65	18.82	36.28	237	343	A	H
			2362.96	49.18	-24.82	74	39.68	27.15	18.58	36.23	120	280	P	V
			2388.56	39.97	-14.03	54	30.33	27.25	18.63	36.24	120	280	A	V
	*		2440	99.84	-	-	89.91	27.46	18.73	36.26	120	280	P	V
	*		2440	99.08	-	-	89.15	27.46	18.73	36.26	120	280	A	V
			2485.04	50.42	-23.58	74	40.23	27.64	18.82	36.27	120	280	P	V
		2499.2	40.35	-13.65	54	30.08	27.7	18.85	36.28	120	280	A	V	
BLE CH 39 2480MHz	*	2480	101.95	-	-	91.79	27.62	18.81	36.27	297	65	P	H	
	*	2480	101.33	-	-	91.17	27.62	18.81	36.27	297	65	A	H	
			2498.12	49.79	-24.21	74	39.53	27.69	18.85	36.28	297	65	P	H
			2494.48	40.73	-13.27	54	30.49	27.68	18.84	36.28	297	65	A	H
													H	
													H	
	*		2480	102.1	-	-	91.94	27.62	18.81	36.27	316	319	P	V
	*		2480	101.49	-	-	91.33	27.62	18.81	36.27	316	319	A	V
			2497.4	50.38	-23.62	74	40.13	27.69	18.84	36.28	316	319	P	V
			2484.08	40.54	-13.46	54	30.35	27.64	18.82	36.27	316	319	A	V
													V	
													V	
Remark	1. No other spurious found. 2. All results are PASS against Peak and Average limit line.													



2.4GHz 2400~2483.5MHz

BLE (Harmonic @ 3m)

BLE	Note	Frequency	Level	Margin	Limit	Read	Antenna	Path	Preamp	Ant	Table	Peak	Pol.
		(MHz)	(dBμV/m)	(dB)	(dBμV/m)	(dBμV)	(dB/m)	(dB)	(dB)	(cm)	(deg)	(P/A)	(H/V)
BLE CH 00 2402MHz		4804	42.54	-31.46	74	34.75	32.4	12.89	37.5	-	-	P	H
													H
													H
													H
													H
													H
													H
													H
													H
													H
													H
													H
													H
													H
													H
													H
													H
			4804	43.88	-30.12	74	36.09	32.4	12.89	37.5	-	-	P
													V
													V
													V
													V
													V
													V
													V
													V
													V
													V
													V
													V
													V



BLE	Note	Frequency (MHz)	Level (dBμV/m)	Margin (dB)	Limit Line (dBμV/m)	Read Level (dBμV)	Antenna Factor (dB/m)	Path Loss (dB)	Preamp Factor (dB)	Ant Pos (cm)	Table Pos (deg)	Peak Avg. (P/A)	Pol. (H/V)
BLE CH 19 2440MHz		4880	43.63	-30.37	74	35.56	32.52	13.11	37.56	-	-	P	H
		7320	47.49	-26.51	74	33.31	36.9	15.89	38.61	-	-	P	H
													H
													H
													H
													H
													H
													H
													H
													H
													H
													H
													H
													H
													H
													H
													H
													H
													H
			4880	43.48	-30.52	74	35.41	32.52	13.11	37.56	-	-	P
		7320	47.13	-26.87	74	32.95	36.9	15.89	38.61	-	-	P	V
													V
													V
													V
													V
													V
													V
													V
													V
													V
													V
													V
													V
													V
													V
													V
													V



BLE	Note	Frequency (MHz)	Level (dBµV/m)	Margin (dB)	Limit Line (dBµV/m)	Read Level (dBµV)	Antenna Factor (dB/m)	Path Loss (dB)	Preamp Factor (dB)	Ant Pos (cm)	Table Pos (deg)	Peak Avg. (P/A)	Pol. (H/V)
BLE CH 39 2480MHz		4960	43.82	-30.18	74	35.17	32.94	13.34	37.63	-	-	P	H
		7440	47.1	-26.9	74	33.28	36.52	16.01	38.71	-	-	P	H
													H
													H
													H
													H
													H
													H
													H
													H
													H
													H
													H
													H
													H
													H
													H
													H
													H
			4960	43.67	-30.33	74	35.02	32.94	13.34	37.63	-	-	P
		7440	46.43	-27.57	74	32.61	36.52	16.01	38.71	-	-	P	V
													V
													V
													V
													V
													V
													V
													V
													V
													V
													V
													V
													V
													V
Remark	<ol style="list-style-type: none"> No other spurious found. All results are PASS against Peak and Average limit line. The emission position marked as "-" means no suspected emission found with sufficient margin against limit line or noise floor only. 												



<Ant.7> <2Mbps>

2.4GHz 2400~2483.5MHz

BLE (Band Edge @ 3m)

BLE	Note	Frequency	Level	Margin	Limit Line	Read Level	Antenna Factor	Path Loss	Preamp Factor	Ant Pos	Table Pos	Peak Avg.	Pol.	
		(MHz)	(dBμV/m)	(dB)	(dBμV/m)	(dBμV)	(dB/m)	(dB)	(dB)	(cm)	(deg)	(P/A)	(H/V)	
BLE CH 00 2402MHz		2317.455	50.05	-23.95	74	40.68	27.1	18.49	36.22	210	353	P	H	
		2375.73	40.68	-13.32	54	31.12	27.2	18.6	36.24	210	353	A	H	
	*	2402	99.2	-	-	89.49	27.31	18.65	36.25	210	353	P	H	
	*	2402	97.75	-	-	88.04	27.31	18.65	36.25	210	353	A	H	
													H	
													H	
			2385.495	50.13	-23.87	74	40.51	27.24	18.62	36.24	100	342	P	V
			2343.705	40.68	-13.32	54	31.27	27.1	18.54	36.23	100	342	A	V
	*		2402	96.93	-	-	87.22	27.31	18.65	36.25	100	342	P	V
	*		2402	95.5	-	-	85.79	27.31	18.65	36.25	100	342	A	V
BLE CH 19 2440MHz		2383.44	49.97	-24.03	74	40.36	27.23	18.62	36.24	307	354	P	H	
		2383.92	40.77	-13.23	54	31.15	27.24	18.62	36.24	307	354	A	H	
	*	2440	99.68	-	-	89.75	27.46	18.73	36.26	307	354	P	H	
	*	2440	98.21	-	-	88.28	27.46	18.73	36.26	307	354	A	H	
			2489.92	49.89	-24.11	74	39.68	27.66	18.83	36.28	307	354	P	H
			2485.68	41.33	-12.67	54	31.15	27.64	18.82	36.28	307	354	A	H
			2329.04	49.46	-24.54	74	40.07	27.1	18.51	36.22	108	323	P	V
			2338	40.65	-13.35	54	31.24	27.1	18.53	36.22	108	323	A	V
	*		2440	95.52	-	-	85.59	27.46	18.73	36.26	108	323	P	V
	*		2440	94.01	-	-	84.08	27.46	18.73	36.26	108	323	A	V
BLE CH 39 2480MHz		2487.76	49.68	-24.32	74	39.48	27.65	18.83	36.28	108	323	P	V	
		2491.36	41.24	-12.76	54	31.02	27.67	18.83	36.28	108	323	A	V	
	*	2480	99.78	-	-	89.62	27.62	18.81	36.27	296	333	P	H	
	*	2480	98.34	-	-	88.18	27.62	18.81	36.27	296	333	A	H	
			2491.92	50.3	-23.7	74	40.08	27.67	18.83	36.28	296	333	P	H
			2484.08	41.32	-12.68	54	31.13	27.64	18.82	36.27	296	333	A	H
													H	
													H	
	*		2480	98.27	-	-	88.11	27.62	18.81	36.27	100	268	P	V
	*		2480	96.82	-	-	86.66	27.62	18.81	36.27	100	268	A	V
		2485.12	51.09	-22.91	74	40.9	27.64	18.82	36.27	100	268	P	V	
		2485.72	41.39	-12.61	54	31.21	27.64	18.82	36.28	100	268	A	V	
												V		
												V		
Remark	1. No other spurious found. 2. All results are PASS against Peak and Average limit line.													



2.4GHz 2400~2483.5MHz

BLE (Harmonic @ 3m)

BLE	Note	Frequency	Level	Margin	Limit Line	Read Level	Antenna Factor	Path Loss	Preamp Factor	Ant Pos	Table Pos	Peak Avg.	Pol.	
		(MHz)	(dBμV/m)	(dB)	(dBμV/m)	(dBμV)	(dB/m)	(dB)	(dB)	(cm)	(deg)	(P/A)	(H/V)	
BLE CH 00 2402MHz		4804	42.21	-31.79	74	34.42	32.4	12.89	37.5	-	-	P	H	
													H	
													H	
													H	
													H	
													H	
													H	
													H	
													H	
													H	
													H	
													H	
													H	
													H	
													H	
													H	
													H	
													H	
			4804	42.29	-31.71	74	34.5	32.4	12.89	37.5	-	-	P	V
														V
													V	
													V	
													V	
													V	
													V	
													V	
													V	
													V	



BLE	Note	Frequency (MHz)	Level (dBµV/m)	Margin (dB)	Limit Line (dBµV/m)	Read Level (dBµV)	Antenna Factor (dB/m)	Path Loss (dB)	Preamp Factor (dB)	Ant Pos (cm)	Table Pos (deg)	Peak Avg. (P/A)	Pol. (H/V)
BLE CH 19 2440MHz		4880	43.42	-30.58	74	35.35	32.52	13.11	37.56	-	-	P	H
		7320	47.88	-26.12	74	33.7	36.9	15.89	38.61	-	-	P	H
													H
													H
													H
													H
													H
													H
													H
													H
													H
													H
													H
													H
													H
													H
													H
													H
													H
			4880	43.55	-30.45	74	35.48	32.52	13.11	37.56	-	-	P
		7320	47.75	-26.25	74	33.57	36.9	15.89	38.61	-	-	P	V
													V
													V
													V
													V
													V
													V
													V
													V
													V
													V
													V
													V
													V
													V
													V



BLE	Note	Frequency (MHz)	Level (dBμV/m)	Margin (dB)	Limit Line (dBμV/m)	Read Level (dBμV)	Antenna Factor (dB/m)	Path Loss (dB)	Preamp Factor (dB)	Ant Pos (cm)	Table Pos (deg)	Peak Avg. (P/A)	Pol. (H/V)
BLE CH 39 2480MHz		4960	43.35	-30.65	74	34.7	32.94	13.34	37.63	-	-	P	H
		7440	46.44	-27.56	74	32.62	36.52	16.01	38.71	-	-	P	H
													H
													H
													H
													H
													H
													H
													H
													H
													H
													H
													H
													H
													H
													H
													H
													H
													H
			4960	43.67	-30.33	74	35.02	32.94	13.34	37.63	-	-	P
		7440	46.6	-27.4	74	32.78	36.52	16.01	38.71	-	-	P	V
													V
													V
													V
													V
													V
													V
													V
													V
													V
													V
													V
													V
													V
Remark	1. No other spurious found. 2. All results are PASS against Peak and Average limit line. 3. The emission position marked as "-" means no suspected emission found with sufficient margin against limit line or noise floor only.												



Note symbol

*	Fundamental Frequency which can be ignored. However, the level of any unwanted emissions shall not exceed the level of the fundamental frequency.
!	Test result is Margin line.
P/A	Peak or Average
H/V	Horizontal or Vertical



A calculation example for radiated spurious emission is shown as below:

BLE	Note	Frequency	Level	Margin	Limit	Read	Antenna	Path	Preamp	Ant	Table	Peak	Pol.
		(MHz)	(dBμV/m)	(dB)	(dBμV/m)	(dBμV)	(dB/m)	(dB)	(dB)	(cm)	(deg)	(P/A)	(H/V)
BLE CH 00 2402MHz		2390	55.45	-18.55	74	54.51	32.22	4.58	35.86	103	308	P	H
		2390	43.54	-10.46	54	42.6	32.22	4.58	35.86	103	308	A	H

1. Path Loss(dB) = Cable loss(dB) + Filter loss(dB) + Attenuator loss(dB)
2. Level(dBμV/m) =
Antenna Factor(dB/m) + Path Loss(dB) + Read Level(dBμV) - Preamp Factor(dB)
3. Margin (dB) = Level(dBμV/m) – Limit Line(dBμV/m)

For Peak Limit @ 2390MHz:

1. Level(dBμV/m)
= Antenna Factor(dB/m) + Path Loss(dB) + Read Level(dBμV) - Preamp Factor(dB)
= 32.22(dB/m) + 4.58(dB) + 54.51(dBμV) – 35.86 (dB)
= 55.45 (dBμV/m)
2. Margin (dB)
= Level(dBμV/m) – Limit Line(dBμV/m)
= 55.45(dBμV/m) – 74(dBμV/m)
= -18.55(dB)

For Average Limit @ 2390MHz:

1. Level(dBμV/m)
= Antenna Factor(dB/m) + Path Loss(dB) + Read Level(dBμV) - Preamp Factor(dB)
= 32.22(dB/m) + 4.58(dB) + 42.6(dBμV) – 35.86 (dB)
= 43.54 (dBμV/m)
2. Margin (dB)
= Level(dBμV/m) – Limit Line(dBμV/m)
= 43.54(dBμV/m) – 54(dBμV/m)
= -10.46(dB)

Both peak and average measured complies with the limit line, so test result is “PASS”.



Appendix D. Radiated Spurious Emission Plots

Test Engineer :	John Chuang, David Dai, and Howard Huang	Temperature :	19.3~23.4°C
		Relative Humidity :	65.9~70.3%

Note symbol

-L	Low channel location
-R	High channel location



<Ant.6> <1Mbps>

2.4GHz 2400~2483.5MHz

BLE (Band Edge @ 3m)

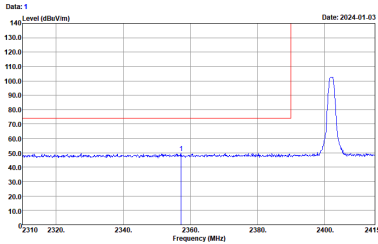
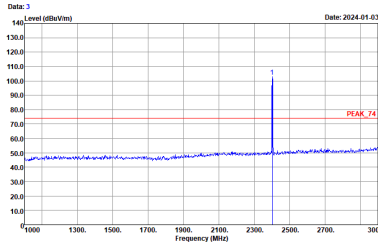
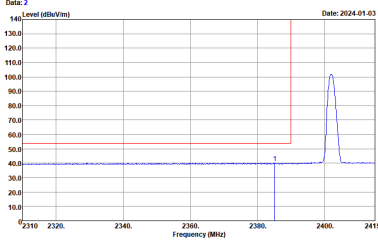
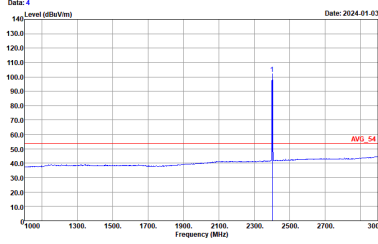
BLE	2.4GHz 2400~2483.5MHz Band Edge @ 3m	
ANT	BLE CH00 2402MHz	
	Horizontal	Fundamental
<p>Peak</p>	 <p>Site : 03CH20-HY Condition : PEAK_BE_74 3m 91200_02360_231030 HORIZONTAL : RBW:1000.000KHz VBW:3000.000KHz SWT:Auto : Detector : Peak Project : 3D0601 Setting : Default</p>	 <p>Site : 03CH20-HY Condition : PEAK_74 3m 91200_02360_231030 HORIZONTAL : RBW:1000.000KHz VBW:3000.000KHz SWT:Auto : Detector : Peak Project : 3D0601 Setting : Default</p>
<p>Avg.</p>	 <p>Site : 03CH20-HY Condition : AVG_BE_54 3m 91200_02360_231030 HORIZONTAL : RBW:1000.000KHz VBW:2.700KHz SWT:Auto : Detector : Peak Project : 3D0601 Setting : Default</p>	 <p>Site : 03CH20-HY Condition : AVG_54 3m 91200_02360_231030 HORIZONTAL : RBW:1000.000KHz VBW:2.700KHz SWT:Auto : Detector : Peak Project : 3D0601 Setting : Default</p>



BLE	2.4GHz 2400~2483.5MHz Band Edge @ 3m	
ANT	BLE CH00 2402MHz	
	Vertical	Fundamental
<p>Peak</p>	<p>Date: 5 140 Level (dBm/Vm) Date: 2024-01-03</p> <p>Site : 03CH20-HY Condition : PEAK_BE_74 3m 91200_02360_231030 VERTICAL : RBW:1000.000KHz VBW:3000.000KHz SWT:Auto : Detector : Peak Project : 3D0601 Setting : default</p>	<p>Date: 7 140 Level (dBm/Vm) Date: 2024-01-03</p> <p>Site : 03CH20-HY Condition : PEAK_74 3m 91200_02360_231030 VERTICAL : RBW:1000.000KHz VBW:3000.000KHz SWT:Auto : Detector : Peak Project : 3D0601 Setting : Default</p>
<p>Avg</p>	<p>Date: 5 140 Level (dBm/Vm) Date: 2024-01-03</p> <p>Site : 03CH20-HY Condition : AVG_BE_54 3m 91200_02360_231030 VERTICAL : RBW:1000.000KHz VBW:2.700KHz SWT:Auto : Detector : Peak Project : 3D0601 Setting : default</p>	<p>Date: 8 140 Level (dBm/Vm) Date: 2024-01-03</p> <p>Site : 03CH20-HY Condition : AVG_54 3m 91200_02360_231030 VERTICAL : RBW:1000.000KHz VBW:2.700KHz SWT:Auto : Detector : Peak Project : 3D0601 Setting : Default</p>

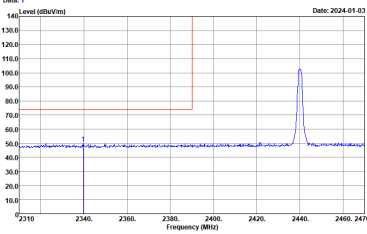
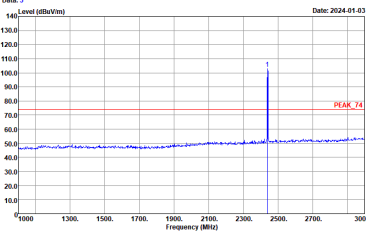
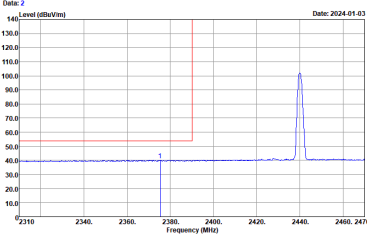
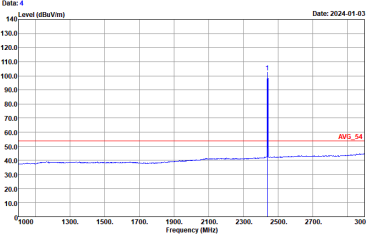

BLE	2.4GHz 2400~2483.5MHz Band Edge @ 3m	
ANT	BLE CH19 2440MHz - L	
	Horizontal	Fundamental
Peak	 <p>Date: 1 Date: 2024-01-03</p> <p>Site : 03CH20-HY Condition : PEAK_BE_74 3m 9120d_02360_231030 HORIZONTAL RBW:1000.000KHz VBW:3000.000KHz SWT:Auto Detector : Peak Project : 3D0601 Setting : Default</p>	 <p>Date: 3 Date: 2024-01-03</p> <p>Site : 03CH20-HY Condition : PEAK_74 3m 9120d_02360_231030 HORIZONTAL RBW:1000.000KHz VBW:3000.000KHz SWT:Auto Detector : Peak Project : 3D0601 Setting : Default</p>
Avg.	 <p>Date: 2 Date: 2024-01-03</p> <p>Site : 03CH20-HY Condition : AVG_BE_54 3m 9120d_02360_231030 HORIZONTAL RBW:1000.000KHz VBW:2.700KHz SWT:Auto Detector : Peak Project : 3D0601 Setting : Default</p>	 <p>Date: 4 Date: 2024-01-03</p> <p>Site : 03CH20-HY Condition : AVG_54 3m 9120d_02360_231030 HORIZONTAL RBW:1000.000KHz VBW:2.700KHz SWT:Auto Detector : Peak Project : 3D0601 Setting : Default</p>

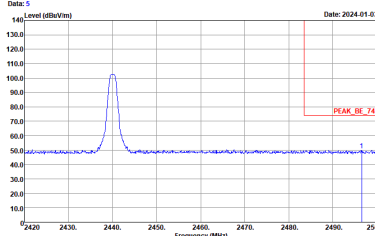
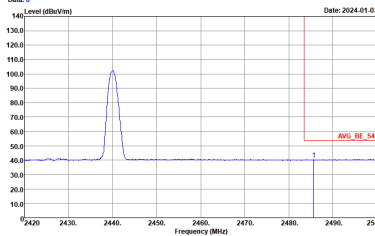

BLE	2.4GHz 2400~2483.5MHz Band Edge @ 3m	
ANT	BLE CH19 2440MHz - R	
	Horizontal	Fundamental
<p>Peak</p>	 <p>Site : 03CH20-HY Condition : PEAK_BE_74 3m 91200_02360_231030 HORIZONTAL : RBW:1000.000KHz VBW:3000.000KHz SWF:Auto : Detector : Peak Project : 3D0601 Setting : default</p>	<p>Left blank</p>
<p>Avg.</p>	 <p>Site : 03CH20-HY Condition : AVG_BE_54 3m 91200_02360_231030 HORIZONTAL : RBW:1000.000KHz VBW:2.700KHz SWF:Auto : Detector : Peak Project : 3D0601 Setting : default</p>	<p>Left blank</p>

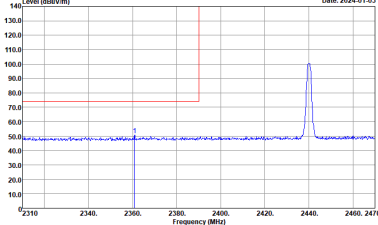
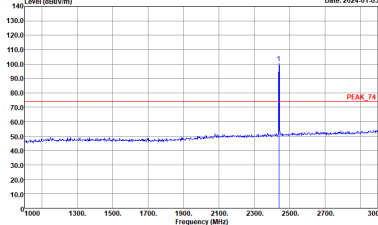
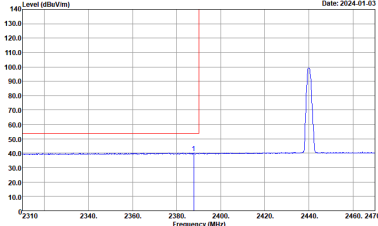
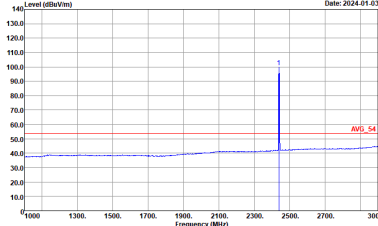

BLE	2.4GHz 2400~2483.5MHz Band Edge @ 3m	
ANT	BLE CH19 2440MHz - L	
	Vertical	Fundamental
Peak	<p data-bbox="432 421 810 660"> Data: 7 Level (dBuV/m) Date: 2024-01-03  </p> <p data-bbox="432 667 707 748"> Site : 03CH20-HY Condition : PEAK_BE_74 3m 91200_02360_231030 VERTICAL : RBW:1000.000kHz VBW:3000.000kHz SWT:Auto : Detector : Peak Project : 3D0601 Setting : default </p>	<p data-bbox="904 421 1283 660"> Data: 9 Level (dBuV/m) Date: 2024-01-03  </p> <p data-bbox="904 667 1179 748"> Site : 03CH20-HY Condition : PEAK_74 3m 91200_02360_231030 VERTICAL : RBW:1000.000kHz VBW:3000.000kHz SWT:Auto : Detector : Peak Project : 3D0601 Setting : Default </p>
Avg.	<p data-bbox="432 1097 810 1337"> Data: 8 Level (dBuV/m) Date: 2024-01-03  </p> <p data-bbox="432 1344 707 1424"> Site : 03CH20-HY Condition : AVG_BE_54 3m 91200_02360_231030 VERTICAL : RBW:1000.000kHz VBW:2.700kHz SWT:Auto : Detector : Peak Project : 3D0601 Setting : default </p>	<p data-bbox="904 1097 1283 1337"> Data: 10 Level (dBuV/m) Date: 2024-01-03  </p> <p data-bbox="904 1344 1179 1424"> Site : 03CH20-HY Condition : AVG_54 3m 91200_02360_231030 VERTICAL : RBW:1000.000kHz VBW:2.700kHz SWT:Auto : Detector : Peak Project : 3D0601 Setting : Default </p>

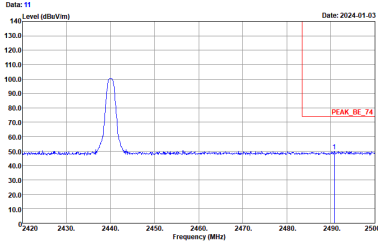
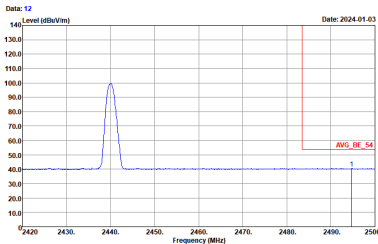

BLE	2.4GHz 2400~2483.5MHz Band Edge @ 3m	
ANT	BLE CH19 2440MHz - R	
	Vertical	Fundamental
<p>Peak</p>	 <p>Date: 11 Date: 2024-01-03</p> <p>Site : 03CH20-HY Condition : PEAK_BE_74 3m 91200_02360_231030 VERTICAL RBW:1000.000kHz VBW:3000.000kHz SWF:Auto Detector : Peak Project : 3D0601 Setting : default</p>	<p>Left blank</p>
<p>Avg.</p>	 <p>Date: 12 Date: 2024-01-03</p> <p>Site : 03CH20-HY Condition : AVG_BE_54 3m 91200_02360_231030 VERTICAL RBW:1000.000kHz VBW:2.700kHz SWF:Auto Detector : Peak Project : 3D0601 Setting : default</p>	<p>Left blank</p>

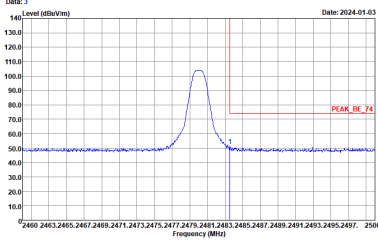
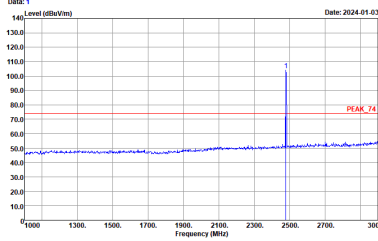
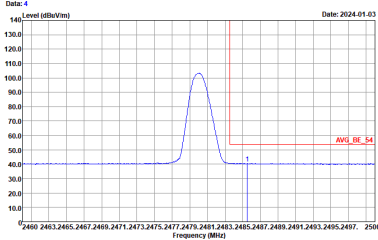
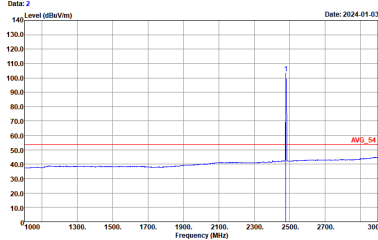

BLE	2.4GHz 2400~2483.5MHz Band Edge @ 3m	
ANT	BLE CH39 2480MHz	
	Horizontal	Fundamental
Peak	 <p>Site : 03CH20-HY Condition : PEAK_BE_74 3m 91200_02360_231030 HORIZONTAL : RBW:1000.000KHz VBW:3000.000KHz SWT:Auto : Detector : Peak Project : 3D0601 Setting : Default</p>	 <p>Site : 03CH20-HY Condition : PEAK_74 3m 91200_02360_231030 HORIZONTAL : RBW:1000.000KHz VBW:3000.000KHz SWT:Auto : Detector : Peak Project : 3D0601 Setting : Default</p>
Avg.	 <p>Site : 03CH20-HY Condition : AVG_BE_54 3m 91200_02360_231030 HORIZONTAL : RBW:1000.000KHz VBW:2.700KHz SWT:Auto : Detector : Peak Project : 3D0601 Setting : Default</p>	 <p>Site : 03CH20-HY Condition : AVG_54 3m 91200_02360_231030 HORIZONTAL : RBW:1000.000KHz VBW:2.700KHz SWT:Auto : Detector : Peak Project : 3D0601 Setting : Default</p>

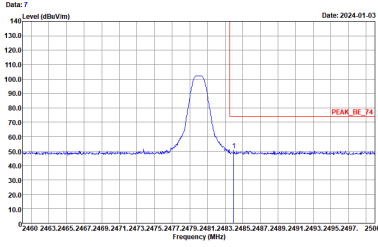
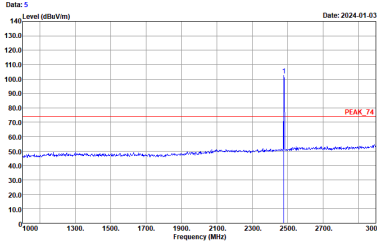
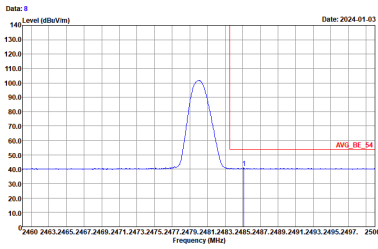
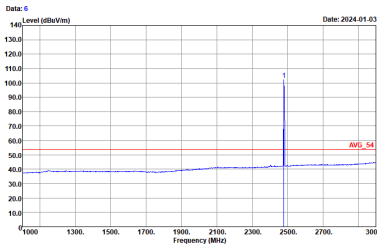

BLE	2.4GHz 2400~2483.5MHz Band Edge @ 3m	
ANT	BLE CH39 2480MHz	
	Vertical	Fundamental
<p>Peak</p>	 <p>Date: 7 Date: 2024-01-03</p> <p>Site : 03CH20-HY Condition : PEAK_BE_74 3m 91200_02360_231030 VERTICAL : RBW:1000.000KHz VBW:3000.000KHz SWT:Auto : Detector : Peak Project : 3D0601 Setting : default</p>	 <p>Date: 5 Date: 2024-01-03</p> <p>Site : 03CH20-HY Condition : PEAK_74 3m 91200_02360_231030 VERTICAL : RBW:1000.000KHz VBW:3000.000KHz SWT:Auto : Detector : Peak Project : 3D0601 Setting : default</p>
<p>Avg.</p>	 <p>Date: 3 Date: 2024-01-03</p> <p>Site : 03CH20-HY Condition : AVG_BE_54 3m 91200_02360_231030 VERTICAL : RBW:1000.000KHz VBW:2.700KHz SWT:Auto : Detector : Peak Project : 3D0601 Setting : default</p>	 <p>Date: 6 Date: 2024-01-03</p> <p>Site : 03CH20-HY Condition : AVG_54 3m 91200_02360_231030 VERTICAL : RBW:1000.000KHz VBW:2.700KHz SWT:Auto : Detector : Peak Project : 3D0601 Setting : default</p>



2.4GHz 2400~2483.5MHz

BLE (Harmonic @ 3m)

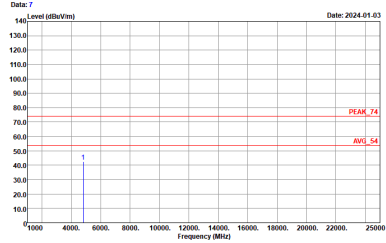
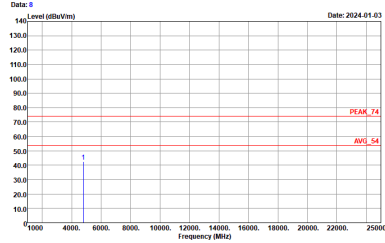
BLE	2.4GHz 2400~2483.5MHz Harmonic @ 3m	
ANT	BLE CH00 2402MHz	
	Horizontal	Vertical
Peak Avg.	 <p>Site : 03CH20-1FY Condition : PEAK_74 3m 91200_02360_231030 HORIZONTAL RBW:1000.000KHz VBW:3000.000KHz SWT:Auto Detector : Peak Project : 3D0601 Setting : default</p>	 <p>Site : 03CH20-1FY Condition : PEAK_74 3m 91200_02360_231030 VERTICAL RBW:1000.000KHz VBW:3000.000KHz SWT:Auto Detector : Peak Project : 3D0601 Setting : Default</p>



BLE	2.4GHz 2400~2483.5MHz Harmonic @ 3m	
ANT	BLE CH19 2440MHz	
	Horizontal	Vertical
Peak Avg.	<p>Site : 03CH20-HY Condition : PEAK_74 3m 91200_02360_231030 HORIZONTAL : RBW:1000.000KHz VBW:3000.000KHz SWT:Auto : Detector : Peak Project : 3D0601 Setting : Default</p>	<p>Site : 03CH20-HY Condition : PEAK_74 3m 91200_02360_231030 VERTICAL : RBW:1000.000KHz VBW:3000.000KHz SWT:Auto : Detector : Peak Project : 3D0601 Setting : Default</p>



BLE	2.4GHz 2400~2483.5MHz Harmonic @ 3m	
ANT	BLE CH39 2480MHz	
	Horizontal	Vertical
Peak	<p>Site : 03CH20-HY Condition : PEAK_74 3m 91200_02360_231030 HORIZONTAL : RBW:1000.000KHz VBW:3000.000KHz SWT:Auto : : Detector : Peak Project : 3D0601 Setting : Default</p>	<p>Site : 03CH20-HY Condition : PEAK_74 3m 91200_02360_231030 VERTICAL : RBW:1000.000KHz VBW:3000.000KHz SWT:Auto : : Detector : Peak Project : 3D0601 Setting : Default</p>



<Ant.6> <2Mbps>

2.4GHz 2400~2483.5MHz

BLE (Band Edge @ 3m)

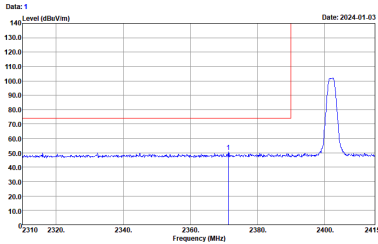
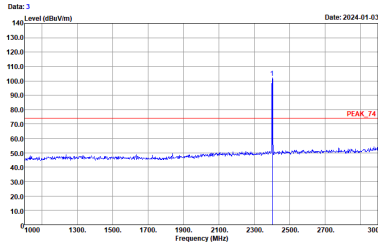
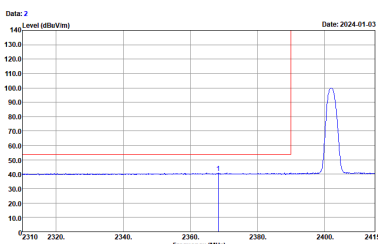
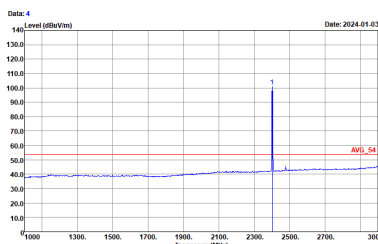
BLE	2.4GHz 2400~2483.5MHz Band Edge @ 3m	
ANT	BLE CH00 2402MHz	
	Horizontal	Fundamental
Peak	 <p>Site : 03CH20-HY Condition : PEAK_BE_74 3m 91200_02360_231030 HORIZONTAL RBW:1000.000KHz VBW:3000.000KHz SWT:Auto Detector : Peak Project : 3D0601 Setting : Default</p>	 <p>Site : 03CH20-HY Condition : PEAK_74 3m 91200_02360_231030 HORIZONTAL RBW:1000.000KHz VBW:3000.000KHz SWT:Auto Detector : Peak Project : 3D0601 Setting : Default</p>
Avg.	 <p>Site : 03CH20-HY Condition : AVG_BE_54 3m 91200_02360_231030 HORIZONTAL RBW:1000.000KHz VBW:5.000KHz SWT:Auto Detector : Peak Project : 3D0601 Setting : Default</p>	 <p>Site : 03CH20-HY Condition : AVG_54 3m 91200_02360_231030 HORIZONTAL RBW:1000.000KHz VBW:5.000KHz SWT:Auto Detector : Peak Project : 3D0601 Setting : Default</p>



BLE	2.4GHz 2400~2483.5MHz Band Edge @ 3m	
ANT	BLE CH00 2402MHz	
	Vertical	Fundamental
<p>Peak</p>	<p>Date: 5 Date: 2024-01-03</p> <p>Site : 03CH20-HY Condition : PEAK_BE_74 3m 91200_02360_231030 VERTICAL : RBW:1000.000KHz VBW:3000.000KHz SWT:Auto : Detector : Peak Project : 3D0601 Setting : default</p>	<p>Date: 7 Date: 2024-01-03</p> <p>Site : 03CH20-HY Condition : PEAK_74 3m 91200_02360_231030 VERTICAL : RBW:1000.000KHz VBW:3000.000KHz SWT:Auto : Detector : Peak Project : 3D0601 Setting : default</p>
<p>Avg</p>	<p>Date: 6 Date: 2024-01-03</p> <p>Site : 03CH20-HY Condition : AVG_BE_54 3m 91200_02360_231030 VERTICAL : RBW:1000.000KHz VBW:5.100KHz SWT:Auto : Detector : Peak Project : 3D0601 Setting : default</p>	<p>Date: 8 Date: 2024-01-03</p> <p>Site : 03CH20-HY Condition : AVG_54 3m 91200_02360_231030 VERTICAL : RBW:1000.000KHz VBW:5.100KHz SWT:Auto : Detector : Peak Project : 3D0601 Setting : default</p>

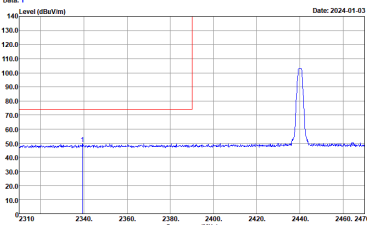
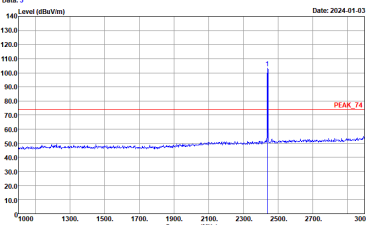
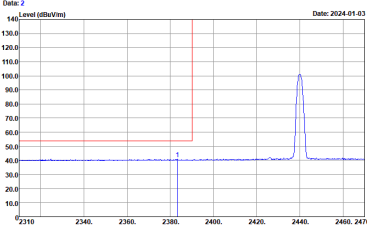
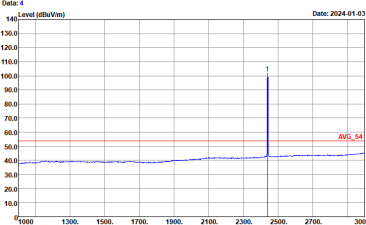

BLE	2.4GHz 2400~2483.5MHz Band Edge @ 3m	
ANT	BLE CH19 2440MHz - L	
	Horizontal	Fundamental
Peak	 <p>Date: 1 Date: 2024-01-03</p> <p>Site : 03CH20-HY Condition : PEAK_BE_74 3m 9120d_02360_231030 HORIZONTAL : RBW:1000.000KHz VBW:3000.000KHz SWT:Auto : . Detector : Peak Project : 3D0601 Setting : Default</p>	 <p>Date: 3 Date: 2024-01-03</p> <p>Site : 03CH20-HY Condition : PEAK_74 3m 9120d_02360_231030 HORIZONTAL : RBW:1000.000KHz VBW:3000.000KHz SWT:Auto : . Detector : Peak Project : 3D0601 Setting : Default</p>
Avg.	 <p>Date: 2 Date: 2024-01-03</p> <p>Site : 03CH20-HY Condition : AVG_BE_54 3m 9120d_02360_231030 HORIZONTAL : RBW:1000.000KHz VBW:5.100KHz SWT:Auto : . Detector : Peak Project : 3D0601 Setting : Default</p>	 <p>Date: 4 Date: 2024-01-03</p> <p>Site : 03CH20-HY Condition : AVG_54 3m 9120d_02360_231030 HORIZONTAL : RBW:1000.000KHz VBW:5.100KHz SWT:Auto : . Detector : Peak Project : 3D0601 Setting : Default</p>

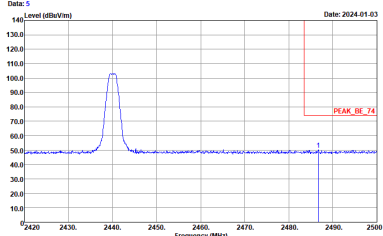
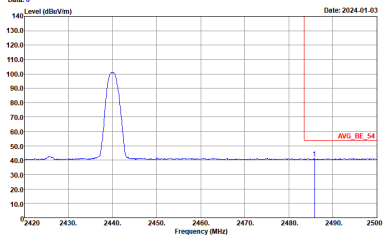

BLE	2.4GHz 2400~2483.5MHz Band Edge @ 3m	
ANT	BLE CH19 2440MHz - R	
	Horizontal	Fundamental
<p>Peak</p>	 <p>Site : 03CH20-HY Condition : PEAK_BE_74 3m 91200_02360_231030 HORIZONTAL : RBW:1000.000KHz VBW:3000.000KHz SWF:Auto : Detector : Peak Project : 3D0601 Setting : default</p>	<p>Left blank</p>
<p>Avg.</p>	 <p>Site : 03CH20-HY Condition : AVG_BE_54 3m 91200_02360_231030 HORIZONTAL : RBW:1000.000KHz VBW:5.100KHz SWF:Auto : Detector : Peak Project : 3D0601 Setting : default</p>	<p>Left blank</p>



BLE	2.4GHz 2400~2483.5MHz Band Edge @ 3m	
ANT	BLE CH19 2440MHz - L	
	Vertical	Fundamental
<p>Peak</p>	<p>Date: 7 Date: 2024-01-03</p> <p>Site : 03CH20-HY Condition : PEAK_BE_74 3m 91200_02360_231030 VERTICAL RBW:1000.000KHz VBW:3000.000KHz SWT:Auto Detector : Peak Project : 3D0601 Setting : default</p>	<p>Date: 9 Date: 2024-01-03</p> <p>Site : 03CH20-HY Condition : PEAK_74 3m 91200_02360_231030 VERTICAL RBW:1000.000KHz VBW:3000.000KHz SWT:Auto Detector : Peak Project : 3D0601 Setting : default</p>
<p>Avg.</p>	<p>Date: 8 Date: 2024-01-03</p> <p>Site : 03CH20-HY Condition : AVG_BE_54 3m 91200_02360_231030 VERTICAL RBW:1000.000KHz VBW:5.100KHz SWT:Auto Detector : Peak Project : 3D0601 Setting : default</p>	<p>Date: 10 Date: 2024-01-03</p> <p>Site : 03CH20-HY Condition : AVG_54 3m 91200_02360_231030 VERTICAL RBW:1000.000KHz VBW:5.100KHz SWT:Auto Detector : Peak Project : 3D0601 Setting : default</p>

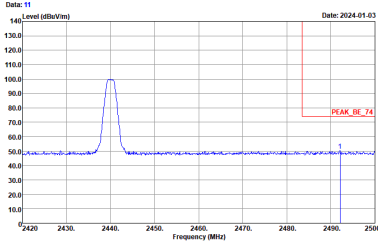
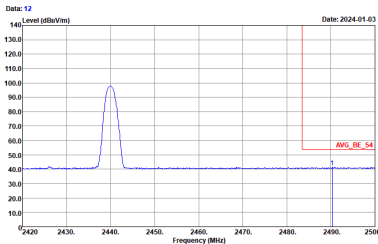

BLE	2.4GHz 2400~2483.5MHz Band Edge @ 3m	
ANT	BLE CH19 2440MHz - R	
	Vertical	Fundamental
<p>Peak</p>	 <p>Date: 11 Date: 2024-01-03</p> <p>Site : 03CH20-HY Condition : PEAK_BE_74 3m 91200_02360_231030 VERTICAL RBW:1000.000kHz VBW:3000.000kHz SWF:Auto Detector : Peak Project : 3D0601 Setting : default</p>	<p>Left blank</p>
<p>Avg.</p>	 <p>Date: 12 Date: 2024-01-03</p> <p>Site : 03CH20-HY Condition : AVG_BE_54 3m 91200_02360_231030 VERTICAL RBW:1000.000kHz VBW:5.100kHz SWF:Auto Detector : Peak Project : 3D0601 Setting : default</p>	<p>Left blank</p>

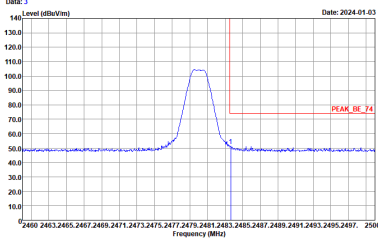
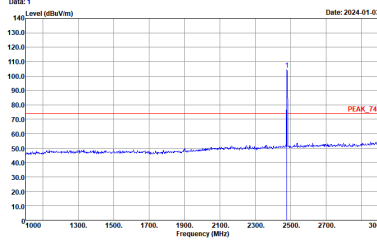
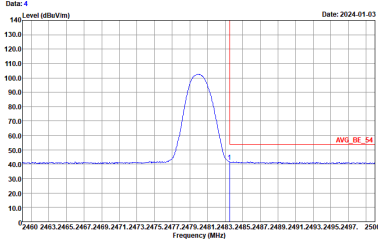
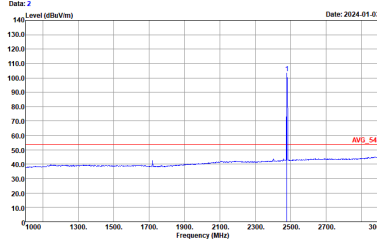

BLE	2.4GHz 2400~2483.5MHz Band Edge @ 3m	
ANT	BLE CH39 2480MHz	
	Horizontal	Fundamental
Peak	 <p>Site : 03CH20-HY Condition : PEAK_BE_74 3m 91200_02360_231030 HORIZONTAL : RBW:1000.000KHz VBW:3000.000KHz SWT:Auto : Detector : Peak Project : 3D0601 Setting : Default</p>	 <p>Site : 03CH20-HY Condition : PEAK_74 3m 91200_02360_231030 HORIZONTAL : RBW:1000.000KHz VBW:3000.000KHz SWT:Auto : Detector : Peak Project : 3D0601 Setting : Default</p>
Avg.	 <p>Site : 03CH20-HY Condition : AVG_BE_54 3m 91200_02360_231030 HORIZONTAL : RBW:1000.000KHz VBW:5.100KHz SWT:Auto : Detector : Peak Project : 3D0601 Setting : Default</p>	 <p>Site : 03CH20-HY Condition : AVG_54 3m 91200_02360_231030 HORIZONTAL : RBW:1000.000KHz VBW:5.100KHz SWT:Auto : Detector : Peak Project : 3D0601 Setting : Default</p>



BLE	2.4GHz 2400~2483.5MHz Band Edge @ 3m	
ANT	BLE CH39 2480MHz	
	Vertical	Fundamental
<p>Peak</p>	<p>Site : 03CH20-HY Condition : PEAK_BE_74 3m 91200_02360_231030 VERTICAL : RBW:1000.000KHz VBW:3000.000KHz SWT:Auto : Detector : Peak Project : 3D0601 Setting : default</p>	<p>Site : 03CH20-HY Condition : PEAK_74 3m 91200_02360_231030 VERTICAL : RBW:1000.000KHz VBW:3000.000KHz SWT:Auto : Detector : Peak Project : 3D0601 Setting : Default</p>
<p>Avg.</p>	<p>Site : 03CH20-HY Condition : AVG_BE_54 3m 91200_02360_231030 VERTICAL : RBW:1000.000KHz VBW:5.100KHz SWT:Auto : Detector : Peak Project : 3D0601 Setting : default</p>	<p>Site : 03CH20-HY Condition : AVG_54 3m 91200_02360_231030 VERTICAL : RBW:1000.000KHz VBW:5.100KHz SWT:Auto : Detector : Peak Project : 3D0601 Setting : Default</p>



2.4GHz 2400~2483.5MHz

BLE (Harmonic @ 3m)

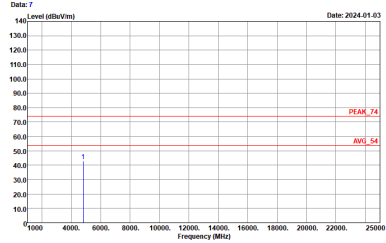
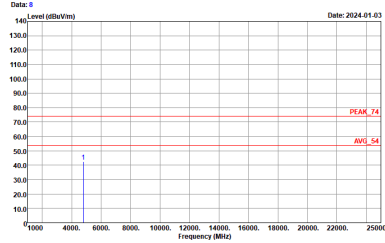
BLE	2.4GHz 2400~2483.5MHz Harmonic @ 3m	
ANT	BLE CH00 2402MHz	
	Horizontal	Vertical
<p>Peak</p> <p>Avg.</p>	 <p>Site : 03CH20-1FY Condition : PEAK_74 3m 91200_02360_231030 HORIZONTAL RBW:1000.000KHz VBW:3000.000KHz SWT:Auto Detector : Peak Project : 3D0601 Setting : default</p>	 <p>Site : 03CH20-1FY Condition : PEAK_74 3m 91200_02360_231030 VERTICAL RBW:1000.000KHz VBW:3000.000KHz SWT:Auto Detector : Peak Project : 3D0601 Setting : Default</p>



BLE	2.4GHz 2400~2483.5MHz Harmonic @ 3m	
ANT	BLE CH19 2440MHz	
	Horizontal	Vertical
Peak Avg.	<p>Site : 03CH20-HY Condition : PEAK_74 3m 91200_02360_231030 HORIZONTAL : RBW:1000.000KHz VBW:3000.000KHz SWT:Auto : Detector : Peak Project : 3D0601 Setting : Default</p>	<p>Site : 03CH20-HY Condition : PEAK_74 3m 91200_02360_231030 VERTICAL : RBW:1000.000KHz VBW:3000.000KHz SWT:Auto : Detector : Peak Project : 3D0601 Setting : Default</p>



BLE	2.4GHz 2400~2483.5MHz Harmonic @ 3m	
ANT	BLE CH39 2480MHz	
	Horizontal	Vertical
Peak	<p>Site : 03CH20-HY Condition : PEAK_74 3m 91200_02360_231030 HORIZONTAL : RBW:1000.000KHz VBW:3000.000KHz SWT:Auto : : Detector : Peak Project : 3D0601 Setting : Default</p>	<p>Site : 03CH20-HY Condition : PEAK_74 3m 91200_02360_231030 VERTICAL : RBW:1000.000KHz VBW:3000.000KHz SWT:Auto : : Detector : Peak Project : 3D0601 Setting : Default</p>



Emission above 18GHz
2.4GHz BLE (SHF @ 1m)

BLE	2.4GHz 2400~2483.5MHz	
ANT	BLE SHF	
	Horizontal	Vertical
Peak Avg.	<p>Data: 1 Level (dBuV/m) Date: 2024-01-25</p> <p>Site : 03CH20-1FY Condition : PEAK_74 1m SHF_1223_230710 HORIZONTAL Detector : Peak Project : 3D0601</p>	<p>Data: 2 Level (dBuV/m) Date: 2024-01-25</p> <p>Site : 03CH20-1FY Condition : PEAK_74 1m SHF_1223_230710 VERTICAL Detector : Peak Project : 3D0601</p>



Emission below 1GHz
2.4GHz BLE (LF)

BLE	2.4GHz 2400~2483.5MHz	
ANT	BLE LF	
	Horizontal	Vertical
QP / Peak	<p>Site : 03CH20-11Y Condition : QP 3m LF_55606_231020_200 HORIZONTAL Detector : Peak Project : 3D0601</p>	<p>Site : 03CH20-11Y Condition : QP 3m LF_55606_231020_200 VERTICAL Detector : Peak Project : 3D0601</p>