



FCC RADIO TEST REPORT

FCC ID : UZ7TC530E
Equipment : Touch Computer
Brand Name : Zebra
Model Name : TC530E
Applicant : Zebra Technologies Corporation
1 Zebra Plaza, Holtsville, NY 11742
Manufacturer : Zebra Technologies Corporation
1 Zebra Plaza, Holtsville, NY 11742
Standard : FCC Part 15 Subpart E §15.407

The product was received on Dec. 05, 2023 and testing was performed from Dec. 12, 2023 to Jan. 18, 2024. We, Sporton International Inc. EMC & Wireless Communications Laboratory, would like to declare that the tested sample has been evaluated in accordance with the test procedures and has been in compliance with the applicable technical standards.

The test results in this report apply exclusively to the tested model / sample. Without written approval from Sporton International Inc. EMC & Wireless Communications Laboratory, the test report shall not be reproduced except in full.

Approved by: Louis Wu

Sporton International Inc. EMC & Wireless Communications Laboratory
No. 52, Huaya 1st Rd., Guishan Dist., Taoyuan City 333, Taiwan (R.O.C.)



Table of Contents

History of this test report..... 3

Summary of Test Result..... 4

1 General Description 5

 1.1 Product Feature of Equipment Under Test..... 5

 1.2 Product Specification of Equipment Under Test..... 6

 1.3 Modification of EUT 11

 1.4 Testing Location 11

 1.5 Applicable Standards..... 11

2 Test Configuration of Equipment Under Test 12

 2.1 Carrier Frequency and Channel 12

 2.2 Test Mode..... 14

 2.3 Connection Diagram of Test System..... 16

 2.4 Support Unit used in test configuration and system 18

 2.5 EUT Operation Test Setup 18

 2.6 Measurement Results Explanation Example..... 18

3 Test Result 19

 3.1 26dB & 99% Occupied Bandwidth Measurement 19

 3.2 Maximum Conducted Output Power Measurement..... 20

 3.3 Power Spectral Density Measurement 22

 3.4 Unwanted Emissions Measurement..... 24

 3.5 AC Conducted Emission Measurement..... 29

 3.6 Antenna Requirements..... 31

4 List of Measuring Equipment..... 32

5 Measurement Uncertainty 34

Appendix A. Conducted Test Results

Appendix B. AC Conducted Emission Test Result

Appendix C. Radiated Spurious Emission

Appendix D. Radiated Spurious Emission Plots

Appendix E. Duty Cycle Plots

Appendix F. Setup Photographs



History of this test report

Report No.	Version	Description	Issue Date
FR3D0601E	01	Initial issue of report	Feb. 07, 2024



Summary of Test Result

Report Clause	Ref Std. Clause	Test Items	Result (PASS/FAIL)	Remark
3.1	15.403(i)	26dB Bandwidth	Pass	-
3.1	2.1049	99% Occupied Bandwidth	Reporting only	-
3.2	15.407(a)	Maximum Conducted Output Power	Pass	-
3.3	15.407(a)	Power Spectral Density	Pass	-
3.4	15.407(b)	Unwanted Emissions	Pass	1.06 dB under the limit at 5382.96 MHz
3.5	15.207	AC Conducted Emission	Pass	15.78 dB under the limit at 0.29 MHz
3.6	15.203	Antenna Requirement	Pass	-

Conformity Assessment Condition:

- The test results (PASS/FAIL) with all measurement uncertainty excluded are presented against the regulation limits or in accordance with the requirements stipulated by the applicant/manufacturer who shall bear all the risks of non-compliance that may potentially occur if measurement uncertainty is taken into account.
- The measurement uncertainty please refer to each test result in the section "Measurement Uncertainty".

Disclaimer:

The product specifications of the EUT presented in the test report that may affect the test assessments are declared by the manufacturer who shall take full responsibility for the authenticity.

Reviewed by: Wei Chen
Report Producer: Michelle Chen



1 General Description

1.1 Product Feature of Equipment Under Test

Product Feature	
Equipment	Touch Computer
Brand Name	Zebra
Model Name	TC530E
FCC ID	UZ7TC530E
Sample 1	SE55 + 8GB (Samsung) 128GB (SK Hynix)
Sample 2	SE55 + 6GB (SK Hynix) 64GB (WD)
Sample 3	SE4720 + 6GB (SK Hynix) 64GB (WD)
EUT supports Radios application	NFC WLAN 11a/b/g/n HT20/HT40 WLAN 11ac VHT20/VHT40/VHT80/VHT160 WLAN 11ax HE20/HE40/HE80/HE160 Bluetooth BR/EDR/LE
HW Version	DV1-1
SW Version	13-11-28.00-TN-U00-PRD-NEM-04
FW Version	FUSION_QA_4_1.2.0.001_R
MFD	13NOV23
EUT Stage	Identical Prototype

Remark: The EUT's information above is declared by manufacturer.

Specification of Accessories				
Adapter	Brand Name	Zebra	Part Number	PWR-WUA5V12W0US
Battery 1 (1x)	Brand Name	Zebra	Part Number	BT-000442-0020
Battery 2 (1.5x)	Brand Name	Zebra	Part Number	BT-000442-0820
Battery 3 (Wireless Battery)	Brand Name	Zebra	Part Number	BT-000442-002B
Battery 4 (1x)	Brand Name	Zebra	Part Number	BT-000442-1020
USB TYPE A to TYPE C cable	Brand Name	Zebra	Part Number	CBL-TC5X-USBC2A-01
USB TYPE C to 3.5mm audio connector	Brand Name	Zebra	Part Number	ADP-USBC-35MM1-01
3.5mm Earphone	Brand Name	Zebra	Part Number	HDST-35MM-PTVP-01
Rugged Headset	Brand Name	Zebra	Part Number	HS2100-OTH
USB TYPE C Earphone	Brand Name	Zebra	Part Number	HPST-USBC-PTT1-01
Trigger Handle	Brand Name	Zebra	Part Number	TRG-NGTC5-ELEC-01
Soft Holster	Brand Name	Zebra	Part Number	SG-NGTC5TC7-HLSTR-01
TC53/TC58 RUGGED BOOT	Brand Name	Zebra	Part Number	SG-NGTC5EXO1-01
3.5mm to 3.5mm audio connector	Brand Name	Zebra	Part Number	CBL-HS2100-3MS1-01



1.2 Product Specification of Equipment Under Test

Product Specification is subject to this standard	
Tx/Rx Frequency Range	5180 MHz ~ 5240 MHz 5260 MHz ~ 5320 MHz 5500 MHz ~ 5720 MHz
Maximum Output Power	<p><5180 MHz ~ 5240 MHz> MIMO <Ant. 6+7> 802.11a: 21.61 dBm / 0.1449 W 802.11n HT20: 21.61 dBm / 0.1449 W 802.11n HT40: 22.17 dBm / 0.1648 W 802.11ac VHT20: 21.71 dBm / 0.1483 W 802.11ac VHT40: 22.27 dBm / 0.1687 W 802.11ac VHT80: 20.32 dBm / 0.1076 W 802.11ac VHT160: 15.91 dBm / 0.0390 W 802.11ax HE20: 22.01 dBm / 0.1589 W 802.11ax HE40: 22.42 dBm / 0.1746 W 802.11ax HE80: 20.51 dBm / 0.1125 W 802.11ax HE160: 16.16 dBm / 0.0413 W</p> <p><5260 MHz ~ 5320 MHz> MIMO <Ant. 6+7> 802.11a: 21.41 dBm / 0.1384 W 802.11n HT20: 22.61 dBm / 0.1824 W 802.11n HT40: 22.61 dBm / 0.1824 W 802.11ac VHT20: 22.11 dBm / 0.1626 W 802.11ac VHT40: 22.31 dBm / 0.1702 W 802.11ac VHT80: 20.06 dBm / 0.1607 W 802.11ax HE20: 22.26 dBm / 0.1683 W 802.11ax HE40: 22.61 dBm / 0.1824 W 802.11ax HE80: 20.31 dBm / 0.1074 W 802.11ax HE160: 16.16 dBm / 0.0413 W</p> <p><5500 MHz ~ 5720 MHz> MIMO <Ant. 6+7> 802.11a: 21.26 dBm / 0.1337 W 802.11n HT20: 21.36 dBm / 0.1368 W 802.11n HT40: 22.91 dBm / 0.1954 W 802.11ac VHT20: 21.46 dBm / 0.1400 W 802.11ac VHT40: 22.51 dBm / 0.1782 W 802.11ac VHT80: 22.81 dBm / 0.1910 W 802.11ac VHT160: 17.76 dBm / 0.0597 W 802.11ax HE20: 21.71 dBm / 0.1483 W 802.11ax HE40: 22.91 dBm / 0.1954 W 802.11ax HE80: 22.42 dBm / 0.1746 W 802.11ax HE160: 18.06 dBm / 0.0640 W</p>



Product Specification is subject to this standard	
99% Occupied Bandwidth	<p>MIMO <Ant. 6> 802.11a: 16.33 MHz 802.11ac VHT20: 17.48 MHz 802.11ac VHT40: 36.06 MHz 802.11ac VHT80: 75.04 MHz 802.11ac VHT160: 154.41 MHz 802.11ax HE20: 18.88 MHz 802.11ax HE40: 37.86 MHz 802.11ax HE80: 76.96 MHz 802.11ax HE160: 156.08 MHz</p> <p>MIMO <Ant. 7> 802.11a: 16.38 MHz 802.11ac VHT20: 17.53 MHz 802.11ac VHT40: 36.06 MHz 802.11ac VHT80: 75.04 MHz 802.11ac VHT160: 154.17 MHz 802.11ax HE20: 18.88 MHz 802.11ax HE40: 37.76 MHz 802.11ax HE80: 76.84 MHz 802.11ax HE160: 155.84 MHz</p>
Antenna Type	<p><5180 MHz ~ 5240 MHz> <Ant. 6>: PIFA Antenna <Ant. 7>: PIFA Antenna</p> <p><5260 MHz ~ 5320 MHz> <Ant. 6>: PIFA Antenna <Ant. 7>: PIFA Antenna</p> <p><5500 MHz ~ 5720 MHz> <Ant. 6>: PIFA Antenna <Ant. 7>: PIFA Antenna</p>



Product Specification is subject to this standard			
Antenna Gain	<5180 MHz ~ 5240 MHz> <Ant. 6>: 3.86 dBi <Ant. 7>: 1.48 dBi <5260 MHz ~ 5320 MHz> <Ant. 6>: 3.86 dBi <Ant. 7>: 1.42 dBi <5500 MHz ~ 5720 MHz> <Ant. 6>: 3.80 dBi <Ant. 7>: 3.04 dBi		
Type of Modulation	802.11a/n : OFDM (BPSK / QPSK / 16QAM / 64QAM) 802.11ac : OFDM (BPSK / QPSK / 16QAM / 64QAM / 256QAM) 802.11ax : OFDMA (BPSK / QPSK / 16QAM / 64QAM / 256QAM / 1024QAM)		
Antenna Function Description		Ant. 6	Ant. 7
	802.11 a/n/ac/ax MIMO	V	V
	802.11ax TXBF	V	V

Remark:

1. MIMO Ant. 6+7 Directional Gain is a calculated result from MIMO Ant. 6 and MIMO Ant. 7. The formula used in calculation is documented in section 1.2.1.
2. Power of MIMO Ant. 6 + Ant. 7 is a calculated result from sum of the power MIMO Ant. 6 and MIMO Ant. 7.
3. 802.11ax Support Tx Beamforming mode, and the manufacturer declares that Tx Beamforming power/EIRP is less than CDD mode 3dbm, so CDD mode cover Tx Beamforming mode.
4. The EUT's information above is declared by manufacturer. Please refer to Disclaimer in report summary

1.2.1 Antenna Directional Gain

<For CDD Mode>

Follows FCC KDB 662911 D01 Multiple Transmitter Output v02r01 F)2)f)ii)

Directional gain = G_{ANT} + Array Gain, where Array Gain is as follows:

For power measurements on IEEE 802.11 devices,

Array Gain = 0 dB (i.e., no array gain) for $N_{ANT} \leq 4$.

G_{ANT} is set equal to the gain of the antenna having the highest gain.

For PSD measurements, the directional gain calculation.

$$DirectionalGain = 10 \cdot \log \left[\frac{\sum_{j=1}^{N_{SS}} \left\{ \sum_{k=1}^{N_{ANT}} g_{j,k} \right\}^2}{N_{ANT}} \right]$$

where

Each antenna is driven by no more than one spatial stream;

N_{SS} = the number of independent spatial streams of data;

N_{ANT} = the total number of antennas

$g_{j,k} = 10^{G_k / 20}$ if the k th antenna is being fed by spatial stream j , or zero if it is not;
 G_k is the gain in dBi of the k th antenna.

As minimum $N_{SS}=1$ is supported by EUT, the formula can be simplified as:

Directional gain = $10 \cdot \log[(10^{G1 / 20} + 10^{G2 / 20} + \dots + 10^{GN / 20})^2 / N_{ANT}]$ dBi

Where $G1, G2, \dots, GN$ denote single antenna gain.

The directional gain "DG" is calculated as following table.

			DG	DG	Power	PSD
			for	for	Limit	Limit
	Ant 6	Ant 7	Power	PSD	Reduction	Reduction
	(dBi)	(dBi)	(dBi)	(dBi)	(dB)	(dB)
Band I	3.86	1.48	3.86	5.76	0.00	0.00
Band II	3.86	1.42	3.86	5.74	0.00	0.00
Band III	3.80	3.04	3.80	6.44	0.00	0.44

Calculation example:

If a device has two antenna, $G_{ANT6} = 3.86$ dBi; $G_{ANT7} = 1.48$ dBi

Directional gain of power measurement = $\max(3.86, 1.48) + 0 = 3.86$ dBi

Directional gain of PSD derived from formula which is

$$10 \times \log \left\{ \left[10^{(3.86 \text{ dBi} / 20)} + 10^{(1.48 \text{ dBi} / 20)} \right]^2 / 2 \right\}$$

= 5.76 dBi

Power and PSD limit reduction = Composite gain – 6dBi, (min = 0)

<For TXBF Modes>

The EUT supports beamforming modes , then

Follows FCC KDB 662911 D01 Multiple Transmitter Output v02r01 F)2)e)ii)

$$DirectionalGain = 10 \cdot \log \left[\frac{\sum_{j=1}^{N_{SS}} \left\{ \sum_{k=1}^{N_{ANT}} g_{j,k} \right\}^2}{N_{ANT}} \right]$$

where

Each antenna is driven by no more than one spatial stream;

N_{SS} = the number of independent spatial streams of data;

N_{ANT} = the total number of antennas

$g_{j,k} = 10^{G_k / 20}$ if the k th antenna is being fed by spatial stream j , or zero if it is not;
 G_k is the gain in dBi of the k th antenna.

The directional gain “DG” is calculated as following table.

	Ant 6 (dBi)	Ant 7 (dBi)	DG for Power (dBi)	DG for PSD (dBi)	Power Limit Reduction (dB)	PSD Limit Reduction (dB)
Band I	3.86	1.48	5.76	5.76	0.00	0.00
Band II	3.86	1.42	5.74	5.74	0.00	0.00
Band III	3.80	3.04	6.44	6.44	0.44	0.44

Calculation example:

Directional gain is derived from formula which is

$$10 \times \log \left\{ \left[10^{3.86 / 20} + 10^{1.48 / 20} \right]^2 / 2 \right\}$$

= 5.76 dBi

Power and PSD limit reduction = Composite gain – 6dBi, (min = 0)



1.3 Modification of EUT

No modifications made to the EUT during the testing.

1.4 Testing Location

Test Site	Sporton International Inc. EMC & Wireless Communications Laboratory
Test Site Location	No.52, Huaya 1st Rd., Guishan Dist., Taoyuan City 333, Taiwan (R.O.C.) TEL: +886-3-327-3456 FAX: +886-3-328-4978
Test Site No.	Sporton Site No. CO05-HY, 03CH07-HY

Note: The test site complies with ANSI C63.4 2014 requirement.

Test Site	Sporton International Inc. Wensan Laboratory
Test Site Location	No.58, Aly. 75, Ln. 564, Wenhua 3rd, Rd., Guishan Dist., Taoyuan City 333010, Taiwan (R.O.C.) TEL: +886-3-327-0868 FAX: +886-3-327-0855
Test Site No.	Sporton Site No. TH05-HY (TAF Code: 3786)
Remark	The Conducted test item subcontracted to Sporton International Inc. Wensan Laboratory.

FCC designation No.: TW1190 and TW3786

1.5 Applicable Standards

According to the specifications declared by the manufacturer, the EUT must comply with the requirements of the following standards:

- ♦ FCC Part 15 Subpart E
- ♦ FCC KDB 789033 D02 General UNII Test Procedures New Rules v02r01.
- ♦ FCC KDB 414788 D01 Radiated Test Site v01r01.
- ♦ FCC KDB 662911 D01 Multiple Transmitter Output v02r01.
- ♦ ANSI C63.10-2013

Remark:

1. All the test items were validated and recorded in accordance with the standards without any modification during the testing.
2. The TAF code is not including all the FCC KDB listed without accreditation.
3. This EUT has also been tested and complied with the requirements of FCC Part 15, Subpart B, recorded in a separate test report.



2 Test Configuration of Equipment Under Test

- a. The EUT has been associated with peripherals and configuration operated in a manner tended to maximize its emission characteristics in a typical application. Frequency range investigated: conduction emission (150 kHz to 30 MHz), radiation emission (9 kHz to the 10th harmonic of the highest fundamental frequency or to 40 GHz, whichever is lower). For radiated measurement, the measured emission level of the EUT was maximized by rotating the EUT on a turntable, adjusting the orientation of the EUT and EUT antenna in three orthogonal axis (X: flat, Y: portrait, Z: landscape) and Accessory (Adapter or Earphone), and adjusting the measurement antenna orientation, following C63.10 exploratory test procedures and only the worst case emissions were reported in this report.
- b. AC power line Conducted Emission was tested under maximum output power.

2.1 Carrier Frequency and Channel

Frequency Band	Channel	Freq. (MHz)	Channel	Freq. (MHz)
5150-5250 MHz Band 1 (U-NII-1)	36	5180	44	5220
	38*	5190	46*	5230
	40	5200	48	5240
	42#	5210		

Frequency Band	Channel	Freq. (MHz)	Channel	Freq. (MHz)
5250-5350 MHz Band 2 (U-NII-2A)	52	5260	60	5300
	54*	5270	62*	5310
	56	5280	64	5320
	58#	5290		

Frequency Band	Channel	Freq. (MHz)	Channel	Freq. (MHz)
5470-5725 MHz Band 3 (U-NII-2C)	100	5500	112	5560
	102*	5510	116	5580
	104	5520	132	5660
	106#	5530	134*	5670
	108	5540	136	5680
	110*	5550	140	5700



Frequency Band	Channel	Freq. (MHz)
5150-5350 MHz	50@	5250
5470-5725 MHz	114@	5570

Frequency Band	Channel	Freq. (MHz)	Channel	Freq. (MHz)
TDWR Channel	118*	5590	124	5620
	120	5600	126*	5630
	122#	5610	128	5640

Frequency Band	Channel	Freq. (MHz)	Channel	Freq. (MHz)
Straddle Channel	138#	5690	144	5720
	142*	5710		

Note:

1. The above Frequency and Channel with "*" are 802.11n HT40 and 802.11ac VHT40 and 802.11ax HE40.
2. The above Frequency and Channel with "#" are 802.11ac VHT80 and 802.11ax HE80.
3. The above Frequency and Channel with "@" are 802.11ac VHT160 and 802.11ax HE160.



2.2 Test Mode

This device support 26/52/106/242/484/996-tone RU but does not support 2x996-tone RU on 160MHz channel.

The PSD of partial RU is reduced to be smaller than full RU according to TCB workshop interim guidance Oct. 2018.

The 802.11ax mode is investigated among different tones, full resource units (RU), partial resource units. The partial RU has no higher power than full RU's, thus the full RU is chosen as main test configuration.

The 242-tone RU is covered by 20MHz channel, 484-tone RU is covered by 40MHz channel and 996-tone RU is covered by 80MHz channel.

The SISO mode conducted power is covered by MIMO mode per chain, so only the MIMO mode is tested.

The power for 802.11n mode is smaller than 802.11ac mode, so all other conducted and radiated test is covered by 802.11ac mode.

The final test modes include the worst data rates for each modulation shown in the table below.

MIMO Mode

Modulation	Data Rate
802.11a	6 Mbps
802.11n HT20 (Covered by VHT20)	MCS0
802.11n HT40 (Covered by VHT40)	MCS0
802.11ac VHT20	MCS0
802.11ac VHT40	MCS0
802.11ac VHT80	MCS0
802.11ac VHT160	MCS0
802.11ax HE20	MCS0
802.11ax HE40	MCS0
802.11ax HE80	MCS0
802.11ax HE160	MCS0

Remark: The conducted power level of each chain in MIMO mode is equal or higher than SISO mode.

Test Cases	
AC Conducted Emission	Mode 1 : WLAN (5GHz) Link + Bluetooth Link + USB TYPE A to TYPE C cable (Charging from Adapter) + Battery 2 (1.5) for Sample 1
Remark: For Radiated Test Cases, the tests were performed with Battery 1 (1x), Sample 1 and Sample 3.	



<Sample 1>

Ch. #		Band I : 5150-5250 MHz	Band II : 5250-5350 MHz	Band III : 5470-5725MHz
		802.11a	802.11a	802.11a
L	Low	36	52	100
M	Middle	44	60	116
H	High	48	64	140
Straddle		-	-	144

Ch. #		Band I : 5150-5250 MHz	Band II : 5250-5350 MHz	Band III : 5470-5725MHz
		802.11ax HE20	802.11ax HE20	802.11ax HE20
L	Low	36	52	100
M	Middle	44	60	116
H	High	48	64	140
Straddle		-	-	144

Ch. #		Band I : 5150-5250 MHz	Band II : 5250-5350 MHz	Band III : 5470-5725MHz
		802.11ax HE40	802.11ax HE40	802.11ax HE40
L	Low	38	54	102
M	Middle	-	-	110
H	High	46	62	134
Straddle		-	-	142

Ch. #		Band I : 5150-5250 MHz	Band II : 5250-5350 MHz	Band III : 5470-5725MHz
		802.11ax HE80	802.11ax HE80	802.11ax HE80
L	Low	-	-	106
M	Middle	42	58	-
H	High	-	-	122
Straddle		-	-	138

BW160	5150-5350 MHz	5470-5725MHz
	802.11ax HE160	802.11ax HE160
Ch. #	50	114

<Sample 3>

Ch. #		Band II : 5250-5350 MHz
		802.11ax HE80
L	Low	-
M	Middle	58
H	High	-
Straddle		-

Remark: For radiation spurious emission, the modulation and the data rate picked for testing are determined by the Max. RF conducted power.

2.3 Connection Diagram of Test System

<AC Conducted Emission Mode>

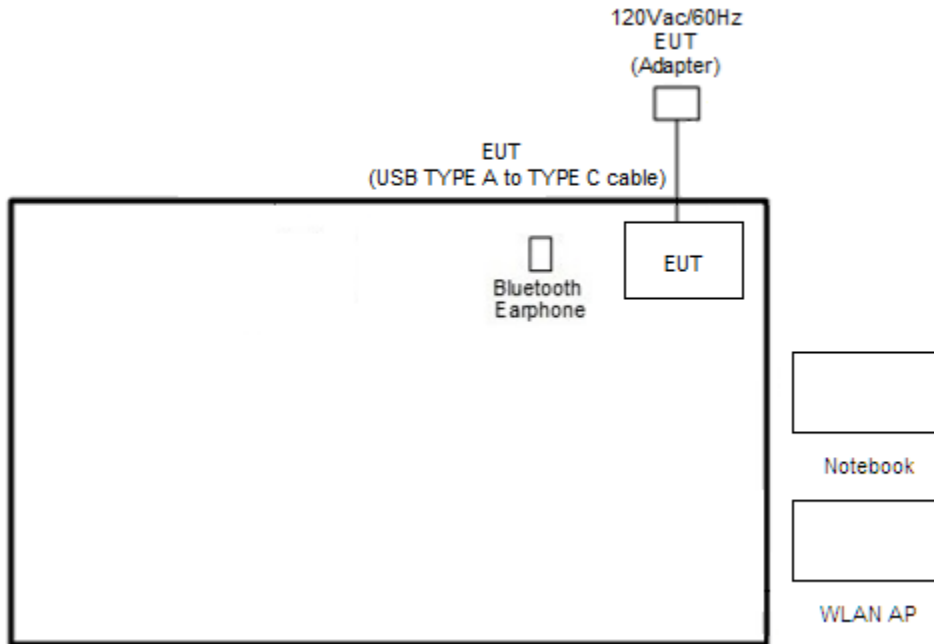

<WLAN Tx with Adapter Mode>

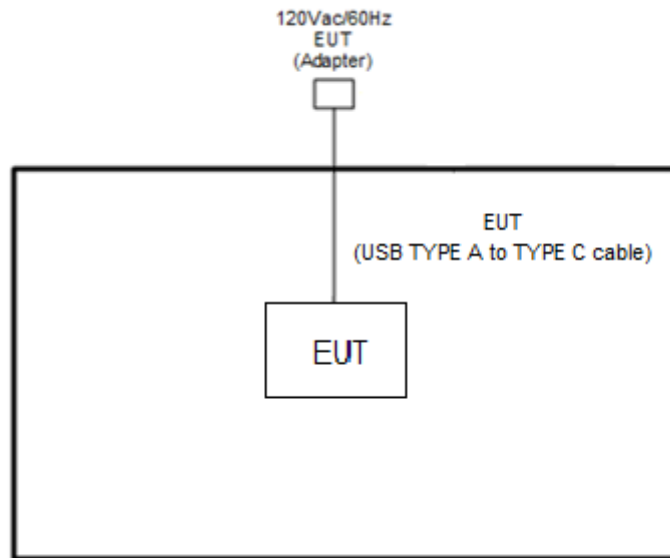

<WLAN Tx with Earphone Mode>

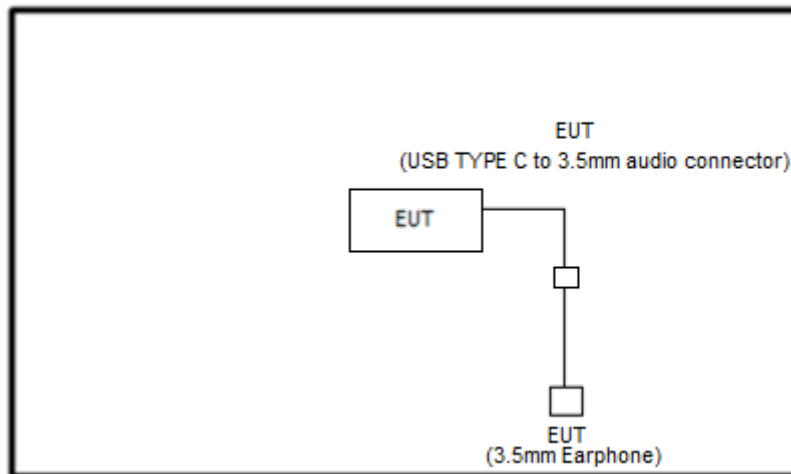



2.4 Support Unit used in test configuration and system

Item	Equipment	Brand Name	Model Name	FCC ID	Data Cable	Power Cord
1.	Bluetooth Earphone	Sony Ericsson	MW600	PY7DDA-2029	N/A	N/A
2.	WLAN AP	ASUS	RT-AC66U	MSQ-RTAC66U	N/A	Unshielded, 1.8 m
3.	Notebook	DELL	Latitude 3420	FCC DoC	N/A	AC I/P: Unshielded, 1.2 m DC O/P: Shielded, 1.8 m
4.	SD Card	SanDisk	MicroSD HC	FCC DoC	N/A	N/A

2.5 EUT Operation Test Setup

The RF test items, utility “QRCT Version 4.0.00206.0” was installed in Notebook which was programmed in order to make the EUT get into the engineering modes to provide channel selection, power level, data rate and the application type and for continuous transmitting signals.

2.6 Measurement Results Explanation Example

For all conducted test items:

The offset level is set in the spectrum analyzer to compensate the RF cable loss and attenuator factor between EUT conducted output port and spectrum analyzer. With the offset compensation, the spectrum analyzer reading level is exactly the EUT RF output level.

Example :

The spectrum analyzer offset is derived from RF cable loss and attenuator factor.

Offset = RF cable loss + attenuator factor.

Following shows an offset computation example with cable loss 4.2 dB and 10 dB attenuator.

$$\begin{aligned} \text{Offset(dB)} &= \text{RF cable loss(dB)} + \text{attenuator factor(dB)}. \\ &= 4.2 + 10 = 14.2 \text{ (dB)} \end{aligned}$$

3 Test Result

3.1 26dB & 99% Occupied Bandwidth Measurement

3.1.1 Description of 26dB & 99% Occupied Bandwidth

This section is for reporting purpose only.

There is no restriction limits for bandwidth.

For Straddle Channel, according to KDB 789033 D02 General UNII Test Procedures New Rules v02r01, if the power and PSD of the devices are uniform and comply with the lower limits specified for the U-NII-2 bands, a single measurement over the entire emission bandwidth can be performed to show compliance.

3.1.2 Measuring Instruments

Please refer to the measuring equipment list in this test report.

3.1.3 Test Procedures

1. The testing follows FCC KDB 789033 D02 General UNII Test Procedures New Rules v02r01. Section C) Emission bandwidth
2. Set RBW = approximately 1% of the emission bandwidth.
3. Set the VBW > RBW.
4. Detector = Peak.
5. Trace mode = max hold
6. Measure the maximum width of the emission that is 26 dB down from the peak of the emission. Compare this with the RBW setting of the analyzer. Readjust RBW and repeat measurement as needed until the RBW/EBW ratio is approximately 1%.
7. For 99% Bandwidth Measurement, the spectrum analyzer's resolution bandwidth (RBW) is set 1-5% of the emission bandwidth and set the Video bandwidth (VBW) $\geq 3 * RBW$.
8. Measure and record the results in the test report.

3.1.4 Test Setup

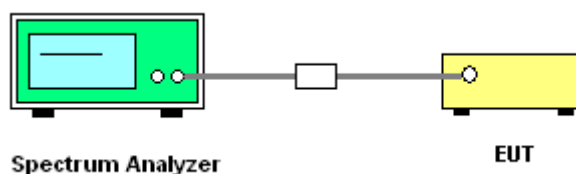

3.1.5 Test Result of 26dB & 99% Occupied Bandwidth

Please refer to Appendix A.



3.2 Maximum Conducted Output Power Measurement

3.2.1 Limit of Maximum Conducted Output Power

<FCC 14-30 CFR 15.407>

For the 5.15–5.25 GHz bands:

■ For mobile and portable client devices in the 5.15–5.25 GHz band, the maximum conducted output power over the frequency band of operation shall not exceed 250 mW. For an indoor access point operating in the band 5.15-5.25 GHz, the maximum conducted output power over the frequency band of operation shall not exceed 1 W.

For the 5.25–5.725 GHz bands:

■ The maximum conducted output power over the frequency bands of operation shall not exceed the lesser of 250 mW or 11 dBm 10 log B, where B is the 26 dB emission bandwidth in megahertz.

For Straddle Channel, according to KDB 789033 D02 General UNII Test Procedures New Rules v02r01, if the power and PSD of the devices are uniform and comply with the lower limits specified for the U-NII-2 bands, a single measurement over the entire emission bandwidth can be performed to show compliance.

If transmitting antennas of directional gain greater than 6 dBi are used, the peak output power shall be reduced by the amount in dB that the directional gain of the antenna exceeds 6 dBi.

Note that U-NII-2 band, devices with a maximum e.i.r.p. greater than 500 mW shall implement TPC in order to have the capability to operate at least 6 dB below the maximum permitted e.i.r.p. of 1 W.

3.2.2 Measuring Instruments

Please refer to the measuring equipment list in this test report.

3.2.3 Test Procedures

The testing follows Method PM-G of FCC KDB 789033 D02 General UNII Test Procedures New Rules v02r01.

Method PM-G (Measurement using a gated RF average power meter):

1. Measurement is performed using a wideband RF power meter.
2. The EUT is configured to transmit at its maximum power control level.
3. Measure the average power of the transmitter.
4. Since the measurement is made only during the ON time of the transmitter, no duty cycle correction factor is required.
5. For MIMO mode, calculation method follows FCC KDB 662911 D01 Multiple Transmitter Output v02r01

For Straddle Channel, according to KDB 789033 D02 General UNII Test Procedures New Rules v02r01, if the power and PSD of the devices are uniform and comply with the lower limits specified for the U-NII-2 bands, a single measurement over the entire emission bandwidth can be performed to show compliance.

3.2.4 Test Setup

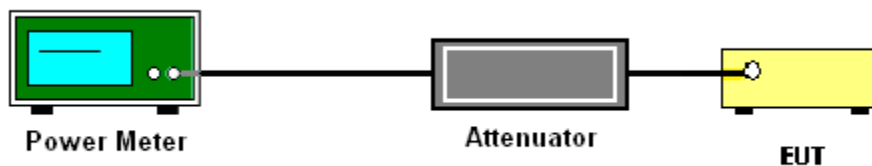

3.2.5 Test Result of Maximum Conducted Output Power

Please refer to Appendix A.



3.3 Power Spectral Density Measurement

3.3.1 Limit of Power Spectral Density

<FCC 14-30 CFR 15.407>

For the 5.15–5.25 GHz bands:

For mobile and portable client devices in the 5.15–5.25 GHz band, the maximum power spectral density shall not exceed 11 dBm in any 1.0 MHz band. For an indoor access point operating in the band 5.15-5.25 GHz, the maximum power spectral density shall not exceed 17 dBm in any 1.0 MHz band.

For the 5.25–5.725 GHz bands:

The maximum power spectral density shall not exceed 11 dBm in any 1.0 MHz band.

For Straddle Channel, according to KDB 789033 D02 General UNII Test Procedures New Rules v02r01, if the power and PSD of the devices are uniform and comply with the lower limits specified for the U-NII-2 bands, a single measurement over the entire emission bandwidth can be performed to show compliance.

If transmitting antennas of directional gain greater than 6 dBi are used, the peak output power shall be reduced by the amount in dB that the directional gain of the antenna exceeds 6 dBi.

3.3.2 Measuring Instruments

Please refer to the measuring equipment list in this test report.

3.3.3 Test Procedures

The testing follows FCC KDB 789033 D02 General UNII Test Procedures New Rules v02r01.
Section F) Maximum power spectral density.

Method SA-2

(trace averaging across on and off times of the EUT transmissions, followed by duty cycle correction).

- Measure the duty cycle.
 - Set span to encompass the entire emission bandwidth (EBW) of the signal.
 - Set RBW = 1 MHz.
 - Set VBW \geq 3 MHz.
 - Number of points in sweep \geq 2 Span / RBW.
 - Sweep time = auto.
 - Detector = RMS
 - Trace average at least 100 traces in power averaging mode.
 - Add $10 \log(1/x)$, where x is the duty cycle, to the measured power in order to compute the average power during the actual transmission times. For example, add $10 \log(1/0.25) = 6$ dB if the duty cycle is 25 percent.
1. The RF output of EUT is connected to the spectrum analyzer by a low loss cable.
 2. Each plot has already offset with cable loss, and attenuator loss. Measure the PPSD and record it.
 3. For MIMO mode, calculation method follows FCC KDB 662911 D01 Multiple Transmitter Output v02r01.

Method (a): Measure and sum the spectra across the outputs.

The total final Power Spectral Density is from a device with 2 transmitter outputs. The spectrum measurements of the individual outputs are all performed with the same span and number of points; the spectrum value in the first spectral bin of output 1 is summed with that in the first spectral bin of output 2 to obtain the value for the first frequency bin of the summed spectrum.

3.3.4 Test Setup

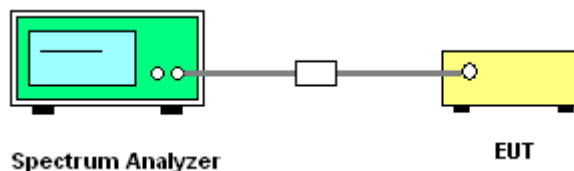

3.3.5 Test Result of Power Spectral Density

Please refer to Appendix A.



3.4 Unwanted Emissions Measurement

This section is to measure unwanted emissions through radiated measurement for band edge spurious emissions and out of band emissions measurement.

3.4.1 Limit of Unwanted Emissions

(1) For transmitters operating in the 5150-5250 MHz band: all emissions outside of the 5150-5350 MHz band shall not exceed an EIRP of -27dBm/MHz.

For transmitters operating in the 5250-5350 MHz band: all emissions outside of the 5150-5350 MHz band shall not exceed an EIRP of -27 dBm/MHz. Devices operating in the 5250-5350 MHz band that generate emissions in the 5150-5250 MHz band must meet all applicable technical requirements for operation in the 5150-5250 MHz band (including indoor use) or alternatively meet an out-of-band emission EIRP limit of -27 dBm/MHz in the 5150-5250 MHz band.

For transmitters operating in the 5470-5600 MHz and 5650-5725MHz band: all emissions outside of the 5470-5600 MHz and 5650-5725MHz band shall not exceed an EIRP of -27 dBm/MHz.

(2) Unwanted spurious emissions falls in restricted bands shall comply with the general field strength limits as below table:

Frequency (MHz)	Field Strength (microvolts/meter)	Measurement Distance (meters)
0.009 – 0.490	2400/F(kHz)	300
0.490 – 1.705	24000/F(kHz)	30
1.705 – 30.0	30	30
30 – 88	100	3
88 – 216	150	3
216 - 960	200	3
Above 960	500	3

Note: The following formula is used to convert the EIRP to field strength.

$$E = \frac{1000000\sqrt{30P}}{3} \mu\text{V/m, where P is the eirp (Watts)}$$



EIRP (dBm)	Field Strength at 3m (dBμV/m)
- 27	68.3

(3) KDB789033 D02 v02r01 G)2)c)

(i) Sections 15.407(b)(1-3) specifies the unwanted emissions limit for the U-NII-1 and U-NII-2 bands. As specified, emissions above 1000 MHz that are outside of the restricted bands are subject to a peak emission limit of -27 dBm/MHz.

(ii) Section 15.407(b)(4) specifies the unwanted emissions limit for the U-NII-3 band. A band emissions mask is specified in Section 15.407(b)(4)(i). The emission limits are based on the use of a peak detector.

3.4.2 Measuring Instruments

Please refer to the measuring equipment list in this test report.

3.4.3 Test Procedures

1. The testing follows FCC KDB 789033 D02 General UNII Test Procedures New Rules v02r01. Section G) Unwanted emissions measurement.

(1) Procedure for Unwanted Emissions Measurements Below 1000 MHz

- RBW = 120 kHz
- VBW = 300 kHz
- Detector = Peak
- Trace mode = max hold

(2) Procedure for Peak Unwanted Emissions Measurements Above 1000 MHz

- RBW = 1 MHz
- VBW ≥ 3 MHz
- Detector = Peak
- Sweep time = auto
- Trace mode = max hold

(3) Procedures for Average Unwanted Emissions Measurements Above 1000 MHz

- RBW = 1 MHz
- VBW = 10 Hz, when duty cycle is no less than 98 percent.
- VBW ≥ 1/T, when duty cycle is less than 98 percent where T is the minimum transmission duration over which the transmitter is on and is transmitting at its maximum power control level for the tested mode of operation.

2. The EUT is placed on a turntable with 0.8 meter for frequency below 1 GHz and 1.5 meter for frequency above 1 GHz respectively above ground.
3. The EUT is set 3 meters away from the receiving antenna which is mounted on the top of a variable height antenna tower.
4. The antenna is a broadband antenna and its height is adjusted between one meter and four meters above ground to find the maximum value of the field strength for both horizontal polarization and vertical polarization of the antenna.
5. For each suspected emission, the EUT is arranged to its worst case and then adjust the antenna tower (from 1 m to 4 m) and turntable (from 0 degree to 360 degrees) to find the maximum reading.
6. Radiated testing below 1 GHz is performed by adjusting the antenna tower from 1 m to 4 m and by rotating the turn table from 0 degree to 360 degrees to find the peak maximum hold reading. When there is no suspected emission found and the emission level is with at least 6 dB margin against QP limit line, the position is marked as “-“.
7. Radiated testing above 1 GHz is performed by adjusting the antenna tower from 1 m to 4 m and by rotating the turn table from 0 degree to 360 degrees to find the peak maximum hold reading for scanning all frequencies. When there is no suspected emission found and the harmonic emission level is with at least 6 dB margin against average limit line, the position is marked as “-“.

3.4.4 Test Setup

For radiated emissions below 30MHz

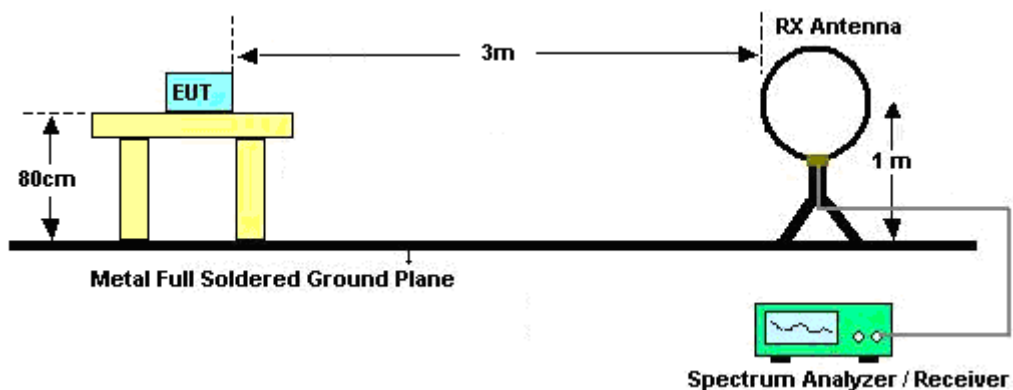

For radiated emissions from 30MHz to 1GHz

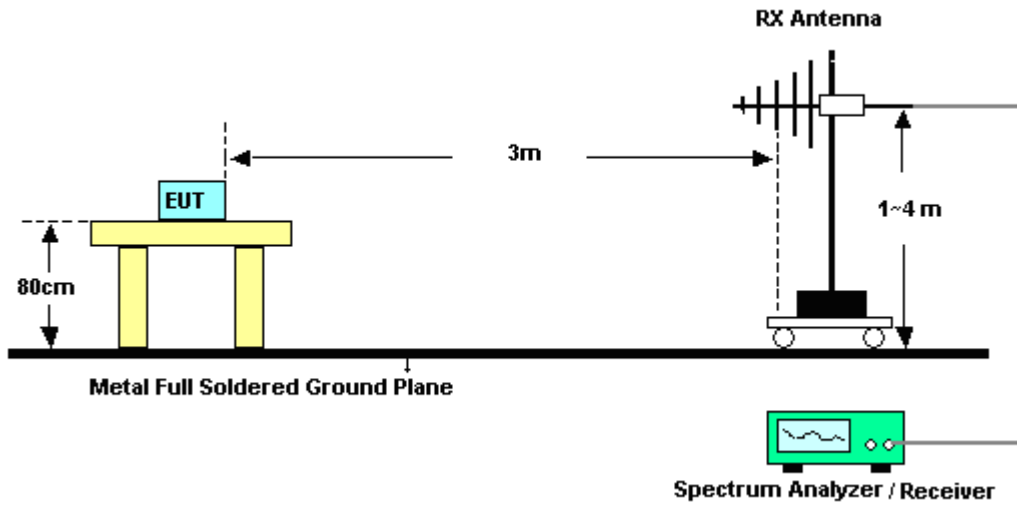

For radiated test from 1GHz to 18GHz

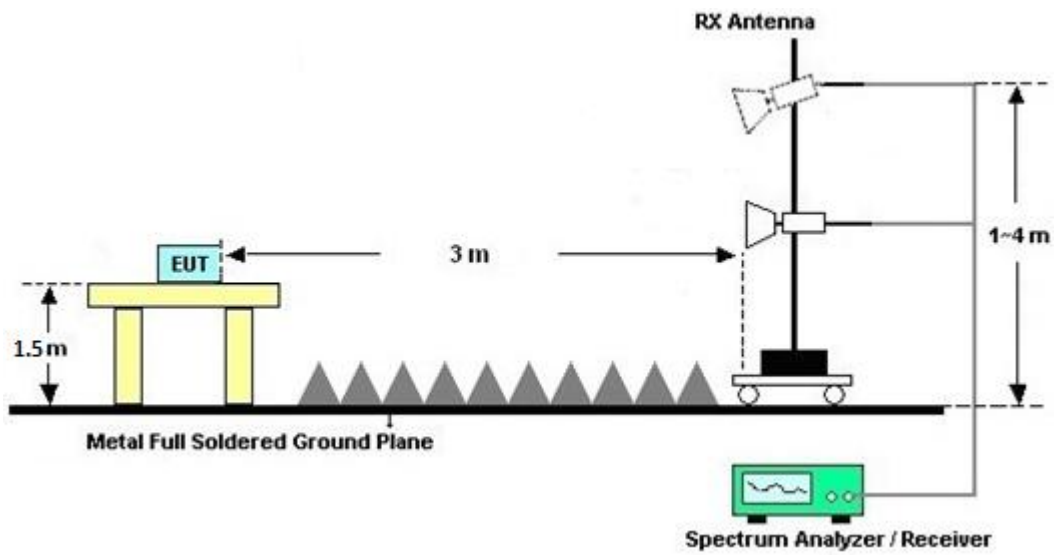

For radiated test above 18GHz

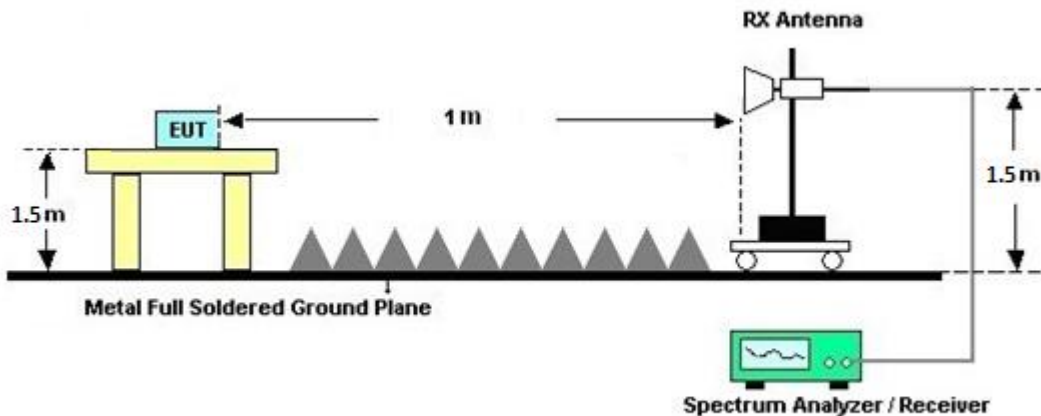

3.4.5 Test Results of Radiated Spurious Emissions (9 kHz ~ 30 MHz)

The low frequency, which starts from 9 kHz to 30 MHz, is pre-scanned and the result which is 20 dB lower than the limit line is not reported.

There is adequate comparison measurement of both open-field test site and alternative test site - semi-Anechoic chamber according to 414788 D01 Radiated Test Site v01r01, and the result came out very similar.

3.4.6 Test Result of Radiated Spurious at Band Edges

Please refer to Appendix C and D.

3.4.7 Duty Cycle

Please refer to Appendix E.

3.4.8 Test Result of Radiated Spurious Emissions (30MHz ~ 10th Harmonic)

Please refer to Appendix C and D.



3.5 AC Conducted Emission Measurement

3.5.1 Limit of AC Conducted Emission

For equipment that is designed to be connected to the public utility (AC) power line, the radio frequency voltage that is conducted back onto the AC power line on any frequency or frequencies within the band 150 kHz to 30 MHz shall not exceed the limits in the following table.

Frequency of emission (MHz)	Conducted limit (dBµV)	
	Quasi-peak	Average
0.15-0.5	66 to 56*	56 to 46*
0.5-5	56	46
5-30	60	50

*Decreases with the logarithm of the frequency.

3.5.2 Measuring Instruments

Please refer to the measuring equipment list in this test report.

3.5.3 Test Procedures

1. The EUT is placed 0.4 meter away from the conducting wall of the shielding room, and is kept at least 80 centimeters from any other grounded conducting surface.
2. Connect EUT to the power mains through a line impedance stabilization network (LISN).
3. All the support units are connecting to the other LISN.
4. The LISN provides 50 ohm coupling impedance for the measuring instrument.
5. The FCC states that a 50 ohm, 50 microhenry LISN shall be used.
6. Both Line and Neutral shall be tested in order to find out the maximum conducted emission.
7. The frequency range from 150 kHz to 30 MHz is scanned.
8. Set the test-receiver system to Peak Detect Function and specified bandwidth with Maximum Hold Mode.

3.5.4 Test Setup

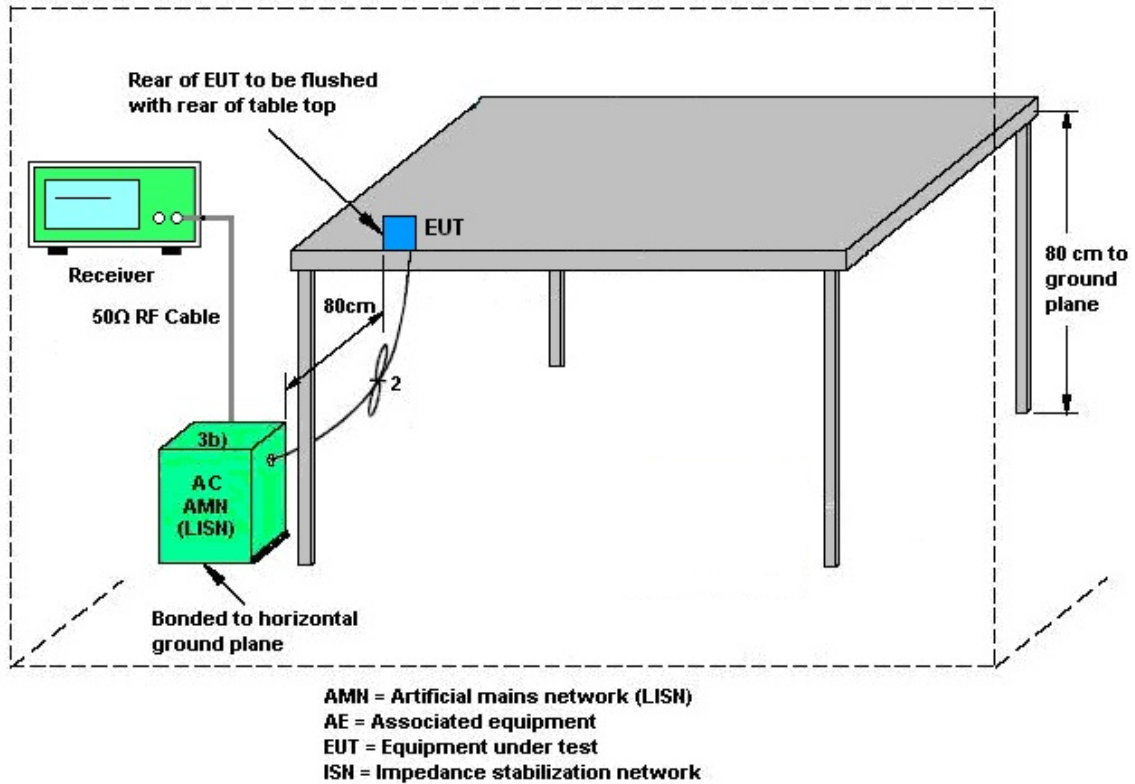

3.5.5 Test Result of AC Conducted Emission

Please refer to Appendix B.



3.6 Antenna Requirements

3.6.1 Standard Applicable

The use of a permanently attached antenna or of an antenna that uses a unique coupling to the intentional radiator shall be considered sufficient to comply with the rule.

3.6.2 Antenna Anti-Replacement Construction

An embedded-in antenna design is used.



4 List of Measuring Equipment

Instrument	Brand Name	Model No.	Serial No.	Characteristics	Calibration Date	Test Date	Due Date	Remark
Bilog Antenna	TESEQ	CBL 6111D & 00800N1D01N-06	35419 & 03	30MHz~1GHz	Apr. 23, 2023	Dec. 20, 2023~Jan. 04, 2024	Apr. 22, 2024	Radiation (03CH07-HY)
Double Ridge Horn Antenna	ESCO	3117	00075962	1GHz ~ 18GHz	Nov. 27, 2023	Dec. 20, 2023~Jan. 04, 2024	Nov. 26, 2024	Radiation (03CH07-HY)
Loop Antenna	Rohde & Schwarz	HFH2-Z2	100315	9 kHz~30 MHz	Feb. 28, 2023	Dec. 20, 2023~Jan. 04, 2024	Feb. 27, 2024	Radiation (03CH07-HY)
Preamplifier	MITEQ	AMF-7D-0010180 0-30-10P	1590075	1GHz~18GHz	Apr. 20, 2023	Dec. 20, 2023~Jan. 04, 2024	Apr. 19, 2024	Radiation (03CH07-HY)
Preamplifier	COM-POWER	PA-103A	161241	10MHz~1GHz	Oct. 02, 2023	Dec. 20, 2023~Jan. 04, 2024	Oct. 01, 2024	Radiation (03CH07-HY)
Preamplifier	Agilent	8449B	3008A02362	1GHz~26.5GHz	Mar. 24, 2023	Dec. 20, 2023~Jan. 04, 2024	Mar. 23, 2024	Radiation (03CH07-HY)
Preamplifier	EMEC	EM18G40G	0600789	18-40GHz	Jul. 25, 2023	Dec. 20, 2023~Jan. 04, 2024	Jul. 24, 2024	Radiation (03CH07-HY)
Spectrum Analyzer	Agilent	N9030A	MY52350276	3Hz~44GHz	Mar. 28, 2023	Dec. 20, 2023~Jan. 04, 2024	Mar. 27, 2024	Radiation (03CH07-HY)
RF Cable	HUBER + SUHNER	SUCOFLEX 104	MY15682/4	30MHz to 18GHz	Feb. 22, 2023	Dec. 20, 2023~Jan. 04, 2024	Feb. 21, 2024	Radiation (03CH07-HY)
RF Cable	HUBER + SUHNER	SUCOFLEX 104	MY24971/4	9kHz to 18GHz	Feb. 22, 2023	Dec. 20, 2023~Jan. 04, 2024	Feb. 21, 2024	Radiation (03CH07-HY)
RF Cable	HUBER + SUHNER	SUCOFLEX 104	MY28655/4	9kHz to 18GHz	Feb. 22, 2023	Dec. 20, 2023~Jan. 04, 2024	Feb. 21, 2024	Radiation (03CH07-HY)
RF Cable	HUBER + SUHNER	SUCOFLEX 126	532078/126E	30MHz~18GHz	Sep. 15, 2023	Dec. 20, 2023~Jan. 04, 2024	Sep. 14, 2024	Radiation (03CH07-HY)
RF Cable	HUBER + SUHNER	SUCOFLEX 102	MY2858/2	18GHz~40GHz	Feb. 22, 2023	Dec. 20, 2023~Jan. 04, 2024	Feb. 21, 2024	Radiation (03CH07-HY)
RF Cable	HUBER + SUHNER	SUCOFLEX 102	801606/2	9KHz ~ 40GHz	Apr. 20, 2023	Dec. 20, 2023~Jan. 04, 2024	Apr. 19, 2024	Radiation (03CH07-HY)
Controller	EMEC	EM1000	N/A	Control Ant Mast	N/A	Dec. 20, 2023~Jan. 04, 2024	N/A	Radiation (03CH07-HY)
Controller	MF	MF-7802	N/A	Control Turn table	N/A	Dec. 20, 2023~Jan. 04, 2024	N/A	Radiation (03CH07-HY)
Antenna Mast	EMEC	AM-BS-4500E	N/A	Boresight mast 1M~4M	N/A	Dec. 20, 2023~Jan. 04, 2024	N/A	Radiation (03CH07-HY)
Turn Table	ChainTek	Chaintek 3000	N/A	0~360 Degree	N/A	Dec. 20, 2023~Jan. 04, 2024	N/A	Radiation (03CH07-HY)
Software	Audix	E3	N/A	N/A	N/A	Dec. 20, 2023~Jan. 04, 2024	N/A	Radiation (03CH07-HY)
USB Data Logger	TECPEL	TR-32	HE17XB2495	N/A	Mar. 14, 2023	Dec. 20, 2023~Jan. 04, 2024	Mar. 13, 2024	Radiation (03CH07-HY)
SHF-EHF Horn Antenna	SCHWARZBECK	BBHA 9170	BBHA9170251	18GHz~40GHz	Nov. 24, 2023	Dec. 20, 2023~Jan. 04, 2024	Nov. 23, 2024	Radiation (03CH07-HY)
Hygrometer	TECPEL	DTM-303A	TP201996	N/A	Nov. 07, 2023	Dec. 12, 2023~Jan. 18, 2024	Nov. 06, 2024	Conducted (TH05-HY)
Power Sensor	DARE	RPR3006W	15I00041SNO10 (NO:248)	10MHz~6GHz	Jan. 05, 2023	Dec. 12, 2023~Dec. 29, 2023	Jan. 04, 2024	Conducted (TH05-HY)
Power Sensor	DARE	RPR3006W	16I00054SNO12 (NO:113)	10MHz~6GHz	Dec. 12, 2023	Jan. 02, 2024~Jan. 18, 2024	Dec. 11, 2024	Conducted (TH05-HY)
Signal Analyzer	Rohde & Schwarz	FSV40	101566	10Hz~40GHz	Aug. 23, 2023	Dec. 12, 2023~Jan. 18, 2024	Aug. 22, 2024	Conducted (TH05-HY)



Instrument	Brand Name	Model No.	Serial No.	Characteristics	Calibration Date	Test Date	Due Date	Remark
AC Power Source	ChainTek	APC-1000W	N/A	N/A	N/A	Dec. 28, 2023	N/A	Conduction (CO05-HY)
EMI Test Receiver	Rohde & Schwarz	ESR3	102388	9kHz~3.6GHz	Dec. 06, 2023	Dec. 28, 2023	Dec. 05, 2024	Conduction (CO05-HY)
Hygrometer	Testo	608-H1	34913912	N/A	Oct. 26, 2023	Dec. 28, 2023	Oct. 25, 2024	Conduction (CO05-HY)
LISN	Rohde & Schwarz	ENV216	100081	9kHz~30MHz	Nov. 22, 2023	Dec. 28, 2023	Nov. 21, 2024	Conduction (CO05-HY)
Software	Rohde & Schwarz	EMC32	N/A	N/A	N/A	Dec. 28, 2023	N/A	Conduction (CO05-HY)
ISN Cable	MVE	RG-400	200260	N/A	Dec. 28, 2023	Dec. 28, 2023	Dec. 27, 2024	Conduction (CO05-HY)
Pulse Limiter	SCHWARZBECK	VTSD 9561-FN	00691	9kHz-200MHz	Jul. 28, 2023	Dec. 28, 2023	Jul. 27, 2024	Conduction (CO05-HY)
LISN Cable	MVE	RG-400	260260	N/A	Dec. 28, 2023	Dec. 28, 2023	Dec. 27, 2024	Conduction (CO05-HY)



5 Measurement Uncertainty

Uncertainty of Conducted Emission Measurement (150kHz ~ 30MHz)

Measuring Uncertainty for a Level of Confidence of 95% ($U = 2Uc(y)$)	3.5 dB
---	--------

Uncertainty of Radiated Emission Measurement (30 MHz ~ 1000 MHz)

Measuring Uncertainty for a Level of Confidence of 95% ($U = 2Uc(y)$)	6.3 dB
---	--------

Uncertainty of Radiated Emission Measurement (1000 MHz ~ 6000 MHz)

Measuring Uncertainty for a Level of Confidence of 95% ($U = 2Uc(y)$)	4.6 dB
---	--------

Uncertainty of Radiated Emission Measurement (6000 MHz ~ 18000 MHz)

Measuring Uncertainty for a Level of Confidence of 95% ($U = 2Uc(y)$)	4.3 dB
---	--------

Uncertainty of Radiated Emission Measurement (18000 MHz ~ 40000 MHz)

Measuring Uncertainty for a Level of Confidence of 95% ($U = 2Uc(y)$)	5.3 dB
---	--------

Appendix A. Test Result of Conducted Test Items

Test Engineer:	Sylvia Li/Willy Chang	Temperature:	21~25	°C
Test Date:	2023/12/12~2024/01/18	Relative Humidity:	51~54	%

TEST RESULTS DATA
26dB and 99% OBW

U-NII-1 MIMO													
Mod.	Data Rate	N _{rx}	CH.	Freq. (MHz)	99% Bandwidth (MHz)		26 dB Bandwidth (MHz)		IC 99% Bandwidth Power Limit (dBm)		IC 99% Bandwidth EIRP Limit (dBm)		Note
					Ant 6	Ant 7	Ant 6	Ant 7	Ant 6	Ant 7	Ant 6	Ant 7	
11a	6Mbps	2	36	5180	16.33	16.33	19.36	19.36	-	-	22.13	-	
11a	6Mbps	2	44	5220	16.33	16.33	19.52	19.52	-	-	22.13	-	
11a	6Mbps	2	48	5240	16.33	16.33	19.60	19.44	-	-	22.13	-	
VHT20	MCS0	2	36	5180	17.48	17.53	20.08	20.40	-	-	22.43	-	
VHT20	MCS0	2	44	5220	17.48	17.48	20.56	20.72	-	-	22.43	-	
VHT20	MCS0	2	48	5240	17.48	17.48	20.56	20.24	-	-	22.43	-	
VHT40	MCS0	2	38	5190	35.96	36.06	40.80	40.80	-	-	23.01	-	
VHT40	MCS0	2	46	5230	36.06	36.06	40.80	40.48	-	-	23.01	-	
VHT80	MCS0	2	42	5210	74.93	75.04	81.60	81.60	-	-	23.01	-	
VHT160	MCS0	2	50	5250	154.41	154.17	165.60	165.12	-	-	23.01	-	

TEST RESULTS DATA
Average Power Table

FCC U-NII-1 MIMO														
Mod.	Data Rate	N _{TX}	CH.	Freq. (MHz)	Duty Factor (dB)		Average Conducted Power (dBm)			FCC Conducted Power Limit (dBm)		DG (dBi)		Pass/Fail
					Ant 6	Ant 7	Ant 6	Ant 7	SUM	Ant 6	Ant 7	Ant 6	Ant 7	
11a	6Mbps	2	36	5180	0.66	0.66	18.80	18.40	21.61	24.00		3.86		Pass
11a	6Mbps	2	44	5220	0.66	0.66	18.60	17.90	21.27	24.00		3.86		Pass
11a	6Mbps	2	48	5240	0.66	0.66	18.20	17.70	20.97	24.00		3.86		Pass
HT20	MCS0	2	36	5180	0.66	0.65	18.30	18.00	21.16	24.00		3.86		Pass
HT20	MCS0	2	44	5220	0.66	0.65	18.80	18.40	21.61	24.00		3.86		Pass
HT20	MCS0	2	48	5240	0.66	0.65	18.70	18.50	21.61	24.00		3.86		Pass
HT40	MCS0	2	38	5190	0.66	0.66	17.40	16.90	20.17	24.00		3.86		Pass
HT40	MCS0	2	46	5230	0.66	0.66	19.50	18.80	22.17	24.00		3.86		Pass
VHT20	MCS0	2	36	5180	0.67	0.65	18.40	18.10	21.26	24.00		3.86		Pass
VHT20	MCS0	2	44	5220	0.67	0.65	18.90	18.50	21.71	24.00		3.86		Pass
VHT20	MCS0	2	48	5240	0.67	0.65	18.80	18.60	21.71	24.00		3.86		Pass
VHT40	MCS0	2	38	5190	0.66	0.66	17.50	17.00	20.27	24.00		3.86		Pass
VHT40	MCS0	2	46	5230	0.66	0.66	19.60	18.90	22.27	24.00		3.86		Pass
VHT80	MCS0	2	42	5210	0.67	0.67	17.60	17.00	20.32	24.00		3.86		Pass
VHT160	MCS0	2	50	5250	0.67	0.67	12.80	13.00	15.91	24.00		3.86		Pass

TEST RESULTS DATA
Power Spectral Density

FCC U-NII-1 MIMO																	
Mod.	Data Rate	N _{rx}	CH.	Freq. (MHz)	Duty Factor (dB)		Average Power Density with Duty Factor (dBm/MHz)			Average PSD Limit (dBm/MHz)		DG (dBi)		Pass /Fail			
					Ant 6	Ant 7	Ant 6	Ant 7	SUM	Ant 6	Ant 7	Ant 6	Ant 7				
11a	6Mbps	2	36	5180	0.66	0.66	-		10.94	11.00	5.76		-	Pass			
11a	6Mbps	2	44	5220	0.66	0.66								10.51	11.00	5.76	Pass
11a	6Mbps	2	48	5240	0.66	0.66								10.50	11.00	5.76	Pass
VHT20	MCS0	2	36	5180	0.67	0.65								10.69	11.00	5.76	Pass
VHT20	MCS0	2	44	5220	0.67	0.65								10.75	11.00	5.76	Pass
VHT20	MCS0	2	48	5240	0.67	0.65								10.84	11.00	5.76	Pass
VHT40	MCS0	2	38	5190	0.66	0.66								6.51	11.00	5.76	Pass
VHT40	MCS0	2	46	5230	0.66	0.66								8.76	11.00	5.76	Pass
VHT80	MCS0	2	42	5210	0.67	0.67								4.07	11.00	5.76	Pass
VHT160	MCS0	2	50	5250	0.67	0.67								-3.08	11.00	5.76	Pass

TEST RESULTS DATA
26dB and 99% OBW

U-NII-2A MIMO															
Mod.	Data Rate	N _{rx}	CH.	Freq. (MHz)	99% Bandwidth (MHz)		26 dB Bandwidth (MHz)		IC 99% Bandwidth Power Limit (dBm)		IC 99% Bandwidth EIRP Limit (dBm)		FCC 26dB Bandwidth Power Limit (dBm)		Note
					Ant 6	Ant 7	Ant 6	Ant 7	Ant 6	Ant 7	Ant 6	Ant 7	Ant 6	Ant 7	
11a	6Mbps	2	52	5260	16.33	16.33	19.52	19.12	23.13		29.13		23.81		-
11a	6Mbps	2	60	5300	16.28	16.33	19.28	19.44	23.12		29.12		23.85		
11a	6Mbps	2	64	5320	16.33	16.28	19.52	19.44	23.12		29.12		23.89		
VHT20	MCS0	2	52	5260	17.48	17.48	20.32	20.24	23.43		29.43		23.98		
VHT20	MCS0	2	60	5300	17.48	17.48	20.08	20.64	23.43		29.43		23.98		
VHT20	MCS0	2	64	5320	17.43	17.53	20.48	21.04	23.41		29.41		23.98		
VHT40	MCS0	2	54	5270	36.06	36.06	40.80	40.64	23.98		30.00		23.98		
VHT40	MCS0	2	62	5310	36.06	36.06	40.80	40.64	23.98		30.00		23.98		
VHT80	MCS0	2	58	5290	75.04	74.93	81.92	81.28	23.98		30.00		23.98		

TEST RESULTS DATA
Average Power Table

FCC U-NII-2A MIMO															
Mod.	Data Rate	N _{TX}	CH.	Freq. (MHz)	Duty Factor (dB)		Average Conducted Power (dBm)			FCC Conducted Power Limit (dBm)		DG (dBi)		EIRP Power Limit (dBm)	Pass/Fail
					Ant 6	Ant 7	Ant 6	Ant 7	SUM	Ant 6	Ant 7	Ant 6	Ant 7		
11a	6Mbps	2	52	5260	0.66	0.66	18.10	17.80	20.96	23.81		3.86		30	Pass
11a	6Mbps	2	60	5300	0.66	0.66	18.60	18.10	21.37	23.85		3.86		30	Pass
11a	6Mbps	2	64	5320	0.66	0.66	18.60	18.20	21.41	23.89		3.86		30	Pass
HT20	MCS0	2	52	5260	0.66	0.65	18.80	18.50	21.66	23.98		3.86		30	Pass
HT20	MCS0	2	60	5300	0.66	0.65	19.60	19.60	22.61	23.98		3.86		30	Pass
HT20	MCS0	2	64	5320	0.66	0.65	19.50	19.70	22.61	23.98		3.86		30	Pass
HT40	MCS0	2	54	5270	0.66	0.66	19.70	19.50	22.61	23.98		3.86		30	Pass
HT40	MCS0	2	62	5310	0.66	0.66	16.50	16.70	19.61	23.98		3.86		30	Pass
VHT20	MCS0	2	52	5260	0.67	0.65	18.80	18.30	21.57	23.98		3.86		30	Pass
VHT20	MCS0	2	60	5300	0.67	0.65	19.30	18.90	22.11	23.98		3.86		30	Pass
VHT20	MCS0	2	64	5320	0.67	0.65	17.80	17.20	20.52	23.98		3.86		30	Pass
VHT40	MCS0	2	54	5270	0.66	0.66	19.50	19.10	22.31	23.98		3.86		30	Pass
VHT40	MCS0	2	62	5310	0.66	0.66	16.60	16.40	19.51	23.98		3.86		30	Pass
VHT80	MCS0	2	58	5290	0.67	0.67	17.10	17.00	20.06	23.98		3.86		30	Pass

TEST RESULTS DATA
Power Spectral Density

U-NII-2A MIMO														
Mod.	Data Rate	N _{rx}	CH.	Freq. (MHz)	Duty Factor (dB)		Average Power Density with Duty Factor (dBm/MHz)			Average PSD Limit (dBm/MHz)		DG (dBi)		Pass /Fail
					Ant 6	Ant 7	Ant 6	Ant 7	SUM	Ant 6	Ant 7	Ant 6	Ant 7	
11a	6Mbps	2	52	5260	0.66	0.66	-			10.54	11.00	5.74		Pass
11a	6Mbps	2	60	5300	0.66	0.66				10.62	11.00	5.74		Pass
11a	6Mbps	2	64	5320	0.66	0.66				10.95	11.00	5.74		Pass
VHT20	MCS0	2	52	5260	0.67	0.65				10.44	11.00	5.74		Pass
VHT20	MCS0	2	60	5300	0.67	0.65				10.25	11.00	5.74		Pass
VHT20	MCS0	2	64	5320	0.67	0.65				10.58	11.00	5.74		Pass
VHT40	MCS0	2	54	5270	0.66	0.66				8.17	11.00	5.74		Pass
VHT40	MCS0	2	62	5310	0.66	0.66				6.09	11.00	5.74		Pass
VHT80	MCS0	2	58	5290	0.67	0.67				3.99	11.00	5.74		Pass

TEST RESULTS DATA
26dB and 99% OBW

U-NII-2C MIMO																
Mod.	Data Rate	N _{TX}	CH.	Freq. (MHz)	99% Bandwidth In U-NII 2C (MHz)		26 dB Bandwidth In U-NII 2C (MHz)		IC 99% Bandwidth Power Limit (dBm)		IC 99% Bandwidth EIRP Limit (dBm)		FCC 26dB Bandwidth Power Limit (dBm)		6 dB Bandwidth for Straddle Channel (MHz)	
					Ant 6	Ant 7	Ant 6	Ant 7	Ant 6	Ant 7	Ant 6	Ant 7	Ant 6	Ant 7	Ant 6	Ant 7
11a	6Mbps	2	100	5500	16.33	16.38	19.68	19.52	23.13	29.13	23.90	----	----			
11a	6Mbps	2	116	5580	16.28	16.33	19.20	19.28	23.12	29.12	23.83	----	----			
11a	6Mbps	2	140	5700	16.33	16.38	19.44	19.60	23.13	29.13	23.89	----	----			
VHT20	MCS0	2	100	5500	17.48	17.53	20.56	20.40	23.43	29.43	23.98	----	----			
VHT20	MCS0	2	116	5580	17.48	17.53	20.48	20.32	23.43	29.43	23.98	----	----			
VHT20	MCS0	2	140	5700	17.48	17.53	20.56	20.56	23.43	29.43	23.98	----	----			
VHT40	MCS0	2	102	5510	36.06	36.06	40.80	40.64	23.98	30.00	23.98	----	----			
VHT40	MCS0	2	110	5550	36.06	36.06	40.48	40.64	23.98	30.00	23.98	----	----			
VHT40	MCS0	2	134	5670	36.06	36.06	40.80	40.80	23.98	30.00	23.98	----	----			
VHT80	MCS0	2	106	5530	75.04	75.04	82.88	82.24	23.98	30.00	23.98	----	----			
VHT80	MCS0	2	122	5610	75.04	75.04	82.24	81.60	23.98	30.00	23.98	----	----			
VHT160	MCS0	2	114	5570	154.41	154.17	166.08	165.12	23.98	30.00	23.98	----	----			

U-NII-2C straddle channel MIMO																
Mod.	Data Rate	N _{TX}	CH.	Freq. (MHz)	99% Bandwidth In U-NII 2C (MHz)		26 dB Bandwidth In U-NII 2C (MHz)		IC 99% Bandwidth Power Limit (dBm)		IC 99% Bandwidth EIRP Limit (dBm)		FCC 26dB Bandwidth Power Limit (dBm)		6 dB Bandwidth for Straddle Channel (MHz)	
					Ant 6	Ant 7	Ant 6	Ant 7	Ant 6	Ant 7	Ant 6	Ant 7	Ant 6	Ant 7	Ant 6	Ant 7
11a	6Mbps	2	144	5720	13.14	13.19	14.84	14.68	22.19	28.19	22.67	3.2	2.6			
VHT20	MCS0	2	144	5720	13.74	13.79	15.40	15.32	22.38	28.38	22.85	1.9	2.6			
VHT40	MCS0	2	142	5710	32.98	33.08	35.48	35.32	23.98	30.00	23.98	2.64	2.64			
VHT80	MCS0	2	138	5690	72.64	72.64	76.28	75.32	23.98	30.00	23.98	2.76	2.76			
6dB Bandwidth Limit \geq 500kHz													Pass			

TEST RESULTS DATA
Average Power Table

FCC U-NII-2C MIMO															
Mod.	Data Rate	N _{TX}	CH.	Freq. (MHz)	Duty Factor (dB)		Average Conducted Power (dBm)			FCC Conducted Power Limit (dBm)		DG (dBi)		EIRP Power Limit (dBm)	Pass/Fail
					Ant 6	Ant 7	Ant 6	Ant 7	SUM	Ant 6	Ant 7	Ant 6	Ant 7		
11a	6Mbps	2	100	5500	0.66	0.66	18.40	18.10	21.26	23.90		3.80		30	Pass
11a	6Mbps	2	116	5580	0.66	0.66	18.10	18.10	21.11	23.83		3.80		30	Pass
11a	6Mbps	2	140	5700	0.66	0.66	18.00	18.10	21.06	23.89		3.80		30	Pass
HT20	MCS0	2	100	5500	0.66	0.65	18.50	18.20	21.36	23.98		3.80		30	Pass
HT20	MCS0	2	116	5580	0.66	0.65	18.40	18.20	21.31	23.98		3.80		30	Pass
HT20	MCS0	2	140	5700	0.66	0.65	18.10	18.10	21.11	23.98		3.80		30	Pass
HT40	MCS0	2	102	5510	0.66	0.66	18.80	18.50	21.66	23.98		3.80		30	Pass
HT40	MCS0	2	110	5550	0.66	0.66	19.10	18.90	22.01	23.98		3.80		30	Pass
HT40	MCS0	2	134	5670	0.66	0.66	18.80	18.50	21.66	23.98		3.80		30	Pass
VHT20	MCS0	2	100	5500	0.67	0.65	18.60	18.30	21.46	23.98		3.80		30	Pass
VHT20	MCS0	2	116	5580	0.67	0.65	18.50	18.30	21.41	23.98		3.80		30	Pass
VHT20	MCS0	2	140	5700	0.67	0.65	18.20	18.20	21.21	23.98		3.80		30	Pass
VHT40	MCS0	2	102	5510	0.66	0.66	18.10	17.90	21.01	23.98		3.80		30	Pass
VHT40	MCS0	2	110	5550	0.66	0.66	18.90	18.60	21.76	23.98		3.80		30	Pass
VHT40	MCS0	2	134	5670	0.66	0.66	18.50	18.30	21.41	23.98		3.80		30	Pass
VHT80	MCS0	2	106	5530	0.67	0.67	17.20	17.00	20.11	23.98		3.80		30	Pass
VHT80	MCS0	2	122	5610	0.67	0.67	18.10	17.80	20.96	23.98		3.80		30	Pass
VHT160	MCS0	2	114	5570	0.67	0.67	14.70	14.80	17.76	23.98		3.80		30	Pass

FCC U-NII-2C straddle channel MIMO															
Mod.	Data Rate	N _{TX}	CH.	Freq. (MHz)	Duty Factor (dB)		Average Conducted Power (dBm)			FCC Conducted Power Limit (dBm)		DG (dBi)		EIRP Power Limit (dBm)	Pass/Fail
					Ant 6	Ant 7	Ant 6	Ant 7	SUM	Ant 6	Ant 7	Ant 6	Ant 7		
11a	6Mbps	2	144	5720	0.66	0.66	18.10	18.00	21.06	22.67		3.80		30	Pass
HT20	MCS0	2	144	5720	0.66	0.65	18.40	18.20	21.31	23.98		3.80		30	Pass
HT40	MCS0	2	142	5710	0.66	0.66	20.00	19.80	22.91	23.98		3.80		30	Pass
VHT20	MCS0	2	144	5720	0.67	0.65	18.50	18.30	21.41	22.85		3.80		30	Pass
VHT40	MCS0	2	142	5710	0.66	0.66	19.50	19.50	22.51	23.98		3.80		30	Pass
VHT80	MCS0	2	138	5690	0.67	0.67	19.60	20.00	22.81	23.98		3.80		30	Pass

TEST RESULTS DATA
Power Spectral Density

U-NII-2C MIMO														
Mod.	Data Rate	N _{rx}	CH.	Freq. (MHz)	Duty Factor (dB)		Average Power Density with Duty Factor (dBm/MHz)			Average PSD Limit (dBm/MHz)		DG (dBi)		Pass /Fail
					Ant 6	Ant 7	Ant 6	Ant 7	SUM	Ant 6	Ant 7	Ant 6	Ant 7	
11a	6Mbps	2	100	5500	0.66	0.66	-	-	-	10.42	10.56	6.44	Pass	
11a	6Mbps	2	116	5580	0.66	0.66				10.47	10.56	6.44	Pass	
11a	6Mbps	2	140	5700	0.66	0.66				10.31	10.56	6.44	Pass	
VHT20	MCS0	2	100	5500	0.67	0.65				10.34	10.56	6.44	Pass	
VHT20	MCS0	2	116	5580	0.67	0.65				10.18	10.56	6.44	Pass	
VHT20	MCS0	2	140	5700	0.67	0.65				10.19	10.56	6.44	Pass	
VHT40	MCS0	2	102	5510	0.66	0.66				7.24	10.56	6.44	Pass	
VHT40	MCS0	2	110	5550	0.66	0.66				8.01	10.56	6.44	Pass	
VHT40	MCS0	2	134	5670	0.66	0.66				7.90	10.56	6.44	Pass	
VHT80	MCS0	2	106	5530	0.67	0.67				3.56	10.56	6.44	Pass	
VHT80	MCS0	2	122	5610	0.67	0.67				4.94	10.56	6.44	Pass	
VHT160	MCS0	2	114	5570	0.67	0.67				-1.55	10.56	6.44	Pass	

U-NII-2C straddle channel MIMO														
Mod.	Data Rate	N _{rx}	CH.	Freq. (MHz)	Duty Factor (dB)		Average Power Density (dBm/MHz)			Average PSD Limit (dBm/MHz)		DG (dBi)		Pass /Fail
					Ant 6	Ant 7	Ant 6	Ant 7	SUM	Ant 6	Ant 7	Ant 6	Ant 7	
11a	6Mbps	2	144	5720	0.66	0.66	-	-	-	10.28	10.56	6.44	Pass	
VHT20	MCS0	2	144	5720	0.67	0.65				10.18	10.56	6.44	Pass	
VHT40	MCS0	2	142	5710	0.66	0.66				8.35	10.56	6.44	Pass	
VHT80	MCS0	2	138	5690	0.67	0.67				5.36	10.56	6.44	Pass	

TEST RESULTS DATA
26dB and 99% OBW

U-NII-1 MIMO														
Mod.	Data Rate	N _{TX}	CH.	Freq. (MHz)	RU Config	99% Bandwidth (MHz)		26 dB Bandwidth (MHz)		IC 99% Bandwidth Power Limit (dBm)		IC 99% Bandwidth EIRP Limit (dBm)		Note
						Ant 6	Ant 7	Ant 6	Ant 7	Ant 6	Ant 7	Ant 6	Ant 7	
HE20	MCS0	2	36	5180	Full	18.88	18.83	21.28	21.04	-	-	22.75	-	-
HE20	MCS0	2	44	5220	Full	18.88	18.88	21.36	21.04	-	-	22.76	-	-
HE20	MCS0	2	48	5240	Full	18.88	18.83	20.88	21.04	-	-	22.75	-	-
HE40	MCS0	2	38	5190	Full	37.66	37.76	41.60	41.44	-	-	23.01	-	-
HE40	MCS0	2	46	5230	Full	37.86	37.76	41.76	41.76	-	-	23.01	-	-
HE80	MCS0	2	42	5210	Full	76.84	76.84	81.92	81.92	-	-	23.01	-	-
HE160	MCS0	2	50	5250	Full	155.84	155.84	164.64	165.12	-	-	23.01	-	-

TEST RESULTS DATA
Average Power Table

FCC U-NII-1 MIMO															
Mod.	Data Rate	N _{TX}	CH.	Freq. (MHz)	RU Config	Duty Factor (dB)		Average Conducted Power (dBm)			FCC Conducted Power Limit (dBm)		DG (dBi)		Pass/Fail
						Ant 6	Ant 7	Ant 6	Ant 7	SUM	Ant 6	Ant 7	Ant 6	Ant 7	
HE20	MCS0	2	36	5180	Full	0.66	0.66	18.60	18.20	21.41	24.00	3.86		Pass	
HE20	MCS0	2	36	5180	26/0	0.64	0.65	10.50	10.40	13.46	24.00	3.86		Pass	
HE20	MCS0	2	36	5180	52/37	0.63	0.65	13.30	13.60	16.46	24.00	3.86		Pass	
HE20	MCS0	2	36	5180	106/53	0.67	0.68	14.50	14.80	17.66	24.00	3.86		Pass	
HE20	MCS0	2	44	5220	Full	0.66	0.66	19.10	18.90	22.01	24.00	3.86		Pass	
HE20	MCS0	2	44	5220	26/4	0.64	0.65	11.90	12.10	15.01	24.00	3.86		Pass	
HE20	MCS0	2	44	5220	52/38	0.63	0.65	13.50	13.70	16.61	24.00	3.86		Pass	
HE20	MCS0	2	44	5220	106/53	0.67	0.68	17.10	16.90	20.01	24.00	3.86		Pass	
HE20	MCS0	2	48	5240	Full	0.66	0.66	19.00	18.90	21.96	24.00	3.86		Pass	
HE20	MCS0	2	48	5240	26/8	0.64	0.65	10.70	10.40	13.56	24.00	3.86		Pass	
HE20	MCS0	2	48	5240	52/40	0.63	0.65	13.30	13.60	16.46	24.00	3.86		Pass	
HE20	MCS0	2	48	5240	106/54	0.67	0.68	16.70	16.60	19.66	24.00	3.86		Pass	
HE40	MCS0	2	38	5190	Full	0.67	0.65	17.60	17.30	20.46	24.00	3.86		Pass	
HE40	MCS0	2	38	5190	242/61	0.67	0.67	14.40	14.70	17.56	24.00	3.86		Pass	
HE40	MCS0	2	46	5230	Full	0.67	0.65	19.70	19.10	22.42	24.00	3.86		Pass	
HE40	MCS0	2	46	5230	242/62	0.67	0.67	18.30	17.70	21.02	24.00	3.86		Pass	
HE80	MCS0	2	42	5210	Full	0.67	0.67	17.70	17.30	20.51	24.00	3.86		Pass	
HE80	MCS0	2	42	5210	484/65	0.67	0.66	14.40	14.60	17.51	24.00	3.86		Pass	
HE160	MCS0	2	50	5250	Full	0.67	0.67	13.10	13.20	16.16	24.00	3.86		Pass	
HE160	MCS0	2	50	5250	996/67	0.67	0.67	12.60	12.30	15.46	24.00	3.86		Pass	

TEST RESULTS DATA
Power Spectral Density

FCC U-NII-1 MIMO															
Mod.	Data Rate	N _{TX}	CH.	Freq. (MHz)	RU Config	Duty Factor (dB)		Average Power Density with Duty Factor (dBm/MHz)			Average PSD Limit (dBm/MHz)		DG (dBi)		Pass /Fail
						Ant 6	Ant 7	Ant 6	Ant 7	SUM	Ant 6	Ant 7	Ant 6	Ant 7	
HE20	MCS0	2	36	5180	Full	0.66	0.66			10.46	11.00	5.76		Pass	
HE20	MCS0	2	36	5180	26/0	0.64	0.65			10.23	11.00	5.76		Pass	
HE20	MCS0	2	36	5180	52/37	0.63	0.65			10.17	11.00	5.76		Pass	
HE20	MCS0	2	36	5180	106/53	0.67	0.68			8.88	11.00	5.76		Pass	
HE20	MCS0	2	44	5220	Full	0.66	0.66			10.57	11.00	5.76		Pass	
HE20	MCS0	2	44	5220	26/4	0.64	0.65			10.50	11.00	5.76		Pass	
HE20	MCS0	2	44	5220	52/38	0.63	0.65			10.11	11.00	5.76		Pass	
HE20	MCS0	2	44	5220	106/53	0.67	0.68			10.56	11.00	5.76		Pass	
HE20	MCS0	2	48	5240	Full	0.66	0.66			10.71	11.00	5.76		Pass	
HE20	MCS0	2	48	5240	26/8	0.64	0.65			10.51	11.00	5.76		Pass	
HE20	MCS0	2	48	5240	52/40	0.63	0.65			10.45	11.00	5.76		Pass	
HE20	MCS0	2	48	5240	106/54	0.67	0.68			10.51	11.00	5.76		Pass	
HE40	MCS0	2	38	5190	Full	0.67	0.65			6.86	11.00	5.76		Pass	
HE40	MCS0	2	38	5190	242/61	0.67	0.67			4.97	11.00	5.76		Pass	
HE40	MCS0	2	46	5230	Full	0.67	0.65			8.67	11.00	5.76		Pass	
HE40	MCS0	2	46	5230	242/62	0.67	0.67			8.58	11.00	5.76		Pass	
HE80	MCS0	2	42	5210	Full	0.67	0.67			4.52	11.00	5.76		Pass	
HE80	MCS0	2	42	5210	484/65	0.67	0.66			1.76	11.00	5.76		Pass	
HE160	MCS0	2	50	5250	Full	0.67	0.67			-2.73	11.00	5.76		Pass	
HE160	MCS0	2	50	5250	996/67	0.67	0.67			-2.84	11.00	5.76		Pass	

TEST RESULTS DATA
26dB and 99% OBW

U-NII-2A MIMO																
Mod.	Data Rate	N _{TX}	CH.	Freq. (MHz)	RU Config	99% Bandwidth (MHz)		26 dB Bandwidth (MHz)		IC 99% Bandwidth Power Limit (dBm)		IC 99% Bandwidth EIRP Limit (dBm)		FCC 26dB Bandwidth Power Limit (dBm)		Note
						Ant 6	Ant 7	Ant 6	Ant 7	Ant 6	Ant 7	Ant 6	Ant 7	Ant 6	Ant 7	
HE20	MCS0	2	52	5260	Full	18.83	18.83	21.20	21.20	23.75		29.75		23.98		
HE20	MCS0	2	60	5300	Full	18.88	18.83	20.96	20.80	23.75		29.75		23.98		
HE20	MCS0	2	64	5320	Full	18.83	18.88	21.04	20.56	23.75		29.75		23.98		
HE40	MCS0	2	54	5270	Full	37.76	37.76	41.28	41.60	23.98		30.00		23.98		
HE40	MCS0	2	62	5310	Full	37.76	37.76	41.60	41.60	23.98		30.00		23.98		
HE80	MCS0	2	58	5290	Full	76.84	76.84	82.24	81.92	23.98		30.00		23.98		

TEST RESULTS DATA
Average Power Table

FCC U-NII-2A MIMO																
Mod.	Data Rate	N _{TX}	CH.	Freq. (MHz)	RU Config	Duty Factor (dB)		Average Conducted Power (dBm)			FCC Conducted Power Limit (dBm)		DG (dBi)		EIRP Power Limit (dBm)	Pass/Fail
						Ant 6	Ant 7	Ant 6	Ant 7	SUM	Ant 6	Ant 7	Ant 6	Ant 7		
HE20	MCS0	2	52	5260	Full	0.66	0.66	18.90	18.50	21.71	23.98	3.86	30	Pass		
HE20	MCS0	2	52	5260	26/0	0.64	0.65	10.70	10.30	13.51	23.98	3.86	30	Pass		
HE20	MCS0	2	52	5260	52/37	0.63	0.65	13.50	13.90	16.71	23.98	3.86	30	Pass		
HE20	MCS0	2	52	5260	106/53	0.67	0.68	16.20	16.30	19.26	23.98	3.86	30	Pass		
HE20	MCS0	2	60	5300	Full	0.66	0.66	19.40	19.10	22.26	23.98	3.86	30	Pass		
HE20	MCS0	2	60	5300	26/4	0.64	0.65	11.90	12.20	15.06	23.98	3.86	30	Pass		
HE20	MCS0	2	60	5300	52/38	0.63	0.65	13.60	14.10	16.87	23.98	3.86	30	Pass		
HE20	MCS0	2	60	5300	106/53	0.67	0.68	16.50	16.70	19.61	23.98	3.86	30	Pass		
HE20	MCS0	2	64	5320	Full	0.66	0.66	17.90	17.40	20.67	23.98	3.86	30	Pass		
HE20	MCS0	2	64	5320	26/8	0.64	0.65	9.60	9.60	12.61	23.98	3.86	30	Pass		
HE20	MCS0	2	64	5320	52/40	0.63	0.65	12.30	12.50	15.41	23.98	3.86	30	Pass		
HE20	MCS0	2	64	5320	106/54	0.67	0.68	14.30	14.80	17.57	23.98	3.86	30	Pass		
HE40	MCS0	2	54	5270	Full	0.67	0.65	19.70	19.50	22.61	23.98	3.86	30	Pass		
HE40	MCS0	2	54	5270	242/61	0.67	0.67	17.70	17.60	20.66	23.98	3.86	30	Pass		
HE40	MCS0	2	62	5310	Full	0.67	0.65	16.80	16.70	19.76	23.98	3.86	30	Pass		
HE40	MCS0	2	62	5310	242/62	0.67	0.67	15.70	15.60	18.66	23.98	3.86	30	Pass		
HE80	MCS0	2	58	5290	Full	0.67	0.67	17.40	17.20	20.31	23.98	3.86	30	Pass		
HE80	MCS0	2	58	5290	484/66	0.67	0.66	13.00	13.30	16.16	23.98	3.86	30	Pass		
HE160	MCS0	2	50	5250	Full	0.67	0.67	13.10	13.20	16.16	23.98	3.86	30	Pass		
HE160	MCS0	2	50	5250	996/S67	0.67	0.67	11.00	10.70	13.86	23.98	3.86	30	Pass		

TEST RESULTS DATA
Power Spectral Density

U-NII-2A MIMO															
Mod.	Data Rate	N _{TX}	CH.	Freq. (MHz)	RU Config	Duty Factor (dB)		Average Power Density with Duty Factor (dBm/MHz)			Average PSD Limit (dBm/MHz)		DG (dBi)		Pass /Fail
						Ant 6	Ant 7	Ant 6	Ant 7	SUM	Ant 6	Ant 7	Ant 6	Ant 7	
HE20	MCS0	2	52	5260	Full	0.66	0.66			10.76	11.00	5.74		Pass	
HE20	MCS0	2	52	5260	26/0	0.64	0.65			10.55	11.00	5.74		Pass	
HE20	MCS0	2	52	5260	52/37	0.63	0.65			10.57	11.00	5.74		Pass	
HE20	MCS0	2	52	5260	106/53	0.67	0.68			10.44	11.00	5.74		Pass	
HE20	MCS0	2	60	5300	Full	0.66	0.66			10.79	11.00	5.74		Pass	
HE20	MCS0	2	60	5300	26/4	0.64	0.65			10.70	11.00	5.74		Pass	
HE20	MCS0	2	60	5300	52/38	0.63	0.65			10.58	11.00	5.74		Pass	
HE20	MCS0	2	60	5300	106/53	0.67	0.68			10.47	11.00	5.74		Pass	
HE20	MCS0	2	64	5320	Full	0.66	0.66			9.75	11.00	5.74		Pass	
HE20	MCS0	2	64	5320	26/8	0.64	0.65			9.65	11.00	5.74		Pass	
HE20	MCS0	2	64	5320	52/40	0.63	0.65			9.37	11.00	5.74		Pass	
HE20	MCS0	2	64	5320	106/54	0.67	0.68			8.40	11.00	5.74		Pass	
HE40	MCS0	2	54	5270	Full	0.67	0.65			8.50	11.00	5.74		Pass	
HE40	MCS0	2	54	5270	242/61	0.67	0.67			8.23	11.00	5.74		Pass	
HE40	MCS0	2	62	5310	Full	0.67	0.65			6.14	11.00	5.74		Pass	
HE40	MCS0	2	62	5310	242/62	0.67	0.67			5.98	11.00	5.74		Pass	
HE80	MCS0	2	58	5290	Full	0.67	0.67			4.24	11.00	5.74		Pass	
HE80	MCS0	2	58	5290	484/66	0.67	0.66			0.56	11.00	5.74		Pass	
HE160	MCS0	2	50	5250	Full	0.67	0.67			-2.73	11.00	5.74		Pass	
HE160	MCS0	2	50	5250	996/S67	0.67	0.67			-4.06	11.00	5.74		Pass	

TEST RESULTS DATA
26dB and 99% OBW

U-NII-2C MIMO																	
Mod.	Data Rate	N _{TX}	CH.	Freq. (MHz)	RU Config	99% Bandwidth In U-NII 2C (MHz)		26 dB Bandwidth In U-NII 2C (MHz)		IC 99% Bandwidth Power Limit (dBm)		IC 99% Bandwidth EIRP Limit (dBm)		FCC 26dB Bandwidth Power Limit (dBm)		6 dB Bandwidth for Straddle Channel (MHz)	
						Ant 6	Ant 7	Ant 6	Ant 7	Ant 6	Ant 7	Ant 6	Ant 7	Ant 6	Ant 7	Ant 6	Ant 7
HE20	MCS0	2	100	5500	Full	18.88	18.83	21.12	20.96	23.75	29.75	23.98	23.98	23.98	----	----	
HE20	MCS0	2	116	5580	Full	18.83	18.88	21.04	21.04	23.75	29.75	23.98	23.98	23.98	----	----	
HE20	MCS0	2	140	5700	Full	18.83	18.88	21.04	20.96	23.75	29.75	23.98	23.98	23.98	----	----	
HE40	MCS0	2	102	5510	Full	37.76	37.76	41.28	41.28	23.98	30.00	23.98	23.98	23.98	----	----	
HE40	MCS0	2	110	5550	Full	37.76	37.66	40.96	41.28	23.98	30.00	23.98	23.98	23.98	----	----	
HE40	MCS0	2	134	5670	Full	37.76	37.76	41.44	41.60	23.98	30.00	23.98	23.98	23.98	----	----	
HE80	MCS0	2	106	5530	Full	76.84	76.72	82.88	82.24	23.98	30.00	23.98	23.98	23.98	----	----	
HE80	MCS0	2	122	5610	Full	76.96	76.84	82.56	81.60	23.98	30.00	23.98	23.98	23.98	----	----	
HE160	MCS0	2	114	5570	Full	156.08	155.84	164.64	165.12	23.98	30.00	23.98	23.98	23.98	----	----	

U-NII-2C straddle channel MIMO																	
Mod.	Data Rate	N _{TX}	CH.	Freq. (MHz)	RU Config	99% Bandwidth In U-NII 2C (MHz)		26 dB Bandwidth In U-NII 2C (MHz)		IC 99% Bandwidth Power Limit (dBm)		IC 99% Bandwidth EIRP Limit (dBm)		FCC 26dB Bandwidth Power Limit (dBm)		6 dB Bandwidth for Straddle Channel (MHz)	
						Ant 6	Ant 7	Ant 6	Ant 7	Ant 6	Ant 7	Ant 6	Ant 7	Ant 6	Ant 7	Ant 6	Ant 7
HE20	MCS0	2	144	5720	Full	14.44	14.39	15.56	15.72	22.58	28.58	22.92	28.92	22.92	22.92	2.5	1.55
HE40	MCS0	2	142	5710	Full	33.88	33.88	35.80	35.64	23.98	30.00	23.98	23.98	23.98	23.98	3.18	2.64
HE80	MCS0	2	138	5690	Full	73.48	73.48	75.96	75.96	23.98	30.00	23.98	23.98	23.98	23.98	2.76	----
6dB Bandwidth Limit \geq 500kHz															Pass		

TEST RESULTS DATA
Average Power Table

FCC U-NII-2C MIMO																
Mod.	Data Rate	N _{TX}	CH.	Freq. (MHz)	RU Config	Duty Factor (dB)		Average Conducted Power (dBm)			FCC Conducted Power Limit (dBm)		DG (dBi)		EIRP Power Limit (dBm)	Pass/Fail
						Ant 6	Ant 7	Ant 6	Ant 7	SUM	Ant 6	Ant 7	Ant 6	Ant 7		
HE20	MCS0	2	100	5500	Full	0.66	0.66	18.80	18.60	21.71	23.98	3.80	30	Pass		
HE20	MCS0	2	100	5500	26/0	0.64	0.65	10.60	10.50	13.56	23.98	3.80	30	Pass		
HE20	MCS0	2	100	5500	52/37	0.63	0.65	13.50	13.80	16.66	23.98	3.80	30	Pass		
HE20	MCS0	2	100	5500	106/53	0.67	0.68	14.60	14.70	17.66	23.98	3.80	30	Pass		
HE20	MCS0	2	116	5580	Full	0.66	0.66	18.70	18.70	21.71	23.98	3.80	30	Pass		
HE20	MCS0	2	116	5580	26/4	0.64	0.65	10.60	10.90	13.76	23.98	3.80	30	Pass		
HE20	MCS0	2	116	5580	52/38	0.63	0.65	13.30	13.60	16.46	23.98	3.80	30	Pass		
HE20	MCS0	2	116	5580	106/53	0.67	0.68	16.60	16.60	19.61	23.98	3.80	30	Pass		
HE20	MCS0	2	140	5700	Full	0.66	0.66	18.40	18.60	21.51	23.98	3.80	30	Pass		
HE20	MCS0	2	140	5700	26/8	0.64	0.65	9.60	10.20	12.92	23.98	3.80	30	Pass		
HE20	MCS0	2	140	5700	52/40	0.63	0.65	13.30	13.50	16.41	23.98	3.80	30	Pass		
HE20	MCS0	2	140	5700	106/54	0.67	0.68	14.40	14.60	17.51	23.98	3.80	30	Pass		
HE40	MCS0	2	102	5510	Full	0.67	0.65	18.40	18.20	21.31	23.98	3.80	30	Pass		
HE40	MCS0	2	102	5510	242/61	0.67	0.67	16.10	16.10	19.11	23.98	3.80	30	Pass		
HE40	MCS0	2	110	5550	Full	0.67	0.65	19.20	19.00	22.11	23.98	3.80	30	Pass		
HE40	MCS0	2	110	5550	242/61	0.67	0.67	18.10	17.90	21.01	23.98	3.80	30	Pass		
HE40	MCS0	2	134	5670	Full	0.67	0.65	18.60	18.70	21.66	23.98	3.80	30	Pass		
HE40	MCS0	2	134	5670	242/62	0.67	0.67	15.30	15.90	18.62	23.98	3.80	30	Pass		
HE80	MCS0	2	106	5530	Full	0.67	0.67	17.20	17.00	20.11	23.98	3.80	30	Pass		
HE80	MCS0	2	106	5530	484/65	0.67	0.66	15.00	15.10	18.06	23.98	3.80	30	Pass		
HE80	MCS0	2	122	5610	Full	0.67	0.67	18.20	18.50	21.36	23.98	3.80	30	Pass		
HE80	MCS0	2	122	5610	484/66	0.67	0.66	14.00	14.10	17.06	23.98	3.80	30	Pass		
HE160	MCS0	2	114	5570	Full	0.67	0.67	15.00	15.10	18.06	23.98	3.80	30	Pass		
HE160	MCS0	2	114	5570	996/67	0.67	0.67	12.80	13.00	15.91	23.98	3.80	30	Pass		
HE160	MCS0	2	114	5570	996/S67	0.67	0.67	14.40	14.40	17.41	23.98	3.80	30	Pass		

FCC U-NII-2C straddle channel MIMO																
Mod.	Data Rate	N _{TX}	CH.	Freq. (MHz)	RU Config	Duty Factor (dB)		Average Conducted Power (dBm)			FCC Conducted Power Limit (dBm)		DG (dBi)		EIRP Power Limit (dBm)	Pass/Fail
						Ant 6	Ant 7	Ant 6	Ant 7	SUM	Ant 6	Ant 7	Ant 6	Ant 7		
HE20	MCS0	2	144	5720	Full	0.66	0.66	18.70	18.60	21.66	22.92	3.80	30	Pass		
HE20	MCS0	2	144	5720	26/8	0.64	0.65	9.80	10.20	13.01	22.92	3.80	30	Pass		
HE20	MCS0	2	144	5720	52/40	0.63	0.65	13.30	13.40	16.36	22.92	3.80	30	Pass		
HE20	MCS0	2	144	5720	106/54	0.67	0.68	16.40	16.50	19.46	22.92	3.80	30	Pass		
HE40	MCS0	2	142	5710	Full	0.67	0.65	19.90	19.90	22.91	23.98	3.80	30	Pass		
HE40	MCS0	2	142	5710	242/62	0.67	0.67	18.20	17.90	21.06	23.98	3.80	30	Pass		
HE80	MCS0	2	138	5690	Full	0.67	0.67	19.10	19.70	22.42	23.98	3.80	30	Pass		
HE80	MCS0	2	138	5690	484/66	0.67	0.66	17.80	17.70	20.76	23.98	3.80	30	Pass		

TEST RESULTS DATA
Power Spectral Density

U-NII-2C MIMO															
Mod.	Data Rate	N _{TX}	CH.	Freq. (MHz)	RU Config	Duty Factor (dB)		Average Power Density with Duty Factor (dBm/MHz)			Average PSD Limit (dBm/MHz)		DG (dBi)		Pass /Fail
						Ant 6	Ant 7	Ant 6	Ant 7	SUM	Ant 6	Ant 7	Ant 6	Ant 7	
HE20	MCS0	2	100	5500	Full	0.66	0.66	-	-	10.33	10.56	6.44	-	Pass	
HE20	MCS0	2	100	5500	26/0	0.64	0.65	-	-	10.06	10.56	6.44	-	Pass	
HE20	MCS0	2	100	5500	52/37	0.63	0.65	-	-	10.26	10.56	6.44	-	Pass	
HE20	MCS0	2	100	5500	106/53	0.67	0.68	-	-	8.12	10.56	6.44	-	Pass	
HE20	MCS0	2	116	5580	Full	0.66	0.66	-	-	10.38	10.56	6.44	-	Pass	
HE20	MCS0	2	116	5580	26/4	0.64	0.65	-	-	9.32	10.56	6.44	-	Pass	
HE20	MCS0	2	116	5580	52/38	0.63	0.65	-	-	10.14	10.56	6.44	-	Pass	
HE20	MCS0	2	116	5580	106/53	0.67	0.68	-	-	10.25	10.56	6.44	-	Pass	
HE20	MCS0	2	140	5700	Full	0.66	0.66	-	-	10.15	10.56	6.44	-	Pass	
HE20	MCS0	2	140	5700	26/8	0.64	0.65	-	-	9.83	10.56	6.44	-	Pass	
HE20	MCS0	2	140	5700	52/40	0.63	0.65	-	-	10.00	10.56	6.44	-	Pass	
HE20	MCS0	2	140	5700	106/54	0.67	0.68	-	-	8.12	10.56	6.44	-	Pass	
HE40	MCS0	2	102	5510	Full	0.67	0.65	-	-	7.53	10.56	6.44	-	Pass	
HE40	MCS0	2	102	5510	242/61	0.67	0.67	-	-	6.44	10.56	6.44	-	Pass	
HE40	MCS0	2	110	5550	Full	0.67	0.65	-	-	8.14	10.56	6.44	-	Pass	
HE40	MCS0	2	110	5550	242/61	0.67	0.67	-	-	7.98	10.56	6.44	-	Pass	
HE40	MCS0	2	134	5670	Full	0.67	0.65	-	-	7.94	10.56	6.44	-	Pass	
HE40	MCS0	2	134	5670	242/62	0.67	0.67	-	-	6.06	10.56	6.44	-	Pass	
HE80	MCS0	2	106	5530	Full	0.67	0.67	-	-	3.89	10.56	6.44	-	Pass	
HE80	MCS0	2	106	5530	484/65	0.67	0.66	-	-	2.77	10.56	6.44	-	Pass	
HE80	MCS0	2	122	5610	Full	0.67	0.67	-	-	5.17	10.56	6.44	-	Pass	
HE80	MCS0	2	122	5610	484/66	0.67	0.66	-	-	1.44	10.56	6.44	-	Pass	
HE160	MCS0	2	114	5570	Full	0.67	0.67	-	-	-1.02	10.56	6.44	-	Pass	
HE160	MCS0	2	114	5570	996/67	0.67	0.67	-	-	-2.72	10.56	6.44	-	Pass	
HE160	MCS0	2	114	5570	996/S67	0.67	0.67	-	-	-1.27	10.56	6.44	-	Pass	

U-NII-2C straddle channel MIMO															
Mod.	Data Rate	N _{TX}	CH.	Freq. (MHz)	RU Config	Duty Factor (dB)		Average Power Density (dBm/MHz)			Average PSD Limit (dBm/MHz)		DG (dBi)		Pass /Fail
						Ant 6	Ant 7	Ant 6	Ant 7	SUM	Ant 6	Ant 7	Ant 6	Ant 7	
HE20	MCS0	2	144	5720	Full	0.66	0.66	-	-	10.04	10.56	6.44	-	Pass	
HE20	MCS0	2	144	5720	26/8	0.64	0.65	-	-	9.75	10.56	6.44	-	Pass	
HE20	MCS0	2	144	5720	52/40	0.63	0.65	-	-	9.91	10.56	6.44	-	Pass	
HE20	MCS0	2	144	5720	106/54	0.67	0.68	-	-	10.01	10.56	6.44	-	Pass	
HE40	MCS0	2	142	5710	Full	0.67	0.65	-	-	8.69	10.56	6.44	-	Pass	
HE40	MCS0	2	142	5710	242/62	0.67	0.67	-	-	8.55	10.56	6.44	-	Pass	
HE80	MCS0	2	138	5690	Full	0.67	0.67	-	-	5.76	10.56	6.44	-	Pass	
HE80	MCS0	2	138	5690	484/66	0.67	0.66	-	-	5.23	10.56	6.44	-	Pass	



Test Result of 26dB & 99% Occupied Bandwidth

MIMO <Ant. 6+7>

<802.11a>

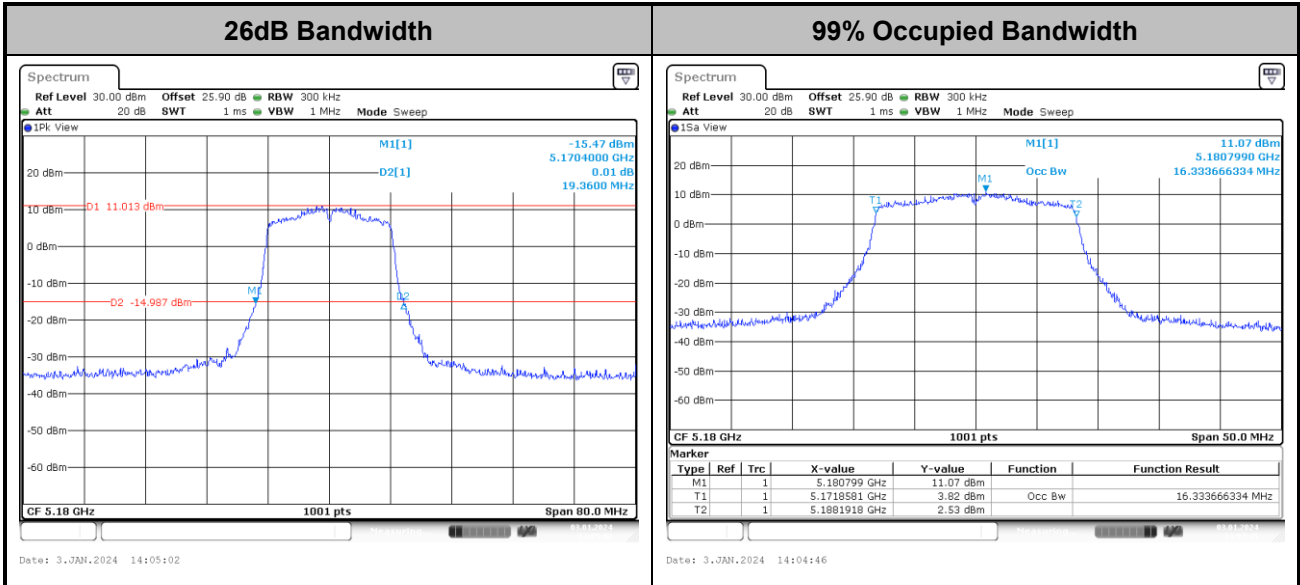

Note: The occupied channel bandwidth is maintained within the band of operation for all of the modulations.

<802.11ac VHT20>

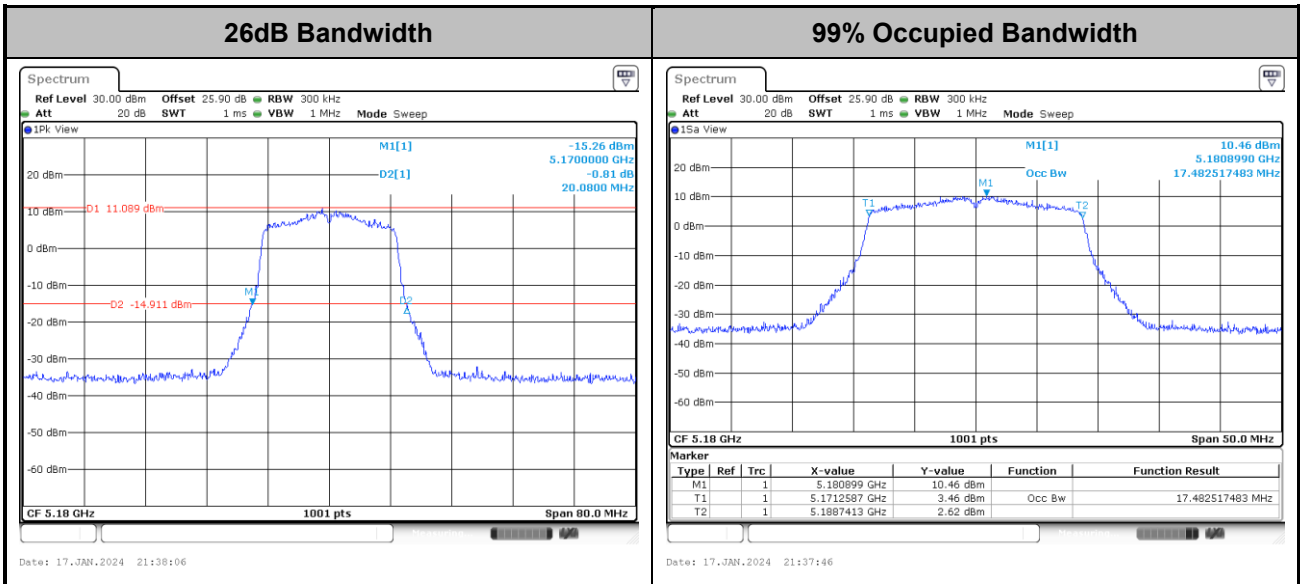

Note: The occupied channel bandwidth is maintained within the band of operation for all of the modulations.



<802.11ac VHT40>

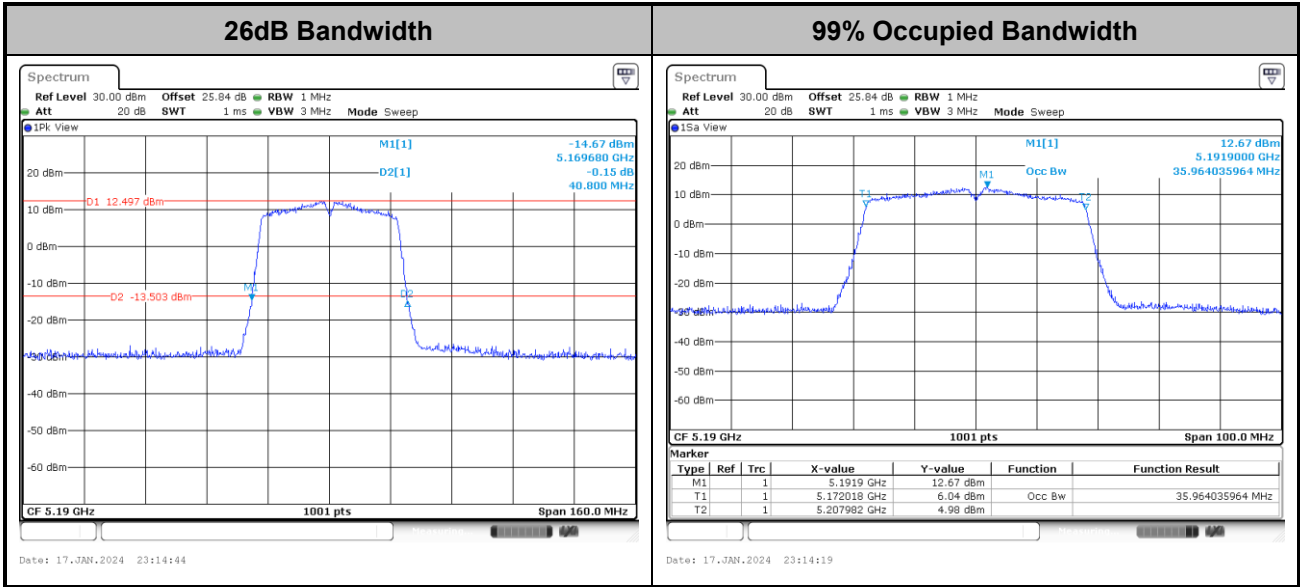

Note: The occupied channel bandwidth is maintained within the band of operation for all of the modulations.

<802.11ac VHT80>

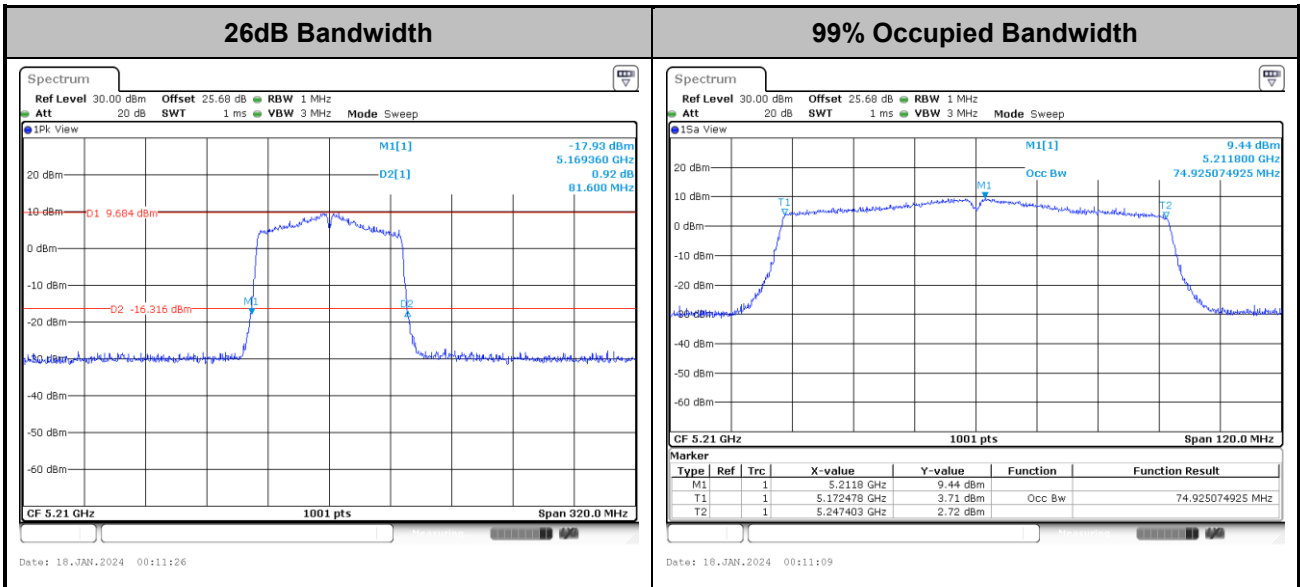

Note: The occupied channel bandwidth is maintained within the band of operation for all of the modulations.



<802.11ac VHT160>

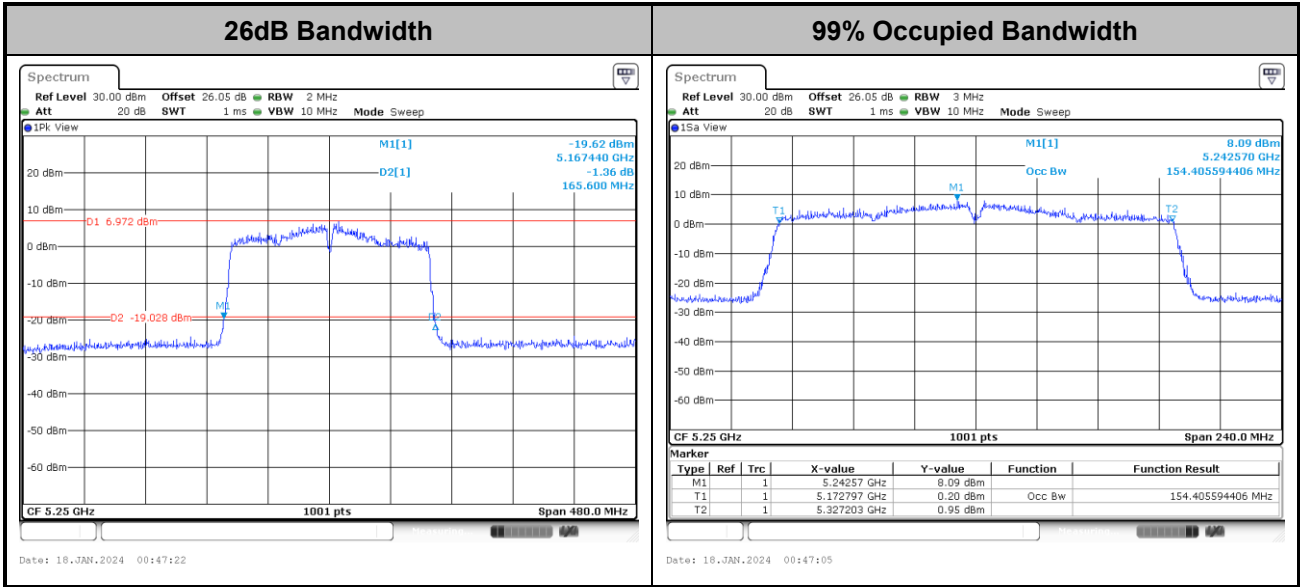

Note: The occupied channel bandwidth is maintained within the band of operation for all of the modulations.

<802.11ax HE20>

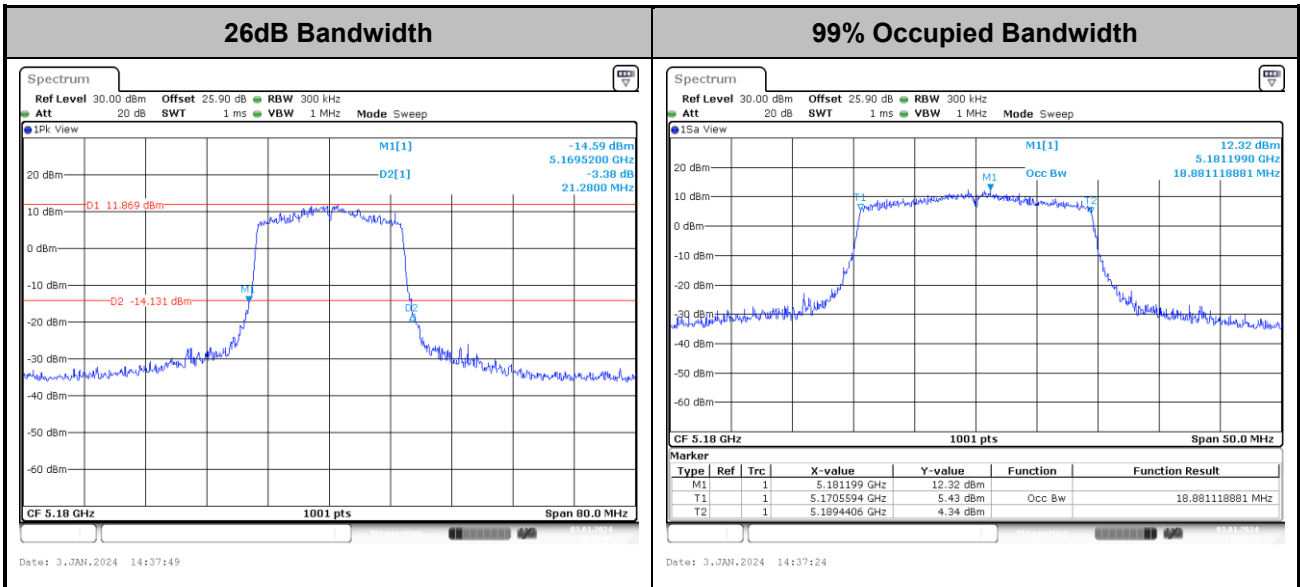

Note: The occupied channel bandwidth is maintained within the band of operation for all of the modulations.



<802.11ax HE40>

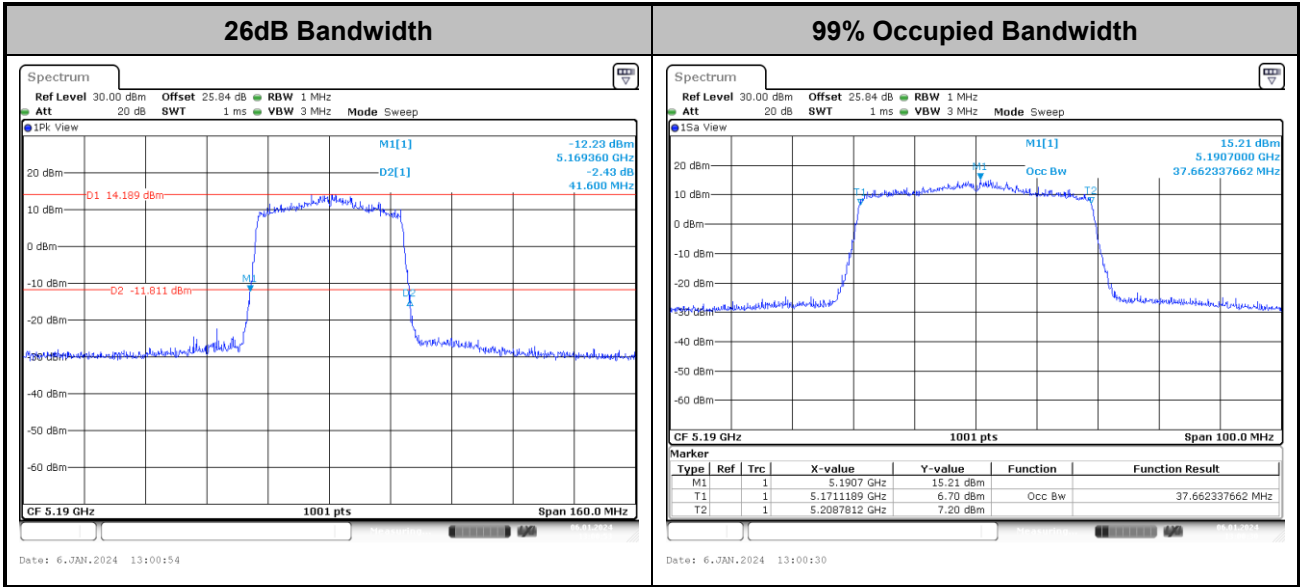

Note: The occupied channel bandwidth is maintained within the band of operation for all of the modulations.

<802.11ax HE80>

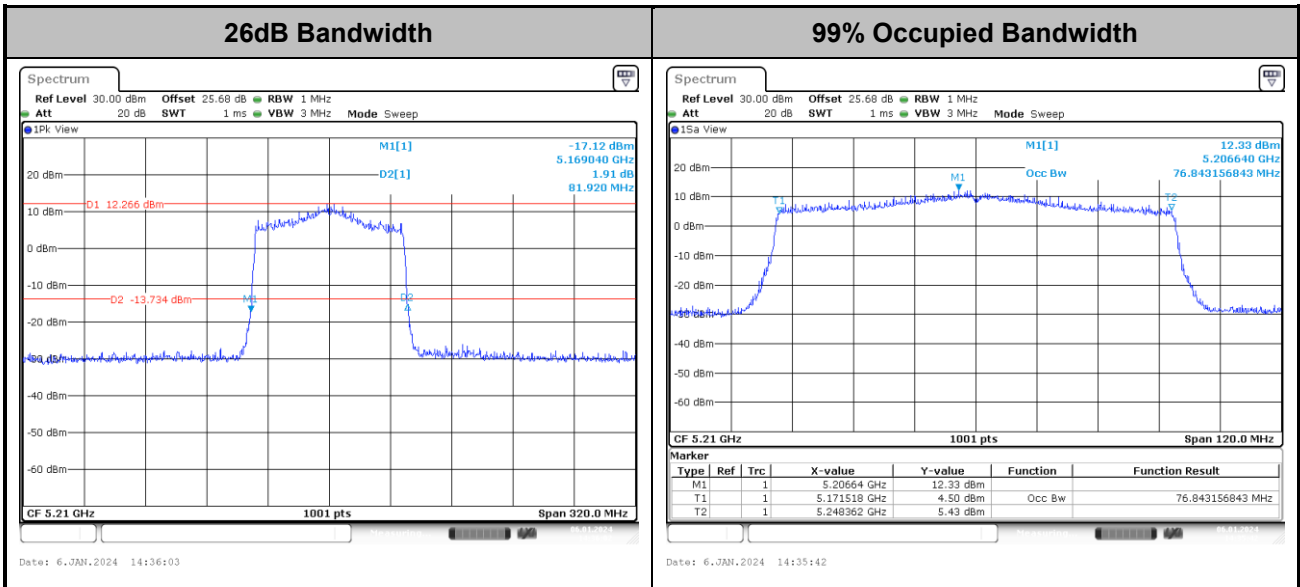

Note: The occupied channel bandwidth is maintained within the band of operation for all of the modulations.



<802.11ax HE160>

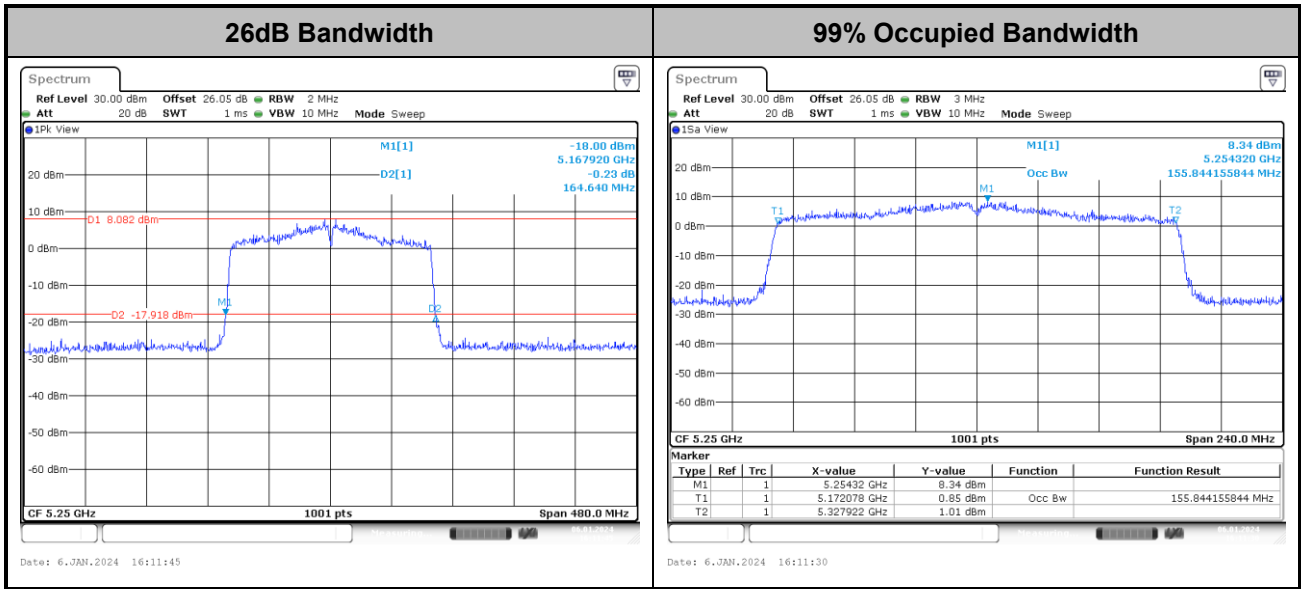

Note: The occupied channel bandwidth is maintained within the band of operation for all of the modulations.



Result of Power Spectral Density

<802.11a>

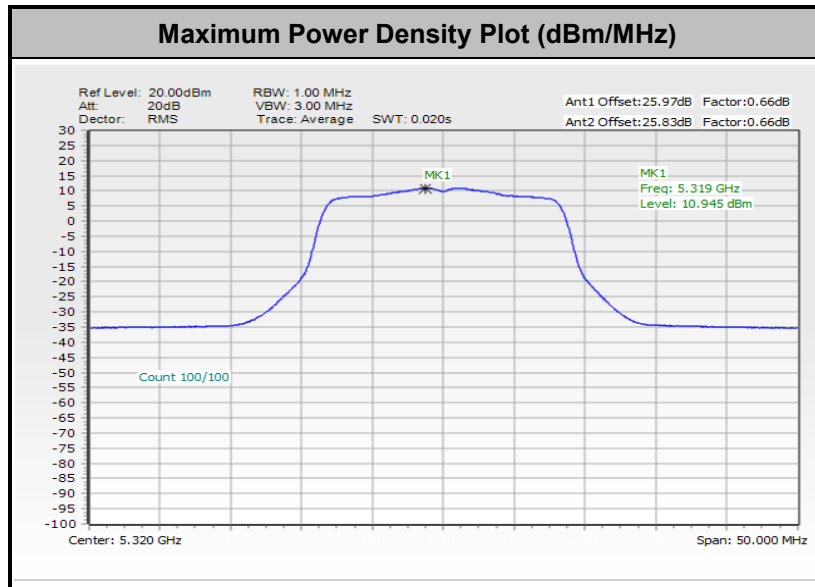

Remark: The test plot is showing a bin by bin combined result mathematically adds two traces.

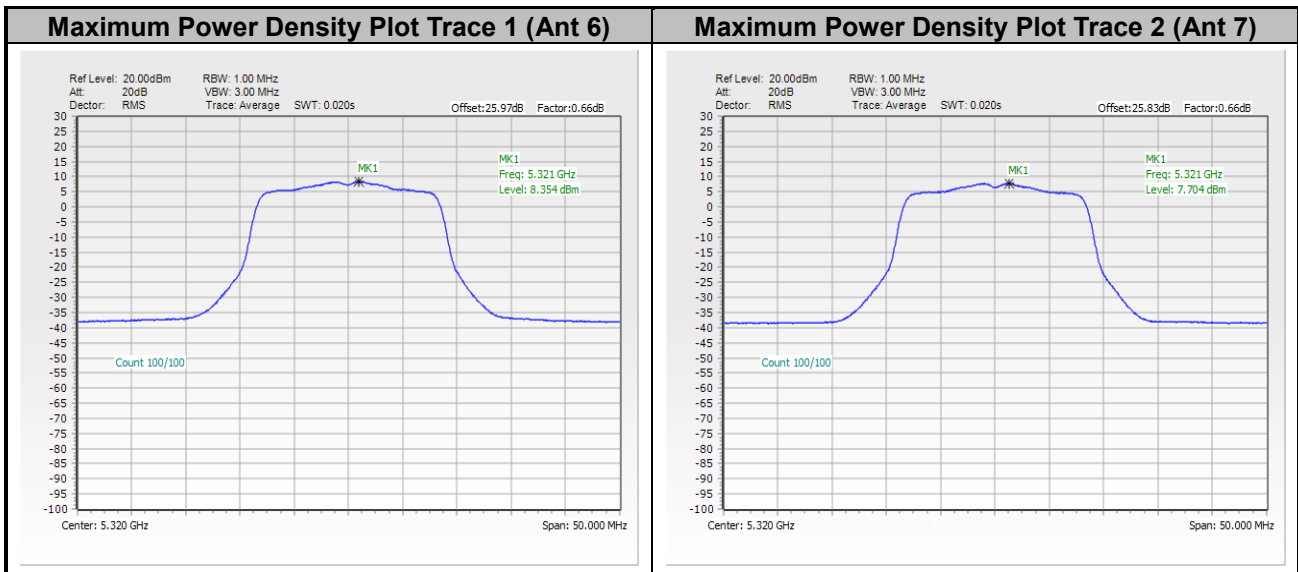



<802.11ac VHT20>

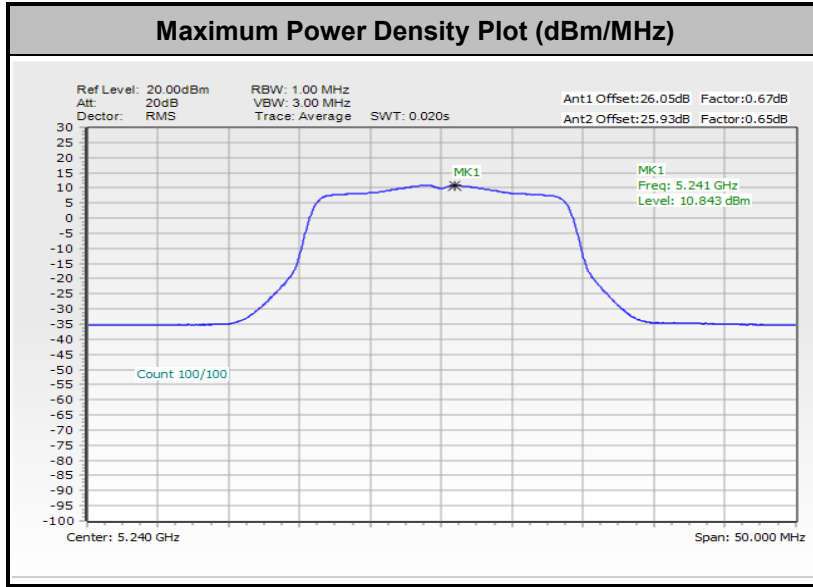

Remark: The test plot is showing a bin by bin combined result mathematically adds two traces.

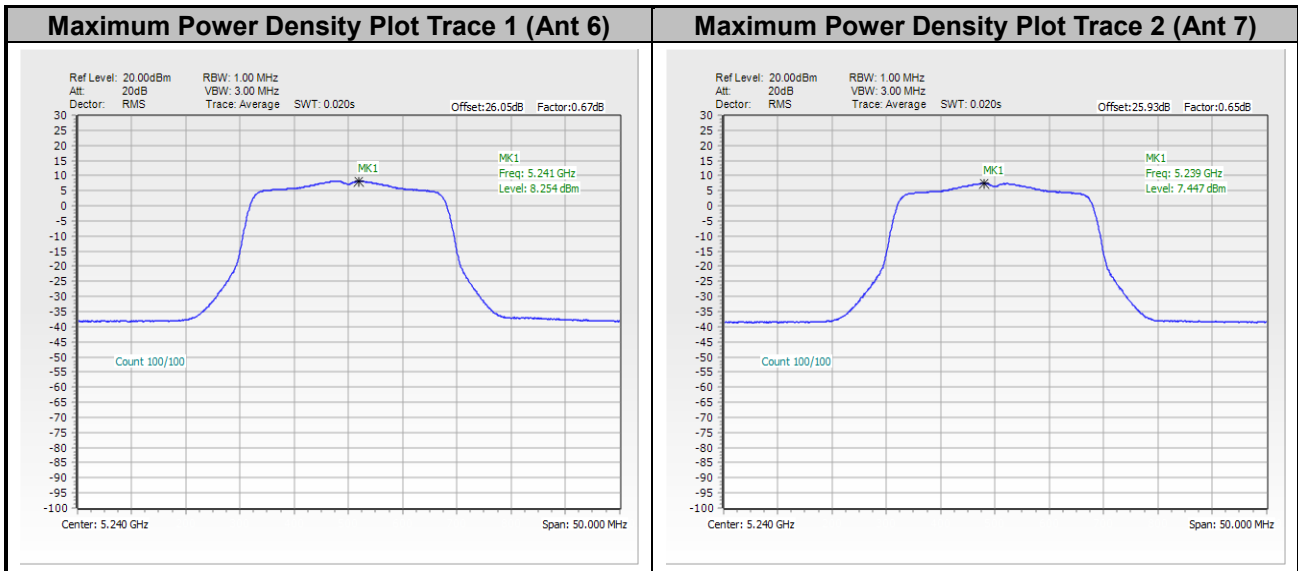



<802.11ac VHT40>

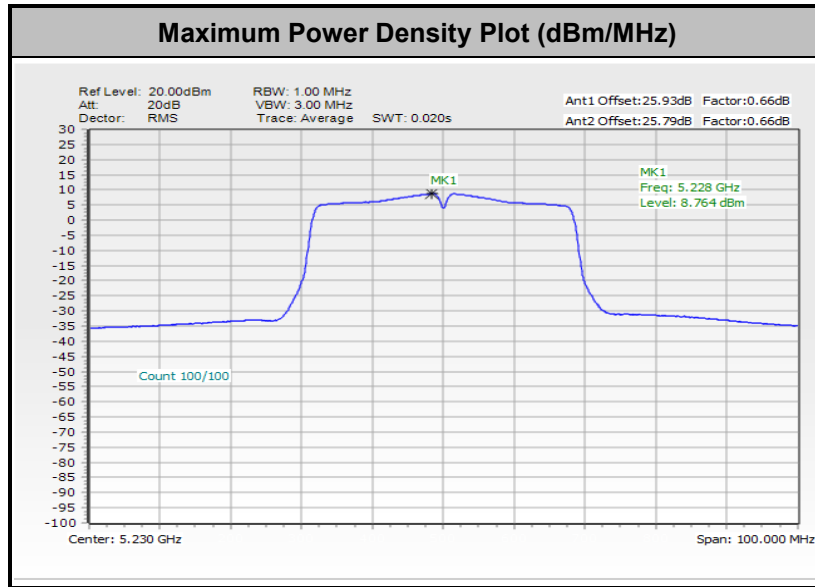

Remark: The test plot is showing a bin by bin combined result mathematically adds two traces.

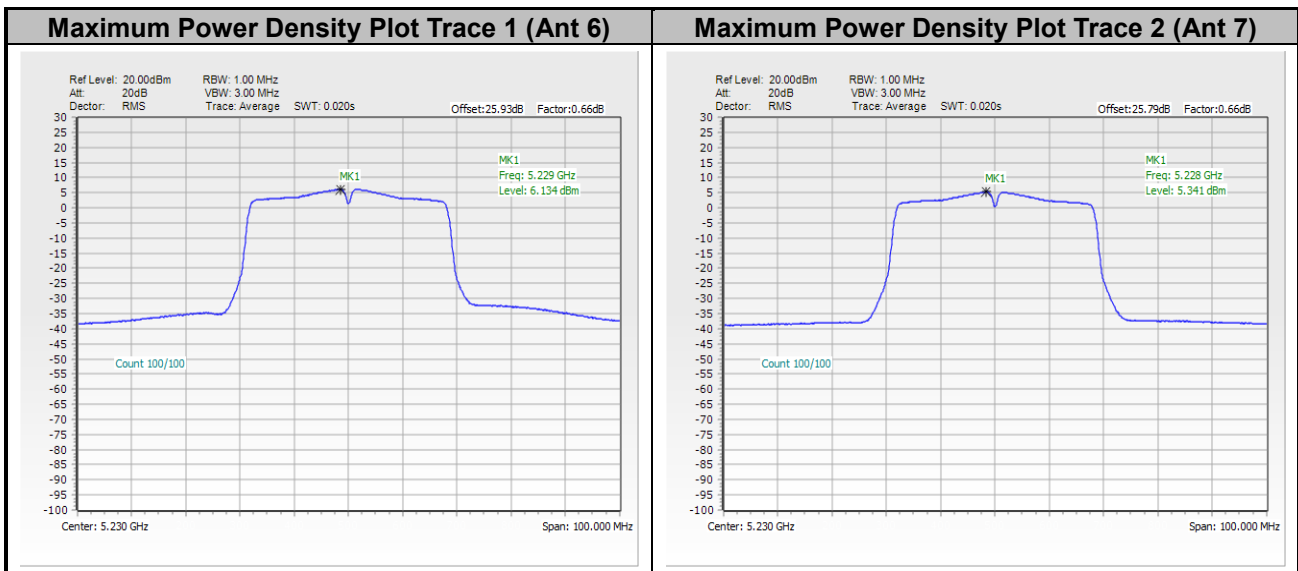



<802.11ac VHT80>

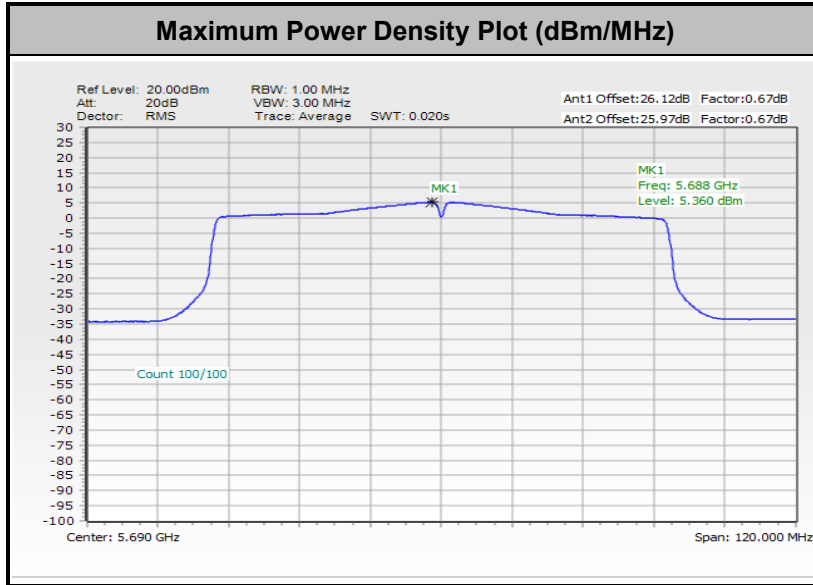

Remark: The test plot is showing a bin by bin combined result mathematically adds two traces.

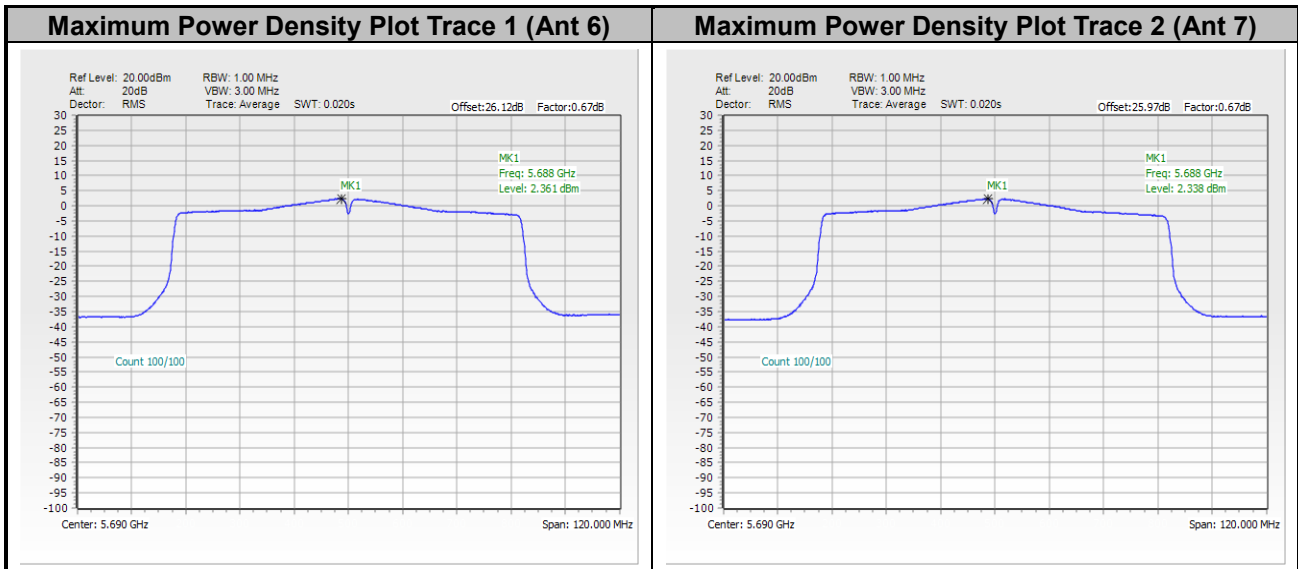



<802.11ac VHT160>

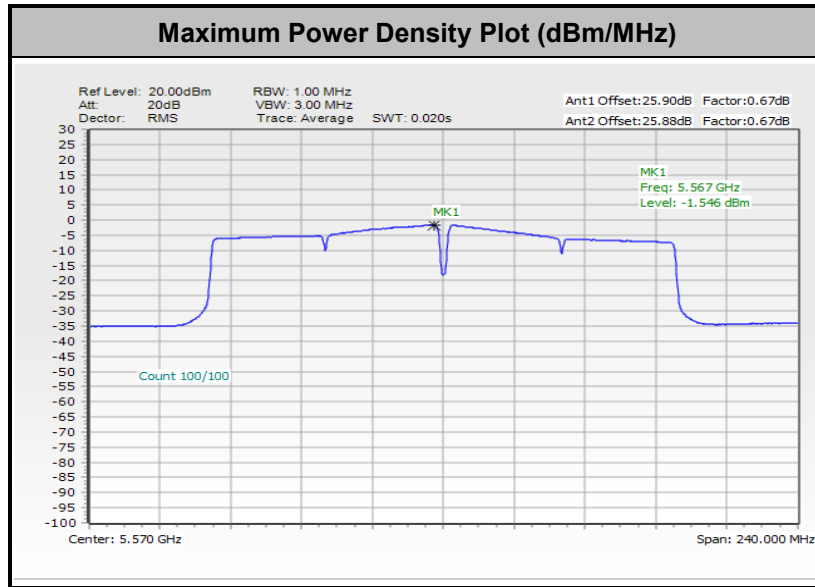

Remark: The test plot is showing a bin by bin combined result mathematically adds two traces.

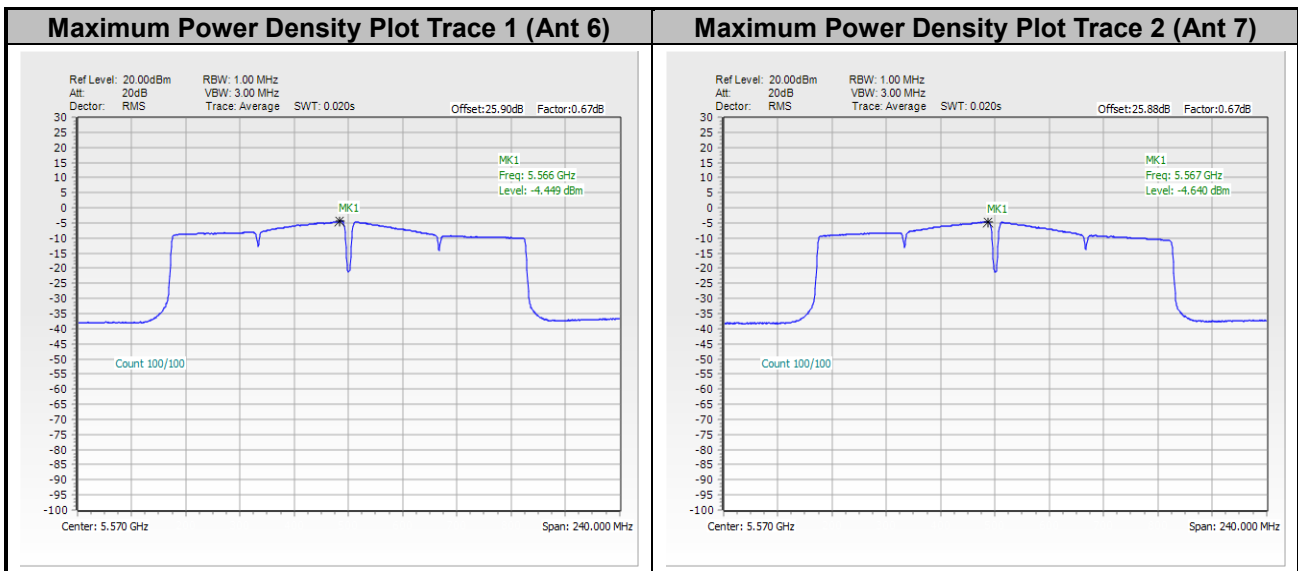



<802.11ax HE20>

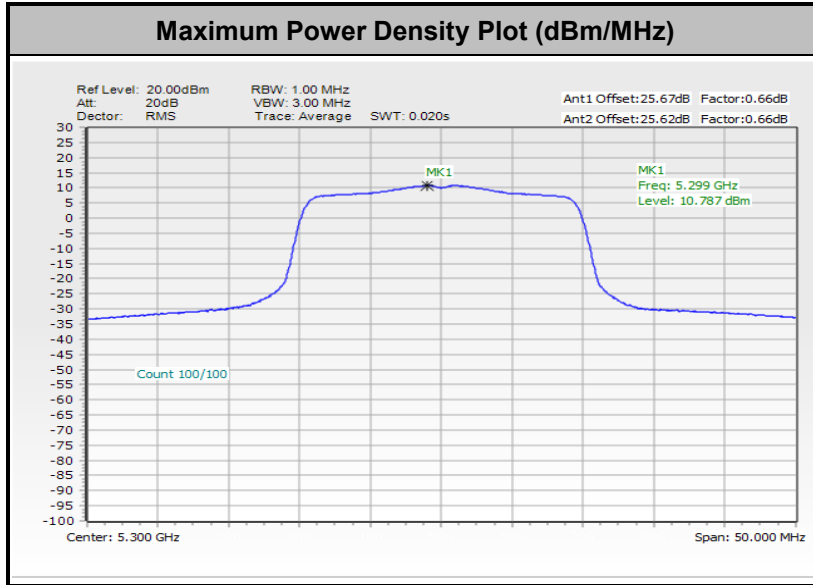

Remark: The test plot is showing a bin by bin combined result mathematically adds two traces.

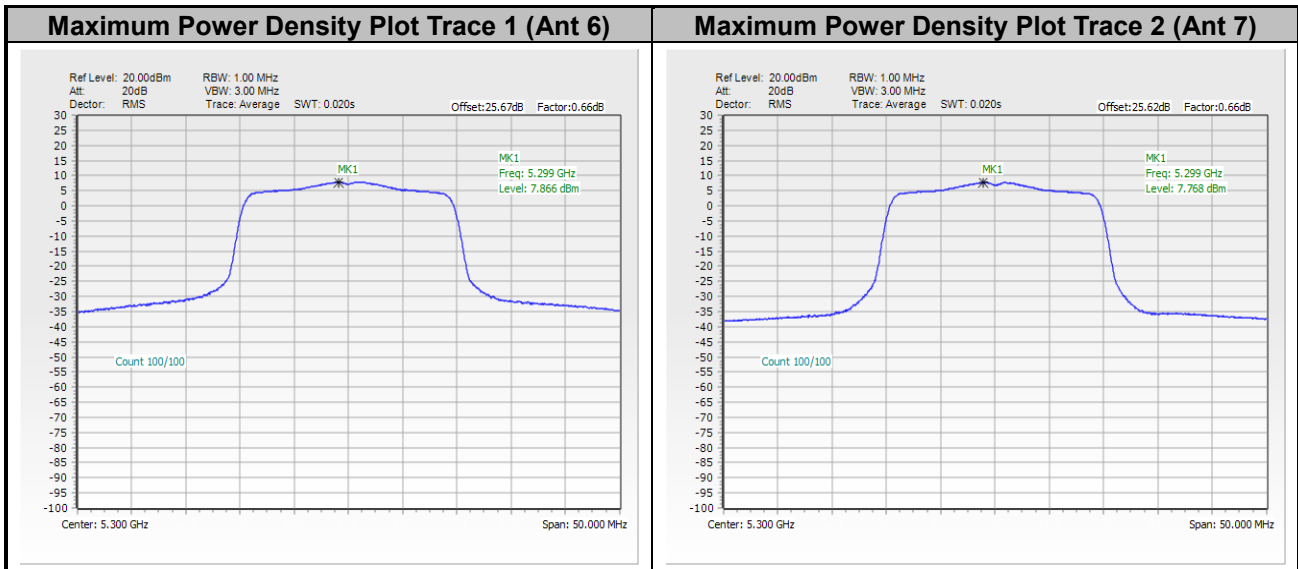



<802.11ax HE40>

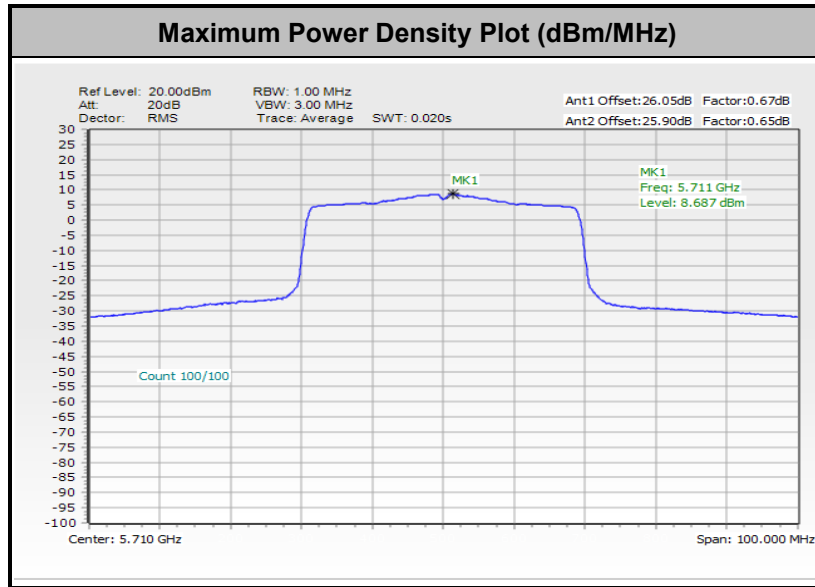

Remark: The test plot is showing a bin by bin combined result mathematically adds two traces.

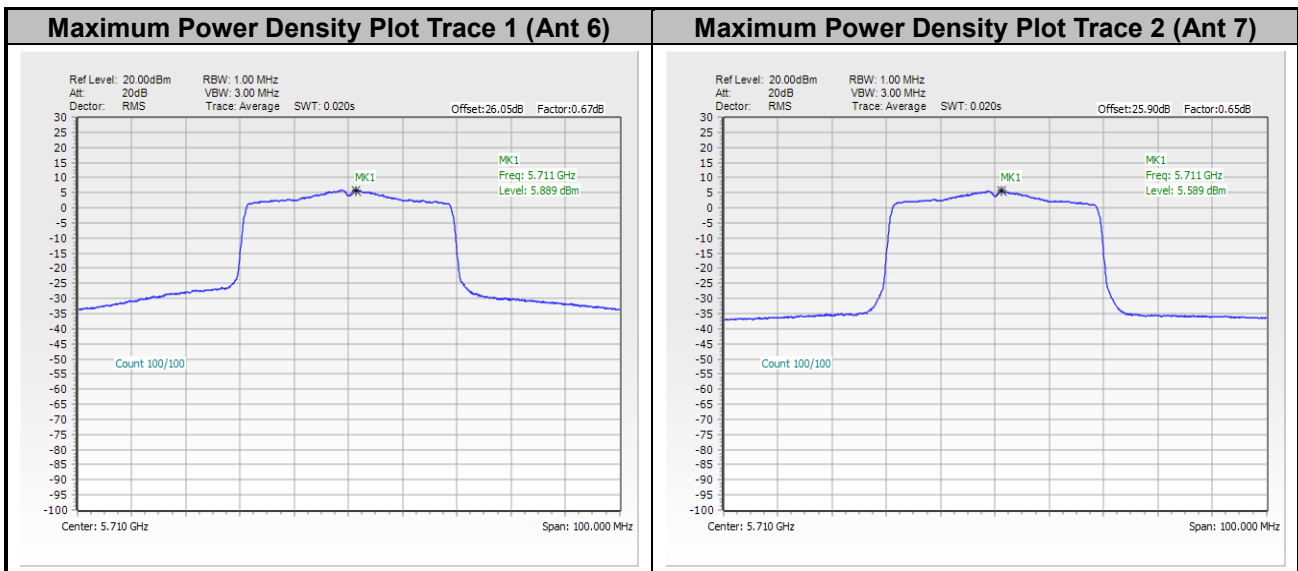



<802.11ax HE80>

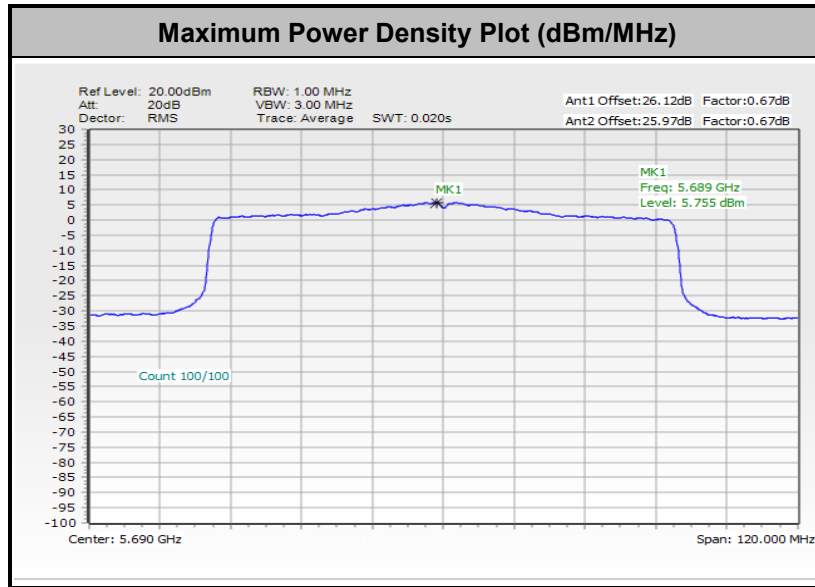

Remark: The test plot is showing a bin by bin combined result mathematically adds two traces.

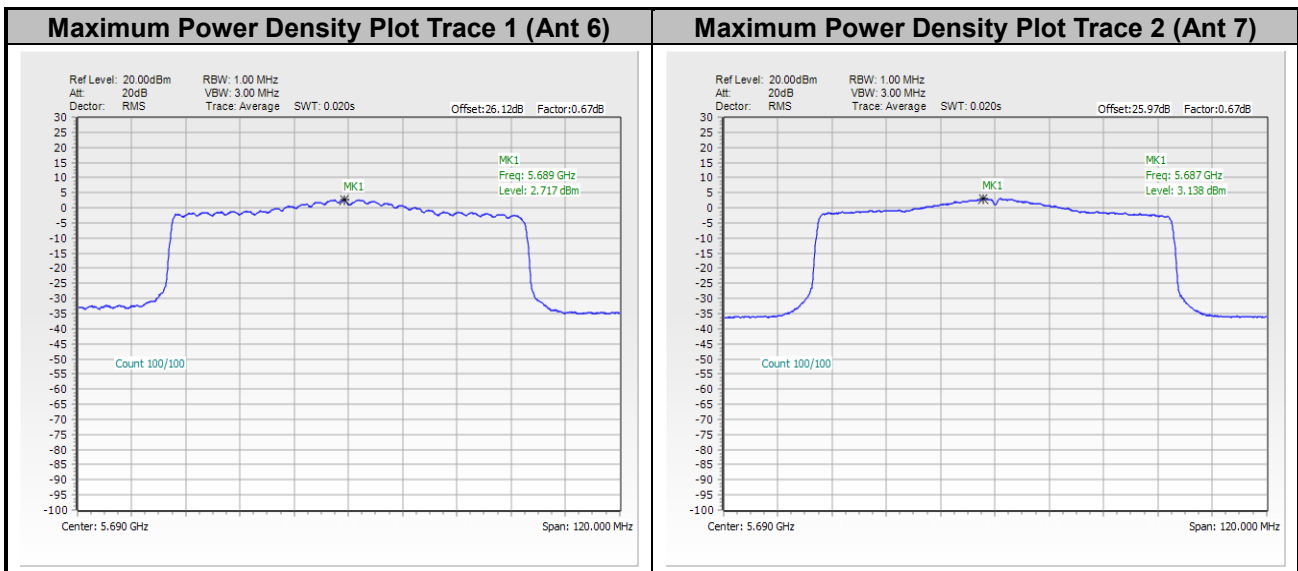



<802.11ax HE160>

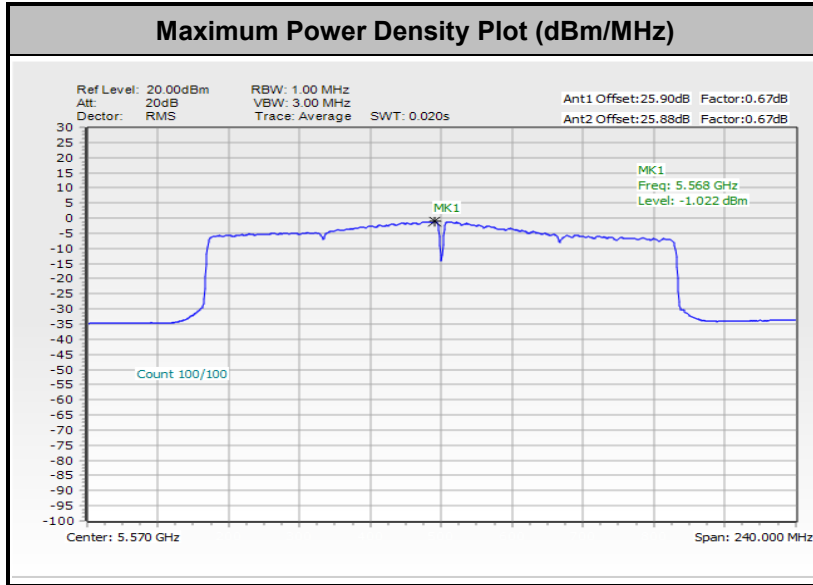

Remark: The test plot is showing a bin by bin combined result mathematically adds two traces.

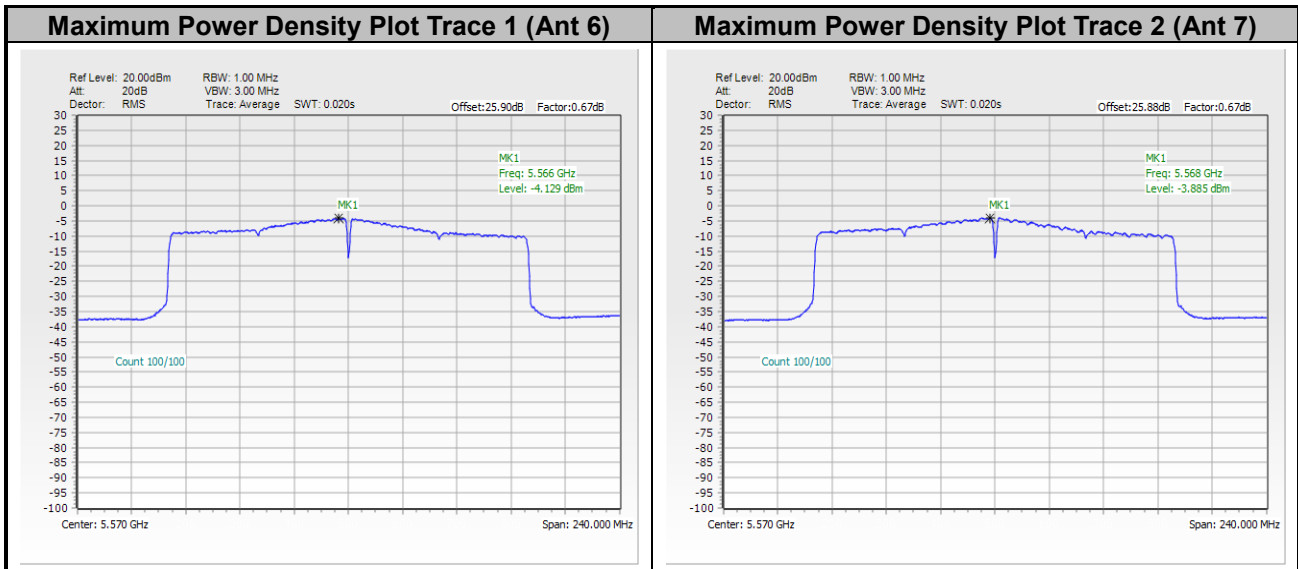



Appendix B. AC Conducted Emission Test Results

Test Engineer :	Calvin Wang	Temperature :	23~26°C
		Relative Humidity :	45~55%

EUT Information

Report NO : 3D0601
 Test Mode : Mode 1
 Test Voltage : 120Vac/60Hz
 Phase : Line

Full Spectrum

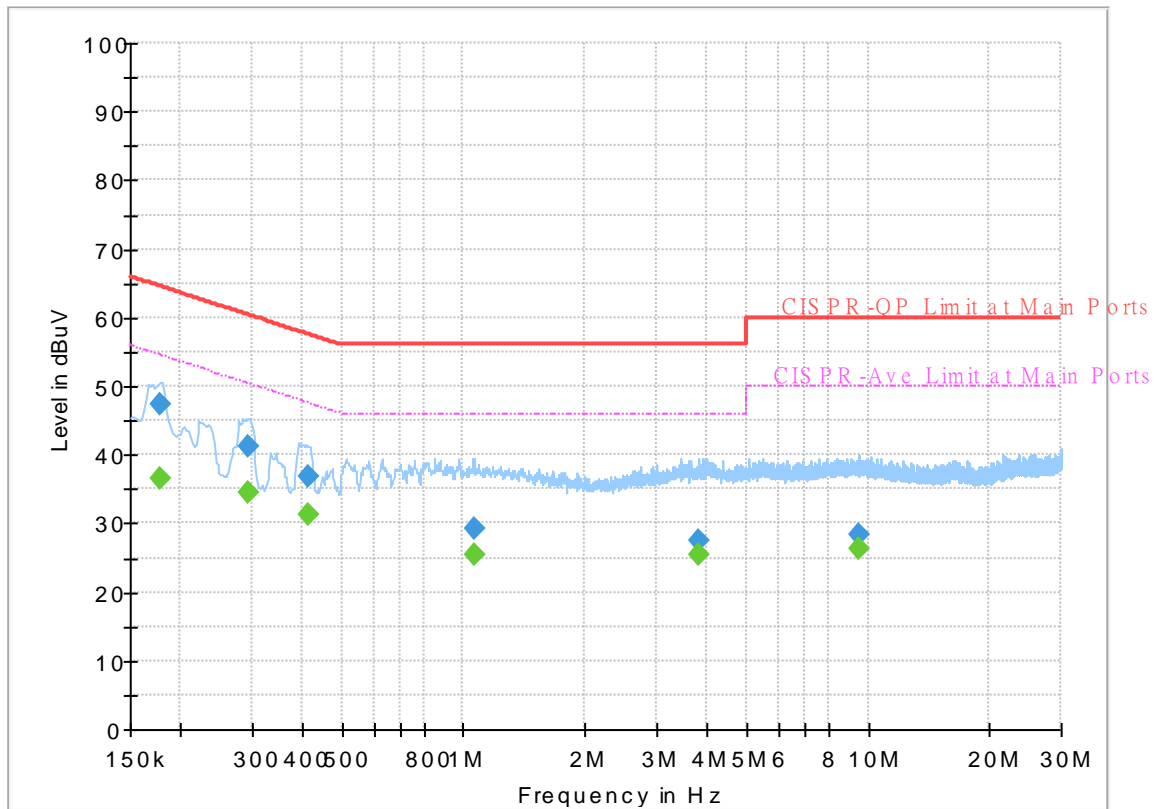

Final_Result

Frequency (MHz)	QuasiPeak (dBuV)	CAverage (dBuV)	Limit (dBuV)	Margin (dB)	Line	Filter	Corr. (dB)
0.177000	---	36.59	54.63	18.04	L1	OFF	19.9
0.177000	47.27	---	64.63	17.36	L1	OFF	19.9
0.294000	---	34.63	50.41	15.78	L1	OFF	19.9
0.294000	41.25	---	60.41	19.16	L1	OFF	19.9
0.413250	---	31.34	47.58	16.24	L1	OFF	19.9
0.413250	36.70	---	57.58	20.88	L1	OFF	19.9
1.063500	---	25.34	46.00	20.66	L1	OFF	19.9
1.063500	29.15	---	56.00	26.85	L1	OFF	19.9
3.826500	---	25.42	46.00	20.58	L1	OFF	20.0
3.826500	27.57	---	56.00	28.43	L1	OFF	20.0
9.534750	---	26.21	50.00	23.79	L1	OFF	20.2
9.534750	28.23	---	60.00	31.77	L1	OFF	20.2

EUT Information

Report NO : 3D0601
 Test Mode : Mode 1
 Test Voltage : 120Vac/60Hz
 Phase : Neutral

Full Spectrum

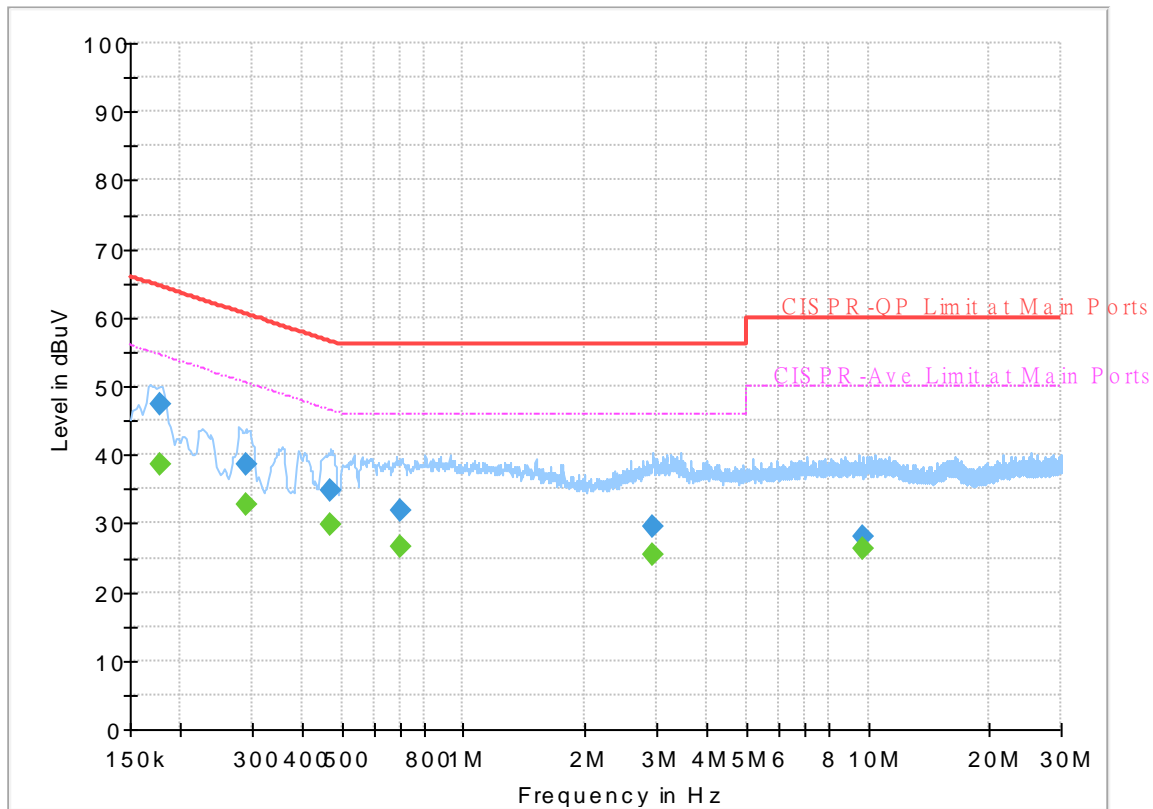

Final_Result

Frequency (MHz)	QuasiPeak (dBuV)	CAverage (dBuV)	Limit (dBuV)	Margin (dB)	Line	Filter	Corr. (dB)
0.177000	---	38.52	54.63	16.11	N	OFF	19.9
0.177000	47.40	---	64.63	17.23	N	OFF	19.9
0.289500	---	32.81	50.54	17.73	N	OFF	19.9
0.289500	38.49	---	60.54	22.05	N	OFF	19.9
0.469500	---	29.71	46.52	16.81	N	OFF	19.9
0.469500	34.83	---	56.52	21.69	N	OFF	19.9
0.696750	---	26.62	46.00	19.38	N	OFF	19.9
0.696750	32.02	---	56.00	23.98	N	OFF	19.9
2.940000	---	25.38	46.00	20.62	N	OFF	20.0
2.940000	29.39	---	56.00	26.61	N	OFF	20.0
9.672000	---	26.24	50.00	23.76	N	OFF	20.2
9.672000	28.13	---	60.00	31.87	N	OFF	20.2



Appendix C. Radiated Spurious Emission

Test Engineer :	Jesse Wang, Stan Hsieh and Ken Wu	Temperature :	17.4~22.3°C
		Relative Humidity :	54.7~65.1%

<Sample 1>

Band 1 - 5150~5250MHz
WIFI 802.11a (Band Edge @ 3m)

WIFI Ant. 6+7	Note	Frequency (MHz)	Level (dBμV/m)	Margin (dB)	Limit Line (dBμV/m)	Read Level (dBμV)	Antenna Factor (dB/m)	Path Loss (dB)	Preamp Factor (dB)	Ant Pos (cm)	Table Pos (deg)	Peak Avg. (P/A)	Pol. (H/V)	
802.11a CH 36 5180MHz		5148.46	57.69	-16.31	74	45.26	34.29	12.03	33.89	203	0	P	H	
		5149.5	49.92	-4.08	54	37.48	34.3	12.03	33.89	203	0	A	H	
	*	5180	112.01	-	-	99.41	34.42	12.07	33.89	203	0	P	H	
	*	5180	105.74	-	-	93.14	34.42	12.07	33.89	203	0	A	H	
													H	
													H	
			5146.12	54.28	-19.72	74	41.86	34.28	12.03	33.89	100	317	P	V
			5150	48.94	-5.06	54	36.5	34.3	12.03	33.89	100	317	A	V
	*		5180	109.37	-	-	96.77	34.42	12.07	33.89	100	317	P	V
	*		5180	102.2	-	-	89.6	34.42	12.07	33.89	100	317	A	V
													V	
													V	
802.11a CH 44 5220MHz		5051.74	49.9	-24.1	74	37.89	34	11.91	33.9	281	0	P	H	
		5149.5	41.85	-12.15	54	29.41	34.3	12.03	33.89	281	0	A	H	
	*	5220	113.47	-	-	100.68	34.58	12.1	33.89	281	0	P	H	
	*	5220	106.32	-	-	93.53	34.58	12.1	33.89	281	0	A	H	
			5356.4	48.78	-25.22	74	35.75	34.79	12.12	33.88	281	0	P	H
			5453	41.02	-12.98	54	27.87	34.8	12.22	33.87	281	0	A	H
			5128.44	50.44	-23.56	74	38.15	34.17	12.01	33.89	100	334	P	V
			5149.76	41.8	-12.2	54	29.36	34.3	12.03	33.89	100	334	A	V
	*		5220	110.33	-	-	97.54	34.58	12.1	33.89	100	334	P	V
	*		5220	103.42	-	-	90.63	34.58	12.1	33.89	100	334	A	V
			5449.92	48.64	-25.36	74	35.5	34.8	12.21	33.87	100	334	P	V
			5443.76	40.77	-13.23	54	27.65	34.79	12.2	33.87	100	334	A	V



802.11a CH 48 5240MHz		5028.86	50.7	-23.3	74	38.55	34.17	11.88	33.9	218	332	P	H
		5146.38	41.89	-12.11	54	29.47	34.28	12.03	33.89	218	332	A	H
	*	5240	114.85	-	-	101.97	34.66	12.11	33.89	218	332	P	H
	*	5240	107.22	-	-	94.34	34.66	12.11	33.89	218	332	A	H
		5396.16	49.89	-24.11	74	36.93	34.71	12.13	33.88	218	332	P	H
		5436.2	41.08	-12.92	54	27.99	34.77	12.19	33.87	218	332	A	H
		5147.16	50.46	-23.54	74	38.04	34.28	12.03	33.89	400	292	P	V
		5132.86	41.38	-12.62	54	29.06	34.2	12.01	33.89	400	292	A	V
	*	5240	109.7	-	-	96.82	34.66	12.11	33.89	400	292	P	V
	*	5240	104.84	-	-	91.96	34.66	12.11	33.89	400	292	A	V
		5446	48.93	-25.07	74	35.8	34.79	12.21	33.87	400	292	P	V
		5450.2	40.84	-13.16	54	27.7	34.8	12.21	33.87	400	292	A	V
Remark	1. No other spurious found. 2. All results are PASS against Peak and Average limit line.												



Band 1 5150~5250MHz
WIFI 802.11a (Harmonic @ 3m)

WIFI Ant. 6+7	Note	Frequency (MHz)	Level (dBμV/m)	Margin (dB)	Limit Line (dBμV/m)	Read Level (dBμV)	Antenna Factor (dB/m)	Path Loss (dB)	Preamp Factor (dB)	Ant Pos (cm)	Table Pos (deg)	Peak Avg. (P/A)	Pol. (H/V)	
802.11a CH 36 5180MHz		10360	51.82	-16.38	68.2	54.73	37.48	18.56	58.95	206	39	P	H	
		15540	59.35	-14.65	74	52.94	40.18	22.49	56.26	284	15	P	H	
		15540	49.46	-4.54	54	43.05	40.18	22.49	56.26	284	15	A	H	
													H	
													H	
													H	
													H	
													H	
													H	
													H	
													H	
			10360	50.42	-17.78	68.2	53.33	37.48	18.56	58.95	100	39	P	V
			15540	60.04	-13.96	74	53.63	40.18	22.49	56.26	205	41	P	V
			15540	50.69	-3.31	54	44.28	40.18	22.49	56.26	205	41	A	V
														V
														V
														V
														V
														V
													V	
													V	



WIFI Ant. 6+7	Note	Frequency (MHz)	Level (dBμV/m)	Margin (dB)	Limit Line (dBμV/m)	Read Level (dBμV)	Antenna Factor (dB/m)	Path Loss (dB)	Preamp Factor (dB)	Ant Pos (cm)	Table Pos (deg)	Peak Avg. (P/A)	Pol. (H/V)	
802.11a CH 44 5220MHz		10440	51.62	-16.58	68.2	54.44	37.4	18.64	58.86	200	39	P	H	
		15660	53.03	-20.97	74	46.2	40.58	22.56	56.31	100	51	P	H	
		15660	42.31	-11.69	54	35.48	40.58	22.56	56.31	100	51	A	H	
													H	
													H	
													H	
													H	
													H	
													H	
													H	
													H	
			10440	50.65	-17.55	68.2	53.47	37.4	18.64	58.86	100	39	P	V
			15660	58.33	-15.67	74	51.5	40.58	22.56	56.31	225	0	P	V
			15660	46.73	-7.27	54	39.9	40.58	22.56	56.31	225	0	A	V
														V
														V
														V
														V
														V
													V	
													V	
													V	



Band 1 5150~5250MHz
WIFI 802.11ax HE20 Full (Band Edge @ 3m)

WIFI Ant. 6+7	Note	Frequency (MHz)	Level (dBμV/m)	Margin (dB)	Limit Line (dBμV/m)	Read Level (dBμV)	Antenna Factor (dB/m)	Path Loss (dB)	Preamp Factor (dB)	Ant Pos (cm)	Table Pos (deg)	Peak Avg. (P/A)	Pol. (H/V)	
802.11ax HE20 Full CH 36 5180MHz		5146.64	60.53	-13.47	74	48.11	34.28	12.03	33.89	100	305	P	H	
		5149.76	52.59	-1.41	54	40.15	34.3	12.03	33.89	100	305	A	H	
	*	5180	114.12	-	-	101.52	34.42	12.07	33.89	100	305	P	H	
	*	5180	105.83	-	-	93.23	34.42	12.07	33.89	100	305	A	H	
													H	
														H
			5150	62.56	-11.44	74	50.12	34.3	12.03	33.89	100	327	P	V
			5150	50.67	-3.33	54	38.23	34.3	12.03	33.89	100	327	A	V
		*	5180	109.6	-	-	97	34.42	12.07	33.89	100	327	P	V
		*	5180	102.93	-	-	90.33	34.42	12.07	33.89	100	327	A	V
													V	
													V	
802.11ax HE20 Full CH 44 5220MHz		5139.1	50.95	-23.05	74	38.59	34.23	12.02	33.89	174	0	P	H	
		5150	42.31	-11.69	54	29.87	34.3	12.03	33.89	174	0	A	H	
		*	5220	113.61	-	-	100.82	34.58	12.1	33.89	174	0	P	H
		*	5220	106.81	-	-	94.02	34.58	12.1	33.89	174	0	A	H
			5430.88	49.21	-24.79	74	36.14	34.76	12.18	33.87	174	0	P	H
			5458.88	40.62	-13.38	54	27.46	34.8	12.23	33.87	174	0	A	H
			5126.88	49.91	-24.09	74	37.64	34.16	12	33.89	357	295	P	V
			5150	41.25	-12.75	54	28.81	34.3	12.03	33.89	357	295	A	V
		*	5220	110.9	-	-	98.11	34.58	12.1	33.89	357	295	P	V
		*	5220	104.38	-	-	91.59	34.58	12.1	33.89	357	295	A	V
		5419.4	49.54	-24.46	74	36.51	34.74	12.16	33.87	357	295	P	V	
		5459.72	40.55	-13.45	54	27.39	34.8	12.23	33.87	357	295	A	V	



802.11ax HE20 Full CH 48 5240MHz		5147.94	50.51	-23.49	74	38.08	34.29	12.03	33.89	192	333	P	H
		5149.5	41.49	-12.51	54	29.05	34.3	12.03	33.89	192	333	A	H
	*	5240	113.8	-	-	100.92	34.66	12.11	33.89	192	333	P	H
	*	5240	107.7	-	-	94.82	34.66	12.11	33.89	192	333	A	H
		5400.36	48.69	-25.31	74	35.74	34.7	12.13	33.88	192	333	P	H
		5353.88	40.67	-13.33	54	27.64	34.79	12.12	33.88	192	333	A	H
		5122.98	49.46	-24.54	74	37.21	34.14	12	33.89	400	298	P	V
		5149.76	41.11	-12.89	54	28.67	34.3	12.03	33.89	400	298	A	V
	*	5240	111	-	-	98.12	34.66	12.11	33.89	400	298	P	V
	*	5240	104.76	-	-	91.88	34.66	12.11	33.89	400	298	A	V
		5352.76	48.48	-25.52	74	35.45	34.79	12.12	33.88	400	298	P	V
		5459.16	40.46	-13.54	54	27.3	34.8	12.23	33.87	400	298	A	V
Remark	1. No other spurious found. 2. All results are PASS against Peak and Average limit line.												



Band 1 5150~5250MHz

WIFI 802.11ax HE20 Full (Harmonic @ 3m)

WIFI Ant. 6+7	Note	Frequency (MHz)	Level (dBμV/m)	Margin (dB)	Limit Line (dBμV/m)	Read Level (dBμV)	Antenna Factor (dB/m)	Path Loss (dB)	Preamp Factor (dB)	Ant Pos (cm)	Table Pos (deg)	Peak Avg. (P/A)	Pol. (H/V)	
802.11ax HE20 Full CH 36 5180MHz		10360	52.6	-15.6	68.2	55.51	37.48	18.56	58.95	203	34	P	H	
		15540	58.55	-15.45	74	52.14	40.18	22.49	56.26	292	17	P	H	
		15540	47.56	-6.44	54	41.15	40.18	22.49	56.26	292	17	A	H	
													H	
													H	
													H	
													H	
													H	
													H	
													H	
													H	
													H	
													H	
													H	
													H	
													H	
			10360	52.88	-15.32	68.2	55.79	37.48	18.56	58.95	189	26	P	V
			15540	60.52	-13.48	74	54.11	40.18	22.49	56.26	224	0	P	V
		15540	50.28	-3.72	54	43.87	40.18	22.49	56.26	224	0	A	V	
													V	
													V	
													V	
													V	
													V	
													V	
													V	
													V	
													V	



WIFI Ant. 6+7	Note	Frequency (MHz)	Level (dBµV/m)	Margin (dB)	Limit Line (dBµV/m)	Read Level (dBµV)	Antenna Factor (dB/m)	Path Loss (dB)	Preamp Factor (dB)	Ant Pos (cm)	Table Pos (deg)	Peak Avg. (P/A)	Pol. (H/V)	
802.11ax HE20 Full CH 44 5220MHz		10440	52.44	-15.76	68.2	55.26	37.4	18.64	58.86	203	37	P	H	
		15660	56.56	-17.44	74	49.73	40.58	22.56	56.31	293	18	P	H	
		15660	46.31	-7.69	54	39.48	40.58	22.56	56.31	293	18	A	H	
													H	
													H	
													H	
													H	
													H	
													H	
													H	
													H	
													H	
													H	
													H	
													H	
													H	
													H	
			10440	50.45	-17.75	68.2	53.27	37.4	18.64	58.86	189	24	P	V
			15660	60.19	-13.81	74	53.36	40.58	22.56	56.31	229	0	P	V
			15660	49.93	-4.07	54	43.1	40.58	22.56	56.31	229	0	A	V
													V	
													V	
													V	
													V	
													V	
													V	
													V	
													V	
													V	
													V	
													V	



Band 1 5150~5250MHz
WIFI 802.11ax HE20 Partial 106 (Band Edge @ 3m)

WIFI Ant. 6+7	Note	Frequency (MHz)	Level (dBμV/m)	Margin (dB)	Limit Line (dBμV/m)	Read Level (dBμV)	Antenna Factor (dB/m)	Path Loss (dB)	Preamp Factor (dB)	Ant Pos (cm)	Table Pos (deg)	Peak Avg. (P/A)	Pol. (H/V)	
802.11ax HE20 Partial 106/53 CH 36 5180MHz		5010.66	50.74	-23.26	74	38.48	34.31	11.85	33.9	249	326	P	H	
		5147.68	48.06	-5.94	54	35.63	34.29	12.03	33.89	249	326	A	H	
	*	5180	113.55	-	-	100.95	34.42	12.07	33.89	249	326	P	H	
	*	5180	106.03	-	-	93.43	34.42	12.07	33.89	249	326	A	H	
													H	
														H
			5145.08	57.09	-16.91	74	44.68	34.27	12.03	33.89	100	325	P	V
			5148.46	47.81	-6.19	54	35.38	34.29	12.03	33.89	100	325	A	V
	*		5180	110.06	-	-	97.46	34.42	12.07	33.89	100	325	P	V
	*		5180	102.03	-	-	89.43	34.42	12.07	33.89	100	325	A	V
													V	
													V	
Remark	1. No other spurious found. 2. All results are PASS against Peak and Average limit line.													



Band 1 5150~5250MHz
WIFI 802.11ax HE40 Full (Band Edge @ 3m)

WIFI Ant. 6+7	Note	Frequency (MHz)	Level (dBμV/m)	Margin (dB)	Limit Line (dBμV/m)	Read Level (dBμV)	Antenna Factor (dB/m)	Path Loss (dB)	Preamp Factor (dB)	Ant Pos (cm)	Table Pos (deg)	Peak Avg. (P/A)	Pol. (H/V)	
802.11ax HE40 Full CH 38 5190MHz		5148.98	64.94	-9.06	74	52.51	34.29	12.03	33.89	203	0	P	H	
		5149.5	51.8	-2.2	54	39.36	34.3	12.03	33.89	203	0	A	H	
	*	5190	108.97	-	-	96.31	34.46	12.09	33.89	203	0	P	H	
	*	5190	102.6	-	-	89.94	34.46	12.09	33.89	203	0	A	H	
		5459.72	48.97	-25.03	74	35.81	34.8	12.23	33.87	203	0	P	H	
		5357.8	41.57	-12.43	54	28.55	34.78	12.12	33.88	203	0	A	H	
		5147.94	61.01	-12.99	74	48.58	34.29	12.03	33.89	100	327	P	V	
		5148.46	51.71	-2.29	54	39.28	34.29	12.03	33.89	100	327	A	V	
	*	5190	105.46	-	-	92.8	34.46	12.09	33.89	100	327	P	V	
	*	5190	99.58	-	-	86.92	34.46	12.09	33.89	100	327	A	V	
		5429.2	49.29	-24.71	74	36.22	34.76	12.18	33.87	100	327	P	V	
		5352.2	40.96	-13.04	54	27.92	34.8	12.12	33.88	100	327	A	V	
	802.11ax HE40 Full CH 46 5230MHz		5135.98	60.72	-13.28	74	48.37	34.22	12.02	33.89	261	0	P	H
			5146.64	52.38	-1.62	54	39.96	34.28	12.03	33.89	261	0	A	H
*		5230	112.26	-	-	99.43	34.62	12.1	33.89	261	0	P	H	
*		5230	104.93	-	-	92.1	34.62	12.1	33.89	261	0	A	H	
		5363.12	54.39	-19.61	74	41.38	34.77	12.12	33.88	261	0	P	H	
		5355.84	46.36	-7.64	54	33.33	34.79	12.12	33.88	261	0	A	H	
		5146.9	60.61	-13.39	74	48.19	34.28	12.03	33.89	100	330	P	V	
		5150	49.96	-4.04	54	37.52	34.3	12.03	33.89	100	330	A	V	
*		5230	109.76	-	-	96.93	34.62	12.1	33.89	100	330	P	V	
*		5230	101.72	-	-	88.89	34.62	12.1	33.89	100	330	A	V	
	5358.92	54.9	-19.1	74	41.88	34.78	12.12	33.88	100	330	P	V		
	5350.24	44.08	-9.92	54	31.04	34.8	12.12	33.88	100	330	A	V		
Remark	1. No other spurious found. 2. All results are PASS against Peak and Average limit line.													



WIFI Ant. 6+7	Note	Frequency (MHz)	Level (dBμV/m)	Margin (dB)	Limit Line (dBμV/m)	Read Level (dBμV)	Antenna Factor (dB/m)	Path Loss (dB)	Preamp Factor (dB)	Ant Pos (cm)	Table Pos (deg)	Peak Avg. (P/A)	Pol. (H/V)	
802.11ax HE40 Full CH 46 5230MHz		10460	49.25	-18.95	68.2	52.02	37.42	18.65	58.84	214	37	P	H	
		15690	51.7	-22.3	74	44.62	40.82	22.58	56.32	296	14	P	H	
		15690	43.03	-10.97	54	35.95	40.82	22.58	56.32	296	14	A	H	
													H	
													H	
													H	
													H	
													H	
													H	
													H	
													H	
													H	
													H	
													H	
			10460	48.23	-19.97	68.2	51	37.42	18.65	58.84	200	28	P	V
			15690	56.96	-17.04	74	49.88	40.82	22.58	56.32	227	0	P	V
			15690	46.25	-7.75	54	39.17	40.82	22.58	56.32	227	0	A	V
														V
														V
														V
													V	
													V	
													V	
													V	
													V	
Remark	<ol style="list-style-type: none"> No other spurious found. All results are PASS against Peak and Average limit line. The emission position marked as "-" means no suspected emission found with sufficient margin against limit line or noise floor only. 													



Band 1 5150~5250MHz
WIFI 802.11ax HE40 Partial 242 (Band Edge @ 3m)

WIFI Ant. 6+7	Note	Frequency (MHz)	Level (dBμV/m)	Margin (dB)	Limit Line (dBμV/m)	Read Level (dBμV)	Antenna Factor (dB/m)	Path Loss (dB)	Preamp Factor (dB)	Ant Pos (cm)	Table Pos (deg)	Peak Avg. (P/A)	Pol. (H/V)
802.11ax HE40 Partial 242/61 CH 38 5190MHz		5147.42	53.56	-20.44	74	41.14	34.28	12.03	33.89	267	328	P	H
		5147.68	49.71	-4.29	54	37.28	34.29	12.03	33.89	267	328	A	H
	*	5190	110.52	-	-	97.86	34.46	12.09	33.89	267	328	P	H
	*	5190	102.24	-	-	89.58	34.46	12.09	33.89	267	328	A	H
		5377.4	49.13	-24.87	74	36.13	34.75	12.13	33.88	267	328	P	H
		5444.6	41.37	-12.63	54	28.25	34.79	12.2	33.87	267	328	A	H
		5122.98	53.56	-20.44	74	41.31	34.14	12	33.89	100	320	P	V
		5147.94	49.02	-4.98	54	36.59	34.29	12.03	33.89	100	320	A	V
	*	5190	107.16	-	-	94.5	34.46	12.09	33.89	100	320	P	V
	*	5190	99.06	-	-	86.4	34.46	12.09	33.89	100	320	A	V
		5386.92	50.18	-23.82	74	37.2	34.73	12.13	33.88	100	320	P	V
		5454.12	41.23	-12.77	54	28.08	34.8	12.22	33.87	100	320	A	V
Remark	1. No other spurious found. 2. All results are PASS against Peak and Average limit line.												



Band 1 5150~5250MHz
WIFI 802.11ax HE80 Full (Band Edge @ 3m)

Table with 14 columns: WIFI Ant. 6+7, Note, Frequency (MHz), Level (dBµV/m), Margin (dB), Limit Line (dBµV/m), Read Level (dBµV), Antenna Factor (dB/m), Path Loss (dB), Preamp Factor (dB), Ant Pos (cm), Table Pos (deg), Peak Avg. (P/A), Pol. (H/V). Rows include test results for frequencies 5133.12, 5146.12, 5210, 5356.96, 5356.68, 5146.12, 5150, 5210, 5210, 5350.8, 5350.24.

Remark

- 1. No other spurious found.
2. All results are PASS against Peak and Average limit line.



Band 1 5150~5250MHz

WIFI 802.11ax HE80 Full (Harmonic @ 3m)

WIFI Ant. 6+7	Note	Frequency (MHz)	Level (dBμV/m)	Margin (dB)	Limit Line (dBμV/m)	Read Level (dBμV)	Antenna Factor (dB/m)	Path Loss (dB)	Preamp Factor (dB)	Ant Pos (cm)	Table Pos (deg)	Peak Avg. (P/A)	Pol. (H/V)	
802.11ax HE80 Full CH 42 5210MHz		10420	45.06	-23.14	68.2	47.92	37.4	18.62	58.88	-	-	P	H	
		15630	47.28	-26.72	74	40.57	40.46	22.54	56.29	-	-	P	H	
													H	
													H	
													H	
													H	
													H	
													H	
													H	
													H	
													H	
													H	
													H	
													H	
													H	
													H	
													H	
													H	
			10420	45.1	-23.1	68.2	47.96	37.4	18.62	58.88	-	-	P	V
			15630	47.34	-26.66	74	40.63	40.46	22.54	56.29	-	-	P	V
													V	
													V	
													V	
													V	
													V	
													V	
													V	
													V	
													V	
													V	
													V	
Remark	<ol style="list-style-type: none"> No other spurious found. All results are PASS against Peak and Average limit line. The emission position marked as "-" means no suspected emission found with sufficient margin against limit line or noise floor only. 													



Band 1 5150~5250MHz
WIFI 802.11ax HE80 Partial 484 (Band Edge @ 3m)

WIFI Ant. 6+7	Note	Frequency (MHz)	Level (dBμV/m)	Margin (dB)	Limit Line (dBμV/m)	Read Level (dBμV)	Antenna Factor (dB/m)	Path Loss (dB)	Preamp Factor (dB)	Ant Pos (cm)	Table Pos (deg)	Peak Avg. (P/A)	Pol. (H/V)
802.11ax HE80 Partial 484/65 CH 42 5210MHz		5149.24	65.1	-8.9	74	52.66	34.3	12.03	33.89	100	299	P	H
		5148.2	52.07	-1.93	54	39.64	34.29	12.03	33.89	100	299	A	H
	*	5210	106.78	-	-	94.03	34.54	12.1	33.89	100	299	P	H
	*	5210	98.31	-	-	85.56	34.54	12.1	33.89	100	299	A	H
		5367.32	53.87	-20.13	74	40.85	34.77	12.13	33.88	100	299	P	H
		5350.8	45.48	-8.52	54	32.44	34.8	12.12	33.88	100	299	A	H
		5147.16	57.09	-16.91	74	44.67	34.28	12.03	33.89	100	325	P	V
		5147.94	49.07	-4.93	54	36.64	34.29	12.03	33.89	100	325	A	V
	*	5210	105.36	-	-	92.61	34.54	12.1	33.89	100	325	P	V
	*	5210	96.52	-	-	83.77	34.54	12.1	33.89	100	325	A	V
		5351.92	52.54	-21.46	74	39.5	34.8	12.12	33.88	100	325	P	V
		5355	45.37	-8.63	54	32.34	34.79	12.12	33.88	100	325	A	V
Remark	1. No other spurious found. 2. All results are PASS against Peak and Average limit line.												



Band 1 5150~5250MHz

WIFI 802.11ax HE160 Full (Band Edge @ 3m)

WIFI Ant. 6+7	Note	Frequency (MHz)	Level (dBμV/m)	Margin (dB)	Limit Line (dBμV/m)	Read Level (dBμV)	Antenna Factor (dB/m)	Path Loss (dB)	Preamp Factor (dB)	Ant Pos (cm)	Table Pos (deg)	Peak Avg. (P/A)	Pol. (H/V)
802.11ax HE160 Full CH 50 5250MHz		5107.8	55.29	-18.71	74	43.15	34.05	11.98	33.89	225	332	P	H
		5106.05	47.53	-6.47	54	35.4	34.04	11.98	33.89	225	332	A	H
	*	5250	101.71	-	-	88.79	34.7	12.11	33.89	225	332	P	H
	*	5250	94.31	-	-	81.39	34.7	12.11	33.89	225	332	A	H
		5398.08	58.12	-15.88	74	45.17	34.7	12.13	33.88	225	332	P	H
		5393.76	52.05	-1.95	54	39.09	34.71	12.13	33.88	225	332	A	H
		5124.95	53.1	-20.9	74	40.84	34.15	12	33.89	101	299	P	V
		5117.6	46.11	-7.89	54	33.9	34.11	11.99	33.89	101	299	A	V
	*	5250	97.96	-	-	85.04	34.7	12.11	33.89	101	299	P	V
	*	5250	90.64	-	-	77.72	34.7	12.11	33.89	101	299	A	V
		5387.28	57.98	-16.02	74	45	34.73	12.13	33.88	101	299	P	V
		5393.76	49.38	-4.62	54	36.42	34.71	12.13	33.88	101	299	A	V
Remark	1. No other spurious found. 2. All results are PASS against Peak and Average limit line.												



Band 1 5150~5250MHz
WIFI 802.11ax HE160 Full (Harmonic @ 3m)

WIFI Ant. 6+7	Note	Frequency (MHz)	Level (dBμV/m)	Margin (dB)	Limit Line (dBμV/m)	Read Level (dBμV)	Antenna Factor (dB/m)	Path Loss (dB)	Preamp Factor (dB)	Ant Pos (cm)	Table Pos (deg)	Peak Avg. (P/A)	Pol. (H/V)	
802.11ax HE160 Full CH 50 5250MHz		7000	61.58	-6.62	68.2	67.86	35.7	15.26	57.24	200	252	P	H	
		10500	45.04	-23.16	68.2	47.65	37.5	18.69	58.8	-	-	P	H	
		15750	49.22	-24.78	74	41.96	41	22.61	56.35	-	-	P	H	
													H	
													H	
													H	
													H	
													H	
													H	
													H	
													H	
													H	
			7000	61.13	-7.07	68.2	67.41	35.7	15.26	57.24	300	301	P	V
			10500	44.75	-23.45	68.2	47.36	37.5	18.69	58.8	-	-	P	V
			15750	48.07	-25.93	74	40.81	41	22.61	56.35	-	-	P	V
														V
														V
														V
													V	
													V	
													V	
													V	
													V	
Remark	1. No other spurious found. 2. All results are PASS against Peak and Average limit line. 3. The emission position marked as "-" means no suspected emission found with sufficient margin against limit line or noise floor only.													



Band 1 5150~5250MHz
WIFI 802.11ax HE160 Partial 996 (Band Edge @ 3m)

WIFI Ant. 6+7	Note	Frequency (MHz)	Level (dBμV/m)	Margin (dB)	Limit Line (dBμV/m)	Read Level (dBμV)	Antenna Factor (dB/m)	Path Loss (dB)	Preamp Factor (dB)	Ant Pos (cm)	Table Pos (deg)	Peak Avg. (P/A)	Pol. (H/V)
802.11ax HE160 Partial 996/67 CH 50 5250MHz		5131.04	55.66	-18.34	74	43.35	34.19	12.01	33.89	100	327	P	H
		5148.2	45.76	-8.24	54	33.33	34.29	12.03	33.89	100	327	A	H
	*	5250	101.07	-	-	88.15	34.7	12.11	33.89	266	0	P	H
	*	5250	92.95	-	-	80.03	34.7	12.11	33.89	266	0	A	H
		5382.44	62.13	-11.87	74	49.14	34.74	12.13	33.88	266	0	P	H
		5396.44	52.19	-1.81	54	39.23	34.71	12.13	33.88	266	0	A	H
		5137.54	55.38	-18.62	74	43.02	34.23	12.02	33.89	100	287	P	V
		5093.34	46.27	-7.73	54	34.2	34	11.96	33.89	100	287	A	V
	*	5250	97.62	-	-	84.7	34.7	12.11	33.89	100	287	P	V
	*	5250	90.68	-	-	77.76	34.7	12.11	33.89	100	287	A	V
		5398.68	67.6	-6.4	74	54.65	34.7	12.13	33.88	100	287	P	V
		5396.44	47.24	-6.76	54	34.28	34.71	12.13	33.88	100	287	A	V
802.11ax HE160 Partial 996/68 CH 50 5250MHz		5094.15	56.09	-17.91	74	44.02	34	11.96	33.89	248	360	P	H
		5093.45	45.82	-8.18	54	33.75	34	11.96	33.89	248	360	A	H
	*	5250	100.58	-	-	87.66	34.7	12.11	33.89	248	360	P	H
	*	5250	92.61	-	-	79.69	34.7	12.11	33.89	248	360	A	H
		5403.6	66.26	-7.74	74	53.29	34.71	12.14	33.88	248	360	P	H
		5398.8	52.72	-1.28	54	39.77	34.7	12.13	33.88	248	360	A	H
		5092.4	53.8	-20.2	74	41.73	34	11.96	33.89	100	282	P	V
		5092.4	44.73	-9.27	54	32.66	34	11.96	33.89	100	282	A	V
	*	5250	99.1	-	-	86.18	34.7	12.11	33.89	100	282	P	V
	*	5250	89.95	-	-	77.03	34.7	12.11	33.89	100	282	A	V
	5388.72	60.24	-13.76	74	47.27	34.72	12.13	33.88	100	282	P	V	
	5398.8	49.02	-4.98	54	36.07	34.7	12.13	33.88	100	282	A	V	
Remark	1. No other spurious found. 2. All results are PASS against Peak and Average limit line.												



Band 2 - 5250~5350MHz
WIFI 802.11a (Band Edge @ 3m)

WIFI Ant. 6+7	Note	Frequency (MHz)	Level (dBμV/m)	Margin (dB)	Limit Line (dBμV/m)	Read Level (dBμV)	Antenna Factor (dB/m)	Path Loss (dB)	Preamp Factor (dB)	Ant Pos (cm)	Table Pos (deg)	Peak Avg. (P/A)	Pol. (H/V)
802.11a CH 52 5260MHz		5094.85	50.74	-23.26	74	38.67	34	11.96	33.89	236	0	P	H
		5146.65	41.63	-12.37	54	29.21	34.28	12.03	33.89	236	0	A	H
	*	5260	114.66	-	-	101.75	34.68	12.11	33.88	236	0	P	H
	*	5260	107.04	-	-	94.13	34.68	12.11	33.88	236	0	A	H
		5356.8	49.59	-24.41	74	36.56	34.79	12.12	33.88	236	0	P	H
		5354.4	41.61	-12.39	54	28.58	34.79	12.12	33.88	236	0	A	H
		5125.65	50.75	-23.25	74	38.49	34.15	12	33.89	102	334	P	V
		5145.6	41.48	-12.52	54	29.07	34.27	12.03	33.89	102	334	A	V
	*	5260	110.35	-	-	97.44	34.68	12.11	33.88	102	334	P	V
	*	5260	102.87	-	-	89.96	34.68	12.11	33.88	102	334	A	V
		5407.68	50.14	-23.86	74	37.16	34.72	12.14	33.88	102	334	P	V
		5455.2	40.99	-13.01	54	27.84	34.8	12.22	33.87	102	334	A	V
802.11a CH 60 5300MHz		5086.45	50.37	-23.63	74	38.31	34	11.95	33.89	248	0	P	H
		5085.05	41.53	-12.47	54	29.47	34	11.95	33.89	248	0	A	H
	*	5300	112.85	-	-	100.02	34.6	12.11	33.88	248	0	P	H
	*	5300	106.79	-	-	93.96	34.6	12.11	33.88	248	0	A	H
		5426.4	50.52	-23.48	74	37.47	34.75	12.17	33.87	248	0	P	H
		5352.24	43.16	-10.84	54	30.12	34.8	12.12	33.88	248	0	A	H
		5146.65	51.41	-22.59	74	38.99	34.28	12.03	33.89	100	300	P	V
		5135.1	41.47	-12.53	54	29.13	34.21	12.02	33.89	100	300	A	V
	*	5300	110.23	-	-	97.4	34.6	12.11	33.88	100	300	P	V
	*	5300	103.56	-	-	90.73	34.6	12.11	33.88	100	300	A	V
		5350.08	52.09	-21.91	74	39.05	34.8	12.12	33.88	100	300	P	V
		5352.24	43.7	-10.3	54	30.66	34.8	12.12	33.88	100	300	A	V



802.11a CH 64 5320MHz	*	5320	112.59	-	-	99.67	34.68	12.12	33.88	281	0	P	H
	*	5320	106.44	-	-	93.52	34.68	12.12	33.88	281	0	A	H
		5356.8	54.9	-19.1	74	41.87	34.79	12.12	33.88	281	0	P	H
		5352.32	48.34	-5.66	54	35.3	34.8	12.12	33.88	281	0	A	H
													H
													H
	*	5320	111.34	-	-	98.42	34.68	12.12	33.88	100	292	P	V
	*	5320	104.45	-	-	91.53	34.68	12.12	33.88	100	292	A	V
		5357.28	53.57	-20.43	74	40.54	34.79	12.12	33.88	100	292	P	V
		5351.84	47.43	-6.57	54	34.39	34.8	12.12	33.88	100	292	A	V
													V
													V
Remark	1. No other spurious found. 2. All results are PASS against Peak and Average limit line.												



Band 2 5250~5350MHz
WIFI 802.11a (Harmonic @ 3m)

WIFI Ant. 6+7	Note	Frequency (MHz)	Level (dBμV/m)	Margin (dB)	Limit Line (dBμV/m)	Read Level (dBμV)	Antenna Factor (dB/m)	Path Loss (dB)	Preamp Factor (dB)	Ant Pos (cm)	Table Pos (deg)	Peak Avg. (P/A)	Pol. (H/V)	
802.11a CH 52 5260MHz		7011	62.96	-5.24	68.2	69.27	35.68	15.26	57.25	191	242	P	H	
		10520	47	-21.2	68.2	49.56	37.5	18.71	58.77	-	-	P	H	
		15780	48.12	-25.88	74	41.04	40.82	22.62	56.36	-	-	P	H	
													H	
													H	
													H	
													H	
													H	
													H	
													H	
													H	
													H	
			7011	61.91	-6.29	68.2	68.22	35.68	15.26	57.25	301	33	P	V
			10520	45.61	-22.59	68.2	48.17	37.5	18.71	58.77	-	-	P	V
			15780	54.94	-19.06	74	47.86	40.82	22.62	56.36	223	0	P	V
			15780	43.91	-10.09	54	36.83	40.82	22.62	56.36	223	0	A	V
														V
														V
													V	
													V	
													V	
													V	



Band 2 5250~5350MHz
WIFI 802.11ax HE20 Full (Band Edge @ 3m)

WIFI Ant. 6+7	Note	Frequency (MHz)	Level (dBμV/m)	Margin (dB)	Limit Line (dBμV/m)	Read Level (dBμV)	Antenna Factor (dB/m)	Path Loss (dB)	Preamp Factor (dB)	Ant Pos (cm)	Table Pos (deg)	Peak Avg. (P/A)	Pol. (H/V)
802.11ax HE20 Full CH 52 5260MHz		5134.4	50.93	-23.07	74	38.6	34.21	12.01	33.89	235	0	P	H
		5148.75	41.33	-12.67	54	28.9	34.29	12.03	33.89	235	0	A	H
	*	5260	114.27	-	-	101.36	34.68	12.11	33.88	235	0	P	H
	*	5260	107.36	-	-	94.45	34.68	12.11	33.88	235	0	A	H
		5357.28	50.74	-23.26	74	37.71	34.79	12.12	33.88	235	0	P	H
		5350.32	41.67	-12.33	54	28.63	34.8	12.12	33.88	235	0	A	H
		5124.6	50.52	-23.48	74	38.26	34.15	12	33.89	100	334	P	V
		5143.5	41.08	-12.92	54	28.68	34.26	12.03	33.89	100	334	A	V
	*	5260	111.47	-	-	98.56	34.68	12.11	33.88	100	334	P	V
	*	5260	103.79	-	-	90.88	34.68	12.11	33.88	100	334	A	V
		5368.56	49.88	-24.12	74	36.87	34.76	12.13	33.88	100	334	P	V
		5455.92	40.58	-13.42	54	27.43	34.8	12.22	33.87	100	334	A	V
	802.11ax HE20 Full CH 60 5300MHz		5107.45	50.59	-23.41	74	38.46	34.04	11.98	33.89	248	0	P
		5127.05	41.06	-12.94	54	28.78	34.16	12.01	33.89	248	0	A	H
*		5300	114.59	-	-	101.76	34.6	12.11	33.88	248	0	P	H
*		5300	107.27	-	-	94.44	34.6	12.11	33.88	248	0	A	H
		5351.76	60.43	-13.57	74	47.39	34.8	12.12	33.88	248	0	P	H
		5350.08	46.94	-7.06	54	33.9	34.8	12.12	33.88	248	0	A	H
		5134.75	50.13	-23.87	74	37.79	34.21	12.02	33.89	100	335	P	V
		5146.3	41.09	-12.91	54	28.67	34.28	12.03	33.89	100	335	A	V
*		5300	110.52	-	-	97.69	34.6	12.11	33.88	100	335	P	V
*		5300	103.56	-	-	90.73	34.6	12.11	33.88	100	335	A	V
		5350.32	56.99	-17.01	74	43.95	34.8	12.12	33.88	100	335	P	V
	5350.56	46.32	-7.68	54	33.28	34.8	12.12	33.88	100	335	A	V	



802.11ax HE20 Full CH 64 5320MHz	*	5320	112.11	-	-	99.19	34.68	12.12	33.88	244	0	P	H
	*	5320	105.81	-	-	92.89	34.68	12.12	33.88	244	0	A	H
		5355.2	61.8	-12.2	74	48.77	34.79	12.12	33.88	244	0	P	H
		5354.72	51.44	-2.56	54	38.41	34.79	12.12	33.88	244	0	A	H
													H
													H
	*	5320	110.15	-	-	97.23	34.68	12.12	33.88	100	294	P	V
	*	5320	103.06	-	-	90.14	34.68	12.12	33.88	100	294	A	V
		5353.12	52.37	-21.63	74	39.34	34.79	12.12	33.88	100	294	P	V
		5352.48	44.38	-9.62	54	31.34	34.8	12.12	33.88	100	294	A	V
												V	
												V	
Remark	1. No other spurious found. 2. All results are PASS against Peak and Average limit line.												



WIFI Ant. 6+7	Note	Frequency (MHz)	Level (dBμV/m)	Margin (dB)	Limit Line (dBμV/m)	Read Level (dBμV)	Antenna Factor (dB/m)	Path Loss (dB)	Preamp Factor (dB)	Ant Pos (cm)	Table Pos (deg)	Peak Avg. (P/A)	Pol. (H/V)	
802.11ax HE20 Full CH 64 5320MHz		7093	61.01	-7.19	68.2	67.45	35.6	15.3	57.34	200	222	P	H	
		10640	45.95	-28.05	74	48.12	37.6	18.83	58.6	-	-	P	H	
		15960	48.15	-25.85	74	40.85	41	22.73	56.43	-	-	P	H	
													H	
													H	
													H	
													H	
													H	
													H	
													H	
													H	
			7093	61.73	-6.47	68.2	68.17	35.6	15.3	57.34	311	37	P	V
			10640	46.44	-27.56	74	48.61	37.6	18.83	58.6	-	-	P	V
			15960	46.66	-27.34	74	39.36	41	22.73	56.43	-	-	P	V
														V
														V
														V
														V
													V	
													V	
													V	
													V	
Remark	1. No other spurious found. 2. All results are PASS against Peak and Average limit line. 3. The emission position marked as "-" means no suspected emission found with sufficient margin against limit line or noise floor only.													



Band 2 5250~5350MHz
WIFI 802.11ax HE20 Partial 106 (Band Edge @ 3m)

WIFI Ant. 6+7	Note	Frequency (MHz)	Level (dBμV/m)	Margin (dB)	Limit Line (dBμV/m)	Read Level (dBμV)	Antenna Factor (dB/m)	Path Loss (dB)	Preamp Factor (dB)	Ant Pos (cm)	Table Pos (deg)	Peak Avg. (P/A)	Pol. (H/V)
802.11ax HE20 Partial 106/54 CH 64 5320MHz	*	5320	111.45	-	-	98.53	34.68	12.12	33.88	100	334	P	H
	*	5320	104.54	-	-	91.62	34.68	12.12	33.88	100	334	A	H
		5358.56	51.64	-22.36	74	38.62	34.78	12.12	33.88	100	334	P	H
		5350.08	45.43	-8.57	54	32.39	34.8	12.12	33.88	100	334	A	H
													H
													H
	*	5320	107.44	-	-	94.52	34.68	12.12	33.88	300	291	P	V
	*	5320	99.94	-	-	87.02	34.68	12.12	33.88	300	291	A	V
		5352.48	61.02	-12.98	74	47.98	34.8	12.12	33.88	300	291	P	V
		5351.04	45.28	-8.72	54	32.24	34.8	12.12	33.88	300	291	A	V
												V	
												V	
Remark	1. No other spurious found. 2. All results are PASS against Peak and Average limit line.												



Band 2 5250~5350MHz
WIFI 802.11ax HE40 Full (Band Edge @ 3m)

WIFI Ant. 6+7	Note	Frequency (MHz)	Level (dBμV/m)	Margin (dB)	Limit Line (dBμV/m)	Read Level (dBμV)	Antenna Factor (dB/m)	Path Loss (dB)	Preamp Factor (dB)	Ant Pos (cm)	Table Pos (deg)	Peak Avg. (P/A)	Pol. (H/V)	
802.11ax HE40 Full CH 54 5270MHz		5137.55	56.54	-17.46	74	44.18	34.23	12.02	33.89	259	0	P	H	
		5148.05	45.86	-8.14	54	33.43	34.29	12.03	33.89	259	0	A	H	
	*	5270	113.6	-	-	100.71	34.66	12.11	33.88	259	0	P	H	
	*	5270	105.29	-	-	92.4	34.66	12.11	33.88	259	0	A	H	
		5353.44	61.04	-12.96	74	48.01	34.79	12.12	33.88	259	0	P	H	
		5355.84	52.03	-1.97	54	39	34.79	12.12	33.88	259	0	A	H	
		5147	54.87	-19.13	74	42.45	34.28	12.03	33.89	100	298	P	V	
		5144.55	44.36	-9.64	54	31.95	34.27	12.03	33.89	100	298	A	V	
	*	5270	110.08	-	-	97.19	34.66	12.11	33.88	100	298	P	V	
	*	5270	102.33	-	-	89.44	34.66	12.11	33.88	100	298	A	V	
		5353.92	62.45	-11.55	74	49.42	34.79	12.12	33.88	100	298	P	V	
		5354.64	51.27	-2.73	54	38.24	34.79	12.12	33.88	100	298	A	V	
	802.11ax HE40 Full CH 62 5310MHz		5029.4	50.61	-23.39	74	38.47	34.16	11.88	33.9	294	333	P	H
			5125.3	41.7	-12.3	54	29.44	34.15	12	33.89	294	333	A	H
*		5310	109.53	-	-	96.65	34.64	12.12	33.88	294	333	P	H	
*		5310	102.6	-	-	89.72	34.64	12.12	33.88	294	333	A	H	
		5358.48	58.44	-15.56	74	45.42	34.78	12.12	33.88	294	333	P	H	
		5355.12	51.9	-2.1	54	38.87	34.79	12.12	33.88	294	333	A	H	
		5117.6	50.68	-23.32	74	38.47	34.11	11.99	33.89	100	302	P	V	
		5140.35	41.61	-12.39	54	29.24	34.24	12.02	33.89	100	302	A	V	
*		5310	106.82	-	-	93.94	34.64	12.12	33.88	100	302	P	V	
*		5310	99.63	-	-	86.75	34.64	12.12	33.88	100	302	A	V	
	5356.56	57.05	-16.95	74	44.02	34.79	12.12	33.88	100	302	P	V		
	5355.6	48.42	-5.58	54	35.39	34.79	12.12	33.88	100	302	A	V		
Remark	1. No other spurious found. 2. All results are PASS against Peak and Average limit line.													



WiFi Ant. 6+7	Note	Frequency (MHz)	Level (dBμV/m)	Margin (dB)	Limit Line (dBμV/m)	Read Level (dBμV)	Antenna Factor (dB/m)	Path Loss (dB)	Preamp Factor (dB)	Ant Pos (cm)	Table Pos (deg)	Peak Avg. (P/A)	Pol. (H/V)	
802.11ax HE40 Full CH 62 5310MHz		7080	61.42	-6.78	68.2	67.85	35.6	15.29	57.32	200	276	P	H	
		10620	45.21	-28.79	74	47.42	37.6	18.82	58.63	-	-	P	H	
		15930	47.78	-26.22	74	40.48	41	22.72	56.42	-	-	P	H	
													H	
													H	
													H	
													H	
													H	
													H	
													H	
													H	
			7080	61.24	-6.96	68.2	67.67	35.6	15.29	57.32	300	311	P	V
			10620	44.66	-29.34	74	46.87	37.6	18.82	58.63	-	-	P	V
			15930	48.05	-25.95	74	40.75	41	22.72	56.42	-	-	P	V
														V
														V
														V
														V
														V
													V	
													V	
Remark	<ol style="list-style-type: none"> No other spurious found. All results are PASS against Peak and Average limit line. The emission position marked as "-" means no suspected emission found with sufficient margin against limit line or noise floor only. 													



Band 2 5250~5350MHz
WIFI 802.11ax HE40 Partial 242 (Band Edge @ 3m)

WIFI Ant. 6+7	Note	Frequency (MHz)	Level (dBμV/m)	Margin (dB)	Limit Line (dBμV/m)	Read Level (dBμV)	Antenna Factor (dB/m)	Path Loss (dB)	Preamp Factor (dB)	Ant Pos (cm)	Table Pos (deg)	Peak Avg. (P/A)	Pol. (H/V)
802.11ax HE40 Partial 242/62 CH 62 5310MHz		5141.4	50.33	-23.67	74	37.95	34.25	12.02	33.89	400	358	P	H
		5127.4	41.57	-12.43	54	29.29	34.16	12.01	33.89	400	358	A	H
	*	5310	110.19	-	-	97.31	34.64	12.12	33.88	400	358	P	H
	*	5310	101.48	-	-	88.6	34.64	12.12	33.88	400	358	A	H
		5360.4	58.74	-15.26	74	45.72	34.78	12.12	33.88	400	358	P	H
		5356.08	52.64	-1.36	54	39.61	34.79	12.12	33.88	400	358	A	H
		5070.35	50.82	-23.18	74	38.79	34	11.93	33.9	100	295	P	V
		5141.4	41.54	-12.46	54	29.16	34.25	12.02	33.89	100	295	A	V
	*	5310	108.72	-	-	95.84	34.64	12.12	33.88	100	295	P	V
	*	5310	100.71	-	-	87.83	34.64	12.12	33.88	100	295	A	V
	5365.2	68.08	-5.92	74	55.07	34.77	12.12	33.88	100	295	P	V	
	5354.88	52.04	-1.96	54	39.01	34.79	12.12	33.88	100	295	A	V	
Remark	1. No other spurious found. 2. All results are PASS against Peak and Average limit line.												



Band 2 5250~5350MHz
WIFI 802.11ax HE80 Full (Band Edge @ 3m)

WIFI Ant. 6+7	Note	Frequency (MHz)	Level (dBμV/m)	Margin (dB)	Limit Line (dBμV/m)	Read Level (dBμV)	Antenna Factor (dB/m)	Path Loss (dB)	Preamp Factor (dB)	Ant Pos (cm)	Table Pos (deg)	Peak Avg. (P/A)	Pol. (H/V)
802.11ax HE80 Full CH 58 5290MHz		5134.05	51.17	-22.83	74	38.85	34.2	12.01	33.89	300	3	P	H
		5144.2	43.11	-10.89	54	30.7	34.27	12.03	33.89	300	3	A	H
	*	5290	107.79	-	-	94.94	34.62	12.11	33.88	300	3	P	H
	*	5290	99.7	-	-	86.85	34.62	12.11	33.88	300	3	A	H
		5362.32	60.19	-13.81	74	47.17	34.78	12.12	33.88	300	3	P	H
		5354.4	52.19	-1.81	54	39.16	34.79	12.12	33.88	300	3	A	H
		5130.2	52.16	-21.84	74	39.86	34.18	12.01	33.89	100	296	P	V
		5143.5	43.92	-10.08	54	31.52	34.26	12.03	33.89	100	296	A	V
	*	5290	106.16	-	-	93.31	34.62	12.11	33.88	100	296	P	V
	*	5290	98.25	-	-	85.4	34.62	12.11	33.88	100	296	A	V
		5350.56	58.01	-15.99	74	44.97	34.8	12.12	33.88	100	296	P	V
		5355.36	52.11	-1.89	54	39.08	34.79	12.12	33.88	100	296	A	V
Remark	1. No other spurious found. 2. All results are PASS against Peak and Average limit line.												



Band 2 5250~5350MHz
WIFI 802.11ax HE80 Partial 484 (Band Edge @ 3m)

WIFI Ant. 6+7	Note	Frequency (MHz)	Level (dBμV/m)	Margin (dB)	Limit Line (dBμV/m)	Read Level (dBμV)	Antenna Factor (dB/m)	Path Loss (dB)	Preamp Factor (dB)	Ant Pos (cm)	Table Pos (deg)	Peak Avg. (P/A)	Pol. (H/V)
802.11ax HE80 Partial 484/66 CH 58 5290MHz		5119.7	52.19	-21.81	74	39.96	34.12	12	33.89	333	360	P	H
		5147.35	43.87	-10.13	54	31.45	34.28	12.03	33.89	333	360	A	H
	*	5290	104.65	-	-	91.8	34.62	12.11	33.88	333	360	P	H
	*	5290	96.58	-	-	83.73	34.62	12.11	33.88	333	360	A	H
		5382.72	65.07	-8.93	74	52.09	34.73	12.13	33.88	333	360	P	H
		5382.96	52.94	-1.06	54	39.96	34.73	12.13	33.88	333	360	A	H
		5142.45	50.71	-23.29	74	38.32	34.25	12.03	33.89	100	334	P	V
		5139.65	42.95	-11.05	54	30.58	34.24	12.02	33.89	100	334	A	V
	*	5290	101.67	-	-	88.82	34.62	12.11	33.88	100	334	P	V
	*	5290	94.47	-	-	81.62	34.62	12.11	33.88	100	334	A	V
	5382.72	61.22	-12.78	74	48.24	34.73	12.13	33.88	100	334	P	V	
	5379.84	50.46	-3.54	54	37.47	34.74	12.13	33.88	100	334	A	V	
Remark	1. No other spurious found. 2. All results are PASS against Peak and Average limit line.												



Band 3 - 5470~5725MHz
WIFI 802.11a (Band Edge @ 3m)

WIFI Ant. 6+7	Note	Frequency (MHz)	Level (dBμV/m)	Margin (dB)	Limit Line (dBμV/m)	Read Level (dBμV)	Antenna Factor (dB/m)	Path Loss (dB)	Preamp Factor (dB)	Ant Pos (cm)	Table Pos (deg)	Peak Avg. (P/A)	Pol. (H/V)	
802.11a CH 100 5500MHz		5442.64	50.89	-23.11	74	37.77	34.79	12.2	33.87	258	0	P	H	
		5466	53.03	-15.17	68.2	39.86	34.8	12.24	33.87	258	0	P	H	
		5457.68	44.09	-9.91	54	30.93	34.8	12.23	33.87	258	0	A	H	
	*	5500	113.55	-	-	100.32	34.8	12.3	33.87	258	0	P	H	
	*	5500	106.44	-	-	93.21	34.8	12.3	33.87	258	0	A	H	
														H
			5455.12	49.29	-24.71	74	36.14	34.8	12.22	33.87	100	284	P	V
			5469.68	51.1	-17.1	68.2	37.93	34.8	12.24	33.87	100	284	P	V
			5459.28	42.19	-11.81	54	29.03	34.8	12.23	33.87	100	284	A	V
	*		5500	108.78	-	-	95.55	34.8	12.3	33.87	100	284	P	V
	*		5500	102.08	-	-	88.85	34.8	12.3	33.87	100	284	A	V
														V
802.11a CH 116 5580MHz		5445.52	48.75	-25.25	74	35.62	34.79	12.21	33.87	100	336	P	H	
		5462.56	48.5	-19.7	68.2	35.34	34.8	12.23	33.87	100	336	P	H	
		5457.52	40.83	-13.17	54	27.68	34.8	12.22	33.87	100	336	A	H	
	*	5580	111.69	-	-	98.45	34.7	12.43	33.89	100	336	P	H	
	*	5580	106.64	-	-	93.4	34.7	12.43	33.89	100	336	A	H	
			5760.275	49.81	-18.39	68.2	36.03	35.2	12.52	33.94	100	336	P	H
			5392.96	48.81	-25.19	74	35.85	34.71	12.13	33.88	296	334	P	V
			5463.04	48.69	-19.51	68.2	35.53	34.8	12.23	33.87	296	334	P	V
			5457.04	40.28	-13.72	54	27.13	34.8	12.22	33.87	296	334	A	V
	*		5580	108.31	-	-	95.07	34.7	12.43	33.89	296	334	P	V
	*		5580	102.66	-	-	89.42	34.7	12.43	33.89	296	334	A	V
			5734.13	48.63	-19.57	68.2	34.85	35.2	12.51	33.93	296	334	P	V



802.11a CH 140 5700MHz	*	5700	112.26	-	-	98.49	35.2	12.49	33.92	100	334	P	H
	*	5700	106.06	-	-	92.29	35.2	12.49	33.92	100	334	A	H
		5727.08	54.44	-13.76	68.2	40.67	35.2	12.5	33.93	100	334	P	H
													H
													H
													H
	*	5700	106.69	-	-	92.92	35.2	12.49	33.92	100	303	P	V
	*	5700	100.65	-	-	86.88	35.2	12.49	33.92	100	303	A	V
		5731.88	51.61	-16.59	68.2	37.83	35.2	12.51	33.93	100	303	P	V
													V
													V
													V
Remark	1. No other spurious found. 2. All results are PASS against Peak and Average limit line.												



Band 3 - 5470~5725MHz
WIFI 802.11a (Harmonic @ 3m)

WIFI Ant. 6+7	Note	Frequency (MHz)	Level (dBμV/m)	Margin (dB)	Limit Line (dBμV/m)	Read Level (dBμV)	Antenna Factor (dB/m)	Path Loss (dB)	Preamp Factor (dB)	Ant Pos (cm)	Table Pos (deg)	Peak Avg. (P/A)	Pol. (H/V)	
802.11a CH 100 5500MHz		7700	53.27	-20.73	74	59.23	35.9	15.78	57.64	300	344	P	H	
		7700	45.34	-8.66	54	51.3	35.9	15.78	57.64	300	344	A	H	
		11000	45.35	-28.65	74	46.47	37.8	19.17	58.09	-	-	P	H	
		16500	49.81	-18.39	68.2	40.88	42.1	23.16	56.33	-	-	P	H	
													H	
													H	
													H	
													H	
													H	
													H	
													H	
													H	
													H	
			7700	47.95	-26.05	74	53.91	35.9	15.78	57.64	100	297	P	V
			7700	43.14	-10.86	54	49.1	35.9	15.78	57.64	100	297	A	V
			11000	46.49	-27.51	74	47.61	37.8	19.17	58.09	-	-	P	V
			16500	48.68	-19.52	68.2	39.75	42.1	23.16	56.33	-	-	P	V
														V
													V	
													V	
													V	
													V	
													V	
													V	



WIFI Ant. 6+7	Note	Frequency (MHz)	Level (dBμV/m)	Margin (dB)	Limit Line (dBμV/m)	Read Level (dBμV)	Antenna Factor (dB/m)	Path Loss (dB)	Preamp Factor (dB)	Ant Pos (cm)	Table Pos (deg)	Peak Avg. (P/A)	Pol. (H/V)
802.11a CH 116 5580MHz		7812	53.87	-14.33	68.2	59.95	35.88	15.62	57.58	369	0	P	H
		11158	44.9	-29.1	74	45.51	37.82	19.33	57.76	-	-	P	H
		16740	47.92	-20.28	68.2	38.29	42.28	23.34	55.99	-	-	P	H
													H
													H
													H
													H
													H
													H
													H
													H
													H
													H
													H
													H
													H
													H
													H
			7812	51.39	-16.81	68.2	57.47	35.88	15.62	57.58	100	298	P
		11160	46.51	-27.49	74	47.11	37.82	19.34	57.76	-	-	P	V
		16740	48.82	-19.38	68.2	39.19	42.28	23.34	55.99	-	-	P	V
													V
													V
													V
													V
													V
													V
													V
													V
													V
													V



WiFi Ant. 6+7	Note	Frequency (MHz)	Level (dBμV/m)	Margin (dB)	Limit Line (dBμV/m)	Read Level (dBμV)	Antenna Factor (dB/m)	Path Loss (dB)	Preamp Factor (dB)	Ant Pos (cm)	Table Pos (deg)	Peak Avg. (P/A)	Pol. (H/V)	
802.11a CH 140 5700MHz		7980	54.7	-13.5	68.2	60.34	35.84	16	57.48	368	7	P	H	
		11400	45.83	-28.17	74	45.32	38.2	19.57	57.26	-	-	P	H	
		17100	49.21	-18.99	68.2	39.4	41.8	23.64	55.63	-	-	P	H	
													H	
													H	
													H	
													H	
													H	
													H	
													H	
													H	
			7980	50.8	-17.4	68.2	56.44	35.84	16	57.48	100	93	P	V
			11400	45.85	-28.15	74	45.34	38.2	19.57	57.26	-	-	P	V
			17100	49.57	-18.63	68.2	39.76	41.8	23.64	55.63	-	-	P	V
														V
														V
														V
														V
														V
														V
													V	
Remark	<ol style="list-style-type: none"> No other spurious found. All results are PASS against Peak and Average limit line. The emission position marked as "-" means no suspected emission found with sufficient margin against limit line or noise floor only. 													



Band 3 - 5470~5725MHz
WIFI 802.11ax HE20 Full (Band Edge @ 3m)

WIFI Ant. 6+7	Note	Frequency (MHz)	Level (dBμV/m)	Margin (dB)	Limit Line (dBμV/m)	Read Level (dBμV)	Antenna Factor (dB/m)	Path Loss (dB)	Preamp Factor (dB)	Ant Pos (cm)	Table Pos (deg)	Peak Avg. (P/A)	Pol. (H/V)
802.11ax HE20 Full CH 100 5500MHz		5459.44	55.7	-18.3	74	42.54	34.8	12.23	33.87	100	332	P	H
		5461.2	59.91	-8.29	68.2	46.75	34.8	12.23	33.87	100	332	P	H
		5459.92	45.77	-8.23	54	32.61	34.8	12.23	33.87	100	332	A	H
	*	5500	114.02	-	-	100.79	34.8	12.3	33.87	100	332	P	H
	*	5500	107.16	-	-	93.93	34.8	12.3	33.87	100	332	A	H
		5458	57.16	-16.84	74	44	34.8	12.23	33.87	100	299	P	V
		5469.52	59.21	-8.99	68.2	46.04	34.8	12.24	33.87	100	299	P	V
		5459.76	43.81	-10.19	54	30.65	34.8	12.23	33.87	100	299	A	V
	*	5500	107.91	-	-	94.68	34.8	12.3	33.87	100	299	P	V
	*	5500	101.48	-	-	88.25	34.8	12.3	33.87	100	299	A	V
													V
													V
802.11ax HE20 Full CH 116 5580MHz		5455.12	49.54	-24.46	74	36.39	34.8	12.22	33.87	100	356	P	H
		5463.28	47.75	-20.45	68.2	34.59	34.8	12.23	33.87	100	356	P	H
		5459.68	40.16	-13.84	54	27	34.8	12.23	33.87	100	356	A	H
	*	5580	112.72	-	-	99.48	34.7	12.43	33.89	100	356	P	H
	*	5580	108.34	-	-	95.1	34.7	12.43	33.89	100	356	A	H
		5754.92	49.69	-18.51	68.2	35.92	35.2	12.51	33.94	100	356	P	H
		5435.2	48.24	-25.76	74	35.15	34.77	12.19	33.87	298	335	P	V
		5468.56	49.07	-19.13	68.2	35.9	34.8	12.24	33.87	298	335	P	V
		5458.96	39.79	-14.21	54	26.63	34.8	12.23	33.87	298	335	A	V
	*	5580	108.71	-	-	95.47	34.7	12.43	33.89	298	335	P	V
	*	5580	103.35	-	-	90.11	34.7	12.43	33.89	298	335	A	V
		5732.555	49.18	-19.02	68.2	35.4	35.2	12.51	33.93	298	335	P	V



802.11ax HE20 Full CH 140 5700MHz	*	5700	113.23	-	-	99.46	35.2	12.49	33.92	100	337	P	H
	*	5700	107.39	-	-	93.62	35.2	12.49	33.92	100	337	A	H
		5725.08	60.98	-7.22	68.2	47.21	35.2	12.5	33.93	100	337	P	H
													H
													H
													H
	*	5700	108.43	-	-	94.66	35.2	12.49	33.92	100	304	P	V
	*	5700	99.16	-	-	85.39	35.2	12.49	33.92	100	304	A	V
		5727	57.36	-10.84	68.2	43.59	35.2	12.5	33.93	100	304	P	V
													V
												V	
												V	
Remark	1. No other spurious found. 2. All results are PASS against Peak and Average limit line.												



Band 3 5470~5725MHz

WIFI 802.11ax HE20 (Harmonic @ 3m)

WIFI Ant. 6+7	Note	Frequency (MHz)	Level (dBμV/m)	Margin (dB)	Limit Line (dBμV/m)	Read Level (dBμV)	Antenna Factor (dB/m)	Path Loss (dB)	Preamp Factor (dB)	Ant Pos (cm)	Table Pos (deg)	Peak Avg. (P/A)	Pol. (H/V)
802.11ax HE20 Full CH 100 5500MHz		7700	59.57	-14.43	74	65.53	35.9	15.78	57.64	305	344	P	H
		7700	50.87	-3.13	54	56.83	35.9	15.78	57.64	305	344	A	H
		11000	44.62	-29.38	74	45.74	37.8	19.17	58.09	-	-	P	H
		16500	49.48	-18.72	68.2	40.55	42.1	23.16	56.33	-	-	P	H
													H
													H
													H
													H
													H
													H
													H
													H
													H
													H
													H
													H
													H
			7700	56.47	-17.53	74	62.43	35.9	15.78	57.64	100	281	P
		7700	47.9	-6.1	54	53.86	35.9	15.78	57.64	100	281	A	V
		11000	46.64	-27.36	74	47.76	37.8	19.17	58.09	-	-	P	V
		16500	48.97	-19.23	68.2	40.04	42.1	23.16	56.33	-	-	P	V
													V
													V
													V
													V
													V
													V
													V
													V



Band 3 5470~5725MHz
WIFI 802.11ax HE20 Partial 106 (Band Edge @ 3m)

WIFI Ant. 6+7	Note	Frequency (MHz)	Level (dBμV/m)	Margin (dB)	Limit Line (dBμV/m)	Read Level (dBμV)	Antenna Factor (dB/m)	Path Loss (dB)	Preamp Factor (dB)	Ant Pos (cm)	Table Pos (deg)	Peak Avg. (P/A)	Pol. (H/V)	
802.11ax HE20 Partial 106/53 CH 100 5500MHz		5459.6	66.22	-7.78	74	53.06	34.8	12.23	33.87	100	332	P	H	
		5461.68	66.85	-1.35	68.2	53.69	34.8	12.23	33.87	100	332	P	H	
		5459.28	45.89	-8.11	54	32.73	34.8	12.23	33.87	100	332	A	H	
	*	5500	112.83	-	-	99.6	34.8	12.3	33.87	100	332	P	H	
	*	5500	103.79	-	-	90.56	34.8	12.3	33.87	100	332	A	H	
														H
			5458	61.54	-12.46	74	48.38	34.8	12.23	33.87	100	289	P	V
			5460.08	61.9	-6.3	68.2	48.74	34.8	12.23	33.87	100	289	P	V
			5459.92	44.21	-9.79	54	31.05	34.8	12.23	33.87	100	289	A	V
		*	5500	108.51	-	-	95.28	34.8	12.3	33.87	100	289	P	V
	*	5500	100.36	-	-	87.13	34.8	12.3	33.87	100	289	A	V	
													V	
802.11ax HE20 Partial 106/54 CH 140 5700MHz		5700	112.96	-	-	99.19	35.2	12.49	33.92	100	339	P	H	
		5700	105.79	-	-	92.02	35.2	12.49	33.92	100	339	A	H	
		5725.56	65.73	-2.47	68.2	51.96	35.2	12.5	33.93	100	339	P	H	
														H
														H
														H
		*	5700	107.92	-	-	94.15	35.2	12.49	33.92	400	304	P	V
		*	5700	99.29	-	-	85.52	35.2	12.49	33.92	400	304	A	V
			5728.44	56.83	-11.37	68.2	43.06	35.2	12.5	33.93	400	304	P	V
														V
													V	
													V	
Remark	1. No other spurious found. 2. All results are PASS against Peak and Average limit line.													



Band 3 5470~5725MHz
WIFI 802.11ax HE40 Full (Band Edge @ 3m)

WIFI Ant. 6+7	Note	Frequency (MHz)	Level (dBμV/m)	Margin (dB)	Limit Line (dBμV/m)	Read Level (dBμV)	Antenna Factor (dB/m)	Path Loss (dB)	Preamp Factor (dB)	Ant Pos (cm)	Table Pos (deg)	Peak Avg. (P/A)	Pol. (H/V)
802.11ax HE40 Full CH 102 5510MHz		5459.92	57.88	-16.12	74	44.72	34.8	12.23	33.87	100	327	P	H
		5470	65.54	-2.66	68.2	52.36	34.8	12.25	33.87	100	327	P	H
		5457.76	49.58	-4.42	54	36.42	34.8	12.23	33.87	100	327	A	H
	*	5510	109.66	-	-	96.44	34.78	12.31	33.87	100	327	P	H
	*	5510	103.87	-	-	90.65	34.78	12.31	33.87	100	327	A	H
		5745.47	49.3	-18.9	68.2	35.52	35.2	12.51	33.93	100	327	P	H
		5453.68	57.65	-16.35	74	44.5	34.8	12.22	33.87	100	286	P	V
		5469.76	63.39	-4.81	68.2	50.21	34.8	12.25	33.87	100	286	P	V
		5457.76	48.09	-5.91	54	34.93	34.8	12.23	33.87	100	286	A	V
	*	5510	105.55	-	-	92.33	34.78	12.31	33.87	100	286	P	V
	*	5510	99.23	-	-	86.01	34.78	12.31	33.87	100	286	A	V
	5757.755	49.02	-19.18	68.2	35.24	35.2	12.52	33.94	100	286	P	V	
802.11ax HE40 Full CH 110 5550MHz		5451.76	59.38	-14.62	74	46.23	34.8	12.22	33.87	269	332	P	H
		5465.2	61.75	-6.45	68.2	48.58	34.8	12.24	33.87	269	332	P	H
		5459.92	47.72	-6.28	54	34.56	34.8	12.23	33.87	269	332	A	H
	*	5550	112.83	-	-	99.63	34.7	12.38	33.88	269	332	P	H
	*	5550	104.69	-	-	91.49	34.7	12.38	33.88	269	332	A	H
		5759.645	52.3	-15.9	68.2	38.52	35.2	12.52	33.94	269	332	P	H
		5453.68	58.88	-15.12	74	45.73	34.8	12.22	33.87	100	289	P	V
		5464.48	58.32	-9.88	68.2	45.15	34.8	12.24	33.87	100	289	P	V
		5459.68	47.73	-6.27	54	34.57	34.8	12.23	33.87	100	289	A	V
	*	5550	106.63	-	-	93.43	34.7	12.38	33.88	100	289	P	V
	*	5550	100.31	-	-	87.11	34.7	12.38	33.88	100	289	A	V
	5764.055	50.98	-17.22	68.2	37.2	35.2	12.52	33.94	100	289	P	V	



802.11ax HE40 Full CH 134 5670MHz		5422.45	49.38	-24.62	74	36.34	34.74	12.17	33.87	100	333	P	H
		5462	52.66	-15.54	68.2	39.5	34.8	12.23	33.87	100	333	P	H
		5459.55	41.91	-12.09	54	28.75	34.8	12.23	33.87	100	333	A	H
	*	5670	113.97	-	-	100.32	35.08	12.48	33.91	100	333	P	H
	*	5670	106.15	-	-	92.5	35.08	12.48	33.91	100	333	A	H
		5726.325	64.77	-3.43	68.2	51	35.2	12.5	33.93	100	333	P	H
		5422.8	49.5	-24.5	74	36.45	34.75	12.17	33.87	316	304	P	V
		5462	48.28	-19.92	68.2	35.12	34.8	12.23	33.87	316	304	P	V
		5457.1	41.47	-12.53	54	28.32	34.8	12.22	33.87	316	304	A	V
	*	5670	109.85	-	-	96.2	35.08	12.48	33.91	316	304	P	V
	*	5670	102.51	-	-	88.86	35.08	12.48	33.91	316	304	A	V
		5729.125	54.32	-13.88	68.2	40.54	35.2	12.51	33.93	316	304	P	V
Remark	1. No other spurious found. 2. All results are PASS against Peak and Average limit line.												



Band 3 5470~5725MHz

WIFI 802.11ax HE40 Full (Harmonic @ 3m)

WIFI Ant. 6+7	Note	Frequency (MHz)	Level (dBμV/m)	Margin (dB)	Limit Line (dBμV/m)	Read Level (dBμV)	Antenna Factor (dB/m)	Path Loss (dB)	Preamp Factor (dB)	Ant Pos (cm)	Table Pos (deg)	Peak Avg. (P/A)	Pol. (H/V)	
802.11ax HE40 Full CH 102 5510MHz		7714	56.84	-17.16	74	62.8	35.93	15.75	57.64	294	344	P	H	
		7714	48.92	-5.08	54	54.88	35.93	15.75	57.64	294	344	A	H	
		11020	45.41	-28.59	74	46.46	37.8	19.2	58.05	-	-	P	H	
		16530	48.44	-19.76	68.2	39.69	41.86	23.18	56.29	-	-	P	H	
													H	
													H	
													H	
													H	
													H	
													H	
													H	
													H	
													H	
													H	
			7714	51.96	-22.04	74	57.92	35.93	15.75	57.64	100	271	P	V
			7714	45.44	-8.56	54	51.4	35.93	15.75	57.64	100	271	A	V
		11020	45.06	-28.94	74	46.11	37.8	19.2	58.05	-	-	P	V	
		16530	48.44	-19.76	68.2	39.69	41.86	23.18	56.29	-	-	P	V	
													V	
													V	
													V	
													V	
													V	
													V	
													V	
													V	



Band 3 5470~5725MHz
WIFI 802.11ax HE40 Partial 242 (Band Edge @ 3m)

WIFI Ant. 6+7	Note	Frequency (MHz)	Level (dBμV/m)	Margin (dB)	Limit Line (dBμV/m)	Read Level (dBμV)	Antenna Factor (dB/m)	Path Loss (dB)	Preamp Factor (dB)	Ant Pos (cm)	Table Pos (deg)	Peak Avg. (P/A)	Pol. (H/V)
802.11ax HE40 Partial 242/61 CH 102 5510MHz		5444.08	60.55	-13.45	74	47.43	34.79	12.2	33.87	100	334	P	H
		5469.76	62.32	-5.88	68.2	49.14	34.8	12.25	33.87	100	334	P	H
		5458.72	50.65	-3.35	54	37.49	34.8	12.23	33.87	100	334	A	H
	*	5510	110.49	-	-	97.27	34.78	12.31	33.87	100	334	P	H
	*	5510	103	-	-	89.78	34.78	12.31	33.87	100	334	A	H
		5729.72	50.24	-17.96	68.2	36.46	35.2	12.51	33.93	100	334	P	H
		5436.64	54.39	-19.61	74	41.3	34.77	12.19	33.87	100	296	P	V
		5469.76	55.74	-12.46	68.2	42.56	34.8	12.25	33.87	100	296	P	V
		5457.28	48.15	-5.85	54	35	34.8	12.22	33.87	100	296	A	V
	*	5510	105.26	-	-	92.04	34.78	12.31	33.87	100	296	P	V
	*	5510	98.52	-	-	85.3	34.78	12.31	33.87	100	296	A	V
		5729.09	49.84	-18.36	68.2	36.06	35.2	12.51	33.93	100	296	P	V
802.11ax HE40 Partial 242/62 CH 134 5670MHz		5442.05	49.33	-24.67	74	36.22	34.78	12.2	33.87	199	360	P	H
		5466.55	48.94	-19.26	68.2	35.77	34.8	12.24	33.87	199	360	P	H
		5444.85	41.59	-12.41	54	28.47	34.79	12.2	33.87	199	360	A	H
	*	5670	111.09	-	-	97.44	35.08	12.48	33.91	199	360	P	H
	*	5670	103.33	-	-	89.68	35.08	12.48	33.91	199	360	A	H
		5725.275	62	-6.2	68.2	48.23	35.2	12.5	33.93	199	360	P	H
		5455	48.97	-25.03	74	35.82	34.8	12.22	33.87	100	300	P	V
		5470	47.56	-20.64	68.2	34.38	34.8	12.25	33.87	100	300	P	V
		5443.45	41.2	-12.8	54	28.08	34.79	12.2	33.87	100	300	A	V
	*	5670	104.47	-	-	90.82	35.08	12.48	33.91	100	300	P	V
*	5670	96.91	-	-	83.26	35.08	12.48	33.91	100	300	A	V	
	5725.45	57.09	-11.11	68.2	43.32	35.2	12.5	33.93	100	300	P	V	
Remark	1. No other spurious found. 2. All results are PASS against Peak and Average limit line.												



Band 3 5470~5725MHz
WIFI 802.11ax HE80 Full (Band Edge @ 3m)

WIFI Ant. 6+7	Note	Frequency (MHz)	Level (dBμV/m)	Margin (dB)	Limit Line (dBμV/m)	Read Level (dBμV)	Antenna Factor (dB/m)	Path Loss (dB)	Preamp Factor (dB)	Ant Pos (cm)	Table Pos (deg)	Peak Avg. (P/A)	Pol. (H/V)
802.11ax HE80 Full CH 106 5530MHz		5452.24	56.24	-17.76	74	43.09	34.8	12.22	33.87	299	328	P	H
		5463.52	59.65	-8.55	68.2	46.49	34.8	12.23	33.87	299	328	P	H
		5452.72	49.27	-4.73	54	36.12	34.8	12.22	33.87	299	328	A	H
	*	5530	107.05	-	-	93.85	34.74	12.34	33.88	299	328	P	H
	*	5530	100.22	-	-	87.02	34.74	12.34	33.88	299	328	A	H
		5755.55	51.63	-16.57	68.2	37.86	35.2	12.51	33.94	299	328	P	H
		5443.6	54.63	-19.37	74	41.51	34.79	12.2	33.87	100	300	P	V
		5464.96	56.11	-12.09	68.2	42.94	34.8	12.24	33.87	100	300	P	V
		5459.44	47.75	-6.25	54	34.59	34.8	12.23	33.87	100	300	A	V
	*	5530	103.58	-	-	90.38	34.74	12.34	33.88	100	300	P	V
	*	5530	98.17	-	-	84.97	34.74	12.34	33.88	100	300	A	V
		5731.61	51.01	-17.19	68.2	37.23	35.2	12.51	33.93	100	300	P	V
802.11ax HE80 Full CH 122 5610MHz		5454.65	57.6	-16.4	74	44.45	34.8	12.22	33.87	297	331	P	H
		5466.55	58.11	-10.09	68.2	44.94	34.8	12.24	33.87	297	331	P	H
		5456.75	48.98	-5.02	54	35.83	34.8	12.22	33.87	297	331	A	H
	*	5610	110.37	-	-	97.05	34.76	12.46	33.9	297	331	P	H
	*	5610	102.82	-	-	89.5	34.76	12.46	33.9	297	331	A	H
		5730.35	61.38	-6.82	68.2	47.6	35.2	12.51	33.93	297	331	P	H
		5454.65	50.96	-23.04	74	37.81	34.8	12.22	33.87	361	336	P	V
		5470	51.34	-16.86	68.2	38.16	34.8	12.25	33.87	361	336	P	V
		5457.8	44.85	-9.15	54	31.69	34.8	12.23	33.87	361	336	A	V
	*	5610	105.3	-	-	91.98	34.76	12.46	33.9	361	336	P	V
	*	5610	98.99	-	-	85.67	34.76	12.46	33.9	361	336	A	V
		5727.2	54.81	-13.39	68.2	41.04	35.2	12.5	33.93	361	336	P	V
Remark	1. No other spurious found. 2. All results are PASS against Peak and Average limit line.												



Band 3 5470~5725MHz
WIFI 802.11ax HE80 Partial 484 (Band Edge @ 3m)

WIFI Ant. 6+7	Note	Frequency (MHz)	Level (dBμV/m)	Margin (dB)	Limit Line (dBμV/m)	Read Level (dBμV)	Antenna Factor (dB/m)	Path Loss (dB)	Preamp Factor (dB)	Ant Pos (cm)	Table Pos (deg)	Peak Avg. (P/A)	Pol. (H/V)
802.11ax HE80 Partial 484/65 CH 106 5530MHz		5417.44	64.59	-9.41	74	51.57	34.73	12.16	33.87	263	0	P	H
		5465.44	65.74	-2.46	68.2	52.57	34.8	12.24	33.87	263	0	P	H
		5428	52.57	-1.43	54	39.5	34.76	12.18	33.87	263	0	A	H
	*	5530	106.41	-	-	93.21	34.74	12.34	33.88	263	0	P	H
	*	5530	99.27	-	-	86.07	34.74	12.34	33.88	263	0	A	H
		5759.96	51.48	-16.72	68.2	37.7	35.2	12.52	33.94	263	0	P	H
		5422.72	63.87	-10.13	74	50.82	34.75	12.17	33.87	100	295	P	V
		5460	62.71	-5.49	68.2	49.55	34.8	12.23	33.87	100	295	P	V
		5432.08	51.79	-2.21	54	38.72	34.76	12.18	33.87	100	295	A	V
	*	5530	102.75	-	-	89.55	34.74	12.34	33.88	100	295	P	V
	*	5530	95.71	-	-	82.51	34.74	12.34	33.88	100	295	A	V
		5759.96	56.2	-12	68.2	42.42	35.2	12.52	33.94	100	295	P	V
802.11ax HE80 Partial 484/66 CH 122 5610MHz		5421.4	55.69	-18.31	74	42.65	34.74	12.17	33.87	101	334	P	H
		5461.3	52.34	-15.86	68.2	39.18	34.8	12.23	33.87	101	334	P	H
		5459.9	47.8	-6.2	54	34.64	34.8	12.23	33.87	101	334	A	H
	*	5610	106.48	-	-	93.16	34.76	12.46	33.9	101	334	P	H
	*	5610	99.74	-	-	86.42	34.76	12.46	33.9	101	334	A	H
		5726.325	64.9	-3.3	68.2	51.13	35.2	12.5	33.93	101	334	P	H
		5421.75	56.22	-17.78	74	43.18	34.74	12.17	33.87	100	301	P	V
		5465.5	57.85	-10.35	68.2	44.68	34.8	12.24	33.87	100	301	P	V
		5459.55	46.75	-7.25	54	33.59	34.8	12.23	33.87	100	301	A	V
	*	5610	103.6	-	-	90.28	34.76	12.46	33.9	100	301	P	V
	*	5610	95.13	-	-	81.81	34.76	12.46	33.9	100	301	A	V
		5728.6	62.08	-6.12	68.2	48.3	35.2	12.51	33.93	100	301	P	V
Remark	1. No other spurious found. 2. All results are PASS against Peak and Average limit line.												



Band 3 5470~5725MHz

WIFI 802.11ax HE160 Full (Band Edge @ 3m)

WIFI Ant. 6+7	Note	Frequency (MHz)	Level (dBμV/m)	Margin (dB)	Limit Line (dBμV/m)	Read Level (dBμV)	Antenna Factor (dB/m)	Path Loss (dB)	Preamp Factor (dB)	Ant Pos (cm)	Table Pos (deg)	Peak Avg. (P/A)	Pol. (H/V)
802.11ax HE160 Full CH 114 5570MHz		5458	58.73	-15.27	74	45.57	34.8	12.23	33.87	298	331	P	H
		5462.8	58.41	-9.79	68.2	45.25	34.8	12.23	33.87	298	331	P	H
		5454.88	52.07	-1.93	54	38.92	34.8	12.22	33.87	298	331	A	H
	*	5570	103.43	-	-	90.21	34.7	12.41	33.89	298	331	P	H
	*	5570	96.24	-	-	83.02	34.7	12.41	33.89	298	331	A	H
		5727.2	60.96	-7.24	68.2	47.19	35.2	12.5	33.93	298	331	P	H
		5456.8	58.57	-15.43	74	45.42	34.8	12.22	33.87	100	300	P	V
		5464.72	57.4	-10.8	68.2	44.23	34.8	12.24	33.87	100	300	P	V
		5457.04	49.98	-4.02	54	36.83	34.8	12.22	33.87	100	300	A	V
		*	5570	99.87	-	-	86.65	34.7	12.41	33.89	100	300	P
	*	5570	93.21	-	-	79.99	34.7	12.41	33.89	100	300	A	V
		5725.31	57.94	-10.26	68.2	44.17	35.2	12.5	33.93	100	300	P	V
Remark	1. No other spurious found. 2. All results are PASS against Peak and Average limit line.												



Band 3 5470~5725MHz
WIFI 802.11ax HE160 Partial 996 (Band Edge @ 3m)

WIFI Ant. 6+7	Note	Frequency (MHz)	Level (dBμV/m)	Margin (dB)	Limit Line (dBμV/m)	Read Level (dBμV)	Antenna Factor (dB/m)	Path Loss (dB)	Preamp Factor (dB)	Ant Pos (cm)	Table Pos (deg)	Peak Avg. (P/A)	Pol. (H/V)
802.11ax HE160 Partial 996/67 CH 114 5570MHz		5417.44	53.7	-20.3	74	40.68	34.73	12.16	33.87	200	2	P	H
		5461.84	56.18	-12.02	68.2	43.02	34.8	12.23	33.87	200	2	P	H
		5455.36	44.73	-9.27	54	31.58	34.8	12.22	33.87	200	2	A	H
	*	5570	101.88	-	-	88.66	34.7	12.41	33.89	200	2	P	H
	*	5570	94.68	-	-	81.46	34.7	12.41	33.89	200	2	A	H
		5728.46	67	-1.2	68.2	53.23	35.2	12.5	33.93	200	2	P	H
		5409.04	56.28	-17.72	74	43.3	34.72	12.14	33.88	100	304	P	V
		5463.76	53.11	-15.09	68.2	39.94	34.8	12.24	33.87	100	304	P	V
		5447.92	44.84	-9.16	54	31.7	34.8	12.21	33.87	100	304	A	V
	*	5570	97.48	-	-	84.26	34.7	12.41	33.89	100	304	P	V
*	5570	90.34	-	-	77.12	34.7	12.41	33.89	100	304	A	V	
		5763.11	54.13	-14.07	68.2	40.35	35.2	12.52	33.94	100	304	P	V
Remark	1. No other spurious found. 2. All results are PASS against Peak and Average limit line.												



Band 3 - Straddle Channel
WIFI 802.11a (Band Edge @ 3m)

WIFI	Note	Frequency	Level	Margin	Limit	Read	Antenna	Path	Preamp	Ant	Table	Peak	Pol.
Ant.					Line	Level	Factor	Loss	Factor	Pos	Pos	Avg.	
6+7		(MHz)	(dBμV/m)	(dB)	(dBμV/m)	(dBμV)	(dB/m)	(dB)	(dB)	(cm)	(deg)	(P/A)	(H/V)
802.11a CH 144 5720MHz		5380.42	49.99	-24.01	74	37	34.74	12.13	33.88	400	340	P	H
		5468.17	50.4	-17.8	68.2	37.23	34.8	12.24	33.87	400	340	P	H
		5444.38	41.49	-12.51	54	28.37	34.79	12.2	33.87	400	340	A	H
	*	5720	113.58	-	-	99.81	35.2	12.5	33.93	400	340	P	H
	*	5720	107.06	-	-	93.29	35.2	12.5	33.93	400	340	A	H
		5942.75	51.54	-16.66	68.2	37.73	35.01	12.79	33.99	400	340	P	H
		5445.16	49.83	-24.17	74	36.71	34.79	12.2	33.87	296	305	P	V
		5465.05	48.69	-19.51	68.2	35.52	34.8	12.24	33.87	296	305	P	V
		5450.23	41.54	-12.46	54	28.4	34.8	12.21	33.87	296	305	A	V
	*	5720	110.2	-	-	96.43	35.2	12.5	33.93	296	305	P	V
	*	5720	104.33	-	-	90.56	35.2	12.5	33.93	296	305	A	V
		5914.25	52.36	-15.84	68.2	38.53	35.07	12.74	33.98	296	305	P	V
Remark	1. No other spurious found. 2. All results are PASS against Peak and Average limit line.												



Band 3 - Straddle Channel
WIFI 802.11a (Harmonic @ 3m)

WIFI Ant. 6+7	Note	Frequency (MHz)	Level (dBμV/m)	Margin (dB)	Limit Line (dBμV/m)	Read Level (dBμV)	Antenna Factor (dB/m)	Path Loss (dB)	Preamp Factor (dB)	Ant Pos (cm)	Table Pos (deg)	Peak Avg. (P/A)	Pol. (H/V)	
802.11a CH 144 5720MHz		8012	53.28	-14.92	68.2	58.88	35.82	16.05	57.47	393	0	P	H	
		11440	45.83	-28.17	74	45.27	38.12	19.61	57.17	-	-	P	H	
		17160	50.64	-17.56	68.2	41.01	41.58	23.68	55.63	-	-	P	H	
													H	
													H	
													H	
													H	
													H	
													H	
													H	
													H	
			8012	48.92	-19.28	68.2	54.52	35.82	16.05	57.47	100	91	P	V
			11440	46.17	-27.83	74	45.61	38.12	19.61	57.17	-	-	P	V
			17160	50.48	-17.72	68.2	40.85	41.58	23.68	55.63	-	-	P	V
														V
														V
														V
														V
														V
													V	
Remark	<ol style="list-style-type: none"> No other spurious found. All results are PASS against Peak and Average limit line. The emission position marked as "-" means no suspected emission found with sufficient margin against limit line or noise floor only. 													



Band 3 - Straddle Channel
WIFI 802.11ax HE20 Full (Band Edge @ 3m)

WIFI Ant. 6+7	Note	Frequency (MHz)	Level (dBμV/m)	Margin (dB)	Limit Line (dBμV/m)	Read Level (dBμV)	Antenna Factor (dB/m)	Path Loss (dB)	Preamp Factor (dB)	Ant Pos (cm)	Table Pos (deg)	Peak Avg. (P/A)	Pol. (H/V)
802.11ax HE20 Full CH 144 5720MHz		5443.6	49.08	-24.92	74	35.96	34.79	12.2	33.87	400	340	P	H
		5463.88	48.95	-19.25	68.2	35.78	34.8	12.24	33.87	400	340	P	H
		5458.42	41.11	-12.89	54	27.95	34.8	12.23	33.87	400	340	A	H
	*	5720	114.64	-	-	100.87	35.2	12.5	33.93	400	340	P	H
	*	5720	107.93	-	-	94.16	35.2	12.5	33.93	400	340	A	H
		5927.75	51.69	-16.51	68.2	37.86	35.04	12.77	33.98	400	340	P	H
		5365.21	49.24	-24.76	74	36.23	34.77	12.12	33.88	294	297	P	V
		5460	49.06	-19.14	68.2	35.9	34.8	12.23	33.87	294	297	P	V
		5454.13	41.08	-12.92	54	27.93	34.8	12.22	33.87	294	297	A	V
	*	5720	109.88	-	-	96.11	35.2	12.5	33.93	294	297	P	V
	*	5720	104.27	-	-	90.5	35.2	12.5	33.93	294	297	A	V
		5883.5	52.11	-16.09	68.2	38.33	35.07	12.68	33.97	294	297	P	V
Remark	1. No other spurious found. 2. All results are PASS against Peak and Average limit line.												



Band 3 - Straddle Channel
WIFI 802.11ax HE40 Full (Band Edge @ 3m)

WIFI Ant. 6+7	Note	Frequency (MHz)	Level (dBμV/m)	Margin (dB)	Limit Line (dBμV/m)	Read Level (dBμV)	Antenna Factor (dB/m)	Path Loss (dB)	Preamp Factor (dB)	Ant Pos (cm)	Table Pos (deg)	Peak Avg. (P/A)	Pol. (H/V)
802.11ax HE40 Full CH 142 5710MHz		5458.81	49.86	-24.14	74	36.7	34.8	12.23	33.87	201	1	P	H
		5467	49.16	-19.04	68.2	35.99	34.8	12.24	33.87	201	1	P	H
		5459.98	41.58	-12.42	54	28.42	34.8	12.23	33.87	201	1	A	H
	*	5710	113.2	-	-	99.42	35.2	12.5	33.92	201	1	P	H
	*	5710	106.72	-	-	92.94	35.2	12.5	33.92	201	1	A	H
		5854.75	55.33	-12.87	68.2	41.65	35.01	12.63	33.96	201	1	P	H
		5399.92	49.37	-24.63	74	36.42	34.7	12.13	33.88	294	305	P	V
		5463.1	48.96	-19.24	68.2	35.8	34.8	12.23	33.87	294	305	P	V
		5446.72	41.52	-12.48	54	28.39	34.79	12.21	33.87	294	305	A	V
	*	5710	110.77	-	-	96.99	35.2	12.5	33.92	294	305	P	V
*	5710	102.92	-	-	89.14	35.2	12.5	33.92	294	305	A	V	
	5871.75	54.02	-14.18	68.2	40.29	35.04	12.66	33.97	294	305	P	V	
Remark	1. No other spurious found. 2. All results are PASS against Peak and Average limit line.												



Band 3 - Straddle Channel
WIFI 802.11ax HE40 Full (Harmonic @ 3m)

WIFI Ant. 6+7	Note	Frequency (MHz)	Level (dBμV/m)	Margin (dB)	Limit Line (dBμV/m)	Read Level (dBμV)	Antenna Factor (dB/m)	Path Loss (dB)	Preamp Factor (dB)	Ant Pos (cm)	Table Pos (deg)	Peak Avg. (P/A)	Pol. (H/V)	
802.11ax HE40 Full CH 142 5710MHz		7990	54.85	-13.35	68.2	60.5	35.82	16.01	57.48	282	349	P	H	
		11420	45.51	-28.49	74	44.98	38.16	19.59	57.22	-	-	P	H	
		17130	50.56	-17.64	68.2	40.85	41.68	23.66	55.63	-	-	P	H	
													H	
													H	
													H	
													H	
													H	
													H	
													H	
													H	
													H	
			7990	48.43	-19.77	68.2	54.08	35.82	16.01	57.48	100	287	P	V
			11420	46.56	-27.44	74	46.03	38.16	19.59	57.22	-	-	P	V
			17130	51.29	-16.91	68.2	41.58	41.68	23.66	55.63	-	-	P	V
														V
														V
														V
														V
													V	
													V	
													V	
													V	
Remark	1. No other spurious found. 2. All results are PASS against Peak and Average limit line. 3. The emission position marked as "-" means no suspected emission found with sufficient margin against limit line or noise floor only.													



**Band 3 Straddle Channel
WIFI 802.11ax HE80 Full (Band Edge @ 3m)**

WIFI Ant. 6+7	Note	Frequency (MHz)	Level (dBμV/m)	Margin (dB)	Limit Line (dBμV/m)	Read Level (dBμV)	Antenna Factor (dB/m)	Path Loss (dB)	Preamp Factor (dB)	Ant Pos (cm)	Table Pos (deg)	Peak Avg. (P/A)	Pol. (H/V)
802.11ax HE80 Full CH 138 5690MHz		5452.57	50.85	-23.15	74	37.7	34.8	12.22	33.87	203	0	P	H
		5467	51.11	-17.09	68.2	37.94	34.8	12.24	33.87	203	0	P	H
		5456.47	44.03	-9.97	54	30.88	34.8	12.22	33.87	203	0	A	H
	*	5690	111.68	-	-	97.95	35.16	12.49	33.92	203	0	P	H
	*	5690	104.86	-	-	91.13	35.16	12.49	33.92	203	0	A	H
		5870.5	62.09	-6.11	68.2	48.36	35.04	12.66	33.97	203	0	P	H
		5354.68	50.93	-23.07	74	37.9	34.79	12.12	33.88	301	304	P	V
		5467.39	49.26	-18.94	68.2	36.09	34.8	12.24	33.87	301	304	P	V
		5458.81	42.93	-11.07	54	29.77	34.8	12.23	33.87	301	304	A	V
	*	5690	106.33	-	-	92.6	35.16	12.49	33.92	301	304	P	V
	*	5690	99.67	-	-	85.94	35.16	12.49	33.92	301	304	A	V
		5858.8	56.48	-11.72	68.2	42.78	35.02	12.64	33.96	301	304	P	V
Remark	1. No other spurious found. 2. All results are PASS against Peak and Average limit line.												



Emission below 1GHz

WIFI 802. 11ax HE80 Partial 484 (LF @ 3m)

WIFI	Note	Frequency	Level	Margin	Limit	Read	Antenna	Path	Preamp	Ant	Table	Peak	Pol.		
Ant.					Line	Level	Factor	Loss	Factor	Pos	Pos	Avg.			
6+7		(MHz)	(dBμV/m)	(dB)	(dBμV/m)	(dBμV)	(dB/m)	(dB)	(dB)	(cm)	(deg)	(P/A)	(H/V)		
802.11ax HE80 Partial 484/66 LF		58.08	23.72	-16.28	40	40.31	11.86	1.46	29.91	58.08	23.72	P	H		
		91.02	27.54	-15.96	43.5	41	14.72	1.73	29.91	91.02	27.54	P	H		
		278.13	30.69	-15.31	46	38.95	18.76	2.79	29.81	278.13	30.69	P	H		
		903.4	32.07	-13.93	46	26.74	28.72	5.44	28.83	903.4	32.07	P	H		
		930.7	32.93	-13.07	46	26.95	29.24	5.48	28.74	930.7	32.93	P	H		
		958	33.44	-12.56	46	25.86	30.65	5.53	28.6	958	33.44	P	H		
														H	
															H
															H
															H
															H
															H
			30	31.48	-8.52	40	35.86	24.51	1.05	29.94	30	31.48	P	V	
			57.27	33.37	-6.63	40	49.86	11.98	1.45	29.92	57.27	33.37	P	V	
			275.43	28.78	-17.22	46	37.08	18.73	2.78	29.81	275.43	28.78	P	V	
			307	26.23	-19.77	46	33.8	19.28	2.96	29.81	307	26.23	P	V	
			720	30.63	-15.37	46	28.9	26.59	4.69	29.55	720	30.63	P	V	
			957.3	33.49	-12.51	46	25.93	30.64	5.53	28.61	957.3	33.49	P	V	
															V
															V
														V	
														V	
														V	
														V	
Remark	1. No other spurious found. 2. All results are PASS against limit line.														



<Sample 3>

Band 2 - 5250~5350MHz

WIFI 802.11ax HE80 Partial 484 (Band Edge @ 3m)

WIFI Ant. 6+7	Note	Frequency (MHz)	Level (dBμV/m)	Margin (dB)	Limit Line (dBμV/m)	Read Level (dBμV)	Antenna Factor (dB/m)	Path Loss (dB)	Preamp Factor (dB)	Ant Pos (cm)	Table Pos (deg)	Peak Avg. (P/A)	Pol. (H/V)
802.11ax HE80 Partial 484/66 CH 58 5290MHz		5130.2	52.81	-21.19	74	40.51	34.18	12.01	33.89	237	0	P	H
		5148.4	43.53	-10.47	54	31.1	34.29	12.03	33.89	237	0	A	H
	*	5290	106.78	-	-	93.93	34.62	12.11	33.88	237	0	P	H
	*	5290	98.81	-	-	85.96	34.62	12.11	33.88	237	0	A	H
		5369.76	63.52	-10.48	74	50.51	34.76	12.13	33.88	237	0	P	H
		5379.12	52.25	-1.75	54	39.26	34.74	12.13	33.88	237	0	A	H
		5126.7	51.36	-22.64	74	39.09	34.16	12	33.89	100	300	P	V
		5147.7	42.82	-11.18	54	30.39	34.29	12.03	33.89	100	300	A	V
	*	5296	102.31	-	-	89.47	34.61	12.11	33.88	100	300	P	V
	*	5290	95.4	-	-	82.55	34.62	12.11	33.88	100	300	A	V
		5363.52	58.07	-15.93	74	45.06	34.77	12.12	33.88	100	300	P	V
		5373.6	51.51	-2.49	54	38.51	34.75	12.13	33.88	100	300	A	V
Remark	1. No other spurious found. 2. All results are PASS against Peak and Average limit line.												



Emission below 1GHz

WIFI 802.11ax HE80 Partial 484 (LF @ 3m)

WIFI	Note	Frequency	Level	Margin	Limit	Read	Antenna	Path	Preamp	Ant	Table	Peak	Pol.	
Ant.					Line	Level	Factor	Loss	Factor	Pos	Pos	Avg.		
6+7		(MHz)	(dBμV/m)	(dB)	(dBμV/m)	(dBμV)	(dB/m)	(dB)	(dB)	(cm)	(deg)	(P/A)	(H/V)	
802.11ax HE80 Partial 484/66 LF		57.54	24.27	-15.73	40	40.78	11.94	1.34	29.91	57.54	24.27	P	H	
		91.02	26.63	-16.87	43.5	40.09	14.72	1.55	29.91	91.02	26.63	P	H	
		270.03	28.96	-17.04	46	36.96	19.07	2.64	29.82	270.03	28.96	P	H	
		869.1	31.92	-14.08	46	26.98	28.76	4.92	29.04	869.1	31.92	P	H	
		933.5	32.52	-13.48	46	26.41	29.36	5.1	28.73	933.5	32.52	P	H	
		959.4	34.43	-11.57	46	26.81	30.67	5.17	28.59	959.4	34.43	P	H	
														H
														H
														H
														H
														H
														H
			30	31.93	-8.07	40	36.31	24.51	1.01	29.94	30	31.93	P	V
			57.54	33.86	-6.14	40	50.37	11.94	1.34	29.91	57.54	33.86	P	V
			80.49	30.7	-9.3	40	45.59	13.29	1.55	29.91	80.49	30.7	P	V
			855.8	31.27	-14.73	46	26.37	28.89	4.88	29.13	855.8	31.27	P	V
			904.8	32.51	-13.49	46	27.16	28.73	5.04	28.82	904.8	32.51	P	V
			946.1	32.92	-13.08	46	26.06	30.05	5.13	28.69	946.1	32.92	P	V
														V
														V
													V	
													V	
													V	
													V	
Remark	1. No other spurious found. 2. All results are PASS against limit line.													



Note symbol

*	Fundamental Frequency which can be ignored. However, the level of any unwanted emissions shall not exceed the level of the fundamental frequency.
!	Test result is Margin line.
P/A	Peak or Average
H/V	Horizontal or Vertical



A calculation example for radiated spurious emission is shown as below:

WIFI	Note	Frequency	Level	Margin	Limit	Read	Antenna	Path	Preamp	Ant	Table	Peak	Pol.
Ant.		(MHz)	(dBμV/m)	(dB)	(dBμV/m)	(dBμV)	(dB/m)	(dB)	(dB)	(cm)	(deg)	(P/A)	(H/V)
6+7													
802.11a		5150	55.45	-18.55	74	54.51	32.22	4.58	35.86	103	308	P	H
CH 36													
5180MHz		5150	43.54	-10.46	54	42.6	32.22	4.58	35.86	103	308	A	H

1. Path Loss(dB) = Cable loss(dB) + Filter loss(dB) + Attenuator loss(dB)
2. Level(dBμV/m) = Antenna Factor(dB/m) + Path Loss(dB) + Read Level(dBμV) - Preamp Factor(dB)
3. Margin (dB) = Level(dBμV/m) – Limit Line(dBμV/m)

For Peak Limit @ 5150MHz:

1. Level(dBμV/m)
= Antenna Factor(dB/m) + Path Loss(dB) + Read Level(dBμV) - Preamp Factor(dB)
= 32.22(dB/m) + 4.58(dB) + 54.51(dBμV) – 35.86 (dB)
= 55.45 (dBμV/m)
2. Margin (dB)
= Leve(dBμV/m) – Limit Line(dBμV/m)
= 55.45(dBμV/m) – 74(dBμV/m)
= -18.55(dB)

For Average Limit @ 5150MHz:

1. Level(dBμV/m)
= Antenna Factor(dB/m) + Path Loss(dB) + Read Level(dBμV) - Preamp Factor(dB)
= 32.22(dB/m) + 4.58(dB) + 42.6(dBμV) – 35.86 (dB)
= 43.54 (dBμV/m)
2. Margin (dB)
= Level(dBμV/m) – Limit Line(dBμV/m)
= 43.54 (dBμV/m) – 54(dBμV/m)
= -10.46(dB)

Both peak and average measured complies with the limit line, so test result is “PASS”.



Appendix D. Radiated Spurious Emission Plots

Test Engineer :	Jesse Wang, Stan Hsieh and Ken Wu	Temperature :	17.4~22.3°C
		Relative Humidity :	54.7~65.1%

Note symbol

-L	Low channel location
-R	High channel location



<Sample 1>

Band 1 - 5150~5250MHz
WIFI 802.11a (Band Edge @ 3m)

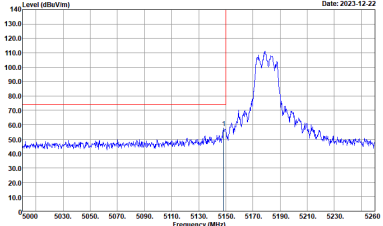
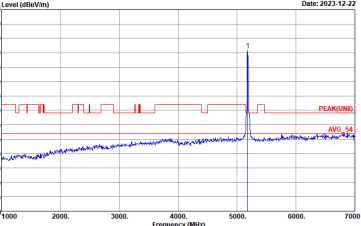
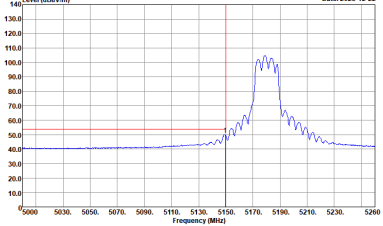
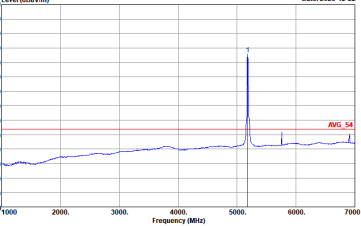
WIFI	Band 1 5150~5250MHz Band Edge @ 3m	
ANT	802.11a CH36 5180MHz	
6+7	Horizontal	Fundamental
Peak	 <p>Site : 03CH07-HY Condition : PEAK_BE_74 3m HF_ANT_00075962 HORIZONTAL : RBW:1000.000kHz VBW:3000.000kHz SWT:Auto</p>	 <p>Site : 03CH07-HY Condition : PEAK(FUN)1 3m HF_ANT_00075962 HORIZONTAL : RBW:1000.000kHz VBW:3000.000kHz SWT:Auto</p>
Avg.	 <p>Site : 03CH07-HY Condition : AVG_BE_54 3m HF_ANT_00075962 HORIZONTAL : RBW:1000.000kHz VBW:1.000kHz SWT:Auto</p>	 <p>Site : 03CH07-HY Condition : AVG_54 3m HF_ANT_00075962 HORIZONTAL : RBW:1000.000kHz VBW:1.000kHz SWT:Auto</p>

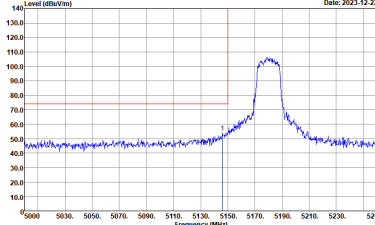
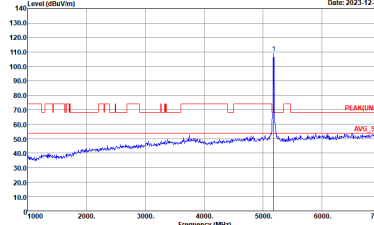
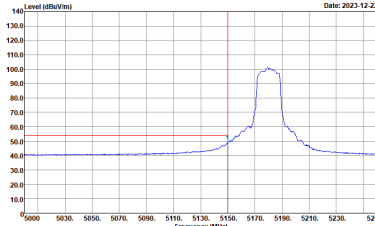
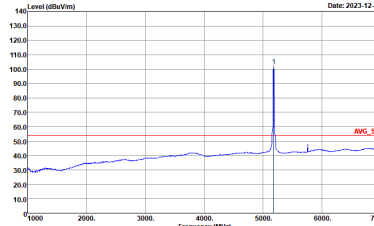

WIFI	Band 1 5150~5250MHz Band Edge @ 3m	
ANT	802.11a CH36 5180MHz	
6+7	Vertical	Fundamental
Peak	 <p>Site : 03CH07-HY Condition : PEAK_BE_74 3m HF_ANT_00075962 VERTICAL : RBW:1000.000kHz VBW:3000.000kHz SWT:Auto</p>	 <p>Site : 03CH07-HY Condition : PEAK(LIN)1 3m HF_ANT_00075962 VERTICAL : RBW:1000.000kHz VBW:3000.000kHz SWT:Auto</p>
Avg.	 <p>Site : 03CH07-HY Condition : AVG_BE_34 3m HF_ANT_00075962 VERTICAL : RBW:1000.000kHz VBW:1.000kHz SWT:Auto</p>	 <p>Site : 03CH07-HY Condition : AVG_34 3m HF_ANT_00075962 VERTICAL : RBW:1000.000kHz VBW:1.000kHz SWT:Auto</p>

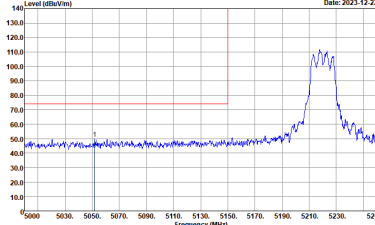
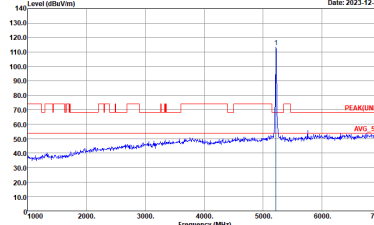
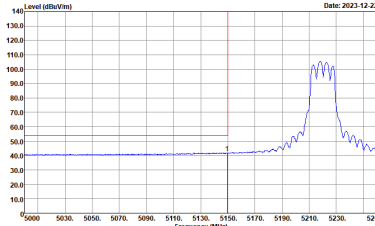
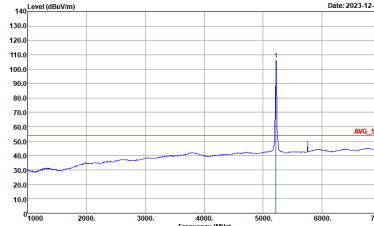

WIFI	Band 1 5150~5250MHz Band Edge @ 3m	
ANT	802.11a CH44 5220MHz - L	
6+7	Horizontal	Fundamental
Peak	 <p>Site : 03CH07-HY Condition : PEAK_BE_74 3m HF_ANT_00075962 HORIZONTAL : RBW:1000.000kHz VBW:3000.000kHz SWT:Auto</p>	 <p>Site : 03CH07-HY Condition : PEAK(LIN) 3m HF_ANT_00075962 HORIZONTAL : RBW:1000.000kHz VBW:3000.000kHz SWT:Auto</p>
Avg.	 <p>Site : 03CH07-HY Condition : AVG_BE_34 3m HF_ANT_00075962 HORIZONTAL : RBW:1000.000kHz VBW:1.000kHz SWT:Auto</p>	 <p>Site : 03CH07-HY Condition : AVG_34 3m HF_ANT_00075962 HORIZONTAL : RBW:1000.000kHz VBW:1.000kHz SWT:Auto</p>



WIFI	Band 1 5150~5250MHz Band Edge @ 3m	
ANT	802.11a CH44 5220MHz - R	
6+7	Horizontal	Fundamental
Peak	<p>Site : 03CH07-RY Condition : PEAK_BE_74 3m HF_ANT_00075962 HORIZONTAL : RBW:1000.000kHz VBW:3000.000kHz SWTA:Auto</p>	Left blank
Avg.	<p>Site : 03CH07-RY Condition : AVG_BE_54 3m HF_ANT_00075962 HORIZONTAL : RBW:1000.000kHz VBW:1.000kHz SWTA:Auto</p>	Left blank

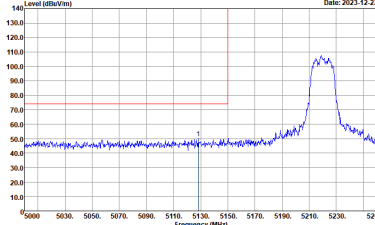
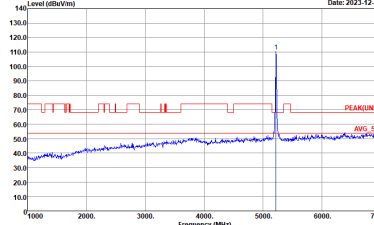
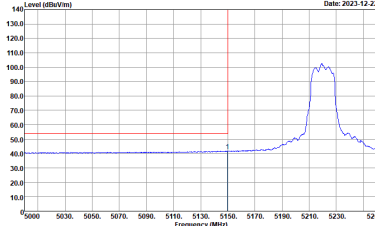
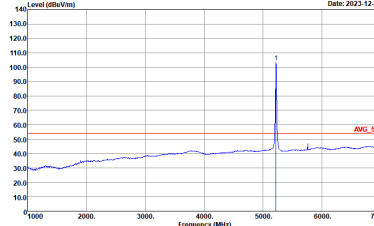

WIFI	Band 1 5150~5250MHz Band Edge @ 3m	
ANT	802.11a CH44 5220MHz - L	
6+7	Vertical	Fundamental
Peak	 <p>Site : 03CH07-HY Condition : PEAK_BE_74 3m HF_ANT_00075962 VERTICAL : RBW:1000.000kHz VBW:3000.000kHz SWT:Auto</p>	 <p>Site : 03CH07-HY Condition : PEAK(LIN) 3m HF_ANT_00075962 VERTICAL : RBW:1000.000kHz VBW:3000.000kHz SWT:Auto</p>
Avg.	 <p>Site : 03CH07-HY Condition : AVG_BE_34 3m HF_ANT_00075962 VERTICAL : RBW:1000.000kHz VBW:1.000kHz SWT:Auto</p>	 <p>Site : 03CH07-HY Condition : AVG_34 3m HF_ANT_00075962 VERTICAL : RBW:1000.000kHz VBW:1.000kHz SWT:Auto</p>

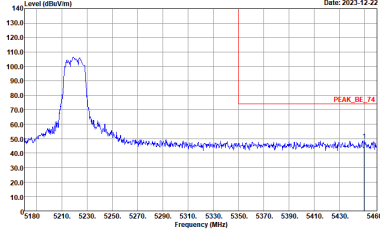
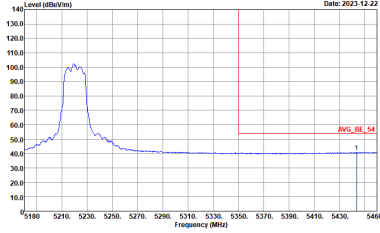

WIFI	Band 1 5150~5250MHz Band Edge @ 3m	
ANT	802.11a CH44 5220MHz - R	
6+7	Vertical	Fundamental
Peak	 <p>Site : 03CH07-RY Condition : PEAK_BE_74 3m HF_ANT_00075962 VERTICAL : RBW:1000.000kHz VBW:3000.000kHz SWTA:Auto</p>	Left blank
Avg.	 <p>Site : 03CH07-RY Condition : AVG_BE_54 3m HF_ANT_00075962 VERTICAL : RBW:1000.000kHz VBW:1.000kHz SWTA:Auto</p>	Left blank

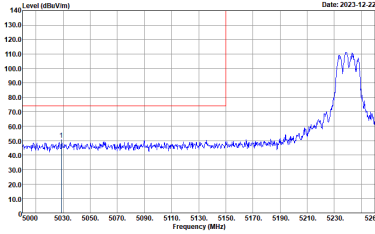
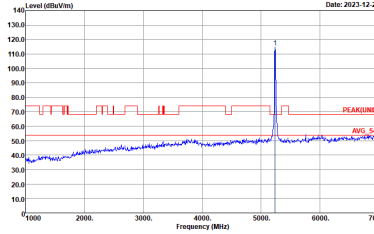
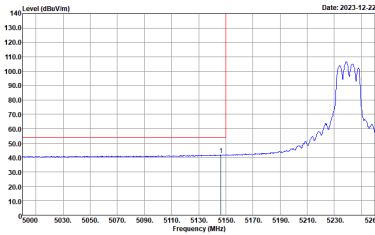
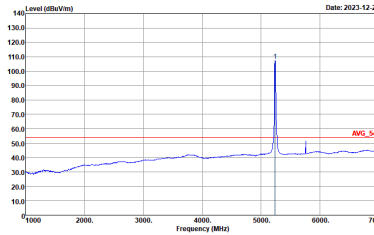

WIFI	Band 1 5150~5250MHz Band Edge @ 3m	
ANT	802.11a CH48 5240MHz - L	
6+7	Horizontal	Fundamental
Peak	 <p>Site : 03CH07-HY Condition : PEAK_BE_74 3m HF_ANT_00075962 HORIZONTAL : RBW:1000.000kHz VBW:3000.000kHz SWT:Auto</p>	 <p>Site : 03CH07-HY Condition : PEAK(LIN) 3m HF_ANT_00075962 HORIZONTAL : RBW:1000.000kHz VBW:3000.000kHz SWT:Auto</p>
Avg.	 <p>Site : 03CH07-HY Condition : AVG_BE_34 3m HF_ANT_00075962 HORIZONTAL : RBW:1000.000kHz VBW:1.000kHz SWT:Auto</p>	 <p>Site : 03CH07-HY Condition : AVG_34 3m HF_ANT_00075962 HORIZONTAL : RBW:1000.000kHz VBW:1.000kHz SWT:Auto</p>



WIFI	Band 1 5150~5250MHz Band Edge @ 3m	
ANT	802.11a CH48 5240MHz - R	
6+7	Horizontal	Fundamental
Peak	<p>Site : 03CH07-RY Condition : PEAK_BE_74 3m HF_ANT_00075962 HORIZONTAL : RBW:1000.000kHz VBW:3000.000kHz SWT:Auto</p>	Left blank
Avg.	<p>Site : 03CH07-RY Condition : AVG_BE_54 3m HF_ANT_00075962 HORIZONTAL : RBW:1000.000kHz VBW:1.000kHz SWT:Auto</p>	Left blank

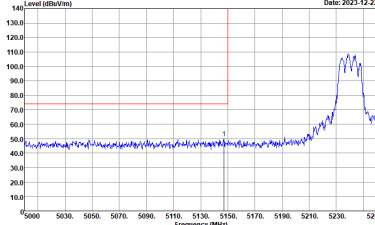
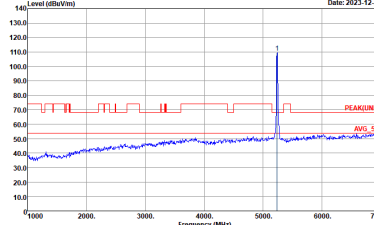
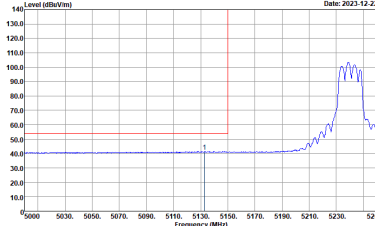
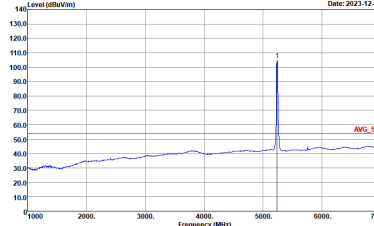

WIFI	Band 1 5150~5250MHz Band Edge @ 3m	
ANT	802.11a CH48 5240MHz - L	
6+7	Vertical	Fundamental
Peak	 <p>Site : 03CH07-HY Condition : PEAK_BE_74 3m HF_ANT_00075962 VERTICAL : RBW:1000.000kHz VBW:3000.000kHz SWT:Auto</p>	 <p>Site : 03CH07-HY Condition : PEAK(LIN) 3m HF_ANT_00075962 VERTICAL : RBW:1000.000kHz VBW:3000.000kHz SWT:Auto</p>
Avg.	 <p>Site : 03CH07-HY Condition : AVG_BE_34 3m HF_ANT_00075962 VERTICAL : RBW:1000.000kHz VBW:1.000kHz SWT:Auto</p>	 <p>Site : 03CH07-HY Condition : AVG_34 3m HF_ANT_00075962 VERTICAL : RBW:1000.000kHz VBW:1.000kHz SWT:Auto</p>

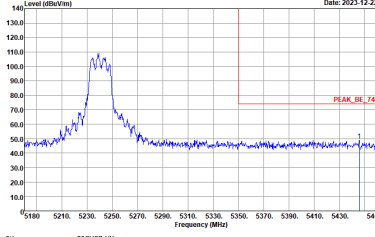
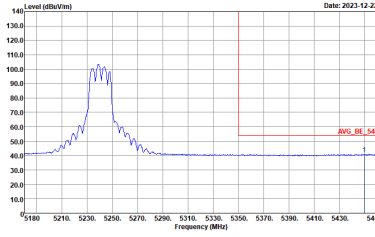

WIFI	Band 1 5150~5250MHz Band Edge @ 3m	
ANT	802.11a CH48 5240MHz - R	
6+7	Vertical	Fundamental
Peak	 <p>Site : 03CH07-RY Condition : PEAK_BE_74 3m HF_ANT_00075962 VERTICAL : RBW:1000.000kHz VBW:3000.000kHz SWTA:Auto</p>	Left blank
Avg.	 <p>Site : 03CH07-RY Condition : AVG_BE_54 3m HF_ANT_00075962 VERTICAL : RBW:1000.000kHz VBW:1.000kHz SWTA:Auto</p>	Left blank

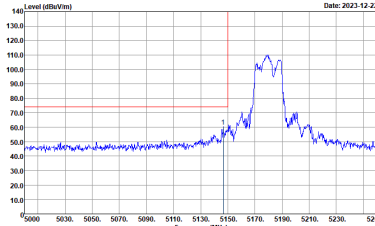
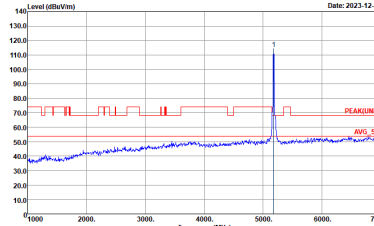
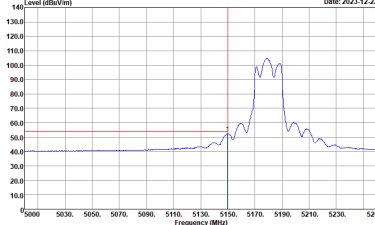
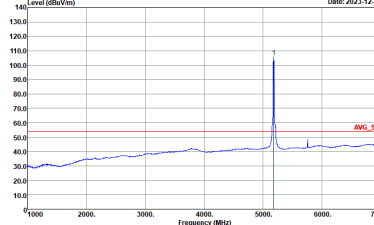

Band 1 5150~5250MHz
WIFI 802.11ax HE20 Full (Band Edge @ 3m)

WIFI	Band 1 5150~5250MHz Band Edge @ 3m	
ANT	802.11ax HE20 Full CH36 5180MHz	
6+7	Horizontal	Fundamental
Peak	 <p>Date: 2023-12-22</p> <p>Site Condition : 03CH07-HY : PEAK_BE_74 3m HF_ANT_00075962 HORIZONTAL : RBW:1000.000kHz VBW:3000.000kHz SWTAuto</p>	 <p>Date: 2023-12-22</p> <p>Site Condition : 03CH07-HY : PEAK(LIN)I 3m HF_ANT_00075962 HORIZONTAL : RBW:1000.000kHz VBW:3000.000kHz SWTAuto</p>
	 <p>Date: 2023-12-22</p> <p>Site Condition : 03CH07-HY : AVG_BE_S4 3m HF_ANT_00075962 HORIZONTAL : RBW:1000.000kHz VBW:0.300kHz SWTAuto</p>	 <p>Date: 2023-12-22</p> <p>Site Condition : 03CH07-HY : AVG_S4 3m HF_ANT_00075962 HORIZONTAL : RBW:1000.000kHz VBW:0.300kHz SWTAuto</p>
Avg.		

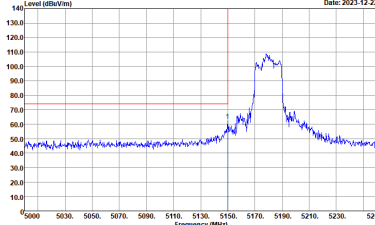
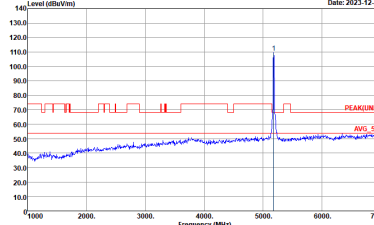
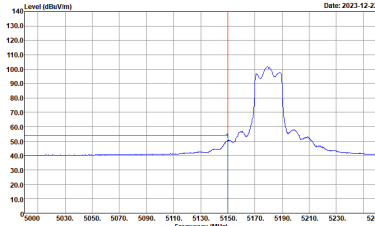
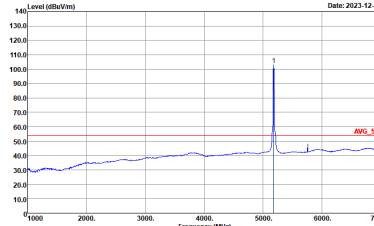

WIFI	Band 1 5150~5250MHz Band Edge @ 3m	
ANT	802.11ax HE20 Full CH36 5180MHz	
6+7	Vertical	Fundamental
Peak	 <p>Site : 03CH07-HY Condition : PEAK_BE_74 3m HF_ANT_00075962 VERTICAL : RBW:1000.000kHz VBW:3000.000kHz SWT:Auto</p>	 <p>Site : 03CH07-HY Condition : PEAK(LIN) 3m HF_ANT_00075962 VERTICAL : RBW:1000.000kHz VBW:3000.000kHz SWT:Auto</p>
Avg.	 <p>Site : 03CH07-HY Condition : AVG_BE_34 3m HF_ANT_00075962 VERTICAL : RBW:1000.000kHz VBW:0.300kHz SWT:Auto</p>	 <p>Site : 03CH07-HY Condition : AVG_34 3m HF_ANT_00075962 VERTICAL : RBW:1000.000kHz VBW:0.300kHz SWT:Auto</p>



WIFI	Band 1 5150~5250MHz Band Edge @ 3m	
ANT	802.11ax HE20 Full CH44 5220MHz - L	
6+7	Horizontal	Fundamental
Peak	<p>Site : 03CH07-HY Condition : PEAK_BE_74 3m HF_ANT_00075962 HORIZONTAL : RBW:1000.000kHz VBW:3000.000kHz SWT:Auto</p>	<p>Site : 03CH07-HY Condition : PEAK(LIN)1 3m HF_ANT_00075962 HORIZONTAL : RBW:1000.000kHz VBW:3000.000kHz SWT:Auto</p>
Avg.	<p>Site : 03CH07-HY Condition : AVG_BE_34 3m HF_ANT_00075962 HORIZONTAL : RBW:1000.000kHz VBW:3000.000kHz SWT:Auto</p>	<p>Site : 03CH07-HY Condition : AVG_34 3m HF_ANT_00075962 HORIZONTAL : RBW:1000.000kHz VBW:3000.000kHz SWT:Auto</p>

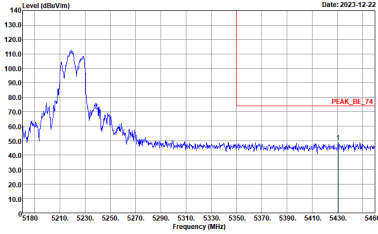
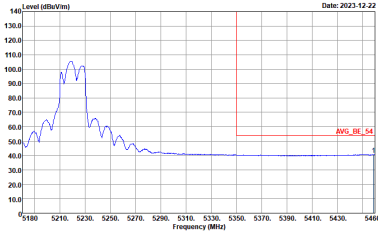

WIFI	Band 1 5150~5250MHz Band Edge @ 3m	
ANT	802.11ax HE20 Full CH44 5220MHz - R	
6+7	Horizontal	Fundamental
Peak	 <p>Site : 03CH07-RY Condition : PEAK_BE_74 3m HF_ANT_00075962 HORIZONTAL : RBW:1000.000kHz VBW:3000.000kHz SWT:Auto</p>	Left blank
Avg.	 <p>Site : 03CH07-RY Condition : AVG_BE_54 3m HF_ANT_00075962 HORIZONTAL : RBW:1000.000kHz VBW:3000.000kHz SWT:Auto</p>	Left blank

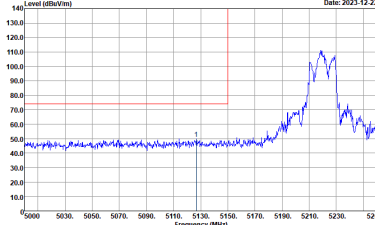
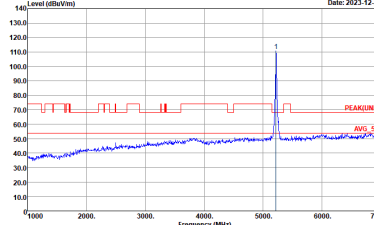
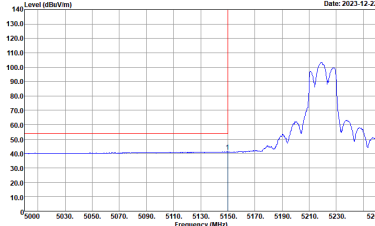
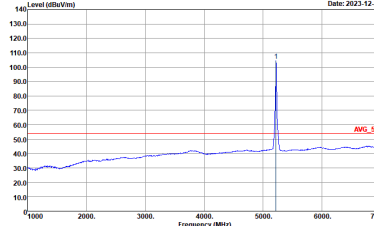

WIFI	Band 1 5150~5250MHz Band Edge @ 3m	
ANT	802.11ax HE20 Full CH44 5220MHz - L	
6+7	Vertical	Fundamental
Peak	 <p>Site : 03CH07-HY Condition : PEAK_BE_74 3m HF_ANT_00075962 VERTICAL : RBW:1000.000kHz VBW:3000.000kHz SWT:Auto</p>	 <p>Site : 03CH07-HY Condition : PEAK(LIN) 3m HF_ANT_00075962 VERTICAL : RBW:1000.000kHz VBW:3000.000kHz SWT:Auto</p>
Avg.	 <p>Site : 03CH07-HY Condition : AVG_BE_34 3m HF_ANT_00075962 VERTICAL : RBW:1000.000kHz VBW:3000.000kHz SWT:Auto</p>	 <p>Site : 03CH07-HY Condition : AVG_34 3m HF_ANT_00075962 VERTICAL : RBW:1000.000kHz VBW:3000.000kHz SWT:Auto</p>

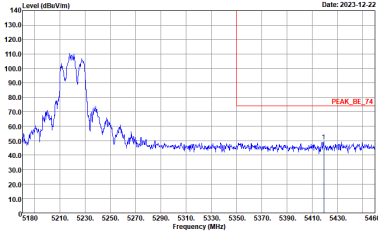
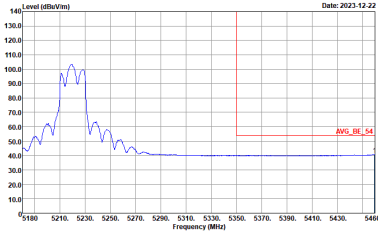

WIFI	Band 1 5150~5250MHz Band Edge @ 3m	
ANT	802.11ax HE20 Full CH44 5220MHz - R	
6+7	Vertical	Fundamental
Peak	 <p>Site : 03CH07-RY Condition : PEAK_BE_74 3m HF_ANT_00075962 VERTICAL : RBW:1000.000kHz VBW:3000.000kHz SWTA:Auto</p>	Left blank
Avg.	 <p>Site : 03CH07-RY Condition : AVG_BE_54 3m HF_ANT_00075962 VERTICAL : RBW:1000.000kHz VBW:3.000kHz SWTA:Auto</p>	Left blank



WIFI	Band 1 5150~5250MHz Band Edge @ 3m	
ANT	802.11ax HE20 Full CH48 5240MHz - L	
6+7	Horizontal	Fundamental
Peak	<p>Site : 03CH07-HY Condition : PEAK_BE_74 3m HF_ANT_00075962 HORIZONTAL : RBW:1000.000kHz VBW:3000.000kHz SWT:Auto</p>	<p>Site : 03CH07-HY Condition : PEAK(LIN) 3m HF_ANT_00075962 HORIZONTAL : RBW:1000.000kHz VBW:3000.000kHz SWT:Auto</p>
Avg.	<p>Site : 03CH07-HY Condition : AVG_BE_34 3m HF_ANT_00075962 HORIZONTAL : RBW:1000.000kHz VBW:0.300kHz SWT:Auto</p>	<p>Site : 03CH07-HY Condition : AVG_34 3m HF_ANT_00075962 HORIZONTAL : RBW:1000.000kHz VBW:0.300kHz SWT:Auto</p>



WIFI	Band 1 5150~5250MHz Band Edge @ 3m	
ANT	802.11ax HE20 Full CH48 5240MHz - R	
6+7	Horizontal	Fundamental
Peak	<p>Site : 03CH07-RY Condition : PEAK_BE_74 3m HF_ANT_00075962 HORIZONTAL : RBW:1000.000kHz VBW:3000.000kHz SWT:Auto</p>	Left blank
Avg.	<p>Site : 03CH07-RY Condition : AVG_BE_54 3m HF_ANT_00075962 HORIZONTAL : RBW:1000.000kHz VBW:3.000kHz SWT:Auto</p>	Left blank





WIFI	Band 1 5150~5250MHz Band Edge @ 3m	
ANT	802.11ax HE20 Full CH48 5240MHz - L	
6+7	Vertical	Fundamental
Peak	<p>Site : 03CH07-HY Condition : PEAK_BE_74 3m HF_ANT_00075962 VERTICAL : RBW:1000.000kHz VBW:3000.000kHz SWT:Auto</p>	<p>Site : 03CH07-HY Condition : PEAK(LIN)I 3m HF_ANT_00075962 VERTICAL : RBW:1000.000kHz VBW:3000.000kHz SWT:Auto</p>
Avg.	<p>Site : 03CH07-HY Condition : AVG_BE_34 3m HF_ANT_00075962 VERTICAL : RBW:1000.000kHz VBW:0.300kHz SWT:Auto</p>	<p>Site : 03CH07-HY Condition : AVG_34 3m HF_ANT_00075962 VERTICAL : RBW:1000.000kHz VBW:0.300kHz SWT:Auto</p>

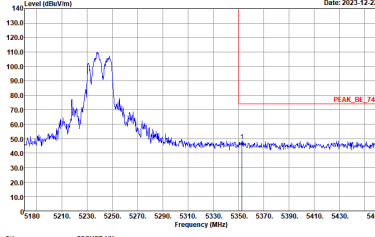
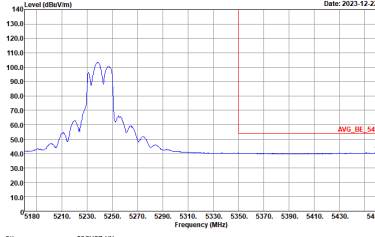

WIFI	Band 1 5150~5250MHz Band Edge @ 3m	
ANT	802.11ax HE20 Full CH48 5240MHz - R	
6+7	Vertical	Fundamental
Peak	 <p>Site : 03CH07-RY Condition : PEAK_BE_74 3m HF_ANT_00075962 VERTICAL : RBW:1000.000KHz VBW:3000.000KHz SWTA:Auto</p>	Left blank
Avg.	 <p>Site : 03CH07-RY Condition : AVG_BE_54 3m HF_ANT_00075962 VERTICAL : RBW:1000.000KHz VBW:3.000KHz SWTA:Auto</p>	Left blank

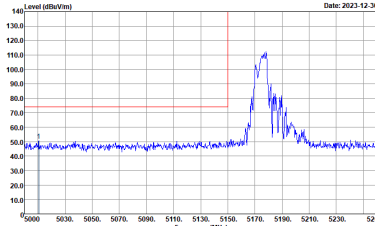
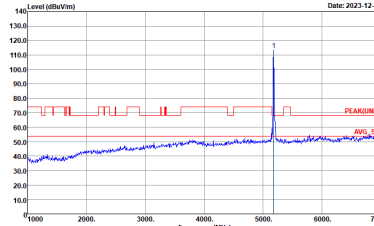

Band 1 5150~5250MHz
WIFI 802.11ax HE20 Partial 106 (Band Edge @ 3m)

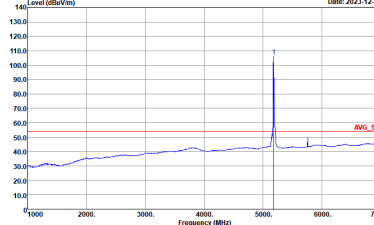
WIFI	Band 1 5150~5250MHz Band Edge @ 3m	
ANT	802.11ax HE20 Partial 106/53 CH36 5180MHz	
6+7	Horizontal	Fundamental
Peak	 <p>Date: 2023-12-30</p> <p>Site Condition : 03CH07-HY : PEAK_BE_74 3m HF_ANT_00075962 HORIZONTAL : RBW:1000.000kHz VBW:3000.000kHz SWTAuto</p>	 <p>Date: 2023-12-30</p> <p>Site Condition : 03CH07-HY : PEAK(LIN)I 3m HF_ANT_00075962 HORIZONTAL : RBW:1000.000kHz VBW:3000.000kHz SWTAuto</p>
Avg.	 <p>Date: 2023-12-30</p> <p>Site Condition : 03CH07-HY : AVG_BE_S4 3m HF_ANT_00075962 HORIZONTAL : RBW:1000.000kHz VBW:0.300kHz SWTAuto</p>	 <p>Date: 2023-12-30</p> <p>Site Condition : 03CH07-HY : AVG_S4 3m HF_ANT_00075962 HORIZONTAL : RBW:1000.000kHz VBW:0.300kHz SWTAuto</p>

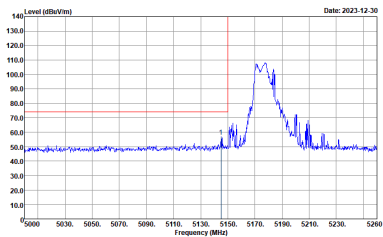
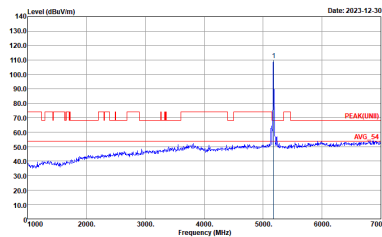
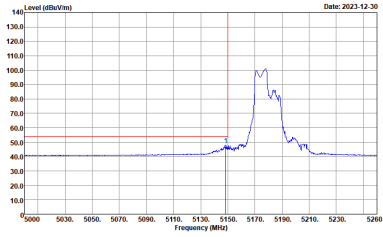
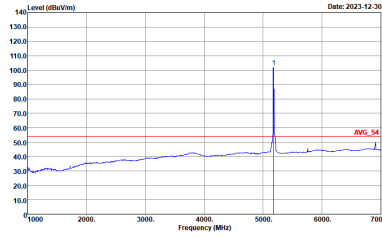

WIFI	Band 1 5150~5250MHz Band Edge @ 3m	
ANT	802.11ax HE20 Partial 106/53 CH36 5180MHz	
6+7	Vertical	Fundamental
Peak	 <p>Site : 03CH07-HY Condition : PEAK_BE_74 3m HF_ANT_00075962 VERTICAL : RBW:1000.000kHz VBW:3000.000kHz SWT:Auto</p>	 <p>Site : 03CH07-HY Condition : PEAK(LIN) 3m HF_ANT_00075962 VERTICAL : RBW:1000.000kHz VBW:3000.000kHz SWT:Auto</p>
	 <p>Site : 03CH07-HY Condition : AVG_BE_34 3m HF_ANT_00075962 VERTICAL : RBW:1000.000kHz VBW:3000.000kHz SWT:Auto</p>	 <p>Site : 03CH07-HY Condition : AVG_34 3m HF_ANT_00075962 VERTICAL : RBW:1000.000kHz VBW:3000.000kHz SWT:Auto</p>

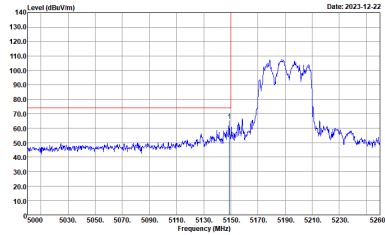
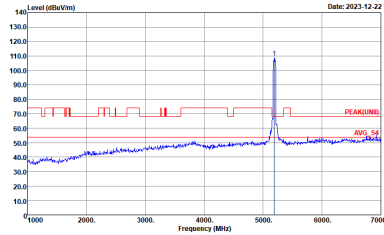
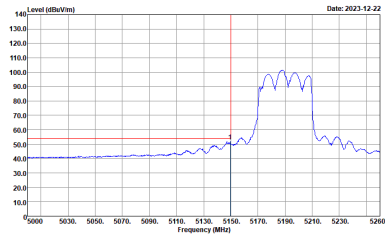
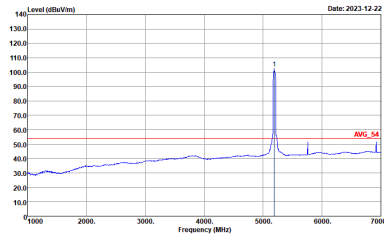

Band 1 5150~5250MHz
WIFI 802.11ax HE40 Full (Band Edge @ 3m)

WIFI	Band 1 5150~5250MHz Band Edge @ 3m	
ANT	802.11ax HE40 Full CH38 5190MHz - L	
6+7	Horizontal	Fundamental
Peak	 <p>Site Condition : 03CH07-HY : PEAK_BE_74 3m HF_ANT_00075962 HORIZONTAL : RBW:1000.000kHz VBW:3000.000kHz SWTAuto</p>	 <p>Site Condition : 03CH07-HY : PEAK(LIN) 3m HF_ANT_00075962 HORIZONTAL : RBW:1000.000kHz VBW:3000.000kHz SWTAuto</p>
Avg.	 <p>Site Condition : 03CH07-HY : AVG_BE_S4 3m HF_ANT_00075962 HORIZONTAL : RBW:1000.000kHz VBW:1.000kHz SWTAuto</p>	 <p>Site Condition : 03CH07-HY : AVG_S4 3m HF_ANT_00075962 HORIZONTAL : RBW:1000.000kHz VBW:1.000kHz SWTAuto</p>

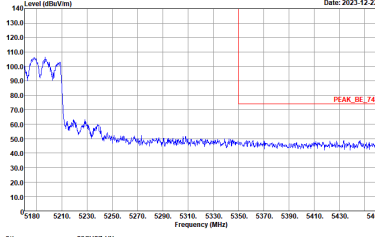
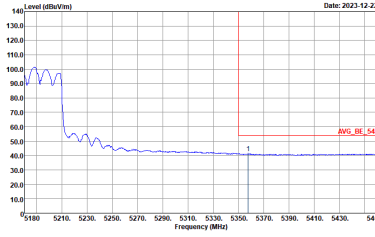

WIFI	Band 1 5150~5250MHz Band Edge @ 3m	
ANT	802.11ax HE40 Full CH38 5190MHz - R	
6+7	Horizontal	Fundamental
Peak	 <p>Site : 03CH07-RY Condition : PEAK_BE_74 3m HF_ANT_00075962 HORIZONTAL : RBW:1000.000kHz VBW:3000.000kHz SWT:Auto</p>	Left blank
Avg.	 <p>Site : 03CH07-RY Condition : AVG_BE_54 3m HF_ANT_00075962 HORIZONTAL : RBW:1000.000kHz VBW:1.000kHz SWT:Auto</p>	Left blank

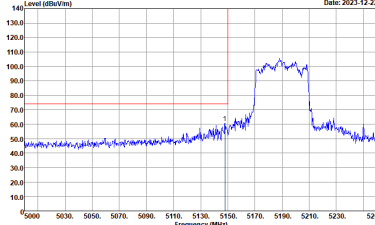
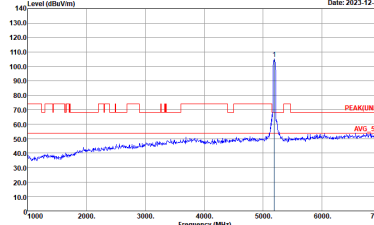
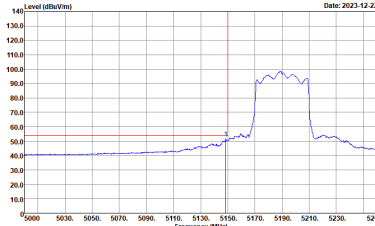
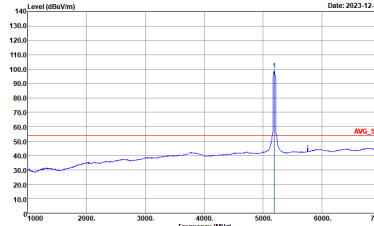

WIFI	Band 1 5150~5250MHz Band Edge @ 3m	
ANT	802.11ax HE40 Full CH38 5190MHz - L	
6+7	Vertical	Fundamental
Peak	 <p>Date: 2023-12-22</p> <p>Site : 03CH07-HY Condition : PEAK_BE_74 3m HF_ANT_00075962 VERTICAL : RBW:1000.000kHz VBW:3000.000kHz SWT:Auto</p>	 <p>Date: 2023-12-22</p> <p>Site : 03CH07-HY Condition : PEAK(LIN)1 3m HF_ANT_00075962 VERTICAL : RBW:1000.000kHz VBW:3000.000kHz SWT:Auto</p>
Avg.	 <p>Date: 2023-12-22</p> <p>Site : 03CH07-HY Condition : AVG_BE_34 3m HF_ANT_00075962 VERTICAL : RBW:1000.000kHz VBW:1.000kHz SWT:Auto</p>	 <p>Date: 2023-12-22</p> <p>Site : 03CH07-HY Condition : AVG_34 3m HF_ANT_00075962 VERTICAL : RBW:1000.000kHz VBW:1.000kHz SWT:Auto</p>

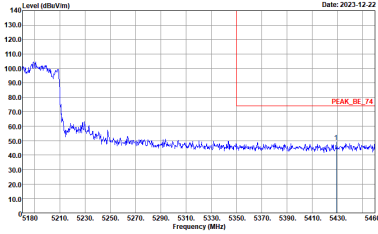
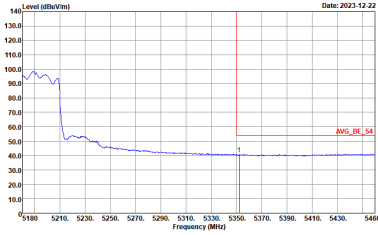

WIFI	Band 1 5150~5250MHz Band Edge @ 3m	
ANT	802.11ax HE40 Full CH38 5190MHz - R	
6+7	Vertical	Fundamental
Peak	 <p>Site : 03CH07-RY Condition : PEAK_BE_74 3m HF_ANT_00075962 VERTICAL : RBW:1000.000kHz VBW:3000.000kHz SWTA:Auto</p>	Left blank
Avg.	 <p>Site : 03CH07-RY Condition : AVG_BE_54 3m HF_ANT_00075962 VERTICAL : RBW:1000.000kHz VBW:1.000kHz SWTA:Auto</p>	Left blank

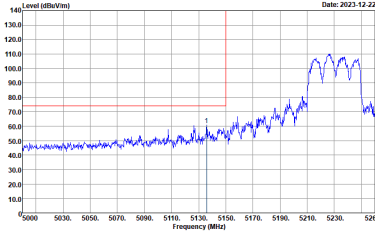
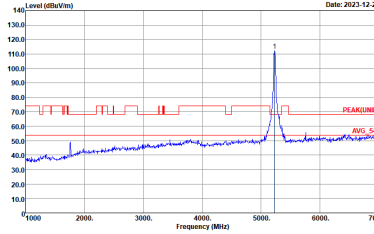
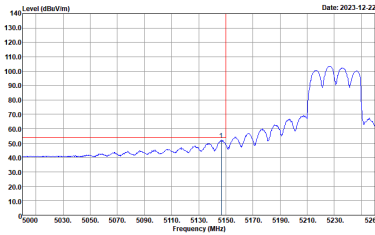
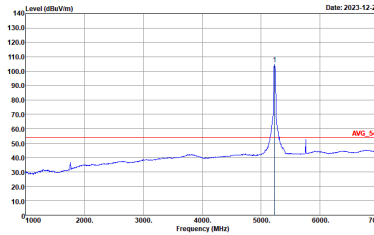

WIFI	Band 1 5150~5250MHz Band Edge @ 3m	
ANT	802.11ax HE40 Full CH46 5230MHz - L	
6+7	Horizontal	Fundamental
Peak	 <p>Site : 03CH07-HY Condition : PEAK_BE_74 3m HF_ANT_00075962 HORIZONTAL : RBW:1000.000kHz VBW:3000.000kHz SWT:Auto</p>	 <p>Site : 03CH07-HY Condition : PEAK(LIN) 3m HF_ANT_00075962 HORIZONTAL : RBW:1000.000kHz VBW:3000.000kHz SWT:Auto</p>
Avg.	 <p>Site : 03CH07-HY Condition : AVG_BE_34 3m HF_ANT_00075962 HORIZONTAL : RBW:1000.000kHz VBW:1.000kHz SWT:Auto</p>	 <p>Site : 03CH07-HY Condition : AVG_34 3m HF_ANT_00075962 HORIZONTAL : RBW:1000.000kHz VBW:1.000kHz SWT:Auto</p>



WIFI	Band 1 5150~5250MHz Band Edge @ 3m	
ANT	802.11ax HE40 Full CH46 5230MHz - R	
6+7	Horizontal	Fundamental
Peak		Left blank
Avg.		Left blank



WIFI	Band 1 5150~5250MHz Band Edge @ 3m	
ANT	802.11ax HE40 Full CH46 5230MHz - L	
6+7	Vertical	Fundamental
Peak	<p>Site : 03CH07-HY Condition : PEAK_BE_74 3m HF_ANT_00075962 VERTICAL : RBW:1000.000kHz VBW:3000.000kHz SWT:Auto</p>	<p>Site : 03CH07-HY Condition : PEAK(LIN) 3m HF_ANT_00075962 VERTICAL : RBW:1000.000kHz VBW:3000.000kHz SWT:Auto</p>
Avg.	<p>Site : 03CH07-HY Condition : AVG_BE_34 3m HF_ANT_00075962 VERTICAL : RBW:1000.000kHz VBW:1.000kHz SWT:Auto</p>	<p>Site : 03CH07-HY Condition : AVG_34 3m HF_ANT_00075962 VERTICAL : RBW:1000.000kHz VBW:1.000kHz SWT:Auto</p>



WIFI	Band 1 5150~5250MHz Band Edge @ 3m	
ANT	802.11ax HE40 Full CH46 5230MHz - R	
6+7	Vertical	Fundamental
Peak	<p>Site : 03CH07-RY Condition : PEAK_BE_74 3m HF_ANT_00075962 VERTICAL : RBW:1000.000kHz VBW:3000.000kHz SWTA:Auto</p>	Left blank
Avg.	<p>Site : 03CH07-RY Condition : AVG_BE_54 3m HF_ANT_00075962 VERTICAL : RBW:1000.000kHz VBW:1.000kHz SWTA:Auto</p>	Left blank



Band 1 5150~5250MHz
WIFI 802.11ax HE40 Partial 242 (Band Edge @ 3m)

WIFI	Band 1 5150~5250MHz Band Edge @ 3m	
ANT	802.11ax HE40 Partial 242/61 CH38 5190MHz - L	
6+7	Horizontal	Fundamental
Peak	<p>Site Condition : 03CH07-HY : PEAK_BE_74 3m HF_ANT_00075962 HORIZONTAL : RBW:1000.000kHz VBW:3000.000kHz SWTAuto</p>	<p>Site Condition : 03CH07-HY : PEAK(LIN) 3m HF_ANT_00075962 HORIZONTAL : RBW:1000.000kHz VBW:3000.000kHz SWTAuto</p>
Avg.	<p>Site Condition : 03CH07-HY : AVG_BE_54 3m HF_ANT_00075962 HORIZONTAL : RBW:1000.000kHz VBW:1.000kHz SWTAuto</p>	<p>Site Condition : 03CH07-HY : AVG_54 3m HF_ANT_00075962 HORIZONTAL : RBW:1000.000kHz VBW:1.000kHz SWTAuto</p>



WIFI	Band 1 5150~5250MHz Band Edge @ 3m	
ANT	802.11ax HE40 Partial 242/61 CH38 5190MHz - R	
6+7	Horizontal	Fundamental
Peak	<p>Site : 03CH07-RY Condition : PEAK_BE_74 3m HF_ANT_00075962 HORIZONTAL : RBW:1000.000kHz VBW:3000.000kHz SWT:Auto</p>	Left blank
Avg.	<p>Site : 03CH07-RY Condition : AVG_BE_54 3m HF_ANT_00075962 HORIZONTAL : RBW:1000.000kHz VBW:1.000kHz SWT:Auto</p>	Left blank

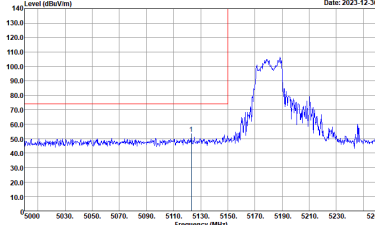
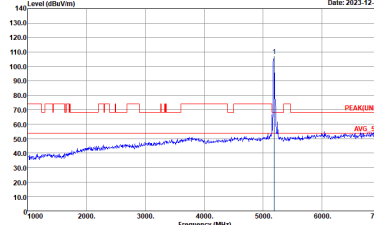
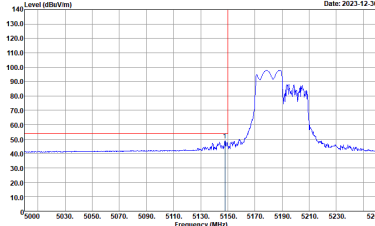
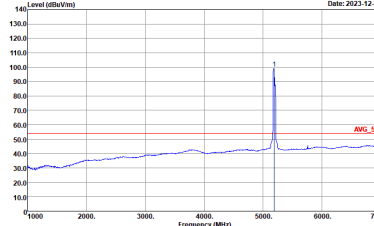

WIFI	Band 1 5150~5250MHz Band Edge @ 3m	
ANT	802.11ax HE40 Partial 242/61 CH38 5190MHz - L	
6+7	Vertical	Fundamental
Peak	 <p>Site : 03CH07-HY Condition : PEAK_BE_74 3m HF_ANT_00075962 VERTICAL : RBW:1000.000kHz VBW:3000.000kHz SWT:Auto</p>	 <p>Site : 03CH07-HY Condition : PEAK(FUN1) 3m HF_ANT_00075962 VERTICAL : RBW:1000.000kHz VBW:3000.000kHz SWT:Auto</p>
Avg.	 <p>Site : 03CH07-HY Condition : AVG_BE_34 3m HF_ANT_00075962 VERTICAL : RBW:1000.000kHz VBW:1.000kHz SWT:Auto</p>	 <p>Site : 03CH07-HY Condition : AVG_34 3m HF_ANT_00075962 VERTICAL : RBW:1000.000kHz VBW:1.000kHz SWT:Auto</p>

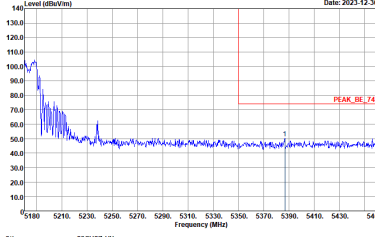
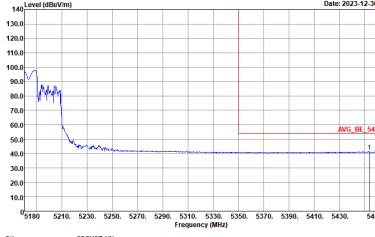

WIFI	Band 1 5150~5250MHz Band Edge @ 3m	
ANT	802.11ax HE40 Partial 242/61 CH38 5190MHz - R	
6+7	Vertical	Fundamental
Peak	 <p>Site : 03CH07-RY Condition : PEAK_BE_74 3m HF_ANT_00075962 VERTICAL : RBW:1000.000kHz VBW:3000.000kHz SWTA:Auto</p>	Left blank
Avg.	 <p>Site : 03CH07-RY Condition : AVG_BE_54 3m HF_ANT_00075962 VERTICAL : RBW:1000.000kHz VBW:1.000kHz SWTA:Auto</p>	Left blank

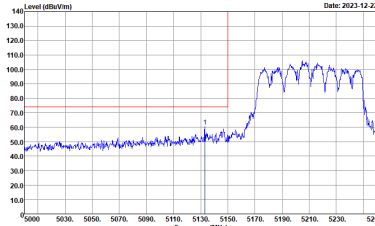
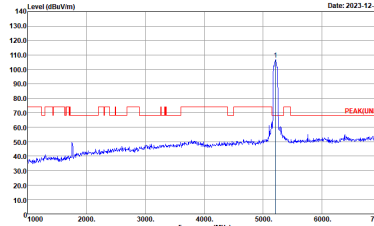
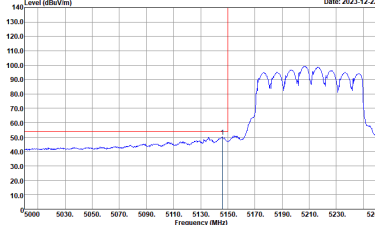
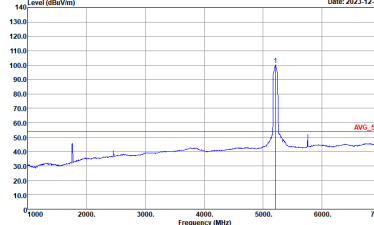

Band 1 5150~5250MHz
WIFI 802.11ax HE80 Full (Band Edge @ 3m)

WIFI	Band 1 5150~5250MHz Band Edge @ 3m	
ANT	802.11ax HE80 Full CH42 5210MHz - L	
6+7	Horizontal	Fundamental
Peak	 <p>Site : 03CH07-HY Condition : PEAK_BE_74 3m HF_ANT_00075962 HORIZONTAL : RBW:1000.000kHz VBW:3000.000kHz SWTAuto</p>	 <p>Site : 03CH07-HY Condition : PEAK(LIN)I 3m HF_ANT_00075962 HORIZONTAL : RBW:1000.000kHz VBW:3000.000kHz SWTAuto</p>
Avg.	 <p>Site : 03CH07-HY Condition : AVG_BE_54 3m HF_ANT_00075962 HORIZONTAL : RBW:1000.000kHz VBW:3.000kHz SWTAuto</p>	 <p>Site : 03CH07-HY Condition : AVG_54 3m HF_ANT_00075962 HORIZONTAL : RBW:1000.000kHz VBW:3.000kHz SWTAuto</p>



WIFI	Band 1 5150~5250MHz Band Edge @ 3m	
ANT	802.11ax HE80 Full CH42 5210MHz - R	
6+7	Horizontal	Fundamental
Peak	<p>Site : 03CH07-RY Condition : PEAK_BE_74 3m HF_ANT_00075962 HORIZONTAL : RBW:1000.000kHz VBW:3000.000kHz SWT:Auto</p>	Left blank
Avg.	<p>Site : 03CH07-RY Condition : AVG_BE_54 3m HF_ANT_00075962 HORIZONTAL : RBW:1000.000kHz VBW:3.000kHz SWT:Auto</p>	Left blank

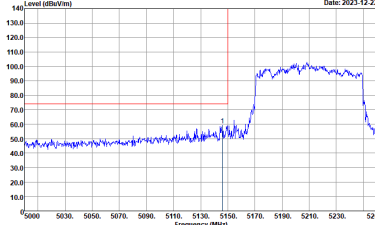
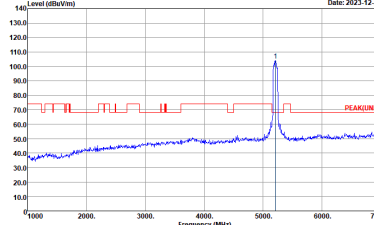
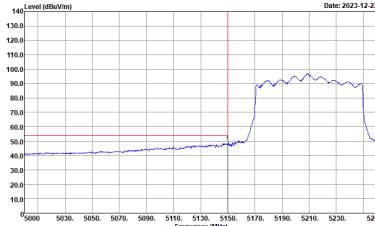
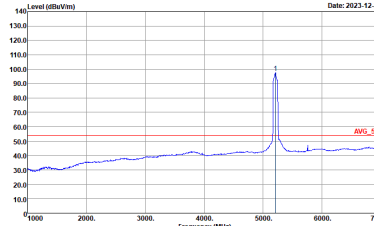

WIFI	Band 1 5150~5250MHz Band Edge @ 3m	
ANT	802.11ax HE80 Full CH42 5210MHz - L	
6+7	Vertical	Fundamental
Peak	 <p>Site : 03CH07-HY Condition : PEAK_BE_74 3m HF_ANT_00075962 VERTICAL : RBW:1000.000kHz VBW:3000.000kHz SWT:Auto</p>	 <p>Site : 03CH07-HY Condition : PEAK(LIN)1 3m HF_ANT_00075962 VERTICAL : RBW:1000.000kHz VBW:3000.000kHz SWT:Auto</p>
Avg.	 <p>Site : 03CH07-HY Condition : AVG_BE_54 3m HF_ANT_00075962 VERTICAL : RBW:1000.000kHz VBW:3.000kHz SWT:Auto</p>	 <p>Site : 03CH07-HY Condition : AVG_54 3m HF_ANT_00075962 VERTICAL : RBW:1000.000kHz VBW:3.000kHz SWT:Auto</p>



WIFI	Band 1 5150~5250MHz Band Edge @ 3m	
ANT	802.11ax HE80 Full CH42 5210MHz - R	
6+7	Vertical	Fundamental
Peak	<p>Site : 03CH07-RY Condition : PEAK_BE_74 3m HF_ANT_00075962 VERTICAL : RBW:1000.000kHz VBW:3000.000kHz SWTA:Auto</p>	Left blank
Avg.	<p>Site : 03CH07-RY Condition : AVG_BE_54 3m HF_ANT_00075962 VERTICAL : RBW:1000.000kHz VBW:3.000kHz SWTA:Auto</p>	Left blank

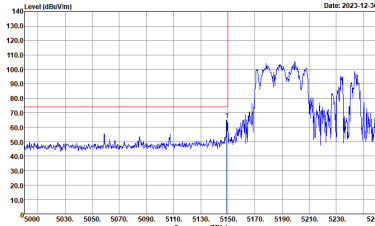
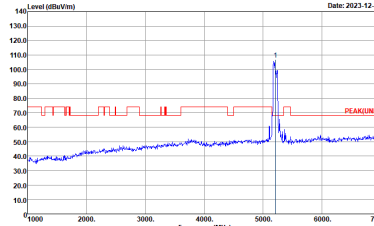
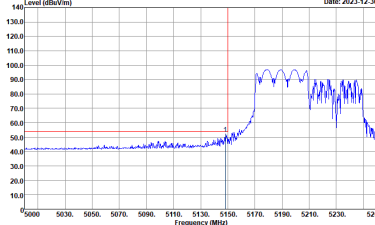
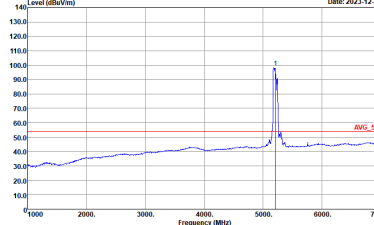

Band 1 5150~5250MHz
WIFI 802.11ax HE80 Partial 484 (Band Edge @ 3m)

WIFI	Band 1 5150~5250MHz Band Edge @ 3m	
ANT	802.11ax HE80 Partial 484/65 CH42 5210MHz - L	
6+7	Horizontal	Fundamental
Peak	 <p>Site : 03CH07-HY Condition : PEAK_BE_74 3m HF_ANT_00075962 HORIZONTAL : RBW:1000.000kHz VBW:3000.000kHz SWTAuto</p>	 <p>Site : 03CH07-HY Condition : PEAK(LIN)I 3m HF_ANT_00075962 HORIZONTAL : RBW:1000.000kHz VBW:3000.000kHz SWTAuto</p>
Avg.	 <p>Site : 03CH07-HY Condition : AVG_BE_54 3m HF_ANT_00075962 HORIZONTAL : RBW:1000.000kHz VBW:3.000kHz SWTAuto</p>	 <p>Site : 03CH07-HY Condition : AVG_54 3m HF_ANT_00075962 HORIZONTAL : RBW:1000.000kHz VBW:3.000kHz SWTAuto</p>

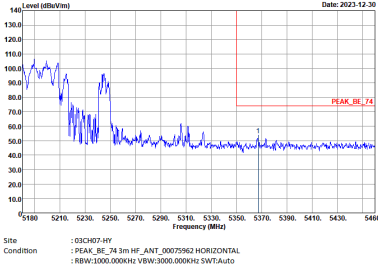
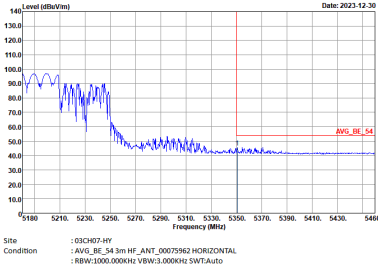

WIFI	Band 1 5150~5250MHz Band Edge @ 3m	
ANT	802.11ax HE80 Partial 484/65 CH42 5210MHz - R	
6+7	Horizontal	Fundamental
Peak	 <p>Site : 03CH07-RY Condition : PEAK_BE_74 3m HF_ANT_00075962 HORIZONTAL : RBW:1000.000kHz VBW:3000.000kHz SWT:Auto</p>	Left blank
Avg.	 <p>Site : 03CH07-RY Condition : AVG_BE_54 3m HF_ANT_00075962 HORIZONTAL : RBW:1000.000kHz VBW:3.000kHz SWT:Auto</p>	Left blank



WIFI	Band 1 5150~5250MHz Band Edge @ 3m	
ANT	802.11ax HE80 Partial 484/65 CH42 5210MHz - L	
6+7	Vertical	Fundamental
Peak	<p>Site : 03CH07-HY Condition : PEAK_BE_74 3m HF_ANT_00075962 VERTICAL : RBW:1000.000kHz VBW:3000.000kHz SWT:Auto</p>	<p>Site : 03CH07-HY Condition : PEAK(LIN) 3m HF_ANT_00075962 VERTICAL : RBW:1000.000kHz VBW:3000.000kHz SWT:Auto</p>
Avg.	<p>Site : 03CH07-HY Condition : AVG_BE_34 3m HF_ANT_00075962 VERTICAL : RBW:1000.000kHz VBW:3.000kHz SWT:Auto</p>	<p>Site : 03CH07-HY Condition : AVG_34 3m HF_ANT_00075962 VERTICAL : RBW:1000.000kHz VBW:3.000kHz SWT:Auto</p>

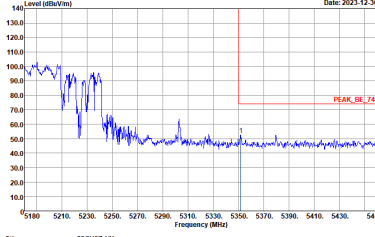
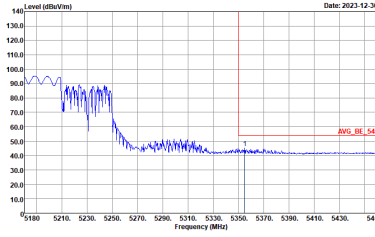

WIFI	Band 1 5150~5250MHz Band Edge @ 3m	
ANT	802.11ax HE80 Partial 484/65 CH42 5210MHz - R	
6+7	Vertical	Fundamental
Peak	 <p>Site : 03CH07-RY Condition : PEAK_BE_74 3m HF_ANT_00075962 VERTICAL : RBW:1000.000kHz VBW:3000.000kHz SWTA:Auto</p>	Left blank
Avg.	 <p>Site : 03CH07-RY Condition : AVG_BE_54 3m HF_ANT_00075962 VERTICAL : RBW:1000.000kHz VBW:3.000kHz SWTA:Auto</p>	Left blank



Band 1 5150~5250MHz
WIFI 802.11ax HE160 Full (Band Edge @ 3m)

WIFI	Band 1 5150~5250MHz Band Edge @ 3m	
ANT	802.11ax HE160 Full CH50 5250MHz - L	
6+7	Horizontal	Fundamental
Peak	<p>Site : 03CH07-HY Condition : PEAK_BE_74 3m HF_ANT_00075962 HORIZONTAL : RBW:1000.000kHz VBW:3000.000kHz SWTAuto</p>	<p>Site : 03CH07-HY Condition : PEAK(LIN) 3m HF_ANT_00075962 HORIZONTAL : RBW:1000.000kHz VBW:3000.000kHz SWTAuto</p>
	<p>Site : 03CH07-HY Condition : AVG_BE_54 3m HF_ANT_00075962 HORIZONTAL : RBW:1000.000kHz VBW:3.000kHz SWTAuto</p>	<p>Site : 03CH07-HY Condition : AVG_54 3m HF_ANT_00075962 HORIZONTAL : RBW:1000.000kHz VBW:3.000kHz SWTAuto</p>
Avg.		



WIFI	Band 1 5150~5250MHz Band Edge @ 3m	
ANT	802.11ax HE160 Full CH50 5250MHz - R	
6+7	Horizontal	Fundamental
Peak	<p>Site : 03CH07-RY Condition : PEAK_BE_74 3m HF_ANT_00075962 HORIZONTAL : RBW:1000.000kHz VBW:3000.000kHz SWT:Auto</p>	Left blank
Avg.	<p>Site : 03CH07-RY Condition : AVG_BE_54 3m HF_ANT_00075962 HORIZONTAL : RBW:1000.000kHz VBW:3.000kHz SWT:Auto</p>	Left blank



WIFI	Band 1 5150~5250MHz Band Edge @ 3m	
ANT	802.11ax HE160 Full CH50 5250MHz - L	
6+7	Vertical	Fundamental
Peak	<p>Site : 03CH07-HY Condition : PEAK_BE_74 3m HF_ANT_00075962 VERTICAL : RBW:1000.000kHz VBW:3000.000kHz SWT:Auto</p>	<p>Site : 03CH07-HY Condition : PEAK(LIN) 3m HF_ANT_00075962 VERTICAL : RBW:1000.000kHz VBW:3000.000kHz SWT:Auto</p>
Avg.	<p>Site : 03CH07-HY Condition : AVG_BE_54 3m HF_ANT_00075962 VERTICAL : RBW:1000.000kHz VBW:3.000kHz SWT:Auto</p>	<p>Site : 03CH07-HY Condition : AVG_54 3m HF_ANT_00075962 VERTICAL : RBW:1000.000kHz VBW:3.000kHz SWT:Auto</p>



WIFI	Band 1 5150~5250MHz Band Edge @ 3m	
ANT	802.11ax HE160 Full CH50 5250MHz - R	
6+7	Vertical	Fundamental
Peak	<p>Site : 03CH07-RY Condition : PEAK_BE_74 3m HF_ANT_00075962 VERTICAL : RBW:1000.000kHz VBW:3000.000kHz SWTA:Auto</p>	Left blank
Avg.	<p>Site : 03CH07-RY Condition : AVG_BE_54 3m HF_ANT_00075962 VERTICAL : RBW:1000.000kHz VBW:3.000kHz SWTA:Auto</p>	Left blank

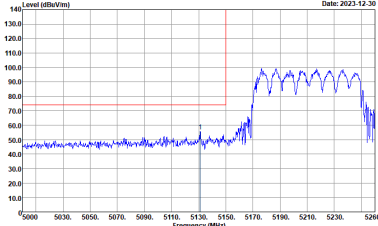
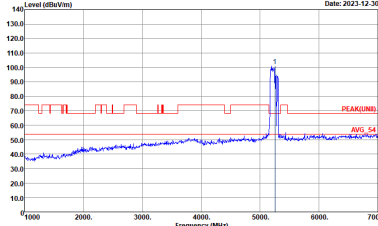
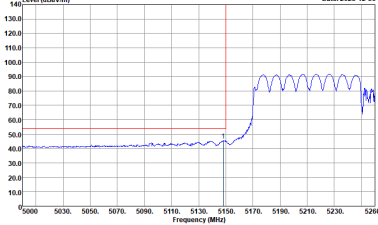
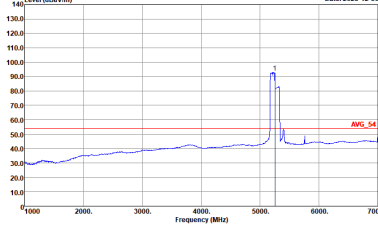

Band 1 5150~5250MHz
WIFI 802.11ax HE160 Partial 996 (Band Edge @ 3m)

WIFI	Band 1 5150~5250MHz Band Edge @ 3m	
ANT	802.11ax HE160 Partial 996/67 CH50 5250MHz - L	
6+7	Horizontal	Fundamental
Peak	 <p>Site : 03CH07-HY Condition : PEAK_BE_74 3m HF_ANT_00075962 HORIZONTAL : RBW:1000.000kHz VBW:3000.000kHz SWTAuto</p>	 <p>Site : 03CH07-HY Condition : PEAK(LIN) 3m HF_ANT_00075962 HORIZONTAL : RBW:1000.000kHz VBW:3000.000kHz SWTAuto</p>
Avg.	 <p>Site : 03CH07-HY Condition : AVG_BE_S4 3m HF_ANT_00075962 HORIZONTAL : RBW:1000.000kHz VBW:1.000kHz SWTAuto</p>	 <p>Site : 03CH07-HY Condition : AVG_S4 3m HF_ANT_00075962 HORIZONTAL : RBW:1000.000kHz VBW:1.000kHz SWTAuto</p>

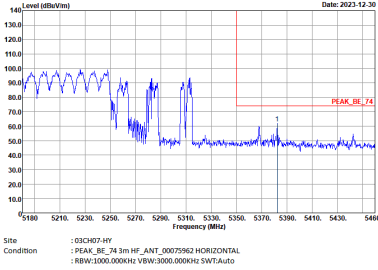
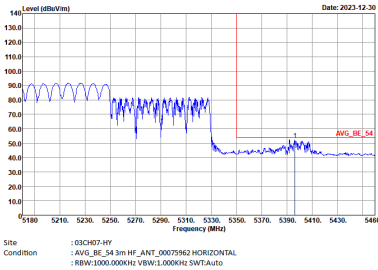

WIFI	Band 1 5150~5250MHz Band Edge @ 3m	
ANT	802.11ax HE160 Partial 996/67 CH50 5250MHz - R	
6+7	Horizontal	Fundamental
Peak	 <p>Site : 03CH07-RY Condition : PEAK_BE_74 3m HF_ANT_00075962 HORIZONTAL : RBW:1000.000kHz VBW:3000.000kHz SWT:Auto</p>	Left blank
Avg.	 <p>Site : 03CH07-RY Condition : AVG_BE_54 3m HF_ANT_00075962 HORIZONTAL : RBW:1000.000kHz VBW:1.000kHz SWT:Auto</p>	Left blank



WIFI	Band 1 5150~5250MHz Band Edge @ 3m	
ANT	802.11ax HE160 Partial 996/67 CH50 5250MHz - L	
6+7	Vertical	Fundamental
Peak	<p>Site : 03CH07-HY Condition : PEAK_BE_74 3m HF_ANT_00075962 VERTICAL : RBW:1000.000kHz VBW:3000.000kHz SWT:Auto</p>	<p>Site : 03CH07-HY Condition : PEAK(LIN)1 3m HF_ANT_00075962 VERTICAL : RBW:1000.000kHz VBW:3000.000kHz SWT:Auto</p>
Avg.	<p>Site : 03CH07-HY Condition : AVG_BE_34 3m HF_ANT_00075962 VERTICAL : RBW:1000.000kHz VBW:1.000kHz SWT:Auto</p>	<p>Site : 03CH07-HY Condition : AVG_34 3m HF_ANT_00075962 VERTICAL : RBW:1000.000kHz VBW:1.000kHz SWT:Auto</p>



WIFI	Band 1 5150~5250MHz Band Edge @ 3m	
ANT	802.11ax HE160 Partial 996/67 CH50 5250MHz - R	
6+7	Vertical	Fundamental
Peak	<p>Site : 03CH07-RY Condition : PEAK_BE_74 3m HF_ANT_00075962 VERTICAL : RBW:1000.000kHz VBW:3000.000kHz SWTAuto</p>	Left blank
Avg.	<p>Site : 03CH07-RY Condition : AVG_BE_54 3m HF_ANT_00075962 VERTICAL : RBW:1000.000kHz VBW:1.000kHz SWTAuto</p>	Left blank

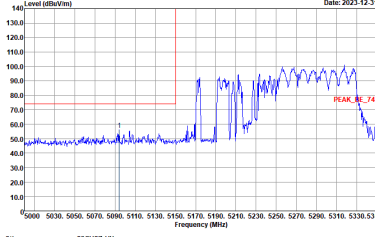
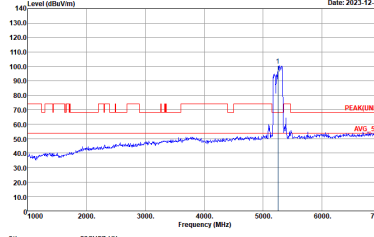
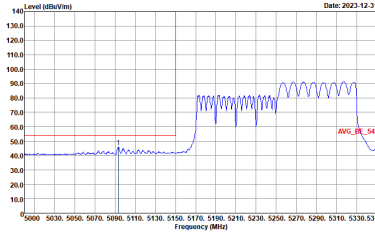
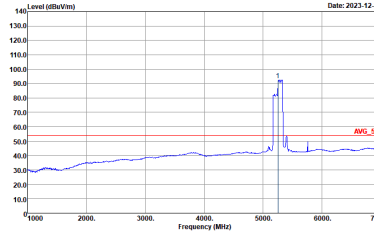

WIFI	Band 1 5150~5250MHz Band Edge @ 3m	
ANT	802.11ax HE160 Partial 996/68 CH50 5250MHz - L	
6+7	Horizontal	Fundamental
Peak	 <p>Site : 03CH07-HY Condition : PEAK_BE_74 3m HF_ANT_00075962 HORIZONTAL : RBW:1000.000kHz VBW:3000.000kHz SWT:Auto</p>	 <p>Site : 03CH07-HY Condition : PEAK(LIN) 3m HF_ANT_00075962 HORIZONTAL : RBW:1000.000kHz VBW:3000.000kHz SWT:Auto</p>
Avg.	 <p>Site : 03CH07-HY Condition : AVG_BE_54 3m HF_ANT_00075962 HORIZONTAL : RBW:1000.000kHz VBW:1.000kHz SWT:Auto</p>	 <p>Site : 03CH07-HY Condition : AVG_54 3m HF_ANT_00075962 HORIZONTAL : RBW:1000.000kHz VBW:1.000kHz SWT:Auto</p>