



FCC RADIO TEST REPORT

FCC ID : UZ7TC5301
Equipment : Touch Computer
Brand Name : Zebra
Model Name : TC5301
Applicant : Zebra Technologies Corporation
1 Zebra Plaza, Holtsville, NY 11742
Manufacturer : Zebra Technologies Corporation
1 Zebra Plaza, Holtsville, NY 11742
Standard : FCC PART 15 Subpart C §15.247

The product was received on Dec. 20, 2021 and testing was performed from Dec. 22, 2021 to Feb. 10, 2022. We, Sporton International Inc. Wensan Laboratory, would like to declare that the tested sample has been evaluated in accordance with the test procedures and has been in compliance with the applicable technical standards.

The test results in this report apply exclusively to the tested model / sample. Without written approval from Sporton International Inc. Wensan Laboratory, the test report shall not be reproduced except in full.

Approved by: Louis Wu

Sporton International Inc. Wensan Laboratory

No.58, Aly. 75, Ln. 564, Wenhua 3rd, Rd., Guishan Dist., Taoyuan City 333010, Taiwan (R.O.C.)



Table of Contents

History of this test report.....	3
Summary of Test Result.....	4
1 General Description	5
1.1 Product Feature of Equipment Under Test.....	5
1.2 Product Specification of Equipment Under Test.....	6
1.3 Modification of EUT	7
1.4 Testing Location	7
1.5 Applicable Standards.....	7
2 Test Configuration of Equipment Under Test	8
2.1 Carrier Frequency and Channel	8
2.2 Test Mode.....	9
2.3 Connection Diagram of Test System.....	12
2.4 Support Unit used in test configuration and system	13
2.5 EUT Operation Test Setup	13
2.6 Measurement Results Explanation Example.....	14
3 Test Result	15
3.1 6dB and 99% Bandwidth Measurement	15
3.2 Output Power Measurement.....	21
3.3 Power Spectral Density Measurement	25
3.4 Conducted Band Edges and Spurious Emission Measurement	32
3.5 Radiated Band Edges and Spurious Emission Measurement	69
3.6 AC Conducted Emission Measurement.....	75
3.7 Antenna Requirements.....	77
4 List of Measuring Equipment.....	79
5 Uncertainty of Evaluation	80
Appendix A. AC Conducted Emission Test Result	
Appendix B. Radiated Spurious Emission	
Appendix C. Radiated Spurious Emission Plots	
Appendix D. Duty Cycle Plots	
Appendix E. Setup Photographs	



History of this test report

Report No.	Version	Description	Issue Date
FR1D2108C	01	Initial issue of report	Mar. 07, 2022



Summary of Test Result

Report Clause	Ref Std. Clause	Test Items	Result (PASS/FAIL)	Remark
3.1	15.247(a)(2)	6dB Bandwidth	Pass	-
3.1	2.1049	99% Occupied Bandwidth	Reporting only	-
3.2	15.247(b)	Power Output Measurement	Pass	-
3.3	15.247(e)	Power Spectral Density	Pass	-
3.4	15.247(d)	Conducted Band Edges	Pass	-
		Conducted Spurious Emission	Pass	-
3.5	15.247(d)	Radiated Band Edges and Radiated Spurious Emission	Pass	1.67 dB under the limit at 2484.460 MHz
3.6	15.207	AC Conducted Emission	Pass	15.60 dB under the limit at 13.560 MHz
3.7	15.203 & 15.247(b)	Antenna Requirement	Pass	-

Declaration of Conformity:

- The test results (PASS/FAIL) with all measurement uncertainty excluded are presented in accordance with the regulation limits or requirements declared by manufacturers. It's means measurement values may risk exceeding the limit of regulation standards, if measurement uncertainty is include in test results.
- The measurement uncertainty please refer to this report "Uncertainty of Evaluation".

Comments and Explanations:

The product specifications of the EUT presented in the report are declared by the manufacturer who shall take full responsibility for the authenticity.

Reviewed by: Wei Chen

Report Producer: Tina Chuang



1 General Description

1.1 Product Feature of Equipment Under Test

Product Feature	
Equipment	Touch Computer
Brand Name	Zebra
Model Name	TC5301
FCC ID	UZ7TC5301
Sample1	Lowell + Premium config
Sample2	SE4720 + Base config
Sample3	Lowell + Base config
EUT supports Radios application	NFC WLAN 11a/b/g/n HT20/HT40 WLAN 11ac VHT20/VHT40/VHT80/VHT160 WLAN 11ax HE20/HE40/HE80/HE160 Bluetooth BR/EDR/LE
HW Version	EV2
SW Version	11-05-19.00-RG-U00-PRD-ATH-04 99 test-keys
FW Version	FUSION_QA_4_1.0.0.007_R
MFD	03DEC21
EUT Stage	Identical Prototype

Remark: The EUT's information above is declared by manufacturer.

Specification of Accessories				
Adapter	Brand Name	Zebra	Part Number	PWR-WUA5V12W0US
Battery 1X	Brand Name	Zebra	Part Number	BT-000442-0020
USB TYPE A to TYPE C cable	Brand Name	Zebra	Part Number	CBL-TC5X-USBC2A-01
3.5mm Earphone	Brand Name	Zebra	Part Number	HDST-35MM-PTVP-01
Headset Jumper	Brand Name	Zebra	Part Number	CBL-TC51-HDST35-01
Trigger Handle	Brand Name	Zebra	Part Number	TRG-NGTC5-ELEC-01
Soft Holster	Brand Name	Zebra	Part Number	SG-NGTC5TC7-HLSTR-01
TC53/TC58 RUGGED BOOT	Brand Name	Zebra	Part Number	SG-NGTC5EXO1-01



1.2 Product Specification of Equipment Under Test

Product Specification is subject to this standard										
Tx/Rx Channel Frequency Range	2412 MHz ~ 2462 MHz									
Maximum Output Power to Antenna <CDD Modes>	MIMO <Ant. 9+8> 802.11b : 22.81 dBm / 0.1910 W 802.11g : 22.11 dBm / 0.1626 W 802.11n HT20 : 21.41 dBm / 0.1384 W 802.11n HT40 : 21.46 dBm / 0.1400 W 802.11ac VHT20: 21.61 dBm / 0.1449 W 802.11ac VHT40: 21.76 dBm / 0.1500 W 802.11ax HE20: 21.71 dBm / 0.1483 W 802.11ax HE40: 21.86 dBm / 0.1535 W									
Maximum Output Power <TXBF Modes>	MIMO <Ant. 9+8> 802.11ax HE20: 21.37 dBm / 0.1371 W 802.11ax HE40: 19.41 dBm / 0.0873 W									
99% Occupied Bandwidth <CDD Mode>	MIMO <Ant. 9> 802.11b : 13.49 MHz 802.11g : 16.53 MHz 802.11ax HE20 : 18.98 MHz 802.11ax HE40 : 37.96 MHz MIMO <Ant. 8> 802.11b : 13.39 MHz 802.11g : 16.48 MHz 802.11ax HE20 : 18.93 MHz 802.11ax HE40 : 37.96 MHz									
99% Occupied Bandwidth <TXBF Mode>	MIMO <Ant. 9> 802.11ax HE20 : 19.48 MHz 802.11ax HE40 : 38.46 MHz MIMO <Ant. 8> 802.11ax HE20 : 19.43 MHz 802.11ax HE40 : 38.56 MHz									
Antenna Type / Gain	<Ant. 9> : PIFA Antenna with gain 2.20 dBi <Ant. 8> : PIFA Antenna with gain 1.10 dBi									
Type of Modulation	802.11b : DSSS (DBPSK / DQPSK / CCK) 802.11g/n : OFDM (BPSK / QPSK / 16QAM / 64QAM) 802.11ac : OFDM (BPSK / QPSK / 16QAM / 64QAM / 256QAM) 802.11ax : OFDMA (BPSK / QPSK / 16QAM / 64QAM / 256QAM / 1024QAM)									
Antenna Function Description	<table border="1"> <thead> <tr> <th></th> <th>Ant. 9</th> <th>Ant. 8</th> </tr> </thead> <tbody> <tr> <td>802.11 b/g/n/ac/ax MIMO</td> <td>V</td> <td>V</td> </tr> <tr> <td>802.11ax TXBF</td> <td>V</td> <td>V</td> </tr> </tbody> </table>		Ant. 9	Ant. 8	802.11 b/g/n/ac/ax MIMO	V	V	802.11ax TXBF	V	V
	Ant. 9	Ant. 8								
802.11 b/g/n/ac/ax MIMO	V	V								
802.11ax TXBF	V	V								

Note:

1. MIMO Ant. 9+8 is a calculated result from sum of the power MIMO Ant. 9 and MIMO Ant. 8.
2. The above EUT's information was declared by manufacturer. Please refer to Comments and Explanations in report summary.



1.3 Modification of EUT

No modifications made to the EUT during the testing.

1.4 Testing Location

Test Site	Sporton International Inc. EMC & Wireless Communications Laboratory
Test Site Location	No.52, Huaya 1st Rd., Guishan Dist., Taoyuan City 333, Taiwan (R.O.C.) TEL: +886-3-327-3456 FAX: +886-3-328-4978
Test Site No.	Sporton Site No. CO05-HY (TAF Code: 1190)
Remark	The AC Conducted Emission test item subcontracted to Sporton International Inc. EMC & Wireless Communications Laboratory.

Note: The test site complies with ANSI C63.4 2014 requirement.

Test Site	Sporton International Inc. Wensan Laboratory
Test Site Location	No.58, Aly. 75, Ln. 564, Wenhua 3rd, Rd., Guishan Dist., Taoyuan City 333010, Taiwan (R.O.C.) TEL: +886-3-327-0868 FAX: +886-3-327-0855
Test Site No.	Sporton Site No. TH05-HY, 03CH16-HY

Note: The test site complies with ANSI C63.4 2014 requirement.

FCC designation No.: TW1190 and TW3786

1.5 Applicable Standards

According to the specifications declared by the manufacturer, the EUT must comply with the requirements of the following standards:

- ♦ FCC Part 15 Subpart C §15.247
- ♦ FCC KDB Publication No. 558074 D01 DTS Meas. Guidance v05r02
- ♦ FCC KDB 414788 D01 Radiated Test Site v01r01.
- ♦ FCC KDB 662911 D01 Multiple Transmitter Output v02r01.
- ♦ ANSI C63.10-2013

Remark:

1. All the test items were validated and recorded in accordance with the standards without any modification during the testing.
2. The TAF code is not including all the FCC KDB listed without accreditation.
3. This EUT has also been tested and complied with the requirements of FCC Part 15, Subpart B, recorded in a separate test report.



2 Test Configuration of Equipment Under Test

- a. The EUT has been associated with peripherals and configuration operated in a manner tended to maximize its emission characteristics in a typical application. Frequency range investigated: conduction emission (150 kHz to 30 MHz), radiation emission (9 kHz to the 10th harmonic of the highest fundamental frequency or to 40 GHz, whichever is lower). For radiated measurement, the measured emission level of the EUT was maximized by rotating the EUT on a turntable, adjusting the orientation of the EUT and EUT antenna in three orthogonal axis (X: flat, Y: portrait, Z: landscape), and adjusting the measurement antenna orientation, following C63.10 exploratory test procedures and find Z plane as worst plane.

- b. AC power line Conducted Emission was tested under maximum output power.

2.1 Carrier Frequency and Channel

Frequency Band	Channel	Freq. (MHz)	Channel	Freq. (MHz)
2400-2483.5 MHz	1	2412	7	2442
	2	2417	8	2447
	3	2422	9	2452
	4	2427	10	2457
	5	2432	11	2462
	6	2437		



2.2 Test Mode

The 802.11ax mode is investigated among different tones, full resource units (RU), partial resource units. The partial RU has no higher power than full RU's, thus the full RU is chosen as main test configuration.

The CDD mode is chosen as worst case configuration for all test cases due to higher power than SISO mode.

The 802.11n/ac mode has no higher power and PSD than 802.11ax mode, thus the 802.11ax mode is chosen as main test configuration, and the 802.11n/ac mode is verified the power.

The final test modes consider the modulation and the worst data rates as shown in the table below.

CDD Mode

Modulation	Data Rate
802.11b	1 Mbps
802.11g	6 Mbps
802.11n HT20 (Covered by HE20)	MCS0
802.11n HT40 (Covered by HE40)	MCS0
802.11ac VHT20 (Covered by HE20)	MCS0
802.11ac VHT40 (Covered by HE40)	MCS0
802.11ax HE20	MCS0
802.11ax HE40	MCS0

TXBF Mode

Modulation	Data Rate
802.11ax HE20	MCS0
802.11ax HE40	MCS0

Test Cases	
AC Conducted Emission	Mode 1 : WLAN (2.4GHz) Link + Bluetooth Link + NFC On + USB TYPE A to TYPE C cable (Charging from Adapter) + Headset Jumper + 3.5mm Earphone + Battery 1X for Sample 2
Remark: For Radiated Test Cases, the tests were performed with Sample 2.	



<CDD Mode>

Ch. #	2400-2483.5 MHz			
	802.11b	802.11g	802.11ax HE20	802.11ax HE40
Low	01	01	01	03
Middle	06	06	06	06
High	11	11	11	09

<TXBF Mode>

Ch. #	2400-2483.5 MHz	
	802.11ax HE20	802.11ax HE40
Low	01	03
Middle	06	06
High	11	09

Remark: For radiation spurious emission, the modulation and the data rate picked for testing are determined by the Max. RF conducted power.

<CDD Mode>

802.11b RF Avg Output Power (dBm)						
Power vs. Channel			Power vs Data Rate			
Channel	Frequency (MHz)	Data Rate (bps)	Channel	Data Rate (bps)		
		1M		2M	5.5M	11M
CH 01	2412	22.71	CH 11	22.76	22.71	22.71
CH 06	2437	22.76				
CH 11	2462	22.81				

802.11g RF Avg Output Power (dBm)									
Power vs. Channel			Power vs Data Rate						
Channel	Frequency (MHz)	Data Rate (bps)	Channel	Data Rate (bps)					
		6M		9M	12M	18M	24M	36M	48M
CH 01	2412	21.86	CH 06	22.06	22.06	22.06	22.01	22.01	22.01
CH 06	2437	22.11							
CH 11	2462	20.91							



802.11ax HE20 RF Output Power (dBm)															
Power vs. Channel				Power vs Data Rate											
Channel	Frequency (MHz)	RU Config.	MCS Index	Channel	MCS Index										
			MCS0		MCS1	MCS2	MCS3	MCS4	MCS5	MCS6	MCS7	MCS8	MCS9	MCS 10	MCS 11
CH 01	2412	Full	21.51	CH 06	21.66	21.61	21.56	21.61	21.66	21.66	21.66	21.61	21.66	21.66	
CH 01	2412	26/0	13.06												
CH 01	2412	52/37	14.77												
CH 01	2412	106/53	17.21												
CH 06	2437	Full	21.71												
CH 06	2437	26/4	11.81												
CH 06	2437	52/39	14.21												
CH 06	2437	106/53	16.71												
CH 11	2462	Full	20.41												
CH 11	2462	26/8	12.17												
CH 11	2462	52/40	13.83												
CH 11	2462	106/54	15.81												

802.11ax HE40 RF Output Power (dBm)															
Power vs. Channel				Power vs Data Rate											
Channel	Frequency (MHz)	RU Config.	MCS Index	Channel	MCS Index										
			MCS0		MCS1	MCS2	MCS3	MCS4	MCS5	MCS6	MCS7	MCS8	MCS9	MCS 10	MCS 11
CH 03	2422	Full	21.86	CH 03	21.81	21.81	21.81	21.76	21.81	21.81	21.76	21.81	21.81	21.81	
CH 03	2422	242/61	19.51												
CH 06	2437	Full	21.51												
CH 06	2437	242/61	19.06												
CH 09	2452	Full	20.86												
CH 09	2452	242/62	18.27												

<TXBF Mode>

802.11ax HE20 RF Output Power (dBm)															
Power vs. Channel				Power vs Data Rate											
Channel	Frequency (MHz)	RU Config.	MCS Index	Channel	MCS Index										
			MCS0		MCS1	MCS2	MCS3	MCS4	MCS5	MCS6	MCS7	MCS8	MCS9	MCS 10	MCS 11
CH 01	2412	Full	20.37												
CH 06	2437	Full	21.37	CH 06	21.27	21.27	21.17	21.17	21.17	21.27	21.21	21.21	21.11	21.21	21.27
CH 11	2462	Full	19.27												

802.11ax HE40 RF Output Power (dBm)															
Power vs. Channel				Power vs Data Rate											
Channel	Frequency (MHz)	RU Config.	MCS Index	Channel	MCS Index										
			MCS0		MCS1	MCS2	MCS3	MCS4	MCS5	MCS6	MCS7	MCS8	MCS9	MCS 10	MCS 11
CH 03	2422	Full	19.41												
CH 06	2437	Full	18.56	CH 03	19.31	19.26	19.21	19.21	19.21	19.31	19.26	19.21	19.31	19.26	19.31
CH 09	2452	Full	17.67												

2.3 Connection Diagram of Test System

<AC Conducted Emission Mode>

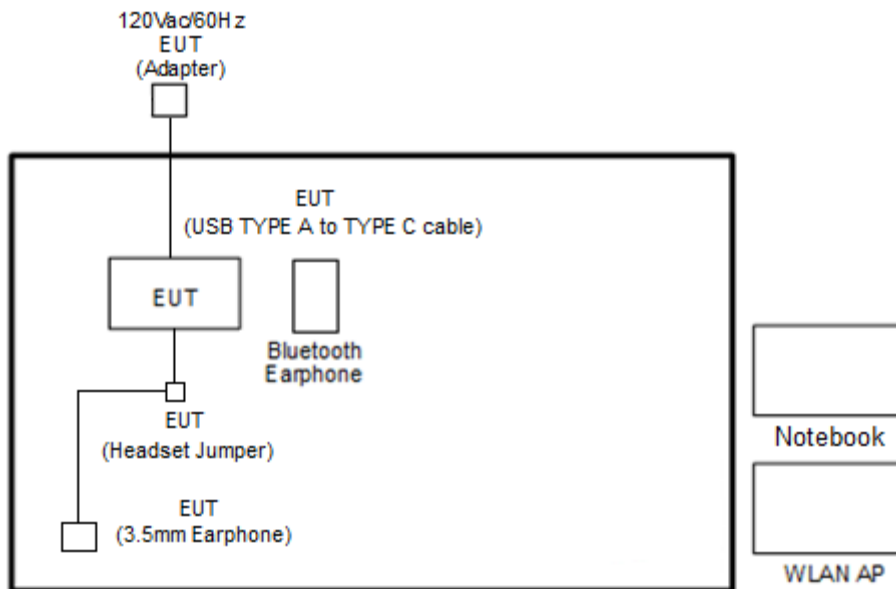

<WLAN Tx Mode>

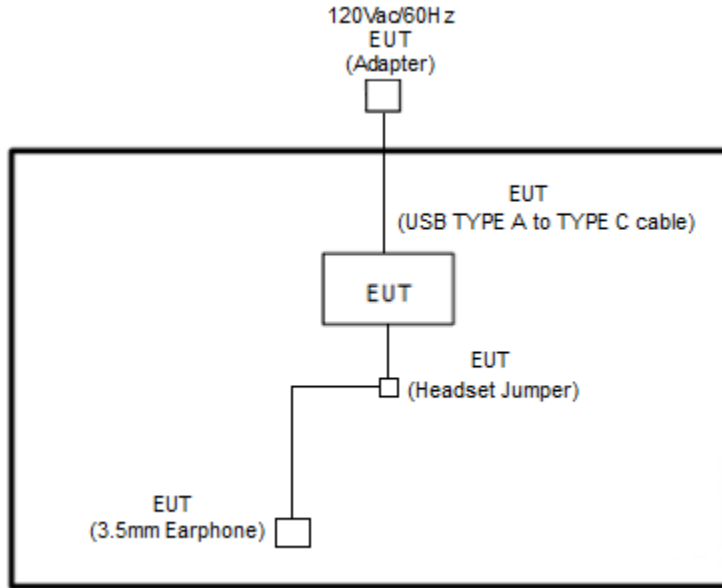

2.4 Support Unit used in test configuration and system

Item	Equipment	Brand Name	Model Name	FCC ID	Data Cable	Power Cord
1.	Bluetooth Earphone	Sony Ericsson	MW600	PY700A2029	N/A	N/A
2.	WLAN AP	ASUS	RT-AC66U	MSQ-RTAC66U	N/A	Unshielded, 1.8m
3.	Notebook	DELL	Latitude 3400	FCC DoC	N/A	AC I/P: Unshielded, 1.2 m DC O/P: Shielded, 1.8 m
4.	SD Card	SanDisk	MicroSD HC	FCC DoC	N/A	N/A

2.5 EUT Operation Test Setup

The RF test items, utility “QRCT Ver.4.0.00195.0” was installed in Notebook which was programmed in order to make the EUT get into the engineering modes to provide channel selection, power level, data rate and the application type and for continuous transmitting signals.

For TXBF mode, the modulation modes and data rates manipulated by the command lines in the engineering program made the EUT link to AP by power under the normal operation. The “Magic iPerf Ver.1.0” software tool was used to enable the EUT to transmit signals continuously.



2.6 Measurement Results Explanation Example

For all conducted test items:

The offset level is set in the spectrum analyzer to compensate the RF cable loss and attenuator factor between EUT conducted output port and spectrum analyzer. With the offset compensation, the spectrum analyzer reading level is exactly the EUT RF output level.

Example:

The spectrum analyzer offset is derived from RF cable loss and attenuator factor.

Offset = RF cable loss + attenuator factor.

Following shows an offset computation example with cable loss 4.2 dB and 10 dB attenuator.

$$\begin{aligned} \text{Offset}(dB) &= \text{RF cable loss}(dB) + \text{attenuator factor}(dB). \\ &= 4.2 + 10 = 14.2 \text{ (dB)} \end{aligned}$$

3 Test Result

3.1 6dB and 99% Bandwidth Measurement

3.1.1 Limit of 6dB and 99% Bandwidth

The minimum 6 dB bandwidth shall be at least 500 kHz.

3.1.2 Measuring Instruments

Please refer to the measuring equipment list in this test report.

3.1.3 Test Procedures

1. The testing follows the ANSI C63.10 Section 6.9.3 (OBW) and 11.8.1 (6dB BW).
2. The RF output of EUT is connected to the spectrum analyzer by RF cable and attenuator. The path loss is compensated to the results for each measurement.
3. Set the maximum power setting and enable the EUT to transmit continuously.
4. Make the measurement with the spectrum analyzer's resolution bandwidth (RBW) = 100 kHz. Set the Video bandwidth (VBW) = 300 kHz. In order to make an accurate measurement. The 6 dB bandwidth must be greater than 500 kHz.
5. For 99% Bandwidth Measurement, the spectrum analyzer's resolution bandwidth (RBW) is set 1-5% of the emission bandwidth and set the Video bandwidth (VBW) $\geq 3 * RBW$.
6. Measure and record the results in the test report.

3.1.4 Test Setup

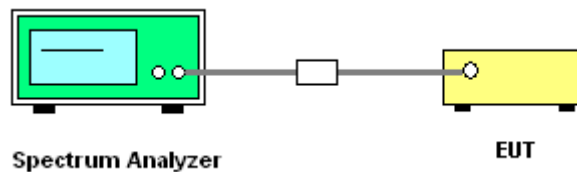



3.1.5 Test Result of 6dB and 99% Occupied Bandwidth

Test Engineer :	Jacob Yu	Temperature :	17.7~22.5°C
		Relative Humidity :	45.1~61.9%

<CDD Mode>

2.4GHz Band MIMO										
Mod.	Data Rate	NTX	CH.	Freq. (MHz)	99% Occupied BW (MHz)		6dB BW (MHz)		6dB BW Limit (MHz)	Pass/Fail
					Ant9	Ant8	Ant9	Ant8		
11b	1Mbps	2	1	2412	13.24	13.09	8.04	8.06	0.50	Pass
11b	1Mbps	2	6	2437	13.49	13.39	8.56	8.04	0.50	Pass
11b	1Mbps	2	11	2462	13.24	13.34	8.54	8.08	0.50	Pass
11g	6Mbps	2	1	2412	16.38	16.43	15.96	15.94	0.50	Pass
11g	6Mbps	2	6	2437	16.53	16.48	16.30	16.33	0.50	Pass
11g	6Mbps	2	11	2462	16.43	16.43	16.31	16.32	0.50	Pass

2.4GHz Band MIMO											
Mod.	Data Rate	NTX	CH.	Freq. (MHz)	RU Config.	99% Occupied BW (MHz)		6dB BW (MHz)		6dB BW Limit (MHz)	Pass/Fail
						Ant9	Ant8	Ant9	Ant8		
HE20	MCS0	2	1	2412	Full	18.93	18.93	18.78	18.37	0.50	Pass
HE20	MCS0	2	6	2437	Full	18.98	18.93	18.89	18.84	0.50	Pass
HE20	MCS0	2	11	2462	Full	18.93	18.88	18.79	18.81	0.50	Pass
HE40	MCS0	2	3	2422	Full	37.86	37.86	37.06	36.94	0.50	Pass
HE40	MCS0	2	6	2437	Full	37.96	37.96	37.94	37.86	0.50	Pass
HE40	MCS0	2	9	2452	Full	37.86	37.86	37.74	37.38	0.50	Pass



<CDD Mode>

<802.11b>

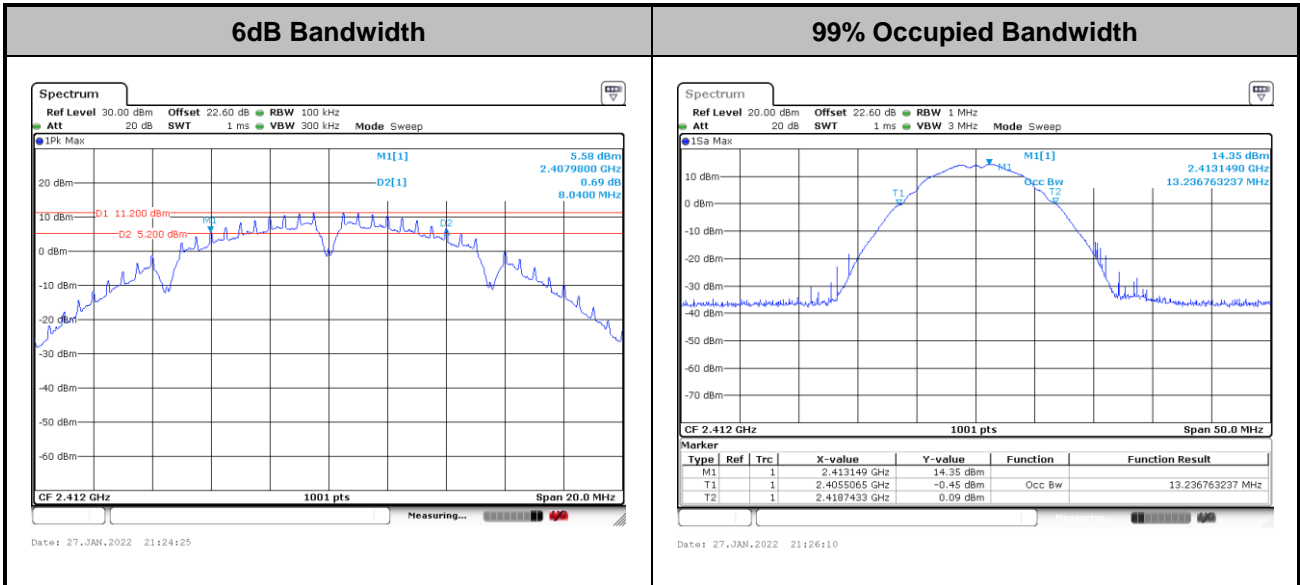

Note: The occupied channel bandwidth is maintained within the band of operation for all of the modulations.

<802.11g>

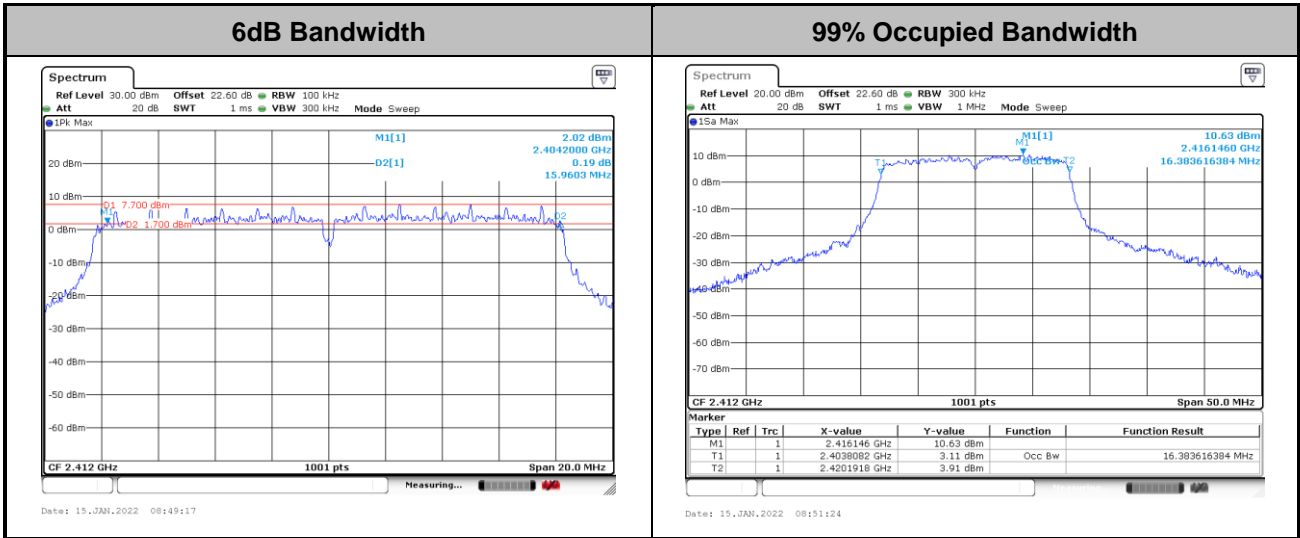

Note: The occupied channel bandwidth is maintained within the band of operation for all of the modulations.



<802.11ax HE20>

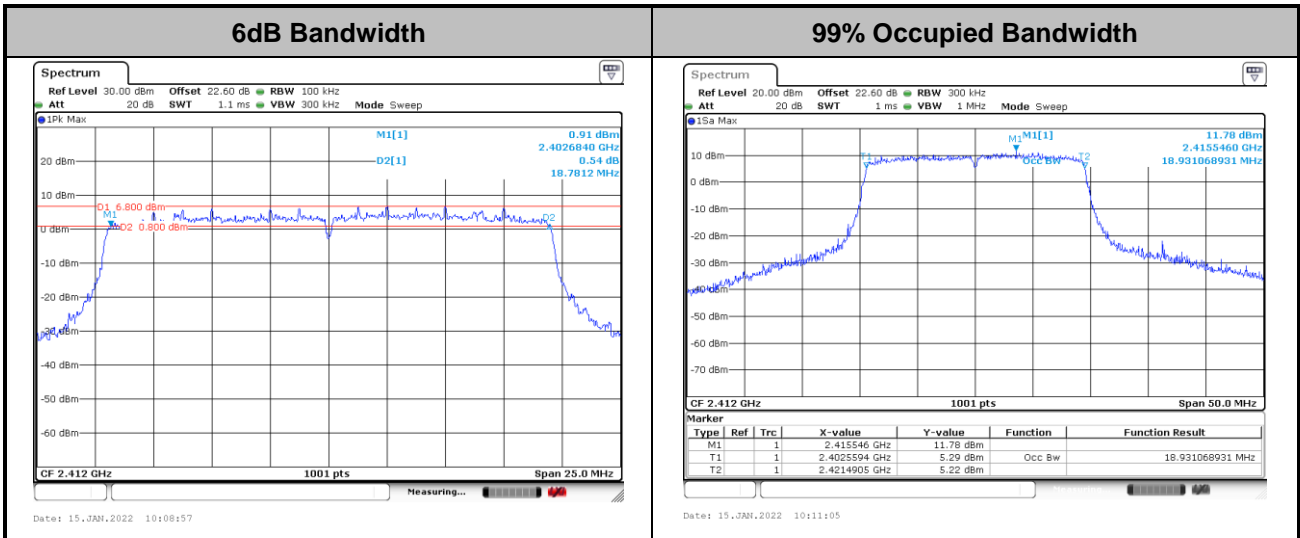

Note: The occupied channel bandwidth is maintained within the band of operation for all of the modulations.

<802.11ax HE40>

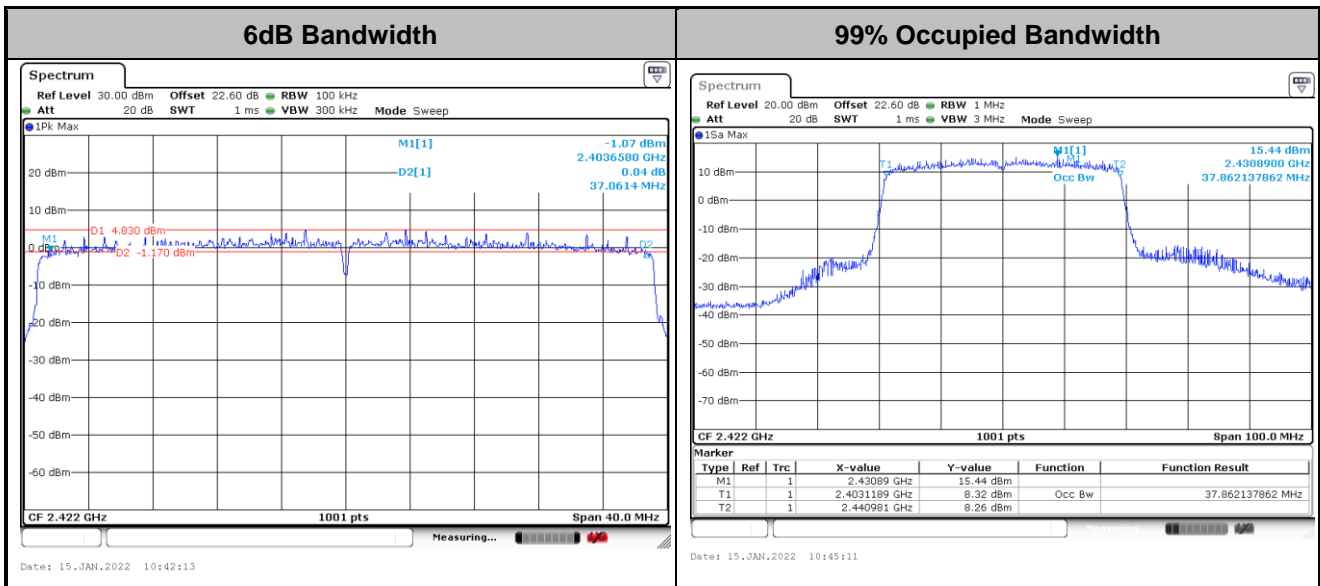

Note: The occupied channel bandwidth is maintained within the band of operation for all of the modulations.



<TXBF Mode>

2.4GHz Band MIMO											
Mod.	Data Rate	NTX	CH.	Freq. (MHz)	RU Config.	99% Occupied BW (MHz)		6dB BW (MHz)		6dB BW Limit (MHz)	Pass/Fail
						Ant9	Ant8	Ant9	Ant8		
HE20	MCS0	2	1	2412	Full	19.43	19.38	18.82	18.24	0.50	Pass
HE20	MCS0	2	6	2437	Full	19.48	19.43	18.97	18.92	0.50	Pass
HE20	MCS0	2	11	2462	Full	19.38	19.43	18.63	18.72	0.50	Pass
HE40	MCS0	2	3	2422	Full	38.06	37.86	37.74	36.38	0.50	Pass
HE40	MCS0	2	6	2437	Full	38.46	37.96	37.92	37.66	0.50	Pass
HE40	MCS0	2	9	2452	Full	38.46	38.56	38.10	36.42	0.50	Pass

<802.11ax HE20>

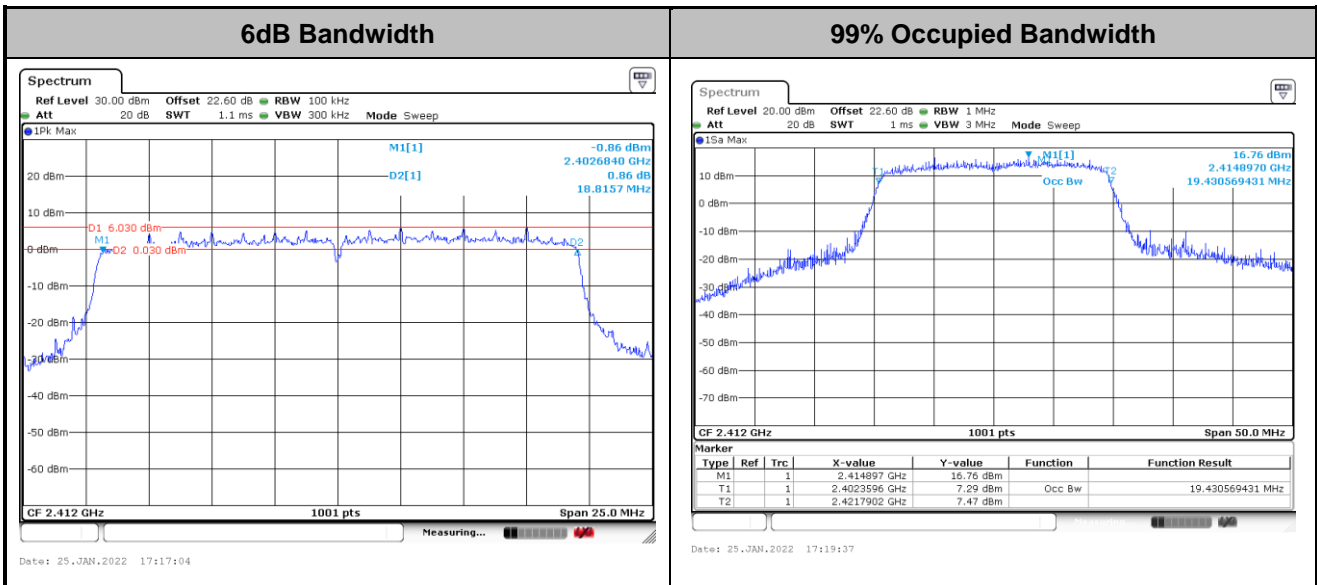

Note: The occupied channel bandwidth is maintained within the band of operation for all of the modulations.



<802.11ax HE40>

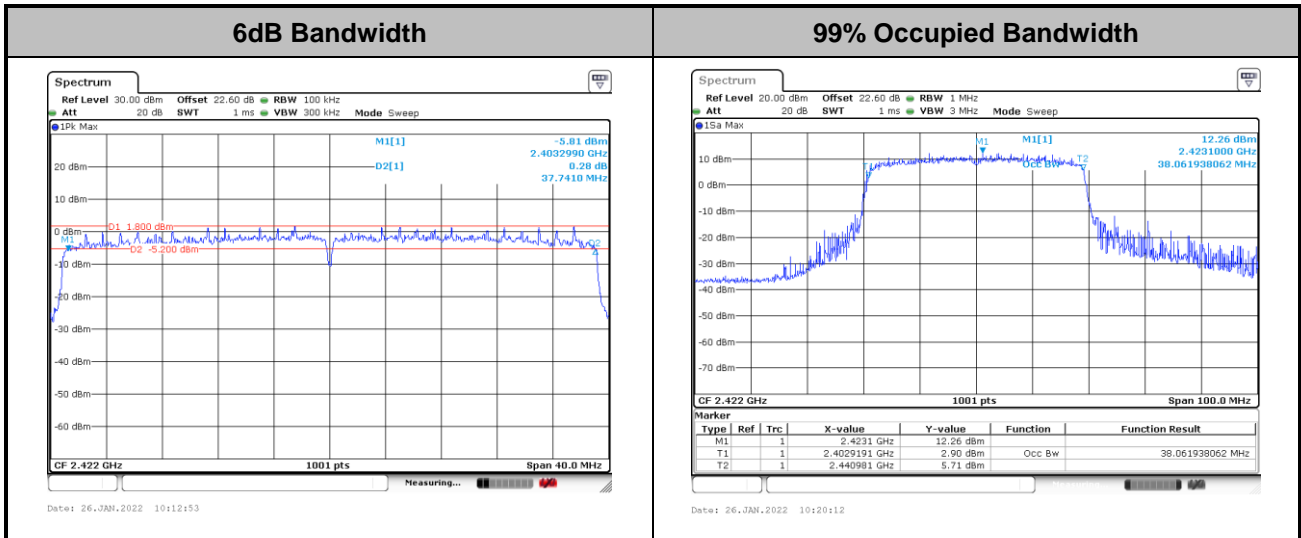

Note: The occupied channel bandwidth is maintained within the band of operation for all of the modulations.

3.2 Output Power Measurement

3.2.1 Limit of Output Power

For systems using digital modulation in the 2400-2483.5 MHz, the limit for output power is 30 dBm. If transmitting antenna with directional gain greater than 6 dBi is used, the output power from the intentional radiator shall be reduced below the above stated value by the amount in dB that the directional gain of the antenna exceeds 6 dBi. In case of point-to-point operation, the limit has to be reduced by 1 dB for every 3 dB that the directional gain of the antenna exceeds 6 dBi.

3.2.2 Measuring Instruments

Please refer to the measuring equipment list in this test report.

3.2.3 Test Procedures

1. For Average Power, the testing follows ANSI C63.10 Section 11.9.2.3.2 Method AVGPM-G
2. The RF output of EUT is connected to the power meter by RF cable and attenuator. The path loss is compensated to the results for each measurement.
3. Set the maximum power setting and enable the EUT to transmit continuously.
4. Measure the conducted output power and record the results in the test report.
5. For MIMO mode, calculation method follows FCC KDB 662911 D01 Multiple Transmitter Output v02r01.

3.2.4 Test Setup

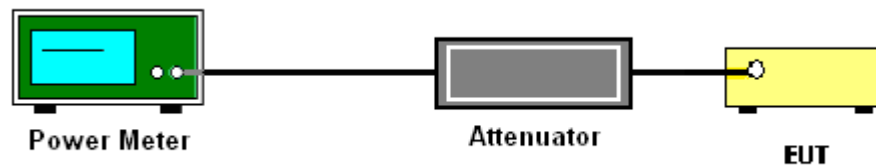



3.2.5 Test Result of Average Output Power

Test Engineer :	Jacob Yu	Temperature :	17.7~22.5°C
		Relative Humidity :	45.1~61.9%

<CDD Mode>

2.4GHz Band MIMO																
Mod.	Data Rate	NTX	CH.	Freq. (MHz)	Average Conducted Power (dBm)			Conducted Power Limit (dBm)		DG (dBi)		EIRP Power (dBm)		EIRP Power Limit (dBm)		Pass /Fail
					Ant9	Ant8	SUM	Ant9	Ant8	Ant9	Ant8	Ant9	Ant8	Ant9	Ant8	
11b	1Mbps	2	1	2412	19.50	19.90	22.71	30.00	2.20	2.20	24.91	36.00	36.00	36.00	Pass	
11b	1Mbps	2	6	2437	19.70	19.80	22.76	30.00	2.20	2.20	24.96	36.00	36.00	36.00	Pass	
11b	1Mbps	2	11	2462	19.70	19.90	22.81	30.00	2.20	2.20	25.01	36.00	36.00	36.00	Pass	
11g	6Mbps	2	1	2412	18.80	18.90	21.86	30.00	2.20	2.20	24.06	36.00	36.00	36.00	Pass	
11g	6Mbps	2	6	2437	19.10	19.10	22.11	30.00	2.20	2.20	24.31	36.00	36.00	36.00	Pass	
11g	6Mbps	2	11	2462	17.90	17.90	20.91	30.00	2.20	2.20	23.11	36.00	36.00	36.00	Pass	
HT20	MCS0	2	1	2412	18.30	18.50	21.41	30.00	2.20	2.20	23.61	36.00	36.00	36.00	Pass	
HT20	MCS0	2	6	2437	18.20	18.20	21.21	30.00	2.20	2.20	23.41	36.00	36.00	36.00	Pass	
HT20	MCS0	2	11	2462	17.20	17.30	20.26	30.00	2.20	2.20	22.46	36.00	36.00	36.00	Pass	
HT40	MCS0	2	3	2422	18.40	18.50	21.46	30.00	2.20	2.20	23.66	36.00	36.00	36.00	Pass	
HT40	MCS0	2	6	2437	18.40	18.30	21.36	30.00	2.20	2.20	23.56	36.00	36.00	36.00	Pass	
HT40	MCS0	2	9	2452	17.70	17.60	20.66	30.00	2.20	2.20	22.86	36.00	36.00	36.00	Pass	
VHT20	MCS0	2	1	2412	18.30	18.50	21.41	30.00	2.20	2.20	23.61	36.00	36.00	36.00	Pass	
VHT20	MCS0	2	6	2437	18.60	18.60	21.61	30.00	2.20	2.20	23.81	36.00	36.00	36.00	Pass	
VHT20	MCS0	2	11	2462	17.10	17.50	20.31	30.00	2.20	2.20	22.51	36.00	36.00	36.00	Pass	
VHT40	MCS0	2	3	2422	18.70	18.80	21.76	30.00	2.20	2.20	23.96	36.00	36.00	36.00	Pass	
VHT40	MCS0	2	6	2437	18.50	18.30	21.41	30.00	2.20	2.20	23.61	36.00	36.00	36.00	Pass	
VHT40	MCS0	2	9	2452	17.80	17.70	20.76	30.00	2.20	2.20	22.96	36.00	36.00	36.00	Pass	



2.4GHz Band MIMO																
Mod.	Data Rate	NTX	CH.	Freq. (MHz)	RU Config.	Average Conducted Power (dBm)			Conducted Power Limit (dBm)		DG (dBi)		EIRP Power (dBm)		EIRP Power Limit (dBm)	Pass /Fail
						Ant9	Ant8	SUM	Ant9	Ant8	Ant9	Ant8	Ant9	Ant8		
HE20	MCS0	2	1	2412	Full	18.40	18.60	21.51	30.00	2.20	23.71	36.00	Pass			
HE20	MCS0	2	1	2412	26/0	10.00	10.10	13.06	30.00	2.20	15.26	36.00	Pass			
HE20	MCS0	2	1	2412	52/37	12.00	11.50	14.77	30.00	2.20	16.97	36.00	Pass			
HE20	MCS0	2	1	2412	106/53	14.20	14.20	17.21	30.00	2.20	19.41	36.00	Pass			
HE20	MCS0	2	6	2437	Full	18.70	18.70	21.71	30.00	2.20	23.91	36.00	Pass			
HE20	MCS0	2	6	2437	26/4	8.60	9.00	11.81	30.00	2.20	14.01	36.00	Pass			
HE20	MCS0	2	6	2437	52/39	11.00	11.40	14.21	30.00	2.20	16.41	36.00	Pass			
HE20	MCS0	2	6	2437	106/53	13.60	13.80	16.71	30.00	2.20	18.91	36.00	Pass			
HE20	MCS0	2	11	2462	Full	17.20	17.60	20.41	30.00	2.20	22.61	36.00	Pass			
HE20	MCS0	2	11	2462	26/8	8.90	9.40	12.17	30.00	2.20	14.37	36.00	Pass			
HE20	MCS0	2	11	2462	52/40	10.40	11.20	13.83	30.00	2.20	16.03	36.00	Pass			
HE20	MCS0	2	11	2462	106/54	12.70	12.90	15.81	30.00	2.20	18.01	36.00	Pass			
HE40	MCS0	2	3	2422	Full	18.80	18.90	21.86	30.00	2.20	24.06	36.00	Pass			
HE40	MCS0	2	3	2422	242/61	16.40	16.60	19.51	30.00	2.20	21.71	36.00	Pass			
HE40	MCS0	2	6	2437	Full	18.60	18.40	21.51	30.00	2.20	23.71	36.00	Pass			
HE40	MCS0	2	6	2437	242/61	16.10	16.00	19.06	30.00	2.20	21.26	36.00	Pass			
HE40	MCS0	2	9	2452	Full	17.90	17.80	20.86	30.00	2.20	23.06	36.00	Pass			
HE40	MCS0	2	9	2452	242/62	15.00	15.50	18.27	30.00	2.20	20.47	36.00	Pass			



<TXBF Mode>

2.4GHz Band MIMO																	
Mod.	Data Rate	NTX	CH.	Freq. (MHz)	RU Config.	Average Conducted Power (dBm)			Conducted Power Limit (dBm)		DG (dBi)		EIRP Power (dBm)		EIRP Power Limit (dBm)		Pass /Fail
						Ant9	Ant8	SUM	Ant9	Ant8	Ant9	Ant8	Ant9	Ant8	Ant9	Ant8	
HE20	MCS0	2	1	2412	Full	17.60	17.10	20.37	30.00		4.68		25.05		36.00	Pass	
HE20	MCS0	2	6	2437	Full	18.60	18.10	21.37	30.00		4.68		26.05		36.00	Pass	
HE20	MCS0	2	11	2462	Full	16.60	15.90	19.27	30.00		4.68		23.95		36.00	Pass	
HE40	MCS0	2	3	2422	Full	16.50	16.30	19.41	30.00		4.68		24.09		36.00	Pass	
HE40	MCS0	2	6	2437	Full	15.60	15.50	18.56	30.00		4.68		23.24		36.00	Pass	
HE40	MCS0	2	9	2452	Full	14.90	14.40	17.67	30.00		4.68		22.35		36.00	Pass	

3.3 Power Spectral Density Measurement

3.3.1 Limit of Power Spectral Density

The peak power spectral density shall not be greater than 8 dBm in any 3 kHz band at any time interval of continuous transmission.

3.3.2 Measuring Instruments

Please refer to the measuring equipment list in this test report.

3.3.3 Test Procedures

1. The testing follows the ANSI C63.10 Section 11.10.2 Method PKPSD.
2. The RF output of EUT is connected to the spectrum analyzer by RF cable and attenuator. The path loss is compensated to the results for each measurement.
3. Set the maximum power setting and enable the EUT to transmit continuously.
4. Make the measurement with the spectrum analyzer's resolution bandwidth (RBW) = 3 kHz. Video bandwidth VBW = 10 kHz In order to make an accurate measurement, set the span to 1.5 times DTS Channel Bandwidth. (6dB BW)
5. Detector = peak, Sweep time = auto couple, Trace mode = max hold, Allow trace to fully stabilize. Use the peak marker function to determine the maximum power level.
6. Measure and record the results in the test report.
7. For MIMO mode, calculation method follows FCC KDB 662911 D01 Multiple Transmitter Output v02r01.

If measurements performed using method (2) plus $10 \log(N)$ exceeds the emission limit, the test should choose method (1) before declaring that the device fails the emission limit.

Method (1): Measure and sum the spectra across the outputs.

The total final Power Spectral Density is from a device with 2 transmitter outputs. The spectrum measurements of the individual outputs are all performed with the same span and number of points, the spectrum value in the first spectral bin of output 1 is summed with that in the first spectral bin of output 2 to obtain the value for the first frequency bin of the summed spectrum.

Method (2): Measure and add $10 \log(N)$ dB, where N is the number of outputs. (N=2)

3.3.4 Test Setup

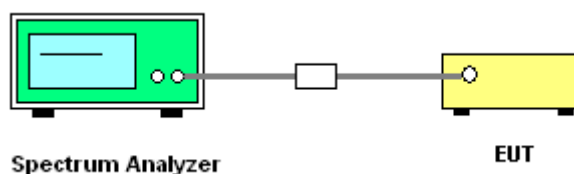



3.3.5 Test Result of Power Spectral Density

Test Engineer :	Jacob Yu	Temperature :	17.7~22.5°C
		Relative Humidity :	45.1~61.9%

<CDD Mode>

2.4GHz Band MIMO												
Mod.	Data Rate	NTX	CH.	Freq. (MHz)	Peak PSD (dBm/3kHz)			DG (dBi)		Peak PSD Limit (dBm/3kHz)		Pass/Fail
					Ant9	Ant8	Worse + 3.01	Ant9	Ant8	Ant9	Ant8	
11b	1Mbps	2	1	2412	-3.80	-3.78	-0.77	4.68		8.00		Pass
11b	1Mbps	2	6	2437	-2.90	-2.70	0.31	4.68		8.00		Pass
11b	1Mbps	2	11	2462	-2.97	-2.79	0.22	4.68		8.00		Pass
11g	6Mbps	2	1	2412	-8.15	-8.25	-5.14	4.68		8.00		Pass
11g	6Mbps	2	6	2437	-7.56	-7.39	-4.38	4.68		8.00		Pass
11g	6Mbps	2	11	2462	-7.96	-8.17	-4.95	4.68		8.00		Pass



2.4GHz Band MIMO													
Mod.	Data Rate	NTX	CH.	Freq. (MHz)	RU Config.	Peak PSD (dBm/3kHz)			DG (dBi)		Peak PSD Limit (dBm/3kHz)		Pass/Fail
						Ant9	Ant8	Worse + 3.01	Ant9	Ant8	Ant9	Ant8	
HE20	MCS0	2	1	2412	Full	-8.12	-7.77	-4.76	4.68		8.00		Pass
HE20	MCS0	2	1	2412	26/0	-8.49	-7.94	-4.93	4.68		8.00		Pass
HE20	MCS0	2	1	2412	52/37	-8.68	-7.80	-4.79	4.68		8.00		Pass
HE20	MCS0	2	1	2412	106/53	-8.35	-8.65	-5.34	4.68		8.00		Pass
HE20	MCS0	2	6	2437	Full	-8.44	-7.65	-4.64	4.68		8.00		Pass
HE20	MCS0	2	6	2437	26/4	-8.47	-8.19	-5.18	4.68		8.00		Pass
HE20	MCS0	2	6	2437	52/39	-8.67	-7.70	-4.69	4.68		8.00		Pass
HE20	MCS0	2	6	2437	106/53	-8.65	-8.27	-5.26	4.68		8.00		Pass
HE20	MCS0	2	11	2462	Full	-8.83	-8.85	-5.82	4.68		8.00		Pass
HE20	MCS0	2	11	2462	26/8	-9.32	-8.86	-5.85	4.68		8.00		Pass
HE20	MCS0	2	11	2462	52/40	-9.32	-9.04	-6.03	4.68		8.00		Pass
HE20	MCS0	2	11	2462	106/54	-9.13	-9.29	-6.12	4.68		8.00		Pass
HE40	MCS0	2	3	2422	Full	-9.56	-10.46	-6.55	4.68		8.00		Pass
HE40	MCS0	2	3	2422	242/61	-9.88	-11.23	-6.87	4.68		8.00		Pass
HE40	MCS0	2	6	2437	Full	-10.51	-10.28	-7.27	4.68		8.00		Pass
HE40	MCS0	2	6	2437	242/61	-10.54	-10.54	-7.53	4.68		8.00		Pass
HE40	MCS0	2	9	2452	Full	-11.56	-11.32	-8.31	4.68		8.00		Pass
HE40	MCS0	2	9	2452	242/62	-11.61	-11.61	-8.60	4.68		8.00		Pass



<802.11b>

Worst Case Power Density (dBm/3kHz)

MIMO Ant. 9

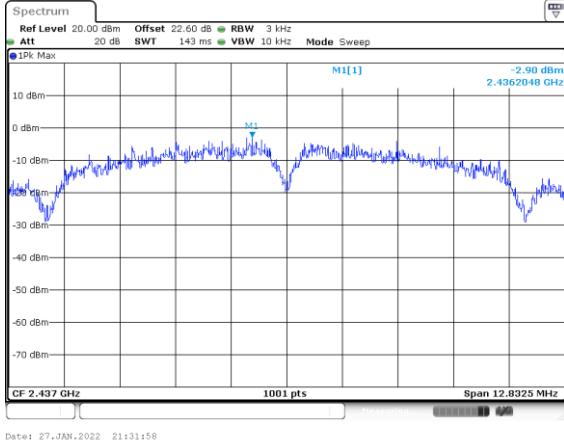

MIMO Ant. 8

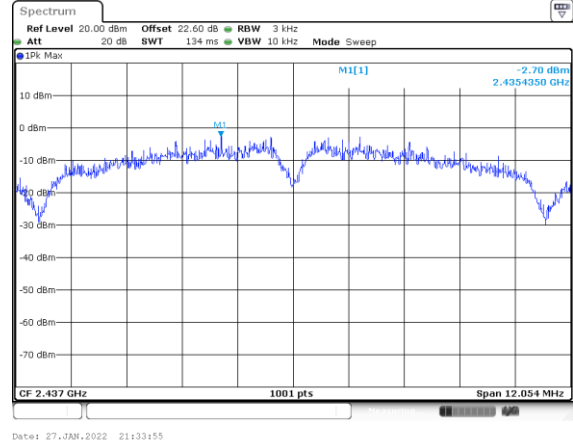

<802.11g>

Worst Case Power Density (dBm/3kHz)

MIMO Ant. 9

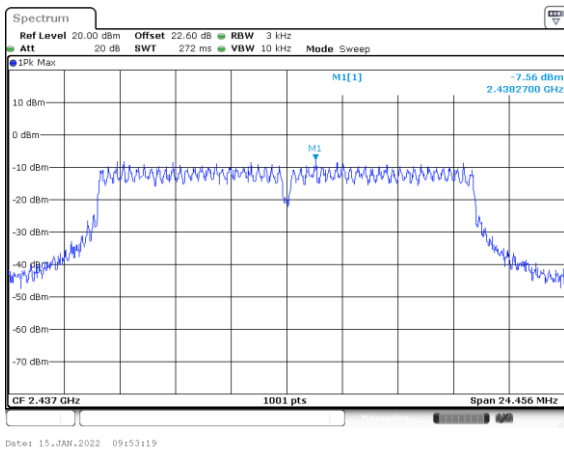

MIMO Ant. 8

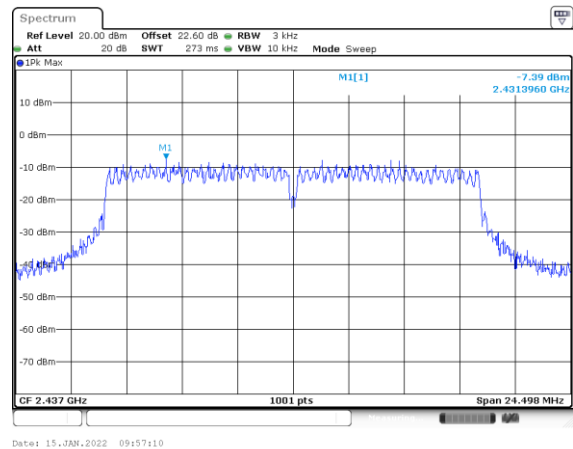



<802.11ax HE20>

Worst Case Power Density (dBm/3kHz)

MIMO Ant. 9

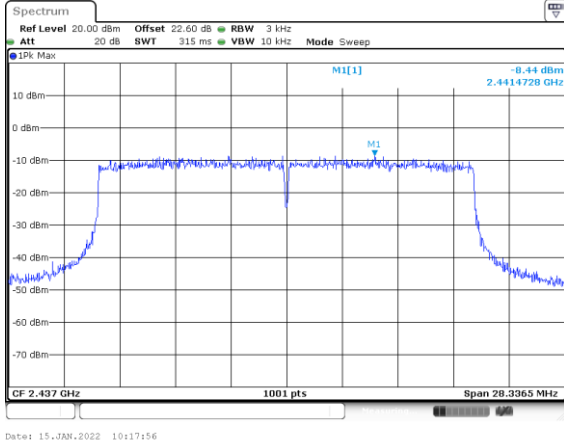

MIMO Ant. 8

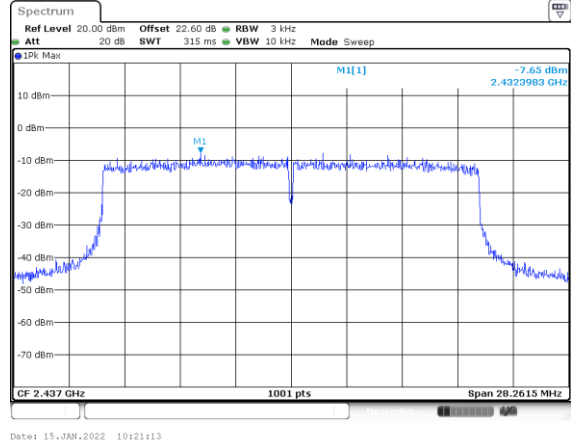

<802.11ax HE40>

Worst Case Power Density (dBm/3kHz)

MIMO Ant. 9

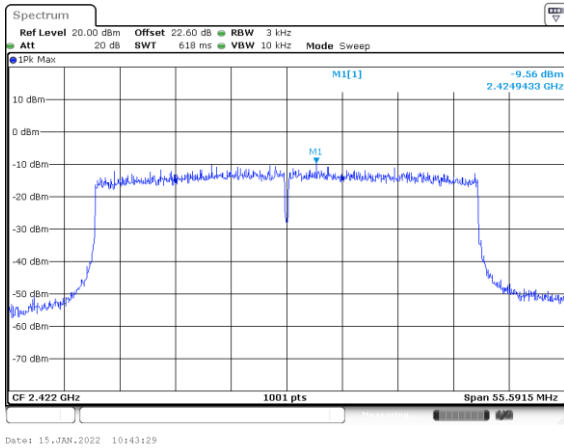

MIMO Ant. 8

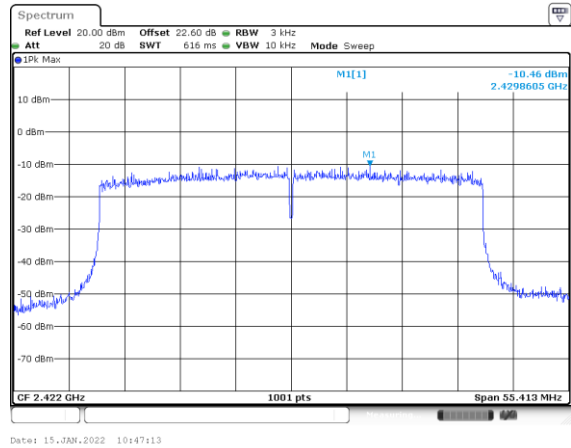



<TXBF Mode>

2.4GHz Band MIMO													
Mod.	Data Rate	NTX	CH.	Freq. (MHz)	RU Config.	Peak PSD (dBm/3kHz)			DG (dBi)		Peak PSD Limit (dBm/3kHz)		Pass/Fail
						Ant9	Ant8	Worse + 3.01	Ant9	Ant8	Ant9	Ant8	
HE20	MCS0	2	1	2412	Full	-8.80	-9.19	-5.79	4.68		8.00		Pass
HE20	MCS0	2	6	2437	Full	-8.27	-8.55	-5.26	4.68		8.00		Pass
HE20	MCS0	2	11	2462	Full	-9.28	-9.52	-6.27	4.68		8.00		Pass
HE40	MCS0	2	3	2422	Full	-13.67	-14.06	-10.66	4.68		8.00		Pass
HE40	MCS0	2	6	2437	Full	-13.86	-14.07	-10.85	4.68		8.00		Pass
HE40	MCS0	2	9	2452	Full	-15.06	-14.65	-11.64	4.68		8.00		Pass

<802.11ax HE20>

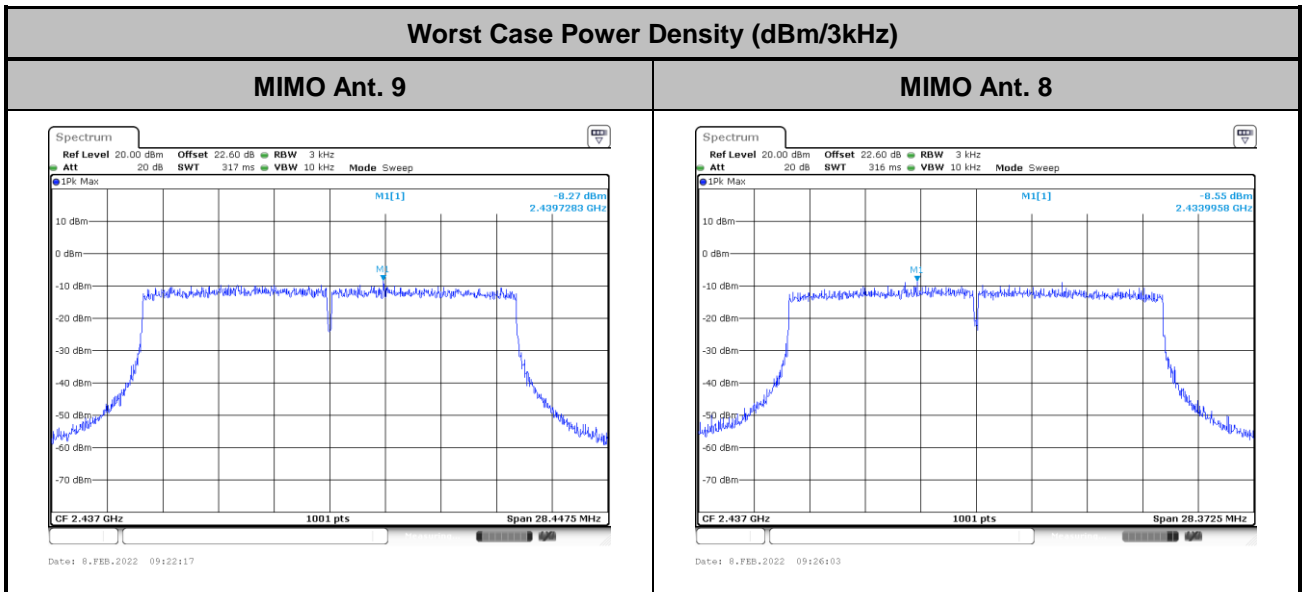



<802.11ax HE40>

Worst Case Power Density (dBm/3kHz)

MIMO Ant. 9

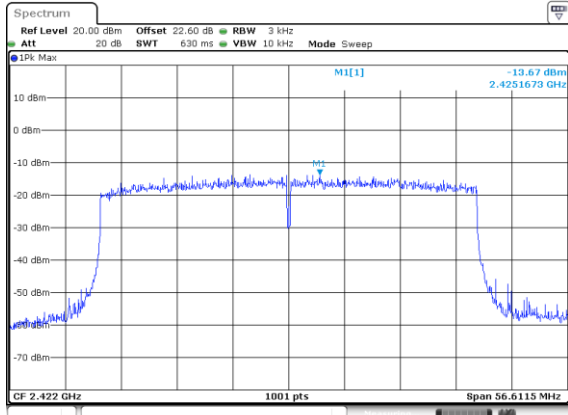

Date: 26.JAN.2022 10:16:06

MIMO Ant. 8

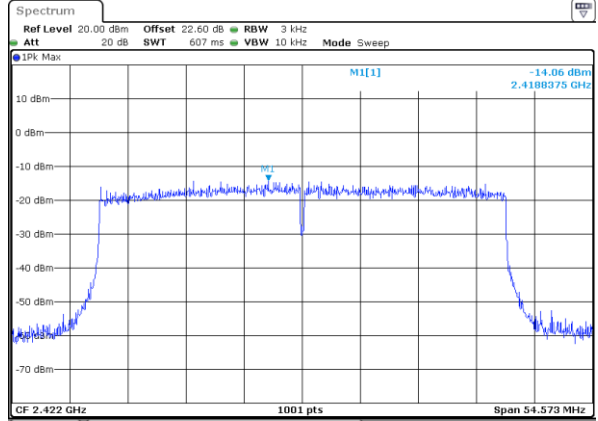

Date: 26.JAN.2022 10:22:43

3.4 Conducted Band Edges and Spurious Emission Measurement

3.4.1 Limit of Conducted Band Edges and Spurious Emission Measurement

In any 100 kHz bandwidth outside of the authorized frequency band, the emissions which fall in the non-restricted bands shall be attenuated at least 20 dB / 30dB relative to the maximum PSD level in 100 kHz by RF conducted measurement.

3.4.2 Measuring Instruments

Please refer to the measuring equipment list in this test report.

3.4.3 Test Procedures

1. The testing follows the ANSI C63.10 Section 11.11.3 Emission level measurement
2. The RF output of EUT is connected to the spectrum analyzer by RF cable and attenuator. The path loss is compensated to the results for each measurement.
3. Set the maximum power setting and enable the EUT to transmit continuously.
4. Set RBW = 100 kHz, VBW = 300 kHz, Peak Detector. Unwanted Emissions measured in any 100 kHz bandwidth outside of the authorized frequency band shall be attenuated by at least 20 dB relative to the maximum in-band peak PSD level in 100 kHz when maximum peak conducted output power procedure is used. If the transmitter complies with the conducted power limits based on the use of RMS averaging over a time interval, the attenuation required under this paragraph shall be 30 dB instead of 20 dB per 15.247(d).
5. Measure and record the results in the test report.
6. The RF fundamental frequency should be excluded against the limit line in the operating frequency band.

3.4.4 Test Setup

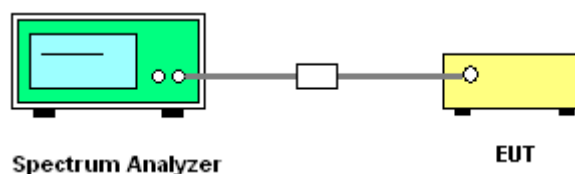



3.4.5 Test Result of Conducted Band Edges and Spurious Emission

<CDD Modes>

Number of TX = 2, Ant. 9 (Measured)

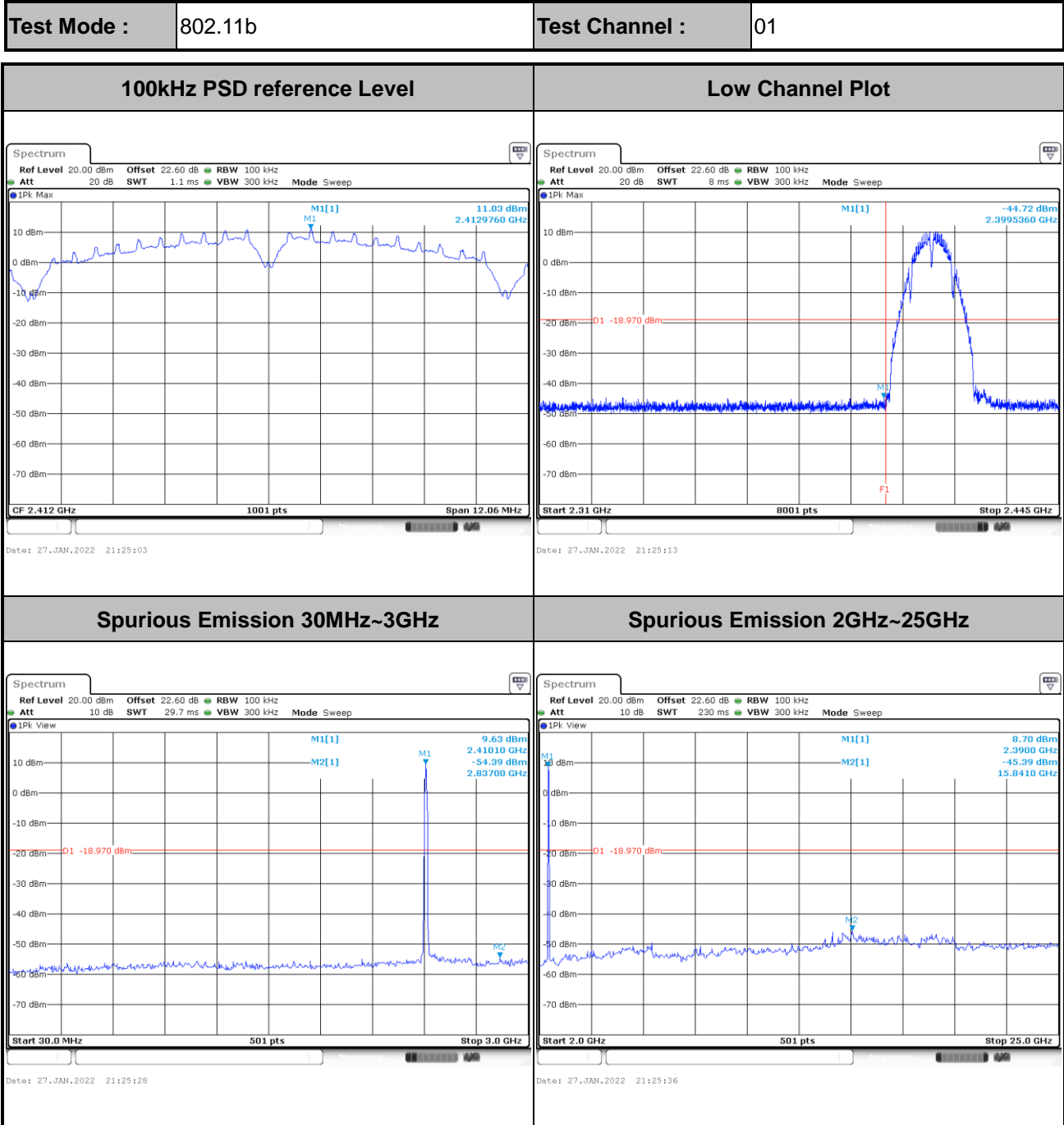



Test Mode :	802.11b	Test Channel :	06
-------------	---------	----------------	----

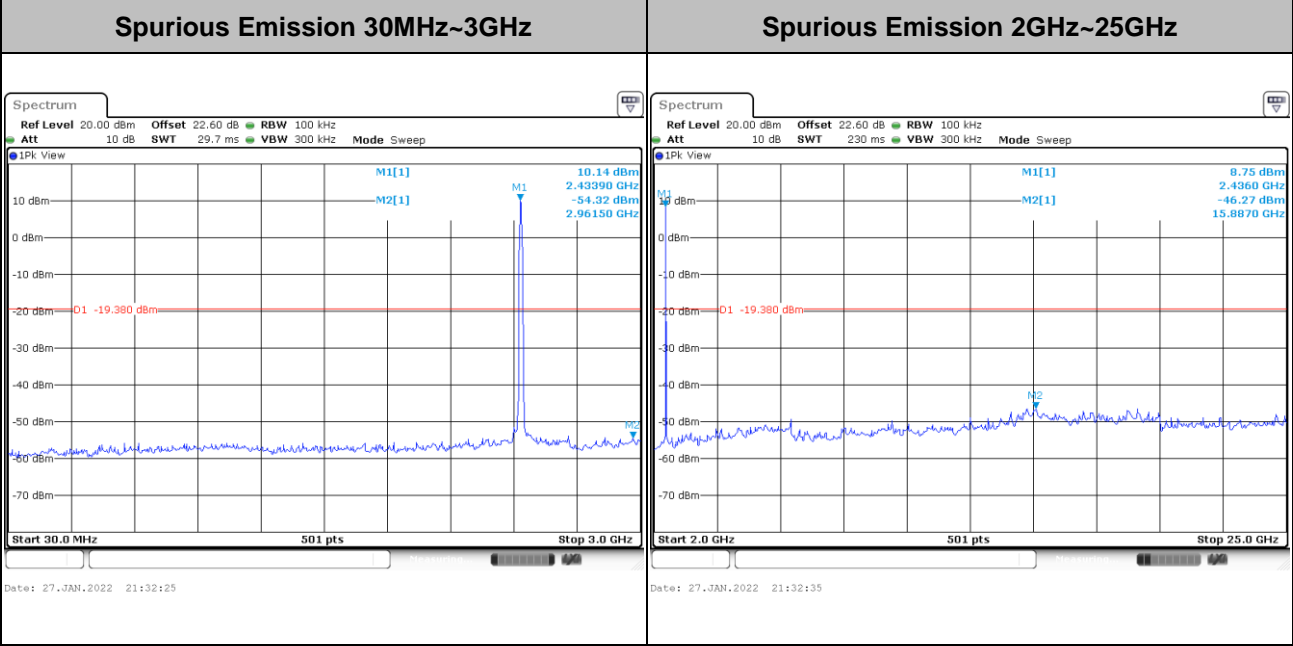
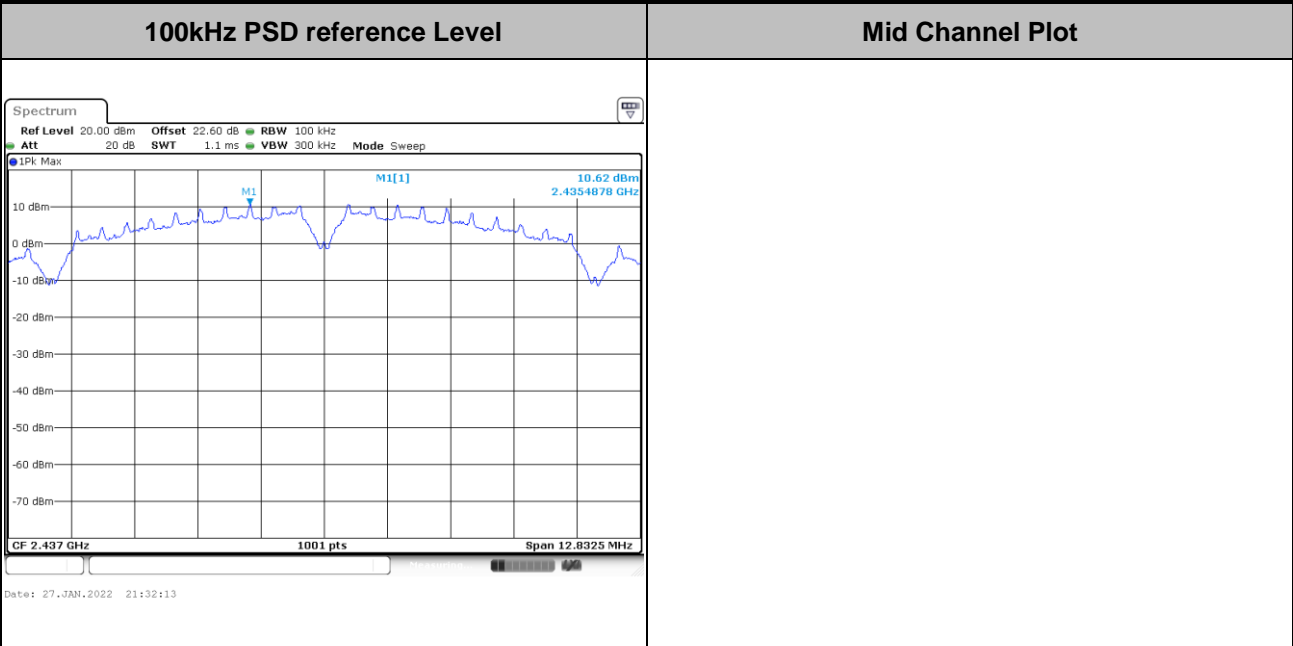



Test Mode :	802.11b	Test Channel :	11
-------------	---------	----------------	----

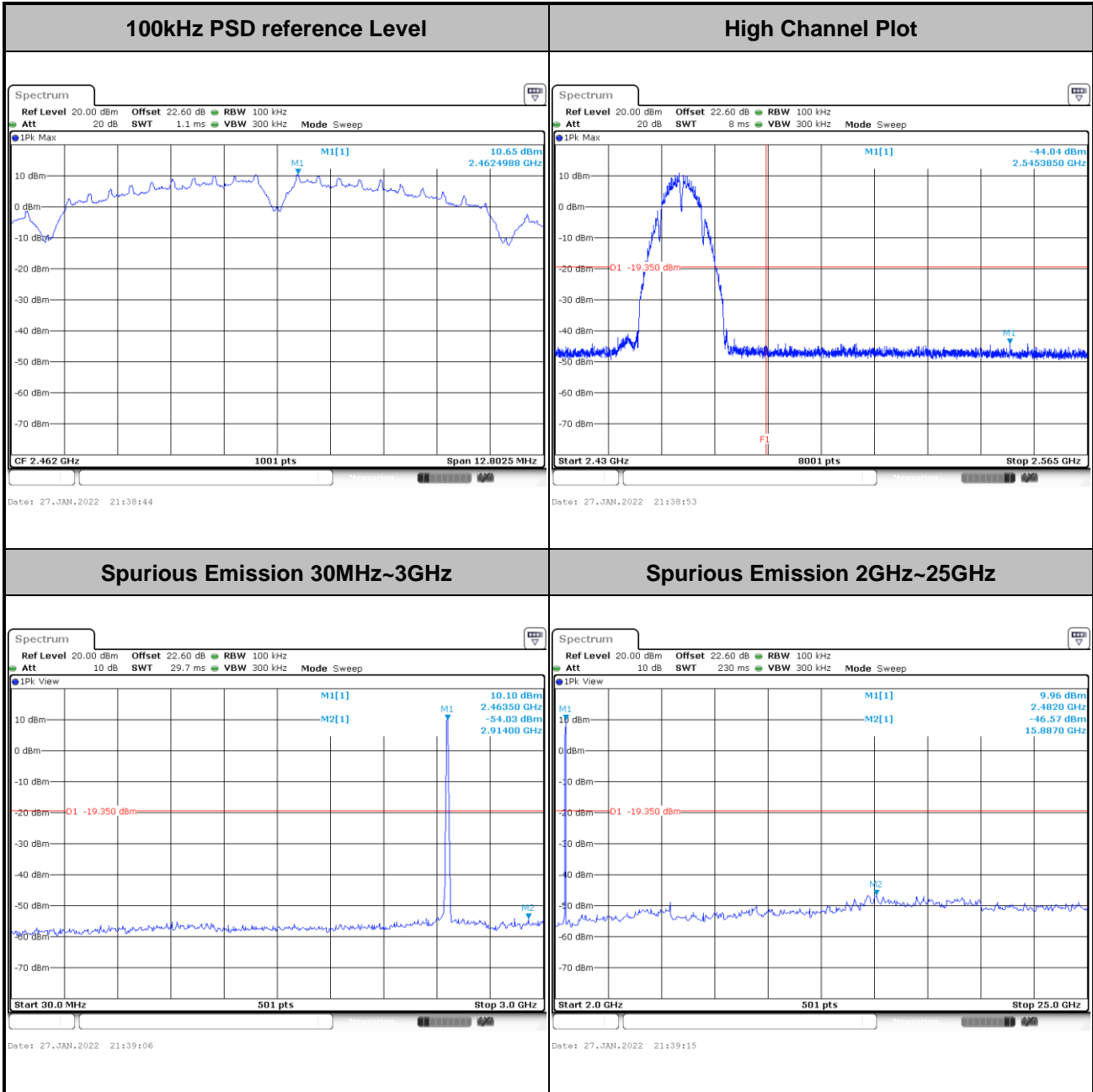



Test Mode :	802.11g	Test Channel :	01
-------------	---------	----------------	----

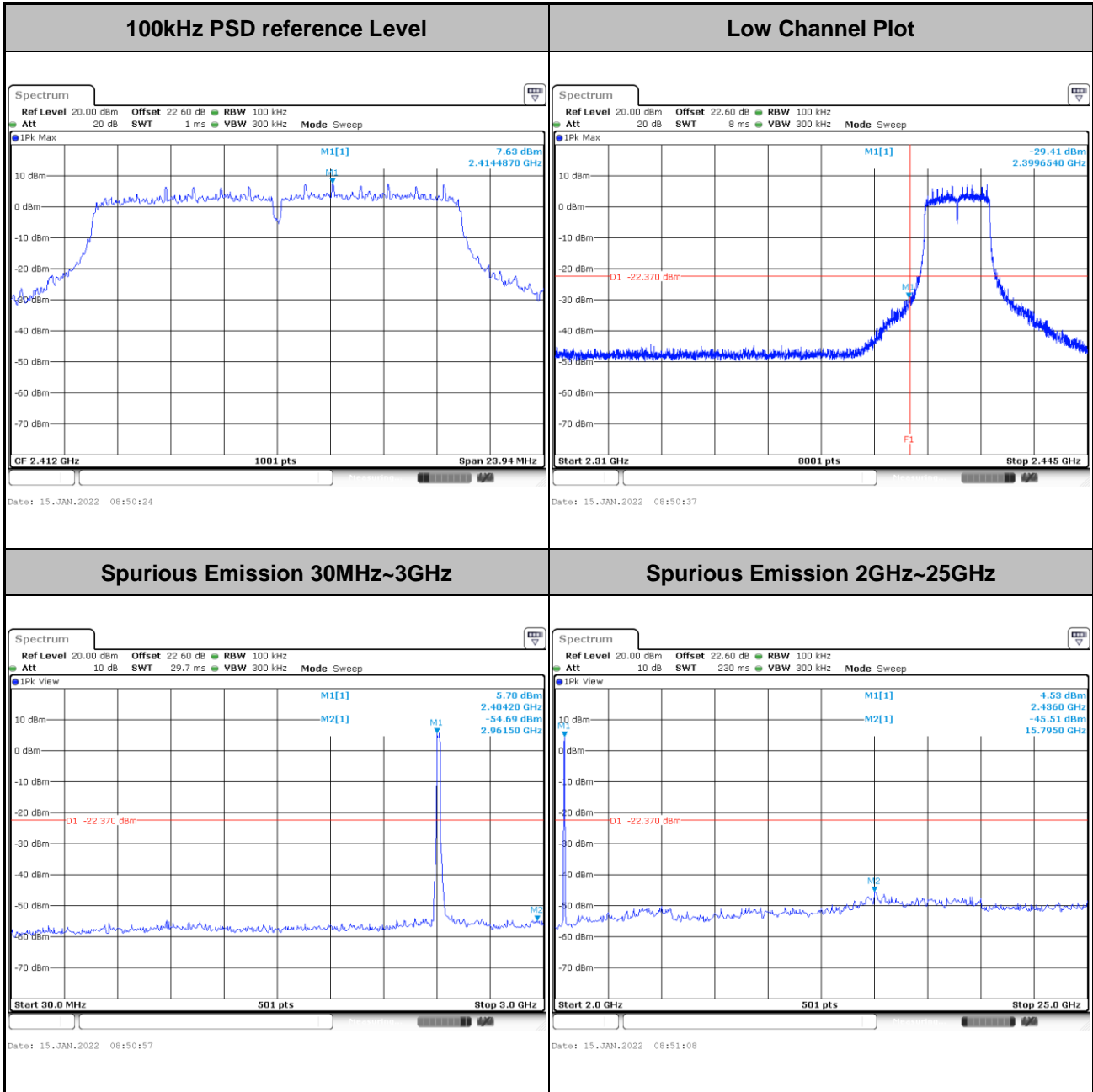



Test Mode :	802.11g	Test Channel :	06
-------------	---------	----------------	----

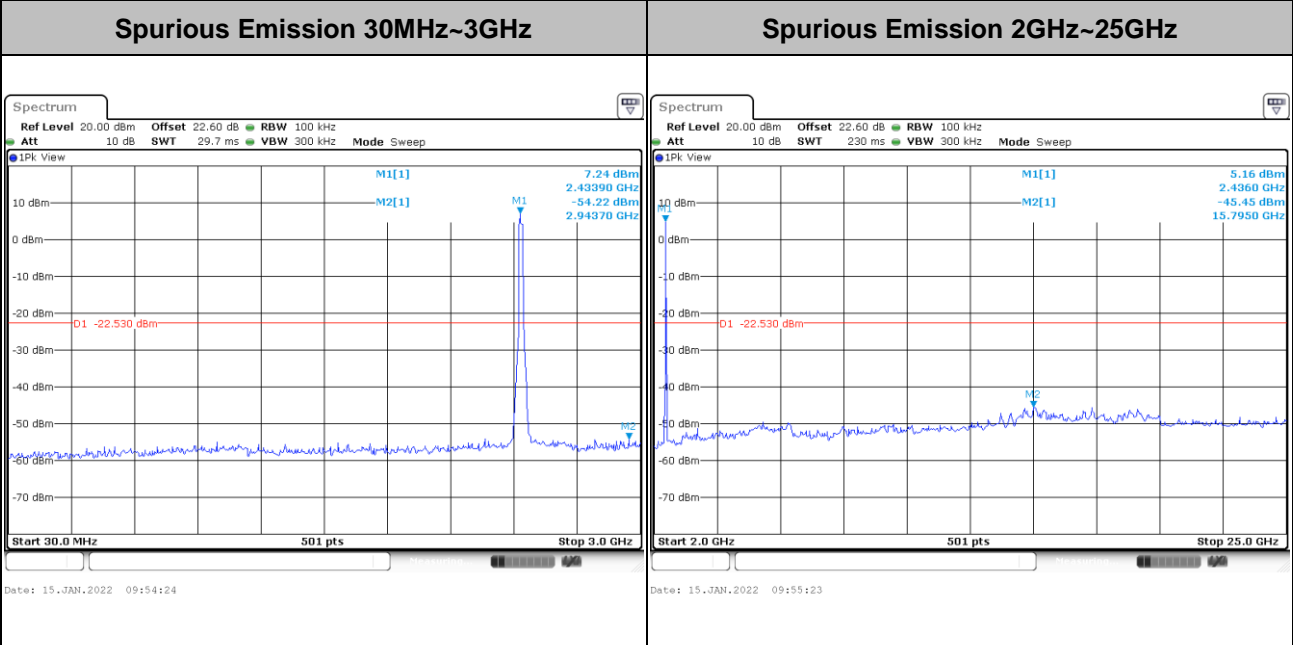
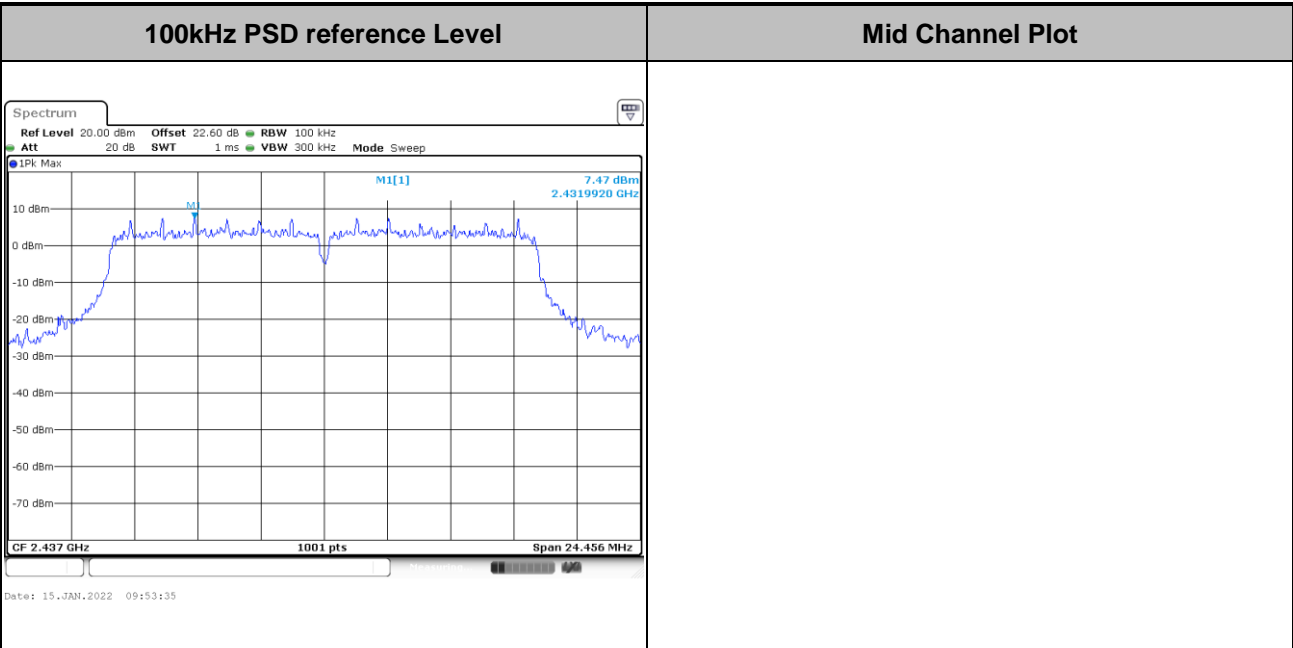



Test Mode :	802.11g	Test Channel :	11
-------------	---------	----------------	----

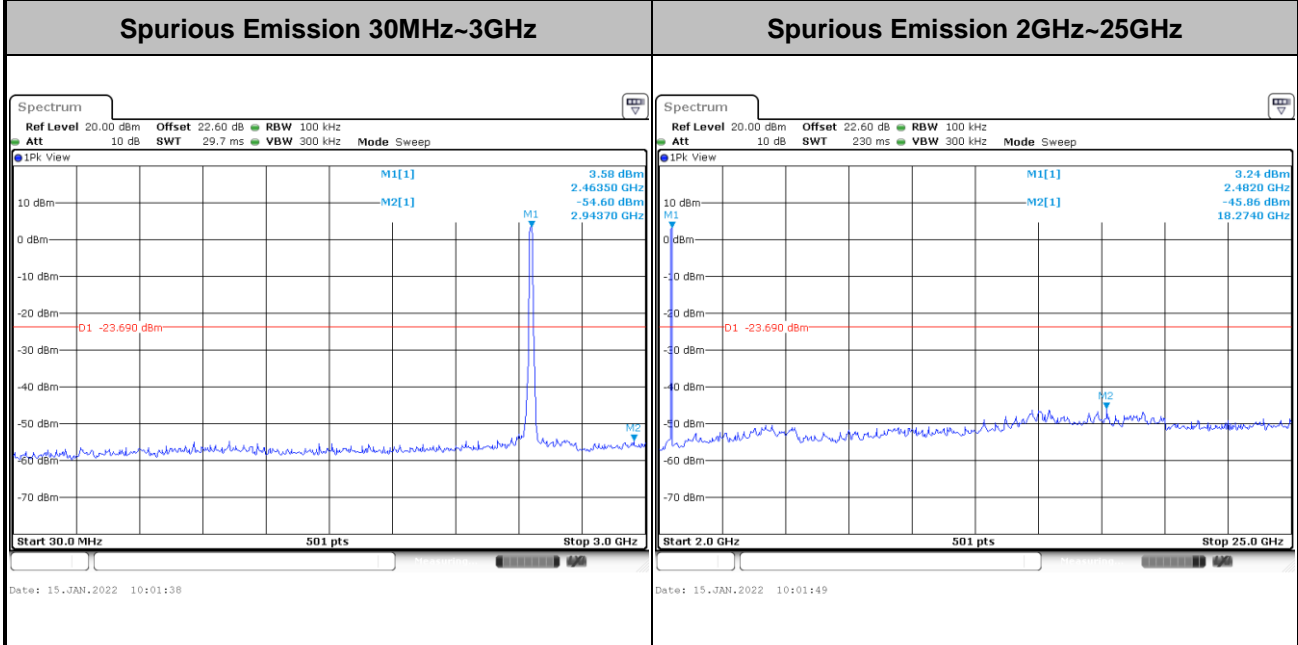
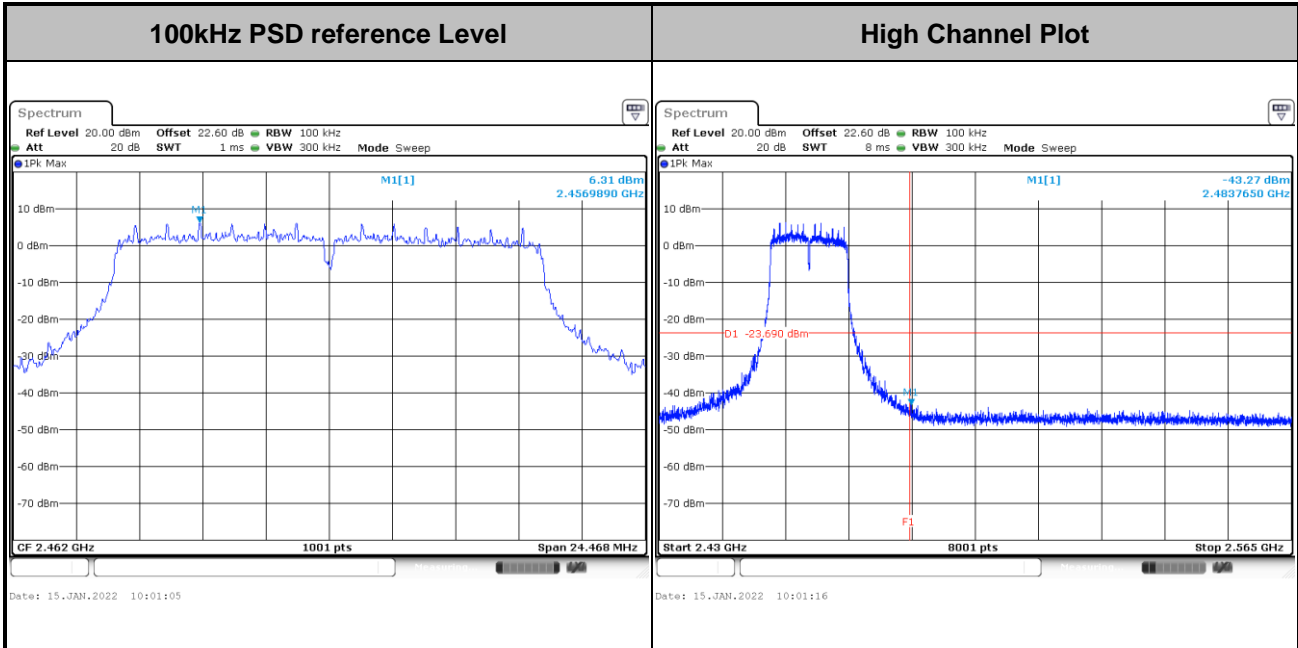



Test Mode :	802.11ax HE20	Test Channel :	01 Full RU
-------------	---------------	----------------	------------

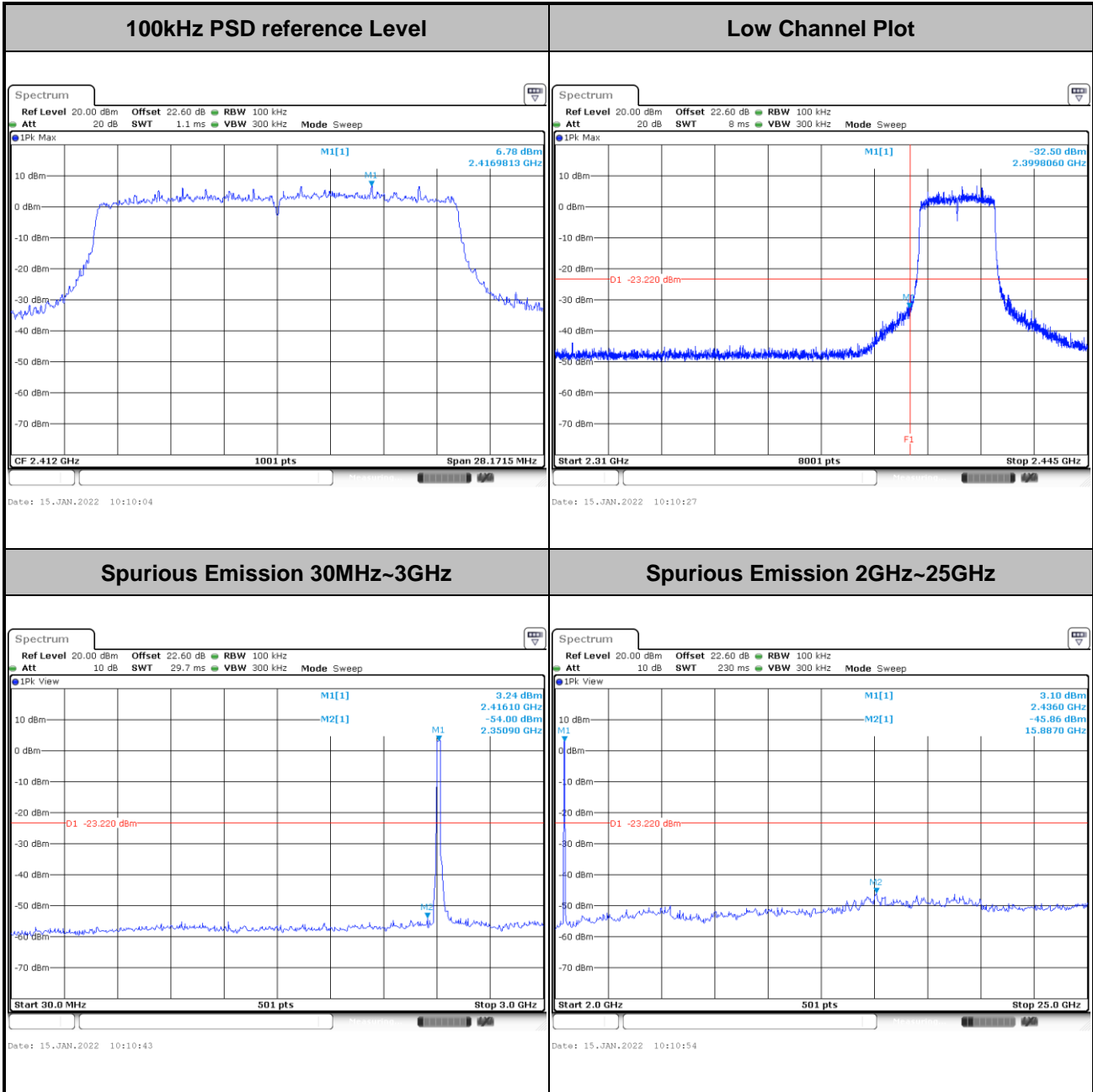



Test Mode :	802.11ax HE20	Test Channel :	06 Full RU
--------------------	---------------	-----------------------	------------

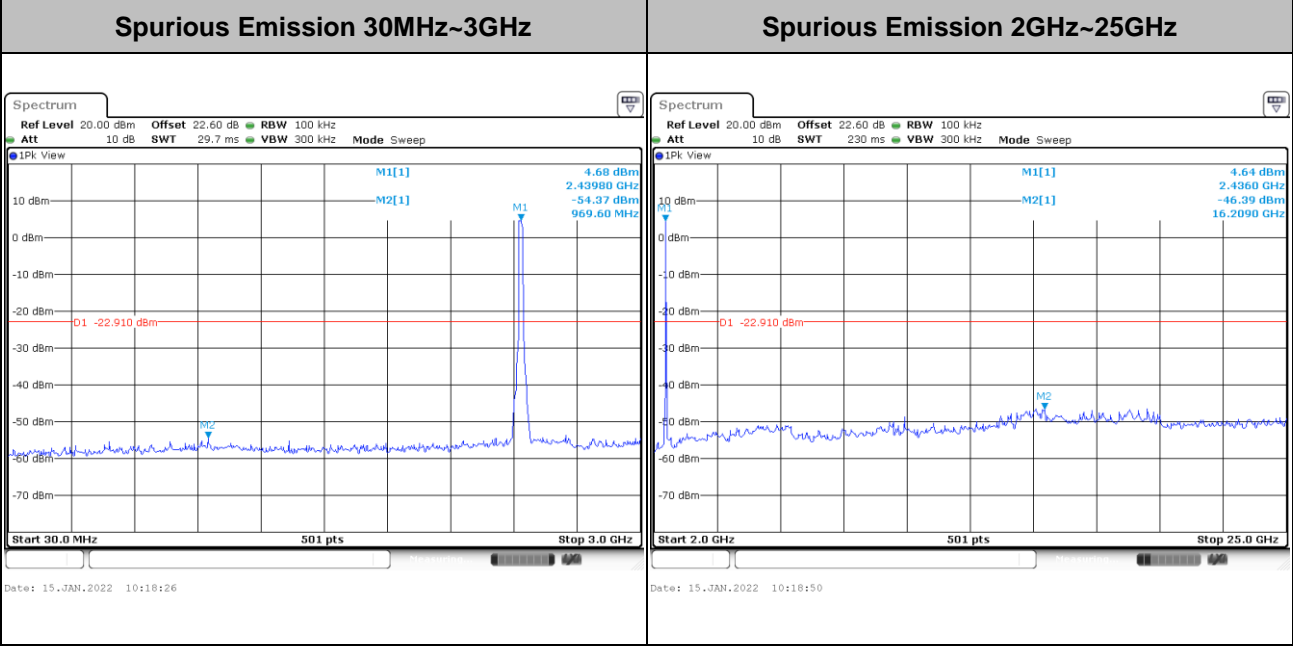
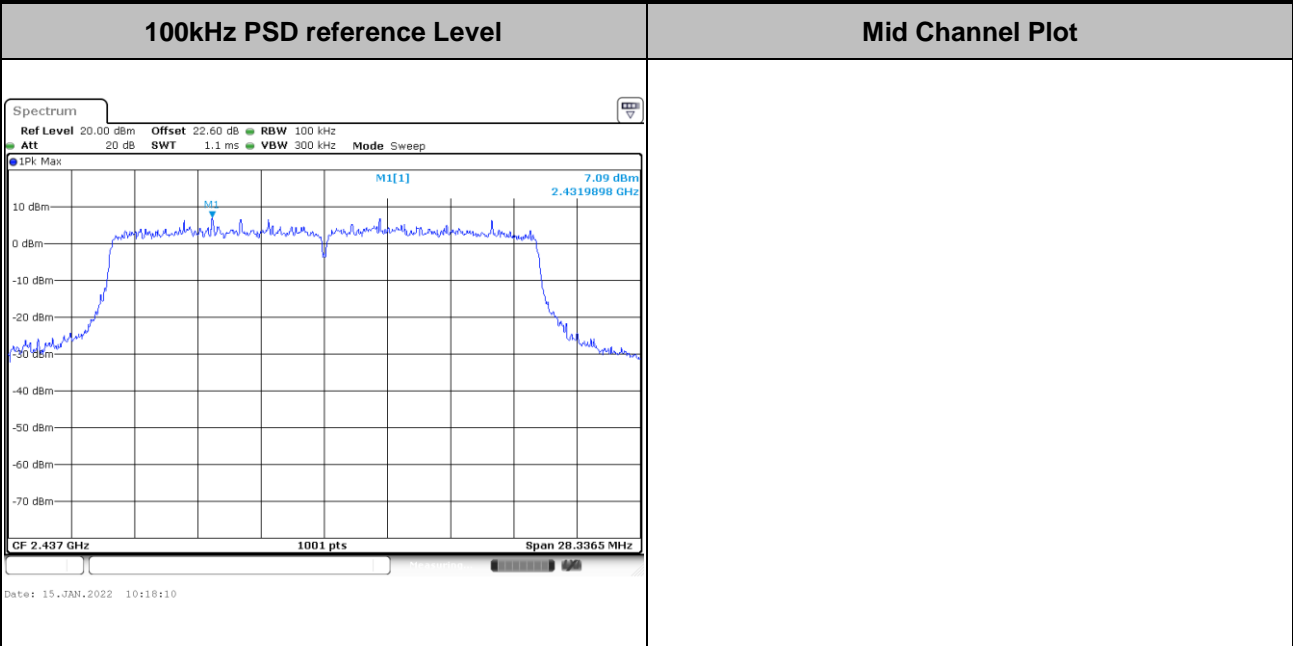



Test Mode :	802.11ax HE20	Test Channel :	11 Full RU
-------------	---------------	----------------	------------

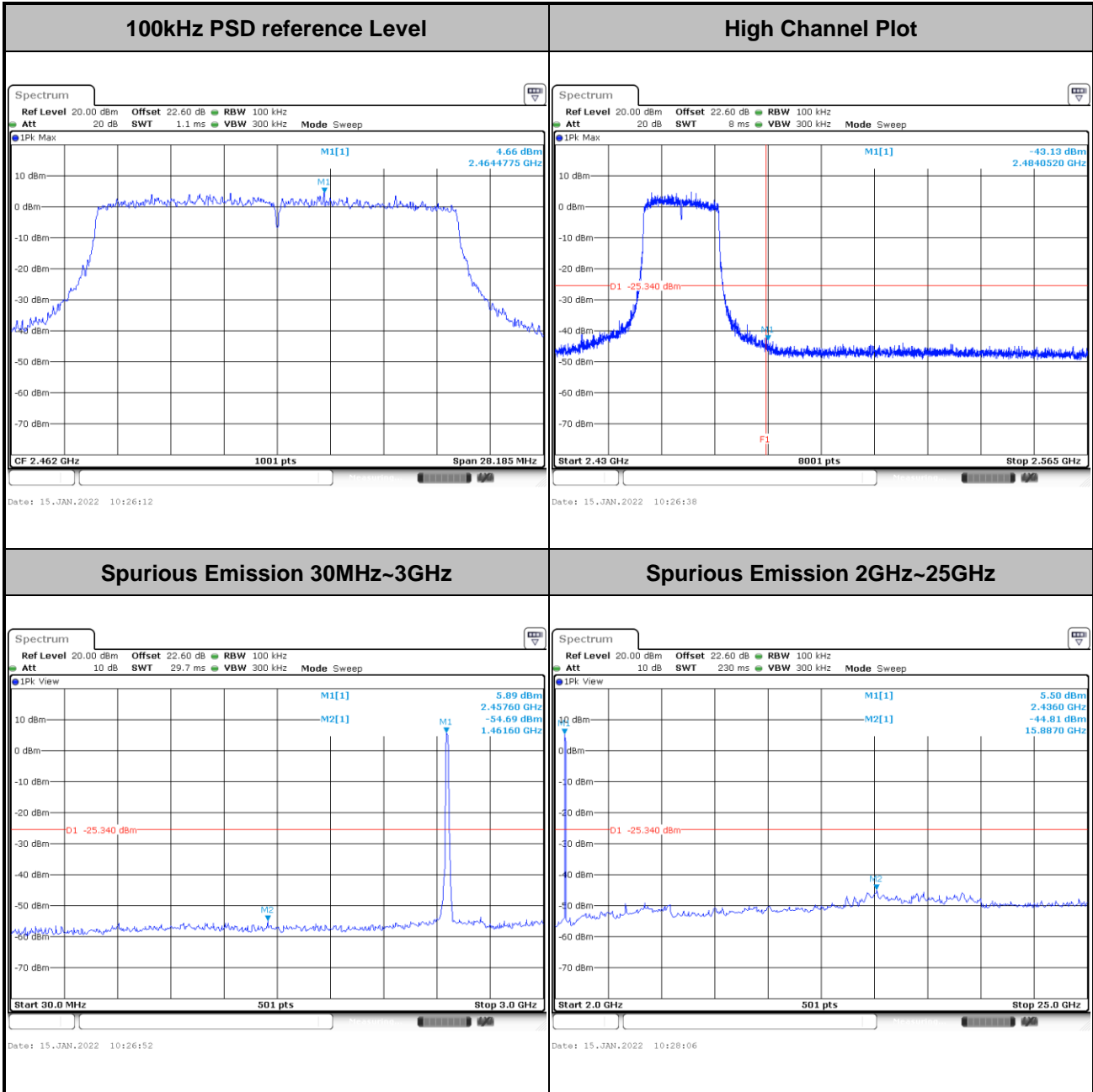



Test Mode :	802.11ax HE40	Test Channel :	03 Full RU
-------------	---------------	----------------	------------

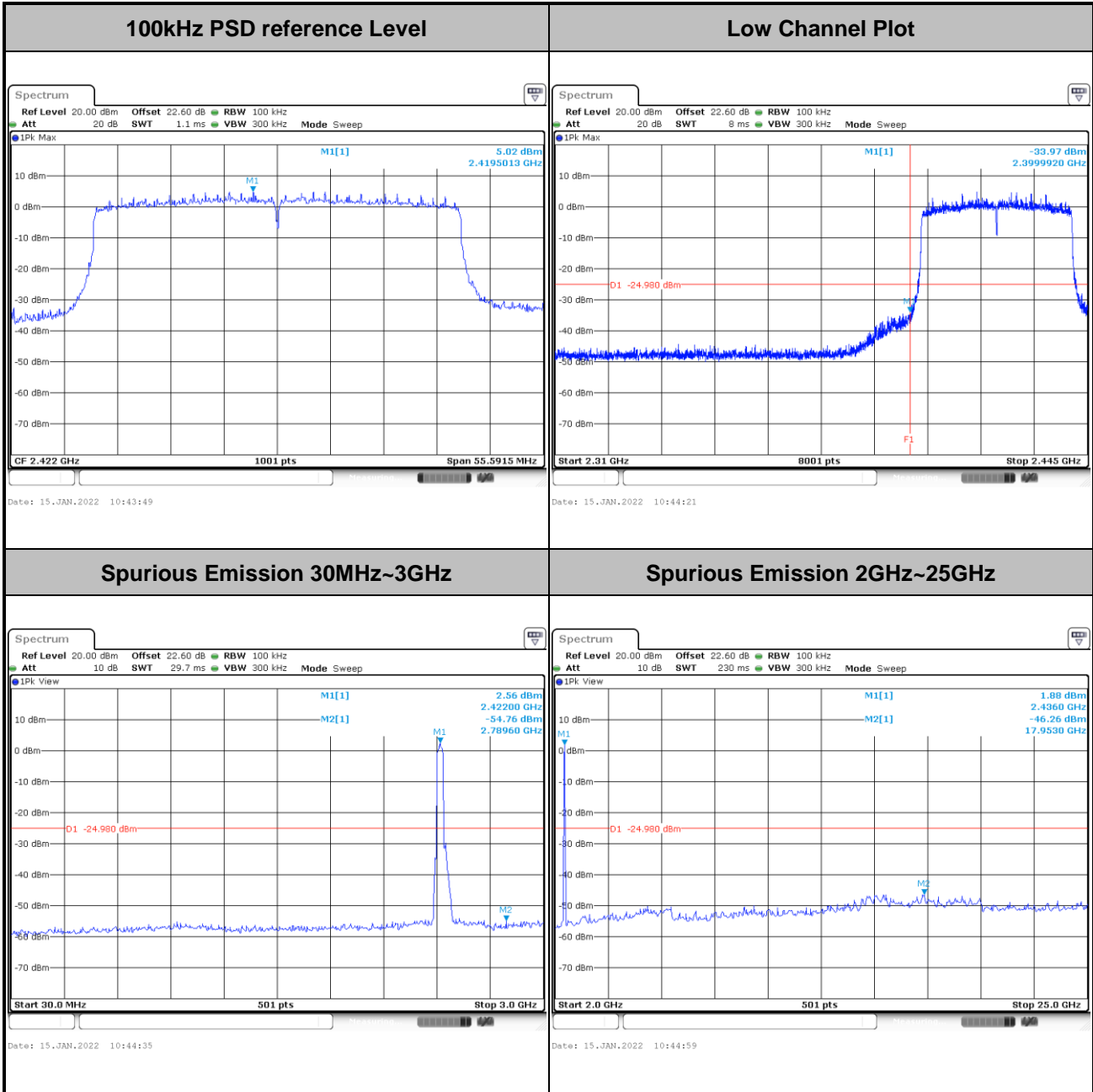



Test Mode :	802.11ax HE40	Test Channel :	06 Full RU
--------------------	---------------	-----------------------	------------

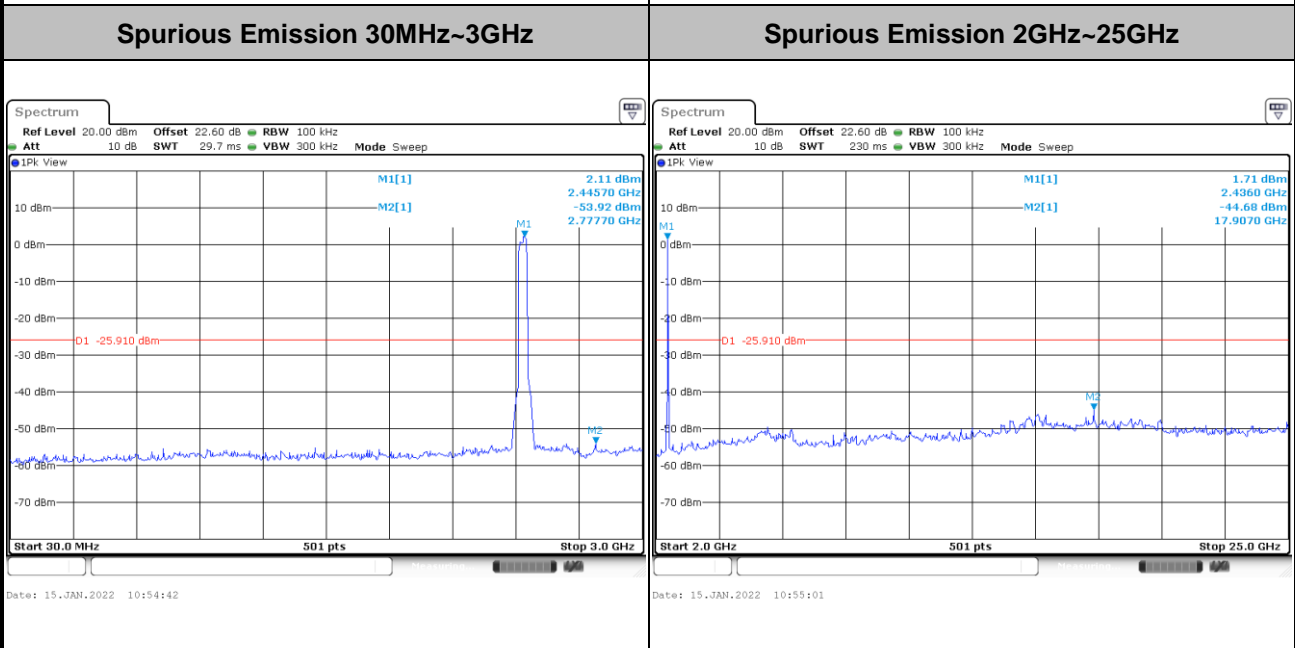
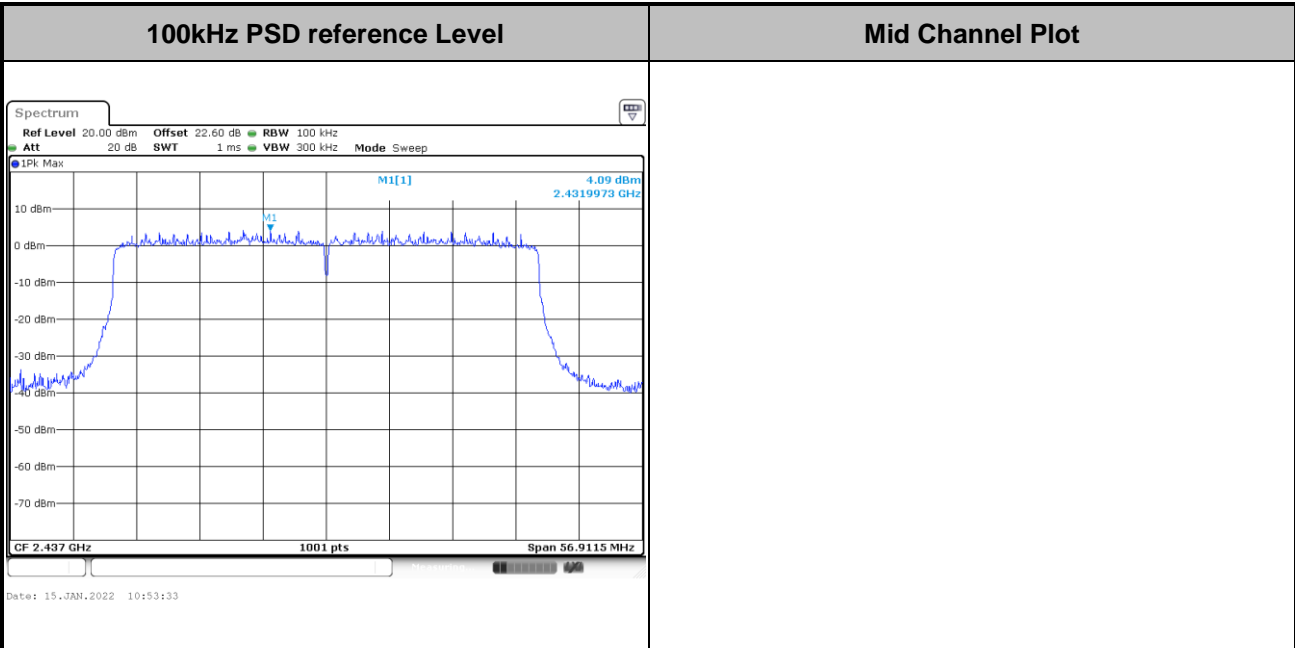



Test Mode :	802.11ax HE40	Test Channel :	09 Full RU
--------------------	---------------	-----------------------	------------

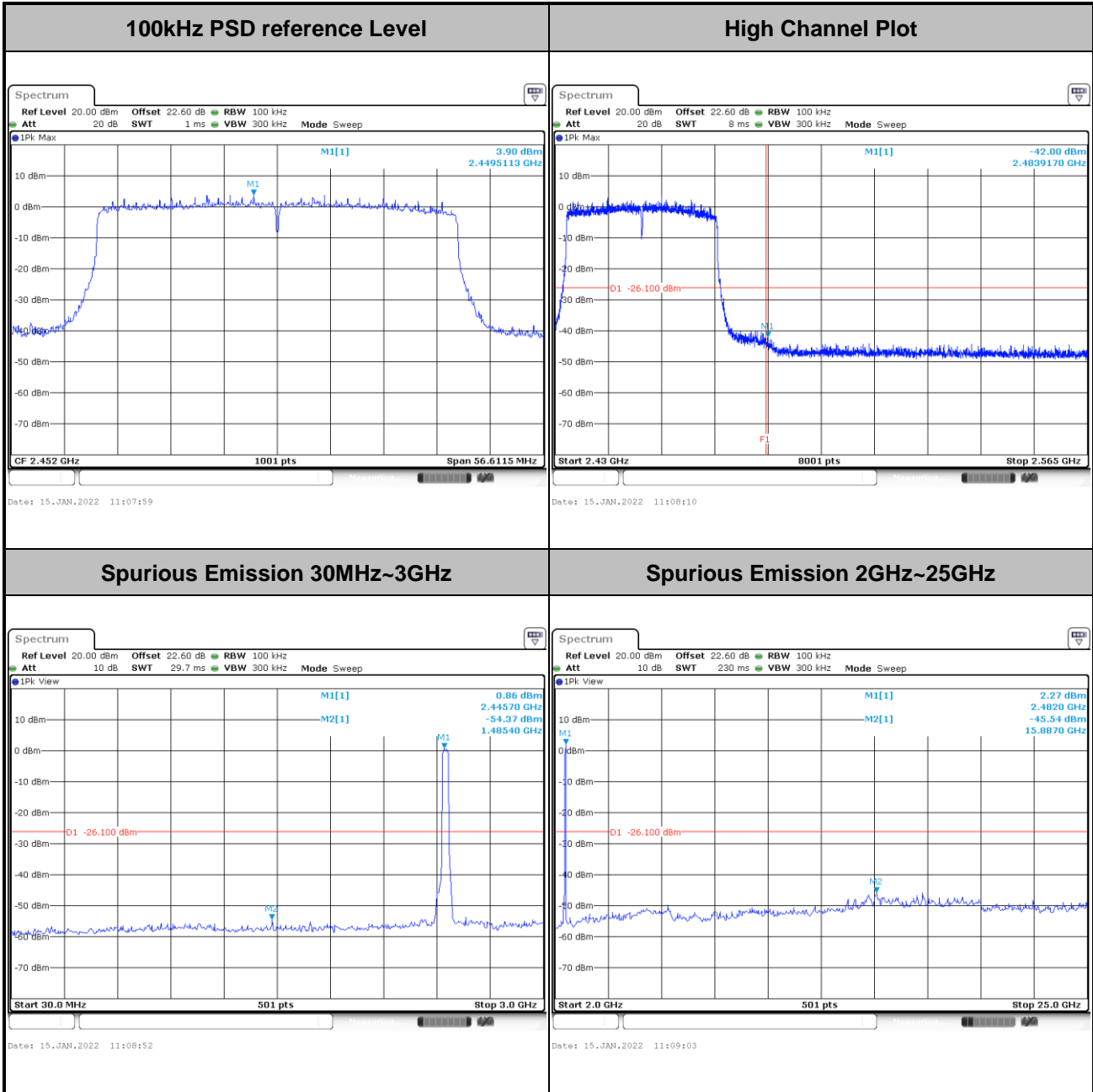



Number of TX = 2, Ant. 8 (Measured)

Test Mode :	802.11b	Test Channel :	01
-------------	---------	----------------	----

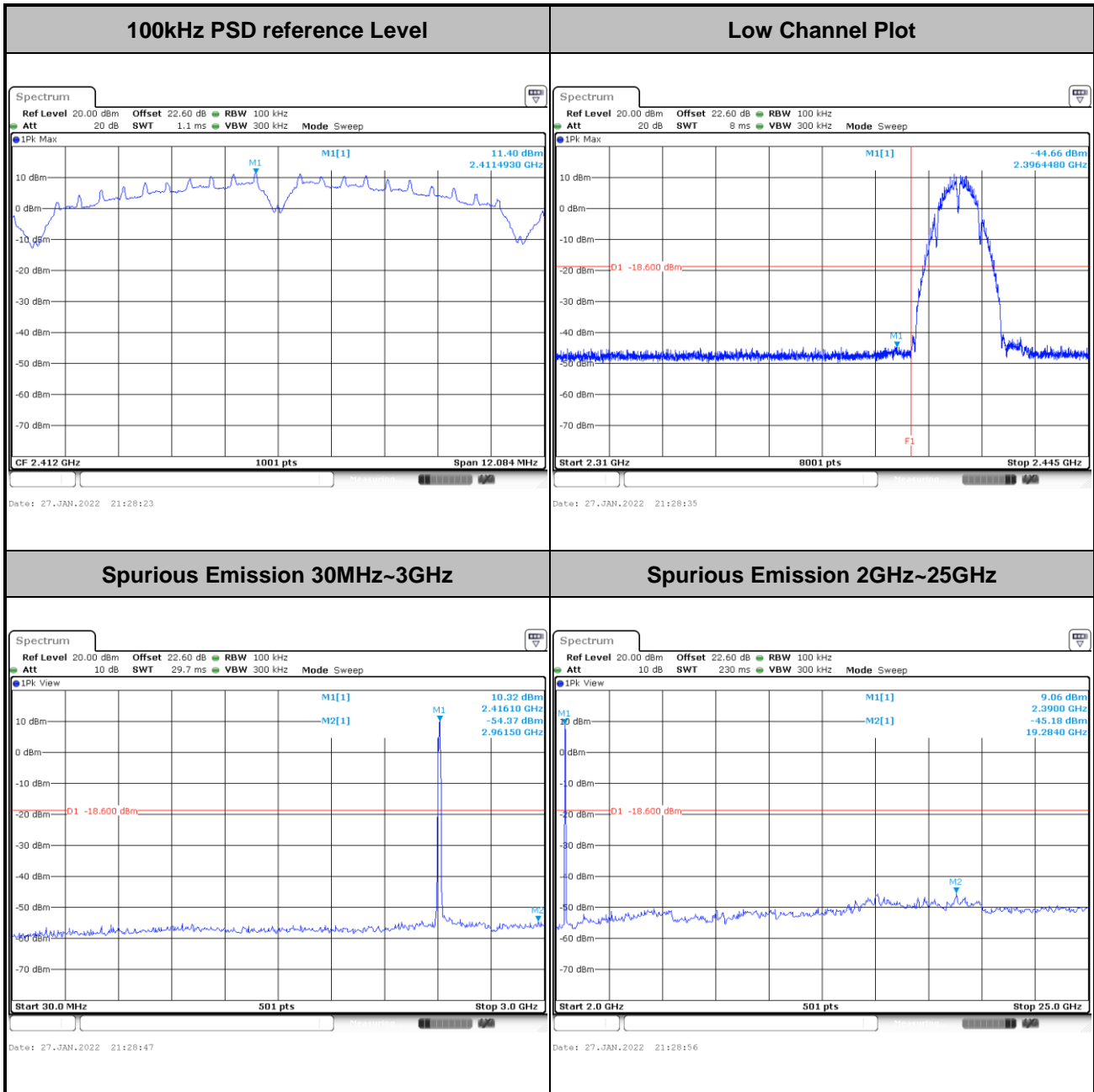



Test Mode :	802.11b	Test Channel :	06
-------------	---------	----------------	----

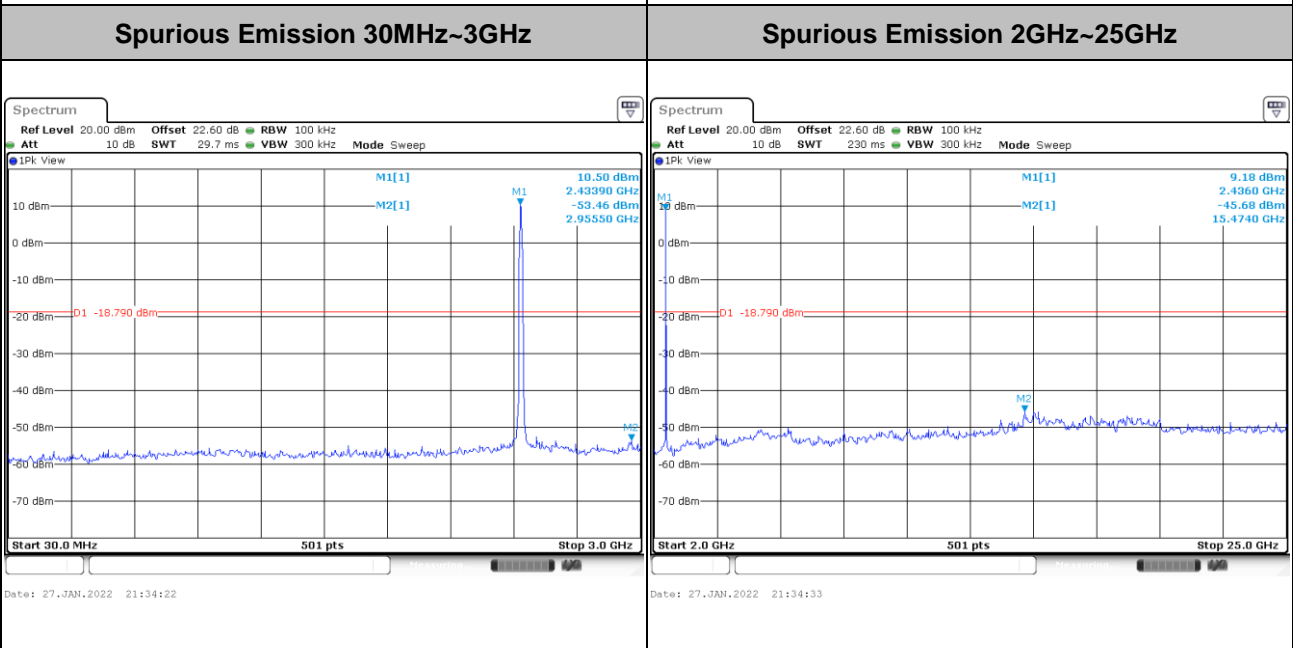
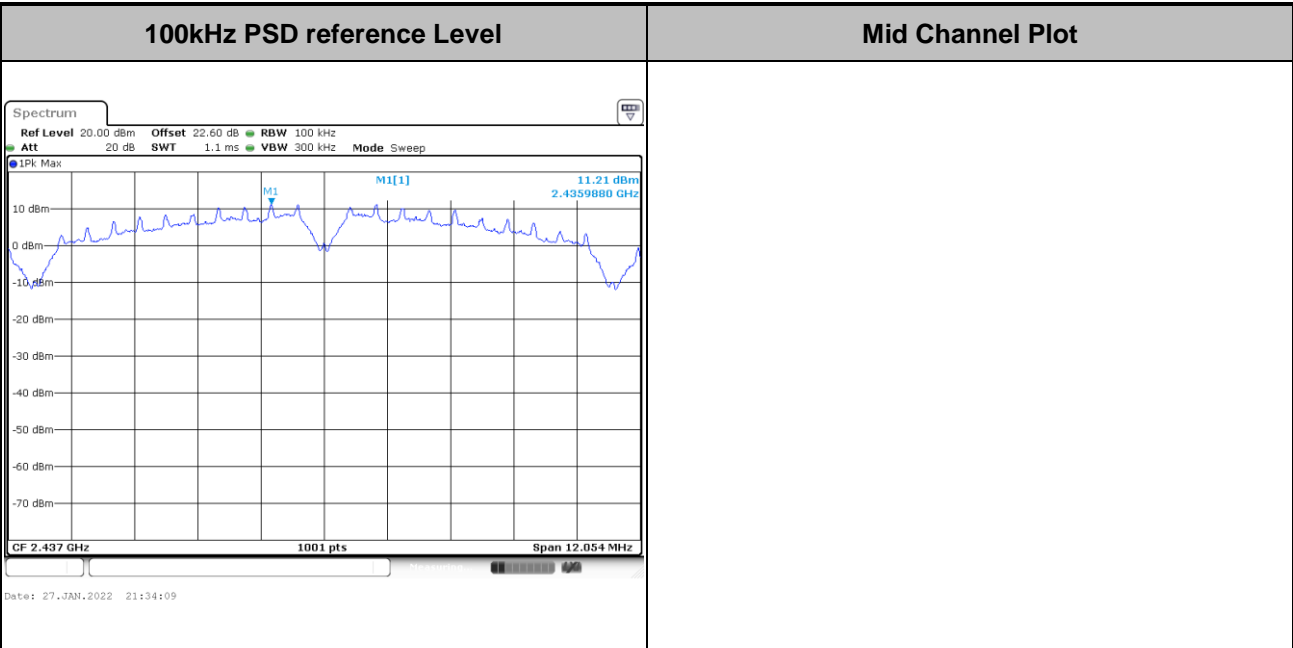



Test Mode :	802.11b	Test Channel :	11
-------------	---------	----------------	----

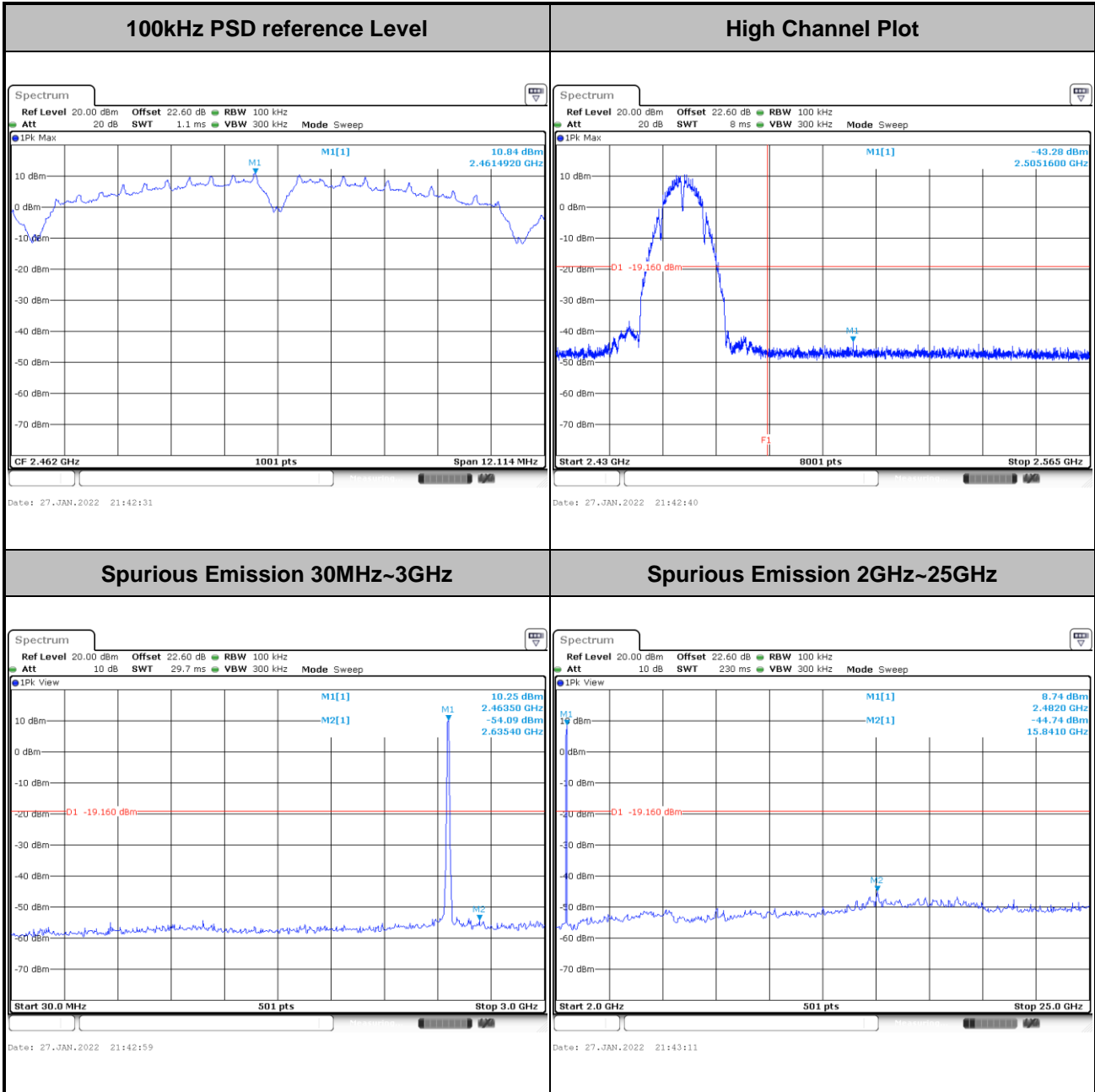



Test Mode :	802.11g	Test Channel :	01
-------------	---------	----------------	----

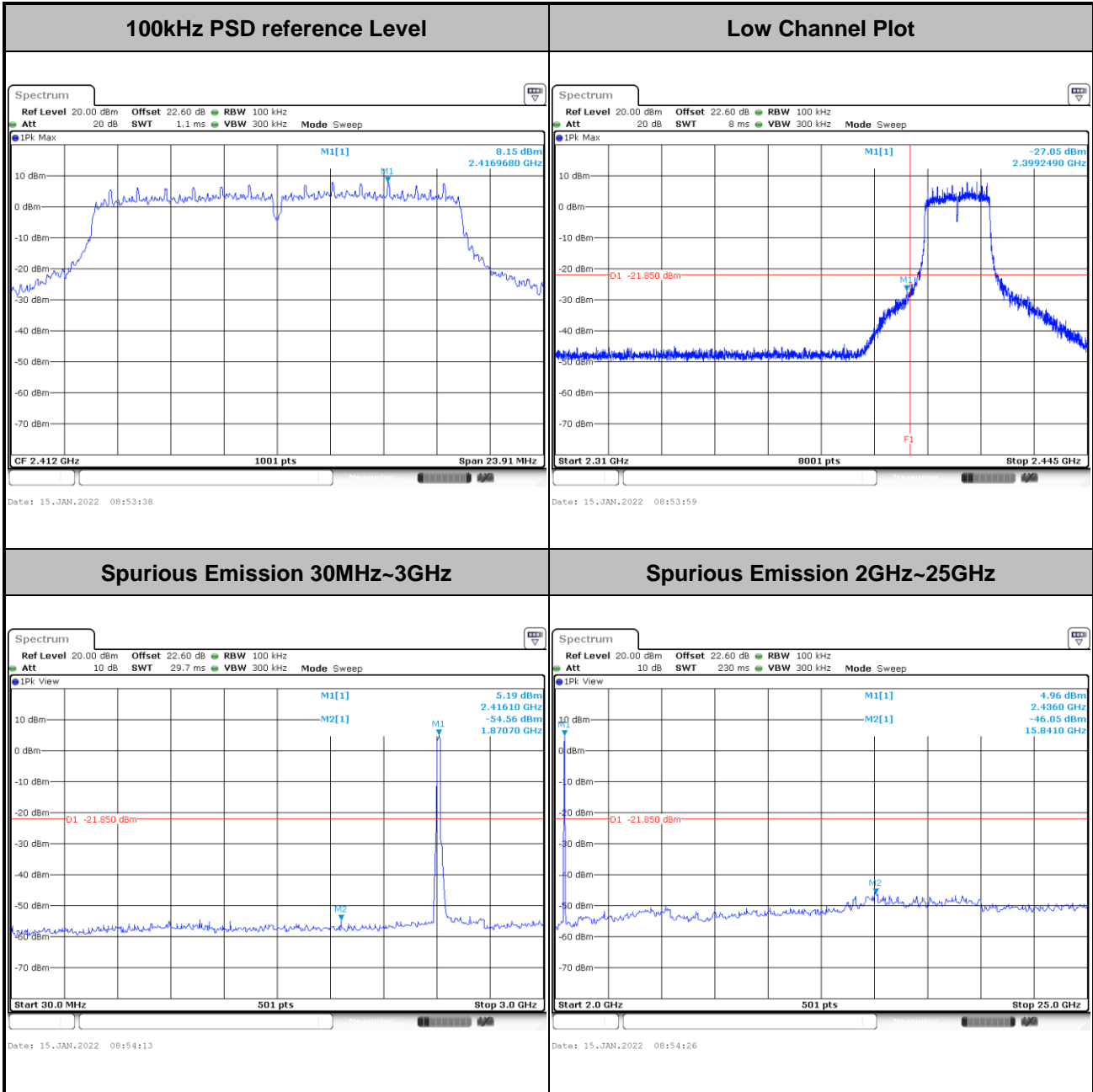



Test Mode :	802.11g	Test Channel :	06
-------------	---------	----------------	----

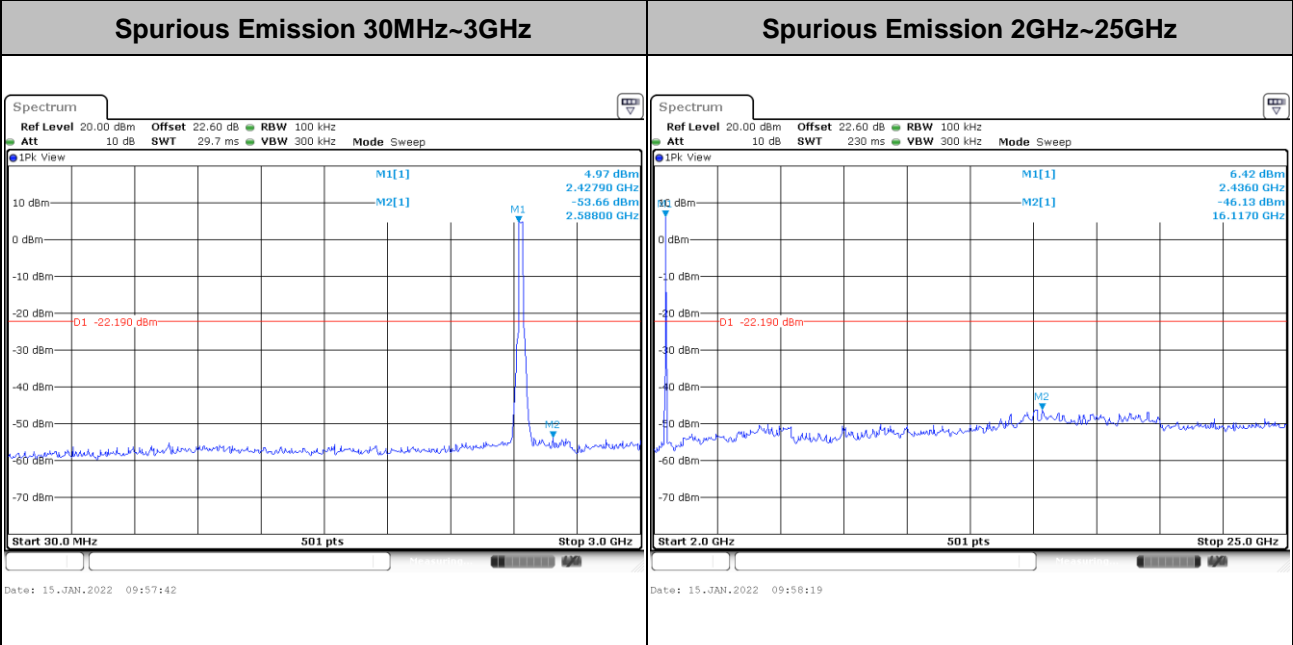
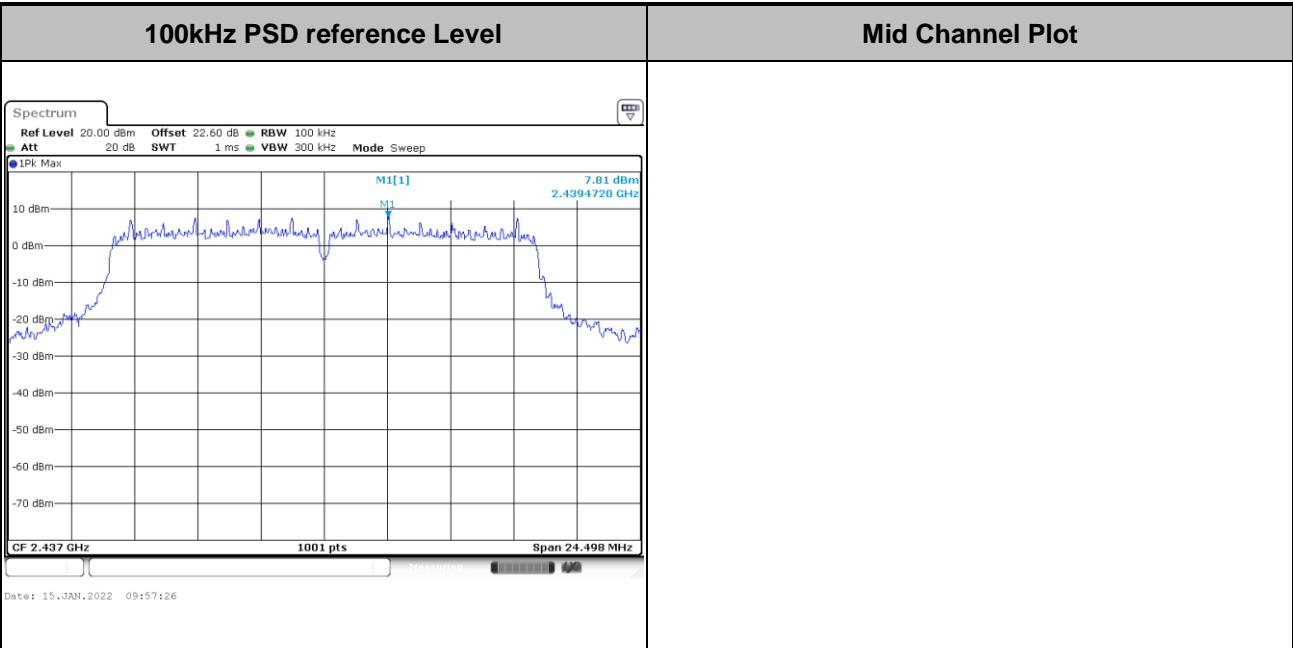



Test Mode :	802.11g	Test Channel :	11
-------------	---------	----------------	----

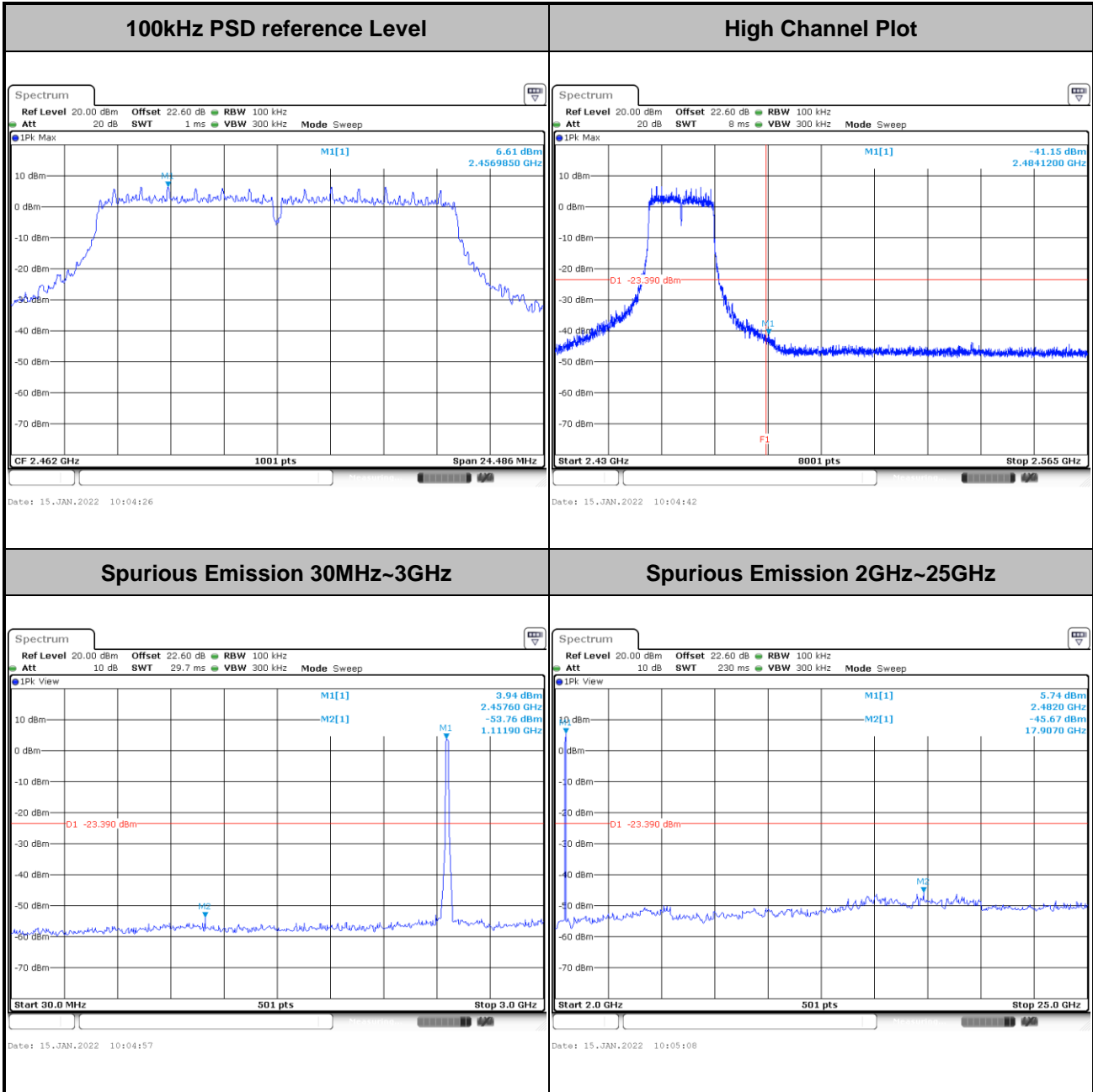



Test Mode :	802.11ax HE20	Test Channel :	01 Full RU
-------------	---------------	----------------	------------

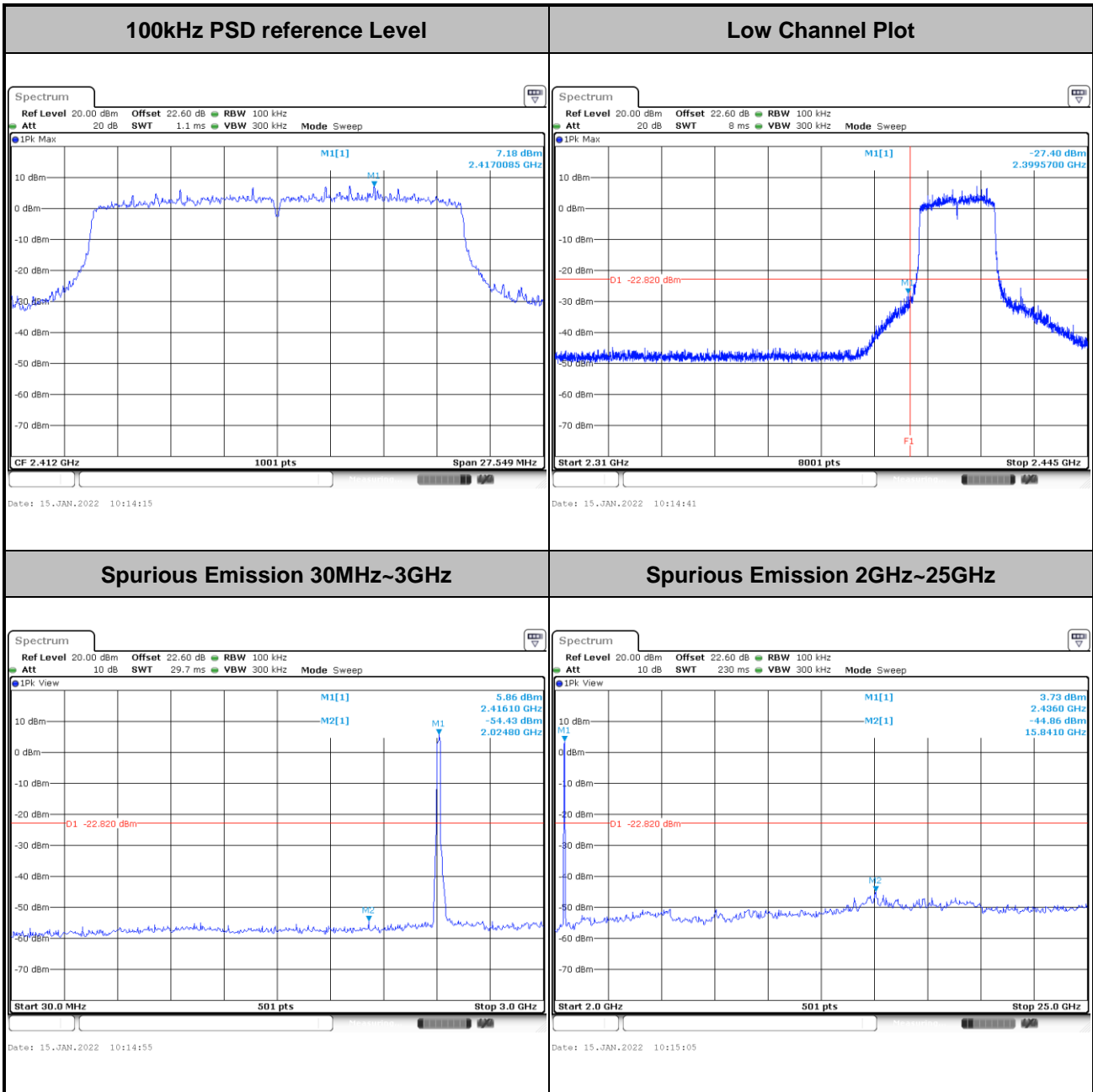



Test Mode :	802.11ax HE20	Test Channel :	06 Full RU
-------------	---------------	----------------	------------

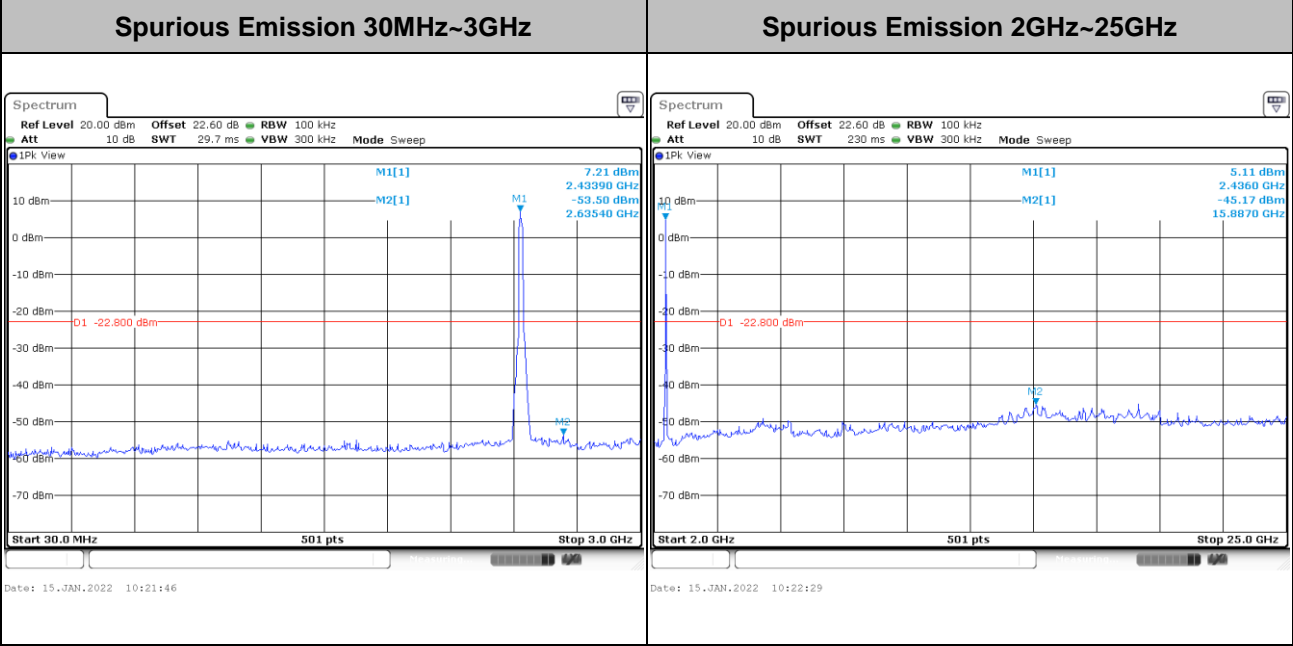
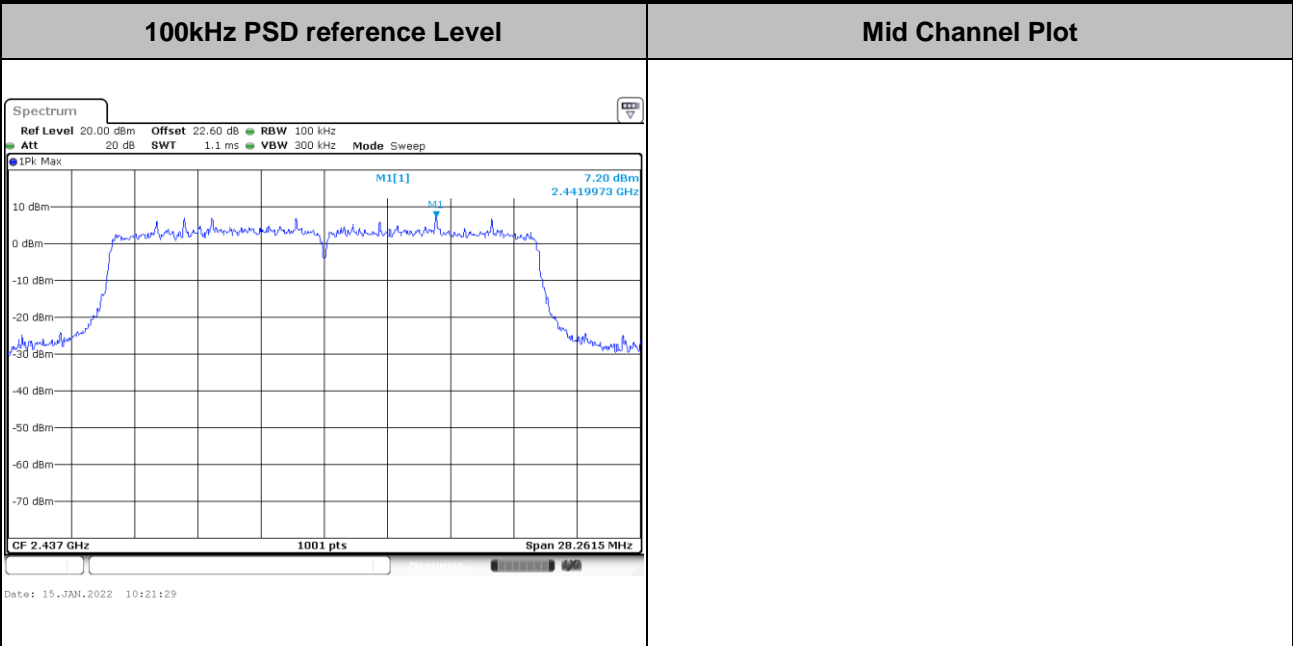



Test Mode :	802.11ax HE20	Test Channel :	11 Full RU
--------------------	---------------	-----------------------	------------

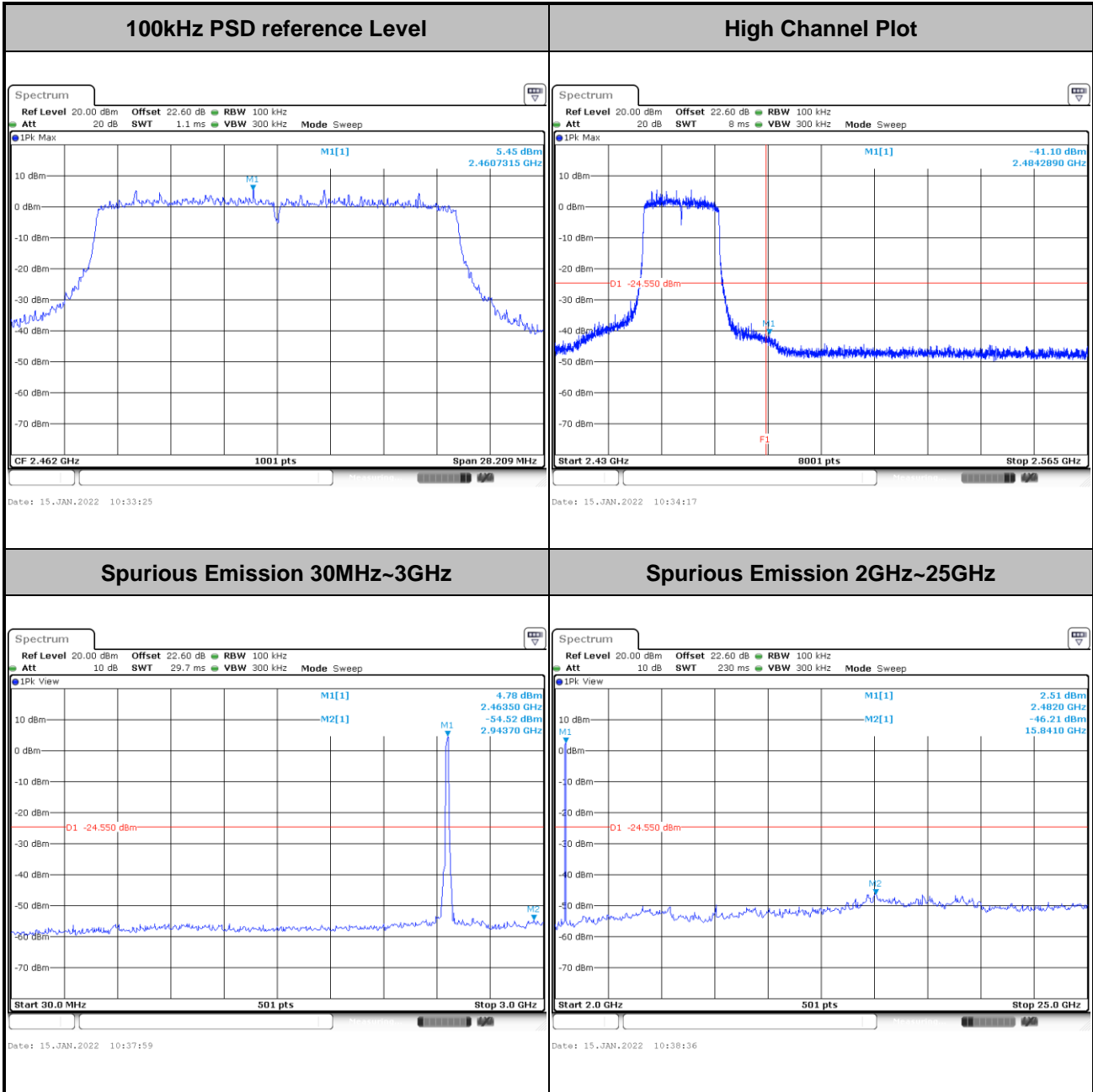



Test Mode :	802.11ax HE40	Test Channel :	03 Full RU
--------------------	---------------	-----------------------	------------

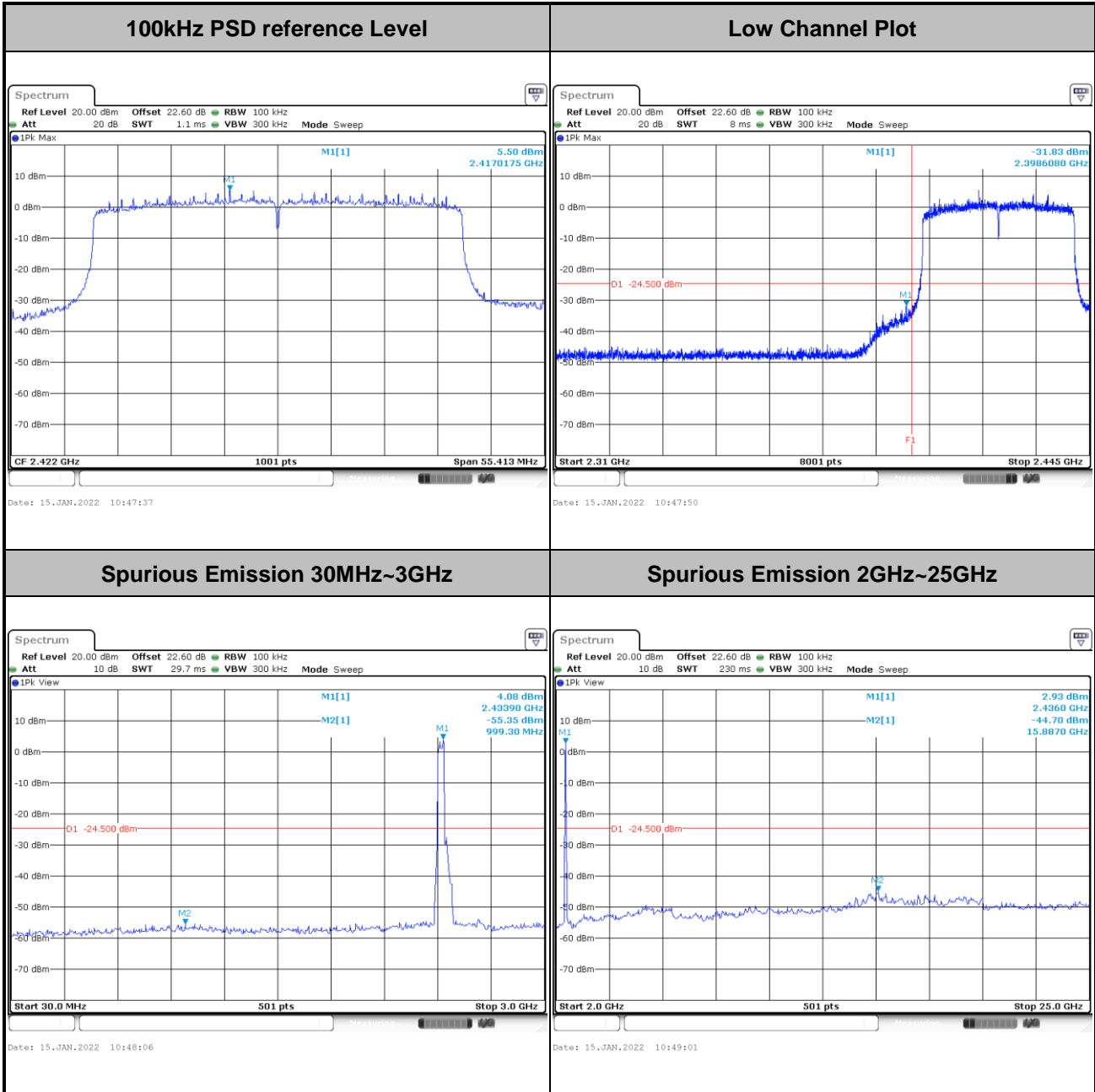



Test Mode :	802.11ax HE40	Test Channel :	06 Full RU
--------------------	---------------	-----------------------	------------

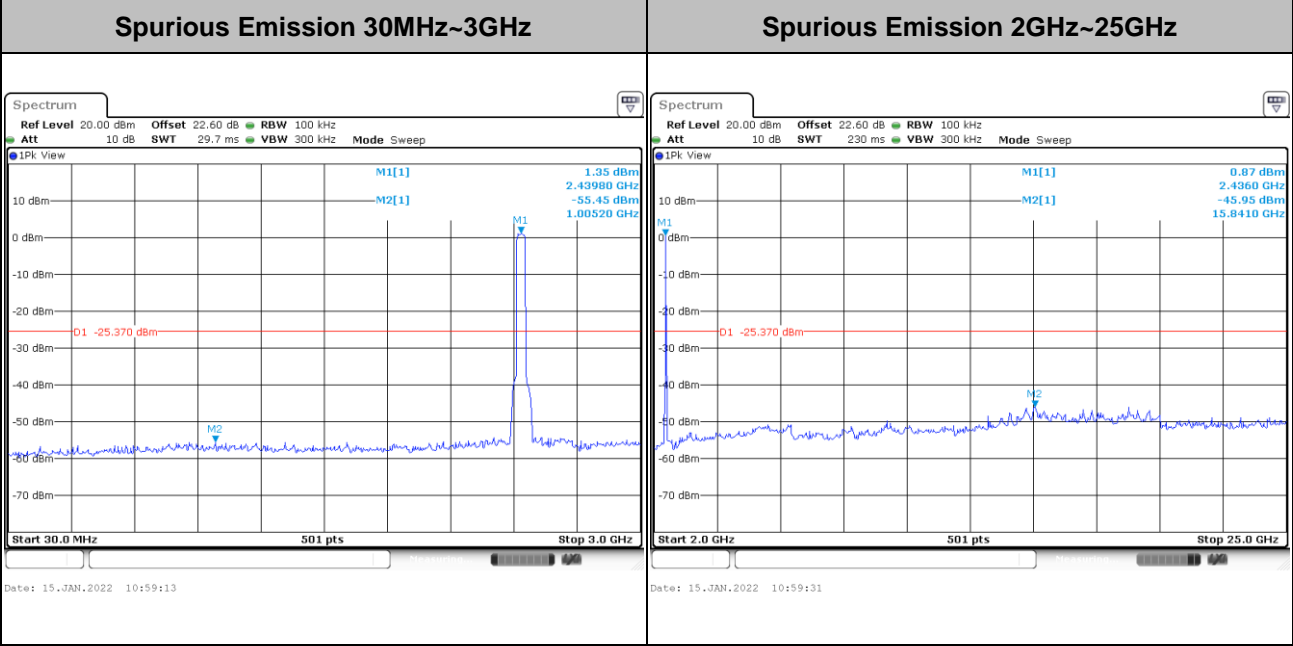
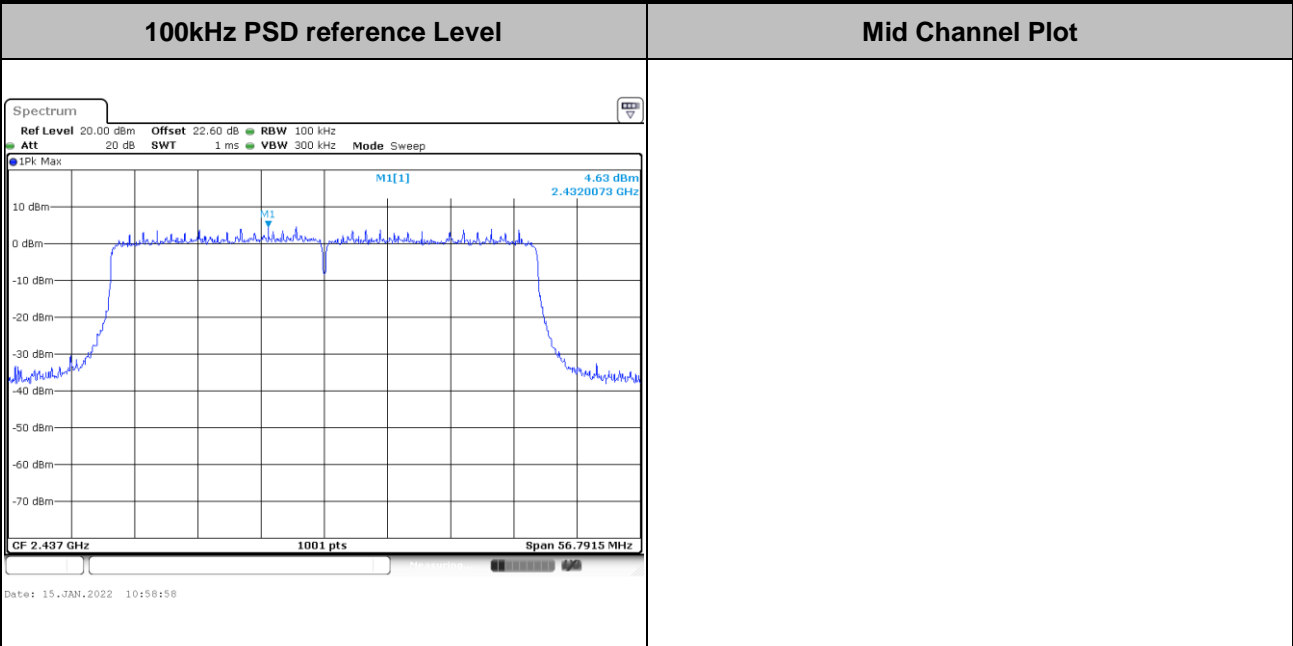



Test Mode :	802.11ax HE40	Test Channel :	09 Full RU
--------------------	---------------	-----------------------	------------

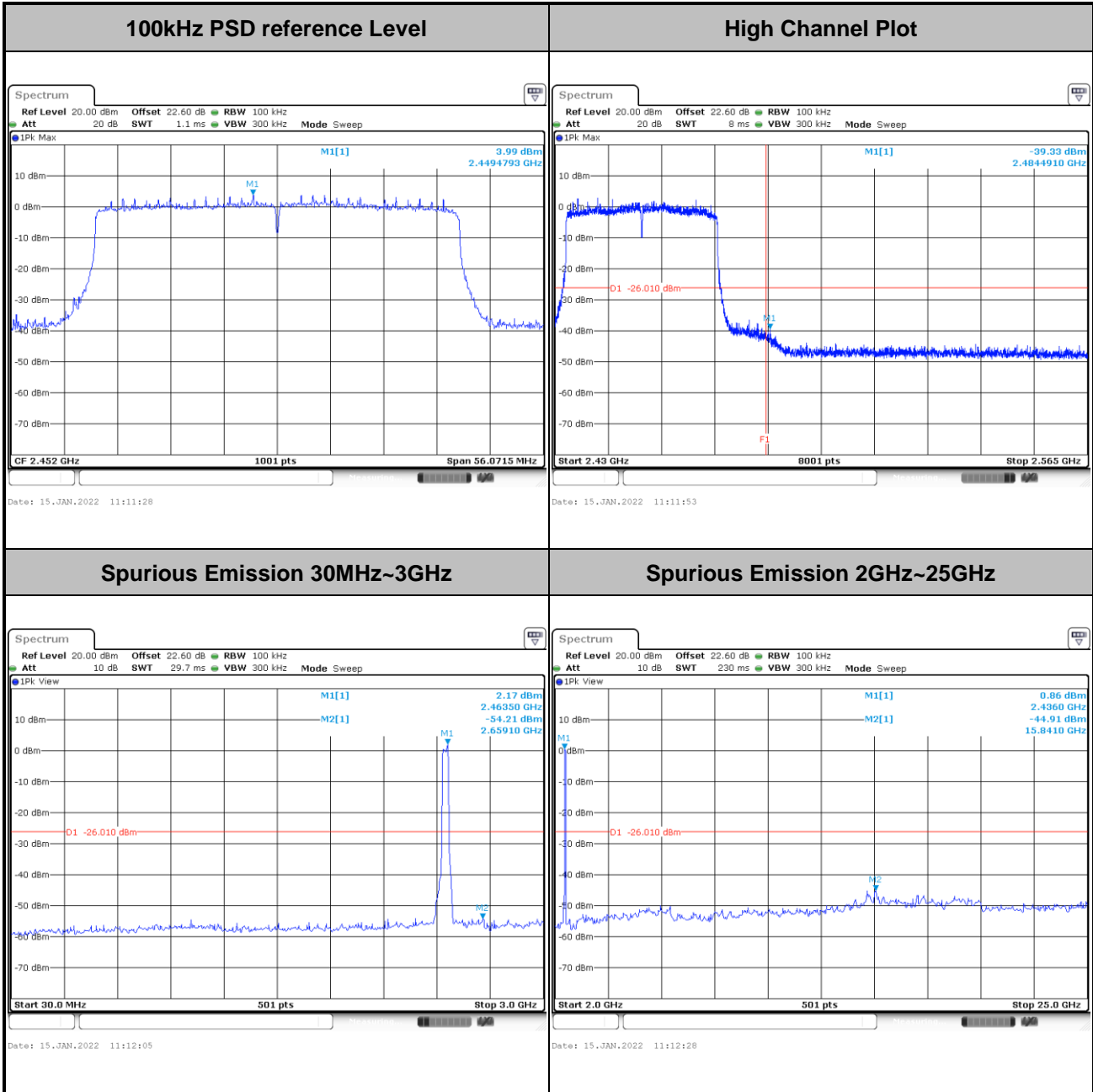



<TXBF Mode>

Number of TX = 2, Ant. 9 (Measured)

Test Mode :	802.11ax HE20	Test Channel :	01 Full RU
-------------	---------------	----------------	------------

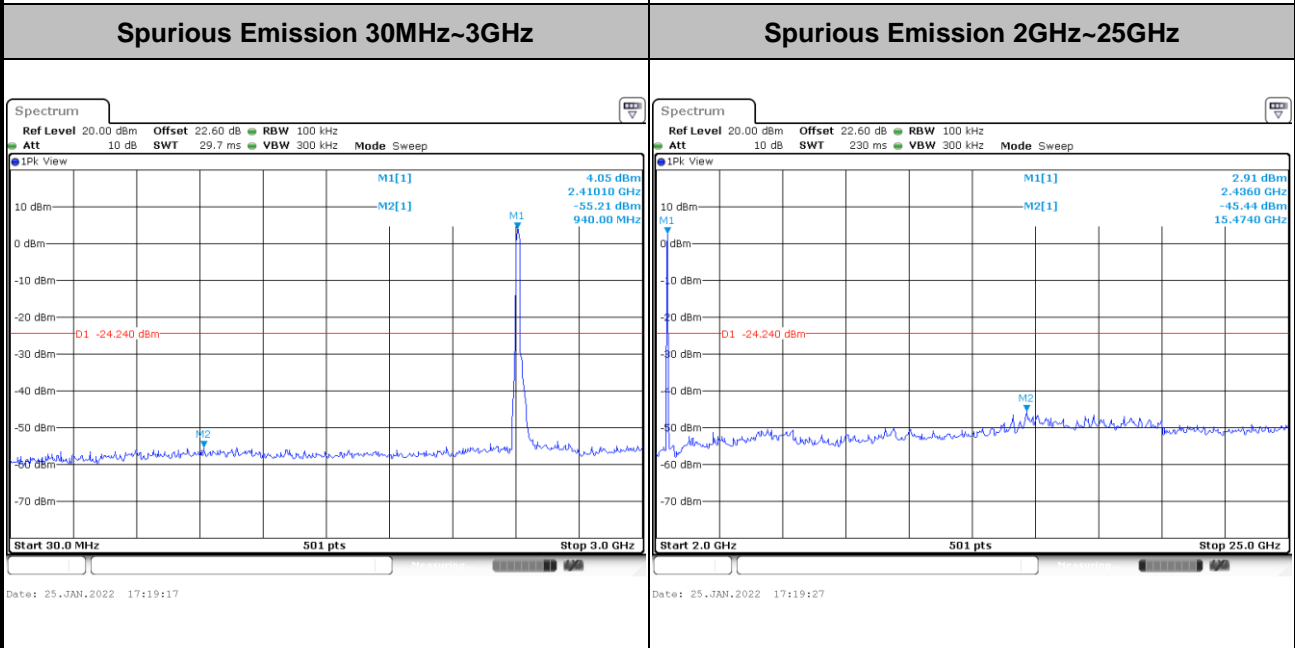
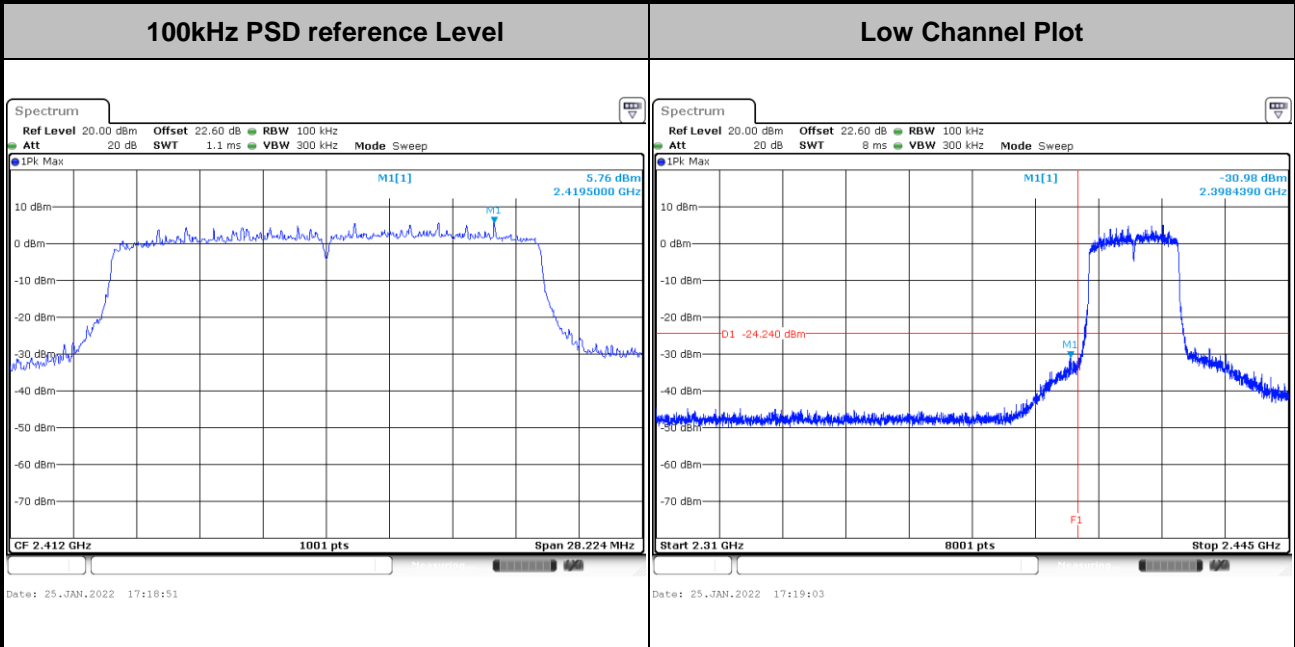



Test Mode :	802.11ax HE20	Test Channel :	06 Full RU
--------------------	---------------	-----------------------	------------

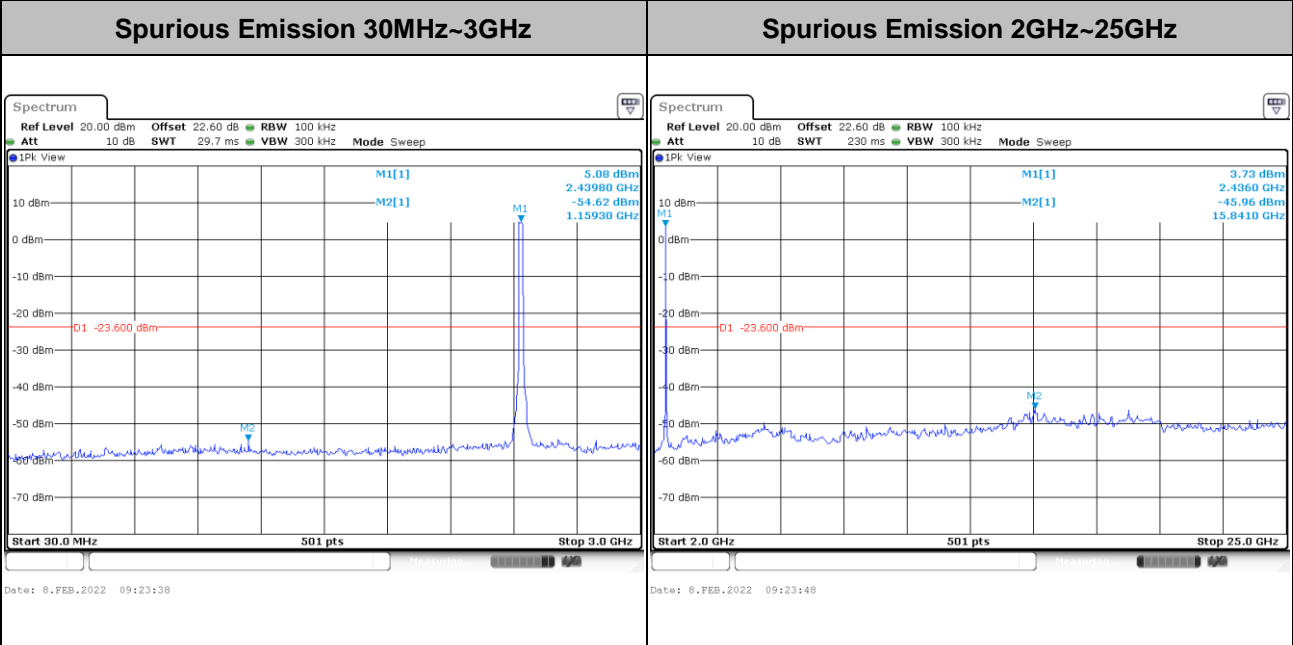
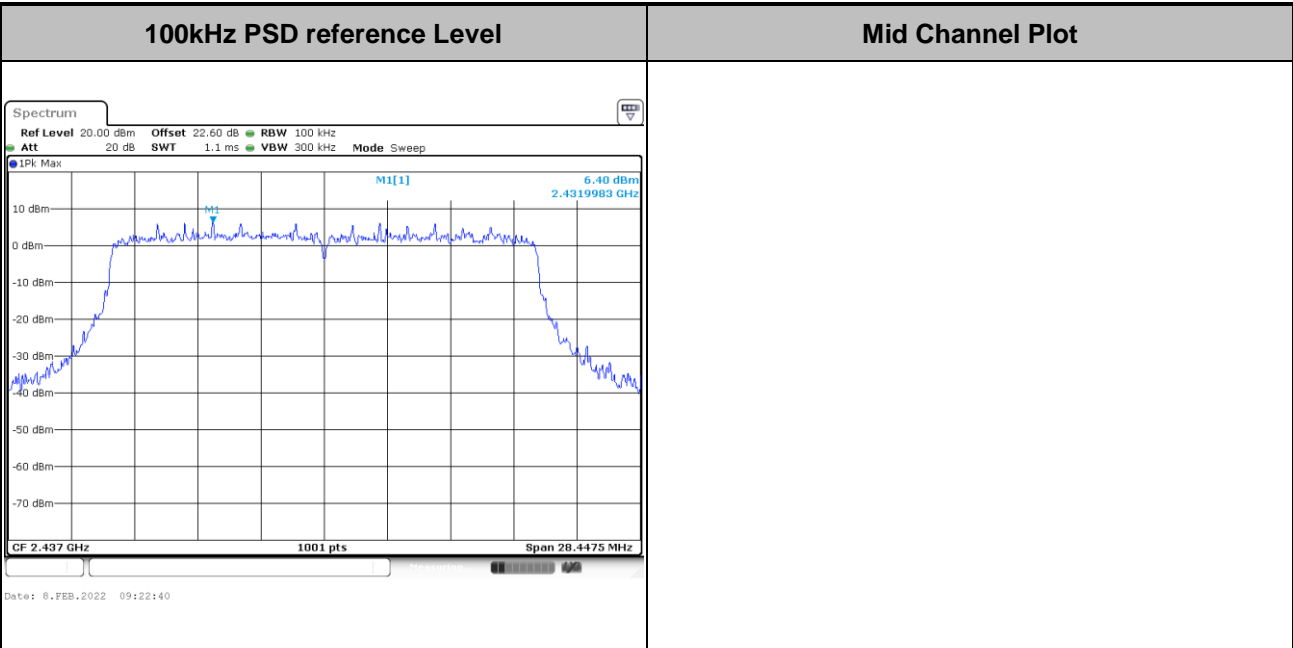



Test Mode :	802.11ax HE20	Test Channel :	11 Full RU
-------------	---------------	----------------	------------

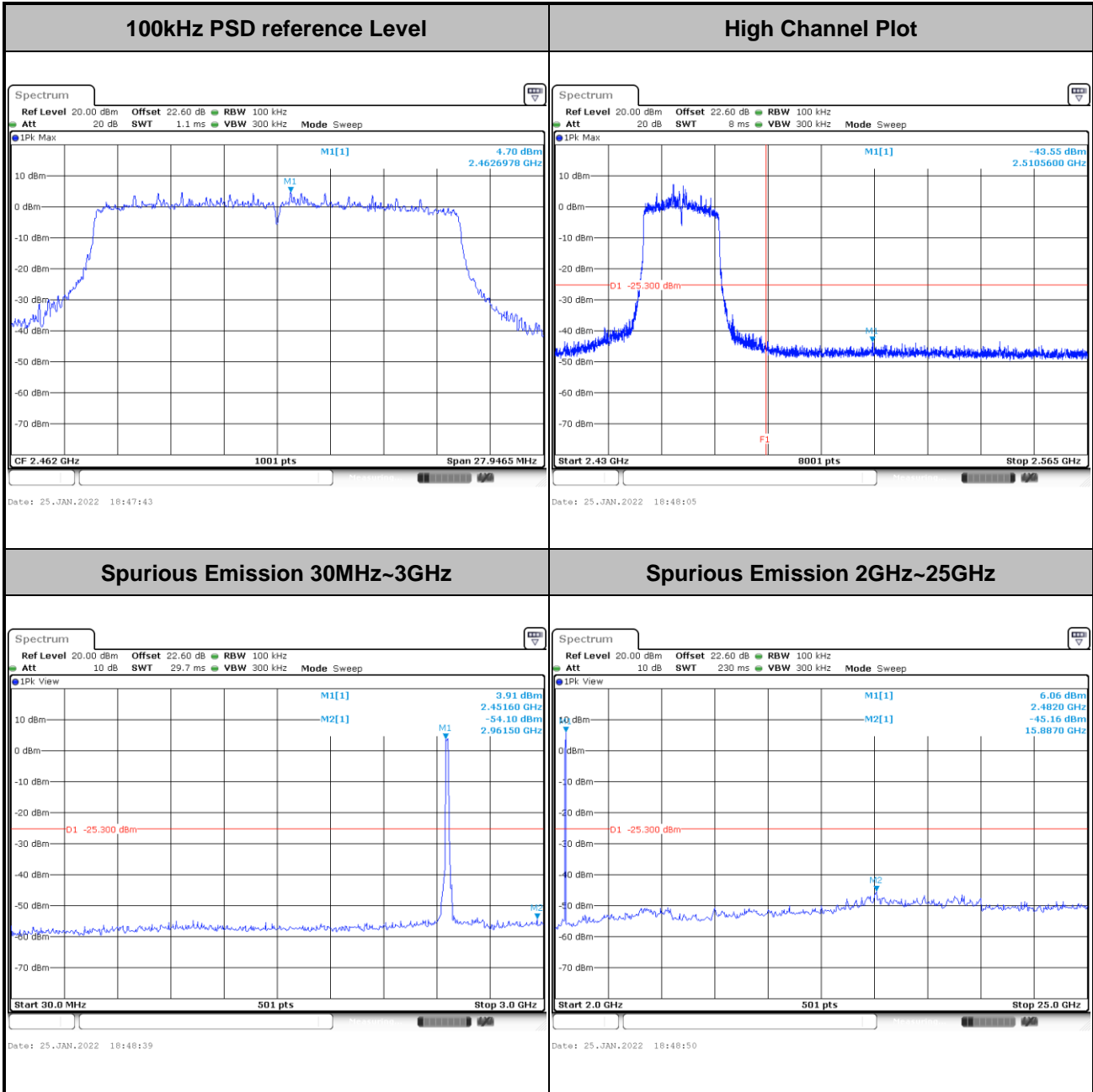



Test Mode :	802.11ax HE40	Test Channel :	03 Full RU
-------------	---------------	----------------	------------

