



FCC CO-LOCATION RADIO TEST REPORT

FCC ID : UZ7TC520K
Equipment : Touch Computer
Brand Name : Zebra
Model Name : TC520K
Applicant : Zebra Technologies Corporation
1 Zebra Plaza Holtsville, NY 11742
Manufacturer : Zebra Technologies Corporation
1 Zebra Plaza Holtsville, NY 11742
Standard : FCC Part 15 Subpart E §15.407

The product was received on May 31, 2018 and testing was started from Aug. 02, 2018 and completed on Aug. 27, 2018. We, SPORTON INTERNATIONAL INC., would like to declare that the tested sample has been evaluated in accordance with the test procedures and has been in compliance with the applicable technical standards.

The report must not be used by the client to claim product certification, approval, or endorsement by TAF or any agency of government.

The test results in this report apply exclusively to the tested model / sample. Without written approval of SPORTON INTERNATIONAL INC. EMC & Wireless Communications Laboratory, the test report shall not be reproduced except in full.

Approved by: Joseph Lin

SPORTON INTERNATIONAL INC. EMC & Wireless Communications Laboratory

No. 52, Huaya 1st Rd., Guishan Dist., Taoyuan City, Taiwan (R.O.C.)



Table of Contents

History of this test report.....	3
Summary of Test Result.....	4
1 General Description	5
1.1 Product Feature of Equipment Under Test.....	5
1.2 Product Specification of Equipment Under Test.....	6
1.3 Modification of EUT	6
1.4 Testing Location	7
1.5 Applicable Standards.....	7
2 Test Configuration of Equipment Under Test	8
2.1 Carrier Frequency and Channel	8
2.2 Test Mode.....	8
2.3 Connection Diagram of Test System.....	9
2.4 Support Unit used in test configuration and system	9
2.5 EUT Operation Test Setup	9
3 Test Result	10
3.1 Unwanted Emissions Measurement.....	10
3.2 Antenna Requirements	15
4 List of Measuring Equipment.....	16
5 Uncertainty of Evaluation	17
Appendix A. Radiated Spurious Emission	
Appendix B. Radiated Spurious Emission Plots	
Appendix C. Duty Cycle Plots	
Appendix D. Setup Photographs	



History of this test report

Report No.	Version	Description	Issued Date
FR853105G	01	Initial issue of report	Aug. 29, 2018



Summary of Test Result

Report Clause	Ref Std. Clause	Test Items	Result (PASS/FAIL)	Remark
3.1	15.407(b)	Unwanted Emissions	Pass	Under limit 3.38 dB at 37.020 MHz
3.2	15.203 15.407(a)	Antenna Requirement	Pass	-

Reviewed by: **Wii Chang**

Report Producer: **Polly Tsai**



1 General Description

1.1 Product Feature of Equipment Under Test

Product Feature	
Equipment	Touch Computer
Brand Name	Zebra
Model Name	TC520K
FCC ID	UZ7TC520K
EUT supports Radios application	NFC WLAN 11a/b/g/n HT20/HT40 WLAN 11ac VHT20/VHT40/VHT80 Bluetooth BR/EDR/LE
HW Version	DV
SW Version	91-09-14.00-ON-U00-STD
FW Version	FUSION_QA_2_1.0.0.027_O
MFD	20-Jul-18
EUT Stage	Engineering Sample

Remark: The above EUT's information was declared by manufacturer.

Specification of Accessories				
Adapter	Brand Name	Zebra	Part Number	PWR-WUA5V12W0US
Battery 1	Brand Name	Zebra	Part Number	BT-000314-50
Battery 2	Brand Name	Zebra	Part Number	BT-000314-01
USB cable	Brand Name	Zebra	Part Number	CBL-TC51-USB1-01
Headset Jumper 1	Brand Name	Zebra	Part Number	CBL-TC51-HDST25-01
Headset Jumper 2	Brand Name	Zebra	Part Number	CBL-TC51-HDST35-01
2.5mm Earphone	Brand Name	Zebra	Part Number	HDST-25MM-PTVP-01
3.5mm Earphone	Brand Name	Zebra	Part Number	HDST-35MM-PTVP-01
Exoskeleton	Brand Name	Zebra	Part Number	SG-TC51-EX01-01
Trigger Handle	Brand Name	Zebra	Part Number	TRG-TC51-SNP1-01
Soft Holster	Brand Name	Zebra	Part Number	SG-TC51-HLSTR1-01
Hand strap	Brand Name	Zebra	Part Number	SG-TC51-BHDSTP1-03
USB-C Adapter	Brand Name	Zebra	Part Number	ADPTR-TC56-USBC-01
USB Type C cable	Brand Name	Zebra	Part Number	N/A



1.2 Product Specification of Equipment Under Test

Standards-related Product Specification	
Tx/Rx Frequency Range	2400 MHz ~ 2483.5 MHz 5180 MHz ~ 5240 MHz 5260 MHz ~ 5320 MHz 5500 MHz ~ 5720 MHz 5745 MHz ~ 5825 MHz
Antenna Type / Gain	<2400 MHz ~ 2483.5 MHz> Ant. 1 : PIFA Antenna type with gain 2.80 dBi Ant. 2 : PIFA Antenna type with gain 2.30 dBi <5180 MHz ~ 5240 MHz> Ant. 1 : PIFA Antenna type with gain 3.80 dBi Ant. 2 : PIFA Antenna type with gain -0.10 dBi <5260 MHz ~ 5320 MHz> Ant. 1 : PIFA Antenna type with gain 3.80 dBi Ant. 2 : PIFA Antenna type with gain -0.10 dBi <5500 MHz ~ 5720 MHz> Ant. 1 : PIFA Antenna type with gain 3.10 dBi Ant. 2 : PIFA Antenna type with gain 2.30 dBi <5745 MHz ~ 5825 MHz> Ant. 1 : PIFA Antenna type with gain 3.00 dBi Ant. 2 : PIFA Antenna type with gain 2.80 dBi
Type of Modulation	802.11b : DSSS (DBPSK / DQPSK / CCK) 802.11a : OFDM (BPSK / QPSK / 16QAM / 64QAM)

1.3 Modification of EUT

No modifications are made to the EUT during all test items.



1.4 Testing Location

Sporton Lab is accredited to ISO 17025 by Taiwan Accreditation Foundation (TAF code : 1190) and the FCC designation No. TW0007 under the FCC 2.948(e) by Mutual Recognition Agreement (MRA) in FCC Test.

Test Site	SPORTON INTERNATIONAL INC.
Test Site Location	No.58, Aly. 75, Ln. 564, Wenhua 3rd, Rd., Guishan Dist., Taoyuan City, Taiwan (R.O.C.) TEL: +886-3-327-0868 FAX: +886-3-327-0855
Test Site No.	Sporton Site No. 03CH12-HY

Note: The test site complies with ANSI C63.4 2014 requirement.

1.5 Applicable Standards

According to the specifications of the manufacturer, the EUT must comply with the requirements of the following standards:

- ♦ FCC Part 15 Subpart E
- ♦ FCC KDB 789033 D02 General UNII Test Procedures New Rules v02r01.
- ♦ ANSI C63.10-2013

Remark: All test items were verified and recorded according to the standards and without any deviation during the test.



2 Test Configuration of Equipment Under Test

The EUT has been associated with peripherals and configuration operated in a manner tended to maximize its emission characteristics in a typical application. Frequency range investigated: radiation emission (9 kHz to the 10th harmonic of the highest fundamental frequency or to 40 GHz, whichever is lower). For radiated measurement, pre-scanned in three orthogonal panels, X, Y, Z. The worst cases (Z plane) were recorded in this report.

2.1 Carrier Frequency and Channel

2400-2483.5 MHz 802.11b	
Channel	Freq. (MHz)
06	2437

5150-5250 MHz 802.11a		5250-5350 MHz 802.11a	
Channel	Channel	Channel	Freq. (MHz)
44	5220	60	5300

5470-5725 MHz 802.11a		5725-5850 MHz 802.11a	
Channel	Channel	Channel	Freq. (MHz)
116	5580	157	5785

2.2 Test Mode

Final test modes are considering the modulation and worse data rates as below table.

<Co-Location>

Modulation	Data Rate
802.11b for Ant. 1 + 802.11a for Ant. 2	1 Mbps + 6 Mbps

2.3 Connection Diagram of Test System

<Co-location Mode>

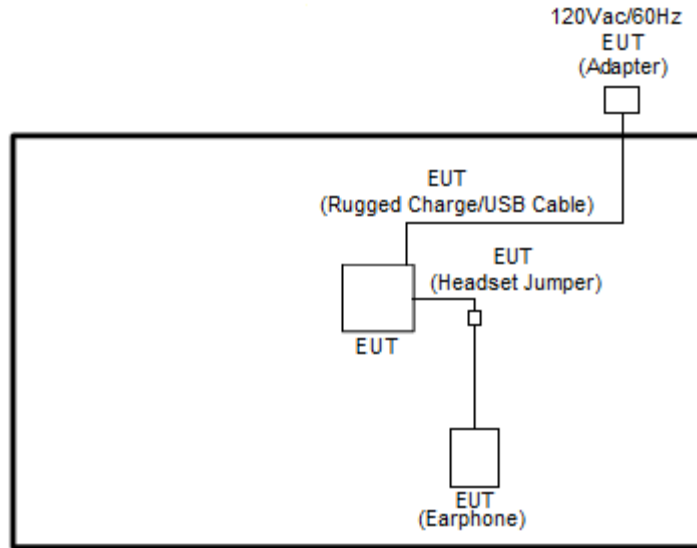

2.4 Support Unit used in test configuration and system

Item	Equipment	Trade Name	Model Name	FCC ID	Data Cable	Power Cord
1.	Notebook	Lenovo	E335	N/A	N/A	AC I/P: Unshielded, 1.2 m DC O/P: Shielded, 1.8 m

2.5 EUT Operation Test Setup

The RF test items, utility “QRCT” was installed in Notebook which was programmed in order to make the EUT get into the engineering modes to provide channel selection, power level, data rate and the application type and for continuous transmitting signals.



3 Test Result

3.1 Unwanted Emissions Measurement

This section is to measure unwanted emissions through radiated measurement for band edge spurious emissions and out of band emissions measurement.

3.1.1 Limit of Unwanted Emissions

(1) Unwanted spurious emissions fallen in restricted bands shall comply with the general field strength limits as below table,

Frequency (MHz)	Field Strength (microvolts/meter)	Measurement Distance (meters)
0.009 – 0.490	2400/F(kHz)	300
0.490 – 1.705	24000/F(kHz)	30
1.705 – 30.0	30	30
30 – 88	100	3
88 – 216	150	3
216 - 960	200	3
Above 960	500	3

Note: The following formula is used to convert the EIRP to field strength.

$$E = \frac{1000000\sqrt{30P}}{3} \mu V/m, \text{ where P is the eirp (Watts)}$$

EIRP (dBm)	Field Strength at 3m (dBμV/m)
- 27	68.3



(2) KDB789033 D02 v02r01 G)2)c)

- (i) Section 15.407(b)(1) to (b)(3) specify the unwanted emission limits for the U-NII-1 and U-NII-2 bands. As specified, emissions above 1000 MHz that are outside of the restricted bands are subject to a peak emission limit of -27 dBm/MHz.³
- (ii) Section 15.407(b)(4) specifies the unwanted emission limit for the U-NII-3 band. A band emissions mask is specified in Section 15.407(b)(4)(i). The emission limits are in terms of a Peak detector. An alternative to the band emissions mask is specified in Section 15.407(b)(4)(ii). The alternative limits are based on the highest antenna gain specified in the filing. There are also marketing and importation restrictions for the devices using the alternative limit.⁴

Note 3: An out-of-band emission that complies with both the average and peak limits of Section 15.209 is not required to satisfy the -27 dBm/MHz peak emission limit.

Note 4: Only devices with antenna gains of 10 dBi or less may be approved using the emission limits specified in Section 15.247(d) till March 2, 2018; all other devices operating in this band must use the mask specified in Section 15.407(b)(4)(i).

3.1.2 Measuring Instruments

See list of measuring equipment of this test report.

3.1.3 Test Procedures

1. The testing follows FCC KDB 789033 D02 General UNII Test Procedures New Rules v02r01. Section G) Unwanted emissions measurement.

(1) Procedure for Unwanted Emissions Measurements Below 1000MHz

- RBW = 120 kHz
- VBW = 300 kHz
- Detector = Peak
- Trace mode = max hold

(2) Procedure for Peak Unwanted Emissions Measurements Above 1000 MHz

- RBW = 1 MHz
- VBW ≥ 3 MHz
- Detector = Peak
- Sweep time = auto
- Trace mode = max hold

(3) Procedures for Average Unwanted Emissions Measurements Above 1000MHz

- RBW = 1 MHz
- VBW = 10 Hz, when duty cycle is no less than 98 percent.
- VBW ≥ 1/T, when duty cycle is less than 98 percent where T is the minimum transmission duration over which the transmitter is on and is transmitting at its maximum power control level for the tested mode of operation.



2. The EUT was placed on a turntable with 0.8 meter for frequency below 1GHz and 1.5 meter for frequency above 1GHz respectively above ground.
3. The EUT was set 3 meters from the interference receiving antenna which was mounted on the top of a variable height antenna tower.
4. The antenna is a broadband antenna and its height is adjusted between one meter and four meters above ground to find the maximum value of the field strength for both horizontal polarization and vertical polarization of the antenna.
5. For each suspected emission, the EUT was arranged to its worst case and then adjust the antenna tower (from 1 m to 4 m) and turntable (from 0 degree to 360 degrees) to find the maximum reading.
6. For testing below 1GHz, if the emission level of the EUT in peak mode was 3 dB lower than the limit specified, then peak values of EUT will be reported, otherwise, the emissions will be repeated one by one using the CISPR quasi-peak method and reported.
7. For testing above 1GHz, the emission level of the EUT in peak mode was 20dB lower than average limit (that means the emission level in average mode also complies with the limit in average mode), then peak values of EUT will be reported, otherwise, the emissions will be measured in average mode again and reported.

3.1.4 Test Setup

For radiated emissions below 30MHz

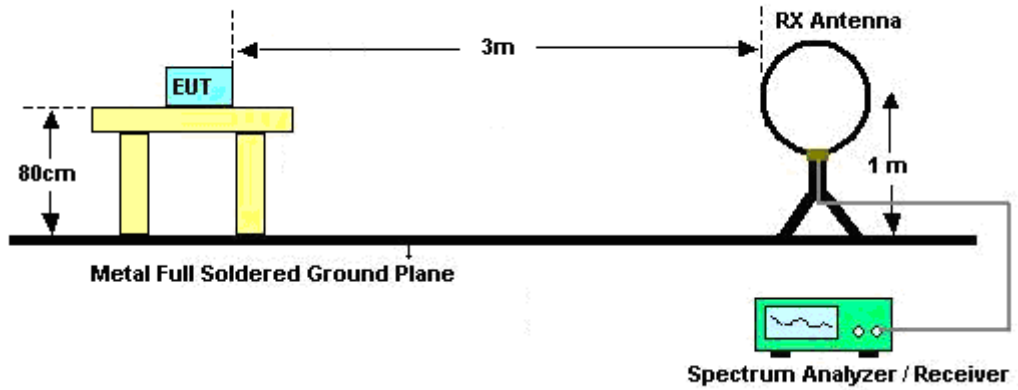

For radiated emissions from 30MHz to 1GHz

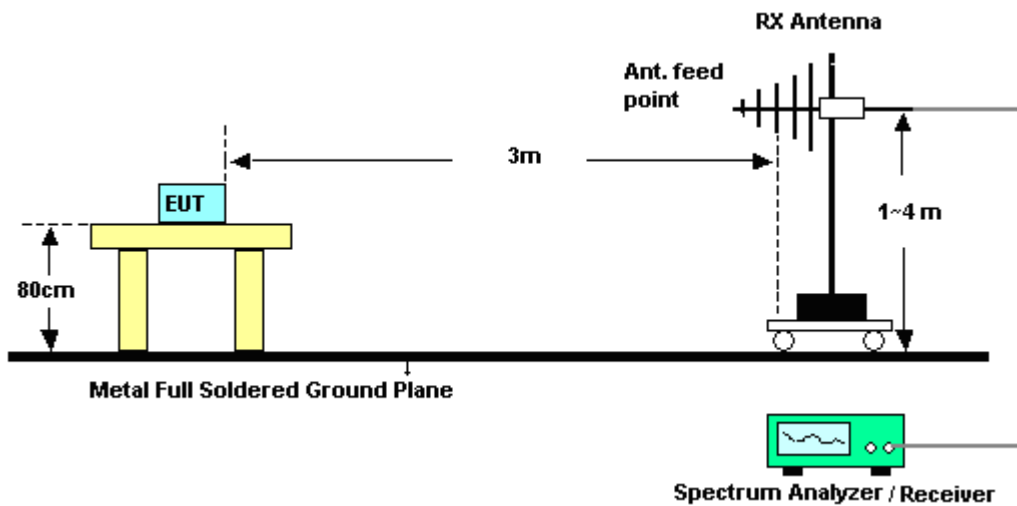

For radiated emissions above 1GHz

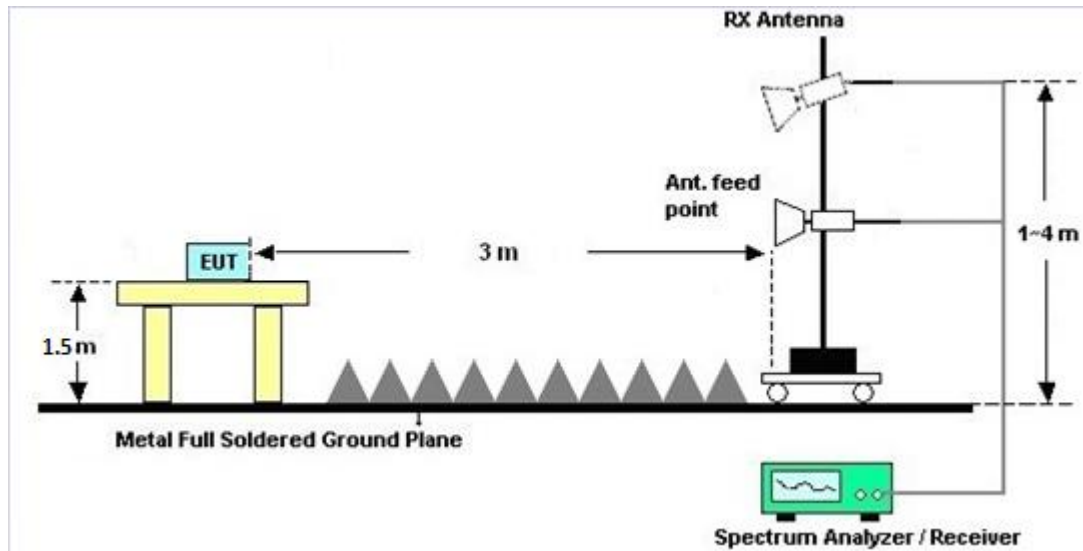

3.1.5 Test Results of Radiated Spurious Emissions (9 kHz ~ 30 MHz)

The low frequency, which started from 9 kHz to 30MHz, was pre-scanned and the result which was 20dB lower than the limit line was not reported.

There is a comparison data of both open-field test site and semi-Anechoic chamber, and the result came out very similar.

3.1.6 Test Result of Radiated Spurious at Band Edges

Please refer to Appendix A and B.

3.1.7 Duty Cycle

Please refer to Appendix C.

3.1.8 Test Result of Radiated Spurious Emissions (30MHz ~ 10th Harmonic)

Please refer to Appendix A and B.



3.2 Antenna Requirements

3.2.1 Standard Applicable

If transmitting antenna directional gain is greater than 6 dBi, both the peak transmit power and the peak power spectral density shall be reduced by the amount in dB that the directional gain of the antenna exceeds 6 dBi.

3.2.2 Antenna Anti-Replacement Construction

An embedded-in antenna design is used.

3.2.3 Antenna Gain

The antenna peak gain of EUT is less than 6 dBi. Therefore, it is not necessary to reduce maximum peak output power limit.



4 List of Measuring Equipment

Instrument	Manufacturer	Model No.	Serial No.	Characteristics	Calibration Date	Test Date	Due Date	Remark
Loop Antenna	Rohde & Schwarz	HFH2-Z2	100488	9 kHz~30 MHz	Nov. 23, 2017	Aug. 02, 2018~ Aug. 27, 2018	Nov. 22, 2018	Radiation (03CH12-HY)
Bilog Antenna	TESEQ	CBL 6111D&00800 N1D01N-06	37059&01	30MHz~1GHz	Oct. 14, 2017	Aug. 02, 2018~ Aug. 27, 2018	Oct. 13, 2018	Radiation (03CH12-HY)
Horn Antenna	SCHWARZBE CK	BBHA 9120D	9120D-132 8	1GHz ~ 18GHz	Oct. 20, 2017	Aug. 02, 2018~ Aug. 27, 2018	Oct. 19, 2018	Radiation (03CH12-HY)
SHF-EHF Horn Antenna	SCHWARZBE CK	BBHA 9170	BBHA9170 584	18GHz ~ 40GHz	Nov. 27, 2017	Aug. 02, 2018~ Aug. 27, 2018	Nov. 26, 2018	Radiation (03CH12-HY)
Preamplifier	COM-POWER	PA-103	161075	10MHz~1GHz	Mar. 26, 2018	Aug. 02, 2018~ Aug. 27, 2018	Mar. 25, 2019	Radiation (03CH12-HY)
Preamplifier	Keysight	83017A	MY532701 48	1GHz~26.5GHz	Jan. 15, 2018	Aug. 02, 2018~ Aug. 27, 2018	Jan. 14, 2019	Radiation (03CH12-HY)
Preamplifier	MITEQ	AMF-7D-0010 1800-30-10P	1590074	1GHz~18GHz	May 21, 2018	Aug. 02, 2018~ Aug. 27, 2018	May 20, 2019	Radiation (03CH12-HY)
Preamplifier	EMEC	EM18G40G	060715	18GHz ~ 40GHz	Dec. 05, 2017	Aug. 02, 2018~ Aug. 27, 2018	Dec. 04, 2018	Radiation (03CH12-HY)
EMI Test Receiver	Rohde & Schwarz	ESU26	100390	20Hz~26.5GHz	Dec. 25, 2017	Aug. 02, 2018~ Aug. 27, 2018	Dec. 24, 2018	Radiation (03CH12-HY)
Spectrum Analyzer	Keysight	N9010A	MY542004 85	10Hz ~ 44GHz	Oct. 31, 2017	Aug. 02, 2018~ Aug. 27, 2018	Oct. 30, 2018	Radiation (03CH12-HY)
Filter	Woken	WHKX8-5272. 5-6750-18000 -40ST	SN2	6.75G Highpass	Mar. 21, 2018	Aug. 02, 2018~ Aug. 27, 2018	Mar. 20, 2019	Radiation (03CH12-HY)
Filter	Wainwright	WLJ4-1000-1 530-6000-40S T	SN3	1.53 GHz Lowpass	Mar. 21, 2018	Aug. 02, 2018~ Aug. 27, 2018	Mar. 20, 2019	Radiation (03CH12-HY)
RF Cable	HUBER + SUHNER	SUCOFLEX 104	MY15539/ 4	30M-18G	Mar. 14, 2018	Aug. 02, 2018~ Aug. 27, 2018	Mar. 13, 2019	Radiation (03CH12-HY)
RF Cable	HUBER + SUHNER	SUCOFLEX 102	505134/2	30M~40GHz	Oct. 17, 2017	Aug. 02, 2018~ Aug. 27, 2018	Oct. 16, 2018	Radiation (03CH12-HY)
RF Cable	HUBER + SUHNER	SUCOFLEX 102	800740/2	30M~40GHz	Oct. 17, 2017	Aug. 02, 2018~ Aug. 27, 2018	Oct. 16, 2018	Radiation (03CH12-HY)
Antenna Mast	EMEC	AM-BS-4500- B	N/A	1m~4m	N/A	Aug. 02, 2018~ Aug. 27, 2018	N/A	Radiation (03CH12-HY)
Turn Table	EMEC	TT2000	N/A	0~360 Degree	N/A	Aug. 02, 2018~ Aug. 27, 2018	N/A	Radiation (03CH12-HY)
Software	Audix	E3 6.2009-8-24	RK-00098 9	N/A	N/A	Aug. 02, 2018~ Aug. 27, 2018	N/A	Radiation (03CH12-HY)



5 Uncertainty of Evaluation

Uncertainty of Radiated Emission Measurement (30 MHz ~ 1000 MHz)

Measuring Uncertainty for a Level of Confidence of 95% ($U = 2Uc(y)$)	5.1
---	-----

Uncertainty of Radiated Emission Measurement (1000 MHz ~ 18000 MHz)

Measuring Uncertainty for a Level of Confidence of 95% ($U = 2Uc(y)$)	5.2
---	-----

Uncertainty of Radiated Emission Measurement (18000 MHz ~ 40000 MHz)

Measuring Uncertainty for a Level of Confidence of 95% ($U = 2Uc(y)$)	4.7
---	-----



Appendix A. Radiated Spurious Emission

Test Engineer :	Jack Cheng, Lance Chiang, and Peter Liao	Temperature :	22~25°C
		Relative Humidity :	53~67%

Co-location Mode

WIFI 802.11b and WIFI 802.11a (Harmonic @ 3m)

WIFI Ant. Simultaneously	Note	Frequency (MHz)	Level (dBμV/m)	Over Limit (dB)	Limit Line (dBμV/m)	Read Level (dBμV)	Antenna Factor (dB/m)	Path Loss (dB)	Preamp Factor (dB)	Ant Pos (cm)	Table Pos (deg)	Peak Avg. (P/A)	Pol. (H/V)	
802.11b CH 06 2437MHz + 802.11a CH 44 5220MHz		4874	52.71	-21.29	74	42.77	31.46	9.64	31.16	100	67	P	H	
		4874	39.61	-14.39	54	29.67	31.46	9.64	31.16	100	67	A	H	
		7311	44.7	-29.3	74	52.55	36.11	13.31	57.27	100	0	P	H	
		10440	48.78	-19.42	68.2	50.05	39.98	15.67	56.92	100	0	P	H	
		15660	48.44	-25.56	74	47.02	38.29	19.64	56.51	100	0	P	H	
														H
														H
														H
			4874	52.62	-21.38	74	42.68	31.46	9.64	31.16	200	287	P	V
			4874	39.02	-14.98	54	29.08	31.46	9.64	31.16	200	287	A	V
			7311	45.38	-28.62	74	53.23	36.11	13.31	57.27	100	0	P	V
			10440	48.67	-19.53	68.2	49.94	39.98	15.67	56.92	100	0	P	V
			15660	47.71	-26.29	74	46.29	38.29	19.64	56.51	100	0	P	V
														V
														V
														V
Remark	<ol style="list-style-type: none"> No other spurious found. All results are PASS against Peak and Average limit line. 													



Emission below 1GHz

WIFI 802.11b and WIFI 802.11a (LF @ 3m)

WIFI	Note	Frequency	Level	Over	Limit	Read	Antenna	Path	Preamp	Ant	Table	Peak	Pol.	
Ant.				Limit	Line	Level	Factor	Loss	Factor	Pos	Pos	Avg.		
Simultaneously		(MHz)	(dBµV/m)	(dB)	(dBµV/m)	(dBµV)	(dB/m)	(dB)	(dB)	(cm)	(deg)	(P/A)	(H/V)	
802.11b CH 06 2437MHz + 802.11a CH 44 5220MHz		38.64	27.94	-12.06	40	37.6	19.82	0.83	30.31	-	-	P	H	
		111.81	31.47	-12.03	43.5	43.55	16.86	1.48	30.42	-	-	P	H	
		130.44	30.89	-12.61	43.5	42.47	17.21	1.61	30.4	-	-	P	H	
		713.7	39.93	-6.07	46	39.02	26.67	3.73	29.49	-	-	P	H	
		720	42.55	-3.45	46	41.33	26.94	3.75	29.47	100	0	P	H	
		926.5	34.41	-11.59	46	29.54	29.58	4.35	29.06	-	-	P	H	
														H
														H
														H
														H
														H
														H
			38.91	34.21	-5.79	40	43.86	19.82	0.84	30.31	100	0	P	V
			79.41	31.38	-8.62	40	47.36	13.2	1.27	30.45	-	-	P	V
			111.54	31.2	-12.3	43.5	43.28	16.86	1.48	30.42	-	-	P	V
			729.8	31.71	-14.29	46	30.03	27.36	3.77	29.45	-	-	P	V
			870.5	33.8	-12.2	46	29.75	29.07	4.16	29.18	-	-	P	V
			956.6	35.79	-10.21	46	29.52	30.81	4.44	28.98	-	-	P	V
														V
													V	
													V	
													V	
													V	
													V	
Remark	1. No other spurious found. 2. All results are PASS against limit line.													



WIFI 802.11b and WIFI 802.11a (Harmonic @ 3m)

WIFI	Note	Frequency	Level	Over	Limit	Read	Antenna	Path	Preamp	Ant	Table	Peak	Pol.	
Ant.				Limit	Line	Level	Factor	Loss	Factor	Pos	Pos	Avg.		
Simultaneously		(MHz)	(dBμV/m)	(dB)	(dBμV/m)	(dBμV)	(dB/m)	(dB)	(dB)	(cm)	(deg)	(P/A)	(H/V)	
802.11b CH 06 2437MHz + 802.11a CH 60 5300MHz		4874	54.52	-19.48	74	44.58	31.46	9.64	31.16	102	65	P	H	
		4874	45.23	-8.77	54	35.29	31.46	9.64	31.16	102	65	A	H	
		7311	46.77	-27.23	74	54.62	36.11	13.31	57.27	100	0	P	H	
		10600	50.36	-23.64	74	51.2	40.18	15.8	56.82	210	282	P	H	
		10600	37.21	-16.79	54	38.05	40.18	15.8	56.82	210	282	A	H	
		15900	45.46	-28.54	74	44.14	37.81	19.73	56.22	100	0	P	H	
														H
														H
			4874	54.94	-19.06	74	45	31.46	9.64	31.16	208	90	P	V
			4874	46.51	-7.49	54	36.57	31.46	9.64	31.16	208	90	A	V
			7311	46.34	-27.66	74	54.19	36.11	13.31	57.27	100	0	P	V
			10600	50.26	-23.74	74	51.1	40.18	15.8	56.82	100	39	P	V
			10600	36.77	-17.23	54	37.61	40.18	15.8	56.82	100	39	A	V
			15900	45.77	-28.23	74	44.45	37.81	19.73	56.22	100	0	P	V
														V
														V
Remark	1. No other spurious found. 2. All results are PASS against Peak and Average limit line.													



Emission below 1GHz

WIFI 802.11b and WIFI 802.11a (LF @ 3m)

WIFI	Note	Frequency	Level	Over	Limit	Read	Antenna	Path	Preamp	Ant	Table	Peak	Pol.	
Ant.				Limit	Line	Level	Factor	Loss	Factor	Pos	Pos	Avg.		
Simultaneously		(MHz)	(dBµV/m)	(dB)	(dBµV/m)	(dBµV)	(dB/m)	(dB)	(dB)	(cm)	(deg)	(P/A)	(H/V)	
802.11b CH 06 2437MHz + 802.11a CH 60 5300MHz		37.02	29.59	-10.41	40	38.18	20.89	0.8	30.28	100	0	P	H	
		77.79	25.81	-14.19	40	42	13.01	1.25	30.45	-	-	P	H	
		128.82	30.73	-12.77	43.5	42.26	17.27	1.6	30.4	-	-	P	H	
		834.8	31.65	-14.35	46	28.69	28.15	4.05	29.24	-	-	P	H	
		920.2	34.62	-11.38	46	29.99	29.39	4.32	29.08	-	-	P	H	
		952.4	35.1	-10.9	46	28.99	30.67	4.43	28.99	-	-	P	H	
														H
														H
														H
														H
														H
														H
														H
			39.18	33.78	-6.22	40	43.43	19.82	0.84	30.31	100	0	P	V
			79.14	31.12	-8.88	40	47.1	13.2	1.27	30.45	-	-	P	V
			110.73	31.11	-12.39	43.5	43.24	16.81	1.48	30.42	-	-	P	V
			761.3	32.45	-13.55	46	30.03	27.94	3.86	29.38	-	-	P	V
			891.5	33.96	-12.04	46	29.94	28.95	4.22	29.15	-	-	P	V
			972	35.97	-18.03	54	29.64	30.8	4.46	28.93	-	-	P	V
														V
													V	
													V	
													V	
													V	
													V	
Remark	1. No other spurious found. 2. All results are PASS against limit line.													



WIFI 802.11b and WIFI 802.11a (Harmonic @ 3m)

WIFI	Note	Frequency	Level	Over	Limit	Read	Antenna	Path	Preamp	Ant	Table	Peak	Pol.	
Ant.				Limit	Line	Level	Factor	Loss	Factor	Pos	Pos	Avg.		
Simultaneously		(MHz)	(dBμV/m)	(dB)	(dBμV/m)	(dBμV)	(dB/m)	(dB)	(dB)	(cm)	(deg)	(P/A)	(H/V)	
802.11b CH 06 2437MHz + 802.11a CH 116 5580MHz		4874	56.52	-17.48	74	46.58	31.46	9.64	31.16	100	299	P	H	
		4874	47.75	-26.25	74	37.81	31.46	9.64	31.16	100	299	P	H	
		7311	46.43	-27.57	74	54.28	36.11	13.31	57.27	100	0	P	H	
		11160	59.31	-14.69	74	59.15	40.37	16.23	56.44	231	176	P	H	
		11160	45.19	-8.81	54	45.03	40.37	16.23	56.44	231	176	A	H	
		16740	48.98	-19.22	68.2	44.37	40.13	20.37	55.89	100	0	P	H	
														H
														H
			4874	55.76	-18.24	74	45.82	31.46	9.64	31.16	203	95	P	V
			4874	47.25	-26.75	74	37.31	31.46	9.64	31.16	203	95	P	V
			7311	46.31	-27.69	74	54.16	36.11	13.31	57.27	100	0	P	V
			11160	56.27	-17.73	74	56.11	40.37	16.23	56.44	100	2	P	V
			11160	41.71	-12.29	54	41.55	40.37	16.23	56.44	100	2	A	V
			16740	48.28	-19.92	68.2	43.67	40.13	20.37	55.89	100	0	P	V
														V
														V
Remark	1. No other spurious found. 2. All results are PASS against Peak and Average limit line.													



Emission below 1GHz

WIFI 802.11b and WIFI 802.11a (LF @ 3m)

WIFI	Note	Frequency	Level	Over	Limit	Read	Antenna	Path	Preamp	Ant	Table	Peak	Pol.	
Ant.				Limit	Line	Level	Factor	Loss	Factor	Pos	Pos	Avg.		
Simultaneously		(MHz)	(dBμV/m)	(dB)	(dBμV/m)	(dBμV)	(dB/m)	(dB)	(dB)	(cm)	(deg)	(P/A)	(H/V)	
802.11b CH 06 2437MHz + 802.11a CH 116 5580MHz		38.37	30.1	-9.9	40	39.76	19.82	0.83	30.31	100	0	P	H	
		111.81	31.21	-12.29	43.5	43.29	16.86	1.48	30.42	-	-	P	H	
		129.63	30.27	-13.23	43.5	41.86	17.21	1.6	30.4	-	-	P	H	
		741	31.28	-14.72	46	29.07	27.84	3.8	29.43	-	-	P	H	
		913.2	34.66	-11.34	46	30.2	29.26	4.3	29.1	-	-	P	H	
		982.5	35.38	-18.62	54	29.2	30.59	4.49	28.9	-	-	P	H	
														H
														H
														H
														H
														H
														H
														H
			38.91	33.11	-6.89	40	42.76	19.82	0.84	30.31	100	0	P	V
			79.14	31.41	-8.59	40	47.39	13.2	1.27	30.45	-	-	P	V
			111.54	31.09	-12.41	43.5	43.17	16.86	1.48	30.42	-	-	P	V
			568.8	29.55	-16.45	46	29.98	25.89	3.36	29.68	-	-	P	V
			791.4	32.74	-13.26	46	30.15	27.96	3.94	29.31	-	-	P	V
			960.8	35.53	-18.47	54	29.1	30.94	4.45	28.96	-	-	P	V
														V
													V	
													V	
													V	
													V	
													V	
Remark	1. No other spurious found. 2. All results are PASS against limit line.													



WIFI 802.11b and WIFI 802.11a (Harmonic @ 3m)

WIFI	Note	Frequency	Level	Over	Limit	Read	Antenna	Path	Preamp	Ant	Table	Peak	Pol.	
Ant.				Limit	Line	Level	Factor	Loss	Factor	Pos	Pos	Avg.		
Simultaneously		(MHz)	(dBμV/m)	(dB)	(dBμV/m)	(dBμV)	(dB/m)	(dB)	(dB)	(cm)	(deg)	(P/A)	(H/V)	
802.11b CH 06 2437MHz + 802.11a CH 157 5785MHz		4874	54.38	-19.62	74	44.44	31.46	9.64	31.16	100	66	P	H	
		4874	44.89	-9.11	54	34.95	31.46	9.64	31.16	100	66	A	H	
		7311	45.73	-28.27	74	53.58	36.11	13.31	57.27	100	0	P	H	
		11570	54.03	-19.97	74	53.85	39.93	16.55	56.3	100	23	P	H	
		11570	39.65	-14.35	54	39.47	39.93	16.55	56.3	100	23	A	H	
		17355	50.5	-17.7	68.2	44.47	41.96	20.88	56.81	100	0	P	H	
														H
														H
			4874	54.76	-19.24	74	44.82	31.46	9.64	31.16	214	88	P	V
			4874	47.08	-6.92	54	37.14	31.46	9.64	31.16	214	88	A	V
			7311	46.42	-27.58	74	54.27	36.11	13.31	57.27	100	0	P	V
			11570	52.65	-21.35	74	52.47	39.93	16.55	56.3	100	1	P	V
			11570	38.97	-15.03	54	38.79	39.93	16.55	56.3	100	1	A	V
			17355	51.23	-16.97	68.2	45.2	41.96	20.88	56.81	100	0	P	V
														V
														V
Remark	1. No other spurious found. 2. All results are PASS against Peak and Average limit line.													



Emission below 1GHz

WIFI 802.11b and WIFI 802.11a (LF @ 3m)

WIFI	Note	Frequency	Level	Over	Limit	Read	Antenna	Path	Preamp	Ant	Table	Peak	Pol.	
Ant.				Limit	Line	Level	Factor	Loss	Factor	Pos	Pos	Avg.		
Simultaneously		(MHz)	(dBμV/m)	(dB)	(dBμV/m)	(dBμV)	(dB/m)	(dB)	(dB)	(cm)	(deg)	(P/A)	(H/V)	
802.11b CH 06 2437MHz + 802.11a CH 157 5785MHz		36.21	27.59	-12.41	40	35.65	21.43	0.78	30.27	-	-	P	H	
		112.89	30.72	-12.78	43.5	42.73	16.92	1.49	30.42	-	-	P	H	
		129.09	30.67	-12.83	43.5	42.2	17.27	1.6	30.4	-	-	P	H	
		714.4	38.69	-7.31	46	37.73	26.72	3.73	29.49	100	0	P	H	
		721.4	38.07	-7.93	46	36.77	27.02	3.75	29.47	-	-	P	H	
		940.5	35.15	-10.85	46	29.56	30.21	4.4	29.02	-	-	P	H	
														H
														H
														H
														H
														H
														H
			37.02	36.62	-3.38	40	45.21	20.89	0.8	30.28	100	0	P	V
			66.45	29.63	-10.37	40	46.97	11.97	1.15	30.46	-	-	P	V
			78.6	30.17	-9.83	40	46.24	13.11	1.27	30.45	-	-	P	V
			466.6	26.03	-19.97	46	29.66	23.22	3	29.85	-	-	P	V
			858.6	32.63	-13.37	46	28.73	28.98	4.12	29.2	-	-	P	V
			970.6	35.94	-18.06	54	29.6	30.82	4.46	28.94	-	-	P	V
														V
														V
													V	
													V	
													V	
													V	
Remark	1. No other spurious found. 2. All results are PASS against limit line.													



Note symbol

*	Fundamental Frequency which can be ignored. However, the level of any unwanted emissions shall not exceed the level of the fundamental frequency.
!	Test result is over limit line.
P/A	Peak or Average
H/V	Horizontal or Vertical



A calculation example for radiated spurious emission is shown as below:

WIFI	Note	Frequency	Level	Over	Limit	Read	Antenna	Path	Preamp	Ant	Table	Peak	Pol.
Ant.				Limit	Line	Level	Factor	Loss	Factor	Pos	Pos	Avg.	
1		(MHz)	(dBμV/m)	(dB)	(dBμV/m)	(dBμV)	(dB/m)	(dB)	(dB)	(cm)	(deg)	(P/A)	(H/V)
802.11b		2390	55.45	-18.55	74	54.51	32.22	4.58	35.86	103	308	P	H
CH 01													
2412MHz		2390	43.54	-10.46	54	42.6	32.22	4.58	35.86	103	308	A	H

1. Path Loss(dB) = Cable loss(dB) + Filter loss(dB) + Attenuator loss(dB)
2. Level(dBμV/m) =
Antenna Factor(dB/m) + Path Loss(dB) + Read Level(dBμV) - Preamp Factor(dB)
3. Over Limit(dB) = Level(dBμV/m) – Limit Line(dBμV/m)

For Peak Limit @ 2390MHz:

1. Level(dBμV/m)
= Antenna Factor(dB/m) + Path Loss(dB) + Read Level(dBμV) - Preamp Factor(dB)
= 32.22(dB/m) + 4.58(dB) + 54.51(dBμV) – 35.86 (dB)
= 55.45 (dBμV/m)
2. Over Limit(dB)
= Level(dBμV/m) – Limit Line(dBμV/m)
= 55.45(dBμV/m) – 74(dBμV/m)
= -18.55(dB)

For Average Limit @ 2390MHz:

1. Level(dBμV/m)
= Antenna Factor(dB/m) + Path Loss(dB) + Read Level(dBμV) - Preamp Factor(dB)
= 32.22(dB/m) + 4.58(dB) + 42.6(dBμV) – 35.86 (dB)
= 43.54 (dBμV/m)
2. Over Limit(dB)
= Level(dBμV/m) – Limit Line(dBμV/m)
= 43.54(dBμV/m) – 54(dBμV/m)
= -10.46(dB)

Both peak and average measured complies with the limit line, so test result is “PASS”.



Appendix B. Radiated Spurious Emission Plots

Test Engineer :	Jack Cheng, Lance Chiang, and Peter Liao	Temperature :	22~25°C
		Relative Humidity :	53~67%

Co-location Mode

WIFI 802.11b and WIFI 802.11a (Harmonic @ 3m)

ANT	11b_Tx_Ch06 + 11a_Tx_Ch44	
Simultaneously	Horizontal	Vertical
<p>Peak</p> <p>Avg.</p>	<p>Site : 09CH12-HY Condition : PEAK(LINEIT) 3m HORN_9120D_1328 HORIZONTAL Detector : Peak Project : 853105 Mode : 158</p>	<p>Site : 09CH12-HY Condition : PEAK(LINEIT) 3m HORN_9120D_1328 VERTICAL Detector : Peak Project : 853105 Mode : 158</p>



Emission below 1GHz

WIFI 802.11b and WIFI 802.11a (LF)

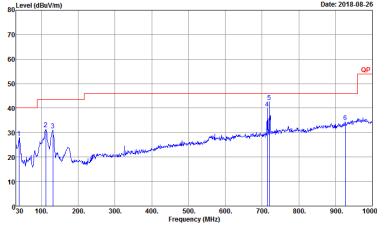
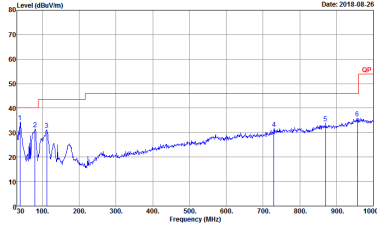
ANT	11b_Tx_Ch06 + 11a_Tx_Ch44 LF	
Simultaneously	Horizontal	Vertical
QP / Peak	 <p data-bbox="483 775 724 831">Site : 03CH12-HY Condition : QP 3m BTL06_6111D_37059 HORIZONTAL Detector : Peak Project : 853105 Mode : 158</p>	 <p data-bbox="957 775 1198 831">Site : 03CH12-HY Condition : QP 3m BTL06_6111D_37059 VERTICAL Detector : Peak Project : 853105 Mode : 158</p>

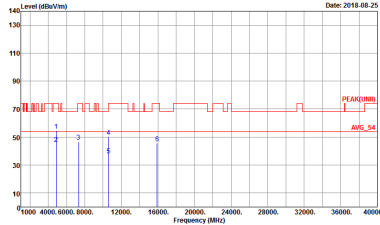
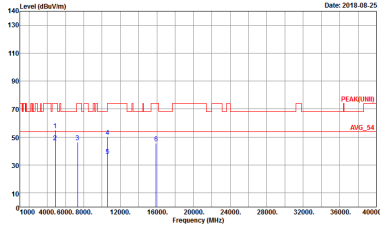

WIFI 802.11b and WIFI 802.11a (Harmonic @ 3m)

ANT	11b_Tx_Ch06 + 11a_Tx_Ch60	
Simultaneously	Horizontal	Vertical
<p>Peak</p> <p>Avg.</p>	 <p>Site : 03CH12-HY Condition : PEAK(UNIT) 3m HORN_91200_1328 HORIZONTAL Detector : Peak Project : 853105 Mode : 159</p>	 <p>Site : 03CH12-HY Condition : PEAK(UNIT) 3m HORN_91200_1328 VERTICAL Detector : Peak Project : 853105 Mode : 159</p>



Emission below 1GHz

WIFI 802.11b and WIFI 802.11a (LF)

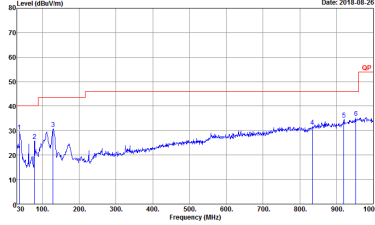
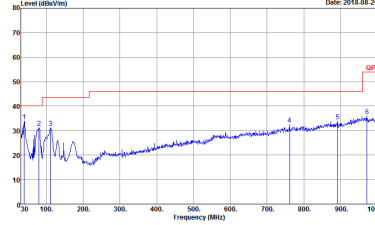
ANT	11b_Tx_Ch06 + 11a_Tx_Ch60 LF	
Simultaneously	Horizontal	Vertical
QP / Peak	 <p>Site : 03CH12-HY Condition : QP 3m 81LO6_6111D_37059 HORIZONTAL Detector : Peak Project : 853105 Mode : 159</p>	 <p>Site : 03CH12-HY Condition : QP 3m 81LO6_6111D_37059 VERTICAL Detector : Peak Project : 853105 Mode : 159</p>

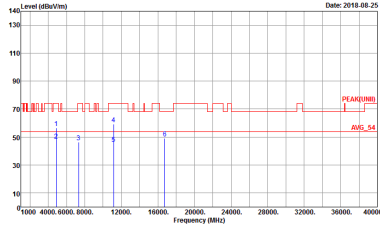
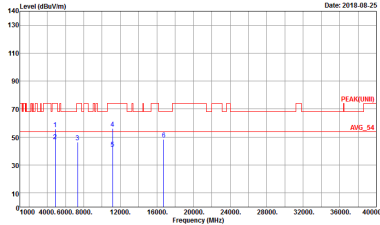

WIFI 802.11b and WIFI 802.11a (Harmonic @ 3m)

ANT	11b_Tx_Ch06 + 11a_Tx_Ch16	
Simultaneously	Horizontal	Vertical
<p>Peak Avg.</p>	 <p>Site : 03CH12-HY Condition : PEAK(UNIT) 3m HORN_9120D_1328 HORIZONTAL Detector : Peak Project : 853105 Mode : 160</p>	 <p>Site : 03CH12-HY Condition : PEAK(UNIT) 3m HORN_9120D_1328 VERTICAL Detector : Peak Project : 853105 Mode : 160</p>



Emission below 1GHz

WIFI 802.11b and WIFI 802.11a (LF)

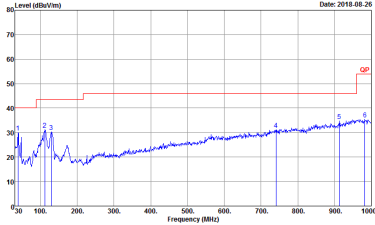
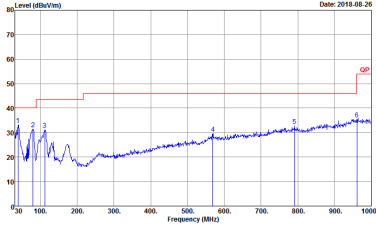
ANT	11b_Tx_Ch06 + 11a_Tx_Ch116 LF	
Simultaneously	Horizontal	Vertical
QP / Peak	 <p data-bbox="488 775 730 831">Site : 03CH12-HY Condition : QP 3m 81L06_6111D_37059 HORIZONTAL Detector : Peak Project : 853105 Mode : 160</p>	 <p data-bbox="963 775 1206 831">Site : 03CH12-HY Condition : QP 3m 81L06_6111D_37059 VERTICAL Detector : Peak Project : 853105 Mode : 160</p>

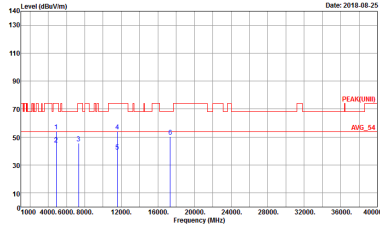
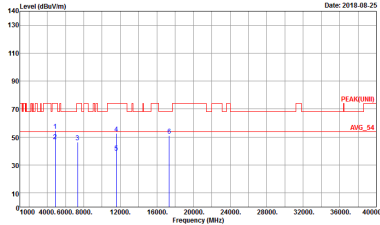

WIFI 802.11b and WIFI 802.11a (Harmonic @ 3m)

ANT	11b_Tx_Ch06 + 11a_Tx_Ch157	
Simultaneously	Horizontal	Vertical
<p>Peak</p> <p>Avg.</p>	 <p>Site : 03CH12-HY Condition : PEAK(UNIT) 3m HORN_91200_1328 HORIZONTAL Detector : Peak Project : 853105 Mode : 161</p>	 <p>Site : 03CH12-HY Condition : PEAK(UNIT) 3m HORN_91200_1328 VERTICAL Detector : Peak Project : 853105 Mode : 161</p>



Emission below 1GHz

WIFI 802.11b and WIFI 802.11a (LF)

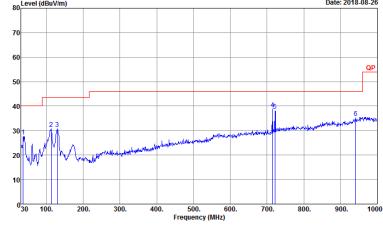
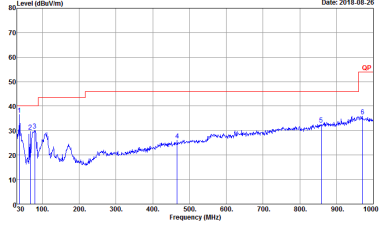
ANT	11b_Tx_Ch06 + 11a_Tx_Ch157 LF	
Simultaneously	Horizontal	Vertical
QP / Peak	 <p>Site : 03CH12-HY Condition : QP 3m BTL06_6111D_37059 HORIZONTAL Detector : Peak Project : 853105 Mode : 161</p>	 <p>Site : 03CH12-HY Condition : QP 3m BTL06_6111D_37059 VERTICAL Detector : Peak Project : 853105 Mode : 161</p>



Appendix C. Duty Cycle Plots

Antenna	Band	Duty Cycle(%)	T(us)	1/T(kHz)	VBW Setting	Duty Factor(dB)
1	802.11b	100.00	1000.00	1.00	10Hz	0.00
2	802.11a	95.31	2030.00	0.49	1kHz	0.21

<Ant. 1>

802.11b

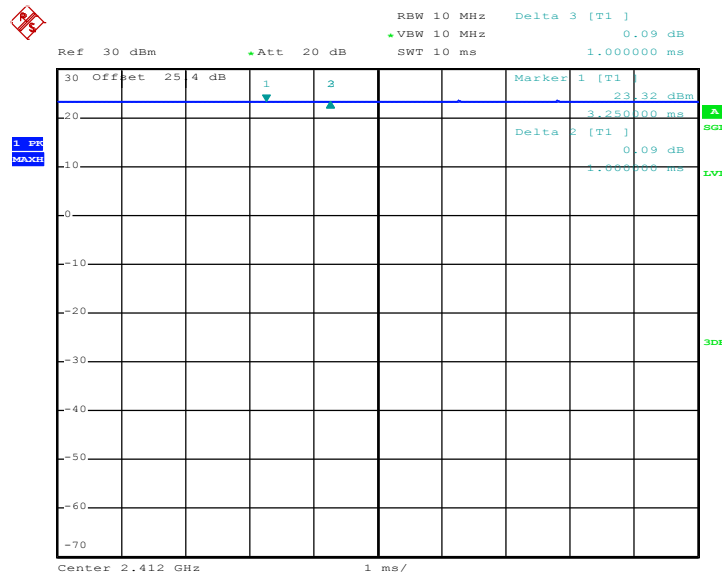

Date: 10.JUL.2018 02:47:45



<Ant. 2>

802.11a

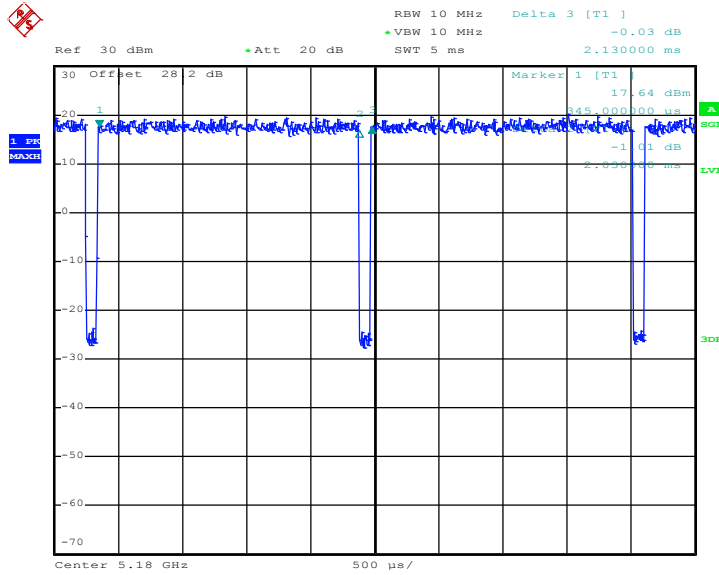

Date: 10.JUL.2018 07:15:00