



# FCC RADIO TEST REPORT

FCC ID : UZ7TC520K  
Equipment : Touch Computer  
Brand Name : Zebra  
Model Name : TC520K  
Applicant : Zebra Technologies Corporation  
1 Zebra Plaza Holtsville, NY 11742  
Manufacturer : Zebra Technologies Corporation  
1 Zebra Plaza Holtsville, NY 11742  
Standard : FCC Part 15 Subpart C §15.247

The product was received on May 31, 2018 and testing was started from Jul. 17, 2018 and completed on Aug. 15, 2018. We, SPORTON INTERNATIONAL INC., would like to declare that the tested sample has been evaluated in accordance with the test procedures and has been in compliance with the applicable technical standards.

The report must not be used by the client to claim product certification, approval, or endorsement by TAF or any agency of government.

The test results in this report apply exclusively to the tested model / sample. Without written approval of SPORTON INTERNATIONAL INC. EMC & Wireless Communications Laboratory, the test report shall not be reproduced except in full.

Approved by: Jones Tsai

**SPORTON INTERNATIONAL INC. EMC & Wireless Communications Laboratory**

No. 52, Huaya 1st Rd., Guishan Dist., Taoyuan City, Taiwan (R.O.C.)



## Table of Contents

<b>History of this test report.....</b>	<b>3</b>
<b>Summary of Test Result.....</b>	<b>4</b>
<b>1 General Description.....</b>	<b>5</b>
1.1 Product Feature of Equipment Under Test.....	5
1.2 Product Specification of Equipment Under Test.....	5
1.3 Modification of EUT .....	6
1.4 Testing Location .....	6
1.5 Applicable Standards.....	6
<b>2 Test Configuration of Equipment Under Test.....</b>	<b>7</b>
2.1 Carrier Frequency Channel .....	7
2.2 Test Mode.....	8
2.3 Connection Diagram of Test System.....	10
2.4 Support Unit used in test configuration and system .....	11
2.5 EUT Operation Test Setup .....	11
2.6 Measurement Results Explanation Example.....	11
<b>3 Test Result.....</b>	<b>12</b>
3.1 6dB and 99% Bandwidth Measurement .....	12
3.2 Output Power Measurement.....	21
3.3 Power Spectral Density Measurement .....	23
3.4 Conducted Band Edges and Spurious Emission Measurement .....	31
3.5 Radiated Band Edges and Spurious Emission Measurement .....	40
3.6 AC Conducted Emission Measurement.....	44
3.7 Antenna Requirements.....	46
<b>4 List of Measuring Equipment .....</b>	<b>47</b>
<b>5 Uncertainty of Evaluation.....</b>	<b>49</b>
<b>Appendix A. AC Conducted Emission Test Result</b>	
<b>Appendix B. Radiated Spurious Emission</b>	
<b>Appendix C. Radiated Spurious Emission Plots</b>	
<b>Appendix D. Duty Cycle Plots</b>	
<b>Appendix E. Setup Photographs</b>	



### History of this test report

Report No.	Version	Description	Issued Date
FR853105B	01	Initial issue of report	Aug. 29, 2018



## Summary of Test Result

Report Clause	Ref Std. Clause	Test Items	Result (PASS/FAIL)	Remark
3.1	15.247(a)(2)	6dB Bandwidth	Pass	-
3.1	2.1049	99% Occupied Bandwidth	Reporting only	-
3.2	15.247(b)(3)	Peak Output Power	Pass	-
3.3	15.247(e)	Power Spectral Density	Pass	-
3.4	15.247(d)	Conducted Band Edges and Spurious Emission	Pass	-
3.5	15.247(d)	Radiated Band Edges and Spurious Emission	Pass	Under limit 3.28 dB at 61.050 MHz
3.6	15.207	AC Conducted Emission	Pass	Under limit 15.60 dB at 0.287 MHz
3.7	15.203 & 15.247(b)	Antenna Requirement	Pass	-

**Reviewed by: Joseph Lin**

**Report Producer: Polly Tsai**



# 1 General Description

## 1.1 Product Feature of Equipment Under Test

Product Feature	
Equipment	Touch Computer
Brand Name	Zebra
Model Name	TC520K
FCC ID	UZ7TC520K
EUT supports Radios application	NFC WLAN 11a/b/g/n HT20/HT40 WLAN 11ac VHT20/VHT40/VHT80 Bluetooth BR/EDR/LE
HW Version	DV
SW Version	91-09-14.00-ON-U00-STD
FW Version	91-09-14.00-ON-U00-STD
MFD	20-JUL-18
EUT Stage	Engineering Sample

Remark: The above EUT's information was declared by manufacturer.

Specification of Accessories				
Adapter	Brand Name	Zebra	Part Number	PWR-WUA5V12W0US
Battery 1	Brand Name	Zebra	Part Number	BT-000314-50
Battery 2	Brand Name	Zebra	Part Number	BT-000314-01
USB cable	Brand Name	Zebra	Part Number	CBL-TC51-USB1-01
Headset Jumper 1	Brand Name	Zebra	Part Number	CBL-TC51-HDST25-01
Headset Jumper 2	Brand Name	Zebra	Part Number	CBL-TC51-HDST35-01
2.5mm Earphone	Brand Name	Zebra	Part Number	HDST-25MM-PTVP-01
3.5mm Earphone	Brand Name	Zebra	Part Number	HDST-35MM-PTVP-01
Exoskeleton	Brand Name	Zebra	Part Number	SG-TC51-EX01-01
Trigger Handle	Brand Name	Zebra	Part Number	TRG-TC51-SNP1-01
Soft Holster	Brand Name	Zebra	Part Number	SG-TC51-HLSTR1-01
Hand strap	Brand Name	Zebra	Part Number	SG-TC51-BHDSTP1-03
USB-C Adapter	Brand Name	Zebra	Part Number	ADPTR-TC56-USBC-01
USB Type C cable	Brand Name	Zebra	Part Number	N/A

## 1.2 Product Specification of Equipment Under Test

Standards-related Product Specification	
Tx/Rx Frequency Range	2402 MHz ~ 2480 MHz
Number of Channels	40
Carrier Frequency of Each Channel	40 Channel(37 hopping + 3 advertising channel)
Maximum Output Power to Antenna	3.17 dBm (0.0021 W) for 1Mbps 3.32 dBm (0.0021 W) for 2Mbps
99% Occupied Bandwidth	1.030MHz for 1Mbps 2.044MHz for 2Mbps
Antenna Type / Gain	PIFA Antenna type with gain 2.8 dBi
Type of Modulation	Bluetooth LE : GFSK



### 1.3 Modification of EUT

No modifications are made to the EUT during all test items.

### 1.4 Testing Location

Sporton Lab is accredited to ISO 17025 by Taiwan Accreditation Foundation (TAF code : 1190) and the FCC designation No. TW1190 and TW0007 under the FCC 2.948(e) by Mutual Recognition Agreement (MRA) in FCC Test.

<b>Test Site</b>	SPORTON INTERNATIONAL INC.	
<b>Test Site Location</b>	No.52, Huaya 1st Rd., Guishan Dist., Taoyuan City, Taiwan (R.O.C.) TEL: +886-3-327-3456 FAX: +886-3-328-4978	
<b>Test Site No.</b>	<b>Sporton Site No.</b>	
	TH05-HY	CO05-HY

**Note:** The test site complies with ANSI C63.4 2014 requirement.

<b>Test Site</b>	SPORTON INTERNATIONAL INC.	
<b>Test Site Location</b>	No.58, Aly. 75, Ln. 564, Wenhua 3rd, Rd., Guishan Dist., Taoyuan City, Taiwan (R.O.C.) TEL: +886-3-327-0868 FAX: +886-3-327-0855	
<b>Test Site No.</b>	<b>Sporton Site No.</b>	
	03CH12-HY	

**Note:** The test site complies with ANSI C63.4 2014 requirement.

### 1.5 Applicable Standards

According to the specifications of the manufacturer, the EUT must comply with the requirements of the following standards:

- ♦ FCC Part 15 Subpart C §15.247
- ♦ FCC KDB Publication No. 558074 D01 DTS Meas. Guidance v04
- ♦ ANSI C63.10-2013

**Remark:**

1. All test items were verified and recorded according to the standards and without any deviation during the test.
2. This EUT has also been tested and complied with the requirements of FCC Part 15, Subpart B, recorded in a separate test report.



## 2 Test Configuration of Equipment Under Test

### 2.1 Carrier Frequency Channel

Frequency Band	Channel	Freq. (MHz)	Channel	Freq. (MHz)
2400-2483.5 MHz	0	2402	21	2444
	1	2404	22	2446
	2	2406	23	2448
	3	2408	24	2450
	4	2410	25	2452
	5	2412	26	2454
	6	2414	27	2456
	7	2416	28	2458
	8	2418	29	2460
	9	2420	30	2462
	10	2422	31	2464
	11	2424	32	2466
	12	2426	33	2468
	13	2428	34	2470
	14	2430	35	2472
	15	2432	36	2474
	16	2434	37	2476
	17	2436	38	2478
	18	2438	39	2480
	19	2440	-	-
20	2442	-	-	



### 2.2 Test Mode

Channel	Frequency	Bluetooth – LE 1Mbps RF Average Output Power	
		Data Rate / Modulation	
		GFSK	
		1Mbps	
Ch00	2402MHz	2.38	dBm
Ch19	2440MHz	2.12	dBm
Ch39	2480MHz	1.15	dBm

Channel	Frequency	Bluetooth – LE 1Mbps RF Peak Output Power	
		Data Rate / Modulation	
		GFSK	
		1Mbps	
Ch00	2402MHz	3.17	dBm
Ch19	2440MHz	2.90	dBm
Ch39	2480MHz	2.14	dBm

Channel	Frequency	Bluetooth – LE 2Mbps RF Average Output Power	
		Data Rate / Modulation	
		GFSK	
		1Mbps	
Ch00	2402MHz	2.33	dBm
Ch19	2440MHz	2.11	dBm
Ch39	2480MHz	1.12	dBm

Channel	Frequency	Bluetooth – LE 2Mbps RF Peak Output Power	
		Data Rate / Modulation	
		GFSK	
		1Mbps	
Ch00	2402MHz	3.32	dBm
Ch19	2440MHz	3.09	dBm
Ch39	2480MHz	2.30	dBm





- a. The EUT has been associated with peripherals and configuration operated in a manner tended to maximize its emission characteristics in a typical application. Frequency range investigated: conduction emission (150 kHz to 30 MHz), radiation emission (9 kHz to the 10th harmonic of the highest fundamental frequency or to 40 GHz, whichever is lower). For radiated measurement, pre-scanned in three orthogonal panels, X, Y, Z. The worst cases (X plane) were recorded in this report.
- b. AC power line Conducted Emission was tested under maximum output power.

The following summary table is showing all test modes to demonstrate in compliance with the standard.

Summary table of Test Cases	
Test Item	Data Rate / Modulation
	Bluetooth – LE / GFSK
<b>Conducted Test Cases</b>	Mode 1: Bluetooth Tx CH00_2402 MHz_1Mbps Mode 2: Bluetooth Tx CH19_2440 MHz_1Mbps Mode 3: Bluetooth Tx CH39_2480 MHz_1Mbps Mode 4: Bluetooth Tx CH00_2402 MHz_2Mbps Mode 5: Bluetooth Tx CH19_2440 MHz_2Mbps Mode 6: Bluetooth Tx CH39_2480 MHz_2Mbps
<b>Radiated Test Cases</b>	Mode 1: Bluetooth Tx CH00_2402 MHz_1Mbps Mode 2: Bluetooth Tx CH19_2440 MHz_1Mbps Mode 3: Bluetooth Tx CH39_2480 MHz_1Mbps Mode 4: Bluetooth Tx CH00_2402 MHz_2Mbps Mode 5: Bluetooth Tx CH19_2440 MHz_2Mbps Mode 6: Bluetooth Tx CH39_2480 MHz_2Mbps
<b>AC Conducted Emission</b>	Mode 1: WLAN 2.4GHz Link + Bluetooth Link + Rugged Charge/USB Cable + Scanner + without Exoskeleton + Battery 1 + Adapter (SAWA-65-20005A (5V/2.5A)) + Headset Jumper (CBL-TC51-HDST25-01) + Earphone (HDST-25MM-PTVP-01)
<b>Remark:</b> For Radiated Test Cases, the tests were performed with Rugged Charge/USB Cable, Battery 1, Earphone (HDST-25MM-PTVP-01), Headset Jumper (CBL-TC51-HDST25-01), and without Exoskeleton.	

## 2.3 Connection Diagram of Test System

### <Radiated Emission Mode>

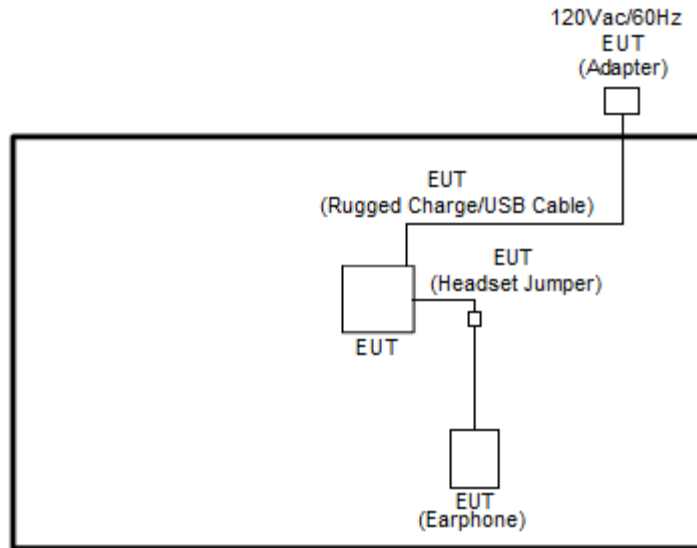

### <AC Conducted Emission Mode>

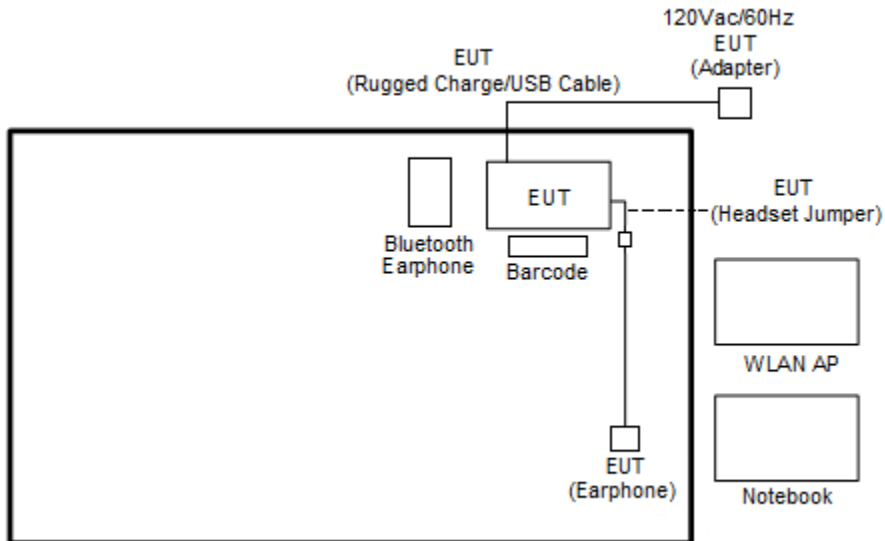



## 2.4 Support Unit used in test configuration and system

Item	Equipment	Trade Name	Model Name	FCC ID	Data Cable	Power Cord
1.	WLAN AP	ASUS	RT-AC66U	MSQ-RTAC66U	N/A	Unshielded, 1.8 m
2.	Bluetooth Earphone	Sony Ericsson	MW600	PY7DDA-2029	N/A	N/A
3.	Notebook	DELL	Latitude E6320	FCC DoC/ Contains FCC ID: QDS-BRCM1054	N/A	AC I/P: Unshielded, 1.2 m DC O/P: Shielded, 1.8 m
4.	SD Card	SanDisk	MicroSD HC	FCC DoC	N/A	N/A

## 2.5 EUT Operation Test Setup

The RF test items, utility “QRCT” was installed in Notebook which was programmed in order to make the EUT get into the engineering modes to provide channel selection, power level, data rate and the application type and for continuous transmitting signals.

## 2.6 Measurement Results Explanation Example

For all conducted test items:

The offset level is set in the spectrum analyzer to compensate the RF cable loss and attenuator factor between EUT conducted output port and spectrum analyzer. With the offset compensation, the spectrum analyzer reading level is exactly the EUT RF output level.

Example :

The spectrum analyzer offset is derived from RF cable loss and attenuator factor.

*Offset = RF cable loss + attenuator factor.*

Following shows an offset computation example with cable loss 4.2 dB and 10dB attenuator.

$$\begin{aligned} \text{Offset(dB)} &= \text{RF cable loss(dB)} + \text{attenuator factor(dB)}. \\ &= 4.2 + 10 = 14.2 \text{ (dB)} \end{aligned}$$

### 3 Test Result

#### 3.1 6dB and 99% Bandwidth Measurement

##### 3.1.1 Limit of 6dB and 99% Bandwidth

The minimum 6 dB bandwidth shall be at least 500 kHz.

##### 3.1.2 Measuring Instruments

See list of measuring equipment of this test report.

##### 3.1.3 Test Procedures

1. The testing follows FCC KDB Publication No. 558074 D01 DTS Meas. Guidance v04.
2. The RF output of EUT was connected to the spectrum analyzer by RF cable and attenuator. The path loss was compensated to the results for each measurement.
3. Set to the maximum power setting and enable the EUT transmit continuously.
4. Make the measurement with the spectrum analyzer's resolution bandwidth (RBW) = 100 kHz. Set the Video bandwidth (VBW) = 300 kHz. In order to make an accurate measurement. The 6 dB bandwidth must be greater than 500 kHz.
5. For 99% Bandwidth Measurement, the spectrum analyzer's resolution bandwidth (RBW) is set 1-5% of the emission bandwidth and set the Video bandwidth (VBW)  $\geq 3 * RBW$ .
6. Measure and record the results in the test report.

##### 3.1.4 Test Setup





3.1.5 Test Result of 6dB Bandwidth

Mod.	Data Rate	NtX	CH.	Freq. (MHz)	6dB BW (MHz)	6dB BW Limit (MHz)	Pass/Fail
BLE	1Mbps	1	0	2402	0.668	0.50	Pass
BLE	1Mbps	1	19	2440	0.672	0.50	Pass
BLE	1Mbps	1	39	2480	0.668	0.50	Pass
BLE	2Mbps	1	0	2402	1.144	0.50	Pass
BLE	2Mbps	1	19	2440	1.144	0.50	Pass
BLE	2Mbps	1	39	2480	1.144	0.50	Pass

<1Mbps>

6 dB Bandwidth Plot on Channel 00

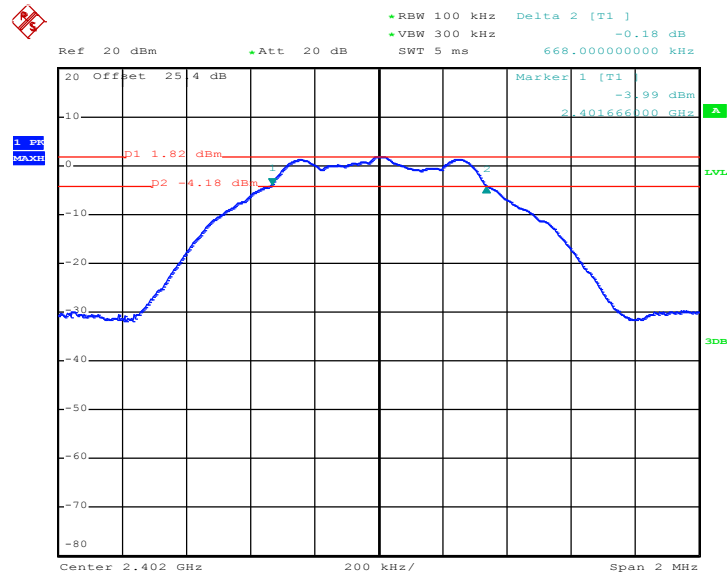

Date: 12.AUG.2018 17:47:36



### 6 dB Bandwidth Plot on Channel 19

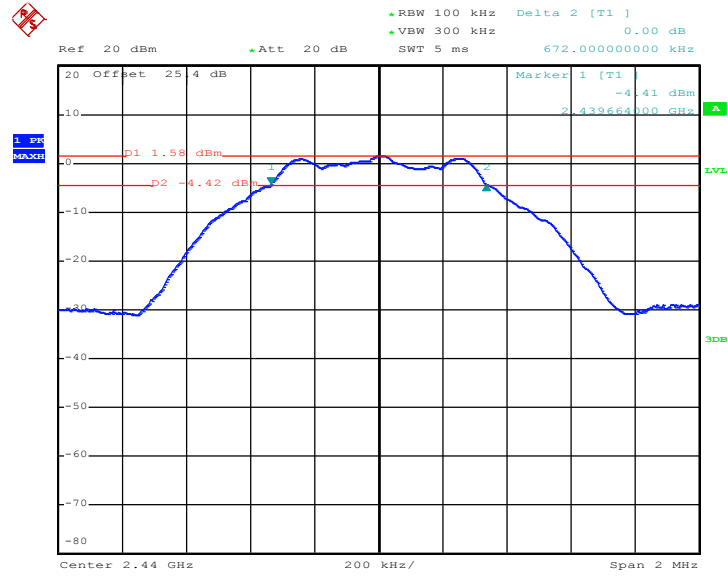

Date: 12.AUG.2018 17:52:20

### 6 dB Bandwidth Plot on Channel 39

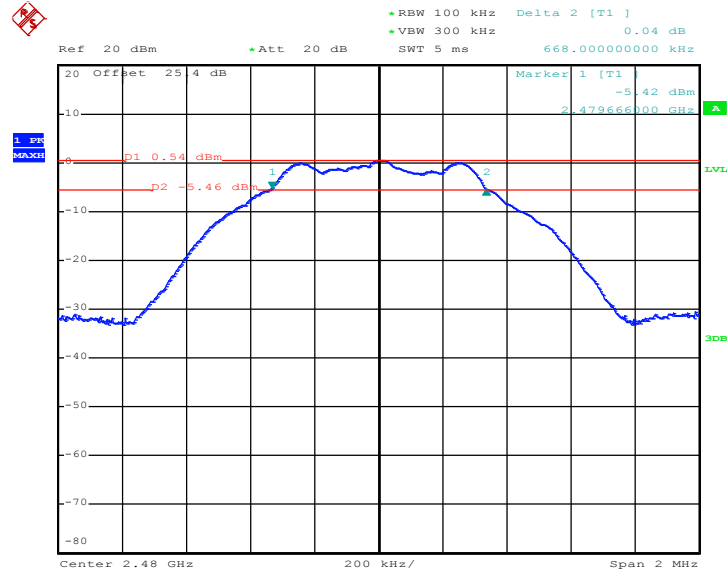

Date: 12.AUG.2018 17:55:32



<2Mbps>

6 dB Bandwidth Plot on Channel 00

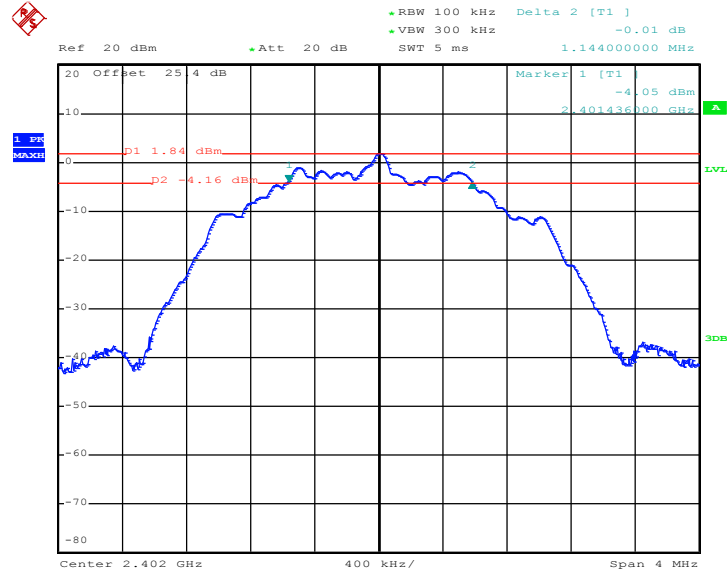

Date: 12.AUG.2018 18:05:01

6 dB Bandwidth Plot on Channel 19

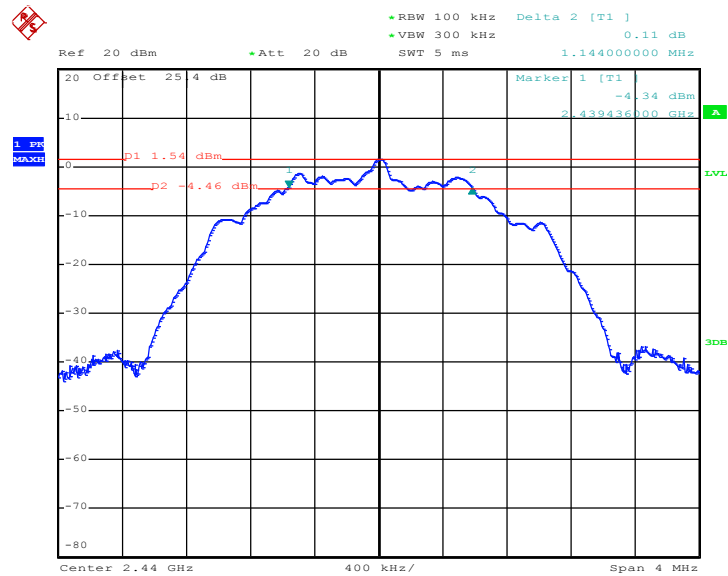

Date: 12.AUG.2018 18:02:18



6 dB Bandwidth Plot on Channel 39

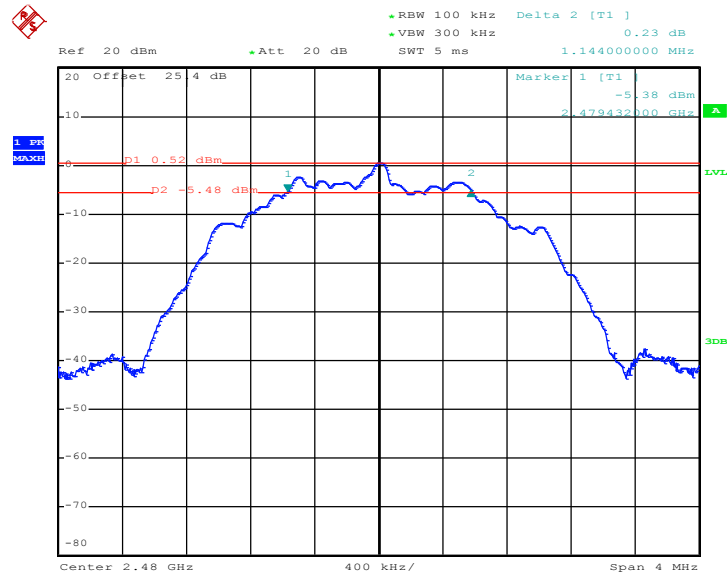

Date: 12.AUG.2018 17:59:53





3.1.6 Test Result of 99% Occupied Bandwidth

Mod.	Data Rate	NTX	CH.	Freq. (MHz)	99% Occupied BW (MHz)	Pass/Fail
BLE	1Mbps	1	0	2402	1.030	Pass
BLE	1Mbps	1	19	2440	1.024	Pass
BLE	1Mbps	1	39	2480	1.030	Pass
BLE	2Mbps	1	0	2402	2.040	Pass
BLE	2Mbps	1	19	2440	2.036	Pass
BLE	2Mbps	1	39	2480	2.044	Pass

<1Mbps>

99% Bandwidth Plot on Channel 00

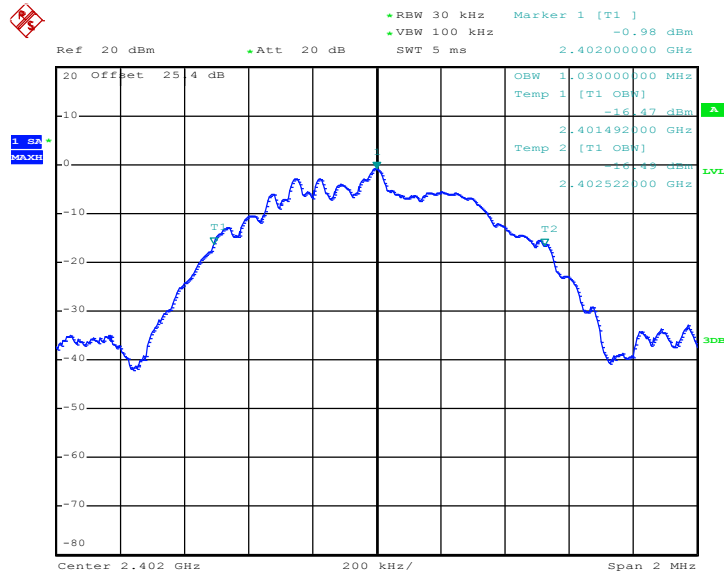

Date: 12.AUG.2018 17:50:26



99% Occupied Bandwidth Plot on Channel 19

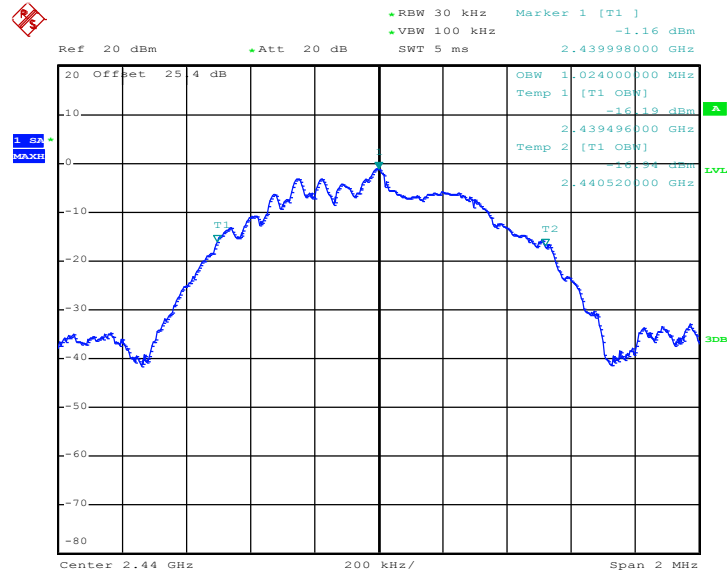

Date: 12.AUG.2018 17:54:35

99% Occupied Bandwidth Plot on Channel 39

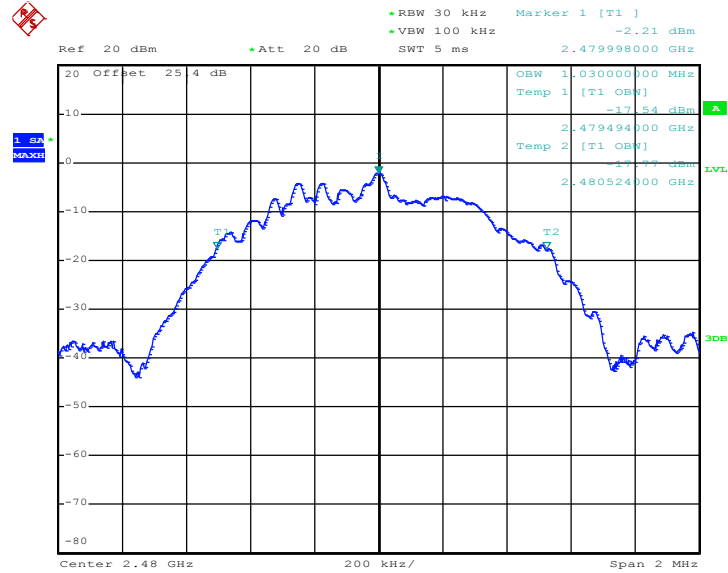

Date: 12.AUG.2018 17:58:29



<2Mbps>

99% Bandwidth Plot on Channel 00

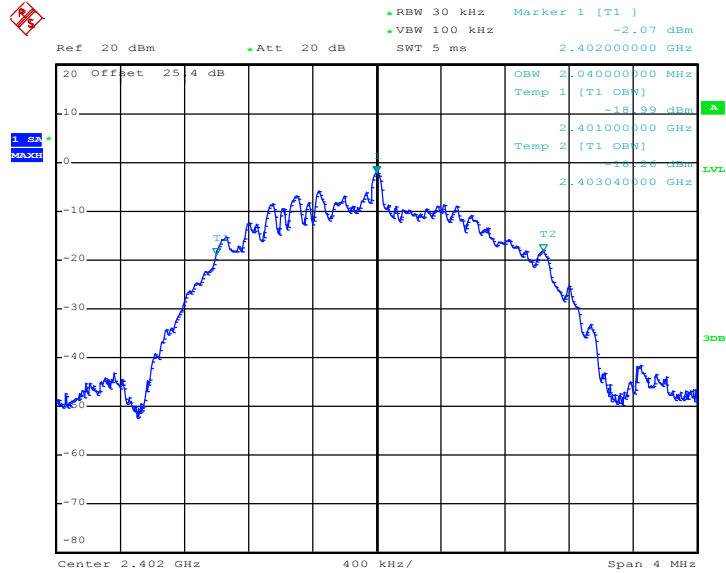

Date: 12.AUG.2018 18:07:07

99% Occupied Bandwidth Plot on Channel 19

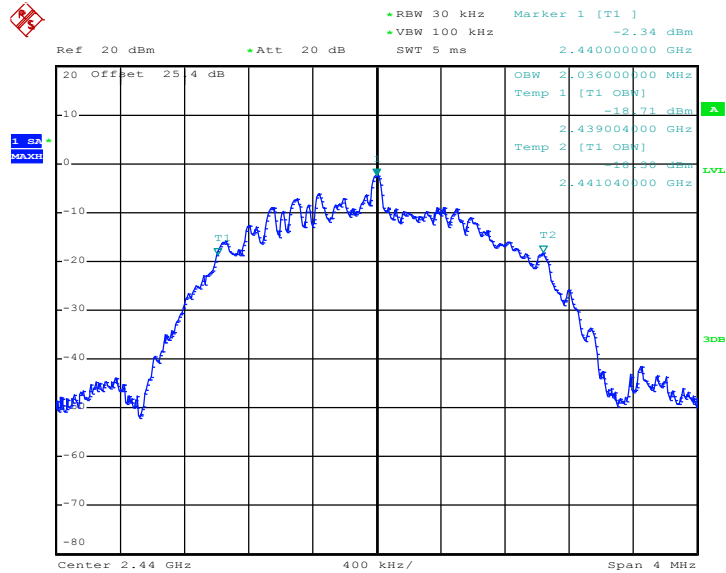

Date: 12.AUG.2018 18:04:02



99% Occupied Bandwidth Plot on Channel 39

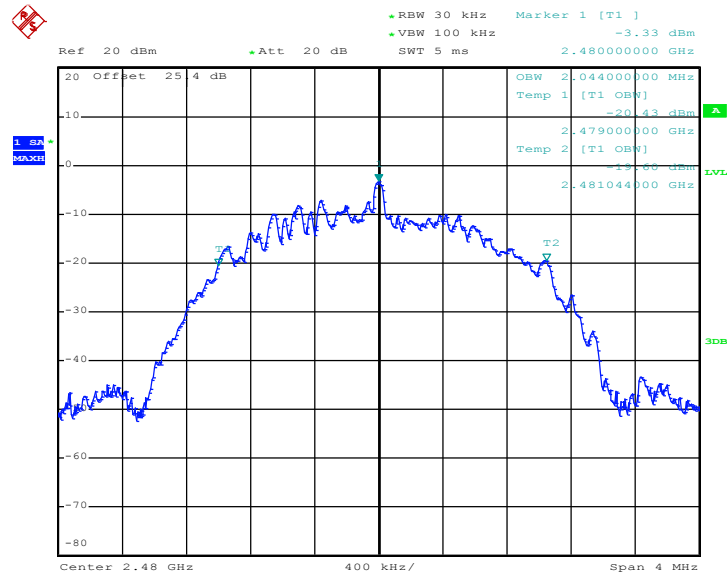

Date: 12.AUG.2018 18:01:37

Note : The occupied channel bandwidth is maintained within the band of operation for all of the modulations.

## 3.2 Output Power Measurement

### 3.2.1 Limit of Output Power

For systems using digital modulation in the 2400-2483.5MHz, the limit for peak output power is 30dBm. If transmitting antenna of directional gain greater than 6dBi is used, the peak output power from the intentional radiator shall be reduced below the above stated value by the amount in dB that the directional gain of the antenna exceeds 6 dBi. In case of point-to-point operation, the limit has to be reduced by 1dB for every 3dB that the directional gain of the antenna exceeds 6dBi.

### 3.2.2 Measuring Instruments

See list of measuring equipment of this test report.

### 3.2.3 Test Procedures

1. For Peak Power, the testing follows the Measurement Procedure of FCC KDB No. 558074 DTS D01 Meas. Guidance v04 section 9.1.3 PKPM1 Peak power meter method.
2. For Average Power, the testing follows the Measurement Procedure of FCC KDB No. 558074 DTS D01 Meas. Guidance v04 section 9.2.3.1 Method AVGPM.
3. The RF output of EUT was connected to the power meter by RF cable and attenuator.
4. The path loss was compensated to the results for each measurement.
5. Set to the maximum power setting and enable the EUT transmit continuously.
6. Measure the conducted output power and record the results in the test report.

### 3.2.4 Test Setup

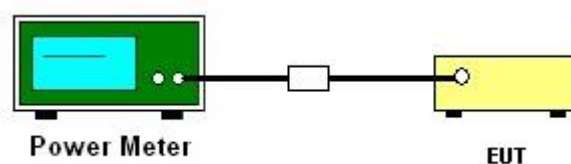



3.2.5 Test Result of Peak Output Power

Mod.	Data Rate	NTX	CH.	Freq. (MHz)	Peak Conducted Power (dBm)	Conducted Power Limit (dBm)	DG (dBi)	EIRP Power (dBm)	EIRP Power Limit (dBm)	Pass /Fail
BLE	1Mbps	1	0	2402	3.17	30.00	2.80	5.97	36.00	Pass
BLE	1Mbps	1	19	2440	2.90	30.00	2.80	5.70	36.00	Pass
BLE	1Mbps	1	39	2480	2.14	30.00	2.80	4.94	36.00	Pass
BLE	2Mbps	1	0	2402	3.32	30.00	2.80	6.12	36.00	Pass
BLE	2Mbps	1	19	2440	3.09	30.00	2.80	5.89	36.00	Pass
BLE	2Mbps	1	39	2480	2.30	30.00	2.80	5.10	36.00	Pass

3.2.6 Test Result of Average Output Power (Reporting Only)

Mod.	Data Rate	NTX	CH.	Freq. (MHz)	Duty Factor (dB)	Average Conducted Power (dBm)
BLE	1Mbps	1	0	2402	2.05	2.38
BLE	1Mbps	1	19	2440	2.05	2.12
BLE	1Mbps	1	39	2480	2.05	1.15
BLE	2Mbps	1	0	2402	4.84	2.33
BLE	2Mbps	1	19	2440	4.84	2.11
BLE	2Mbps	1	39	2480	4.84	1.12

### 3.3 Power Spectral Density Measurement

#### 3.3.1 Limit of Power Spectral Density

The peak power spectral density shall not be greater than 8dBm in any 3kHz band at any time interval of continuous transmission.

#### 3.3.2 Measuring Instruments

See list of measuring equipment of this test report.

#### 3.3.3 Test Procedures

1. The testing follows Measurement Procedure 10.2 Method PKPSD of FCC KDB Publication No. 558074 D01 DTS Meas. Guidance v04
2. The RF output of EUT was connected to the spectrum analyzer by RF cable and attenuator. The path loss was compensated to the results for each measurement.
3. Set to the maximum power setting and enable the EUT transmit continuously.
4. Make the measurement with the spectrum analyzer's resolution bandwidth (RBW) = 3 kHz. Video bandwidth VBW = 10 kHz In order to make an accurate measurement, set the span to 1.5 times DTS Channel Bandwidth. (6dB BW)
5. Detector = peak, Sweep time = auto couple, Trace mode = max hold, Allow trace to fully stabilize. Use the peak marker function to determine the maximum power level.
6. Measure and record the results in the test report.
7. The Measured power density (dBm)/ 100kHz is a reference level and used as 20dBc down limit line for Conducted Band Edges and Conducted Spurious Emission.

#### 3.3.4 Test Setup

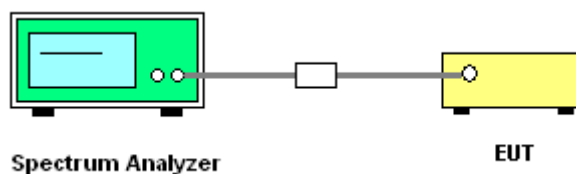



3.3.5 Test Result of Power Spectral Density

Mod.	Data Rate	NTX	CH.	Freq. (MHz)	Peak PSD (dBm /100kHz)	Peak PSD (dBm /3kHz)	DG (dBi)	Peak PSD Limit (dBm /3kHz)	Pass/Fail
BLE	1Mbps	1	0	2402	1.82	-12.89	2.80	8.00	Pass
BLE	1Mbps	1	19	2440	1.57	-13.07	2.80	8.00	Pass
BLE	1Mbps	1	39	2480	0.56	-14.16	2.80	8.00	Pass
BLE	2Mbps	1	0	2402	1.82	-16.39	2.80	8.00	Pass
BLE	2Mbps	1	19	2440	1.55	-16.64	2.80	8.00	Pass
BLE	2Mbps	1	39	2480	0.52	-17.78	2.80	8.00	Pass

3.3.6 Test Result of Power Spectral Density Plots (100kHz)

<1Mbps>

PSD 100kHz Plot on Channel 00

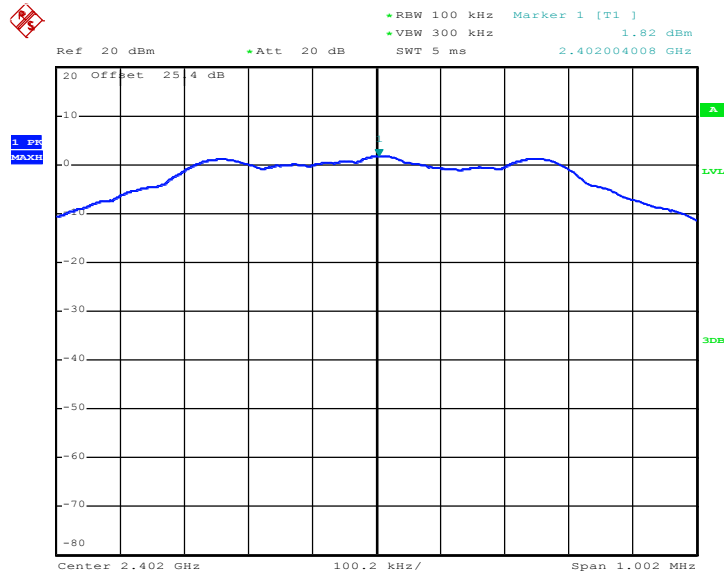

Date: 12.AUG.2018 17:48:22





PSD 100kHz Plot on Channel 19

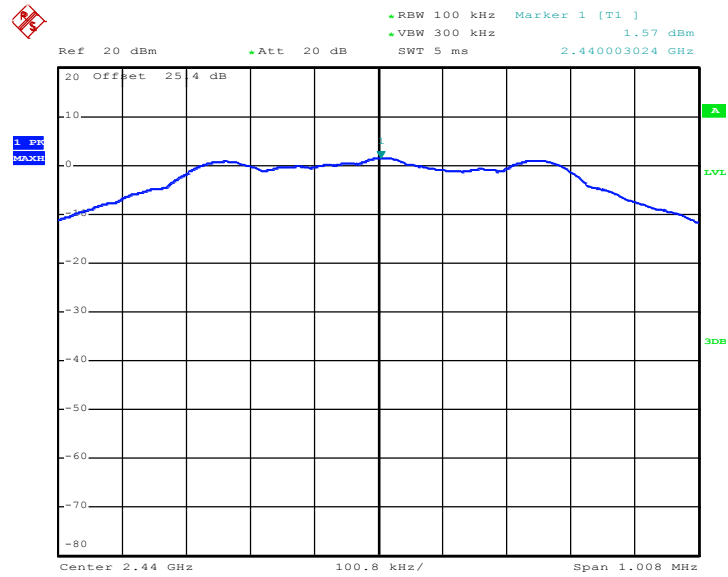

Date: 12.AUG.2018 17:53:39

PSD 100kHz Plot on Channel 39

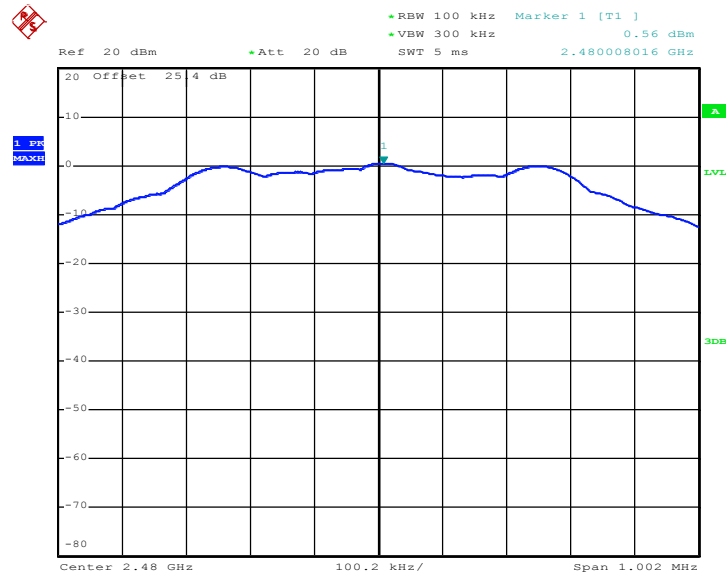

Date: 12.AUG.2018 17:56:53



<2Mbps>

PSD 100kHz Plot on Channel 00

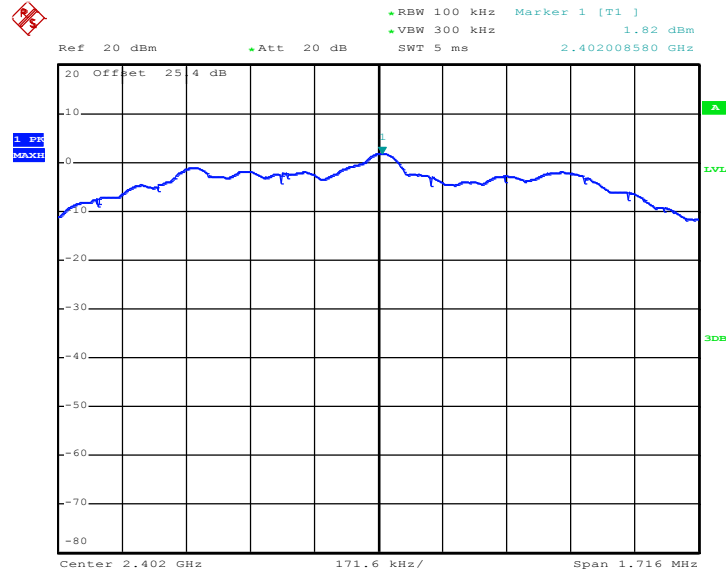

Date: 12.AUG.2018 18:05:44

PSD 100kHz Plot on Channel 19

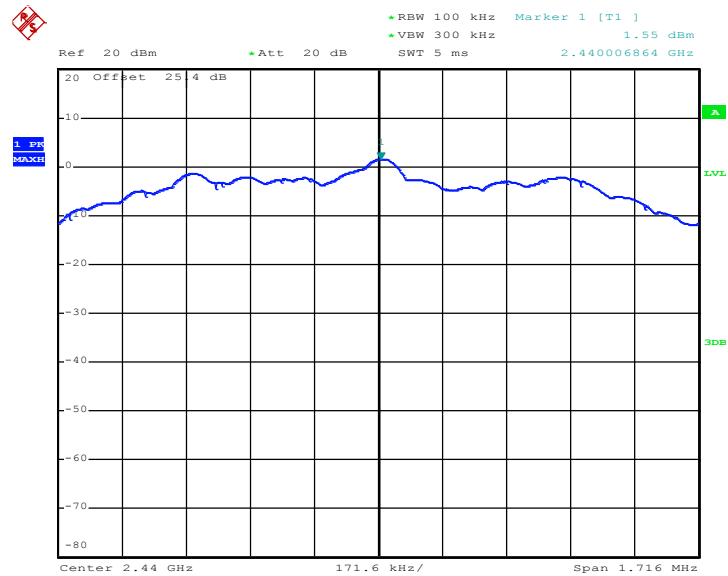

Date: 12.AUG.2018 18:02:56



PSD 100kHz Plot on Channel 39

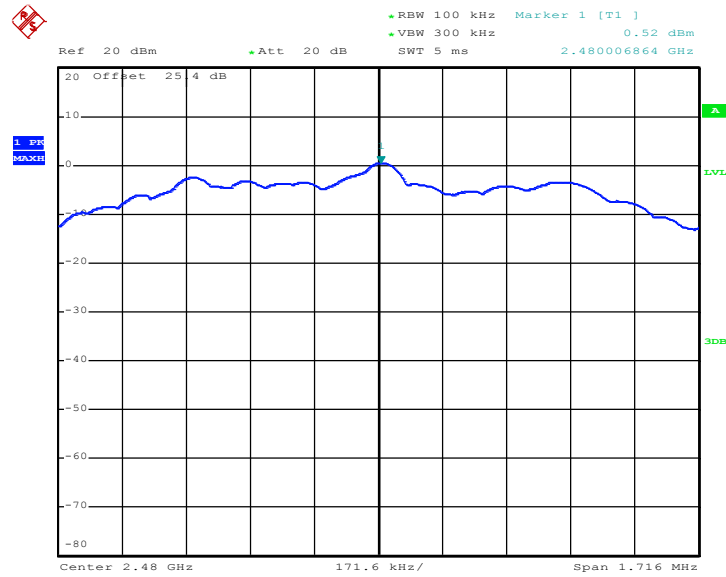

Date: 12.AUG.2018 18:00:27

3.3.7 Test Result of Power Spectral Density Plots (3kHz)

<1Mbps>

PSD 3kHz Plot on Channel 00

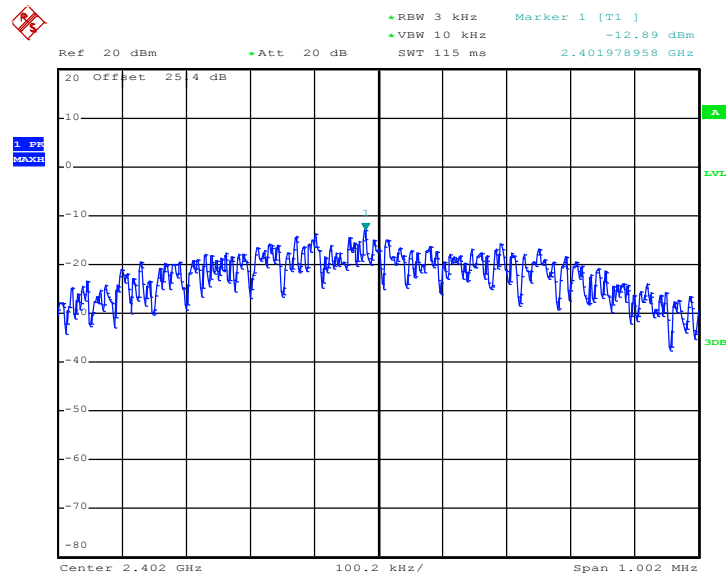

Date: 12.AUG.2018 17:47:54



PSD 3kHz Plot on Channel 19

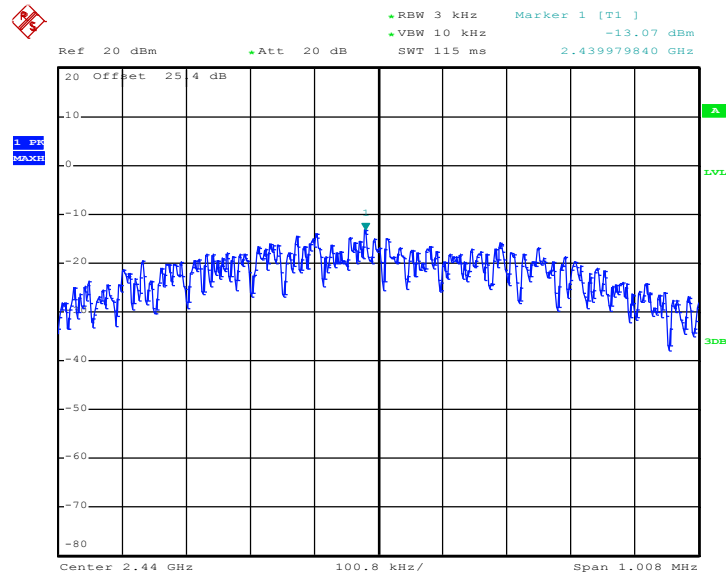

Date: 12.AUG.2018 17:53:19

PSD 3kHz Plot on Channel 39

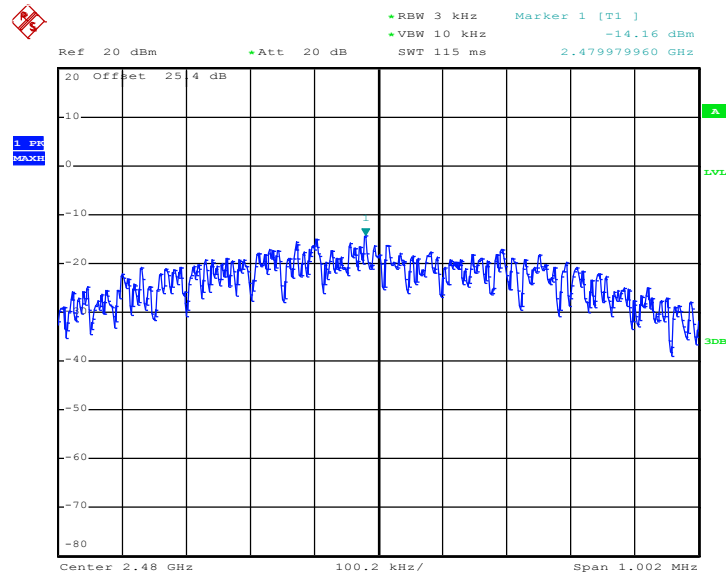

Date: 12.AUG.2018 17:56:07



<2Mbps>

PSD 3kHz Plot on Channel 00

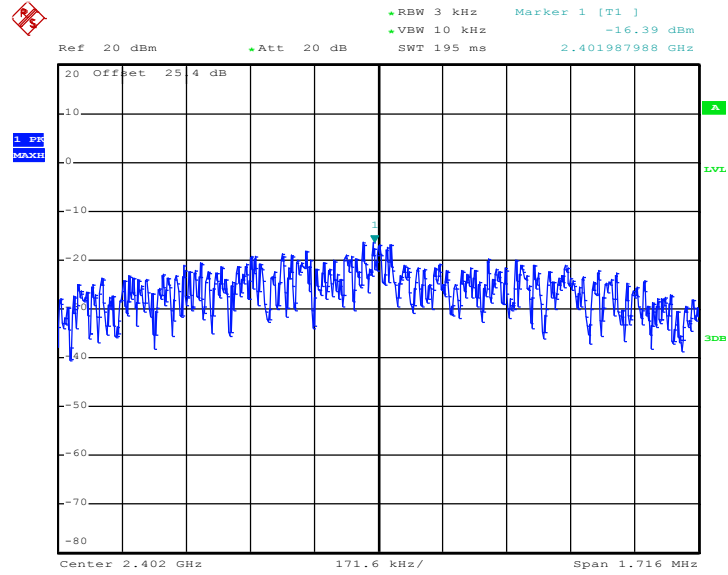

Date: 12.AUG.2018 18:05:25

PSD 3kHz Plot on Channel 19

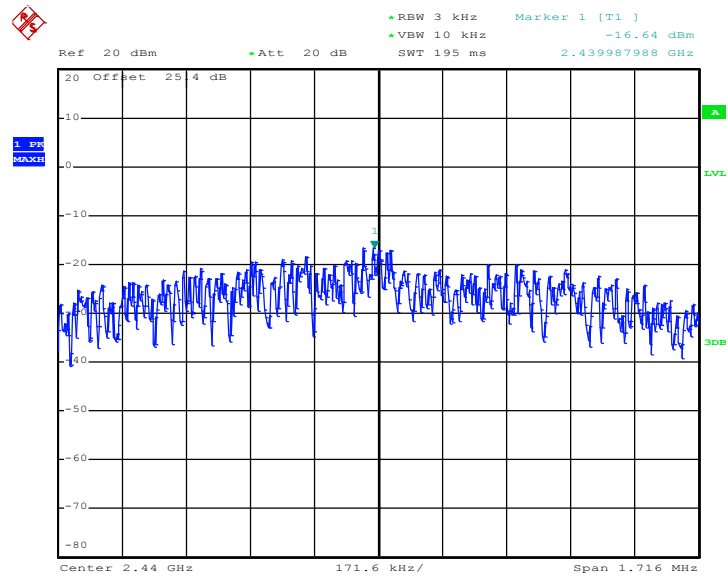

Date: 12.AUG.2018 18:02:38



PSD 3kHz Plot on Channel 39

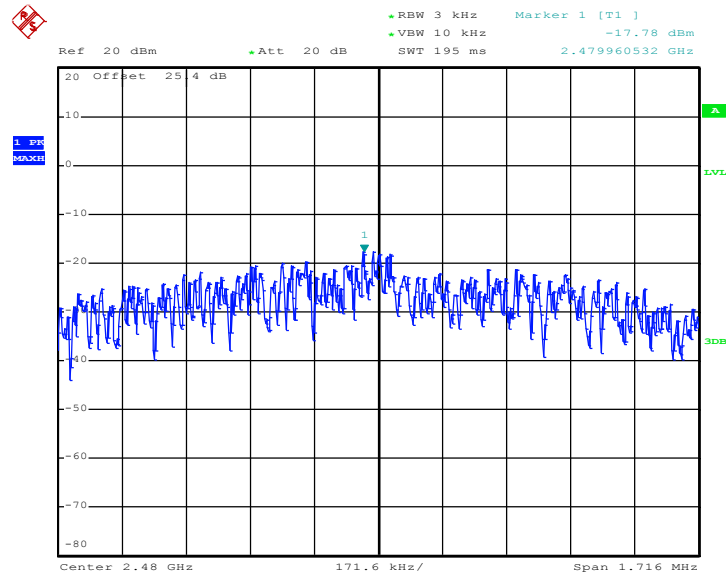

Date: 12.AUG.2018 18:00:07

## 3.4 Conducted Band Edges and Spurious Emission Measurement

### 3.4.1 Limit of Conducted Band Edges and Spurious Emission

All harmonics/spurious must be at least 20 dB down from the highest emission level within the authorized band.

### 3.4.2 Measuring Instruments

See list of measuring equipment of this test report.

### 3.4.3 Test Procedure

1. The testing follows FCC KDB Publication No. 558074 D01 DTS Meas. Guidance v04
2. The RF output of EUT was connected to the spectrum analyzer by RF cable and attenuator. The path loss was compensated to the results for each measurement.
3. Set to the maximum power setting and enable the EUT transmit continuously.
4. Set RBW = 100 kHz, VBW=300 kHz, Peak Detector. Unwanted Emissions measured in any 100 kHz bandwidth outside of the authorized frequency band shall be attenuated by at least 20 dB relative to the maximum in-band peak PSD level in 100 kHz when maximum peak conducted output power procedure is used. If the transmitter complies with the conducted power limits based on the use of RMS averaging over a time interval, the attenuation required under this paragraph shall be 30 dB instead of 20 dB.
5. Measure and record the results in the test report.
6. The RF fundamental frequency should be excluded against the limit line in the operating frequency band.

### 3.4.4 Test Setup

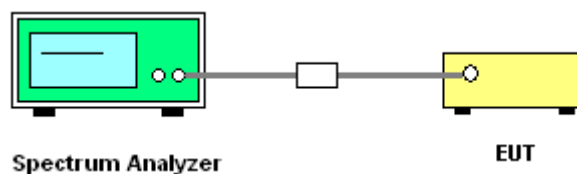



### 3.4.5 Test Result of Conducted Band Edges Plots

<1Mbps>

#### Low Band Edge Plot on Channel 00

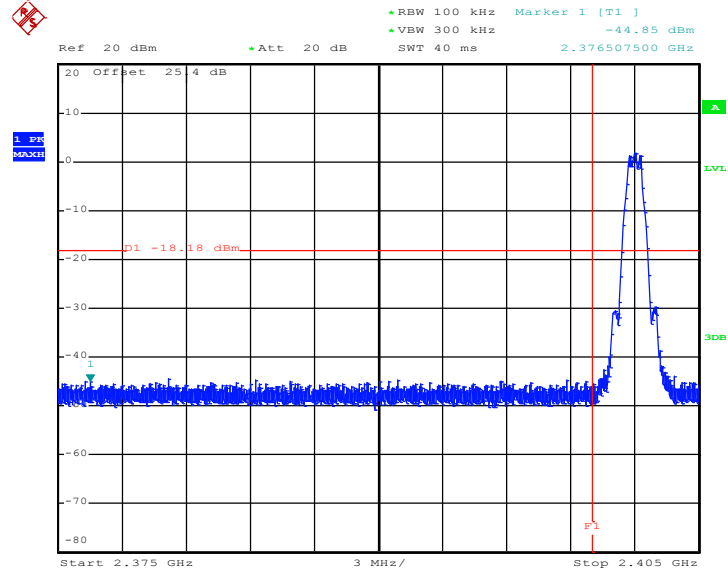

Date: 12.AUG.2018 17:48:55

#### High Band Edge Plot on Channel 39

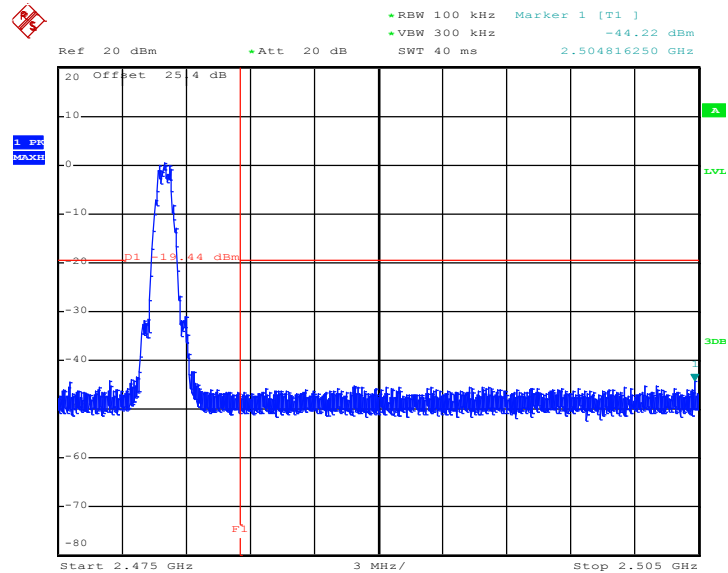

Date: 12.AUG.2018 17:57:42





<2Mbps>

Low Band Edge Plot on Channel 00

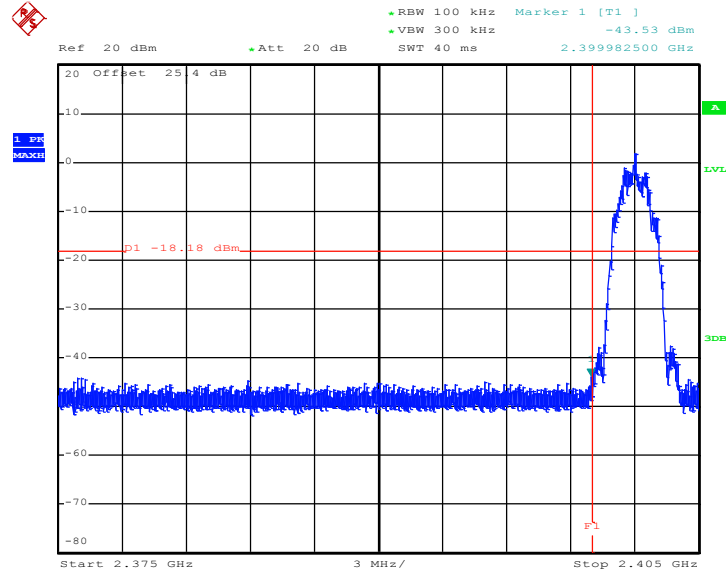

Date: 12.AUG.2018 18:06:02

High Band Edge Plot on Channel 39

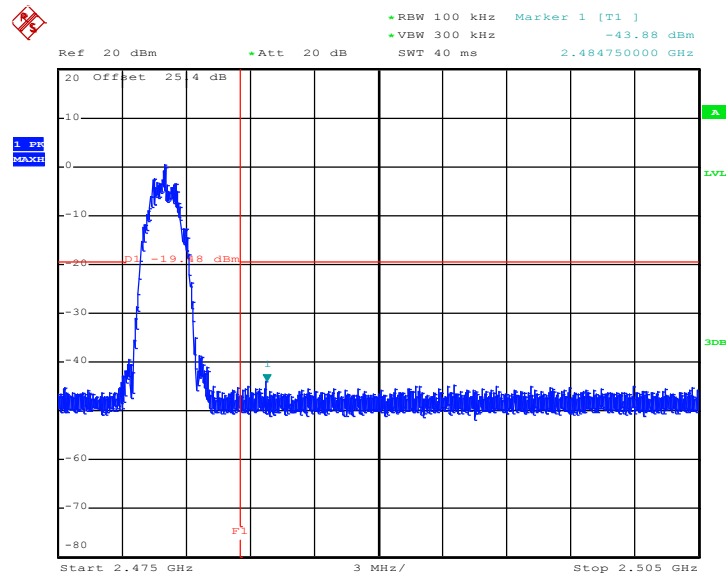

Date: 12.AUG.2018 18:00:46



### 3.4.6 Test Result of Conducted Spurious Emission Plots

#### Conducted Spurious Emission Plot on Bluetooth LE 1Mbps GFSK Channel 00

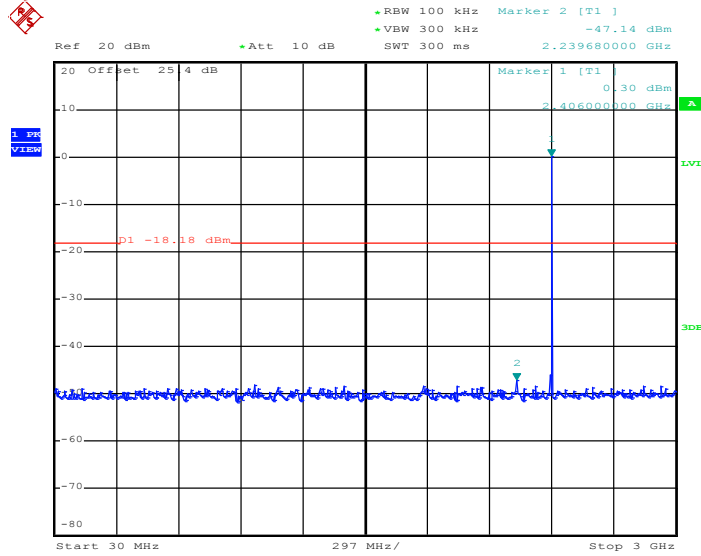

Date: 12.AUG.2018 17:49:32

#### Conducted Spurious Emission Plot on Bluetooth LE 1Mbps GFSK Channel 00

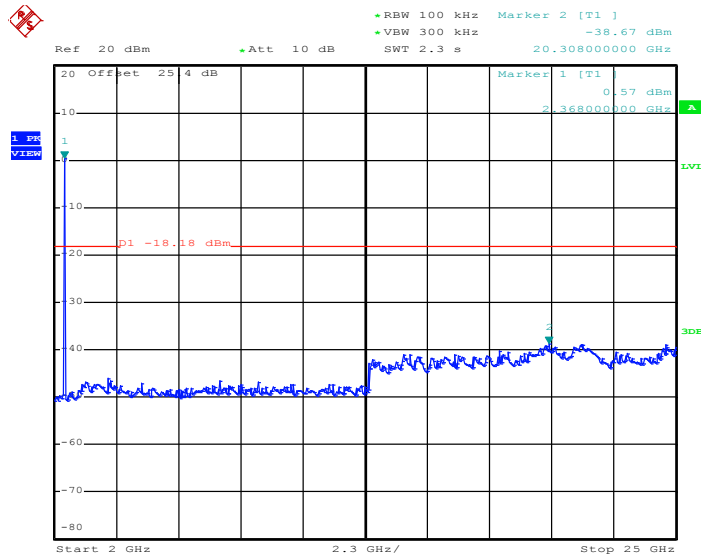

Date: 12.AUG.2018 17:49:49



### Conducted Spurious Emission Plot on Bluetooth LE 1Mbps GFSK Channel 19

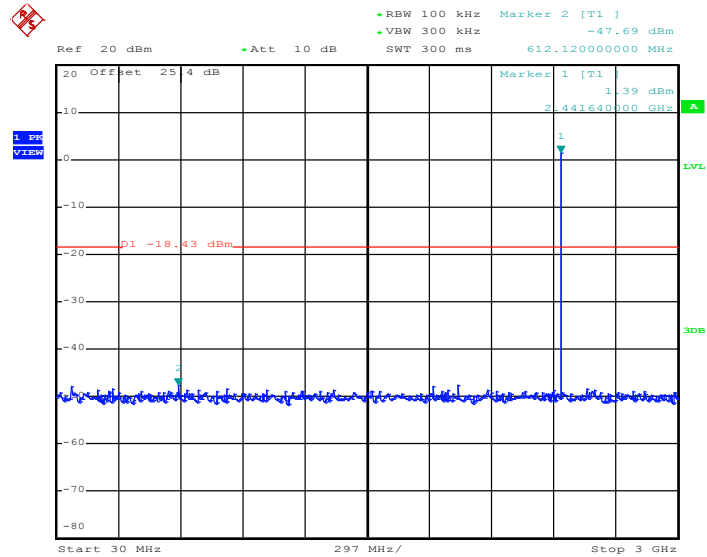

Date: 12.AUG.2018 17:54:02

### Conducted Spurious Emission Plot on Bluetooth LE 1Mbps GFSK Channel 19

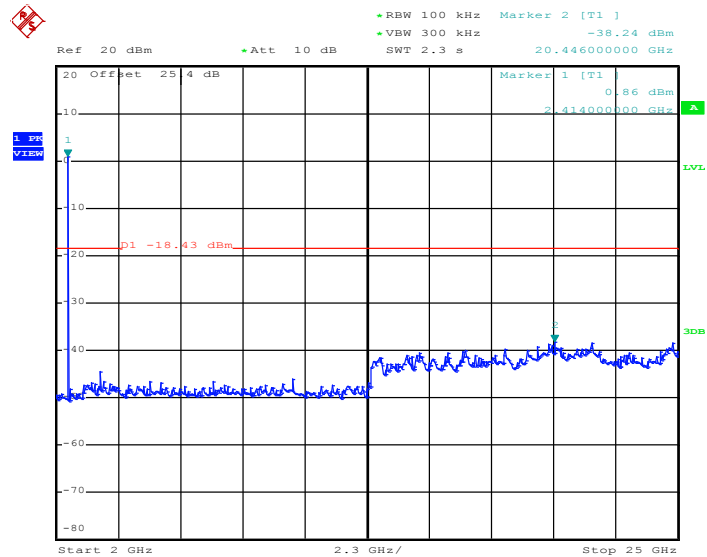

Date: 12.AUG.2018 17:54:21



### Conducted Spurious Emission Plot on Bluetooth LE 1Mbps GFSK Channel 39

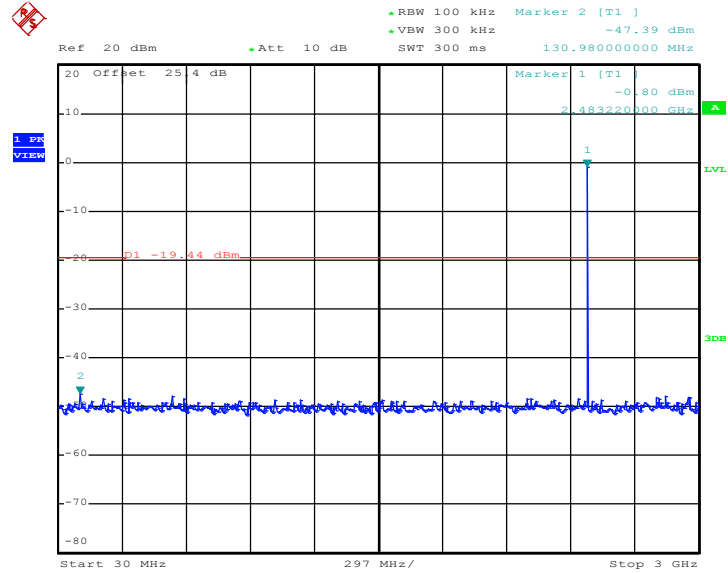

Date: 12.AUG.2018 17:57:57

### Conducted Spurious Emission Plot on Bluetooth LE 1Mbps GFSK Channel 39

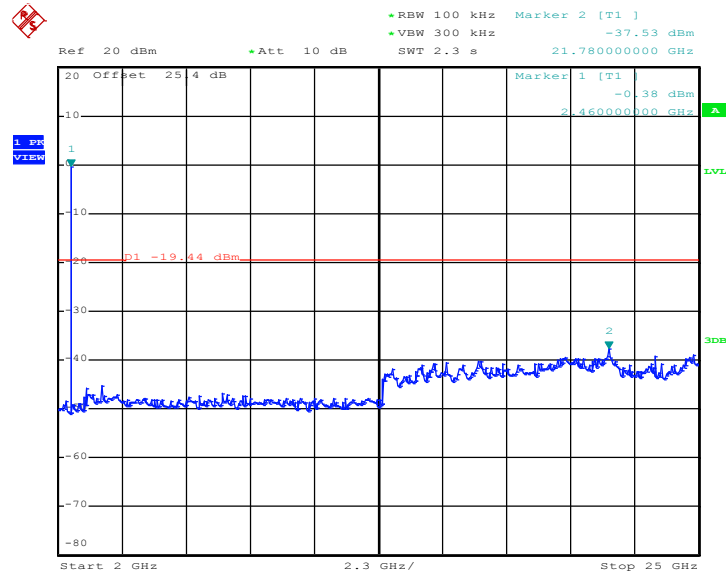

Date: 12.AUG.2018 17:58:11



### Conducted Spurious Emission Plot on Bluetooth LE 2Mbps GFSK Channel 00

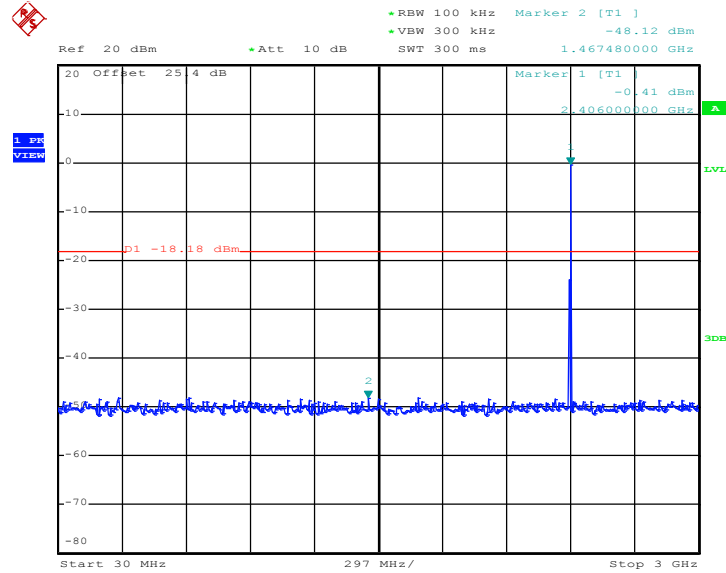

Date: 12.AUG.2018 18:06:23

### Conducted Spurious Emission Plot on Bluetooth LE 2Mbps GFSK Channel 00

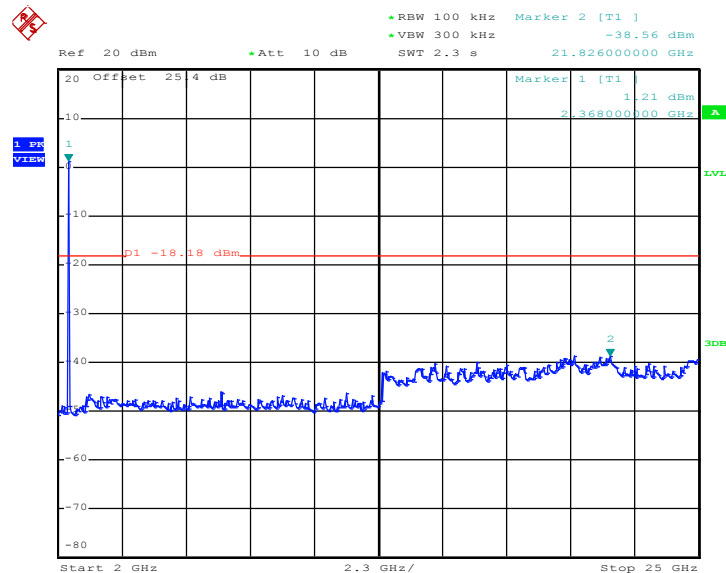

Date: 12.AUG.2018 18:06:37



### Conducted Spurious Emission Plot on Bluetooth LE 2Mbps GFSK Channel 19

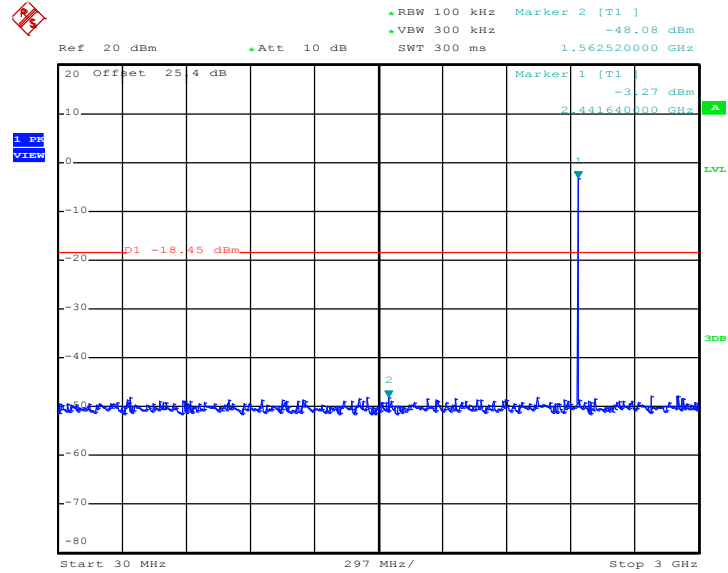

Date: 12.AUG.2018 18:03:16

### Conducted Spurious Emission Plot on Bluetooth LE 2Mbps GFSK Channel 19

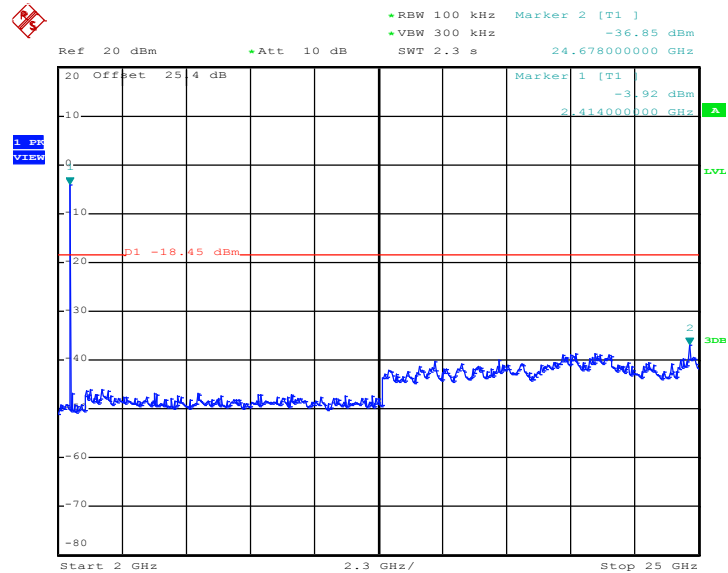

Date: 12.AUG.2018 18:03:44



### Conducted Spurious Emission Plot on Bluetooth LE 2Mbps GFSK Channel 39

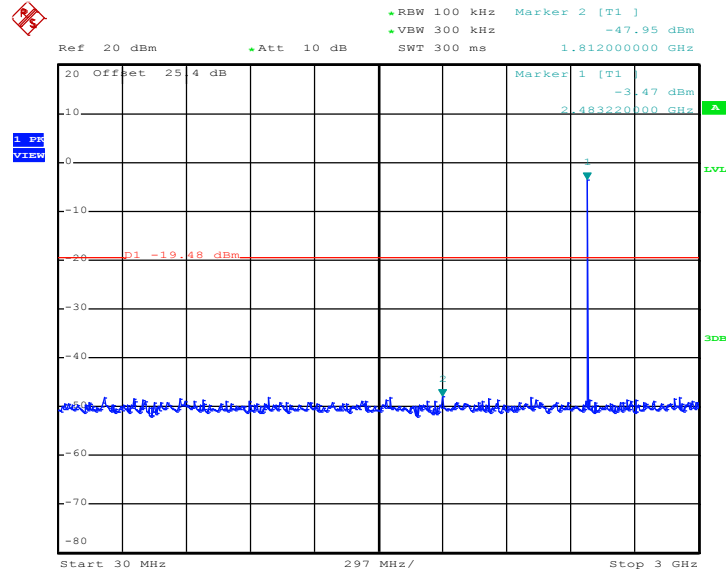

Date: 12.AUG.2018 18:01:05

### Conducted Spurious Emission Plot on Bluetooth LE 2Mbps GFSK Channel 39

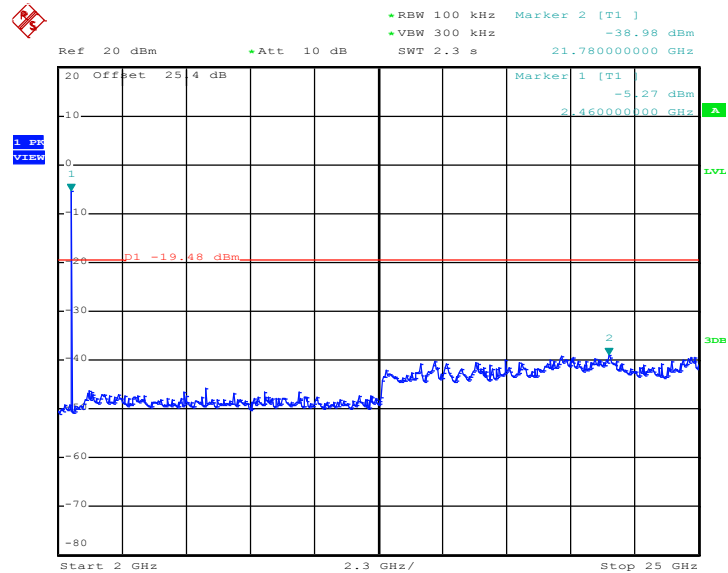

Date: 12.AUG.2018 18:01:20



### 3.5 Radiated Band Edges and Spurious Emission Measurement

#### 3.5.1 Limit of Radiated Band Edges and Spurious Emission

In any 100 kHz bandwidth outside the intentional radiator frequency band, all harmonics/spurious must be at least 20 dB below the highest emission level within the authorized band. If the output power of this device was measured by spectrum analyzer, the attenuation under this paragraph shall be 30 dB instead of 20 dB. In addition, radiated emissions which fall in the restricted bands must also comply with the limits as below.

Frequency (MHz)	Field Strength (microvolts/meter)	Measurement Distance (meters)
0.009 – 0.490	2400/F(kHz)	300
0.490 – 1.705	24000/F(kHz)	30
1.705 – 30.0	30	30
30 – 88	100	3
88 – 216	150	3
216 - 960	200	3
Above 960	500	3

#### 3.5.2 Measuring Instruments

See list of measuring equipment of this test report.





### 3.5.3 Test Procedures

1. The testing follows FCC KDB Publication No. 558074 D01 DTS Meas. Guidance v04
2. The EUT was arranged to its worst case and then tune the antenna tower (from 1 m to 4 m) and turntable (from 0 degree to 360 degrees) to find the maximum reading. A pre-amp and a high pass filter are used for the test in order to get better signal level.
3. The EUT was placed on a turntable with 0.8 meter for frequency below 1GHz and 1.5 meter for frequency above 1GHz respectively above ground.
4. The EUT was set 3 meters from the interference receiving antenna, which was mounted on the top of a variable height antenna tower.
5. Corrected Reading: Antenna Factor + Cable Loss + Read Level - Preamp Factor = Level
6. For testing below 1GHz, if the emission level of the EUT in peak mode was 3 dB lower than the limit specified, then peak values of EUT will be reported, otherwise, the emissions will be repeated one by one using the CISPR quasi-peak method and reported.
7. For testing above 1GHz, the emission level of the EUT in peak mode was 20dB lower than average limit (that means the emission level in average mode also complies with the limit in average mode), then peak values of EUT will be reported, otherwise, the emissions will be measured in average mode again and reported.
8. Use the following spectrum analyzer settings:
  - (1) Span shall wide enough to fully capture the emission being measured;
  - (2) Set RBW=100 kHz for  $f < 1$  GHz;  $VBW \geq RBW$ ; Sweep = auto; Detector function = peak; Trace = max hold;
  - (3) Set RBW = 1 MHz, VBW= 3MHz for  $f \geq 1$  GHz for peak measurement.  
For average measurement:
    - $VBW = 10$  Hz, when duty cycle is no less than 98 percent.
    - $VBW \geq 1/T$ , when duty cycle is less than 98 percent where T is the minimum transmission duration over which the transmitter is on and is transmitting at its maximum power control level for the tested mode of operation.

### 3.5.4 Test Setup

For radiated emissions below 30MHz

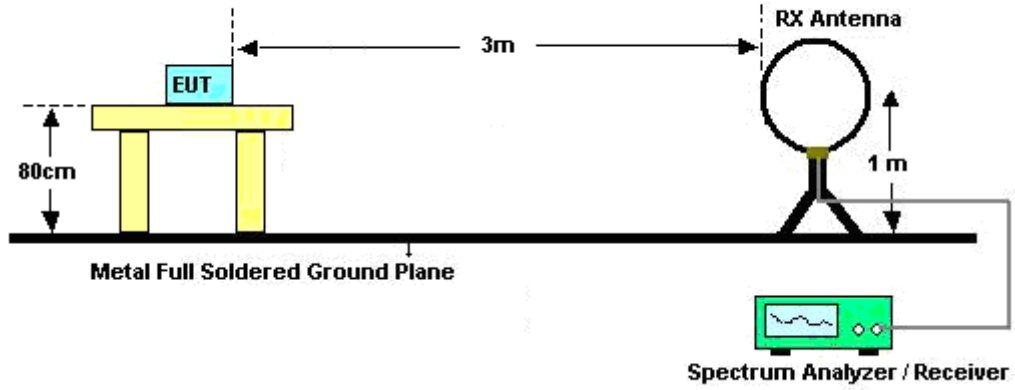

For radiated emissions from 30MHz to 1GHz

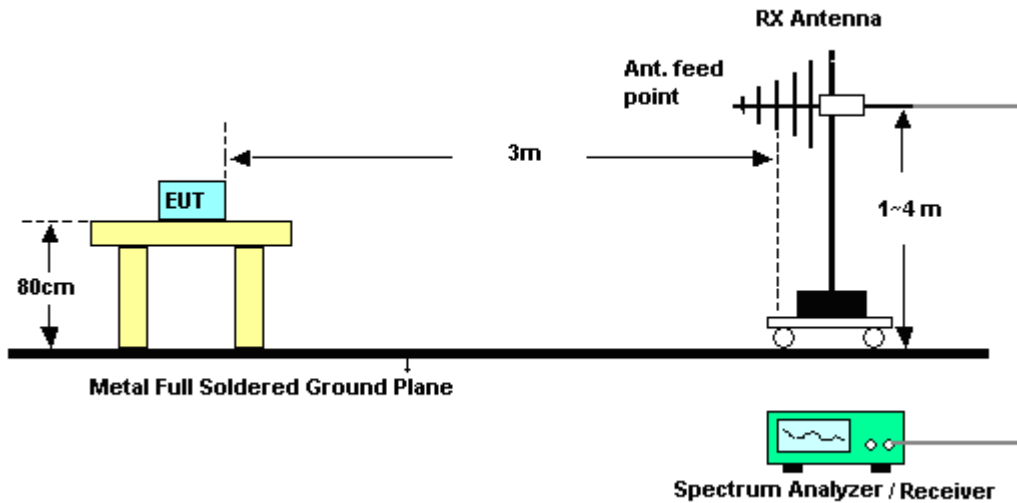

For radiated emissions above 1GHz

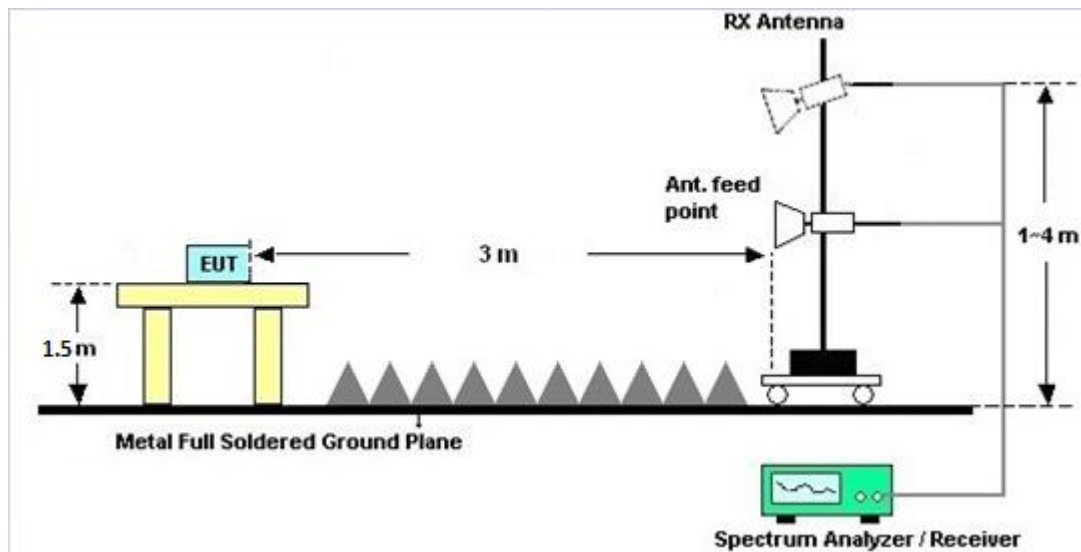

### 3.5.5 Test Results of Radiated Spurious Emissions (9 kHz ~ 30 MHz)

The low frequency, which started from 9 kHz to 30MHz, was pre-scanned and the result which was 20dB lower than the limit line was not reported.

There is a comparison data of both open-field test site and semi-Anechoic chamber, and the result came out very similar.

### 3.5.6 Test Result of Radiated Spurious at Band Edges

Please refer to Appendix B and C.

### 3.5.7 Duty Cycle

Please refer to Appendix D.

### 3.5.8 Test Result of Radiated Spurious Emission (30MHz ~ 10th Harmonic)

Please refer to Appendix B and C.



### 3.6 AC Conducted Emission Measurement

#### 3.6.1 Limit of AC Conducted Emission

For equipment that is designed to be connected to the public utility (AC) power line, the radio frequency voltage that is conducted back onto the AC power line on any frequency or frequencies within the band 150 kHz to 30 MHz shall not exceed the limits in the following table.

Frequency of emission (MHz)	Conducted limit (dB $\mu$ V)	
	Quasi-peak	Average
0.15-0.5	66 to 56*	56 to 46*
0.5-5	56	46
5-30	60	50

\*Decreases with the logarithm of the frequency.

#### 3.6.2 Measuring Instruments

See list of measuring equipment of this test report.

#### 3.6.3 Test Procedures

1. The EUT was placed 0.4 meter from the conducting wall of the shielding room was kept at least 80 centimeters from any other grounded conducting surface.
2. Connect EUT to the power mains through a line impedance stabilization network (LISN).
3. All the support units are connecting to the other LISN.
4. The LISN provides 50 ohm coupling impedance for the measuring instrument.
5. The FCC states that a 50 ohm, 50 microhenry LISN should be used.
6. Both sides of AC line were checked for maximum conducted interference.
7. The frequency range from 150 kHz to 30 MHz was searched.
8. Set the test-receiver system to Peak Detect Function and specified bandwidth (IF Bandwidth = 9kHz) with Maximum Hold Mode. Then measurement is also conducted by Average Detector and Quasi-Peak Detector Function respectively.

### 3.6.4 Test Setup

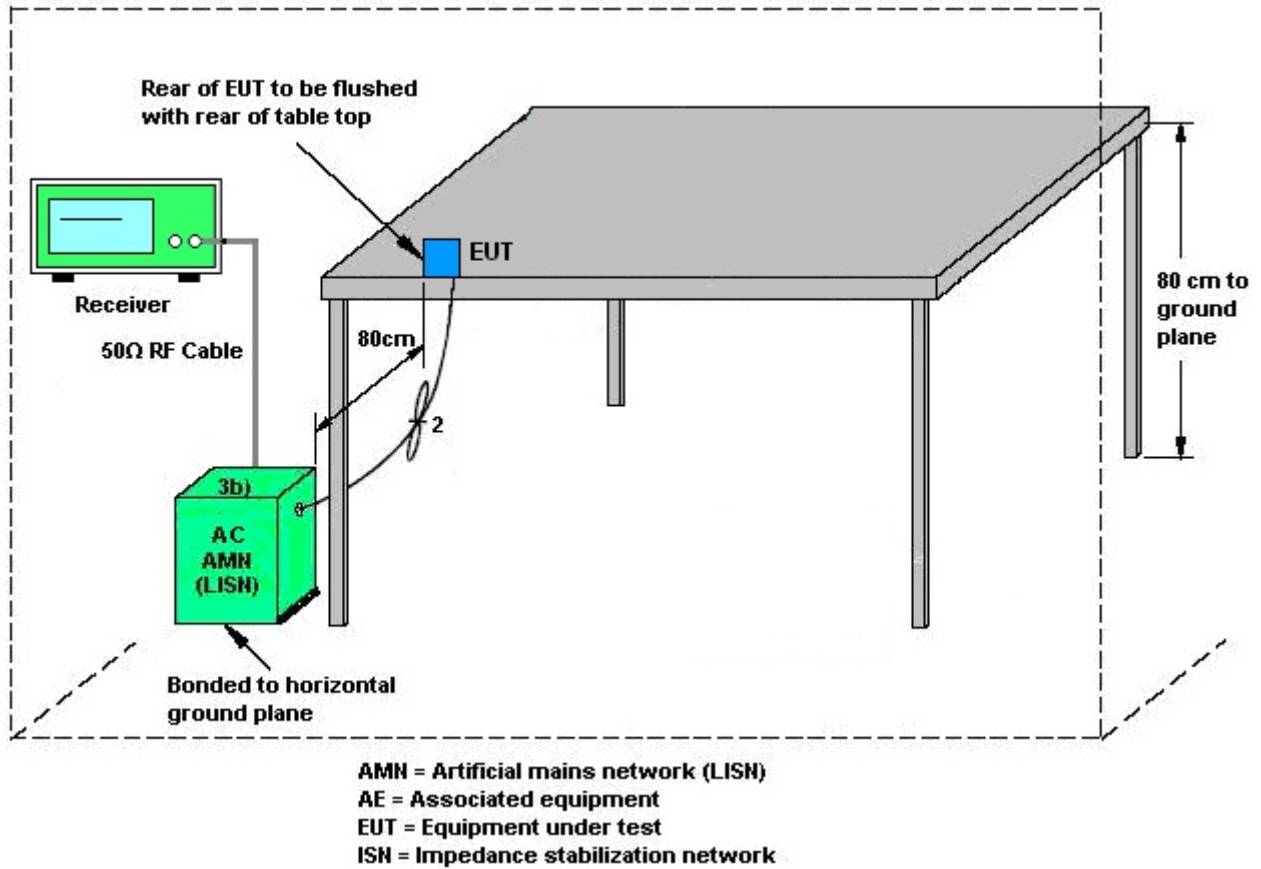

### 3.6.5 Test Result of AC Conducted Emission

Please refer to Appendix A.



## **3.7 Antenna Requirements**

### **3.7.1 Standard Applicable**

If directional gain of transmitting antennas is greater than 6dBi, the power shall be reduced by the same level in dB comparing to gain minus 6dBi. The use of a permanently attached antenna or of an antenna that uses a unique coupling to the intentional radiator shall be considered sufficient to comply with the rule.

### **3.7.2 Antenna Anti-Replacement Construction**

An embedded-in antenna design is used.

### **3.7.3 Antenna Gain**

The antenna peak gain of EUT is less than 6 dBi. Therefore, it is not necessary to reduce maximum peak output power limit.



## 4 List of Measuring Equipment

Instrument	Manufacturer	Model No.	Serial No.	Characteristics	Calibration Date	Test Date	Due Date	Remark
Power Sensor	Agilent	E9327A	US404415 48	50MHz~18GHz	Dec. 20, 2017	Aug. 03, 2018~ Aug. 12, 2018	Dec. 19, 2018	Conducted (TH05-HY)
Spectrum Analyzer	Rohde & Schwarz	FSP30	101067	9kHz ~ 30GHz	Nov. 13, 2017	Aug. 03, 2018~ Aug. 12, 2018	Nov. 12, 2018	Conducted (TH05-HY)
Switch Box & RF Cable	Burgeon	ETF-058	EC130048 4	N/A	Mar. 01, 2018	Aug. 03, 2018~ Aug. 12, 2018	Feb. 28, 2019	Conducted (TH05-HY)
AC Power Source	ChainTek	APC-1000W	N/A	N/A	N/A	Jul. 17, 2018	N/A	Conduction (CO05-HY)
EMI Test Receiver	Rohde & Schwarz	ESR3	102388	3.6GHz	Dec. 08, 2017	Jul. 17, 2018	Dec. 07, 2018	Conduction (CO05-HY)
LISN	Rohde & Schwarz	ENV216	100080	9kHz~30MHz	Nov. 30, 2017	Jul. 17, 2018	Nov. 29, 2018	Conduction (CO05-HY)
Software	Rohde & Schwarz	EMC32 V10.30	N/A	N/A	N/A	Jul. 17, 2018	N/A	Conduction (CO05-HY)
LF Cable	HUBER + SUHNER	RG-214/U	LF01	N/A	Jan. 03, 2018	Jul. 17, 2018	Jan. 02, 2019	Conduction (CO05-HY)
Pulse Limiter	Rohde & Schwarz	ESH3-Z2	100851	N/A	Jan. 03, 2018	Jul. 17, 2018	Jan. 02, 2019	Conduction (CO05-HY)
Loop Antenna	Rohde & Schwarz	HFH2-Z2	100488	9 kHz~30 MHz	Nov. 23, 2017	Aug. 04, 2018~ Aug. 15, 2018	Nov. 22, 2018	Radiation (03CH12-HY)
Bilog Antenna	TESEQ	CBL 6111D&00800 N1D01N-06	37059&01	30MHz~1GHz	Oct. 14, 2017	Aug. 04, 2018~ Aug. 15, 2018	Oct. 13, 2018	Radiation (03CH12-HY)
Horn Antenna	SCHWARZBE CK	BBHA 9120D	9120D-132 8	1GHz ~ 18GHz	Oct. 20, 2017	Aug. 04, 2018~ Aug. 15, 2018	Oct. 19, 2018	Radiation (03CH12-HY)
SHF-EHF Horn Antenna	SCHWARZBE CK	BBHA 9170	BBHA9170 584	18GHz ~ 40GHz	Nov. 27, 2017	Aug. 04, 2018~ Aug. 15, 2018	Nov. 26, 2018	Radiation (03CH12-HY)
Preamplifier	COM-POWER	PA-103	161075	10MHz~1GHz	Mar. 26, 2018	Aug. 04, 2018~ Aug. 15, 2018	Mar. 25, 2019	Radiation (03CH12-HY)
Preamplifier	Keysight	83017A	MY532701 48	1GHz~26.5GHz	Jan. 15, 2018	Aug. 04, 2018~ Aug. 15, 2018	Jan. 14, 2019	Radiation (03CH12-HY)
Preamplifier	MITEQ	AMF-7D-0010 1800-30-10P	1590074	1GHz~18GHz	May 21, 2018	Aug. 04, 2018~ Aug. 15, 2018	May 20, 2019	Radiation (03CH12-HY)
Preamplifier	EMEC	EM18G40G	060715	18GHz ~ 40GHz	Dec. 05, 2017	Aug. 04, 2018~ Aug. 15, 2018	Dec. 04, 2018	Radiation (03CH12-HY)
EMI Test Receiver	Rohde & Schwarz	ESU26	100390	20Hz~26.5GHz	Dec. 25, 2017	Aug. 04, 2018~ Aug. 15, 2018	Dec. 24, 2018	Radiation (03CH12-HY)
Filter	Wainwright	WHKX12-270 0-3000-18000 -60ST	SN2	3 GHz Highpass	Mar. 21, 2018	Aug. 04, 2018~ Aug. 15, 2018	Mar. 20, 2019	Radiation (03CH12-HY)
Filter	Wainwright	WLJ4-1000-1 530-6000-40S T	SN3	1.53 GHz Lowpass	Mar. 21, 2018	Aug. 04, 2018~ Aug. 15, 2018	Mar. 20, 2019	Radiation (03CH12-HY)



Instrument	Manufacturer	Model No.	Serial No.	Characteristics	Calibration Date	Test Date	Due Date	Remark
RF Cable	HUBER + SUHNER	SUCOFLEX 104	MY15539/4	30M-18G	Mar. 14, 2018	Aug. 04, 2018~ Aug. 15, 2018	Mar. 13, 2019	Radiation (03CH12-HY)
RF Cable	HUBER + SUHNER	SUCOFLEX 102	505134/2	30M~40GHz	Oct. 17, 2017	Aug. 04, 2018~ Aug. 15, 2018	Oct. 16, 2018	Radiation (03CH12-HY)
RF Cable	HUBER + SUHNER	SUCOFLEX 102	800740/2	30M~40GHz	Oct. 17, 2017	Aug. 04, 2018~ Aug. 15, 2018	Oct. 16, 2018	Radiation (03CH12-HY)
Antenna Mast	EMEC	AM-BS-4500-B	N/A	1m~4m	N/A	Aug. 04, 2018~ Aug. 15, 2018	N/A	Radiation (03CH12-HY)
Turn Table	EMEC	TT2000	N/A	0~360 Degree	N/A	Aug. 04, 2018~ Aug. 15, 2018	N/A	Radiation (03CH12-HY)
Software	Audix	E3 6.2009-8-24	RK-00098 9	N/A	N/A	Aug. 04, 2018~ Aug. 15, 2018	N/A	Radiation (03CH12-HY)





## 5 Uncertainty of Evaluation

### Uncertainty of Conducted Emission Measurement (150 kHz ~ 30 MHz)

Measuring Uncertainty for a Level of Confidence of 95% ( $U = 2Uc(y)$ )	2.7
---	-----

### Uncertainty of Radiated Emission Measurement (30 MHz ~ 1000 MHz)

Measuring Uncertainty for a Level of Confidence of 95% ( $U = 2Uc(y)$ )	5.1
---	-----

### Uncertainty of Radiated Emission Measurement (1000 MHz ~ 18000 MHz)

Measuring Uncertainty for a Level of Confidence of 95% ( $U = 2Uc(y)$ )	5.2
---	-----

### Uncertainty of Radiated Emission Measurement (18000 MHz ~ 40000 MHz)

Measuring Uncertainty for a Level of Confidence of 95% ( $U = 2Uc(y)$ )	4.7
---	-----



## Appendix A. AC Conducted Emission Test Results

Test Engineer :	Kai-Chun Chu	Temperature :	25~27°C
		Relative Humidity :	50~52%

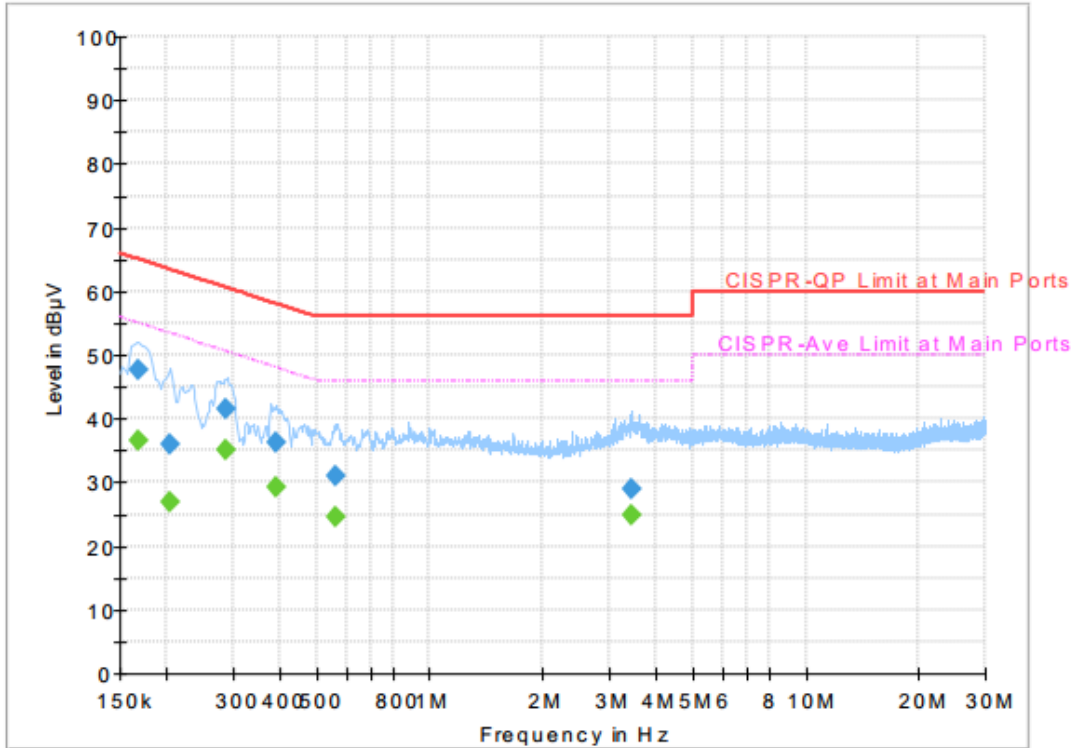

### Final Result

Frequency (MHz)	QuasiPeak (dBµV)	CAverage (dBµV)	Limit (dBµV)	Margin (dB)	Line	Filter	Corr. (dB)
0.168000	---	36.58	55.06	18.48	L1	OFF	19.5
0.168000	47.63	---	65.06	17.43	L1	OFF	19.5
0.204000	---	26.76	53.45	26.69	L1	OFF	19.5
0.204000	35.98	---	63.45	27.47	L1	OFF	19.5
0.287250	---	35.00	50.60	15.60	L1	OFF	19.5
0.287250	41.39	---	60.60	19.21	L1	OFF	19.5
0.390750	---	29.15	48.05	18.90	L1	OFF	19.5
0.390750	36.24	---	58.05	21.81	L1	OFF	19.5
0.559500	---	24.60	46.00	21.40	L1	OFF	19.5
0.559500	30.90	---	56.00	25.10	L1	OFF	19.5
3.432750	---	24.87	46.00	21.13	L1	OFF	19.7
3.432750	28.92	---	56.00	27.08	L1	OFF	19.7

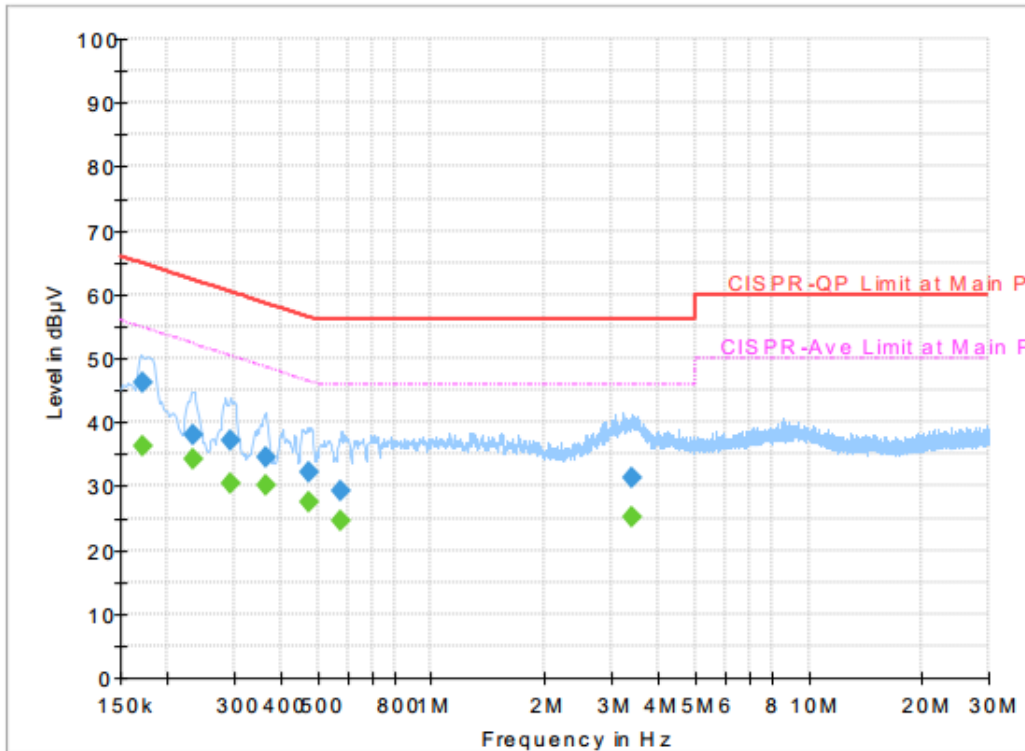

**Final Result**

Frequency (MHz)	QuasiPeak (dBµV)	CAverage (dBµV)	Limit (dBµV)	Margin (dB)	Line	Filter	Corr. (dB)
0.172500	---	36.17	54.84	18.67	N	OFF	19.5
0.172500	46.24	---	64.84	18.60	N	OFF	19.5
0.233250	---	34.11	52.33	18.22	N	OFF	19.5
0.233250	37.93	---	62.33	24.40	N	OFF	19.5
0.294000	---	30.49	50.41	19.92	N	OFF	19.5
0.294000	37.21	---	60.41	23.20	N	OFF	19.5
0.363750	---	30.14	48.64	18.50	N	OFF	19.5
0.363750	34.54	---	58.64	24.10	N	OFF	19.5
0.471750	---	27.41	46.48	19.07	N	OFF	19.5
0.471750	32.22	---	56.48	24.26	N	OFF	19.5
0.577500	---	24.51	46.00	21.49	N	OFF	19.5
0.577500	29.24	---	56.00	26.76	N	OFF	19.5
3.392250	---	25.01	46.00	20.99	N	OFF	19.7
3.392250	31.32	---	56.00	24.68	N	OFF	19.7



## Appendix B. Radiated Spurious Emission

Test Engineer :	Jack Cheng, Lance Chiang, and Peter Liao	Temperature :	22~25°C
		Relative Humidity :	53~62%

### 2.4GHz 2400~2483.5MHz

#### BLE 1Mbps (Band Edge @ 3m)

BLE	Note	Frequency	Level	Over	Limit	Read	Antenna	Path	Preamp	Ant	Table	Peak	Pol.	
		( MHz )	( dBμV/m )	( dB )	Limit	Line	Level	Factor	Loss	Factor	Pos	Pos	Avg.	
					( dBμV/m )	( dBμV )	( dB/m )	( dB )	( dB )	( cm )	( deg )	( P/A )	( H/V )	
BLE CH 00 2402MHz		2338.77	56.51	-17.49	74	44.45	27.03	16.61	31.58	129	141	P	H	
		2358.72	45.51	-8.49	54	33.38	27.07	16.64	31.58	129	141	A	H	
	*	2402	97.34	-	-	85.06	27.15	16.7	31.57	129	141	P	H	
	*	2402	96.67	-	-	84.39	27.15	16.7	31.57	129	141	A	H	
														H
														H
			2377.41	56.06	-17.94	74	43.86	27.11	16.67	31.58	100	86	P	V
			2376.57	45.37	-8.63	54	33.18	27.11	16.66	31.58	100	86	A	V
	*		2402	93	-	-	80.72	27.15	16.7	31.57	100	86	P	V
	*		2402	92.07	-	-	79.79	27.15	16.7	31.57	100	86	A	V
														V
														V
BLE CH 19 2440MHz		2369.64	56.46	-17.54	74	44.28	27.11	16.65	31.58	118	144	P	H	
		2362.36	45.56	-8.44	54	33.43	27.07	16.64	31.58	118	144	A	H	
	*	2440	97.66	-	-	85.19	27.28	16.76	31.57	118	144	P	H	
	*	2440	96.64	-	-	84.17	27.28	16.76	31.57	118	144	A	H	
			2485.09	56.32	-17.68	74	43.7	27.36	16.82	31.56	118	144	P	H
			2484.81	45.67	-8.33	54	33.05	27.36	16.82	31.56	118	144	A	H
			2386.86	55.76	-18.24	74	43.51	27.15	16.68	31.58	100	75	P	V
			2377.2	45.61	-8.39	54	33.41	27.11	16.67	31.58	100	75	A	V
	*		2440	93.29	-	-	80.82	27.28	16.76	31.57	100	75	P	V
	*		2440	92.25	-	-	79.78	27.28	16.76	31.57	100	75	A	V
			2499.02	56.1	-17.9	74	43.41	27.4	16.84	31.55	100	75	P	V
			2495.31	45.82	-8.18	54	33.13	27.4	16.84	31.55	100	75	A	V



<b>BLE CH 39 2480MHz</b>	*	2482	97.78	-	-	85.16	27.36	16.82	31.56	116	145	P	H
	*	2480	96.61	-	-	83.99	27.36	16.82	31.56	116	145	A	H
		2490.88	56.62	-17.38	74	43.95	27.4	16.83	31.56	116	145	P	H
		2495.16	45.55	-8.45	54	32.86	27.4	16.84	31.55	116	145	A	H
													H
													H
	*	2480	93.27	-	-	80.65	27.36	16.82	31.56	100	229	P	V
	*	2480	92.25	-	-	79.63	27.36	16.82	31.56	100	229	A	V
		2493.04	57.06	-16.94	74	44.38	27.4	16.83	31.55	100	229	P	V
		2499.04	46.15	-7.85	54	33.46	27.4	16.84	31.55	100	229	A	V
													V
													V
<b>Remark</b>	1. No other spurious found. 2. All results are PASS against Peak and Average limit line.												



2.4GHz 2400~2483.5MHz  
BLE 1Mbps (Harmonic @ 3m)

BLE	Note	Frequency ( MHz )	Level ( dBµV/m )	Over Limit ( dB )	Limit Line ( dBµV/m )	Read Level ( dBµV )	Antenna Factor ( dB/m )	Path Loss ( dB )	Preamp Factor ( dB )	Ant Pos ( cm )	Table Pos ( deg )	Peak Avg. ( P/A )	Pol. ( H/V )	
BLE CH 00 2402MHz		4804	41.08	-32.92	74	56.93	31.32	10.42	57.59	100	0	P	H	
													H	
													H	
													H	
			4804	42.91	-31.09	74	58.76	31.32	10.42	57.59	100	0	P	V
														V
														V
BLE CH 19 2440MHz		4880	39.99	-34.01	74	55.5	31.46	10.47	57.44	100	0	P	H	
		7320	45.91	-28.09	74	54.26	36.15	12.78	57.28	100	0	P	H	
													H	
													H	
			4880	40.34	-33.66	74	55.85	31.46	10.47	57.44	100	0	P	V
			7320	44.97	-29.03	74	53.32	36.15	12.78	57.28	100	0	P	V
														V
BLE CH 39 2480MHz		4960	40.69	-33.31	74	55.83	31.63	10.51	57.28	100	0	P	H	
		7440	45.4	-28.6	74	53.56	36.47	12.8	57.43	100	0	P	H	
													H	
													H	
			4960	39.79	-34.21	74	54.93	31.63	10.51	57.28	100	0	P	V
			7440	45.82	-28.18	74	53.98	36.47	12.8	57.43	100	0	P	V
														V
Remark	1. No other spurious found. 2. All results are PASS against Peak and Average limit line.													



2.4GHz 2400~2483.5MHz

BLE 2Mbps (Band Edge @ 3m)

BLE	Note	Frequency	Level	Over	Limit	Read	Antenna	Path	Preamp	Ant	Table	Peak	Pol.	
		( MHz )	( dBμV/m )	( dB )	( dBμV/m )	( dBμV )	( dB/m )	( dB )	( dB )	( cm )	( deg )	( P/A )	( H/V )	
BLE CH 00 2402MHz		2375.625	56.56	-17.44	74	44.37	27.11	16.66	31.58	143	144	P	H	
		2366.07	46.9	-7.1	54	34.76	27.07	16.65	31.58	143	144	A	H	
	*	2402	98.55	-	-	86.27	27.15	16.7	31.57	143	144	P	H	
	*	2402	96.66	-	-	84.38	27.15	16.7	31.57	143	144	A	H	
													H	
														H
			2360.505	55.95	-18.05	74	43.82	27.07	16.64	31.58	100	84	P	V
			2368.695	47.06	-6.94	54	34.88	27.11	16.65	31.58	100	84	A	V
	*		2402	92.69	-	-	80.41	27.15	16.7	31.57	100	84	P	V
	*		2402	90.65	-	-	78.37	27.15	16.7	31.57	100	84	A	V
														V
														V
BLE CH 19 2440MHz		2358.72	56.05	-17.95	74	43.92	27.07	16.64	31.58	140	143	P	H	
		2351.02	46.51	-7.49	54	34.43	27.03	16.63	31.58	140	143	A	H	
	*	2440	97.62	-	-	85.15	27.28	16.76	31.57	140	143	P	H	
	*	2440	96.54	-	-	84.07	27.28	16.76	31.57	140	143	A	H	
			2490.41	55.68	-18.32	74	43.01	27.4	16.83	31.56	140	143	P	H
			2492.65	47.67	-6.33	54	34.99	27.4	16.83	31.55	140	143	A	H
			2322.32	56.07	-17.93	74	44.09	26.99	16.58	31.59	100	84	P	V
			2350.88	46.55	-7.45	54	34.47	27.03	16.63	31.58	100	84	A	V
	*		2440	93.19	-	-	80.72	27.28	16.76	31.57	100	84	P	V
	*		2440	91.41	-	-	78.94	27.28	16.76	31.57	100	84	A	V
			2491.39	56.39	-17.61	74	43.72	27.4	16.83	31.56	100	84	P	V
			2493.63	46.8	-7.2	54	34.11	27.4	16.84	31.55	100	84	A	V



<b>BLE CH 39 2480MHz</b>	*	2480	98.49	-	-	85.87	27.36	16.82	31.56	140	149	P	H
	*	2480	96.73	-	-	84.11	27.36	16.82	31.56	140	149	A	H
		2488.52	56.68	-17.32	74	44.01	27.4	16.83	31.56	140	149	P	H
		2490.68	46.97	-7.03	54	34.3	27.4	16.83	31.56	140	149	A	H
													H
													H
	*	2480	92.24	-	-	79.62	27.36	16.82	31.56	100	187	P	V
	*	2480	90.4	-	-	77.78	27.36	16.82	31.56	100	187	A	V
		2495.6	56.45	-17.55	74	43.76	27.4	16.84	31.55	100	187	P	V
		2489.76	46.7	-7.3	54	34.03	27.4	16.83	31.56	100	187	A	V
													V
													V
<b>Remark</b>	1. No other spurious found. 2. All results are PASS against Peak and Average limit line.												





2.4GHz 2400~2483.5MHz  
BLE 2Mbps (Harmonic @ 3m)

BLE	Note	Frequency ( MHz )	Level ( dBμV/m )	Over Limit ( dB )	Limit Line ( dBμV/m )	Read Level ( dBμV )	Antenna Factor ( dB/m )	Path Loss ( dB )	Preamp Factor ( dB )	Ant Pos ( cm )	Table Pos ( deg )	Peak Avg. ( P/A )	Pol. ( H/V )	
BLE CH 00 2402MHz		4804	40.12	-33.88	74	55.97	31.32	10.42	57.59	100	0	P	H	
													H	
													H	
													H	
			4804	44.13	-29.87	74	59.98	31.32	10.42	57.59	100	0	P	V
														V
														V
BLE CH 19 2440MHz		4880	40.24	-33.76	74	55.75	31.46	10.47	57.44	100	0	P	H	
		7320	45.71	-28.29	74	54.06	36.15	12.78	57.28	100	0	P	H	
													H	
													H	
			4880	40.37	-33.63	74	55.88	31.46	10.47	57.44	100	0	P	V
			7320	45.17	-28.83	74	53.52	36.15	12.78	57.28	100	0	P	V
														V
BLE CH 39 2480MHz		4960	40.38	-33.62	74	55.52	31.63	10.51	57.28	100	0	P	H	
		7440	45.95	-28.05	74	54.11	36.47	12.8	57.43	100	0	P	H	
													H	
													H	
			4960	40.93	-33.07	74	56.07	31.63	10.51	57.28	100	0	P	V
			7440	45.69	-28.31	74	53.85	36.47	12.8	57.43	100	0	P	V
														V
Remark	1. No other spurious found. 2. All results are PASS against Peak and Average limit line.													



Emission below 1GHz

2.4GHz BLE 2Mbps (LF)

BLE	Note	Frequency	Level	Over	Limit	Read	Antenna	Path	Preamp	Ant	Table	Peak	Pol.	
		( MHz )	( dBμV/m )	( dB )	( dBμV/m )	( dBμV )	( dB/m )	( dB )	( dB )	( cm )	( deg )	( P/A )	( H/V )	
2.4GHz BLE LF		146.64	39.1	-4.4	43.5	50.72	17.01	1.75	30.38	100	0	P	H	
		170.94	38.51	-4.99	43.5	51.47	15.43	1.96	30.35	-	-	P	H	
		244.38	40.31	-5.69	46	50.51	17.74	2.3	30.24	-	-	P	H	
		366.5	31.35	-14.65	46	37.95	20.73	2.7	30.03	-	-	P	H	
		440	31.06	-14.94	46	35.22	22.83	2.91	29.9	-	-	P	H	
		960.1	36.12	-17.88	54	29.68	30.95	4.45	28.96	-	-	P	H	
														H
														H
														H
														H
														H
														H
			48.63	35.94	-4.06	40	50.43	15	0.97	30.46	-	-	P	V
			61.05	36.72	-3.28	40	54.3	11.77	1.11	30.46	100	0	P	V
			244.38	34.05	-11.95	46	44.25	17.74	2.3	30.24	-	-	P	V
			481.3	30.24	-15.76	46	33.55	23.46	3.05	29.82	-	-	P	V
			747.3	36.66	-9.34	46	34.38	27.87	3.82	29.41	-	-	P	V
			962.2	36.13	-17.87	54	29.72	30.93	4.44	28.96	-	-	P	V
														V
														V
													V	
													V	
													V	
													V	
Remark	1. No other spurious found. 2. All results are PASS against limit line.													



**Note symbol**

*	<b>Fundamental Frequency</b> which can be ignored. However, the level of any unwanted emissions shall not exceed the level of the fundamental frequency.
!	Test result is <b>over limit</b> line.
P/A	<b>Peak</b> or <b>Average</b>
H/V	<b>Horizontal</b> or <b>Vertical</b>



A calculation example for radiated spurious emission is shown as below:

BLE	Note	Frequency	Level	Over	Limit	Read	Antenna	Path	Preamp	Ant	Table	Peak	Pol.
		( MHz )	( dBμV/m )	( dB )	( dBμV/m )	( dBμV )	( dB/m )	( dB )	( dB )	( cm )	( deg )	( P/A )	( H/V )
BLE CH 00 2402MHz		2390	55.45	-18.55	74	54.51	32.22	4.58	35.86	103	308	P	H
		2390	43.54	-10.46	54	42.6	32.22	4.58	35.86	103	308	A	H

1. Path Loss(dB) = Cable loss(dB) + Filter loss(dB) + Attenuator loss(dB)
2. Level(dBμV/m) =  
Antenna Factor(dB/m) + Path Loss(dB) + Read Level(dBμV) - Preamp Factor(dB)
3. Over Limit(dB) = Level(dBμV/m) – Limit Line(dBμV/m)

**For Peak Limit @ 2390MHz:**

1. Level(dBμV/m)  
= Antenna Factor(dB/m) + Path Loss(dB) + Read Level(dBμV) - Preamp Factor(dB)  
= 32.22(dB/m) + 4.58(dB) + 54.51(dBμV) – 35.86 (dB)  
= 55.45 (dBμV/m)
2. Over Limit(dB)  
= Level(dBμV/m) – Limit Line(dBμV/m)  
= 55.45(dBμV/m) – 74(dBμV/m)  
= -18.55(dB)

**For Average Limit @ 2390MHz:**

1. Level(dBμV/m)  
= Antenna Factor(dB/m) + Path Loss(dB) + Read Level(dBμV) - Preamp Factor(dB)  
= 32.22(dB/m) + 4.58(dB) + 42.6(dBμV) – 35.86 (dB)  
= 43.54 (dBμV/m)
2. Over Limit(dB)  
= Level(dBμV/m) – Limit Line(dBμV/m)  
= 43.54(dBμV/m) – 54(dBμV/m)  
= -10.46(dB)

**Both peak and average measured complies with the limit line, so test result is “PASS”.**



## Appendix C. Radiated Spurious Emission Plots

Test Engineer :	Jack Cheng, Lance Chiang, and Peter Liao	Temperature :	22~25°C
		Relative Humidity :	53~62%

### Note symbol

-L	Low channel location
-R	High channel location



2.4GHz 2400~2483.5MHz
BLE 1Mbps (Band Edge @ 3m)

Table with 4 quadrants showing spectral plots for Peak and Avg. measurements in Horizontal and Fundamental orientations. Each plot includes a graph of Level (dBuV/m) vs Frequency (MHz) and associated test parameters like Site, Condition, Detector, Project, and Mode.

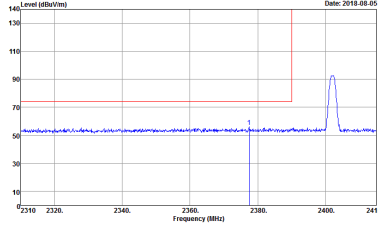
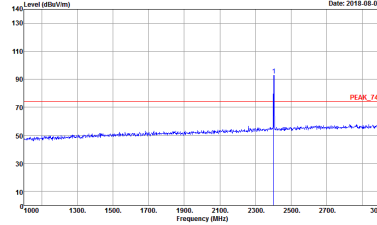
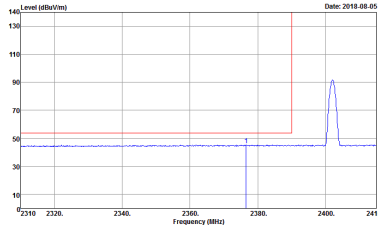
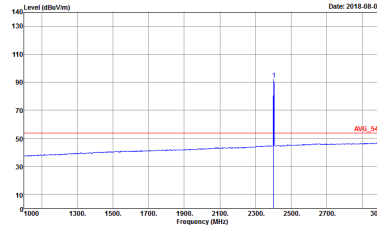

BLE	2.4GHz 2400~2483.5MHz Band Edge @ 3m	
ANT	BLE CH00 2402MHz	
1	Vertical	Fundamental
Peak	 <p>Site : 03CH12-HY            Condition : PEAK_BE_74 3m HORN_9120D_1328 VERTICAL            RBW:3000.000kHz VBW:3000.000kHz SWT:Auto            Detector : Peak            Project : 853105            Mode : 5</p>	 <p>Site : 03CH12-HY            Condition : PEAK_F4 3m HORN_9120D_1328 VERTICAL            RBW:3000.000kHz VBW:3000.000kHz SWT:Auto            Detector : Peak            Project : 853105            Mode : 5</p>
Avg	 <p>Site : 03CH12-HY            Condition : AVG_BE_54 3m HORN_9120D_1328 VERTICAL            RBW:3000.000kHz VBW:3.000kHz SWT:Auto            Detector : Peak            Project : 853105            Mode : 5</p>	 <p>Site : 03CH12-HY            Condition : AVG_54 3m HORN_9120D_1328 VERTICAL            RBW:3000.000kHz VBW:3.000kHz SWT:Auto            Detector : Peak            Project : 853105            Mode : 5</p>

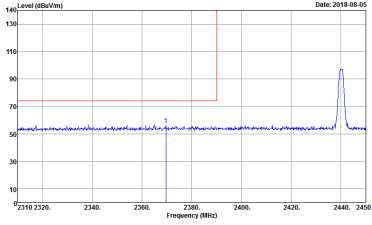
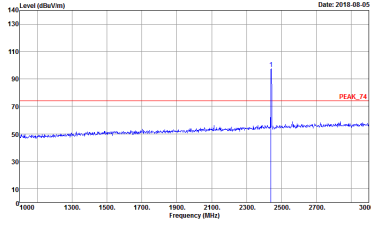
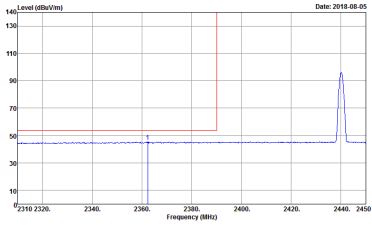
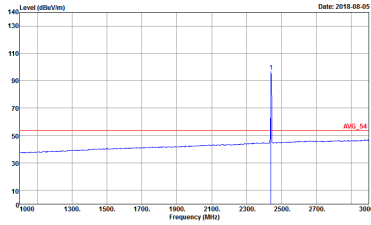

BLE	2.4GHz 2400~2483.5MHz Band Edge @ 3m	
ANT	BLE CH19 2440MHz - L	
1	Horizontal	Fundamental
Peak	 <p>Site : 03CH12-HY          Condition : PEAK_BE_74 3m HORN_91200_1328 HORIZONTAL          Detector : Peak          Project : 853105          Mode : 6</p>	 <p>Site : 03CH12-HY          Condition : PEAK_74 3m HORN_91200_1328 HORIZONTAL          Detector : Peak          Project : 853105          Mode : 6</p>
Avg.	 <p>Site : 03CH12-HY          Condition : AVG_BE_54 3m HORN_91200_1328 HORIZONTAL          Detector : Peak          Project : 853105          Mode : 6</p>	 <p>Site : 03CH12-HY          Condition : AVG_54 3m HORN_91200_1328 HORIZONTAL          Detector : Peak          Project : 853105          Mode : 6</p>





BLE	2.4GHz 2400~2483.5MHz Band Edge @ 3m	
ANT	BLE CH19 2440MHz - R	
1	Horizontal	Fundamental
Peak	<p>Site : 03CH2-HY Condition : PEAK_BE_74 3m HORN_9120D_1328 HORIZONTAL Detector : Peak Project : 853105 Mode : 0</p>	Left blank
Avg.	<p>Site : 03CH2-HY Condition : AVG_BE_54 3m HORN_9120D_1328 HORIZONTAL Detector : Peak Project : 853105 Mode : 0</p>	Left blank

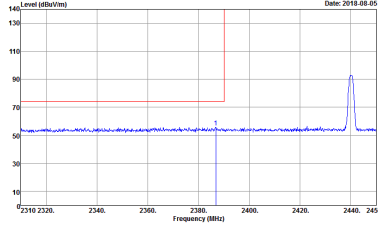
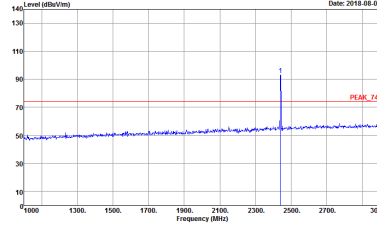
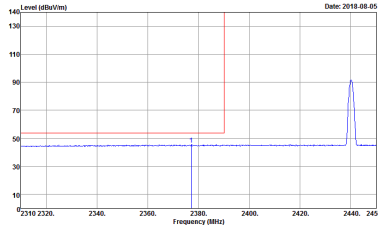
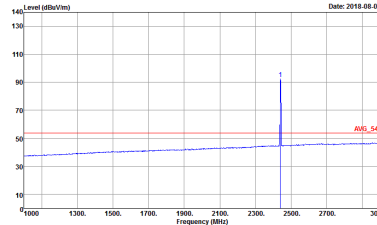

BLE	2.4GHz 2400~2483.5MHz Band Edge @ 3m	
ANT	BLE CH19 2440MHz - L	
1	Vertical	Fundamental
Peak	 <p>Site : 03CH12-HY            Condition : PEAK_BE_74 3m HORN_9120D_1328 VERTICAL            RBW:3000.000kHz VBW:3000.000kHz SWT:Auto            Detector : Peak            Project : 853105            Mode : 0</p>	 <p>Site : 03CH12-HY            Condition : PEAK_F4 3m HORN_9120D_1328 VERTICAL            RBW:3000.000kHz VBW:3000.000kHz SWT:Auto            Detector : Peak            Project : 853105            Mode : 0</p>
Avg.	 <p>Site : 03CH12-HY            Condition : AVG_BE_54 3m HORN_9120D_1328 VERTICAL            RBW:3000.000kHz VBW:3.000kHz SWT:Auto            Detector : Peak            Project : 853105            Mode : 0</p>	 <p>Site : 03CH12-HY            Condition : AVG_F4 3m HORN_9120D_1328 VERTICAL            RBW:3000.000kHz VBW:3.000kHz SWT:Auto            Detector : Peak            Project : 853105            Mode : 0</p>



BLE	2.4GHz 2400~2483.5MHz Band Edge @ 3m	
ANT	BLE CH19 2440MHz - R	
1	Vertical	Fundamental
Peak	<p>Site : 03CH2-HY Condition : PEAK_BE_74 3m HORN_9120D_1328 VERTICAL Detector : Peak Project : 853105 Mode : 0</p>	Left blank
Avg.	<p>Site : 03CH2-HY Condition : AVG_BE_54 3m HORN_9120D_1328 VERTICAL Detector : Peak Project : 853105 Mode : 0</p>	Left blank

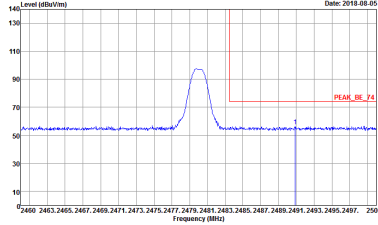
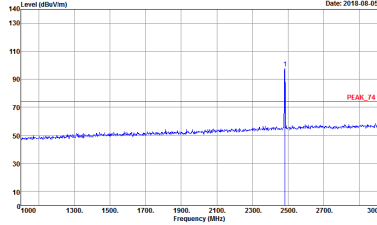
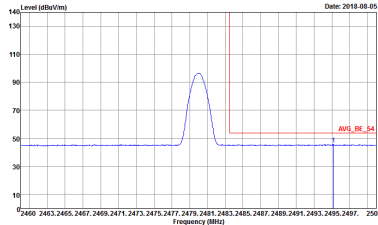
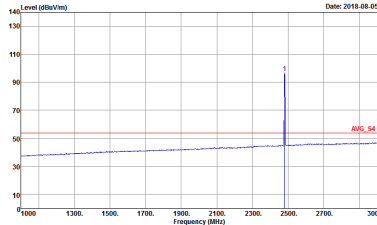

BLE	2.4GHz 2400~2483.5MHz Band Edge @ 3m	
ANT	BLE CH39 2480MHz	
1	Horizontal	Fundamental
<p><b>Peak</b></p>	 <p>Site : 03CH12-HY            Condition : PEAK_BE_74 3m HORN_9120D_1328 HORIZONTAL            RBW:3000.000kHz VBW:3000.000kHz SWT:Auto            Detector : Peak            Project : 853105            Mode : 7</p>	 <p>Site : 03CH12-HY            Condition : PEAK_F4 3m HORN_9120D_1328 HORIZONTAL            RBW:3000.000kHz VBW:3000.000kHz SWT:Auto            Detector : Peak            Project : 853105            Mode : 7</p>
<p><b>Avg.</b></p>	 <p>Site : 03CH12-HY            Condition : AVG_BE_54 3m HORN_9120D_1328 HORIZONTAL            RBW:3000.000kHz VBW:3.000kHz SWT:Auto            Detector : Peak            Project : 853105            Mode : 7</p>	 <p>Site : 03CH12-HY            Condition : AVG_54 3m HORN_9120D_1328 HORIZONTAL            RBW:3000.000kHz VBW:3.000kHz SWT:Auto            Detector : Peak            Project : 853105            Mode : 7</p>

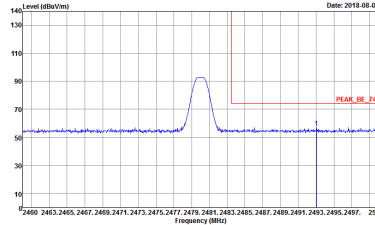
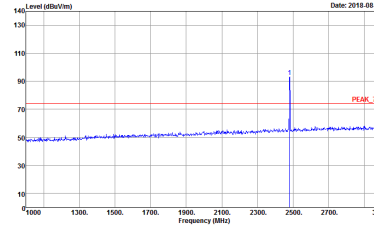
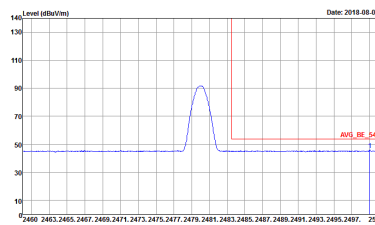
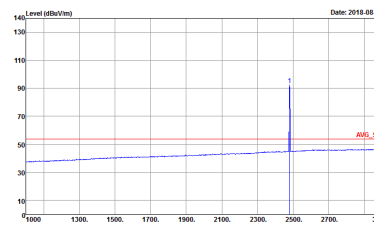

BLE	2.4GHz 2400~2483.5MHz Band Edge @ 3m	
ANT	BLE CH39 2480MHz	
1	Vertical	Fundamental
Peak	 <p>Site : 03CH12-HY            Condition : PEAK_BE_74 3m HORN_9120D_1328 VERTICAL            RBW:3000.000kHz VBW:3000.000kHz SWT:Auto            Detector : Peak            Project : 853105            Mode : 7</p>	 <p>Site : 03CH12-HY            Condition : PEAK_74 3m HORN_9120D_1328 VERTICAL            RBW:3000.000kHz VBW:3000.000kHz SWT:Auto            Detector : Peak            Project : 853105            Mode : 7</p>
Avg.	 <p>Site : 03CH12-HY            Condition : AVG_BE_54 3m HORN_9120D_1328 VERTICAL            RBW:3000.000kHz VBW:3.000kHz SWT:Auto            Detector : Peak            Project : 853105            Mode : 7</p>	 <p>Site : 03CH12-HY            Condition : AVG_54 3m HORN_9120D_1328 VERTICAL            RBW:3000.000kHz VBW:3.000kHz SWT:Auto            Detector : Peak            Project : 853105            Mode : 7</p>



2.4GHz 2400~2483.5MHz  
BLE 1Mbps (Harmonic @ 3m)

BLE	2.4GHz 2400~2483.5MHz Harmonic @ 3m	
ANT	BLE CH00 2402MHz	
1	Horizontal	Vertical
Peak Avg.	<p>Site : 03CH12-44Y Condition : PEAK_74 3m HORN_91200_1328 HORIZONTAL Detector : Peak Project : 853105 Mode : 5</p>	<p>Site : 03CH12-44Y Condition : PEAK_74 3m HORN_91200_1328 VERTICAL Detector : Peak Project : 853105 Mode : 5</p>



BLE	2.4GHz 2400~2483.5MHz Harmonic @ 3m	
ANT	BLE CH19 2440MHz	
1	Horizontal	Vertical
<b>Peak</b> <b>Avg.</b>	<p>Site : 03CHZ-11Y Condition : PEAK_74 3m HORN_9120D_1328 HORIZONTAL Detector : Peak Project : 853105 Mode : -6</p>	<p>Site : 03CHZ-11Y Condition : PEAK_74 3m HORN_9120D_1328 VERTICAL Detector : Peak Project : 853105 Mode : -6</p>



<b>BLE</b>	<b>2.4GHz 2400~2483.5MHz Harmonic @ 3m</b>	
<b>ANT</b>	<b>BLE CH39 2480MHz</b>	
<b>1</b>	<b>Horizontal</b>	<b>Vertical</b>
<b>Peak</b>	<p>Site : 03CH12-11Y          Condition : PEAK_74 3m HORN_91200_1328 HORIZONTAL          Detector : Peak          Project : 853105          Mode : 7</p>	<p>Site : 03CH12-11Y          Condition : PEAK_74 3m HORN_91200_1328 VERTICAL          Detector : Peak          Project : 853105          Mode : 7</p>





2.4GHz 2400~2483.5MHz  
BLE 2Mbps (Band Edge @ 3m)

BLE	2.4GHz 2400~2483.5MHz Band Edge @ 3m	
ANT	BLE CH00 2402MHz	
1	Horizontal	Fundamental
Peak	<p>Site : 03CH12-HY Condition : PEAK_BE_74 3m HORN_9120D_1328 HORIZONTAL Detector : Peak Project : 853105 Mode : 8</p>	<p>Site : 03CH12-HY Condition : PEAK_F4 3m HORN_9120D_1328 HORIZONTAL Detector : Peak Project : 853105 Mode : 8</p>
Avg.	<p>Site : 03CH12-HY Condition : AVG_BE_54 3m HORN_9120D_1328 HORIZONTAL Detector : Peak Project : 853105 Mode : 8</p>	<p>Site : 03CH12-HY Condition : AVG_F4 3m HORN_9120D_1328 HORIZONTAL Detector : Peak Project : 853105 Mode : 8</p>

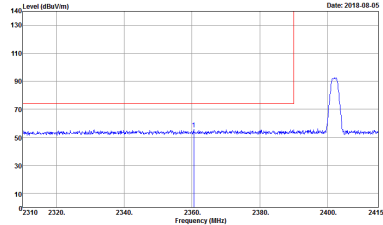
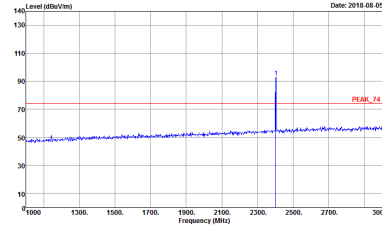
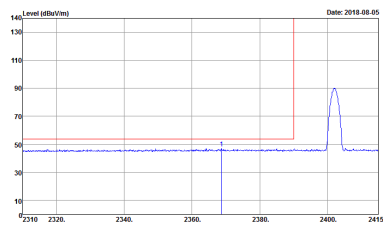
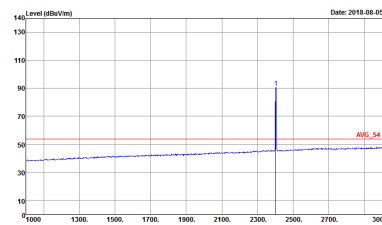

BLE	2.4GHz 2400~2483.5MHz Band Edge @ 3m	
ANT	BLE CH00 2402MHz	
1	Vertical	Fundamental
<p><b>Peak</b></p>	 <p>Site : 03CH12-HY            Condition : PEAK_9C_74 3m HORN_9120D_1328 VERTICAL            RBW:1000.000kHz VBW:3000.000kHz SWT:Auto            Detector : Peak            Project : 853105            Mode : 8</p>	 <p>Site : 03CH12-HY            Condition : PEAK_74 3m HORN_9120D_1328 VERTICAL            RBW:1000.000kHz VBW:3000.000kHz SWT:Auto            Detector : Peak            Project : 853105            Mode : 8</p>
<p><b>Avg</b></p>	 <p>Site : 03CH12-HY            Condition : AVG_BE_54 3m HORN_9120D_1328 VERTICAL            RBW:1000.000kHz VBW:10.000kHz SWT:Auto            Detector : Peak            Project : 853105            Mode : 8</p>	 <p>Site : 03CH12-HY            Condition : AVG_54 3m HORN_9120D_1328 VERTICAL            RBW:1000.000kHz VBW:10.000kHz SWT:Auto            Detector : Peak            Project : 853105            Mode : 8</p>

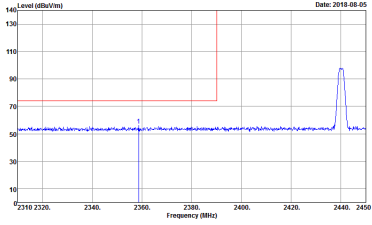
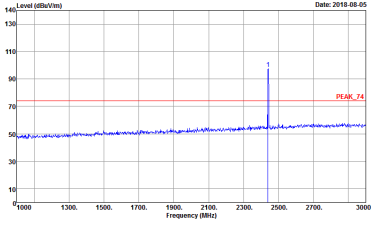
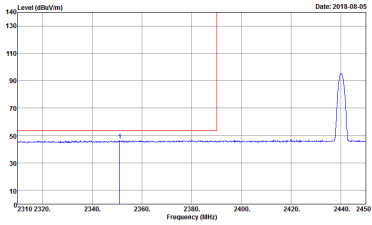
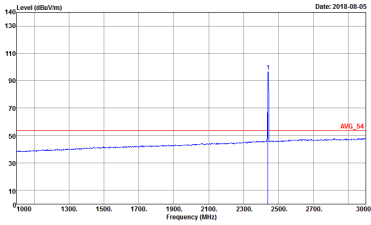

BLE	2.4GHz 2400~2483.5MHz Band Edge @ 3m	
ANT	BLE CH19 2440MHz - L	
1	Horizontal	Fundamental
Peak	 <p>Site : 03CH12-HY            Condition : PEAK_BE_74 3m HORN_91200_1328 HORIZONTAL            Detector : Peak            Project : 853105            Mode : 9</p>	 <p>Site : 03CH12-HY            Condition : PEAK_74 3m HORN_91200_1328 HORIZONTAL            Detector : Peak            Project : 853105            Mode : 9</p>
Avg.	 <p>Site : 03CH12-HY            Condition : AVG_BE_54 3m HORN_91200_1328 HORIZONTAL            Detector : Peak            Project : 853105            Mode : 9</p>	 <p>Site : 03CH12-HY            Condition : AVG_54 3m HORN_91200_1328 HORIZONTAL            Detector : Peak            Project : 853105            Mode : 9</p>



BLE	2.4GHz 2400~2483.5MHz Band Edge @ 3m	
ANT	BLE CH19 2440MHz - R	
1	Horizontal	Fundamental
Peak	<p>Site : 03CH2-HY Condition : PEAK_BE_74 3m HORN_9120D_1328 HORIZONTAL Detector : Peak Project : 853105 Mode : 9</p>	Left blank
Avg.	<p>Site : 03CH2-HY Condition : AVG_BE_54 3m HORN_9120D_1328 HORIZONTAL Detector : Peak Project : 853105 Mode : 9</p>	Left blank

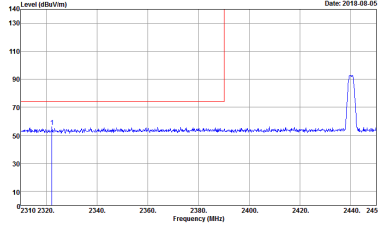
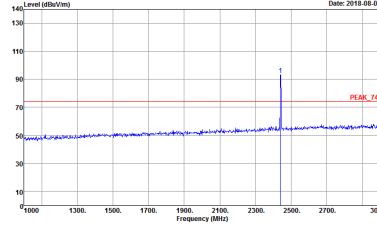
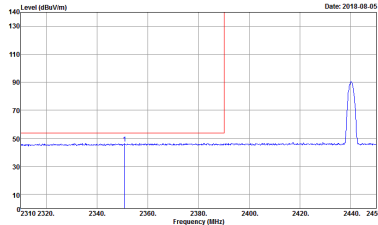
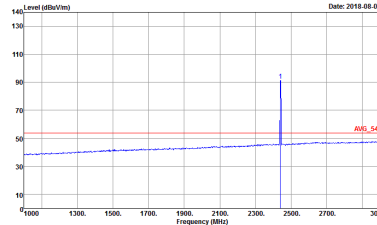

BLE	2.4GHz 2400~2483.5MHz Band Edge @ 3m	
ANT	BLE CH19 2440MHz - L	
1	Vertical	Fundamental
Peak	 <p>Site : 03CH12-HY            Condition : PEAK_BE_74 3m HORN_9120D_1328 VERTICAL            RBW:3000.000kHz VBW:3000.000kHz SWT:Auto            Detector : Peak            Project : 853105            Mode : 9</p>	 <p>Site : 03CH12-HY            Condition : PEAK_F4 3m HORN_9120D_1328 VERTICAL            RBW:3000.000kHz VBW:3000.000kHz SWT:Auto            Detector : Peak            Project : 853105            Mode : 9</p>
Avg.	 <p>Site : 03CH12-HY            Condition : AVG_BE_54 3m HORN_9120D_1328 VERTICAL            RBW:3000.000kHz VBW:10.000kHz SWT:Auto            Detector : Peak            Project : 853105            Mode : 9</p>	 <p>Site : 03CH12-HY            Condition : AVG_F4 3m HORN_9120D_1328 VERTICAL            RBW:3000.000kHz VBW:10.000kHz SWT:Auto            Detector : Peak            Project : 853105            Mode : 9</p>

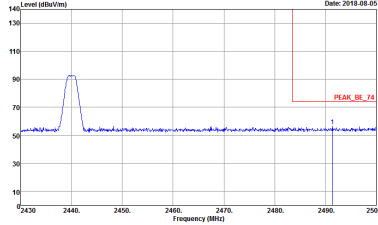
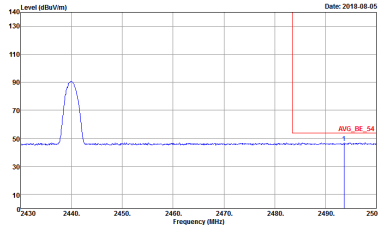

BLE	2.4GHz 2400~2483.5MHz Band Edge @ 3m	
ANT	BLE CH19 2440MHz - R	
1	Vertical	Fundamental
<p><b>Peak</b></p>	 <p>Site : 03CH12-HY            Condition : PEAK_BE_74 3m HORN_9120D_1328 VERTICAL            Detector : Peak            Project : 853105            Mode : 9</p>	<p>Left blank</p>
<p><b>Avg.</b></p>	 <p>Site : 03CH12-HY            Condition : AVG_BE_54 3m HORN_9120D_1328 VERTICAL            Detector : Peak            Project : 853105            Mode : 9</p>	<p>Left blank</p>

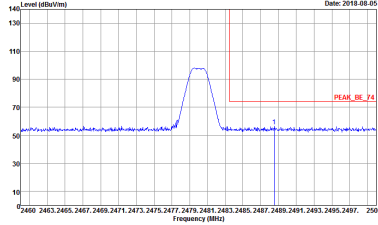
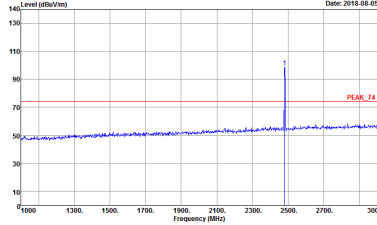
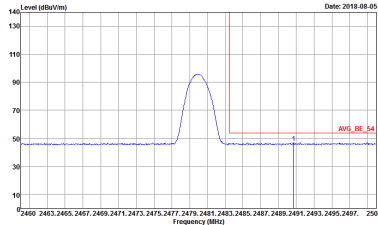
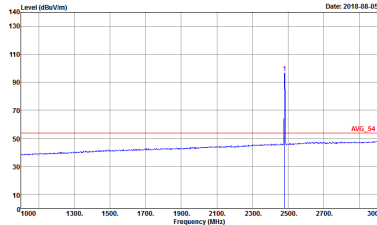

BLE	2.4GHz 2400~2483.5MHz Band Edge @ 3m	
ANT	BLE CH39 2480MHz	
1	Horizontal	Fundamental
Peak	 <p>Site : 03CH12-HY            Condition : PEAK_BE_74 3m HORN_9120D_1328 HORIZONTAL            RBW:3000.000kHz VBW:3000.000kHz SWT:Auto            Detector : Peak            Project : 853105            Mode : 10</p>	 <p>Site : 03CH12-HY            Condition : PEAK_74 3m HORN_9120D_1328 HORIZONTAL            RBW:3000.000kHz VBW:3000.000kHz SWT:Auto            Detector : Peak            Project : 853105            Mode : 10</p>
Avg.	 <p>Site : 03CH12-HY            Condition : AVG_BE_54 3m HORN_9120D_1328 HORIZONTAL            RBW:1000.000kHz VBW:10.000kHz SWT:Auto            Detector : Peak            Project : 853105            Mode : 10</p>	 <p>Site : 03CH12-HY            Condition : AVG_54 3m HORN_9120D_1328 HORIZONTAL            RBW:1000.000kHz VBW:10.000kHz SWT:Auto            Detector : Peak            Project : 853105            Mode : 10</p>

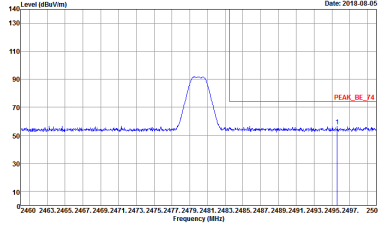
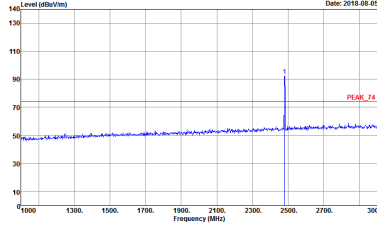
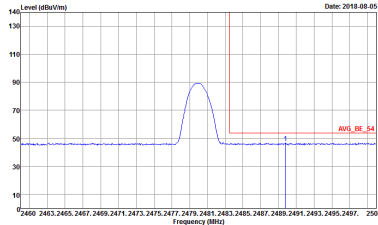
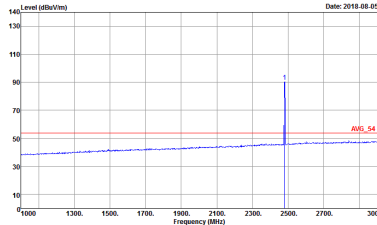

BLE	2.4GHz 2400~2483.5MHz Band Edge @ 3m	
ANT	BLE CH39 2480MHz	
1	Vertical	Fundamental
<p><b>Peak</b></p>	 <p>Site : 03CH12-HY            Condition : PEAK_BE_74 3m HORN_9120D_1328 VERTICAL            RBW:3000.000KHz VBW:3000.000KHz SWT:Auto            Detector : Peak            Project : 853105            Mode : 10</p>	 <p>Site : 03CH12-HY            Condition : PEAK_74 3m HORN_9120D_1328 VERTICAL            RBW:3000.000KHz VBW:3000.000KHz SWT:Auto            Detector : Peak            Project : 853105            Mode : 10</p>
<p><b>Avg.</b></p>	 <p>Site : 03CH12-HY            Condition : AVG_BE_54 3m HORN_9120D_1328 VERTICAL            RBW:3000.000KHz VBW:10.000KHz SWT:Auto            Detector : Peak            Project : 853105            Mode : 10</p>	 <p>Site : 03CH12-HY            Condition : AVG_54 3m HORN_9120D_1328 VERTICAL            RBW:3000.000KHz VBW:10.000KHz SWT:Auto            Detector : Peak            Project : 853105            Mode : 10</p>



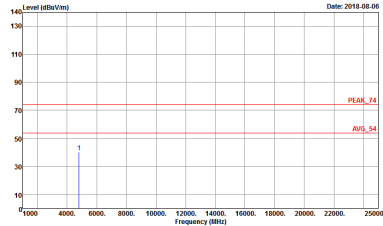
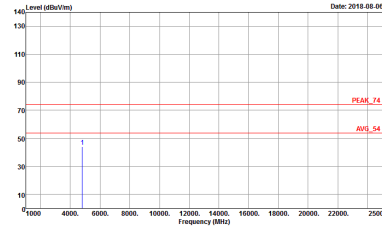

2.4GHz 2400~2483.5MHz  
BLE 2Mbps (Harmonic @ 3m)

BLE	2.4GHz 2400~2483.5MHz Harmonic @ 3m	
ANT	BLE CH00 2402MHz	
1	Horizontal	Vertical
<p><b>Peak</b> <b>Avg.</b></p>	 <p>Site : 03CH12-44Y Condition : PEAK_74 3m HORN_91200_1328 HORIZONTAL Detector : Peak Project : 853105 Mode : 8</p>	 <p>Site : 03CH12-44Y Condition : PEAK_74 3m HORN_91200_1328 VERTICAL Detector : Peak Project : 853105 Mode : 8</p>



<b>BLE</b>	<b>2.4GHz 2400~2483.5MHz Harmonic @ 3m</b>	
<b>ANT</b>	<b>BLE CH19 2440MHz</b>	
<b>1</b>	<b>Horizontal</b>	<b>Vertical</b>
<b>Peak</b> <b>Avg.</b>	<p>Site : 03CH12-11Y Condition : PEAK_74 3m HORN_91200_1328 HORIZONTAL Detector : Peak Project : 853105 Mode : -9</p>	<p>Site : 03CH12-11Y Condition : PEAK_74 3m HORN_91200_1328 VERTICAL Detector : Peak Project : 853105 Mode : -9</p>



<b>BLE</b>	<b>2.4GHz 2400~2483.5MHz Harmonic @ 3m</b>	
<b>ANT</b>	<b>BLE CH39 2480MHz</b>	
<b>1</b>	<b>Horizontal</b>	<b>Vertical</b>
<b>Peak</b>	<p>Site : 03CH12-11Y Condition : PEAK_74 3m HORN_91200_1328 HORIZONTAL Detector : Peak Project : 853105 Mode : -10</p>	<p>Site : 03CH12-11Y Condition : PEAK_74 3m HORN_91200_1328 VERTICAL Detector : Peak Project : 853105 Mode : -10</p>



Emission below 1GHz  
2.4GHz BLE 2Mbps (LF)

BLE	2.4GHz 2400~2483.5MHz	
ANT	BLE LF	
1	Horizontal	Vertical
QP / Peak	<p>Site : 03CH12-HY Condition : QP 3m 81LO6_6111D_37059 HORIZONTAL Detector : Peak Project : 853105 Mode : 11</p>	<p>Site : 03CH12-HY Condition : QP 3m 81LO6_6111D_37059 VERTICAL Detector : Peak Project : 853105 Mode : 11</p>



## Appendix D. Duty Cycle Plots

Band	Duty Cycle(%)	T(us)	1/T(kHz)	VBW Setting	Duty Factor(dB)
Bluetooth – LE for 1Mbps	62.4	390.00	2.56	3kHz	2.05
Bluetooth – LE for 2Mbps	32.8	205.00	4.88	10kHz	4.84

### Bluetooth – LE for 1Mbps

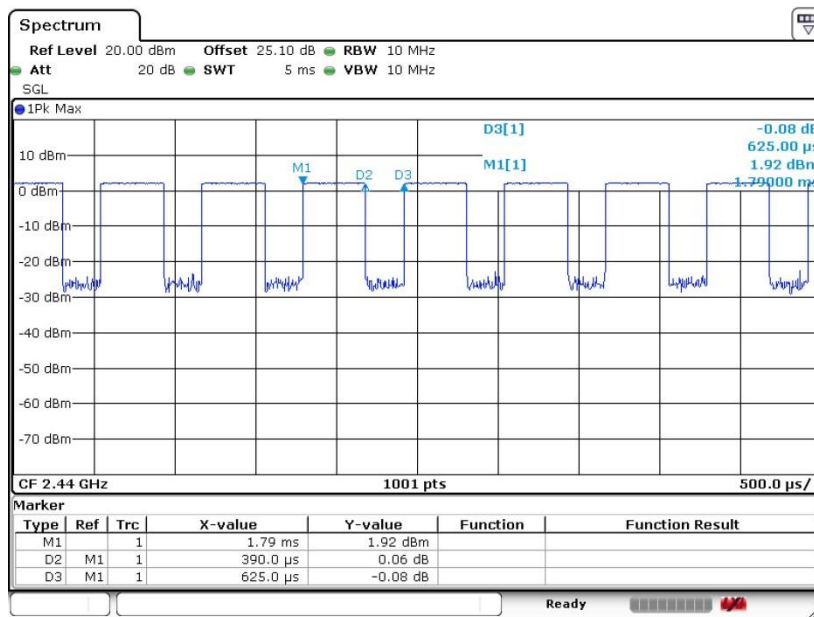

Date: 3.AUG.2018 05:27:55



Bluetooth – LE for 2Mbps

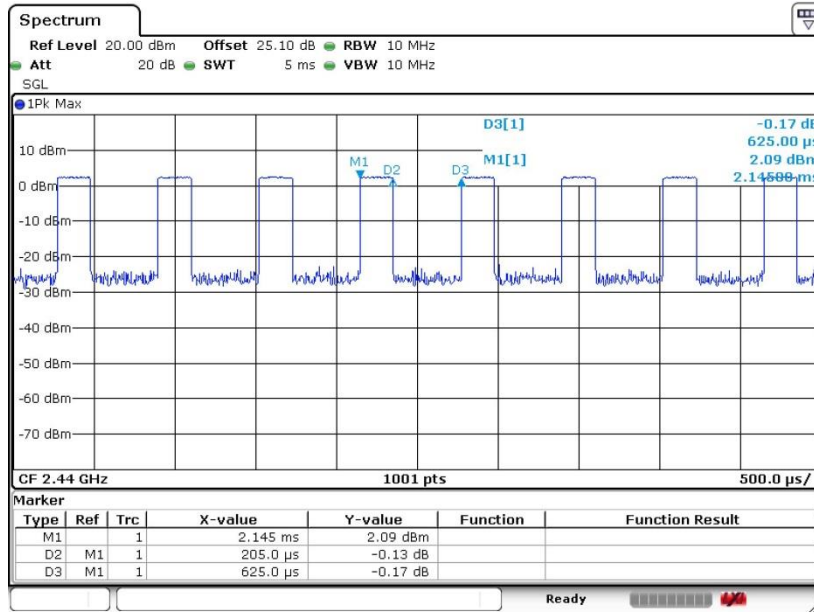

Date: 3.AUG.2018 05:29:27