



# FCC RF Test Report

**APPLICANT** : Zebra Technologies Corporation  
**EQUIPMENT** : Touch computer  
**BRAND NAME** : Zebra  
**MODEL NAME** : TC510K  
**FCC ID** : UZ7TC510K  
**STANDARD** : FCC Part 15 Subpart C §15.247  
**CLASSIFICATION** : (DTS) Digital Transmission System

The product was received on Aug. 15, 2016 and testing was completed on Aug. 29, 2016. We, SPORTON INTERNATIONAL INC., would like to declare that the tested sample has been evaluated in accordance with the test procedures and has been in compliance with the applicable technical standards.

The test results in this report apply exclusively to the tested model / sample. Without written approval of SPORTON INTERNATIONAL INC., the test report shall not be reproduced except in full.

Reviewed by: Joseph Lin / Supervisor

Approved by: Jones Tsai / Manager



## **SPORTON INTERNATIONAL INC.**

**No. 52, Hwa Ya 1<sup>st</sup> Rd., Hwa Ya Technology Park, Kwei-Shan District, Tao Yuan City, Taiwan, R.O.C.**



# TABLE OF CONTENTS

**SUMMARY OF TEST RESULT ..... 4**

**1 GENERAL DESCRIPTION..... 5**

1.1 Applicant ..... 5

1.2 Manufacturer..... 5

1.3 Product Feature of Equipment Under Test..... 5

1.4 Product Specification of Equipment Under Test..... 6

1.5 Modification of EUT ..... 6

1.6 Testing Location ..... 6

1.7 Applicable Standards..... 7

**2 TEST CONFIGURATION OF EQUIPMENT UNDER TEST..... 8**

2.1 Descriptions of Test Mode ..... 8

2.2 Test Mode ..... 9

2.3 Connection Diagram of Test System ..... 10

2.4 Support Unit used in test configuration and system ..... 11

2.5 EUT Operation Test Setup ..... 11

2.6 Measurement Results Explanation Example..... 11

**3 TEST RESULT ..... 12**

3.1 6dB and 99% Bandwidth Measurement ..... 12

3.2 Peak Output Power Measurement ..... 17

3.3 Power Spectral Density Measurement ..... 18

3.4 Conducted Band Edges and Spurious Emission Measurement ..... 23

3.5 Radiated Band Edges and Spurious Emission Measurement ..... 32

3.6 AC Conducted Emission Measurement..... 36

3.7 Antenna Requirements ..... 40

**4 LIST OF MEASURING EQUIPMENT..... 41**

**5 UNCERTAINTY OF EVALUATION..... 42**

**APPENDIX A. CONDUCTED TEST RESULTS**

**APPENDIX B. RADIATED SPURIOUS EMISSION**

**APPENDIX C. RADIATED SPURIOUS EMISSION PLOTS**

**APPENDIX D. DUTY CYCLE PLOTS**

**APPENDIX E. SETUP PHOTOGRAPHS**





### SUMMARY OF TEST RESULT

Report Section	FCC Rule	Description	Limit	Result	Remark
3.1	15.247(a)(2)	6dB Bandwidth	$\geq 0.5\text{MHz}$	Pass	-
3.1	-	99% Bandwidth	-	Pass	-
3.2	15.247(b)(3)	Peak Output Power	$\leq 30\text{dBm}$	Pass	-
3.3	15.247(e)	Power Spectral Density	$\leq 8\text{dBm}/3\text{kHz}$	Pass	-
3.4	15.247(d)	Conducted Band Edges and Spurious Emission	$\leq 20\text{dBc}$	Pass	-
3.5	15.247(d)	Radiated Band Edges and Spurious Emission	15.209(a) & 15.247(d)	Pass	Under limit 8.29 dB at 2374.680 MHz
3.6	15.207	AC Conducted Emission	15.207(a)	Pass	Under limit 12.30 dB at 0.182 MHz
3.7	15.203 & 15.247(b)	Antenna Requirement	N/A	Pass	-



# 1 General Description

## 1.1 Applicant

**Zebra Technologies Corporation**  
1 Zebra Plaza Holtsville, NY 11742

## 1.2 Manufacturer

**Wistron Corporation**  
21F, No. 88, Sec. 1, Hsin Tai Wu Rd., Hsichih Dist, New Taipei City 221, Taiwan R.O.C.

## 1.3 Product Feature of Equipment Under Test

Product Feature	
Equipment	Touch computer
Brand Name	Zebra
Model Name	TC510K
FCC ID	UZ7TC510K
EUT supports Radios application	NFC WLAN 11a/b/g/n HT20/HT40 WLAN 11ac VHT20/VHT40/VHT80 Bluetooth BR/EDR/LE
HW Version	EV2
SW Version	91-10-03-MG-00
FW Version	91-10-03-MG-00
EUT Stage	Engineering sample

**Remark:** The above EUT's information was declared by manufacturer. Please refer to the specifications or user's manual for more detailed description.

Specification of Accessories				
Adapter 1 (5V/2.5A)	Brand Name	Zebra	Model Number	SAWA-65-20005A
Adapter 2 (5V/1.2A)	Brand Name	Zebra	Model Number	PS000081A01
Headset Jumper 1	Brand Name	Zebra	Part Number	CBL-TC51-HDST25-01
Headset Jumper 2	Brand Name	Zebra	Part Number	CBL-TC51-HDST35-01
Battery	Brand Name	Zebra	Part Number	BT-000314-01
2.5mm Earphone	Brand Name	Zebra	Part Number	HDST-25MM-PTVP-01
3.5mm Earphone	Brand Name	Zebra	Part Number	HDST-35MM-PTVP-01
Trigger Handle	Brand Name	Zebra	Part Number	TRG-TC51-SNP1-01
USB cable	Brand Name	Zebra	Part Number	CBL-TC51-USB1-01
Soft Holster	Brand Name	Zebra	Part Number	SG-TC51-HLSTR1-01
Exoskeleton	Brand Name	Zebra	Part Number	SG-TC51-EX01-01
Hand strap	Brand Name	Zebra	Part Number	SG-TC51-BHDSTP1-03



### 1.4 Product Specification of Equipment Under Test

Standards-related Product Specification	
Tx/Rx Frequency Range	2402 MHz ~ 2480 MHz
Maximum Output Power to Antenna	3.84 dBm (0.0024 W)
99% Occupied Bandwidth	1.054MHz
Antenna Type / Gain	Loop Antenna with gain 2.50 dBi
Type of Modulation	Bluetooth LE : GFSK

### 1.5 Modification of EUT

No modifications are made to the EUT during all test items.

### 1.6 Testing Location

Sporton Lab is accredited to ISO 17025 by Taiwan Accreditation Foundation (TAF code : 1190) and the FCC designation No. TW1022 under the FCC 2.948(e) by Mutual Recognition Agreement (MRA) in FCC Test.

<b>Test Site</b>	SPORTON INTERNATIONAL INC.	
<b>Test Site Location</b>	No. 52, Hwa Ya 1 <sup>st</sup> Rd., Hwa Ya Technology Park, Kwei-Shan District, Tao Yuan City, Taiwan, R.O.C. TEL: +886-3-327-3456 FAX: +886-3-328-4978	
<b>Test Site No.</b>	<b>Sporton Site No.</b>	
	TH05-HY	CO05-HY

**Note:** The test site complies with ANSI C63.4 2014 requirement.

<b>Test Site</b>	SPORTON INTERNATIONAL INC.	
<b>Test Site Location</b>	No.58, Aly. 75, Ln. 564, Wenhua 3rd Rd. Guishan Dist, Taoyuan City, Taiwan (R.O.C.) TEL: +886-3-327-0868 FAX: +886-3-327-0855	
<b>Test Site No.</b>	<b>Sporton Site No.</b>	
	03CH12-HY	

**Note:** The test site complies with ANSI C63.4 2014 requirement.



## 1.7 Applicable Standards

According to the specifications of the manufacturer, the EUT must comply with the requirements of the following standards:

- ♦ FCC Part 15 Subpart C §15.247
- ♦ FCC KDB Publication No. 558074 D01 DTS Meas. Guidance v03r05
- ♦ ANSI C63.10-2013

### **Remark:**

1. All test items were verified and recorded according to the standards and without any deviation during the test.
2. This EUT has also been tested and complied with the requirements of FCC Part 15, Subpart B, recorded in a separate test report.



## 2 Test Configuration of Equipment Under Test

### 2.1 Descriptions of Test Mode

The RF output power was recorded in the following table:

Channel	Frequency	Bluetooth – LE Average Output Power	
		Data Rate / Modulation	
		GFSK	
		1Mbps	
Ch00	2402MHz	1.70 dBm	
Ch19	2440MHz	3.51 dBm	
Ch39	2480MHz	3.17 dBm	

Channel	Frequency	Bluetooth – LE Peak Output Power	
		Data Rate / Modulation	
		GFSK	
		1Mbps	
Ch00	2402MHz	2.24 dBm	
Ch19	2440MHz	3.84 dBm	
Ch39	2480MHz	3.55 dBm	

- a. The EUT has been associated with peripherals and configuration operated in a manner tended to maximize its emission characteristics in a typical application. Frequency range investigated: conduction (150 kHz to 30 MHz), radiation (9 kHz to the 10th harmonic of the highest fundamental frequency or to 40 GHz, whichever is lower). Pre-scanned tests, X, Y, Z in three orthogonal panels to determine the final configuration (Z plane as worst plane) from all possible combinations.
  
- b. AC power line Conducted Emission was tested under maximum output power.





## 2.2 Test Mode

The following summary table is showing all test modes to demonstrate in compliance with the standard.

Summary table of Test Cases	
Test Item	Data Rate / Modulation
	Bluetooth – LE / GFSK
Conducted TCs	Mode 1: Bluetooth Tx CH00_2402 MHz_1Mbps Mode 2: Bluetooth Tx CH19_2440 MHz_1Mbps Mode 3: Bluetooth Tx CH39_2480 MHz_1Mbps
Radiated TCs	Mode 1: Bluetooth Tx CH00_2402 MHz_1Mbps Mode 2: Bluetooth Tx CH19_2440 MHz_1Mbps Mode 3: Bluetooth Tx CH39_2480 MHz_1Mbps
AC Conducted Emission	Mode 1 :WLAN (2.4GHz) Link + Bluetooth Link + Battery + Scanner + without Exoskeleton + Headset Jumper (CBL-TC51-HDST25-01) + Earphone (HDST-25MM-PTVP-01) + Rugged Charge/USB Cable + Adapter 1 (SAWA-65-20005A (5V/2.5A))

## 2.3 Connection Diagram of Test System

<Bluetooth – LE Tx Mode>

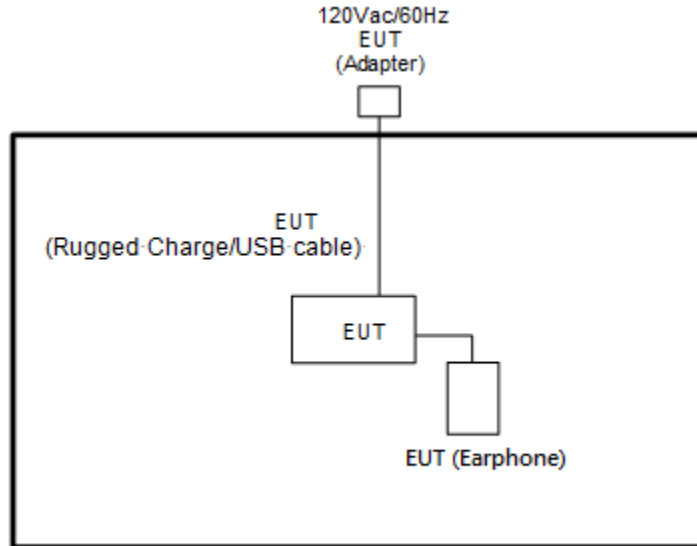

<AC Conducted Emission Mode>

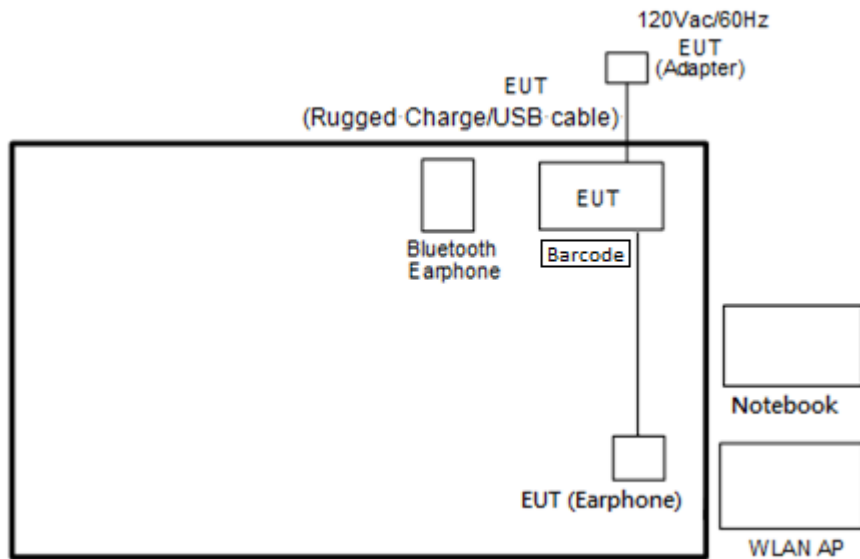



## 2.4 Support Unit used in test configuration and system

Item	Equipment	Trade Name	Model Name	FCC ID	Data Cable	Power Cord
1.	Bluetooth Earphone	Sony Ericsson	MW600	PY7DDA-2029	N/A	N/A
2.	WLAN AP	ASUS	RT-AC66U	MSQ-RTAC66U	N/A	Unshielded, 1.8 m
3.	Notebook	DELL	Latitude E6320	FCC DoC/ Contains FCC ID: QDS-BRCM1054	N/A	AC I/P: Unshielded, 1.2 m DC O/P: Shielded, 1.8 m
4.	SD Card	SanDisk	MicroSD HC	FCC DoC	N/A	N/A

## 2.5 EUT Operation Test Setup

For Bluetooth function, the RF utility, “abd” was installed in EUT which was programmed in order to make the EUT get into the engineering modes for continuous transmitting and receiving signals.

## 2.6 Measurement Results Explanation Example

**For all conducted test items:**

The offset level is set in the spectrum analyzer to compensate the RF cable loss and attenuator factor between EUT conducted output port and spectrum analyzer. With the offset compensation, the spectrum analyzer reading level is exactly the EUT RF output level.

Example :

The spectrum analyzer offset is derived from RF cable loss and attenuator factor.

*Offset = RF cable loss + attenuator factor.*

Following shows an offset computation example with cable loss 4.2 dB and 10dB attenuator.

$$\begin{aligned} \text{Offset(dB)} &= \text{RF cable loss(dB)} + \text{attenuator factor(dB)}. \\ &= 4.2 + 10 = 14.2 \text{ (dB)} \end{aligned}$$

### 3 Test Result

#### 3.1 6dB and 99% Bandwidth Measurement

##### 3.1.1 Limit of 6dB and 99% Bandwidth

The minimum 6 dB bandwidth shall be at least 500 kHz.

##### 3.1.2 Measuring Instruments

The section 4.0 of List of Measuring Equipment of this test report is used for test.

##### 3.1.3 Test Procedures

1. The testing follows FCC KDB Publication No. 558074 D01 DTS Meas. Guidance v03r05.
2. The RF output of EUT was connected to the spectrum analyzer by RF cable and attenuator. The path loss was compensated to the results for each measurement.
3. Set to the maximum power setting and enable the EUT transmit continuously.
4. Make the measurement with the spectrum analyzer's resolution bandwidth (RBW) = 100 kHz. Set the Video bandwidth (VBW) = 300 kHz. In order to make an accurate measurement. The 6 dB bandwidth must be greater than 500 kHz.
5. For 99% Bandwidth Measurement, the spectrum analyzer's resolution bandwidth (RBW) is set 30kHz and set the Video bandwidth (VBW) = 100kHz.
6. Measure and record the results in the test report.

##### 3.1.4 Test Setup





### 3.1.5 Test Result of 6dB Bandwidth

Test data refer to Appendix A.

6 dB Bandwidth Plot on Channel 00

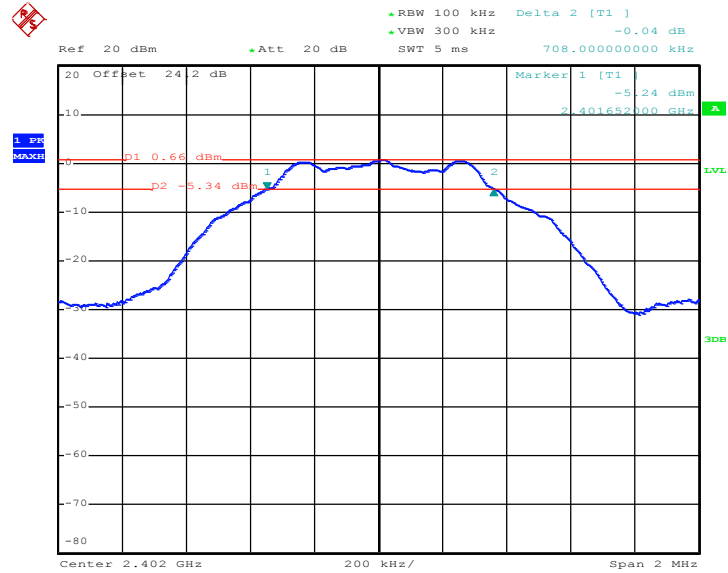

Date: 22.AUG.2016 21:19:39



6 dB Bandwidth Plot on Channel 19

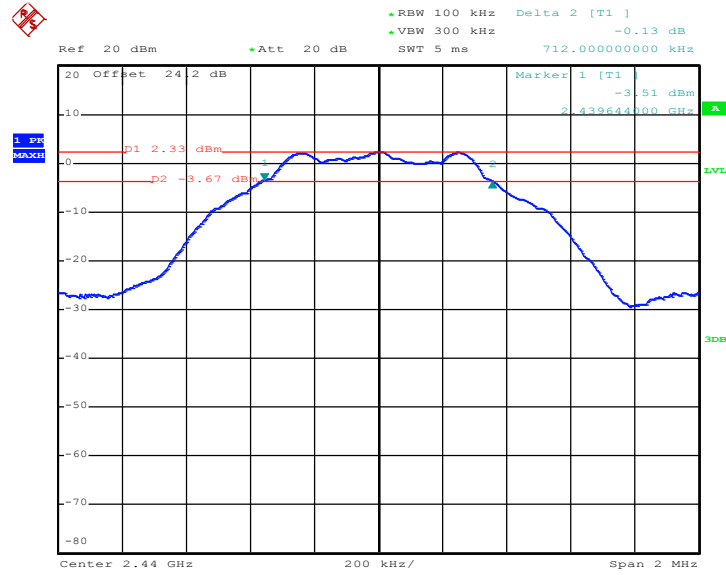

Date: 22.AUG.2016 20:54:51

6 dB Bandwidth Plot on Channel 39

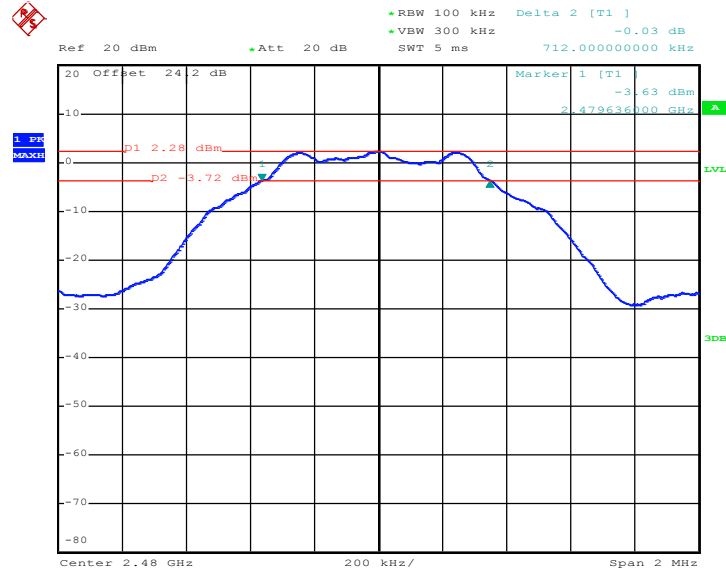

Date: 22.AUG.2016 21:14:18



### 3.1.6 Test Result of 99% Occupied Bandwidth

Test data refer to Appendix A.

99% Bandwidth Plot on Channel 00

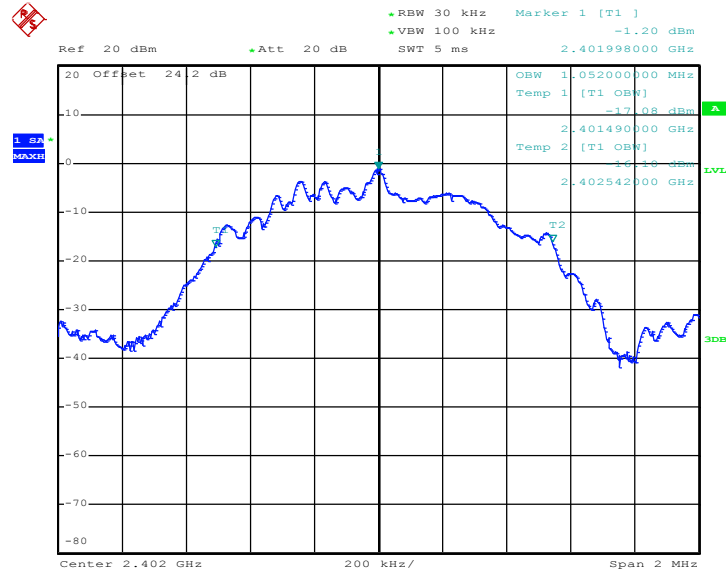

Date: 22.AUG.2016 21:23:02



99% Occupied Bandwidth Plot on Channel 19

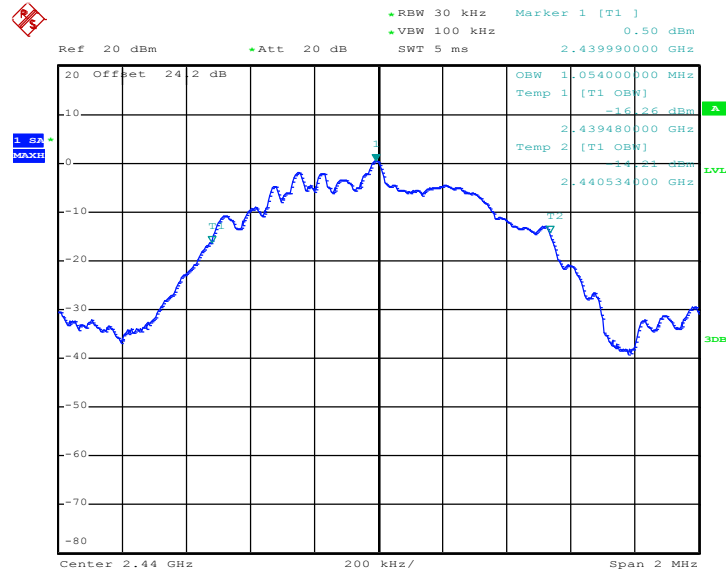

Date: 22.AUG.2016 20:58:06

99% Occupied Bandwidth Plot on Channel 39

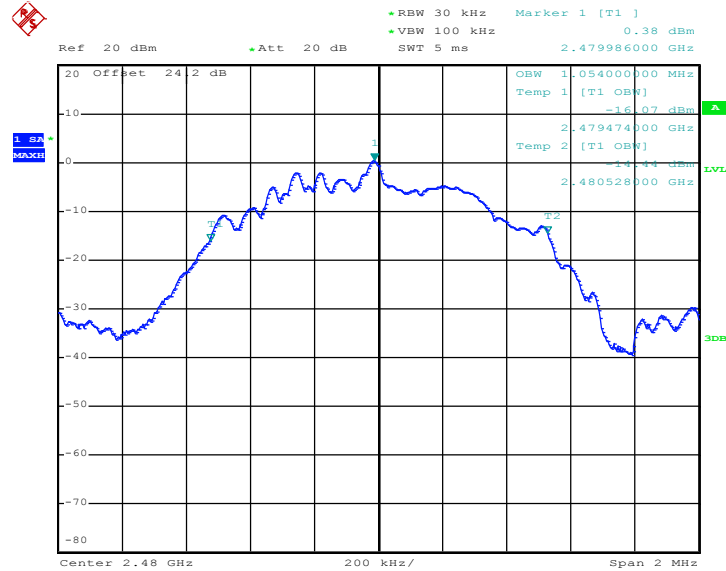

Date: 22.AUG.2016 21:15:59

Note : The occupied channel bandwidth is maintained within the band of operation for all of the modulations.



## 3.2 Peak Output Power Measurement

### 3.2.1 Limit of Peak Output Power

For systems using digital modulation in the 2400-2483.5MHz, the limit for peak output power is 30dBm. If transmitting antenna of directional gain greater than 6dBi is used, the peak output power from the intentional radiator shall be reduced below the above stated value by the amount in dB that the directional gain of the antenna exceeds 6 dBi. In case of point-to-point operation, the limit has to be reduced by 1dB for every 3dB that the directional gain of the antenna exceeds 6dBi.

### 3.2.2 Measuring Instruments

The section 4.0 of List of Measuring Equipment of this test report is used for test.

### 3.2.3 Test Procedures

1. The testing follows the Measurement Procedure of FCC KDB No. 558074 DTS D01 Meas. Guidance v03r05 section 9.1.2 PKPM1 Peak power meter method.
2. The RF output of EUT was connected to the power meter by RF cable and attenuator. The path loss was compensated to the results for each measurement.
3. Set to the maximum power setting and enable the EUT transmit continuously.
4. Measure the conducted output power and record the results in the test report.

### 3.2.4 Test Setup

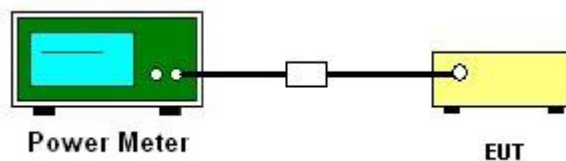

### 3.2.5 Test Result of Peak Output Power

Test data refers to Appendix A.

### 3.3 Power Spectral Density Measurement

#### 3.3.1 Limit of Power Spectral Density

The peak power spectral density shall not be greater than 8dBm in any 3kHz band at any time interval of continuous transmission.

#### 3.3.2 Measuring Instruments

The section 4.0 of List of Measuring Equipment of this test report is used for test.

#### 3.3.3 Test Procedures

1. The testing follows Measurement Procedure 10.2 Method PKPSD of FCC KDB Publication No. 558074 D01 DTS Meas. Guidance v03r05
2. The RF output of EUT was connected to the spectrum analyzer by RF cable and attenuator. The path loss was compensated to the results for each measurement.
3. Set to the maximum power setting and enable the EUT transmit continuously.
4. Make the measurement with the spectrum analyzer's resolution bandwidth (RBW) = 3 kHz. Video bandwidth VBW = 10 kHz In order to make an accurate measurement, set the span to 1.5 times DTS Channel Bandwidth. (6dB BW)
5. Detector = peak, Sweep time = auto couple, Trace mode = max hold, Allow trace to fully stabilize. Use the peak marker function to determine the maximum power level.
6. Measure and record the results in the test report.
7. The Measured power density (dBm)/ 100kHz is a reference level and used as 20dBc down limit line for Conducted Band Edges and Conducted Spurious Emission.

#### 3.3.4 Test Setup

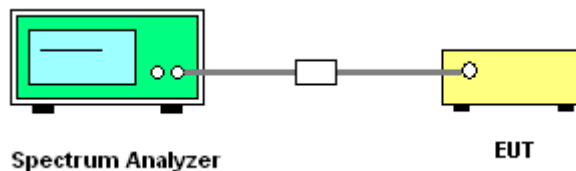



### 3.3.5 Test Result of Power Spectral Density

Test data refers to Appendix A.

### 3.3.6 Test Result of Power Spectral Density Plots (100kHz)

PSD 100kHz Plot on Channel 00

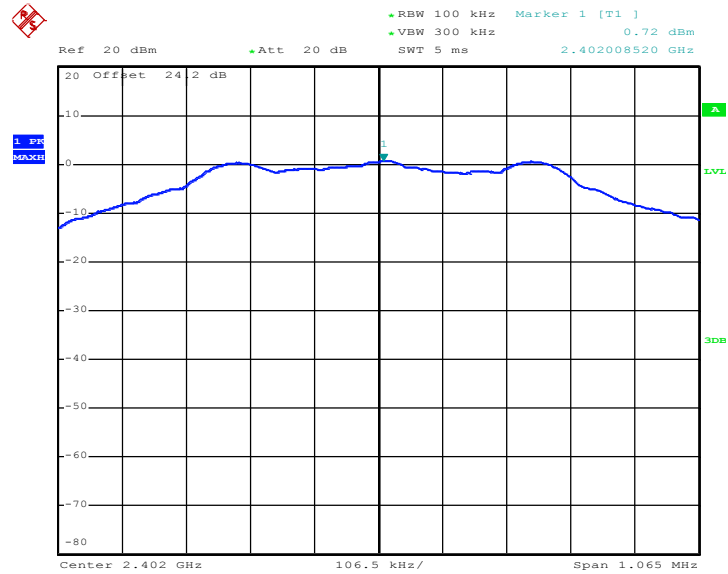

Date: 22.AUG.2016 21:21:11



PSD 100kHz Plot on Channel 19

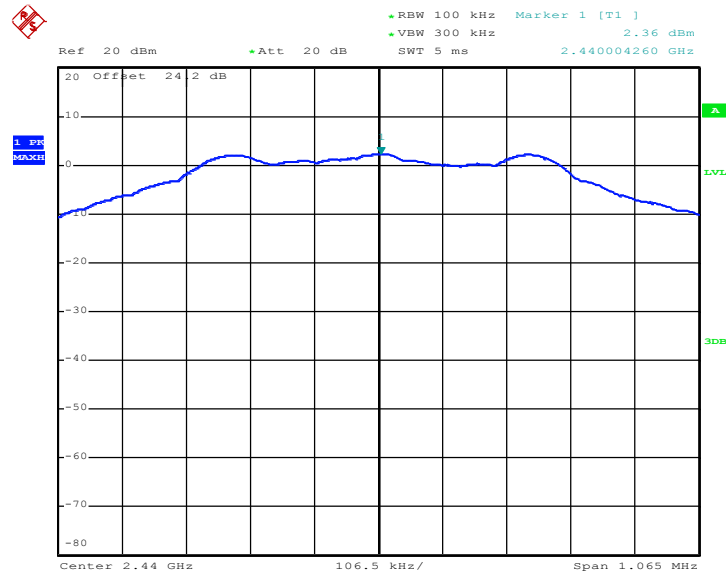

Date: 22.AUG.2016 20:55:53

PSD 100kHz Plot on Channel 39

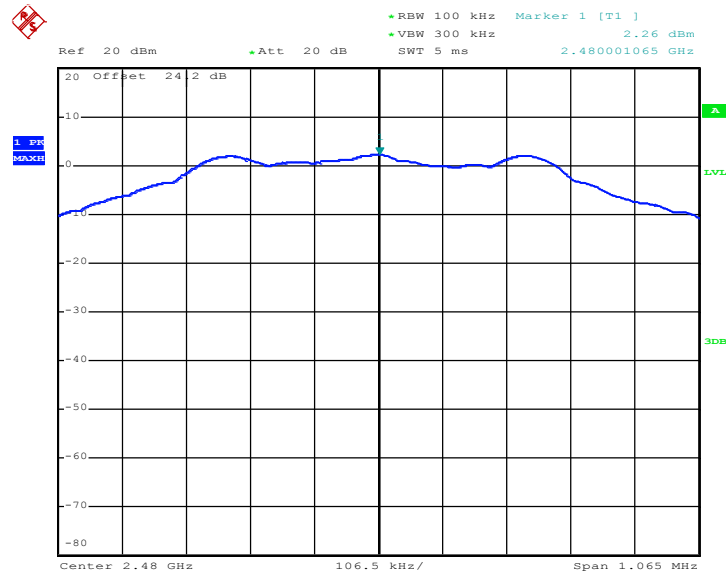

Date: 22.AUG.2016 21:15:01



### 3.3.7 Test Result of Power Spectral Density Plots (3kHz)

PSD 3kHz Plot on Channel 00

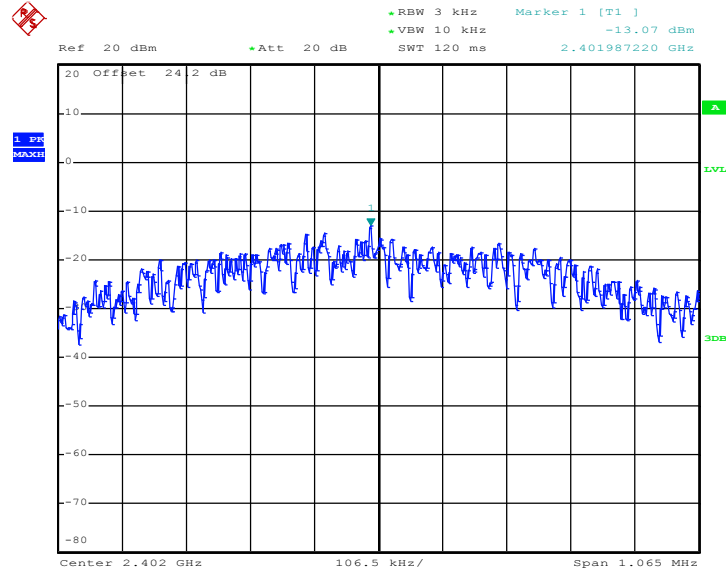

Date: 22.AUG.2016 21:20:46



PSD 3kHz Plot on Channel 19

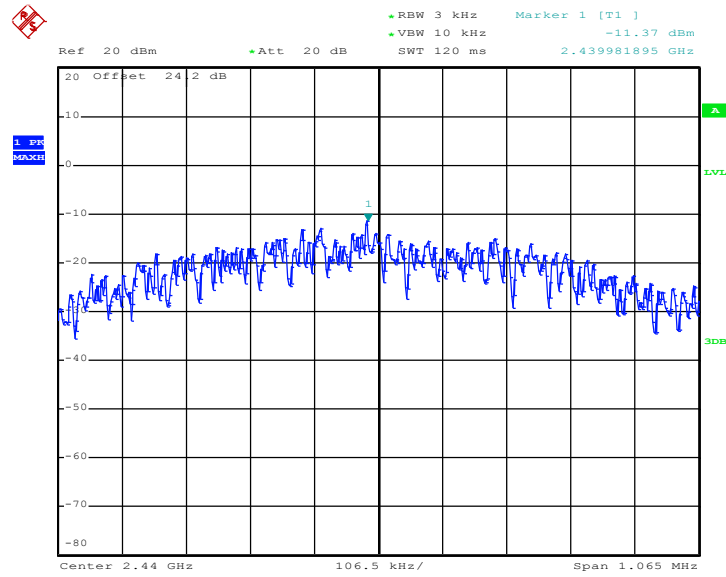

Date: 22.AUG.2016 20:55:35

PSD 3kHz Plot on Channel 39

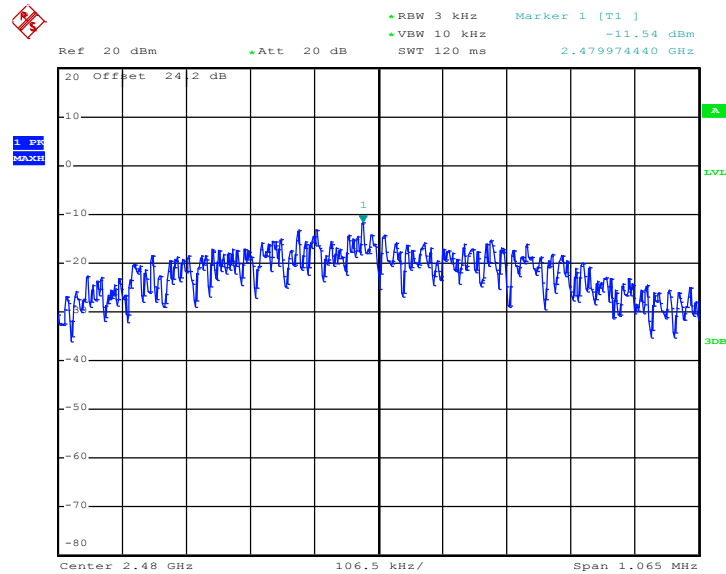

Date: 22.AUG.2016 21:14:47

## 3.4 Conducted Band Edges and Spurious Emission Measurement

### 3.4.1 Limit of Conducted Band Edges and Spurious Emission

All harmonics/spurious must be at least 20 dB down from the highest emission level within the authorized band.

### 3.4.2 Measuring Instruments

The section 4.0 of List of Measuring Equipment of this test report is used for test.

### 3.4.3 Test Procedure

1. The testing follows FCC KDB Publication No. 558074 D01 DTS Meas. Guidance v03r05.
2. The RF output of EUT was connected to the spectrum analyzer by RF cable and attenuator. The path loss was compensated to the results for each measurement.
3. Set to the maximum power setting and enable the EUT transmit continuously.
4. Set RBW = 100 kHz, VBW=300 kHz, Peak Detector. Unwanted Emissions measured in any 100 kHz bandwidth outside of the authorized frequency band shall be attenuated by at least 20 dB relative to the maximum in-band peak PSD level in 100 kHz when maximum peak conducted output power procedure is used. If the transmitter complies with the conducted power limits based on the use of RMS averaging over a time interval, the attenuation required under this paragraph shall be 30 dB instead of 20 dB per 15.247(d).
5. Measure and record the results in the test report.
6. The RF fundamental frequency should be excluded against the limit line in the operating frequency band.

### 3.4.4 Test Setup





### 3.4.5 Test Result of Conducted Band Edges Plots

#### Low Band Edge Plot on Channel 00

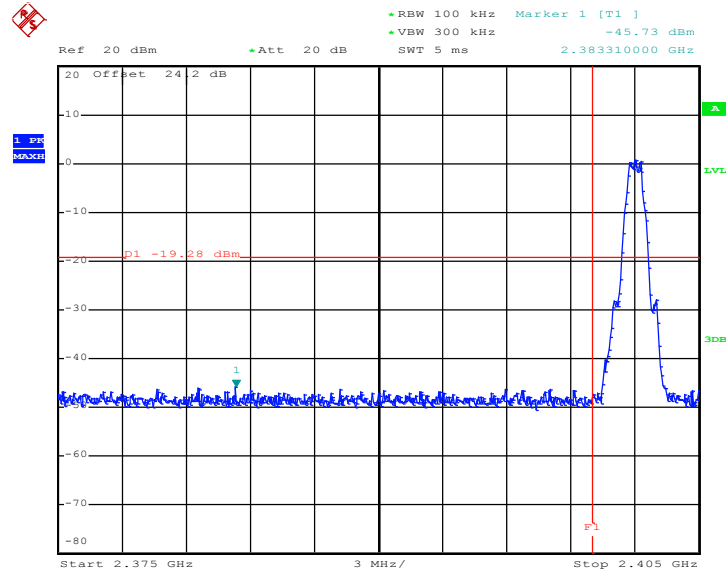

Date: 22.AUG.2016 21:21:27





High Band Edge Plot on Channel 39

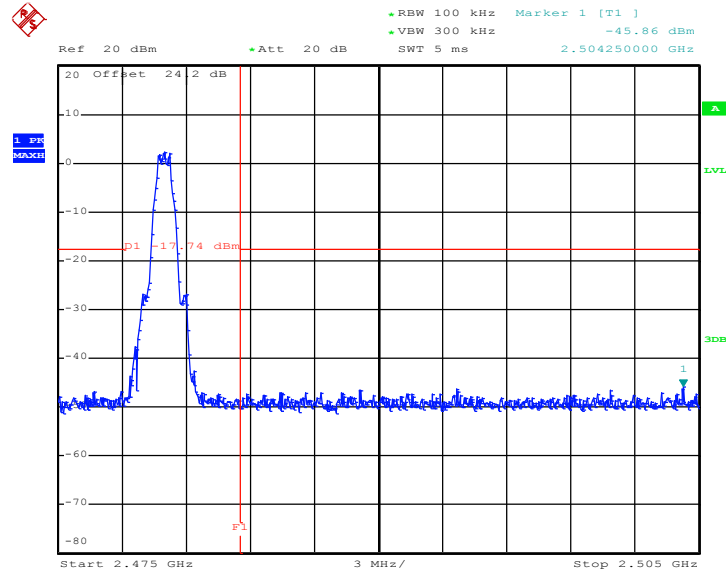

Date: 22.AUG.2016 21:15:14



### 3.4.6 Test Result of Conducted Spurious Emission Plots

#### Conducted Spurious Emission Plot on Bluetooth LE 1Mbps GFSK Channel 00

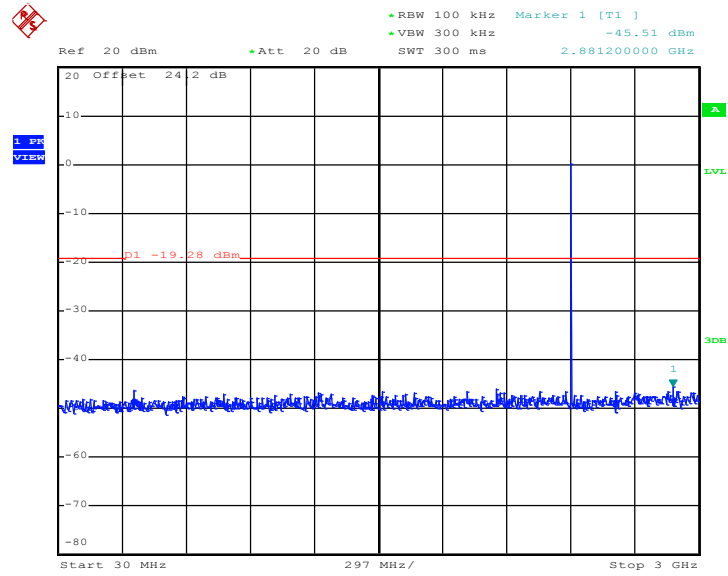

Date: 22.AUG.2016 21:22:15



Conducted Spurious Emission Plot on Bluetooth LE 1Mbps  
GFSK Channel 00

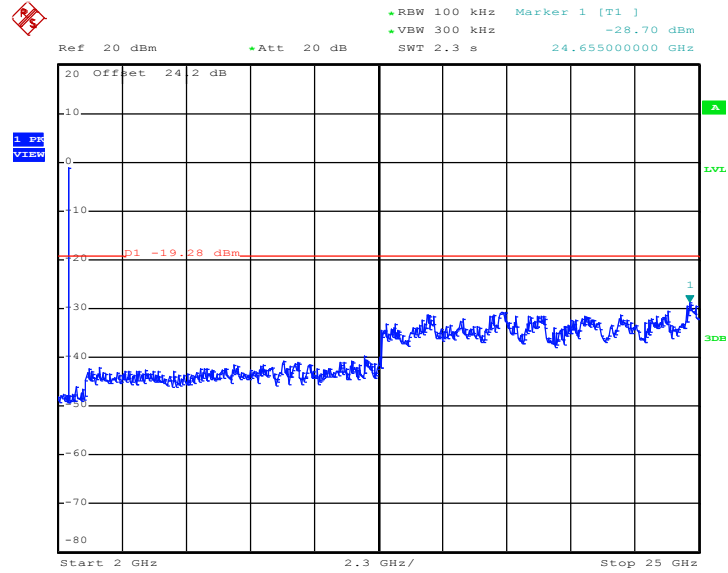

Date: 22.AUG.2016 21:22:24



### Conducted Spurious Emission Plot on Bluetooth LE 1Mbps GFSK Channel 19

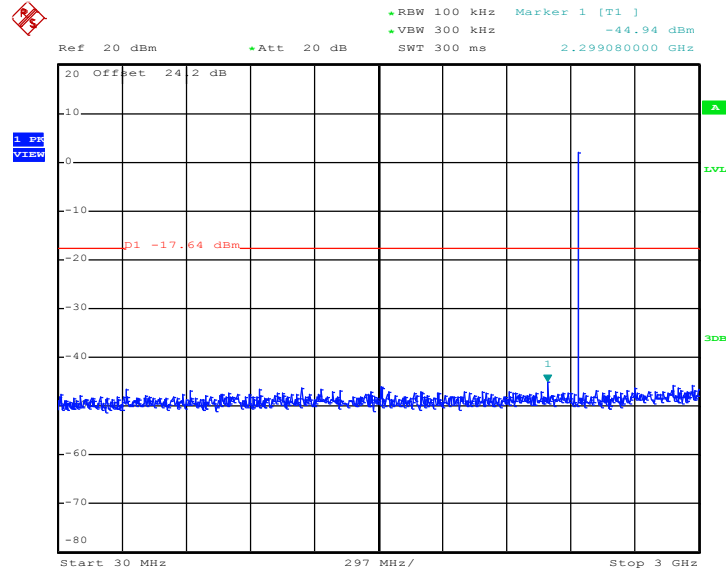

Date: 22.AUG.2016 20:57:08



Conducted Spurious Emission Plot on Bluetooth LE 1Mbps  
GFSK Channel 19

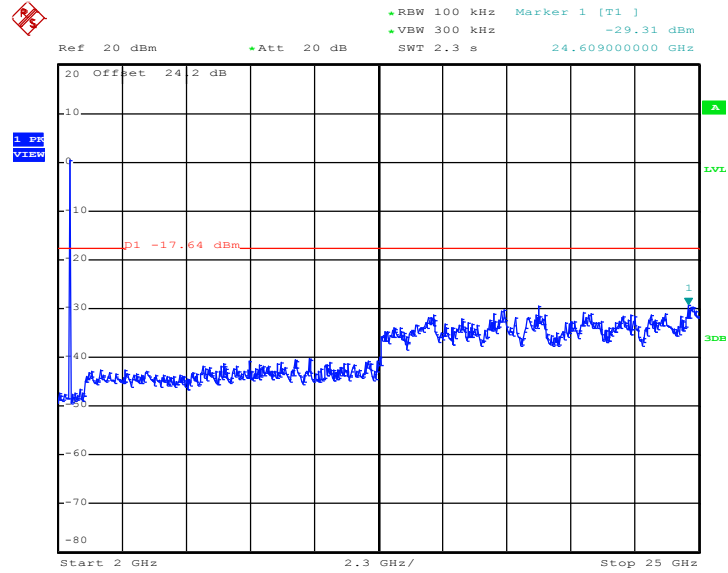

Date: 22.AUG.2016 20:57:16



Conducted Spurious Emission Plot on Bluetooth LE 1Mbps  
GFSK Channel 39

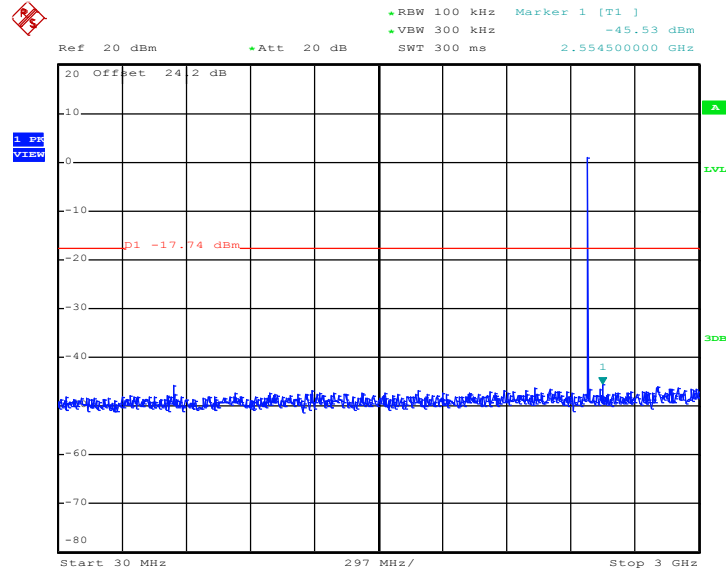

Date: 22.AUG.2016 21:15:30



Conducted Spurious Emission Plot on Bluetooth LE 1Mbps  
GFSK Channel 39

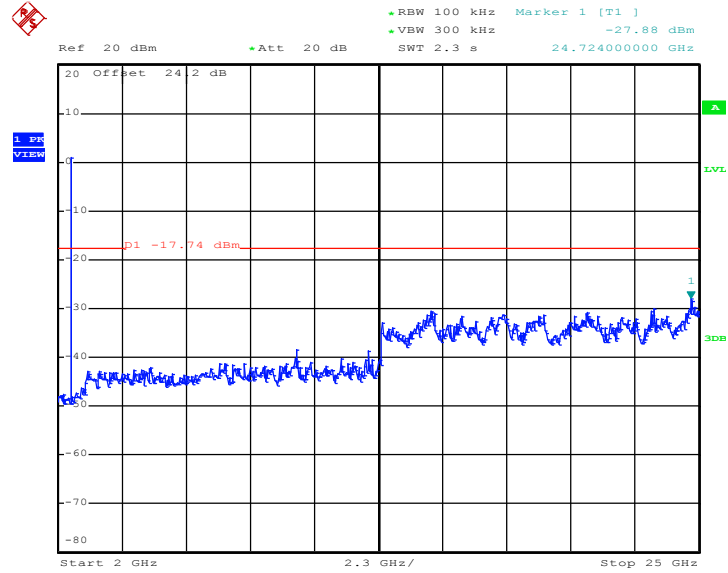

Date: 22.AUG.2016 21:15:38



### 3.5 Radiated Band Edges and Spurious Emission Measurement

#### 3.5.1 Limit of Radiated Band Edges and Spurious Emission

In any 100 kHz bandwidth outside the intentional radiator frequency band, all harmonics/spurious must be at least 20 dB below the highest emission level within the authorized band. If the output power of this device was measured by spectrum analyzer, the attenuation under this paragraph shall be 30 dB instead of 20 dB. In addition, radiated emissions which fall in the restricted bands must also comply with the FCC section 15.209 limits as below.

Frequency (MHz)	Field Strength (microvolts/meter)	Measurement Distance (meters)
0.009 – 0.490	2400/F(kHz)	300
0.490 – 1.705	24000/F(kHz)	30
1.705 – 30.0	30	30
30 – 88	100	3
88 – 216	150	3
216 - 960	200	3
Above 960	500	3

#### 3.5.2 Measuring Instruments

The section 4.0 of List of Measuring Equipment of this test report is used for test.





3.5.3 Test Procedures

1. The testing follows FCC KDB Publication No. 558074 D01 DTS Meas. Guidance v03r05.
2. The EUT was arranged to its worst case and then tune the antenna tower (from 1 m to 4 m) and turntable (from 0 degree to 360 degrees) to find the maximum reading. A pre-amp and a high pass filter are used for the test in order to get better signal level.
3. The EUT was placed on a turntable with 0.8 meter for frequency below 1GHz and 1.5 meter for frequency above 1GHz respectively above ground.
4. The EUT was set 3 meters from the interference receiving antenna, which was mounted on the top of a variable height antenna tower.
5. Corrected Reading: Antenna Factor + Cable Loss + Read Level - Preamp Factor = Level
6. For measurement below 1GHz, If the emission level of the EUT measured by the peak detector is 3 dB lower than the applicable limit, the peak emission level will be reported. Otherwise, the emission measurement will be repeated using the quasi-peak detector and reported.
7. Use the following spectrum analyzer settings:
  - (1) Span shall wide enough to fully capture the emission being measured;
  - (2) Set RBW=100 kHz for  $f < 1$  GHz;  $VBW \geq RBW$ ; Sweep = auto; Detector function = peak; Trace = max hold;
  - (3) Set RBW = 1 MHz, VBW= 3MHz for  $f \geq 1$  GHz for peak measurement.
 

For average measurement:

    - $VBW = 10$  Hz, when duty cycle is no less than 98 percent.
    - $VBW \geq 1/T$ , when duty cycle is less than 98 percent where T is the minimum transmission duration over which the transmitter is on and is transmitting at its maximum power control level for the tested mode of operation.

Band	Duty Cycle(%)	T(μs)	1/T(kHz)	VBW Setting
Bluetooth - LE	62.42	392.00	2.55	3kHz

### 3.5.4 Test Setup

For radiated emissions below 30MHz

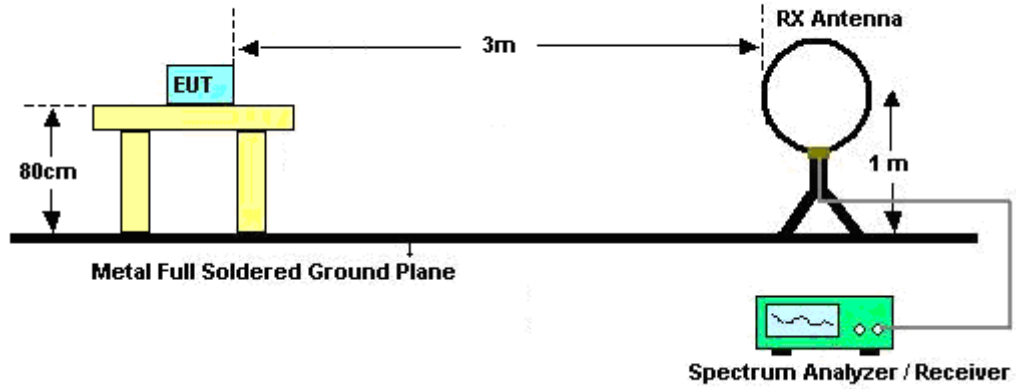

For radiated emissions from 30MHz to 1GHz

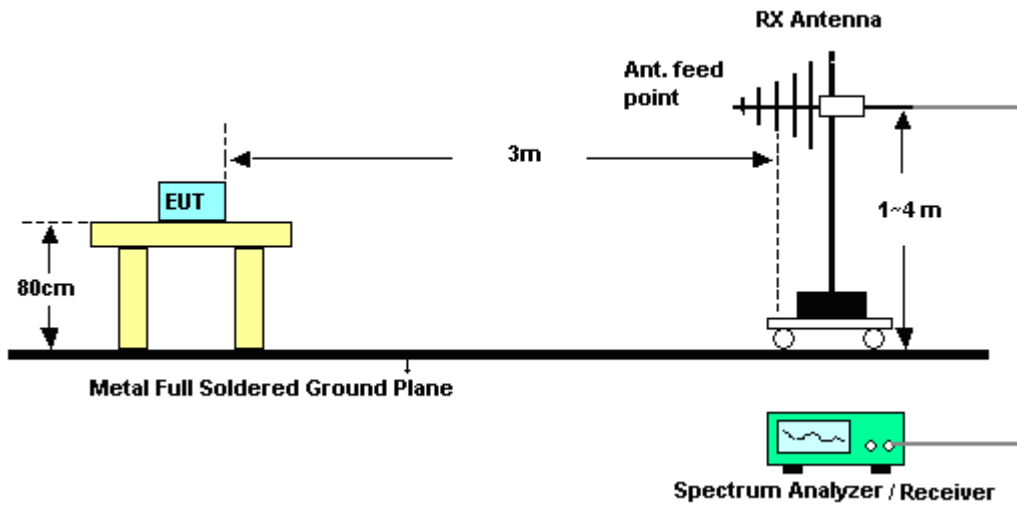

For radiated emissions above 1GHz

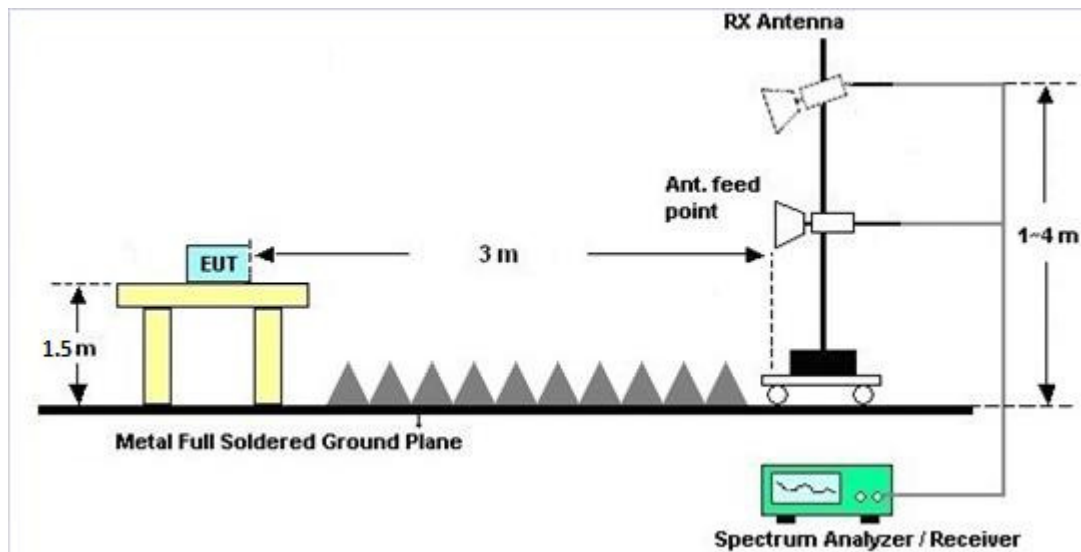

### 3.5.5 Test Results of Radiated Spurious Emissions (9 kHz ~ 30 MHz)

The low frequency, which started from 9 kHz to 30MHz, was pre-scanned and the result which was 20dB lower than the limit line per 15.31(o) was not reported.

### 3.5.6 Test Result of Radiated Spurious at Band Edges

Please refer to Appendix B and C.

### 3.5.7 Duty Cycle

Please refer to Appendix D.

### 3.5.8 Test Result of Radiated Spurious Emission (30MHz ~ 10th Harmonic)

Please refer to Appendix B and C.



### 3.6 AC Conducted Emission Measurement

#### 3.6.1 Limit of AC Conducted Emission

For equipment that is designed to be connected to the public utility (AC) power line, the radio frequency voltage that is conducted back onto the AC power line on any frequency or frequencies within the band 150 kHz to 30 MHz shall not exceed the limits in the following table.

Frequency of emission (MHz)	Conducted limit (dB $\mu$ V)	
	Quasi-peak	Average
0.15-0.5	66 to 56*	56 to 46*
0.5-5	56	46
5-30	60	50

\*Decreases with the logarithm of the frequency.

#### 3.6.2 Measuring Instruments

The section 4.0 of List of Measuring Equipment of this test report is used for test.

#### 3.6.3 Test Procedures

1. The EUT was placed 0.4 meter from the conducting wall of the shielding room was kept at least 80 centimeters from any other grounded conducting surface.
2. Connect EUT to the power mains through a line impedance stabilization network (LISN).
3. All the support units are connecting to the other LISN.
4. The LISN provides 50 ohm coupling impedance for the measuring instrument.
5. The FCC states that a 50 ohm, 50 microhenry LISN should be used.
6. Both sides of AC line were checked for maximum conducted interference.
7. The frequency range from 150 kHz to 30 MHz was searched.
8. Set the test-receiver system to Peak Detect Function and specified bandwidth (IF Bandwidth = 9kHz) with Maximum Hold Mode. Then measurement is also conducted by Average Detector and Quasi-Peak Detector Function respectively.

### 3.6.4 Test Setup

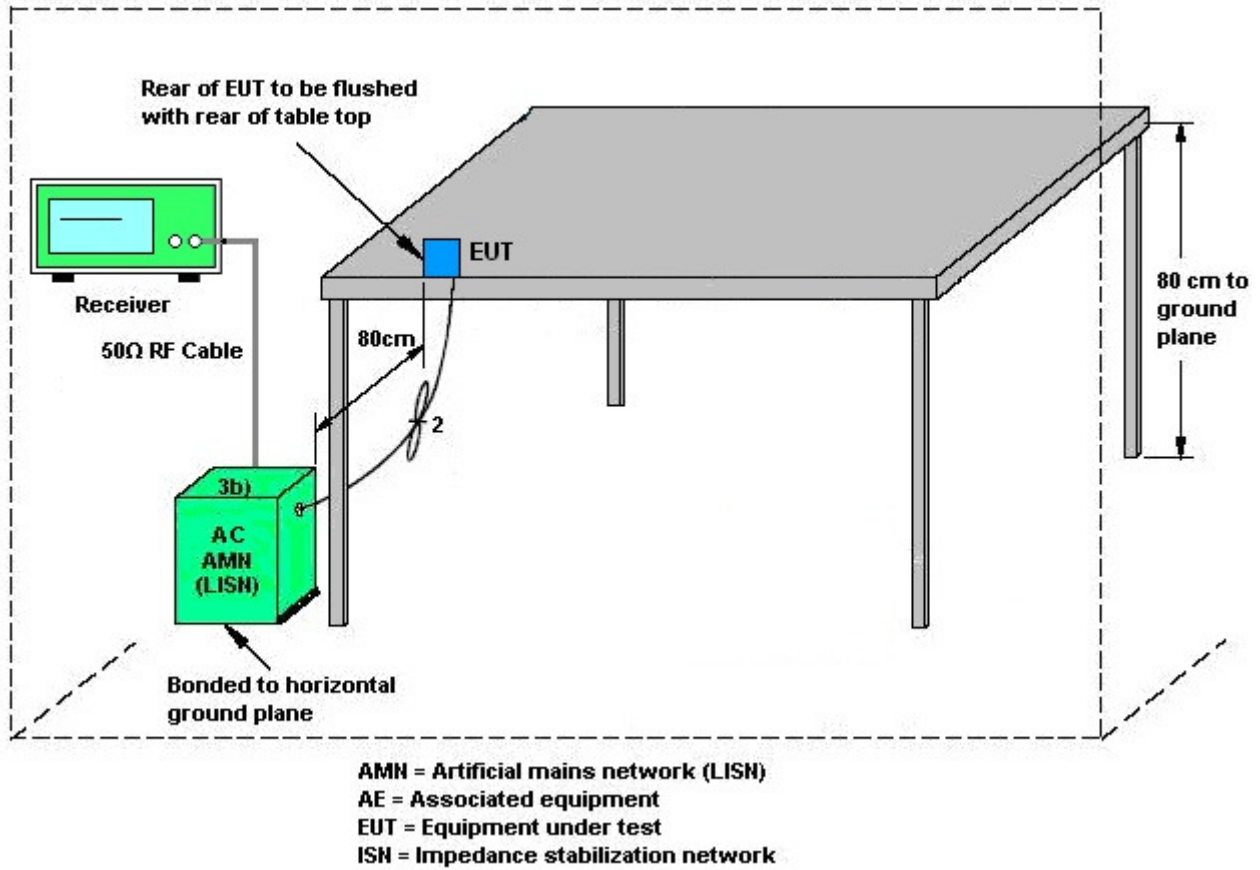



3.6.5 Test Result of AC Conducted Emission

Test Mode :	Mode 1	Temperature :	24~25°C
Test Engineer :	Kai-Chun Chu	Relative Humidity :	45~46%
Test Voltage :	120Vac / 60Hz	Phase :	Line
Function Type :	WLAN (2.4GHz) Link + Bluetooth Link + Battery + Scanner + without Exoskeleton + Headset Jumper (CBL-TC51-HDST25-01) + Earphone (HDST-25MM-PTVP-01) + Rugged Charge/USB Cable + Adapter 1 (SAWA-65-20005A (5V/2.5A))		

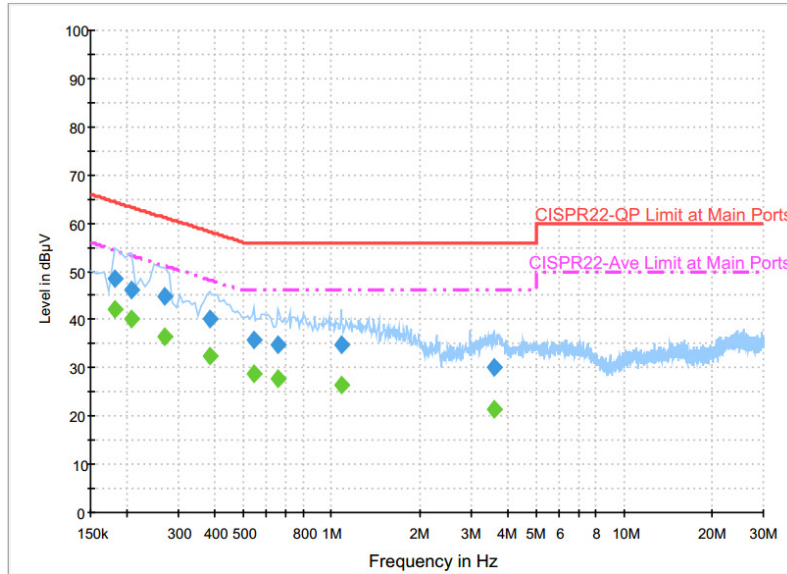

Final Result : QuasiPeak

Frequency (MHz)	QuasiPeak (dBµV)	Filter	Line	Corr. (dB)	Margin (dB)	Limit (dBµV)
0.182000	48.4	Off	L1	19.6	16.0	64.4
0.206000	46.1	Off	L1	19.6	17.3	63.4
0.270000	45.0	Off	L1	19.6	16.1	61.1
0.382000	40.0	Off	L1	19.6	18.2	58.2
0.542000	35.8	Off	L1	19.6	20.2	56.0
0.654000	34.6	Off	L1	19.6	21.4	56.0
1.078000	34.6	Off	L1	19.7	21.4	56.0
3.622000	30.2	Off	L1	19.8	25.8	56.0

Final Result : Average

Frequency (MHz)	Average (dBµV)	Filter	Line	Corr. (dB)	Margin (dB)	Limit (dBµV)
0.182000	42.1	Off	L1	19.6	12.3	54.4
0.206000	40.1	Off	L1	19.6	13.3	53.4
0.270000	36.6	Off	L1	19.6	14.5	51.1
0.382000	32.5	Off	L1	19.6	15.7	48.2
0.542000	28.8	Off	L1	19.6	17.2	46.0
0.654000	27.6	Off	L1	19.6	18.4	46.0
1.078000	26.5	Off	L1	19.7	19.5	46.0
3.622000	21.3	Off	L1	19.8	24.7	46.0



Test Mode :	Mode 1	Temperature :	24~25°C
Test Engineer :	Kai-Chun Chu	Relative Humidity :	45~46%
Test Voltage :	120Vac / 60Hz	Phase :	Neutral
Function Type :	WLAN (2.4GHz) Link + Bluetooth Link + Battery + Scanner + without Exoskeleton + Headset Jumper (CBL-TC51-HDST25-01) + Earphone (HDST-25MM-PTVP-01) + Rugged Charge/USB Cable + Adapter 1 (SAWA-65-20005A (5V/2.5A))		

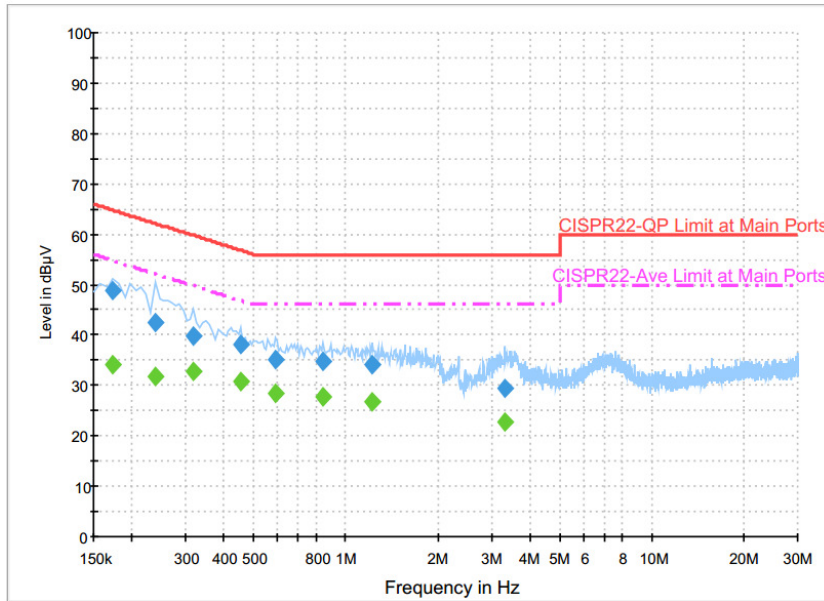

**Final Result : QuasiPeak**

Frequency (MHz)	QuasiPeak (dBµV)	Filter	Line	Corr. (dB)	Margin (dB)	Limit (dBµV)
0.174000	48.8	Off	N	19.6	16.0	64.8
0.238000	42.5	Off	N	19.6	19.7	62.2
0.318000	39.9	Off	N	19.6	19.9	59.8
0.454000	38.2	Off	N	19.6	18.6	56.8
0.590000	35.3	Off	N	19.6	20.7	56.0
0.846000	34.8	Off	N	19.6	21.2	56.0
1.222000	34.2	Off	N	19.6	21.8	56.0
3.310000	29.5	Off	N	19.7	26.5	56.0

**Final Result : Average**

Frequency (MHz)	Average (dBµV)	Filter	Line	Corr. (dB)	Margin (dB)	Limit (dBµV)
0.174000	34.0	Off	N	19.6	20.8	54.8
0.238000	31.7	Off	N	19.6	20.5	52.2
0.318000	32.9	Off	N	19.6	16.9	49.8
0.454000	30.8	Off	N	19.6	16.0	46.8
0.590000	28.5	Off	N	19.6	17.5	46.0
0.846000	27.8	Off	N	19.6	18.2	46.0
1.222000	26.9	Off	N	19.6	19.1	46.0
3.310000	22.7	Off	N	19.7	23.3	46.0



## **3.7 Antenna Requirements**

### **3.7.1 Standard Applicable**

If directional gain of transmitting antennas is greater than 6dBi, the power shall be reduced by the same level in dB comparing to gain minus 6dBi. The use of a permanently attached antenna or of an antenna that uses a unique coupling to the intentional radiator shall be considered sufficient to comply with the FCC rule.

### **3.7.2 Antenna Anti-Replacement Construction**

An embedded-in antenna design is used.

### **3.7.3 Antenna Gain**

The antenna peak gain of EUT is less than 6 dBi. Therefore, it is not necessary to reduce maximum peak output power limit.





## 4 List of Measuring Equipment

Instrument	Manufacturer	Model No.	Serial No.	Characteristics	Calibration Date	Test Date	Due Date	Remark
Power Meter	Agilent	E4416A	GB4129 2344	300MHz~40GHz	Jan. 08, 2016	Aug. 22, 2016 ~ Aug. 24, 2016	Jan. 07, 2017	Conducted (TH05-HY)
Power Sensor	Agilent	E9327A	US40441 548	300MHz~40GHz	Jan. 07, 2016	Aug. 22, 2016 ~ Aug. 24, 2016	Jan. 06, 2017	Conducted (TH05-HY)
Spectrum Analyzer	Rohde & Schwarz	FSP40	100057	9kHz-40GHz	Nov. 23, 2015	Aug. 22, 2016 ~ Aug. 24, 2016	Nov. 22, 2016	Conducted (TH05-HY)
Temperature Chamber	ESPEC	SU-241	9200371 3	-30℃ ~95℃	Jun. 06, 2016	Aug. 22, 2016 ~ Aug. 24, 2016	Jun. 05, 2017	Conducted (TH05-HY)
Programmable Power Supply	GW Instek	PSS-2005	GEO821 763	N/A	Nov. 13, 2015	Aug. 22, 2016 ~ Aug. 24, 2016	Nov. 12, 2016	Conducted (TH05-HY)
AC Power Source	ChainTek	APC-1000W	N/A	N/A	N/A	Aug. 26, 2016	N/A	Conduction (CO05-HY)
LISN	Rohde & Schwarz	ENV216	100080	9kHz~30MHz	Dec. 02, 2015	Aug. 26, 2016	Dec. 01, 2016	Conduction (CO05-HY)
EMI Test Receiver	Keysight	N9038A(MXE)	MY5413 0085	20Hz ~ 8.4GHz	Nov. 04, 2015	Aug. 26, 2016	Nov. 03, 2016	Conduction (CO05-HY)
Loop Antenna	Rohde & Schwarz	HFH2-Z2	100315	9 kHz~30 MHz	Sep. 02, 2015	Aug. 22, 2016 ~ Aug. 29, 2016	Sep. 01, 2016	Radiation (03CH12-HY)
Spectrum Analyzer	Keysight	N9010A	MY5420 0486	10Hz ~ 44GHZ	Sep. 24, 2015	Aug. 22, 2016 ~ Aug. 29, 2016	Sep. 23, 2016	Radiation (03CH12-HY)
Bilog Antenna	TESEQ	CBL 6111D	37059	30MHz~1GHz	Dec. 29, 2015	Aug. 22, 2016 ~ Aug. 29, 2016	Dec. 28, 2016	Radiation (03CH12-HY)
EMI Test Receiver	Rohde & Schwarz	ESU26	100390	20Hz~26.5GHz	Dec. 21, 2015	Aug. 22, 2016 ~ Aug. 29, 2016	Dec. 20, 2016	Radiation (03CH12-HY)
Horn Antenna	SCHWARZBECK	BBHA 9120D	9120D-1 328	1GHz ~ 18GHz	Nov. 02, 2015	Aug. 22, 2016 ~ Aug. 29, 2016	Nov. 01, 2016	Radiation (03CH12-HY)
Preamplifier	MITEQ	AMF-7D-00101 800-30-10P	1815698	1GHz~18GHz	Dec. 14, 2015	Aug. 22, 2016 ~ Aug. 29, 2016	Dec. 13, 2016	Radiation (03CH12-HY)
Preamplifier	Keysight	83017A	MY5327 0148	1GHz~26.5GHz	Jan. 30, 2016	Aug. 22, 2016 ~ Aug. 29, 2016	Jan. 29, 2017	Radiation (03CH12-HY)
Antenna Mast	EMEC	AM-BS-4500-B	N/A	1m~4m	N/A	Aug. 22, 2016 ~ Aug. 29, 2016	N/A	Radiation (03CH12-HY)
Turn Table	EMEC	TT2000	N/A	0~360 Degree	N/A	Aug. 22, 2016 ~ Aug. 29, 2016	N/A	Radiation (03CH12-HY)
Preamplifier	MITEQ	JS44-18004000 -33-8P	1840917	18GHz ~ 40GHz	Jun. 14, 2016	Aug. 22, 2016 ~ Aug. 29, 2016	Jun. 13, 2017	Radiation (03CH12-HY)
SHF-EHF Horn Antenna	SCHWARZBECK	BBHA 9170	BBHA91 70584	18GHz- 40GHz	Nov. 02, 2015	Aug. 22, 2016 ~ Aug. 29, 2016	Nov. 01, 2016	Radiation (03CH12-HY)



## 5 Uncertainty of Evaluation

### Uncertainty of Conducted Emission Measurement (150kHz ~ 30MHz)

Measuring Uncertainty for a Level of Confidence of 95% ( $U = 2Uc(y)$ )	2.70
---	------

### Uncertainty of Radiated Emission Measurement (30 MHz ~ 1000 MHz)

Measuring Uncertainty for a Level of Confidence of 95% ( $U = 2Uc(y)$ )	5.10
---	------

### Uncertainty of Radiated Emission Measurement (1000 MHz ~ 18000 MHz)

Measuring Uncertainty for a Level of Confidence of 95% ( $U = 2Uc(y)$ )	5.20
---	------

### Uncertainty of Radiated Emission Measurement (18000 MHz ~ 40000 MHz)

Measuring Uncertainty for a Level of Confidence of 95% ( $U = 2Uc(y)$ )	4.70
---	------



## **Appendix A. Conducted Test Results**