



FCC RF Test Report

APPLICANT : Zebra Technologies Corporation
EQUIPMENT : Touch computer
BRAND NAME : Zebra
MODEL NAME : TC510K
FCC ID : UZ7TC510K
STANDARD : FCC Part 15 Subpart E §15.407
CLASSIFICATION : (NII) Unlicensed National Information Infrastructure

The product was received on Jun. 18, 2016 and testing was completed on Aug. 26, 2016. We, SPORTON INTERNATIONAL INC., would like to declare that the tested sample has been evaluated in accordance with the test procedures and has been in compliance with the applicable technical standards.

The test results in this report apply exclusively to the tested model / sample. Without written approval of SPORTON INTERNATIONAL INC., the test report shall not be reproduced except in full.

Reviewed by: Joseph Lin / Supervisor

Approved by: Jones Tsai / Manager



SPORTON INTERNATIONAL INC.

No. 52, Hwa Ya 1st Rd., Hwa Ya Technology Park, Kwei-Shan District, Tao Yuan City, Taiwan, R.O.C.



TABLE OF CONTENTS

REVISION HISTORY 3

SUMMARY OF TEST RESULT 4

1 GENERAL DESCRIPTION 5

 1.1 Applicant 5

 1.2 Manufacturer 5

 1.3 Product Feature of Equipment Under Test 5

 1.4 Product Specification of Equipment Under Test 6

 1.5 Modification of EUT 9

 1.6 Testing Location 10

 1.7 Applicable Standards 10

2 TEST CONFIGURATION OF EQUIPMENT UNDER TEST 11

 2.1 Carrier Frequency and Channel 11

 2.2 Pre-Scanned RF Power 13

 2.3 Test Mode 26

 2.4 Connection Diagram of Test System 29

 2.5 Support Unit used in test configuration and system 31

 2.6 EUT Operation Test Setup 31

 2.7 Measurement Results Explanation Example 31

3 TEST RESULT 32

 3.1 26dB & 99% Occupied Bandwidth Measurement 32

 3.2 Maximum Conducted Output Power Measurement 35

 3.3 Power Spectral Density Measurement 40

 3.4 Unwanted Emissions Measurement 44

 3.5 AC Conducted Emission Measurement 50

 3.6 Frequency Stability Measurement 54

 3.7 Automatically Discontinue Transmission 55

 3.8 Antenna Requirements 56

4 LIST OF MEASURING EQUIPMENT 58

5 UNCERTAINTY OF EVALUATION 59

APPENDIX A. CONDUCTED TEST RESULTS

APPENDIX B. RADIATED SPURIOUS EMISSION

APPENDIX C. RADIATED SPURIOUS EMISSION PLOTS

APPENDIX D. DUTY CYCLE PLOTS

APPENDIX E. SETUP PHOTOGRAPHS



REVISION HISTORY

REPORT NO.	VERSION	DESCRIPTION	ISSUED DATE
FR672014-01E	Rev. 01	Initial issue of report	Sep. 19, 2016



SUMMARY OF TEST RESULT

Report Section	FCC Rule	Description	Limit	Result	Remark
3.1	2.1049 15.403(i)	26dB & 99% Bandwidth	-	Pass	-
3.2	15.407(a)	Maximum Conducted Output Power	≤ 24 dBm (depend on band)	Pass	-
3.3	15.407(a)	Power Spectral Density	≤ 11 dBm (depend on band)	Pass	-
3.4	15.407(b)	Unwanted Emissions	≤ -17, -27 dBm (depend on band)&15.209(a)	Pass	Under limit 1.00 dB at 5150.000 MHz
3.5	15.207	AC Conducted Emission	15.207(a)	Pass	Under limit 11.40 dB at 0.366 MHz
3.6	15.407(g)	Frequency Stability	Within Operation Band	Pass	-
3.7	15.407(c)	Automatically Discontinue Transmission	Discontinue Transmission	Pass	-
3.8	15.203 & 15.407(a)	Antenna Requirement	N/A	Pass	-



1 General Description

1.1 Applicant

Zebra Technologies Corporation
1 Zebra Plaza Holtsville, NY 11742

1.2 Manufacturer

Wistron Corporation
21F, No. 88, Sec. 1, Hsin Tai Wu Rd., Hsichih Dist, New Taipei City 221, Taiwan R.O.C.

1.3 Product Feature of Equipment Under Test

Product Feature	
Equipment	Touch computer
Brand Name	Zebra
Model Name	TC510K
FCC ID	UZ7TC510K
EUT supports Radios application	NFC WLAN 11a/b/g/n HT20/HT40 WLAN 11ac VHT20/VHT40/VHT80 Bluetooth BR/EDR/LE
HW Version	EV2
SW Version	91-10-03-MG-00
FW Version	FUSION_BA_2.00.0.0.008
EUT Stage	Engineering sample

Remark: The above EUT's information was declared by manufacturer. Please refer to the specifications or user's manual for more detailed description.

Specification of Accessories				
Adapter 1 (5V/2.5A)	Brand Name	Zebra	Model Number	SAWA-65-20005A
Adapter 2 (5V/1.2A)	Brand Name	Zebra	Model Number	PS000081A01
Headset Jumper 1	Brand Name	Zebra	Part Number	CBL-TC51-HDST25-01
Headset Jumper 2	Brand Name	Zebra	Part Number	CBL-TC51-HDST35-01
Battery	Brand Name	Zebra	Part Number	BT-000314-01
2.5mm Earphone	Brand Name	Zebra	Part Number	HDST-25MM-PTVP-01
3.5mm Earphone	Brand Name	Zebra	Part Number	HDST-35MM-PTVP-01
Trigger Handle	Brand Name	Zebra	Part Number	TRG-TC51-SNP1-01
USB cable	Brand Name	Zebra	Part Number	CBL-TC51-USB1-01
Soft Holster	Brand Name	Zebra	Part Number	SG-TC51-HLSTR1-01
Exoskeleton	Brand Name	Zebra	Part Number	SG-TC51-EX01-01
Hand strap	Brand Name	Zebra	Part Number	SG-TC51-BHDSTP1-03



1.4 Product Specification of Equipment Under Test

Standards-related Product Specification	
Tx/Rx Channel Frequency Range	5180 MHz ~ 5240 MHz 5260 MHz ~ 5320 MHz 5500 MHz ~ 5720 MHz
Maximum Output Power <CDD Modes>	<p><5180 MHz ~ 5240 MHz></p> <p><Ant. 1> 802.11a : 16.54 dBm / 0.0451 W 802.11n HT20 : 16.39 dBm / 0.0436 W 802.11n HT40 : 15.98 dBm / 0.0396 W 802.11ac VHT20: 16.47 dBm / 0.0444 W 802.11ac VHT40: 16.04 dBm / 0.0402 W 802.11ac VHT80: 11.40 dBm / 0.0138 W</p> <p><Ant. 2> 802.11a : 16.34 dBm / 0.0431 W 802.11n HT20 : 16.27 dBm / 0.0424 W 802.11n HT40 : 15.35 dBm / 0.0343 W 802.11ac VHT20: 16.30 dBm / 0.0427 W 802.11ac VHT40: 15.42 dBm / 0.0348 W 802.11ac VHT80: 10.90 dBm / 0.0123 W</p> <p>MIMO <Ant. 1 + 2> 802.11a : 19.49 dBm / 0.0889 W 802.11n HT20 : 19.47 dBm / 0.0885 W 802.11n HT40 : 18.97 dBm / 0.0789 W 802.11ac VHT20: 19.49 dBm / 0.0889 W 802.11ac VHT40: 18.99 dBm / 0.0793 W 802.11ac VHT80: 14.41 dBm / 0.0276 W</p> <p><5260 MHz ~ 5320 MHz></p> <p><Ant. 1> 802.11a : 16.53 dBm / 0.0450 W 802.11n HT20 : 16.42 dBm / 0.0439 W 802.11n HT40 : 15.92 dBm / 0.0391 W 802.11ac VHT20: 16.45 dBm / 0.0442 W 802.11ac VHT40: 16.02 dBm / 0.0400 W 802.11ac VHT80: 11.13 dBm / 0.0130 W</p> <p><Ant. 2> 802.11a : 16.33 dBm / 0.0430 W 802.11n HT20 : 16.14 dBm / 0.0411 W 802.11n HT40 : 15.69 dBm / 0.0371 W 802.11ac VHT20: 16.15 dBm / 0.0412 W 802.11ac VHT40: 15.78 dBm / 0.0378 W 802.11ac VHT80: 10.76 dBm / 0.0119 W</p> <p>MIMO <Ant. 1 + 2> 802.11a : 19.49 dBm / 0.0889 W 802.11n HT20 : 19.45 dBm / 0.0881 W 802.11n HT40 : 18.93 dBm / 0.0782 W 802.11ac VHT20: 19.47 dBm / 0.0885 W 802.11ac VHT40: 18.98 dBm / 0.0791 W 802.11ac VHT80: 14.19 dBm / 0.0262 W</p>



Standards-related Product Specification	
<p>Maximum Output Power <CDD Modes></p>	<p><5500 MHz ~ 5720 MHz> <Ant. 1> 802.11a : 16.50 dBm / 0.0447 W 802.11n HT20 : 16.14 dBm / 0.0411 W 802.11n HT40 : 15.80 dBm / 0.0380 W 802.11ac VHT20: 16.24 dBm / 0.0421 W 802.11ac VHT40: 15.81 dBm / 0.0381 W 802.11ac VHT80: 15.01 dBm / 0.0317 W <Ant. 2> 802.11a : 16.39 dBm / 0.0436 W 802.11n HT20 : 15.92 dBm / 0.0391 W 802.11n HT40 : 15.39 dBm / 0.0346 W 802.11ac VHT20: 16.14 dBm / 0.0411 W 802.11ac VHT40: 15.41 dBm / 0.0348 W 802.11ac VHT80: 14.50 dBm / 0.0282 W MIMO <Ant. 1 + 2> 802.11a : 19.17 dBm / 0.0826 W 802.11n HT20 : 19.18 dBm / 0.0828 W 802.11n HT40 : 18.70 dBm / 0.0741 W 802.11ac VHT20: 19.25 dBm / 0.0841 W 802.11ac VHT40: 18.82 dBm / 0.0762 W 802.11ac VHT80: 17.97 dBm / 0.0627 W</p>
<p>Maximum Output Power <TXBF Modes></p>	<p>MIMO <Ant. 1 + 2> <5180 MHz ~ 5240 MHz> 802.11n HT20 : 19.22 dBm / 0.0836 W 802.11n HT40 : 18.61 dBm / 0.0726 W 802.11ac VHT20: 19.37 dBm / 0.0865 W 802.11ac VHT40: 19.02 dBm / 0.0798 W 802.11ac VHT80: 14.41 dBm / 0.0276 W <5260 MHz ~ 5320 MHz> 802.11n HT20 : 18.86 dBm / 0.0769 W 802.11n HT40 : 18.66 dBm / 0.0735 W 802.11ac VHT20: 19.27 dBm / 0.0845 W 802.11ac VHT40: 18.91 dBm / 0.0778 W 802.11ac VHT80: 14.06 dBm / 0.0255 W <5500 MHz ~ 5720 MHz> 802.11n HT20 : 19.01 dBm / 0.0796 W 802.11n HT40 : 18.81 dBm / 0.0760 W 802.11ac VHT20: 19.51 dBm / 0.0893 W 802.11ac VHT40: 18.97 dBm / 0.0789 W 802.11ac VHT80: 18.01 dBm / 0.0632 W</p>



Standards-related Product Specification	
<p>Maximum Output Power to Antenna for Straddle Channel <CDD Modes></p>	<p><Ant. 1> 802.11a : 16.40 dBm / 0.0437 W 802.11n HT20 : 15.82 dBm / 0.0382 W 802.11n HT40 : 14.77 dBm / 0.0300 W 802.11ac VHT20: 16.27 dBm / 0.0424 W 802.11ac VHT40: 15.53 dBm / 0.0357 W 802.11ac VHT80: 14.75 dBm / 0.0299 W</p> <p><Ant. 2> 802.11a : 16.38 dBm / 0.0435 W 802.11n HT20 : 15.47 dBm / 0.0352 W 802.11n HT40 : 14.76 dBm / 0.0301 W 802.11ac VHT20: 16.02 dBm / 0.0400 W 802.11ac VHT40: 15.24 dBm / 0.0334 W 802.11ac VHT80: 14.53 dBm / 0.0284 W</p> <p>MIMO <Ant. 1 + 2> 802.11a : 19.20 dBm / 0.0832 W 802.11n HT20 : 19.03 dBm / 0.0800 W 802.11n HT40 : 18.19 dBm / 0.0659 W 802.11ac VHT20: 19.53 dBm / 0.0897 W 802.11ac VHT40: 18.68 dBm / 0.0738 W 802.11ac VHT80: 17.80 dBm / 0.0603 W</p>
<p>Maximum Output Power to Antenna for Straddle Channel <TXBF Modes></p>	<p>MIMO <Ant. 1 + 2> 802.11n HT20 : 19.44 dBm / 0.0879 W 802.11n HT40 : 18.92 dBm / 0.0780 W 802.11ac VHT20: 19.55 dBm / 0.0902 W 802.11ac VHT40: 19.04 dBm / 0.0802 W 802.11ac VHT80: 17.98 dBm / 0.0628 W</p>
<p>99% Occupied Bandwidth <CDD Modes></p>	<p>802.11a : 18.70 MHz 802.11n HT20 : 19.45 MHz 802.11n HT40 : 37.40 MHz 802.11ac VHT20 : 19.40 MHz 802.11ac VHT40 : 37.20 MHz 802.11ac VHT80 : 75.96 MHz</p>
<p>99% Occupied Bandwidth <TXBF Modes></p>	<p>802.11n HT20 : 19.20 MHz 802.11n HT40 : 37.10 MHz 802.11ac VHT20 : 19.30 MHz 802.11ac VHT40 : 37.10 MHz 802.11ac VHT80 : 76.44 MHz</p>



Standards-related Product Specification										
99% Occupied Bandwidth for Straddle Channel <CDD Modes>	802.11a : 18.70 MHz 802.11n HT20 : 19.05 MHz 802.11n HT40 : 36.80 MHz 802.11ac VHT20 : 19.50 MHz 802.11ac VHT40 : 37.20 MHz 802.11ac VHT80 : 76.08 MHz									
99% Occupied Bandwidth for Straddle Channel <TXBF Modes>	802.11n HT20 : 19.35 MHz 802.11n HT40 : 36.70 MHz 802.11ac VHT20 : 19.05 MHz 802.11ac VHT40 : 36.90 MHz 802.11ac VHT80 : 75.96 MHz									
Antenna Type / Gain	<5180 MHz ~ 5240 MHz> Ant. 1 : Loop Antenna with gain 3.07 dBi Ant. 2 : PIFA Antenna with gain 3.00 dBi <5260 MHz ~ 5320 MHz> Ant. 1 : Loop Antenna with gain 2.78 dBi Ant. 2 : PIFA Antenna with gain 3.11 dBi <5500 MHz ~ 5720 MHz> Ant. 1 : Loop Antenna with gain 2.48 dBi Ant. 2 : PIFA Antenna with gain 3.73 dBi									
Type of Modulation	802.11a/n : OFDM (BPSK / QPSK / 16QAM / 64QAM) 802.11ac : OFDM (BPSK / QPSK / 16QAM / 64QAM / 256QAM)									
Antenna Function Description	<table border="1"> <thead> <tr> <th></th> <th>Ant. 1</th> <th>Ant. 2</th> </tr> </thead> <tbody> <tr> <td>802.11 a/n/ac</td> <td>V</td> <td>V</td> </tr> <tr> <td>802.11 a/n/ac MIMO</td> <td>V</td> <td>V</td> </tr> </tbody> </table>		Ant. 1	Ant. 2	802.11 a/n/ac	V	V	802.11 a/n/ac MIMO	V	V
	Ant. 1	Ant. 2								
802.11 a/n/ac	V	V								
802.11 a/n/ac MIMO	V	V								

Note: MIMO Ant. 1+2 is a calculated result from sum of the power MIMO Ant. 1 and MIMO Ant. 2.

1.5 Modification of EUT

No modifications are made to the EUT during all test items.



1.6 Testing Location

Sporton Lab is accredited to ISO 17025 by Taiwan Accreditation Foundation (TAF code : 1190) and the FCC designation No. TW1022 under the FCC 2.948(e) by Mutual Recognition Agreement (MRA) in FCC Test.

Test Site	SPORTON INTERNATIONAL INC.	
Test Site Location	No. 52, Hwa Ya 1 st Rd., Hwa Ya Technology Park, Kwei-Shan District, Tao Yuan City, Taiwan, R.O.C. TEL: +886-3-327-3456 FAX: +886-3-328-4978	
Test Site No.	Sporton Site No.	
	TH05-HY	CO05-HY

Note: The test site complies with ANSI C63.4 2014 requirement.

Test Site	SPORTON INTERNATIONAL INC.	
Test Site Location	No.58, Aly. 75, Ln. 564, Wenhua 3rd Rd. Guishan Dist, Taoyuan City, Taiwan (R.O.C.) TEL: +886-3-327-0868 FAX: +886-3-327-0855	
Test Site No.	Sporton Site No.	
	03CH12-HY	

Note: The test site complies with ANSI C63.4 2014 requirement.

1.7 Applicable Standards

According to the specifications of the manufacturer, the EUT must comply with the requirements of the following standards:

- ♦ FCC Part 15 Subpart E
- ♦ FCC KDB 789033 D02 General UNII Test Procedures New Rules v01r03
- ♦ FCC KDB 662911 D01 Multiple Transmitter Output v02r01.
- ♦ FCC KDB 644545 D03 Guidance for IEEE 802 11ac New Rules v01
- ♦ ANSI C63.10-2013

Remark:

1. All test items were verified and recorded according to the standards and without any deviation during the test.
2. This EUT has also been tested and complied with the requirements of FCC Part 15, Subpart B, recorded in a separate test report.



2 Test Configuration of Equipment Under Test

The EUT has been associated with peripherals and configuration operated in a manner tended to maximize its emission characteristics in a typical application. Frequency range investigated: conducted emission (150 kHz to 30 MHz) and radiated emission (9 kHz to the 10th harmonic of the highest fundamental frequency or to 40 GHz, whichever is lower). For radiated measurement, pre-scanned in three orthogonal panels, X, Y, Z. The worst cases (X plane for CDD Mode ANT 2 and CDD Mode MIMO Ant. 1+2, Z plane for CDD Mode Ant. 1 and TXBF MIMO Ant. 1+2) were recorded in this report.

2.1 Carrier Frequency and Channel

Frequency Band	Channel	Freq. (MHz)	Channel	Freq. (MHz)
5150-5250 MHz Band 1 (U-NII-1)	36	5180	44	5220
	38*	5190	46*	5230
	40	5200	48	5240
	42 [#]	5210		

Frequency Band	Channel	Freq. (MHz)	Channel	Freq. (MHz)
5250-5350 MHz Band 2 (U-NII-2A)	52	5260	60	5300
	54*	5270	62*	5310
	56	5280	64	5320
	58 [#]	5290		

Frequency Band	Channel	Freq. (MHz)	Channel	Freq. (MHz)
5470-5725 MHz Band 3 (U-NII-2C)	100	5500	112	5560
	102*	5510	116	5580
	104	5520	132	5660
	106 [#]	5530	134*	5670
	108	5540	136	5680
	110*	5550	140	5700



Frequency Band	Channel	Freq. (MHz)	Channel	Freq. (MHz)
TDWR Channel	118*	5590	124	5620
	120	5600	126*	5630
	122 [#]	5610	128	5640

Frequency Band	Channel	Freq. (MHz)	Channel	Freq. (MHz)
Straddle Channel	138 [#]	5690	144	5720
	142*	5710		

Note:

1. The above Frequency and Channel in "*" were 802.11n HT40 and 802.11ac VHT40.
2. The above Frequency and Channel in "[#]" were 802.11ac VHT80.



2.2 Pre-Scanned RF Power

Preliminary tests were performed in different data rate and data rate associated with the highest power were chosen for full test in the following tables. Final Output Power equals to Measured Output Power adds the duty factor.

<CDD Modes>

<Ant. 1>

802.11a mode										
Power vs. Channel			Power vs. Data Rate							
Channel	Frequency (MHz)	Data Rate (bps)	Channel	Data Rate (bps)						
		6M		9M	12M	18M	24M	36M	48M	54M
CH 36	5180	15.84	CH 48	16.30	16.28	16.40	16.47	16.51	16.51	16.49
CH 44	5220	16.52								
CH 48	5240	16.54								
CH 52	5260	16.53	CH 52	16.48	16.42	16.50	16.53	16.52	16.50	16.50
CH 60	5300	16.52								
CH 64	5320	15.54								
CH 100	5500	16.50	CH 100	16.45	16.44	16.44	16.26	16.36	16.40	16.49
CH 116	5580	16.45								
CH 140	5700	14.64								
CH 144*	5720	16.40								

Note: The above Frequency and Channel in "*" were straddle channel.



802.11n HT20 mode										
Power vs. Channel			Power vs. Data Rate							
Channel	Frequency (MHz)	MCS Index	Channel	MCS Index						
		MCS0		MCS1	MCS2	MCS3	MCS4	MCS5	MCS6	MCS7
CH 36	5180	15.40	CH 44	16.33	16.26	16.27	16.26	16.34	16.34	16.30
CH 44	5220	16.39								
CH 48	5240	16.38								
CH 52	5260	16.02	CH 60	16.40	16.39	16.31	16.39	16.36	16.34	16.34
CH 60	5300	16.42								
CH 64	5320	14.39								
CH 100	5500	14.47	CH 116	16.13	16.11	16.11	16.14	16.11	16.11	16.09
CH 116	5580	16.14								
CH 140	5700	13.17								
CH 144*	5720	15.82								

Note: The above Frequency and Channel in "*" were straddle channel.



802.11n HT40 mode										
Power vs. Channel			Power vs. Data Rate							
Channel	Frequency (MHz)	MCS Index	Channel	MCS Index						
		MCS0		MCS1	MCS2	MCS3	MCS4	MCS5	MCS6	MCS7
CH 38	5190	12.08	CH 46	15.95	15.90	15.83	15.89	15.91	15.96	15.95
CH 46	5230	15.98								
CH 54	5270	15.92	CH 54	15.89	15.85	15.83	15.89	15.90	15.89	15.91
CH 62	5310	10.75								
CH 102	5510	11.68	CH 110	15.79	15.73	15.72	15.77	15.75	15.74	15.73
CH 110	5550	15.80								
CH 134	5670	15.43								
CH 142*	5710	14.77								

Note: The above Frequency and Channel in "*" were straddle channel.

802.11ac VHT20 mode											
Power vs. Channel			Power vs. Data Rate								
Channel	Frequency (MHz)	MCS Index	Channel	MCS Index							
		MCS0		MCS1	MCS2	MCS3	MCS4	MCS5	MCS6	MCS7	MCS8
CH 36	5180	15.41	CH 44	16.45	16.36	16.40	16.42	16.44	16.43	16.42	16.44
CH 44	5220	16.47									
CH 48	5240	16.42									
CH 52	5260	16.14	CH 60	16.42	16.30	16.32	16.41	16.40	16.40	16.42	16.43
CH 60	5300	16.45									
CH 64	5320	14.45									
CH 100	5500	14.49	CH 116	16.15	16.13	16.10	16.16	16.20	16.21	16.23	16.23
CH 116	5580	16.24									
CH 140	5700	13.18									
CH 144*	5720	16.27									

Note: The above Frequency and Channel in "*" were straddle channel.



802.11ac VHT40 mode												
Power vs. Channel			Power vs. Data Rate									
Channel	Frequency (MHz)	MCS Index	Channel	MCS Index								
		MCS0		MCS1	MCS2	MCS3	MCS4	MCS5	MCS6	MCS7	MCS8	MCS9
CH 38	5190	12.23	CH 46	15.95	15.94	15.98	16.00	16.02	16.01	16.00	16.02	16.01
CH 46	5230	16.04										
CH 54	5270	16.02	CH 54	15.97	15.93	15.79	15.92	15.97	15.98	16.01	16.00	15.97
CH 62	5310	10.78										
CH 102	5510	11.74	CH 110	15.74	15.77	15.69	15.79	15.80	15.80	15.78	15.77	15.73
CH 110	5550	15.81										
CH 134	5670	15.59										
CH 142*	5710	15.53										

Note: The above Frequency and Channel in "*" were straddle channel.

802.11ac VHT80 mode												
Power vs. Channel			Power vs. Data Rate									
Channel	Frequency (MHz)	MCS Index	Channel	MCS Index								
		MCS0		MCS1	MCS2	MCS3	MCS4	MCS5	MCS6	MCS7	MCS8	MCS9
CH 042	5210	11.40	CH 42	10.80	10.72	10.56	10.35	10.02	10.10	10.02	9.95	9.89
CH 058	5290	11.13	CH 58	10.27	9.92	9.70	9.40	9.05	9.15	8.99	8.94	9.25
CH 106	5530	9.98	CH 122	14.42	14.13	13.83	13.77	13.25	13.32	13.23	13.23	13.12
CH 122	5610	15.01										
CH 138*	5690	14.75										

Note: The above Frequency and Channel in "*" were straddle channel.



<Ant. 2>

802.11a mode										
Power vs. Channel			Power vs. Data Rate							
Channel	Frequency (MHz)	Data Rate (bps)	Channel	Data Rate (bps)						
		6M		9M	12M	18M	24M	36M	48M	54M
CH 36	5180	16.22	CH 44	16.28	16.30	16.27	16.30	16.31	16.28	16.23
CH 44	5220	16.34								
CH 48	5240	16.25								
CH 52	5260	16.31	CH 60	16.30	16.27	16.29	16.28	16.30	16.25	16.23
CH 60	5300	16.33								
CH 64	5320	15.67								
CH 100	5500	15.23	CH 116	16.29	16.29	16.29	16.32	16.37	16.31	16.36
CH 116	5580	16.39								
CH 140	5700	13.72								
CH 144*	5720	16.38								

Note: The above Frequency and Channel in "*" were straddle channel.

802.11n HT20 mode										
Power vs. Channel			Power vs. Data Rate							
Channel	Frequency (MHz)	MCS Index	Channel	MCS Index						
		MCS0		MCS1	MCS2	MCS3	MCS4	MCS5	MCS6	MCS7
CH 36	5180	15.12	CH 44	16.24	16.23	16.23	16.26	16.26	16.25	16.24
CH 44	5220	16.27								
CH 48	5240	16.22								
CH 52	5260	16.08	CH 60	16.13	16.09	16.05	16.09	16.11	16.08	16.09
CH 60	5300	16.14								
CH 64	5320	14.21								
CH 100	5500	14.16	CH 116	15.90	15.87	15.87	15.88	15.90	15.88	15.89
CH 116	5580	15.92								
CH 140	5700	12.14								
CH 144*	5720	15.47								

Note: The above Frequency and Channel in "*" were straddle channel.



802.11n HT40 mode										
Power vs. Channel			Power vs. Data Rate							
Channel	Frequency (MHz)	MCS Index	Channel	MCS Index						
		MCS0		MCS1	MCS2	MCS3	MCS4	MCS5	MCS6	MCS7
CH 38	5190	11.51	CH 46	15.32	15.30	15.31	15.26	15.32	15.30	15.27
CH 46	5230	15.35								
CH 54	5270	15.69	CH 54	15.64	15.61	15.60	15.59	15.66	15.65	15.65
CH 62	5310	10.59								
CH 102	5510	11.47								
CH 110	5550	15.39	CH 110	15.36	15.31	15.33	15.33	15.37	15.34	15.31
CH 134	5670	14.84								
CH 142*	5710	14.76								

Note: The above Frequency and Channel in "*" were straddle channel.

802.11ac VHT20 mode											
Power vs. Channel			Power vs. Data Rate								
Channel	Frequency (MHz)	MCS Index	Channel	MCS Index							
		MCS0		MCS1	MCS2	MCS3	MCS4	MCS5	MCS6	MCS7	MCS8
CH 36	5180	15.13	CH 48	16.25	16.19	16.16	16.20	16.24	16.22	16.21	16.25
CH 44	5220	16.28									
CH 48	5240	16.30									
CH 52	5260	16.09	CH 60	16.04	16.02	16.05	16.06	16.12	16.10	16.14	16.13
CH 60	5300	16.15									
CH 64	5320	14.24									
CH 100	5500	14.18	CH 116	15.97	16.02	16.09	16.09	16.11	16.08	16.07	16.11
CH 116	5580	16.14									
CH 140	5700	12.35									
CH 144*	5720	16.02									

Note: The above Frequency and Channel in "*" were straddle channel.



802.11ac VHT40 mode												
Power vs. Channel			Power vs. Data Rate									
Channel	Frequency (MHz)	MCS Index	Channel	MCS Index								
		MCS0		MCS1	MCS2	MCS3	MCS4	MCS5	MCS6	MCS7	MCS8	MCS9
CH 38	5190	11.58	CH 46	15.39	15.36	15.31	15.37	15.31	15.38	15.34	15.31	15.36
CH 46	5230	15.42										
CH 54	5270	15.78	CH 54	15.69	15.66	15.62	15.64	15.67	15.73	15.66	15.68	15.66
CH 62	5310	10.63										
CH 102	5510	11.76	CH 110	15.33	15.35	15.36	15.40	15.33	15.32	15.22	15.40	15.38
CH 110	5550	15.41										
CH 134	5670	15.20										
CH 142*	5710	15.24										

Note: The above Frequency and Channel in "*" were straddle channel.

802.11ac VHT80 mode												
Power vs. Channel			Power vs. Data Rate									
Channel	Frequency (MHz)	MCS Index	Channel	MCS Index								
		MCS0		MCS1	MCS2	MCS3	MCS4	MCS5	MCS6	MCS7	MCS8	MCS9
CH 042	5210	10.90	CH 42	10.40	10.32	10.14	9.88	9.55	9.51	9.55	9.45	9.31
CH 058	5290z	10.76	CH 58	10.17	10.17	10.11	9.95	9.72	9.68	9.67	9.49	9.35
CH 106	5530	9.46	CH 122	13.71	13.68	13.51	13.25	12.95	12.93	13.00	12.89	12.76
CH 122	5610	14.50										
CH 138*	5690	14.53										

Note: The above Frequency and Channel in "*" were straddle channel.



MIMO <Ant. 1+2>

802.11a mode										
Power vs. Channel			Power vs. Data Rate							
Channel	Frequency (MHz)	Data Rate (bps)	Channel	Data Rate (bps)						
		6M		9M	12M	18M	24M	36M	48M	54M
CH 36	5180	18.40	CH 48	19.49	19.40	19.33	19.39	19.48	19.49	19.49
CH 44	5220	19.48								
CH 48	5240	19.49								
CH 52	5260	19.49	CH 52	19.48	19.44	19.46	19.48	19.48	19.47	19.42
CH 60	5300	19.25								
CH 64	5320	17.76								
CH 100	5500	18.14	CH 116	19.15	19.16	19.16	19.15	19.16	19.11	19.11
CH 116	5580	19.17								
CH 140	5700	16.30								
CH 144*	5720	19.20								

Note: The above Frequency and Channel in "*" were straddle channel.

802.11n HT20 mode										
Power vs. Channel			Power vs. Data Rate							
Channel	Frequency (MHz)	MCS Index	Channel	MCS Index						
		MCS0		MCS1	MCS2	MCS3	MCS4	MCS5	MCS6	MCS7
CH 36	5180	18.38	CH 44	19.46	19.43	19.33	19.45	19.43	19.35	19.23
CH 44	5220	19.47								
CH 48	5240	19.45								
CH 52	5260	19.15	CH 60	19.44	19.42	19.41	19.38	19.43	19.36	19.35
CH 60	5300	19.45								
CH 64	5320	17.50								
CH 100	5500	17.47	CH 116	19.17	19.11	19.07	19.11	19.17	19.08	19.08
CH 116	5580	19.18								
CH 140	5700	15.89								
CH 144*	5720	19.03								

Note: The above Frequency and Channel in "*" were straddle channel.



802.11n HT40 mode										
Power vs. Channel			Power vs. Data Rate							
Channel	Frequency (MHz)	MCS Index	Channel	MCS Index						
		MCS0		MCS1	MCS2	MCS3	MCS4	MCS5	MCS6	MCS7
CH 38	5190	15.09	CH 46	18.91	18.87	18.84	18.90	18.92	18.93	18.89
CH 46	5230	18.97								
CH 54	5270	18.93	CH 54	18.85	18.82	18.83	18.87	18.90	18.91	18.85
CH 62	5310	13.77								
CH 102	5510	14.71	CH 110	18.64	18.61	18.53	18.53	18.53	18.50	18.67
CH 110	5550	18.70								
CH 134	5670	18.44								
CH 142*	5710	18.19								

Note: The above Frequency and Channel in "*" were straddle channel.

802.11ac VHT20 mode											
Power vs. Channel			Power vs. Data Rate								
Channel	Frequency (MHz)	MCS Index	Channel	MCS Index							
		MCS0		MCS1	MCS2	MCS3	MCS4	MCS5	MCS6	MCS7	MCS8
CH 36	5180	18.42	CH 44	19.48	19.47	19.46	19.39	19.47	19.47	19.47	19.48
CH 44	5220	19.49									
CH 48	5240	19.48									
CH 52	5260	19.16	CH 60	19.45	19.33	19.22	19.45	19.44	19.44	19.44	19.41
CH 60	5300	19.47									
CH 64	5320	17.53									
CH 100	5500	17.50	CH 116	19.22	19.23	19.17	19.20	19.22	19.24	19.21	19.23
CH 116	5580	19.25									
CH 140	5700	15.91									
CH 144*	5720	19.53									

Note: The above Frequency and Channel in "*" were straddle channel.



802.11ac VHT40 mode												
Power vs. Channel			Power vs. Data Rate									
Channel	Frequency (MHz)	MCS Index	Channel	MCS Index								
		MCS0		MCS1	MCS2	MCS3	MCS4	MCS5	MCS6	MCS7	MCS8	MCS9
CH 38	5190	15.19	CH 46	18.88	18.88	18.98	18.98	18.93	18.94	18.91	18.98	18.96
CH 46	5230	18.99										
CH 54	5270	18.98	CH 54	18.90	18.93	18.89	18.89	18.87	18.82	18.94	18.96	18.96
CH 62	5310	13.87										
CH 102	5510	14.89	CH 110	18.80	18.81	18.80	18.79	18.75	18.74	18.71	18.77	18.81
CH 110	5550	18.82										
CH 134	5670	18.60										
CH 142*	5710	18.68										

Note: The above Frequency and Channel in "*" were straddle channel.

802.11ac VHT80 mode												
Power vs. Channel			Power vs. Data Rate									
Channel	Frequency (MHz)	MCS Index	Channel	MCS Index								
		MCS0		MCS1	MCS2	MCS3	MCS4	MCS5	MCS6	MCS7	MCS8	MCS9
CH 42	5210	14.41	CH 42	14.40	14.37	14.38	14.37	14.40	14.38	14.40	14.36	14.35
CH 58	5290	14.19	CH 58	14.14	14.13	14.15	14.19	14.15	14.12	14.12	14.11	14.07
CH 106	5530	13.00	CH 122	17.88	17.90	17.91	17.95	17.87	17.89	17.80	17.82	17.82
CH 122	5610	17.97										
CH 138*	5690	17.80										

Note:

1. The above Frequency and Channel in "*" were straddle channel.
2. MIMO Ant. 1+2 is a calculated result from sum of the power MIMO Ant. 1 and MIMO Ant. 2.



<TXBF Modes>

MIMO <Ant. 1+2>

802.11n HT20 mode										
Power vs. Channel			Power vs. Data Rate							
Channel	Frequency (MHz)	MCS Index	Channel	MCS Index						
		MCS0		MCS1	MCS2	MCS3	MCS4	MCS5	MCS6	MCS7
CH 36	5180	18.56	CH 48	19.17	19.17	19.12	19.17	19.13	19.12	19.13
CH 44	5220	19.12								
CH 48	5240	19.22								
CH 52	5260	18.86	CH 52	18.81	18.76	18.81	18.81	18.76	18.81	18.76
CH 60	5300	18.77								
CH 64	5320	17.61								
CH 100	5500	18.67	CH 116	18.97	18.91	18.97	18.91	18.97	18.92	18.92
CH 116	5580	19.01								
CH 140	5700	17.37								
CH 144*	5720	19.44								

Note: The above Frequency and Channel in "*" were straddle channel.

802.11n HT40 mode										
Power vs. Channel			Power vs. Data Rate							
Channel	Frequency (MHz)	MCS Index	Channel	MCS Index						
		MCS0		MCS1	MCS2	MCS3	MCS4	MCS5	MCS6	MCS7
CH 38	5190	15.66	CH 46	18.57	18.56	18.56	18.57	18.52	18.56	18.57
CH 46	5230	18.61								
CH 54	5270	18.66	CH 54	18.61	18.61	18.56	18.56	18.57	18.61	18.57
CH 62	5310	13.57								
CH 102	5510	16.37	CH 110	18.77	18.77	18.72	18.71	18.71	18.72	18.71
CH 110	5550	18.81								
CH 134	5670	18.34								
CH 142*	5710	18.92								

Note: The above Frequency and Channel in "*" were straddle channel.



802.11ac VHT20 mode											
Power vs. Channel			Power vs. Data Rate								
Channel	Frequency (MHz)	MCS Index	Channel	MCS Index							
		MCS0		MCS1	MCS2	MCS3	MCS4	MCS5	MCS6	MCS7	MCS8
CH 36	5180	18.76	CH 48	19.28	19.28	19.23	19.23	19.18	19.23	19.28	19.23
CH 44	5220	19.33									
CH 48	5240	19.37									
CH 52	5260	19.21	CH 60	19.23	19.17	19.23	19.22	19.23	19.22	19.22	19.23
CH 60	5300	19.27									
CH 64	5320	17.71									
CH 100	5500	18.77	CH 116	19.47	19.47	19.46	19.46	19.47	19.41	19.46	19.41
CH 116	5580	19.51									
CH 140	5700	17.47									
CH 144*	5720	19.55									

Note: The above Frequency and Channel in "*" were straddle channel.

802.11ac VHT40 mode												
Power vs. Channel			Power vs. Data Rate									
Channel	Frequency (MHz)	MCS Index	Channel	MCS Index								
		MCS0		MCS1	MCS2	MCS3	MCS4	MCS5	MCS6	MCS7	MCS8	MCS9
CH 38	5190	15.81	CH 46	18.97	18.97	18.92	18.97	18.93	18.92	18.93	18.92	18.87
CH 46	5230	19.02										
CH 54	5270	18.91	CH 54	18.86	18.81	18.76	18.86	18.86	18.81	18.86	18.76	18.81
CH 62	5310	13.66										
CH 102	5510	16.46	CH 110	18.91	18.92	18.91	18.87	18.87	18.92	18.82	18.92	18.87
CH 110	5550	18.97										
CH 134	5670	18.76										
CH 142*	5710	19.04										

Note: The above Frequency and Channel in "*" were straddle channel.



802.11ac VHT80 mode												
Power vs. Channel			Power vs. Data Rate									
Channel	Frequency (MHz)	MCS Index	Channel	MCS Index								
		MCS0		MCS1	MCS2	MCS3	MCS4	MCS5	MCS6	MCS7	MCS8	MCS9
CH 42	5210	14.41	CH 42	14.37	14.36	14.36	14.37	14.36	14.36	14.31	14.37	14.36
CH 58	5290	14.06	CH 58	14.01	14.01	14.01	13.96	13.96	13.96	13.91	13.91	13.96
CH 106	5530	14.72	CH 122	17.97	17.96	17.96	17.92	17.96	17.92	17.91	17.91	17.92
CH 122	5610	18.01										
CH 138*	5690	17.98										

Note:

1. The above Frequency and Channel in "*" were straddle channel.
2. MIMO Ant. 1+2 is a calculated result from sum of the power MIMO Ant. 1 and MIMO Ant. 2.



2.3 Test Mode

Final test mode of conducted test items and radiated spurious emissions are considering the modulation and worse data rates from the power table described in section 2.2.

Single Antenna

Modulation	Data Rate
802.11a	6 Mbps
802.11n HT20	MCS0
802.11n HT40	MCS0
802.11ac VHT20	MCS0
802.11ac VHT40	MCS0
802.11ac VHT80	MCS0

MIMO Antenna

Modulation	Data Rate
802.11a	6 Mbps
802.11n HT20	MCS0
802.11n HT40	MCS0
802.11ac VHT20	MCS0
802.11ac VHT40	MCS0
802.11ac VHT80	MCS0

Test Cases	
AC Conducted Emission	Mode 1 : WLAN (5GHz) Link + Bluetooth Link + Battery + Scanner + without Exoskeleton + Headset Jumper (CBL-TC51-HDST25-01) + Earphone (HDST-25MM-PTVP-01) + Rugged Charge/USB Cable + Adapter 1 (SAWA-65-20005A (5V/2.5A))



Ch. #		Band I : 5150-5250 MHz	Band II : 5250-5350 MHz	Band III : 5470-5725MHz
		802.11a	802.11a	802.11a
L	Low	36	52	100
M	Middle	44	60	116
H	High	48	64	140
Straddle				144

Ch. #		Band I : 5150-5250 MHz	Band II : 5250-5350 MHz	Band III : 5470-5725MHz
		802.11n HT20	802.11n HT20	802.11n HT20
L	Low	36	52	100
M	Middle	44	60	116
H	High	48	64	140
Straddle				144

Ch. #		Band I : 5150-5250 MHz	Band II : 5250-5350 MHz	Band III : 5470-5725MHz
		802.11n HT40	802.11n HT40	802.11n HT40
L	Low	38	54	102
M	Middle	-	-	110
H	High	46	62	134
Straddle				142



Ch. #		Band I : 5150-5250 MHz	Band II : 5250-5350 MHz	Band III : 5470-5725MHz
		802.11ac VHT20	802.11ac VHT20	802.11ac VHT20
L	Low	36	52	100
M	Middle	44	60	116
H	High	48	64	140
Straddle				144

Ch. #		Band I : 5150-5250 MHz	Band II : 5250-5350 MHz	Band III : 5470-5725MHz
		802.11ac VHT40	802.11ac VHT40	802.11ac VHT40
L	Low	38	54	102
M	Middle	-	-	110
H	High	46	62	134
Straddle				142

Ch. #		Band I : 5150-5250 MHz	Band II : 5250-5350 MHz	Band III : 5470-5725MHz
		802.11ac VHT80	802.11ac VHT80	802.11ac VHT80
L	Low	-	-	-
M	Middle	42	58	106
H	High	-	-	-
Straddle				138

2.4 Connection Diagram of Test System

<WLAN Tx CDD Mode>

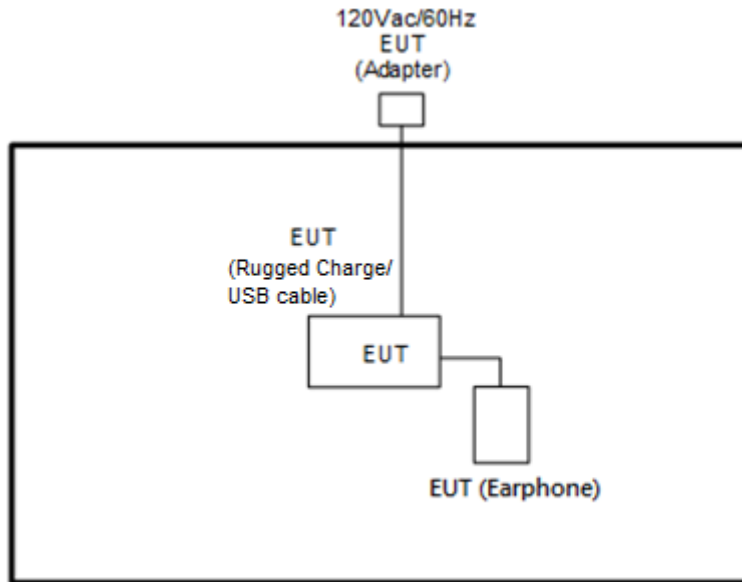

<WLAN Tx TXBF Mode>

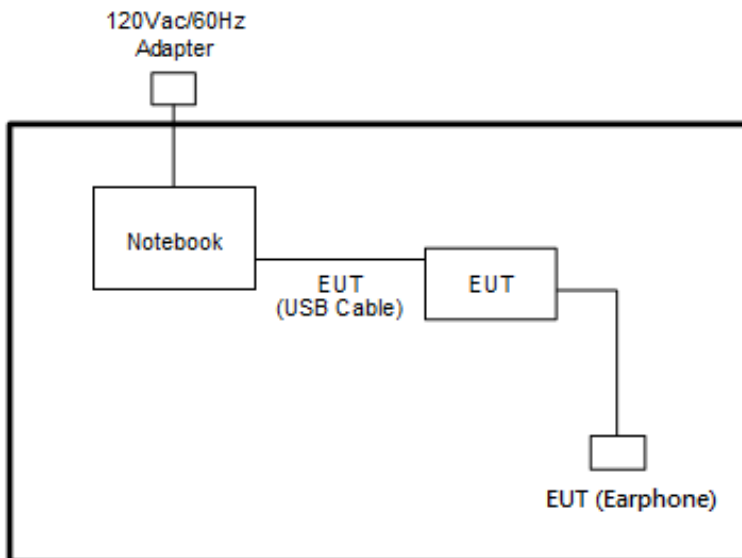

<AC Conducted Emission Mode>

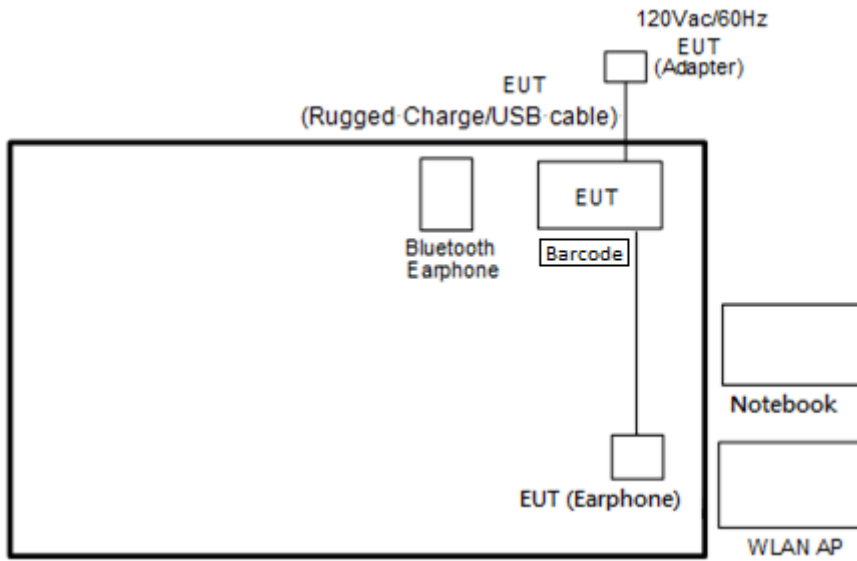



2.5 Support Unit used in test configuration and system

Item	Equipment	Trade Name	Model Name	FCC ID	Data Cable	Power Cord
1.	Bluetooth Earphone	Sony Ericsson	MW600	PY7DDA-2029	N/A	N/A
2.	WLAN AP	ASUS	RT-AC66U	MSQ-RTAC66U	N/A	Unshielded, 1.8 m
3.	Notebook	DELL	Latitude E6320	FCC DoC/ Contains FCC ID: QDS-BRCM1054	N/A	AC I/P: Unshielded, 1.2 m DC O/P: Shielded, 1.8 m
4.	Notebook	Lenovo	M490S(E330)	QDS-BRCM1063	N/A	AC I/P: Unshielded, 1.2 m DC O/P: Shielded, 1.8 m
5.	SD Card	SanDisk	MicroSD HC	FCC DoC	N/A	N/A
6.	Touch computer	Zebra	TC510K	UZ7TC510K	N/A	N/A

2.6 EUT Operation Test Setup

For WLAN CDD modes, programmed RF utility, "CMD" installed in the notebook make the EUT provide functions like channel selection and power level for continuous transmitting and receiving signals.

For WLAN MIMO TXBF modes, the EUT was tested under normal operation and link to another device with power, modulation modes and data rates controlled by engineer mode command lines. The CMD software tool was used to make EUT continuous transmitting signals.

2.7 Measurement Results Explanation Example

For all conducted test items:

The offset level is set in the spectrum analyzer to compensate the RF cable loss and attenuator factor between EUT conducted output port and spectrum analyzer. With the offset compensation, the spectrum analyzer reading level is exactly the EUT RF output level.

Example :

The spectrum analyzer offset is derived from RF cable loss and attenuator factor.

Offset = RF cable loss + attenuator factor.

Following shows an offset computation example with cable loss 4.2 dB and 10dB attenuator.

Offset(dB) = RF cable loss(dB) + attenuator factor(dB).

$$= 4.2 + 10 = 14.2 \text{ (dB)}$$

3 Test Result

3.1 26dB & 99% Occupied Bandwidth Measurement

3.1.1 Description of 26dB & 99% Occupied Bandwidth

This section is for reporting purpose only.

There is no restriction limits for bandwidth.

For Straddle Channel, U-NII procedures were applied for operations in the frequency band in accordance with FCC KDB 644545 D03.

3.1.2 Measuring Instruments

The measuring equipment is listed in the section 4 of this test report.

3.1.3 Test Procedures

1. The testing follows FCC KDB 789033 D02 General UNII Test Procedures New Rules v01r03. Section C) Emission bandwidth
2. Set RBW = approximately 1% of the emission bandwidth.
3. Set the VBW > RBW.
4. Detector = Peak.
5. Trace mode = max hold
6. Measure the maximum width of the emission that is 26 dB down from the peak of the emission. Compare this with the RBW setting of the analyzer. Readjust RBW and repeat measurement as needed until the RBW/EBW ratio is approximately 1%.
7. For 99% Bandwidth Measurement, the spectrum analyzer's resolution bandwidth (RBW) is set 1MHz and set the Video bandwidth (VBW) $\geq 3 * RBW$.
8. Measure and record the results in the test report.

3.1.4 Test Setup

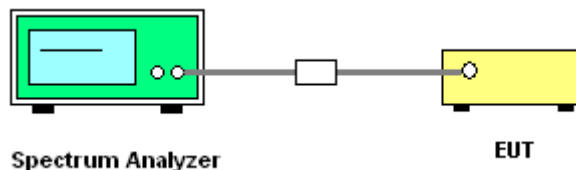



3.1.5 Test Result of 26dB & 99% Occupied Bandwidth

Please refer to Appendix A.

<CDD Modes>

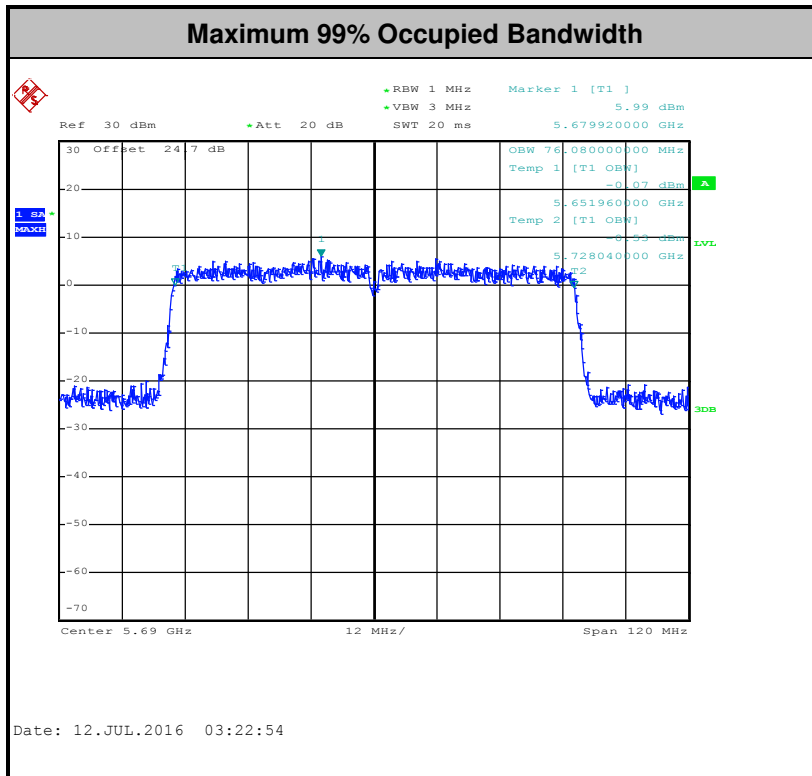
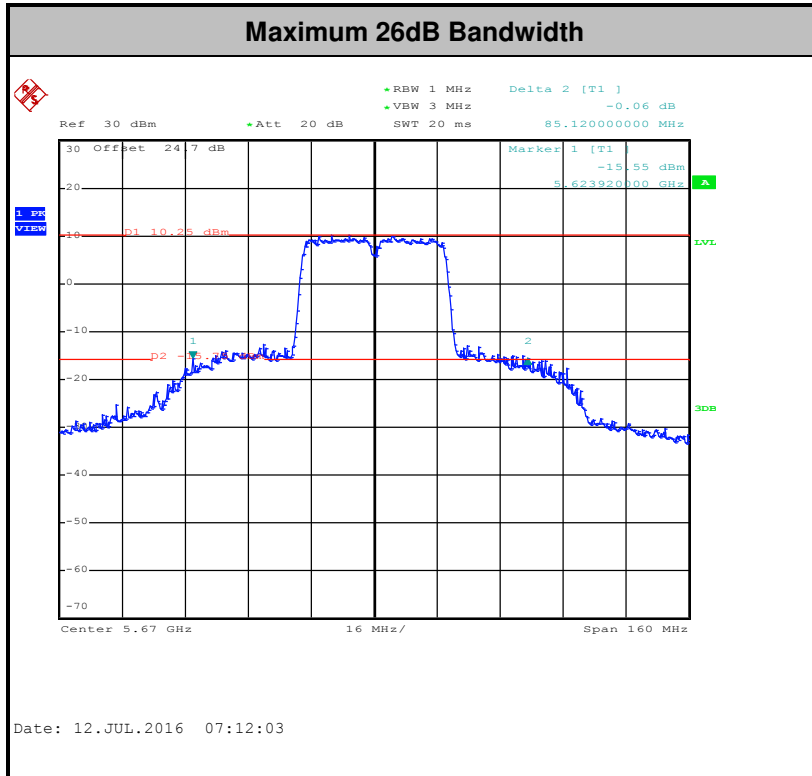

Note: The occupied channel bandwidth is maintained within the band of operation for all of the modulations.



<TXBF Modes>

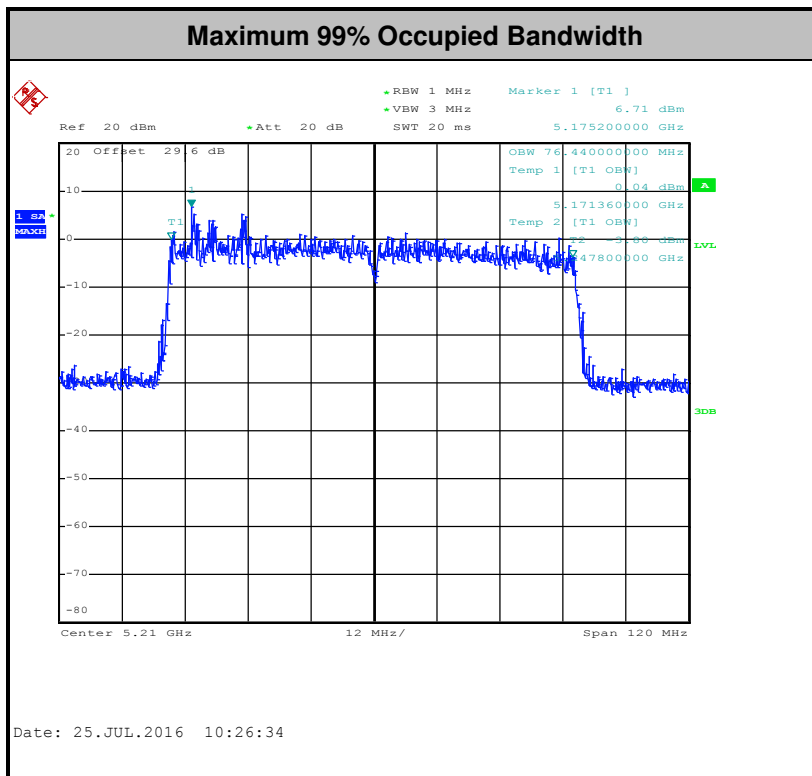
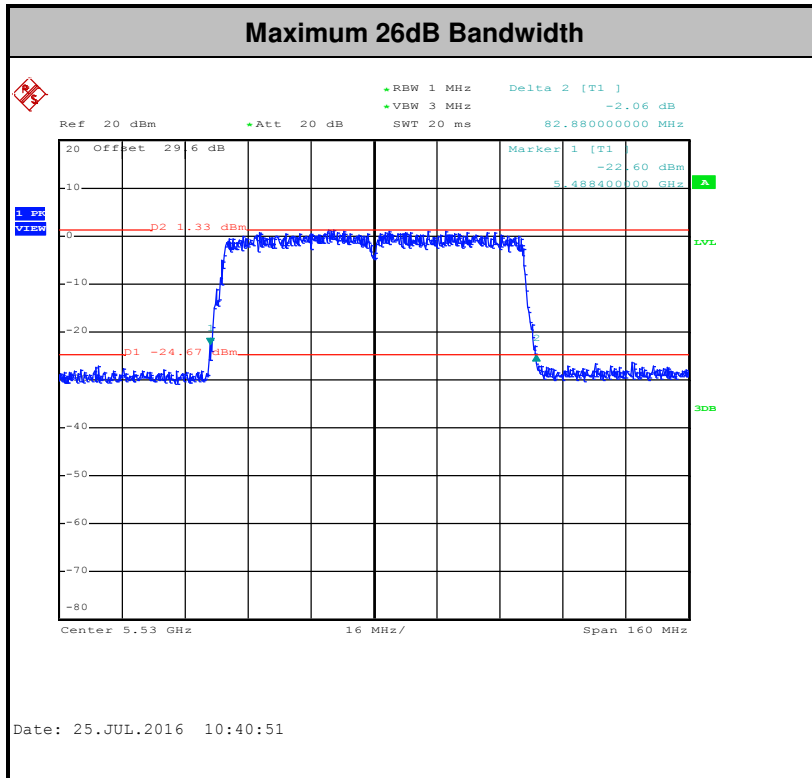

Note: The occupied channel bandwidth is maintained within the band of operation for all of the modulations.



3.2 Maximum Conducted Output Power Measurement

3.2.1 Limit of Maximum Conducted Output Power

For mobile and portable client devices in the 5.15–5.25 GHz band, the maximum conducted output power over the frequency band of operation shall not exceed 250 mW.

For the 5.25–5.725 GHz bands, the maximum conducted output power over the frequency bands of operation shall not exceed the lesser of 250 mW or $11 \text{ dBm} + 10 \log B$, where B is the 26 dB emission bandwidth in megahertz.

For the band 5.725–5.85 GHz, the maximum conducted output power over the frequency band of operation shall not exceed 1 W.

For Straddle Channel, U-NII procedures and limits were applied for operations in the frequency band in accordance with FCC KDB 644545 D03.

If transmitting antennas of directional gain greater than 6 dBi are used, the peak output power shall be reduced by the amount in dB that the directional gain of the antenna exceeds 6 dBi.

Note that U-NII-2 band, devices with a maximum e.i.r.p. greater than 500 mW shall implement TPC in order to have the capability to operate at least 6 dB below the maximum permitted e.i.r.p. of 1 W.

3.2.2 Measuring Instruments

The measuring equipment is listed in the section 4 of this test report.



3.2.3 Test Procedures

CDD modes

The testing follows Method PM of FCC KDB 789033 D02 General UNII Test Procedures New Rules v01r03 for CDD modes.

Method PM (Measurement using an RF average power meter):

1. Measurement is performed using a wideband RF power meter.
2. The EUT is configured to transmit continuously with a consistent duty cycle at its maximum power control level.
3. Measure the average power of the transmitter, and the average power is corrected with duty factor, $10 \log(1/x)$, where x is the duty cycle.

TXBF modes

The testing follows Method PM-G of FCC KDB 789033 D02 General UNII Test Procedures New Rules v01r03 for TXBF modes.

Method PM-G (Measurement using a gated RF average power meter):

1. Measurement is performed using a wideband RF power meter.
2. The EUT is configured to transmit at its maximum power control level.
3. Measure the average power of the transmitter
4. Since the measurement is made only during the ON time of the transmitter, no duty cycle correction factor is required.

For straddle channel, the testing follows Method SA-3 (RMS detection with max hold) of FCC KDB 789033 D02 General UNII Test Procedures New Rules v01r03.

Compute power by integrating the spectrum across the 99% occupied bandwidth of the signal using the instrument's band power measurement function.

3.2.4 Test Setup

For normal channel:

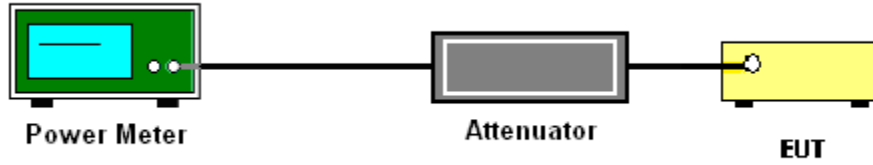

For straddle channel:

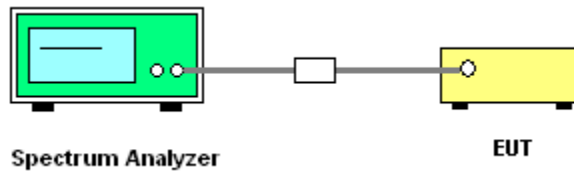



3.2.5 Test Result of Maximum Conducted Output Power

Please refer to Appendix A.

<CDD Modes>

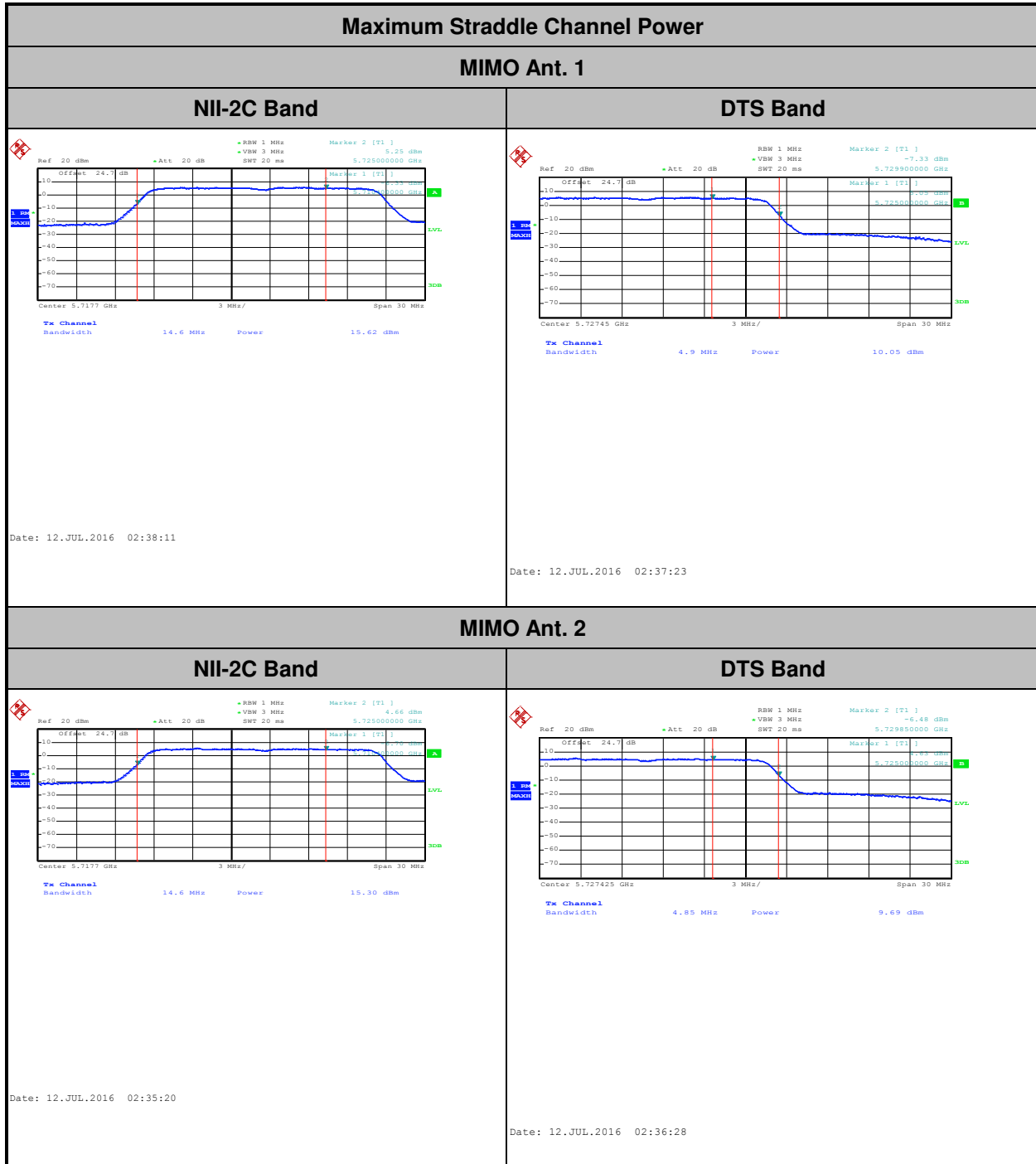



<TXBF Modes>

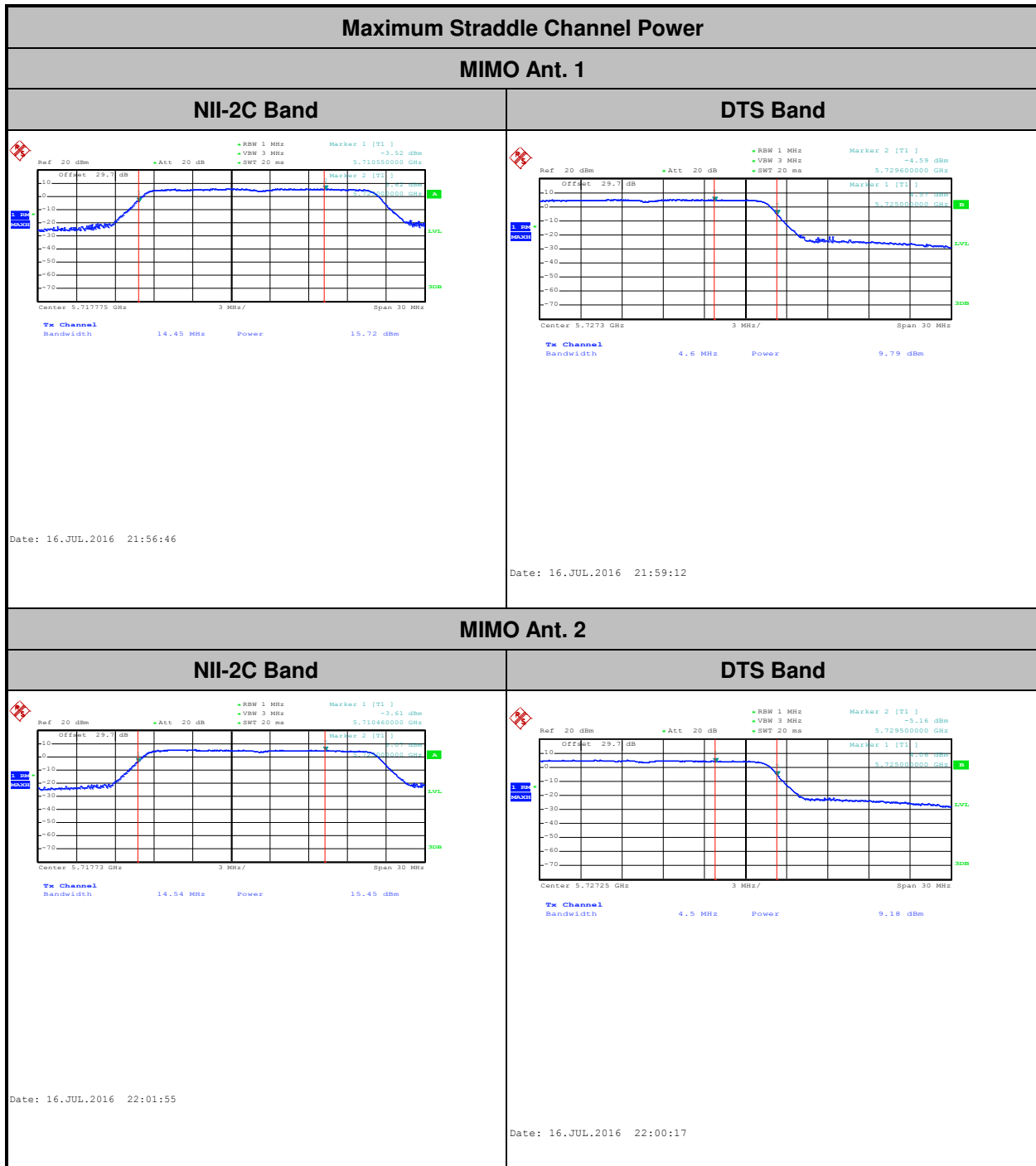



3.3 Power Spectral Density Measurement

3.3.1 Limit of Power Spectral Density

For mobile and portable client devices in the 5.15–5.25 GHz band, the maximum power spectral density shall not exceed 11dBm in any 1 megahertz band.

For the 5.25–5.725 GHz bands, the maximum power spectral density shall not exceed 11 dBm in any 1 megahertz band.

For the band 5.725–5.85 GHz, the maximum power spectral density shall not exceed 30 dBm in any 500-kHz band.

For Straddle Channel, U-NII procedures and limits were applied for operations in the frequency band in accordance with FCC KDB 644545 D03.

If transmitting antennas of directional gain greater than 6 dBi are used, the peak output power shall be reduced by the amount in dB that the directional gain of the antenna exceeds 6 dBi.

3.3.2 Measuring Instruments

The measuring equipment is listed in the section 4 of this test report.



3.3.3 Test Procedures

The testing follows FCC KDB 789033 D02 General UNII Test Procedures New Rules v01r03.
Section F) Maximum power spectral density.

CDD modes

Method SA-2

(trace averaging across on and off times of the EUT transmissions, followed by duty cycle correction).

- Measure the duty cycle.
- Set span to encompass the entire emission bandwidth (EBW) of the signal.
- Set RBW = 1 MHz.
- Set VBW \geq 3 MHz.
- Number of points in sweep \geq 2 Span / RBW.
- Sweep time = auto.
- Detector = RMS
- Trace average at least 100 traces in power averaging mode.
- Add $10 \log(1/x)$, where x is the duty cycle, to the measured power in order to compute the average power during the actual transmission times. For example, add $10 \log(1/0.25) = 6$ dB if the duty cycle is 25 percent.

TXBF modes

Method SA-3

(power averaging (rms) detection with max hold):

- Set span to encompass the entire emission bandwidth (EBW) of the signal.
- Set RBW = 1 MHz.
- Set VBW \geq 3 MHz
- Number of points in sweep \geq 2 Span / RBW.
- Sweep time \leq (number of points in sweep) \times T, when duty cycle is less than 98 percent where T is the minimum transmission duration over which the transmitter is on and is transmitting at its maximum power control level for the tested mode of operation.
- Detector = power averaging (rms).
- Trace mode = max hold.
- Allow max hold to run for at least 60 seconds, or longer as needed to allow the trace to stabilize.

1. The RF output of EUT was connected to the spectrum analyzer by a low loss cable.
2. Each plot has already offset with cable loss, and attenuator loss. Measure the PPSD and record it.
3. For MIMO mode, calculation method follows FCC KDB 662911 D01 Multiple Transmitter Output v02r01.

Method (a): Measure and sum the spectra across the outputs.

The total final Power Spectral Density is from a device with 2 transmitter outputs. The spectrum measurements of the individual outputs are all performed with the same span and number of points, the spectrum value in the first spectral bin of output 1 is summed with that in the first spectral bin of output 2 to obtain the value for the first frequency bin of the summed spectrum.

3.3.4 Test Setup

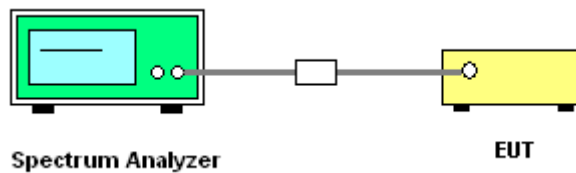

3.3.5 Test Result of Power Spectral Density

Please refer to Appendix A.



<CDD Modes>

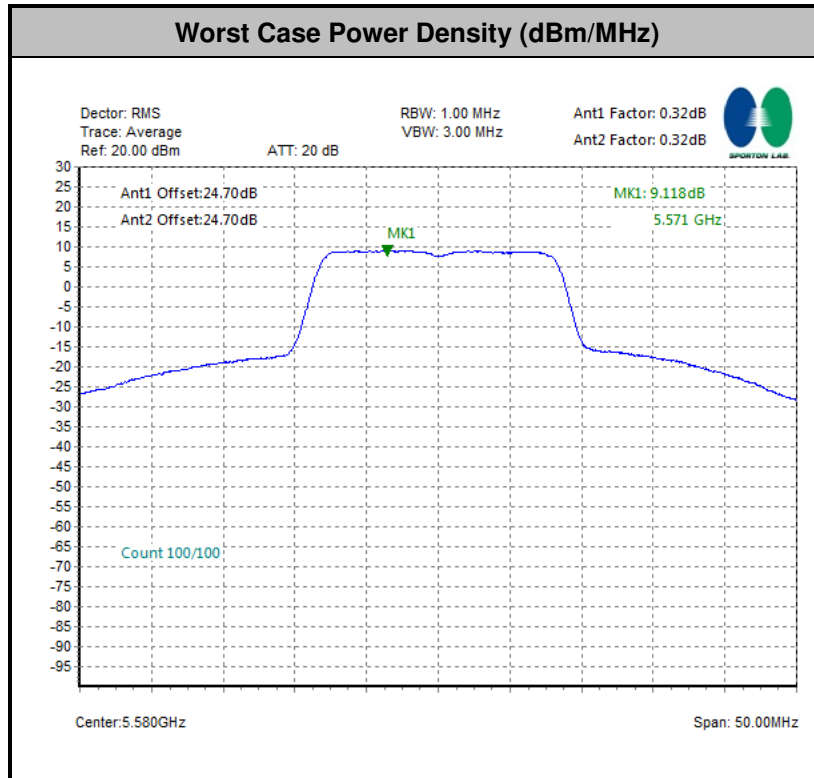

Note: Average Power Density (dB) = Measured value+ Duty Factor

<TXBF Modes>

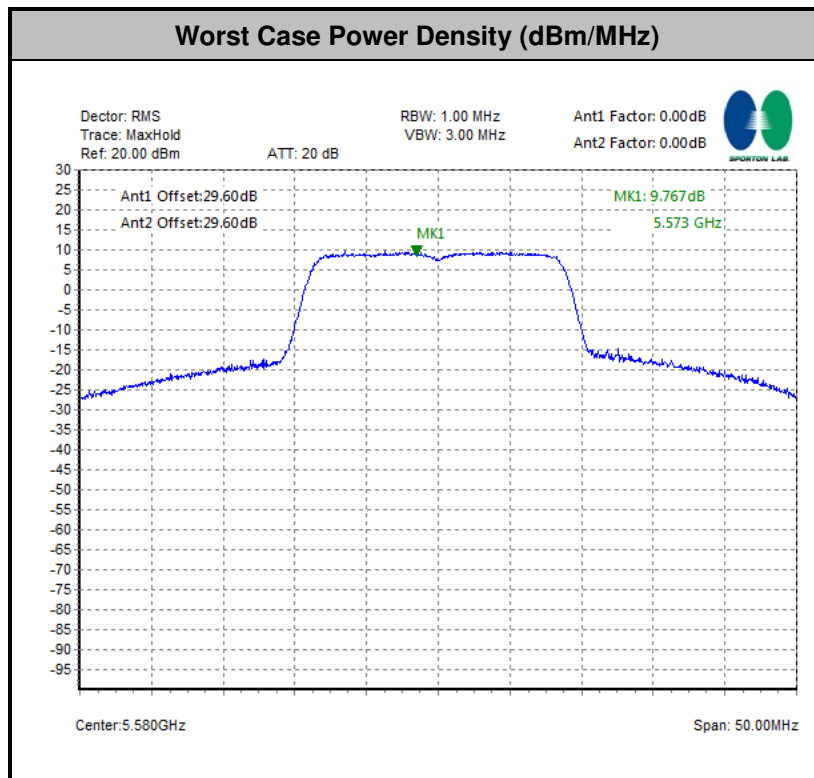

Note: Average Power Density (dB) = Measured value+ Duty Factor



3.4 Unwanted Emissions Measurement

This section as specified in FCC Part 15.407(b) is to measure unwanted emissions through radiated measurement for band edge spurious emissions and out of band emissions measurement. The unwanted emissions shall comply with 15.407(b)(1) to (6), and restricted bands per FCC Part15.205.

3.4.1 Limit of Unwanted Emissions

(1) For transmitters operating in the 5150-5250 MHz band: all emissions outside of the 5150-5350 MHz band shall not exceed an EIRP of -27dBm/MHz.

For transmitters operating in the 5250-5350 MHz band: all emissions outside of the 5150-5350 MHz band shall not exceed an EIRP of -27 dBm/MHz. Devices operating in the 5250-5350 MHz band that generate emissions in the 5150-5250 MHz band must meet all applicable technical requirements for operation in the 5150-5250 MHz band (including indoor use) or alternatively meet an out-of-band emission EIRP limit of -27 dBm/MHz in the 5150-5250 MHz band.

For transmitters operating in the 5470-5600 MHz and 5650-5725MHz band: all emissions outside of the 5470-5600 MHz and 5650-5725MHz band shall not exceed an EIRP of -27 dBm/MHz.

(2) Unwanted spurious emissions fallen in restricted bands per FCC Part15.205 shall comply with the general field strength limits set forth in § 15.209 as below table,

Frequency (MHz)	Field Strength (microvolts/meter)	Measurement Distance (meters)
0.009 – 0.490	2400/F(kHz)	300
0.490 – 1.705	24000/F(kHz)	30
1.705 – 30.0	30	30
30 – 88	100	3
88 – 216	150	3
216 - 960	200	3
Above 960	500	3

Note: The following formula is used to convert the EIRP to field strength.

$$E = \frac{1000000\sqrt{30P}}{3} \mu\text{V/m, where P is the eirp (Watts)}$$

EIRP (dBm)	Field Strength at 3m (dBμV/m)
-17	78.3
- 27	68.3



- (3) KDB789033 D02 v01r03 G)2)c) As specified in 15.407(b), emissions above 1000 MHz that are outside of the restricted bands are subject to a peak emission limit of -27 dBm/MHz (or -17 dBm/MHz as specified in 15.407(b)(4)). However, an out-of-band emission that complies with both the average and peak limits of 15.209 is not required to satisfy the -27 dBm/MHz or -17 dBm/MHz peak emission limit.

3.4.2 Measuring Instruments

The measuring equipment is listed in the section 4 of this test report.

3.4.3 Test Procedures

1. The testing follows FCC KDB 789033 D02 General UNII Test Procedures New Rules v01r03. Section G) Unwanted emissions measurement.
 - (1) Procedure for Unwanted Emissions Measurements Below 1000MHz
 - RBW = 120 kHz
 - VBW = 300 kHz
 - Detector = Peak
 - Trace mode = max hold
 - (2) Procedure for Peak Unwanted Emissions Measurements Above 1000 MHz
 - RBW = 1 MHz
 - VBW \geq 3 MHz
 - Detector = Peak
 - Sweep time = auto
 - Trace mode = max hold
 - (3) Procedures for Average Unwanted Emissions Measurements Above 1000MHz
 - RBW = 1 MHz
 - VBW = 10 Hz, when duty cycle is no less than 98 percent.
 - VBW \geq 1/T, when duty cycle is less than 98 percent where T is the minimum transmission duration over which the transmitter is on and is transmitting at its maximum power control level for the tested mode of operation.



2. The EUT was placed on a turntable with 0.8 meter for frequency below 1GHz and 1.5 meter for frequency above 1GHz respectively above ground.
3. The EUT was set 3 meters from the interference receiving antenna which was mounted on the top of a variable height antenna tower.
4. The antenna is a broadband antenna and its height is adjusted between one meter and four meters above ground to find the maximum value of the field strength for both horizontal polarization and vertical polarization of the antenna.
5. For each suspected emission, the EUT was arranged to its worst case and then adjust the antenna tower (from 1 m to 4 m) and turntable (from 0 degree to 360 degrees) to find the maximum reading.
6. For testing below 1GHz, if the emission level of the EUT in peak mode was 3 dB lower than the limit specified, then peak values of EUT will be reported, otherwise, the emissions will be repeated one by one using the CISPR quasi-peak method and reported.
7. For testing above 1GHz, the emission level of the EUT in peak mode was 20dB lower than average limit (that means the emission level in average mode also complies with the limit in average mode), then peak values of EUT will be reported, otherwise, the emissions will be measured in average mode again and reported.

3.4.4 Test Setup

For radiated emissions below 30MHz

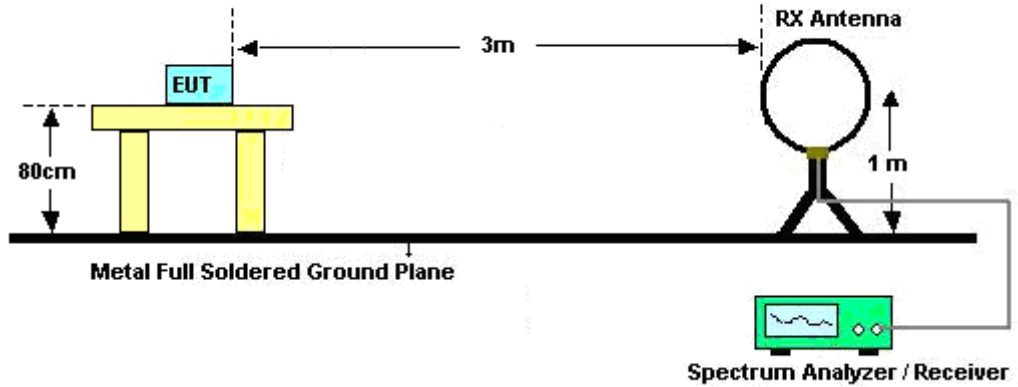

For radiated emissions from 30MHz to 1GHz

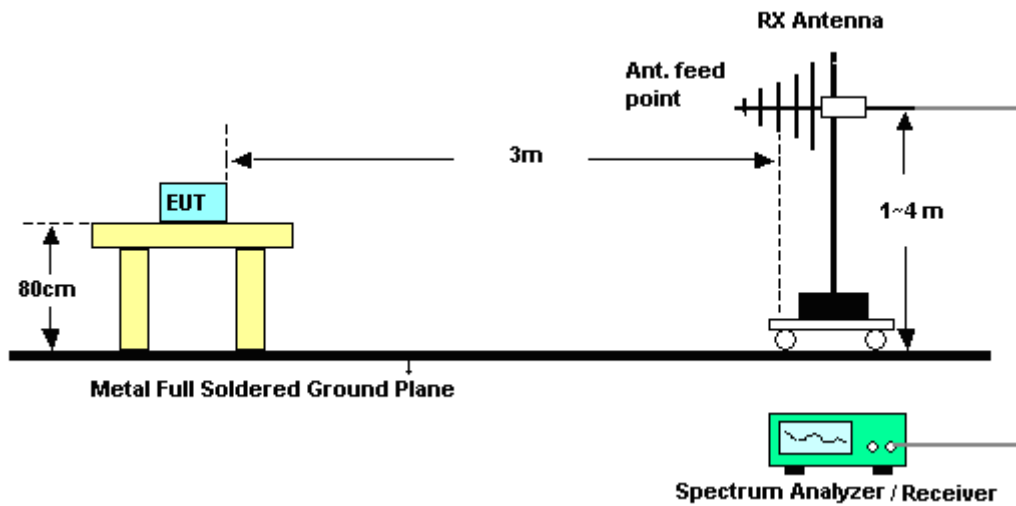

For radiated emissions above 1GHz

CDD modes

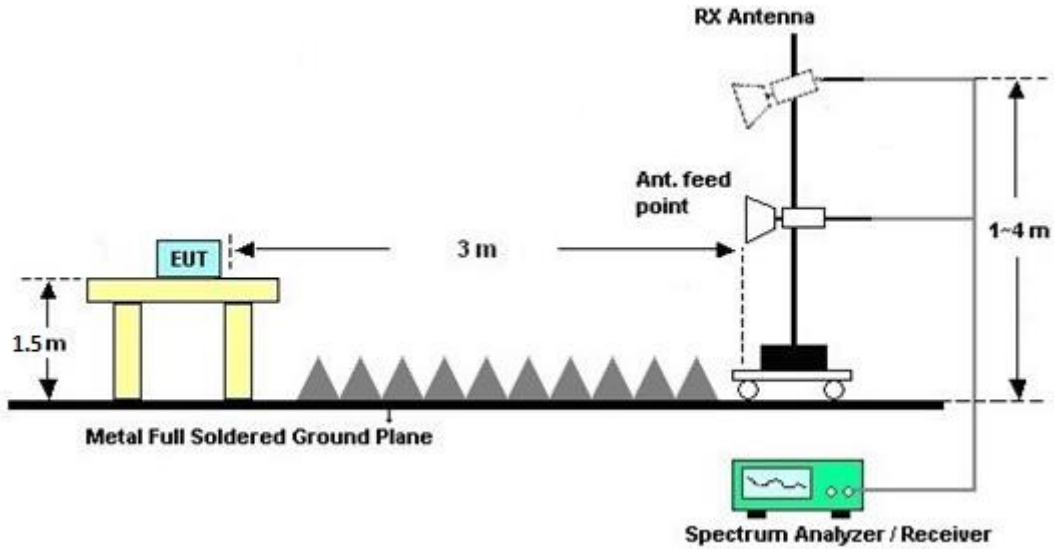

TXBF mode

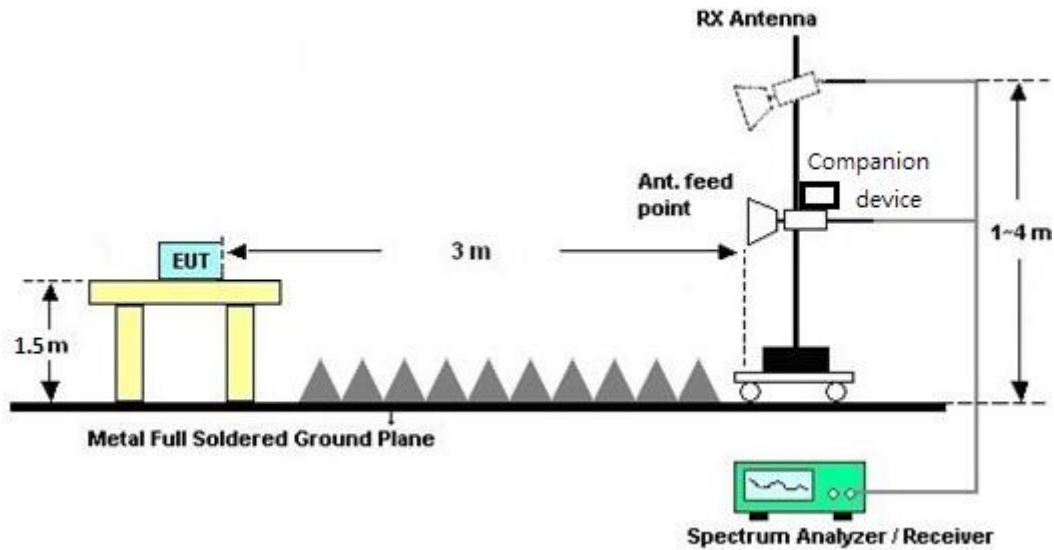



3.4.5 Test Results of Radiated Spurious Emissions (9 kHz ~ 30 MHz)

The low frequency, which started from 9 kHz to 30MHz, was pre-scanned and the result which was 20dB lower than the limit line per 15.31(o) was not reported.

3.4.6 Test Result of Radiated Spurious at Band Edges

Please refer to Appendix B and C.

3.4.7 Duty Cycle

Please refer to Appendix D.

3.4.8 Test Result of Radiated Spurious Emissions (30MHz ~ 10th Harmonic)

Please refer to Appendix B and C.



3.5 AC Conducted Emission Measurement

3.5.1 Limit of AC Conducted Emission

For equipment that is designed to be connected to the public utility (AC) power line, the radio frequency voltage that is conducted back onto the AC power line on any frequency or frequencies within the band 150 kHz to 30 MHz shall not exceed the limits in the following table.

Frequency of emission (MHz)	Conducted limit (dB μ V)	
	Quasi-peak	Average
0.15-0.5	66 to 56*	56 to 46*
0.5-5	56	46
5-30	60	50

*Decreases with the logarithm of the frequency.

3.5.2 Measuring Instruments

The measuring equipment is listed in the section 4 of this test report.

3.5.3 Test Procedures

1. The EUT was placed 0.4 meter from the conducting wall of the shielding room was kept at least 80 centimeters from any other grounded conducting surface.
2. Connect EUT to the power mains through a line impedance stabilization network (LISN).
3. All the support units are connecting to the other LISN.
4. The LISN provides 50 ohm coupling impedance for the measuring instrument.
5. The FCC states that a 50 ohm, 50 microhenry LISN should be used.
6. Both sides of AC line were checked for maximum conducted interference.
7. The frequency range from 150 kHz to 30 MHz was searched.
8. Set the test-receiver system to Peak Detect Function and specified bandwidth with Maximum Hold Mode.

3.5.4 Test Setup

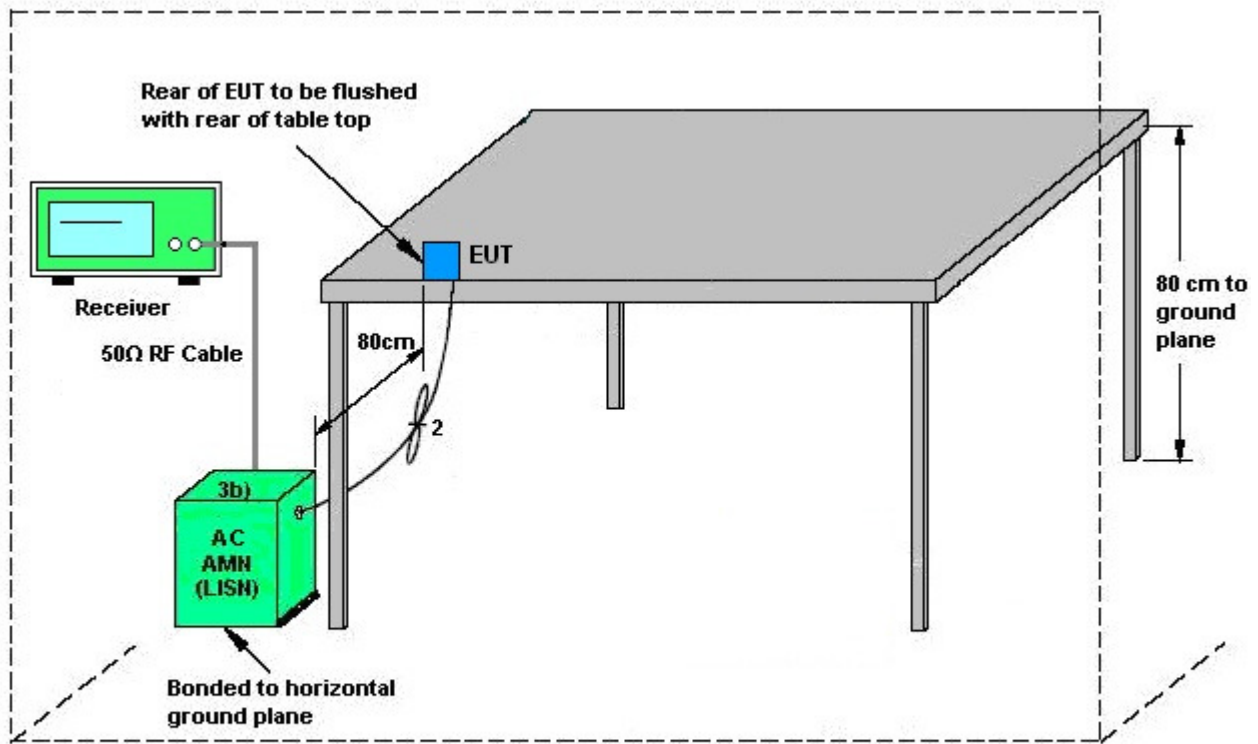

AMN = Artificial mains network (LISN)
AE = Associated equipment
EUT = Equipment under test
ISN = Impedance stabilization network

3.5.5 Test Result of AC Conducted Emission

Test Mode :	Mode 1	Temperature :	24~25°C
Test Engineer :	Kai-Chun Chu	Relative Humidity :	45~46%
Test Voltage :	120Vac / 60Hz	Phase :	Line
Function Type :	WLAN (5GHz) Link + Bluetooth Link + Battery + Scanner + without Exoskeleton + Headset Jumper (CBL-TC51-HDST25-01) + Earphone (HDST-25MM-PTVP-01) + Rugged Charge/USB Cable + Adapter 1 (SAWA-65-20005A (5V/2.5A))		

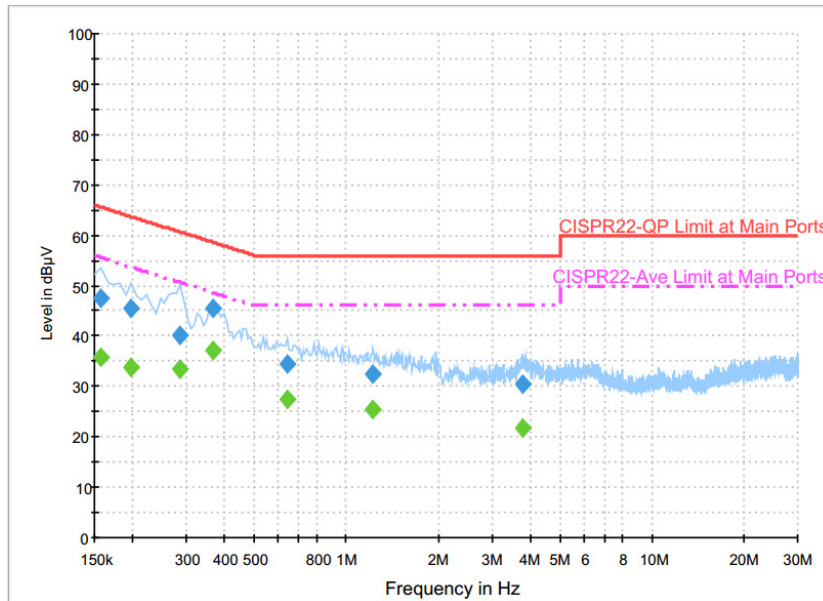

Final Result : QuasiPeak

Frequency (MHz)	QuasiPeak (dBµV)	Filter	Line	Corr. (dB)	Margin (dB)	Limit (dBµV)
0.158000	47.4	Off	L1	19.6	18.2	65.6
0.198000	45.6	Off	L1	19.6	18.1	63.7
0.286000	40.1	Off	L1	19.6	20.5	60.6
0.366000	45.6	Off	L1	19.6	13.0	58.6
0.638000	34.4	Off	L1	19.6	21.6	56.0
1.222000	32.3	Off	L1	19.7	23.7	56.0
3.774000	30.4	Off	L1	19.8	25.6	56.0

Final Result : Average

Frequency (MHz)	Average (dBµV)	Filter	Line	Corr. (dB)	Margin (dB)	Limit (dBµV)
0.158000	35.6	Off	L1	19.6	20.0	55.6
0.198000	33.7	Off	L1	19.6	20.0	53.7
0.286000	33.6	Off	L1	19.6	17.0	50.6
0.366000	37.2	Off	L1	19.6	11.4	48.6
0.638000	27.4	Off	L1	19.6	18.6	46.0
1.222000	25.4	Off	L1	19.7	20.6	46.0
3.774000	21.9	Off	L1	19.8	24.1	46.0



Test Mode :	Mode 1	Temperature :	24~25°C
Test Engineer :	Kai-Chun Chu	Relative Humidity :	45~46%
Test Voltage :	120Vac / 60Hz	Phase :	Neutral
Function Type :	WLAN (5GHz) Link + Bluetooth Link + Battery + Scanner + without Exoskeleton + Headset Jumper (CBL-TC51-HDST25-01) + Earphone (HDST-25MM-PTVP-01) + Rugged Charge/USB Cable + Adapter 1 (SAWA-65-20005A (5V/2.5A))		

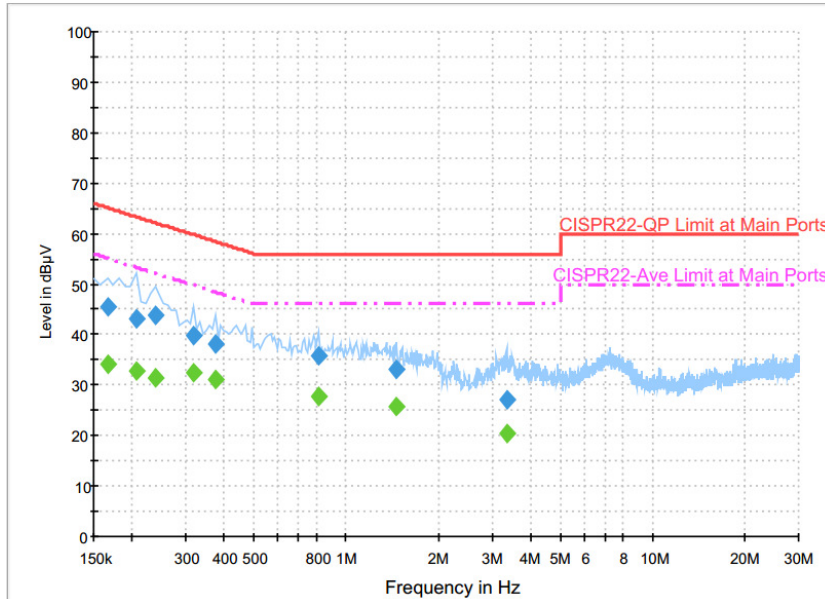

Final Result : QuasiPeak

Frequency (MHz)	QuasiPeak (dBµV)	Filter	Line	Corr. (dB)	Margin (dB)	Limit (dBµV)
0.166000	45.6	Off	N	19.6	19.6	65.2
0.206000	43.0	Off	N	19.6	20.4	63.4
0.238000	43.7	Off	N	19.6	18.5	62.2
0.318000	39.9	Off	N	19.6	19.9	59.8
0.374000	38.0	Off	N	19.6	20.4	58.4
0.814000	35.6	Off	N	19.6	20.4	56.0
1.462000	33.0	Off	N	19.6	23.0	56.0
3.342000	27.2	Off	N	19.7	28.8	56.0

Final Result : Average

Frequency (MHz)	Average (dBµV)	Filter	Line	Corr. (dB)	Margin (dB)	Limit (dBµV)
0.166000	34.0	Off	N	19.6	21.2	55.2
0.206000	32.7	Off	N	19.6	20.7	53.4
0.238000	31.6	Off	N	19.6	20.6	52.2
0.318000	32.5	Off	N	19.6	17.3	49.8
0.374000	31.0	Off	N	19.6	17.4	48.4
0.814000	27.9	Off	N	19.6	18.1	46.0
1.462000	25.7	Off	N	19.6	20.3	46.0
3.342000	20.3	Off	N	19.7	25.7	46.0

3.6 Frequency Stability Measurement

3.6.1 Limit of Frequency Stability

Manufacturers of U-NII devices are responsible for ensuring frequency stability such that an emission is maintained within the band of operation under all conditions of normal operation as specified in the user's manual.

3.6.2 Measuring Instruments

The measuring equipment is listed in the section 4 of this test report.

3.6.3 Test Procedures

1. To ensure emission at the band edge is maintained within the authorized band, those values shall be measured by radiation emissions at upper and lower frequency points, and finally compensated by frequency deviation as procedures below.
2. The EUT was operated at the maximum output power, and connected to the spectrum analyzer, which is set to maximum hold function and peak detector. The peak value of the power envelope was measured and noted. The upper and lower frequency points were respectively measured relatively 10dB lower than the measured peak value.
3. The frequency deviation was calculated by adding the upper frequency point and the lower frequency point divided by two. Those detailed values of frequency deviation are provided in table below.

3.6.4 Test Setup

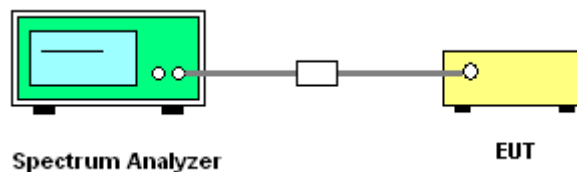

3.6.5 Test Result of Frequency Stability

Please refer to Appendix A.



3.7 Automatically Discontinue Transmission

3.7.1 Limit of Automatically Discontinue Transmission

The device shall automatically discontinue transmission in case of either absence of information to transmit or operational failure. These provisions are not intended to preclude the transmission of control or signaling information or the use of repetitive codes used by certain digital technologies to complete frame or burst intervals. Applicants shall include in their application for equipment authorization to describe how this requirement is met.

3.7.2 Measuring Instruments

The measuring equipment is listed in the section 4 of this test report.

3.7.3 Test Result of Automatically Discontinue Transmission

While the EUT is not transmitting any information, the EUT can automatically discontinue transmission and become standby mode for power saving. The EUT can detect the controlling signal of ACK message transmitting from remote device and verify whether it shall resend or discontinue transmission.



3.8 Antenna Requirements

3.8.1 Standard Applicable

According to FCC 47 CFR Section 15.407(a)(1)(2) ,if transmitting antenna directional gain is greater than 6 dBi, both the peak transmit power and the peak power spectral density shall be reduced by the amount in dB that the directional gain of the antenna exceeds 6 dBi.

3.8.2 Antenna Anti-Replacement Construction

An embedded-in antenna design is used.

3.8.3 Antenna Gain

CDD modes

FCC KDB 662911 D01 Multiple Transmitter Output v02r01

For CDD transmissions, directional gain is calculated as

Directional gain = G_{ANT} + Array Gain, where Array Gain is as follows.

For power spectral density (PSD) measurements on all devices,

Array Gain = $10 \log(N_{ANT}/N_{SS}=1)$ dB.

For power measurements on IEEE 802.11 devices,

Array Gain = 0 dB (i.e., no array gain) for $N_{ANT} \leq 4$.

Directional gain may be calculated by using the formulas applicable to equal gain antennas with G_{ANT} set equal to the gain of the antenna having the highest gain;

The EUT supports CDD mode.

For power, the directional gain G_{ANT} is set equal to the antenna having the highest gain, i.e., F)2)f)i).

For PSD, the directional gain calculation is following F)2)f)ii) of KDB 662911 D01 v02r01.

The power and PSD limit should be modified if the directional gain of EUT is over 6 dBi,

The directional gain "DG" is calculated as following table.

	Ant 1	Ant 2	for	for	Limit	Limit
	(dBi)	(dBi)	Power	PSD	Reduction	Reduction
			(dBi)	(dBi)	(dB)	(dB)
Band I	3.07	3.00	3.07	6.05	0.00	0.05
Band II	2.78	3.11	3.11	5.96	0.00	0.00
Band III	2.48	3.73	3.73	6.14	0.00	0.14

Power limit reduction = Composite gain – 6dBi, (min = 0)

PSD limit reduction = Composite gain + PSD Array gain – 6dBi, (min = 0)

TXBF modes

FCC KDB 662911 D01 Multiple Transmitter Output v02r01

For CDD transmissions, directional gain is calculated as

$$DirectionalGain = 10 \cdot \log \left[\frac{\sum_{j=1}^{N_{SS}} \left\{ \sum_{k=1}^{N_{ANT}} g_{j,k} \right\}^2}{N_{ANT}} \right]$$

where

Each antenna is driven by no more than one spatial stream;

N_{SS} = the number of independent spatial streams of data;

N_{ANT} = the total number of antennas

$g_{j,k} = 10^{G_k / 20}$ if the k th antenna is being fed by spatial stream j , or zero if it is not;
 G_k is the gain in dBi of the k th antenna.

The EUT supports beamforming for 802.11ac modes.

The directional gain calculation is following F2)e)ii) of KDB 662911 D01 v02r01.

The power and PSD limit should be modified if the directional gain of EUT is over 6 dBi,

The directional gain "DG" is calculated as following table.

			DG for Power (dBi)	DG for PSD (dBi)	Power Limit Reduction (dB)	PSD Limit Reduction (dB)
	Ant 1 (dBi)	Ant 2 (dBi)				
Band I	3.07	3.00	6.05	6.05	0.05	0.05
Band II	2.78	3.11	5.96	5.96	0.00	0.00
Band III	2.48	3.73	6.14	6.14	0.14	0.14

$Power\ Limit\ Reduction = DG(Power) - 6dBi, (min = 0)$

$PSD\ Limit\ Reduction = DG(PSD) - 6dBi, (min = 0)$



4 List of Measuring Equipment

Instrument	Manufacturer	Model No.	Serial No.	Characteristics	Calibration Date	Test Date	Due Date	Remark
Power Meter	Anritsu	ML2495A	1132003	300MHz~40GHz	Aug. 12, 2015	Jun. 18, 2016 ~ Jul. 31, 2016	Aug. 11, 2016	Conducted (TH05-HY)
Power Sensor	Anritsu	MA2411B	1126017	300MHz~40GHz	Aug. 12, 2015	Jun. 18, 2016 ~ Jul. 31, 2016	Aug. 11, 2016	Conducted (TH05-HY)
Spectrum Analyzer	Rohde & Schwarz	FSP40	100057	9kHz-40GHz	Nov. 23, 2015	Jun. 18, 2016 ~ Jul. 31, 2016	Nov. 22, 2016	Conducted (TH05-HY)
Temperature Chamber	ESPEC	SU-241	92003713	-30℃ ~95℃	Jun. 06, 2016	Jun. 18, 2016 ~ Jul. 31, 2016	Jun. 05, 2017	Conducted (TH05-HY)
Power Sensor	DARE	RadiPower	15I00041SN O09	10MHz~6GHz	May 03, 2016	Jun. 18, 2016 ~ Jul. 31, 2016	May 02, 2017	Conducted (TH05-HY)
Power Sensor	DARE	RadiPower	15I00041SN O10	10MHz~6GHz	May 03, 2016	Jun. 18, 2016 ~ Jul. 31, 2016	May 02, 2017	Conducted (TH05-HY)
AC Power Source	ChainTek	APC-1000W	N/A	N/A	N/A	Aug. 26, 2016	N/A	Conduction (CO05-HY)
LISN	Rohde & Schwarz	ENV216	100080	9kHz~30MHz	Dec. 02, 2015	Aug. 26, 2016	Dec. 01, 2016	Conduction (CO05-HY)
EMI Test Receiver	Keysight	N9038A(MXE)	MY54130085	20Hz ~ 8.4GHz	Nov. 04, 2015	Aug. 26, 2016	Nov. 03, 2016	Conduction (CO05-HY)
Loop Antenna	Rohde & Schwarz	HFH2-Z2	100315	9 kHz~30 MHz	Sep. 02, 2015	Jul. 02, 2016 ~ Jul. 28, 2016	Sep. 01, 2016	Radiation (03CH12-HY)
Spectrum Analyzer	Keysight	N9010A	MY54200486	10Hz ~ 44GHz	Sep. 24, 2015	Jul. 02, 2016 ~ Jul. 28, 2016	Sep. 23, 2016	Radiation (03CH12-HY)
Bilog Antenna	TESEQ	CBL 6111D	37059	30MHz~1GHz	Dec. 29, 2015	Jul. 02, 2016 ~ Jul. 28, 2016	Dec. 28, 2016	Radiation (03CH12-HY)
EMI Test Receiver	Rohde & Schwarz	ESU26	100390	20Hz~26.5GHz	Dec. 21, 2015	Jul. 02, 2016 ~ Jul. 28, 2016	Dec. 20, 2016	Radiation (03CH12-HY)
Horn Antenna	SCHWARZBECK	BBHA 9120D	9120D-1328	1GHz ~ 18GHz	Nov. 02, 2015	Jul. 02, 2016 ~ Jul. 28, 2016	Nov. 01, 2016	Radiation (03CH12-HY)
Preamplifier	MITEQ	AMF-7D-0010 1800-30-10P	1815698	1GHz~18GHz	Dec. 14, 2015	Jul. 02, 2016 ~ Jul. 28, 2016	Dec. 13, 2016	Radiation (03CH12-HY)
Preamplifier	Keysight	83017A	MY53270148	1GHz~26.5GHz	Jan. 30, 2016	Jul. 02, 2016 ~ Jul. 28, 2016	Jan. 29, 2017	Radiation (03CH12-HY)
Antenna Mast	EMEC	AM-BS-4500-B	N/A	1m~4m	N/A	Jul. 02, 2016 ~ Jul. 28, 2016	N/A	Radiation (03CH12-HY)
Turn Table	EMEC	TT2000	N/A	0~360 Degree	N/A	Jul. 02, 2016 ~ Jul. 28, 2016	N/A	Radiation (03CH12-HY)
Preamplifier	MITEQ	JS44-1800400 0-33-8P	1840917	18GHz ~ 40GHz	Jun. 14, 2016	Jul. 02, 2016 ~ Jul. 28, 2016	Jun. 13, 2017	Radiation (03CH12-HY)
SHF-EHF Horn Antenna	SCHWARZBECK	BBHA 9170	BBHA9170584	18GHz- 40GHz	Nov. 02, 2015	Jul. 02, 2016 ~ Jul. 28, 2016	Nov. 01, 2016	Radiation (03CH12-HY)



5 Uncertainty of Evaluation

Uncertainty of Conducted Emission Measurement (150kHz ~ 30MHz)

Measuring Uncertainty for a Level of Confidence of 95% ($U = 2Uc(y)$)	2.70
---	------

Uncertainty of Radiated Emission Measurement (30 MHz ~ 1000 MHz)

Measuring Uncertainty for a Level of Confidence of 95% ($U = 2Uc(y)$)	5.10
---	------

Uncertainty of Radiated Emission Measurement (1000 MHz ~ 18 GHz)

Measuring Uncertainty for a Level of Confidence of 95% ($U = 2Uc(y)$)	5.20
---	------

Uncertainty of Radiated Emission Measurement (18 GHz ~ 40 GHz)

Measuring Uncertainty for a Level of Confidence of 95% ($U = 2Uc(y)$)	4.70
---	------



Appendix A. Conducted Test Results

<CDD Modes>



<TXBF Modes>