



FCC RADIO TEST REPORT

FCC ID : UZ7TC26EK
Equipment : Touch computer
Brand Name : Zebra
Model Name : TC26EK
Applicant : Zebra Technologies Corporation
1 Zebra Plaza, Holtsville, NY 11742
Manufacturer : Zebra Technologies Corporation
1 Zebra Plaza, Holtsville, NY 11742
Standard : FCC 47 CFR Part 2, 22(H), 24(E), 27(L)

The product was received on Jan. 27, 2021 and testing was started from Feb. 01, 2021 and completed on Feb. 19, 2021. We, Sporton International Inc., EMC & Wireless Communications Laboratory, would like to declare that the tested sample has been evaluated in accordance with the test procedures given in ANSI / TIA-603-E and has been in compliance with the applicable technical standards.

The test results in this report apply exclusively to the tested model / sample. Without written approval of Sporton International Inc., EMC & Wireless Communications Laboratory, the test report shall not be reproduced except in full.

Louis Wu

Approved by: Louis Wu

Sporton International Inc. EMC & Wireless Communications Laboratory

No. 52, Huaya 1st Rd., Guishan Dist., Taoyuan City 333, Taiwan (R.O.C.)



Table of Contents

History of this test report.....	3
Summary of Test Result.....	4
1 General Description	5
1.1 Product Feature of Equipment Under Test	5
1.2 Product Specification of Equipment Under Test	6
1.3 Modification of EUT	6
1.4 Maximum ERP/EIRP Power, Frequency Tolerance, and Emission Designator	6
1.5 Testing Location	7
1.6 Applicable Standards	8
2 Test Configuration of Equipment Under Test	9
2.1 Test Mode.....	9
2.2 Connection Diagram of Test System	10
2.3 Support Unit used in test configuration	11
2.4 Measurement Results Explanation Example	11
2.5 Frequency List of Low/Middle/High Channels.....	11
3 Conducted Test Result	12
3.1 Measuring Instruments.....	12
3.2 Conducted Output Power and ERP/EIRP	13
3.3 Peak-to-Average Ratio	14
3.4 99% Occupied Bandwidth and 26dB Bandwidth Measurement.....	15
3.5 Conducted Band Edge	16
3.6 Conducted Spurious Emission	17
3.7 Frequency Stability.....	18
4 Radiated Test Items	19
4.1 Measuring Instruments.....	19
4.2 Test Setup	19
4.3 Test Result of Radiated Test.....	20
4.4 Field Strength of Spurious Radiation Measurement	21
5 List of Measuring Equipment.....	22
6 Uncertainty of Evaluation	24
Appendix A. Test Results of Conducted Test	
Appendix B. Test Results of Radiated Test	
Appendix C. Test Setup Photographs	



History of this test report

Report No.	Version	Description	Issued Date
FG002628-02A	01	Initial issue of report	Mar. 04, 2021



Summary of Test Result

Report Clause	Ref Std. Clause	Test Items	Result (PASS/FAIL)	Remark
3.2	§2.1046	Conducted Output Power	Pass	-
	§22.913 (a)(2)	Effective Radiated Power (WCDMA Band V)		
	§24.232 (c)	Equivalent Isotropic Radiated Power (WCDMA Band II)		
	§27.50 (d)(4)	Equivalent Isotropic Radiated Power (WCDMA Band IV)		
3.3	§24.232 (d)	Peak-to-Average Ratio	Pass	
3.4	§2.1049 §22.917 (b) §24.238 (b) §27.53 (g)	Occupied Bandwidth (WCDMA Band V) (WCDMA Band II) (WCDMA Band IV)	Pass	-
3.5	§2.1051 §22.917 (a) §24.238 (a) §27.53 (g)	Band Edge Measurement (WCDMA Band V) (WCDMA Band II) (WCDMA Band IV)	Pass	-
3.6	§2.1051 §22.917 (a) §24.238 (a) §27.53 (g)	Conducted Emission (WCDMA Band V) (WCDMA Band II) (WCDMA Band IV)	Pass	-
3.7	§2.1055 §22.355 §24.235 §27.54	Frequency Stability Temperature & Voltage	Pass	-
4.4	§2.1053 §22.917 (a) §24.238 (a) §27.53 (h)	Field Strength of Spurious Radiation (WCDMA Band V) (WCDMA Band II) (WCDMA Band IV)	Pass	Under limit 33.98 dB at 3510.000 MHz

Declaration of Conformity:

The test results with all measurement uncertainty excluded are presented in accordance with the regulation limits or requirements declared by manufacturers.

Comments and Explanations:

The declared of product specification for EUT presented in the report are provided by the manufacturer, and the manufacturer takes all the responsibilities for the accuracy of product specification.

Reviewed by: Wii Chang

Report Producer: Lucy Wu



1 General Description

1.1 Product Feature of Equipment Under Test

Product Feature	
Equipment	Touch computer
Brand Name	Zebra
Model Name	TC26EK
FCC ID	UZ7TC26EK
EUT supports Radios application	WCDMA/HSPA/LTE/NFC/GNSS WLAN 11a/b/g/n HT20/HT40 WLAN 11ac VHT20/VHT40/VHT80 Bluetooth BR/EDR/LE
HW Version	EV1.5
SW Version	Android version 10
OS Version	FUSION_QA_2_1.3.0.019_Q
FW Version	Zebra/TC26PG/TC26:10/10-16-10.00-QG-U33-STD-HEL-04/11 5:userdebug/release-keys
MFD	13JAN21
EUT Stage	Engineering Sample

Remark: The above EUT's information was declared by manufacturer.

Specification of Accessories				
AC Adapter	Brand Name	Zebra	Model Name	SAWA-65-20005A
Battery	Brand Name	Zebra	Model Name	BT-000409A
USB Cable 1 (TypeA plug to TypeC plug)	Brand Name	Zebra	Part Number	CBL-TC5X-USBC2A-01
USB Cable 2 (TypeA plug to TypeC plug)	Brand Name	Zebra	Part Number	CBL-TC2Y-USBC90A-01
Headset 3.5mm type with PTT/micassy	Brand Name	Zebra	Part Number	HDST-35MM-PTVP-01
Adapter Cable PTT headset (3.5mm to 3.5mm)	Brand Name	Zebra	Part Number	CBL-TC51-HDST35-01
Type C to 3.5mm adapter	Brand Name	Zebra	Part Number	ADP-USBC-35MM1-01
Snap on Trigger handle	Brand Name	Zebra	Part Number	TRG-TC2Y-SNP1-01
Belt Holster	Brand Name	Zebra	Part Number	SG-TC2Y-HLSTR1-01
Wearable Arm Mount	Brand Name	Zebra	Part Number	SG-TC2Y-ARMNT-01



1.2 Product Specification of Equipment Under Test

Standards-related Product Specification	
Tx Frequency	WCDMA: Band V: 826.4 MHz ~ 846.6 MHz Band II: 1852.4 MHz ~ 1907.6 MHz Band IV: 1712.4 MHz ~ 1752.6 MHz
Rx Frequency	WCDMA: Band V: 871.4 MHz ~ 891.6 MHz Band II: 1932.4 MHz ~ 1987.6 MHz Band IV: 2112.4 MHz ~ 2152.6 MHz
Maximum Output Power to Antenna	WCDMA: Band V: 25.00 dBm Band II: 24.77 dBm Band IV: 24.88 dBm
Antenna Type	PIFA Antenna
Antenna Gain	Cellular Band: 0.7 dBi PCS Band: 2.8 dBi AWS Band: 2.8 dBi
Type of Modulation	WCDMA: QPSK (Uplink) HSDPA: 64QAM (Downlink) HSUPA: QPSK (Uplink)

Remark: The above EUT's information was declared by manufacturer. Please refer to Comments and Explanations in report summary.

1.3 Modification of EUT

No modifications are made to the EUT during all test items.

1.4 Maximum ERP/EIRP Power, Frequency Tolerance, and Emission Designator

FCC Rule	Frequency Range (MHz)	System	Type of Modulation	Maximum ERP/EIRP (W)	Frequency Tolerance (ppm)	Emission Designator
Part 22	826.4 ~846.6	WCDMA Band V RMC 12.2Kbps	QPSK	0.2265	0.0167	4M15F9W
Part 24	1852.4 ~ 1907.6	WCDMA Band II RMC 12.2Kbps	QPSK	0.5715	0.0053	4M14F9W
Part 27	1712.4 ~ 1752.6	WCDMA Band IV RMC 12.2Kbps	QPSK	0.5861	0.0254	4M14F9W



1.5 Testing Location

Test Site	Sporton International Inc., EMC & Wireless Communications Laboratory
Test Site Location	No.52, Huaya 1st Rd., Guishan Dist., Taoyuan City 333, Taiwan (R.O.C.) TEL: +886-3-327-3456 FAX: +886-3-328-4978
Test Site No.	Sporton Site No.
	TH03HY
Test Engineer	Oscar Chi
Temperature	21~24°C
Relative Humidity	51~55%

Test Site	Sporton International Inc., Wensan Laboratory.
Test Site Location	No.58, Aly. 75, Ln. 564, Wenhua 3rd, Rd., Guishan Dist., Taoyuan City 333010, Taiwan (R.O.C.) TEL: +886-3-327-0868 FAX: +886-3-327-0855
Test Site No.	Sporton Site No.
	03CH11-HY (TAF Code: 3786)
Test Engineer	Bill Chang ,Fu Chen ,Quentin Liu and Troye Hsieh
Temperature	19~22.5°C
Relative Humidity	42.9~59.3%
Remark	The Radiated test item subcontracted to Sporton International Inc. Wensan Laboratory.

Note: The test site complies with ANSI C63.4 2014 requirement.

FCC Designation No.: TW1190 and TW0007



1.6 Applicable Standards

According to the specifications of the manufacturer, the EUT must comply with the requirements of the following standards:

- ♦ ANSI C63.26-2015
- ♦ ANSI / TIA-603-E
- ♦ FCC 47 CFR Part 2, 22(H), 24(E), 27(L)
- ♦ FCC KDB 971168 D01 Power Meas. License Digital Systems v03r01
- ♦ FCC KDB 412172 D01 Determining ERP and EIRP v01r01
- ♦ FCC KDB 414788 D01 Radiated Test Site v01r01

Remark:

1. All test items were verified and recorded according to the standards and without any deviation during the test.
2. This EUT has also been tested and complied with the requirements of FCC Part 15, Subpart B, recorded in a separate test report.
3. The TAF code is not including all the FCC KDB listed without accreditation.



2 Test Configuration of Equipment Under Test

2.1 Test Mode

Antenna port conducted and radiated test items were performed according to KDB 971168 D01 Power Meas. License Digital Systems v03r01 with maximum output power.

For radiated measurement, pre-scanned in three orthogonal panels, X, Y, Z. The worst cases (X Plane with Adapter for Cellular Band and PCS Band; Z plane for AWS Band) were recorded in this report.

Radiated emissions were investigated as following frequency range:

1. 30 MHz to 9000 MHz for WCDMA Band V
2. 30 MHz to 18000 MHz for WCDMA Band IV
3. 30 MHz to 19100 MHz for WCDMA Band II

All modes and data rates and positions were investigated.

Test modes are chosen to be reported as the worst case configuration below:

Test Modes		
Band	Radiated TCs	Conducted TCs
WCDMA Band V	■ RMC 12.2Kbps Link	■ RMC 12.2Kbps Link
WCDMA Band II	■ RMC 12.2Kbps Link	■ RMC 12.2Kbps Link
WCDMA Band IV	■ RMC 12.2Kbps Link	■ RMC 12.2Kbps Link

Remark: All the radiated test cases were performed with USB Cable 1.

2.2 Connection Diagram of Test System

<EUT without Accessory>

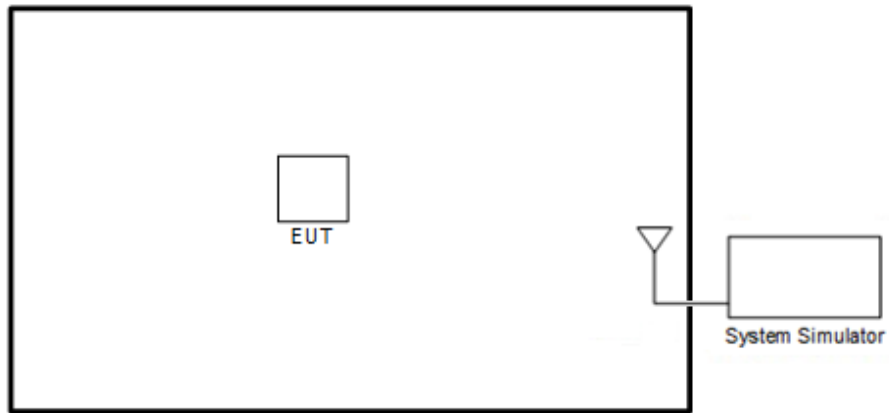

<EUT with Adapter>

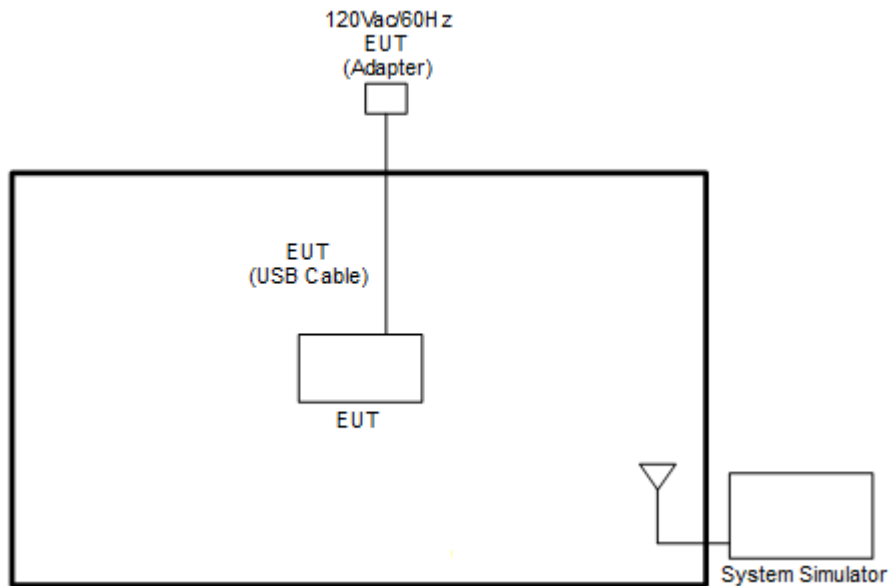



2.3 Support Unit used in test configuration

Item	Equipment	Brand Name	Model No.	FCC ID	Data Cable	Power Cord
1.	System Simulator	Anritsu	MT8820C	N/A	N/A	Unshielded, 1.8 m

2.4 Measurement Results Explanation Example

For all conducted test items:

The offset level is set in the spectrum analyzer to compensate the RF cable loss and attenuator factor between RF conducted output port and spectrum analyzer. With the offset compensation, the spectrum analyzer reading level will be exactly the RF output level.

The spectrum analyzer offset is derived from RF cable loss and attenuator factor.

$$\text{Offset} = \text{RF cable loss} + \text{attenuator factor}.$$

The following shows an offset computation example with RF cable loss 4.2 dB and a 10dB attenuator.

Example:

$$\begin{aligned} \text{Offset(dB)} &= \text{RF cable loss(dB)} + \text{attenuator factor(dB)} \\ &= 4.2 + 10 = 14.2 \text{ (dB)} \end{aligned}$$

2.5 Frequency List of Low/Middle/High Channels

Frequency List				
Band	Channel/Frequency(MHz)	Lowest	Middle	Highest
WCDMA Band V	Channel	4132	4182	4233
	Frequency	826.4	836.4	846.6
WCDMA Band II	Channel	9262	9400	9538
	Frequency	1852.4	1880.0	1907.6
WCDMA Band IV	Channel	1312	1413	1513
	Frequency	1712.4	1732.6	1752.6

3 Conducted Test Result

3.1 Measuring Instruments

See list of measuring instruments of this test report.

3.1.1 Test Setup

3.1.2 Conducted Output Power



3.1.3 Peak-to-Average Ratio, Occupied Bandwidth, Conducted Band-Edge and Conducted Spurious Emission

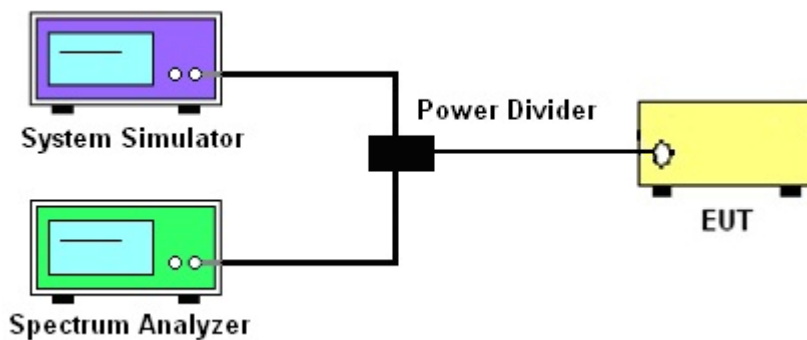

3.1.4 Frequency Stability

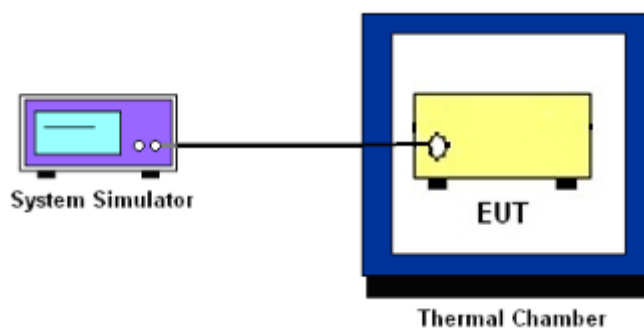

3.1.5 Test Result of Conducted Test

Please refer to Appendix A.



3.2 Conducted Output Power and ERP/EIRP

3.2.1 Description of the Conducted Output Power and ERP/EIRP

A system simulator was used to establish communication with the EUT. Its parameters were set to enforce EUT transmitting at the maximum power. The measured power in the radio frequency on the transmitter output terminals shall be reported.

The ERP of mobile transmitters must not exceed 7 Watts for WCDMA Band V

The EIRP of mobile transmitters must not exceed 2 Watts for WCDMA Band II

The EIRP of mobile transmitters must not exceed 1 Watts for WCDMA Band IV

According to KDB 412172 D01 Power Approach,

$EIRP = P_T + G_T - L_C$, $ERP = EIRP - 2.15$, where

P_T = transmitter output power in dBm

G_T = gain of the transmitting antenna in dBi

L_C = signal attenuation in the connecting cable between the transmitter and antenna in dB

3.2.2 Test Procedures

1. The transmitter output port was connected to the system simulator.
2. Set EUT at maximum power through system simulator.
3. Select lowest, middle, and highest channels for each band and different modulation.
4. Measure the maximum burst average power for GSM and maximum average power for other modulation signal.



3.3 Peak-to-Average Ratio

3.3.1 Description of the PAR Measurement

The peak-to-average ratio (PAR) of the transmission may not exceed 13 dB.

3.3.2 Test Procedures

The testing follows ANSI C63.26-2015 Section 5.2.6

1. The EUT was connected to spectrum analyzer and system simulator via a power divider.
2. Set EUT to transmit at maximum output power.
3. When the duty cycle is less than 98%, then signal gating will be implemented on the spectrum analyzer by triggering from the system simulator.
4. Set the CCDF (Complementary Cumulative Distribution Function) option of the spectrum analyzer.
5. Record the maximum PAPR level associated with a probability of 0.1%.



3.4 99% Occupied Bandwidth and 26dB Bandwidth Measurement

3.4.1 Description of 99% Occupied Bandwidth and 26dB Bandwidth Measurement

The occupied bandwidth is the width of a frequency band such that, below the lower and above the upper frequency limits, the mean powers emitted are each equal to a specified percentage 0.5% of the total mean transmitted power.

The 26 dB emission bandwidth is defined as the frequency range between two points, one above and one below the carrier frequency, at which the spectral density of the emission is attenuated 26 dB below the maximum in-band spectral density of the modulated signal. Spectral density (power per unit bandwidth) is to be measured with a detector of resolution bandwidth equal to approximately 1.0% of the emission bandwidth.

3.4.2 Test Procedures

The testing follows ANSI C63.26-2015 Section 5.4.3 (26dB) and Section 5.4.4 (99OB)

1. The EUT was connected to spectrum analyzer and system simulator via a power divider.
2. The spectrum analyzer center frequency is set to the nominal EUT channel center frequency. The span range for the spectrum analyzer shall be between two and five times the anticipated OBW.
3. The nominal resolution bandwidth (RBW) shall be in the range of 1 to 5 % of the anticipated OBW, and the VBW shall be at least 3 times the RBW.
4. Set the detection mode to peak, and the trace mode to max hold.
5. Determine the reference value: Set the EUT to transmit a modulated signal. Allow the trace to stabilize. Set the spectrum analyzer marker to the highest level of the displayed trace.
(this is the reference value)
6. Determine the “-26 dB down amplitude” as equal to (Reference Value – X).
7. Place two markers, one at the lowest and the other at the highest frequency of the envelope of the spectral display such that each marker is at or slightly below the “-X dB down amplitude” determined in step 6. If a marker is below this “-X dB down amplitude” value it shall be placed as close as possible to this value. The OBW is the positive frequency difference between the two markers.
8. Use the 99 % power bandwidth function of the spectrum analyzer and report the measured bandwidth.



3.5 Conducted Band Edge

3.5.1 Description of Conducted Band Edge Measurement

The power of any emission outside of the authorized operating frequency ranges must be lower than the transmitter power (P) by a factor of at least $43 + 10 \log (P)$ dB.

3.5.2 Test Procedures

The testing follows FCC KDB 971168 D01 v03r01 Section 6.1.

1. The EUT was connected to the spectrum analyzer and system simulator via a power divider.
2. The RF output of EUT was connected to the spectrum analyzer by an RF cable and attenuator. The path loss was compensated to the results for each measurement.
3. The band edges of low and high channels for the highest RF powers were measured.
4. The RF fundamental frequency should be excluded against the limit line in the operating frequency band.
5. The limit line is derived from $43 + 10\log(P)$ dB below the transmitter power P(Watts)



3.6 Conducted Spurious Emission

3.6.1 Description of Conducted Spurious Emission Measurement

The power of any emission outside of the authorized operating frequency ranges must be lower than the transmitter power (P) by a factor of at least $43 + 10 \log (P)$ dB.

It is measured by means of a calibrated spectrum analyzer and scanned from 30 MHz up to a frequency including its 10th harmonic.

3.6.2 Test Procedures

The testing follows FCC KDB 971168 D01 v03r01 Section 6.1.

1. The EUT was connected to the spectrum analyzer and system simulator via a power divider.
2. The RF output of EUT was connected to the spectrum analyzer by an RF cable and attenuator. The path loss was compensated to the results for each measurement.
3. The middle channel for the highest RF power within the transmitting frequency was measured.
4. The conducted spurious emission for the whole frequency range was taken.
5. The RF fundamental frequency should be excluded against the limit line in the operating frequency band.
6. The limit line is derived from $43 + 10\log(P)$ dB below the transmitter power P(Watts)



3.7 Frequency Stability

3.7.1 Description of Frequency Stability Measurement

22.355

The frequency stability shall be measured by variation of ambient temperature and variation of primary supply voltage to ensure that the fundamental emission stays within the authorized frequency block. The frequency stability of the transmitter shall be maintained within $\pm 0.00025\%$ ($\pm 2.5\text{ppm}$) of the center frequency.

24.235 & 27.54

The frequency stability shall be sufficient to ensure that the fundamental emission stays within the authorized frequency block.

3.7.2 Test Procedures for Temperature Variation

The testing follows FCC KDB 971168 D01 v03r01 Section 9.0.

1. The EUT was set up in the thermal chamber and connected with the system simulator.
2. With power OFF, the temperature was decreased to -30°C and the EUT was stabilized before testing. Power was applied and the maximum change in frequency was recorded within one minute.
3. With power OFF, the temperature was raised in 10°C steps up to 50°C . The EUT was stabilized at each step for at least half an hour. Power was applied and the maximum frequency change was recorded within one minute.

3.7.3 Test Procedures for Voltage Variation

The testing follows FCC KDB 971168 D01 v03r01 Section 9.0.

1. The EUT was placed in a temperature chamber at $20\pm 5^{\circ}\text{C}$ and connected with the system simulator.
2. The power supply voltage to the EUT was varied from 85% to 115% of the nominal value measured at the input to the EUT.
3. The variation in frequency was measured for the worst case.

4 Radiated Test Items

4.1 Measuring Instruments

See list of measuring instruments of this test report.

4.2 Test Setup

For radiated test below 30MHz

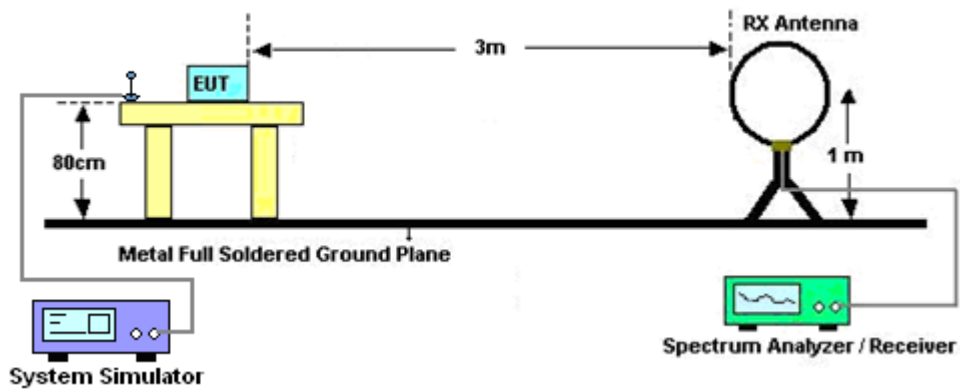

For radiated test from 30MHz to 1GHz

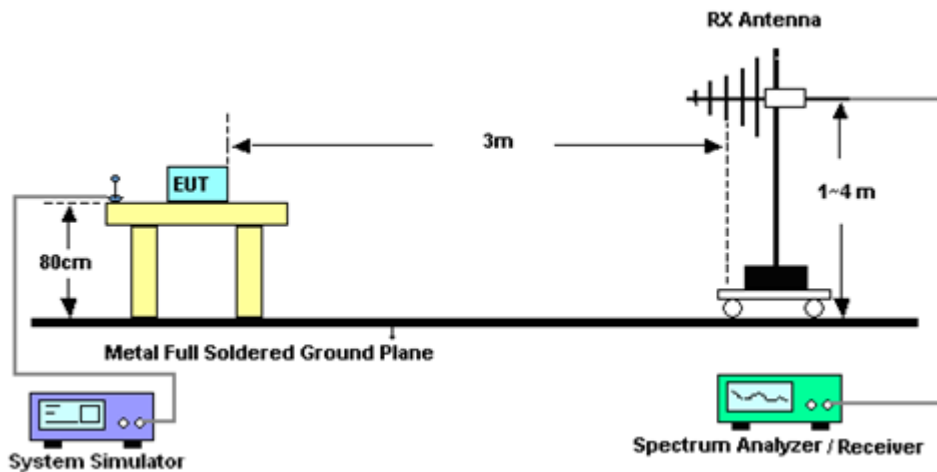

For radiated test above 1GHz

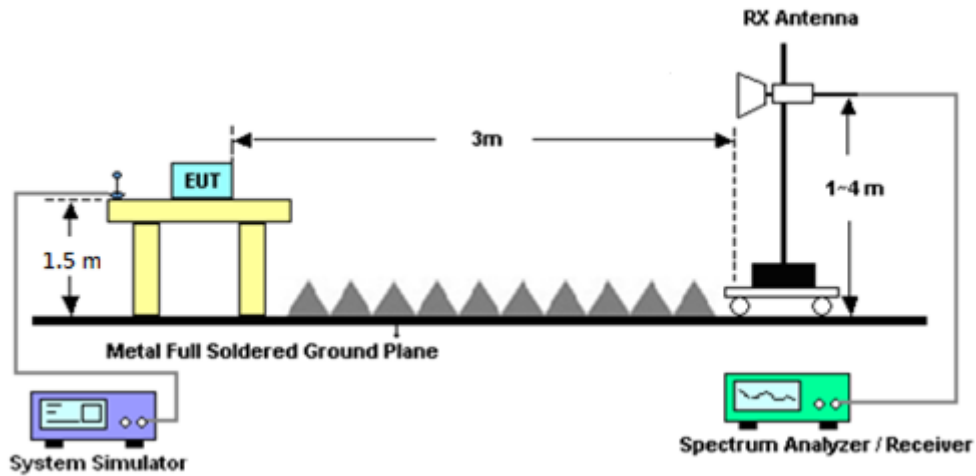

4.3 Test Result of Radiated Test

Please refer to Appendix B.

Note:

The low frequency, which started from 9 kHz to 30MHz, was pre-scanned and the result which was 20dB lower than the limit line was not reported.

There is a comparison data of both open-field test site and alternative test site - semi-Anechoic chamber according to 414788 D01 Radiated Test Site v01r01, and the result came out very similar.



4.4 Field Strength of Spurious Radiation Measurement

4.4.1 Description of Field Strength of Spurious Radiated Measurement

The power of any emission outside of the authorized operating frequency ranges must be attenuated below the transmitter power (P) by a factor of at least $43 + 10 \log (P)$ dB. The spectrum is scanned from 30 MHz up to a frequency including its 10th harmonic.

4.4.2 Test Procedures

The testing follows FCC KDB 971168 D01 v03r01 Section 7 and ANSI / TIA-603-E Section 2.2.12.

1. The EUT was placed on a rotatable wooden table 0.8 meters for frequency below 1GHz and 1.5 meter for frequency above 1GHz above the ground.
2. The EUT was set 3 meters from the receiving antenna, which was mounted on the antenna tower.
3. The table was rotated 360 degrees to determine the position of the highest spurious emission.
4. The height of the receiving antenna is varied between one meter and four meters to search for the maximum spurious emission for both horizontal and vertical polarizations.
5. Make the measurement with the spectrum analyzer's RBW = 1MHz, VBW = 3MHz, taking record of maximum spurious emission.
6. A horn antenna was substituted in place of the EUT and was driven by a signal generator.
7. Tune the output power of signal generator to the same emission level with EUT maximum spurious emission.
8. Taking the record of output power at antenna port.
9. Repeat step 7 to step 8 for another polarization.
10. $EIRP (dBm) = S.G. Power - Tx Cable Loss + Tx Antenna Gain$
11. $ERP (dBm) = EIRP - 2.15$
12. The RF fundamental frequency should be excluded against the limit line in the operating frequency band.
13. The limit line is derived from $43 + 10\log(P)$ dB below the transmitter power P(Watts)



5 List of Measuring Equipment

Instrument	Brand Name	Model No.	Serial No.	Characteristics	Calibration Date	Test Date	Due Date	Remark
Loop Antenna	Rohde & Schwarz	HFH2-Z2	100488	9 kHz~30 MHz	Jul. 14, 2020	Feb. 01, 2021~ Feb. 19, 2021	Jul. 13, 2021	Radiation (03CH11-HY)
Horn Antenna	SCHWARZBECK	BBHA 9120 D	9120D-1326	1GHz ~ 18GHz	Nov. 03, 2020	Feb. 01, 2021~ Feb. 19, 2021	Nov. 02, 2021	Radiation (03CH11-HY)
Horn Antenna	SCHWARZBECK	BBHA 9120 D	9120D-1212	1GHz ~ 18GHz	May 20, 2020	Feb. 01, 2021~ Feb. 19, 2021	May 19, 2021	Radiation (03CH11-HY)
SHF-EHF Horn Antenna	SCHWARZBECK	BBHA 9170	BBHA9170576	18GHz~40GHz	May 22, 2020	Feb. 01, 2021~ Feb. 19, 2021	May 21, 2021	Radiation (03CH11-HY)
SHF-EHF Horn Antenna	SCHWARZBECK	BBHA 9170	BBHA9170980	18GHz~40GHz	Jan. 11, 2021	Feb. 01, 2021~ Feb. 19, 2021	Jan. 10, 2022	Radiation (03CH11-HY)
Bilog Antenna	TESEQ	CBL 6111D & N-6-06	35414 & AT-N0602	30MHz~1GHz	Oct. 11, 2020	Feb. 01, 2021~ Feb. 19, 2021	Oct. 10, 2021	Radiation (03CH11-HY)
Bilog Antenna	TESEQ	CBL 6111D & 00800N1D01N-06	37059 & 01	30MHz~1GHz	Oct. 11, 2020	Feb. 01, 2021~ Feb. 19, 2021	Oct. 10, 2021	Radiation (03CH11-HY)
Preamplifier	Keysight	83017A	MY53270080	1GHz~26.5GHz	Nov. 12, 2020	Feb. 01, 2021~ Feb. 19, 2021	Nov. 11, 2021	Radiation (03CH11-HY)
Preamplifier	EMEC	EM18G40G	060801	18GHz~40GHz	Jun. 15, 2020	Feb. 01, 2021~ Feb. 19, 2021	Jun. 14, 2021	Radiation (03CH11-HY)
Amplifier	SONOMA	310N	187312	9kHz~1GHz	Dec. 02, 2020	Feb. 01, 2021~ Feb. 19, 2021	Dec. 01, 2021	Radiation (03CH11-HY)
Spectrum Analyzer	Keysight	N9010A	MY54200486	10Hz~44GHz	Oct. 23, 2020	Feb. 01, 2021~ Feb. 19, 2021	Oct. 22, 2021	Radiation (03CH11-HY)
Signal Generator	Rohde & Schwarz	SMF100A	101107	100kHz~40GHz	Dec. 14, 2020	Feb. 01, 2021~ Feb. 19, 2021	Dec. 13, 2021	Radiation (03CH11-HY)
Controller	EMEC	EM 1000	N/A	Control Turn table & Ant Mast	N/A	Feb. 01, 2021~ Feb. 19, 2021	N/A	Radiation (03CH11-HY)
Antenna Mast	EMEC	AM-BS-4500-B	N/A	1~4m	N/A	Feb. 01, 2021~ Feb. 19, 2021	N/A	Radiation (03CH11-HY)
Turn Table	EMEC	TT 2000	N/A	0~360 Degree	N/A	Feb. 01, 2021~ Feb. 19, 2021	N/A	Radiation (03CH11-HY)
Software	Audix	E3 6.2009-8-24	RK-001053	N/A	N/A	Feb. 01, 2021~ Feb. 19, 2021	N/A	Radiation (03CH11-HY)
RF Cable	HUBER + SUHNER	SUCOFLEX 104	MY9837/4PE	9kHz-30MHz	Mar. 12, 2020	Feb. 01, 2021~ Feb. 19, 2021	Mar. 11, 2021	Radiation (03CH11-HY)
RF Cable	HUBER + SUHNER	SUCOFLEX 102	MY2859/2	30MHz-40GHz	Mar. 12, 2020	Feb. 01, 2021~ Feb. 19, 2021	Mar. 11, 2021	Radiation (03CH11-HY)
RF Cable	HUBER + SUHNER	SUCOFLEX 104	MY9837/4PE	30M-18G	Mar. 12, 2020	Feb. 01, 2021~ Feb. 19, 2021	Mar. 11, 2021	Radiation (03CH11-HY)
RF Cable	HUBER + SUHNER	SUCOFLEX 102	MY4274/2	30MHz-40GHz	Mar. 12, 2020	Feb. 01, 2021~ Feb. 19, 2021	Mar. 11, 2021	Radiation (03CH11-HY)



Instrument	Brand Name	Model No.	Serial No.	Characteristics	Calibration Date	Test Date	Due Date	Remark
Filter	Wainwright	WHKX12-1080 -1200-15000-6 0SS	SN2	1.2GHz High Pass Filter	Sep. 14, 2020	Feb. 01, 2021~ Feb. 19, 2021	Sep. 13, 2021	Radiation (03CH11-HY)
Filter	Wainwright	WHKX12-2700 -3000-18000-6 0SS	SN3	3GHz High Pass Filter	Sep. 14, 2020	Feb. 01, 2021~ Feb. 19, 2021	Sep. 13, 2021	Radiation (03CH11-HY)
Hygrometer	TECPEL	DTM-303B	TP140325	N/A	Nov. 18, 2020	Feb. 01, 2021~ Feb. 19, 2021	Nov. 17, 2021	Radiation (03CH11-HY)
Hygrometer	TECPEL	DTM-303B	TP200880	QA-3-031	Oct. 22, 2020	Feb. 01, 2021~ Feb. 19, 2021	Oct. 21, 2021	Radiation (03CH11-HY)
Hygrometer	Testo	608-H1	34893241	N/A	Mar. 02, 2020	Feb. 04, 2021	Mar. 01, 2021	Conducted (TH03-HY)
Spectrum Analyzer	Rohde & Schwarz	FSP30	101329	9kHz~30GHz	Sep. 03, 2020	Feb. 04, 2021	Sep. 02, 2021	Conducted (TH03-HY)
Temperature Chamber	ESPEC	SH-641	92013720	-40°C ~90°C	Sep. 14, 2020	Feb. 04, 2021	Sep. 13, 2021	Conducted (TH03-HY)
Programmable Power Supply	GW Instek	PSS-2005	EL890001	1V~20V 0.5A~4A	Oct. 05, 2020	Feb. 04, 2021	Oct. 04, 2021	Conducted (TH03-HY)
Base Station (Measure)	Rohde & Schwarz	CMU200	117995	GSM / GPRS / WCDMA / CDMA	Sep. 07, 2020	Feb. 04, 2021	Sep. 06, 2021	Conducted (TH03-HY)
Power Divider	Warison	WCOU-0.4-26. 5S-20	#A	N/A	Nov. 03, 2020	Feb. 04, 2021	Nov. 02, 2021	Conducted (TH03-HY)



6 Uncertainty of Evaluation

Uncertainty of Radiated Emission Measurement (30 MHz ~ 1000 MHz)

Measuring Uncertainty for a Level of Confidence of 95% ($U = 2Uc(y)$)	3.29
---	------

Uncertainty of Radiated Emission Measurement (1 GHz ~ 18 GHz)

Measuring Uncertainty for a Level of Confidence of 95% ($U = 2Uc(y)$)	3.32
---	------

Uncertainty of Radiated Emission Measurement (18 GHz ~ 40 GHz)

Measuring Uncertainty for a Level of Confidence of 95% ($U = 2Uc(y)$)	4.08
---	------



Appendix A. Test Results of Conducted Test

Conducted Output Power(Average power) & ERP / EIRP

WCDMA Band V Maximum Average Power [dBm] (GT - LC = 0.7 dB)					
Channel	4132	4182	4233	ERP (dBm)	ERP (W)
Frequency	826.4	836.4	846.6		
RMC 12.2K	24.98	25.00	24.76	23.55	0.2265
HSDPA Subtest-1	23.94	23.82	23.67		
HSDPA Subtest-2	24.00	23.93	23.72		
HSDPA Subtest-3	23.50	23.38	23.18		
HSDPA Subtest-4	23.47	23.44	23.16		
HSUPA Subtest-1	23.92	23.88	23.65		
HSUPA Subtest-2	21.91	21.76	21.78		
HSUPA Subtest-3	22.97	22.86	22.61		
HSUPA Subtest-4	21.90	21.82	21.60		
HSUPA Subtest-5	23.92	23.85	23.71		
Limit	ERP < 7W				

WCDMA Band II Maximum Average Power [dBm] (GT - LC = 2.8 dB)					
Channel	9262	9400	9538	EIRP (dBm)	EIRP (W)
Frequency	1852.4	1880	1907.6		
RMC 12.2K	24.55	24.77	24.60	27.57	0.5715
HSDPA Subtest-1	23.59	23.68	23.92		
HSDPA Subtest-2	23.66	23.69	23.84		
HSDPA Subtest-3	23.22	23.11	23.28		
HSDPA Subtest-4	23.13	23.24	23.33		
HSUPA Subtest-1	23.68	23.59	23.87		
HSUPA Subtest-2	21.69	21.70	22.00		
HSUPA Subtest-3	22.72	22.66	22.90		
HSUPA Subtest-4	21.66	21.70	21.82		
HSUPA Subtest-5	23.60	23.69	23.85		
Limit	EIRP < 2W				

WCDMA Band IV Maximum Average Power [dBm] (GT - LC = 2.8 dB)					
Channel	1312	1413	1513	EIRP (dBm)	EIRP (W)
Frequency	1712.4	1732.6	1752.6		
RMC 12.2K	24.74	24.88	24.56	27.68	0.5861
HSDPA Subtest-1	23.96	23.82	23.70		
HSDPA Subtest-2	23.92	23.83	23.73		
HSDPA Subtest-3	23.39	23.33	23.13		
HSDPA Subtest-4	23.39	23.38	23.19		
HSUPA Subtest-1	23.98	23.83	23.60		
HSUPA Subtest-2	21.90	21.82	21.69		
HSUPA Subtest-3	22.92	22.73	22.20		
HSUPA Subtest-4	21.89	21.81	21.98		
HSUPA Subtest-5	23.99	23.87	23.68		
Limit	EIRP < 1W				



A2. WCDMA

Peak-to-Average Ratio

Mode	WCDMA Band V	WCDMA Band II	WCDMA Band IV	Limit: 13dB
Mod.	RMC 12.2Kbps	RMC 12.2Kbps	RMC 12.2Kbps	Result
Lowest CH	3.24	3.28	3.00	PASS
Middle CH	3.20	3.12	3.20	
Highest CH	3.04	3.16	2.88	

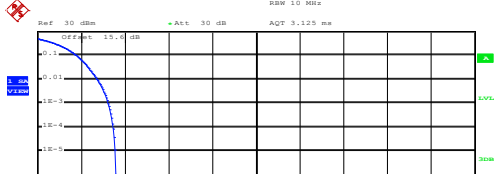
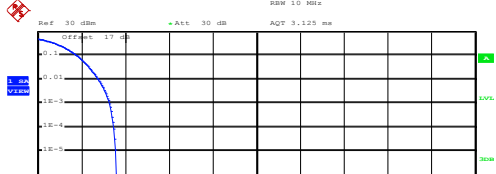
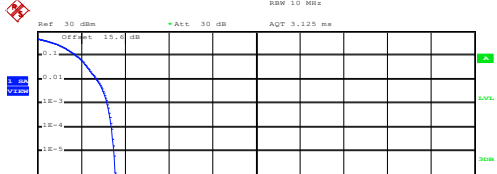
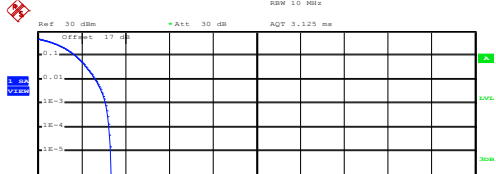
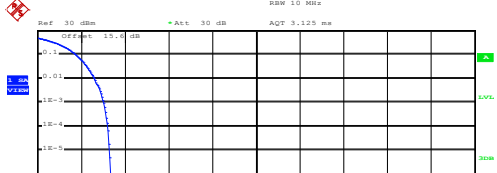
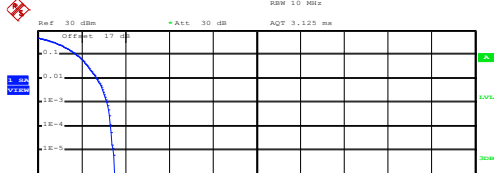

WCDMA Band V (RMC 12.2Kbps)	WCDMA Band II (RMC 12.2Kbps)
<p style="text-align: center;">Lowest Channel</p>  <p>Center 826.4 MHz 2 dB/ Mean Pwr + 20 dB</p> <p>Complementary Cumulative Distribution Function (100000 samples)</p> <p>Trace 1</p> <p>Mean 22.78 dBm Peak 26.35 dBm Crest 3.57 dB</p> <p>10 % 1.80 dB 1 % 2.76 dB .1 % 3.24 dB .01 % 3.48 dB</p> <p>Date: 4.FEB.2021 12:00:19</p>	<p style="text-align: center;">Lowest Channel</p>  <p>Center 1.8524 GHz 2 dB/ Mean Pwr + 20 dB</p> <p>Complementary Cumulative Distribution Function (100000 samples)</p> <p>Trace 1</p> <p>Mean 22.19 dBm Peak 25.78 dBm Crest 3.59 dB</p> <p>10 % 1.80 dB 1 % 2.76 dB .1 % 3.28 dB .01 % 3.48 dB</p> <p>Date: 4.FEB.2021 11:39:46</p>
<p style="text-align: center;">Middle Channel</p>  <p>Center 826.4 MHz 2 dB/ Mean Pwr + 20 dB</p> <p>Complementary Cumulative Distribution Function (100000 samples)</p> <p>Trace 1</p> <p>Mean 22.78 dBm Peak 26.35 dBm Crest 3.56 dB</p> <p>10 % 1.76 dB 1 % 2.72 dB .1 % 3.20 dB .01 % 3.40 dB</p> <p>Date: 4.FEB.2021 12:00:37</p>	<p style="text-align: center;">Middle Channel</p>  <p>Center 1.88 GHz 2 dB/ Mean Pwr + 20 dB</p> <p>Complementary Cumulative Distribution Function (100000 samples)</p> <p>Trace 1</p> <p>Mean 22.43 dBm Peak 25.78 dBm Crest 3.35 dB</p> <p>10 % 1.72 dB 1 % 2.64 dB .1 % 3.12 dB .01 % 3.24 dB</p> <p>Date: 4.FEB.2021 11:40:04</p>
<p style="text-align: center;">Highest Channel</p>  <p>Center 846.6 MHz 2 dB/ Mean Pwr + 20 dB</p> <p>Complementary Cumulative Distribution Function (100000 samples)</p> <p>Trace 1</p> <p>Mean 22.85 dBm Peak 26.21 dBm Crest 3.35 dB</p> <p>10 % 1.76 dB 1 % 2.60 dB .1 % 3.04 dB .01 % 3.24 dB</p> <p>Date: 4.FEB.2021 12:00:54</p>	<p style="text-align: center;">Highest Channel</p>  <p>Center 1.9076 GHz 2 dB/ Mean Pwr + 20 dB</p> <p>Complementary Cumulative Distribution Function (100000 samples)</p> <p>Trace 1</p> <p>Mean 22.26 dBm Peak 25.78 dBm Crest 3.52 dB</p> <p>10 % 1.76 dB 1 % 2.72 dB .1 % 3.16 dB .01 % 3.32 dB</p> <p>Date: 4.FEB.2021 11:40:25</p>



WCDMA Band IV (RMC 12.2Kbps)

Lowest Channel

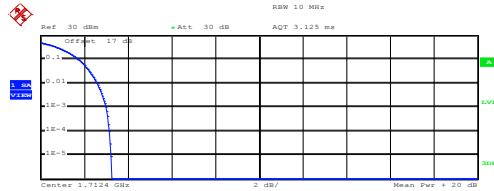

Complementary Cumulative Distribution Function (100000 samples)

Trace 1
 Mean 22.04 dBm
 Peak 25.29 dBm
 Crest 3.25 dB

10 %	1.76 dB
1 %	2.60 dB
.1 %	3.00 dB
.01 %	3.16 dB

Date: 4.FEB.2021 14:08:31

Middle Channel

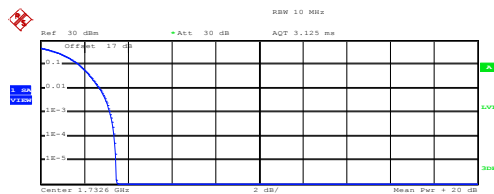

Complementary Cumulative Distribution Function (100000 samples)

Trace 1
 Mean 22.09 dBm
 Peak 25.57 dBm
 Crest 3.48 dB

10 %	1.76 dB
1 %	2.72 dB
.1 %	3.20 dB
.01 %	3.36 dB

Date: 4.FEB.2021 14:08:50

Highest Channel

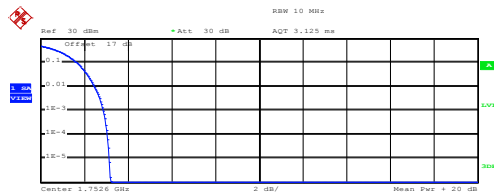

Complementary Cumulative Distribution Function (100000 samples)

Trace 1
 Mean 21.94 dBm
 Peak 25.15 dBm
 Crest 3.21 dB

10 %	1.68 dB
1 %	2.48 dB
.1 %	2.88 dB
.01 %	3.08 dB

Date: 4.FEB.2021 14:09:08



26dB Bandwidth

Mode	WCDMA Band V	WCDMA Band II	WCDMA Band IV
Mod.	RMC 12.2Kbps	RMC 12.2Kbps	RMC 12.2Kbps
Lowest CH	4.70	4.71	4.72
Middle CH	4.71	4.71	4.70
Highest CH	4.71	4.70	4.71



WCDMA Band V (RMC 12.2Kbps)

WCDMA Band II (RMC 12.2Kbps)

Lowest Channel

Lowest Channel

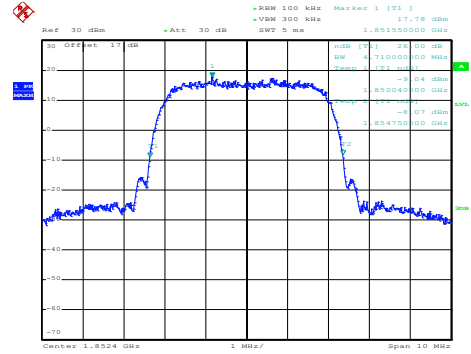
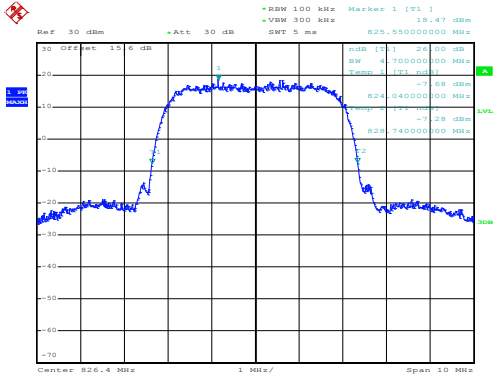

Date: 4.FEB.2021 11:46:50

Date: 4.FEB.2021 11:29:12

Middle Channel

Middle Channel

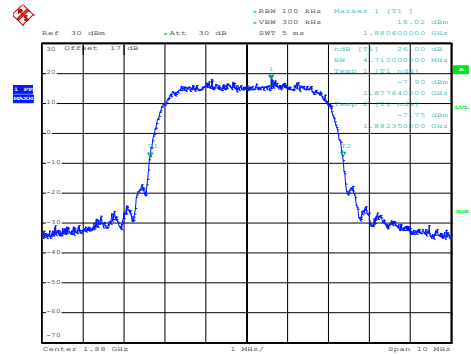
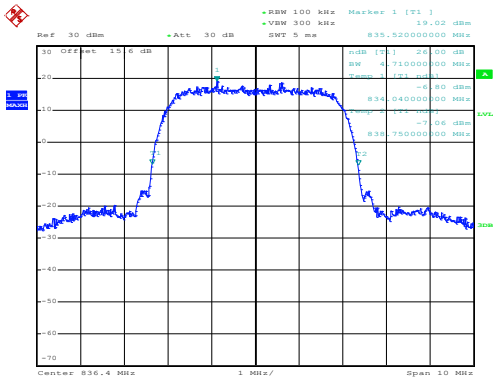

Date: 4.FEB.2021 11:48:23

Date: 4.FEB.2021 11:29:52

Highest Channel

Highest Channel

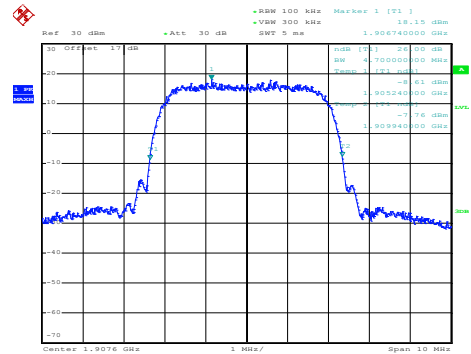
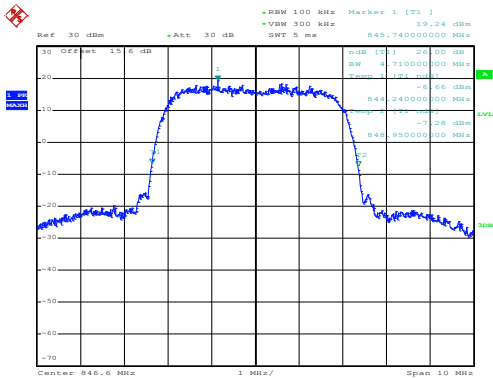

Date: 4.FEB.2021 11:49:00

Date: 4.FEB.2021 11:30:30



WCDMA Band IV (RMC 12.2Kbps)

Lowest Channel

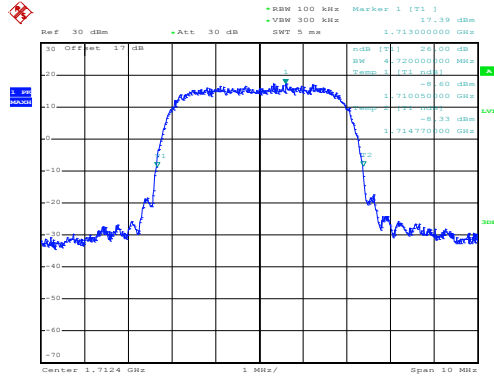

Date: 4.FEB.2021 13:55:28

Middle Channel

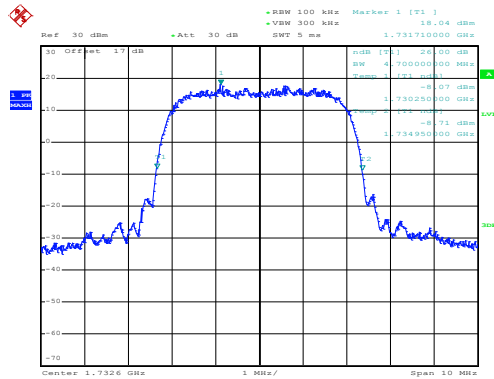

Date: 4.FEB.2021 13:56:05

Highest Channel

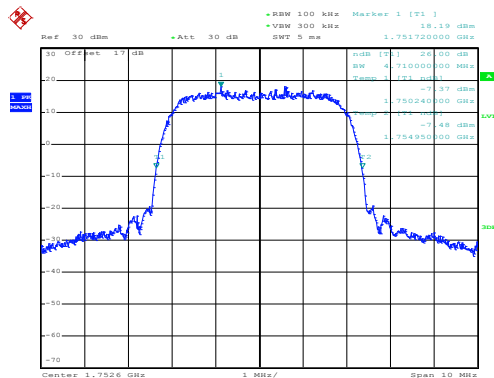

Date: 4.FEB.2021 13:56:43



Occupied Bandwidth

Mode	WCDMA Band V	WCDMA Band II	WCDMA Band IV
Mod.	RMC 12.2Kbps	RMC 12.2Kbps	RMC 12.2Kbps
Lowest CH	4.15	4.13	4.14
Middle CH	4.15	4.14	4.14
Highest CH	4.15	4.13	4.13



WCDMA Band V (RMC 12.2Kbps)	WCDMA Band II (RMC 12.2Kbps)
Lowest Channel	Lowest Channel
<p>Ref: 30 dBm, Att: 30 dB, RSW: 100 kHz, VSW: 300 kHz, SWT: 5 ms, Marker 1: 18.43 dBm @ 825.50000000 MHz.</p> <p>OSW: 1.130000000 MHz, Temp: 1 (71.0dB)</p> <p>OSW: 1.355000000 MHz, Temp: 2 (71.0dB)</p> <p>OSW: 1.470000000 MHz, Temp: 3 (71.0dB)</p> <p>Center: 826.4 MHz, 1 MHz/, Span: 10 MHz</p> <p>Date: 4.FEB.2021 11:52:39</p>	<p>Ref: 30 dBm, Att: 30 dB, RSW: 100 kHz, VSW: 300 kHz, SWT: 5 ms, Marker 1: 17.62 dBm @ 1.853010000 GHz.</p> <p>OSW: 1.130000000 MHz, Temp: 1 (71.0dB)</p> <p>OSW: 1.355000000 MHz, Temp: 2 (71.0dB)</p> <p>OSW: 1.470000000 MHz, Temp: 3 (71.0dB)</p> <p>Center: 1.8524 GHz, 1 MHz/, Span: 10 MHz</p> <p>Date: 4.FEB.2021 11:31:16</p>
Middle Channel	Middle Channel
<p>Ref: 30 dBm, Att: 30 dB, RSW: 100 kHz, VSW: 300 kHz, SWT: 5 ms, Marker 1: 18.67 dBm @ 826.58000000 MHz.</p> <p>OSW: 1.130000000 MHz, Temp: 1 (71.0dB)</p> <p>OSW: 1.355000000 MHz, Temp: 2 (71.0dB)</p> <p>OSW: 1.470000000 MHz, Temp: 3 (71.0dB)</p> <p>Center: 826.4 MHz, 1 MHz/, Span: 10 MHz</p> <p>Date: 4.FEB.2021 11:53:18</p>	<p>Ref: 30 dBm, Att: 30 dB, RSW: 100 kHz, VSW: 300 kHz, SWT: 5 ms, Marker 1: 18.56 dBm @ 1.879240000 GHz.</p> <p>OSW: 1.130000000 MHz, Temp: 1 (71.0dB)</p> <p>OSW: 1.355000000 MHz, Temp: 2 (71.0dB)</p> <p>OSW: 1.470000000 MHz, Temp: 3 (71.0dB)</p> <p>Center: 1.85 GHz, 1 MHz/, Span: 10 MHz</p> <p>Date: 4.FEB.2021 11:31:57</p>
Highest Channel	Highest Channel
<p>Ref: 30 dBm, Att: 30 dB, RSW: 100 kHz, VSW: 300 kHz, SWT: 5 ms, Marker 1: 18.43 dBm @ 847.18000000 MHz.</p> <p>OSW: 1.130000000 MHz, Temp: 1 (71.0dB)</p> <p>OSW: 1.355000000 MHz, Temp: 2 (71.0dB)</p> <p>OSW: 1.470000000 MHz, Temp: 3 (71.0dB)</p> <p>Center: 846.6 MHz, 1 MHz/, Span: 10 MHz</p> <p>Date: 4.FEB.2021 11:53:56</p>	<p>Ref: 30 dBm, Att: 30 dB, RSW: 100 kHz, VSW: 300 kHz, SWT: 5 ms, Marker 1: 18.48 dBm @ 1.906730000 GHz.</p> <p>OSW: 1.130000000 MHz, Temp: 1 (71.0dB)</p> <p>OSW: 1.355000000 MHz, Temp: 2 (71.0dB)</p> <p>OSW: 1.470000000 MHz, Temp: 3 (71.0dB)</p> <p>Center: 1.9076 GHz, 1 MHz/, Span: 10 MHz</p> <p>Date: 4.FEB.2021 11:32:36</p>



WCDMA Band IV (RMC 12.2Kbps)

Lowest Channel

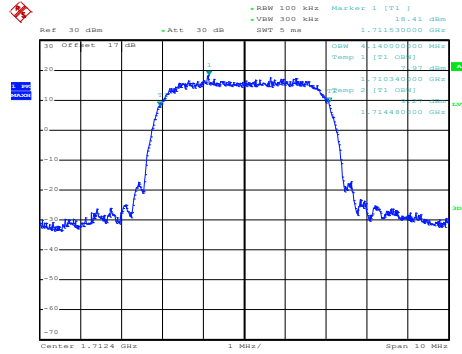

Date: 4.FEB.2021 14:00:17

Middle Channel

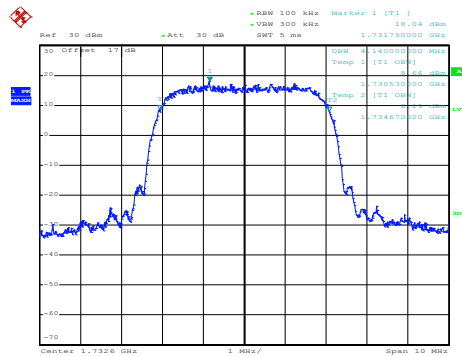

Date: 4.FEB.2021 14:01:21

Highest Channel

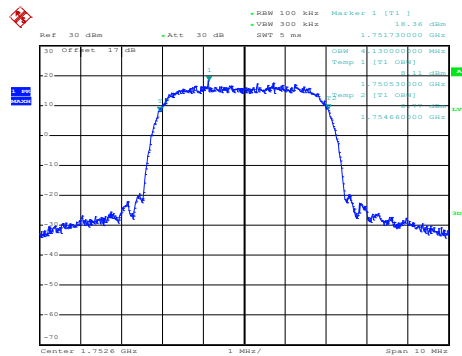

Date: 4.FEB.2021 14:02:01



Conducted Band Edge

WCDMA Band V (RMC 12.2Kbps)

Lowest Band Edge

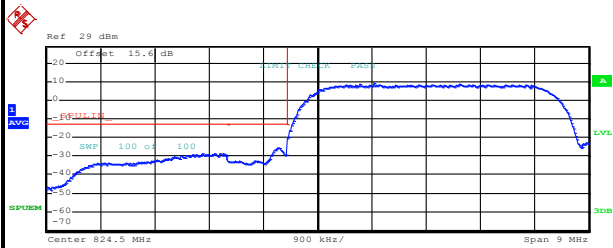

Start [Hz]	Stop [Hz]	RBW [Hz]	Freq [Hz]	PwrAbs [dBm]	ΔLimit [dB]
820.000 M	823.000 M	100.00 k	822.874000 M	-28.59	-15.59
823.000 M	824.000 M	50.00 k	823.824000 M	-25.83	-12.83
824.000 M	829.000 M	100.00 k	825.435000 M	9.68	-25.32

Date: 4.FEB.2021 11:56:51

Highest Band Edge

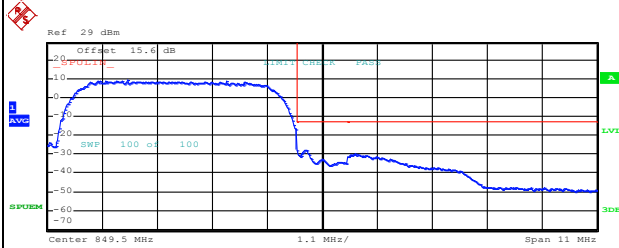

Start [Hz]	Stop [Hz]	RBW [Hz]	Freq [Hz]	PwrAbs [dBm]	ΔLimit [dB]
844.000 M	849.000 M	100.00 k	845.610000 M	9.12	-25.88
849.000 M	850.000 M	50.00 k	849.004000 M	-27.92	-14.92
850.000 M	855.000 M	100.00 k	850.160000 M	-29.94	-16.94

Date: 4.FEB.2021 11:59:45

WCDMA Band II (RMC 12.2Kbps)

Lowest Band Edge

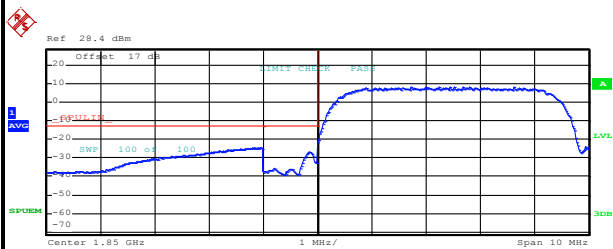

Start [Hz]	Stop [Hz]	RBW [Hz]	Freq [Hz]	PwrAbs [dBm]	ΔLimit [dB]
1.845 G	1.849 G	1.00 M	1.848796 G	-24.58	-11.58
1.849 G	1.850 G	50.00 k	1.849860 G	-26.79	-13.79
1.850 G	1.855 G	100.00 k	1.852510 G	8.41	-26.59

Date: 4.FEB.2021 11:35:53

Highest Band Edge

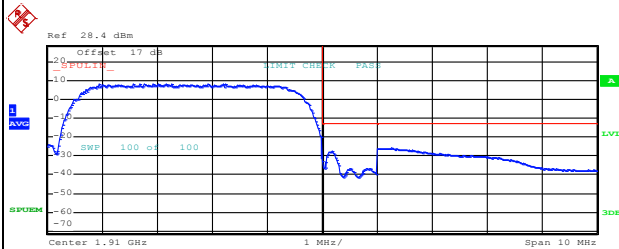

Start [Hz]	Stop [Hz]	RBW [Hz]	Freq [Hz]	PwrAbs [dBm]	ΔLimit [dB]
1.905 G	1.910 G	100.00 k	1.906565 G	8.50	-26.50
1.910 G	1.911 G	50.00 k	1.910168 G	-27.60	-14.60
1.911 G	1.915 G	1.00 M	1.911256 G	-25.91	-12.91

Date: 4.FEB.2021 11:39:00



WCDMA Band IV (RMC 12.2Kbps)

Lowest Band Edge

Highest Band Edge

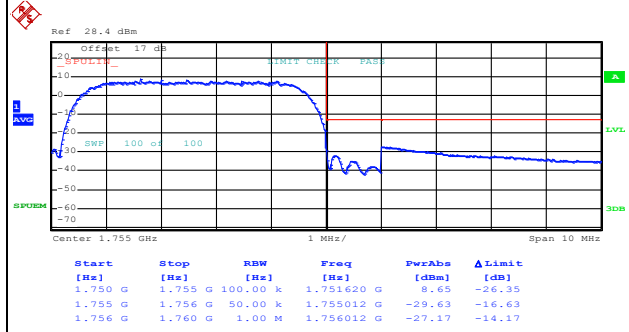
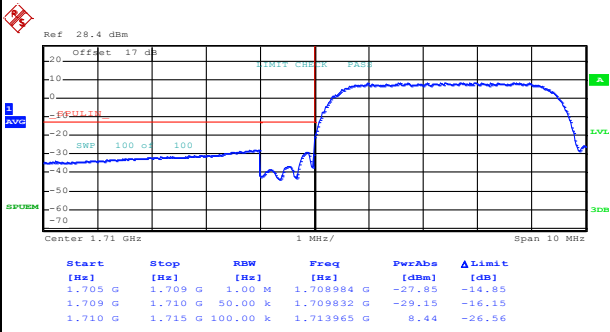

Date: 4.FEB.2021 14:04:57

Date: 4.FEB.2021 14:07:49

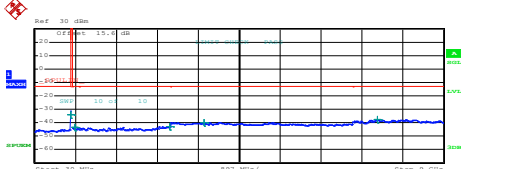
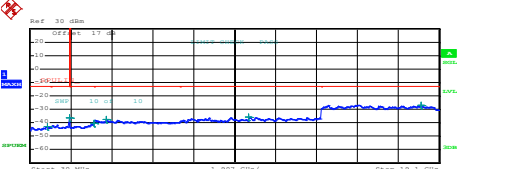
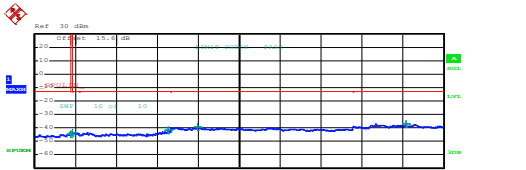
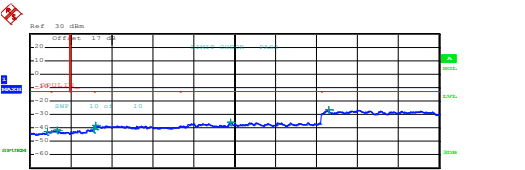
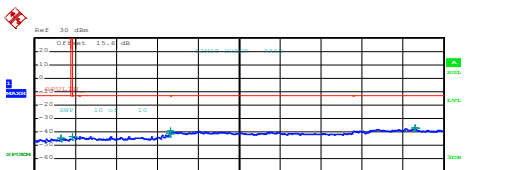
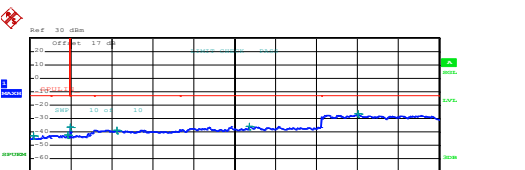

Conducted Spurious Emission

WCDMA Band V (RMC 12.2Kbps)	WCDMA Band II (RMC 12.2Kbps)																																																																														
Lowest Channel	Lowest Channel																																																																														
 <table border="1" data-bbox="239 627 766 705"> <thead> <tr> <th>Start [Hz]</th> <th>Stop [Hz]</th> <th>RBW [Hz]</th> <th>Freq [Hz]</th> <th>PerAbs [dBm]</th> <th>ΔLimit [dB]</th> </tr> </thead> <tbody> <tr><td>30.000 M</td><td>820.000 M</td><td>1.00 M</td><td>816.802500 M</td><td>-33.87</td><td>-29.87</td></tr> <tr><td>855.000 M</td><td>1.000 G</td><td>1.00 M</td><td>914.015004 M</td><td>-43.65</td><td>-30.65</td></tr> <tr><td>1.000 G</td><td>3.000 G</td><td>1.00 M</td><td>2.9945000 G</td><td>-42.56</td><td>-29.56</td></tr> <tr><td>3.000 G</td><td>7.000 G</td><td>1.00 M</td><td>3.7490000 G</td><td>-39.63</td><td>-26.63</td></tr> <tr><td>7.000 G</td><td>9.000 G</td><td>1.00 M</td><td>7.5410000 G</td><td>-37.69</td><td>-24.69</td></tr> </tbody> </table> <p>Date: 4.FEB.2021 11:50:01</p>	Start [Hz]	Stop [Hz]	RBW [Hz]	Freq [Hz]	PerAbs [dBm]	ΔLimit [dB]	30.000 M	820.000 M	1.00 M	816.802500 M	-33.87	-29.87	855.000 M	1.000 G	1.00 M	914.015004 M	-43.65	-30.65	1.000 G	3.000 G	1.00 M	2.9945000 G	-42.56	-29.56	3.000 G	7.000 G	1.00 M	3.7490000 G	-39.63	-26.63	7.000 G	9.000 G	1.00 M	7.5410000 G	-37.69	-24.69	 <table border="1" data-bbox="893 627 1420 705"> <thead> <tr> <th>Start [Hz]</th> <th>Stop [Hz]</th> <th>RBW [Hz]</th> <th>Freq [Hz]</th> <th>PerAbs [dBm]</th> <th>ΔLimit [dB]</th> </tr> </thead> <tbody> <tr><td>30.000 M</td><td>1.000 G</td><td>1.00 M</td><td>839.255000 M</td><td>-42.69</td><td>-29.69</td></tr> <tr><td>1.000 G</td><td>1.845 G</td><td>1.00 M</td><td>1.842676 G</td><td>-36.40</td><td>-23.40</td></tr> <tr><td>1.915 G</td><td>3.000 G</td><td>1.00 M</td><td>2.998879 G</td><td>-43.35</td><td>-27.35</td></tr> <tr><td>3.000 G</td><td>7.000 G</td><td>1.00 M</td><td>3.596000 G</td><td>-37.39</td><td>-24.39</td></tr> <tr><td>7.000 G</td><td>13.600 G</td><td>1.00 M</td><td>10.230700 G</td><td>-35.87</td><td>-22.87</td></tr> <tr><td>13.600 G</td><td>19.100 G</td><td>1.00 M</td><td>16.233625 G</td><td>-26.73</td><td>-13.73</td></tr> </tbody> </table> <p>Date: 4.FEB.2021 11:26:29</p>	Start [Hz]	Stop [Hz]	RBW [Hz]	Freq [Hz]	PerAbs [dBm]	ΔLimit [dB]	30.000 M	1.000 G	1.00 M	839.255000 M	-42.69	-29.69	1.000 G	1.845 G	1.00 M	1.842676 G	-36.40	-23.40	1.915 G	3.000 G	1.00 M	2.998879 G	-43.35	-27.35	3.000 G	7.000 G	1.00 M	3.596000 G	-37.39	-24.39	7.000 G	13.600 G	1.00 M	10.230700 G	-35.87	-22.87	13.600 G	19.100 G	1.00 M	16.233625 G	-26.73	-13.73
Start [Hz]	Stop [Hz]	RBW [Hz]	Freq [Hz]	PerAbs [dBm]	ΔLimit [dB]																																																																										
30.000 M	820.000 M	1.00 M	816.802500 M	-33.87	-29.87																																																																										
855.000 M	1.000 G	1.00 M	914.015004 M	-43.65	-30.65																																																																										
1.000 G	3.000 G	1.00 M	2.9945000 G	-42.56	-29.56																																																																										
3.000 G	7.000 G	1.00 M	3.7490000 G	-39.63	-26.63																																																																										
7.000 G	9.000 G	1.00 M	7.5410000 G	-37.69	-24.69																																																																										
Start [Hz]	Stop [Hz]	RBW [Hz]	Freq [Hz]	PerAbs [dBm]	ΔLimit [dB]																																																																										
30.000 M	1.000 G	1.00 M	839.255000 M	-42.69	-29.69																																																																										
1.000 G	1.845 G	1.00 M	1.842676 G	-36.40	-23.40																																																																										
1.915 G	3.000 G	1.00 M	2.998879 G	-43.35	-27.35																																																																										
3.000 G	7.000 G	1.00 M	3.596000 G	-37.39	-24.39																																																																										
7.000 G	13.600 G	1.00 M	10.230700 G	-35.87	-22.87																																																																										
13.600 G	19.100 G	1.00 M	16.233625 G	-26.73	-13.73																																																																										
Middle Channel	Middle Channel																																																																														
 <table border="1" data-bbox="239 1142 766 1220"> <thead> <tr> <th>Start [Hz]</th> <th>Stop [Hz]</th> <th>RBW [Hz]</th> <th>Freq [Hz]</th> <th>PerAbs [dBm]</th> <th>ΔLimit [dB]</th> </tr> </thead> <tbody> <tr><td>30.000 M</td><td>820.000 M</td><td>1.00 M</td><td>817.235000 M</td><td>-44.77</td><td>-31.77</td></tr> <tr><td>855.000 M</td><td>1.000 G</td><td>1.00 M</td><td>839.332500 M</td><td>-43.66</td><td>-30.66</td></tr> <tr><td>1.000 G</td><td>3.000 G</td><td>1.00 M</td><td>2.9959000 G</td><td>-41.64</td><td>-28.64</td></tr> <tr><td>3.000 G</td><td>7.000 G</td><td>1.00 M</td><td>3.5950000 G</td><td>-39.37</td><td>-26.37</td></tr> <tr><td>7.000 G</td><td>9.000 G</td><td>1.00 M</td><td>8.1760000 G</td><td>-36.74</td><td>-23.74</td></tr> </tbody> </table> <p>Date: 4.FEB.2021 11:51:00</p>	Start [Hz]	Stop [Hz]	RBW [Hz]	Freq [Hz]	PerAbs [dBm]	ΔLimit [dB]	30.000 M	820.000 M	1.00 M	817.235000 M	-44.77	-31.77	855.000 M	1.000 G	1.00 M	839.332500 M	-43.66	-30.66	1.000 G	3.000 G	1.00 M	2.9959000 G	-41.64	-28.64	3.000 G	7.000 G	1.00 M	3.5950000 G	-39.37	-26.37	7.000 G	9.000 G	1.00 M	8.1760000 G	-36.74	-23.74	 <table border="1" data-bbox="893 1142 1420 1220"> <thead> <tr> <th>Start [Hz]</th> <th>Stop [Hz]</th> <th>RBW [Hz]</th> <th>Freq [Hz]</th> <th>PerAbs [dBm]</th> <th>ΔLimit [dB]</th> </tr> </thead> <tbody> <tr><td>30.000 M</td><td>1.000 G</td><td>1.00 M</td><td>820.792500 M</td><td>-42.78</td><td>-29.78</td></tr> <tr><td>1.000 G</td><td>1.845 G</td><td>1.00 M</td><td>1.8258256 G</td><td>-43.84</td><td>-28.84</td></tr> <tr><td>1.915 G</td><td>3.000 G</td><td>1.00 M</td><td>2.995895 G</td><td>-40.80</td><td>-27.80</td></tr> <tr><td>3.000 G</td><td>7.000 G</td><td>1.00 M</td><td>3.0890000 G</td><td>-38.01</td><td>-25.01</td></tr> <tr><td>7.000 G</td><td>13.600 G</td><td>1.00 M</td><td>8.2376825 G</td><td>-35.50</td><td>-22.50</td></tr> <tr><td>13.600 G</td><td>19.100 G</td><td>1.00 M</td><td>13.955438 G</td><td>-26.63</td><td>-13.63</td></tr> </tbody> </table> <p>Date: 4.FEB.2021 11:27:24</p>	Start [Hz]	Stop [Hz]	RBW [Hz]	Freq [Hz]	PerAbs [dBm]	ΔLimit [dB]	30.000 M	1.000 G	1.00 M	820.792500 M	-42.78	-29.78	1.000 G	1.845 G	1.00 M	1.8258256 G	-43.84	-28.84	1.915 G	3.000 G	1.00 M	2.995895 G	-40.80	-27.80	3.000 G	7.000 G	1.00 M	3.0890000 G	-38.01	-25.01	7.000 G	13.600 G	1.00 M	8.2376825 G	-35.50	-22.50	13.600 G	19.100 G	1.00 M	13.955438 G	-26.63	-13.63
Start [Hz]	Stop [Hz]	RBW [Hz]	Freq [Hz]	PerAbs [dBm]	ΔLimit [dB]																																																																										
30.000 M	820.000 M	1.00 M	817.235000 M	-44.77	-31.77																																																																										
855.000 M	1.000 G	1.00 M	839.332500 M	-43.66	-30.66																																																																										
1.000 G	3.000 G	1.00 M	2.9959000 G	-41.64	-28.64																																																																										
3.000 G	7.000 G	1.00 M	3.5950000 G	-39.37	-26.37																																																																										
7.000 G	9.000 G	1.00 M	8.1760000 G	-36.74	-23.74																																																																										
Start [Hz]	Stop [Hz]	RBW [Hz]	Freq [Hz]	PerAbs [dBm]	ΔLimit [dB]																																																																										
30.000 M	1.000 G	1.00 M	820.792500 M	-42.78	-29.78																																																																										
1.000 G	1.845 G	1.00 M	1.8258256 G	-43.84	-28.84																																																																										
1.915 G	3.000 G	1.00 M	2.995895 G	-40.80	-27.80																																																																										
3.000 G	7.000 G	1.00 M	3.0890000 G	-38.01	-25.01																																																																										
7.000 G	13.600 G	1.00 M	8.2376825 G	-35.50	-22.50																																																																										
13.600 G	19.100 G	1.00 M	13.955438 G	-26.63	-13.63																																																																										
Highest Channel	Highest Channel																																																																														
 <table border="1" data-bbox="239 1657 766 1736"> <thead> <tr> <th>Start [Hz]</th> <th>Stop [Hz]</th> <th>RBW [Hz]</th> <th>Freq [Hz]</th> <th>PerAbs [dBm]</th> <th>ΔLimit [dB]</th> </tr> </thead> <tbody> <tr><td>30.000 M</td><td>820.000 M</td><td>1.00 M</td><td>611.252500 M</td><td>-44.82</td><td>-31.82</td></tr> <tr><td>855.000 M</td><td>1.000 G</td><td>1.00 M</td><td>855.036250 M</td><td>-43.37</td><td>-30.37</td></tr> <tr><td>1.000 G</td><td>3.000 G</td><td>1.00 M</td><td>2.9900000 G</td><td>-43.27</td><td>-28.27</td></tr> <tr><td>3.000 G</td><td>7.000 G</td><td>1.00 M</td><td>3.0170000 G</td><td>-39.24</td><td>-26.24</td></tr> <tr><td>7.000 G</td><td>9.000 G</td><td>1.00 M</td><td>8.3665000 G</td><td>-37.00</td><td>-24.00</td></tr> </tbody> </table> <p>Date: 4.FEB.2021 11:51:55</p>	Start [Hz]	Stop [Hz]	RBW [Hz]	Freq [Hz]	PerAbs [dBm]	ΔLimit [dB]	30.000 M	820.000 M	1.00 M	611.252500 M	-44.82	-31.82	855.000 M	1.000 G	1.00 M	855.036250 M	-43.37	-30.37	1.000 G	3.000 G	1.00 M	2.9900000 G	-43.27	-28.27	3.000 G	7.000 G	1.00 M	3.0170000 G	-39.24	-26.24	7.000 G	9.000 G	1.00 M	8.3665000 G	-37.00	-24.00	 <table border="1" data-bbox="893 1657 1420 1736"> <thead> <tr> <th>Start [Hz]</th> <th>Stop [Hz]</th> <th>RBW [Hz]</th> <th>Freq [Hz]</th> <th>PerAbs [dBm]</th> <th>ΔLimit [dB]</th> </tr> </thead> <tbody> <tr><td>30.000 M</td><td>1.000 G</td><td>1.00 M</td><td>170.407500 M</td><td>-42.85</td><td>-29.85</td></tr> <tr><td>1.000 G</td><td>1.845 G</td><td>1.00 M</td><td>1.799370 G</td><td>-42.50</td><td>-29.50</td></tr> <tr><td>1.915 G</td><td>3.000 G</td><td>1.00 M</td><td>1.936000 G</td><td>-36.64</td><td>-23.64</td></tr> <tr><td>3.000 G</td><td>7.000 G</td><td>1.00 M</td><td>4.089000 G</td><td>-38.52</td><td>-25.52</td></tr> <tr><td>7.000 G</td><td>13.600 G</td><td>1.00 M</td><td>10.237300 G</td><td>-35.53</td><td>-22.53</td></tr> <tr><td>13.600 G</td><td>19.100 G</td><td>1.00 M</td><td>15.337312 G</td><td>-26.72</td><td>-13.72</td></tr> </tbody> </table> <p>Date: 4.FEB.2021 11:28:22</p>	Start [Hz]	Stop [Hz]	RBW [Hz]	Freq [Hz]	PerAbs [dBm]	ΔLimit [dB]	30.000 M	1.000 G	1.00 M	170.407500 M	-42.85	-29.85	1.000 G	1.845 G	1.00 M	1.799370 G	-42.50	-29.50	1.915 G	3.000 G	1.00 M	1.936000 G	-36.64	-23.64	3.000 G	7.000 G	1.00 M	4.089000 G	-38.52	-25.52	7.000 G	13.600 G	1.00 M	10.237300 G	-35.53	-22.53	13.600 G	19.100 G	1.00 M	15.337312 G	-26.72	-13.72
Start [Hz]	Stop [Hz]	RBW [Hz]	Freq [Hz]	PerAbs [dBm]	ΔLimit [dB]																																																																										
30.000 M	820.000 M	1.00 M	611.252500 M	-44.82	-31.82																																																																										
855.000 M	1.000 G	1.00 M	855.036250 M	-43.37	-30.37																																																																										
1.000 G	3.000 G	1.00 M	2.9900000 G	-43.27	-28.27																																																																										
3.000 G	7.000 G	1.00 M	3.0170000 G	-39.24	-26.24																																																																										
7.000 G	9.000 G	1.00 M	8.3665000 G	-37.00	-24.00																																																																										
Start [Hz]	Stop [Hz]	RBW [Hz]	Freq [Hz]	PerAbs [dBm]	ΔLimit [dB]																																																																										
30.000 M	1.000 G	1.00 M	170.407500 M	-42.85	-29.85																																																																										
1.000 G	1.845 G	1.00 M	1.799370 G	-42.50	-29.50																																																																										
1.915 G	3.000 G	1.00 M	1.936000 G	-36.64	-23.64																																																																										
3.000 G	7.000 G	1.00 M	4.089000 G	-38.52	-25.52																																																																										
7.000 G	13.600 G	1.00 M	10.237300 G	-35.53	-22.53																																																																										
13.600 G	19.100 G	1.00 M	15.337312 G	-26.72	-13.72																																																																										



WCDMA Band IV (RMC 12.2Kbps)

Lowest Channel

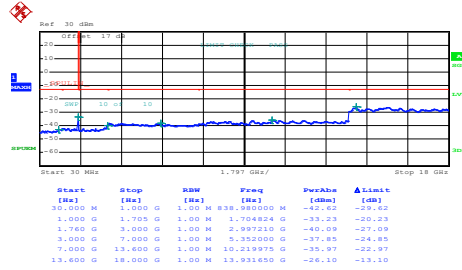

Date: 4.FEB.2021 13:57:41

Middle Channel

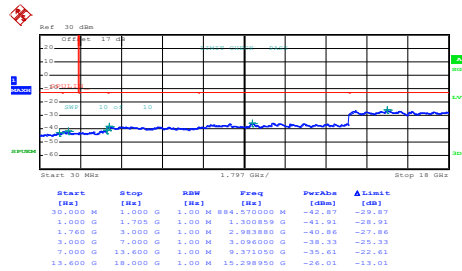

Date: 4.FEB.2021 13:58:35

Highest Channel

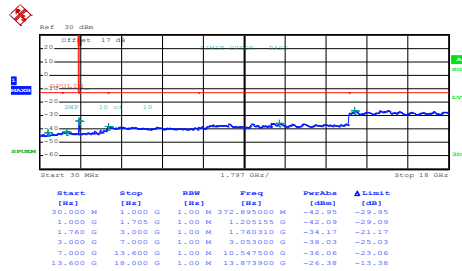

Date: 4.FEB.2021 13:59:32



Frequency Stability

Test Conditions	Middle Channel	WCDMA Band V (RMC 12.2Kbps)	Limit 2.5ppm
Temperature (°C)	Voltage (Volt)	Deviation (ppm)	Result
50	Normal Voltage	0.0167	PASS
40	Normal Voltage	0.0120	
30	Normal Voltage	0.0024	
20(Ref.)	Normal Voltage	0.0000	
10	Normal Voltage	0.0012	
0	Normal Voltage	0.0036	
-10	Normal Voltage	0.0048	
-20	Normal Voltage	0.0060	
-30	Normal Voltage	0.0084	
20	Maximum Voltage	0.0024	
20	Normal Voltage	0.0000	
20	Battery End Point	0.0012	

Test Conditions	Middle Channel	WCDMA Band II (RMC 12.2Kbps)	Limit Note 2.
Temperature (°C)	Voltage (Volt)	Deviation (ppm)	Result
50	Normal Voltage	0.0053	PASS
40	Normal Voltage	0.0027	
30	Normal Voltage	0.0016	
20(Ref.)	Normal Voltage	0.0000	
10	Normal Voltage	0.0011	
0	Normal Voltage	0.0037	
-10	Normal Voltage	0.0048	
-20	Normal Voltage	0.0037	
-30	Normal Voltage	0.0027	
20	Maximum Voltage	0.0032	
20	Normal Voltage	0.0000	
20	Battery End Point	0.0005	



Test Conditions	Middle Channel	WCDMA Band IV (RMC 12.2Kbps)	Limit Note 2.
Temperature (°C)	Voltage (Volt)	Deviation (ppm)	Result
50	Normal Voltage	0.0058	PASS
40	Normal Voltage	0.0040	
30	Normal Voltage	0.0017	
20(Ref.)	Normal Voltage	0.0000	
10	Normal Voltage	0.0139	
0	Normal Voltage	0.0202	
-10	Normal Voltage	0.0231	
-20	Normal Voltage	0.0242	
-30	Normal Voltage	0.0254	
20	Maximum Voltage	0.0104	
20	Normal Voltage	0.0000	
20	Battery End Point	0.0092	

Note:

1. Normal Voltage = 3.8V ; Battery End Point (BEP) = 3.5 V ; Maximum Voltage =4.2 V
2. The frequency fundamental emissions stay within the authorized frequency block.



Appendix B. Test Results of Radiated Test

WCDMA 850

WCDMA 850									
Channel	Frequency (MHz)	ERP (dBm)	Limit (dBm)	Over Limit (dB)	SPA Reading (dBm)	S.G. Power (dBm)	TX Cable loss (dB)	TX Antenna Gain (dBi)	Polarization (H/V)
Lowest	1652	-62.90	-13	-49.90	-73	-69.86	0.53	9.63	H
	2479	-60.78	-13	-47.78	-74.47	-68.76	0.65	10.78	H
	3305	-58.60	-13	-45.60	-74.97	-67.71	0.76	12.02	H
									H
									H
									H
	1652	-63.57	-13	-50.57	-73.38	-70.53	0.53	9.63	V
	2479	-60.32	-13	-47.32	-74.5	-68.3	0.65	10.78	V
	3305	-58.87	-13	-45.87	-75.19	-67.98	0.76	12.02	V
									V
									V
									V
Middle	1672	-62.24	-13	-49.24	-72.49	-69.24	0.53	9.68	H
	2509	-60.63	-13	-47.63	-74.3	-68.63	0.66	10.81	H
	3345	-58.46	-13	-45.46	-74.94	-67.68	0.76	12.14	H
									H
									H
									H
	1672	-63.57	-13	-50.57	-73.42	-70.57	0.53	9.68	V
	2509	-60.66	-13	-47.66	-74.73	-68.66	0.66	10.81	V
	3345	-58.68	-13	-45.68	-74.91	-67.9	0.76	12.14	V
									V
									V
									V



Highest	1693	-62.87	-13	-49.87	-73.39	-69.91	0.53	9.72	H
	2539	-60.76	-13	-47.76	-74.48	-68.77	0.67	10.82	H
	3386	-58.89	-13	-45.89	-75.44	-68.23	0.77	12.26	H
									H
									H
									H
	1693	-63.72	-13	-50.72	-73.6	-70.76	0.53	9.72	V
	2539	-60.28	-13	-47.28	-74.37	-68.29	0.67	10.82	V
	3386	-59.20	-13	-46.20	-75.33	-68.54	0.77	12.26	V
									V
									V
									V

Remark: Spurious emissions within 30-1000MHz were found more than 20dB below limit line.



WCDMA 1700

WCDMA 1700									
Channel	Frequency (MHz)	EIRP (dBm)	Limit (dBm)	Over Limit (dB)	SPA Reading (dBm)	S.G. Power (dBm)	TX Cable loss (dB)	TX Antenna Gain (dBi)	Polarization (H/V)
Lowest	3426	-52.60	-13	-39.60	-69.96	-64.2	0.77	12.38	H
	5139	-56.27	-13	-43.27	-77.29	-67.77	0.97	12.48	H
	6852	-53.49	-13	-40.49	-77.48	-64.28	0.83	11.63	H
									H
									H
									H
	3426	-56.58	-13	-43.58	-73.84	-68.18	0.77	12.38	V
	5139	-56.37	-13	-43.37	-77.58	-67.87	0.97	12.48	V
	6852	-53.50	-13	-40.50	-77.94	-64.29	0.83	11.63	V
									V
									V
									V
Middle	3462	-48.78	-13	-35.78	-66.19	-60.49	0.78	12.49	H
	5193	-56.96	-13	-43.96	-78.05	-68.56	0.99	12.59	H
	6924	-53.14	-13	-40.14	-77.25	-63.61	0.99	11.47	H
									H
									H
									H
	3462	-52.13	-13	-39.13	-69.96	-63.84	0.78	12.49	V
	5193	-56.70	-13	-43.70	-77.97	-68.3	0.99	12.59	V
	6924	-53.38	-13	-40.38	-77.86	-63.85	0.99	11.47	V
									V
									V
									V



Highest	3510	-46.98	-13	-33.98	-64.37	-58.8	0.78	12.60	H
	5265	-57.65	-13	-44.65	-78.88	-69.36	1.02	12.73	H
	7020	-52.95	-13	-39.95	-77.23	-63.05	1.17	11.26	H
									H
									H
									H
	3510	-48.76	-13	-35.76	-67.16	-60.58	0.78	12.60	V
	5265	-57.44	-13	-44.44	-78.84	-69.15	1.02	12.73	V
	7020	-52.31	-13	-39.31	-76.89	-62.41	1.17	11.26	V
									V
									V
									V

Remark: Spurious emissions within 30-1000MHz were found more than 20dB below limit line.



WCDMA 1900

WCDMA 1900									
Channel	Frequency (MHz)	EIRP (dBm)	Limit (dBm)	Over Limit (dB)	SPA Reading (dBm)	S.G. Power (dBm)	TX Cable loss (dB)	TX Antenna Gain (dBi)	Polarization (H/V)
Lowest	3704	-53.52	-13	-40.52	-70.79	-65.31	0.72	12.52	H
	5557	-54.03	-13	-41.03	-75.98	-66.2	1.00	13.17	H
	7409	-51.62	-13	-38.62	-76.49	-61	1.18	10.56	H
									H
									H
									H
	3704	-50.77	-13	-37.77	-69.25	-62.56	0.72	12.52	V
	5557	-54.38	-13	-41.38	-76.45	-66.55	1.00	13.17	V
	7409	-51.87	-13	-38.87	-76.58	-61.25	1.18	10.56	V
									V
									V
									V
Middle	3760	-53.63	-13	-40.63	-71.07	-65.44	0.69	12.50	H
	5640	-54.57	-13	-41.57	-76.49	-66.7	0.98	13.12	H
	7520	-52.09	-13	-39.09	-76.72	-61.37	1.18	10.46	H
									H
									H
									H
	3760	-49.95	-13	-36.95	-68.59	-61.76	0.69	12.50	V
	5640	-54.35	-13	-41.35	-76.45	-66.48	0.98	13.12	V
	7520	-51.79	-13	-38.79	-76.47	-61.07	1.18	10.46	V
									V
									V
									V



Highest	3815	-52.12	-13	-39.12	-69.69	-63.91	0.68	12.47	H
	5722	-54.36	-13	-41.36	-76.35	-66.44	0.99	13.07	H
	7630	-51.21	-13	-38.21	-76.09	-60.79	1.18	10.76	H
									H
									H
									H
	3815	-50.68	-13	-37.68	-69.46	-62.47	0.68	12.47	V
	5722	-53.51	-13	-40.51	-75.7	-65.59	0.99	13.07	V
	7630	-51.61	-13	-38.61	-76.22	-61.19	1.18	10.76	V
									V
									V
									V

Remark: Spurious emissions within 30-1000MHz were found more than 20dB below limit line.