



# FCC RADIO TEST REPORT

**FCC ID** : UZ7TC26AK  
**Equipment** : Touch computer  
**Brand Name** : Zebra  
**Model Name** : TC26AK  
**Applicant** : Zebra Technologies Corporation  
1 Zebra Plaza, Holtsville, NY 11742  
**Manufacturer** : Zebra Technologies Corporation  
1 Zebra Plaza, Holtsville, NY 11742  
**Standard** : FCC Part 15 Subpart E §15.407

The product was received on Mar. 12, 2020 and testing was started from Mar. 17, 2020 and completed on Apr. 28, 2020. We, SPORTON INTERNATIONAL INC., EMC & Wireless Communications Laboratory, would like to declare that the tested sample has been evaluated in accordance with the test procedures and has been in compliance with the applicable technical standards.

The report must not be used by the client to claim product certification, approval, or endorsement by TAF or any agency of government.

The test results in this report apply exclusively to the tested model / sample. Without written approval of SPORTON INTERNATIONAL INC. EMC & Wireless Communications Laboratory, the test report shall not be reproduced except in full.

*Louis Wu*

Approved by: Louis Wu

**SPORTON INTERNATIONAL INC. EMC & Wireless Communications Laboratory**

No. 52, Huaya 1st Rd., Guishan Dist., Taoyuan City, Taiwan (R.O.C.)



## Table of Contents

History of this test report.....	3
Summary of Test Result.....	4
<b>1 General Description .....</b>	<b>5</b>
1.1 Product Feature of Equipment Under Test.....	5
1.2 Product Specification of Equipment Under Test.....	6
1.3 Modification of EUT .....	6
1.4 Testing Location .....	7
1.5 Applicable Standards.....	7
<b>2 Test Configuration of Equipment Under Test .....</b>	<b>8</b>
2.1 Carrier Frequency and Channel .....	8
2.2 Test Mode.....	8
2.3 Connection Diagram of Test System.....	11
2.4 Support Unit used in test configuration and system .....	12
2.5 EUT Operation Test Setup .....	12
2.6 Measurement Results Explanation Example.....	12
<b>3 Test Result .....</b>	<b>13</b>
3.1 6dB and 26dB and 99% Occupied Bandwidth Measurement .....	13
3.2 Maximum Conducted Output Power Measurement .....	16
3.3 Power Spectral Density Measurement .....	18
3.4 Unwanted Emissions Measurement.....	20
3.5 AC Conducted Emission Measurement.....	24
3.6 Automatically Discontinue Transmission .....	26
3.7 Antenna Requirements.....	27
<b>4 List of Measuring Equipment.....</b>	<b>28</b>
<b>5 Uncertainty of Evaluation.....</b>	<b>30</b>
<b>Appendix A. AC Conducted Emission Test Result</b>	
<b>Appendix B. Radiated Spurious Emission</b>	
<b>Appendix C. Radiated Spurious Emission Plots</b>	
<b>Appendix D. Duty Cycle Plots</b>	
<b>Appendix E. Setup Photographs</b>	



### History of this test report

Report No.	Version	Description	Issued Date
FR010720F	01	Initial issue of report	Apr. 30, 2020



## Summary of Test Result

Report Clause	Ref Std. Clause	Test Items	Result (PASS/FAIL)	Remark
3.1	15.403 (i)	6dB & 26dB Bandwidth	Pass	-
3.1	2.1049	99% Occupied Bandwidth	Reporting only	-
3.2	15.407 (a)	Maximum Conducted Output Power	Pass	-
3.3	15.407 (a)	Power Spectral Density	Pass	-
3.4	15.407(b)	Unwanted Emissions	Pass	Under limit 5.03 dB at 11490.000 MHz
3.5	15.207	AC Conducted Emission	Pass	Under limit 14.68 dB at 13.560 MHz
3.6	15.407 (c)	Automatically Discontinue Transmission	Pass	-
3.7	15.203 & 15.407 (a)	Antenna Requirement	Pass	-

**Declaration of Conformity:**

The test results with all measurement uncertainty excluded are presented in accordance with the regulation limits or requirements declared by manufacturers.

**Comments and Explanations:**

The declared of product specification for EUT presented in the report are provided by the manufacturer, and the manufacturer takes all the responsibilities for the accuracy of product specification.

**Reviewed by: Wii Chang**

**Report Producer: Yimin Ho**



# 1 General Description

## 1.1 Product Feature of Equipment Under Test

Product Feature	
Equipment	Touch computer
Brand Name	Zebra
Model Name	TC26AK
FCC ID	UZ7TC26AK
Sample	Single-WAN, WLAN, GMS, SE4710, NFC, 4GB/64GB, Rear camera and Front camera, 2-pin connector
EUT supports Radios application	WCDMA/HSPA/LTE/NFC/GNSS WLAN 11a/b/g/n HT20/HT40 WLAN 11ac VHT20/VHT40/VHT80 Bluetooth BR/EDR/LE
HW Version	DV0
SW Version	Android version 10
OS Version	FUSION_QA_2_1.0.0.008_Q
FW Version	Zebra/TC26PA/TC26:10/03-09-09.00-QN-U00-PRD/Nabe030 91333:userdebug/test-keys
MFD	26MAR20
EUT Stage	Engineering Sample

Remark: The above EUT's information was declared by manufacturer.

Specification of Accessories				
AC Adapter	Brand Name	Zebra	Part Number	PWR-WUA5V12W0US
Battery 1	Brand Name	Zebra	Part Number	BT-000409-00
Battery 2	Brand Name	Zebra	Part Number	BT-000409-50
Battery 3	Brand Name	Zebra	Part Number	BT-000411-08
USB Cable 1 (Type A plug to Type C plug)	Brand Name	Zebra	Part Number	CBL-TC5X-USBC2A-01
USB Cable 2 (Type A plug to Type C plug)	Brand Name	Zebra	Part Number	CBL-TC2Y-USBC90A-01
Headset 3.5mm type with PTT/micassy	Brand Name	Zebra	Part Number	HDST-35MM-PTVP-01
Adapter Cable PTT headset (3.5mm to 3.5mm)	Brand Name	Zebra	Part Number	CBL-TC51-HDST35-01
Snap on Trigger handle	Brand Name	Zebra	Part Number	TRG-TC2Y-SNP1-01
Belt Holster	Brand Name	Zebra	Part Number	SG-TC2Y-HLSTR1-01
Wearable Arm Mount	Brand Name	Zebra	Part Number	SG-TC2Y-ARMNT-01

Support Unit used in test configuration and system				
Type C to 3.5mm headset adaptor	Brand Name	Google	Part Number	Pixel-2-2XL



## 1.2 Product Specification of Equipment Under Test

Standards-related Product Specification	
<b>Tx/Rx Channel Frequency Range</b>	5745 MHz ~ 5825 MHz
<b>Maximum Output Power</b>	802.11a : 17.81 dBm / 0.0604 W 802.11n HT20 : 17.81 dBm / 0.0604 W 802.11n HT40 : 17.71 dBm / 0.0590 W 802.11ac VHT20: 17.91 dBm / 0.0618 W 802.11ac VHT40: 17.81 dBm / 0.0604 W 802.11ac VHT80: 17.91 dBm / 0.0618 W
<b>99% Occupied Bandwidth</b>	802.11a : 17.23 MHz 802.11ac VHT20 : 18.38 MHz 802.11ac VHT40 : 36.66 MHz 802.11ac VHT80 : 77.08 MHz
<b>Type of Modulation</b>	802.11a/n : OFDM (BPSK / QPSK / 16QAM / 64QAM) 802.11ac : OFDM (BPSK / QPSK / 16QAM / 64QAM / 256QAM)
<b>Antenna Type / Gain</b>	PIFA Antenna with gain 2.5 dBi

## 1.3 Modification of EUT

No modifications are made to the EUT during all test items.



### 1.4 Testing Location

<b>Test Site</b>	SPORTON INTERNATIONAL INC. EMC & Wireless Communications Laboratory	
<b>Test Site Location</b>	No.52, Huaya 1st Rd., Guishan Dist., Taoyuan City, Taiwan (R.O.C.) TEL: +886-3-327-3456 FAX: +886-3-328-4978	
<b>Test Site No.</b>	<b>Sporton Site No.</b>	
	TH05-HY	CO05-HY

**Note:** The test site complies with ANSI C63.4 2014 requirement.

<b>Test Site</b>	SPORTON INTERNATIONAL INC. EMC & Wireless Communications Laboratory	
<b>Test Site Location</b>	No.58, Aly. 75, Ln. 564, Wenhua 3rd, Rd., Guishan Dist., Taoyuan City, Taiwan (R.O.C.) TEL: +886-3-327-0868 FAX: +886-3-327-0855	
<b>Test Site No.</b>	<b>Sporton Site No.</b>	
	03CH12-HY	

**Note:** The test site complies with ANSI C63.4 2014 requirement.

FCC designation No.: TW1190 and TW0007

### 1.5 Applicable Standards

According to the specifications of the manufacturer, the EUT must comply with the requirements of the following standards:

- ♦ FCC Part 15 Subpart E
- ♦ FCC KDB 789033 D02 General UNII Test Procedures New Rules v02r01.
- ♦ FCC KDB 414788 D01 Radiated Test Site v01r01.
- ♦ ANSI C63.10-2013

**Remark:**

1. All test items were verified and recorded according to the standards and without any deviation during the test.
2. This EUT has also been tested and complied with the requirements of FCC Part 15, Subpart B, recorded in a separate test report.



## 2 Test Configuration of Equipment Under Test

- a. The EUT has been associated with peripherals and configuration operated in a manner tended to maximize its emission characteristics in a typical application. Frequency range investigated: conduction emission (150 kHz to 30 MHz), radiation emission (9 kHz to the 10th harmonic of the highest fundamental frequency or to 40 GHz, whichever is lower). For radiated measurement, pre-scanned in three orthogonal panels, X, Y, Z and Accessory. The worst cases (X plane with Adapter) were recorded in this report.
- b. AC power line Conducted Emission was tested under maximum output power.

### 2.1 Carrier Frequency and Channel

Frequency Band	Channel	Freq. (MHz)	Channel	Freq. (MHz)
5725-5850 MHz Band 4 (U-NII-3)	149	5745	157	5785
	151*	5755	159*	5795
	153	5765	161	5805
	155 <sup>#</sup>	5775	165	5825

**Note:**

1. The above Frequency and Channel in "\*" were 802.11n HT40 and 802.11ac VHT40.
2. The above Frequency and Channel in "<sup>#</sup>" were 802.11ac VHT80.

### 2.2 Test Mode

Final test modes are considering the modulation and worse data rates as below table.

Modulation	Data Rate
802.11a	6 Mbps
802.11n HT20 (Covered by VHT20)	MCS0
802.11n HT40 (Covered by VHT40)	MCS0
802.11ac VHT20	MCS0
802.11ac VHT40	MCS0
802.11ac VHT80	MCS0

Test Cases	
AC Conducted Emission	Mode 1 : WLAN (5GHz) Link + Bluetooth Link + NFC On + Battery 1 + USB Cable 1 (Charging from AC Adapter)
<b>Remark:</b> For Radiated Test Cases, the tests were performed with Battery 1 and USB Cable 1.	





Ch. #		Band IV : 5725-5850 MHz			
		802.11a	802.11ac VHT20	802.11ac VHT40	802.11ac VHT80
L	Low	149	149	151	-
M	Middle	157	157	-	155
H	High	165	165	159	-

Remark: For radiation spurious emission, the final modulation and the worst data rate was reference the max RF conducted power.

802.11a RF Output Power (dBm)										
Power vs. Channel			Power vs Data Rate							
Channel	Frequency (MHz)	Data Rate (bps)	Channel	Data Rate (bps)						
		6M		9M	12M	18M	24M	36M	48M	54M
CH 149	5745	17.61	CH 157	17.41	17.41	17.61	17.51	17.61	17.61	17.61
CH 157	5785	17.81								
CH 165	5825	17.61								

802.11n HT20 RF Output Power (dBm)										
Power vs. Channel			Power vs Data Rate							
Channel	Frequency (MHz)	MCS Index	Channel	MCS Index						
		MCS0		MCS1	MCS2	MCS3	MCS4	MCS5	MCS6	MCS7
CH 149	5745	17.21	CH 157	17.71	17.51	17.51	17.71	17.71	17.71	17.71
CH 157	5785	17.81								
CH 165	5825	17.31								

802.11n HT40 RF Output Power (dBm)										
Power vs. Channel			Power vs Data Rate							
Channel	Frequency (MHz)	MCS Index	Channel	MCS Index						
		MCS0		MCS1	MCS2	MCS3	MCS4	MCS5	MCS6	MCS7
CH 151	5755	17.51	CH 159	17.61	17.61	17.61	17.61	17.61	17.61	17.61
CH 159	5795	17.71								

802.11ac VHT20 RF Output Power (dBm)										
Power vs. Channel			Power vs Data Rate							
Channel	Frequency (MHz)	MCS Index	Channel	MCS Index						
		MCS0		MCS1	MCS2	MCS3	MCS4	MCS5	MCS6	MCS7
CH 149	5745	17.31	CH 157	17.81	17.61	17.61	17.71	17.71	17.71	17.71
CH 157	5785	17.91								
CH 165	5825	17.41								



802.11ac VHT40 RF Output Power (dBm)												
Power vs. Channel			Power vs Data Rate									
Channel	Frequency (MHz)	MCS Index	Channel	MCS Index								
		MCS0		MCS1	MCS2	MCS3	MCS4	MCS5	MCS6	MCS7	MCS8	MCS9
CH 151	5755	17.61	CH 159	17.71	17.61	17.61	17.71	17.61	17.61	17.61	17.71	17.61
CH 159	5795	17.81										

802.11ac VHT80 RF Output Power (dBm)												
Power vs. Channel			Power vs Data Rate									
Channel	Frequency (MHz)	MCS Index	Channel	MCS Index								
		MCS0		MCS1	MCS2	MCS3	MCS4	MCS5	MCS6	MCS7	MCS8	MCS9
CH 155	5775	17.91	CH 155	17.51	17.51	17.51	17.51	17.51	17.51	17.61	17.51	17.51

## 2.3 Connection Diagram of Test System

<WLAN Tx Mode>

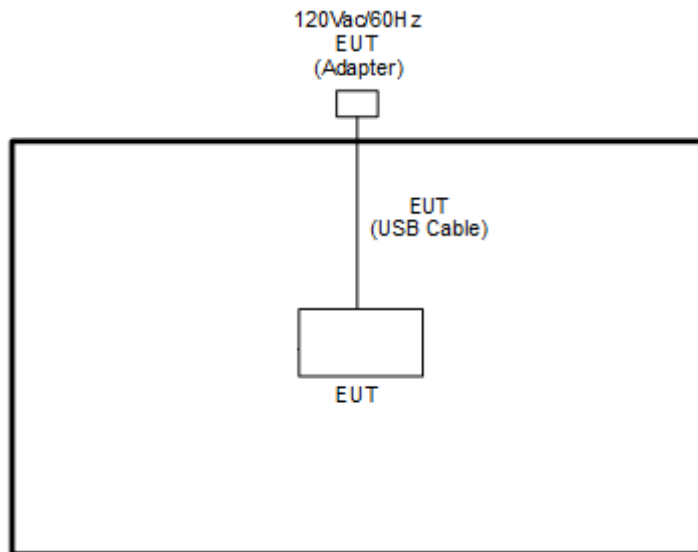

<AC Conducted Emission Mode>

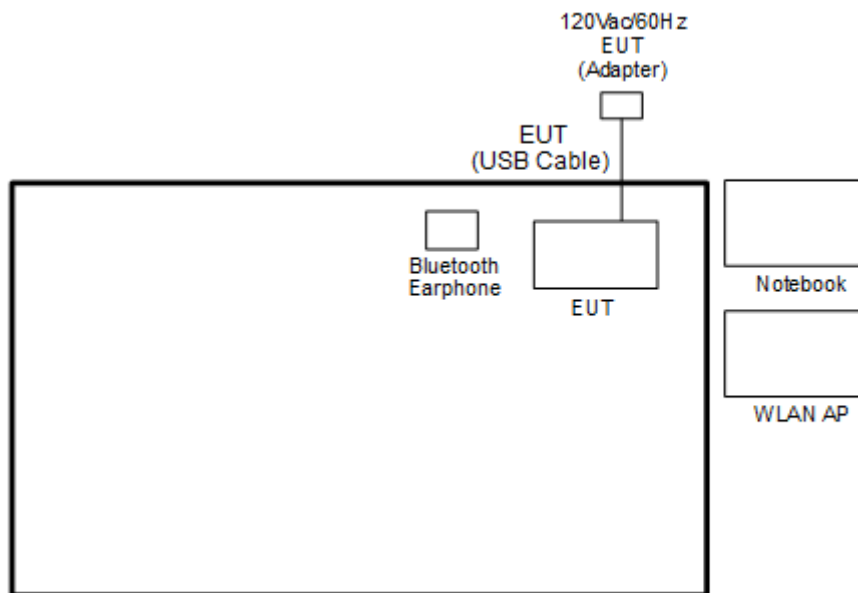



## 2.4 Support Unit used in test configuration and system

Item	Equipment	Trade Name	Model Name	FCC ID	Data Cable	Power Cord
1.	Bluetooth Earphone	Sony Ericsson	MW600	PY7DDA-2029	N/A	N/A
2.	WLAN AP	ASUS	RT-AC66U	MSQ-RTAC66U	N/A	Unshielded, 1.8 m
3.	Notebook	DELL	Latitude 3400	FCC DoC	N/A	AC I/P: Unshielded, 1.2 m DC O/P: Shielded, 1.8 m
4.	SD Card	SanDisk	MicroSD HC	FCC DoC	N/A	N/A

## 2.5 EUT Operation Test Setup

The RF test items, utility "QRCT v3.0.298.0" was installed in Notebook which was programmed in order to make the EUT get into the engineering modes to provide channel selection, power level, data rate and the application type and for continuous transmitting signals.

## 2.6 Measurement Results Explanation Example

**For all conducted test items:**

The offset level is set in the spectrum analyzer to compensate the RF cable loss and attenuator factor between EUT conducted output port and spectrum analyzer. With the offset compensation, the spectrum analyzer reading level is exactly the EUT RF output level.

Example :

The spectrum analyzer offset is derived from RF cable loss and attenuator factor.

*Offset = RF cable loss + attenuator factor.*

Following shows an offset computation example with cable loss 4.2 dB and 10dB attenuator.

$$\begin{aligned} \text{Offset(dB)} &= \text{RF cable loss(dB)} + \text{attenuator factor(dB)}. \\ &= 4.2 + 10 = 14.2 \text{ (dB)} \end{aligned}$$

### 3 Test Result

#### 3.1 6dB and 26dB and 99% Occupied Bandwidth Measurement

##### 3.1.1 Description of 6dB and 26dB and 99% Occupied Bandwidth

The minimum 6 dB bandwidth shall be at least 500 kHz.

26dB and 99% Occupied bandwidth are reporting only.

##### 3.1.2 Measuring Instruments

See list of measuring equipment of this test report.

##### 3.1.3 Test Procedures

1. The testing follows FCC KDB 789033 D02 General UNII Test Procedures New Rules v02r01. Section C) Emission bandwidth for the band 5.725-5.85GHz
2. Set RBW = 100kHz.
3. Set the VBW  $\geq 3 \times$  RBW.
4. Detector = Peak.
5. Trace mode = max hold
6. Measure the maximum width of the emission that is 6 dB down from the peak of the emission.
7. Measure and record the results in the test report.

##### 3.1.4 Test Setup

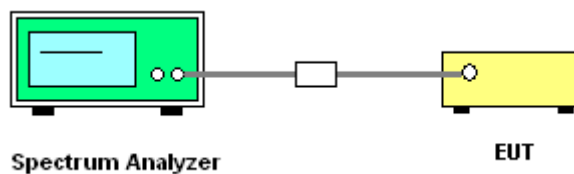



3.1.5 Test Result of 6dB and 26dB and 99% Occupied Bandwidth

Test Engineer :	Richard Qiu	Temperature :	21~25°C
		Relative Humidity :	51~54%

Band IV single antenna													
Mod.	Data Rate	NTX	CH.	Freq. (MHz)	99% Bandwidth (MHz)		26dB Bandwidth (MHz)		6 dB Bandwidth (MHz)		6 dB Bandwidth Min. Limit (MHz)	Pass/Fail	
					Ant 1	Ant 2	Ant 1	Ant 2	Ant 1	Ant 2			
11a	6Mbps	1	149	5745	16.93	-	25.97	-	16.28	-	0.5	Pass	
11a	6Mbps	1	157	5785	17.18	-	27.42	-	16.28	-	0.5	Pass	
11a	6Mbps	1	165	5825	17.23	-	28.07	-	16.03	-	0.5	Pass	
VHT20	MCS0	1	149	5745	18.38	-	29.27	-	17.18	-	0.5	Pass	
VHT20	MCS0	1	157	5785	18.03	-	27.07	-	16.23	-	0.5	Pass	
VHT20	MCS0	1	165	5825	18.18	-	30.37	-	16.48	-	0.5	Pass	
VHT40	MCS0	1	151	5755	36.66	-	42.53	-	36.23	-	0.5	Pass	
VHT40	MCS0	1	159	5795	36.66	-	42.62	-	36.23	-	0.5	Pass	
VHT80	MCS0	1	155	5775	77.08	-	89.03	-	75.13	-	0.5	Pass	

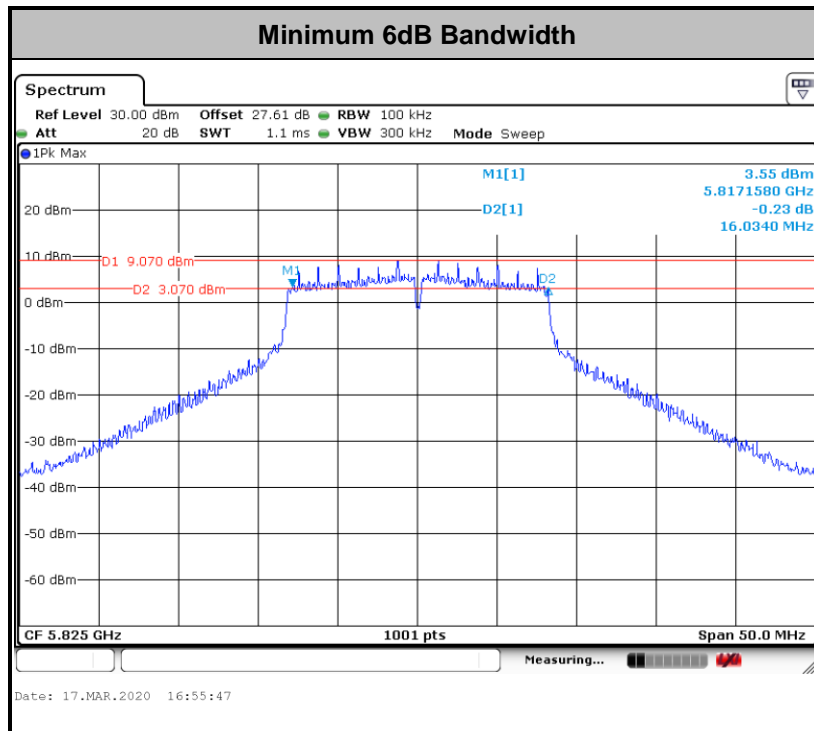

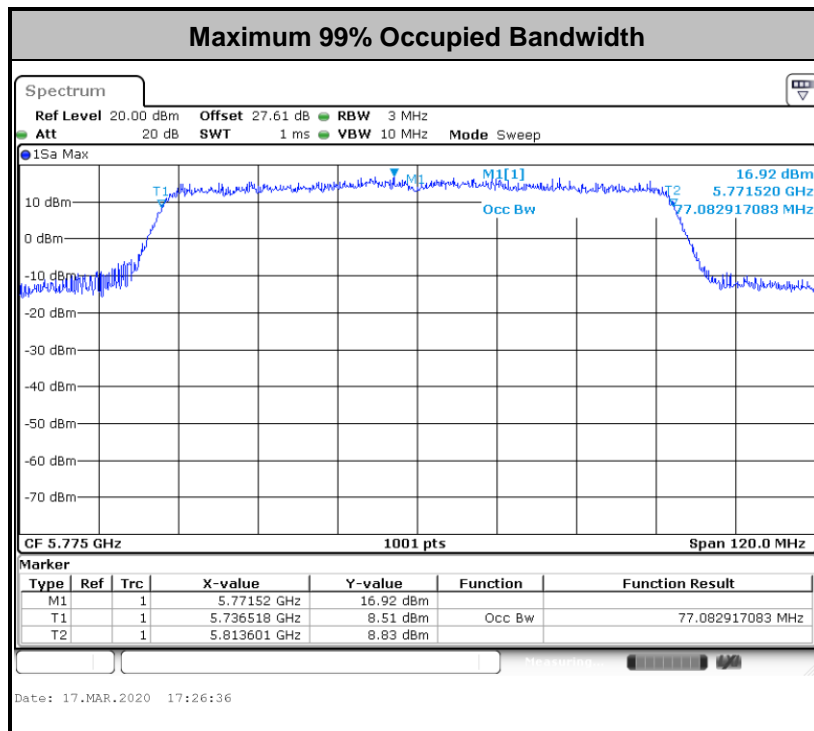
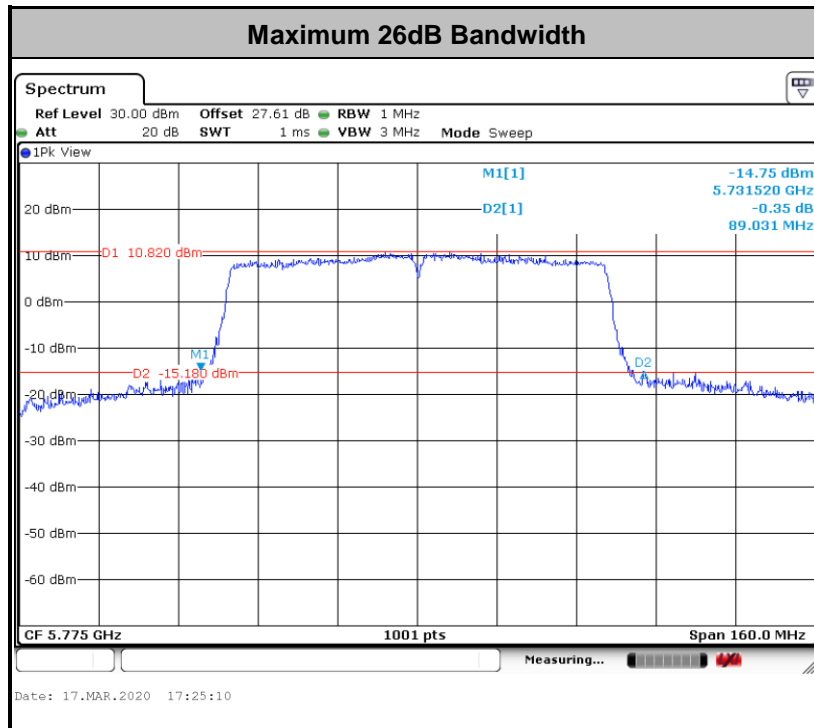

**Note:** The occupied channel bandwidth is maintained within the band of operation for all of the modulations.

## 3.2 Maximum Conducted Output Power Measurement

### 3.2.1 Limit of Maximum Conducted Output Power

For the band 5.725–5.85 GHz, the maximum conducted output power over the frequency band of operation shall not exceed 1 W.

If transmitting antennas of directional gain greater than 6 dBi are used, the peak output power shall be reduced by the amount in dB that the directional gain of the antenna exceeds 6 dBi.

### 3.2.2 Measuring Instruments

See list of measuring equipment of this test report.

### 3.2.3 Test Procedures

The testing follows Method PM-G of FCC KDB 789033 D02 General UNII Test Procedures New Rules v02r01.

Method PM-G (Measurement using a gated RF average power meter):

1. Measurement is performed using a wideband RF power meter.
2. The EUT is configured to transmit at its maximum power control level.
3. Measure the average power of the transmitter
4. Since the measurement is made only during the ON time of the transmitter, no duty cycle correction factor is required.

### 3.2.4 Test Setup

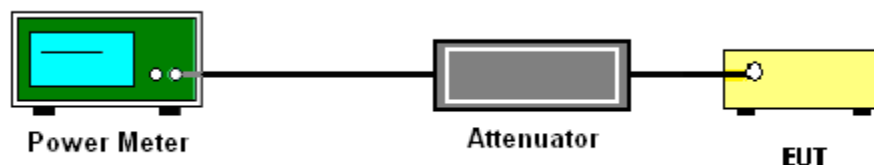





3.2.5 Test Result of Maximum Conducted Output Power

Test Engineer :	Richard Qiu	Temperature :	21~25°C
		Relative Humidity :	51~54%

Band IV single antenna												
Mod.	Data Rate	NTX	CH.	Freq. (MHz)	Average Conducted Power (dBm)			FCC Conducted Power Limit (dBm)		DG (dBi)		Pass/Fail
					Ant 1	Ant 2	SUM	Ant 1	Ant 2	Ant 1	Ant 2	
11a	6Mbps	1	149	5745	17.61	-		30.00	-	2.50	-	Pass
11a	6Mbps	1	157	5785	17.81	-		30.00	-	2.50	-	Pass
11a	6Mbps	1	165	5825	17.61	-		30.00	-	2.50	-	Pass
HT20	MCS0	1	149	5745	17.21	-		30.00	-	2.50	-	Pass
HT20	MCS0	1	157	5785	17.81	-		30.00	-	2.50	-	Pass
HT20	MCS0	1	165	5825	17.31	-		30.00	-	2.50	-	Pass
HT40	MCS0	1	151	5755	17.51	-		30.00	-	2.50	-	Pass
HT40	MCS0	1	159	5795	17.71	-		30.00	-	2.50	-	Pass
VHT20	MCS0	1	149	5745	17.31	-		30.00	-	2.50	-	Pass
VHT20	MCS0	1	157	5785	17.91	-		30.00	-	2.50	-	Pass
VHT20	MCS0	1	165	5825	17.41	-		30.00	-	2.50	-	Pass
VHT40	MCS0	1	151	5755	17.61	-		30.00	-	2.50	-	Pass
VHT40	MCS0	1	159	5795	17.81	-		30.00	-	2.50	-	Pass
VHT80	MCS0	1	155	5775	17.91	-		30.00	-	2.50	-	Pass

### 3.3 Power Spectral Density Measurement

#### 3.3.1 Limit of Power Spectral Density

For the band 5.725–5.85 GHz, the maximum power spectral density shall not exceed 30 dBm in any 500-kHz band.

If transmitting antennas of directional gain greater than 6 dBi are used, the peak output power shall be reduced by the amount in dB that the directional gain of the antenna exceeds 6 dBi.

#### 3.3.2 Measuring Instruments

See list of measuring equipment of this test report.

#### 3.3.3 Test Procedures

The testing follows FCC KDB 789033 D02 General UNII Test Procedures New Rules v02r01. Section F) Maximum power spectral density.

##### # Method SA-3 #

(power averaging (rms) detection with max hold):

- Set span to encompass the entire emission bandwidth (EBW) of the signal.
  - Set RBW = 300 kHz.
  - Set VBW  $\geq$  1 MHz.
  - Number of points in sweep  $\geq$  2 Span / RBW.
  - Sweep time  $\leq$  (number of points in sweep)  $\times$  T, when duty cycle is less than 98 percent where T is the minimum transmission duration over which the transmitter is on and is transmitting at its maximum power control level for the tested mode of operation.
  - Detector = power averaging (rms).
  - Trace mode = max hold.
  - Allow max hold to run for at least 60 seconds, or longer as needed to allow the trace to stabilize.
1. The RF output of EUT was connected to the spectrum analyzer by a low loss cable.
  2. Each plot has already offset with cable loss, and attenuator loss. Measure the PPSD and record it.

#### 3.3.4 Test Setup

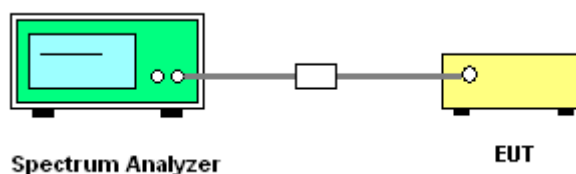



3.3.5 Test Result of Power Spectral Density

Test Engineer :	Richard Qiu	Temperature :	21~25°C
		Relative Humidity :	51~54%

Band IV single antenna														
Mod.	Data Rate	NTX	CH.	Freq. (MHz)	10log (500kHz /RBW) Factor (dB)		Average Power Density (dBm/500kHz)			Average PSD Limit (dBm/500kHz)		DG (dBi)		Pass /Fail
					Ant 1	Ant 2	Ant 1	Ant 2	SUM	Ant 1	Ant 2	Ant 1	Ant 2	
11a	6Mbps	1	149	5745	2.22	-	7.54	-		30.00	-	2.50	-	Pass
11a	6Mbps	1	157	5785	2.22	-	7.85	-		30.00	-	2.50	-	Pass
11a	6Mbps	1	165	5825	2.22	-	7.66	-		30.00	-	2.50	-	Pass
VHT20	MCS0	1	149	5745	2.22	-	7.65	-		30.00	-	2.50	-	Pass
VHT20	MCS0	1	157	5785	2.22	-	<b>8.02</b>	-		30.00	-	2.50	-	Pass
VHT20	MCS0	1	165	5825	2.22	-	7.72	-		30.00	-	2.50	-	Pass
VHT40	MCS0	1	151	5755	2.22	-	3.56	-		30.00	-	2.50	-	Pass
VHT40	MCS0	1	159	5795	2.22	-	3.92	-		30.00	-	2.50	-	Pass
VHT80	MCS0	1	155	5775	2.22	-	2.45	-		30.00	-	2.50	-	Pass

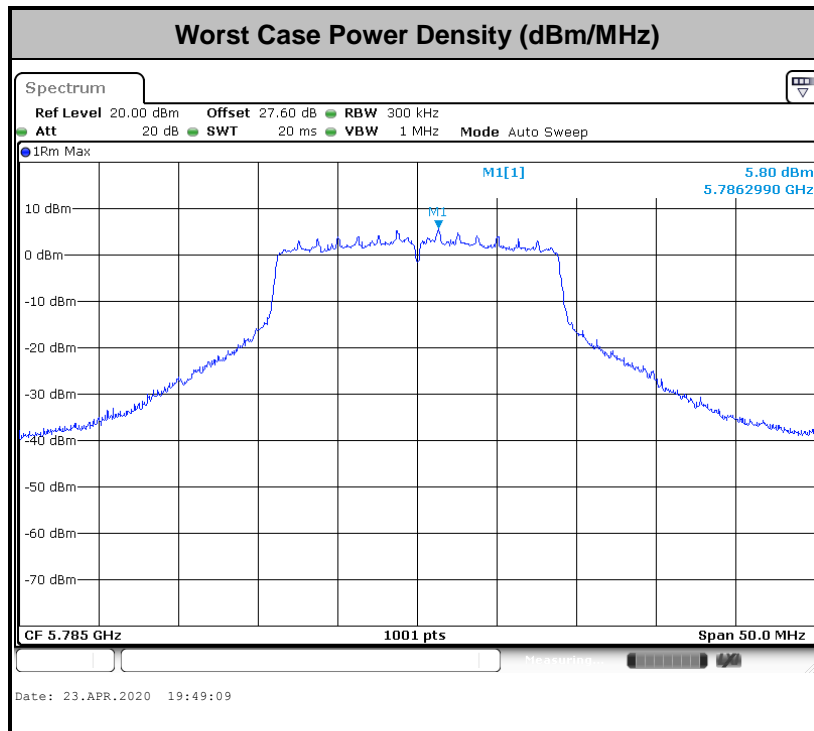



### 3.4 Unwanted Emissions Measurement

This section is to measure unwanted emissions through radiated measurement for band edge spurious emissions and out of band emissions measurement.

#### 3.4.1 Limit of Unwanted Emissions

- (1) For transmitters operating in the 5.725-5.85 GHz band:  
15.407(b)(4)(i) All emissions shall be limited to a level of -27 dBm/MHz at 75 MHz or more above or below the band edge increasing linearly to 10 dBm/MHz at 25 MHz above or below the band edge, and from 25 MHz above or below the band edge increasing linearly to a level of 15.6 dBm/MHz at 5 MHz above or below the band edge, and from 5 MHz above or below the band edge increasing linearly to a level of 27 dBm/MHz at the band edge.
- (2) Unwanted spurious emissions fallen in restricted bands shall comply with the general field strength limits as below table,

Frequency (MHz)	Field Strength (microvolts/meter)	Measurement Distance (meters)
0.009 – 0.490	2400/F(kHz)	300
0.490 – 1.705	24000/F(kHz)	30
1.705 – 30.0	30	30
30 – 88	100	3
88 – 216	150	3
216 - 960	200	3
Above 960	500	3

**Note:** The following formula is used to convert the EIRP to field strength.

$$E = \frac{1000000\sqrt{30P}}{3} \mu\text{V/m, where P is the eirp (Watts)}$$

EIRP (dBm)	Field Strength at 3m (dBμV/m)
- 27	68.3

- (3) KDB789033 D02 v02r01 G)2)c)
  - (i) Sections 15.407(b)(1-3) specifies the unwanted emissions limit for the U-NII-1 and U-NII-2 bands. As specified, emissions above 1000 MHz that are outside of the restricted bands are subject to a peak emission limit of -27 dBm/MHz.
  - (ii) Section 15.407(b)(4) specifies the unwanted emissions limit for the U-NII-3 band. A band emissions mask is specified in Section 15.407(b)(4)(i). The emission limits are based on the use of a peak detector.

#### 3.4.2 Measuring Instruments

See list of measuring equipment of this test report.



### 3.4.3 Test Procedures

1. The testing follows FCC KDB 789033 D02 General UNII Test Procedures New Rules v02r01. Section G) Unwanted emissions measurement.
  - (1) Procedure for Unwanted Emissions Measurements Below 1000MHz
    - RBW = 120 kHz
    - VBW = 300 kHz
    - Detector = Peak
    - Trace mode = max hold
  - (2) Procedure for Peak Unwanted Emissions Measurements Above 1000 MHz
    - RBW = 1 MHz
    - VBW  $\geq$  3 MHz
    - Detector = Peak
    - Sweep time = auto
    - Trace mode = max hold
  - (3) Procedures for Average Unwanted Emissions Measurements Above 1000MHz
    - RBW = 1 MHz
    - VBW = 10 Hz, when duty cycle is no less than 98 percent.
    - VBW  $\geq$  1/T, when duty cycle is less than 98 percent where T is the minimum transmission duration over which the transmitter is on and is transmitting at its maximum power control level for the tested mode of operation.
2. The EUT was placed on a turntable with 0.8 meter for frequency below 1GHz and 1.5 meter for frequency above 1GHz respectively above ground.
3. The EUT was set 3 meters from the interference receiving antenna which was mounted on the top of a variable height antenna tower.
4. The antenna is a broadband antenna and its height is adjusted between one meter and four meters above ground to find the maximum value of the field strength for both horizontal polarization and vertical polarization of the antenna.
5. For each suspected emission, the EUT was arranged to its worst case and then adjust the antenna tower (from 1 m to 4 m) and turntable (from 0 degree to 360 degrees) to find the maximum reading.
6. For testing below 1GHz, if the emission level of the EUT in peak mode was 3 dB lower than the limit specified, then peak values of EUT will be reported, otherwise, the emissions will be repeated one by one using the CISPR quasi-peak method and reported.
7. For testing above 1GHz, the emission level of the EUT in peak mode was 20dB lower than average limit (that means the emission level in average mode also complies with the limit in average mode), then peak values of EUT will be reported, otherwise, the emissions will be measured in average mode again and reported.

### 3.4.4 Test Setup

For radiated emissions below 30MHz

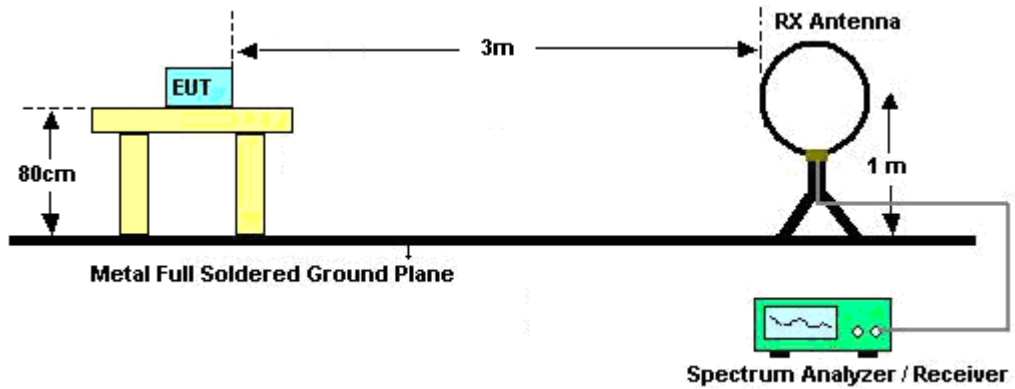

For radiated emissions from 30MHz to 1GHz

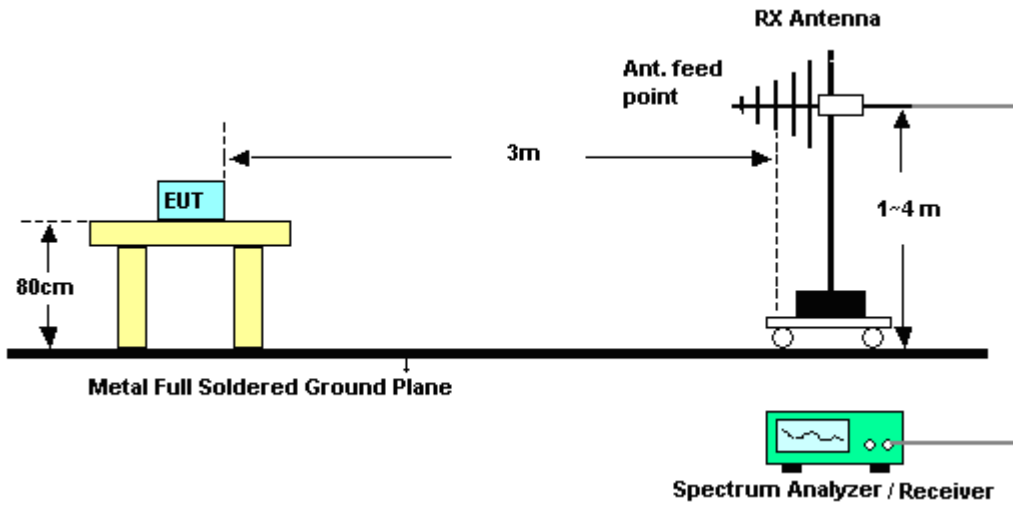

For radiated emissions above 1GHz

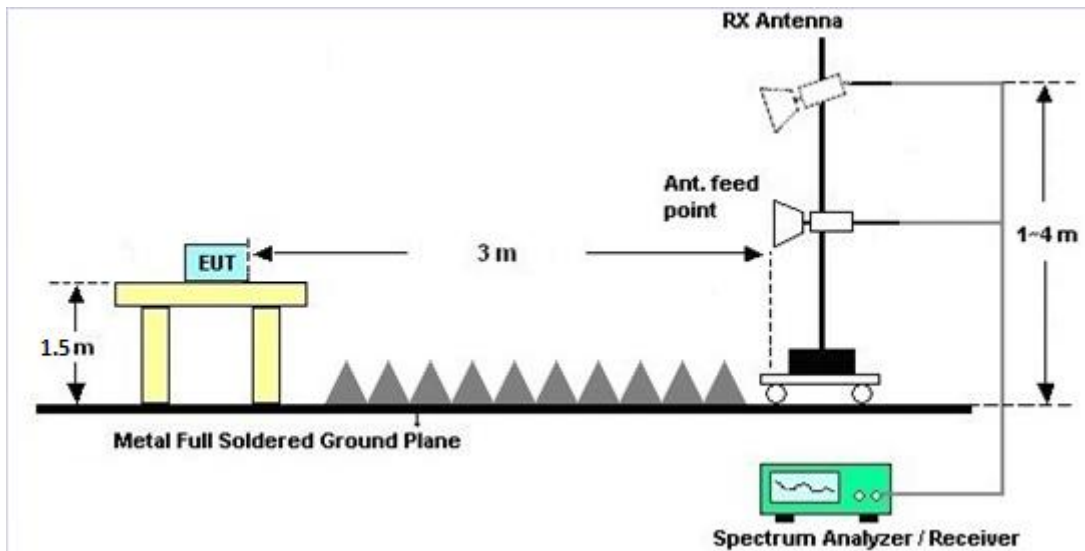



### **3.4.5 Test Results of Radiated Emissions (9 kHz ~ 30 MHz)**

The low frequency, which started from 9 kHz to 30MHz, was pre-scanned and the result which was 20dB lower than the limit line was not reported.

There is a comparison data of both open-field test site and alternative test site - semi-Anechoic chamber according to 414788 D01 Radiated Test Site v01r01, and the result came out very similar.

### **3.4.6 Test Result of Radiated Band Edges**

Please refer to Appendix B and C.

### **3.4.7 Duty Cycle**

Please refer to Appendix D.

### **3.4.8 Test Result of Unwanted Radiated Emission (30MHz ~ 10th Harmonic)**

Please refer to Appendix B and C.



### 3.5 AC Conducted Emission Measurement

#### 3.5.1 Limit of AC Conducted Emission

For equipment that is designed to be connected to the public utility (AC) power line, the radio frequency voltage that is conducted back onto the AC power line on any frequency or frequencies within the band 150 kHz to 30 MHz shall not exceed the limits in the following table.

Frequency of emission (MHz)	Conducted limit (dB $\mu$ V)	
	Quasi-peak	Average
0.15-0.5	66 to 56*	56 to 46*
0.5-5	56	46
5-30	60	50

\*Decreases with the logarithm of the frequency.

#### 3.5.2 Measuring Instruments

See list of measuring equipment of this test report.

#### 3.5.3 Test Procedures

1. The EUT was placed 0.4 meter from the conducting wall of the shielding room was kept at least 80 centimeters from any other grounded conducting surface.
2. Connect EUT to the power mains through a line impedance stabilization network (LISN).
3. All the support units are connecting to the other LISN.
4. The LISN provides 50 ohm coupling impedance for the measuring instrument.
5. The FCC states that a 50 ohm, 50 microhenry LISN should be used.
6. Both sides of AC line were checked for maximum conducted interference.
7. The frequency range from 150 kHz to 30 MHz was searched.
8. Set the test-receiver system to Peak Detect Function and specified bandwidth with Maximum Hold Mode.



### 3.5.4 Test Setup

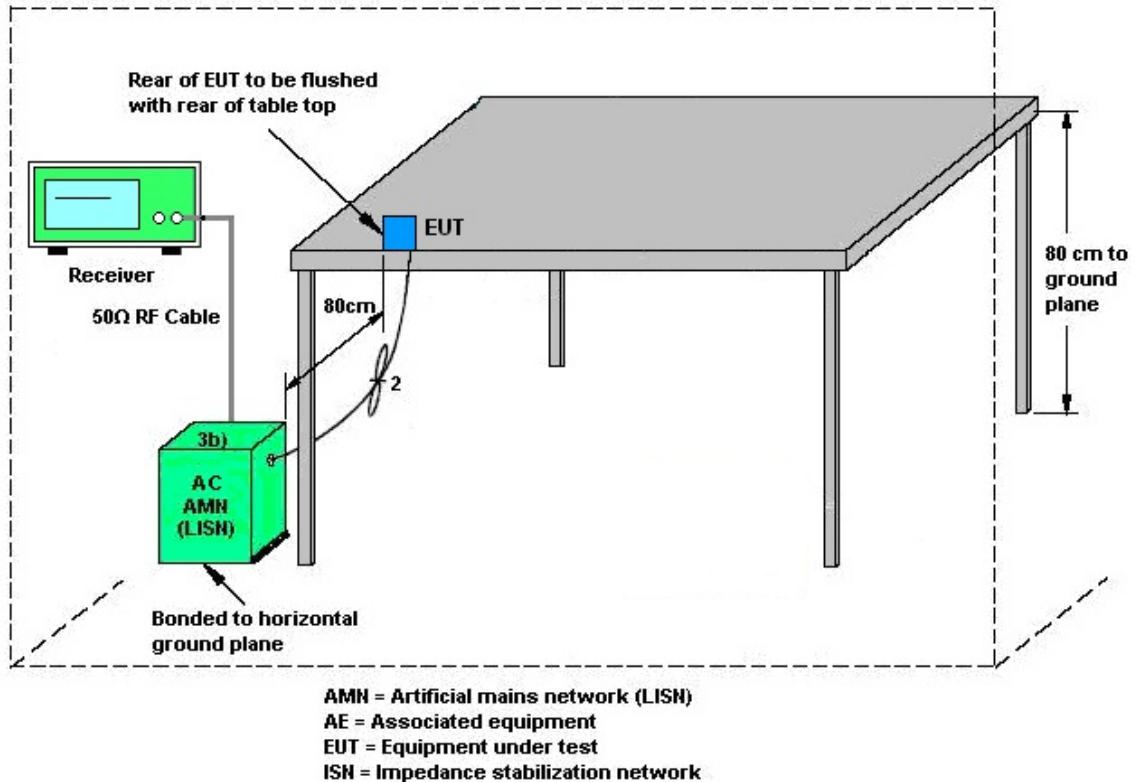

### 3.5.5 Test Result of AC Conducted Emission

Please refer to Appendix A.



## **3.6 Automatically Discontinue Transmission**

### **3.6.1 Limit of Automatically Discontinue Transmission**

The device shall automatically discontinue transmission in case of either absence of information to transmit or operational failure. These provisions are not intended to preclude the transmission of control or signaling information or the use of repetitive codes used by certain digital technologies to complete frame or burst intervals. Applicants shall include in their application for equipment authorization to describe how this requirement is met.

### **3.6.2 Measuring Instruments**

See list of measuring equipment of this test report.

### **3.6.3 Test Result of Automatically Discontinue Transmission**

While the EUT is not transmitting any information, the EUT can automatically discontinue transmission and become standby mode for power saving. The EUT can detect the controlling signal of ACK message transmitting from remote device and verify whether it shall resend or discontinue transmission.



## **3.7 Antenna Requirements**

### **3.7.1 Standard Applicable**

If transmitting antenna directional gain is greater than 6 dBi, both the peak transmit power and the peak power spectral density shall be reduced by the amount in dB that the directional gain of the antenna exceeds 6 dBi.

### **3.7.2 Antenna Anti-Replacement Construction**

An embedded-in antenna design is used.

### **3.7.3 Antenna Gain**

The antenna peak gain of EUT is less than 6 dBi. Therefore, it is not necessary to reduce maximum peak output power limit.



## 4 List of Measuring Equipment

Instrument	Manufacturer	Model No.	Serial No.	Characteristics	Calibration Date	Test Date	Due Date	Remark
Loop Antenna	Rohde & Schwarz	HFH2-Z2	100315	9 kHz~30 MHz	Dec. 26, 2019	Mar. 19, 2020~ Apr. 24, 2020	Dec. 25, 2020	Radiation (03CH12-HY)
Bilog Antenna	TESEQ	CBL 6111D & 00800N1D01 N-06	37059 & 01	30MHz~1GHz	Oct. 12, 2019	Mar. 19, 2020~ Apr. 24, 2020	Oct. 11, 2020	Radiation (03CH12-HY)
Horn Antenna	SCHWARZBE CK	BBHA 9120D	9120D-132 8	1GHz ~ 18GHz	Nov. 14, 2019	Mar. 19, 2020~ Apr. 24, 2020	Nov. 13, 2020	Radiation (03CH12-HY)
SHF-EHF Horn Antenna	SCHWARZBE CK	BBHA 9170	BBHA9170 584	18GHz ~ 40GHz	Dec. 10, 2019	Mar. 19, 2020~ Apr. 24, 2020	Dec. 09, 2020	Radiation (03CH12-HY)
Preamplifier	COM-POWER	PA-103	161075	10MHz~1GHz	Mar. 25, 2020	Apr. 24, 2020	Mar. 24, 2021	Radiation (03CH12-HY)
Preamplifier	Jet-Power	JPA00101800 -30-10P	160118000 2	1GHz~18GHz	Feb. 07, 2020	Mar. 19, 2020~ Apr. 24, 2020	Feb. 06, 2021	Radiation (03CH12-HY)
Preamplifier	Keysight	83017A	MY532701 48	1GHz~26.5GHz	Dec. 20, 2019	Mar. 19, 2020~ Apr. 24, 2020	Dec. 19, 2020	Radiation (03CH12-HY)
Preamplifier	EMEC	EM18G40G	060715	18GHz ~ 40GHz	Dec. 13, 2019	Mar. 19, 2020~ Apr. 24, 2020	Dec. 12, 2020	Radiation (03CH12-HY)
Spectrum Analyzer	Rohde & Schwarz	FSV40	101408	10Hz~40GHz	Aug. 13, 2019	Mar. 19, 2020~ Apr. 24, 2020	Aug. 12, 2020	Radiation (03CH12-HY)
Hygrometer	TECEPEL	DTM-303B	TP161243	N/A	May 11, 2019	Mar. 19, 2020~ Apr. 24, 2020	May 10, 2020	Radiation (03CH12-HY)
RF Cable	HUBER + SUHNER	SUCOFLEX 126E	0058/126E	30M-18G	Dec. 12, 2019	Mar. 19, 2020~ Apr. 24, 2020	Dec. 11, 2020	Radiation (03CH12-HY)
RF Cable	HUBER + SUHNER	SUCOFLEX 102	505134/2	30M~40GHz	Feb. 25, 2020	Mar. 19, 2020~ Apr. 24, 2020	Feb. 24, 2021	Radiation (03CH12-HY)
RF Cable	HUBER + SUHNER	SUCOFLEX 102	800740/2	30M~40GHz	Feb. 25, 2020	Mar. 19, 2020~ Apr. 24, 2020	Feb. 24, 2021	Radiation (03CH12-HY)
Controller	EMEC	EM1000	N/A	Control Turn table & Ant Mast	N/A	Mar. 19, 2020~ Apr. 24, 2020	N/A	Radiation (03CH12-HY)
Antenna Mast	EMEC	AM-BS-4500- B	N/A	1m~4m	N/A	Mar. 19, 2020~ Apr. 24, 2020	N/A	Radiation (03CH12-HY)
Turn Table	EMEC	TT2000	N/A	0~360 Degree	N/A	Mar. 19, 2020~ Apr. 24, 2020	N/A	Radiation (03CH12-HY)
Software	Audix	E3 6.2009-8-24	RK-00098 9	N/A	N/A	Mar. 19, 2020~ Apr. 24, 2020	N/A	Radiation (03CH12-HY)
Hygrometer	Testo	608-H2	41410069	N/A	Jun. 17, 2019	Mar. 17, 2020~ Apr. 28, 2020	Jun. 16, 2020	Conducted (TH05-HY)
Power Sensor	DARE	RPR3006W	16I00054S NO10	10MHz~6GHz	Dec. 23, 2019	Mar. 17, 2020~ Apr. 28, 2020	Dec. 22, 2020	Conducted (TH05-HY)
Signal Analyzer	Rohde & Schwarz	FSV40	101566	10Hz~40GHz	Jul. 15, 2019	Mar. 17, 2020~ Apr. 28, 2020	Jul. 14, 2020	Conducted (TH05-HY)
Switch Box & RF Cable	Burgeon	ETF-058	EC130048 4	N/A	Aug. 22, 2019	Mar. 17, 2020~ Apr. 28, 2020	Aug. 21, 2020	Conducted (TH05-HY)



Instrument	Manufacturer	Model No.	Serial No.	Characteristics	Calibration Date	Test Date	Due Date	Remark
AC Power Source	ChainTek	APC-1000W	N/A	N/A	N/A	Mar. 18, 2020	N/A	Conduction (CO05-HY)
EMI Test Receiver	Rohde & Schwarz	ESR3	102388	9kHz~3.6GHz	Nov. 15, 2019	Mar. 18, 2020	Nov. 14, 2020	Conduction (CO05-HY)
Hygrometer	Testo	608-H1	34913912	N/A	Nov. 07, 2020	Mar. 18, 2020	Nov. 06, 2020	Conduction (CO05-HY)
LISN	Rohde & Schwarz	ENV216	100080	9kHz~30MHz	Nov. 20, 2019	Mar. 18, 2020	Nov. 19, 2020	Conduction (CO05-HY)
LISN	Rohde & Schwarz	ENV216	100081	9kHz~30MHz	Nov. 15, 2019	Mar. 18, 2020	Nov. 14, 2020	Conduction (CO05-HY)
Software	Rohde & Schwarz	EMC32 V10.30	N/A	N/A	N/A	Mar. 18, 2020	N/A	Conduction (CO05-HY)
LF Cable	HUBER + SUHNER	RG-214/U	LF01	N/A	Jan. 02, 2020	Mar. 18, 2020	Jan. 01, 2021	Conduction (CO05-HY)
Pulse Limiter	Rohde & Schwarz	ESH3-Z2	100851	N/A	Jan. 02, 2020	Mar. 18, 2020	Jan. 01, 2021	Conduction (CO05-HY)



## 5 Uncertainty of Evaluation

### Uncertainty of Conducted Emission Measurement (150kHz ~ 30MHz)

Measuring Uncertainty for a Level of Confidence of 95% ( $U = 2Uc(y)$ )	2.3
---	-----

### Uncertainty of Radiated Emission Measurement (30 MHz ~ 1000 MHz)

Measuring Uncertainty for a Level of Confidence of 95% ( $U = 2Uc(y)$ )	5.1
---	-----

### Uncertainty of Radiated Emission Measurement (1000 MHz ~ 18000 MHz)

Measuring Uncertainty for a Level of Confidence of 95% ( $U = 2Uc(y)$ )	5.6
---	-----

### Uncertainty of Radiated Emission Measurement (18000 MHz ~ 40000 MHz)

Measuring Uncertainty for a Level of Confidence of 95% ( $U = 2Uc(y)$ )	5.0
---	-----



## Appendix A. AC Conducted Emission Test Results

Test Engineer :	Howard Huang	Temperature :	21~25°C
		Relative Humidity :	42~50%
Test Voltage :	120Vac / 60Hz	Phase :	Line

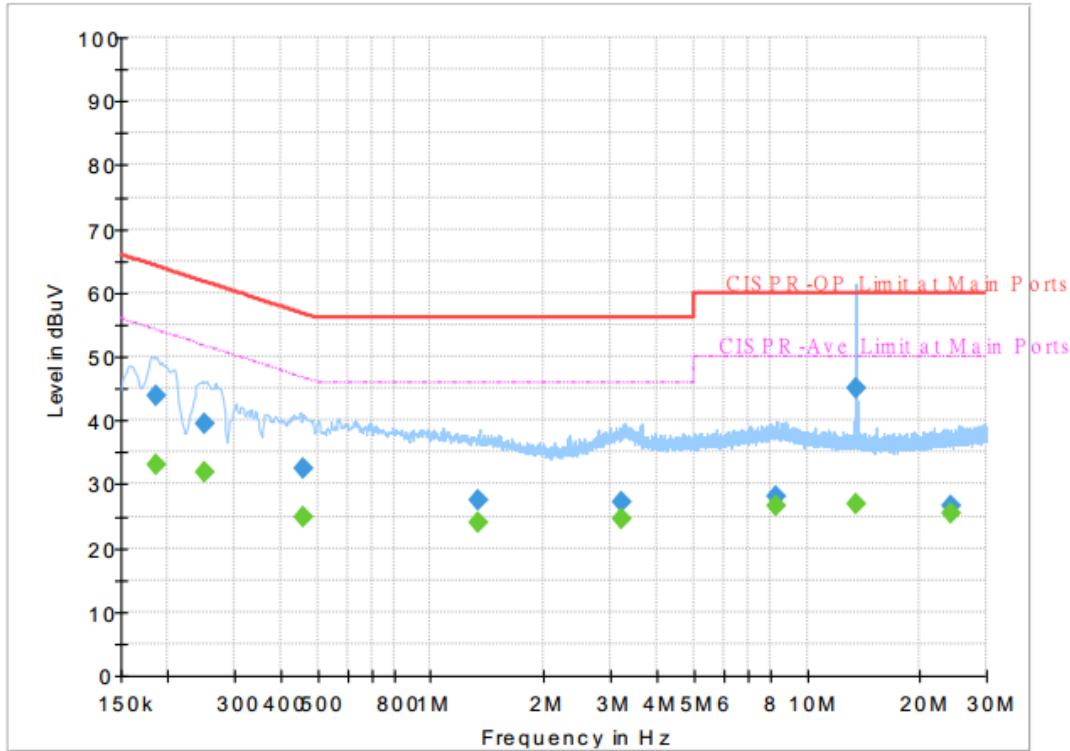

### Final Result

Frequency (MHz)	QuasiPeak (dBuV)	CAverage (dBuV)	Limit (dBuV)	Margin (dB)	Line	Filter	Corr. (dB)
0.186000	---	33.04	54.21	21.17	L1	OFF	19.6
0.186000	43.91	---	64.21	20.30	L1	OFF	19.6
0.251250	---	31.80	51.72	19.92	L1	OFF	19.6
0.251250	39.53	---	61.72	22.19	L1	OFF	19.6
0.456000	---	24.73	46.77	22.04	L1	OFF	19.6
0.456000	32.50	---	56.77	24.27	L1	OFF	19.6
1.342500	---	24.09	46.00	21.91	L1	OFF	19.6
1.342500	27.49	---	56.00	28.51	L1	OFF	19.6
3.223500	---	24.54	46.00	21.46	L1	OFF	19.7
3.223500	27.15	---	56.00	28.85	L1	OFF	19.7
8.258280	---	26.51	50.00	23.49	L1	OFF	20.0
8.258280	28.18	---	60.00	31.82	L1	OFF	20.0
13.560000	---	27.03	50.00	22.97	L1	OFF	20.2
13.560000	44.94	---	60.00	15.06	L1	OFF	20.2
24.249750	---	25.56	50.00	24.44	L1	OFF	20.5
24.249750	26.70	---	60.00	33.30	L1	OFF	20.5



Test Engineer :	Howard Huang	Temperature :	21~25°C
		Relative Humidity :	42~50%
Test Voltage :	120Vac / 60Hz	Phase :	Neutral

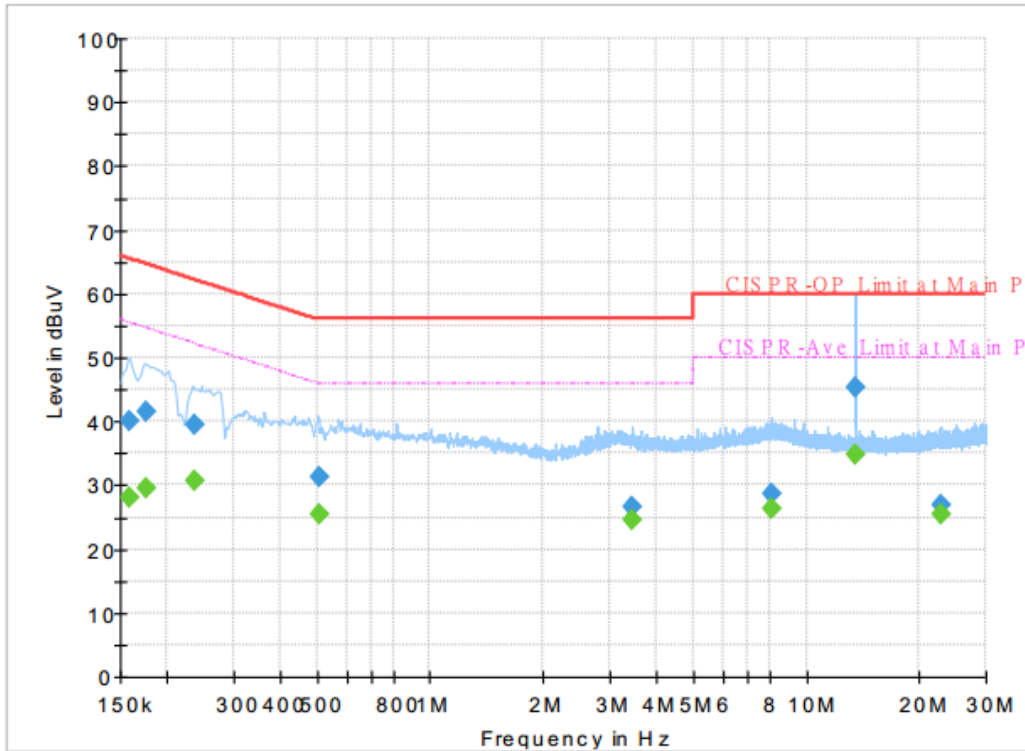

**Final Result**

Frequency (MHz)	QuasiPeak (dBuV)	CAverage (dBuV)	Limit (dBuV)	Margin (dB)	Line	Filter	Corr. (dB)
0.159270	---	28.04	55.50	27.46	N	OFF	19.6
0.159270	40.13	---	65.50	25.37	N	OFF	19.6
0.176460	---	29.49	54.65	25.16	N	OFF	19.6
0.176460	41.51	---	64.65	23.14	N	OFF	19.6
0.237750	---	30.62	52.17	21.55	N	OFF	19.6
0.237750	39.55	---	62.17	22.62	N	OFF	19.6
0.507750	---	25.36	46.00	20.64	N	OFF	19.6
0.507750	31.26	---	56.00	24.74	N	OFF	19.6
3.450750	---	24.53	46.00	21.47	N	OFF	19.7
3.450750	26.55	---	56.00	29.45	N	OFF	19.7
8.055510	---	26.42	50.00	23.58	N	OFF	20.0
8.055510	28.54	---	60.00	31.46	N	OFF	20.0
13.560000	---	34.75	50.00	15.25	N	OFF	20.2
13.560000	45.32	---	60.00	14.68	N	OFF	20.2
22.947630	---	25.38	50.00	24.62	N	OFF	20.5
22.947630	26.78	---	60.00	33.22	N	OFF	20.5





## Appendix B. Radiated Spurious Emission

Test Engineer :	Jack Cheng, Lance Chiang and Chuan Chu	Temperature :	19.2~26.8°C
		Relative Humidity :	53.5~69%

Band 4 - 5725~5850MHz

WIFI 802.11a (Band Edge @ 3m)

WIFI Ant.	Note	Frequency ( MHz )	Level ( dBμV/m )	Over Limit ( dB )	Limit Line ( dBμV/m )	Read Level ( dBμV )	Antenna Factor ( dB/m )	Path Loss ( dB )	Preamp Factor ( dB )	Ant Pos ( cm )	Table Pos ( deg )	Peak Avg. ( P/A )	Pol. ( H/V )	
802.11a CH 149 5745MHz		5648.8	56.24	-11.96	68.2	43.87	31.6	9.6	28.83	113	89	P	H	
		5699.8	60.48	-44.57	105.05	47.88	31.8	9.66	28.86	113	89	P	H	
		5708.2	61.03	-46.47	107.5	48.39	31.83	9.68	28.87	113	89	P	H	
		5725	61.09	-61.11	122.2	48.37	31.9	9.7	28.88	113	89	P	H	
	*	5745	106.73	-	-	93.92	31.98	9.72	28.89	113	89	P	H	
	*	5745	95.26	-	-	82.45	31.98	9.72	28.89	113	89	A	H	
														H
														H
			5637.4	55.48	-12.72	68.2	43.07	31.65	9.59	28.83	100	134	P	V
			5697.2	59.99	-43.15	103.14	47.4	31.79	9.66	28.86	100	134	P	V
			5706.2	60.77	-46.17	106.94	48.15	31.82	9.67	28.87	100	134	P	V
			5724.6	62.12	-59.17	121.29	49.4	31.9	9.7	28.88	100	134	P	V
	*	5745	109.01	-	-	96.2	31.98	9.72	28.89	100	134	P	V	
	*	5745	97.74	-	-	84.93	31.98	9.72	28.89	100	134	A	V	
														V
														V



WIFI Ant. 1	Note	Frequency ( MHz )	Level ( dBμV/m )	Over Limit ( dB )	Limit Line ( dBμV/m )	Read Level ( dBμV )	Antenna Factor ( dB/m )	Path Loss ( dB )	Preamp Factor ( dB )	Ant Pos ( cm )	Table Pos ( deg )	Peak Avg. ( P/A )	Pol. ( H/V )
		5628.2	55.84	-12.36	68.2	43.39	31.69	9.58	28.82	106	88	P	H
		5674.6	56.02	-30.42	86.44	43.54	31.7	9.63	28.85	106	88	P	H
		5714	56.19	-52.93	109.12	43.52	31.86	9.68	28.87	106	88	P	H
		5722	56.34	-59.02	115.36	43.63	31.89	9.69	28.87	106	88	P	H
	*	5785	106.29	-	-	93.36	32.07	9.77	28.91	106	88	P	H
	*	5785	94.99	-	-	82.06	32.07	9.77	28.91	106	88	A	H
		5851.4	56.26	-62.75	119.01	43.16	32.2	9.85	28.95	106	88	P	H
		5859.2	57.28	-52.34	109.62	44.15	32.22	9.86	28.95	106	88	P	H
		5909.2	57.26	-22.6	79.86	43.99	32.34	9.91	28.98	106	88	P	H
		5932.2	57.1	-11.1	68.2	43.72	32.43	9.94	28.99	106	88	P	H
													H
													H
<b>802.11a</b>													
<b>CH 157</b>													
<b>5785MHz</b>		5601.4	56.04	-12.16	68.2	43.52	31.79	9.54	28.81	105	137	P	V
		5684.8	56.12	-37.87	93.99	43.58	31.74	9.65	28.85	105	137	P	V
		5718.8	56.22	-54.24	110.46	43.52	31.88	9.69	28.87	105	137	P	V
		5724	55.43	-64.49	119.92	42.72	31.9	9.69	28.88	105	137	P	V
	*	5785	107.68	-	-	94.75	32.07	9.77	28.91	105	137	P	V
	*	5785	96.68	-	-	83.75	32.07	9.77	28.91	105	137	A	V
		5853.6	59.36	-54.63	113.99	46.25	32.21	9.85	28.95	105	137	P	V
		5858.4	58.37	-51.48	109.85	45.25	32.22	9.85	28.95	105	137	P	V
		5915	57.48	-18.09	75.57	44.18	32.36	9.92	28.98	105	137	P	V
		5943.6	57.84	-10.36	68.2	44.42	32.47	9.95	29	105	137	P	V
													V
													V



WIFI Ant. 1	Note	Frequency ( MHz )	Level ( dBµV/m )	Over Limit ( dB )	Limit Line ( dBµV/m )	Read Level ( dBµV )	Antenna Factor ( dB/m )	Path Loss ( dB )	Preamp Factor ( dB )	Ant Pos ( cm )	Table Pos ( deg )	Peak Avg. ( P/A )	Pol. ( H/V )	
802.11a CH 165 5825MHz	*	5825	106.71	-	-	93.67	32.15	9.82	28.93	122	88	P	H	
	*	5825	95.16	-	-	82.12	32.15	9.82	28.93	122	88	A	H	
		5853.8	65.29	-48.25	113.54	52.18	32.21	9.85	28.95	122	88	P	H	
		5862.6	65.67	-43	108.67	52.53	32.23	9.86	28.95	122	88	P	H	
		5877	64.32	-39.39	103.71	51.16	32.25	9.87	28.96	122	88	P	H	
		5930	57.96	-10.24	68.2	44.6	32.42	9.93	28.99	122	88	P	H	
														H
														H
	*	5825	109.31	-	-	96.27	32.15	9.82	28.93	105	133	P	V	
	*	5825	97.23	-	-	84.19	32.15	9.82	28.93	105	133	A	V	
		5850.4	67.37	-53.92	121.29	54.27	32.2	9.85	28.95	105	133	P	V	
		5864.8	67.43	-40.62	108.05	54.29	32.23	9.86	28.95	105	133	P	V	
		5875.4	63.98	-40.92	104.9	50.82	32.25	9.87	28.96	105	133	P	V	
		5931.2	58.1	-10.1	68.2	44.74	32.42	9.93	28.99	105	133	P	V	
														V
														V
														V
	<b>Remark</b>	1. No other spurious found. 2. All results are PASS against Peak and Average limit line.												



**Band 4 5725~5850MHz**

**WIFI 802.11a (Harmonic @ 3m)**

WIFI Ant. 1	Note	Frequency ( MHz )	Level ( dBμV/m )	Over Limit ( dB )	Limit Line ( dBμV/m )	Read Level ( dBμV )	Antenna Factor ( dB/m )	Path Loss ( dB )	Preamp Factor ( dB )	Ant Pos ( cm )	Table Pos ( deg )	Peak Avg. ( P/A )	Pol. ( H/V )
802.11a CH 149 5745MHz		11490	61.27	-12.73	74	65.89	39.99	17.7	62.31	400	41	P	H
		11490	46.34	-7.66	54	50.96	39.99	17.7	62.31	400	41	A	H
		17235	48.82	-19.38	68.2	45.32	40.81	21.17	58.48	100	0	P	H
													H
		11490	59.52	-14.48	74	64.14	39.99	17.7	62.31	195	27	P	V
		11490	45.14	-8.86	54	49.76	39.99	17.7	62.31	195	27	A	V
		17235	48.07	-20.13	68.2	44.57	40.81	21.17	58.48	100	0	P	V
802.11a CH 157 5785MHz		11570	60.89	-13.11	74	65.71	39.72	17.77	62.31	376	41	P	H
		11570	46.19	-7.81	54	51.01	39.72	17.77	62.31	376	41	A	H
		17355	49.69	-18.51	68.2	45.25	41.39	21.31	58.26	100	0	P	H
													H
		11570	61	-13	74	65.82	39.72	17.77	62.31	196	314	P	V
		11570	46.33	-7.67	54	51.15	39.72	17.77	62.31	196	314	A	V
		17355	49.8	-18.4	68.2	45.36	41.39	21.31	58.26	100	0	P	V
802.11a CH 165 5825MHz		11650	61.17	-12.83	74	66.25	39.4	17.85	62.33	122	168	P	H
		11650	47.01	-6.99	54	52.09	39.4	17.85	62.33	122	168	A	H
		17475	52.36	-15.84	68.2	46.94	42	21.46	58.04	100	0	P	H
													H
		11650	65.09	-8.91	74	70.17	39.4	17.85	62.33	114	143	P	V
		11650	50.92	-3.08	54	56	39.4	17.85	62.33	114	143	A	V
		17475	53	-15.2	68.2	47.58	42	21.46	58.04	100	0	P	V
Remark	1. No other spurious found. 2. All results are PASS against Peak and Average limit line.												



**Band 4 5725~5850MHz**

**WIFI 802.11ac VHT20 (Band Edge @ 3m)**

WIFI Ant. 1	Note	Frequency ( MHz )	Level ( dBμV/m )	Over Limit ( dB )	Limit Line ( dBμV/m )	Read Level ( dBμV )	Antenna Factor ( dB/m )	Path Loss ( dB )	Preamp Factor ( dB )	Ant Pos ( cm )	Table Pos ( deg )	Peak Avg. ( P/A )	Pol. ( H/V )	
802.11ac VHT20 CH 149 5745MHz		5601.4	55.8	-12.4	68.2	43.28	31.79	9.54	28.81	119	87	P	H	
		5700	59.76	-45.44	105.2	47.16	31.8	9.66	28.86	119	87	P	H	
		5708	63.73	-43.71	107.44	51.09	31.83	9.68	28.87	119	87	P	H	
		5724.8	62.15	-59.59	121.74	49.43	31.9	9.7	28.88	119	87	P	H	
	*	5745	108.23	-	-	95.42	31.98	9.72	28.89	119	87	P	H	
	*	5745	95.48	-	-	82.67	31.98	9.72	28.89	119	87	A	H	
														H
														H
			5630	55.62	-12.58	68.2	43.18	31.68	9.58	28.82	100	131	P	V
			5690.2	60.93	-37.04	97.97	48.38	31.76	9.65	28.86	100	131	P	V
			5706	65.25	-41.63	106.88	52.63	31.82	9.67	28.87	100	131	P	V
			5724.6	64.49	-56.8	121.29	51.77	31.9	9.7	28.88	100	131	P	V
	*		5745	109.07	-	-	96.26	31.98	9.72	28.89	100	131	P	V
	*		5745	96.6	-	-	83.79	31.98	9.72	28.89	100	131	A	V
													V	
													V	



WIFI Ant. 1	Note	Frequency ( MHz )	Level ( dBμV/m )	Over Limit ( dB )	Limit Line ( dBμV/m )	Read Level ( dBμV )	Antenna Factor ( dB/m )	Path Loss ( dB )	Preamp Factor ( dB )	Ant Pos ( cm )	Table Pos ( deg )	Peak Avg. ( P/A )	Pol. ( H/V )
		5603.2	55.78	-12.42	68.2	43.26	31.79	9.54	28.81	120	91	P	H
		5698.2	56.12	-47.75	103.87	43.53	31.79	9.66	28.86	120	91	P	H
		5720	56.12	-54.68	110.8	43.42	31.88	9.69	28.87	120	91	P	H
		5720	56.12	-54.68	110.8	43.42	31.88	9.69	28.87	120	91	P	H
	*	5785	105.74	-	-	92.81	32.07	9.77	28.91	120	91	P	H
	*	5785	95.69	-	-	82.76	32.07	9.77	28.91	120	91	A	H
		5852.8	56.7	-59.12	115.82	43.59	32.21	9.85	28.95	120	91	P	H
		5863.6	57.27	-51.12	108.39	44.13	32.23	9.86	28.95	120	91	P	H
		5908	56.86	-23.88	80.74	43.6	32.33	9.91	28.98	120	91	P	H
		5942	56.9	-11.3	68.2	43.48	32.47	9.95	29	120	91	P	H
802.11ac													H
VHT20													H
CH 157		5600	55.23	-12.97	68.2	42.7	31.8	9.54	28.81	105	130	P	V
5785MHz		5665	56.04	-23.29	79.33	43.6	31.66	9.62	28.84	105	130	P	V
		5720	57.43	-53.37	110.8	44.73	31.88	9.69	28.87	105	130	P	V
		5720	57.43	-53.37	110.8	44.73	31.88	9.69	28.87	105	130	P	V
	*	5785	107.74	-	-	94.81	32.07	9.77	28.91	105	130	P	V
	*	5785	97.22	-	-	84.29	32.07	9.77	28.91	105	130	A	V
		5850.8	58.86	-61.52	120.38	45.76	32.2	9.85	28.95	105	130	P	V
		5856.8	58.07	-52.23	110.3	44.96	32.21	9.85	28.95	105	130	P	V
		5907	57.82	-23.66	81.48	44.56	32.33	9.91	28.98	105	130	P	V
		5948.4	58.08	-10.12	68.2	44.64	32.49	9.95	29	105	130	P	V
													V
													V



WIFI Ant. 1	Note	Frequency ( MHz )	Level ( dBμV/m )	Over Limit ( dB )	Limit Line ( dBμV/m )	Read Level ( dBμV )	Antenna Factor ( dB/m )	Path Loss ( dB )	Preamp Factor ( dB )	Ant Pos ( cm )	Table Pos ( deg )	Peak Avg. ( P/A )	Pol. ( H/V )	
802.11ac VHT20 CH 165 5825MHz	*	5825	108.02	-	-	94.24	32.15	10.56	28.93	100	140	P	H	
	*	5825	97.66	-	-	83.88	32.15	10.56	28.93	100	140	A	H	
		5852.6	67.09	-49.18	116.27	53.24	32.21	10.59	28.95	100	140	P	H	
		5861.4	65.87	-43.14	109.01	52	32.22	10.6	28.95	100	140	P	H	
		5879.4	63.42	-38.51	101.93	49.51	32.26	10.61	28.96	100	140	P	H	
		5943.6	57.87	-10.33	68.2	43.73	32.47	10.67	29	100	140	P	H	
														H
														H
	*	5825	110.12	-	-	96.34	32.15	10.56	28.93	101	162	P	V	
	*	5825	99.92	-	-	86.14	32.15	10.56	28.93	101	162	A	V	
		5852.8	68.17	-47.65	115.82	54.32	32.21	10.59	28.95	101	162	P	V	
		5867.8	68.08	-39.13	107.21	54.2	32.24	10.6	28.96	101	162	P	V	
		5879	64.7	-37.53	102.23	50.79	32.26	10.61	28.96	101	162	P	V	
		5935.4	57.41	-10.79	68.2	43.3	32.44	10.66	28.99	101	162	P	V	
														V
														V
Remark	1. No other spurious found. 2. All results are PASS against Peak and Average limit line.													



**Band 4 5725~5850MHz**

**WIFI 802.11ac VHT20 (Harmonic @ 3m)**

WIFI Ant. 1	Note	Frequency ( MHz )	Level ( dBμV/m )	Over Limit ( dB )	Limit Line ( dBμV/m )	Read Level ( dBμV )	Antenna Factor ( dB/m )	Path Loss ( dB )	Preamp Factor ( dB )	Ant Pos ( cm )	Table Pos ( deg )	Peak Avg. ( P/A )	Pol. ( H/V )
802.11ac VHT20 CH 149 5745MHz		11490	62.68	-11.32	74	67.3	39.99	17.7	62.31	115	157	P	H
		11490	48.97	-5.03	54	53.59	39.99	17.7	62.31	115	157	A	H
		17235	51.44	-16.76	68.2	47.94	40.81	21.17	58.48	100	0	P	H
													H
		11490	66.05	-7.95	74	70.67	39.99	17.7	62.31	123	121	P	V
		11490	50.52	-3.48	54	55.14	39.99	17.7	62.31	123	121	A	V
		17235	51.73	-16.47	68.2	48.23	40.81	21.17	58.48	100	0	P	V
													V
802.11ac VHT20 CH 157 5785MHz		11570	60.35	-13.65	74	65.17	39.72	17.77	62.31	376	40	P	H
		11570	45.41	-8.59	54	50.23	39.72	17.77	62.31	376	40	A	H
		17355	50.39	-17.81	68.2	45.95	41.39	21.31	58.26	100	0	P	H
													H
		11570	59.37	-14.63	74	64.19	39.72	17.77	62.31	197	63	P	V
		11570	44.58	-9.42	54	49.4	39.72	17.77	62.31	197	63	A	V
		17355	50.75	-17.45	68.2	46.31	41.39	21.31	58.26	100	0	P	V
													V
802.11ac VHT20 CH 165 5825MHz		11650	60.39	-13.61	74	65.47	39.4	17.85	62.33	400	52	P	H
		11650	46.69	-7.31	54	51.77	39.4	17.85	62.33	400	52	A	H
		17475	50.49	-17.71	68.2	45.07	42	21.46	58.04	100	0	P	H
													H
		11650	59.24	-14.76	74	64.32	39.4	17.85	62.33	199	301	P	V
		11650	45.55	-8.45	54	50.63	39.4	17.85	62.33	199	301	A	V
		17475	50.23	-17.97	68.2	44.81	42	21.46	58.04	100	0	P	V
													V
Remark	1. No other spurious found. 2. All results are PASS against Peak and Average limit line.												





Band 4 5725~5850MHz

WIFI 802.11ac VHT40 (Band Edge @ 3m)

WIFI Ant. 1	Note	Frequency ( MHz )	Level ( dBμV/m )	Over Limit ( dB )	Limit Line ( dBμV/m )	Read Level ( dBμV )	Antenna Factor ( dB/m )	Path Loss ( dB )	Preamp Factor ( dB )	Ant Pos ( cm )	Table Pos ( deg )	Peak Avg. ( P/A )	Pol. ( H/V )
		5650	56.54	-11.66	68.2	43.31	31.6	10.46	28.83	112	90	P	H
		5684	56.92	-36.48	93.4	43.55	31.74	10.48	28.85	112	90	P	H
		5720	59.93	-50.87	110.8	46.42	31.88	10.5	28.87	112	90	P	H
		5724	60.67	-59.25	119.92	47.15	31.9	10.5	28.88	112	90	P	H
	*	5755	104.68	-	-	91.04	32.01	10.52	28.89	112	90	P	H
	*	5755	94.85	-	-	81.21	32.01	10.52	28.89	112	90	A	H
		5853.6	57.53	-56.46	113.99	43.68	32.21	10.59	28.95	112	90	P	H
		5870.6	57.53	-48.9	106.43	43.65	32.24	10.6	28.96	112	90	P	H
		5919.4	58.08	-14.25	72.33	44.03	32.38	10.65	28.98	112	90	P	H
		5943.8	57.66	-10.54	68.2	43.51	32.48	10.67	29	112	90	P	H
													H
													H
<b>802.11ac</b>													
<b>VHT40</b>													
<b>CH 151</b>		5649.8	56.61	-11.59	68.2	43.38	31.6	10.46	28.83	100	129	P	V
<b>5755MHz</b>		5696.2	59.04	-43.36	102.4	45.64	31.78	10.48	28.86	100	129	P	V
		5720	60.28	-50.52	110.8	46.77	31.88	10.5	28.87	100	129	P	V
		5724.2	62.79	-57.59	120.38	49.27	31.9	10.5	28.88	100	129	P	V
	*	5755	106.63	-	-	92.99	32.01	10.52	28.89	100	129	P	V
	*	5755	96.52	-	-	82.88	32.01	10.52	28.89	100	129	A	V
		5851.4	57.97	-61.04	119.01	44.13	32.2	10.59	28.95	100	129	P	V
		5858	57.96	-52	109.96	44.1	32.22	10.59	28.95	100	129	P	V
		5889.6	57.95	-36.41	94.36	44.02	32.28	10.62	28.97	100	129	P	V
		5937.8	58.04	-10.16	68.2	43.93	32.45	10.66	29	100	129	P	V
													V
													V



WIFI Ant. 1	Note	Frequency ( MHz )	Level ( dBμV/m )	Over Limit ( dB )	Limit Line ( dBμV/m )	Read Level ( dBμV )	Antenna Factor ( dB/m )	Path Loss ( dB )	Preamp Factor ( dB )	Ant Pos ( cm )	Table Pos ( deg )	Peak Avg. ( P/A )	Pol. ( H/V )
		5622	56.08	-12.12	68.2	42.75	31.71	10.44	28.82	105	92	P	H
		5681	57.14	-34.04	91.18	43.8	31.72	10.47	28.85	105	92	P	H
		5702.6	56.6	-49.33	105.93	43.16	31.81	10.49	28.86	105	92	P	H
		5720.2	56.65	-54.61	111.26	43.14	31.88	10.5	28.87	105	92	P	H
	*	5795	104.52	-	-	90.81	32.09	10.54	28.92	105	92	P	H
	*	5795	94.5	-	-	80.79	32.09	10.54	28.92	105	92	A	H
		5854.6	59.18	-52.53	111.71	45.33	32.21	10.59	28.95	105	92	P	H
		5871.6	58.93	-47.22	106.15	45.05	32.24	10.6	28.96	105	92	P	H
		5913.4	58.38	-18.38	76.76	44.37	32.35	10.64	28.98	105	92	P	H
		5949.6	58.26	-9.94	68.2	44.09	32.5	10.67	29	105	92	P	H
802.11ac													H
VHT40													H
CH 159		5605	55.99	-12.21	68.2	42.59	31.78	10.43	28.81	100	131	P	V
5795MHz		5694.2	56.1	-44.82	100.92	42.7	31.78	10.48	28.86	100	131	P	V
		5705.2	57.35	-49.31	106.66	43.9	31.82	10.49	28.86	100	131	P	V
		5724.4	57.97	-62.86	120.83	44.45	31.9	10.5	28.88	100	131	P	V
	*	5795	106.41	-	-	92.7	32.09	10.54	28.92	100	131	P	V
	*	5795	96.39	-	-	82.68	32.09	10.54	28.92	100	131	A	V
		5850.8	60.75	-59.63	120.38	46.91	32.2	10.59	28.95	100	131	P	V
		5869.8	59.92	-46.73	106.65	46.04	32.24	10.6	28.96	100	131	P	V
		5910.4	58.38	-20.59	78.97	44.38	32.34	10.64	28.98	100	131	P	V
		5946	58.67	-9.53	68.2	44.52	32.48	10.67	29	100	131	P	V
													V
													V
Remark	1. No other spurious found. 2. All results are PASS against Peak and Average limit line.												



**Band 4 5725~5850MHz**

**WIFI 802.11ac VHT40 (Harmonic @ 3m)**

WIFI Ant. 1	Note	Frequency ( MHz )	Level ( dBμV/m )	Over Limit ( dB )	Limit Line ( dBμV/m )	Read Level ( dBμV )	Antenna Factor ( dB/m )	Path Loss ( dB )	Preamp Factor ( dB )	Ant Pos ( cm )	Table Pos ( deg )	Peak Avg. ( P/A )	Pol. ( H/V )	
802.11ac VHT40 CH 151 5755MHz		11510	57.86	-16.14	74	62.49	39.96	17.71	62.3	400	40	P	H	
		11510	45.17	-8.83	54	49.8	39.96	17.71	62.3	400	40	A	H	
		17265	49.41	-18.79	68.2	45.72	40.9	21.21	58.42	100	0	P	H	
													H	
			11510	56.43	-17.57	74	61.06	39.96	17.71	62.3	200	289	P	V
			11510	44.22	-9.78	54	48.85	39.96	17.71	62.3	200	289	A	V
			17265	49.59	-18.61	68.2	45.9	40.9	21.21	58.42	100	0	P	V
802.11ac VHT40 CH 159 5795MHz		11590	55.42	-18.58	74	60.31	39.64	17.79	62.32	394	46	P	H	
		11590	44.88	-9.12	54	49.77	39.64	17.79	62.32	394	46	A	H	
		17385	50.34	-17.86	68.2	45.6	41.6	21.35	58.21	100	0	P	H	
													H	
			11590	55.02	-18.98	74	59.91	39.64	17.79	62.32	279	298	P	V
			11590	44.85	-9.15	54	49.74	39.64	17.79	62.32	279	298	A	V
			17385	50.17	-18.03	68.2	45.43	41.6	21.35	58.21	100	0	P	V
													V	
<b>Remark</b>	1. No other spurious found. 2. All results are PASS against Peak and Average limit line.													



Band 4 5725~5850MHz

WIFI 802.11ac VHT80 (Band Edge @ 3m)

WIFI Ant. 1	Note	Frequency ( MHz )	Level ( dBμV/m )	Over Limit ( dB )	Limit Line ( dBμV/m )	Read Level ( dBμV )	Antenna Factor ( dB/m )	Path Loss ( dB )	Preamp Factor ( dB )	Ant Pos ( cm )	Table Pos ( deg )	Peak Avg. ( P/A )	Pol. ( H/V )
		5631.2	56.99	-11.21	68.2	43.68	31.68	10.45	28.82	110	88	P	H
		5695.8	66.25	-35.85	102.1	52.85	31.78	10.48	28.86	110	88	P	H
		5719.2	69.3	-41.28	110.58	55.79	31.88	10.5	28.87	110	88	P	H
		5720.4	70.52	-41.19	111.71	57.01	31.88	10.5	28.87	110	88	P	H
	*	5775	103.32	-	-	89.64	32.05	10.53	28.9	110	88	P	H
	*	5775	93.19	-	-	79.51	32.05	10.53	28.9	110	88	A	H
		5853.8	69.67	-43.87	113.54	55.82	32.21	10.59	28.95	110	88	P	H
		5860.6	67.31	-41.92	109.23	53.45	32.22	10.59	28.95	110	88	P	H
		5877	62.1	-41.61	103.71	48.2	32.25	10.61	28.96	110	88	P	H
		5925.6	59.28	-8.92	68.2	45.22	32.4	10.65	28.99	110	88	P	H
802.11ac													H
VHT80													H
CH 155		5647	58.38	-9.82	68.2	45.14	31.61	10.46	28.83	100	131	P	V
5775MHz		5696.8	68.42	-34.42	102.84	55.01	31.79	10.48	28.86	100	131	P	V
		5717.4	70.91	-39.16	110.07	57.42	31.87	10.49	28.87	100	131	P	V
		5720.4	72.77	-38.94	111.71	59.26	31.88	10.5	28.87	100	131	P	V
	*	5775	105.08	-	-	91.4	32.05	10.53	28.9	100	131	P	V
	*	5775	94.91	-	-	81.23	32.05	10.53	28.9	100	131	A	V
		5851.4	71.65	-47.36	119.01	57.81	32.2	10.59	28.95	100	131	P	V
		5856.4	69.56	-40.85	110.41	55.71	32.21	10.59	28.95	100	131	P	V
		5877	65.28	-38.43	103.71	51.38	32.25	10.61	28.96	100	131	P	V
		5949.4	57.99	-10.21	68.2	43.82	32.5	10.67	29	100	131	P	V
													V
													V
Remark	1. No other spurious found. 2. All results are PASS against Peak and Average limit line.												



**Band 4 5725~5850MHz**

**WIFI 802.11ac VHT80 (Harmonic @ 3m)**

WIFI Ant. 1	Note	Frequency ( MHz )	Level ( dBμV/m )	Over Limit ( dB )	Limit Line ( dBμV/m )	Read Level ( dBμV )	Antenna Factor ( dB/m )	Path Loss ( dB )	Preamp Factor ( dB )	Ant Pos ( cm )	Table Pos ( deg )	Peak Avg. ( P/A )	Pol. ( H/V )	
802.11ac VHT80 CH 155 5775MHz		11550	61.64	-12.36	74	66.4	39.8	17.75	62.31	101	154	P	H	
		11550	48.22	-5.78	54	52.98	39.8	17.75	62.31	101	154	A	H	
		17325	52.55	-15.65	68.2	48.42	41.17	21.28	58.32	100	0	P	H	
													H	
			11550	62.47	-11.53	74	67.23	39.8	17.75	62.31	100	144	P	V
			11550	50.83	-3.17	54	55.59	39.8	17.75	62.31	100	144	A	V
			17325	53.45	-14.75	68.2	49.32	41.17	21.28	58.32	100	0	P	V
													V	
<b>Remark</b>	1. No other spurious found. 2. All results are PASS against Peak and Average limit line.													



Emission below 1GHz

5GHz WIFI 802. 11ac VHT20 (LF @ 3m)

WIFI	Note	Frequency	Level	Over	Limit	Read	Antenna	Path	Preamp	Ant	Table	Peak	Pol.	
Ant.				Limit	Line	Level	Factor	Loss	Factor	Pos	Pos	Avg.		
1		( MHz )	( dBμV/m )	( dB )	( dBμV/m )	( dBμV )	( dB/m )	( dB )	( dB )	( cm )	( deg )	( P/A )	( H/V )	
5GHz 802.11ac VHT20 LF		66.86	21.31	-18.69	40	38.48	11.79	0.72	29.68	-	-	P	H	
		112.45	23.71	-19.79	43.5	35.37	16.91	1.06	29.63	-	-	P	H	
		153.19	24.71	-18.79	43.5	36.3	16.77	1.21	29.57	-	-	P	H	
		715.79	32.49	-13.51	46	31.35	26.72	2.99	28.57	-	-	P	H	
		836.07	33.47	-12.53	46	29.79	28.65	3.44	28.41	-	-	P	H	
		942.77	36.19	-9.81	46	30.37	30.3	3.67	28.15	100	0	P	H	
														H
														H
														H
														H
														H
														H
														H
			31.94	29.38	-10.62	40	35.17	23.36	0.5	29.65	-	-	P	V
			44.55	33.58	-6.42	40	45.71	16.98	0.55	29.66	100	0	P	V
			66.86	27.36	-12.64	40	44.53	11.79	0.72	29.68	-	-	P	V
			737.13	33.14	-12.86	46	30.76	27.86	3.11	28.59	-	-	P	V
			835.1	33.96	-12.04	46	30.32	28.61	3.44	28.41	-	-	P	V
			947.62	36.87	-9.13	46	30.85	30.49	3.67	28.14	-	-	P	V
														V
													V	
													V	
													V	
													V	
													V	
Remark	1. No other spurious found. 2. All results are PASS against limit line.													



**Note symbol**

*	<b>Fundamental Frequency</b> which can be ignored. However, the level of any unwanted emissions shall not exceed the level of the fundamental frequency.
!	Test result is <b>over limit</b> line.
P/A	<b>Peak</b> or <b>Average</b>
H/V	<b>Horizontal</b> or <b>Vertical</b>



A calculation example for radiated spurious emission is shown as below:

WIFI	Note	Frequency	Level	Over	Limit	Read	Antenna	Path	Preamp	Ant	Table	Peak	Pol.
Ant.				Limit	Line	Level	Factor	Loss	Factor	Pos	Pos	Avg.	
1		( MHz )	( dBμV/m )	( dB )	( dBμV/m )	( dBμV )	( dB/m )	( dB )	( dB )	( cm )	( deg )	( P/A )	( H/V )
802.11b		2390	55.45	-18.55	74	54.51	32.22	4.58	35.86	103	308	P	H
CH 01		2390	43.54	-10.46	54	42.6	32.22	4.58	35.86	103	308	A	H
2412MHz													

1. Path Loss(dB) = Cable loss(dB) + Filter loss(dB) + Attenuator loss(dB)
2. Level(dBμV/m) = Antenna Factor(dB/m) + Path Loss(dB) + Read Level(dBμV) - Preamp Factor(dB)
3. Over Limit(dB) = Level(dBμV/m) – Limit Line(dBμV/m)

**For Peak Limit @ 2390MHz:**

1. Level(dBμV/m)  
= Antenna Factor(dB/m) + Path Loss(dB) + Read Level(dBμV) - Preamp Factor(dB)  
= 32.22(dB/m) + 4.58(dB) + 54.51(dBμV) – 35.86 (dB)  
= 55.45 (dBμV/m)
2. Over Limit(dB)  
= Level(dBμV/m) – Limit Line(dBμV/m)  
= 55.45(dBμV/m) – 74(dBμV/m)  
= -18.55(dB)

**For Average Limit @ 2390MHz:**

1. Level(dBμV/m)  
= Antenna Factor(dB/m) + Path Loss(dB) + Read Level(dBμV) - Preamp Factor(dB)  
= 32.22(dB/m) + 4.58(dB) + 42.6(dBμV) – 35.86 (dB)  
= 43.54 (dBμV/m)
2. Over Limit(dB) = Level(dBμV/m) – Limit Line(dBμV/m)  
= 43.54(dBμV/m) – 54(dBμV/m)  
= -10.46(dB)

**Both peak and average measured complies with the limit line, so test result is “PASS”.**





## Appendix C. Radiated Spurious Emission Plots

Test Engineer :	Jack Cheng, Lance Chiang and Chuan Chu	Temperature :	19.2~26.8°C
		Relative Humidity :	53.5~69%

**Band 4 - 5725~5850MHz**  
**WIFI 802.11a (Band Edge @ 3m)**

WIFI	Band 4 5725~5850MHz Band Edge @ 3m	
ANT	802.11a CH149 5745MHz	
1	Horizontal	Fundamental
<b>Peak</b>	<p>Site : 03CH12-HY Condition : PEAK_BE(B4)_16-24 3m HORN_9120D_1328 HORIZONTAL Detector : Peak Project : 010720</p>	<p>Site : 03CH12-HY Condition : PEAK(UNL) 3m HORN_9120D_1328 HORIZONTAL Detector : Peak Project : 010720</p>



WIFI	Band 4 5725~5850MHz Band Edge @ 3m	
ANT	802.11a CH149 5745MHz	
1	Vertical	Fundamental
Peak	<p>Site : 03CH12-HY          Condition : PEAK_BF(04)_16-24 3m HORN_91200_1328 VERTICAL          Detector : Peak          Project : 010720</p>	<p>Site : 03CH12-HY          Condition : PEAK(08)_3m HORN_91200_1328 VERTICAL          Detector : Peak          Project : 010720</p>



WIFI	Band 4 5725~5850MHz Band Edge @ 3m	
ANT	802.11a CH157 5785MHz	
1	Horizontal	Fundamental
Peak	<p>Site : 03CH2-HY          Condition : PEAK_BE(B4)_16-24 3m HORN_9120D_1328 HORIZONTAL          Detector : Peak          Project : 010720</p>	<p>Site : 03CH2-HY          Condition : PEAK(UNIT) 3m HORN_9120D_1328 HORIZONTAL          Detector : Peak          Project : 010720</p>
Peak	<p>Site : 03CH2-HY          Condition : PEAK_BE(B4)_16-24 3m HORN_9120D_1328 HORIZONTAL          Detector : Peak          Project : 010720</p>	Left blank



WIFI	Band 4 5725~5850MHz Band Edge @ 3m	
ANT	802.11a CH157 5785MHz	
1	Vertical	Fundamental
<p><b>Peak</b></p>	<p>Site : 03CH12-HY            Condition : PEAK_BE(B4)_16-24 3m HORN_9120D_1328 VERTICAL            Detector : Peak            Project : 010720</p>	<p>Site : 03CH12-HY            Condition : PEAK(UNIT) 3m HORN_9120D_1328 VERTICAL            Detector : Peak            Project : 010720</p>
<p><b>Peak</b></p>	<p>Site : 03CH12-HY            Condition : PEAK_BE(B4)_16-24 3m HORN_9120D_1328 VERTICAL            Detector : Peak            Project : 010720</p>	<p><b>Left blank</b></p>



WIFI	Band 4 5725~5850MHz Band Edge @ 3m	
ANT	802.11a CH165 5825MHz	
1	Horizontal	Fundamental
Peak	<p>Site : 03CH2-HY          Condition : PEAK_SEC04_16-24 3m HORN_91200_1338 HORIZONTAL          Detector : Peak          Project : 010720</p>	<p>Site : 03CH2-HY          Condition : PEAK_UNIT_3m HORN_91200_1338 HORIZONTAL          Detector : Peak          Project : 010720</p>

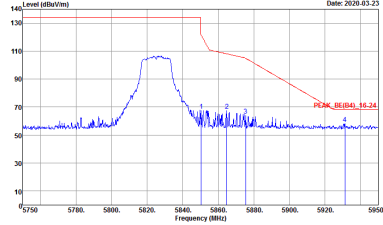
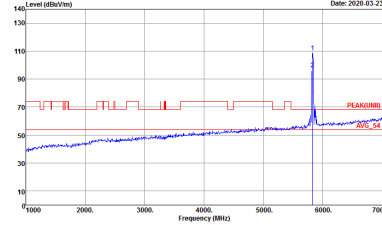

WIFI	Band 4 5725~5850MHz Band Edge @ 3m	
ANT	802.11a CH165 5825MHz	
1	Vertical	Fundamental
Peak	 <p>Site : 03CH2-HY          Condition : PEAK_8E(04)_16-24 3m HORN_91200_1338 VERTICAL          Detector : Peak          Project : 010720</p>	 <p>Site : 03CH2-HY          Condition : PEAK(UNIT) 3m HORN_91200_1338 VERTICAL          Detector : Peak          Project : 010720</p>



**Band 4 5725~5850MHz**  
**WIFI 802.11ac VHT20 (Band Edge @ 3m)**

WIFI	Band 4 5725~5850MHz Band Edge @ 3m	
ANT	802.11ac VHT20 CH149 5745MHz	
1	Horizontal	Fundamental
Peak	<div style="display: flex; justify-content: space-around;"> <div style="width: 45%;"> <p>Site : 03CH12-1HY            Condition : PEAK_BE(B4)_16-24 3m HORN_9120D_1328 HORIZONTAL            Detector : Peak            Project : 010720</p> </div> <div style="width: 45%;"> <p>Site : 03CH12-1HY            Condition : PEAK(UNII) 3m HORN_9120D_1328 HORIZONTAL            Detector : Peak            Project : 010720</p> </div> </div>	

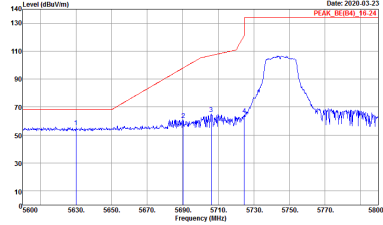
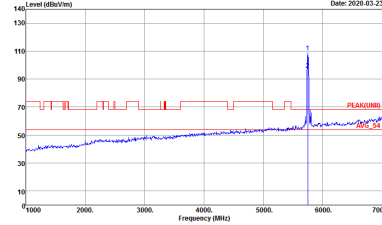

WIFI	Band 4 5725~5850MHz Band Edge @ 3m	
ANT	802.11ac VHT20 CH149 5745MHz	
1	Vertical	Fundamental
Peak Avg.	 <p>Site : 03CH2-HY          Condition : PEAK_SEC04_16-24 3m HORN_91200_1328 VERTICAL          Detector : Peak          Project : 010720</p>	 <p>Site : 03CH2-HY          Condition : PEAK_UNIT_3m HORN_91200_1328 VERTICAL          Detector : Peak          Project : 010720</p>





WIFI	Band 4 5725~5850MHz Band Edge @ 3m	
ANT	802.11ac VHT20 CH157 5785MHz	
1	Horizontal	Fundamental
<p><b>Peak</b></p>	<p>Site : 03CH2-HY            Condition : PEAK_BE(B4)_16-24 3m HORN_9120D_1328 HORIZONTAL            Detector : Peak            Project : 010720</p>	<p>Site : 03CH2-HY            Condition : PEAK(UNIT) 3m HORN_9120D_1328 HORIZONTAL            Detector : Peak            Project : 010720</p>
<p><b>Peak</b></p>	<p>Site : 03CH2-HY            Condition : PEAK_BE(B4)_16-24 3m HORN_9120D_1328 HORIZONTAL            Detector : Peak            Project : 010720</p>	<p><b>Left blank</b></p>



WIFI	Band 4 5725~5850MHz Band Edge @ 3m	
ANT	802.11ac VHT20 CH157 5785MHz	
1	Vertical	Fundamental
Peak	<p>Site : 03CH2-HY          Condition : PEAK_BE(B4)_16-24 3m HORN_9120D_1328 VERTICAL          Detector : Peak          Project : 010720</p>	<p>Site : 03CH2-HY          Condition : PEAK(UNIT) 3m HORN_9120D_1328 VERTICAL          Detector : Peak          Project : 010720</p>
Peak	<p>Site : 03CH2-HY          Condition : PEAK_BE(B4)_16-24 3m HORN_9120D_1328 VERTICAL          Detector : Peak          Project : 010720</p>	Left blank

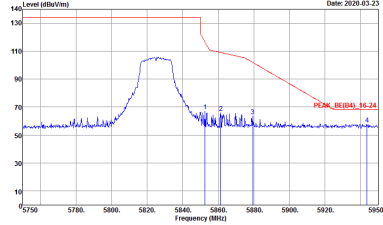
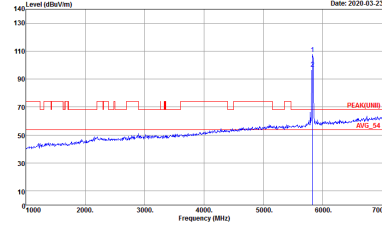

WIFI	Band 4 5725~5850MHz Band Edge @ 3m	
ANT	802.11ac VHT20 CH165 5825MHz	
1	Horizontal	Fundamental
Peak	 <p>Site : 03CH2-HY          Condition : PEAK_SEC04_16-24 3m HORN_91200_1338 HORIZONTAL          Detector : Peak          Project : 010720</p>	 <p>Site : 03CH2-HY          Condition : PEAK_UNIT_3m HORN_91200_1338 HORIZONTAL          Detector : Peak          Project : 010720</p>

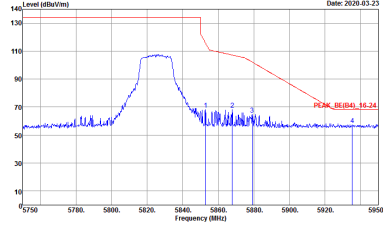
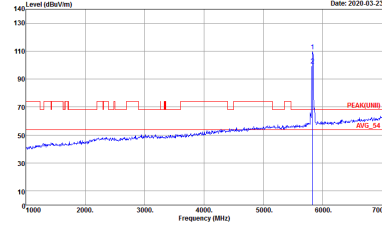

WIFI	Band 4 5725~5850MHz Band Edge @ 3m	
ANT	802.11ac VHT20 CH165 5825MHz	
1	Vertical	Fundamental
Peak Avg.	 <p>Site : 03CH2-HY          Condition : PEAK_SEC04_16-24 3m HORN_91200_1328 VERTICAL          Detector : Peak          Project : 010720</p>	 <p>Site : 03CH2-HY          Condition : PEAK_UNIT_3m HORN_91200_1328 VERTICAL          Detector : Peak          Project : 010720</p>



**Band 4 5725~5850MHz**  
**WIFI 802.11ac VHT40 (Band Edge @ 3m)**

WIFI	Band 4 5725~5850MHz Band Edge @ 3m	
ANT	802.11ac VHT40 CH151 5755MHz	
1	Horizontal	Fundamental
<b>Peak</b>	<p>Site : 03CH12-HY            Condition : PEAK_BE(B4)_16-24 3m HORN_9120D_1328 HORIZONTAL            Detector : RBW:1000.000kHz VBW:3000.000kHz SWT:Auto            Project : 010720</p>	<p>Site : 03CH12-HY            Condition : PEAK(UIN1) 3m HORN_9120D_1328 HORIZONTAL            Detector : RBW:1000.000kHz VBW:3000.000kHz SWT:Auto            Project : 010720</p>
<b>Peak</b>	<p>Site : 03CH12-HY            Condition : PEAK_BE(B4)_16-24 3m HORN_9120D_1328 HORIZONTAL            Detector : RBW:1000.000kHz VBW:3000.000kHz SWT:Auto            Project : 010720</p>	<b>Left blank</b>

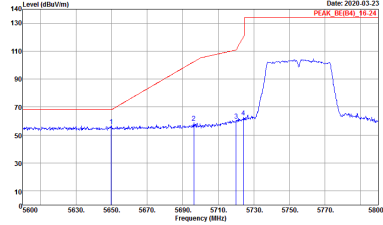
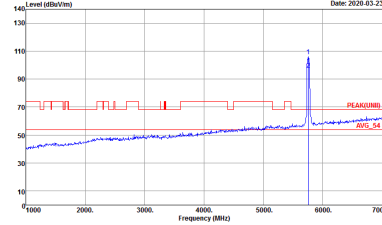
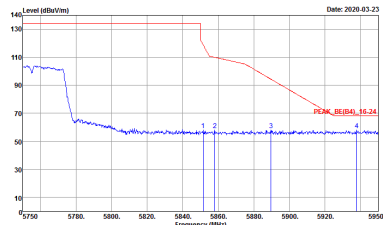

WIFI	Band 4 5725~5850MHz Band Edge @ 3m	
ANT	802.11ac VHT40 CH151 5755MHz	
1	Vertical	Fundamental
<p><b>Peak</b></p>	 <p>Site : 03CH12-HY            Condition : PEAK_BE(B4)_16-24 3m HORN_9120D_1328 VERTICAL            Detector : Peak            Project : 010720</p>	 <p>Site : 03CH12-HY            Condition : PEAK(UNIT) 3m HORN_9120D_1328 VERTICAL            Detector : Peak            Project : 010720</p>
<p><b>Peak</b></p>	 <p>Site : 03CH12-HY            Condition : PEAK_BE(B4)_16-24 3m HORN_9120D_1328 VERTICAL            Detector : Peak            Project : 010720</p>	<p><b>Left blank</b></p>



WIFI	Band 4 5725~5850MHz Band Edge @ 3m	
ANT	802.11ac VHT40 CH159 5795MHz	
1	Horizontal	Fundamental
<p><b>Peak</b></p>	<p>Site : 03CH12-HY            Condition : PEAK_BE(B4)_16-24 3m HORN_9120D_1328 HORIZONTAL            Detector : Peak            Project : 010720</p>	<p>Site : 03CH12-HY            Condition : PEAK(FUNTE) 3m HORN_9120D_1328 HORIZONTAL            Detector : Peak            Project : 010720</p>
<p><b>Peak</b></p>	<p>Site : 03CH12-HY            Condition : PEAK_BE(B4)_16-24 3m HORN_9120D_1328 HORIZONTAL            Detector : Peak            Project : 010720</p>	<p><b>Left blank</b></p>



WIFI	Band 4 5725~5850MHz Band Edge @ 3m	
ANT	802.11ac VHT40 CH159 5795MHz	
1	Vertical	Fundamental
Peak	<p>Site : 03CH2-HY            Condition : PEAK_BE(B4)_16-24 3m HORN_9120D_1328 VERTICAL            Detector : Peak            Project : 010720</p>	<p>Site : 03CH2-HY            Condition : PEAK(UNIT) 3m HORN_9120D_1328 VERTICAL            Detector : Peak            Project : 010720</p>
Peak	<p>Site : 03CH2-HY            Condition : PEAK_BE(B4)_16-24 3m HORN_9120D_1328 VERTICAL            Detector : Peak            Project : 010720</p>	Left blank





**Band 4 5725~5850MHz**  
**WIFI 802.11ac VHT80 (Band Edge @ 3m)**

WIFI	Band 4 5725~5850MHz Band Edge @ 3m	
ANT	802.11ac VHT80 CH155 5775MHz	
1	Horizontal	Fundamental
<b>Peak</b>	<p>Site : 03CH12-HY            Condition : PEAK_BE(B4)_16-24 3m HORN_9120D_1328 HORIZONTAL            Detector : RBW:1000.000kHz VBW:3000.000kHz SWT:Auto            Project : Peak : 010720</p>	<p>Site : 03CH12-HY            Condition : PEAK(UIN1) 3m HORN_9120D_1328 HORIZONTAL            Detector : RBW:1000.000kHz VBW:3000.000kHz SWT:Auto            Project : Peak : 010720</p>
<b>Peak</b>	<p>Site : 03CH12-HY            Condition : PEAK_BE(B4)_16-24 3m HORN_9120D_1328 HORIZONTAL            Detector : RBW:1000.000kHz VBW:3000.000kHz SWT:Auto            Project : Peak : 010720</p>	<b>Left blank</b>



WIFI	Band 4 5725~5850MHz Band Edge @ 3m	
ANT	802.11ac VHT80 CH155 5775MHz	
1	Vertical	Fundamental
Peak	<p>Site : 03CH12-HY            Condition : PEAK_BE(B4)_16-24 3m HORN_9120D_1328 VERTICAL            Detector : Peak            Project : 010720</p>	<p>Site : 03CH12-HY            Condition : PEAK(UNIT) 3m HORN_9120D_1328 VERTICAL            Detector : Peak            Project : 010720</p>
Peak	<p>Site : 03CH12-HY            Condition : PEAK_BE(B4)_16-24 3m HORN_9120D_1328 VERTICAL            Detector : Peak            Project : 010720</p>	Left blank



**Band 4 - 5725~5850MHz**

**WIFI 802.11a (Harmonic @ 3m)**

WIFI	Band 4 5725~5850MHz Harmonic @ 3m	
ANT	802.11a CH149 5745MHz	
1	Horizontal	Vertical
<p><b>Peak</b></p> <p><b>Avg.</b></p>	<p>Site : 03CH12-HY            Condition : PEAK(LINE) 3m HORN_91200_1328 HORIZONTAL            Detector : Peak            Project : 010720</p>	<p>Site : 03CH12-HY            Condition : PEAK(LINE) 3m HORN_91200_1328 VERTICAL            Detector : Peak            Project : 010720</p>



WIFI	Band 4 5725~5850MHz Harmonic @ 3m	
ANT	802.11a CH157 5785MHz	
1	Horizontal	Vertical
Peak Avg.	<p>Site : 03CH12-HY Condition : PEAK(UNIT) 3m HORN_9120D_1328 HORIZONTAL Detector : Peak Project : 010720</p>	<p>Site : 03CH12-HY Condition : PEAK(UNIT) 3m HORN_9120D_1328 VERTICAL Detector : Peak Project : 010720</p>



WIFI	Band 4 5725~5850MHz Harmonic @ 3m	
ANT	802.11a CH165 5825MHz	
1	Horizontal	Vertical
<p>Peak Avg.</p>	<p>Site : 03CH12-HY Condition : PEAK(UNIT) 3m HORN_9120D_1328 HORIZONTAL Detector : Peak Project : 010720</p>	<p>Site : 03CH12-HY Condition : PEAK(UNIT) 3m HORN_9120D_1328 VERTICAL Detector : Peak Project : 010720</p>



**Band 4 5725~5850MHz  
WIFI 802.11ac VHT20 (Harmonic @ 3m)**

WIFI	Band 4 5725~5850MHz Harmonic @ 3m	
ANT	802.11ac VHT20 CH149 5745MHz	
1	Horizontal	Vertical
<p><b>Peak</b> <b>Avg.</b></p>	<p>Site : 03CH12-HY Condition : PEAK(UNII) 3m HORN_9120D_1328 HORIZONTAL Detector : Peak Project : 010720</p>	<p>Site : 03CH12-HY Condition : PEAK(UNII) 3m HORN_9120D_1328 VERTICAL Detector : Peak Project : 010720</p>

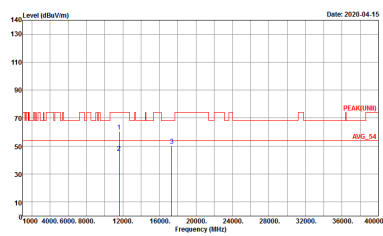
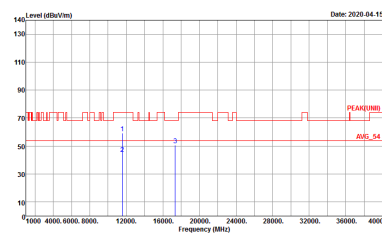

WIFI	Band 4 5725~5850MHz Harmonic @ 3m	
ANT	802.11ac VHT20 CH157 5785MHz	
1	Horizontal	Vertical
<p>Peak Avg.</p>	 <p>Site : 03CH12-HY Condition : PEAK(UNIT) 3m HORN_9120D_1328 HORIZONTAL Detector : Peak Project : 010720</p>	 <p>Site : 03CH12-HY Condition : PEAK(UNIT) 3m HORN_9120D_1328 VERTICAL Detector : Peak Project : 010720</p>

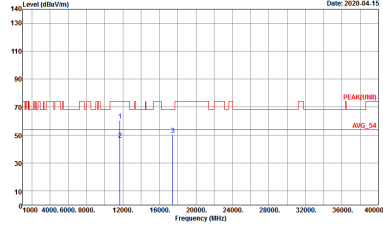
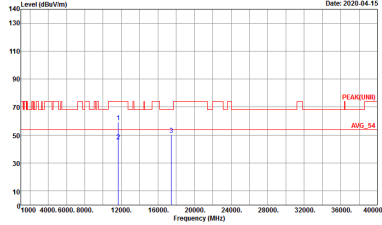

WIFI	Band 4 5725~5850MHz Harmonic @ 3m	
ANT	802.11ac VHT20 CH165 5825MHz	
1	Horizontal	Vertical
<p>Peak Avg.</p>	 <p>Site : 03CH12-HY Condition : PEAK(UNIT) 3m HORN_9120D_1328 HORIZONTAL Detector : Peak Project : 010720</p>	 <p>Site : 03CH12-HY Condition : PEAK(UNIT) 3m HORN_9120D_1328 VERTICAL Detector : Peak Project : 010720</p>





**Band 4 5725~5850MHz  
WIFI 802.11ac VHT40 (Harmonic @ 3m)**

WIFI	Band 4 5725~5850MHz Harmonic @ 3m	
ANT	802.11ac VHT40 CH151 5755MHz	
1	Horizontal	Vertical
<p><b>Peak</b> <b>Avg.</b></p>	<p>Site : 03CH12-HY Condition : PEAK(UNII) 3m HORN_9120D_1328 HORIZONTAL Detector : Peak Project : 010720</p>	<p>Site : 03CH12-HY Condition : PEAK(UNII) 3m HORN_9120D_1328 VERTICAL Detector : Peak Project : 010720</p>

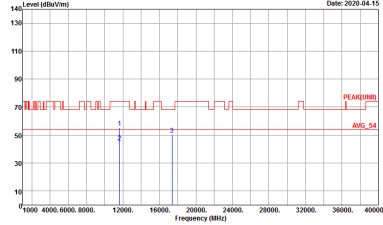
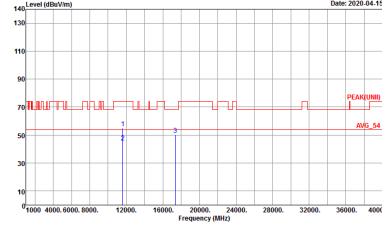

WIFI	Band 4 5725~5850MHz Harmonic @ 3m	
ANT	802.11ac VHT40 CH159 5795MHz	
1	Horizontal	Vertical
<p>Peak Avg.</p>	 <p>Site : 03CH12-HY Condition : PEAK(UNIT) 3m HORN_9120D_1328 HORIZONTAL Detector : Peak Project : 010720</p>	 <p>Site : 03CH12-HY Condition : PEAK(UNIT) 3m HORN_9120D_1328 VERTICAL Detector : Peak Project : 010720</p>



**Band 4 5725~5850MHz**  
**WIFI 802.11ac VHT80 (Harmonic @ 3m)**

WIFI	Band 4 5725~5850MHz Harmonic @ 3m	
ANT	802.11ac VHT80 CH155 5775MHz	
1	Horizontal	Vertical
<b>Peak</b> <b>Avg.</b>	<p>Site : 03CH12-HY Condition : PEAK(UNII) 3m HORN_9120D_1328 HORIZONTAL Detector : Peak Project : 010720</p>	<p>Site : 03CH12-HY Condition : PEAK(UNII) 3m HORN_9120D_1328 VERTICAL Detector : Peak Project : 010720</p>

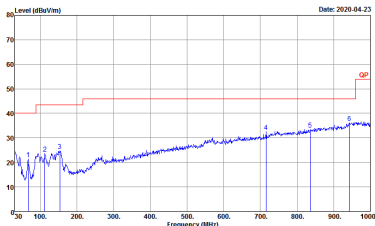
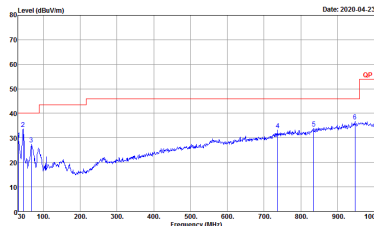

Emission below 1GHz  
5GHz WIFI 802.11ac VHT20 (LF)

WIFI	5GHz 5725-5850MHz	
ANT	802.11ac VHT20 LF	
1	Horizontal	Vertical
<p>QP / Peak</p>	 <p>Site : 03CH12-HY Condition : QP 3m BIL06_6111D_37059 HORIZONTAL Detector : Peak Project : 010720</p>	 <p>Site : 03CH12-HY Condition : QP 3m BIL05_6111D_37059 VERTICAL Detector : Peak Project : 010720</p>



### Appendix D. Duty Cycle Plots

Band	Duty Cycle(%)	T(us)	1/T(kHz)	VBW Setting	Duty Factor(dB)
802.11a	98.45	-	-	10Hz	0.07
5GHz 802.11ac VHT20	97.94	1900	0.53	1kHz	0.09
5GHz 802.11ac VHT40	95.90	935	1.07	3kHz	0.18
5GHz 802.11ac VHT80	92.68	456	2.19	3kHz	0.33



802.11a

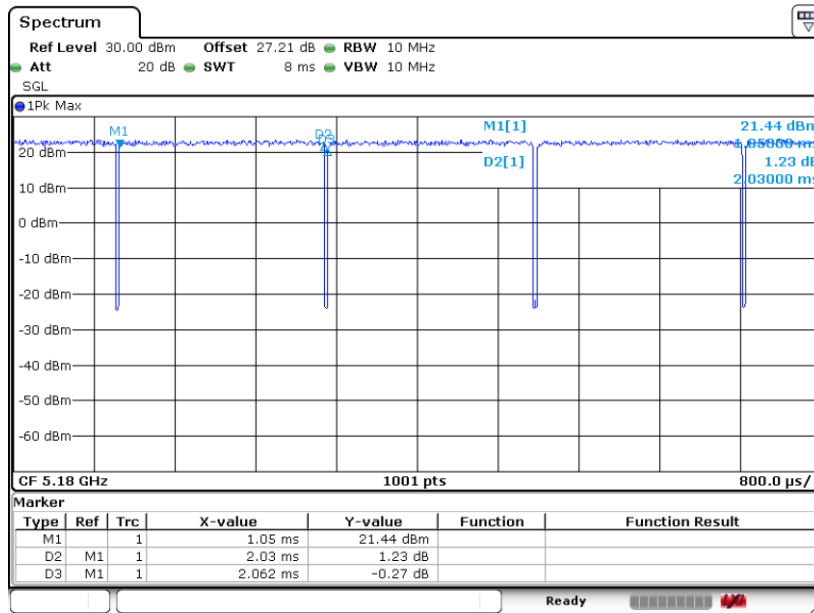

Date: 18.MAR.2020 09:04:35

802.11ac VHT20

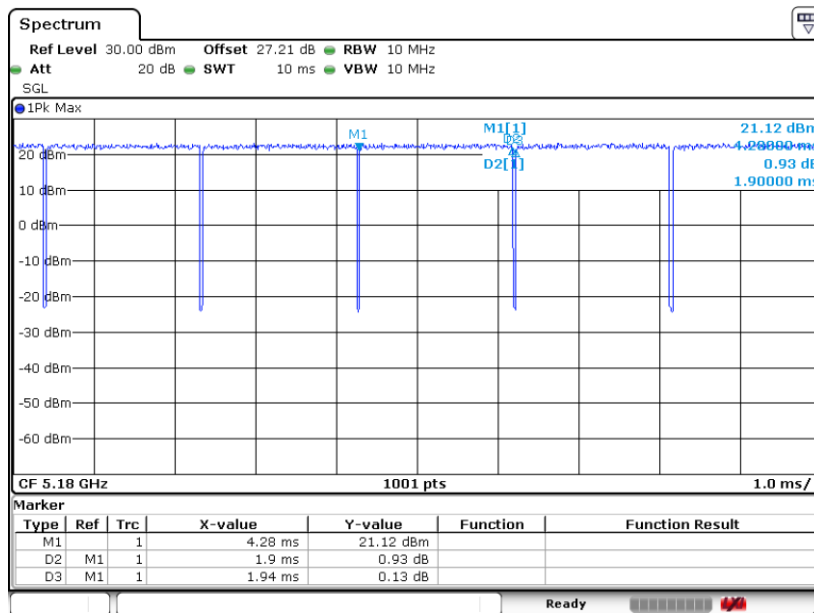

Date: 18.MAR.2020 10:12:21



802.11ac VHT40

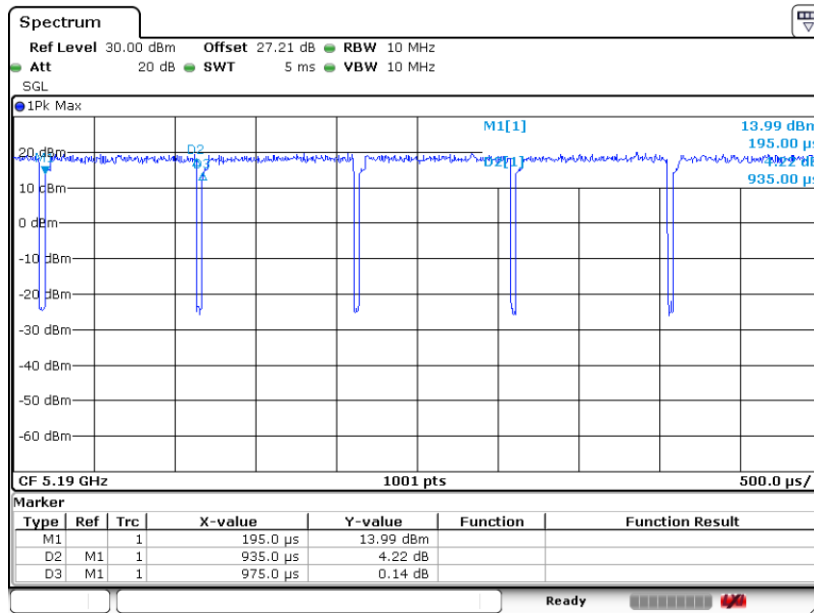

Date: 18.MAR.2020 10:14:18

802.11ac VHT80

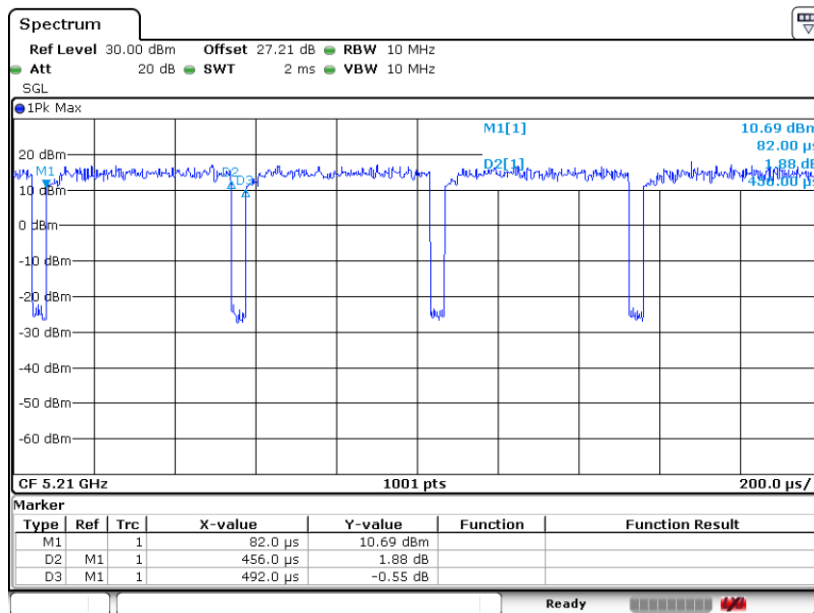

Date: 18.MAR.2020 10:42:38