

FCC SAR Test Report

Report No. : SA170427C12
Applicant : Zebra Technologies Corporation
Address : 1 Zebra Plaza Holtsville New York United States 11742
Product : Touch Computer
FCC ID : UZ7TC25AJ
Brand : Zebra
Model No. : TC25AJ
Standards : FCC 47 CFR PART 2 (2.1093), IEEE C95.1:1992, IEEE STD 1528:2013
 KDB 865664 D01 v01r04, KDB 865664 D02 v01r02, KDB 248227 D01 v02r02
 KDB 447498 D01 v06 , KDB 648474 D04 v01r03 , KDB 941225 D01 v03r01
 KDB 941225 D05 v02r05 , KDB 941225 D06 v02r01
Sample Received Date : Apr. 27, 2017
Date of Testing : Aug. 12, 2017 ~ Sep. 28, 2017
Lab Address : No. 47-2, 14th Ling, Chia Pau Vil., Lin Kou Dist., New Taipei City, Taiwan, R.O.C.
Test Location : No. 19, Hwa Ya 2nd Rd, Wen Hwa Vil, Kwei Shan Dist., Taoyuan City 33383, Taiwan (R.O.C)

CERTIFICATION: The above equipment have been tested by **Bureau Veritas Consumer Products Services (H.K.) Ltd., Taoyuan Branch – Lin Kou Laboratories**, and found compliance with the requirement of the above standards. The test record, data evaluation & Equipment Under Test (EUT) configurations represented herein are true and accurate accounts of the measurements of the sample’s SAR characteristics under the conditions specified in this report. It should not be reproduced except in full, without the written approval of our laboratory. The client should not use it to claim product certification, approval, or endorsement by TAF or any government agencies.

Prepared By : Evonne Liu
 Evonne Liu / Specialist

Approved By : Eli Hsu
 Eli Hsu / Project Engineer



This report is for your exclusive use. Any copying or replication of this report to or for any other person or entity, or use of our name or trademark, is permitted only with our prior written permission. This report sets forth our findings solely with respect to the test samples identified herein. The results set forth in this report are not indicative or representative of the quality or characteristics of the lot from which a test sample was taken or any similar or identical product unless specifically and expressly noted. Our report includes all of the tests requested by you and the results thereof based upon the information that you provided to us. You have 60 days from date of issuance of this report to notify us of any material error or omission caused by our negligence, provided, however, that such notice shall be in writing and shall specifically address the issue you wish to raise. A failure to raise such issue within the prescribed time shall constitute your unqualified acceptance of the completeness of this report, the tests conducted and the correctness of the report contents. Unless specific mention, the uncertainty of measurement has been explicitly taken into account to declare the compliance or non-compliance to the specification.

Table of Contents

Release Control Record	3
1. Summary of Maximum SAR Value	4
2. Description of Equipment Under Test	5
3. SAR Measurement System	7
3.1 Definition of Specific Absorption Rate (SAR)	7
3.2 SPEAG DASY52 System	7
3.2.1 Robot.....	8
3.2.2 Probes.....	9
3.2.3 Data Acquisition Electronics (DAE)	10
3.2.4 Phantoms	10
3.2.5 Device Holder.....	11
3.2.6 System Validation Dipoles.....	11
3.2.7 Tissue Simulating Liquids.....	12
3.3 SAR System Verification	15
3.4 SAR Measurement Procedure	16
3.4.1 Area & Zoom Scan Procedure	16
3.4.2 Volume Scan Procedure.....	16
3.4.3 Power Drift Monitoring.....	17
3.4.4 Spatial Peak SAR Evaluation	17
3.4.5 SAR Averaged Methods	17
4. SAR Measurement Evaluation	18
4.1 EUT Configuration and Setting.....	18
4.2 EUT Testing Position	23
4.2.1 Head Exposure Conditions.....	23
4.2.2 Body-worn Accessory Exposure Conditions.....	25
4.2.3 Hotspot Mode Exposure Conditions	26
4.2.4 SAR Test Exclusion Evaluations	26
4.3 Tissue Verification	27
4.4 System Validation.....	29
4.5 System Verification.....	30
4.6 Maximum Output Power.....	31
4.6.1 Maximum Target Conducted Power	31
4.6.2 Measured Conducted Power Result.....	33
4.7 SAR Testing Results	43
4.7.1 SAR Test Reduction Considerations	43
4.7.2 SAR Results for Head Exposure Condition	45
4.7.3 SAR Results for Body-worn Exposure Condition (Test Separation Distance is 15 mm).....	48
4.7.4 SAR Results for Hotpot Exposure Condition	50
4.7.5 SAR Results for Holster Exposure Condition (Test Separation Distance is 0 mm).....	53
4.7.6 SAR Results for Arm Mount Exposure Condition (Test Separation Distance is 0 mm).....	56
4.7.7 SAR Measurement Variability.....	57
4.7.8 Simultaneous Multi-band Transmission Evaluation	58
5. Calibration of Test Equipment.....	95
6. Measurement Uncertainty.....	96
7. Information on the Testing Laboratories.....	100
Appendix A. SAR Plots of System Verification	
Appendix B. SAR Plots of SAR Measurement	
Appendix C. Calibration Certificate for Probe and Dipole	
Appendix D. Photographs of EUT and Setup	



Release Control Record

Report No.	Reason for Change	Date Issued
SA170427C12	Initial release	Sep. 29, 2017

1. Summary of Maximum SAR Value

Equipment Class	Mode	Highest SAR-1g Head (W/kg)	Highest SAR-1g Body-Worn (W/kg)	Highest SAR-1g Hotspot (W/kg)	Highest SAR-1g Holster (W/kg)	Highest SAR-10g Arm Mount (W/kg)
PCE	GSM850	0.49	0.40	1.01	0.40	0.35
	GSM1900	0.57	0.29	1.04	0.57	0.17
	WCDMA II	0.88	0.42	0.89	1.09	0.29
	WCDMA IV	1.05	0.71	1.31	0.76	0.22
	WCDMA V	0.47	0.40	0.82	0.28	0.30
	LTE 2	0.81	0.41	0.72	0.44	0.13
	LTE 4	0.53	0.75	1.28	0.41	0.11
	LTE 5	0.56	0.78	0.97	0.26	0.28
	LTE 12	0.34	0.39	0.45	0.41	0.24
LTE 17	0.31	0.37	0.45	0.41	0.23	
DTS	2.4G WLAN	1.36	0.41	1.00	0.31	0.19
NII	5.3G WLAN	0.51	1.06	N/A	0.63	0.18
	5.6G WLAN	0.40	1.25	N/A	0.80	0.32
	5.8G WLAN	0.31	0.94	N/A	0.47	0.23
DSS	Bluetooth	N/A	N/A	N/A	N/A	N/A
Highest Simultaneous Transmission SAR		Head	Body-Worn	Hotspot	Holster	Arm Mount
		1.56	1.59	1.56	1.56	0.67

Note:

- The SAR criteria (**Head & Body: SAR-1g 1.6 W/kg, and Extremity: SAR-10g 4.0 W/kg**) for general population / uncontrolled exposure is specified in FCC 47 CFR part 2 (2.1093) and ANSI/IEEE C95.1-1992.

2. Description of Equipment Under Test

EUT Type	Touch Computer
FCC ID	UZ7TC25AJ
Brand Name	Zebra
Model Name	TC25AJ
EUT Configuration	EUT1: Scanner SE4710 EUT2: Scanner SE2100
MFD	11JUL17
HW Version	DV
SW Version	90-06-05-N-00-E1
Tx Frequency Bands (Unit: MHz)	GSM850 : 824.2 ~ 848.8 GSM1900 : 1850.2 ~ 1909.8 WCDMA Band II : 1852.4 ~ 1907.6 WCDMA Band IV : 1712.4 ~ 1752.6 WCDMA Band V : 826.4 ~ 846.6 LTE Band 2 : 1850.7 ~ 1909.3 (BW: 1.4M, 3M, 5M, 10M, 15M, 20M) LTE Band 4 : 1710.7 ~ 1754.3 (BW: 1.4M, 3M, 5M, 10M, 15M, 20M) LTE Band 5 : 824.7 ~ 848.3 (BW: 1.4M, 3M, 5M, 10M) LTE Band 12 : 699.7 ~ 715.3 (BW: 1.4M, 3M, 5M, 10M) LTE Band 17 : 706.5 ~ 713.5 (BW: 5M, 10M) WLAN : 2412 ~ 2462, 5180 ~ 5240, 5260 ~ 5320, 5500 ~ 5720, 5745 ~ 5825 Bluetooth : 2402 ~ 2480
Uplink Modulations	GSM & GPRS : GMSK EDGE : 8PSK WCDMA : QPSK LTE : QPSK, 16QAM 802.11b : DSSS 802.11a/g/n/ac : OFDM Bluetooth : GFSK, $\pi/4$ -DQPSK, 8-DPSK
Maximum Tune-up Conducted Power (Unit: dBm)	Please refer to section 4.6.1 of this report
Antenna Type	PIFA Antenna
EUT Stage	Engineering sample

Note:

- The following antennas were provided to the EUT.

Type	Connector	Gain (dBi)		
		2.4GHz	5GHz	BT
PIFA	NA	2.25	4.20	2.24

- The above EUT information is declared by manufacturer and for more detailed features description please refers to the manufacturer's specifications or User's Manual.

FCC SAR Test Report

List of Accessory:

Battery	Brand Name	ZEBRA
	Model Name	BT-000334
	Power Rating	3.85Vdc, 3000mAh
	Type	Li-ion
Gun Handle	Brand Name	ZEBRA
	P/N Number	TRG-TC2X-SNP1-01
Arm Mount	Brand Name	ZEBRA
	P/N Number	SG-TC2X-ARMNT-01
AC Adapter	Brand Name	ZEBRA
	Model Name	SAWA-65-20005A
USB Type C cable	Brand Name	ZEBRA
	P/N Number	CBL-MPM-USB1-01
Holster (short)	Brand Name	ZEBRA
	P/N Number	SG-TC2X-HLSTR1-01
Vehicle Cigarette Adaptor	Brand Name	ZEBRA
	P/N Number	SAWA-68-25005A
Power Pack	Brand Name	ZEBRA
	P/N Number	BT-000343

3. SAR Measurement System

3.1 Definition of Specific Absorption Rate (SAR)

SAR is related to the rate at which energy is absorbed per unit mass in an object exposed to a radio field. The SAR distribution in a biological body is complicated and is usually carried out by experimental techniques or numerical modeling. The standard recommends limits for two tiers of groups, occupational/controlled and general population/uncontrolled, based on a person's awareness and ability to exercise control over his or her exposure. In general, occupational/controlled exposure limits are higher than the limits for general population/uncontrolled.

The SAR definition is the time derivative (rate) of the incremental energy (dW) absorbed by (dissipated in) an incremental mass (dm) contained in a volume element (dv) of a given density (ρ). The equation description is as below:

$$\text{SAR} = \frac{d}{dt} \left(\frac{dW}{dm} \right) = \frac{d}{dt} \left(\frac{dW}{\rho dv} \right)$$

SAR is expressed in units of Watts per kilogram (W/kg)

SAR measurement can be related to the electrical field in the tissue by

$$\text{SAR} = \frac{\sigma |E|^2}{\rho}$$

Where: σ is the conductivity of the tissue, ρ is the mass density of the tissue and E is the RMS electrical field strength.

3.2 SPEAG DASY52 System

DASY52 system consists of high precision robot, probe alignment sensor, phantom, robot controller, controlled measurement server and near-field probe. The robot includes six axes that can move to the precision position of the DASY52 software defined. The DASY52 software can define the area that is detected by the probe. The robot is connected to controlled box. Controlled measurement server is connected to the controlled robot box. The DAE includes amplifier, signal multiplexing, AD converter, offset measurement and surface detection. It is connected to the Electro-optical coupler (ECO). The ECO performs the conversion from the optical into digital electric signal of the DAE and transfers data to the PC.

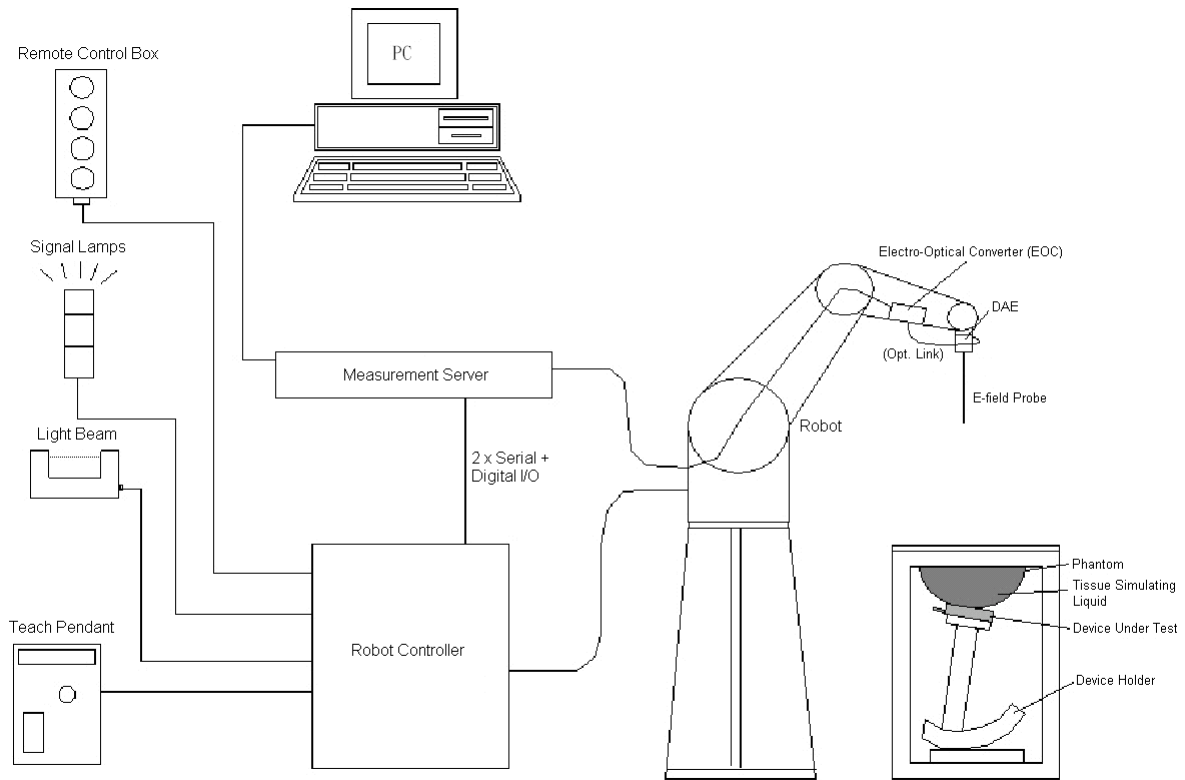

Fig-3.1 SPEAG DASY52 System Setup

3.2.1 Robot

The DASY52 system uses the high precision robots from Stäubli SA (France). For the 6-axis controller system, the robot controller version of CS8c from Stäubli is used. The Stäubli robot series have many features that are important for our application:

- High precision (repeatability ± 0.035 mm)
- High reliability (industrial design)
- Jerk-free straight movements
- Low ELF interference (the closed metallic construction shields against motor control fields)





Fig-3.2 SPEAG DASY52 System

FCC SAR Test Report

3.2.2 Probes

The SAR measurement is conducted with the dosimetric probe. The probe is specially designed and calibrated for use in liquid with high permittivity. The dosimetric probe has special calibration in liquid at different frequency.

Model	EX3DV4	
Construction	Symmetrical design with triangular core. Built-in shielding against static charges. PEEK enclosure material (resistant to organic solvents, e.g., DGBE).	
Frequency	10 MHz to 6 GHz Linearity: ± 0.2 dB	
Directivity	± 0.3 dB in HSL (rotation around probe axis) ± 0.5 dB in tissue material (rotation normal to probe axis)	
Dynamic Range	10 μ W/g to 100 mW/g Linearity: ± 0.2 dB (noise: typically < 1 μ W/g)	
Dimensions	Overall length: 337 mm (Tip: 20 mm) Tip diameter: 2.5 mm (Body: 12 mm) Typical distance from probe tip to dipole centers: 1 mm	

Model	ES3DV3	
Construction	Symmetrical design with triangular core. Interleaved sensors. Built-in shielding against static charges. PEEK enclosure material (resistant to organic solvents, e.g., DGBE).	
Frequency	10 MHz to 4 GHz Linearity: ± 0.2 dB	
Directivity	± 0.2 dB in HSL (rotation around probe axis) ± 0.3 dB in tissue material (rotation normal to probe axis)	
Dynamic Range	5 μ W/g to 100 mW/g Linearity: ± 0.2 dB	
Dimensions	Overall length: 337 mm (Tip: 20 mm) Tip diameter: 3.9 mm (Body: 12 mm) Distance from probe tip to dipole centers: 2.0 mm	

Model	ET3DV6	
Construction	Symmetrical design with triangular core Built-in optical fiber for surface detection system. Built-in shielding against static charges. PEEK enclosure material (resistant to organic solvents, e.g., DGBE)	
Frequency	10 MHz to 2.3 GHz; Linearity: ± 0.2 dB	
Directivity	± 0.2 dB in TSL (rotation around probe axis) ± 0.4 dB in TSL (rotation normal to probe axis)	
Dynamic Range	5 μ W/g to 100 mW/g; Linearity: ± 0.2 dB	
Dimensions	Overall length: 337 mm (Tip: 16 mm) Tip diameter: 6.8 mm (Body: 12 mm) Distance from probe tip to dipole centers: 2.7 mm	

FCC SAR Test Report

3.2.3 Data Acquisition Electronics (DAE)

Model	DAE3, DAE4	
Construction	Signal amplifier, multiplexer, A/D converter and control logic. Serial optical link for communication with DASY embedded system (fully remote controlled). Two step probe touch detector for mechanical surface detection and emergency robot stop.	
Measurement Range	-100 to +300 mV (16 bit resolution and two range settings: 4mV, 400mV)	
Input Offset Voltage	< 5µV (with auto zero)	
Input Bias Current	< 50 fA	
Dimensions	60 x 60 x 68 mm	

3.2.4 Phantoms

Model	Twin SAM	
Construction	The shell corresponds to the specifications of the Specific Anthropomorphic Mannequin (SAM) phantom defined in IEEE 1528 and IEC 62209-1. It enables the dosimetric evaluation of left and right hand phone usage as well as body mounted usage at the flat phantom region. A cover prevents evaporation of the liquid. Reference markings on the phantom allow the complete setup of all predefined phantom positions and measurement grids by teaching three points with the robot.	
Material	Vinylester, glass fiber reinforced (VE-GF)	
Shell Thickness	2 ± 0.2 mm (6 ± 0.2 mm at ear point)	
Dimensions	Length: 1000 mm Width: 500 mm Height: adjustable feet	
Filling Volume	approx. 25 liters	

Model	ELI	
Construction	Phantom for compliance testing of handheld and body-mounted wireless devices in the frequency range of 30 MHz to 6 GHz. ELI is fully compatible with the IEC 62209-2 standard and all known tissue simulating liquids. ELI has been optimized regarding its performance and can be integrated into our standard phantom tables. A cover prevents evaporation of the liquid. Reference markings on the phantom allow installation of the complete setup, including all predefined phantom positions and measurement grids, by teaching three points. The phantom is compatible with all SPEAG dosimetric probes and dipoles.	
Material	Vinylester, glass fiber reinforced (VE-GF)	
Shell Thickness	2.0 ± 0.2 mm (bottom plate)	
Dimensions	Major axis: 600 mm Minor axis: 400 mm	
Filling Volume	approx. 30 liters	

FCC SAR Test Report

3.2.5 Device Holder

Model	Mounting Device	
Construction	In combination with the Twin SAM Phantom or ELI4, the Mounting Device enables the rotation of the mounted transmitter device in spherical coordinates. Rotation point is the ear opening point. Transmitter devices can be easily and accurately positioned according to IEC, IEEE, FCC or other specifications. The device holder can be locked for positioning at different phantom sections (left head, right head, flat).	
Material	POM	

Model	Laptop Extensions Kit	
Construction	Simple but effective and easy-to-use extension for Mounting Device that facilitates the testing of larger devices according to IEC 62209-2 (e.g., laptops, cameras, etc.). It is lightweight and fits easily on the upper part of the Mounting Device in place of the phone positioner.	
Material	POM, Acrylic glass, Foam	

3.2.6 System Validation Dipoles

Model	D-Serial	
Construction	Symmetrical dipole with 1/4 balun. Enables measurement of feed point impedance with NWA. Matched for use near flat phantoms filled with tissue simulating solutions.	
Frequency	750 MHz to 5800 MHz	
Return Loss	> 20 dB	
Power Capability	> 100 W (f < 1GHz), > 40 W (f > 1GHz)	

3.2.7 Tissue Simulating Liquids

For SAR measurement of the field distribution inside the phantom, the phantom must be filled with homogeneous tissue simulating liquid to a depth of at least 15 cm. For head SAR testing, the liquid height from the ear reference point (ERP) of the phantom to the liquid top surface is larger than 15 cm. For body SAR testing, the liquid height from the center of the flat phantom to the liquid top surface is larger than 15 cm. The nominal dielectric values of the tissue simulating liquids in the phantom and the tolerance of 5% are listed in Table-3.1.

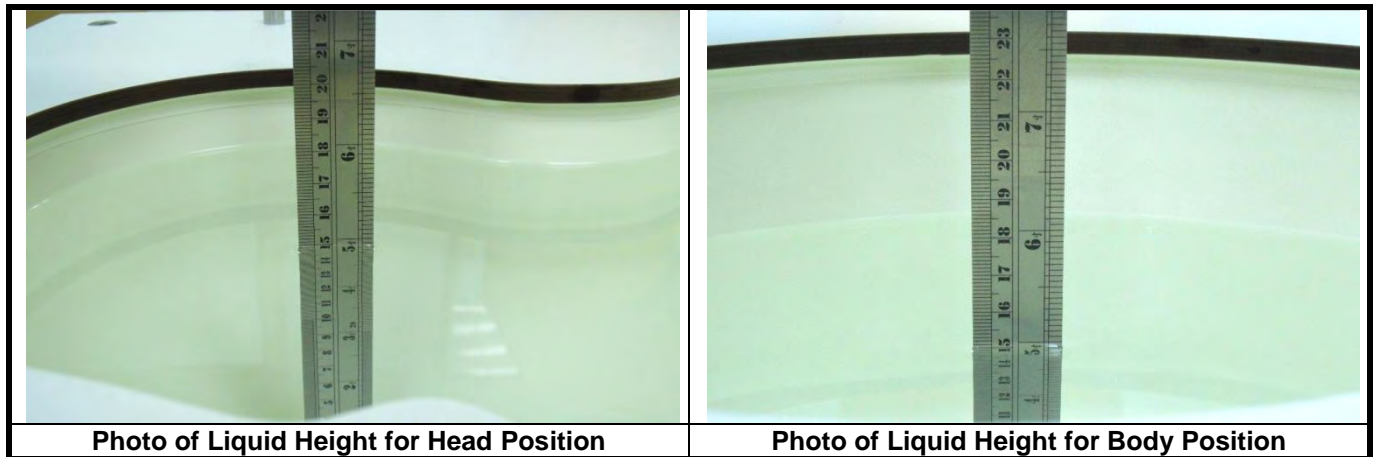

The dielectric properties of the head tissue simulating liquids are defined in IEEE 1528, and KDB 865664 D01 Appendix A. For the body tissue simulating liquids, the dielectric properties are defined in KDB 865664 D01 Appendix A. The dielectric properties of the tissue simulating liquids were verified prior to the SAR evaluation using a dielectric assessment kit and a network analyzer.

Table-3.1 Targets of Tissue Simulating Liquid

Frequency (MHz)	Target Permittivity	Range of $\pm 5\%$	Target Conductivity	Range of $\pm 5\%$
For Head				
750	41.9	39.8 ~ 44.0	0.89	0.85 ~ 0.93
835	41.5	39.4 ~ 43.6	0.90	0.86 ~ 0.95
900	41.5	39.4 ~ 43.6	0.97	0.92 ~ 1.02
1450	40.5	38.5 ~ 42.5	1.20	1.14 ~ 1.26
1640	40.3	38.3 ~ 42.3	1.29	1.23 ~ 1.35
1750	40.1	38.1 ~ 42.1	1.37	1.30 ~ 1.44
1800	40.0	38.0 ~ 42.0	1.40	1.33 ~ 1.47
1900	40.0	38.0 ~ 42.0	1.40	1.33 ~ 1.47
2000	40.0	38.0 ~ 42.0	1.40	1.33 ~ 1.47
2300	39.5	37.5 ~ 41.5	1.67	1.59 ~ 1.75
2450	39.2	37.2 ~ 41.2	1.80	1.71 ~ 1.89
2600	39.0	37.1 ~ 41.0	1.96	1.86 ~ 2.06
3500	37.9	36.0 ~ 39.8	2.91	2.76 ~ 3.06
5200	36.0	34.2 ~ 37.8	4.66	4.43 ~ 4.89
5300	35.9	34.1 ~ 37.7	4.76	4.52 ~ 5.00
5500	35.6	33.8 ~ 37.4	4.96	4.71 ~ 5.21
5600	35.5	33.7 ~ 37.3	5.07	4.82 ~ 5.32
5800	35.3	33.5 ~ 37.1	5.27	5.01 ~ 5.53
For Body				
750	55.5	52.7 ~ 58.3	0.96	0.91 ~ 1.01
835	55.2	52.4 ~ 58.0	0.97	0.92 ~ 1.02
900	55.0	52.3 ~ 57.8	1.05	1.00 ~ 1.10
1450	54.0	51.3 ~ 56.7	1.30	1.24 ~ 1.37
1640	53.8	51.1 ~ 56.5	1.40	1.33 ~ 1.47
1750	53.4	50.7 ~ 56.1	1.49	1.42 ~ 1.56
1800	53.3	50.6 ~ 56.0	1.52	1.44 ~ 1.60
1900	53.3	50.6 ~ 56.0	1.52	1.44 ~ 1.60
2000	53.3	50.6 ~ 56.0	1.52	1.44 ~ 1.60
2300	52.9	50.3 ~ 55.5	1.81	1.72 ~ 1.90
2450	52.7	50.1 ~ 55.3	1.95	1.85 ~ 2.05
2600	52.5	49.9 ~ 55.1	2.16	2.05 ~ 2.27
3500	51.3	48.7 ~ 53.9	3.31	3.14 ~ 3.48
5200	49.0	46.6 ~ 51.5	5.30	5.04 ~ 5.57
5300	48.9	46.5 ~ 51.3	5.42	5.15 ~ 5.69
5500	48.6	46.2 ~ 51.0	5.65	5.37 ~ 5.93
5600	48.5	46.1 ~ 50.9	5.77	5.48 ~ 6.06
5800	48.2	45.8 ~ 50.6	6.00	5.70 ~ 6.30

FCC SAR Test Report

The following table gives the recipes for tissue simulating liquids.

Table-3.2 Recipes of Tissue Simulating Liquid

Tissue Type	Bactericide	DGBE	HEC	NaCl	Sucrose	Triton X-100	Water	Diethylene Glycol Mono-hexylether
H750	0.2	-	0.2	1.5	56.0	-	42.1	-
H835	0.2	-	0.2	1.5	57.0	-	41.1	-
H900	0.2	-	0.2	1.4	58.0	-	40.2	-
H1450	-	43.3	-	0.6	-	-	56.1	-
H1640	-	45.8	-	0.5	-	-	53.7	-
H1750	-	47.0	-	0.4	-	-	52.6	-
H1800	-	44.5	-	0.3	-	-	55.2	-
H1900	-	44.5	-	0.2	-	-	55.3	-
H2000	-	44.5	-	0.1	-	-	55.4	-
H2300	-	44.9	-	0.1	-	-	55.0	-
H2450	-	45.0	-	0.1	-	-	54.9	-
H2600	-	45.1	-	0.1	-	-	54.8	-
H3500	-	8.0	-	0.2	-	20.0	71.8	-
H5G	-	-	-	-	-	17.2	65.5	17.3
B750	0.2	-	0.2	0.8	48.8	-	50.0	-
B835	0.2	-	0.2	0.9	48.5	-	50.2	-
B900	0.2	-	0.2	0.9	48.2	-	50.5	-
B1450	-	34.0	-	0.3	-	-	65.7	-
B1640	-	32.5	-	0.3	-	-	67.2	-
B1750	-	31.0	-	0.2	-	-	68.8	-
B1800	-	29.5	-	0.4	-	-	70.1	-
B1900	-	29.5	-	0.3	-	-	70.2	-
B2000	-	30.0	-	0.2	-	-	69.8	-
B2300	-	31.0	-	0.1	-	-	68.9	-
B2450	-	31.4	-	0.1	-	-	68.5	-
B2600	-	31.8	-	0.1	-	-	68.1	-
B3500	-	28.8	-	0.1	-	-	71.1	-
B5G	-	-	-	-	-	10.7	78.6	10.7

3.3 SAR System Verification

The system check verifies that the system operates within its specifications. It is performed daily or before every SAR measurement. The system check uses normal SAR measurements in the flat section of the phantom with a matched dipole at a specified distance. The system verification setup is shown as below.

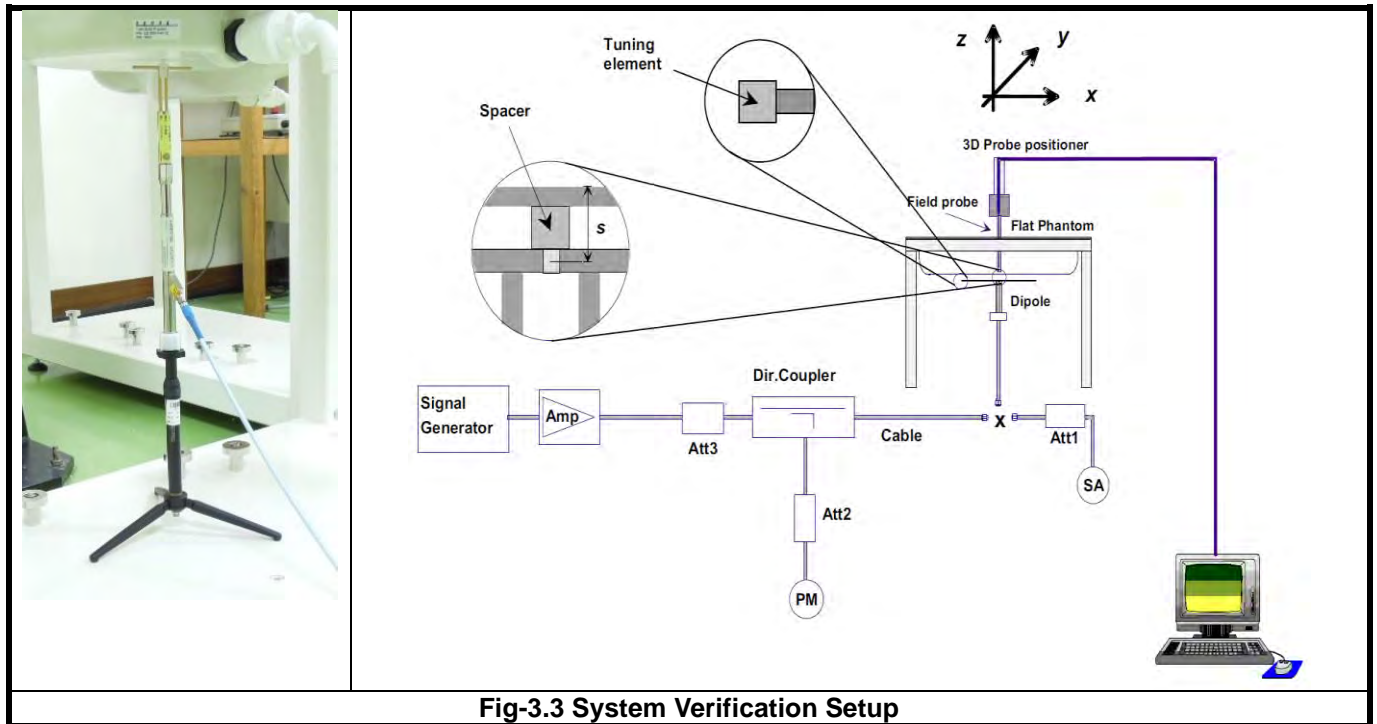

Fig-3.3 System Verification Setup

The validation dipole is placed beneath the flat phantom with the specific spacer in place. The distance spacer is touch the phantom surface with a light pressure at the reference marking and be oriented parallel to the long side of the phantom. The spectrum analyzer measures the forward power at the location of the system check dipole connector. The signal generator is adjusted for the desired forward power (250 mW is used for 700 MHz to 3 GHz, 100 mW is used for 3.5 GHz to 6 GHz) at the dipole connector and the power meter is read at that level. After connecting the cable to the dipole, the signal generator is readjusted for the same reading at power meter.

After system check testing, the SAR result will be normalized to 1W forward input power and compared with the reference SAR value derived from validation dipole certificate report. The deviation of system check should be within 10 %.

3.4 SAR Measurement Procedure

According to the SAR test standard, the recommended procedure for assessing the peak spatial-average SAR value consists of the following steps:

- (a) Power reference measurement
- (b) Area scan
- (c) Zoom scan
- (d) Power drift measurement

The SAR measurement procedures for each of test conditions are as follows:

- (a) Make EUT to transmit maximum output power
- (b) Measure conducted output power through RF cable
- (c) Place the EUT in the specific position of phantom
- (d) Perform SAR testing steps on the DASY system
- (e) Record the SAR value

3.4.1 Area & Zoom Scan Procedure

First Area Scan is used to locate the approximate location(s) of the local peak SAR value(s). The measurement grid within an Area Scan is defined by the grid extent, grid step size and grid offset. Next, in order to determine the EM field distribution in a three-dimensional spatial extension, Zoom Scan is required. The Zoom Scan is performed around the highest E-field value to determine the averaged SAR-distribution over 10 g. According to KDB 865664 D01, the resolution for Area and Zoom scan is specified in the table below.

Items	<= 2 GHz	2-3 GHz	3-4 GHz	4-5 GHz	5-6 GHz
Area Scan ($\Delta x, \Delta y$)	<= 15 mm	<= 12 mm	<= 12 mm	<= 10 mm	<= 10 mm
Zoom Scan ($\Delta x, \Delta y$)	<= 8 mm	<= 5 mm	<= 5 mm	<= 4 mm	<= 4 mm
Zoom Scan (Δz)	<= 5 mm	<= 5 mm	<= 4 mm	<= 3 mm	<= 2 mm
Zoom Scan Volume	>= 30 mm	>= 30 mm	>= 28 mm	>= 25 mm	>= 22 mm

Note:

When zoom scan is required and report SAR is <= 1.4 W/kg, the zoom scan resolution of $\Delta x / \Delta y$ (2-3GHz: <= 8 mm, 3-4GHz: <= 7 mm, 4-6GHz: <= 5 mm) may be applied.

3.4.2 Volume Scan Procedure

The volume scan is used for assess overlapping SAR distributions for antennas transmitting in different frequency bands. It is equivalent to an oversized zoom scan used in standalone measurements. The measurement volume will be used to enclose all the simultaneous transmitting antennas. For antennas transmitting simultaneously in different frequency bands, the volume scan is measured separately in each frequency band. In order to sum correctly to compute the 1g aggregate SAR, the EUT remain in the same test position for all measurements and all volume scan use the same spatial resolution and grid spacing. When all volume scan were completed, the software, SEMCAD postprocessor can combine and subsequently superpose these measurement data to calculating the multiband SAR.

3.4.3 Power Drift Monitoring

All SAR testing is under the EUT install full charged battery and transmit maximum output power. In DASY measurement software, the power reference measurement and power drift measurement procedures are used for monitoring the power drift of EUT during SAR test. Both these procedures measure the field at a specified reference position before and after the SAR testing. The software will calculate the field difference in dB. If the power drift more than 5%, the SAR will be retested.

3.4.4 Spatial Peak SAR Evaluation

The procedure for spatial peak SAR evaluation has been implemented according to the test standard. It can be conducted for 1g and 10g, as well as for user-specific masses. The DASY software includes all numerical procedures necessary to evaluate the spatial peak SAR value.

The base for the evaluation is a "cube" measurement. The measured volume must include the 1g and 10g cubes with the highest averaged SAR values. For that purpose, the center of the measured volume is aligned to the interpolated peak SAR value of a previously performed area scan.

The entire evaluation of the spatial peak values is performed within the post-processing engine (SEMCAD). The system always gives the maximum values for the 1g and 10g cubes. The algorithm to find the cube with highest averaged SAR is divided into the following stages:

- (a) Extraction of the measured data (grid and values) from the Zoom Scan
- (b) Calculation of the SAR value at every measurement point based on all stored data (A/D values and measurement parameters)
- (c) Generation of a high-resolution mesh within the measured volume
- (d) Interpolation of all measured values from the measurement grid to the high-resolution grid
- (e) Extrapolation of the entire 3-D field distribution to the phantom surface over the distance from sensor to surface
- (f) Calculation of the averaged SAR within masses of 1g and 10g

3.4.5 SAR Averaged Methods

In DASY, the interpolation and extrapolation are both based on the modified Quadratic Shepard's method. The interpolation scheme combines a least-square fitted function method and a weighted average method which are the two basic types of computational interpolation and approximation.

Extrapolation routines are used to obtain SAR values between the lowest measurement points and the inner phantom surface. The extrapolation distance is determined by the surface detection distance and the probe sensor offset. The uncertainty increases with the extrapolation distance. To keep the uncertainty within 1% for the 1 g and 10 g cubes, the extrapolation distance should not be larger than 5 mm.

4. SAR Measurement Evaluation

4.1 EUT Configuration and Setting

<Connections between EUT and System Simulator>

For WWAN SAR testing, the EUT was linked and controlled by base station emulator. Communication between the EUT and the emulator was established by air link. The distance between the EUT and the communicating antenna of the emulator is larger than 50 cm and the output power radiated from the emulator antenna is at least 30 dB smaller than the output power of EUT. The EUT was set from the emulator to radiate maximum output power during SAR testing.

<Considerations Related to GSM / GPRS / EDGE for Setup and Testing>

The maximum multi-slot capability supported by this device is as below.

1. This EUT is class B device
2. This EUT supports GPRS multi-slot class 12 (max. uplink: 4, max. downlink: 4, total timeslots: 5)
3. This EUT supports EDGE multi-slot class 12 (max. uplink: 4, max. downlink: 4, total timeslots: 5)

For GSM850 frequency band, the power control level is set to 5 for GSM mode and GPRS (GMSK: CS1), and set to 8 for EDGE (GMSK: MCS1, 8PSK: MCS9). For GSM1900 frequency band, the power control level is set to 0 for GSM mode and GPRS (GMSK: CS1), and set to 2 for EDGE (GMSK: MCS1, 8PSK: MCS9).

SAR test reduction for GPRS and EDGE modes is determined by the source-based time-averaged output power specified for production units, including tune-up tolerance. The data mode with highest specified time-averaged output power should be tested for SAR compliance in the applicable exposure conditions. For modes with the same specified maximum output power and tolerance, the higher number time-slot configuration should be tested.

<Considerations Related to WCDMA for Setup and Testing>

WCDMA Handsets Head SAR

SAR for next to the ear head exposure is measured using a 12.2 kbps RMC with TPC bits configured to all “1’s”. The 3G SAR test reduction procedure is applied to AMR configurations with 12.2 kbps RMC as the primary mode.

WCDMA Handsets Body-worn SAR

SAR for body-worn configurations is measured using a 12.2 kbps RMC with TPC bits configured to all “1’s”. The 3G SAR test reduction procedure is applied to other spreading codes and multiple DPDCH_n configurations supported by the handset with 12.2 kbps RMC as the primary mode.

Handsets with Release 5 HSDPA

The 3G SAR test reduction procedure is applied to HSDPA body-worn configurations with 12.2 kbps RMC as the primary mode. Otherwise, SAR is measured for HSDPA using the HSDPA body SAR procedures in the “Release 5 HSDPA Data Devices”, for the highest reported SAR body-worn exposure configuration in 12.2 kbps RMC. Handsets with both HSDPA and HSUPA are tested according to Release 6 HSPA test procedures.

Handsets with Release 6 HSUPA

The 3G SAR test reduction procedure is applied to HSPA (HSUPA/HSDPA with RMC) body-worn configurations with 12.2 kbps RMC as the primary mode. Otherwise, SAR is measured for HSPA using the HSPA body SAR procedures in the “Release 6 HSPA Data Devices”, for the highest reported body-worn exposure SAR configuration in 12.2 kbps RMC. When VOIP is applicable for next to the ear head exposure in HSPA, the 3G SAR test reduction procedure is applied to HSPA with 12.2 kbps RMC as the primary mode; otherwise, the same HSPA configuration used for body-worn measurements is tested for next to the ear head exposure.

Release 5 HSDPA Data Devices

The 3G SAR test reduction procedure is applied to body SAR with 12.2 kbps RMC as the primary mode. Otherwise, body SAR for HSDPA is measured using an FRC with H-Set 1 in Sub-test 1 and a 12.2 kbps RMC configured in Test Loop Mode 1, for the highest reported SAR configuration in 12.2 kbps RMC without HSDPA. HSDPA is configured according to the applicable UE category of a test device. The number of HS-DSCH / HS-PDSCHs, HARQ processes, minimum inter-TTI interval, transport block sizes and RV coding sequence are defined by the H-set. To maintain a consistent test configuration and stable transmission conditions, QPSK is used in the H-set for SAR testing. HS-DPCCH should be configured with a CQI feedback cycle of 4 ms and a CQI repetition factor of 2 to maintain a constant rate of active CQI slots. DPCCH and DPDCH gain factors (β_c , β_d), and HS-DPCCH power offset parameters (Δ_{ACK} , Δ_{NACK} , Δ_{CQI}) are set according to values indicated in below. The CQI value is determined by the UE category, transport block size, number of HS-PDSCHs and modulation used in the H-set.

Sub-test	β_c	β_d	β_d (SF)	β_c/β_d	$\beta_{HS}^{(1)(2)}$	CM ⁽³⁾ (dB)	MPR ⁽³⁾ (dB)
1	2/15	15/15	64	2/15	4/15	0.0	0.0
2	12/15 ⁽⁴⁾	15/15 ⁽⁴⁾	64	12/15 ⁽⁴⁾	24/15	1.0	0.0
3	15/15	8/15	64	15/8	30/15	1.5	0.5
4	15/15	4/15	64	15/4	30/15	1.5	0.5

Note 1: Δ_{ACK} , Δ_{NACK} and $\Delta_{CQI} = 30/15$ with $\beta_{HS} = 30/15 * \beta_c$.
 Note 2: For the HS-DPCCH power mask requirement test in clause 5.2C, 5.7A, and the Error Vector Magnitude (EVM) with HS-DPCCH test in clause 5.13.1A, and HSDPA EVM with phase discontinuity in clause 5.13.1AA, Δ_{ACK} and $\Delta_{NACK} = 30/15$ with $\beta_{HS} = 30/15 * \beta_c$, and $\Delta_{CQI} = 24/15$ with $\beta_{HS} = 24/15 * \beta_c$.
 Note 3: CM = 1 for $\beta_c/\beta_d = 12/15$, $\beta_{HS}/\beta_c = 24/15$. For all other combinations of DPDCH, DPCCH and HS-DPCCH the MPR is based on the relative CM difference. This is applicable for only UEs that support HSDPA in release 6 and later releases.
 Note 4: For subtest 2 the β_c/β_d ratio of 12/15 for the TFC during the measurement period (TF1, TF0) is achieved by setting the signalled gain factors for the reference TFC (TF1, TF1) to $\beta_c = 11/15$ and $\beta_d = 15/15$.

Release 6 HSUPA Data Devices

The 3G SAR test reduction procedure is applied to body SAR with 12.2 kbps RMC as the primary mode. Otherwise, body SAR for HSPA is measured with E-DCH Sub-test 5, using H-Set 1 and QPSK for FRC and a 12.2 kbps RMC configured in Test Loop Mode 1 and power control algorithm 2, according to the highest reported body SAR configuration in 12.2 kbps RMC without HSPA. When VOIP applies to head exposure, the 3G SAR test reduction procedure is applied with 12.2 kbps RMC as the primary mode. Otherwise, the same HSPA configuration used for body SAR measurements are applied to head exposure testing. Due to inner loop power control requirements in HSPA, a communication test set is required for output power and SAR tests. The 12.2 kbps RMC, FRC H-set 1 and E-DCH configurations for HSPA are configured according to the β values indicated in below.

FCC SAR Test Report

Sub-test	β_c	β_d	β_d (SF)	β_c / β_d	$\beta_{HS}^{(1)}$	β_{ec}	$\beta_{ed}^{(4)(5)}$	β_{ed} (SF)	β_{ed} (Codes)	CM ⁽²⁾ (dB)	MPR ⁽²⁾⁽⁶⁾ (dB)	AG ⁽⁵⁾ Index	E-TFCI
1	11/15 ⁽³⁾	15/15 ⁽³⁾	64	11/15 ⁽³⁾	22/15	209/225	1309/225	4	1	1.0	0.0	20	75
2	6/15	15/15	64	6/15	12/15	12/15	94/75	4	1	3.0	2.0	12	67
3	15/15	9/15	64	15/9	30/15	30/15	β_{ed1} : 47/15 β_{ed2} : 47/15	4 4	2	2.0	1.0	15	92
4	2/15	15/15	64	2/15	4/15	2/15	56/75	4	1	3.0	2.0	17	71
5	15/15	0	-	-	5/15	5/15	47/15	4	1	1.0	0.0	12	67

Note 1: For sub-test 1 to 4, Δ_{ACK} , Δ_{NACK} and $\Delta_{CQI} = 30/15$ with $\beta_{HS} = 30/15 * \beta_c$. For sub-test 5, Δ_{ACK} , Δ_{NACK} and $\Delta_{CQI} = 5/15$ with $\beta_{HS} = 5/15 * \beta_c$.
Note 2: CM = 1 for $\beta_c/\beta_d = 12/15$, $\beta_{HS}/\beta_c = 24/15$. For all other combinations of DPDCH, DPCCH, HS-DPCCH, E-DPDCH and E-DPCCH the MPR is based on the relative CM difference.
Note 3: For subtest 1 the β_c/β_d ratio of 11/15 for the TFC during the measurement period (TF1, TF0) is achieved by setting the signalled gain factors for the reference TFC (TF1, TF1) to $\beta_c = 10/15$ and $\beta_d = 15/15$.
Note 4: In case of testing by UE using E-DPDCH Physical Layer category 1, Sub-test 3 is omitted according to TS25.306 Table 5.1g.
Note 5: β_{ed} can not be set directly; it is set by Absolute Grant Value.
Note 6: For subtests 2, 3 and 4, UE may perform E-DPDCH power scaling at max power which could results in slightly smaller MPR values.

<Considerations Related to WLAN for Setup and Testing>

In general, various vendor specific external test software and chipset based internal test modes are typically used for SAR measurement. These chipset based test mode utilities are generally hardware and manufacturer dependent, and often include substantial flexibility to reconfigure or reprogram a device. A Wi-Fi device must be configured to transmit continuously at the required data rate, channel bandwidth and signal modulation, using the highest transmission duty factor supported by the test mode tools for SAR measurement. The test frequencies established using test mode must correspond to the actual channel frequencies. When 802.11 frame gaps are accounted for in the transmission, a maximum transmission duty factor of 92 - 96% is typically achievable in most test mode configurations. A minimum transmission duty factor of 85% is required to avoid certain hardware and device implementation issues related to wide range SAR scaling. In addition, a periodic transmission duty factor is required for current generation SAR systems to measure SAR correctly. The reported SAR must be scaled to 100% transmission duty factor to determine compliance at the maximum tune-up tolerance limit.

According to KDB 248227 D01, this device has installed WLAN engineering testing software which can provide continuous transmitting RF signal. During WLAN SAR testing, this device was operated to transmit continuously at the maximum transmission duty with specified transmission mode, operating frequency, lowest data rate, and maximum output power.

Initial Test Configuration

An initial test configuration is determined for OFDM transmission modes in 2.4 GHz and 5 GHz bands according to the channel bandwidth, modulation and data rate combination(s) with the highest maximum output power specified for production units in each standalone and aggregated frequency band. When the same maximum power is specified for multiple transmission modes in a frequency band, the largest channel bandwidth, lowest order modulation, lowest data rate and lowest order 802.11a/g/n/ac mode is used for SAR measurement, on the highest measured output power channel in the initial test configuration, for each frequency band.

Subsequent Test Configuration

SAR measurement requirements for the remaining 802.11 transmission mode configurations that have not been tested in the initial test configuration are determined separately for each standalone and aggregated frequency band, in each exposure condition, according to the maximum output power specified for production units. Additional power measurements may be required to determine if SAR measurements are required for subsequent highest output power channels in a subsequent test configuration. When the highest reported SAR for the initial test configuration according to the initial test position or fixed exposure position requirements, is adjusted by the ratio of the subsequent test configuration to initial test configuration specified maximum output power and the adjusted SAR is ≤ 1.2 W/kg, SAR is not required for that subsequent test configuration.

SAR Test Configuration and Channel Selection

When multiple channel bandwidth configurations in a frequency band have the same specified maximum output power, the initial test configuration is using largest channel bandwidth, lowest order modulation, lowest data rate, and lowest order 802.11 mode (i.e., 802.11a is chosen over 802.11n then 802.11ac or 802.11g is chosen over 802.11n). After an initial test configuration is determined, if multiple test channels have the same measured maximum output power, the channel chosen for SAR measurement is determined according to the following.

- 1) The channel closest to mid-band frequency is selected for SAR measurement.
- 2) For channels with equal separation from mid-band frequency; for example, high and low channels or two mid-band channels, the higher frequency (number) channel is selected for SAR measurement.

Test Reduction for U-NII-1 (5.2 GHz) and U-NII-2A (5.3 GHz) Bands

For devices that operate in both U-NII bands using the same transmitter and antenna(s), SAR test reduction is determined according to the following.

- 1) When the same maximum output power is specified for both bands, begin SAR measurement in U-NII-2A band by applying the OFDM SAR requirements. If the highest reported SAR for a test configuration is ≤ 1.2 W/kg, SAR is not required for U-NII-1 band for that configuration (802.11 mode and exposure condition).
- 2) When different maximum output power is specified for the bands, begin SAR measurement in the band with higher specified maximum output power. The highest reported SAR for the tested configuration is adjusted by the ratio of lower to higher specified maximum output power for the two bands. When the adjusted SAR is ≤ 1.2 W/kg, SAR is not required for the band with lower maximum output power in that test configuration.

4.2 EUT Testing Position

According to KDB 648474 D04, handsets are tested for SAR compliance in head, body-worn accessory and other use configurations described in the following subsections.

4.2.1 Head Exposure Conditions

Head exposure is limited to next to the ear voice mode operations. Head SAR compliance is tested according to the test positions defined in IEEE Std 1528-2003 using the SAM phantom illustrated as below.

1. Define two imaginary lines on the handset
 - (a) The vertical centerline passes through two points on the front side of the handset - the midpoint of the width w_t of the handset at the level of the acoustic output, and the midpoint of the width w_b of the bottom of the handset.
 - (b) The horizontal line is perpendicular to the vertical centerline and passes through the center of the acoustic output. The horizontal line is also tangential to the face of the handset at point A.
 - (c) The two lines intersect at point A. Note that for many handsets, point A coincides with the center of the acoustic output; however, the acoustic output may be located elsewhere on the horizontal line. Also note that the vertical centerline is not necessarily parallel to the front face of the handset, especially for clamshell handsets, handsets with flip covers, and other irregularly shaped handsets.

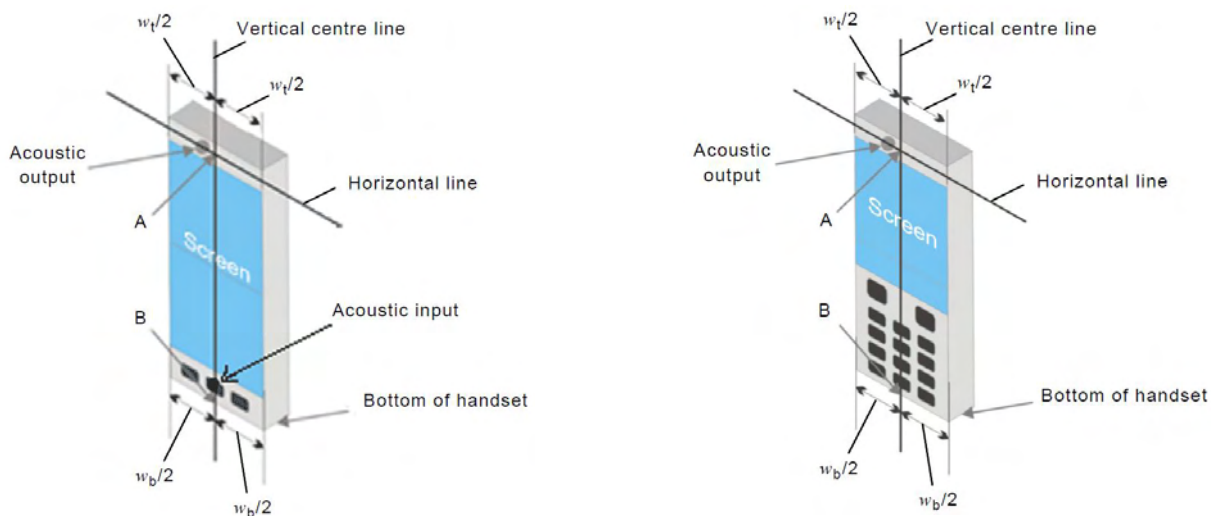

Fig-4.1 Illustration for Handset Vertical and Horizontal Reference Lines

2. Cheek Position

- (a) To position the device with the vertical center line of the body of the device and the horizontal line crossing the center piece in a plane parallel to the sagittal plane of the phantom. While maintaining the device in this plane, align the vertical center line with the reference plane containing the three ear and mouth reference point (M: Mouth, RE: Right Ear, and LE: Left Ear) and align the center of the ear piece with the line RE-LE.
- (b) To move the device towards the phantom with the ear piece aligned with the line LE-RE until the phone touched the ear. While maintaining the device in the reference plane and maintaining the phone contact with the ear, move the bottom of the phone until any point on the front side is in contact with the cheek of the phantom or until contact with the ear is lost (see Fig-4.2).

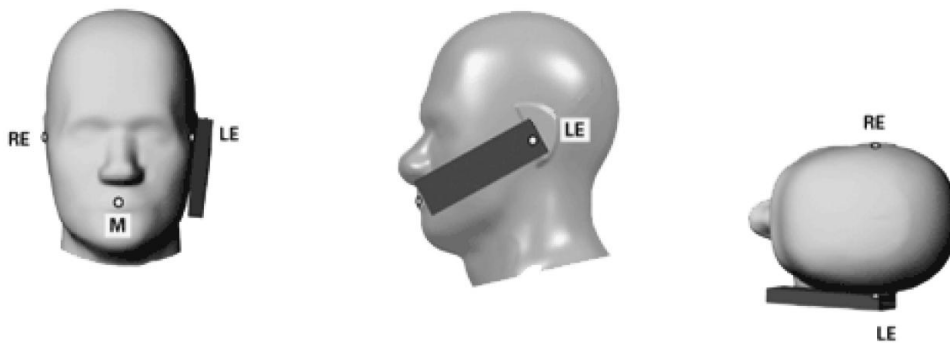

Fig-4.2 Illustration for Cheek Position

3. Tilted Position

- (a) To position the device in the “cheek” position described above.
- (b) While maintaining the device the reference plane described above and pivoting against the ear, moves it outward away from the mouth by an angle of 15 degrees or until contact with the ear is lost (see Fig-4.3).

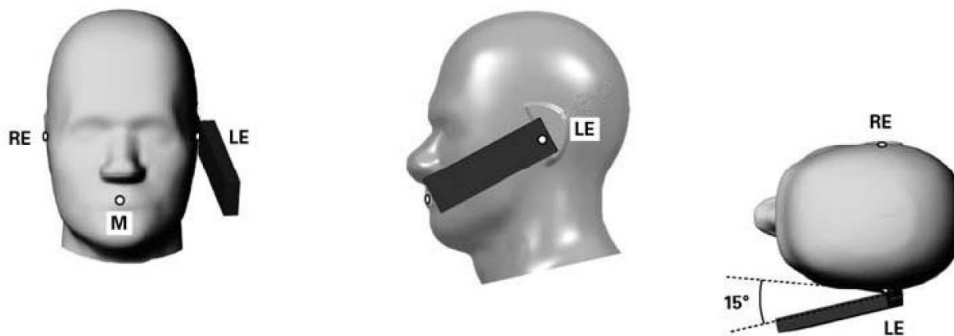

Fig-4.3 Illustration for Tilted Position

4.2.2 Body-worn Accessory Exposure Conditions

Body-worn accessory exposure is typically related to voice mode operations when handsets are carried in body-worn accessories. The body-worn accessory procedures in KDB 447498 are used to test for body-worn accessory SAR compliance, without a headset connected to it. This enables the test results for such configuration to be compatible with that required for hotspot mode when the body-worn accessory test separation distance is greater than or equal to that required for hotspot mode. When the reported SAR for a body-worn accessory, measured without a headset connected to the handset, is $> 1.2 \text{ W/kg}$, the highest reported SAR configuration for that wireless mode and frequency band should be repeated for that body-worn accessory with a headset attached to the handset.

Body-worn accessories that do not contain metallic or conductive components may be tested according to worst-case exposure configurations, typically according to the smallest test separation distance required for the group of body-worn accessories with similar operating and exposure characteristics. All body-worn accessories containing metallic components are tested in conjunction with the host device.

Body-worn accessory SAR compliance is based on a single minimum test separation distance for all wireless and operating modes applicable to each body-worn accessory used by the host, and according to the relevant voice and/or data mode transmissions and operations. If a body-worn accessory supports voice only operations in its normal and expected use conditions, testing of data mode for body-worn compliance is not required.

A conservative minimum test separation distance for supporting off-the-shelf body-worn accessories that may be acquired by users of consumer handsets is used to test for body-worn accessory SAR compliance. This distance is determined by the handset manufacturer, according to the requirements of Supplement C 01-01. Devices that are designed to operate on the body of users using lanyards and straps, or without requiring additional body-worn accessories, will be tested using a conservative minimum test separation distance $\leq 5 \text{ mm}$ to support compliance.

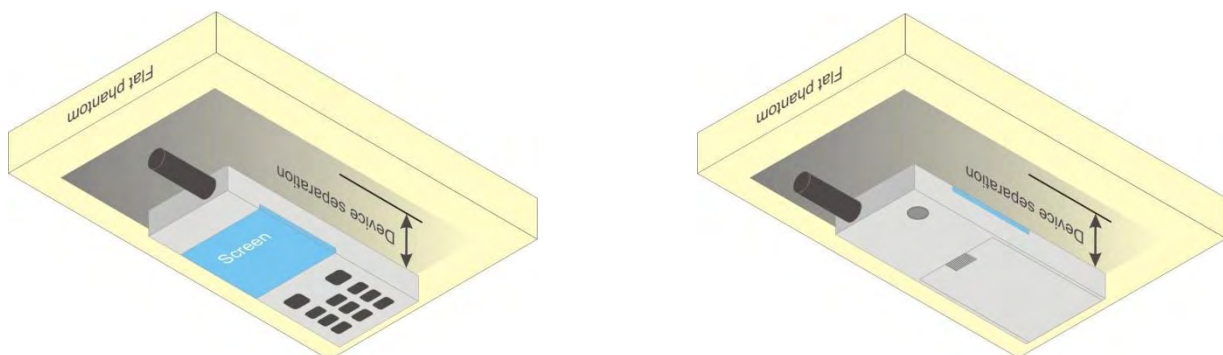
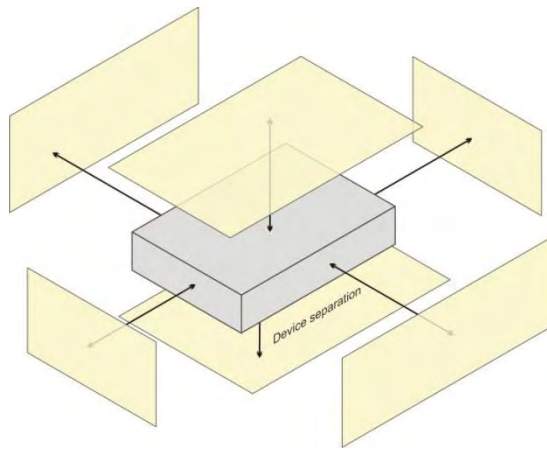

Fig-4.4 Illustration for Body Worn Position

4.2.3 Hotspot Mode Exposure Conditions

For handsets that support hotspot mode operations, with wireless router capabilities and various web browsing functions, the relevant hand and body exposure conditions are tested according to the hotspot SAR procedures in KDB 941225 D06. A test separation distance of 10 mm is required between the phantom and all surfaces and edges with a transmitting antenna located within 25 mm from that surface or edge. When the form factor of a handset is smaller than 9 cm x 5 cm, a test separation distance of 5 mm (instead of 10 mm) is required for testing hotspot mode. When the separation distance required for body-worn accessory testing is larger than or equal to that tested for hotspot mode, in the same wireless mode and for the same surface of the phone, the hotspot mode SAR data may be used to support body-worn accessory SAR compliance for that particular configuration (surface).



Based on the antenna location shown on appendix D of this report, the SAR testing required for hotspot mode is listed as below.

Antenna	Front Face	Rear Face	Left Side	Right Side	Top Side	Bottom Side
WWAN	V	V	V	V		V
WLAN / BT	V	V		V	V	

4.2.4 SAR Test Exclusion Evaluations

According to KDB 447498 D01, the SAR test exclusion condition is based on source-based time-averaged maximum conducted output power, adjusted for tune-up tolerance, and the minimum test separation distance required for the exposure conditions. The SAR exclusion threshold is determined by the following formula.

$$\frac{\text{Max. Tune up Power}_{(mW)}}{\text{Min. Test Separation Distance}_{(mm)}} \times \sqrt{f_{(GHz)}} \leq 3.0 \text{ for SAR-1g, } \leq 7.5 \text{ for SAR-10g}$$

When the minimum test separation distance is < 5 mm, a distance of 5 mm is applied to determine SAR test exclusion.

Mode	Max. Tune-up Power (dBm)	Max. Tune-up Power (mW)	Body-Worn			Holster			Extremity		
			Ant. to Surface (mm)	Calculated Result	Require SAR Testing?	Ant. to Surface (mm)	Calculated Result	Require SAR Testing?	Ant. to Surface (mm)	Calculated Result	Require SAR Testing?
BT	3.5	2.24	15	0.24	No	5	0.71	No	5	0.71	No

4.3 Tissue Verification

The measuring results for tissue simulating liquid are shown as below.

Test Date	Tissue Type	Frequency (MHz)	Liquid Temp. (°C)	Measured Conductivity (σ)	Measured Permittivity (ϵ_r)	Target Conductivity (σ)	Target Permittivity (ϵ_r)	Conductivity Deviation (%)	Permittivity Deviation (%)
Aug. 13, 2017	Head	750	23.6	0.886	42.919	0.89	41.9	-0.45	2.43
Aug. 21, 2017	Head	835	23.2	0.903	42.765	0.90	41.5	0.33	3.05
Sep. 12, 2017	Head	835	23.4	0.922	41.329	0.90	41.5	2.44	-0.41
Aug. 14, 2017	Head	1750	23.6	1.324	39.865	1.37	40.1	-3.36	-0.59
Aug. 21, 2017	Head	1750	23.2	1.335	38.757	1.37	40.1	-2.55	-3.35
Aug. 22, 2017	Head	1900	23.2	1.460	38.262	1.40	40.0	4.29	-4.35
Sep. 12, 2017	Head	1900	23.4	1.462	39.099	1.40	40.0	4.43	-2.25
Sep. 27, 2017	Head	1900	23.3	1.450	39.271	1.40	40.0	3.57	-1.82
Aug. 16, 2017	Head	2450	23.3	1.852	38.383	1.80	39.2	2.89	-2.08
Sep. 28, 2017	Head	5300	23.6	4.920	35.436	4.76	35.9	3.36	-1.29
Aug. 23, 2017	Head	5600	23.3	5.132	36.728	5.07	35.5	1.22	3.46
Aug. 23, 2017	Head	5800	23.3	5.374	36.384	5.27	35.3	1.97	3.07
Aug. 13, 2017	Body	750	23.6	0.912	55.743	0.96	55.5	-5.00	0.44
Sep. 03, 2017	Body	750	23.3	0.958	55.485	0.96	55.5	-0.21	-0.03
Aug. 13, 2017	Body	835	23.6	0.968	54.993	0.97	55.2	-0.21	-0.38
Aug. 22, 2017	Body	835	23.3	1.002	54.231	0.97	55.2	3.30	-1.76
Sep. 03, 2017	Body	835	23.1	0.980	56.496	0.97	55.2	1.03	2.35
Sep. 14, 2017	Body	835	23.1	1.002	54.242	0.97	55.2	3.30	-1.74
Aug. 12, 2017	Body	1750	23.3	1.428	51.415	1.49	53.4	-4.16	-3.72
Aug. 14, 2017	Body	1750	23.6	1.452	52.476	1.49	53.4	-2.55	-1.73
Aug. 22, 2017	Body	1750	23.4	1.434	51.402	1.49	53.4	-3.76	-3.74
Sep. 03, 2017	Body	1750	23.3	1.429	51.404	1.49	53.4	-4.09	-3.74
Aug. 12, 2017	Body	1900	23.3	1.560	50.965	1.52	53.3	2.63	-4.38
Aug. 14, 2017	Body	1900	23.6	1.586	52.033	1.52	53.3	4.34	-2.38
Aug. 22, 2017	Body	1900	23.1	1.570	51.004	1.52	53.3	3.29	-4.31
Sep. 03, 2017	Body	1900	23.3	1.565	51.015	1.52	53.3	2.96	-4.29
Aug. 17, 2017	Body	2450	23.2	2.024	51.413	1.95	52.7	3.79	-2.44
Aug. 24, 2017	Body	2450	23.4	1.997	51.334	1.95	52.7	2.41	-2.59
Sep. 03, 2017	Body	2450	23.1	2.033	51.900	1.95	52.7	4.26	-1.52
Sep. 28, 2017	Body	5300	23.3	5.523	47.744	5.42	48.9	1.90	-2.36
Aug. 23, 2017	Body	5600	23.3	5.922	47.005	5.77	48.5	2.63	-3.08
Aug. 23, 2017	Body	5800	23.3	6.211	46.610	6.00	48.2	3.52	-3.30

FCC SAR Test Report

Test Date	Tissue Type	Frequency (MHz)	Liquid Temp. (°C)	Measured Conductivity (σ)	Measured Permittivity (ϵ_r)	Target Conductivity (σ)	Target Permittivity (ϵ_r)	Conductivity Deviation (%)	Permittivity Deviation (%)
Aug. 13, 2017	Body	750	23.6	0.912	55.743	0.96	55.5	-5.00	0.44
		707.5		0.920	56.834	0.96	55.5	-4.17	2.40
		710		0.923	56.822	0.96	55.5	-3.85	2.38
Aug. 13, 2017	Body	835	23.6	0.968	54.993	0.97	55.2	-0.21	-0.38
		836.5		0.970	54.990	0.97	55.2	0.00	-0.38
		846.6		0.979	54.908	0.98	55.2	-0.51	-0.46
		848.8		0.981	54.884	0.97	55.2	1.13	-0.57
Aug. 14, 2017	Body	1750	23.6	1.452	52.476	1.49	53.4	-2.55	-1.73
		1732.5		1.436	52.524	1.48	53.5	-2.71	-1.75
		1752.6		1.455	52.464	1.49	53.4	-2.41	-1.73
Aug. 14, 2017	Body	1900	23.6	1.586	52.033	1.52	53.3	4.34	-2.38
		1880		1.569	52.098	1.52	53.3	3.22	-2.26
Aug. 14, 2017	Body	1900	23.6	1.586	52.033	1.52	53.3	4.34	-2.38
		1850.2		1.543	52.181	1.52	53.3	1.51	-2.10
Aug. 24, 2017	Body	2450	23.4	1.997	51.334	1.95	52.7	2.41	-2.59
		2437		1.982	51.361	1.94	52.7	2.32	-2.56
Sep. 28, 2017	Body	5300	23.3	5.523	47.744	5.42	48.9	1.90	-2.36
		5270		5.497	47.850	5.38	48.9	2.16	-2.19
Aug. 24, 2017	Body	5600	23.5	5.894	46.817	5.77	48.5	2.15	-3.47
		5690		6.014	46.684	5.87	48.4	2.40	-3.47
Aug. 24, 2017	Body	5800	23.5	6.172	46.486	6.00	48.2	2.87	-3.56
		5775		6.150	46.565	5.97	48.2	3.00	-3.45

Note:

The dielectric properties of the tissue simulating liquid must be measured within 24 hours before the SAR testing and within $\pm 5\%$ of the target values. Liquid temperature during the SAR testing must be within $\pm 2^\circ\text{C}$.

FCC SAR Test Report

4.4 System Validation

The SAR measurement system was validated according to procedures in KDB 865664 D01. The validation status in tabulated summary is as below.

Test Date	Probe S/N	Calibration Point		Measured Conductivity (σ)	Measured Permittivity (ϵ_r)	Validation for CW			Validation for Modulation		
						Sensitivity Range	Probe Linearity	Probe Isotropy	Modulation Type	Duty Factor	PAR
Aug. 13, 2017	7375	Head	750	0.886	42.919	Pass	Pass	Pass	N/A	N/A	N/A
Aug. 21, 2017	1790	Head	835	0.903	42.765	Pass	Pass	Pass	N/A	N/A	N/A
Sep. 12, 2017	1790	Head	835	0.922	41.329	Pass	Pass	Pass	GMSK	Pass	N/A
Aug. 14, 2017	7375	Head	1750	1.324	39.865	Pass	Pass	Pass	N/A	N/A	N/A
Aug. 21, 2017	1790	Head	1750	1.335	38.757	Pass	Pass	Pass	N/A	N/A	N/A
Aug. 22, 2017	1790	Head	1900	1.460	38.262	Pass	Pass	Pass	N/A	N/A	N/A
Sep. 12, 2017	1790	Head	1900	1.462	39.099	Pass	Pass	Pass	GMSK	Pass	N/A
Sep. 27, 2017	1790	Head	1900	1.450	39.271	Pass	Pass	Pass	N/A	N/A	N/A
Aug. 16, 2017	7375	Head	2450	1.852	38.383	Pass	Pass	Pass	OFDM	N/A	Pass
Sep. 28, 2017	3971	Head	5300	4.920	35.436	Pass	Pass	Pass	OFDM	N/A	Pass
Aug. 23, 2017	7375	Head	5600	5.132	36.728	Pass	Pass	Pass	OFDM	N/A	Pass
Aug. 23, 2017	7375	Head	5800	5.374	36.384	Pass	Pass	Pass	OFDM	N/A	Pass
Aug. 13, 2017	7375	Body	750	0.912	55.743	Pass	Pass	Pass	N/A	N/A	N/A
Sep. 03, 2017	3971	Body	750	0.958	55.485	Pass	Pass	Pass	N/A	N/A	N/A
Aug. 13, 2017	7375	Body	835	0.968	54.993	Pass	Pass	Pass	N/A	N/A	N/A
Aug. 22, 2017	7375	Body	835	1.002	54.231	Pass	Pass	Pass	GMSK	Pass	N/A
Sep. 03, 2017	3971	Body	835	0.980	56.496	Pass	Pass	Pass	N/A	N/A	N/A
Sep. 14, 2017	7375	Body	835	1.002	54.242	Pass	Pass	Pass	GMSK	Pass	N/A
Aug. 12, 2017	3650	Body	1750	1.428	51.415	Pass	Pass	Pass	N/A	N/A	N/A
Aug. 14, 2017	7375	Body	1750	1.452	52.476	Pass	Pass	Pass	N/A	N/A	N/A
Aug. 22, 2017	7375	Body	1750	1.434	51.402	Pass	Pass	Pass	N/A	N/A	N/A
Sep. 03, 2017	3971	Body	1750	1.429	51.404	Pass	Pass	Pass	N/A	N/A	N/A
Aug. 12, 2017	3650	Body	1900	1.560	50.965	Pass	Pass	Pass	GMSK	Pass	N/A
Aug. 14, 2017	7375	Body	1900	1.586	52.033	Pass	Pass	Pass	N/A	N/A	N/A
Aug. 22, 2017	7375	Body	1900	1.570	51.004	Pass	Pass	Pass	N/A	N/A	N/A
Sep. 03, 2017	3971	Body	1900	1.565	51.015	Pass	Pass	Pass	GMSK	Pass	N/A
Aug. 17, 2017	7375	Body	2450	2.024	51.413	Pass	Pass	Pass	OFDM	N/A	Pass
Aug. 24, 2017	7375	Body	2450	1.997	51.334	Pass	Pass	Pass	OFDM	N/A	Pass
Sep. 03, 2017	3971	Body	2450	2.033	51.900	Pass	Pass	Pass	OFDM	N/A	Pass
Sep. 28, 2017	3971	Body	5300	5.523	47.744	Pass	Pass	Pass	OFDM	N/A	Pass
Aug. 23, 2017	7375	Body	5600	5.922	47.005	Pass	Pass	Pass	OFDM	N/A	Pass
Aug. 23, 2017	7375	Body	5800	6.211	46.610	Pass	Pass	Pass	OFDM	N/A	Pass

Test Date	Probe S/N	Calibration Point		Measured Conductivity (σ)	Measured Permittivity (ϵ_r)	Validation for CW			Validation for Modulation		
						Sensitivity Range	Probe Linearity	Probe Isotropy	Modulation Type	Duty Factor	PAR
Aug. 13, 2017	7375	Body	750	0.912	55.743	Pass	Pass	Pass	N/A	N/A	N/A
Aug. 13, 2017	7375	Body	835	0.968	54.993	Pass	Pass	Pass	GMSK	Pass	N/A
Aug. 14, 2017	7375	Body	1750	1.452	52.476	Pass	Pass	Pass	N/A	N/A	N/A
Aug. 14, 2017	7375	Body	1900	1.586	52.033	Pass	Pass	Pass	GMSK	Pass	N/A
Aug. 14, 2017	7375	Body	1900	1.586	52.033	Pass	Pass	Pass	GMSK	Pass	N/A
Aug. 24, 2017	7375	Body	2450	1.997	51.334	Pass	Pass	Pass	OFDM	N/A	Pass
Sep. 28, 2017	3971	Body	5300	5.523	47.744	Pass	Pass	Pass	OFDM	N/A	Pass
Aug. 24, 2017	7375	Body	5600	5.894	46.817	Pass	Pass	Pass	OFDM	N/A	Pass
Aug. 24, 2017	7375	Body	5800	6.172	46.486	Pass	Pass	Pass	OFDM	N/A	Pass

FCC SAR Test Report

4.5 System Verification

The measuring result for system verification is tabulated as below.

Test Date	Mode	Frequency (MHz)	1W Target SAR-1g (W/kg)	Measured SAR-1g (W/kg)	Normalized to 1W SAR-1g (W/kg)	Deviation (%)	Dipole S/N	Probe S/N	DAE S/N
Aug. 13, 2017	Head	750	8.17	2.13	8.52	4.28	1132	7375	1431
Aug. 21, 2017	Head	835	9.38	2.19	8.76	-6.61	4d092	1790	917
Sep. 12, 2017	Head	835	9.38	2.33	9.32	-0.64	4d092	1790	917
Aug. 14, 2017	Head	1750	36.90	8.83	35.32	-4.28	1023	7375	1431
Aug. 21, 2017	Head	1750	36.90	8.97	35.88	-2.76	1023	1790	917
Aug. 22, 2017	Head	1900	40.20	10.20	40.80	1.49	5d036	1790	917
Sep. 12, 2017	Head	1900	40.20	9.87	39.48	-1.79	5d036	1790	917
Sep. 27, 2017	Head	1900	40.20	10.30	41.20	2.49	5d036	1790	917
Aug. 16, 2017	Head	2450	52.90	13.30	53.20	0.57	869	7375	1431
Sep. 28, 2017	Head	5300	82.60	8.54	85.40	3.39	1203	3971	1431
Aug. 23, 2017	Head	5600	82.20	8.50	85.00	3.41	1203	7375	1431
Aug. 23, 2017	Head	5800	78.70	8.17	81.70	3.81	1203	7375	1431
Aug. 13, 2017	Body	750	8.58	2.01	8.04	-6.29	1132	7375	1431
Sep. 03, 2017	Body	750	8.58	2.04	8.16	-4.90	1132	3971	916
Aug. 13, 2017	Body	835	9.60	2.42	9.68	0.83	4d092	7375	1431
Aug. 22, 2017	Body	835	9.60	2.40	9.60	0.00	4d092	7375	1431
Sep. 03, 2017	Body	835	9.60	2.38	9.52	-0.83	4d092	3971	916
Sep. 14, 2017	Body	835	9.60	2.47	9.88	2.92	4d092	7375	579
Aug. 12, 2017	Body	1750	36.90	8.76	35.04	-5.04	1023	3650	1277
Aug. 14, 2017	Body	1750	36.90	9.40	37.60	1.90	1023	7375	1431
Aug. 22, 2017	Body	1750	36.90	9.00	36.00	-2.44	1023	7375	1431
Sep. 03, 2017	Body	1750	36.90	9.22	36.88	-0.05	1023	3971	916
Aug. 12, 2017	Body	1900	40.10	10.20	40.80	1.75	5d036	3650	1277
Aug. 14, 2017	Body	1900	40.10	10.00	40.00	-0.25	5d036	7375	1431
Aug. 22, 2017	Body	1900	40.10	10.00	40.00	-0.25	5d036	7375	1431
Sep. 03, 2017	Body	1900	40.10	9.63	38.52	-3.94	5d036	3971	916
Aug. 17, 2017	Body	2450	51.60	12.20	48.80	-5.43	869	7375	1431
Aug. 24, 2017	Body	2450	51.60	13.00	52.00	0.78	869	7375	1431
Sep. 03, 2017	Body	2450	51.60	12.60	50.40	-2.33	869	3971	916
Sep. 28, 2017	Body	5300	76.40	7.41	74.10	-3.01	1203	3971	1431
Aug. 23, 2017	Body	5600	77.40	8.11	81.10	4.78	1203	7375	1431
Aug. 23, 2017	Body	5800	74.10	7.88	78.80	6.34	1203	7375	1431

Test Date	Mode	Frequency (MHz)	1W Target SAR-10g (W/kg)	Measured SAR-10g (W/kg)	Normalized to 1W SAR-10g (W/kg)	Deviation (%)	Dipole S/N	Probe S/N	DAE S/N
Aug. 13, 2017	Body	750	5.67	1.36	5.44	-4.06	1132	7375	1431
Aug. 13, 2017	Body	835	6.28	1.62	6.48	3.18	4d092	7375	1431
Aug. 14, 2017	Body	1750	19.70	5.08	20.32	3.15	1023	7375	1431
Aug. 14, 2017	Body	1900	21.10	5.24	20.96	-0.66	5d036	7375	1431
Aug. 14, 2017	Body	1900	21.10	5.26	21.04	-0.28	5d036	7375	1431
Aug. 24, 2017	Body	2450	24.60	6.05	24.20	-1.63	869	7375	1431
Sep. 28, 2017	Body	5300	21.50	2.06	20.60	-4.19	1203	3971	1431
Aug. 24, 2017	Body	5600	21.60	2.15	21.50	-0.46	1203	7375	1431
Aug. 24, 2017	Body	5800	20.40	2.11	21.10	3.43	1203	7375	1431

Note:

Comparing to the reference SAR value provided by SPEAG, the validation data should be within its specification of 10 %. The result indicates the system check can meet the variation criterion and the plots can be referred to Appendix A of this report.

4.6 Maximum Output Power

4.6.1 Maximum Target Conducted Power

The maximum conducted average power (Unit: dBm) including tune-up tolerance is shown as below.

Mode	Maximum Burst-Averaged Output Power		Maximum Frame-Averaged Output Power	
	GSM850	GSM1900	GSM850	GSM1900
GSM (GMSK, 1Tx-slot)	33.5	31.0	24.5	22.0
GPRS (GMSK, 1Tx-slot)	33.5	31.0	24.5	22.0
GPRS (GMSK, 2Tx-slot)	32.0	28.0	26.0	22.0
GPRS (GMSK, 3Tx-slot)	29.0	26.0	24.7	21.7
GPRS (GMSK, 4Tx-slot)	27.0	25.0	24.0	22.0
EDGE (8PSK, 1Tx-slot)	28.0	27.0	19.0	18.0
EDGE (8PSK, 2Tx-slot)	28.0	25.0	22.0	19.0
EDGE (8PSK, 3Tx-slot)	26.2	23.2	21.9	18.9
EDGE (8PSK, 4Tx-slot)	25.0	22	22.0	19.0

Note:

1. SAR testing was performed on the maximum frame-averaged power mode.
2. The frame-averaged power is linearly proportion to the slot number configured and it is linearly scaled the maximum burst-averaged power based on time slots. The calculated method is shown as below:

$$\text{Frame-averaged power} = 10 \times \log (\text{Burst-averaged power mW} \times \text{Slot used} / 8)$$

Mode	WCDMA Band II	WCDMA Band IV	WCDMA Band V
RMC 12.2K	24.5	24.5	24.5
HSDPA / HSUPA / DC-HSDPA	23.0	24.0	24.0

Mode	LTE 2	LTE 4	LTE 5
Maximum Target Power	24.0	24.0	24.0

Mode	LTE 12	LTE 17
Maximum Target Power	24.0	24.0

FCC SAR Test Report

Mode	2.4G WLAN	5.2G WLAN	5.3G WLAN	5.6G WLAN	5.8G WLAN
802.11b	20.0	N/A	N/A	N/A	N/A
802.11g	Ch1:17.0 Ch6:20.0 Ch11:15.0	N/A	N/A	N/A	N/A
802.11a	N/A	18.0	18.5	18.5	17.5
802.11n HT20	Ch1:16.0 Ch6:20.0 Ch11:14.5	18.0	18.5	Ch100-116:18.5 Ch140:17.0 Ch144:18.5	17.5
802.11n HT40	Ch1:15.0 Ch6:16.0 Ch11:13.0	18.0	Ch54:18.5 Ch62:15.5	Ch102:15.0 Ch110-134:18.5 Ch142:18.0	18.5
802.11ac VHT80	N/A	17.0	17.0	Ch106:17.0 Ch122-138:18.5	18.5

Mode	2.4G Bluetooth
Bluetooth	Ch 0 2.0 Ch 39 3.5 Ch 78 1.0

FCC SAR Test Report

4.6.2 Measured Conducted Power Result

The measuring conducted average power (Unit: dBm) is shown as below.

Band	GSM850			GSM1900		
Channel	128	189	251	512	661	810
Frequency (MHz)	824.2	836.4	848.8	1850.2	1880.0	1909.8
Maximum Burst-Averaged Output Power						
GSM (GMSK, 1Tx-slot)	32.21	32.73	33.15	29.58	29.05	28.15
GPRS (GMSK, 1Tx-slot)	32.24	32.77	33.19	29.61	29.06	28.17
GPRS (GMSK, 2Tx-slot)	31.72	31.88	31.96	27.94	27.50	27.15
GPRS (GMSK, 3Tx-slot)	28.26	28.73	28.96	25.97	25.63	25.49
GPRS (GMSK, 4Tx-slot)	26.50	26.92	26.99	24.92	24.89	24.64
EDGE (8PSK, 1Tx-slot)	26.69	26.64	26.74	25.28	25.34	25.27
EDGE (8PSK, 2Tx-slot)	26.39	26.52	26.57	23.73	23.80	23.79
EDGE (8PSK, 3Tx-slot)	24.90	24.92	25.03	21.73	21.74	21.67
EDGE (8PSK, 4Tx-slot)	23.79	23.87	23.90	20.70	20.53	20.63

Band	WCDMA Band II			WCDMA Band IV			WCDMA Band V			3GPP MPR (dB)
Channel	9262	9400	9538	1312	1413	1513	4132	4182	4233	
Frequency (MHz)	1852.4	1880.0	1907.6	1712.4	1732.6	1752.6	826.4	836.4	846.6	
RMC 12.2K	23.15	23.37	23.11	24.15	24.25	24.39	23.65	23.95	23.98	-
HSDPA Subtest-1	21.86	22.08	21.65	23.96	23.73	23.89	22.43	22.73	23.39	0
HSDPA Subtest-2	21.92	21.94	21.71	23.91	23.68	23.86	22.53	22.83	23.49	0
HSDPA Subtest-3	21.44	21.66	21.23	23.43	23.20	23.88	22.02	22.32	22.98	0.5
HSDPA Subtest-4	21.44	21.66	21.23	23.42	23.19	23.87	22.02	22.32	22.98	0.5
HSUPA Subtest-1	21.82	22.04	21.61	23.87	23.64	23.92	22.48	22.78	23.44	0
HSUPA Subtest-2	20.78	21.00	20.57	22.86	22.63	22.78	21.46	21.76	22.42	2
HSUPA Subtest-3	20.39	20.61	20.18	22.87	22.64	22.96	21.03	21.33	21.99	1
HSUPA Subtest-4	21.18	21.30	21.15	22.86	22.63	22.88	22.10	22.24	22.90	2
HSUPA Subtest-5	21.88	22.10	21.67	23.94	23.71	23.86	22.50	22.80	23.46	0

FCC SAR Test Report

LTE Band 2										
BW (MHz)	RB Size	RB Offset	QPSK				16QAM			
			Low CH 18700	Mid CH 18900	High CH 19100	3GPP MPR (dB)	Low CH 18607	Mid CH 18900	High CH 19193	3GPP MPR (dB)
			1860.0 MHz	1880.0 MHz	1900.0 MHz		1850.7 MHz	1880.0 MHz	1909.3 MHz	
20	1	0	23.81	23.97	23.78	0	22.79	22.97	22.76	1
	1	50	23.48	23.78	23.45	0	22.46	22.76	22.43	1
	1	99	23.32	23.62	23.29	0	22.30	22.60	22.27	1
	50	0	22.63	22.93	22.60	1	21.61	21.91	21.58	2
	50	25	22.36	22.66	22.33	1	21.34	21.64	21.31	2
	50	50	22.12	22.42	22.09	1	21.10	21.40	21.07	2
100	0	22.28	22.58	22.25	1	21.26	21.56	21.23	2	
BW (MHz)	RB Size	RB Offset	QPSK				16QAM			
			Low CH 18675	Mid CH 18900	High CH 19125	3GPP MPR (dB)	Low CH 18675	Mid CH 18900	High CH 19125	3GPP MPR (dB)
			1857.5 MHz	1880.0 MHz	1902.5 MHz		1857.5 MHz	1880.0 MHz	1902.5 MHz	
15	1	0	23.74	23.91	23.71	0	22.72	22.89	22.69	1
	1	37	23.41	23.71	23.38	0	22.39	22.69	22.36	1
	1	74	23.25	23.55	23.22	0	22.23	22.53	22.20	1
	36	0	22.56	22.86	22.53	1	21.54	21.84	21.51	2
	36	19	22.29	22.59	22.26	1	21.27	21.57	21.24	2
	36	39	22.05	22.35	22.02	1	21.03	21.33	21.00	2
75	0	22.21	22.51	22.18	1	21.19	21.49	21.16	2	
BW (MHz)	RB Size	RB Offset	QPSK				16QAM			
			Low CH 18650	Mid CH 18900	High CH 19150	3GPP MPR (dB)	Low CH 18650	Mid CH 18900	High CH 19150	3GPP MPR (dB)
			1855.0 MHz	1880.0 MHz	1905.0 MHz		1855.0 MHz	1880.0 MHz	1905.0 MHz	
10	1	0	23.70	23.87	23.67	0	22.68	22.85	22.65	1
	1	24	23.37	23.67	23.34	0	22.35	22.65	22.32	1
	1	49	23.21	23.51	23.18	0	22.19	22.49	22.16	1
	25	0	22.52	22.82	22.49	1	21.50	21.80	21.47	2
	25	12	22.25	22.55	22.22	1	21.23	21.53	21.20	2
	25	25	22.01	22.31	21.98	1	20.99	21.29	20.96	2
50	0	22.17	22.47	22.14	1	21.15	21.45	21.12	2	
BW (MHz)	RB Size	RB Offset	QPSK				16QAM			
			Low CH 18625	Mid CH 18900	High CH 19175	3GPP MPR (dB)	Low CH 18625	Mid CH 18900	High CH 19175	3GPP MPR (dB)
			1852.5 MHz	1880.0 MHz	1907.5 MHz		1852.5 MHz	1880.0 MHz	1907.5 MHz	
5	1	0	23.62	23.79	23.59	0	22.60	22.77	22.57	1
	1	12	23.29	23.59	23.26	0	22.27	22.57	22.24	1
	1	24	23.13	23.43	23.10	0	22.11	22.41	22.08	1
	12	0	22.44	22.74	22.41	1	21.42	21.72	21.39	2
	12	6	22.17	22.47	22.14	1	21.15	21.45	21.12	2
	12	13	21.93	22.23	21.90	1	20.91	21.21	20.88	2
25	0	22.09	22.39	22.06	1	21.07	21.37	21.04	2	
BW (MHz)	RB Size	RB Offset	QPSK				16QAM			
			Low CH 18615	Mid CH 18900	High CH 19185	3GPP MPR (dB)	Low CH 18615	Mid CH 18900	High CH 19185	3GPP MPR (dB)
			1851.5 MHz	1880.0 MHz	1908.5 MHz		1851.5 MHz	1880.0 MHz	1908.5 MHz	
3	1	0	23.52	23.69	23.49	0	22.50	22.67	22.47	1
	1	7	23.19	23.49	23.16	0	22.17	22.47	22.14	1
	1	14	23.03	23.33	23.00	0	22.01	22.31	21.98	1
	8	0	22.34	22.64	22.31	1	21.32	21.62	21.29	2
	8	3	22.07	22.37	22.04	1	21.05	21.35	21.02	2
	8	7	21.83	22.13	21.80	1	20.81	21.11	20.78	2
15	0	21.99	22.29	21.96	1	20.97	21.27	20.94	2	
BW (MHz)	RB Size	RB Offset	QPSK				16QAM			
			Low CH 18607	Mid CH 18900	High CH 19193	3GPP MPR (dB)	Low CH 18607	Mid CH 18900	High CH 19193	3GPP MPR (dB)
			1850.7 MHz	1880.0 MHz	1909.3 MHz		1850.7 MHz	1880.0 MHz	1909.3 MHz	
1.4	1	0	23.45	23.62	23.42	0	22.43	22.61	22.40	1
	1	2	23.12	23.42	23.09	0	22.10	22.40	22.07	1
	1	5	22.96	23.26	22.93	0	21.94	22.24	21.91	1
	3	0	22.54	22.57	22.55	0	21.52	21.55	21.51	1
	3	1	22.53	22.53	22.56	0	21.57	21.58	21.55	1
	3	3	22.52	22.53	22.51	0	21.57	21.54	21.52	1
6	0	21.92	22.22	21.89	1	20.90	21.20	20.87	2	

FCC SAR Test Report

LTE Band 4										
BW (MHz)	RB Size	RB Offset	QPSK				16QAM			
			Low CH 20050	Mid CH 20175	High CH 20300	3GPP MPR (dB)	Low CH 20050	Mid CH 20175	High CH 20300	3GPP MPR (dB)
			1720.0 MHz	1732.5 MHz	1745.0 MHz		1720.0 MHz	1732.5 MHz	1745.0 MHz	
20	1	0	23.88	23.98	23.78	0	22.22	22.97	22.26	1
	1	50	23.21	23.69	23.18	0	22.20	22.68	22.17	1
	1	99	22.23	22.71	22.20	0	21.22	21.70	21.19	1
	50	0	22.32	22.80	22.29	1	21.31	21.79	21.28	2
	50	25	21.95	22.43	21.92	1	20.94	21.42	20.91	2
	50	50	21.61	22.09	21.58	1	20.60	21.08	20.57	2
100	0	21.78	22.26	21.75	1	20.77	21.25	20.74	2	
BW (MHz)	RB Size	RB Offset	QPSK				16QAM			
			Low CH 20025	Mid CH 20175	High CH 20325	3GPP MPR (dB)	Low CH 20025	Mid CH 20175	High CH 20325	3GPP MPR (dB)
			1717.5 MHz	1732.5 MHz	1747.5 MHz		1717.5 MHz	1732.5 MHz	1747.5 MHz	
15	1	0	23.15	23.90	23.19	0	22.14	22.89	22.18	1
	1	37	23.13	23.61	23.10	0	22.12	22.60	22.09	1
	1	74	22.15	22.63	22.12	0	21.14	21.62	21.11	1
	36	0	22.24	22.72	22.21	1	21.23	21.71	21.20	2
	36	19	21.87	22.35	21.84	1	20.86	21.34	20.83	2
	36	39	21.53	22.01	21.50	1	20.52	21.00	20.49	2
	75	0	21.70	22.18	21.67	1	20.69	21.17	20.66	2
BW (MHz)	RB Size	RB Offset	QPSK				16QAM			
			Low CH 20000	Mid CH 20175	High CH 20350	3GPP MPR (dB)	Low CH 20000	Mid CH 20175	High CH 20350	3GPP MPR (dB)
			1715.0 MHz	1732.5 MHz	1750.0 MHz		1715.0 MHz	1732.5 MHz	1750.0 MHz	
10	1	0	23.07	23.82	23.11	0	22.06	22.81	22.10	1
	1	24	23.05	23.53	23.02	0	22.04	22.52	22.01	1
	1	49	22.07	22.55	22.04	0	21.06	21.54	21.03	1
	25	0	22.16	22.64	22.13	1	21.15	21.63	21.12	2
	25	12	21.79	22.27	21.76	1	20.78	21.26	20.75	2
	25	25	21.45	21.93	21.42	1	20.44	20.92	20.41	2
	50	0	21.62	22.10	21.59	1	20.61	21.09	20.58	2
BW (MHz)	RB Size	RB Offset	QPSK				16QAM			
			Low CH 19975	Mid CH 20175	High CH 20375	3GPP MPR (dB)	Low CH 19975	Mid CH 20175	High CH 20375	3GPP MPR (dB)
			1712.5 MHz	1732.5 MHz	1752.5 MHz		1712.5 MHz	1732.5 MHz	1752.5 MHz	
5	1	0	22.97	23.72	23.01	0	21.96	22.71	22.00	1
	1	12	22.95	23.43	22.92	0	21.94	22.42	21.91	1
	1	24	22.27	22.45	22.24	0	21.26	21.44	21.23	1
	12	0	22.06	22.54	22.03	1	21.05	21.53	21.02	2
	12	6	21.69	22.17	21.66	1	20.68	21.16	20.65	2
	12	13	21.35	21.83	21.32	1	20.34	20.82	20.31	2
	25	0	21.52	22.00	21.49	1	20.51	20.99	20.48	2
BW (MHz)	RB Size	RB Offset	QPSK				16QAM			
			Low CH 19965	Mid CH 20175	High CH 20385	3GPP MPR (dB)	Low CH 19965	Mid CH 20175	High CH 20385	3GPP MPR (dB)
			1711.5 MHz	1732.5 MHz	1753.5 MHz		1711.5 MHz	1732.5 MHz	1753.5 MHz	
3	1	0	22.90	23.65	22.94	0	21.89	22.64	21.93	1
	1	7	22.88	23.36	22.85	0	21.87	22.35	21.84	1
	1	14	22.20	22.38	22.17	0	21.19	21.37	21.16	1
	8	0	21.99	22.47	21.96	1	20.98	21.46	20.95	2
	8	3	21.62	22.10	21.59	1	20.61	21.09	20.58	2
	8	7	21.28	21.76	21.25	1	20.27	20.75	20.24	2
	15	0	21.45	21.93	21.42	1	20.44	20.92	20.41	2
BW (MHz)	RB Size	RB Offset	QPSK				16QAM			
			Low CH 19957	Mid CH 20175	High CH 20393	3GPP MPR (dB)	Low CH 19957	Mid CH 20175	High CH 20393	3GPP MPR (dB)
			1710.7 MHz	1732.5 MHz	1754.3 MHz		1710.7 MHz	1732.5 MHz	1754.3 MHz	
1.4	1	0	22.85	23.60	22.89	0	21.84	22.59	21.88	1
	1	2	22.83	23.31	22.80	0	21.82	22.30	21.79	1
	1	5	22.15	22.33	22.12	0	21.14	21.32	21.11	1
	3	0	22.24	22.42	22.21	0	21.23	21.41	21.30	1
	3	1	22.17	22.05	22.14	0	21.21	21.04	21.13	1
	3	3	22.03	22.07	22.20	0	21.02	21.07	21.09	1
6	0	21.40	21.88	21.37	1	20.39	20.87	20.36	2	

FCC SAR Test Report

LTE Band 5											
BW (MHz)	RB Size	RB Offset	QPSK				3GPP MPR (dB)	16QAM			
			Low CH 20450	Mid CH 20525	High CH 20600	Low CH 20450		Mid CH 20525	High CH 20600	3GPP MPR (dB)	
			829.0 MHz	836.5 MHz	844.0 MHz	829.0 MHz		836.5 MHz	844.0 MHz		
10	1	0	23.10	23.16	22.97	0	22.12	22.19	21.98	1	
	1	24	23.32	23.40	23.20	0	22.36	22.45	22.16	1	
	1	49	23.17	23.24	23.04	0	22.17	22.27	22.09	1	
	25	0	22.26	22.38	22.21	1	21.30	21.37	21.18	2	
	25	12	22.38	22.45	22.30	1	21.41	21.46	21.22	2	
	25	25	22.33	22.40	22.22	1	21.33	21.39	21.17	2	
50	0	22.25	22.37	22.19	1	21.26	21.36	21.14	2		
BW (MHz)	RB Size	RB Offset	QPSK				3GPP MPR (dB)	16QAM			
			Low CH 20425	Mid CH 20525	High CH 20625	Low CH 20425		Mid CH 20525	High CH 20625	3GPP MPR (dB)	
			826.5 MHz	836.5 MHz	846.5 MHz	826.5 MHz		836.5 MHz	846.5 MHz		
5	1	0	23.03	23.09	22.88	0	22.05	22.11	21.91	1	
	1	12	23.29	23.35	23.12	0	22.32	22.39	22.18	1	
	1	24	23.09	23.18	22.93	0	22.13	22.21	21.93	1	
	12	0	22.16	22.27	22.06	1	21.17	21.26	21.02	2	
	12	6	22.26	22.35	22.12	1	21.27	21.38	21.11	2	
	12	13	22.21	22.30	22.06	1	21.20	21.32	21.04	2	
25	0	22.13	22.26	22.04	1	21.09	21.24	20.98	2		
BW (MHz)	RB Size	RB Offset	QPSK				3GPP MPR (dB)	16QAM			
			Low CH 20415	Mid CH 20525	High CH 20635	Low CH 20415		Mid CH 20525	High CH 20635	3GPP MPR (dB)	
			825.5 MHz	836.5 MHz	847.5 MHz	825.5 MHz		836.5 MHz	847.5 MHz		
3	1	0	22.93	23.01	22.77	0	21.99	22.09	21.83	1	
	1	7	23.22	23.30	23.06	0	22.28	22.35	22.05	1	
	1	14	22.98	23.10	22.83	0	22.09	22.17	21.90	1	
	8	0	22.02	22.15	21.93	1	21.07	21.20	20.90	2	
	8	3	22.16	22.23	22.07	1	21.20	21.30	21.02	2	
	8	7	22.09	22.18	21.93	1	21.09	21.24	20.90	2	
15	0	21.98	22.13	21.88	1	20.99	21.15	20.83	2		
BW (MHz)	RB Size	RB Offset	QPSK				3GPP MPR (dB)	16QAM			
			Low CH 20407	Mid CH 20525	High CH 20643	Low CH 20407		Mid CH 20525	High CH 20643	3GPP MPR (dB)	
			824.7 MHz	836.5 MHz	848.3 MHz	824.7 MHz		836.5 MHz	848.3 MHz		
1.4	1	0	22.87	22.96	22.72	0	21.87	21.95	21.72	1	
	1	2	23.19	23.25	23.03	0	22.21	22.30	22.10	1	
	1	5	22.93	23.07	22.72	0	21.99	22.08	21.82	1	
	3	0	22.74	22.97	22.66	0	21.85	21.98	21.65	1	
	3	1	22.99	23.07	22.79	0	21.98	22.08	21.80	1	
	3	3	22.92	23.02	22.70	0	21.89	22.01	21.68	1	
6	0	21.90	22.05	21.74	1	20.89	21.04	20.69	2		

FCC SAR Test Report

LTE Band 12										
BW (MHz)	RB Size	RB Offset	QPSK				16QAM			
			Low CH 23060	Mid CH 23095	High CH 23130	3GPP MPR (dB)	Low CH 23060	Mid CH 23095	High CH 23130	3GPP MPR (dB)
			704.0 MHz	707.5 MHz	711.0 MHz		704.0 MHz	707.5 MHz	711.0 MHz	
10	1	0	23.49	23.73	23.47	0	22.45	22.69	22.43	1
	1	24	23.45	23.69	23.43	0	22.41	22.65	22.39	1
	1	49	23.42	23.66	23.40	0	22.38	22.62	22.36	1
	25	0	22.54	22.78	22.52	1	21.44	21.68	21.42	2
	25	12	22.48	22.72	22.46	1	21.50	21.74	21.48	2
	25	25	22.49	22.73	22.47	1	21.45	21.69	21.43	2
50	0	22.48	22.72	22.46	1	21.44	21.68	21.42	2	
BW (MHz)	RB Size	RB Offset	QPSK				16QAM			
			Low CH 23035	Mid CH 23095	High CH 23155	3GPP MPR (dB)	Low CH 23035	Mid CH 23095	High CH 23155	3GPP MPR (dB)
			701.5 MHz	707.5 MHz	713.5 MHz		701.5 MHz	707.5 MHz	713.5 MHz	
5	1	0	23.42	23.66	23.40	0	22.38	22.62	22.36	1
	1	12	23.38	23.62	23.36	0	22.34	22.58	22.32	1
	1	24	23.35	23.59	23.33	0	22.31	22.55	22.29	1
	12	0	22.41	22.65	22.39	1	21.37	21.61	21.35	2
	12	6	22.47	22.71	22.45	1	21.43	21.67	21.41	2
	12	13	22.42	22.66	22.40	1	21.38	21.62	21.36	2
25	0	22.41	22.65	22.39	1	21.37	21.61	21.35	2	
BW (MHz)	RB Size	RB Offset	QPSK				16QAM			
			Low CH 23025	Mid CH 23095	High CH 23165	3GPP MPR (dB)	Low CH 23025	Mid CH 23095	High CH 23165	3GPP MPR (dB)
			700.5 MHz	707.5 MHz	714.5 MHz		700.5 MHz	707.5 MHz	714.5 MHz	
3	1	0	23.31	23.55	23.29	0	22.27	22.51	22.25	1
	1	7	23.27	23.51	23.25	0	22.23	22.47	22.21	1
	1	14	23.24	23.48	23.22	0	22.20	22.44	22.18	1
	8	0	22.30	22.54	22.28	1	21.26	21.50	21.24	2
	8	3	22.36	22.60	22.34	1	21.32	21.56	21.30	2
	8	7	22.31	22.55	22.29	1	21.27	21.51	21.25	2
15	0	22.30	22.54	22.28	1	21.26	21.50	21.24	2	
BW (MHz)	RB Size	RB Offset	QPSK				16QAM			
			Low CH 23755	Mid CH 23790	High CH 23825	3GPP MPR (dB)	Low CH 23755	Mid CH 23790	High CH 23825	3GPP MPR (dB)
			706.5 MHz	710.0 MHz	713.5 MHz		706.5 MHz	710.0 MHz	713.5 MHz	
1.4	1	0	23.25	23.53	23.22	0	22.23	22.50	22.18	1
	1	2	23.20	23.47	23.12	0	22.15	22.46	22.09	1
	1	5	23.15	23.43	23.03	0	22.09	22.41	22.02	1
	3	0	23.14	23.41	23.04	0	22.20	22.46	22.07	1
	3	1	23.00	23.31	22.93	0	22.03	22.38	21.98	1
	3	3	23.10	23.33	22.96	0	22.16	22.41	21.99	1
6	0	22.10	22.41	22.03	1	21.06	21.41	20.98	2	

FCC SAR Test Report

LTE Band 17										
BW (MHz)	RB Size	RB Offset	QPSK				16QAM			
			Low CH 23780	Mid CH 23790	High CH 23800	3GPP MPR (dB)	Low CH 23780	Mid CH 23790	High CH 23800	3GPP MPR (dB)
			709.0 MHz	710.0 MHz	711.0 MHz		709.0 MHz	710.0 MHz	711.0 MHz	
10	1	0	23.82	23.91	23.31	0	22.78	22.87	22.27	1
	1	24	23.37	23.46	22.86	0	22.33	22.42	21.82	1
	1	49	23.42	23.51	22.91	0	22.38	22.47	21.87	1
	25	0	22.71	22.81	22.20	1	21.54	21.63	21.03	2
	25	12	22.63	22.72	22.12	1	21.59	21.68	21.08	2
	25	25	22.58	22.71	22.09	1	21.67	21.76	21.16	2
	50	0	22.56	22.65	22.05	1	21.52	21.61	21.01	2
BW (MHz)	RB Size	RB Offset	QPSK				16QAM			
			Low CH 23755	Mid CH 23790	High CH 23825	3GPP MPR (dB)	Low CH 23755	Mid CH 23790	High CH 23825	3GPP MPR (dB)
			706.5 MHz	710.0 MHz	713.5 MHz		706.5 MHz	710.0 MHz	713.5 MHz	
5	1	0	23.74	23.83	23.23	0	22.70	22.79	22.19	1
	1	12	23.29	23.38	22.78	0	22.25	22.34	21.74	1
	1	24	23.34	23.43	22.83	0	22.30	22.39	21.79	1
	12	0	22.50	22.59	21.99	1	21.46	21.55	20.95	2
	12	6	22.55	22.64	22.04	1	21.51	21.60	21.00	2
	12	13	22.63	22.72	22.12	1	21.59	21.68	21.08	2
	25	0	22.48	22.57	21.97	1	21.44	21.53	20.93	2

FCC SAR Test Report

<WLAN 2.4G>

	802.11b Real Average Power			
	1Mbps	2Mbps	5.5Mb	11Mbps
Ch1	19.40	-	-	-
Ch6	19.71	19.68	19.48	19.69
Ch11	19.46	-	-	-

	802.11g Real Average Power							
	6Mbps	9Mbps	12Mbps	18Mbps	24Mbps	36Mbps	48Mbps	54Mbps
Ch1	16.57	-	-	-	-	-	-	-
Ch6	19.68	19.46	19.49	19.51	19.44	19.45	19.58	19.62
Ch11	14.65	-	-	-	-	-	-	-

	802.11n(HT20) Real Average Power							
	MCS0	MCS1	MCS2	MCS3	MCS4	MCS5	MCS6	MCS7
Ch1	15.72	-	-	-	-	-	-	-
Ch6	19.62	19.38	19.42	19.58	19.50	19.55	19.58	19.43
Ch11	14.22	-	-	-	-	-	-	-

	802.11n(HT40) Real Average Power							
	MCS0	MCS1	MCS2	MCS3	MCS4	MCS5	MCS6	MCS7
Ch3	14.92	-	-	-	-	-	-	-
Ch6	15.64	15.55	15.59	15.46	15.39	15.45	15.62	15.54
Ch9	12.89	-	-	-	-	-	-	-

FCC SAR Test Report

<WLAN 5G>

		802.11a Real Average Power							
		6Mbps	9Mbps	12Mbps	18Mbps	24Mbps	36Mbps	48Mbps	54Mbps
Band 1	Ch36	17.91	-	-	-	-	-	-	-
	Ch40	17.95	17.72	17.74	17.75	17.90	17.86	17.94	17.80
	Ch48	17.92	-	-	-	-	-	-	-
Band 2	Ch52	18.34	-	-	-	-	-	-	-
	Ch60	18.45	18.32	18.43	18.38	18.43	18.39	18.36	18.22
	Ch64	17.41	-	-	-	-	-	-	-
Band 3	Ch100	18.26	-	-	-	-	-	-	-
	Ch116	18.31	18.21	18.24	18.15	18.21	18.18	18.18	18.19
	Ch140	17.30	-	-	-	-	-	-	-
	Ch144	17.38	-	-	-	-	-	-	-
Band 4	Ch149	17.32	-	-	-	-	-	-	-
	Ch157	17.45	17.21	17.42	17.23	17.30	17.25	17.21	17.25
	Ch165	17.26	-	-	-	-	-	-	-

		802.11n(HT20) Real Average Power									
		MCS0	MCS1	MCS2	MCS3	MCS4	MCS5	MCS6	MCS7	MCS8	MCS9
Band 1	Ch36	17.93	-	-	-	-	-	-	-	-	-
	Ch40	17.96	17.77	17.80	17.77	17.75	17.79	17.83	17.84	17.90	17.71
	Ch48	17.90	-	-	-	-	-	-	-	-	-
Band 2	Ch52	18.30	-	-	-	-	-	-	-	-	-
	Ch60	18.37	18.22	18.25	18.25	18.17	18.25	18.14	18.22	18.35	18.28
	Ch64	18.27	-	-	-	-	-	-	-	-	-
Band 3	Ch100	18.28	-	-	-	-	-	-	-	-	-
	Ch116	18.43	18.26	18.21	18.31	18.26	18.41	18.41	18.35	18.40	18.19
	Ch140	16.68	-	-	-	-	-	-	-	-	-
	Ch144	18.35	-	-	-	-	-	-	-	-	-
Band 4	Ch149	17.31	-	-	-	-	-	-	-	-	-
	Ch157	17.33	-	-	-	-	-	-	-	-	-
	Ch165	17.39	17.19	17.23	17.19	17.21	17.38	17.32	17.34	17.15	17.36

FCC SAR Test Report

		802.11ac (VHT20) Real Average Power									
		MCS0	MCS1	MCS2	MCS3	MCS4	MCS5	MCS6	MCS7	MCS8	MCS9
Band 1	Ch36	17.91	17.73	17.87	17.82	17.83	17.74	17.78	17.84	17.79	17.80
	Ch40	17.86	-	-	-	-	-	-	-	-	-
	Ch48	17.71	-	-	-	-	-	-	-	-	-
Band 2	Ch52	18.28	-	-	-	-	-	-	-	-	-
	Ch60	18.36	18.27	18.28	18.21	18.24	18.35	18.26	18.16	18.31	18.23
	Ch64	18.20	-	-	-	-	-	-	-	-	-
Band 3	Ch100	18.18	-	-	-	-	-	-	-	-	-
	Ch116	18.19	-	-	-	-	-	-	-	-	-
	Ch140	16.67	-	-	-	-	-	-	-	-	-
	Ch144	18.31	18.15	18.19	18.12	18.22	18.15	18.19	18.17	18.08	18.09
Band 4	Ch149	17.17	-	-	-	-	-	-	-	-	-
	Ch157	17.17	-	-	-	-	-	-	-	-	-
	Ch165	17.20	17.16	17.06	17.08	17.08	17.09	17.03	17.06	17.08	17.17

		802.11n(HT40) Real Average Power									
		MCS0	MCS1	MCS2	MCS3	MCS4	MCS5	MCS6	MCS7	MCS8	MCS9
Band 1	Ch38	17.47	-	-	-	-	-	-	-	-	-
	Ch46	17.89	17.71	17.74	17.85	17.84	17.66	17.65	17.80	17.81	17.79
Band 2	Ch54	18.41	18.33	18.38	18.36	18.40	18.37	18.17	18.20	18.18	18.17
	Ch62	15.48	-	-	-	-	-	-	-	-	-
Band 3	Ch102	14.99	-	-	-	-	-	-	-	-	-
	Ch110	18.37	18.20	18.29	18.35	18.27	18.15	18.15	18.22	18.23	18.35
	Ch134	18.27	-	-	-	-	-	-	-	-	-
	Ch142	17.66	-	-	-	-	-	-	-	-	-
Band 4	Ch151	18.22	-	-	-	-	-	-	-	-	-
	Ch159	18.39	18.20	18.21	18.20	18.29	18.17	18.27	18.26	18.34	18.19

FCC SAR Test Report

		802.11ac (VHT40) Real Average Power									
		MCS0	MCS1	MCS2	MCS3	MCS4	MCS5	MCS6	MCS7	MCS8	MCS9
Band 1	Ch38	17.24	-	-	-	-	-	-	-	-	-
	Ch46	17.87	17.73	17.83	17.75	17.84	17.69	17.69	17.64	17.75	17.83
Band 2	Ch54	18.35	18.17	18.14	18.24	18.10	18.20	18.18	18.10	18.29	18.32
	Ch62	15.24	-	-	-	-	-	-	-	-	-
Band 3	Ch102	14.97	-	-	-	-	-	-	-	-	-
	Ch110	18.21	18.13	18.12	17.98	18.14	18.19	18.06	18.14	18.11	18.13
	Ch134	18.05	-	-	-	-	-	-	-	-	-
	Ch142	17.44	-	-	-	-	-	-	-	-	-
Band 4	Ch151	17.99	-	-	-	-	-	-	-	-	-
	Ch159	18.16	18.07	18.02	18.10	18.03	17.99	17.95	18.04	18.05	17.99

		802.11ac (VHT80) Real Average Power									
		MCS0	MCS1	MCS2	MCS3	MCS4	MCS5	MCS6	MCS7	MCS8	MCS9
Band 1	Ch42	16.88	16.81	16.82	16.80	16.66	16.66	16.77	16.82	16.67	16.63
Band 2	Ch58	16.98	16.79	16.96	16.79	16.74	16.84	16.88	16.93	16.74	16.91
Band 3	Ch106	16.78	-	-	-	-	-	-	-	-	-
	Ch122	18.39	-	-	-	-	-	-	-	-	-
	Ch138	18.47	18.26	18.24	18.23	18.24	18.25	18.45	18.26	18.23	18.24
Band 4	Ch155	18.47	18.23	18.36	18.35	18.31	18.32	18.40	18.34	18.37	18.36

<Bluetooth>

Mode	Bluetooth		
Channel / Frequency (MHz)	0 (2402)	39 (2441)	78 (2480)
Average Power	1.76	2.48	0.79

<Bluetooth LE>

Mode	Bluetooth		
Channel / Frequency (MHz)	37 (2402)	17 (2440)	39 (2480)
Average Power	0.72	2.44	0.02

4.7 SAR Testing Results

4.7.1 SAR Test Reduction Considerations

<KDB 447498 D01, General RF Exposure Guidance>

Testing of other required channels within the operating mode of a frequency band is not required when the reported SAR for the mid-band or highest output power channel is:

- (1) ≤ 0.8 W/kg or 2.0 W/kg, for 1-g or 10-g respectively, when the transmission band is ≤ 100 MHz
- (2) ≤ 0.6 W/kg or 1.5 W/kg, for 1-g or 10-g respectively, when the transmission band is between 100 MHz and 200 MHz
- (3) ≤ 0.4 W/kg or 1.0 W/kg, for 1-g or 10-g respectively, when the transmission band is ≥ 200 MHz

<KDB 941225 D01, 3G SAR Measurement Procedures>

The mode tested for SAR is referred to as the primary mode. The equivalent modes considered for SAR test reduction are denoted as secondary modes. Both primary and secondary modes must be in the same frequency band. When the maximum output power and tune-up tolerance specified for production units in a secondary mode is $\leq 1/4$ dB higher than the primary mode or when the highest reported SAR of the primary mode is scaled by the ratio of specified maximum output power and tune-up tolerance of secondary to primary mode and the adjusted SAR is ≤ 1.2 W/kg, SAR measurement is not required for the secondary mode.

<KDB 941225 D05, SAR Evaluation Considerations for LTE Devices>

(1) QPSK with 1 RB and 50% RB allocation

Start with the largest channel bandwidth and measure SAR, using the RB offset and required test channel combination with the highest maximum output power among RB offsets at the upper edge, middle and lower edge of each required test channel. When the reported SAR is ≤ 0.8 W/kg, testing of the remaining RB offset configurations and required test channels is not required; otherwise, SAR is required for the remaining required test channels and only for the RB offset configuration with the highest output power for that channel. When the reported SAR of a required test channel is > 1.45 W/kg, SAR is required for all three RB offset configurations for that required test channel.

(2) QPSK with 100% RB allocation

SAR is not required when the highest maximum output power for 100% RB allocation is less than the highest maximum output power in 50% and 1 RB allocations and the highest reported SAR for 1 RB and 50% RB allocation are ≤ 0.8 W/kg. Otherwise, SAR is measured for the highest output power channel; and if the reported SAR is > 1.45 W/kg, the remaining required test channels must also be tested.

(3) Higher order modulations

SAR is required only when the highest maximum output power for the configuration in the higher order modulation is $> 1/2$ dB higher than the same configuration in QPSK or when the reported SAR for the QPSK configuration is > 1.45 W/kg.

(4) Other channel bandwidth

SAR is required when the highest maximum output power of the smaller channel bandwidth is $> 1/2$ dB higher than the equivalent channel configurations in the largest channel bandwidth configuration or the reported SAR of a configuration for the largest channel bandwidth is > 1.45 W/kg.

<KDB 248227 D01, SAR Guidance for Wi-Fi Transmitters>

- (1) For handsets operating next to ear, hotspot mode or mini-tablet configurations, the initial test position procedures were applied. The test position with the highest extrapolated peak SAR will be used as the initial test position. When the reported SAR of initial test position is ≤ 0.4 W/kg, SAR testing for remaining test positions is not required. Otherwise, SAR is evaluated at the subsequent highest peak SAR positions until the reported SAR result is ≤ 0.8 W/kg or all test positions are measured.
- (2) For WLAN 2.4 GHz, the highest measured maximum output power channel for DSSS was selected for SAR measurement. When the reported SAR is ≤ 0.8 W/kg, no further SAR testing is required. Otherwise, SAR is evaluated at the next highest measured output power channel. When any reported SAR is > 1.2 W/kg, SAR is required for the third channel. For OFDM modes (802.11g/n), SAR is not required when the highest reported SAR for DSSS is adjusted by the ratio of OFDM to DSSS specified maximum output power and it is ≤ 1.2 W/kg.
- (3) For WLAN 5 GHz, the initial test configuration was selected according to the transmission mode with the highest maximum output power. When the reported SAR of initial test configuration is > 0.8 W/kg, SAR is required for the subsequent highest measured output power channel until the reported SAR result is ≤ 1.2 W/kg or all required channels are measured. For other transmission modes, SAR is not required when the highest reported SAR for initial test configuration is adjusted by the ratio of subsequent test configuration to initial test configuration specified maximum output power and it is ≤ 1.2 W/kg.

FCC SAR Test Report

4.7.2 SAR Results for Head Exposure Condition

Plot No.	Band	Mode	Test Position	Ch.	EUT Config.	Power Pack	Max. Tune-up Power (dBm)	Measured Conducted Power (dBm)	Scaling Factor	Power Drift (dB)	Measured SAR-1g (W/kg)	Scaled SAR-1g (W/kg)
01	GSM850	GSM	Right Cheek	251	1		33.5	33.15	1.08	-0.05	0.449	0.49
	GSM850	GSM	Right Tilted	251	1		33.5	33.15	1.08	0.15	0.308	0.33
	GSM850	GSM	Left Cheek	251	1		33.5	33.15	1.08	-0.08	0.368	0.40
	GSM850	GSM	Left Tilted	251	1		33.5	33.15	1.08	0.08	0.301	0.33
	GSM850	GSM	Right Cheek	251	2		33.5	33.15	1.08	0.11	0.424	0.46
	GSM850	GSM	Right Cheek	251	1	w/	33.5	33.15	1.08	0.15	0.445	0.48
02	GSM1900	GSM	Right Cheek	512	1		31.0	29.58	1.39	0.15	0.215	0.30
	GSM1900	GSM	Right Tilted	512	1		31.0	29.58	1.39	0.15	0.152	0.21
	GSM1900	GSM	Left Cheek	512	1		31.0	29.58	1.39	0	0.413	0.57
	GSM1900	GSM	Left Tilted	512	1		31.0	29.58	1.39	0.14	0.196	0.27
	GSM1900	GSM	Left Cheek	512	2		31.0	29.58	1.39	0.11	0.388	0.54
	GSM1900	GSM	Left Cheek	512	2	w/	31.0	29.58	1.39	0.12	0.206	0.29
03	WCDMA II	RMC12.2K	Right Cheek	9400	1		24.5	23.37	1.30	0.14	0.365	0.47
	WCDMA II	RMC12.2K	Right Tilted	9400	1		24.5	23.37	1.30	0.05	0.280	0.36
	WCDMA II	RMC12.2K	Left Cheek	9400	1		24.5	23.37	1.30	-0.06	0.682	0.88
	WCDMA II	RMC12.2K	Left Tilted	9400	1		24.5	23.37	1.30	0.14	0.358	0.46
	WCDMA II	RMC12.2K	Left Cheek	9262	1		24.5	23.15	1.36	0.05	0.645	0.88
	WCDMA II	RMC12.2K	Left Cheek	9538	1		24.5	23.11	1.38	-0.19	0.633	0.87
	WCDMA II	RMC12.2K	Left Cheek	9400	2		24.5	23.37	1.30	0.02	0.621	0.81
	WCDMA II	RMC12.2K	Left Cheek	9262	2		24.5	23.15	1.36	-0.06	0.628	0.86
	WCDMA II	RMC12.2K	Left Cheek	9538	2		24.5	23.11	1.38	0.04	0.615	0.85
	WCDMA II	RMC12.2K	Left Cheek	9400	1	w/	24.5	23.37	1.30	0.11	0.670	0.87
	WCDMA II	RMC12.2K	Left Cheek	9262	1	w/	24.5	23.15	1.36	0.08	0.641	0.87
	WCDMA II	RMC12.2K	Left Cheek	9538	1	w/	24.5	23.11	1.38	0.01	0.633	0.87
04	WCDMA IV	RMC12.2K	Right Cheek	1513	1		24.5	24.39	1.03	0.15	0.553	0.57
	WCDMA IV	RMC12.2K	Right Tilted	1513	1		24.5	24.39	1.03	0.12	0.423	0.43
	WCDMA IV	RMC12.2K	Left Cheek	1513	1		24.5	24.39	1.03	-0.11	1.02	1.05
	WCDMA IV	RMC12.2K	Left Tilted	1513	1		24.5	24.39	1.03	-0.06	0.503	0.52
	WCDMA IV	RMC12.2K	Left Cheek	1312	1		24.5	24.15	1.08	-0.11	0.957	1.04
	WCDMA IV	RMC12.2K	Left Cheek	1413	1		24.5	24.25	1.06	-0.11	0.975	1.03
	WCDMA IV	RMC12.2K	Left Cheek	1513	2		24.5	24.39	1.03	0.15	0.82	0.84
	WCDMA IV	RMC12.2K	Left Cheek	1312	2		24.5	24.15	1.08	0.11	0.843	0.91
	WCDMA IV	RMC12.2K	Left Cheek	1413	2		24.5	24.25	1.06	0.13	0.812	0.86
	WCDMA IV	RMC12.2K	Left Cheek	1513	1	w/	24.5	24.39	1.03	0.15	0.934	0.96
	WCDMA IV	RMC12.2K	Left Cheek	1312	1	w/	24.5	24.15	1.08	0.11	0.928	1.01
	WCDMA IV	RMC12.2K	Left Cheek	1413	1	w/	24.5	24.25	1.06	0.13	0.921	0.98
05	WCDMA V	RMC12.2K	Right Cheek	4233	1		24.5	23.98	1.13	-0.07	0.413	0.47
	WCDMA V	RMC12.2K	Right Tilted	4233	1		24.5	23.98	1.13	0.15	0.355	0.40
	WCDMA V	RMC12.2K	Left Cheek	4233	1		24.5	23.98	1.13	0.11	0.391	0.44
	WCDMA V	RMC12.2K	Left Tilted	4233	1		24.5	23.98	1.13	0.13	0.379	0.43
	WCDMA V	RMC12.2K	Right Cheek	4233	2		24.5	23.98	1.13	0.13	0.388	0.44
	WCDMA V	RMC12.2K	Right Cheek	4233	1	w/	24.5	23.98	1.13	0.15	0.403	0.45

FCC SAR Test Report

Plot No.	Band	Mode	Test Position	Ch.	EUT Config.	Power Pack	RB#	RB Offset	Max. Tune-up Power (dBm)	Measured Conducted Power (dBm)	Scaling Factor	Power Drift (dB)	Measured SAR-1g (W/kg)	Scaled SAR-1g (W/kg)
	LTE 2	QPSK20M	Right Cheek	18900	1		1	0	24.0	23.97	1.01	0.11	0.429	0.43
	LTE 2	QPSK20M	Right Tilted	18900	1		1	0	24.0	23.97	1.01	0.15	0.301	0.30
06	LTE 2	QPSK20M	Left Cheek	18900	1		1	0	24.0	23.97	1.01	-0.12	0.805	0.81
	LTE 2	QPSK20M	Left Tilted	18900	1		1	0	24.0	23.97	1.01	0.11	0.417	0.42
	LTE 2	QPSK20M	Right Cheek	18900	1		50	0	23.0	22.93	1.02	0.15	0.318	0.32
	LTE 2	QPSK20M	Right Tilted	18900	1		50	0	23.0	22.93	1.02	0.13	0.220	0.22
	LTE 2	QPSK20M	Left Cheek	18900	1		50	0	23.0	22.93	1.02	0.15	0.501	0.51
	LTE 2	QPSK20M	Left Tilted	18900	1		50	0	23.0	22.93	1.02	-0.12	0.298	0.30
	LTE 2	QPSK20M	Left Cheek	18700	1		1	0	24.0	23.81	1.04	-0.15	0.562	0.59
	LTE 2	QPSK20M	Left Cheek	19100	1		1	0	24.0	23.78	1.05	-0.13	0.747	0.79
	LTE 2	QPSK20M	Left Cheek	18900	2		1	0	24.0	23.97	1.01	0.15	0.659	0.66
	LTE 2	QPSK20M	Left Cheek	18900	1	w/	1	0	24.0	23.97	1.01	0.11	0.405	0.41
	LTE 2	QPSK20M	Left Cheek	18900	1	w/	1	0	24.0	23.97	1.01	-0.13	0.793	0.80
	LTE 4	QPSK20M	Right Cheek	20175	1		1	0	24.0	23.98	1.00	0.15	0.261	0.26
	LTE 4	QPSK20M	Right Tilted	20175	1		1	0	24.0	23.98	1.00	0.11	0.201	0.20
07	LTE 4	QPSK20M	Left Cheek	20175	1		1	0	24.0	23.98	1.00	-0.15	0.524	0.53
	LTE 4	QPSK20M	Left Tilted	20175	1		1	0	24.0	23.98	1.00	0.13	0.248	0.25
	LTE 4	QPSK20M	Right Cheek	20175	1		50	0	23.0	22.80	1.05	0.15	0.223	0.23
	LTE 4	QPSK20M	Right Tilted	20175	1		50	0	23.0	22.80	1.05	0.12	0.180	0.19
	LTE 4	QPSK20M	Left Cheek	20175	1		50	0	23.0	22.80	1.05	0.12	0.417	0.44
	LTE 4	QPSK20M	Left Tilted	20175	1		50	0	23.0	22.80	1.05	0.15	0.214	0.22
	LTE 4	QPSK20M	Left Cheek	20175	2		1	0	24.0	23.98	1.00	0.11	0.482	0.48
	LTE 4	QPSK20M	Left Cheek	20175	1	w/	1	0	24.0	23.98	1.00	0.15	0.157	0.16
08	LTE 5	QPSK10M	Right Cheek	20525	1		1	24	24.0	23.40	1.15	0.09	0.487	0.56
	LTE 5	QPSK10M	Right Tilted	20525	1		1	24	24.0	23.40	1.15	0.15	0.420	0.48
	LTE 5	QPSK10M	Left Cheek	20525	1		1	24	24.0	23.40	1.15	0.13	0.460	0.53
	LTE 5	QPSK10M	Left Tilted	20525	1		1	24	24.0	23.40	1.15	0.11	0.404	0.46
	LTE 5	QPSK10M	Right Cheek	20525	1		25	12	23.0	22.45	1.14	0.11	0.299	0.34
	LTE 5	QPSK10M	Right Tilted	20525	1		25	12	23.0	22.45	1.14	0.15	0.214	0.24
	LTE 5	QPSK10M	Left Cheek	20525	1		25	12	23.0	22.45	1.14	0.12	0.262	0.30
	LTE 5	QPSK10M	Left Tilted	20525	1		25	12	23.0	22.45	1.14	0.18	0.243	0.28
	LTE 5	QPSK10M	Right Cheek	20525	2		1	24	24.0	23.40	1.15	0.11	0.364	0.42
	LTE 5	QPSK10M	Right Cheek	20525	1	w/	1	24	24.0	23.40	1.15	0.15	0.473	0.54
09	LTE 12	QPSK10M	Right Cheek	23095	1		1	0	24.0	23.73	1.06	-0.05	0.323	0.34
	LTE 12	QPSK10M	Right Tilted	23095	1		1	0	24.0	23.73	1.06	0.13	0.288	0.31
	LTE 12	QPSK10M	Left Cheek	23095	1		1	0	24.0	23.73	1.06	0.15	0.285	0.30
	LTE 12	QPSK10M	Left Tilted	23095	1		1	0	24.0	23.73	1.06	0.11	0.257	0.27
	LTE 12	QPSK10M	Right Cheek	23095	1		25	0	23.0	22.78	1.05	0.15	0.259	0.27
	LTE 12	QPSK10M	Right Tilted	23095	1		25	0	23.0	22.78	1.05	0.12	0.229	0.24
	LTE 12	QPSK10M	Left Cheek	23095	1		25	0	23.0	22.78	1.05	0.15	0.225	0.24
	LTE 12	QPSK10M	Left Tilted	23095	1		25	0	23.0	22.78	1.05	0.13	0.205	0.22
	LTE 12	QPSK10M	Right Cheek	23095	2		1	0	24.0	23.73	1.06	0.12	0.321	0.34
	LTE 12	QPSK10M	Right Cheek	23095	1	w/	1	0	24.0	23.73	1.06	0.15	0.173	0.18
10	LTE 17	QPSK10M	Right Cheek	23790	1		1	0	24.0	23.91	1.02	-0.05	0.307	0.31
	LTE 17	QPSK10M	Right Tilted	23790	1		1	0	24.0	23.91	1.02	0.13	0.164	0.17
	LTE 17	QPSK10M	Left Cheek	23790	1		1	0	24.0	23.91	1.02	0.11	0.294	0.30
	LTE 17	QPSK10M	Left Tilted	23790	1		1	0	24.0	23.91	1.02	0.15	0.202	0.21
	LTE 17	QPSK10M	Right Cheek	23790	1		25	0	23.0	22.81	1.04	0.12	0.251	0.26
	LTE 17	QPSK10M	Right Tilted	23790	1		25	0	23.0	22.81	1.04	0.15	0.143	0.15
	LTE 17	QPSK10M	Left Cheek	23790	1		25	0	23.0	22.81	1.04	0.13	0.258	0.27
	LTE 17	QPSK10M	Left Tilted	23790	1		25	0	23.0	22.81	1.04	0.11	0.185	0.19
	LTE 17	QPSK10M	Right Cheek	23790	2		1	0	24.0	23.91	1.02	0.17	0.288	0.29
	LTE 17	QPSK10M	Right Cheek	23790	1	w/	1	0	24.0	23.91	1.02	0.12	0.142	0.14

FCC SAR Test Report

Plot No.	Band	Mode	Test Position	Ch.	EUT Config.	Power Pack	Max. Tune-up Power (dBm)	Measured Conducted Power (dBm)	Scaling Factor	Power Drift (dB)	Measured SAR-1g (W/kg)	Scaled SAR-1g (W/kg)
	2.4G WLAN	802.11b	Right Cheek	6	1		20.0	19.71	1.07	0.11	0.557	0.60
	2.4G WLAN	802.11b	Right Tilted	6	1		20.0	19.71	1.07	0.12	0.476	0.51
11	2.4G WLAN	802.11b	Left Cheek	6	1		20.0	19.71	1.07	-0.13	1.27	1.36
	2.4G WLAN	802.11b	Left Tilted	6	1		20.0	19.71	1.07	-0.11	0.727	0.78
	2.4G WLAN	802.11b	Left Cheek	11	1		20.0	19.46	1.13	-0.15	1.19	1.35
	2.4G WLAN	802.11b	Left Cheek	1	1		20.0	19.40	1.15	-0.15	1.13	1.30
	2.4G WLAN	802.11g	Left Cheek	6	1		20.0	19.68	1.08	0.15	0.818	0.88
	2.4G WLAN	802.11g	Left Cheek	1	1		17.0	16.57	1.10	0.11	0.65	0.72
	2.4G WLAN	802.11n HT20	Left Cheek	6	1		20.0	19.62	1.09	0.11	0.61	0.67
	2.4G WLAN	802.11n HT20	Left Cheek	1	1		16.0	15.72	1.07	0.11	0.57	0.61
	2.4G WLAN	802.11b	Left Cheek	6	2		20.0	19.71	1.07	-0.08	1.16	1.24
	2.4G WLAN	802.11b	Left Cheek	11	2		20.0	19.46	1.13	-0.15	1.11	1.26
	2.4G WLAN	802.11b	Left Cheek	1	2		20.0	19.40	1.15	0.15	1.18	1.35
	2.4G WLAN	802.11b	Left Cheek	6	1	w/	20.0	19.71	1.07	0.12	1.04	1.11
	2.4G WLAN	802.11b	Left Cheek	11	1	w/	20.0	19.46	1.13	0.15	0.988	1.12
	2.4G WLAN	802.11b	Left Cheek	6	1		20.0	19.71	1.07	0.15	1.18	1.26
	5.3G WLAN	802.11n HT40	Right Cheek	54	1		18.5	18.41	1.02	-0.03	0.146	0.15
	5.3G WLAN	802.11n HT40	Right Tilted	54	1		18.5	18.41	1.02	0.09	0.115	0.12
12	5.3G WLAN	802.11n HT40	Left Cheek	54	1		18.5	18.41	1.02	-0.12	0.501	0.51
	5.3G WLAN	802.11n HT40	Left Tilted	54	1		18.5	18.41	1.02	0.01	0.253	0.26
	5.3G WLAN	802.11n HT40	Left Cheek	54	2		18.5	18.41	1.02	-0.07	0.479	0.49
	5.3G WLAN	802.11n HT40	Left Cheek	54	1	w/	18.5	18.41	1.02	0.02	0.431	0.44
	5.6G WLAN	802.11ac VH80	Right Cheek	138	1		18.5	18.47	1.01	0.11	0.140	0.14
	5.6G WLAN	802.11ac VH80	Right Tilted	138	1		18.5	18.47	1.01	0.12	0.106	0.11
13	5.6G WLAN	802.11ac VH80	Left Cheek	138	1		18.5	18.47	1.01	0.09	0.396	0.40
	5.6G WLAN	802.11ac VH80	Left Tilted	138	1		18.5	18.47	1.01	-0.02	0.213	0.21
	5.6G WLAN	802.11ac VH80	Left Cheek	138	2		18.5	18.47	1.01	-0.03	0.383	0.39
	5.6G WLAN	802.11ac VH80	Left Cheek	138	1	w/	18.5	18.47	1.01	0.11	0.341	0.34
	5.8G WLAN	802.11ac VH80	Right Cheek	155	1		18.5	18.47	1.01	0.05	0.125	0.13
	5.8G WLAN	802.11ac VH80	Right Tilted	155	1		18.5	18.47	1.01	0.11	0.101	0.10
14	5.8G WLAN	802.11ac VH80	Left Cheek	155	1		18.5	18.47	1.01	-0.04	0.310	0.31
	5.8G WLAN	802.11ac VH80	Left Tilted	155	1		18.5	18.47	1.01	0.01	0.267	0.27
	5.8G WLAN	802.11ac VH80	Left Cheek	155	2		18.5	18.47	1.01	0.11	0.256	0.26
	5.8G WLAN	802.11ac VH80	Left Cheek	155	1	w/	18.5	18.47	1.01	0.14	0.264	0.27

FCC SAR Test Report

4.7.3 SAR Results for Body-worn Exposure Condition (Test Separation Distance is 15 mm)

Plot No.	Band	Mode	Test Position	Ch.	EUT Config.	Power Pack	Max. Tune-up Power (dBm)	Measured Conducted Power (dBm)	Scaling Factor	Power Drift (dB)	Measured SAR-1g (W/kg)	Scaled SAR-1g (W/kg)
15	GSM850	GPRS10	Front Face	251	1		32.0	31.96	1.01	0.05	0.387	0.39
	GSM850	GPRS10	Rear Face	251	1		32.0	31.96	1.01	-0.07	0.401	0.40
	GSM850	GPRS10	Rear Face	251	2		32.0	31.96	1.01	-0.01	0.375	0.38
	GSM850	GPRS10	Rear Face	251	1	w/	32.0	31.96	1.01	-0.08	0.388	0.39
16	GSM1900	GPRS10	Front Face	512	1		28.0	27.94	1.01	0.05	0.283	0.29
	GSM1900	GPRS10	Rear Face	512	1		28.0	27.94	1.01	-0.01	0.217	0.22
	GSM1900	GPRS10	Front Face	512	2		28.0	27.94	1.01	0.03	0.254	0.26
	GSM1900	GPRS10	Front Face	512	1	w/	28.0	27.94	1.01	-0.01	0.229	0.23
17	WCDMA II	RMC12.2K	Front Face	9400	1		24.5	23.37	1.30	0.12	0.282	0.37
	WCDMA II	RMC12.2K	Rear Face	9400	1		24.5	23.37	1.30	0.06	0.323	0.42
	WCDMA II	RMC12.2K	Rear Face	9400	2		24.5	23.37	1.30	-0.01	0.316	0.41
	WCDMA II	RMC12.2K	Rear Face	9400	1	w/	24.5	23.37	1.30	0.11	0.293	0.38
18	WCDMA IV	RMC12.2K	Front Face	1513	1		24.5	24.39	1.03	0.05	0.434	0.45
	WCDMA IV	RMC12.2K	Rear Face	1513	1		24.5	24.39	1.03	-0.14	0.688	0.71
	WCDMA IV	RMC12.2K	Rear Face	1513	2		24.5	24.39	1.03	0.03	0.613	0.63
	WCDMA IV	RMC12.2K	Rear Face	1513	1	w/	24.5	24.39	1.03	-0.14	0.552	0.57
19	WCDMA V	RMC12.2K	Front Face	4233	1		24.5	23.98	1.13	-0.03	0.335	0.38
	WCDMA V	RMC12.2K	Rear Face	4233	1		24.5	23.98	1.13	-0.10	0.359	0.40
	WCDMA V	RMC12.2K	Rear Face	4233	2		24.5	23.98	1.13	0.07	0.332	0.37
	WCDMA V	RMC12.2K	Rear Face	4233	1	w/	24.5	23.98	1.13	0.08	0.262	0.30

Plot No.	Band	Mode	Test Position	Ch.	EUT Config.	Power Pack	RB#	RB Offset	Max. Tune-up Power (dBm)	Measured Conducted Power (dBm)	Scaling Factor	Power Drift (dB)	Measured SAR-10g (W/kg)	Scaled SAR-10g (W/kg)
20	LTE 2	QPSK20M	Front Face	18900	1		1	0	24.0	23.97	1.01	-0.12	0.403	0.41
	LTE 2	QPSK20M	Rear Face	18900	1		1	0	24.0	23.97	1.01	-0.11	0.340	0.34
	LTE 2	QPSK20M	Front Face	18900	1		50	0	23.0	22.93	1.02	-0.03	0.286	0.29
	LTE 2	QPSK20M	Rear Face	18900	1		50	0	23.0	22.93	1.02	0.07	0.283	0.29
	LTE 2	QPSK20M	Front Face	18900	2		1	0	24.0	23.97	1.01	0.02	0.398	0.40
	LTE 2	QPSK20M	Front Face	18900	1	w/	1	0	24.0	23.97	1.01	-0.13	0.296	0.30
21	LTE 4	QPSK20M	Front Face	20175	1		1	0	24.0	23.98	1.00	0.03	0.454	0.46
	LTE 4	QPSK20M	Rear Face	20175	1		1	0	24.0	23.98	1.00	-0.06	0.751	0.75
	LTE 4	QPSK20M	Front Face	20175	1		50	0	23.0	22.80	1.05	-0.05	0.385	0.40
	LTE 4	QPSK20M	Rear Face	20175	1		50	0	23.0	22.80	1.05	0.12	0.562	0.59
	LTE 4	QPSK20M	Rear Face	20175	2		1	0	24.0	23.98	1.00	0.07	0.726	0.73
22	LTE 5	QPSK10M	Rear Face	20525	1		1	0	24.0	23.98	1.00	0.08	0.377	0.38
	LTE 5	QPSK10M	Front Face	20525	1		1	24	24.0	23.40	1.15	0.05	0.388	0.45
	LTE 5	QPSK10M	Rear Face	20525	1		1	24	24.0	23.40	1.15	-0.03	0.681	0.78
	LTE 5	QPSK10M	Front Face	20525	1		25	12	23.0	22.45	1.14	-0.12	0.325	0.37
	LTE 5	QPSK10M	Rear Face	20525	1		25	12	23.0	22.45	1.14	0.07	0.607	0.69
	LTE 5	QPSK10M	Rear Face	20525	2		1	24	24.0	23.40	1.15	-0.03	0.506	0.58
23	LTE 5	QPSK10M	Rear Face	20525	1	w/	1	24	24.0	23.40	1.15	0.07	0.239	0.27
	LTE 12	QPSK10M	Front Face	23095	1		1	0	24.0	23.73	1.06	0.07	0.236	0.25
	LTE 12	QPSK10M	Rear Face	23095	1		1	0	24.0	23.73	1.06	-0.02	0.371	0.39
	LTE 12	QPSK10M	Front Face	23095	1		25	0	23.0	22.78	1.05	-0.03	0.189	0.20
	LTE 12	QPSK10M	Rear Face	23095	1		25	0	23.0	22.78	1.05	0.05	0.333	0.35
	LTE 12	QPSK10M	Rear Face	23095	2		1	0	24.0	23.73	1.06	-0.09	0.355	0.38
24	LTE 12	QPSK10M	Rear Face	23095	1	w/	1	0	24.0	23.73	1.06	-0.05	0.154	0.16
	LTE 17	QPSK10M	Front Face	23790	1		1	0	24.0	23.91	1.02	0.13	0.214	0.22
	LTE 17	QPSK10M	Rear Face	23790	1		1	0	24.0	23.91	1.02	0.06	0.358	0.37
	LTE 17	QPSK10M	Front Face	23790	1		25	0	23.0	22.81	1.04	-0.05	0.185	0.19
	LTE 17	QPSK10M	Rear Face	23790	1		25	0	23.0	22.81	1.04	0.07	0.355	0.37

FCC SAR Test Report

Plot No.	Band	Mode	Test Position	Ch.	EUT Config.	Power Pack	Max. Tune-up Power (dBm)	Measured Conducted Power (dBm)	Scaling Factor	Power Drift (dB)	Measured SAR-1g (W/kg)	Scaled SAR-1g (W/kg)
25	2.4G WLAN	802.11b	Front Face	6	1		20.0	19.71	1.07	-0.05	0.135	0.14
	2.4G WLAN	802.11b	Rear Face	6	1		20.0	19.71	1.07	0.03	0.379	0.41
	2.4G WLAN	802.11b	Rear Face	6	2		20.0	19.71	1.07	0.08	0.377	0.40
	2.4G WLAN	802.11b	Rear Face	6	1	w/	20.0	19.71	1.07	-0.07	0.194	0.19
26	5.3G WLAN	802.11n HT40	Front Face	54	1		18.5	18.41	1.02	0.06	0.019	0.02
	5.3G WLAN	802.11n HT40	Rear Face	54	1		18.5	18.41	1.02	0.02	1.04	1.06
	5.3G WLAN	802.11n HT40	Rear Face	62	1		15.5	15.48	1.00	-0.13	0.638	0.64
	5.3G WLAN	802.11n HT40	Rear Face	54	2		18.5	18.41	1.02	-0.03	0.828	0.85
	5.3G WLAN	802.11n HT40	Rear Face	62	2		15.5	15.48	1.00	0.05	0.572	0.57
	5.3G WLAN	802.11n HT40	Rear Face	54	1	w/	18.5	18.41	1.02	-0.07	0.647	0.66
27	5.6G WLAN	802.11ac VH80	Front Face	138	1		18.5	18.47	1.01	0.07	0.029	0.03
	5.6G WLAN	802.11ac VH80	Rear Face	138	1		18.5	18.47	1.01	-0.17	1.24	1.25
	5.6G WLAN	802.11ac VH80	Rear Face	122	1		18.5	18.39	1.03	0.08	1.13	1.16
	5.6G WLAN	802.11n HT20	Rear Face	116	1		18.5	18.43	1.02	-0.03	1.08	1.10
	5.6G WLAN	802.11n HT20	Rear Face	144	1		18.5	18.35	1.04	-0.09	1.08	1.12
	5.6G WLAN	802.11n HT40	Rear Face	110	1		18.5	18.37	1.03	0.05	1.11	1.14
	5.6G WLAN	802.11n HT40	Rear Face	134	1		18.5	18.27	1.05	0.01	1.05	1.11
	5.6G WLAN	802.11ac VH80	Rear Face	138	2		18.5	18.47	1.01	0.02	0.926	0.93
	5.6G WLAN	802.11ac VH80	Rear Face	122	2		18.5	18.39	1.03	0.09	0.862	0.88
	5.6G WLAN	802.11ac VH80	Rear Face	138	1	w/	18.5	18.47	1.01	-0.07	0.983	0.99
	5.6G WLAN	802.11ac VH80	Rear Face	122	1	w/	18.5	18.39	1.03	-0.12	0.857	0.88
28	5.6G WLAN	802.11ac VH80	Rear Face	138	1		18.5	18.47	1.01	0.08	1.21	1.22
	5.8G WLAN	802.11ac VH80	Front Face	155	1		18.5	18.47	1.01	0.03	0.036	0.04
	5.8G WLAN	802.11ac VH80	Rear Face	155	1		18.5	18.47	1.01	-0.09	0.938	0.94
	5.8G WLAN	802.11ac VH80	Rear Face	155	2		18.5	18.47	1.01	-0.01	0.86	0.87
	5.8G WLAN	802.11ac VH80	Rear Face	155	1	w/	18.5	18.47	1.01	-0.08	0.911	0.92
5.8G WLAN	802.11ac VH80	Rear Face	155	1		18.5	18.47	1.01	-0.05	0.912	0.92	

FCC SAR Test Report

4.7.4 SAR Results for Hotspot Exposure Condition

Plot No.	Band	Mode	Test Position	Separation Distance (cm)	Ch.	EUT Config.	Power Pack	Max. Tune-up Power (dBm)	Measured Conducted Power (dBm)	Scaling Factor	Power Drift (dB)	Measured SAR-1g (W/kg)	Scaled SAR-1g (W/kg)
29	GSM850	GPRS10	Front Face	1	251	1		32.0	31.96	1.01	0.03	0.575	0.58
	GSM850	GPRS10	Rear Face	1	251	1		32.0	31.96	1.01	-0.10	0.999	1.01
	GSM850	GPRS10	Left Side	1	251	1		32.0	31.96	1.01	0.05	0.097	0.10
	GSM850	GPRS10	Right Side	1	251	1		32.0	31.96	1.01	-0.01	0.194	0.20
	GSM850	GPRS10	Bottom Side	1	251	1		32.0	31.96	1.01	0.05	0.149	0.15
	GSM850	GPRS10	Rear Face	1	128	1		32.0	31.72	1.07	0.11	0.900	0.96
	GSM850	GPRS10	Rear Face	1	189	1		32.0	31.88	1.03	0.02	0.960	0.99
	GSM850	GPRS10	Rear Face	1	251	2		32.0	31.96	1.01	0.11	0.760	0.77
	GSM850	GPRS10	Rear Face	1	251	1	w/	32.0	31.96	1.01	0.04	0.570	0.58
	GSM850	GPRS10	Rear Face	1	251	1		32.0	31.96	1.01	0.02	0.980	0.99
30	GSM1900	GPRS10	Front Face	1	512	1		28.0	27.94	1.01	-0.02	0.788	0.80
	GSM1900	GPRS10	Rear Face	1	512	1		28.0	27.94	1.01	0.11	0.726	0.74
	GSM1900	GPRS10	Left Side	1	512	1		28.0	27.94	1.01	-0.13	0.467	0.47
	GSM1900	GPRS10	Right Side	1	512	1		28.0	27.94	1.01	0.02	0.398	0.40
	GSM1900	GPRS10	Bottom Side	1	512	1		28.0	27.94	1.01	0.07	0.656	0.67
	GSM1900	GPRS10	Front Face	1	661	1		28.0	27.50	1.12	-0.09	0.714	0.80
	GSM1900	GPRS10	Front Face	1	810	1		28.0	27.15	1.22	-0.07	0.852	1.04
	GSM1900	GPRS10	Front Face	1	810	2		28.0	27.15	1.22	0.08	0.672	0.82
	GSM1900	GPRS10	Front Face	1	512	2		28.0	27.94	1.01	-0.05	0.708	0.72
	GSM1900	GPRS10	Front Face	1	661	2		28.0	27.50	1.12	0.04	0.642	0.72
31	GSM1900	GPRS10	Front Face	1	810	1	w/	28.0	27.15	1.22	-0.01	0.503	0.61
	GSM1900	GPRS10	Front Face	1	810	1		28.0	27.15	1.22	0.06	0.844	1.03
	WCDMA II	RMC12.2K	Front Face	1	9400	1		24.5	23.37	1.30	0.11	0.600	0.78
	WCDMA II	RMC12.2K	Rear Face	1	9400	1		24.5	23.37	1.30	-0.14	0.687	0.89
	WCDMA II	RMC12.2K	Left Side	1	9400	1		24.5	23.37	1.30	-0.08	0.271	0.35
	WCDMA II	RMC12.2K	Right Side	1	9400	1		24.5	23.37	1.30	0.02	0.228	0.30
	WCDMA II	RMC12.2K	Bottom Side	1	9400	1		24.5	23.37	1.30	-0.14	0.668	0.87
	WCDMA II	RMC12.2K	Rear Face	1	9262	1		24.5	23.15	1.36	0.12	0.645	0.88
	WCDMA II	RMC12.2K	Rear Face	1	9538	1		24.5	23.11	1.38	0.06	0.627	0.86
	WCDMA II	RMC12.2K	Bottom Side	1	9262	1		24.5	23.15	1.36	-0.11	0.645	0.88
32	WCDMA II	RMC12.2K	Bottom Side	1	9538	1		24.5	23.11	1.38	-0.04	0.617	0.85
	WCDMA II	RMC12.2K	Rear Face	1	9400	2		24.5	23.37	1.30	0.14	0.672	0.87
	WCDMA II	RMC12.2K	Rear Face	1	9262	2		24.5	23.15	1.36	0.08	0.631	0.86
	WCDMA II	RMC12.2K	Rear Face	1	9538	2		24.5	23.11	1.38	0.01	0.598	0.82
	WCDMA II	RMC12.2K	Rear Face	1	9400	1	w/	24.5	23.37	1.30	0.11	0.429	0.56
	WCDMA IV	RMC12.2K	Front Face	1	1513	1		24.5	24.39	1.03	0.12	0.807	0.83
	WCDMA IV	RMC12.2K	Rear Face	1	1513	1		24.5	24.39	1.03	-0.04	1.28	1.31
	WCDMA IV	RMC12.2K	Left Side	1	1513	1		24.5	24.39	1.03	0.11	0.239	0.25
	WCDMA IV	RMC12.2K	Right Side	1	1513	1		24.5	24.39	1.03	0.01	0.258	0.26
	WCDMA IV	RMC12.2K	Bottom Side	1	1513	1		24.5	24.39	1.03	0.11	0.705	0.72
	WCDMA IV	RMC12.2K	Front Face	1	1312	1		24.5	24.15	1.08	0.03	0.799	0.87
	WCDMA IV	RMC12.2K	Front Face	1	1413	1		24.5	24.25	1.06	0.07	0.792	0.84
	WCDMA IV	RMC12.2K	Rear Face	1	1312	1		24.5	24.15	1.08	0.12	1.19	1.29
	WCDMA IV	RMC12.2K	Rear Face	1	1413	1		24.5	24.25	1.06	0.02	1.10	1.17
	WCDMA IV	RMC12.2K	Rear Face	1	1513	2		24.5	24.39	1.03	0.14	1.14	1.17
	WCDMA IV	RMC12.2K	Rear Face	1	1312	2		24.5	24.15	1.08	0.11	1.02	1.11
	WCDMA IV	RMC12.2K	Rear Face	1	1413	2		24.5	24.25	1.06	0.14	0.90	0.95
	WCDMA IV	RMC12.2K	Rear Face	1	1513	1	w/	24.5	24.39	1.03	0.14	0.553	0.57
	WCDMA IV	RMC12.2K	Rear Face	1	1513	1		24.5	24.39	1.03	-0.04	1.22	1.25

FCC SAR Test Report

Plot No.	Band	Mode	Test Position	Separation Distance (cm)	Ch.	EUT Config.	Power Pack	Max. Tune-up Power (dBm)	Measured Conducted Power (dBm)	Scaling Factor	Power Drift (dB)	Measured SAR-1g (W/kg)	Scaled SAR-1g (W/kg)
33	WCDMA V	RMC12.2K	Front Face	1	4233	1		24.5	23.98	1.13	-0.13	0.458	0.52
	WCDMA V	RMC12.2K	Rear Face	1	4233	1		24.5	23.98	1.13	-0.14	0.727	0.82
	WCDMA V	RMC12.2K	Left Side	1	4233	1		24.5	23.98	1.13	0.07	0.056	0.06
	WCDMA V	RMC12.2K	Right Side	1	4233	1		24.5	23.98	1.13	-0.03	0.258	0.29
	WCDMA V	RMC12.2K	Bottom Side	1	4233	1		24.5	23.98	1.13	0.16	0.161	0.18
	WCDMA V	RMC12.2K	Rear Face	1	4132	1		24.5	23.65	1.22	0.05	0.677	0.82
	WCDMA V	RMC12.2K	Rear Face	1	4182	1		24.5	23.95	1.14	0.08	0.701	0.80
	WCDMA V	RMC12.2K	Rear Face	1	4233	2		24.5	23.98	1.13	-0.07	0.688	0.78
	WCDMA V	RMC12.2K	Rear Face	1	4233	1	w/	24.5	23.98	1.13	0.06	0.365	0.41

Plot No.	Band	Mode	Test Position	Separation Distance (cm)	Ch.	EUT Config.	Power Pack	RB#	RB Offset	Max. Tune-up Power (dBm)	Measured Conducted Power (dBm)	Scaling Factor	Power Drift (dB)	Measured SAR-1g (W/kg)	Scaled SAR-1g (W/kg)
34	LTE 2	QPSK20M	Front Face	1	18900	1		1	0	24.0	23.97	1.01	-0.12	0.714	0.72
	LTE 2	QPSK20M	Rear Face	1	18900	1		1	0	24.0	23.97	1.01	-0.09	0.695	0.70
	LTE 2	QPSK20M	Left Side	1	18900	1		1	0	24.0	23.97	1.01	0	0.232	0.23
	LTE 2	QPSK20M	Right Side	1	18900	1		1	0	24.0	23.97	1.01	0.01	0.231	0.23
	LTE 2	QPSK20M	Bottom Side	1	18900	1		1	0	24.0	23.97	1.01	-0.13	0.579	0.58
	LTE 2	QPSK20M	Front Face	1	18900	1		50	0	23.0	22.93	1.02	0.05	0.507	0.52
	LTE 2	QPSK20M	Rear Face	1	18900	1		50	0	23.0	22.93	1.02	0.04	0.502	0.51
	LTE 2	QPSK20M	Left Side	1	18900	1		50	0	23.0	22.93	1.02	0.09	0.382	0.39
	LTE 2	QPSK20M	Right Side	1	18900	1		50	0	23.0	22.93	1.02	-0.11	0.146	0.15
	LTE 2	QPSK20M	Bottom Side	1	18900	1		50	0	23.0	22.93	1.02	0.08	0.396	0.40
	LTE 2	QPSK20M	Front Face	1	18900	2		1	0	24.0	23.97	1.01	0.03	0.706	0.71
	LTE 2	QPSK20M	Front Face	1	18900	1	w/	1	0	24.0	23.97	1.01	0.02	0.504	0.51
	LTE 4	QPSK20M	Front Face	1	20175	1		1	0	24.0	23.98	1.00	-0.08	0.719	0.72
	LTE 4	QPSK20M	Rear Face	1	20175	1		1	0	24.0	23.98	1.00	-0.14	1.19	1.20
	LTE 4	QPSK20M	Left Side	1	20175	1		1	0	24.0	23.98	1.00	-0.08	0.20	0.20
	LTE 4	QPSK20M	Right Side	1	20175	1		1	0	24.0	23.98	1.00	0.07	0.09	0.09
	LTE 4	QPSK20M	Bottom Side	1	20175	1		1	0	24.0	23.98	1.00	0.13	1.12	1.13
	LTE 4	QPSK20M	Front Face	1	20175	1		50	0	23.0	22.80	1.05	-0.05	0.61	0.64
LTE 4	QPSK20M	Rear Face	1	20175	1		50	0	23.0	22.80	1.05	0.08	0.89	0.93	
LTE 4	QPSK20M	Left Side	1	20175	1		50	0	23.0	22.80	1.05	0	0.152	0.16	
LTE 4	QPSK20M	Right Side	1	20175	1		50	0	23.0	22.80	1.05	0.02	0.059	0.06	
LTE 4	QPSK20M	Bottom Side	1	20175	1		50	0	23.0	22.80	1.05	-0.05	0.971	1.02	
LTE 4	QPSK20M	Rear Face	1	20050	1		1	0	24.0	23.88	1.03	0.03	1.14	1.17	
35	LTE 4	QPSK20M	Rear Face	1	20300	1		1	0	24.0	23.78	1.05	-0.11	1.22	1.28
	LTE 4	QPSK20M	Bottom Side	1	20050	1		1	0	24.0	23.88	1.03	0.01	1.08	1.11
	LTE 4	QPSK20M	Bottom Side	1	20300	1		1	0	24.0	23.78	1.05	0.1	1.11	1.17
	LTE 4	QPSK20M	Rear Face	1	20050	1		50	0	23.0	22.32	1.17	-0.14	0.86	1.01
	LTE 4	QPSK20M	Rear Face	1	20300	1		50	0	23.0	22.29	1.18	0.08	0.865	1.02
	LTE 4	QPSK20M	Bottom Side	1	20050	1		50	0	23.0	22.32	1.17	0.07	0.967	1.13
	LTE 4	QPSK20M	Bottom Side	1	20300	1		50	0	23.0	22.29	1.18	0.08	0.943	1.11
	LTE 4	QPSK20M	Rear Face	1	20175	1		100	0	23.0	22.26	1.19	-0.09	0.886	1.05
	LTE 4	QPSK20M	Bottom Side	1	20175	1		100	0	23.0	22.26	1.19	0.11	0.966	1.15
	LTE 4	QPSK20M	Rear Face	1	20300	2		1	0	24.0	23.78	1.05	-0.07	1.01	1.06
	LTE 4	QPSK20M	Rear Face	1	20050	2		1	0	24.0	23.88	1.03	0.03	1.06	1.09
	LTE 4	QPSK20M	Rear Face	1	20175	2		1	0	24.0	23.98	1.00	-0.08	1.17	1.18
LTE 4	QPSK20M	Rear Face	1	20300	1	w/	1	0	24.0	23.78	1.05	-0.02	0.961	1.01	
LTE 4	QPSK20M	Rear Face	1	20050	1	w/	1	0	24.0	23.88	1.03	0.05	0.977	1.00	
LTE 4	QPSK20M	Rear Face	1	20175	1	w/	1	0	24.0	23.98	1.00	0.04	0.991	1.00	
LTE 4	QPSK20M	Rear Face	1	20300	1		1	0	24.0	23.78	1.05	0.03	1.18	1.24	

FCC SAR Test Report

Plot No.	Band	Mode	Test Position	Separation Distance (cm)	Ch.	EUT Config.	Power Pack	RB#	RB Offset	Max. Tune-up Power (dBm)	Measured Conducted Power (dBm)	Scaling Factor	Power Drift (dB)	Measured SAR-1g (W/kg)	Scaled SAR-1g (W/kg)
36	LTE 5	QPSK10M	Front Face	1	20525	1		1	24	24.0	23.40	1.15	-0.01	0.480	0.55
	LTE 5	QPSK10M	Rear Face	1	20525	1		1	24	24.0	23.40	1.15	-0.04	0.843	0.97
	LTE 5	QPSK10M	Left Side	1	20525	1		1	24	24.0	23.40	1.15	0.03	0.117	0.13
	LTE 5	QPSK10M	Right Side	1	20525	1		1	24	24.0	23.40	1.15	0.01	0.271	0.31
	LTE 5	QPSK10M	Bottom Side	1	20525	1		1	24	24.0	23.40	1.15	0.08	0.140	0.16
	LTE 5	QPSK10M	Front Face	1	20525	1		25	12	23.0	22.45	1.14	0.12	0.521	0.59
	LTE 5	QPSK10M	Rear Face	1	20525	1		25	12	23.0	22.45	1.14	0.15	0.322	0.37
	LTE 5	QPSK10M	Left Side	1	20525	1		25	12	23.0	22.45	1.14	0.11	0.050	0.06
	LTE 5	QPSK10M	Right Side	1	20525	1		25	12	23.0	22.45	1.14	0.15	0.070	0.08
	LTE 5	QPSK10M	Bottom Side	1	20525	1		25	12	23.0	22.45	1.14	0.11	0.115	0.13
	LTE 5	QPSK10M	Rear Face	1	20450	1		1	24	24.0	23.32	1.17	0.14	0.83	0.97
	LTE 5	QPSK10M	Rear Face	1	20600	1		1	24	24.0	23.20	1.20	0.11	0.79	0.95
	LTE 5	QPSK10M	Rear Face	1	20525	1		50	0	23.0	22.37	1.16	0.12	0.311	0.36
	LTE 5	QPSK10M	Rear Face	1	20525	2		1	24	24.0	23.40	1.15	0.03	0.626	0.72
	LTE 5	QPSK10M	Rear Face	1	20525	1	w/	1	24	24.0	23.40	1.15	-0.03	0.447	0.51
	LTE 5	QPSK10M	Rear Face	1	20525	1		1	24	24.0	23.40	1.15	-0.04	0.83	0.95
37	LTE 12	QPSK10M	Front Face	1	23095	1		1	0	24.0	23.73	1.06	0.15	0.271	0.29
	LTE 12	QPSK10M	Rear Face	1	23095	1		1	0	24.0	23.73	1.06	-0.05	0.426	0.45
	LTE 12	QPSK10M	Left Side	1	23095	1		1	0	24.0	23.73	1.06	0.13	0.044	0.05
	LTE 12	QPSK10M	Right Side	1	23095	1		1	0	24.0	23.73	1.06	0.15	0.076	0.08
	LTE 12	QPSK10M	Bottom Side	1	23095	1		1	0	24.0	23.73	1.06	0.11	0.077	0.08
	LTE 12	QPSK10M	Front Face	1	23095	1		25	0	23.0	22.78	1.05	0.15	0.218	0.23
	LTE 12	QPSK10M	Rear Face	1	23095	1		25	0	23.0	22.78	1.05	0.13	0.383	0.40
	LTE 12	QPSK10M	Left Side	1	23095	1		25	0	23.0	22.78	1.05	0.12	0.052	0.05
	LTE 12	QPSK10M	Right Side	1	23095	1		25	0	23.0	22.78	1.05	0.12	0.084	0.09
	LTE 12	QPSK10M	Bottom Side	1	23095	1		25	0	23.0	22.78	1.05	0.15	0.063	0.07
	LTE 12	QPSK10M	Rear Face	1	23095	2		1	0	24.0	23.73	1.06	0.03	0.408	0.43
	LTE 12	QPSK10M	Rear Face	1	23095	1	w/	1	0	24.0	23.73	1.06	0.15	0.178	0.19
38	LTE 17	QPSK10M	Front Face	1	23790	1		1	0	24.0	23.91	1.02	0.11	0.262	0.27
	LTE 17	QPSK10M	Rear Face	1	23790	1		1	0	24.0	23.91	1.02	0.03	0.438	0.45
	LTE 17	QPSK10M	Left Side	1	23790	1		1	0	24.0	23.91	1.02	0.13	0.119	0.12
	LTE 17	QPSK10M	Right Side	1	23790	1		1	0	24.0	23.91	1.02	0.15	0.199	0.20
	LTE 17	QPSK10M	Bottom Side	1	23790	1		1	0	24.0	23.91	1.02	0.11	0.117	0.12
	LTE 17	QPSK10M	Front Face	1	23790	1		25	0	23.0	22.81	1.04	0.13	0.226	0.24
	LTE 17	QPSK10M	Rear Face	1	23790	1		25	0	23.0	22.81	1.04	0.15	0.434	0.45
	LTE 17	QPSK10M	Left Side	1	23790	1		25	0	23.0	22.81	1.04	-0.15	0.050	0.05
	LTE 17	QPSK10M	Right Side	1	23790	1		25	0	23.0	22.81	1.04	0.11	0.082	0.09
	LTE 17	QPSK10M	Bottom Side	1	23790	1		25	0	23.0	22.81	1.04	0.12	0.069	0.07
	LTE 17	QPSK10M	Rear Face	1	23790	2		1	0	24.0	23.91	1.02	0.13	0.410	0.42
	LTE 17	QPSK10M	Rear Face	1	23790	1	w/	1	0	24.0	23.91	1.02	0.15	0.190	0.19

Plot No.	Band	Mode	Test Position	Separation Distance (cm)	Ch.	EUT Config.	Power Pack	Max. Tune-up Power (dBm)	Measured Conducted Power (dBm)	Scaling Factor	Power Drift (dB)	Measured SAR-1g (W/kg)	Scaled SAR-1g (W/kg)
39	2.4G WLAN	802.11b	Front Face	1	6	1		20.0	19.71	1.07	0.02	0.288	0.31
	2.4G WLAN	802.11b	Rear Face	1	6	1		20.0	19.71	1.07	0.04	0.809	0.86
	2.4G WLAN	802.11b	Right Side	1	6	1		20.0	19.71	1.07	0.13	0.934	1.00
	2.4G WLAN	802.11b	Top Side	1	6	1		20.0	19.71	1.07	0.11	0.225	0.24
	2.4G WLAN	802.11b	Rear Face	1	11	1		20.0	19.46	1.13	0.05	0.755	0.85
	2.4G WLAN	802.11b	Right Side	1	11	1		20.0	19.46	1.13	0.15	0.878	0.99
	2.4G WLAN	802.11b	Right Side	1	6	2		20.0	19.71	1.07	0.13	0.904	0.97
	2.4G WLAN	802.11b	Right Side	1	11	2		20.0	19.46	1.13	0.13	0.869	0.98
	2.4G WLAN	802.11b	Right Side	1	6	1	w/	20.0	19.71	1.07	0.11	0.422	0.45
	2.4G WLAN	802.11b	Right Side	1	6	1		20.0	19.71	1.07	0.15	0.928	0.99

FCC SAR Test Report

4.7.5 SAR Results for Holster Exposure Condition (Test Separation Distance is 0 mm)

Plot No.	Band	Mode	Test Position	Ch.	EUT Config.	Power Pack	Max. Tune-up Power (dBm)	Measured Conducted Power (dBm)	Scaling Factor	Power Drift (dB)	Measured SAR-1g (W/kg)	Scaled SAR-1g (W/kg)
	GSM850	GPRS10	(Front)_Bottom join	251	1		32.0	31.96	1.01	0.15	0.388	0.39
	GSM850	GPRS10	(Front)_Top join	251	1		32.0	31.96	1.01	0.13	0.389	0.39
	GSM850	GPRS10	(Rear)_Bottom join	251	1		32.0	31.96	1.01	0.11	0.259	0.26
	GSM850	GPRS10	(Rear)_Top join	251	1		32.0	31.96	1.01	0.15	0.281	0.28
40	GSM850	GPRS10	(Front)_Top join	251	2		32.0	31.96	1.01	-0.16	0.395	0.40
	GSM850	GPRS10	(Front)_Top join	251	2	w/	32.0	31.96	1.01	0.15	0.210	0.21
	GSM1900	GPRS10	(Front)_Bottom join	512	1		28.0	27.94	1.01	0.15	0.274	0.28
41	GSM1900	GPRS10	(Front)_Top join	512	1		28.0	27.94	1.01	0.13	0.565	0.57
	GSM1900	GPRS10	(Rear)_Bottom join	512	1		28.0	27.94	1.01	0.13	0.362	0.37
	GSM1900	GPRS10	(Rear)_Top join	512	1		28.0	27.94	1.01	0.11	0.260	0.26
	GSM1900	GPRS10	(Front)_Top join	512	2		28.0	27.94	1.01	0.12	0.378	0.38
	GSM1900	GPRS10	(Front)_Top join	512	1	w/	28.0	27.94	1.01	0.15	0.400	0.41
	WCDMA II	RMC12.2K	(Front)_Bottom join	9400	1		24.5	23.37	1.30	-0.09	0.340	0.44
	WCDMA II	RMC12.2K	(Front)_Top join	9400	1		24.5	23.37	1.30	0.1	0.490	0.64
	WCDMA II	RMC12.2K	(Rear)_Bottom join	9400	1		24.5	23.37	1.30	0.03	0.454	0.59
	WCDMA II	RMC12.2K	(Rear)_Top join	9400	1		24.5	23.37	1.30	-0.05	0.359	0.47
	WCDMA II	RMC12.2K	(Front)_Top join	9400	2		24.5	23.37	1.30	0.02	0.483	0.63
42	WCDMA II	RMC12.2K	(Front)_Top join	9400	1	w/	24.5	23.37	1.30	-0.03	0.838	1.09
	WCDMA II	RMC12.2K	(Front)_Top join	9262	1	w/	24.5	23.15	1.36	0.01	0.794	1.08
	WCDMA II	RMC12.2K	(Front)_Top join	9538	1	w/	24.5	23.11	1.38	0.07	0.684	0.94
	WCDMA II	RMC12.2K	(Front)_Top join	9400	1	w/	24.5	23.37	1.30	0.1	0.827	1.07
	WCDMA IV	RMC12.2K	(Front)_Bottom join	1513	1		24.5	24.39	1.03	0.15	0.589	0.60
43	WCDMA IV	RMC12.2K	(Front)_Top join	1513	1		24.5	24.39	1.03	-0.12	0.739	0.76
	WCDMA IV	RMC12.2K	(Rear)_Bottom join	1513	1		24.5	24.39	1.03	0.11	0.541	0.55
	WCDMA IV	RMC12.2K	(Rear)_Top join	1513	1		24.5	24.39	1.03	0.15	0.451	0.46
	WCDMA IV	RMC12.2K	(Front)_Top join	1513	2		24.5	24.39	1.03	0.14	0.733	0.75
	WCDMA IV	RMC12.2K	(Front)_Top join	1513	1	w/	24.5	24.39	1.03	0.15	0.519	0.53
	WCDMA V	RMC12.2K	(Front)_Bottom join	4233	1		24.5	23.98	1.13	0.15	0.242	0.27
44	WCDMA V	RMC12.2K	(Front)_Top join	4233	1		24.5	23.98	1.13	-0.12	0.247	0.28
	WCDMA V	RMC12.2K	(Rear)_Bottom join	4233	1		24.5	23.98	1.13	0.13	0.124	0.14
	WCDMA V	RMC12.2K	(Rear)_Top join	4233	1		24.5	23.98	1.13	0.12	0.169	0.19
	WCDMA V	RMC12.2K	(Front)_Top join	4233	2		24.5	23.98	1.13	0.02	0.232	0.26
	WCDMA V	RMC12.2K	(Front)_Top join	4233	1	w/	24.5	23.98	1.13	0.15	0.124	0.14

FCC SAR Test Report

Plot No.	Band	Mode	Test Position	Ch.	EUT Config.	Power Pack	RB#	RB Offset	Max. Tune-up Power (dBm)	Measured Conducted Power (dBm)	Scaling Factor	Power Drift (dB)	Measured SAR-1g (W/kg)	Scaled SAR-1g (W/kg)
45	LTE 2	QPSK20M	(Front)_Bottom join	18900	1		1	0	24.0	23.97	1.01	0.15	0.204	0.21
	LTE 2	QPSK20M	(Front)_Top join	18900	1		1	0	24.0	23.97	1.01	-0.17	0.441	0.44
	LTE 2	QPSK20M	(Rear)_Bottom join	18900	1		1	0	24.0	23.97	1.01	0.13	0.247	0.25
	LTE 2	QPSK20M	(Rear)_Top join	18900	1		1	0	24.0	23.97	1.01	0.12	0.207	0.21
	LTE 2	QPSK20M	(Front)_Bottom join	18900	1		50	0	23.0	22.93	1.02	0.01	0.155	0.16
	LTE 2	QPSK20M	(Front)_Top join	18900	1		50	0	23.0	22.93	1.02	0.05	0.209	0.21
	LTE 2	QPSK20M	(Rear)_Bottom join	18900	1		50	0	23.0	22.93	1.02	0.05	0.180	0.18
	LTE 2	QPSK20M	(Rear)_Top join	18900	1		50	0	23.0	22.93	1.02	0.15	0.154	0.16
	LTE 2	QPSK20M	(Front)_Top join	18900	2		1	0	24.0	23.97	1.01	0.13	0.284	0.29
	LTE 2	QPSK20M	(Front)_Top join	18900	1	w/	1	0	24.0	23.97	1.01	0.11	0.294	0.30
46	LTE 4	QPSK20M	(Front)_Bottom join	20175	1		1	0	24.0	23.98	1.00	0.11	0.3998	0.40
	LTE 4	QPSK20M	(Front)_Top join	20175	1		1	0	24.0	23.98	1.00	-0.17	0.406	0.41
	LTE 4	QPSK20M	(Rear)_Bottom join	20175	1		1	0	24.0	23.98	1.00	0.15	0.311	0.31
	LTE 4	QPSK20M	(Rear)_Top join	20175	1		1	0	24.0	23.98	1.00	0.11	0.274	0.28
	LTE 4	QPSK20M	(Front)_Bottom join	20175	1		50	0	23.0	22.80	1.05	0.13	0.352	0.37
	LTE 4	QPSK20M	(Front)_Top join	20175	1		50	0	23.0	22.80	1.05	0.15	0.331	0.35
	LTE 4	QPSK20M	(Rear)_Bottom join	20175	1		50	0	23.0	22.80	1.05	0.12	0.262	0.27
	LTE 4	QPSK20M	(Rear)_Top join	20175	1		50	0	23.0	22.80	1.05	0.12	0.103	0.11
	LTE 4	QPSK20M	(Front)_Top join	20175	2		1	0	24.0	23.98	1.00	0.15	0.402	0.40
	LTE 4	QPSK20M	(Front)_Top join	20175	1	w/	1	0	24.0	23.98	1.00	0.13	0.205	0.21
47	LTE 5	QPSK10M	(Front)_Bottom join	20525	1		1	24	24.0	23.40	1.15	0.00	0.223	0.26
	LTE 5	QPSK10M	(Front)_Top join	20525	1		1	24	24.0	23.40	1.15	0.13	0.209	0.24
	LTE 5	QPSK10M	(Rear)_Bottom join	20525	1		1	24	24.0	23.40	1.15	0.15	0.139	0.16
	LTE 5	QPSK10M	(Rear)_Top join	20525	1		1	24	24.0	23.40	1.15	0.11	0.157	0.18
	LTE 5	QPSK10M	(Front)_Bottom join	20525	1		25	12	23.0	22.45	1.14	0.12	0.177	0.20
	LTE 5	QPSK10M	(Front)_Top join	20525	1		25	12	23.0	22.45	1.14	0.15	0.146	0.17
	LTE 5	QPSK10M	(Rear)_Bottom join	20525	1		25	12	23.0	22.45	1.14	0.13	0.108	0.12
	LTE 5	QPSK10M	(Rear)_Top join	20525	1		25	12	23.0	22.45	1.14	0.11	0.145	0.16
	LTE 5	QPSK10M	(Front)_Bottom join	20525	2		1	24	24.0	23.40	1.15	0.15	0.177	0.20
	LTE 5	QPSK10M	(Front)_Bottom join	20525	1	w/	1	24	24.0	23.40	1.15	0.05	0.131	0.15
48	LTE 12	QPSK10M	(Front)_Bottom join	23095	1		1	0	24.0	23.73	1.06	-0.01	0.384	0.41
	LTE 12	QPSK10M	(Front)_Top join	23095	1		1	0	24.0	23.73	1.06	0.15	0.289	0.31
	LTE 12	QPSK10M	(Rear)_Bottom join	23095	1		1	0	24.0	23.73	1.06	0.03	0.335	0.36
	LTE 12	QPSK10M	(Rear)_Top join	23095	1		1	0	24.0	23.73	1.06	0.12	0.220	0.23
	LTE 12	QPSK10M	(Front)_Bottom join	23095	1		25	0	23.0	22.78	1.05	0.11	0.351	0.37
	LTE 12	QPSK10M	(Front)_Top join	23095	1		25	0	23.0	22.78	1.05	0.15	0.270	0.28
	LTE 12	QPSK10M	(Rear)_Bottom join	23095	1		25	0	23.0	22.78	1.05	0.11	0.268	0.28
	LTE 12	QPSK10M	(Rear)_Top join	23095	1		25	0	23.0	22.78	1.05	0.12	0.190	0.20
	LTE 12	QPSK10M	(Front)_Bottom join	23095	2		1	0	24.0	23.73	1.06	0.15	0.374	0.40
	LTE 12	QPSK10M	(Front)_Bottom join	23095	1	w/	1	0	24.0	23.73	1.06	0.01	0.208	0.22
49	LTE 17	QPSK10M	(Front)_Bottom join	23790	1		1	0	24.0	23.91	1.02	0.15	0.399	0.41
	LTE 17	QPSK10M	(Front)_Top join	23790	1		1	0	24.0	23.91	1.02	0.15	0.285	0.29
	LTE 17	QPSK10M	(Rear)_Bottom join	23790	1		1	0	24.0	23.91	1.02	0.13	0.307	0.31
	LTE 17	QPSK10M	(Rear)_Top join	23790	1		1	0	24.0	23.91	1.02	0.12	0.211	0.22
	LTE 17	QPSK10M	(Front)_Bottom join	23790	1		25	0	23.0	22.81	1.04	0.12	0.395	0.41
	LTE 17	QPSK10M	(Front)_Top join	23790	1		25	0	23.0	22.81	1.04	0.12	0.306	0.32
	LTE 17	QPSK10M	(Rear)_Bottom join	23790	1		25	0	23.0	22.81	1.04	0.05	0.286	0.30
	LTE 17	QPSK10M	(Rear)_Top join	23790	1		25	0	23.0	22.81	1.04	0.11	0.204	0.21
	LTE 17	QPSK10M	(Front)_Bottom join	23790	2		1	0	24.0	23.91	1.02	0.15	0.375	0.38
	LTE 17	QPSK10M	(Front)_Bottom join	23790	1	w/	1	0	24.0	23.91	1.02	0.15	0.235	0.24

FCC SAR Test Report

Plot No.	Band	Mode	Test Position	Ch.	EUT Config.	Power Pack	Max. Tune-up Power (dBm)	Measured Conducted Power (dBm)	Scaling Factor	Power Drift (dB)	Measured SAR-1g (W/kg)	Scaled SAR-1g (W/kg)
50	2.4G WLAN	802.11b	(Front)_Bottom join	6	1		20.0	19.71	1.07	0.11	0.182	0.19
	2.4G WLAN	802.11b	(Front)_Top join	6	1		20.0	19.71	1.07	-0.06	0.292	0.31
	2.4G WLAN	802.11b	(Rear)_Bottom join	6	1		20.0	19.71	1.07	0.14	0.057	0.06
	2.4G WLAN	802.11b	(Rear)_Top join	6	1		20.0	19.71	1.07	0.02	0.099	0.11
	2.4G WLAN	802.11b	(Front)_Top join	6	2		20.0	19.71	1.07	0.08	0.277	0.30
	2.4G WLAN	802.11b	(Front)_Top join	6	1	w/	20.0	19.71	1.07	0.1	0.185	0.20
51	5.3G WLAN	802.11n HT40	(Front)_Bottom join	54	1		18.5	18.41	1.02	-0.03	0.452	0.46
	5.3G WLAN	802.11n HT40	(Front)_Top join	54	1		18.5	18.41	1.02	-0.11	0.616	0.63
	5.3G WLAN	802.11n HT40	(Rear)_Bottom join	54	1		18.5	18.41	1.02	0.08	0.069	0.07
	5.3G WLAN	802.11n HT40	(Rear)_Top join	54	1		18.5	18.41	1.02	-0.05	0.115	0.12
	5.3G WLAN	802.11n HT40	(Front)_Top join	54	2		18.5	18.41	1.02	0.13	0.597	0.61
	5.3G WLAN	802.11n HT40	(Front)_Top join	54	1	w/	18.5	18.41	1.02	-0.05	0.565	0.58
52	5.6G WLAN	802.11ac VH80	(Front)_Bottom join	138	1		18.5	18.47	1.01	-0.08	0.518	0.52
	5.6G WLAN	802.11ac VH80	(Front)_Top join	138	1		18.5	18.47	1.01	0.04	0.798	0.80
	5.6G WLAN	802.11ac VH80	(Rear)_Bottom join	138	1		18.5	18.47	1.01	0.01	0.067	0.07
	5.6G WLAN	802.11ac VH80	(Rear)_Top join	138	1		18.5	18.47	1.01	-0.11	0.096	0.10
	5.6G WLAN	802.11ac VH80	(Front)_Top join	122	1		18.5	18.39	1.03	0.07	0.738	0.76
	5.6G WLAN	802.11ac VH80	(Front)_Top join	138	2		18.5	18.47	1.01	0.03	0.743	0.75
	5.6G WLAN	802.11ac VH80	(Front)_Top join	138	1	w/	18.5	18.47	1.01	-0.05	0.645	0.65
53	5.8G WLAN	802.11ac VH80	(Front)_Bottom join	155	1		18.5	18.47	1.01	-0.11	0.362	0.36
	5.8G WLAN	802.11ac VH80	(Front)_Top join	155	1		18.5	18.47	1.01	-0.13	0.465	0.47
	5.8G WLAN	802.11ac VH80	(Rear)_Bottom join	155	1		18.5	18.47	1.01	0.09	0.038	0.04
	5.8G WLAN	802.11ac VH80	(Rear)_Top join	155	1		18.5	18.47	1.01	-0.08	0.047	0.05
	5.8G WLAN	802.11ac VH80	(Front)_Top join	155	2		18.5	18.47	1.01	0.03	0.441	0.44
	5.8G WLAN	802.11ac VH80	(Front)_Top join	155	1	w/	18.5	18.47	1.01	-0.07	0.360	0.36

FCC SAR Test Report

4.7.6 SAR Results for Arm Mount Exposure Condition (Test Separation Distance is 0 mm)

Plot No.	Band	Mode	Test Position	Ch.	EUT Config.	Power Pack	Max. Tune-up Power (dBm)	Measured Conducted Power (dBm)	Scaling Factor	Power Drift (dB)	Measured SAR-10g (W/kg)	Scaled SAR-10g (W/kg)
	GSM850	GPRS10	Rear Face	251	1		32.0	31.96	1.01	0.13	0.341	0.34
54	GSM850	GPRS10	Rear Face	251	2		32.0	31.96	1.01	0.15	0.351	0.35
55	GSM1900	GPRS10	Rear Face	512	1		28.0	27.94	1.01	-0.14	0.166	0.17
	GSM1900	GPRS10	Rear Face	512	2		28.0	27.94	1.01	0.15	0.121	0.12
56	WCDMA II	RMC12.2K	Rear Face	9400	1		24.5	23.37	1.30	-0.15	0.222	0.29
	WCDMA II	RMC12.2K	Rear Face	9400	2		24.5	23.37	1.30	0.15	0.209	0.27
57	WCDMA IV	RMC12.2K	Rear Face	1513	1		24.5	24.39	1.03	-0.04	0.211	0.22
	WCDMA IV	RMC12.2K	Rear Face	1513	2		24.5	24.39	1.03	0.15	0.165	0.17
58	WCDMA V	RMC12.2K	Rear Face	4233	1		24.5	23.98	1.13	-0.07	0.267	0.30
	WCDMA V	RMC12.2K	Rear Face	4233	2		24.5	23.98	1.13	0.15	0.236	0.27

Plot No.	Band	Mode	Test Position	Ch.	EUT Config.	Power Pack	RB#	RB Offset	Max. Tune-up Power (dBm)	Measured Conducted Power (dBm)	Scaling Factor	Power Drift (dB)	Measured SAR-10g (W/kg)	Scaled SAR-10g (W/kg)
59	LTE 2	QPSK20M	Rear Face	18900	1		1	0	24.0	23.97	1.01	-0.11	0.127	0.13
	LTE 2	QPSK20M	Rear Face	18900	1		50	0	23.0	22.93	1.02	0.15	0.123	0.12
	LTE 2	QPSK20M	Rear Face	18900	2		1	0	24.0	23.97	1.01	0.12	0.124	0.12
60	LTE 4	QPSK20M	Rear Face	20175	1		1	0	24.0	23.98	1.00	-0.08	0.108	0.11
	LTE 4	QPSK20M	Rear Face	20175	1		50	0	23.0	22.80	1.05	0.11	0.099	0.10
	LTE 4	QPSK20M	Rear Face	20175	2		1	0	24.0	23.98	1.00	0.15	0.101	0.10
61	LTE 5	QPSK10M	Rear Face	20525	1		1	24	24.0	23.40	1.15	-0.11	0.241	0.28
	LTE 5	QPSK10M	Rear Face	20525	1		25	12	23.0	22.45	1.14	0.15	0.227	0.26
	LTE 5	QPSK10M	Rear Face	20525	2		1	24	24.0	23.40	1.15	0.11	0.232	0.27
62	LTE 12	QPSK10M	Rear Face	23095	1		1	0	24.0	23.73	1.06	-0.06	0.223	0.24
	LTE 12	QPSK10M	Rear Face	23095	1		25	0	24.0	23.78	1.05	0.15	0.204	0.21
	LTE 12	QPSK10M	Rear Face	23095	2		1	0	24.0	23.73	1.06	0.13	0.208	0.22
63	LTE 17	QPSK10M	Rear Face	23790	1		1	0	24.0	23.91	1.02	0.01	0.222	0.23
	LTE 17	QPSK10M	Rear Face	23790	1		25	0	23.0	22.81	1.04	0.15	0.213	0.22
	LTE 17	QPSK10M	Rear Face	23790	2		1	0	24.0	23.91	1.02	0.11	0.221	0.23

Plot No.	Band	Mode	Test Position	Ch.	EUT Config.	Power Pack	Max. Tune-up Power (dBm)	Measured Conducted Power (dBm)	Scaling Factor	Power Drift (dB)	Measured SAR-10g (W/kg)	Scaled SAR-10g (W/kg)
64	2.4G WLAN	802.11b	Rear Face	6	1		20.0	19.71	1.07	-0.19	0.174	0.19
	2.4G WLAN	802.11b	Rear Face	6	2		20.0	19.71	1.07	0.12	0.122	0.13
65	5.3G WLAN	802.11n HT40	Rear Face	54	1		18.5	18.41	1.02	0.08	0.173	0.18
	5.3G WLAN	802.11n HT40	Rear Face	54	2		18.5	18.41	1.02	0.02	0.105	0.11
66	5.6G WLAN	802.11ac VH80	Rear Face	138	1		18.5	18.47	1.01	-0.04	0.322	0.32
	5.6G WLAN	802.11ac VH80	Rear Face	138	2		18.5	18.47	1.01	-0.11	0.316	0.32
67	5.8G WLAN	802.11ac VH80	Rear Face	155	1		18.5	18.47	1.01	-0.14	0.227	0.23
	5.8G WLAN	802.11ac VH80	Rear Face	155	2		18.5	18.47	1.01	-0.02	0.201	0.20

FCC SAR Test Report

4.7.7 SAR Measurement Variability

According to KDB 865664 D01, SAR measurement variability was assessed for each frequency band, which is determined by the SAR probe calibration point and tissue-equivalent medium used for the device measurements. When both head and body tissue-equivalent media are required for SAR measurements in a frequency band, the variability measurement procedures should be applied to the tissue medium with the highest measured SAR, using the highest measured SAR configuration for that tissue-equivalent medium. Alternatively, if the highest measured SAR for both head and body tissue-equivalent media are ≤ 1.45 W/kg and the ratio of these highest SAR values, i.e., largest divided by smallest value, is ≤ 1.10 , the highest SAR configuration for either head or body tissue-equivalent medium may be used to perform the repeated measurement. These additional measurements are repeated after the completion of all measurements requiring the same head or body tissue-equivalent medium in a frequency band. The test device should be returned to ambient conditions (normal room temperature) with the battery fully charged before it is re-mounted on the device holder for the repeated measurement(s) to minimize any unexpected variations in the repeated results.

SAR repeated measurement procedure:

1. When the highest measured SAR is < 0.80 W/kg, repeated measurement is not required.
2. When the highest measured SAR is ≥ 0.80 W/kg, repeat that measurement once.
3. If the ratio of largest to smallest SAR for the original and first repeated measurements is > 1.20 , or when the original or repeated measurement is ≥ 1.45 W/kg, perform a second repeated measurement.
4. If the ratio of largest to smallest SAR for the original, first and second repeated measurements is > 1.20 , and the original, first or second repeated measurement is ≥ 1.5 W/kg, perform a third repeated measurement.

Band	Mode	Test Position	Ch.	Original Measured SAR-1g (W/kg)	1st Repeated SAR-1g (W/kg)	L/S Ratio	2nd Repeated SAR-1g (W/kg)	L/S Ratio	3rd Repeated SAR-1g (W/kg)	L/S Ratio
WCDMA IV	RMC12.2K	Left Cheek	1513	1.02	0.99	1.03	N/A	N/A	N/A	N/A
LTE 2	QPSK20M	Left Cheek	18900	0.805	0.793	1.02	N/A	N/A	N/A	N/A
2.4G WLAN	802.11b	Left Cheek	6	1.27	1.18	1.08	N/A	N/A	N/A	N/A
5.3G WLAN	802.11n HT40	Rear Face	54	1.04	1.01	1.03	N/A	N/A	N/A	N/A
5.6G WLAN	802.11ac VH80	Rear Face	138	1.24	1.21	1.02	N/A	N/A	N/A	N/A
5.8G WLAN	802.11ac VH80	Rear Face	155	0.938	0.912	1.03	N/A	N/A	N/A	N/A
GSM850	GPRS10	Rear Face	251	0.999	0.98	1.02	N/A	N/A	N/A	N/A
GSM1900	GPRS10	Front Face	810	0.852	0.844	1.01	N/A	N/A	N/A	N/A
WCDMA IV	RMC12.2K	Rear Face	1513	1.28	1.22	1.05	N/A	N/A	N/A	N/A
LTE 4	QPSK20M	Rear Face	20300	1.22	1.18	1.03	N/A	N/A	N/A	N/A
LTE 5	QPSK10M	Rear Face	20525	0.843	0.830	1.02	N/A	N/A	N/A	N/A
2.4G WLAN	802.11b	Right Side	6	0.934	0.928	1.01	N/A	N/A	N/A	N/A
WCDMA II	RMC12.2K	(Front)_Top Join	9400	0.838	0.827	1.01	N/A	N/A	N/A	N/A

4.7.8 Simultaneous Multi-band Transmission Evaluation

<Possibilities of Simultaneous Transmission>

The simultaneous transmission possibilities for this device are listed as below.

Simultaneous TX Combination	Capable Transmit Configurations	Head Exposure Condition	Body-worn Exposure Condition	Hotpot Exposure Condition	Holster Exposure Condition	Arm Mount Exposure Condition
1	GSM + WLAN 2.4G	Yes	Yes	Yes	Yes	Yes
2	GSM + WLAN 5G	Yes	Yes	No	Yes	Yes
3	GSM + BT	No	Yes	No	Yes	Yes
4	WCDMA + WLAN 2.4G	Yes	Yes	Yes	Yes	Yes
5	WCDMA + WLAN 5G	Yes	Yes	No	Yes	Yes
6	WCDMA + BT	No	Yes	No	Yes	Yes
7	LTE + WLAN 2.4G	Yes	Yes	Yes	Yes	Yes
8	LTE + WLAN 5G	Yes	Yes	No	Yes	Yes
9	LTE + BT	No	Yes	No	Yes	Yes

Note :

1. The WLAN 2.4G and WLAN 5G cannot transmit simultaneously.
2. The WLAN and Bluetooth cannot transmit simultaneously.

FCC SAR Test Report

<Estimated SAR Calculation>

According to KDB 447498 D01, when standalone SAR test exclusion applies to an antenna that transmits simultaneously with other antennas, the standalone SAR was estimated according to following formula to result in substantially conservative SAR values of ≤ 0.4 W/kg to determine simultaneous transmission SAR test exclusion.

$$\text{Estimated SAR} = \frac{\text{Max. Tune up Power}_{(mW)}}{\text{Min. Test Separation Distance}_{(mm)}} \times \frac{\sqrt{f_{(GHz)}}}{7.5}$$

If the minimum test separation distance is < 5 mm, a distance of 5 mm is used for estimated SAR calculation. When the test separation distance is > 50 mm, the 0.4 W/kg is used for SAR-1g.

Mode / Band	Frequency (GHz)	Max. Tune-up Power (dBm)	Test Position	Separation Distance (mm)	Estimated 1g SAR (W/kg)
BT (DSS)	2.48	3.5	Body-worn	15	0.03

Mode / Band	Frequency (GHz)	Max. Tune-up Power (dBm)	Test Position	Separation Distance (mm)	Estimated 1g SAR (W/kg)
BT (DSS)	2.48	3.5	Holster	5	0.09

Mode / Band	Frequency (GHz)	Max. Tune-up Power (dBm)	Test Position	Separation Distance (mm)	Estimated 10g SAR (W/kg)
BT (DSS)	2.48	3.5	Extremity	5	0.04

Note:

1. The separation distance is determined from the outer housing of the tablet to the user.
2. When standalone SAR testing is not required, an estimated SAR can be applied to determine simultaneous transmission SAR test exclusion.

<SAR Summation Analysis>

Simultaneous transmission SAR test exclusion is determined for each operating configuration and exposure condition according to the reported standalone SAR of each applicable simultaneous transmitting antenna. When the sum of SAR_{1g} of all simultaneously transmitting antennas in an operating mode and exposure condition combination is within the SAR limit (SAR_{1g} 1.6 W/kg), the simultaneous transmission SAR is not required. When the sum of SAR_{1g} is greater than the SAR limit (SAR_{1g} 1.6 W/kg), SAR test exclusion is determined by the SPLSR.

FCC SAR Test Report

No.	Conditions (SAR1 + SAR2)	Exposure Condition	Test Position	Max. SAR1	Max. SAR2	SAR Summation	SPLSR Analysis
1	GSM850 + WLAN (DTS)	Head	Right Cheek	0.49	0.60	1.09	Σ SAR < 1.6, Not required
			Right Tilted	0.33	0.51	0.84	Σ SAR < 1.6, Not required
			Left Cheek	0.40	1.36	1.76	Analyzed as below
			Left Tilted	0.33	0.78	1.11	Σ SAR < 1.6, Not required
		Body-worn	Front Face	0.39	0.14	0.53	Σ SAR < 1.6, Not required
			Rear Face	0.40	0.41	0.81	Σ SAR < 1.6, Not required
		Hotspot	Front Face	0.58	0.31	0.89	Σ SAR < 1.6, Not required
			Rear Face	1.01	0.86	1.87	Analyzed as below
			Left Side	0.10	0	0.1	Σ SAR < 1.6, Not required
			Right Side	0.20	1.00	1.2	Σ SAR < 1.6, Not required
			Top Side	0	0.24	0.24	Σ SAR < 1.6, Not required
			Bottom Side	0.15	0	0.15	Σ SAR < 1.6, Not required
		Holster	(Front)_Bottom join	0.39	0.19	0.58	Σ SAR < 1.6, Not required
			(Front)_Top join	0.40	0.31	0.71	Σ SAR < 1.6, Not required
			(Rear)_Bottom join	0.26	0.06	0.32	Σ SAR < 1.6, Not required
			(Rear)_Top join	0.28	0.11	0.39	Σ SAR < 1.6, Not required
		Arm	Rear Face	0.35	0.19	0.54	Σ SAR < 4.0, Not required
2	GSM850 + WLAN (NII)	Head	Right Cheek	0.49	0.15	0.64	Σ SAR < 1.6, Not required
			Right Tilted	0.33	0.12	0.45	Σ SAR < 1.6, Not required
			Left Cheek	0.40	0.51	0.91	Σ SAR < 1.6, Not required
			Left Tilted	0.33	0.27	0.6	Σ SAR < 1.6, Not required
		Body-worn	Front Face	0.39	0.04	0.43	Σ SAR < 1.6, Not required
			Rear Face	0.40	1.25	1.65	Analyzed as below
		Holster	(Front)_Bottom join	0.39	0.52	0.91	Σ SAR < 1.6, Not required
			(Front)_Top join	0.40	0.80	1.2	Σ SAR < 1.6, Not required
			(Rear)_Bottom join	0.26	0.07	0.33	Σ SAR < 1.6, Not required
			(Rear)_Top join	0.28	0.12	0.4	Σ SAR < 1.6, Not required
		Arm	Rear Face	0.35	0.32	0.67	Σ SAR < 4.0, Not required

FCC SAR Test Report

3	GSM850 + BT (DSS)	Body-Worn	Front Face	0.39	0.03	0.41	Σ SAR < 1.6, Not required
			Rear Face	0.40	0.03	0.42	Σ SAR < 1.6, Not required
		Holster	(Front)_Bottom join	0.39	0.09	0.46	Σ SAR < 1.6, Not required
			(Front)_Top join	0.40	0.09	0.47	Σ SAR < 1.6, Not required
			(Rear)_Bottom join	0.26	0.09	0.33	Σ SAR < 1.6, Not required
			(Rear)_Top join	0.28	0.09	0.35	Σ SAR < 1.6, Not required
		Arm	Rear Face	0.35	0.04	0.38	Σ SAR < 4.0, Not required

FCC SAR Test Report

No.	Conditions (SAR1 + SAR2)	Exposure Condition	Test Position	Max. SAR1	Max. SAR2	SAR Summation	SPLSR Analysis
4	GSM1900 + WLAN (DTS)	Head	Right Cheek	0.30	0.60	0.90	Σ SAR < 1.6, Not required
			Right Tilted	0.21	0.51	0.72	Σ SAR < 1.6, Not required
			Left Cheek	0.57	1.36	1.93	Analyzed as below
			Left Tilted	0.27	0.78	1.05	Σ SAR < 1.6, Not required
		Body-worn	Front Face	0.29	0.14	0.43	Σ SAR < 1.6, Not required
			Rear Face	0.22	0.41	0.63	Σ SAR < 1.6, Not required
		Hotspot	Front Face	1.04	0.31	1.35	Σ SAR < 1.6, Not required
			Rear Face	0.74	0.86	1.6	Analyzed as below
			Left Side	0.47	0	0.47	Σ SAR < 1.6, Not required
			Right Side	0.40	1.00	1.4	Σ SAR < 1.6, Not required
			Top Side	0	0.24	0.24	Σ SAR < 1.6, Not required
			Bottom Side	0.67	0	0.67	Σ SAR < 1.6, Not required
		Holster	(Front)_Bottom join	0.28	0.19	0.47	Σ SAR < 1.6, Not required
			(Front)_Top join	0.57	0.31	0.88	Σ SAR < 1.6, Not required
			(Rear)_Bottom join	0.37	0.06	0.43	Σ SAR < 1.6, Not required
			(Rear)_Top join	0.26	0.11	0.37	Σ SAR < 1.6, Not required
		Arm	Rear Face	0.17	0.19	0.36	Σ SAR < 4.0, Not required
5	GSM1900 + WLAN (NII)	Head	Right Cheek	0.30	0.15	0.45	Σ SAR < 1.6, Not required
			Right Tilted	0.21	0.12	0.33	Σ SAR < 1.6, Not required
			Left Cheek	0.57	0.51	1.08	Σ SAR < 1.6, Not required
			Left Tilted	0.27	0.27	0.54	Σ SAR < 1.6, Not required
		Body-worn	Front Face	0.29	0.04	0.33	Σ SAR < 1.6, Not required
			Rear Face	0.22	1.25	1.47	Σ SAR < 1.6, Not required
		Holster	(Front)_Bottom join	0.28	0.52	0.8	Σ SAR < 1.6, Not required
			(Front)_Top join	0.57	0.80	1.37	Σ SAR < 1.6, Not required
			(Rear)_Bottom join	0.37	0.07	0.44	Σ SAR < 1.6, Not required
			(Rear)_Top join	0.26	0.12	0.38	Σ SAR < 1.6, Not required
		Arm	Rear Face	0.17	0.32	0.49	Σ SAR < 4.0, Not required

FCC SAR Test Report

6	GSM1900 + BT (DSS)	Body-Worn	Front Face	0.29	0.03	0.31	Σ SAR < 1.6, Not required
			Rear Face	0.22	0.03	0.24	Σ SAR < 1.6, Not required
		Holster	(Front)_Bottom join	0.28	0.09	0.35	Σ SAR < 1.6, Not required
			(Front)_Top join	0.57	0.09	0.64	Σ SAR < 1.6, Not required
			(Rear)_Bottom join	0.37	0.09	0.44	Σ SAR < 1.6, Not required
			(Rear)_Top join	0.26	0.09	0.33	Σ SAR < 1.6, Not required
		Arm	Rear Face	0.17	0.04	0.20	Σ SAR < 4.0, Not required

FCC SAR Test Report

No.	Conditions (SAR1 + SAR2)	Exposure Condition	Test Position	Max. SAR1	Max. SAR2	SAR Summation	SPLSR Analysis
7	WCDMA II + WLAN (DTS)	Head	Right Cheek	0.47	0.60	1.07	Σ SAR < 1.6, Not required
			Right Tilted	0.36	0.51	0.87	Σ SAR < 1.6, Not required
			Left Cheek	0.88	1.36	2.24	Analyzed as below
			Left Tilted	0.46	0.78	1.24	Σ SAR < 1.6, Not required
		Body-worn	Front Face	0.37	0.14	0.51	Σ SAR < 1.6, Not required
			Rear Face	0.42	0.41	0.83	Σ SAR < 1.6, Not required
		Hotspot	Front Face	0.78	0.31	1.09	Σ SAR < 1.6, Not required
			Rear Face	0.89	0.86	1.75	Analyzed as below
			Left Side	0.35	0	0.35	Σ SAR < 1.6, Not required
			Right Side	0.30	1.00	1.3	Σ SAR < 1.6, Not required
			Top Side	0	0.24	0.24	Σ SAR < 1.6, Not required
			Bottom Side	0.88	0	0.88	Σ SAR < 1.6, Not required
		Holster	(Front)_Bottom join	0.44	0.19	0.63	Σ SAR < 1.6, Not required
			(Front)_Top join	1.09	0.31	1.4	Σ SAR < 1.6, Not required
			(Rear)_Bottom join	0.59	0.06	0.65	Σ SAR < 1.6, Not required
			(Rear)_Top join	0.47	0.11	0.58	Σ SAR < 1.6, Not required
		Arm	Rear Face	0.29	0.19	0.48	Σ SAR < 4.0, Not required
8	WCDMA II + WLAN (NII)	Head	Right Cheek	0.47	0.15	0.62	Σ SAR < 1.6, Not required
			Right Tilted	0.36	0.12	0.48	Σ SAR < 1.6, Not required
			Left Cheek	0.88	0.51	1.39	Σ SAR < 1.6, Not required
			Left Tilted	0.46	0.27	0.73	Σ SAR < 1.6, Not required
		Body-worn	Front Face	0.37	0.04	0.41	Σ SAR < 1.6, Not required
			Rear Face	0.42	1.25	1.67	Analyzed as below
		Holster	(Front)_Bottom join	0.44	0.52	0.96	Σ SAR < 1.6, Not required
			(Front)_Top join	1.09	0.80	1.89	Analyzed as below
			(Rear)_Bottom join	0.59	0.07	0.66	Σ SAR < 1.6, Not required
			(Rear)_Top join	0.47	0.12	0.59	Σ SAR < 1.6, Not required
		Arm	Rear Face	0.29	0.32	0.61	Σ SAR < 4.0, Not required

FCC SAR Test Report

9	WCDMA II + BT (DSS)	Body-Worn	Front Face	0.37	0.03	0.39	Σ SAR < 1.6, Not required
			Rear Face	0.42	0.03	0.44	Σ SAR < 1.6, Not required
		Holster	(Front)_Bottom join	0.44	0.09	0.51	Σ SAR < 1.6, Not required
			(Front)_Top join	1.09	0.09	1.16	Σ SAR < 1.6, Not required
			(Rear)_Bottom join	0.59	0.09	0.66	Σ SAR < 1.6, Not required
			(Rear)_Top join	0.47	0.09	0.54	Σ SAR < 1.6, Not required
		Arm	Rear Face	0.29	0.04	0.32	Σ SAR < 4.0, Not required

FCC SAR Test Report

No.	Conditions (SAR1 + SAR2)	Exposure Condition	Test Position	Max. SAR1	Max. SAR2	SAR Summation	SPLSR Analysis
10	WCDMA IV + WLAN (DTS)	Head	Right Cheek	0.57	0.60	1.17	Σ SAR < 1.6, Not required
			Right Tilted	0.43	0.51	0.94	Σ SAR < 1.6, Not required
			Left Cheek	1.05	1.36	2.41	Analyzed as below
			Left Tilted	0.52	0.78	1.3	Σ SAR < 1.6, Not required
		Body-worn	Front Face	0.45	0.14	0.59	Σ SAR < 1.6, Not required
			Rear Face	0.71	0.41	1.12	Σ SAR < 1.6, Not required
		Hotspot	Front Face	0.87	0.31	1.18	Σ SAR < 1.6, Not required
			Rear Face	1.31	0.86	2.17	Analyzed as below
			Left Side	0.25	0	0.25	Σ SAR < 1.6, Not required
			Right Side	0.26	1.00	1.26	Σ SAR < 1.6, Not required
			Top Side	0	0.24	0.24	Σ SAR < 1.6, Not required
			Bottom Side	0.72	0	0.72	Σ SAR < 1.6, Not required
		Holster	(Front)_Bottom join	0.60	0.19	0.79	Σ SAR < 1.6, Not required
			(Front)_Top join	0.76	0.31	1.07	Σ SAR < 1.6, Not required
			(Rear)_Bottom join	0.55	0.06	0.61	Σ SAR < 1.6, Not required
			(Rear)_Top join	0.46	0.11	0.57	Σ SAR < 1.6, Not required
		Arm	Rear Face	0.22	0.19	0.41	Σ SAR < 4.0, Not required
11	WCDMA IV + WLAN (NII)	Head	Right Cheek	0.57	0.15	0.72	Σ SAR < 1.6, Not required
			Right Tilted	0.43	0.12	0.55	Σ SAR < 1.6, Not required
			Left Cheek	1.05	0.51	1.56	Σ SAR < 1.6, Not required
			Left Tilted	0.52	0.27	0.79	Σ SAR < 1.6, Not required
		Body-worn	Front Face	0.45	0.04	0.49	Σ SAR < 1.6, Not required
			Rear Face	0.71	1.25	1.96	Analyzed as below
		Holster	(Front)_Bottom join	0.60	0.52	1.12	Σ SAR < 1.6, Not required
			(Front)_Top join	0.76	0.80	1.56	Σ SAR < 1.6, Not required
			(Rear)_Bottom join	0.55	0.07	0.62	Σ SAR < 1.6, Not required
			(Rear)_Top join	0.46	0.12	0.58	Σ SAR < 1.6, Not required
		Arm	Rear Face	0.22	0.32	0.54	Σ SAR < 4.0, Not required

FCC SAR Test Report

12	WCDMA IV + BT (DSS)	Body-Worn	Front Face	0.45	0.03	0.47	Σ SAR < 1.6, Not required
			Rear Face	0.71	0.03	0.73	Σ SAR < 1.6, Not required
		Holster	(Front)_Bottom join	0.60	0.09	0.67	Σ SAR < 1.6, Not required
			(Front)_Top join	0.76	0.09	0.83	Σ SAR < 1.6, Not required
			(Rear)_Bottom join	0.55	0.09	0.62	Σ SAR < 1.6, Not required
			(Rear)_Top join	0.46	0.09	0.53	Σ SAR < 1.6, Not required
		Arm	Rear Face	0.22	0.04	0.25	Σ SAR < 4.0, Not required

FCC SAR Test Report

No.	Conditions (SAR1 + SAR2)	Exposure Condition	Test Position	Max. SAR1	Max. SAR2	SAR Summation	SPLSR Analysis
13	WCDMA V + WLAN (DTS)	Head	Right Cheek	0.47	0.60	1.07	Σ SAR < 1.6, Not required
			Right Tilted	0.40	0.51	0.91	Σ SAR < 1.6, Not required
			Left Cheek	0.44	1.36	1.8	Analyzed as below
			Left Tilted	0.43	0.78	1.21	Σ SAR < 1.6, Not required
		Body-worn	Front Face	0.38	0.14	0.52	Σ SAR < 1.6, Not required
			Rear Face	0.40	0.41	0.81	Σ SAR < 1.6, Not required
		Hotspot	Front Face	0.52	0.31	0.83	Σ SAR < 1.6, Not required
			Rear Face	0.82	0.86	1.68	Analyzed as below
			Left Side	0.06	0	0.06	Σ SAR < 1.6, Not required
			Right Side	0.29	1.00	1.29	Σ SAR < 1.6, Not required
			Top Side	0	0.24	0.24	Σ SAR < 1.6, Not required
			Bottom Side	0.18	0	0.18	Σ SAR < 1.6, Not required
		Holster	(Front)_Bottom join	0.27	0.19	0.46	Σ SAR < 1.6, Not required
			(Front)_Top join	0.28	0.31	0.59	Σ SAR < 1.6, Not required
			(Rear)_Bottom join	0.14	0.06	0.2	Σ SAR < 1.6, Not required
			(Rear)_Top join	0.19	0.11	0.3	Σ SAR < 1.6, Not required
		Arm	Rear Face	0.30	0.19	0.49	Σ SAR < 4.0, Not required
14	WCDMA V + WLAN (NII)	Head	Right Cheek	0.47	0.15	0.62	Σ SAR < 1.6, Not required
			Right Tilted	0.40	0.12	0.52	Σ SAR < 1.6, Not required
			Left Cheek	0.44	0.51	0.95	Σ SAR < 1.6, Not required
			Left Tilted	0.43	0.27	0.7	Σ SAR < 1.6, Not required
		Body-worn	Front Face	0.38	0.04	0.42	Σ SAR < 1.6, Not required
			Rear Face	0.40	1.25	1.65	Analyzed as below
		Holster	(Front)_Bottom join	0.27	0.52	0.79	Σ SAR < 1.6, Not required
			(Front)_Top join	0.28	0.80	1.08	Σ SAR < 1.6, Not required
			(Rear)_Bottom join	0.14	0.07	0.21	Σ SAR < 1.6, Not required
			(Rear)_Top join	0.19	0.12	0.31	Σ SAR < 1.6, Not required
		Arm	Rear Face	0.30	0.32	0.62	Σ SAR < 4.0, Not required

FCC SAR Test Report

15	WCDMA V + BT (DSS)	Body-Worn	Front Face	0.38	0.03	0.40	Σ SAR < 1.6, Not required
			Rear Face	0.40	0.03	0.42	Σ SAR < 1.6, Not required
		Holster	(Front)_Bottom join	0.27	0.09	0.34	Σ SAR < 1.6, Not required
			(Front)_Top join	0.28	0.09	0.35	Σ SAR < 1.6, Not required
			(Rear)_Bottom join	0.14	0.09	0.21	Σ SAR < 1.6, Not required
			(Rear)_Top join	0.19	0.09	0.26	Σ SAR < 1.6, Not required
		Arm	Rear Face	0.30	0.04	0.33	Σ SAR < 4.0, Not required

FCC SAR Test Report

No.	Conditions (SAR1 + SAR2)	Exposure Condition	Test Position	Max. SAR1	Max. SAR2	SAR Summation	SPLSR Analysis
16	LTE 2 + WLAN (DTS)	Head	Right Cheek	0.43	0.60	1.03	Σ SAR < 1.6, Not required
			Right Tilted	0.30	0.51	0.81	Σ SAR < 1.6, Not required
			Left Cheek	0.81	1.36	2.17	Analyzed as below
			Left Tilted	0.42	0.78	1.2	Σ SAR < 1.6, Not required
		Body-worn	Front Face	0.41	0.14	0.55	Σ SAR < 1.6, Not required
			Rear Face	0.34	0.41	0.75	Σ SAR < 1.6, Not required
		Hotspot	Front Face	0.72	0.31	1.03	Σ SAR < 1.6, Not required
			Rear Face	0.70	0.86	1.56	Σ SAR < 1.6, Not required
			Left Side	0.39	0	0.39	Σ SAR < 1.6, Not required
			Right Side	0.23	1.00	1.23	Σ SAR < 1.6, Not required
			Top Side	0	0.24	0.24	Σ SAR < 1.6, Not required
			Bottom Side	0.58	0	0.58	Σ SAR < 1.6, Not required
		Holster	(Front)_Bottom join	0.21	0.19	0.4	Σ SAR < 1.6, Not required
			(Front)_Top join	0.44	0.31	0.75	Σ SAR < 1.6, Not required
			(Rear)_Bottom join	0.25	0.06	0.31	Σ SAR < 1.6, Not required
			(Rear)_Top join	0.21	0.11	0.32	Σ SAR < 1.6, Not required
		Arm	Rear Face	0.13	0.19	0.32	Σ SAR < 4.0, Not required
17	LTE 2 + WLAN (NII)	Head	Right Cheek	0.43	0.15	0.58	Σ SAR < 1.6, Not required
			Right Tilted	0.30	0.12	0.42	Σ SAR < 1.6, Not required
			Left Cheek	0.81	0.51	1.32	Σ SAR < 1.6, Not required
			Left Tilted	0.42	0.27	0.69	Σ SAR < 1.6, Not required
		Body-worn	Front Face	0.41	0.04	0.45	Σ SAR < 1.6, Not required
			Rear Face	0.34	1.25	1.59	Σ SAR < 1.6, Not required
		Holster	(Front)_Bottom join	0.21	0.52	0.73	Σ SAR < 1.6, Not required
			(Front)_Top join	0.44	0.80	1.24	Σ SAR < 1.6, Not required
			(Rear)_Bottom join	0.25	0.07	0.32	Σ SAR < 1.6, Not required
			(Rear)_Top join	0.21	0.12	0.33	Σ SAR < 1.6, Not required
		Arm	Rear Face	0.13	0.32	0.45	Σ SAR < 4.0, Not required

FCC SAR Test Report

18	LTE 2 + BT (DSS)	Body-Worn	Front Face	0.41	0.03	0.43	Σ SAR < 1.6, Not required
			Rear Face	0.34	0.03	0.36	Σ SAR < 1.6, Not required
		Holster	(Front)_Bottom join	0.21	0.09	0.28	Σ SAR < 1.6, Not required
			(Front)_Top join	0.44	0.09	0.51	Σ SAR < 1.6, Not required
			(Rear)_Bottom join	0.25	0.09	0.32	Σ SAR < 1.6, Not required
			(Rear)_Top join	0.21	0.09	0.28	Σ SAR < 1.6, Not required
		Arm	Rear Face	0.13	0.04	0.16	Σ SAR < 4.0, Not required

FCC SAR Test Report

No.	Conditions (SAR1 + SAR2)	Exposure Condition	Test Position	Max. SAR1	Max. SAR2	SAR Summation	SPLSR Analysis
19	LTE 4 + WLAN (DTS)	Head	Right Cheek	0.26	0.60	0.86	Σ SAR < 1.6, Not required
			Right Tilted	0.20	0.51	0.71	Σ SAR < 1.6, Not required
			Left Cheek	0.53	1.36	1.89	Analyzed as below
			Left Tilted	0.25	0.78	1.03	Σ SAR < 1.6, Not required
		Body-worn	Front Face	0.46	0.14	0.60	Σ SAR < 1.6, Not required
			Rear Face	0.75	0.41	1.16	Σ SAR < 1.6, Not required
		Hotspot	Front Face	0.72	0.31	1.03	Σ SAR < 1.6, Not required
			Rear Face	1.28	0.86	2.14	Analyzed as below
			Left Side	0.20	0	0.2	Σ SAR < 1.6, Not required
			Right Side	0.09	1.00	1.09	Σ SAR < 1.6, Not required
			Top Side	0	0.24	0.24	Σ SAR < 1.6, Not required
		Holster	Bottom Side	1.17	0	1.17	Σ SAR < 1.6, Not required
			(Front)_Bottom join	0.40	0.19	0.59	Σ SAR < 1.6, Not required
			(Front)_Top join	0.41	0.31	0.72	Σ SAR < 1.6, Not required
			(Rear)_Bottom join	0.31	0.06	0.37	Σ SAR < 1.6, Not required
		Arm	(Rear)_Top join	0.28	0.11	0.39	Σ SAR < 1.6, Not required
			Rear Face	0.11	0.19	0.30	Σ SAR < 4.0, Not required
20	LTE 4 + WLAN (NII)	Head	Right Cheek	0.26	0.15	0.41	Σ SAR < 1.6, Not required
			Right Tilted	0.20	0.12	0.32	Σ SAR < 1.6, Not required
			Left Cheek	0.53	0.51	1.04	Σ SAR < 1.6, Not required
			Left Tilted	0.25	0.27	0.52	Σ SAR < 1.6, Not required
		Body-worn	Front Face	0.46	0.04	0.50	Σ SAR < 1.6, Not required
			Rear Face	0.75	1.25	2.00	Analyzed as below
		Holster	(Front)_Bottom join	0.40	0.52	0.92	Σ SAR < 1.6, Not required
			(Front)_Top join	0.41	0.80	1.21	Σ SAR < 1.6, Not required
			(Rear)_Bottom join	0.31	0.07	0.38	Σ SAR < 1.6, Not required
			(Rear)_Top join	0.28	0.12	0.4	Σ SAR < 1.6, Not required
		Arm	Rear Face	0.11	0.32	0.43	Σ SAR < 4.0, Not required

FCC SAR Test Report

21	LTE 4 + BT (DSS)	Body-Worn	Front Face	0.46	0.03	0.48	Σ SAR < 1.6, Not required
			Rear Face	0.75	0.03	0.77	Σ SAR < 1.6, Not required
		Holster	(Front)_Bottom join	0.40	0.09	0.47	Σ SAR < 1.6, Not required
			(Front)_Top join	0.41	0.09	0.48	Σ SAR < 1.6, Not required
			(Rear)_Bottom join	0.31	0.09	0.38	Σ SAR < 1.6, Not required
			(Rear)_Top join	0.28	0.09	0.35	Σ SAR < 1.6, Not required
		Arm	Rear Face	0.11	0.04	0.14	Σ SAR < 4.0, Not required

FCC SAR Test Report

No.	Conditions (SAR1 + SAR2)	Exposure Condition	Test Position	Max. SAR1	Max. SAR2	SAR Summation	SPLSR Analysis
22	LTE 5 + WLAN (DTS)	Head	Right Cheek	0.56	0.60	1.16	Σ SAR < 1.6, Not required
			Right Tilted	0.48	0.51	0.99	Σ SAR < 1.6, Not required
			Left Cheek	0.53	1.36	1.89	Analyzed as below
			Left Tilted	0.46	0.78	1.24	Σ SAR < 1.6, Not required
		Body-worn	Front Face	0.45	0.14	0.59	Σ SAR < 1.6, Not required
			Rear Face	0.78	0.41	1.19	Σ SAR < 1.6, Not required
		Hotspot	Front Face	0.59	0.31	0.9	Σ SAR < 1.6, Not required
			Rear Face	0.97	0.86	1.83	Analyzed as below
			Left Side	0.13	0	0.13	Σ SAR < 1.6, Not required
			Right Side	0.31	1.00	1.31	Σ SAR < 1.6, Not required
			Top Side	0	0.24	0.24	Σ SAR < 1.6, Not required
			Bottom Side	0.16	0	0.16	Σ SAR < 1.6, Not required
		Holster	(Front)_Bottom join	0.26	0.19	0.45	Σ SAR < 1.6, Not required
			(Front)_Top join	0.24	0.31	0.55	Σ SAR < 1.6, Not required
			(Rear)_Bottom join	0.16	0.06	0.22	Σ SAR < 1.6, Not required
			(Rear)_Top join	0.18	0.11	0.29	Σ SAR < 1.6, Not required
		Arm	Rear Face	0.28	0.19	0.47	Σ SAR < 4.0, Not required
23	LTE 5 + WLAN (NII)	Head	Right Cheek	0.56	0.15	0.71	Σ SAR < 1.6, Not required
			Right Tilted	0.48	0.12	0.6	Σ SAR < 1.6, Not required
			Left Cheek	0.53	0.51	1.04	Σ SAR < 1.6, Not required
			Left Tilted	0.46	0.27	0.73	Σ SAR < 1.6, Not required
		Body-worn	Front Face	0.45	0.04	0.49	Σ SAR < 1.6, Not required
			Rear Face	0.78	1.25	2.03	Analyzed as below
		Holster	(Front)_Bottom join	0.26	0.52	0.78	Σ SAR < 1.6, Not required
			(Front)_Top join	0.24	0.80	1.04	Σ SAR < 1.6, Not required
			(Rear)_Bottom join	0.16	0.07	0.23	Σ SAR < 1.6, Not required
			(Rear)_Top join	0.18	0.12	0.3	Σ SAR < 1.6, Not required
		Arm	Rear Face	0.28	0.32	0.60	Σ SAR < 4.0, Not required

FCC SAR Test Report

24	LTE 5 + BT (DSS)	Body-Worn	Front Face	0.45	0.03	0.47	Σ SAR < 1.6, Not required
			Rear Face	0.78	0.03	0.80	Σ SAR < 1.6, Not required
		Holster	(Front)_Bottom join	0.26	0.09	0.33	Σ SAR < 1.6, Not required
			(Front)_Top join	0.24	0.09	0.31	Σ SAR < 1.6, Not required
			(Rear)_Bottom join	0.16	0.09	0.23	Σ SAR < 1.6, Not required
			(Rear)_Top join	0.18	0.09	0.25	Σ SAR < 1.6, Not required
		Arm	Rear Face	0.28	0.04	0.31	Σ SAR < 4.0, Not required

FCC SAR Test Report

No.	Conditions (SAR1 + SAR2)	Exposure Condition	Test Position	Max. SAR1	Max. SAR2	SAR Summation	SPLSR Analysis
25	LTE 12 + WLAN (DTS)	Head	Right Cheek	0.34	0.60	0.94	Σ SAR < 1.6, Not required
			Right Tilted	0.31	0.51	0.82	Σ SAR < 1.6, Not required
			Left Cheek	0.30	1.36	1.66	Analyzed as below
			Left Tilted	0.27	0.78	1.05	Σ SAR < 1.6, Not required
		Body-worn	Front Face	0.25	0.14	0.39	Σ SAR < 1.6, Not required
			Rear Face	0.39	0.41	0.8	Σ SAR < 1.6, Not required
		Hotspot	Front Face	0.29	0.31	0.6	Σ SAR < 1.6, Not required
			Rear Face	0.45	0.86	1.31	Σ SAR < 1.6, Not required
			Left Side	0.05	0	0.05	Σ SAR < 1.6, Not required
			Right Side	0.09	1.00	1.09	Σ SAR < 1.6, Not required
			Top Side	0	0.24	0.24	Σ SAR < 1.6, Not required
		Holster	Bottom Side	0.08	0	0.08	Σ SAR < 1.6, Not required
			(Front)_Bottom join	0.41	0.19	0.6	Σ SAR < 1.6, Not required
			(Front)_Top join	0.31	0.31	0.62	Σ SAR < 1.6, Not required
			(Rear)_Bottom join	0.36	0.06	0.42	Σ SAR < 1.6, Not required
		Arm	(Rear)_Top join	0.23	0.11	0.34	Σ SAR < 1.6, Not required
			Rear Face	0.24	0.19	0.43	Σ SAR < 4.0, Not required
26	LTE 12 + WLAN (NII)	Head	Right Cheek	0.34	0.15	0.49	Σ SAR < 1.6, Not required
			Right Tilted	0.31	0.12	0.43	Σ SAR < 1.6, Not required
			Left Cheek	0.30	0.51	0.81	Σ SAR < 1.6, Not required
			Left Tilted	0.27	0.27	0.54	Σ SAR < 1.6, Not required
		Body-worn	Front Face	0.25	0.04	0.29	Σ SAR < 1.6, Not required
			Rear Face	0.39	1.25	1.64	Analyzed as below
		Holster	(Front)_Bottom join	0.41	0.52	0.93	Σ SAR < 1.6, Not required
			(Front)_Top join	0.31	0.80	1.11	Σ SAR < 1.6, Not required
			(Rear)_Bottom join	0.36	0.07	0.43	Σ SAR < 1.6, Not required
			(Rear)_Top join	0.23	0.12	0.35	Σ SAR < 1.6, Not required
		Arm	Rear Face	0.24	0.32	0.56	Σ SAR < 4.0, Not required

FCC SAR Test Report

27	LTE 12 + BT (DSS)	Body-Worn	Front Face	0.25	0.03	0.27	Σ SAR < 1.6, Not required
			Rear Face	0.39	0.03	0.41	Σ SAR < 1.6, Not required
		Holster	(Front)_Bottom join	0.41	0.09	0.48	Σ SAR < 1.6, Not required
			(Front)_Top join	0.31	0.09	0.38	Σ SAR < 1.6, Not required
			(Rear)_Bottom join	0.36	0.09	0.43	Σ SAR < 1.6, Not required
			(Rear)_Top join	0.23	0.09	0.30	Σ SAR < 1.6, Not required
		Arm	Rear Face	0.24	0.04	0.27	Σ SAR < 4.0, Not required

FCC SAR Test Report

No.	Conditions (SAR1 + SAR2)	Exposure Condition	Test Position	Max. SAR1	Max. SAR2	SAR Summation	SPLSR Analysis		
28	LTE 17 + WLAN (DTS)	Head	Right Cheek	0.31	0.60	0.91	Σ SAR < 1.6, Not required		
			Right Tilted	0.17	0.51	0.68	Σ SAR < 1.6, Not required		
			Left Cheek	0.30	1.36	1.66	Analyzed as below		
			Left Tilted	0.21	0.78	0.99	Σ SAR < 1.6, Not required		
		Body-worn	Front Face	0.22	0.14	0.36	Σ SAR < 1.6, Not required		
			Rear Face	0.37	0.41	0.78	Σ SAR < 1.6, Not required		
		Hotspot	Front Face	0.27	0.31	0.58	Σ SAR < 1.6, Not required		
			Rear Face	0.45	0.86	1.31	Σ SAR < 1.6, Not required		
			Left Side	0.12	0	0.12	Σ SAR < 1.6, Not required		
			Right Side	0.20	1.00	1.2	Σ SAR < 1.6, Not required		
			Top Side	0	0.24	0.24	Σ SAR < 1.6, Not required		
			Bottom Side	0.12	0	0.12	Σ SAR < 1.6, Not required		
		Holster	(Front)_Bottom join	0.41	0.19	0.6	Σ SAR < 1.6, Not required		
			(Front)_Top join	0.32	0.31	0.63	Σ SAR < 1.6, Not required		
			(Rear)_Bottom join	0.31	0.06	0.37	Σ SAR < 1.6, Not required		
			(Rear)_Top join	0.22	0.11	0.33	Σ SAR < 1.6, Not required		
		Arm	Rear Face	0.23	0.19	0.42	Σ SAR < 4.0, Not required		
		29	LTE 17 + WLAN (NII)	Head	Right Cheek	0.31	0.15	0.46	Σ SAR < 1.6, Not required
					Right Tilted	0.17	0.12	0.29	Σ SAR < 1.6, Not required
					Left Cheek	0.30	0.51	0.81	Σ SAR < 1.6, Not required
Left Tilted	0.21				0.27	0.48	Σ SAR < 1.6, Not required		
Body-worn	Front Face			0.22	0.04	0.26	Σ SAR < 1.6, Not required		
	Rear Face			0.37	1.25	1.62	Analyzed as below		
Holster	(Front)_Bottom join			0.41	0.52	0.93	Σ SAR < 1.6, Not required		
	(Front)_Top join			0.32	0.80	1.12	Σ SAR < 1.6, Not required		
	(Rear)_Bottom join			0.31	0.07	0.38	Σ SAR < 1.6, Not required		
	(Rear)_Top join			0.22	0.12	0.34	Σ SAR < 1.6, Not required		
Arm	Rear Face			0.23	0.32	0.55	Σ SAR < 4.0, Not required		

FCC SAR Test Report

30	LTE 17 + BT (DSS)	Body-Worn	Front Face	0.22	0.03	0.24	Σ SAR < 1.6, Not required
			Rear Face	0.37	0.03	0.39	Σ SAR < 1.6, Not required
		Holster	(Front)_Bottom join	0.41	0.09	0.48	Σ SAR < 1.6, Not required
			(Front)_Top join	0.32	0.09	0.39	Σ SAR < 1.6, Not required
			(Rear)_Bottom join	0.31	0.09	0.38	Σ SAR < 1.6, Not required
			(Rear)_Top join	0.22	0.09	0.29	Σ SAR < 1.6, Not required
		Arm	Rear Face	0.23	0.04	0.26	Σ SAR < 4.0, Not required

FCC SAR Test Report

<SAR to Peak Location Separation Ratio Analysis>

The simultaneous transmitting antennas in each operating mode and exposure condition combination are considered one pair at a time to determine the SPLSR. When SAR is measured for both antennas in the pair, the peak location separation distance is computed by the following formula.

$$\text{Peak Location Separation Distance} = \sqrt{(x_1 - x_2)^2 + (y_1 - y_2)^2 + (z_1 - z_2)^2}$$

Where (x_1, y_1, z_1) and (x_2, y_2, z_2) are the coordinates of the extrapolated peak SAR locations in the area or zoom scans.

When standalone test exclusion applies, SAR is estimated; the peak location is assumed to be at the feed-point or geometric center of the antenna. Due to curvatures on the SAM phantom, when SAR is estimated for one of the antennas in an antenna pair, the measured peak SAR location will be translated onto the test device to determine the peak location separation for the antenna pair.

The SPLSR is determined by the following formula.

$$\text{SPLSR} = \frac{(\text{SAR}_1 + \text{SAR}_2)^{1.5}}{R_i}$$

Where SAR_1 and SAR_2 are the highest reported or estimated SAR for each antenna in the pair, and R_i is the separation distance between the peak SAR locations for the antenna pair in mm.

When the SPLSR is ≤ 0.04 , the simultaneous transmission SAR is not required. Otherwise, the enlarged zoom scan and volume scan post-processing procedures will be performed.

Conditions	Exposure Condition	Test Position	SAR Value (W/kg)	Coordinates			Peak Location Separation Distance (R_i , mm)	SPLSR	Simultaneous Transmission SAR Test
				x	y	z			
GSM850 Ch251	Head	Left Cheek	0.40	53.6	-33.25	-1.97	59.8	0.04	SPLSR ≤ 0.04 , Not required
802.11b Ch6			1.36	27.55	20.58	-1.76			

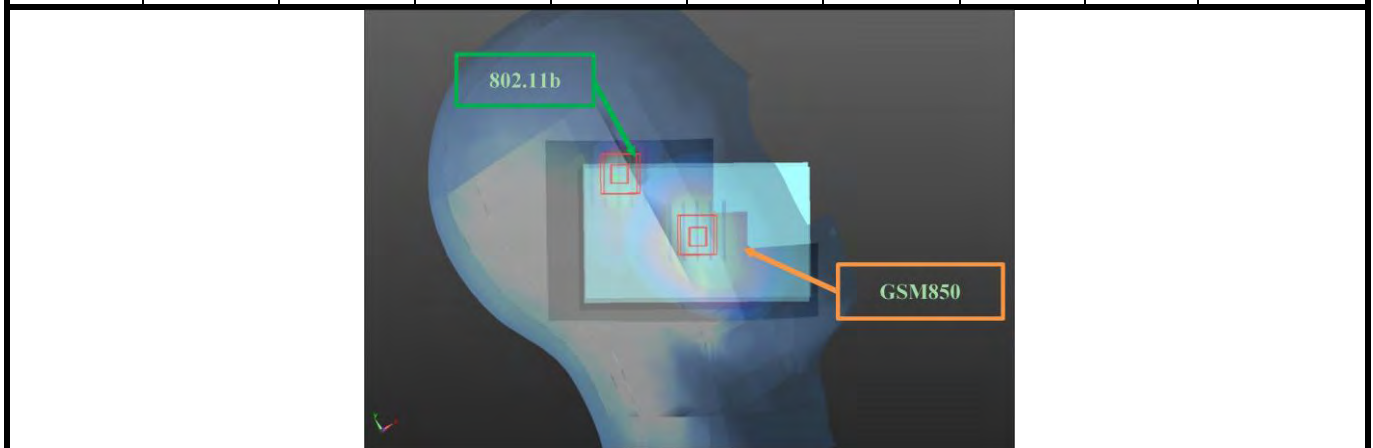

FCC SAR Test Report

Conditions	Exposure Condition	Test Position	SAR Value (W/kg)	Coordinates			Peak Location Separation Distance (R _i , mm)	SPLSR	Simultaneous Transmission SAR Test
				x	y	z			
GSM850 Ch251 Cube 0	Hotspot	Rear Face	1.01	-4.4	-18.8	-1.58	77.1	0.03	SPLSR ≤ 0.04, Not required
802.11b Ch6			0.86	-34	52.4	-0.71			

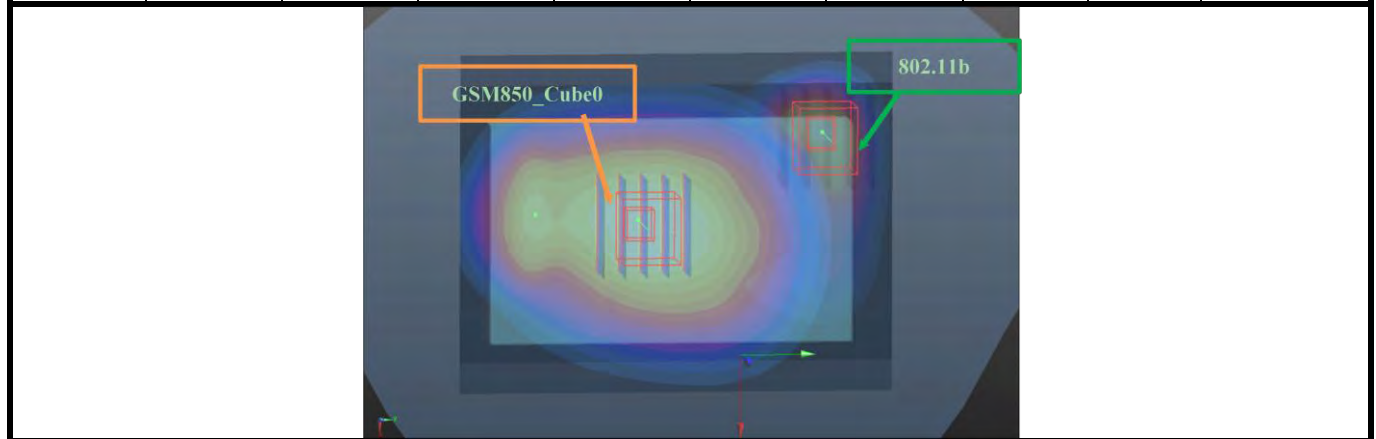

Conditions	Exposure Condition	Test Position	SAR Value (W/kg)	Coordinates			Peak Location Separation Distance (R _i , mm)	SPLSR	Simultaneous Transmission SAR Test
				x	y	z			
GSM850 Ch251 Cube 1	Hotspot	Rear Face	1.01	-8	-36	-1.57	92.1	0.03	SPLSR ≤ 0.04, Not required
802.11b Ch6			0.86	-34	52.4	-0.71			

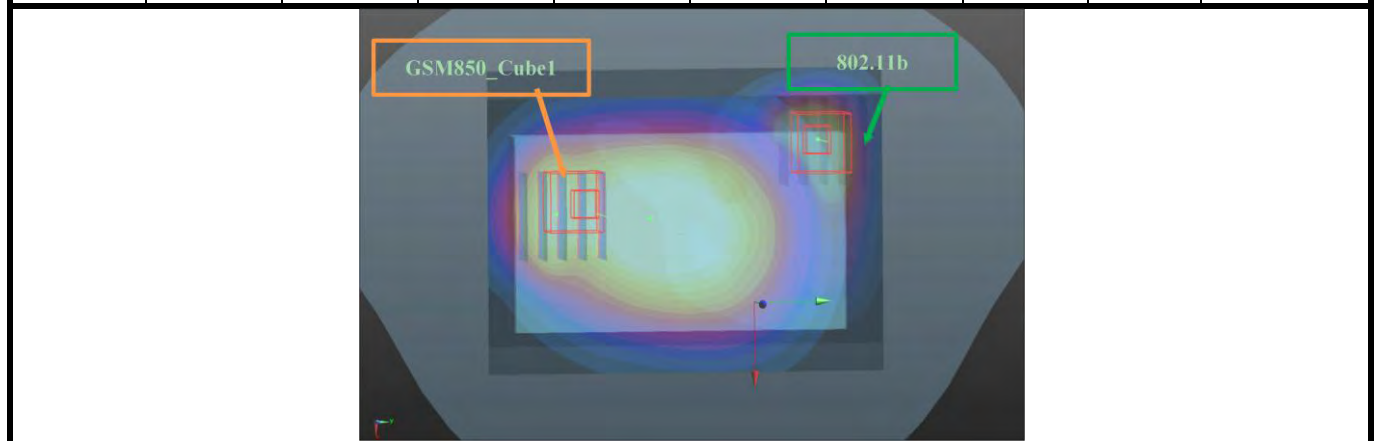

FCC SAR Test Report

Conditions	Exposure Condition	Test Position	SAR Value (W/kg)	Coordinates			Peak Location Separation Distance (R _i , mm)	SPLSR	Simultaneous Transmission SAR Test
				x	y	z			
GSM850 Ch251	Body-Wron	Rear Face	0.40	-2	2	0.69	58.2	0.04	SPLSR ≤ 0.04, Not required
802.11ac Ch138			1.25	-29.5	47.5	-1.3			



Conditions	Exposure Condition	Test Position	SAR Value (W/kg)	Coordinates			Peak Location Separation Distance (R _i , mm)	SPLSR	Simultaneous Transmission SAR Test
				x	y	z			
GSM1900 Ch512	Head	Left Cheek	0.57	47.89	-51.71	-1.87	75.1	0.04	SPLSR ≤ 0.04, Not required
802.11b Ch6			1.36	27.55	20.58	-1.76			

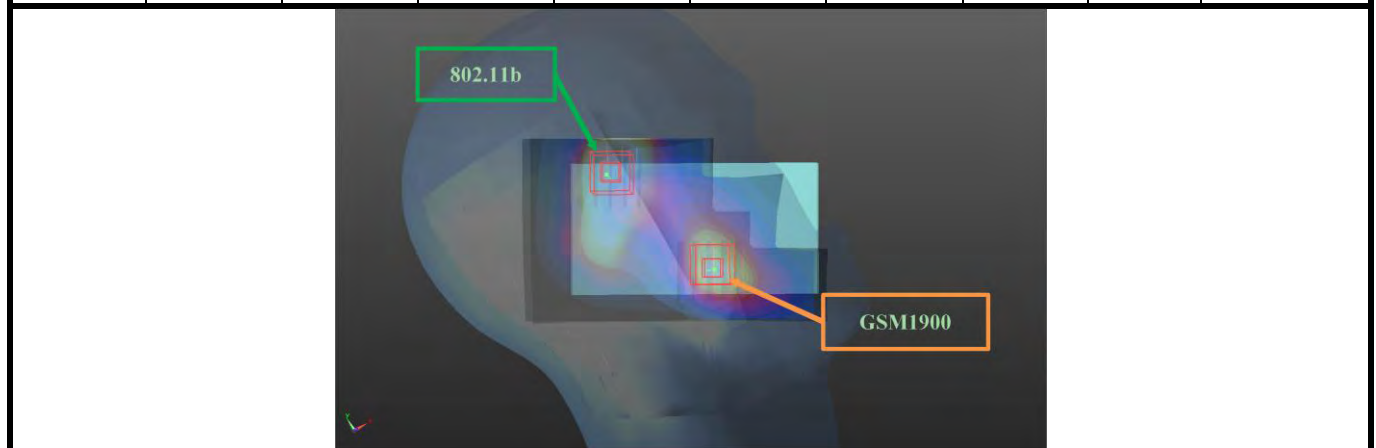

FCC SAR Test Report

Conditions	Exposure Condition	Test Position	SAR Value (W/kg)	Coordinates			Peak Location Separation Distance (R _i , mm)	SPLSR	Simultaneous Transmission SAR Test
				x	y	z			
GSM1900 Ch512	Hotspot	Rear Face	0.74	16.4	-59.6	-0.31	122.8	0.02	SPLSR ≤ 0.04, Not required
802.11b Ch6			0.86	-34	52.4	-0.71			



Conditions	Exposure Condition	Test Position	SAR Value (W/kg)	Coordinates			Peak Location Separation Distance (R _i , mm)	SPLSR	Simultaneous Transmission SAR Test
				x	y	z			
WCDMA II Ch9400	Head	Left Cheek	0.88	48.84	-51.32	-1.57	75.0	0.04	SPLSR ≤ 0.04, Not required
802.11b Ch6			1.36	27.55	20.58	-1.76			

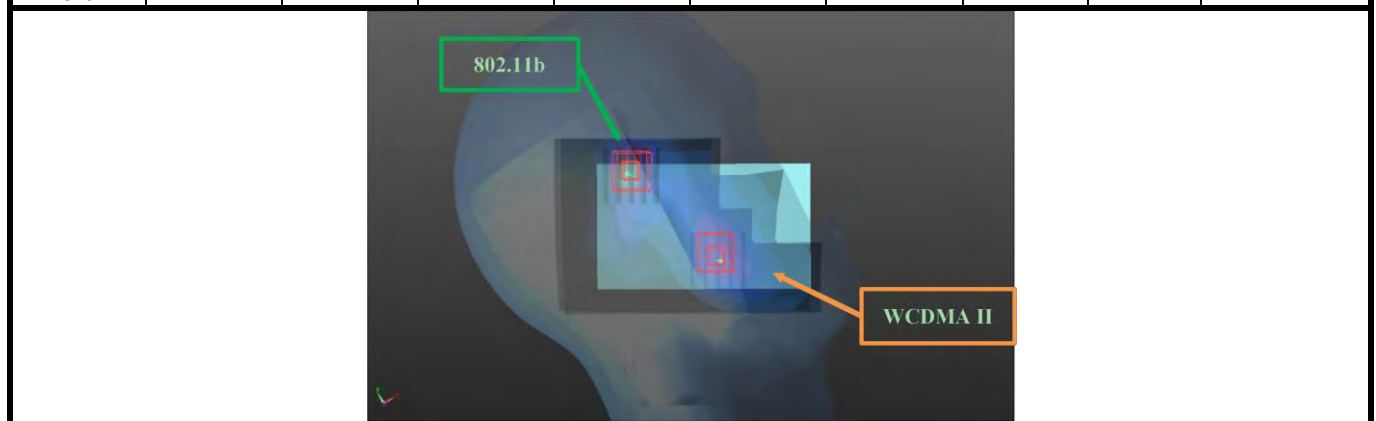

FCC SAR Test Report

Conditions	Exposure Condition	Test Position	SAR Value (W/kg)	Coordinates			Peak Location Separation Distance (R _i , mm)	SPLSR	Simultaneous Transmission SAR Test
				x	y	z			
WCDMA II Ch9400	Hotspot	Rear Face	0.89	13.2	-64.4	-1.21	126.0	0.02	SPLSR ≤ 0.04, Not required
802.11b Ch6			0.86	-34	52.4	-0.71			



Conditions	Exposure Condition	Test Position	SAR Value (W/kg)	Coordinates			Peak Location Separation Distance (R _i , mm)	SPLSR	Simultaneous Transmission SAR Test
				x	y	z			
WCDMA II Ch9400	Body-Wron	Rear Face	0.42	-18.4	-31.6	-0.54	82.9	0.03	SPLSR ≤ 0.04, Not required
802.11ac Ch138			1.25	-29.5	47.5	-1.3			

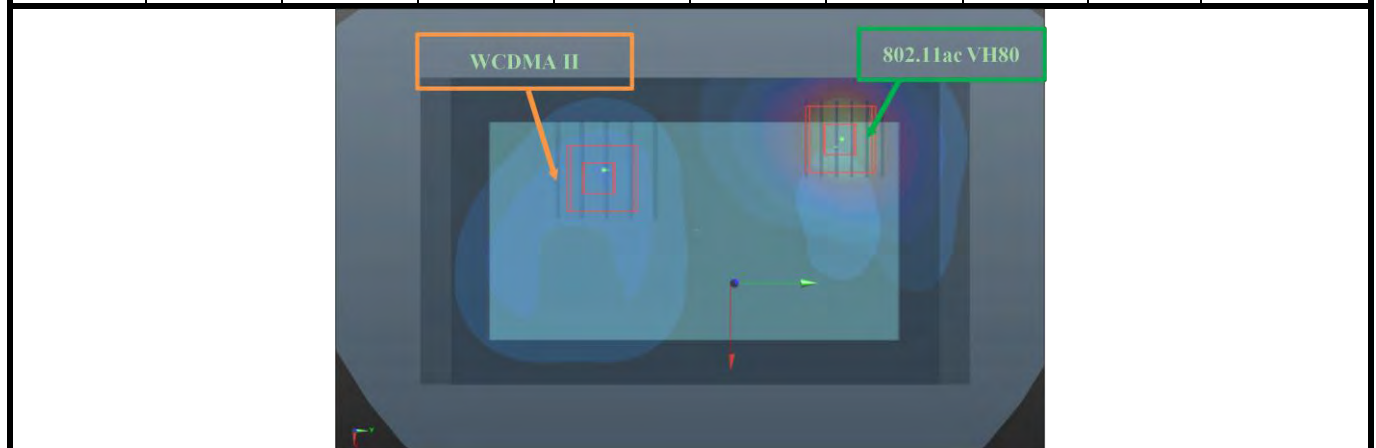

FCC SAR Test Report

Conditions	Exposure Condition	Test Position	SAR Value (W/kg)	Coordinates			Peak Location Separation Distance (R _i , mm)	SPLSR	Simultaneous Transmission SAR Test
				x	y	z			
WCDMA II Ch9400	Holster	(Front)_Top	1.09	-5.9	-1.06	-0.98	60.0	0.04	SPLSR ≤ 0.04, Not required
802.11ac Ch155		Join	0.80	38.9	-40.9	-1			

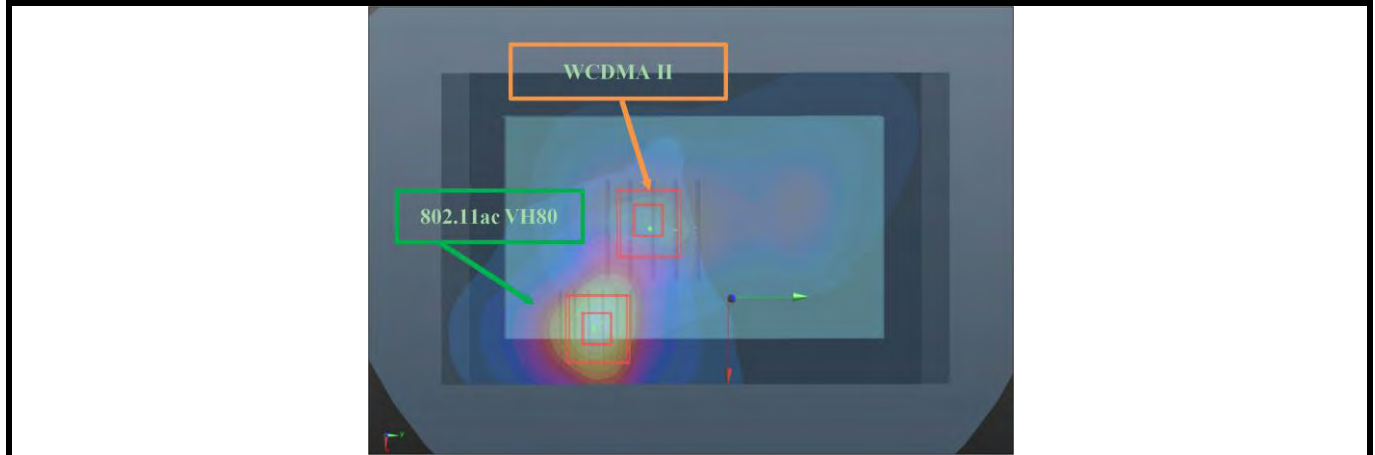

Conditions	Exposure Condition	Test Position	SAR Value (W/kg)	Coordinates			Peak Location Separation Distance (R _i , mm)	SPLSR	Simultaneous Transmission SAR Test
				x	y	z			
WCDMA IV Ch1513	Head	Left Cheek	1.05	53.38	-59.94	0.31	84.6	0.04	SPLSR ≤ 0.04, Not required
802.11b Ch6			1.36	27.55	20.58	-1.76			

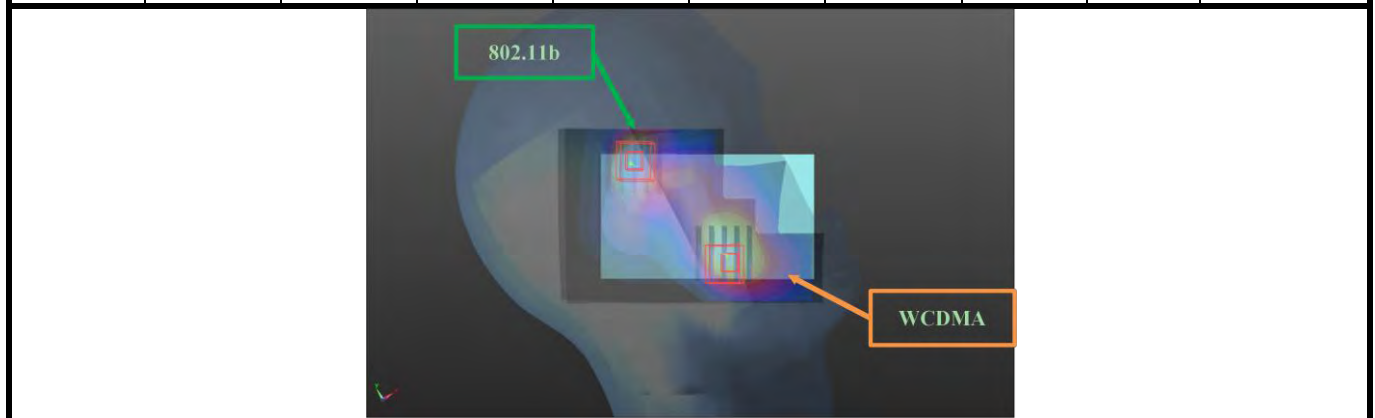

FCC SAR Test Report

Conditions	Exposure Condition	Test Position	SAR Value (W/kg)	Coordinates			Peak Location Separation Distance (R _i , mm)	SPLSR	Simultaneous Transmission SAR Test
				x	y	z			
WCDMA IV Ch1513	Hotspot	Rear Face	1.31	0.8	-60.8	-1.24	118.4	0.03	SPLSR ≤ 0.04, Not required
802.11b Ch6			0.86	-34	52.4	-0.71			

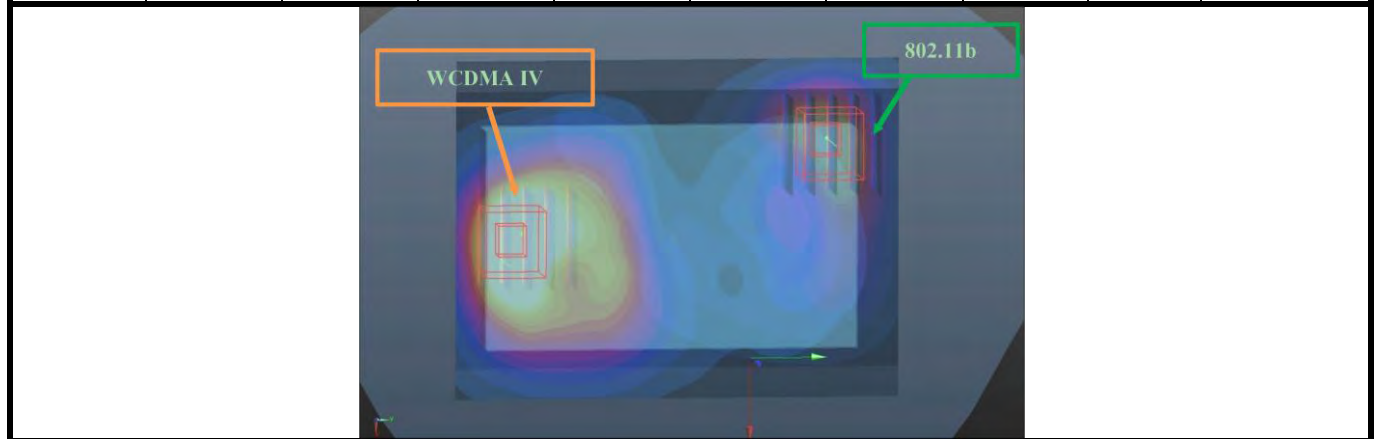

FCC SAR Test Report

Conditions	Exposure Condition	Test Position	SAR Value (W/kg)	Coordinates			Peak Location Separation Distance (R _i , mm)	SPLSR	Simultaneous Transmission SAR Test
				x	y	z			
WCDMA IV Ch1513	Body-Wron	Rear Face	0.71	-2.4	-58	-0.47	112.5	0.02	SPLSR ≤ 0.04, Not required
802.11ac Ch138			1.25	-29.5	47.5	-1.3			



Conditions	Exposure Condition	Test Position	SAR Value (W/kg)	Coordinates			Peak Location Separation Distance (R _i , mm)	SPLSR	Simultaneous Transmission SAR Test
				x	y	z			
WCDMA V Ch4233	Head	Left Cheek	0.44	53.6	-33.25	-1.97	59.8	0.04	SPLSR ≤ 0.04, Not required
802.11b Ch6			1.36	27.55	20.58	-1.76			

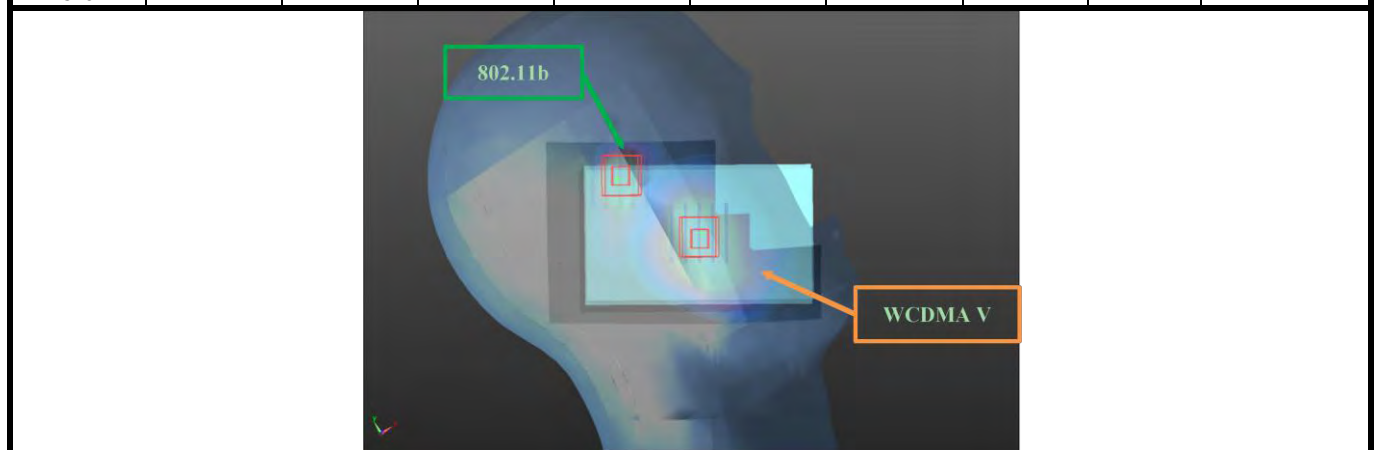

FCC SAR Test Report

Conditions	Exposure Condition	Test Position	SAR Value (W/kg)	Coordinates			Peak Location Separation Distance (R _i , mm)	SPLSR	Simultaneous Transmission SAR Test
				x	y	z			
WCDMA V Ch4233	Hotspot	Rear Face	0.82	-6	-16	-1.63	73.9	0.03	SPLSR ≤ 0.04, Not required
802.11b Ch6			0.86	-34	52.4	-0.71			

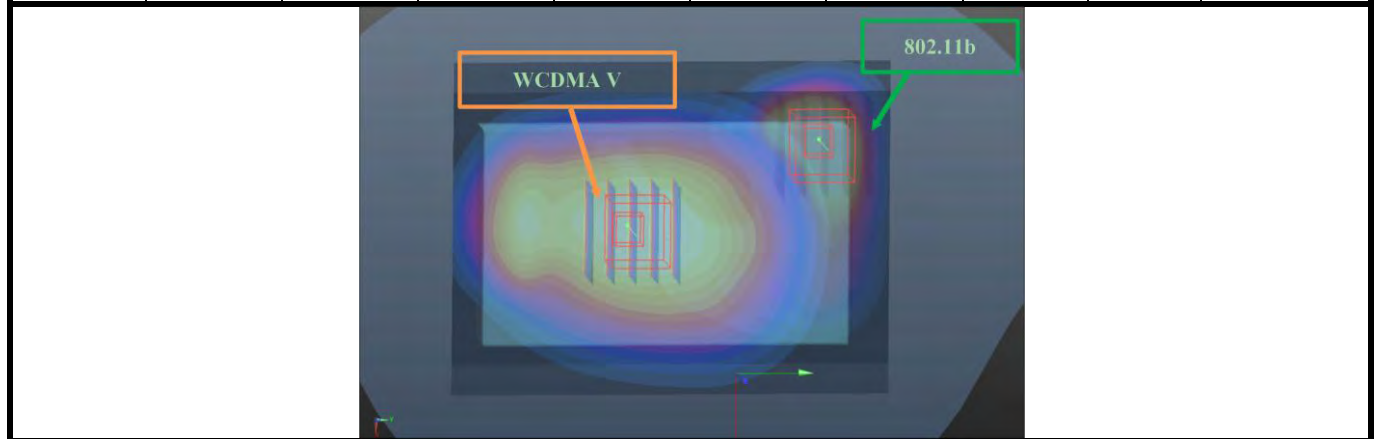

Conditions	Exposure Condition	Test Position	SAR Value (W/kg)	Coordinates			Peak Location Separation Distance (R _i , mm)	SPLSR	Simultaneous Transmission SAR Test
				x	y	z			
WCDMA V Ch4233	Body-Wron	Rear Face	0.40	-3.6	-7.6	-0.73	65.4	0.03	SPLSR ≤ 0.04, Not required
802.11ac Ch138			1.25	-29.5	47.5	-1.3			

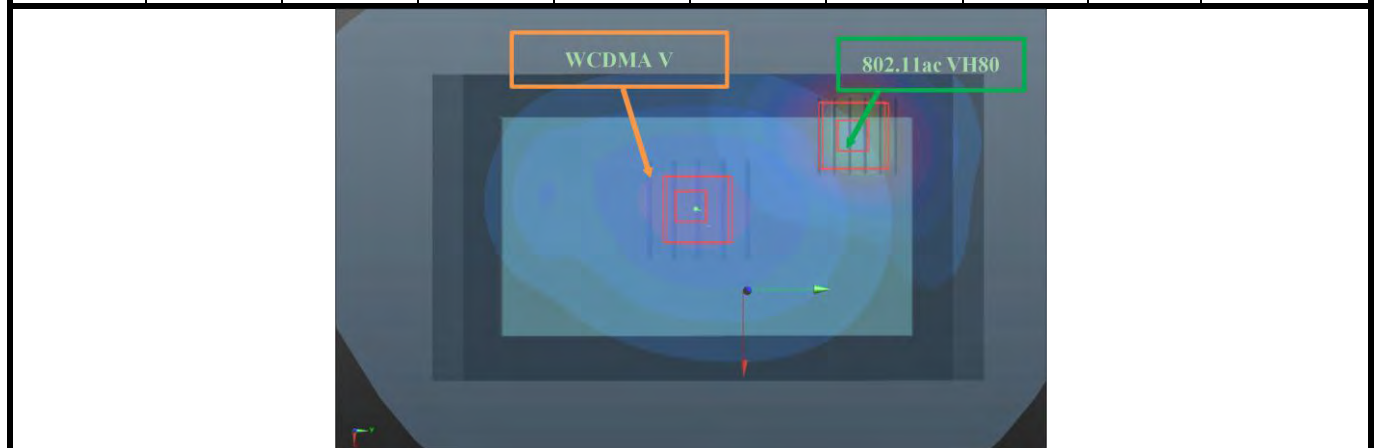

FCC SAR Test Report

Conditions	Exposure Condition	Test Position	SAR Value (W/kg)	Coordinates			Peak Location Separation Distance (R _i , mm)	SPLSR	Simultaneous Transmission SAR Test
				x	y	z			
LTE 2 Ch18900	Head	Left Cheek	0.81	50.79	-57.09	-0.87	81.1	0.04	SPLSR ≤ 0.04, Not required
802.11b Ch6			1.36	27.55	20.58	-1.76			

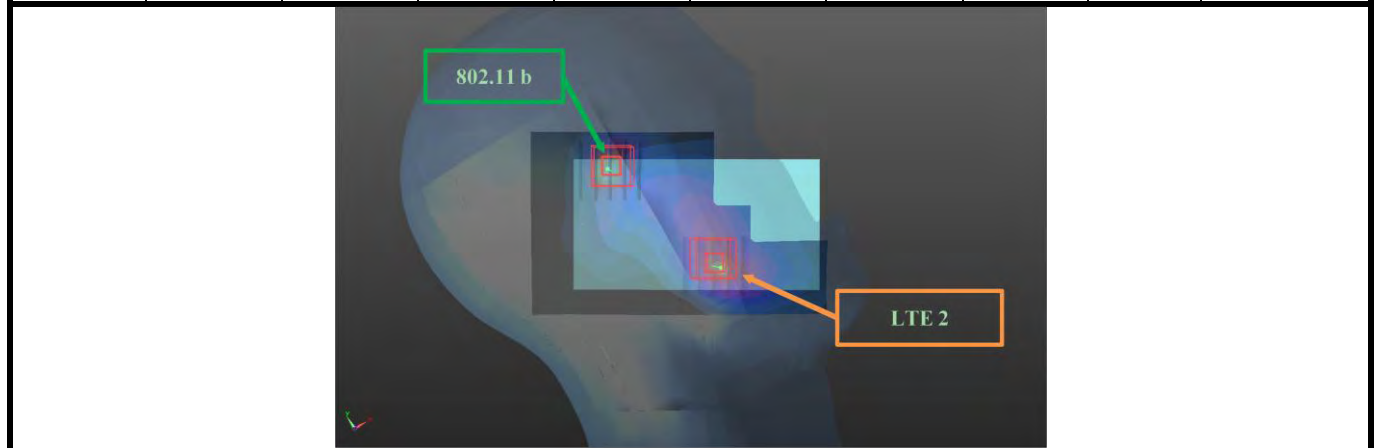

Conditions	Exposure Condition	Test Position	SAR Value (W/kg)	Coordinates			Peak Location Separation Distance (R _i , mm)	SPLSR	Simultaneous Transmission SAR Test
				x	y	z			
LTE 2 Ch18900	Body-Wron	Rear Face	0.34	13.2	-61.2	-0.31	120.9	0.02	SPLSR ≤ 0.04, Not required
802.11ac Ch138			1.25	-29.5	47.5	-1.3			



FCC SAR Test Report

Conditions	Exposure Condition	Test Position	SAR Value (W/kg)	Coordinates			Peak Location Separation Distance (R _i , mm)	SPLSR	Simultaneous Transmission SAR Test
				x	y	z			
LTE 4 Ch20175	Head	Left Cheek	0.53	54.46	-61.04	0.41	86.0	0.03	SPLSR ≤ 0.04, Not required
802.11b Ch6			1.36	27.55	20.58	-1.76			

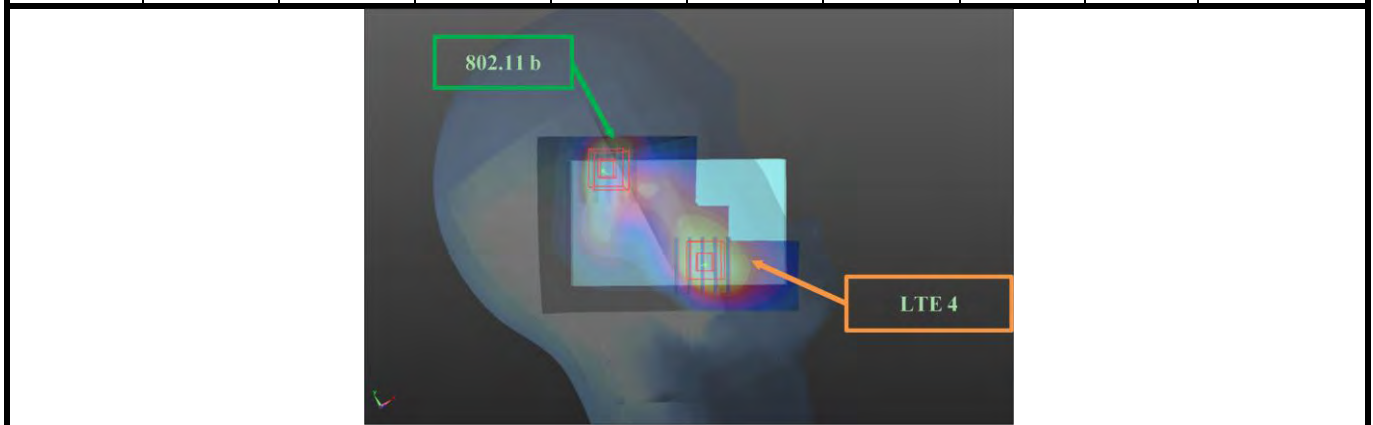

Conditions	Exposure Condition	Test Position	SAR Value (W/kg)	Coordinates			Peak Location Separation Distance (R _i , mm)	SPLSR	Simultaneous Transmission SAR Test
				x	y	z			
LTE 4 Ch20175	Body	Rear Face	1.28	3.2	-59.6	-0.92	118	0.03	SPLSR ≤ 0.04, Not required
802.11b Ch6			0.86	-34	52.4	-0.71			

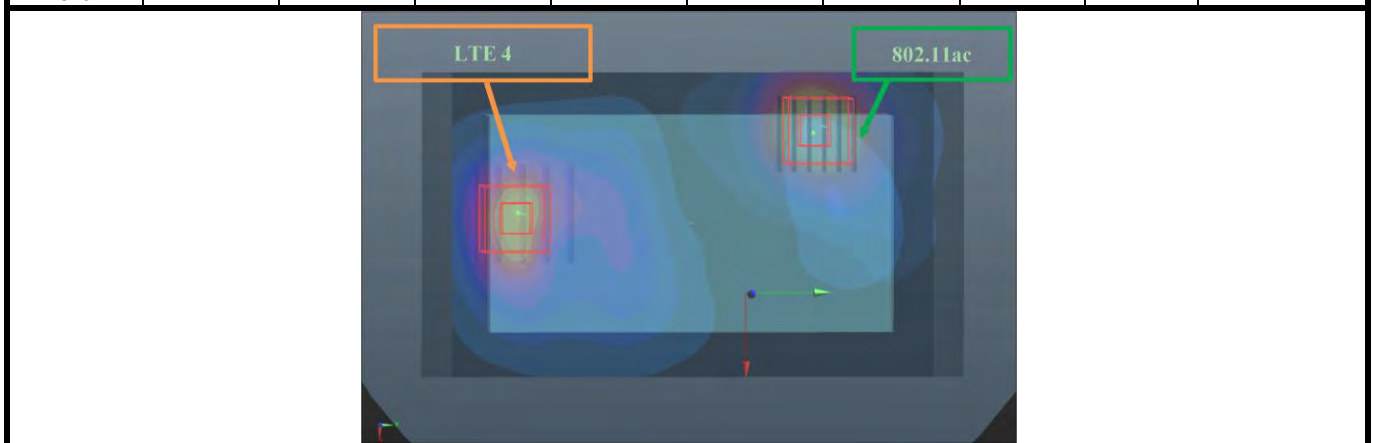

FCC SAR Test Report

Conditions	Exposure Condition	Test Position	SAR Value (W/kg)	Coordinates			Peak Location Separation Distance (R _i , mm)	SPLSR	Simultaneous Transmission SAR Test
				x	y	z			
LTE 4 Ch20175	Body-Wron	Rear Face	0.75	-2.4	-58	-0.46	112.5	0.03	SPLSR ≤ 0.04, Not required
802.11ac Ch138			1.25	-29.5	47.5	-1.3			



Conditions	Exposure Condition	Test Position	SAR Value (W/kg)	Coordinates			Peak Location Separation Distance (R _i , mm)	SPLSR	Simultaneous Transmission SAR Test
				x	y	z			
LTE 5 Ch20525	Head	Left Cheek	0.53	53.88	-31.24	-1.84	58.1	0.04	SPLSR ≤ 0.04, Not required
802.11b Ch6			1.36	27.55	20.58	-1.76			

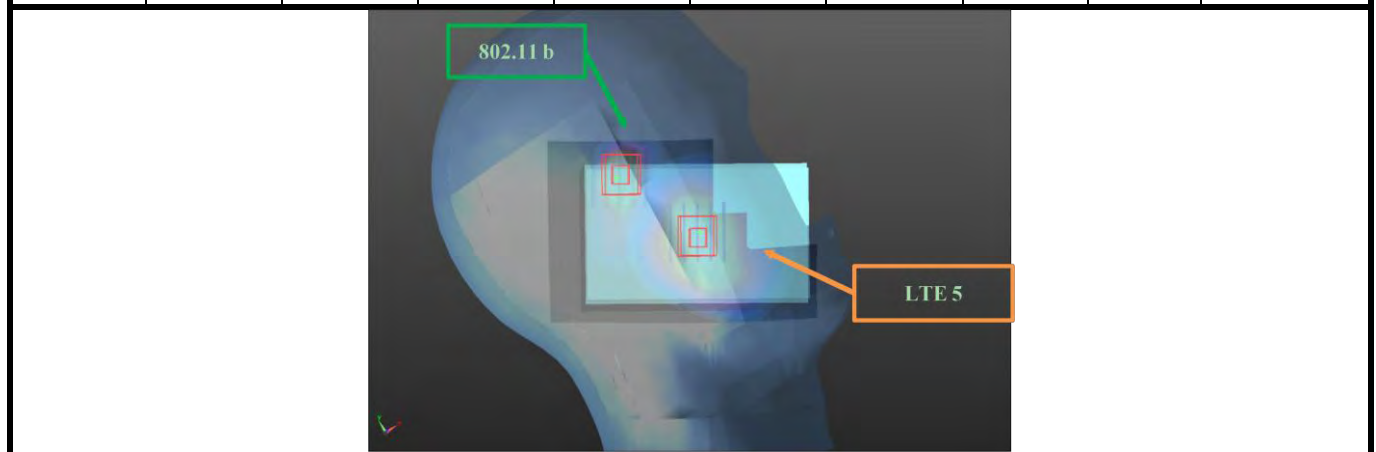

FCC SAR Test Report

Conditions	Exposure Condition	Test Position	SAR Value (W/kg)	Coordinates			Peak Location Separation Distance (R _i , mm)	SPLSR	Simultaneous Transmission SAR Test
				x	y	z			
LTE 5 Ch20525	Hotspot	Rear Face	0.97	-3.6	-6	-1.57	65.8	0.04	SPLSR ≤ 0.04, Not required
802.11b Ch6			0.86	-34	52.4	-0.71			

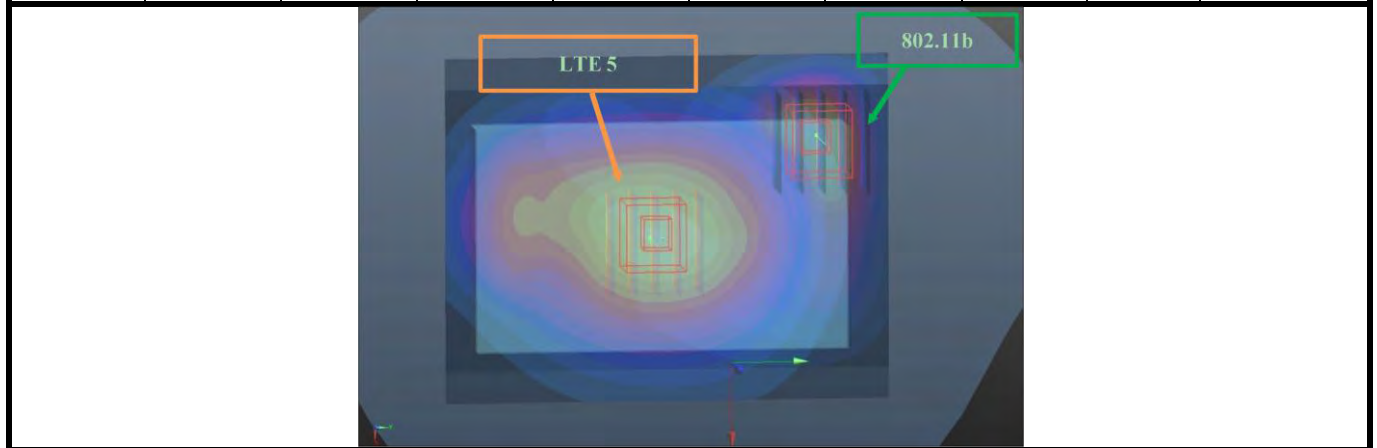

Conditions	Exposure Condition	Test Position	SAR Value (W/kg)	Coordinates			Peak Location Separation Distance (R _i , mm)	SPLSR	Simultaneous Transmission SAR Test
				x	y	z			
LTE 5 Ch20525	Body-Wron	Rear Face	0.78	-3	2	-0.75	64.3	0.04	SPLSR ≤ 0.04, Not required
802.11ac Ch155			1.25	-29.5	47.5	-1.3			



FCC SAR Test Report

Conditions	Exposure Condition	Test Position	SAR Value (W/kg)	Coordinates			Peak Location Separation Distance (R _i , mm)	SPLSR	Simultaneous Transmission SAR Test
				x	y	z			
LTE 12 Ch23095	Head	Left Cheek	0.30	52.76	-29.77	-0.37	56.3	0.04	SPLSR ≤ 0.04, Not required
802.11b Ch6			1.36	27.55	20.58	-1.76			

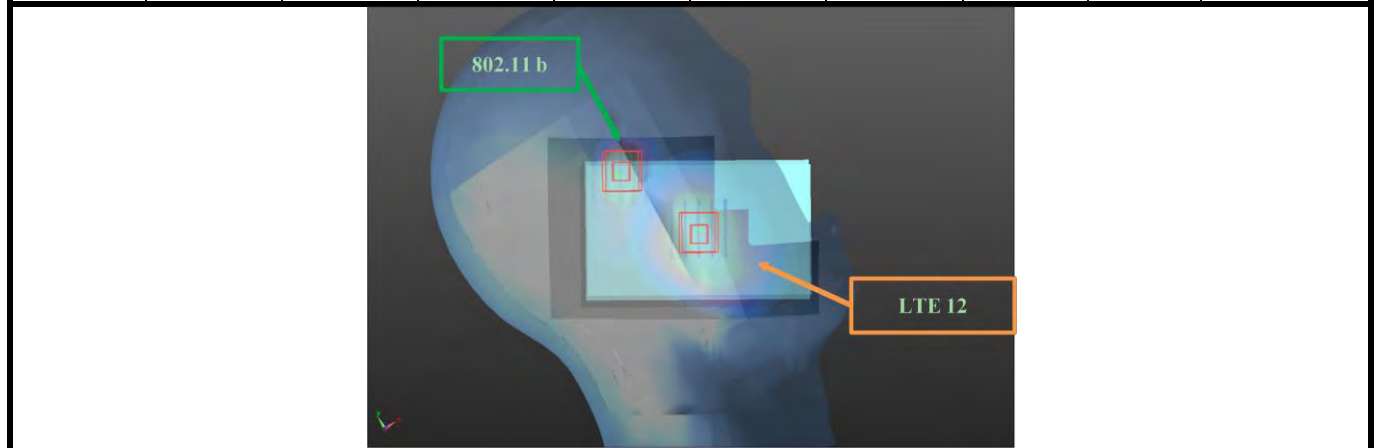

Conditions	Exposure Condition	Test Position	SAR Value (W/kg)	Coordinates			Peak Location Separation Distance (R _i , mm)	SPLSR	Simultaneous Transmission SAR Test
				x	y	z			
LTE 12 Ch23095	Body-Wron	Rear Face	0.39	0.4	-20.4	-0.73	78.6	0.03	SPLSR ≤ 0.04, Not required
802.11ac Ch138			1.25	-29.5	47.5	-1.3			

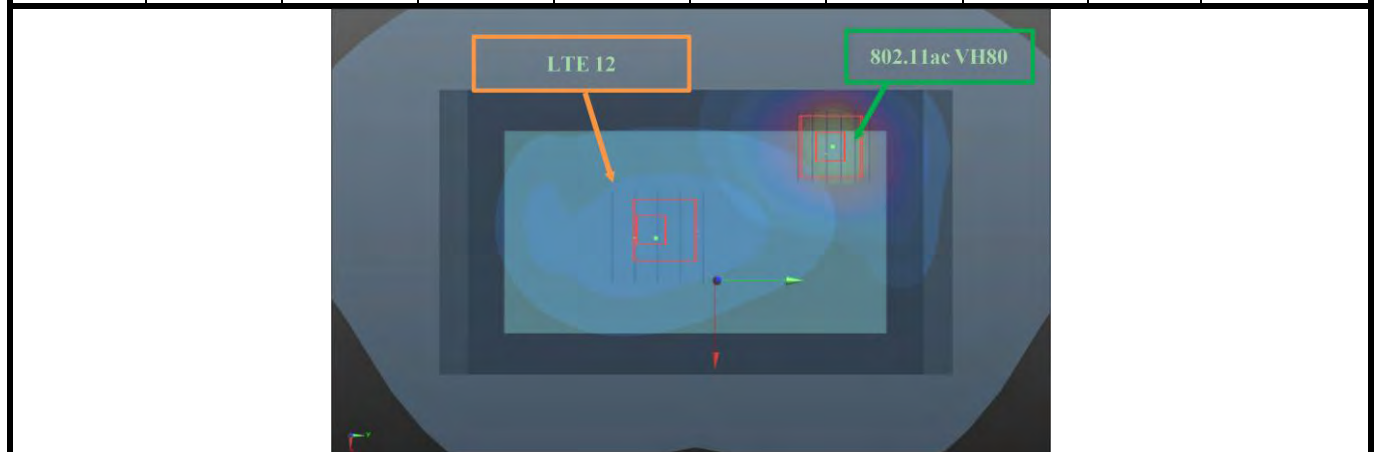

FCC SAR Test Report

Conditions	Exposure Condition	Test Position	SAR Value (W/kg)	Coordinates			Peak Location Separation Distance (R _i , mm)	SPLSR	Simultaneous Transmission SAR Test
				x	y	z			
LTE 17 Ch23790	Head	Left Cheek	0.30	52.84	-30.13	-1.05	56.7	0.04	SPLSR ≤ 0.04, Not required
802.11b Ch6			1.36	27.55	20.58	-1.76			

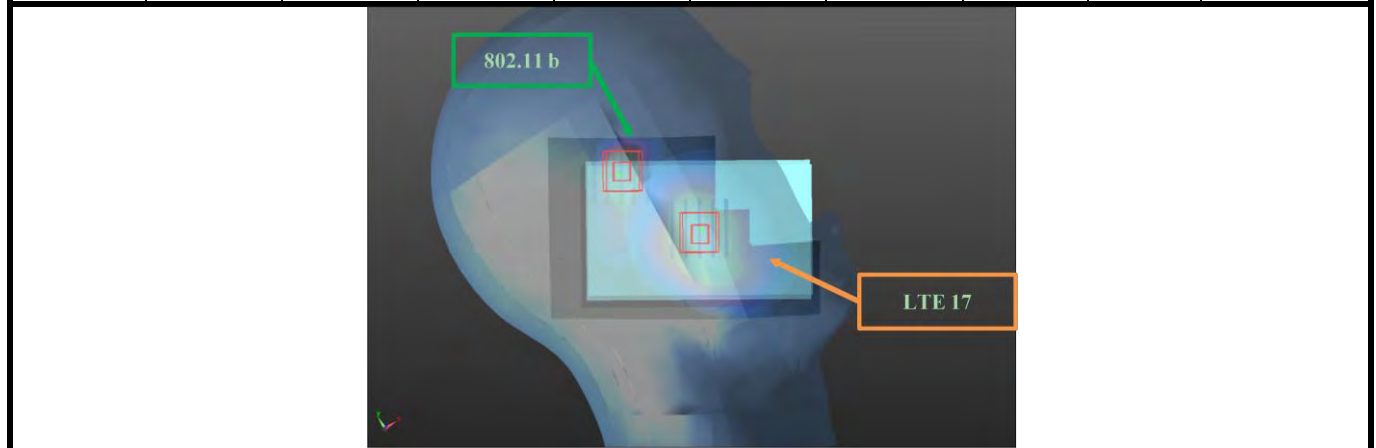

Conditions	Exposure Condition	Test Position	SAR Value (W/kg)	Coordinates			Peak Location Separation Distance (R _i , mm)	SPLSR	Simultaneous Transmission SAR Test
				x	y	z			
LTE 17 Ch23790	Body-Wron	Rear Face	0.37	5.6	-24.4	-0.7	84.6	0.02	SPLSR ≤ 0.04, Not required
802.11ac Ch138			1.25	-29.5	47.5	-1.3			

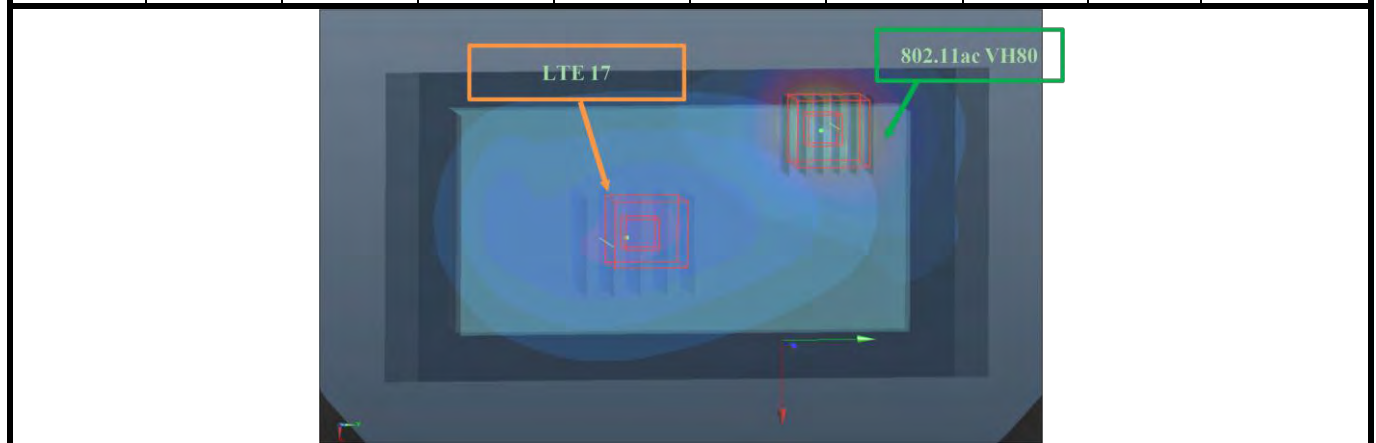

Test Engineer : Blake Wang, and Mars Chang

5. Calibration of Test Equipment

Equipment	Manufacturer	Model	SN	Cal. Date	Cal. Interval
System Validation Dipole	SPEAG	D750V3	1132	Dec. 28, 2016	1 Year
System Validation Dipole	SPEAG	D835V2	4d092	Jun. 28, 2017	1 Year
System Validation Dipole	SPEAG	D1750V2	1023	Jun. 27, 2017	1 Year
System Validation Dipole	SPEAG	D1900V2	5d036	Jan. 23, 2017	1 Year
System Validation Dipole	SPEAG	D2450V2	869	Jun. 27, 2017	1 Year
System Validation Dipole	SPEAG	D5GHzV2	1203	Dec. 16, 2016	1 Year
Dosimetric E-Field Probe	SPEAG	EX3DV4	3650	Jul. 24, 2017	1 Year
Dosimetric E-Field Probe	SPEAG	EX3DV4	3971	Mar. 24, 2017	1 Year
Dosimetric E-Field Probe	SPEAG	ET3DV6	1790	May. 24, 2017	1 Year
Dosimetric E-Field Probe	SPEAG	EX3DV4	7375	Dec. 08, 2016	1 Year
Data Acquisition Electronics	SPEAG	DAE4	1431	Mar. 20, 2017	1 Year
Data Acquisition Electronics	SPEAG	DAE4	1277	Jul. 20, 2017	1 Year
Data Acquisition Electronics	SPEAG	DAE4	916	Dec. 15, 2016	1 Year
Data Acquisition Electronics	SPEAG	DAE4	917	Jan. 06, 2017	1 Year
Data Acquisition Electronics	SPEAG	DAE3	579	Aug. 17, 2017	1 Year
Wireless Communication Test Set	Agilent	E5515C	MY50266628	Dec. 12, 2016	1 Year
Radio Communication Analyzer	Anritsu	MT8820C	6201381727	May. 26, 2017	1 Year
Spectrum Analyzer	R&S	FSL6	102006	Mar. 27, 2017	1 Year
ENA Series Network Analyzer	Agilent	E5071C	MY46214281	Jun. 09, 2017	1 Year
Vector Signal Generator	Anritsu	MG3710A	6201599977	Mar. 27, 2017	1 Year
Power Meter	Anritsu	ML2495A	1218009	Jul. 12, 2017	1 Year
Power Sensor	Anritsu	MA2411B	1207252	Jul. 12, 2017	1 Year
Thermometer	YFE	YF-160A	130504591	Mar. 24, 2017	1 Year

6. Measurement Uncertainty

Source of Uncertainty	Uncertainty (± %)	Probability Distribution	Divisor	Ci (1g)	Ci (10g)	Standard Uncertainty (± %, 1g)	Standard Uncertainty (± %, 10g)	Vi
Measurement System								
Probe Calibration	6.0	Normal	1	1	1	6.0	6.0	∞
Axial Isotropy	4.7	Rectangular	√3	√0.5	√0.5	1.9	1.9	∞
Hemispherical Isotropy	9.6	Rectangular	√3	√0.5	√0.5	3.9	3.9	∞
Boundary Effect	1.0	Rectangular	√3	1	1	0.6	0.6	∞
Linearity	4.7	Rectangular	√3	1	1	2.7	2.7	∞
Detection Limits	0.25	Rectangular	√3	1	1	0.14	0.14	∞
Probe Modulation Response	3.5	Rectangular	√3	1	1	2.0	2.0	∞
Readout Electronics	0.3	Normal	1	1	1	0.3	0.3	∞
Response Time	0.0	Rectangular	√3	1	1	0.0	0.0	∞
Integration Time	1.7	Rectangular	√3	1	1	1.0	1.0	∞
RF Ambient Conditions – Noise	3.0	Rectangular	√3	1	1	1.7	1.7	∞
RF Ambient Conditions – Reflections	3.0	Rectangular	√3	1	1	1.7	1.7	∞
Probe Positioner Mechanical Tolerance	0.4	Rectangular	√3	1	1	0.2	0.2	∞
Probe Positioning with Respect to Phantom	2.9	Rectangular	√3	1	1	1.7	1.7	∞
Post-processing	2.0	Rectangular	√3	1	1	1.2	1.2	∞
Test Sample Related								
Test Sample Positioning	3.9 / 2.06	Normal	1	1	1	3.9	2.1	35
Device Holder Uncertainty	2.9 / 4.1	Normal	1	1	1	2.9	4.1	11
Power Drift of Measurement	5.0	Rectangular	√3	1	1	2.9	2.9	∞
Power Scaling	0.0	Rectangular	√3	1	1	0.0	0.0	∞
Phantom and Setup								
Phantom Uncertainty (Shape and Thickness Tolerances)	6.1	Rectangular	√3	1	1	3.5	3.5	∞
Liquid Conductivity (Temperature Uncertainty)	3.24	Rectangular	√3	0.78	0.71	1.5	1.3	∞
Liquid Conductivity (Measured)	2.88	Normal	1	0.78	0.71	2.2	2.0	43
Liquid Permittivity (Temperature Uncertainty)	1.13	Rectangular	√3	0.23	0.26	0.2	0.2	∞
Liquid Permittivity (Measured)	2.50	Normal	1	0.23	0.26	0.6	0.7	54
Combined Standard Uncertainty						± 11.4 %	± 11.2 %	
Expanded Uncertainty (K=2)						± 22.8 %	± 22.4 %	

Head SAR Uncertainty Budget for Frequency Range of 300 MHz to 3 GHz

FCC SAR Test Report

Source of Uncertainty	Uncertainty (± %)	Probability Distribution	Divisor	Ci (1g)	Ci (10g)	Standard Uncertainty (± %, 1g)	Standard Uncertainty (± %, 10g)	Vi
Measurement System								
Probe Calibration	6.55	Normal	1	1	1	6.55	6.55	∞
Axial Isotropy	4.7	Rectangular	√3	0.7	0.7	1.9	1.9	∞
Hemispherical Isotropy	9.6	Rectangular	√3	0.7	0.7	3.9	3.9	∞
Boundary Effect	2.0	Rectangular	√3	1	1	1.2	1.2	∞
Linearity	4.7	Rectangular	√3	1	1	2.7	2.7	∞
Detection Limits	0.25	Rectangular	√3	1	1	0.14	0.14	∞
Probe Modulation Response	3.5	Rectangular	√3	1	1	2.0	2.0	∞
Readout Electronics	0.3	Normal	1	1	1	0.3	0.3	∞
Response Time	0.0	Rectangular	√3	1	1	0.0	0.0	∞
Integration Time	1.7	Rectangular	√3	1	1	1.0	1.0	∞
RF Ambient Conditions – Noise	3.0	Rectangular	√3	1	1	1.7	1.7	∞
RF Ambient Conditions – Reflections	3.0	Rectangular	√3	1	1	1.7	1.7	∞
Probe Positioner Mechanical Tolerance	0.4	Rectangular	√3	1	1	0.2	0.2	∞
Probe Positioning with Respect to Phantom	6.7	Rectangular	√3	1	1	3.9	3.9	∞
Post-processing	4.0	Rectangular	√3	1	1	2.3	2.3	∞
Test Sample Related								
Test Sample Positioning	3.9 / 2.06	Normal	1	1	1	3.9	2.1	35
Device Holder Uncertainty	2.9 / 4.1	Normal	1	1	1	2.9	4.1	11
Power Drift of Measurement	5.0	Rectangular	√3	1	1	2.9	2.9	∞
Power Scaling	0.0	Rectangular	√3	1	1	0.0	0.0	∞
Phantom and Setup								
Phantom Uncertainty (Shape and Thickness Tolerances)	6.6	Rectangular	√3	1	1	3.8	3.8	∞
Liquid Conductivity (Temperature Uncertainty)	3.24	Rectangular	√3	0.78	0.71	1.5	1.3	∞
Liquid Conductivity (Measured)	2.88	Normal	1	0.78	0.71	2.2	2.0	43
Liquid Permittivity (Temperature Uncertainty)	1.13	Rectangular	√3	0.23	0.26	0.2	0.2	∞
Liquid Permittivity (Measured)	2.50	Normal	1	0.23	0.26	0.6	0.7	54
Combined Standard Uncertainty						± 12.5 %	± 12.3 %	
Expanded Uncertainty (K=2)						± 25.0 %	± 24.6 %	

Head SAR Uncertainty Budget for Frequency Range of 3 GHz to 6 GHz

FCC SAR Test Report

Source of Uncertainty	Uncertainty (± %)	Probability Distribution	Divisor	Ci (1g)	Ci (10g)	Standard Uncertainty (± %, 1g)	Standard Uncertainty (± %, 10g)	Vi
Measurement System								
Probe Calibration	6.0	Normal	1	1	1	6.0	6.0	∞
Axial Isotropy	4.7	Rectangular	√3	√0.5	√0.5	1.9	1.9	∞
Hemispherical Isotropy	9.6	Rectangular	√3	√0.5	√0.5	3.9	3.9	∞
Boundary Effect	1.0	Rectangular	√3	1	1	0.6	0.6	∞
Linearity	4.7	Rectangular	√3	1	1	2.7	2.7	∞
Detection Limits	0.25	Rectangular	√3	1	1	0.14	0.14	∞
Probe Modulation Response	3.5	Rectangular	√3	1	1	2.0	2.0	∞
Readout Electronics	0.3	Normal	1	1	1	0.3	0.3	∞
Response Time	0.0	Rectangular	√3	1	1	0.0	0.0	∞
Integration Time	1.7	Rectangular	√3	1	1	1.0	1.0	∞
RF Ambient Conditions – Noise	3.0	Rectangular	√3	1	1	1.7	1.7	∞
RF Ambient Conditions – Reflections	3.0	Rectangular	√3	1	1	1.7	1.7	∞
Probe Positioner Mechanical Tolerance	0.4	Rectangular	√3	1	1	0.2	0.2	∞
Probe Positioning with Respect to Phantom	2.9	Rectangular	√3	1	1	1.7	1.7	∞
Post-processing	2.0	Rectangular	√3	1	1	1.2	1.2	∞
Test Sample Related								
Test Sample Positioning	4.38 / 1.35	Normal	1	1	1	4.4	1.4	29
Device Holder Uncertainty	2.9 / 4.1	Normal	1	1	1	2.9	4.1	11
Power Drift of Measurement	5.0	Rectangular	√3	1	1	2.9	2.9	∞
Power Scaling	0.0	Rectangular	√3	1	1	0.0	0.0	∞
Phantom and Setup								
Phantom Uncertainty (Shape and Thickness Tolerances)	7.2	Rectangular	√3	1	1	4.2	4.2	∞
Liquid Conductivity (Temperature Uncertainty)	3.24	Rectangular	√3	0.78	0.71	1.5	1.3	∞
Liquid Conductivity (Measured)	2.88	Normal	1	0.78	0.71	2.2	2.0	43
Liquid Permittivity (Temperature Uncertainty)	1.13	Rectangular	√3	0.23	0.26	0.2	0.2	∞
Liquid Permittivity (Measured)	2.50	Normal	1	0.23	0.26	0.6	0.7	54
Combined Standard Uncertainty						± 11.8 %	± 11.3 %	
Expanded Uncertainty (K=2)						± 23.6 %	± 22.6 %	

Body SAR Uncertainty Budget for Frequency Range of 300 MHz to 3 GHz

FCC SAR Test Report

Source of Uncertainty	Uncertainty (± %)	Probability Distribution	Divisor	C _i (1g)	C _i (10g)	Standard Uncertainty (± %, 1g)	Standard Uncertainty (± %, 10g)	V _i
Measurement System								
Probe Calibration	6.55	Normal	1	1	1	6.55	6.55	∞
Axial Isotropy	4.7	Rectangular	√3	0.7	0.7	1.9	1.9	∞
Hemispherical Isotropy	9.6	Rectangular	√3	0.7	0.7	3.9	3.9	∞
Boundary Effect	2.0	Rectangular	√3	1	1	1.2	1.2	∞
Linearity	4.7	Rectangular	√3	1	1	2.7	2.7	∞
Detection Limits	0.25	Rectangular	√3	1	1	0.14	0.14	∞
Probe Modulation Response	3.5	Rectangular	√3	1	1	2.0	2.0	∞
Readout Electronics	0.3	Normal	1	1	1	0.3	0.3	∞
Response Time	0.0	Rectangular	√3	1	1	0.0	0.0	∞
Integration Time	1.7	Rectangular	√3	1	1	1.0	1.0	∞
RF Ambient Conditions – Noise	3.0	Rectangular	√3	1	1	1.7	1.7	∞
RF Ambient Conditions – Reflections	3.0	Rectangular	√3	1	1	1.7	1.7	∞
Probe Positioner Mechanical Tolerance	0.4	Rectangular	√3	1	1	0.2	0.2	∞
Probe Positioning with Respect to Phantom	6.7	Rectangular	√3	1	1	3.9	3.9	∞
Post-processing	4.0	Rectangular	√3	1	1	2.3	2.3	∞
Test Sample Related								
Test Sample Positioning	4.38 / 1.35	Normal	1	1	1	4.4	1.4	29
Device Holder Uncertainty	2.9 / 4.1	Normal	1	1	1	2.9	4.1	11
Power Drift of Measurement	5.0	Rectangular	√3	1	1	2.9	2.9	∞
Power Scaling	0.0	Rectangular	√3	1	1	0.0	0.0	∞
Phantom and Setup								
Phantom Uncertainty (Shape and Thickness Tolerances)	7.6	Rectangular	√3	1	1	4.4	4.4	∞
Liquid Conductivity (Temperature Uncertainty)	3.24	Rectangular	√3	0.78	0.71	1.5	1.3	∞
Liquid Conductivity (Measured)	2.88	Normal	1	0.78	0.71	2.2	2.0	43
Liquid Permittivity (Temperature Uncertainty)	1.13	Rectangular	√3	0.23	0.26	0.2	0.2	∞
Liquid Permittivity (Measured)	2.50	Normal	1	0.23	0.26	0.6	0.7	54
Combined Standard Uncertainty						± 12.8 %	± 12.4 %	
Expanded Uncertainty (K=2)						± 25.6 %	± 24.8 %	

Body SAR Uncertainty Budget for Frequency Range of 3 GHz to 6 GHz

7. Information on the Testing Laboratories

We, Bureau Veritas Consumer Products Services (H.K.) Ltd., Taoyuan Branch, were founded in 1988 to provide our best service in EMC, Radio, Telecom and Safety consultation. Our laboratories are accredited and approved according to ISO/IEC 17025.

If you have any comments, please feel free to contact us at the following:

Taiwan HwaYa EMC/RF/Safety/Telecom Lab:

Add: No. 19, Hwa Ya 2nd Rd, Wen Hwa Vil., Kwei Shan Hsiang, Taoyuan Hsien 333, Taiwan, R.O.C.

Tel: 886-3-318-3232

Fax: 886-3-327-0892

Taiwan LinKo EMC/RF Lab:

Add: No. 47-2, 14th Ling, Chia Pau Vil., Linkou Dist., New Taipei City 244, Taiwan, R.O.C.

Tel: 886-2-2605-2180

Fax: 886-2-2605-1924

Taiwan HsinChu EMC/RF Lab:

Add: No. 81-1, Lu Liao Keng, 9th Ling, Wu Lung Vil., Chiung Lin Township, Hsinchu County 307, Taiwan, R.O.C.

Tel: 886-3-593-5343

Fax: 886-3-593-5342

Email: service.adt@tw.bureauveritas.com

Web Site: www.adt.com.tw

The road map of all our labs can be found in our web site also.

---END---



Appendix A. SAR Plots of System Verification

The plots for system verification with largest deviation for each SAR system combination are shown as follows.

System Check_H750_170813

DUT: Dipole 750 MHz; Type: D750V3; SN: 1132

Communication System: CW; Frequency: 750 MHz; Duty Cycle: 1:1

Medium: H06T09N1_0813 Medium parameters used: $f = 750 \text{ MHz}$; $\sigma = 0.886 \text{ S/m}$; $\epsilon_r = 42.919$; $\rho = 1000 \text{ kg/m}^3$

Ambient Temperature : $23.9 \text{ }^\circ\text{C}$; Liquid Temperature : $23.6 \text{ }^\circ\text{C}$

DASY5 Configuration:

- Probe: EX3DV4 - SN7375; ConvF(9.9, 9.9, 9.9); Calibrated: 2016/12/08;
- Sensor-Surface: 1.4mm (Mechanical Surface Detection)
- Electronics: DAE4 Sn1431; Calibrated: 2017/03/20
- Phantom: Twin SAM Phantom_1653; Type: QD000P40;
- Measurement SW: DASY52, Version 52.8 (8); SEMCAD X Version 14.6.10 (7373)

Pin=250mW/Area Scan (61x81x1): Interpolated grid: $dx=1.500 \text{ mm}$, $dy=1.500 \text{ mm}$
Maximum value of SAR (interpolated) = 2.65 W/kg

Pin=250mW/Zoom Scan (5x5x7)/Cube 0: Measurement grid: $dx=8\text{mm}$, $dy=8\text{mm}$, $dz=5\text{mm}$
Reference Value = 55.88 V/m ; Power Drift = 0.00 dB
Peak SAR (extrapolated) = 3.05 W/kg
SAR(1 g) = 2.13 W/kg ; SAR(10 g) = 1.45 W/kg
Maximum value of SAR (measured) = 2.64 W/kg

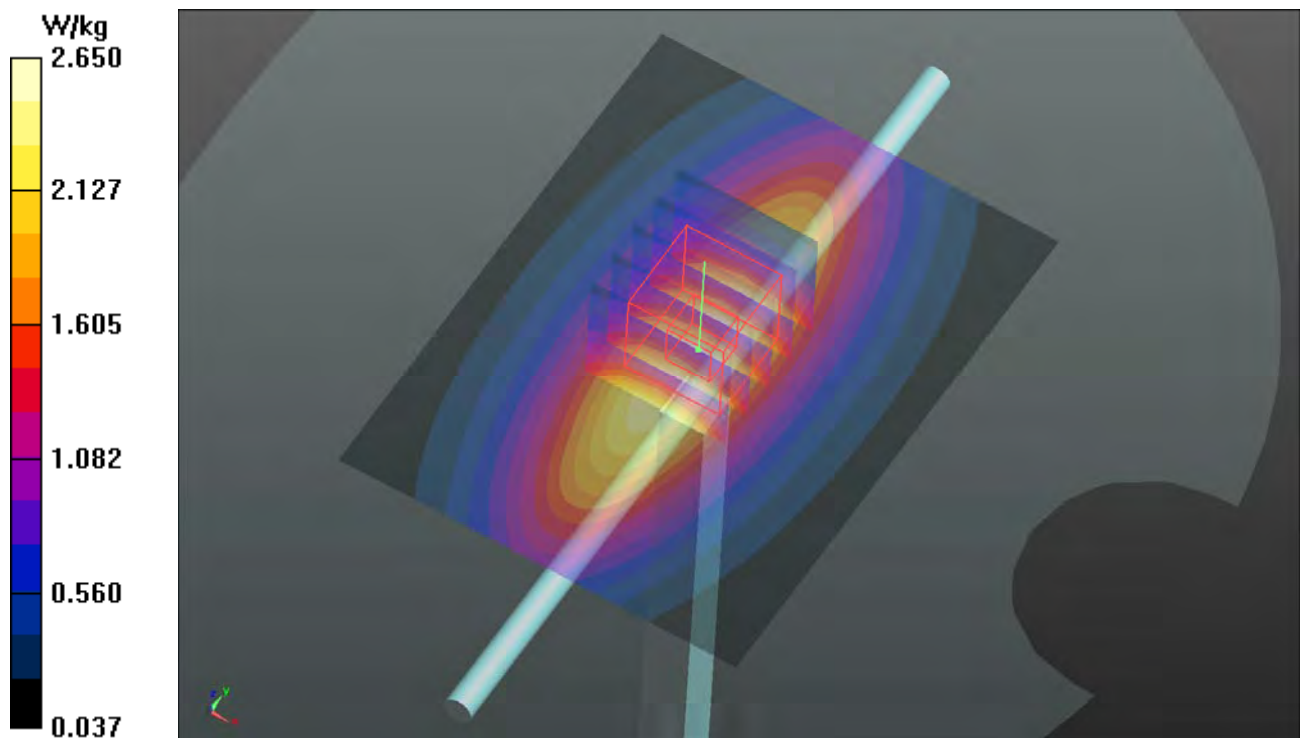

System Check_H835_170821

DUT: Dipole 835 MHz; Type: D835V2; SN: 4d092

Communication System: CW; Frequency: 835 MHz; Duty Cycle: 1:1

Medium: H07T10N1_0821 Medium parameters used: $f = 835 \text{ MHz}$; $\sigma = 0.903 \text{ S/m}$; $\epsilon_r = 42.765$; $\rho = 1000 \text{ kg/m}^3$

Ambient Temperature : $23.8 \text{ }^\circ\text{C}$; Liquid Temperature : $23.2 \text{ }^\circ\text{C}$

DASY5 Configuration:

- Probe: ET3DV6 - SN1790; ConvF(7.04, 7.04, 7.04); Calibrated: 2017/05/24;
- Sensor-Surface: 4mm (Mechanical Surface Detection)
- Electronics: DAE4 Sn917; Calibrated: 2017/01/06
- Phantom: Twin SAM Phantom_1653; Type: QD000P40;
- Measurement SW: DASY52, Version 52.8 (8); SEMCAD X Version 14.6.10 (7373)

Pin=250mW/Area Scan (61x61x1): Interpolated grid: $dx=1.500 \text{ mm}$, $dy=1.500 \text{ mm}$
Maximum value of SAR (interpolated) = 2.91 W/kg

Pin=250mW/Zoom Scan (5x5x7)/Cube 0: Measurement grid: $dx=8\text{mm}$, $dy=8\text{mm}$, $dz=5\text{mm}$

Reference Value = 53.49 V/m ; Power Drift = -0.05 dB

Peak SAR (extrapolated) = 3.30 W/kg

SAR(1 g) = 2.19 W/kg ; SAR(10 g) = 1.44 W/kg

Maximum value of SAR (measured) = 2.92 W/kg

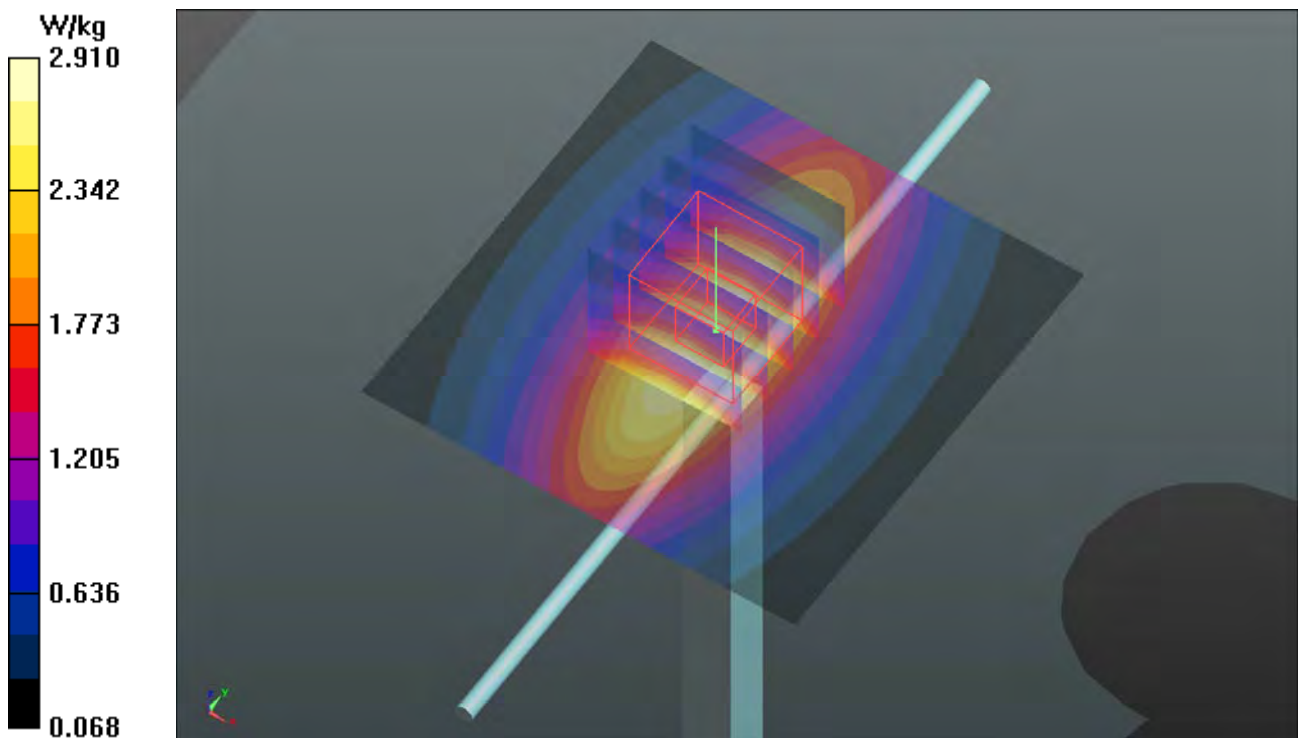

System Check_H1750_170814

DUT: Dipole 1750 MHz; Type: D1750V2; SN: 1023

Communication System: CW; Frequency: 1750 MHz; Duty Cycle: 1:1

Medium: H16T20N1_0814 Medium parameters used: $f = 1750$ MHz; $\sigma = 1.324$ S/m; $\epsilon_r = 39.865$; $\rho = 1000$ kg/m³

Ambient Temperature : 23.8 °C ; Liquid Temperature : 23.6 °C

DASY5 Configuration:

- Probe: EX3DV4 - SN7375; ConvF(8.31, 8.31, 8.31); Calibrated: 2016/12/08;
- Sensor-Surface: 1.4mm (Mechanical Surface Detection)
- Electronics: DAE4 Sn1431; Calibrated: 2017/03/20
- Phantom: Twin SAM Phantom_1653; Type: QD000P40;
- Measurement SW: DASY52, Version 52.8 (8); SEMCAD X Version 14.6.10 (7373)

Pin=250mW/Area Scan (61x61x1): Interpolated grid: dx=1.500 mm, dy=1.500 mm
Maximum value of SAR (interpolated) = 13.7 W/kg

Pin=250mW/Zoom Scan (5x5x7)/Cube 0: Measurement grid: dx=8mm, dy=8mm, dz=5mm
Reference Value = 98.25 V/m; Power Drift = -0.01 dB
Peak SAR (extrapolated) = 16.3 W/kg
SAR(1 g) = 8.83 W/kg; SAR(10 g) = 4.7 W/kg
Maximum value of SAR (measured) = 13.7 W/kg

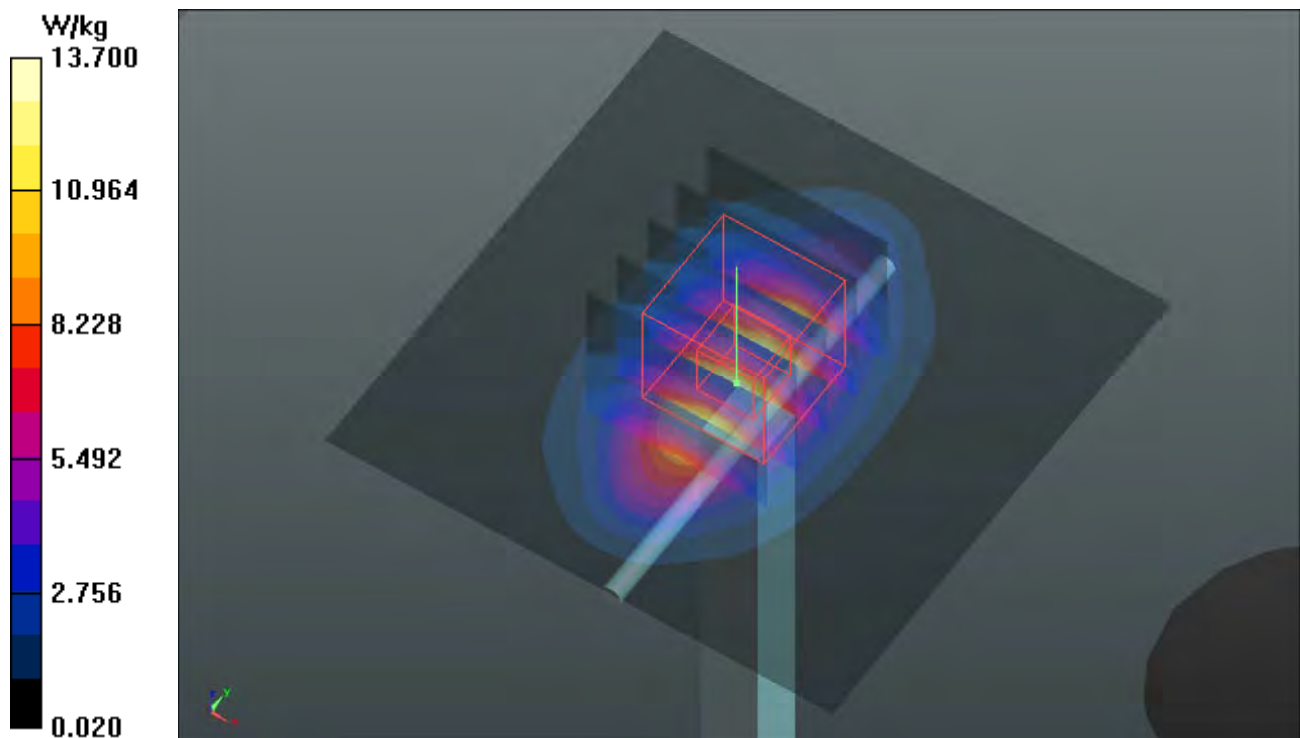

System Check_H1900_170927

DUT: Dipole 1900 MHz; Type: D1900V2; SN: 5d036

Communication System: CW; Frequency: 1900 MHz; Duty Cycle: 1:1

Medium: H16T20N1_0927 Medium parameters used: $f = 1900$ MHz; $\sigma = 1.45$ S/m; $\epsilon_r = 39.271$; $\rho = 1000$ kg/m³

Ambient Temperature : 23.6 °C ; Liquid Temperature : 23.3 °C

DASY5 Configuration:

- Probe: ET3DV6 - SN1790; ConvF(5.59, 5.59, 5.59); Calibrated: 2017/05/24;
- Sensor-Surface: 4mm (Mechanical Surface Detection)
- Electronics: DAE4 Sn917; Calibrated: 2017/01/06
- Phantom: Twin SAM Phantom_1127; Type: QD000P40CA;
- Measurement SW: DASY52, Version 52.8 (8); SEMCAD X Version 14.6.10 (7373)

Pin=250mW/Area Scan (61x61x1): Interpolated grid: dx=1.500 mm, dy=1.500 mm
Maximum value of SAR (interpolated) = 16.9 W/kg

Pin=250mW/Zoom Scan (5x5x7)/Cube 0: Measurement grid: dx=8mm, dy=8mm, dz=5mm
Reference Value = 111.3 V/m; Power Drift = -0.13 dB
Peak SAR (extrapolated) = 20.1 W/kg
SAR(1 g) = 10.3 W/kg; SAR(10 g) = 5.49 W/kg
Maximum value of SAR (measured) = 16.7 W/kg

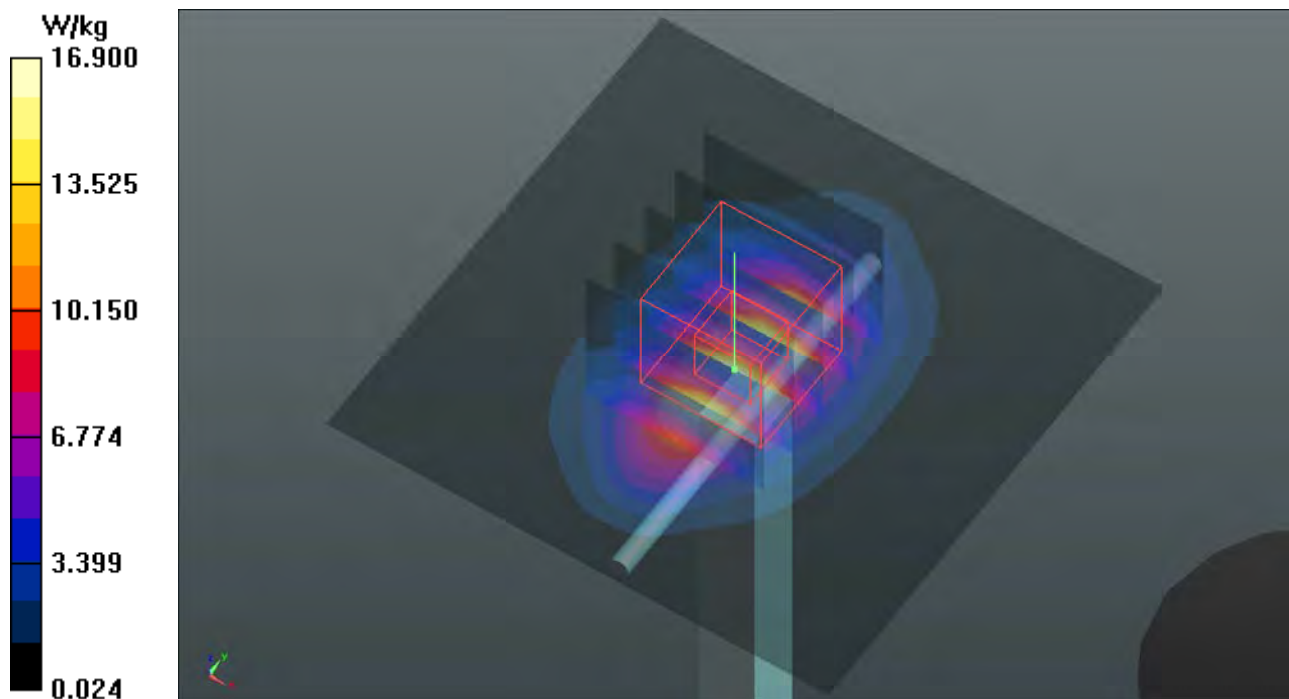

System Check_H2450_170816

DUT: Dipole 2450 MHz; Type: D2450V2; SN: 869

Communication System: CW; Frequency: 2450 MHz; Duty Cycle: 1:1

Medium: H19T27N1_0816 Medium parameters used: $f = 2450$ MHz; $\sigma = 1.852$ S/m; $\epsilon_r = 38.383$; $\rho = 1000$ kg/m³

Ambient Temperature : 23.5 °C ; Liquid Temperature : 23.3 °C

DASY5 Configuration:

- Probe: EX3DV4 - SN7375; ConvF(7.27, 7.27, 7.27); Calibrated: 2016/12/08;
- Sensor-Surface: 1.4mm (Mechanical Surface Detection)
- Electronics: DAE4 Sn1431; Calibrated: 2017/03/20
- Phantom: Twin SAM Phantom_1653; Type: QD000P40;
- Measurement SW: DASY52, Version 52.8 (8); SEMCAD X Version 14.6.10 (7373)

Pin=250mW/Area Scan (81x81x1): Interpolated grid: dx=1.200 mm, dy=1.200 mm
Maximum value of SAR (interpolated) = 20.8 W/kg

Pin=250mW/Zoom Scan (7x7x7)/Cube 0: Measurement grid: dx=5mm, dy=5mm, dz=5mm
Reference Value = 107.9 V/m; Power Drift = -0.07 dB
Peak SAR (extrapolated) = 28.5 W/kg
SAR(1 g) = 13.3 W/kg; SAR(10 g) = 6.07 W/kg
Maximum value of SAR (measured) = 20.7 W/kg

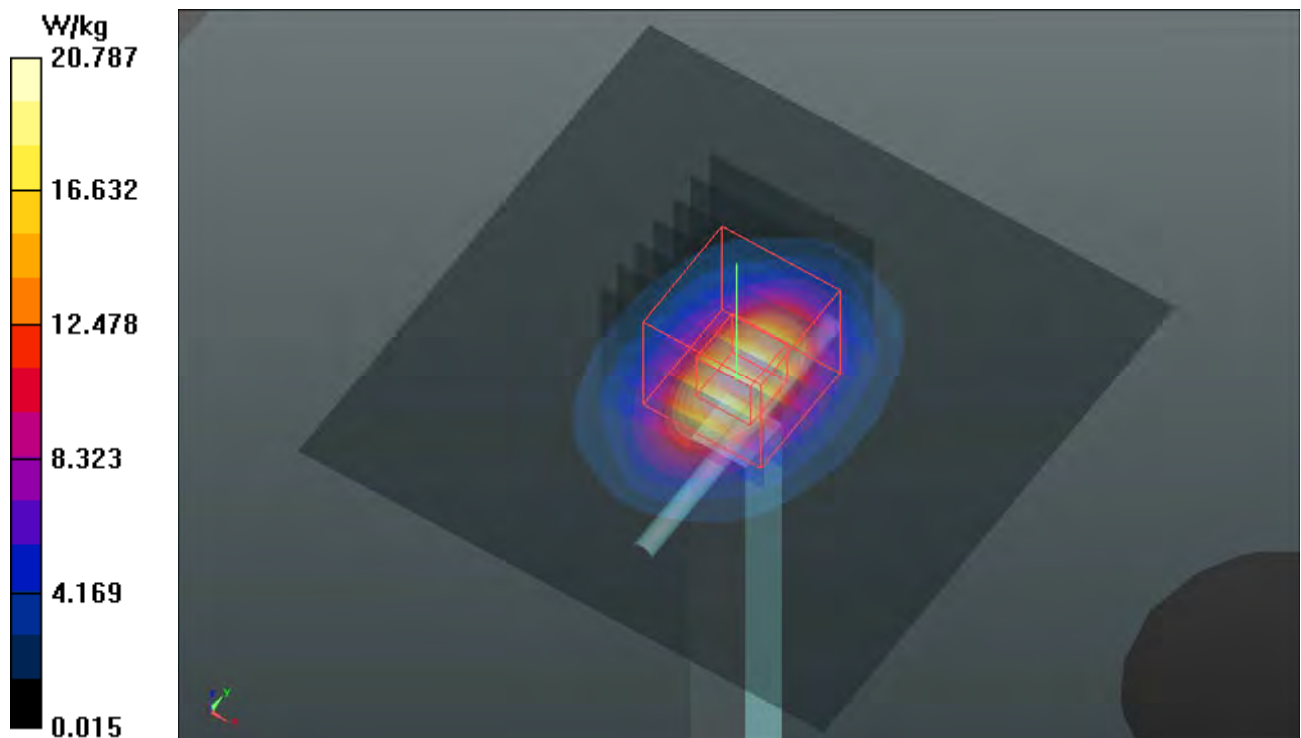

System Check_H5300_170928

DUT: Dipole 5 GHz; Type: D5GHzV2; SN: 1203

Communication System: CW; Frequency: 5300 MHz; Duty Cycle: 1:1

Medium: H34T60N3_0928 Medium parameters used: $f = 5300$ MHz; $\sigma = 4.92$ S/m; $\epsilon_r = 35.436$; $\rho = 1000$ kg/m³

Ambient Temperature : 23.8 °C ; Liquid Temperature : 23.6 °C

DASY5 Configuration:

- Probe: EX3DV4 - SN3971; ConvF(5.34, 5.34, 5.34); Calibrated: 2017/03/24;
- Sensor-Surface: 1.4mm (Mechanical Surface Detection)
- Electronics: DAE4 Sn1431; Calibrated: 2017/03/20
- Phantom: Twin SAM Phantom_1127; Type: QD000P40CA;
- Measurement SW: DASY52, Version 52.8 (8); SEMCAD X Version 14.6.10 (7373)

Pin=100mW/Area Scan (91x91x1): Interpolated grid: dx=1.000 mm, dy=1.000 mm
Maximum value of SAR (interpolated) = 19.5 W/kg

Pin=100mW/Zoom Scan (7x7x12)/Cube 0: Measurement grid: dx=4mm, dy=4mm, dz=2mm
Reference Value = 71.02 V/m; Power Drift = -0.03 dB
Peak SAR (extrapolated) = 34.9 W/kg
SAR(1 g) = 8.54 W/kg; SAR(10 g) = 2.45 W/kg
Maximum value of SAR (measured) = 21.5 W/kg

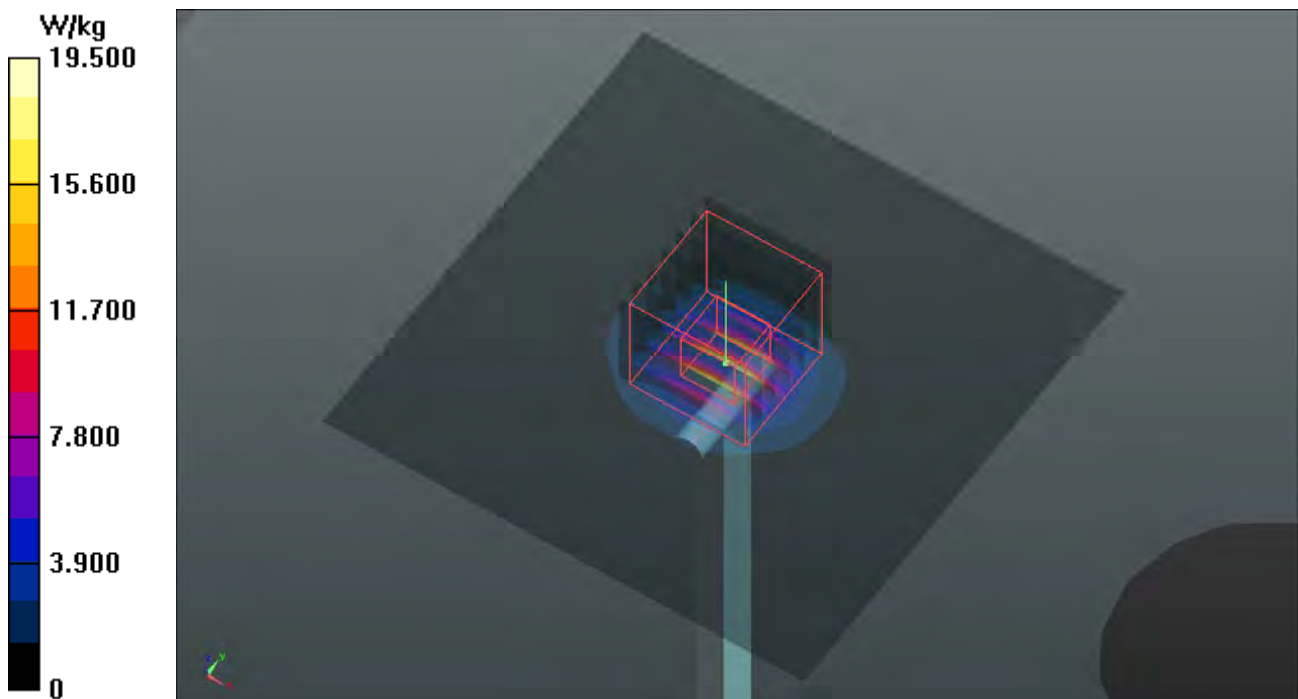

System Check_H5600_170823

DUT: Dipole 5 GHz; Type: D5GHzV2; SN: 1203

Communication System: CW; Frequency: 5600 MHz; Duty Cycle: 1:1

Medium: H34T60N1_0823 Medium parameters used: $f = 5600$ MHz; $\sigma = 5.132$ S/m; $\epsilon_r = 36.728$; $\rho = 1000$ kg/m³

Ambient Temperature : 23.5 °C ; Liquid Temperature : 23.3 °C

DASY5 Configuration:

- Probe: EX3DV4 - SN7375; ConvF(4.79, 4.79, 4.79); Calibrated: 2016/12/08;
- Sensor-Surface: 1.4mm (Mechanical Surface Detection)
- Electronics: DAE4 Sn1431; Calibrated: 2017/03/20
- Phantom: Twin SAM Phantom_1654; Type: QD000P40;
- Measurement SW: DASY52, Version 52.8 (8); SEMCAD X Version 14.6.10 (7373)

Pin=100mW/Area Scan (91x91x1): Interpolated grid: dx=1.000 mm, dy=1.000 mm
Maximum value of SAR (interpolated) = 19.5 W/kg

Pin=100mW/Zoom Scan (7x7x12)/Cube 0: Measurement grid: dx=4mm, dy=4mm, dz=2mm
Reference Value = 72.24 V/m; Power Drift = -0.18 dB
Peak SAR (extrapolated) = 35.6 W/kg
SAR(1 g) = 8.5 W/kg; SAR(10 g) = 2.37 W/kg
Maximum value of SAR (measured) = 21.4 W/kg

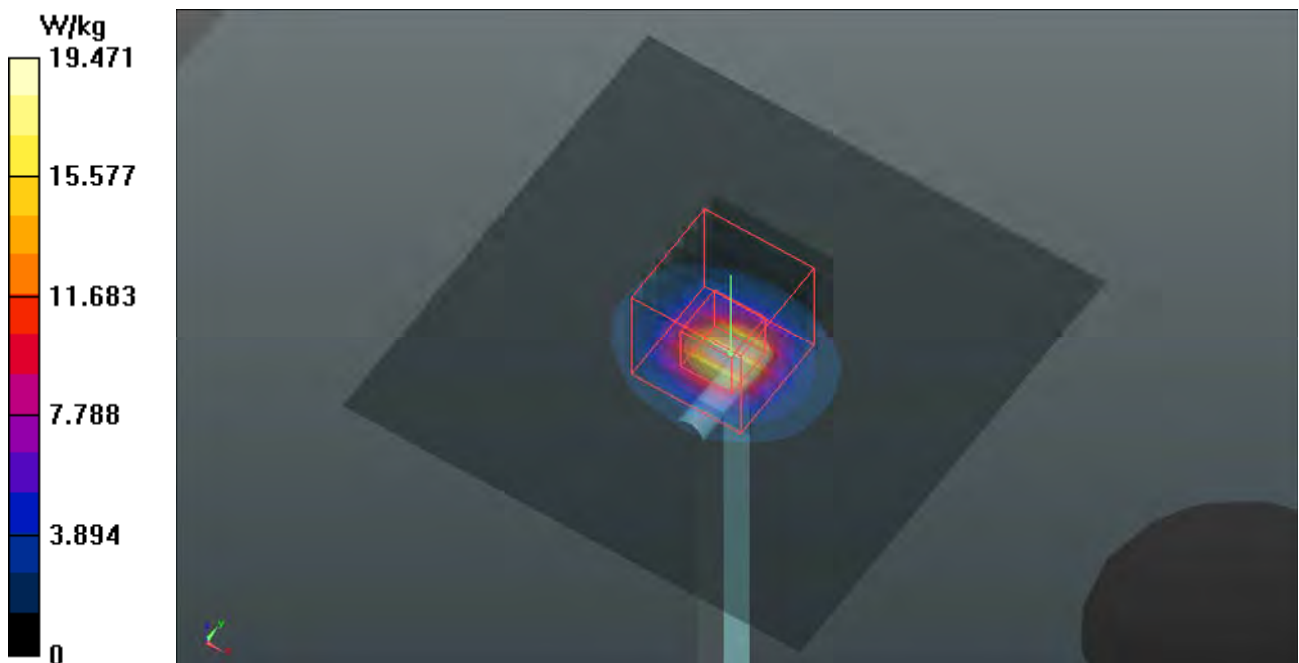

System Check_H5800_170823

DUT: Dipole 5 GHz; Type: D5GHzV2; SN: 1203

Communication System: CW; Frequency: 5800 MHz; Duty Cycle: 1:1

Medium: H34T60N1_0823 Medium parameters used: $f = 5800$ MHz; $\sigma = 5.374$ S/m; $\epsilon_r = 36.384$; $\rho = 1000$ kg/m³

Ambient Temperature : 23.7 °C ; Liquid Temperature : 23.5 °C

DASY5 Configuration:

- Probe: EX3DV4 - SN7375; ConvF(4.78, 4.78, 4.78); Calibrated: 2016/12/08;
- Sensor-Surface: 1.4mm (Mechanical Surface Detection)
- Electronics: DAE4 Sn1431; Calibrated: 2017/03/20
- Phantom: Twin SAM Phantom_1654; Type: QD000P40;
- Measurement SW: DASY52, Version 52.8 (8); SEMCAD X Version 14.6.10 (7373)

Pin=100mW/Area Scan (91x91x1): Interpolated grid: dx=1.000 mm, dy=1.000 mm
Maximum value of SAR (interpolated) = 19.6 W/kg

Pin=100mW/Zoom Scan (7x7x12)/Cube 0: Measurement grid: dx=4mm, dy=4mm, dz=2mm
Reference Value = 69.06 V/m; Power Drift = 0.03 dB
Peak SAR (extrapolated) = 35.7 W/kg
SAR(1 g) = 8.17 W/kg; SAR(10 g) = 2.34 W/kg
Maximum value of SAR (measured) = 21.1 W/kg

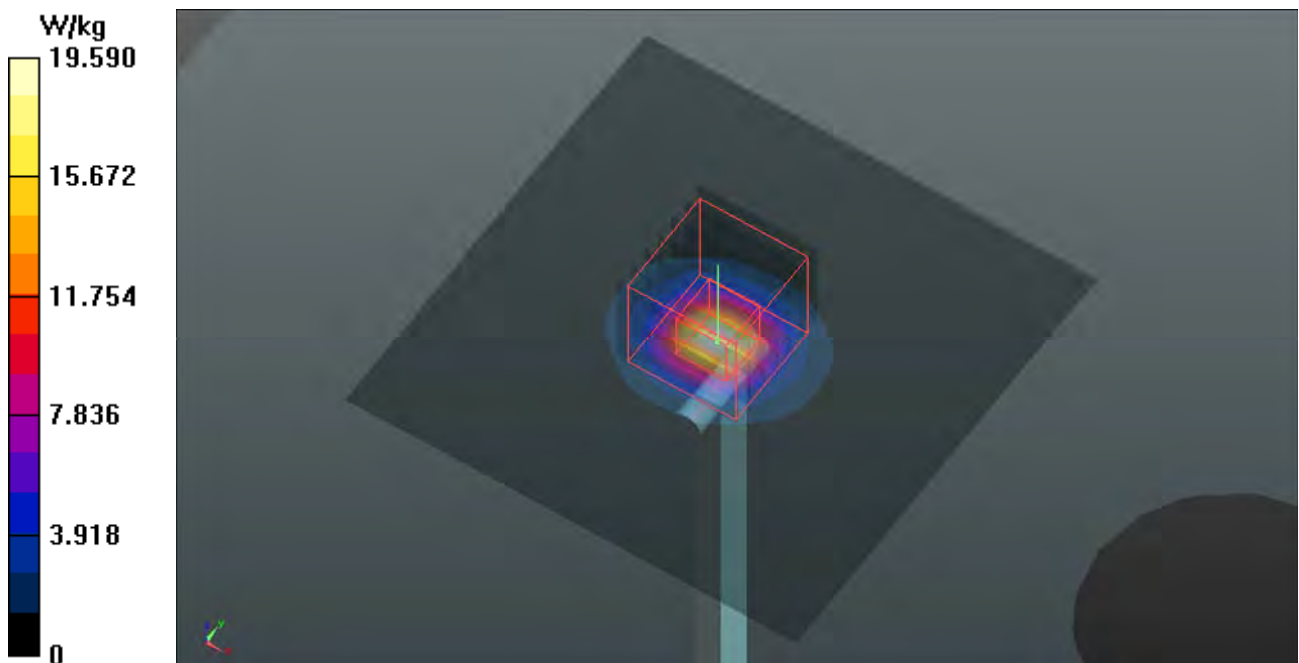

System Check_B750_170813

DUT: Dipole 750 MHz; Type: D750V3; SN: 1132

Communication System: CW; Frequency: 750 MHz; Duty Cycle: 1:1

Medium: B07T10N1_0813 Medium parameters used: $f = 750 \text{ MHz}$; $\sigma = 0.912 \text{ S/m}$; $\epsilon_r = 55.743$; $\rho = 1000 \text{ kg/m}^3$

Ambient Temperature : $23.9 \text{ }^\circ\text{C}$; Liquid Temperature : $23.6 \text{ }^\circ\text{C}$

DASY5 Configuration:

- Probe: EX3DV4 - SN7375; ConvF(9.94, 9.94, 9.94); Calibrated: 2016/12/08;
- Sensor-Surface: 1.4mm (Mechanical Surface Detection)
- Electronics: DAE4 Sn1431; Calibrated: 2017/03/20
- Phantom: Twin SAM Phantom_1653; Type: QD000P40;
- Measurement SW: DASY52, Version 52.8 (8); SEMCAD X Version 14.6.10 (7373)

Pin=250mW/Area Scan (61x81x1): Interpolated grid: $dx=1.500 \text{ mm}$, $dy=1.500 \text{ mm}$
Maximum value of SAR (interpolated) = 2.50 W/kg

Pin=250mW/Zoom Scan (5x5x7)/Cube 0: Measurement grid: $dx=8\text{mm}$, $dy=8\text{mm}$, $dz=5\text{mm}$

Reference Value = 53.80 V/m ; Power Drift = 0.01 dB

Peak SAR (extrapolated) = 2.90 W/kg

SAR(1 g) = 2.01 W/kg ; SAR(10 g) = 1.36 W/kg

Maximum value of SAR (measured) = 2.50 W/kg

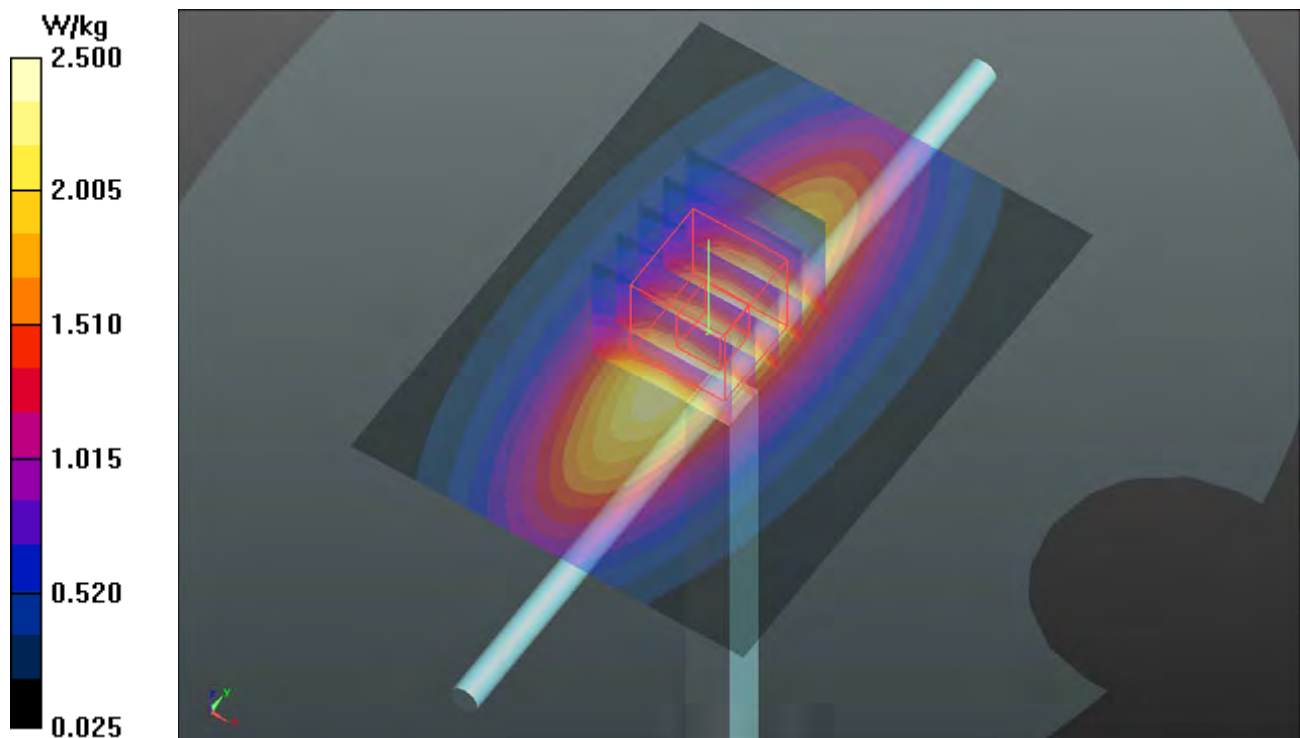

System Check_B835_170914

DUT: Dipole 835 MHz; Type: D835V2; SN: 4d092

Communication System: CW; Frequency: 835 MHz; Duty Cycle: 1:1

Medium: B07T10N3_0914 Medium parameters used: $f = 835 \text{ MHz}$; $\sigma = 1.002 \text{ S/m}$; $\epsilon_r = 54.242$; $\rho = 1000 \text{ kg/m}^3$

Ambient Temperature : $23.5 \text{ }^\circ\text{C}$; Liquid Temperature : $23.1 \text{ }^\circ\text{C}$

DASY5 Configuration:

- Probe: EX3DV4 - SN7375; ConvF(9.94, 9.94, 9.94); Calibrated: 2016/12/08;
- Sensor-Surface: 1.4mm (Mechanical Surface Detection)
- Electronics: DAE3 Sn579; Calibrated: 2016/09/05
- Phantom: Twin SAM Phantom_1485; Type: QD000P40;
- Measurement SW: DASY52, Version 52.8 (8); SEMCAD X Version 14.6.10 (7373)

Pin=250mW/Area Scan (61x61x1): Interpolated grid: $dx=1.500 \text{ mm}$, $dy=1.500 \text{ mm}$
Maximum value of SAR (interpolated) = 3.10 W/kg

Pin=250mW/Zoom Scan (5x5x7)/Cube 0: Measurement grid: $dx=8\text{mm}$, $dy=8\text{mm}$, $dz=5\text{mm}$

Reference Value = 53.89 V/m ; Power Drift = -0.04 dB

Peak SAR (extrapolated) = 3.56 W/kg

SAR(1 g) = 2.47 W/kg ; SAR(10 g) = 1.64 W/kg

Maximum value of SAR (measured) = 3.09 W/kg

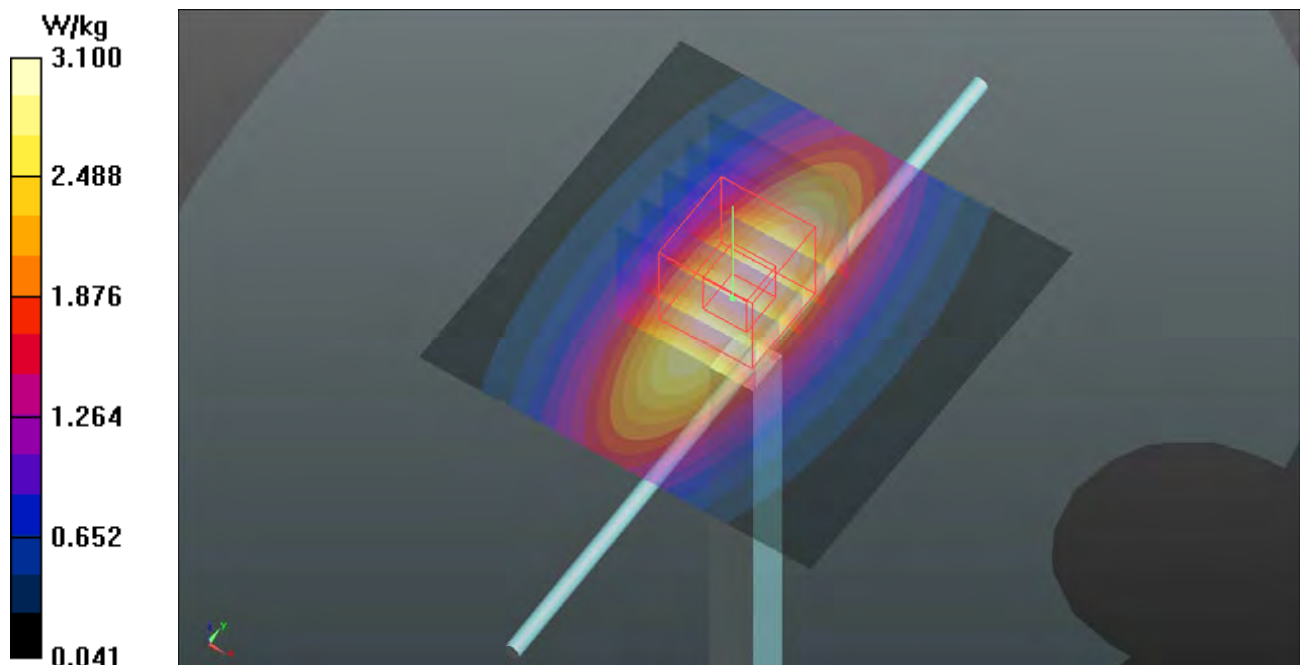

System Check_B1750_170812

DUT: Dipole 1750 MHz; Type: D1750V2; SN: 1023

Communication System: CW; Frequency: 1750 MHz; Duty Cycle: 1:1

Medium: B16T20N2_0812 Medium parameters used: $f = 1750$ MHz; $\sigma = 1.428$ S/m; $\epsilon_r = 51.415$; $\rho = 1000$ kg/m³

Ambient Temperature : 23.7 °C ; Liquid Temperature : 23.3 °C

DASY5 Configuration:

- Probe: EX3DV4 - SN3650; ConvF(8.27, 8.27, 8.27); Calibrated: 2017/07/24;
- Sensor-Surface: 1.4mm (Mechanical Surface Detection)
- Electronics: DAE4 Sn1277; Calibrated: 2017/07/20
- Phantom: Twin SAM Phantom_1822; Type: QD000P40;
- Measurement SW: DASY52, Version 52.8 (8); SEMCAD X Version 14.6.10 (7373)

Pin=250mW/Area Scan (61x61x1): Interpolated grid: dx=1.500 mm, dy=1.500 mm
Maximum value of SAR (interpolated) = 13.4 W/kg

Pin=250mW/Zoom Scan (5x5x7)/Cube 0: Measurement grid: dx=8mm, dy=8mm, dz=5mm

Reference Value = 100.6 V/m; Power Drift = -0.08 dB

Peak SAR (extrapolated) = 15.6 W/kg

SAR(1 g) = 8.76 W/kg; SAR(10 g) = 4.67 W/kg

Maximum value of SAR (measured) = 13.3 W/kg

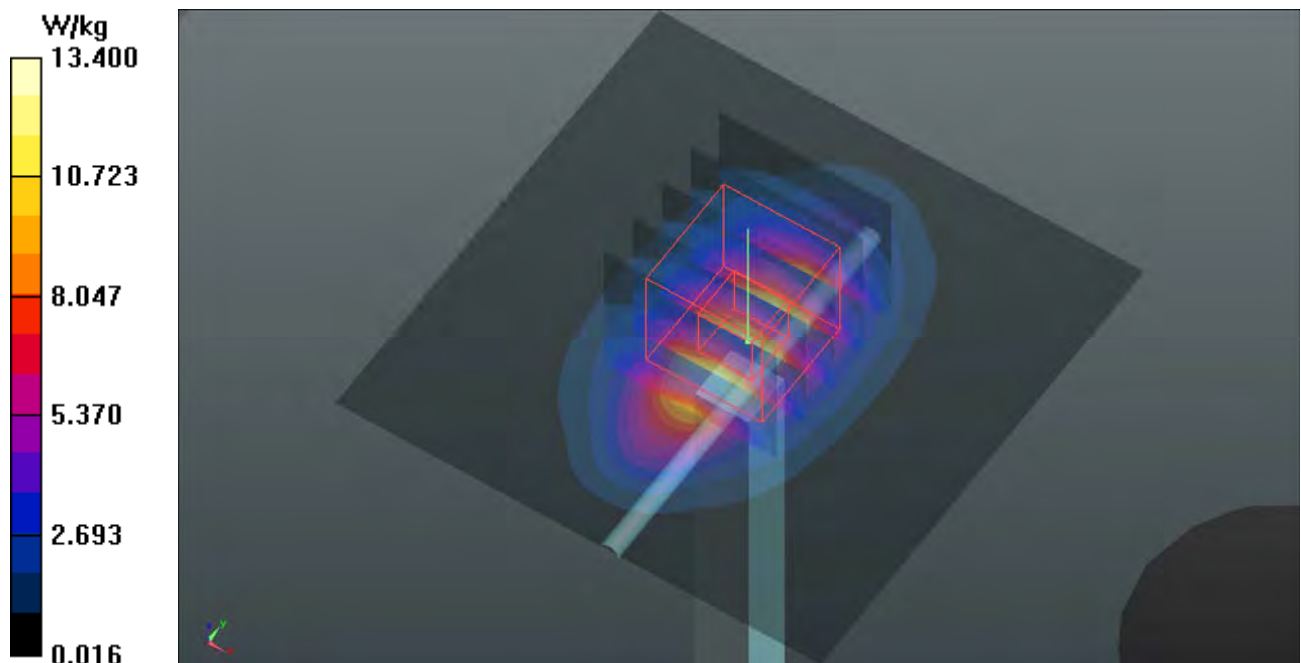

System Check_B1900_170903

DUT: Dipole 1900 MHz; Type: D1900V2; SN: 5d036

Communication System: CW; Frequency: 1900 MHz; Duty Cycle: 1:1

Medium: B16T20N1_0903 Medium parameters used: $f = 1900$ MHz; $\sigma = 1.565$ S/m; $\epsilon_r = 51.015$; $\rho = 1000$ kg/m³

Ambient Temperature : 23.8 °C ; Liquid Temperature : 23.3 °C

DASY5 Configuration:

- Probe: EX3DV4 - SN3971; ConvF(8.26, 8.26, 8.26); Calibrated: 2017/03/24;
- Sensor-Surface: 1.4mm (Mechanical Surface Detection)
- Electronics: DAE4 Sn916; Calibrated: 2016/12/15
- Phantom: Twin SAM Phantom_1653; Type: QD000P40;
- Measurement SW: DASY52, Version 52.8 (8); SEMCAD X Version 14.6.10 (7373)

Pin=250mW/Area Scan (61x61x1): Interpolated grid: dx=1.500 mm, dy=1.500 mm
Maximum value of SAR (interpolated) = 14.0 W/kg

Pin=250mW/Zoom Scan (5x5x7)/Cube 0: Measurement grid: dx=8mm, dy=8mm, dz=5mm
Reference Value = 94.57 V/m; Power Drift = 0.03 dB
Peak SAR (extrapolated) = 17.2 W/kg
SAR(1 g) = 9.63 W/kg; SAR(10 g) = 5.03 W/kg
Maximum value of SAR (measured) = 13.7 W/kg

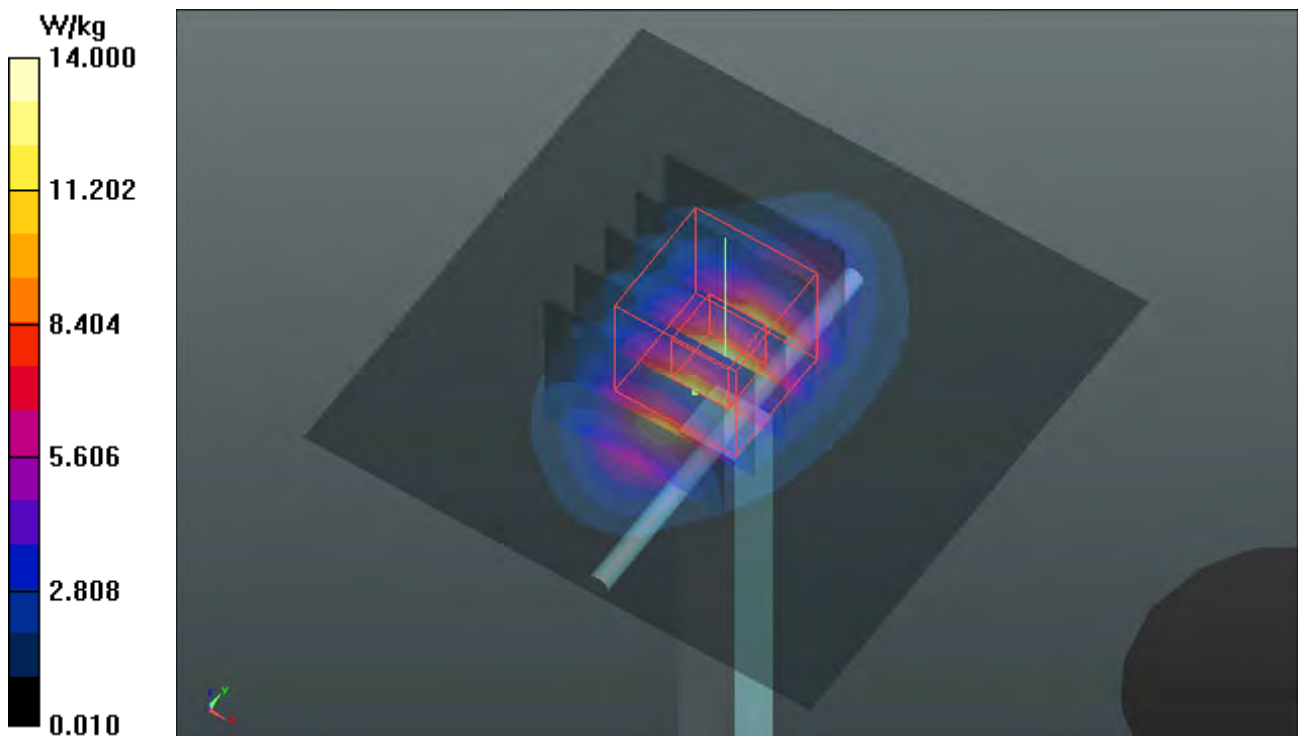

System Check_B2450_170817

DUT: Dipole 2450 MHz; Type: D2450V2; SN: 869

Communication System: CW; Frequency: 2450 MHz; Duty Cycle: 1:1

Medium: B19T27N1_0817 Medium parameters used: $f = 2450$ MHz; $\sigma = 2.024$ S/m; $\epsilon_r = 51.413$; $\rho = 1000$ kg/m³

Ambient Temperature : 23.8 °C ; Liquid Temperature : 23.2 °C

DASY5 Configuration:

- Probe: EX3DV4 - SN7375; ConvF(7.33, 7.33, 7.33); Calibrated: 2016/12/08;
- Sensor-Surface: 1.4mm (Mechanical Surface Detection)
- Electronics: DAE4 Sn1431; Calibrated: 2017/03/20
- Phantom: Twin SAM Phantom_1652; Type: QD000P40;
- Measurement SW: DASY52, Version 52.8 (8); SEMCAD X Version 14.6.10 (7373)

Pin=250mW/Area Scan (81x81x1): Interpolated grid: dx=1.200 mm, dy=1.200 mm
Maximum value of SAR (interpolated) = 19.0 W/kg

Pin=250mW/Zoom Scan (7x7x7)/Cube 0: Measurement grid: dx=5mm, dy=5mm, dz=5mm
Reference Value = 96.13 V/m; Power Drift = 0.02 dB
Peak SAR (extrapolated) = 25.6 W/kg
SAR(1 g) = 12.2 W/kg; SAR(10 g) = 5.66 W/kg
Maximum value of SAR (measured) = 18.7 W/kg

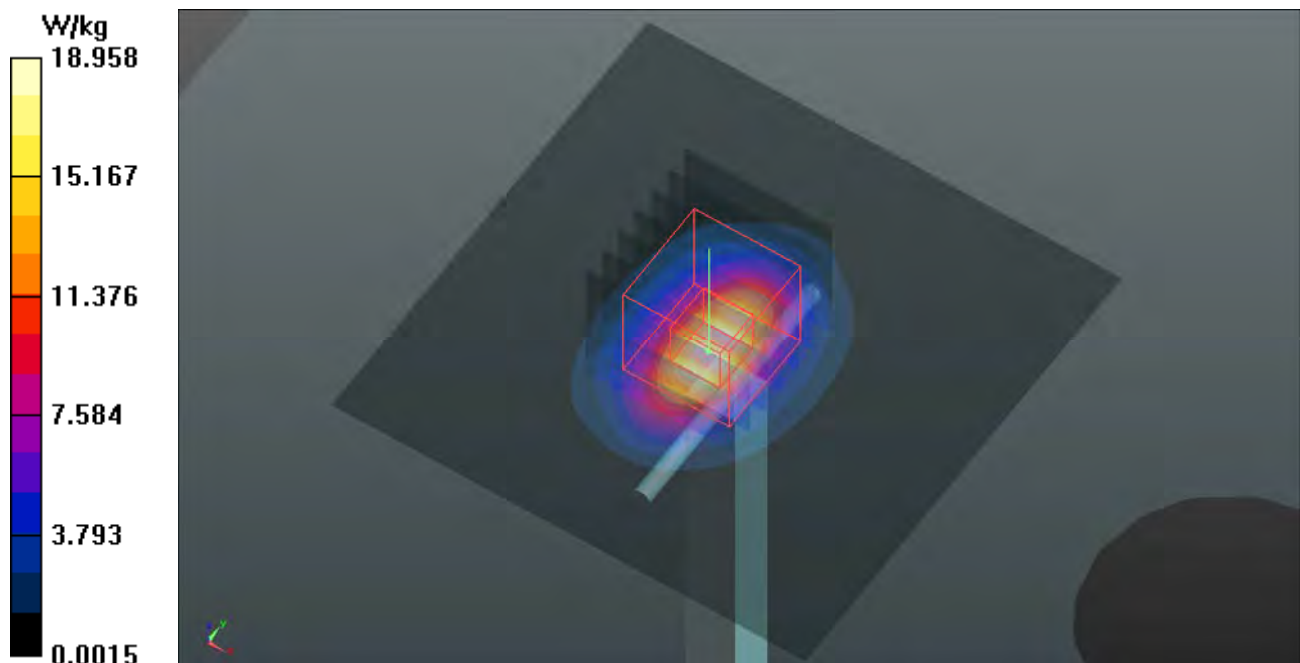

System Check_B5300_170928

DUT: Dipole 5 GHz; Type: D5GHzV2; SN: 1203

Communication System: CW; Frequency: 5300 MHz; Duty Cycle: 1:1

Medium: B34T60N2_0928 Medium parameters used: $f = 5300$ MHz; $\sigma = 5.523$ S/m; $\epsilon_r = 47.744$; $\rho = 1000$ kg/m³

Ambient Temperature : 23.6 °C ; Liquid Temperature : 23.3 °C

DASY5 Configuration:

- Probe: EX3DV4 - SN3971; ConvF(4.7, 4.7, 4.7); Calibrated: 2017/03/24;
- Sensor-Surface: 1.4mm (Mechanical Surface Detection)
- Electronics: DAE4 Sn1431; Calibrated: 2017/03/20
- Phantom: Twin SAM Phantom_1127; Type: QD000P40CA;
- Measurement SW: DASY52, Version 52.8 (8); SEMCAD X Version 14.6.10 (7373)

Pin=100mW/Area Scan (91x91x1): Interpolated grid: dx=1.000 mm, dy=1.000 mm
Maximum value of SAR (interpolated) = 16.0 W/kg

Pin=100mW/Zoom Scan (7x7x12)/Cube 0: Measurement grid: dx=4mm, dy=4mm, dz=2mm
Reference Value = 60.64 V/m; Power Drift = 0.03 dB
Peak SAR (extrapolated) = 30.9 W/kg
SAR(1 g) = 7.41 W/kg; SAR(10 g) = 2.06 W/kg
Maximum value of SAR (measured) = 18.8 W/kg

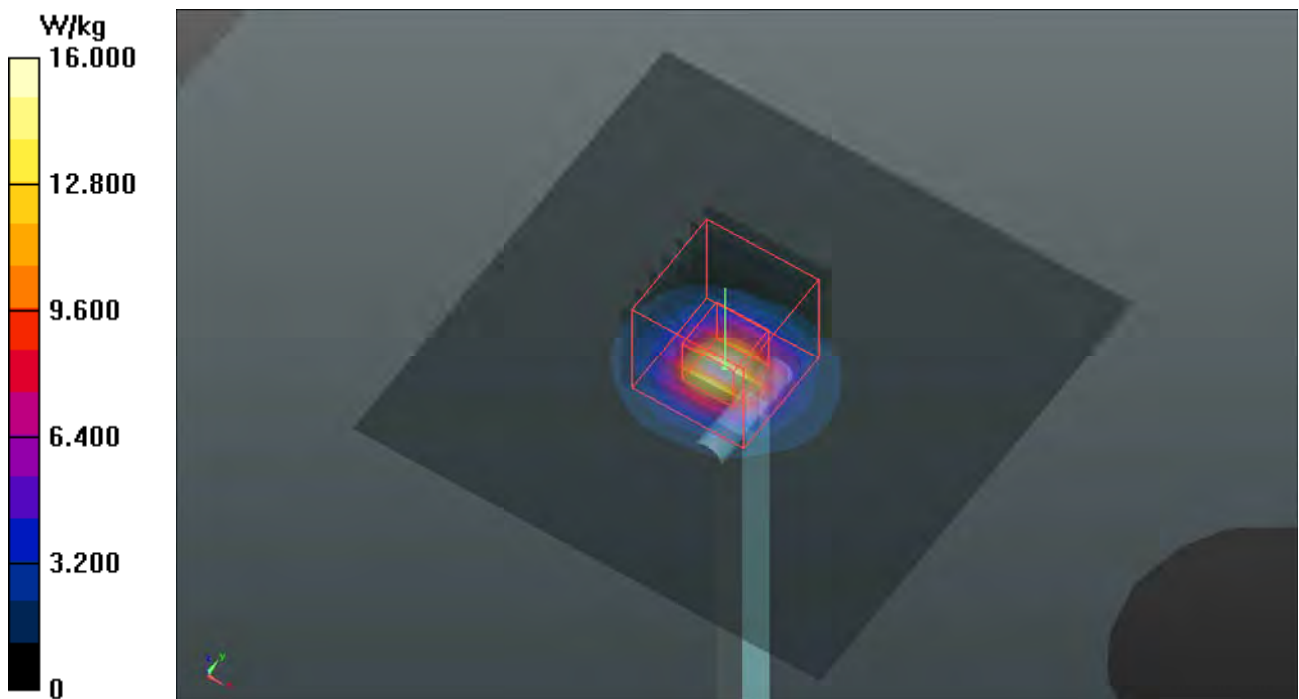

System Check_B5600_170823

DUT: Dipole 5 GHz; Type: D5GHzV2; SN: 1203

Communication System: CW; Frequency: 5600 MHz; Duty Cycle: 1:1

Medium: B34T60N1_0823 Medium parameters used: $f = 5600$ MHz; $\sigma = 5.922$ S/m; $\epsilon_r = 47.005$; $\rho = 1000$ kg/m³

Ambient Temperature : 23.7 °C ; Liquid Temperature : 23.3 °C

DASY5 Configuration:

- Probe: EX3DV4 - SN7375; ConvF(3.99, 3.99, 3.99); Calibrated: 2016/12/08;
- Sensor-Surface: 1.4mm (Mechanical Surface Detection)
- Electronics: DAE4 Sn1431; Calibrated: 2017/03/20
- Phantom: Twin SAM Phantom_1822; Type: QD000P40;
- Measurement SW: DASY52, Version 52.8 (8); SEMCAD X Version 14.6.10 (7373)

Pin=100mW/Area Scan (91x91x1): Interpolated grid: dx=1.000 mm, dy=1.000 mm
Maximum value of SAR (interpolated) = 19.2 W/kg

Pin=100mW/Zoom Scan (7x7x12)/Cube 0: Measurement grid: dx=4mm, dy=4mm, dz=2mm
Reference Value = 68.54 V/m; Power Drift = -0.08 dB

Peak SAR (extrapolated) = 34.5 W/kg

SAR(1 g) = 8.11 W/kg; SAR(10 g) = 2.32 W/kg

Maximum value of SAR (measured) = 21.3 W/kg

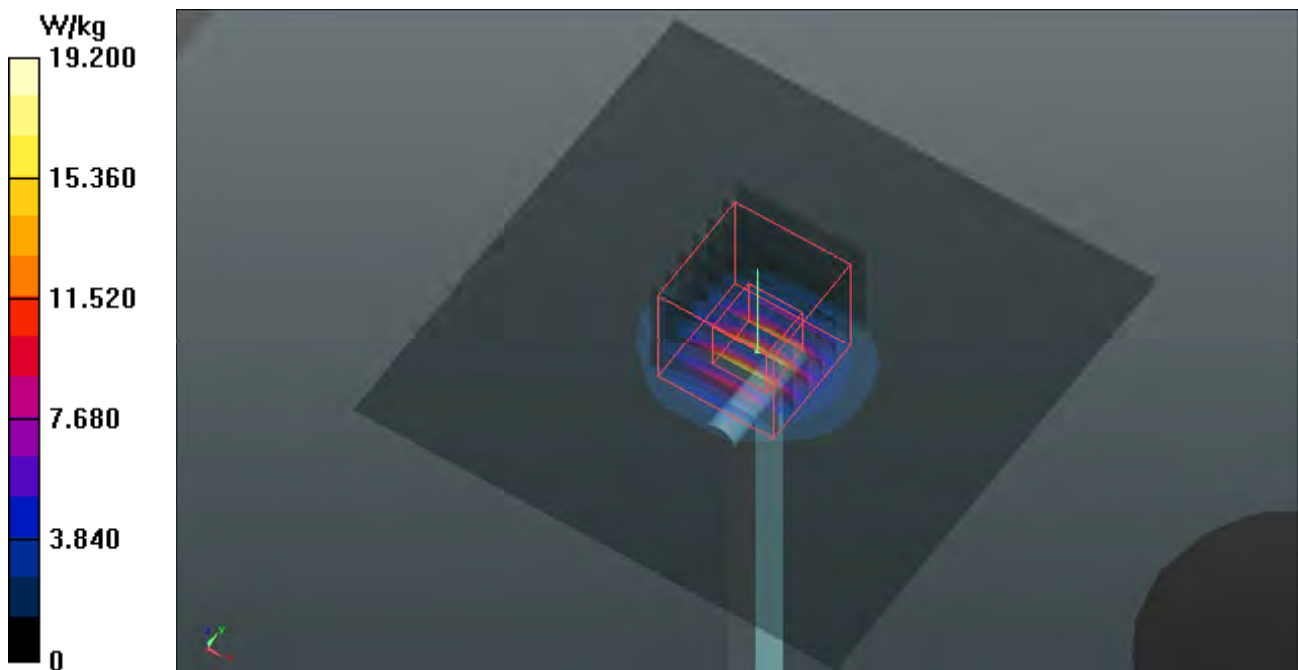

System Check_B5800_170823

DUT: Dipole 5 GHz; Type: D5GHzV2; SN: 1203

Communication System: CW; Frequency: 5800 MHz; Duty Cycle: 1:1

Medium: B34T60N1_0823 Medium parameters used: $f = 5800$ MHz; $\sigma = 6.211$ S/m; $\epsilon_r = 46.61$; $\rho = 1000$ kg/m³

Ambient Temperature : 23.7 °C ; Liquid Temperature : 23.3 °C

DASY5 Configuration:

- Probe: EX3DV4 - SN7375; ConvF(4.08, 4.08, 4.08); Calibrated: 2016/12/08;
- Sensor-Surface: 1.4mm (Mechanical Surface Detection)
- Electronics: DAE4 Sn1431; Calibrated: 2017/03/20
- Phantom: Twin SAM Phantom_1822; Type: QD000P40;
- Measurement SW: DASY52, Version 52.8 (8); SEMCAD X Version 14.6.10 (7373)

Pin=100mW/Area Scan (91x91x1): Interpolated grid: dx=1.000 mm, dy=1.000 mm
Maximum value of SAR (interpolated) = 15.4 W/kg

Pin=100mW/Zoom Scan (7x7x12)/Cube 0: Measurement grid: dx=4mm, dy=4mm, dz=2mm
Reference Value = 56.45 V/m; Power Drift = -0.13 dB

Peak SAR (extrapolated) = 34.1 W/kg

SAR(1 g) = 7.88 W/kg; SAR(10 g) = 2.22 W/kg

Maximum value of SAR (measured) = 16.8 W/kg

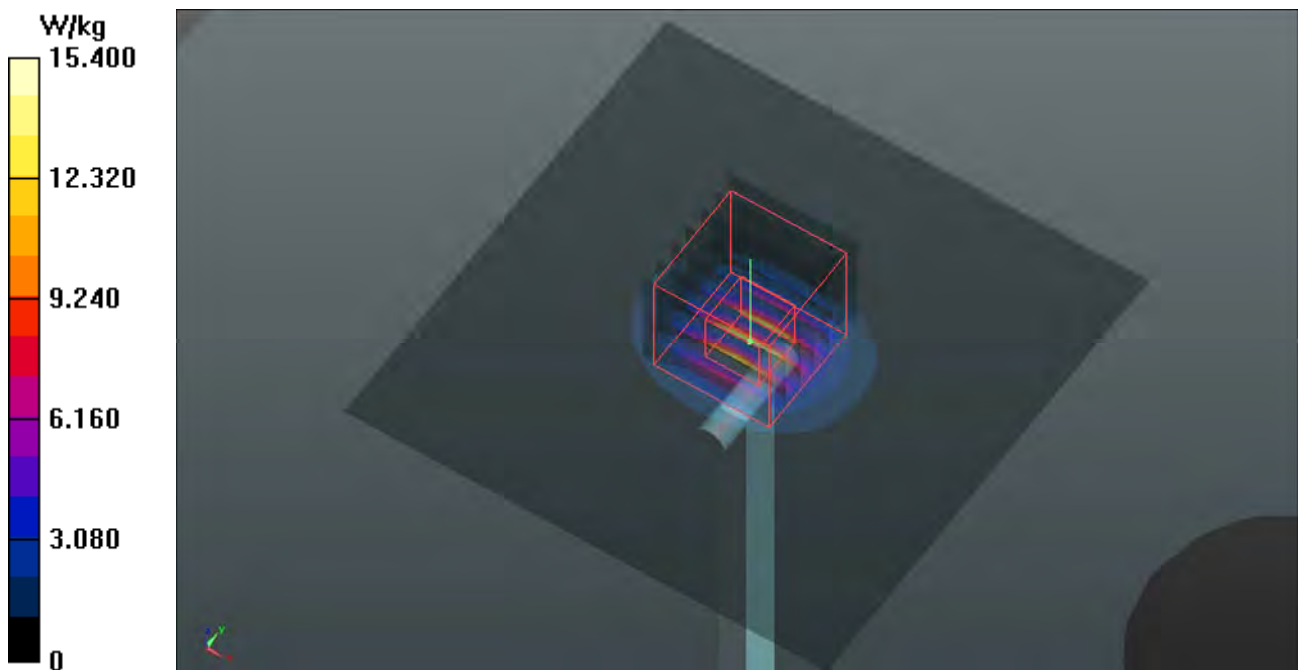

System Check_B750_170813

DUT: Dipole 750 MHz; Type: D750V3; SN: 1132

Communication System: CW; Frequency: 750 MHz; Duty Cycle: 1:1

Medium: B07T10N1_0813 Medium parameters used: $f = 750 \text{ MHz}$; $\sigma = 0.912 \text{ S/m}$; $\epsilon_r = 55.743$; $\rho = 1000 \text{ kg/m}^3$

Ambient Temperature : $23.9 \text{ }^\circ\text{C}$; Liquid Temperature : $23.6 \text{ }^\circ\text{C}$

DASY5 Configuration:

- Probe: EX3DV4 - SN7375; ConvF(9.94, 9.94, 9.94); Calibrated: 2016/12/08;
- Sensor-Surface: 1.4mm (Mechanical Surface Detection)
- Electronics: DAE4 Sn1431; Calibrated: 2017/03/20
- Phantom: Twin SAM Phantom_1653; Type: QD000P40;
- Measurement SW: DASY52, Version 52.8 (8); SEMCAD X Version 14.6.10 (7373)

Pin=250mW/Area Scan (61x81x1): Interpolated grid: $dx=1.500 \text{ mm}$, $dy=1.500 \text{ mm}$
Maximum value of SAR (interpolated) = 2.50 W/kg

Pin=250mW/Zoom Scan (5x5x7)/Cube 0: Measurement grid: $dx=8\text{mm}$, $dy=8\text{mm}$, $dz=5\text{mm}$

Reference Value = 53.80 V/m ; Power Drift = 0.01 dB

Peak SAR (extrapolated) = 2.90 W/kg

SAR(1 g) = 2.01 W/kg ; SAR(10 g) = 1.36 W/kg

Maximum value of SAR (measured) = 2.50 W/kg

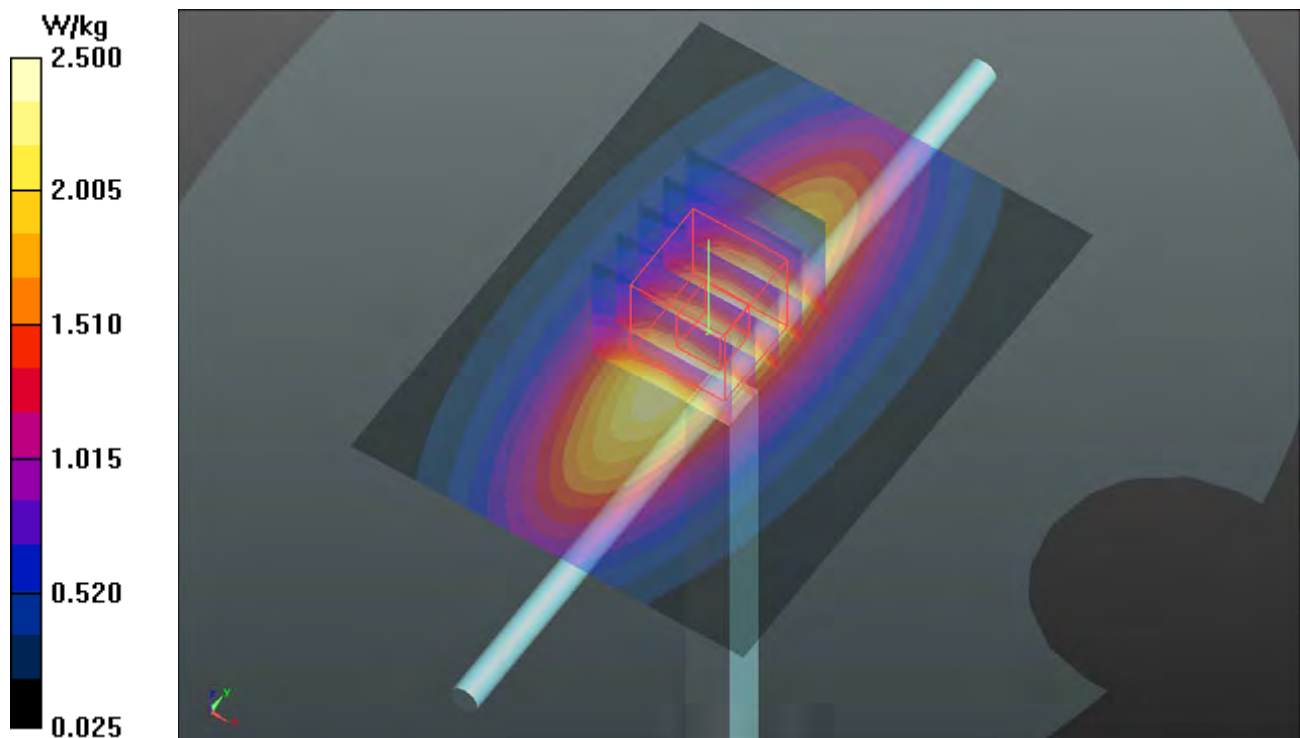

System Check_B835_170813

DUT: Dipole 835 MHz; Type: D835V2; SN: 4d092

Communication System: CW; Frequency: 835 MHz; Duty Cycle: 1:1

Medium: B07T10N2_0813 Medium parameters used: $f = 835 \text{ MHz}$; $\sigma = 0.968 \text{ S/m}$; $\epsilon_r = 54.993$; $\rho = 1000 \text{ kg/m}^3$

Ambient Temperature : $23.9 \text{ }^\circ\text{C}$; Liquid Temperature : $23.6 \text{ }^\circ\text{C}$

DASY5 Configuration:

- Probe: EX3DV4 - SN7375; ConvF(9.94, 9.94, 9.94); Calibrated: 2016/12/08;
- Sensor-Surface: 1.4mm (Mechanical Surface Detection)
- Electronics: DAE4 Sn1431; Calibrated: 2017/03/20
- Phantom: Twin SAM Phantom_1653; Type: QD000P40;
- Measurement SW: DASY52, Version 52.8 (8); SEMCAD X Version 14.6.10 (7373)

Pin=250mW/Area Scan (61x61x1): Interpolated grid: $dx=1.500 \text{ mm}$, $dy=1.500 \text{ mm}$
Maximum value of SAR (interpolated) = 3.06 W/kg

Pin=250mW/Zoom Scan (5x5x7)/Cube 0: Measurement grid: $dx=8\text{mm}$, $dy=8\text{mm}$, $dz=5\text{mm}$
Reference Value = 54.50 V/m ; Power Drift = 0.00 dB
Peak SAR (extrapolated) = 3.51 W/kg
SAR(1 g) = 2.43 W/kg ; SAR(10 g) = 1.62 W/kg
Maximum value of SAR (measured) = 3.05 W/kg

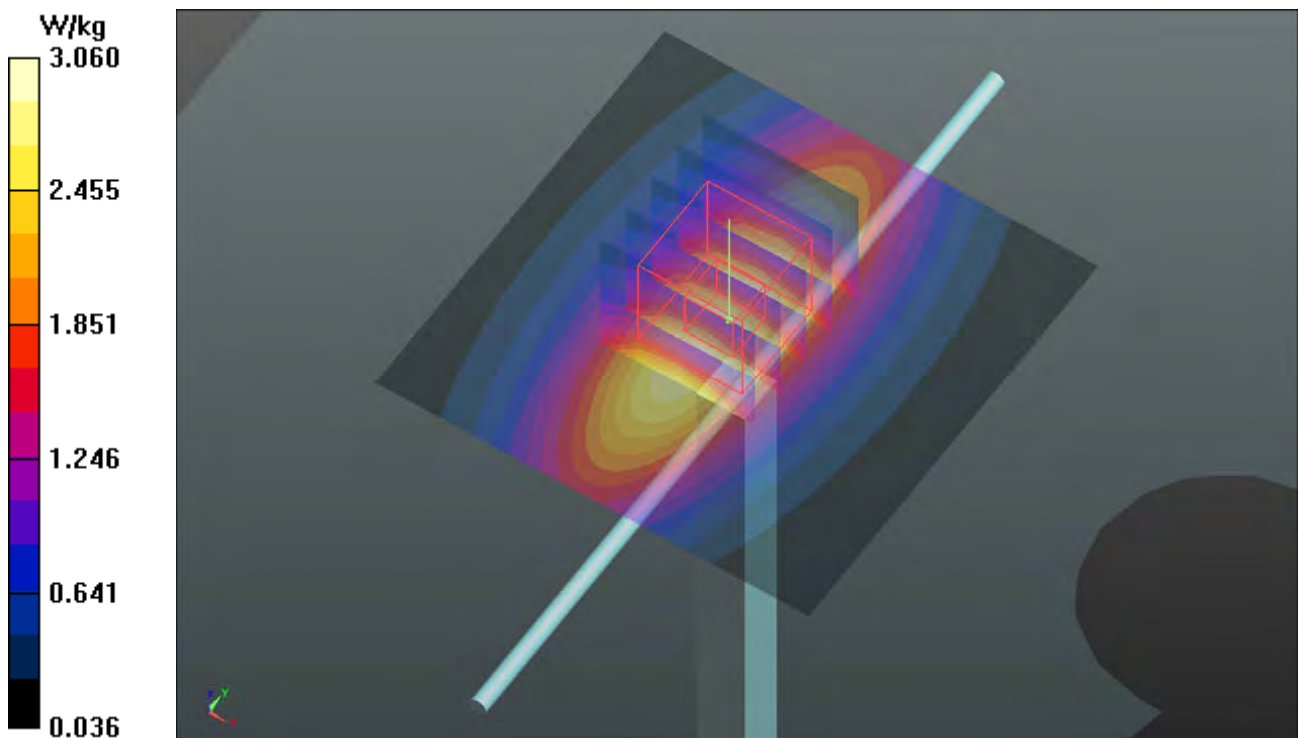

System Check_B1750_170814

DUT: Dipole 1750 MHz; Type: D1750V2; SN: 1023

Communication System: CW; Frequency: 1750 MHz; Duty Cycle: 1:1

Medium: B16T20N1_0814 Medium parameters used: $f = 1750$ MHz; $\sigma = 1.452$ S/m; $\epsilon_r = 52.476$; $\rho = 1000$ kg/m³

Ambient Temperature : 23.8 °C ; Liquid Temperature : 23.6 °C

DASY5 Configuration:

- Probe: EX3DV4 - SN7375; ConvF(8.22, 8.22, 8.22); Calibrated: 2016/12/08;
- Sensor-Surface: 1.4mm (Mechanical Surface Detection)
- Electronics: DAE4 Sn1431; Calibrated: 2017/03/20
- Phantom: Twin SAM Phantom_1652; Type: QD000P40;
- Measurement SW: DASY52, Version 52.8 (8); SEMCAD X Version 14.6.10 (7373)

Pin=250mW/Area Scan (61x61x1): Interpolated grid: dx=1.500 mm, dy=1.500 mm
Maximum value of SAR (interpolated) = 13.6 W/kg

Pin=250mW/Zoom Scan (5x5x7)/Cube 0: Measurement grid: dx=8mm, dy=8mm, dz=5mm
Reference Value = 96.45 V/m; Power Drift = 0.02 dB
Peak SAR (extrapolated) = 16.2 W/kg
SAR(1 g) = 9.4 W/kg; SAR(10 g) = 5.08 W/kg
Maximum value of SAR (measured) = 13.1 W/kg

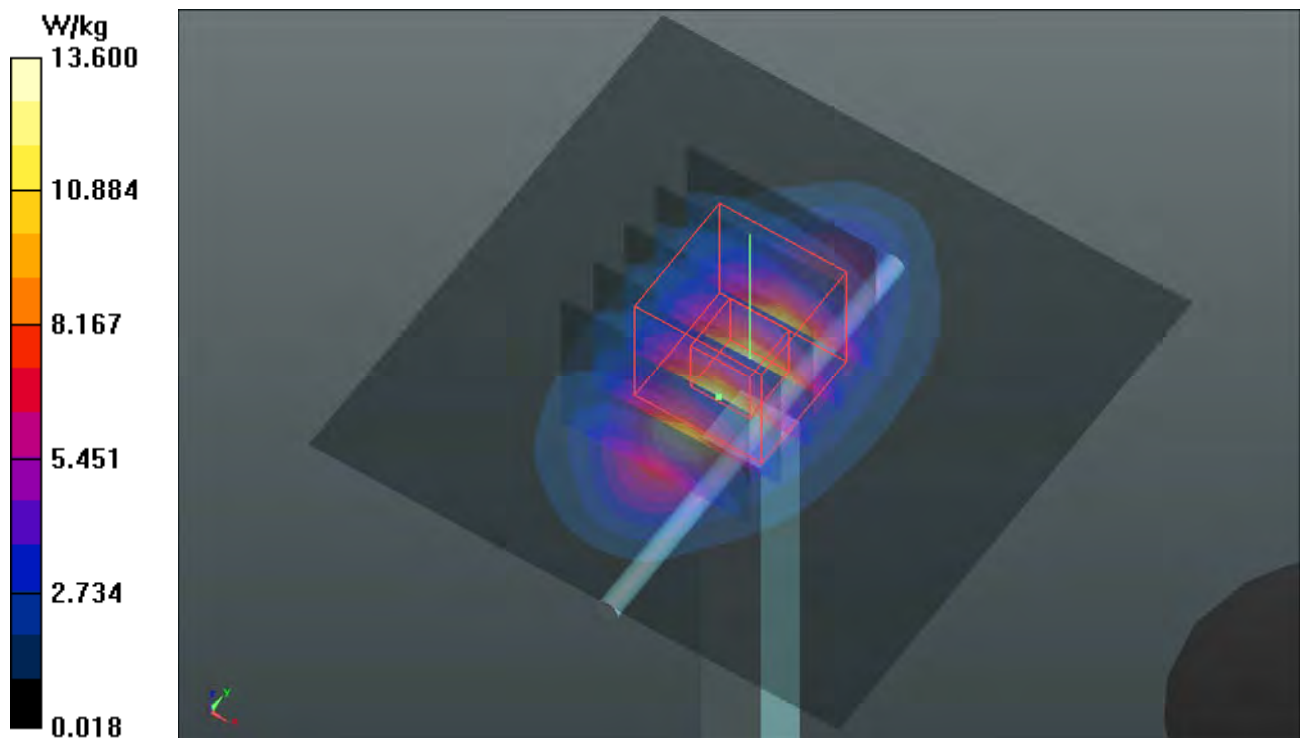

System Check_B1900_170814

DUT: Dipole 1900 MHz; Type: D1900V2; SN: 5d036

Communication System: CW; Frequency: 1900 MHz; Duty Cycle: 1:1

Medium: B16T20N1_0814 Medium parameters used: $f = 1900$ MHz; $\sigma = 1.586$ S/m; $\epsilon_r = 52.033$; $\rho = 1000$ kg/m³

Ambient Temperature : 23.8 °C ; Liquid Temperature : 23.6 °C

DASY5 Configuration:

- Probe: EX3DV4 - SN7375; ConvF(7.62, 7.62, 7.62); Calibrated: 2016/12/08;
- Sensor-Surface: 1.4mm (Mechanical Surface Detection)
- Electronics: DAE4 Sn1431; Calibrated: 2017/03/20
- Phantom: Twin SAM Phantom_1652; Type: QD000P40;
- Measurement SW: DASY52, Version 52.8 (8); SEMCAD X Version 14.6.10 (7373)

Pin=250mW/Area Scan (61x61x1): Interpolated grid: dx=1.500 mm, dy=1.500 mm
Maximum value of SAR (interpolated) = 14.6 W/kg

Pin=250mW/Zoom Scan (5x5x7)/Cube 0: Measurement grid: dx=8mm, dy=8mm, dz=5mm

Reference Value = 95.84 V/m; Power Drift = 0.03 dB

Peak SAR (extrapolated) = 17.8 W/kg

SAR(1 g) = 10 W/kg; SAR(10 g) = 5.24 W/kg

Maximum value of SAR (measured) = 14.2 W/kg

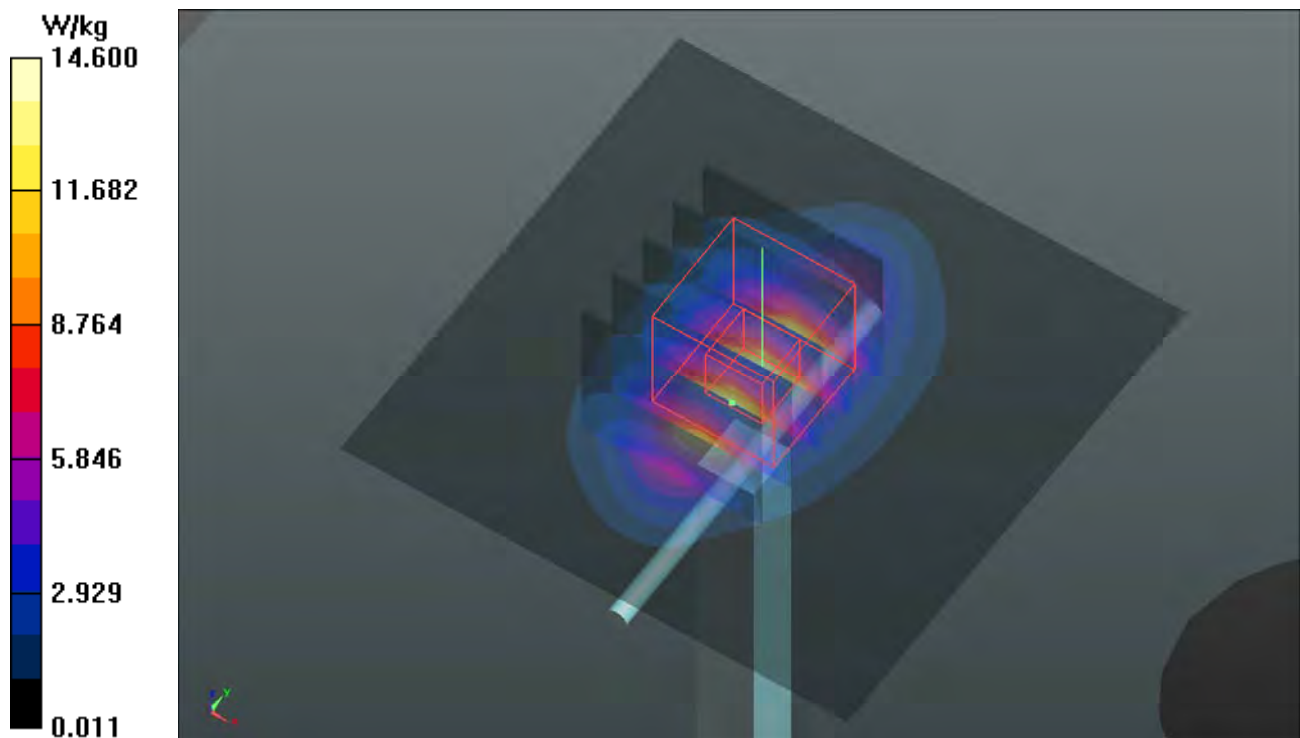

System Check_B2450_170824

DUT: Dipole 2450 MHz; Type: D2450V2; SN: 869

Communication System: CW; Frequency: 2450 MHz; Duty Cycle: 1:1

Medium: B19T27N5_0824 Medium parameters used: $f = 2450$ MHz; $\sigma = 1.997$ S/m; $\epsilon_r = 51.334$; $\rho = 1000$ kg/m³

Ambient Temperature : 23.6 °C ; Liquid Temperature : 23.4 °C

DASY5 Configuration:

- Probe: EX3DV4 - SN7375; ConvF(7.33, 7.33, 7.33); Calibrated: 2016/12/08;
- Sensor-Surface: 1.4mm (Mechanical Surface Detection)
- Electronics: DAE4 Sn1431; Calibrated: 2017/03/20
- Phantom: Twin SAM Phantom_1822; Type: QD000P40;
- Measurement SW: DASY52, Version 52.8 (8); SEMCAD X Version 14.6.10 (7373)

Pin=250mW/Area Scan (81x81x1): Interpolated grid: dx=1.200 mm, dy=1.200 mm
Maximum value of SAR (interpolated) = 20.4 W/kg

Pin=250mW/Zoom Scan (7x7x7)/Cube 0: Measurement grid: dx=5mm, dy=5mm, dz=5mm
Reference Value = 99.85 V/m; Power Drift = 0.01 dB
Peak SAR (extrapolated) = 27.3 W/kg
SAR(1 g) = 13 W/kg; SAR(10 g) = 6.05 W/kg
Maximum value of SAR (measured) = 19.8 W/kg

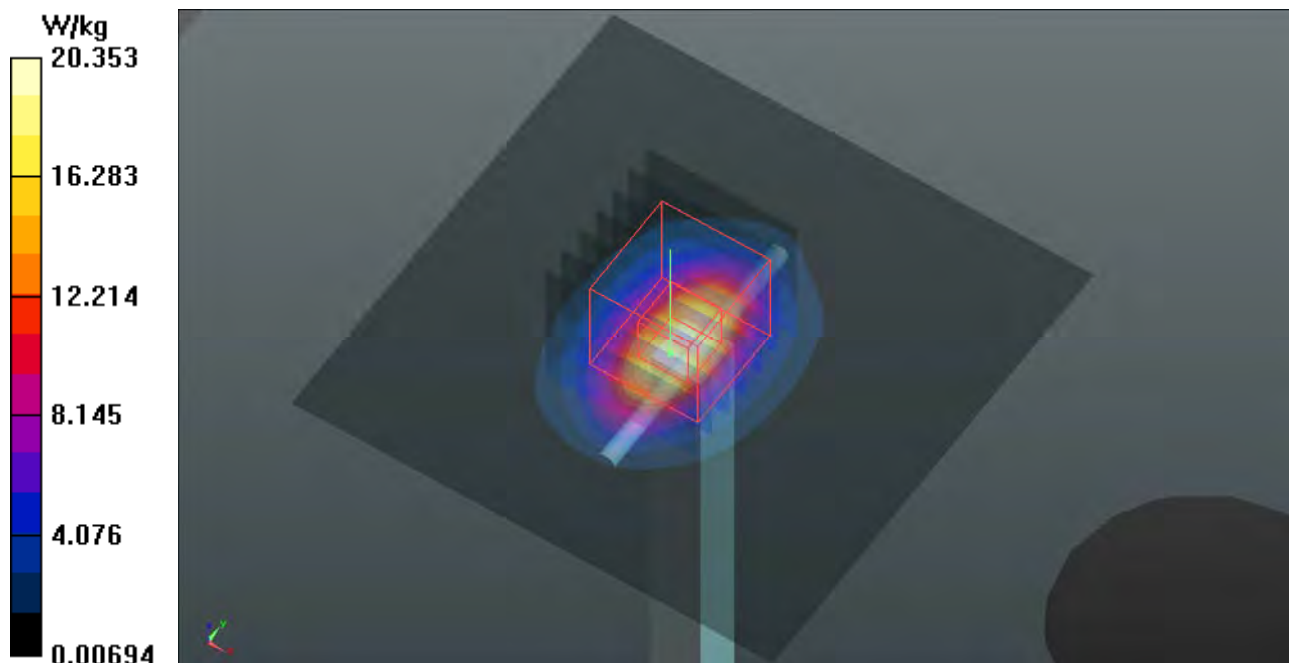

System Check_B5300_170928

DUT: Dipole 5 GHz; Type: D5GHzV2; SN: 1203

Communication System: CW; Frequency: 5300 MHz; Duty Cycle: 1:1

Medium: B34T60N2_0928 Medium parameters used: $f = 5300$ MHz; $\sigma = 5.523$ S/m; $\epsilon_r = 47.744$; $\rho = 1000$ kg/m³

Ambient Temperature : 23.6 °C ; Liquid Temperature : 23.3 °C

DASY5 Configuration:

- Probe: EX3DV4 - SN3971; ConvF(4.7, 4.7, 4.7); Calibrated: 2017/03/24;
- Sensor-Surface: 1.4mm (Mechanical Surface Detection)
- Electronics: DAE4 Sn1431; Calibrated: 2017/03/20
- Phantom: Twin SAM Phantom_1127; Type: QD000P40CA;
- Measurement SW: DASY52, Version 52.8 (8); SEMCAD X Version 14.6.10 (7373)

Pin=100mW/Area Scan (91x91x1): Interpolated grid: dx=1.000 mm, dy=1.000 mm
Maximum value of SAR (interpolated) = 16.0 W/kg

Pin=100mW/Zoom Scan (7x7x12)/Cube 0: Measurement grid: dx=4mm, dy=4mm, dz=2mm
Reference Value = 60.64 V/m; Power Drift = 0.03 dB
Peak SAR (extrapolated) = 30.9 W/kg
SAR(1 g) = 7.41 W/kg; SAR(10 g) = 2.06 W/kg
Maximum value of SAR (measured) = 18.8 W/kg

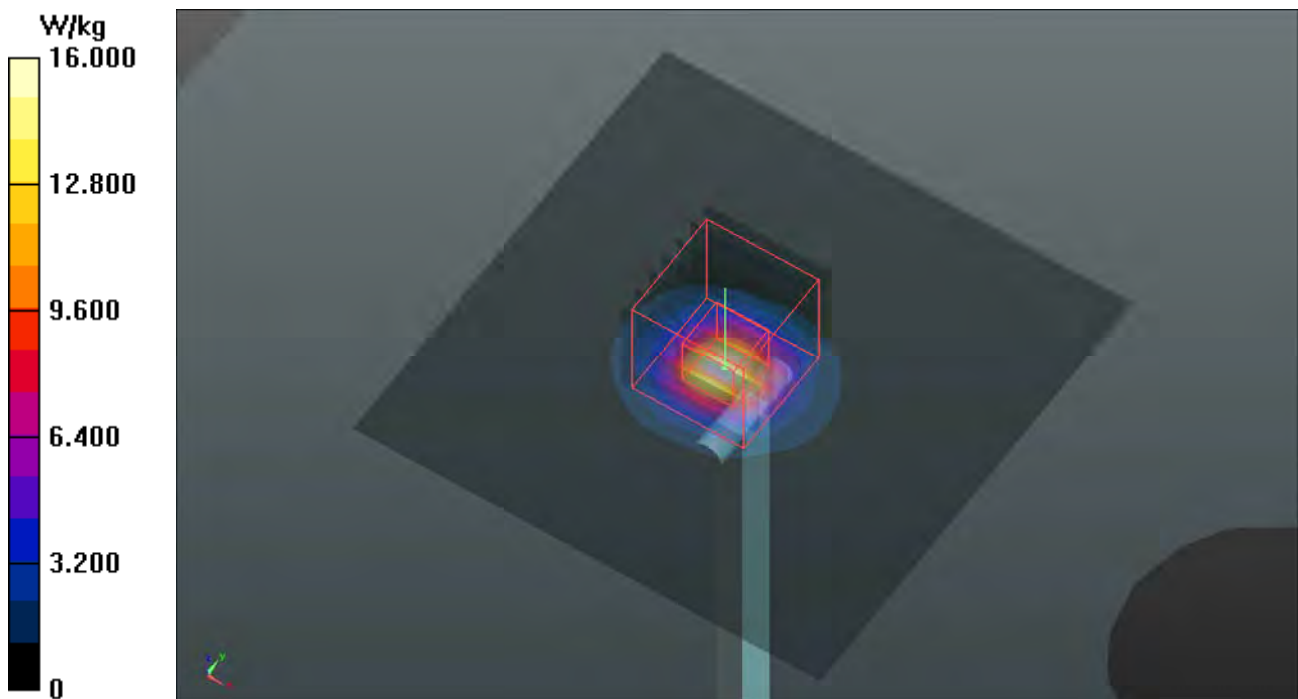

System Check_B5600_170824

DUT: Dipole 5 GHz; Type: D5GHzV2; SN: 1203

Communication System: CW; Frequency: 5600 MHz; Duty Cycle: 1:1

Medium: B34T60N1_0824 Medium parameters used: $f = 5600$ MHz; $\sigma = 5.894$ S/m; $\epsilon_r = 46.817$; $\rho = 1000$ kg/m³

Ambient Temperature : 23.7 °C ; Liquid Temperature : 23.5 °C

DASY5 Configuration:

- Probe: EX3DV4 - SN7375; ConvF(3.99, 3.99, 3.99); Calibrated: 2016/12/08;
- Sensor-Surface: 1.4mm (Mechanical Surface Detection)
- Electronics: DAE4 Sn1431; Calibrated: 2017/03/20
- Phantom: Twin SAM Phantom_1822; Type: QD000P40;
- Measurement SW: DASY52, Version 52.8 (8); SEMCAD X Version 14.6.10 (7373)

Pin=100mW/Area Scan (91x91x1): Interpolated grid: dx=1.000 mm, dy=1.000 mm
Maximum value of SAR (interpolated) = 18.9 W/kg

Pin=100mW/Zoom Scan (7x7x12)/Cube 0: Measurement grid: dx=4mm, dy=4mm, dz=2mm
Reference Value = 66.13 V/m; Power Drift = -0.17 dB
Peak SAR (extrapolated) = 34.3 W/kg
SAR(1 g) = 7.69 W/kg; SAR(10 g) = 2.15 W/kg
Maximum value of SAR (measured) = 20.4 W/kg

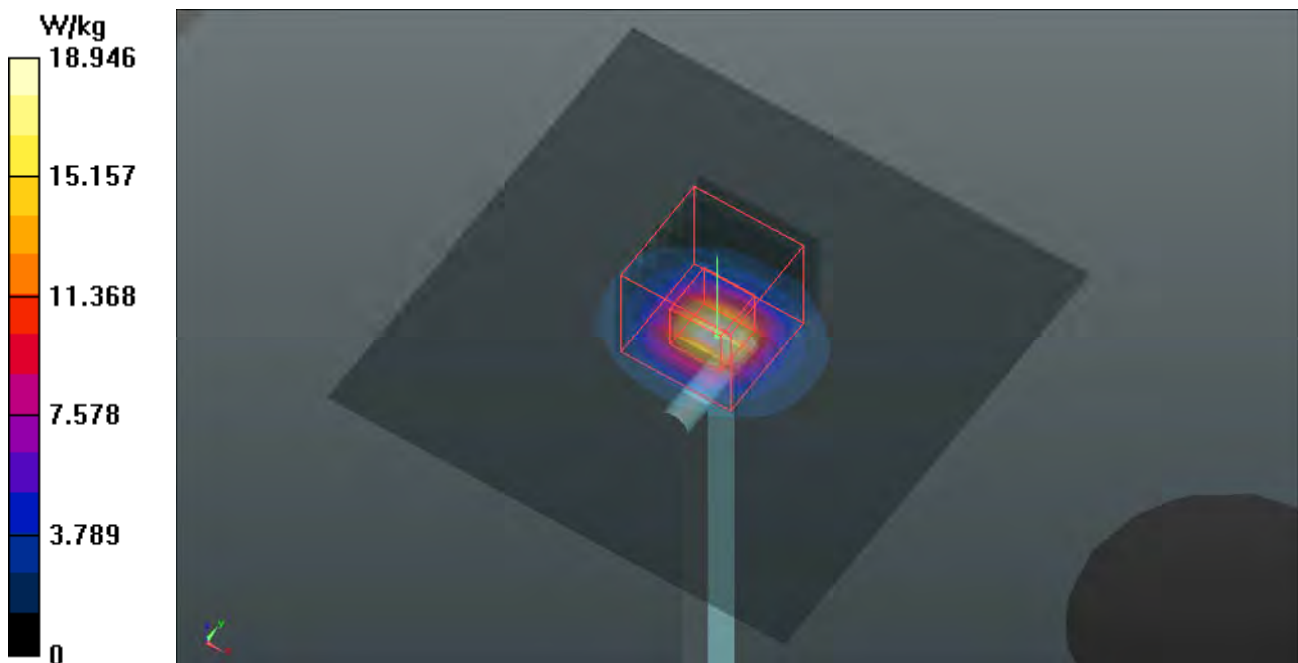

System Check_B5800_170824

DUT: Dipole 5 GHz; Type: D5GHzV2; SN: 1203

Communication System: CW; Frequency: 5800 MHz; Duty Cycle: 1:1

Medium: B34T60N1_0824 Medium parameters used: $f = 5800$ MHz; $\sigma = 6.172$ S/m; $\epsilon_r = 46.486$; $\rho = 1000$ kg/m³

Ambient Temperature : 23.7 °C ; Liquid Temperature : 23.5 °C

DASY5 Configuration:

- Probe: EX3DV4 - SN7375; ConvF(4.08, 4.08, 4.08); Calibrated: 2016/12/08;
- Sensor-Surface: 1.4mm (Mechanical Surface Detection)
- Electronics: DAE4 Sn1431; Calibrated: 2017/03/20
- Phantom: Twin SAM Phantom_1822; Type: QD000P40;
- Measurement SW: DASY52, Version 52.8 (8); SEMCAD X Version 14.6.10 (7373)

Pin=100mW/Area Scan (91x91x1): Interpolated grid: dx=1.000 mm, dy=1.000 mm
Maximum value of SAR (interpolated) = 17.9 W/kg

Pin=100mW/Zoom Scan (7x7x12)/Cube 0: Measurement grid: dx=4mm, dy=4mm, dz=2mm
Reference Value = 64.99 V/m; Power Drift = -0.10 dB
Peak SAR (extrapolated) = 33.1 W/kg
SAR(1 g) = 7.53 W/kg; SAR(10 g) = 2.11 W/kg
Maximum value of SAR (measured) = 19.8 W/kg

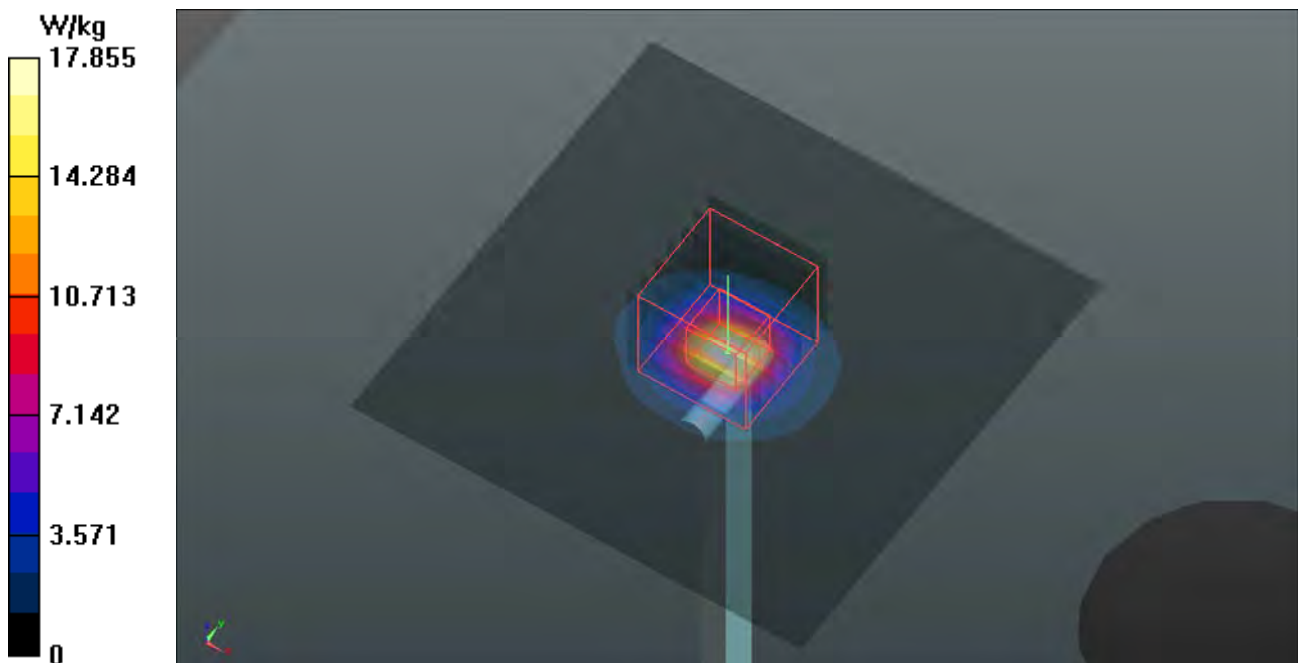



Appendix B. SAR Plots of SAR Measurement

The SAR plots for highest measured SAR in each exposure configuration, wireless mode and frequency band combination, and measured SAR > 1.5 W/kg are shown as follows.

P01 GSM850_GSM_Right Cheek_Ch251_Sample1

DUT: 170427C12

Communication System: GSM; Frequency: 848.8 MHz; Duty Cycle: 1:8.3

Medium: H07T10N1_0912 Medium parameters used: $f = 849$ MHz; $\sigma = 0.936$ S/m; $\epsilon_r = 41.164$; $\rho = 1000$ kg/m³

Ambient Temperature : 23.6 °C ; Liquid Temperature : 23.4 °C

DASY5 Configuration:

- Probe: ET3DV6 - SN1790; ConvF(7.04, 7.04, 7.04); Calibrated: 2017/05/24;
- Sensor-Surface: 4mm (Mechanical Surface Detection)
- Electronics: DAE4 Sn917; Calibrated: 2017/01/06
- Phantom: Twin SAM Phantom_1654; Type: QD000P40;
- Measurement SW: DASY52, Version 52.8 (8); SEMCAD X Version 14.6.10 (7373)

- **Area Scan (71x121x1):** Interpolated grid: dx=1.500 mm, dy=1.500 mm

Maximum value of SAR (interpolated) = 0.486 W/kg

- **Zoom Scan (5x5x7)/Cube 0:** Measurement grid: dx=8mm, dy=8mm, dz=5mm

Reference Value = 1.606 V/m; Power Drift = -0.05 dB

Peak SAR (extrapolated) = 0.588 W/kg

SAR(1 g) = 0.449 W/kg; SAR(10 g) = 0.329 W/kg

Maximum value of SAR (measured) = 0.472 W/kg

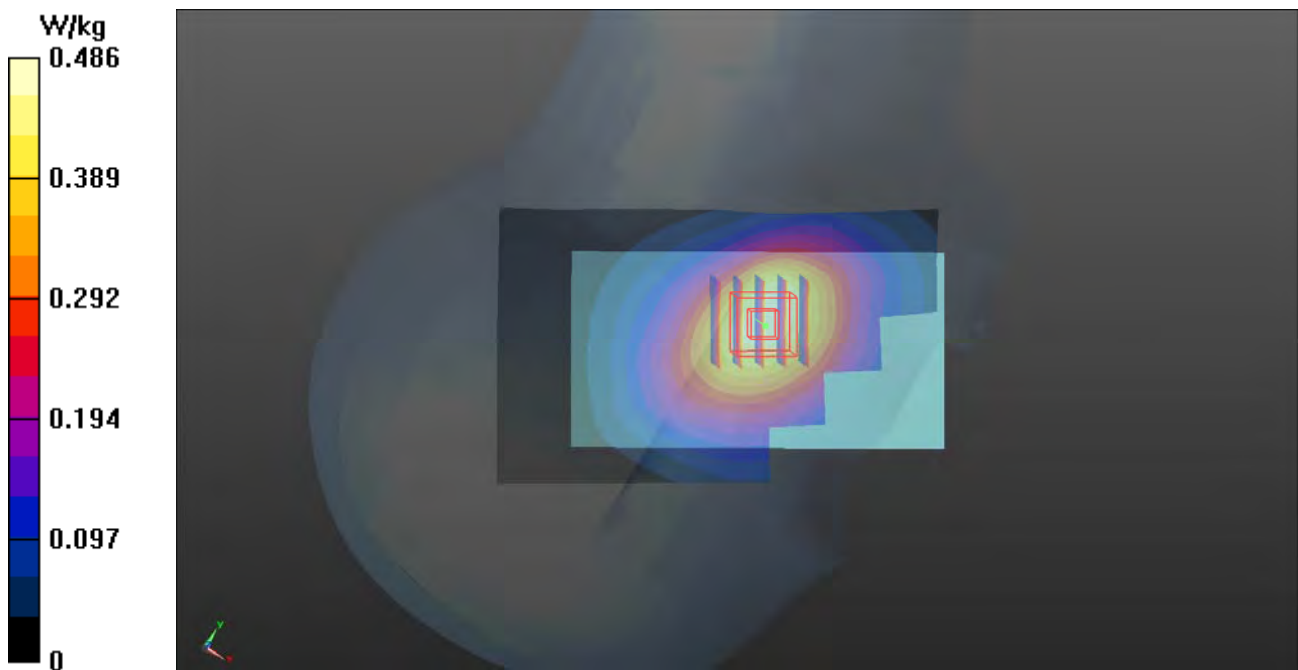

P02 GSM1900_GSM_Left Cheek_Ch512_Sample1

DUT: 170427C12

Communication System: GSM; Frequency: 1850.2 MHz; Duty Cycle: 1:8.3

Medium: H16T20N1_0912 Medium parameters used: $f = 1850.2$ MHz; $\sigma = 1.413$ S/m; $\epsilon_r = 39.777$; $\rho = 1000$ kg/m³

Ambient Temperature : 23.6 °C ; Liquid Temperature : 23.4 °C

DASY5 Configuration:

- Probe: ET3DV6 - SN1790; ConvF(5.59, 5.59, 5.59); Calibrated: 2017/05/24;
- Sensor-Surface: 4mm (Mechanical Surface Detection)
- Electronics: DAE4 Sn917; Calibrated: 2017/01/06
- Phantom: Twin SAM Phantom_1654; Type: QD000P40;
- Measurement SW: DASY52, Version 52.8 (8); SEMCAD X Version 14.6.10 (7373)

- **Area Scan (71x121x1):** Interpolated grid: dx=1.500 mm, dy=1.500 mm

Maximum value of SAR (interpolated) = 0.470 W/kg

- **Zoom Scan (5x5x7)/Cube 0:** Measurement grid: dx=8mm, dy=8mm, dz=5mm

Reference Value = 17.32 V/m; Power Drift = 0.00 dB

Peak SAR (extrapolated) = 0.586 W/kg

SAR(1 g) = 0.413 W/kg; SAR(10 g) = 0.261 W/kg

Maximum value of SAR (measured) = 0.449 W/kg

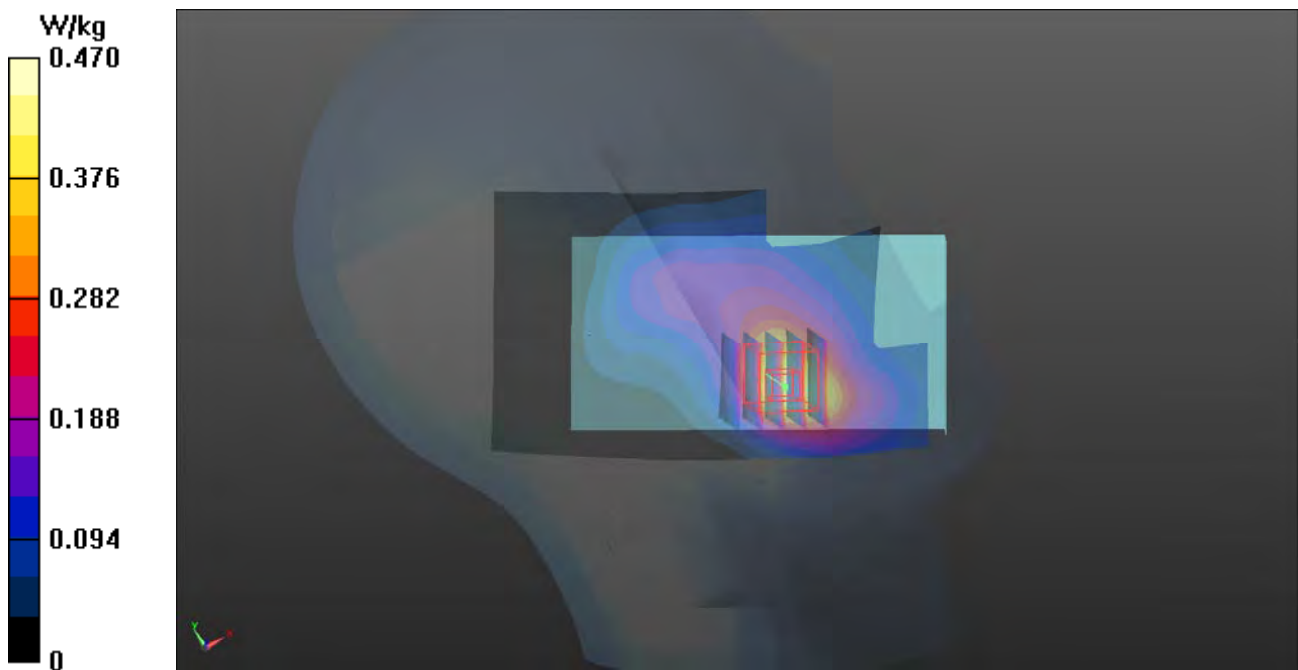

P03 WCDMA II_RMC12.2K_Left Cheek_Ch9400_Sample1

DUT: 170427C12

Communication System: WCDMA; Frequency: 1880 MHz; Duty Cycle: 1:1

Medium: H16T20N1_0822 Medium parameters used: $f = 1880$ MHz; $\sigma = 1.446$ S/m; $\epsilon_r = 38.304$; $\rho = 1000$ kg/m³

Ambient Temperature : 23.8 °C ; Liquid Temperature : 23.2 °C

DASY5 Configuration:

- Probe: ET3DV6 - SN1790; ConvF(5.59, 5.59, 5.59); Calibrated: 2017/05/24;
- Sensor-Surface: 4mm (Mechanical Surface Detection)
- Electronics: DAE4 Sn917; Calibrated: 2017/01/06
- Phantom: Twin SAM Phantom_1653; Type: QD000P40;
- Measurement SW: DASY52, Version 52.8 (8); SEMCAD X Version 14.6.10 (7373)

- **Area Scan (71x121x1):** Interpolated grid: dx=1.500 mm, dy=1.500 mm

Maximum value of SAR (interpolated) = 0.746 W/kg

- **Zoom Scan (5x5x7)/Cube 0:** Measurement grid: dx=8mm, dy=8mm, dz=5mm

Reference Value = 22.90 V/m; Power Drift = -0.06 dB

Peak SAR (extrapolated) = 0.965 W/kg

SAR(1 g) = 0.682 W/kg; SAR(10 g) = 0.435 W/kg

Maximum value of SAR (measured) = 0.732 W/kg

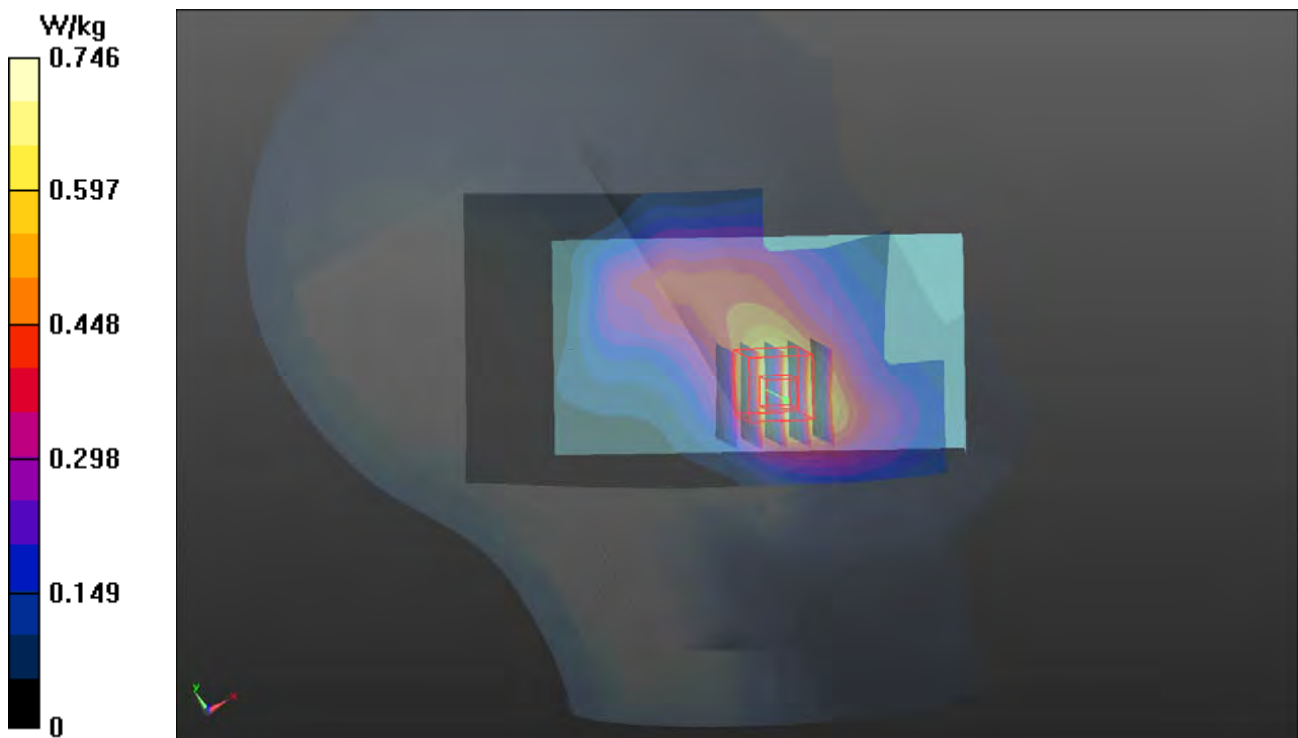

P04 WCDMA IV_RMC12.2K_Left Cheek_Ch1513_Sample1

DUT: 170427C12

Communication System: WCDMA; Frequency: 1752.6 MHz; Duty Cycle: 1:1

Medium: H16T20N1_0821 Medium parameters used: $f = 1753$ MHz; $\sigma = 1.338$ S/m; $\epsilon_r = 38.747$; $\rho = 1000$ kg/m³

Ambient Temperature : 23.8 °C ; Liquid Temperature : 23.2 °C

DASY5 Configuration:

- Probe: ET3DV6 - SN1790; ConvF(5.81, 5.81, 5.81); Calibrated: 2017/05/24;
- Sensor-Surface: 4mm (Mechanical Surface Detection)
- Electronics: DAE4 Sn917; Calibrated: 2017/01/06
- Phantom: Twin SAM Phantom_1653; Type: QD000P40;
- Measurement SW: DASY52, Version 52.8 (8); SEMCAD X Version 14.6.10 (7373)

- **Area Scan (71x121x1):** Interpolated grid: dx=1.500 mm, dy=1.500 mm

Maximum value of SAR (interpolated) = 0.895 W/kg

- **Zoom Scan (5x5x7)/Cube 0:** Measurement grid: dx=8mm, dy=8mm, dz=5mm

Reference Value = 24.71 V/m; Power Drift = -0.11 dB

Peak SAR (extrapolated) = 2.37 W/kg

SAR(1 g) = 1.02 W/kg; SAR(10 g) = 0.422 W/kg

Maximum value of SAR (measured) = 0.870 W/kg

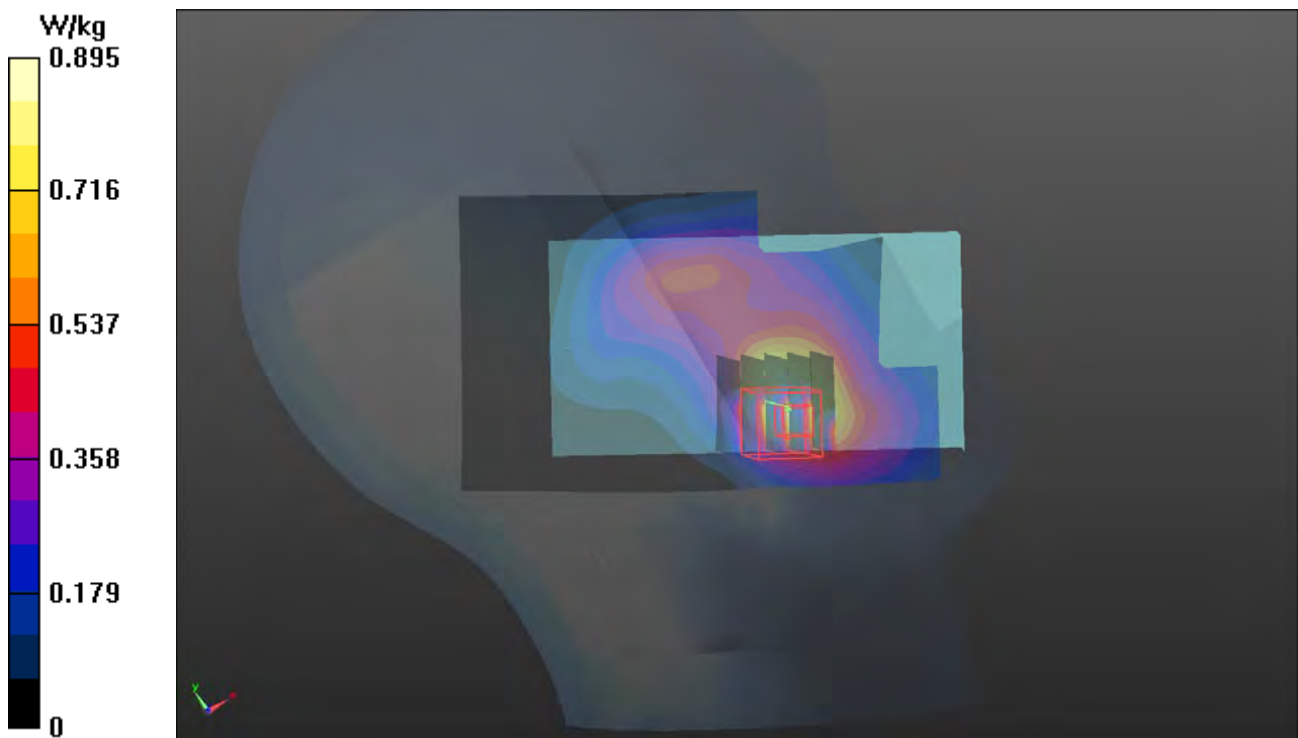

P05 WCDMA V_RMC12.2K_Right Cheek_Ch4233_Sample1

DUT: 170427C12

Communication System: WCDMA; Frequency: 846.6 MHz; Duty Cycle: 1:1

Medium: H07T10N1_0821 Medium parameters used: $f = 847$ MHz; $\sigma = 0.914$ S/m; $\epsilon_r = 42.623$; $\rho = 1000$ kg/m³

Ambient Temperature : 23.8 °C ; Liquid Temperature : 23.2 °C

DASY5 Configuration:

- Probe: ET3DV6 - SN1790; ConvF(7.04, 7.04, 7.04); Calibrated: 2017/05/24;
- Sensor-Surface: 4mm (Mechanical Surface Detection)
- Electronics: DAE4 Sn917; Calibrated: 2017/01/06
- Phantom: Twin SAM Phantom_1653; Type: QD000P40;
- Measurement SW: DASY52, Version 52.8 (8); SEMCAD X Version 14.6.10 (7373)

- **Area Scan (71x121x1):** Interpolated grid: dx=1.500 mm, dy=1.500 mm

Maximum value of SAR (interpolated) = 0.445 W/kg

- **Zoom Scan (5x5x7)/Cube 0:** Measurement grid: dx=8mm, dy=8mm, dz=5mm

Reference Value = 22.74 V/m; Power Drift = -0.07 dB

Peak SAR (extrapolated) = 0.559 W/kg

SAR(1 g) = 0.413 W/kg; SAR(10 g) = 0.302 W/kg

Maximum value of SAR (measured) = 0.433 W/kg

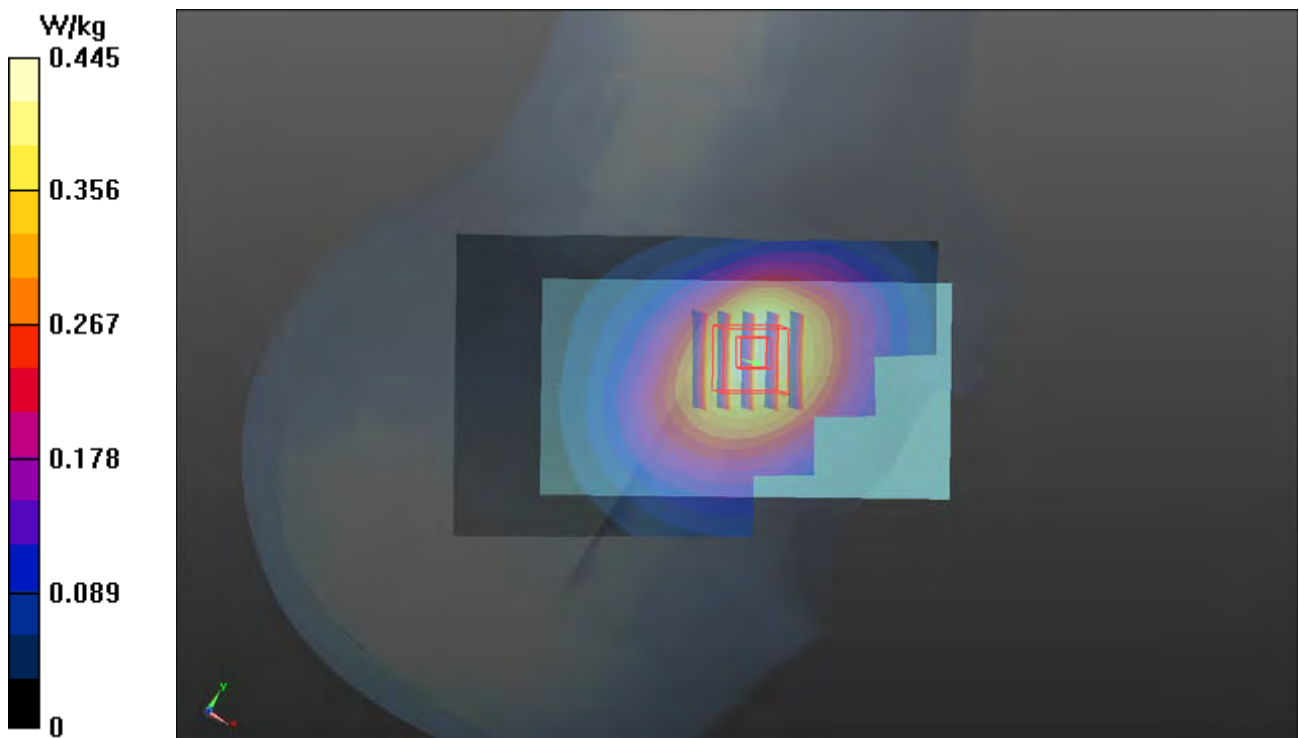

P06 LTE 2_QPSK20M_Left Cheek_Ch18900_Sample1_1RB_OS0

DUT: 170427C12

Communication System: LTE; Frequency: 1880 MHz; Duty Cycle: 1:1

Medium: H16T20N1_0927 Medium parameters used: $f = 1880$ MHz; $\sigma = 1.432$ S/m; $\epsilon_r = 39.327$; $\rho = 1000$ kg/m³

Ambient Temperature : 23.6 °C ; Liquid Temperature : 23.3 °C

DASY5 Configuration:

- Probe: ET3DV6 - SN1790; ConvF(5.59, 5.59, 5.59); Calibrated: 2017/05/24;
- Sensor-Surface: 4mm (Mechanical Surface Detection)
- Electronics: DAE4 Sn917; Calibrated: 2017/01/06
- Phantom: Twin SAM Phantom_1127; Type: QD000P40CA;
- Measurement SW: DASY52, Version 52.8 (8); SEMCAD X Version 14.6.10 (7373)

- **Area Scan (71x121x1):** Interpolated grid: dx=1.500 mm, dy=1.500 mm

Maximum value of SAR (interpolated) = 0.856 W/kg

- **Zoom Scan (5x5x7)/Cube 0:** Measurement grid: dx=8mm, dy=8mm, dz=5mm

Reference Value = 23.43 V/m; Power Drift = -0.12 dB

Peak SAR (extrapolated) = 1.07 W/kg

SAR(1 g) = 0.805 W/kg; SAR(10 g) = 0.537 W/kg

Maximum value of SAR (measured) = 0.853 W/kg

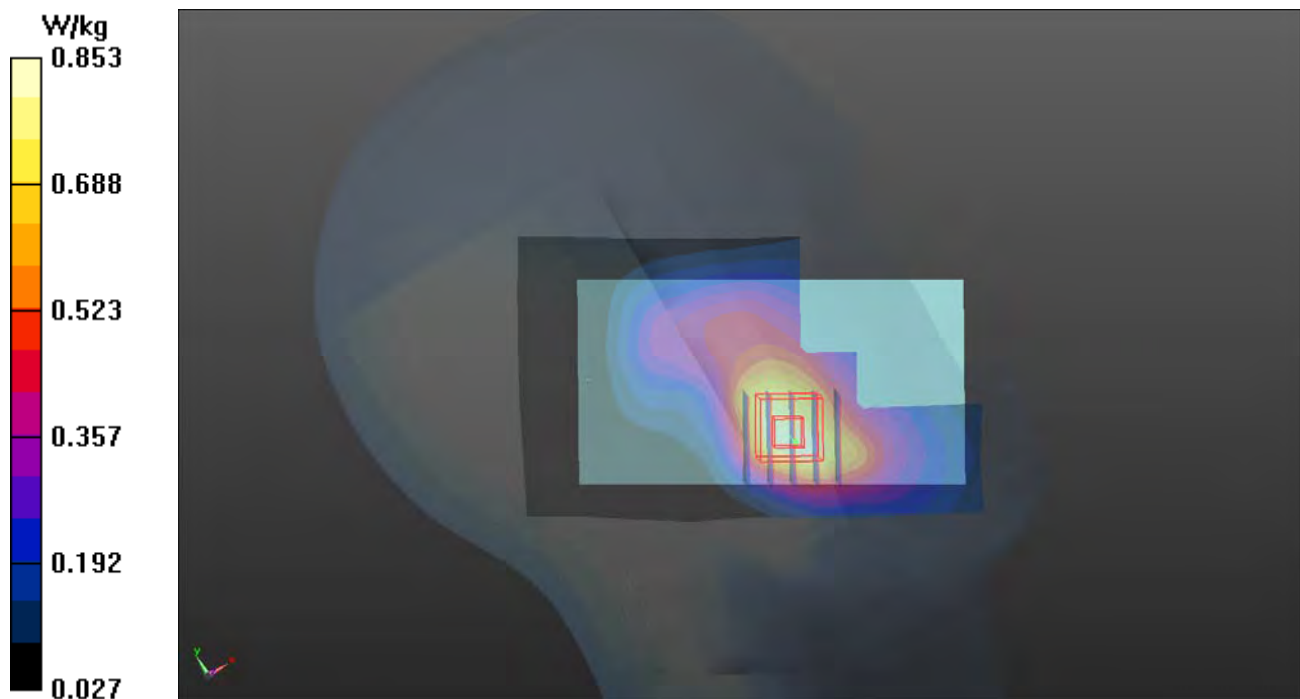

P07 LTE 4_QPSK20M_Left Cheek_Ch20175_Sample1_1RB_OS0

DUT: 170427C12

Communication System: LTE; Frequency: 1732.5 MHz; Duty Cycle: 1:1

Medium: H16T20N1_0814 Medium parameters used: $f = 1732.5$ MHz; $\sigma = 1.31$ S/m; $\epsilon_r = 39.939$; $\rho = 1000$ kg/m³

Ambient Temperature : 23.8 °C ; Liquid Temperature : 23.6 °C

DASY5 Configuration:

- Probe: EX3DV4 - SN7375; ConvF(8.31, 8.31, 8.31); Calibrated: 2016/12/08;
- Sensor-Surface: 1.4mm (Mechanical Surface Detection)
- Electronics: DAE4 Sn1431; Calibrated: 2017/03/20
- Phantom: Twin SAM Phantom_1653; Type: QD000P40;
- Measurement SW: DASY52, Version 52.8 (8); SEMCAD X Version 14.6.10 (7373)

- **Area Scan (71x121x1):** Interpolated grid: dx=1.500 mm, dy=1.500 mm

Maximum value of SAR (interpolated) = 0.800 W/kg

- **Zoom Scan (5x5x7)/Cube 0:** Measurement grid: dx=8mm, dy=8mm, dz=5mm

Reference Value = 22.56 V/m; Power Drift = -0.15 dB

Peak SAR (extrapolated) = 0.788 W/kg

SAR(1 g) = 0.524 W/kg; SAR(10 g) = 0.346 W/kg

Maximum value of SAR (measured) = 0.693 W/kg

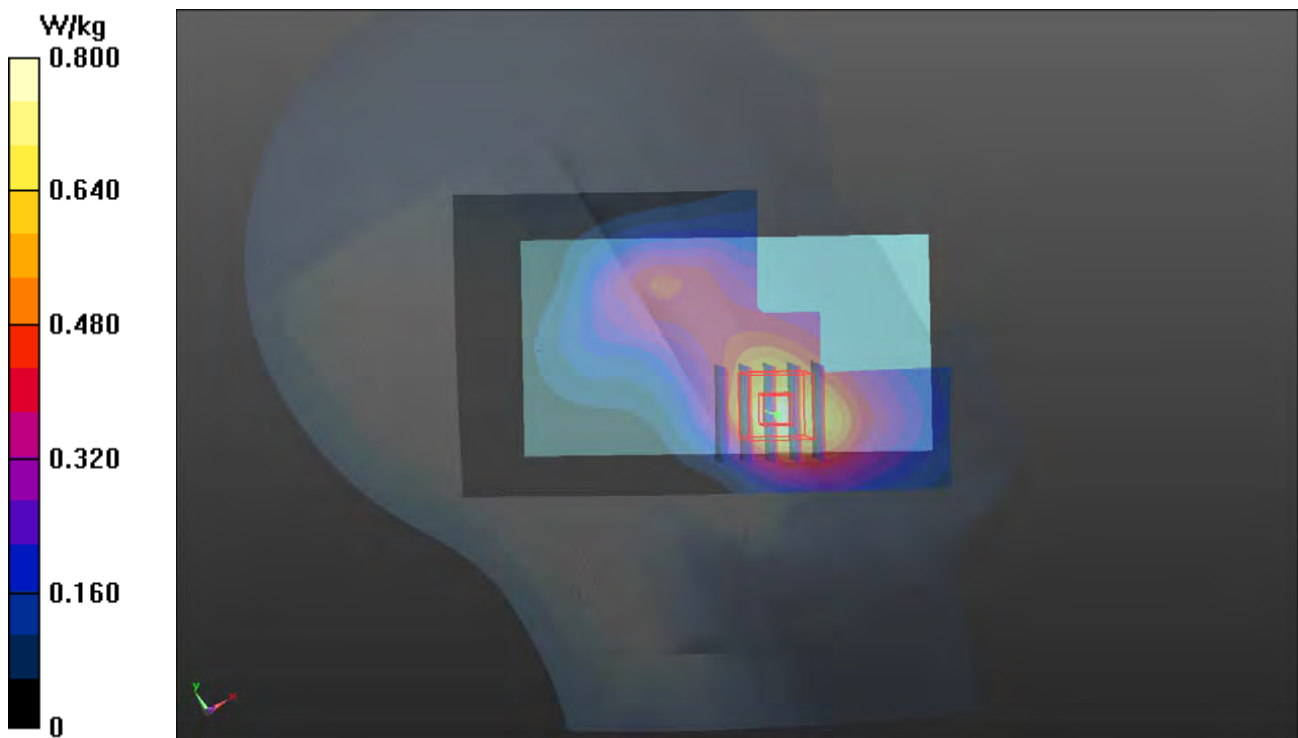

P08 LTE 5_QPSK10M_Right Cheek_Ch20525_Sample1_1RB_OS24

DUT: 170427C12

Communication System: LTE; Frequency: 836.5 MHz; Duty Cycle: 1:1

Medium: H07T10N1_0821 Medium parameters used: $f = 836.5$ MHz; $\sigma = 0.904$ S/m; $\epsilon_r = 42.749$; $\rho = 1000$ kg/m³

Ambient Temperature : 23.8 °C ; Liquid Temperature : 23.2 °C

DASY5 Configuration:

- Probe: ET3DV6 - SN1790; ConvF(7.04, 7.04, 7.04); Calibrated: 2017/05/24;
- Sensor-Surface: 4mm (Mechanical Surface Detection)
- Electronics: DAE4 Sn917; Calibrated: 2017/01/06
- Phantom: Twin SAM Phantom_1653; Type: QD000P40;
- Measurement SW: DASY52, Version 52.8 (8); SEMCAD X Version 14.6.10 (7373)

- **Area Scan (71x121x1):** Interpolated grid: dx=1.500 mm, dy=1.500 mm

Maximum value of SAR (interpolated) = 0.518 W/kg

- **Zoom Scan (5x5x7)/Cube 0:** Measurement grid: dx=8mm, dy=8mm, dz=5mm

Reference Value = 24.28 V/m; Power Drift = 0.09 dB

Peak SAR (extrapolated) = 0.653 W/kg

SAR(1 g) = 0.487 W/kg; SAR(10 g) = 0.353 W/kg

Maximum value of SAR (measured) = 0.506 W/kg

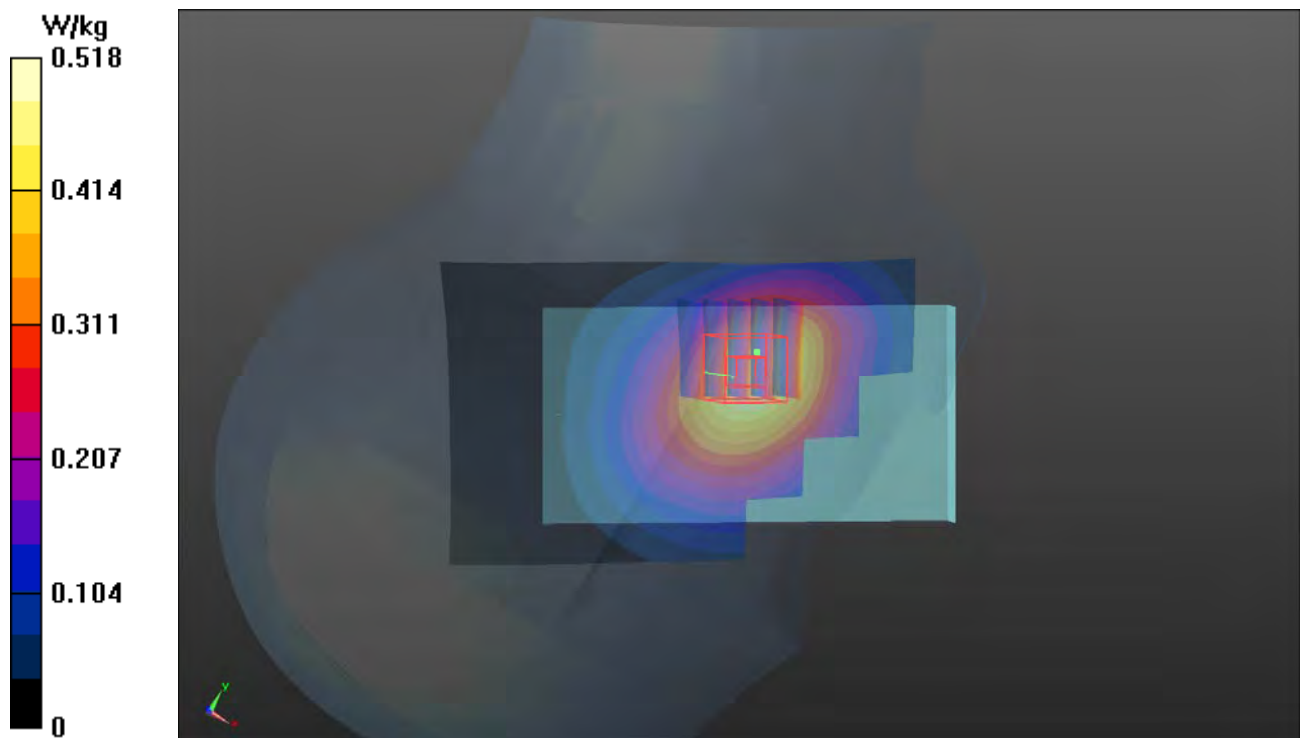

P09 LTE 12_QPSK10M_Right Cheek_1cm_Ch23095_Sample1_1RB_OS0

DUT: 170427C12

Communication System: LTE; Frequency: 707.5 MHz; Duty Cycle: 1:1

Medium: H06T09N1_0813 Medium parameters used: $f = 707.5 \text{ MHz}$; $\sigma = 0.848 \text{ S/m}$; $\epsilon_r = 43.469$; $\rho = 1000 \text{ kg/m}^3$

Ambient Temperature : 23.9 °C ; Liquid Temperature : 23.6 °C

DASY5 Configuration:

- Probe: EX3DV4 - SN7375; ConvF(9.9, 9.9, 9.9); Calibrated: 2016/12/08;
- Sensor-Surface: 1.4mm (Mechanical Surface Detection)
- Electronics: DAE4 Sn1431; Calibrated: 2017/03/20
- Phantom: Twin SAM Phantom_1653; Type: QD000P40;
- Measurement SW: DASY52, Version 52.8 (8); SEMCAD X Version 14.6.10 (7373)

- **Area Scan (71x121x1):** Interpolated grid: $dx=1.500 \text{ mm}$, $dy=1.500 \text{ mm}$

Maximum value of SAR (interpolated) = 0.381 W/kg

- **Zoom Scan (5x5x7)/Cube 0:** Measurement grid: $dx=8\text{mm}$, $dy=8\text{mm}$, $dz=5\text{mm}$

Reference Value = 22.13 V/m; Power Drift = -0.05 dB

Peak SAR (extrapolated) = 0.423 W/kg

SAR(1 g) = 0.323 W/kg; SAR(10 g) = 0.235 W/kg

Maximum value of SAR (measured) = 0.386 W/kg

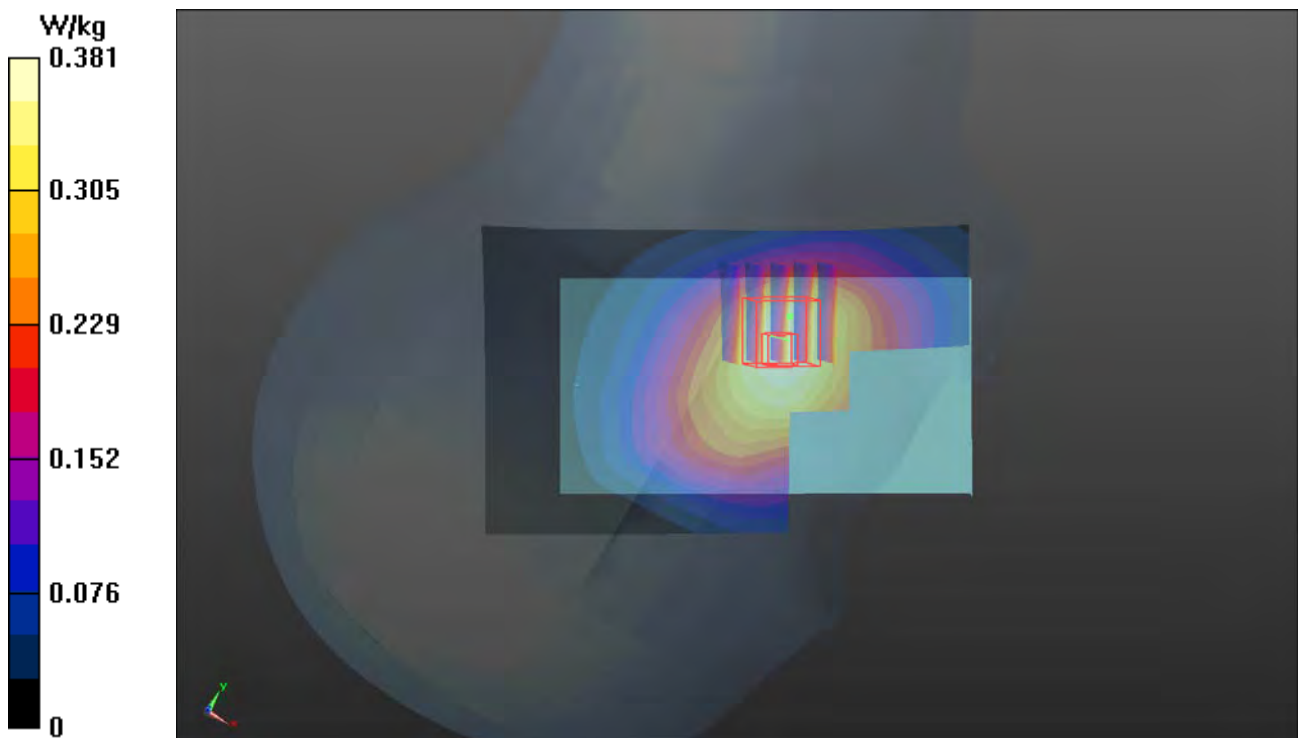

P10 LTE 17_QPSK10M_Right Cheek_1cm_Ch23790_Sample1_1RB_OS0

DUT: 170427C12

Communication System: LTE; Frequency: 710 MHz; Duty Cycle: 1:1

Medium: H06T09N1_0813 Medium parameters used: $f = 710 \text{ MHz}$; $\sigma = 0.85 \text{ S/m}$; $\epsilon_r = 43.439$; $\rho = 1000 \text{ kg/m}^3$

Ambient Temperature : $23.9 \text{ }^\circ\text{C}$; Liquid Temperature : $23.6 \text{ }^\circ\text{C}$

DASY5 Configuration:

- Probe: EX3DV4 - SN7375; ConvF(9.9, 9.9, 9.9); Calibrated: 2016/12/08;
- Sensor-Surface: 1.4mm (Mechanical Surface Detection)
- Electronics: DAE4 Sn1431; Calibrated: 2017/03/20
- Phantom: Twin SAM Phantom_1653; Type: QD000P40;
- Measurement SW: DASY52, Version 52.8 (8); SEMCAD X Version 14.6.10 (7373)

- **Area Scan (71x121x1):** Interpolated grid: $dx=1.500 \text{ mm}$, $dy=1.500 \text{ mm}$

Maximum value of SAR (interpolated) = 0.362 W/kg

- **Zoom Scan (5x5x7)/Cube 0:** Measurement grid: $dx=8\text{mm}$, $dy=8\text{mm}$, $dz=5\text{mm}$

Reference Value = 21.48 V/m ; Power Drift = -0.05 dB

Peak SAR (extrapolated) = 0.408 W/kg

SAR(1 g) = 0.307 W/kg ; SAR(10 g) = 0.232 W/kg

Maximum value of SAR (measured) = 0.372 W/kg

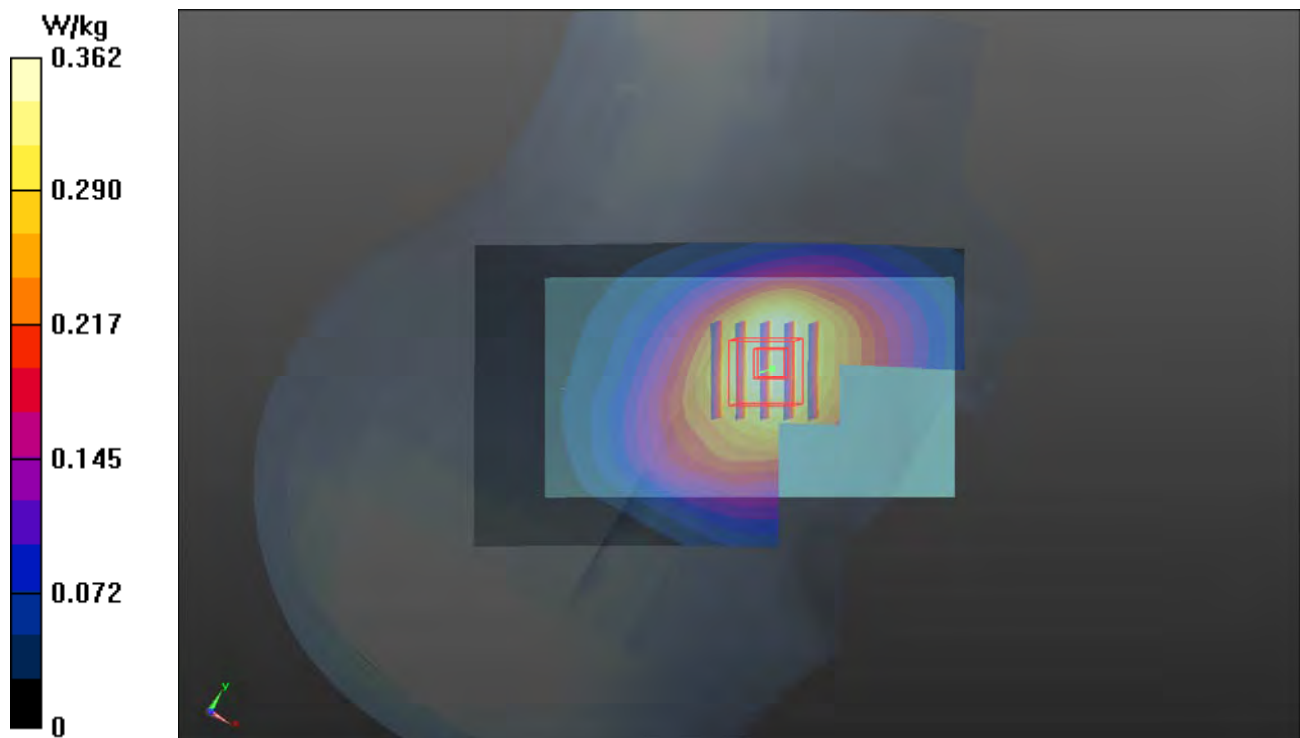

P11 2.4G WLAN_802.11b_Left Cheek_Ch6_Sample1

DUT: 170427C12

Communication System: WLAN_2.4G; Frequency: 2437 MHz; Duty Cycle: 1:1

Medium: H19T27N1_0816 Medium parameters used: $f = 2437$ MHz; $\sigma = 1.839$ S/m; $\epsilon_r = 38.43$; $\rho = 1000$ kg/m³

Ambient Temperature : 23.5 °C ; Liquid Temperature : 23.3 °C

DASY5 Configuration:

- Probe: EX3DV4 - SN7375; ConvF(7.27, 7.27, 7.27); Calibrated: 2016/12/08;
- Sensor-Surface: 1.4mm (Mechanical Surface Detection)
- Electronics: DAE4 Sn1431; Calibrated: 2017/03/20
- Phantom: Twin SAM Phantom_1653; Type: QD000P40;
- Measurement SW: DASY52, Version 52.8 (8); SEMCAD X Version 14.6.10 (7373)

- **Area Scan (91x151x1):** Interpolated grid: dx=1.200 mm, dy=1.200 mm

Maximum value of SAR (interpolated) = 1.75 W/kg

- **Zoom Scan (5x5x7)/Cube 0:** Measurement grid: dx=8mm, dy=8mm, dz=5mm

Reference Value = 32.02 V/m; Power Drift = -0.13 dB

Peak SAR (extrapolated) = 2.21 W/kg

SAR(1 g) = 1.27 W/kg; SAR(10 g) = 0.581 W/kg

Maximum value of SAR (measured) = 1.77 W/kg

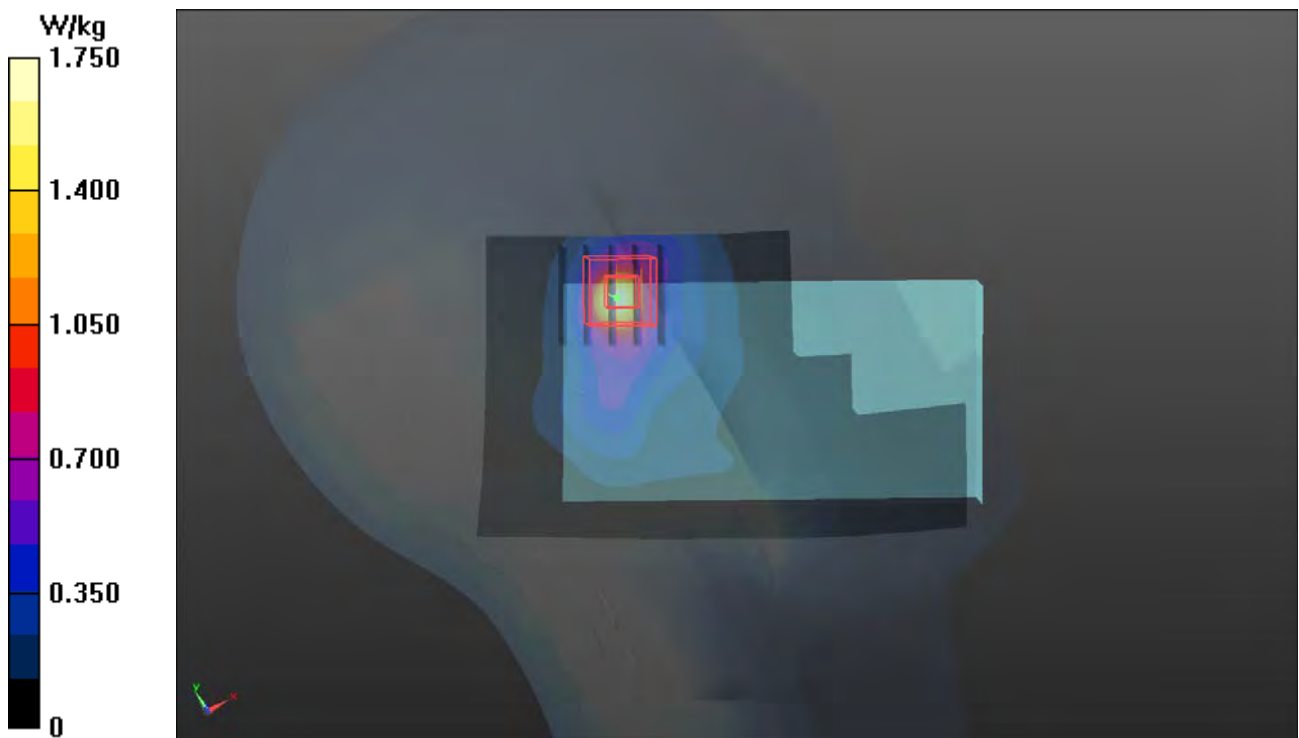

P12 5.3G WLAN_802.11n HT40_Left Cheek_Ch54_Sample1

DUT: 170427C12

Communication System: WLAN_5G; Frequency: 5270 MHz; Duty Cycle: 1:1

Medium: H34T60N3_0928 Medium parameters used: $f = 5270$ MHz; $\sigma = 4.881$ S/m; $\epsilon_r = 35.458$; $\rho = 1000$ kg/m³

Ambient Temperature : 23.8 °C ; Liquid Temperature : 23.6 °C

DASY5 Configuration:

- Probe: EX3DV4 - SN3971; ConvF(5.34, 5.34, 5.34); Calibrated: 2017/03/24;
- Sensor-Surface: 1.4mm (Mechanical Surface Detection)
- Electronics: DAE4 Sn1431; Calibrated: 2017/03/20
- Phantom: Twin SAM Phantom_1127; Type: QD000P40CA;
- Measurement SW: DASY52, Version 52.8 (8); SEMCAD X Version 14.6.10 (7373)

- **Area Scan (101x181x1)**: Interpolated grid: dx=1.000 mm, dy=1.000 mm

Maximum value of SAR (interpolated) = 0.670 W/kg

- **Zoom Scan (6x6x12)/Cube 0**: Measurement grid: dx=5mm, dy=5mm, dz=2mm

Reference Value = 12.88 V/m; Power Drift = -0.12 dB

Peak SAR (extrapolated) = 2.00 W/kg

SAR(1 g) = 0.501 W/kg; SAR(10 g) = 0.162 W/kg

Maximum value of SAR (measured) = 1.16 W/kg

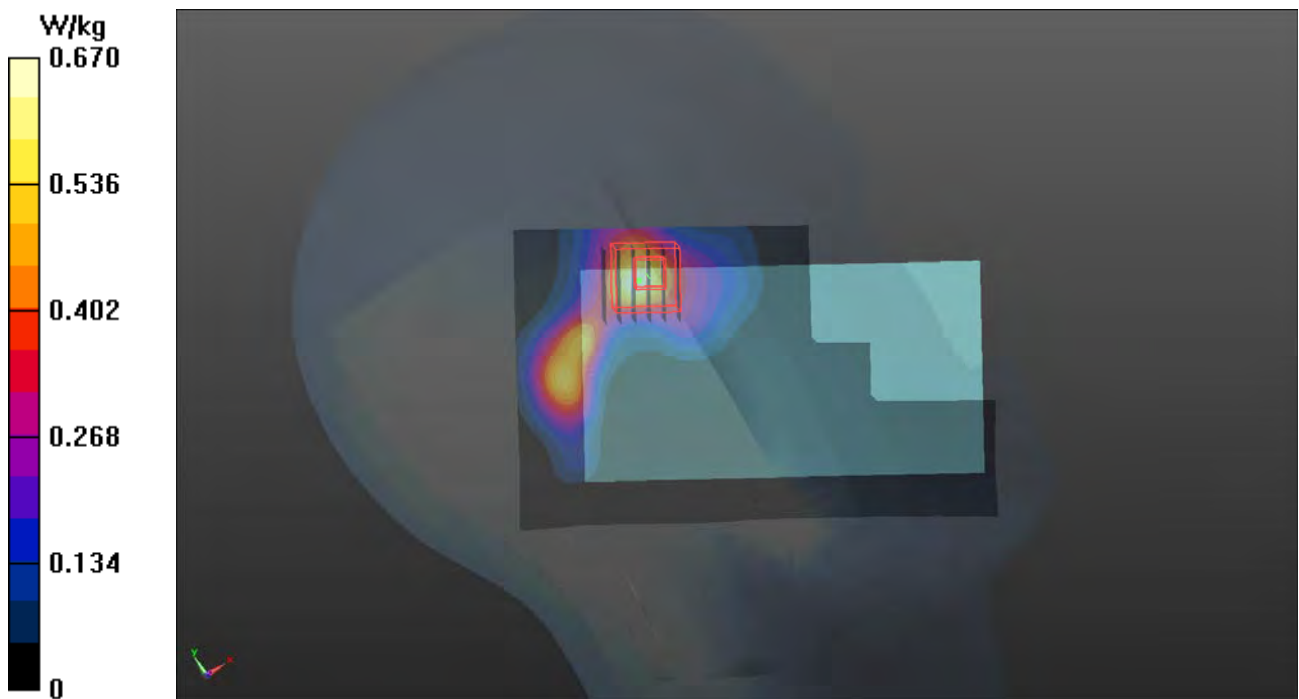

P13 5.6G WLAN_802.11ac VH80_Left Cheek_Ch138_Sample1

DUT: 170427C12

Communication System: WLAN_5G; Frequency: 5690 MHz; Duty Cycle: 1:1

Medium: H34T60N1_0823 Medium parameters used: $f = 5690$ MHz; $\sigma = 5.254$ S/m; $\epsilon_r = 36.551$; $\rho = 1000$ kg/m³

Ambient Temperature : 23.6 °C ; Liquid Temperature : 23.4 °C

DASY5 Configuration:

- Probe: EX3DV4 - SN7375; ConvF(4.79, 4.79, 4.79); Calibrated: 2016/12/08;
- Sensor-Surface: 1.4mm (Mechanical Surface Detection)
- Electronics: DAE4 Sn1431; Calibrated: 2017/03/20
- Phantom: Twin SAM Phantom_1654; Type: QD000P40;
- Measurement SW: DASY52, Version 52.8 (8); SEMCAD X Version 14.6.10 (7373)

- **Area Scan (101x181x1):** Interpolated grid: dx=1.000 mm, dy=1.000 mm

Maximum value of SAR (interpolated) = 0.719 W/kg

- **Zoom Scan (6x6x12)/Cube 0:** Measurement grid: dx=5mm, dy=5mm, dz=2mm

Reference Value = 12.21 V/m; Power Drift = 0.09 dB

Peak SAR (extrapolated) = 1.47 W/kg

SAR(1 g) = 0.396 W/kg; SAR(10 g) = 0.133 W/kg

Maximum value of SAR (measured) = 0.887 W/kg

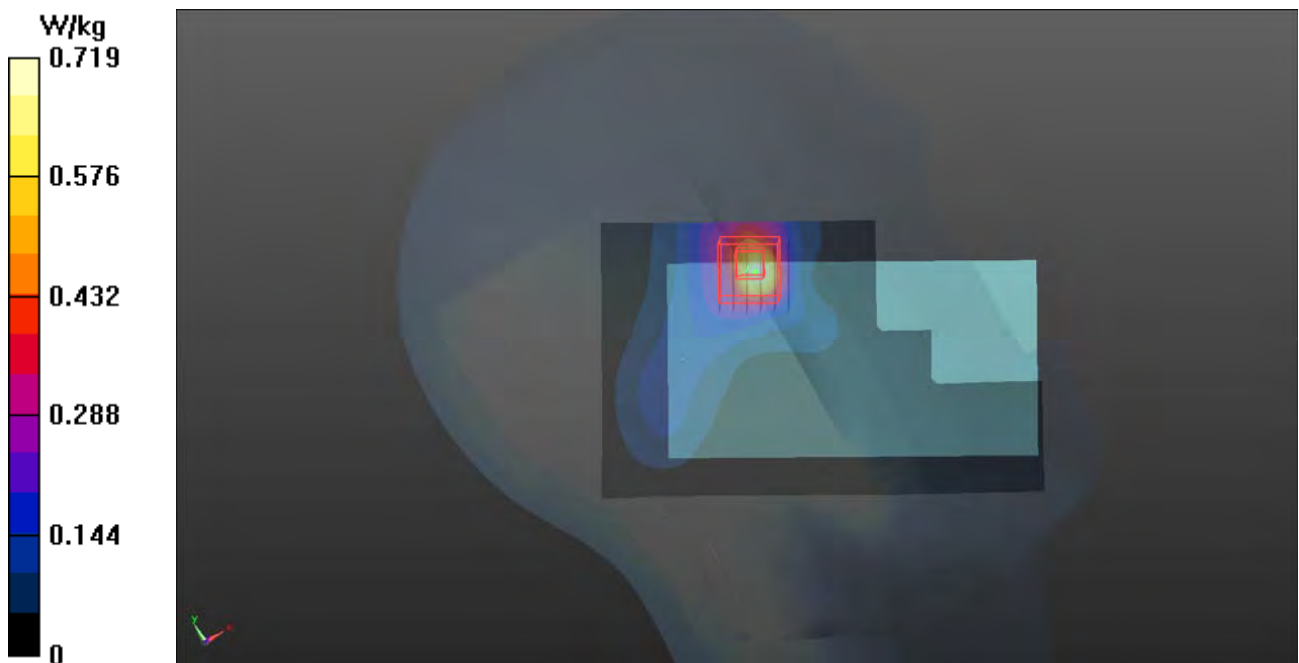

P14 5.8G WLAN_802.11ac VH80_Left Cheek_Ch155_Sample1

DUT: 170427C12

Communication System: WLAN_5G; Frequency: 5775 MHz; Duty Cycle: 1:1

Medium: H34T60N1_0823 Medium parameters used: $f = 5775$ MHz; $\sigma = 5.338$ S/m; $\epsilon_r = 36.319$; $\rho = 1000$ kg/m³

Ambient Temperature : 23.6 °C ; Liquid Temperature : 23.4 °C

DASY5 Configuration:

- Probe: EX3DV4 - SN7375; ConvF(4.78, 4.78, 4.78); Calibrated: 2016/12/08;
- Sensor-Surface: 1.4mm (Mechanical Surface Detection)
- Electronics: DAE4 Sn1431; Calibrated: 2017/03/20
- Phantom: Twin SAM Phantom_1654; Type: QD000P40;
- Measurement SW: DASY52, Version 52.8 (8); SEMCAD X Version 14.6.10 (7373)

- **Area Scan (101x181x1):** Interpolated grid: dx=1.000 mm, dy=1.000 mm

Maximum value of SAR (interpolated) = 0.577 W/kg

- **Zoom Scan (6x6x12)/Cube 0:** Measurement grid: dx=5mm, dy=5mm, dz=2mm

Reference Value = 10.85 V/m; Power Drift = -0.04 dB

Peak SAR (extrapolated) = 1.11 W/kg

SAR(1 g) = 0.310 W/kg; SAR(10 g) = 0.101 W/kg

Maximum value of SAR (measured) = 0.698 W/kg

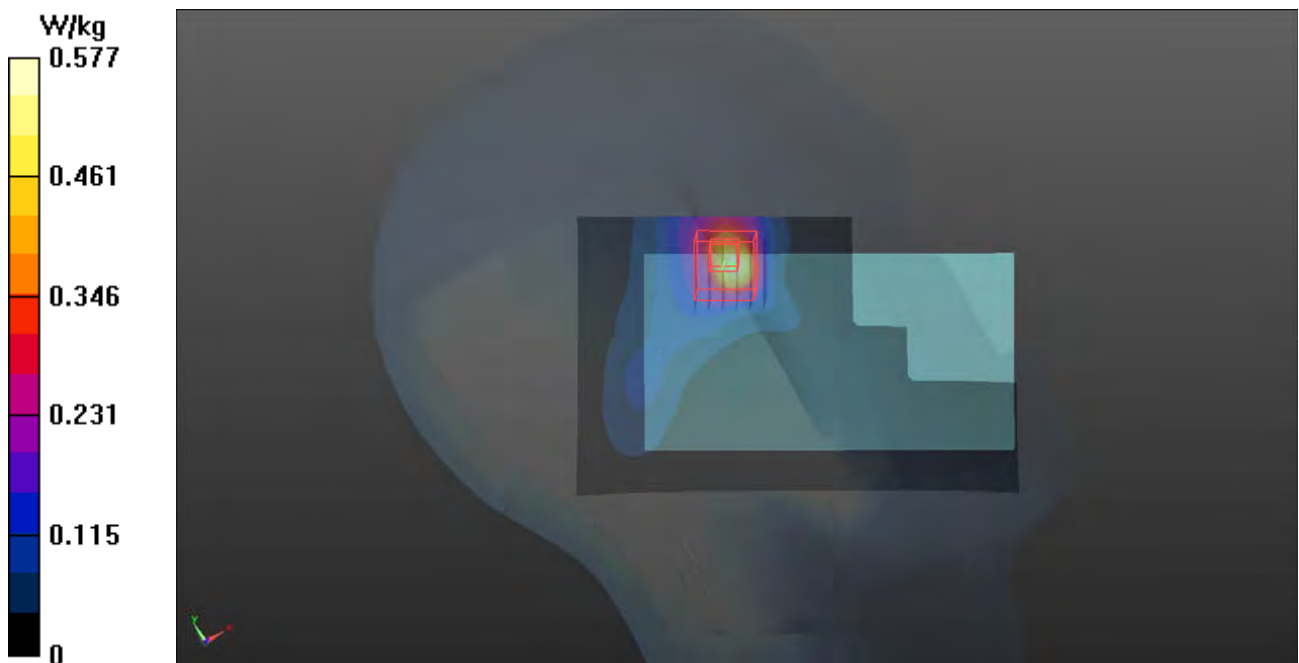

P15 GSM850_GPRS10_Rear Face_1.5cm_Ch251_Sample1

DUT: 170427C12

Communication System: GPRS10; Frequency: 848.8 MHz; Duty Cycle: 1:4

Medium: B07T10N3_0914 Medium parameters used: $f = 849 \text{ MHz}$; $\sigma = 1.015 \text{ S/m}$; $\epsilon_r = 54.123$; $\rho = 1000 \text{ kg/m}^3$

Ambient Temperature : $23.5 \text{ }^\circ\text{C}$; Liquid Temperature : $23.1 \text{ }^\circ\text{C}$

DASY5 Configuration:

- Probe: EX3DV4 - SN7375; ConvF(9.94, 9.94, 9.94); Calibrated: 2016/12/08;
- Sensor-Surface: 1.4mm (Mechanical Surface Detection)
- Electronics: DAE3 Sn579; Calibrated: 2017/08/17
- Phantom: Twin SAM Phantom_1485; Type: QD000P40;
- Measurement SW: DASY52, Version 52.8 (8); SEMCAD X Version 14.6.10 (7373)

- **Area Scan (71x121x1):** Interpolated grid: $dx=1.500 \text{ mm}$, $dy=1.500 \text{ mm}$

Maximum value of SAR (interpolated) = 0.631 W/kg

- **Zoom Scan (5x5x7)/Cube 0:** Measurement grid: $dx=8\text{mm}$, $dy=8\text{mm}$, $dz=5\text{mm}$

Reference Value = 25.36 V/m ; Power Drift = -0.07 dB

Peak SAR (extrapolated) = 0.706 W/kg

SAR(1 g) = 0.401 W/kg ; SAR(10 g) = 0.386 W/kg

Maximum value of SAR (measured) = 0.635 W/kg

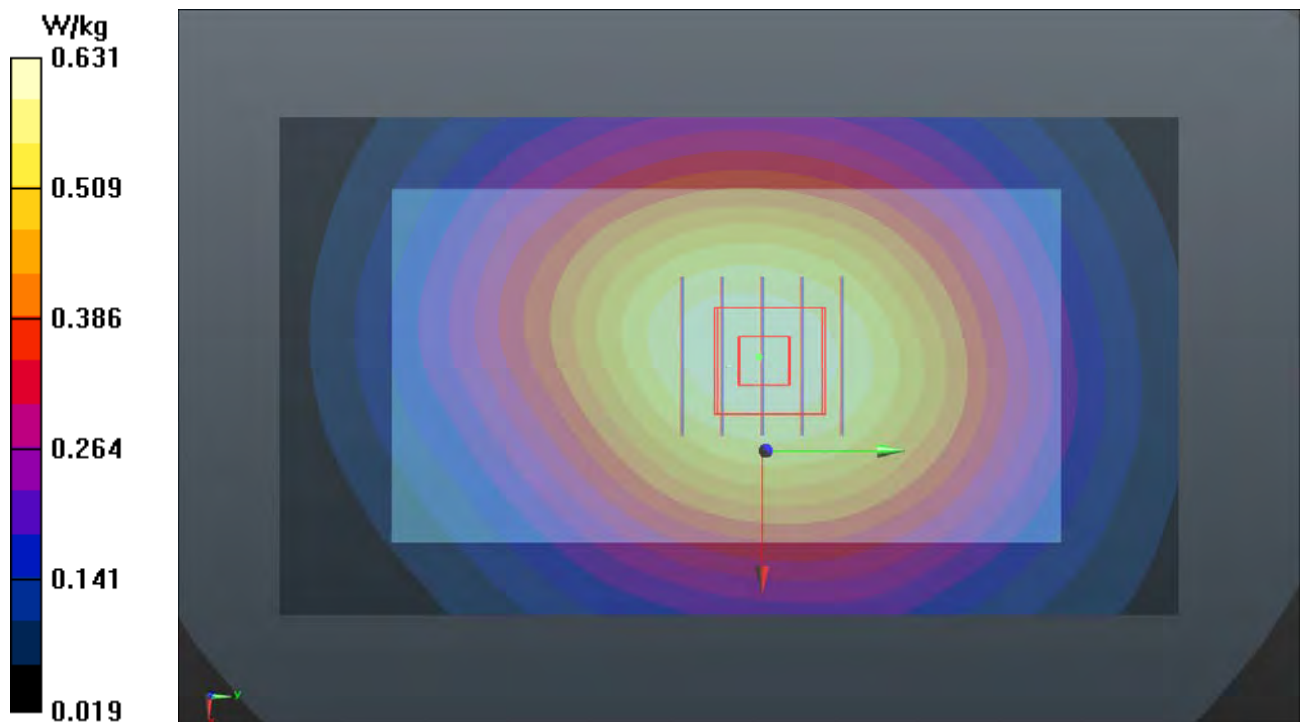

P16 GSM1900_GPRS10_Front Face_1.5cm_Ch512_Sample1

DUT: 170427C12

Communication System: GPRS10; Frequency: 1850.2 MHz; Duty Cycle: 1:4

Medium: B16T20N1_0903 Medium parameters used: $f = 1850.2$ MHz; $\sigma = 1.524$ S/m; $\epsilon_r = 51.115$; $\rho = 1000$ kg/m³

Ambient Temperature : 23.8 °C ; Liquid Temperature : 23.3 °C

DASY5 Configuration:

- Probe: EX3DV4 - SN3971; ConvF(8.26, 8.26, 8.26); Calibrated: 2017/03/24;
- Sensor-Surface: 1.4mm (Mechanical Surface Detection)
- Electronics: DAE4 Sn916; Calibrated: 2016/12/15
- Phantom: Twin SAM Phantom_1653; Type: QD000P40;
- Measurement SW: DASY52, Version 52.8 (8); SEMCAD X Version 14.6.10 (7373)

- **Area Scan (71x111x1):** Interpolated grid: dx=1.500 mm, dy=1.500 mm

Maximum value of SAR (interpolated) = 0.413 W/kg

- **Zoom Scan (5x5x7)/Cube 0:** Measurement grid: dx=8mm, dy=8mm, dz=5mm

Reference Value = 15.83 V/m; Power Drift = 0.05 dB

Peak SAR (extrapolated) = 0.455 W/kg

SAR(1 g) = 0.283 W/kg; SAR(10 g) = 0.182 W/kg

Maximum value of SAR (measured) = 0.389 W/kg

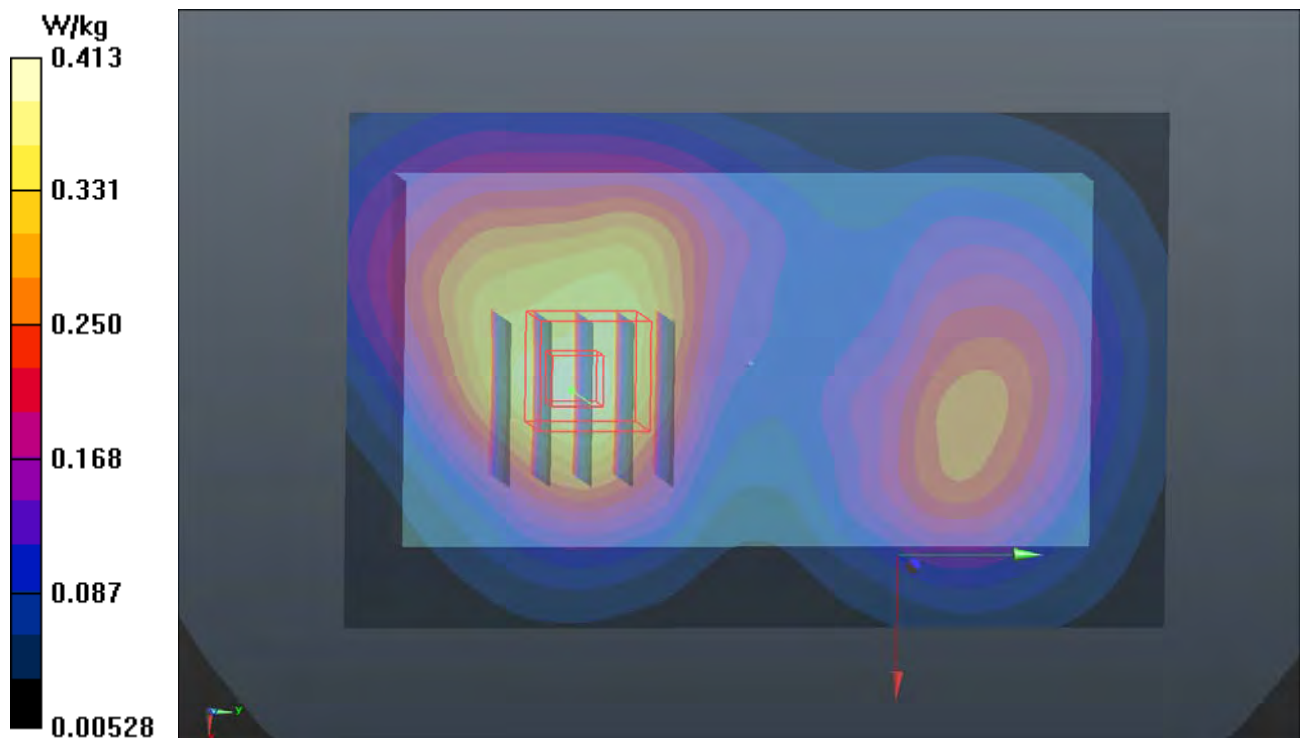

P17 WCDMA II_RMC12.2K_Rear Face_1.5cm_Ch9400_Sample1

DUT: 170427C12

Communication System: WCDMA; Frequency: 1880 MHz; Duty Cycle: 1:1

Medium: B16T20N1_0903 Medium parameters used: $f = 1880$ MHz; $\sigma = 1.549$ S/m; $\epsilon_r = 51.056$; $\rho = 1000$ kg/m³

Ambient Temperature : 23.8 °C ; Liquid Temperature : 23.3 °C

DASY5 Configuration:

- Probe: EX3DV4 - SN3971; ConvF(8.26, 8.26, 8.26); Calibrated: 2017/03/24;
- Sensor-Surface: 1.4mm (Mechanical Surface Detection)
- Electronics: DAE4 Sn916; Calibrated: 2016/12/15
- Phantom: Twin SAM Phantom_1653; Type: QD000P40;
- Measurement SW: DASY52, Version 52.8 (8); SEMCAD X Version 14.6.10 (7373)

- **Area Scan (71x111x1):** Interpolated grid: dx=1.500 mm, dy=1.500 mm

Maximum value of SAR (interpolated) = 0.464 W/kg

- **Zoom Scan (5x5x7)/Cube 0:** Measurement grid: dx=8mm, dy=8mm, dz=5mm

Reference Value = 16.51 V/m; Power Drift = 0.06 dB

Peak SAR (extrapolated) = 0.515 W/kg

SAR(1 g) = 0.323 W/kg; SAR(10 g) = 0.203 W/kg

Maximum value of SAR (measured) = 0.439 W/kg

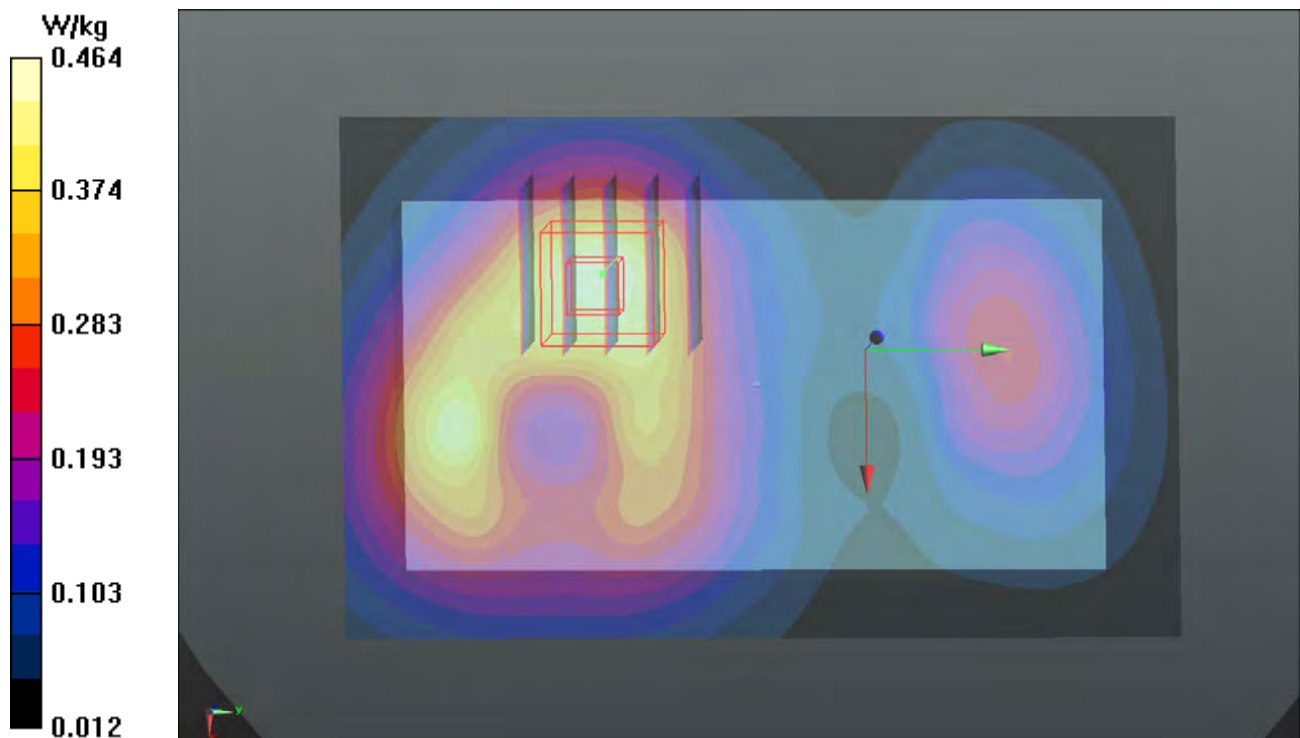

P18 WCDMA IV_RMC12.2K_Rear Face_1.5cm_Ch1513_Sample1

DUT: 170427C12

Communication System: WCDMA; Frequency: 1752.6 MHz; Duty Cycle: 1:1

Medium: B16T20N1_0903 Medium parameters used: $f = 1753$ MHz; $\sigma = 1.432$ S/m; $\epsilon_r = 51.402$; $\rho =$

1000 kg/m³

Ambient Temperature : 23.8 °C ; Liquid Temperature : 23.3 °C

DASY5 Configuration:

- Probe: EX3DV4 - SN3971; ConvF(8.51, 8.51, 8.51); Calibrated: 2017/03/24;
- Sensor-Surface: 1.4mm (Mechanical Surface Detection)
- Electronics: DAE4 Sn916; Calibrated: 2016/12/15
- Phantom: Twin SAM Phantom_1653; Type: QD000P40;
- Measurement SW: DASY52, Version 52.8 (8); SEMCAD X Version 14.6.10 (7373)

- **Area Scan (71x111x1):** Interpolated grid: dx=1.500 mm, dy=1.500 mm

Maximum value of SAR (interpolated) = 1.01 W/kg

- **Zoom Scan (5x5x7)/Cube 0:** Measurement grid: dx=8mm, dy=8mm, dz=5mm

Reference Value = 25.79 V/m; Power Drift = -0.14 dB

Peak SAR (extrapolated) = 1.15 W/kg

SAR(1 g) = 0.688 W/kg; SAR(10 g) = 0.401 W/kg

Maximum value of SAR (measured) = 0.979 W/kg

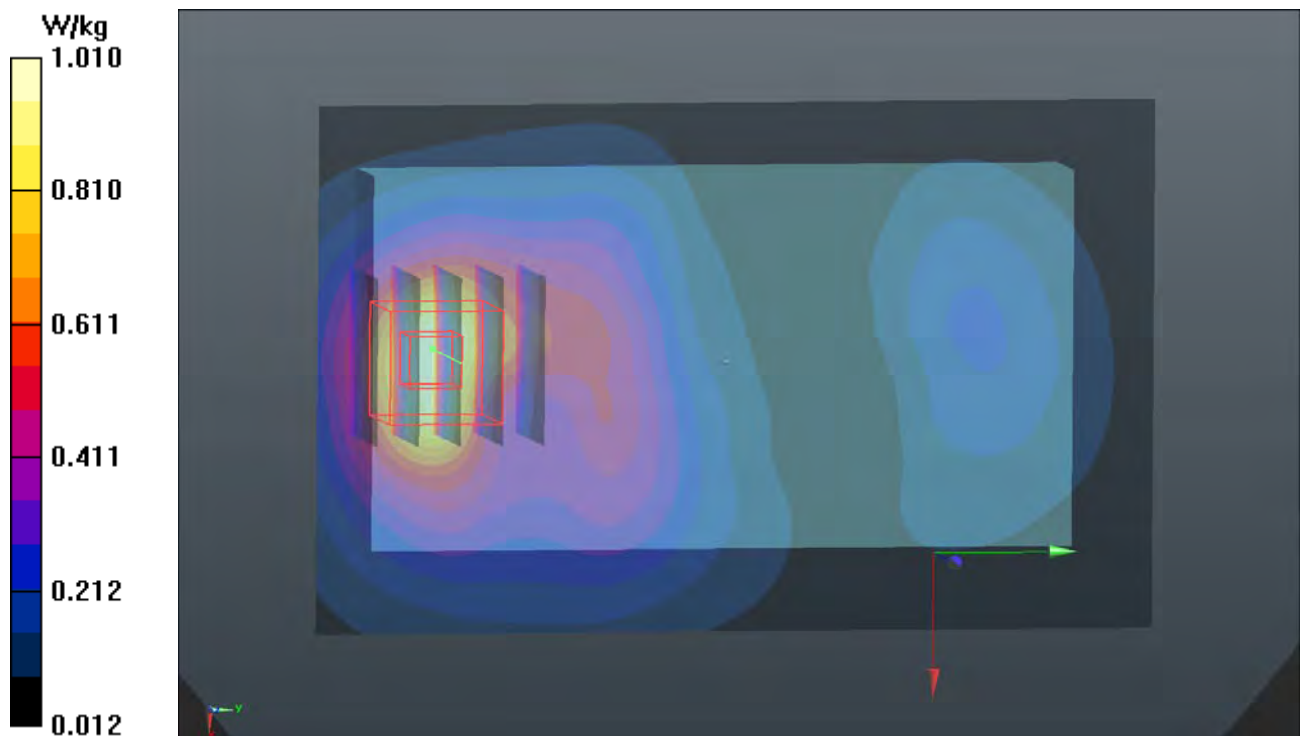

P19 WCDMA V_RMC12.2K_Rear Face_1.5cm_Ch4233_Sample1

DUT: 170427C12

Communication System: WCDMA; Frequency: 846.6 MHz; Duty Cycle: 1:1

Medium: B07T10N3_0914 Medium parameters used: $f = 847$ MHz; $\sigma = 1.013$ S/m; $\epsilon_r = 54.14$; $\rho = 1000$ kg/m³

Ambient Temperature : 23.5 °C ; Liquid Temperature : 23.1 °C

DASY5 Configuration:

- Probe: EX3DV4 - SN7375; ConvF(9.94, 9.94, 9.94); Calibrated: 2016/12/08;
- Sensor-Surface: 1.4mm (Mechanical Surface Detection)
- Electronics: DAE3 Sn579; Calibrated: 2017/08/17
- Phantom: Twin SAM Phantom_1485; Type: QD000P40;
- Measurement SW: DASY52, Version 52.8 (8); SEMCAD X Version 14.6.10 (7373)

- **Area Scan (71x121x1):** Interpolated grid: dx=1.500 mm, dy=1.500 mm

Maximum value of SAR (interpolated) = 0.452 W/kg

- **Zoom Scan (5x5x7)/Cube 0:** Measurement grid: dx=8mm, dy=8mm, dz=5mm

Reference Value = 21.38 V/m; Power Drift = -0.10 dB

Peak SAR (extrapolated) = 0.498 W/kg

SAR(1 g) = 0.359 W/kg; SAR(10 g) = 0.269 W/kg

Maximum value of SAR (measured) = 0.446 W/kg

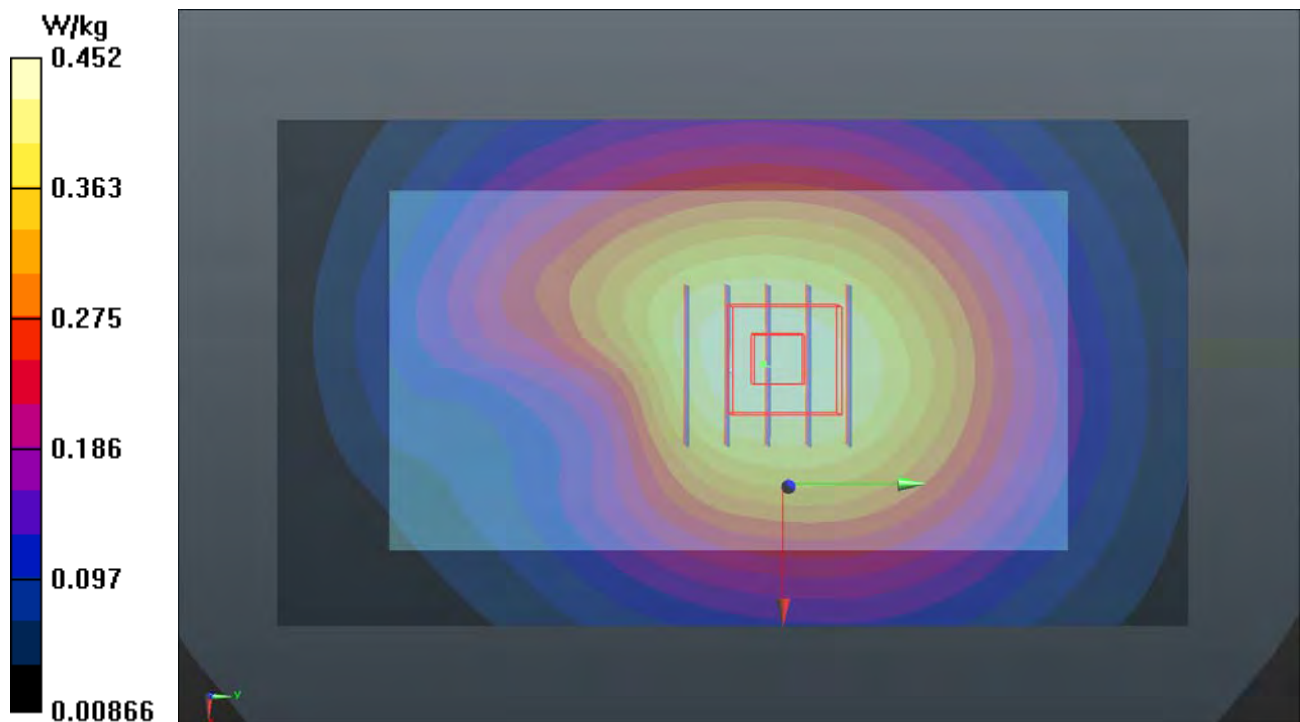

P20 LTE 2_QPSK20M_Front Face_1.5cm_Ch18900_Sample1_1RB_OS0

DUT: 170427C12

Communication System: LTE; Frequency: 1880 MHz; Duty Cycle: 1:1

Medium: B16T20N1_0903 Medium parameters used: $f = 1880$ MHz; $\sigma = 1.549$ S/m; $\epsilon_r = 51.056$; $\rho = 1000$ kg/m³

Ambient Temperature : 23.8 °C ; Liquid Temperature : 23.3 °C

DASY5 Configuration:

- Probe: EX3DV4 - SN3971; ConvF(8.26, 8.26, 8.26); Calibrated: 2017/03/24;
- Sensor-Surface: 1.4mm (Mechanical Surface Detection)
- Electronics: DAE4 Sn916; Calibrated: 2016/12/15
- Phantom: Twin SAM Phantom_1653; Type: QD000P40;
- Measurement SW: DASY52, Version 52.8 (8); SEMCAD X Version 14.6.10 (7373)

- **Area Scan (71x111x1):** Interpolated grid: dx=1.500 mm, dy=1.500 mm

Maximum value of SAR (interpolated) = 0.598 W/kg

- **Zoom Scan (5x5x7)/Cube 0:** Measurement grid: dx=8mm, dy=8mm, dz=5mm

Reference Value = 19.12 V/m; Power Drift = -0.12 dB

Peak SAR (extrapolated) = 0.640 W/kg

SAR(1 g) = 0.403 W/kg; SAR(10 g) = 0.261 W/kg

Maximum value of SAR (measured) = 0.553 W/kg

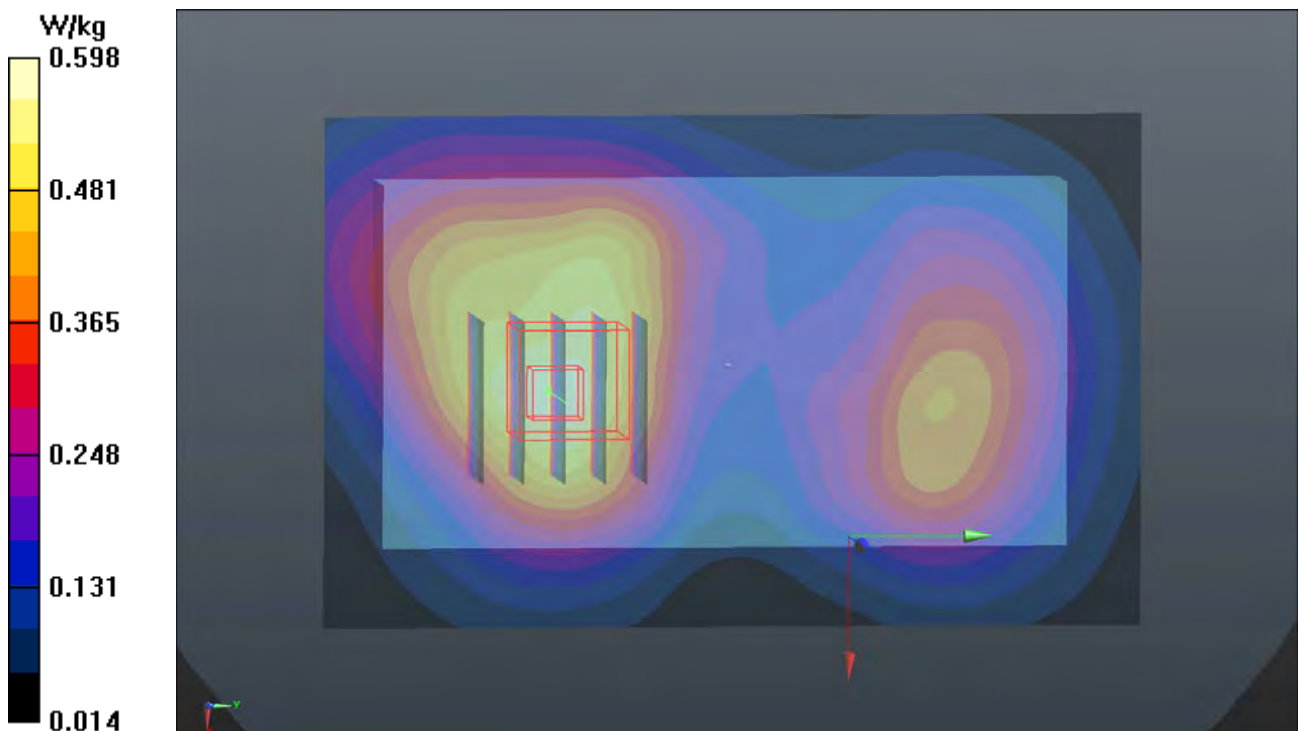

P21 LTE 4_QPSK20M_Rear Face_1.5cm_Ch20175_Sample1_1RB_OS0

DUT: 170427C12

Communication System: LTE; Frequency: 1732.5 MHz; Duty Cycle: 1:1

Medium: B16T20N1_0903 Medium parameters used: $f = 1732.5$ MHz; $\sigma = 1.413$ S/m; $\epsilon_r = 51.438$; $\rho = 1000$ kg/m³

Ambient Temperature : 23.8 °C ; Liquid Temperature : 23.3 °C

DASY5 Configuration:

- Probe: EX3DV4 - SN3971; ConvF(8.51, 8.51, 8.51); Calibrated: 2017/03/24;
- Sensor-Surface: 1.4mm (Mechanical Surface Detection)
- Electronics: DAE4 Sn916; Calibrated: 2016/12/15
- Phantom: Twin SAM Phantom_1653; Type: QD000P40;
- Measurement SW: DASY52, Version 52.8 (8); SEMCAD X Version 14.6.10 (7373)

- **Area Scan (71x111x1):** Interpolated grid: dx=1.500 mm, dy=1.500 mm

Maximum value of SAR (interpolated) = 1.11 W/kg

- **Zoom Scan (5x5x7)/Cube 0:** Measurement grid: dx=8mm, dy=8mm, dz=5mm

Reference Value = 27.38 V/m; Power Drift = -0.06 dB

Peak SAR (extrapolated) = 1.24 W/kg

SAR(1 g) = 0.751 W/kg; SAR(10 g) = 0.436 W/kg

Maximum value of SAR (measured) = 1.07 W/kg

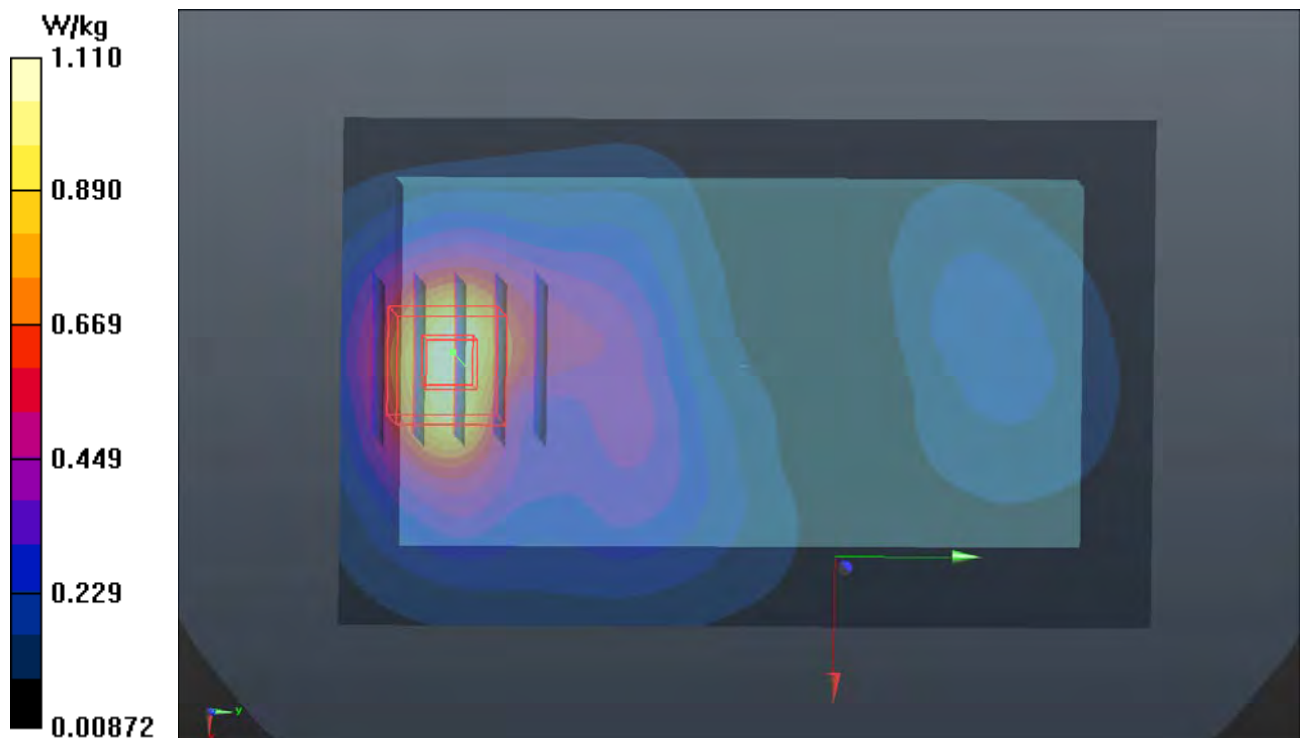

P22 LTE 5_QPSK10M_Rear Face_1.5cm_Ch20525_Sample1_1RB_OS24

DUT: 170427C12

Communication System: LTE; Frequency: 836.5 MHz; Duty Cycle: 1:1

Medium: B07T10N1_0903 Medium parameters used: $f = 836.5$ MHz; $\sigma = 0.981$ S/m; $\epsilon_r = 56.472$; $\rho = 1000$ kg/m³

Ambient Temperature : 23.5 °C ; Liquid Temperature : 23.1 °C

DASY5 Configuration:

- Probe: EX3DV4 - SN3971; ConvF(10.52, 10.52, 10.52); Calibrated: 2017/03/24;
- Sensor-Surface: 1.4mm (Mechanical Surface Detection)
- Electronics: DAE4 Sn916; Calibrated: 2016/12/15
- Phantom: Twin SAM Phantom_1653; Type: QD000P40;
- Measurement SW: DASY52, Version 52.8 (8); SEMCAD X Version 14.6.10 (7373)

- **Area Scan (71x111x1):** Interpolated grid: dx=1.500 mm, dy=1.500 mm

Maximum value of SAR (interpolated) = 0.866 W/kg

- **Zoom Scan (5x5x7)/Cube 0:** Measurement grid: dx=8mm, dy=8mm, dz=5mm

Reference Value = 30.55 V/m; Power Drift = -0.03 dB

Peak SAR (extrapolated) = 0.938 W/kg

SAR(1 g) = 0.681 W/kg; SAR(10 g) = 0.528 W/kg

Maximum value of SAR (measured) = 0.856 W/kg

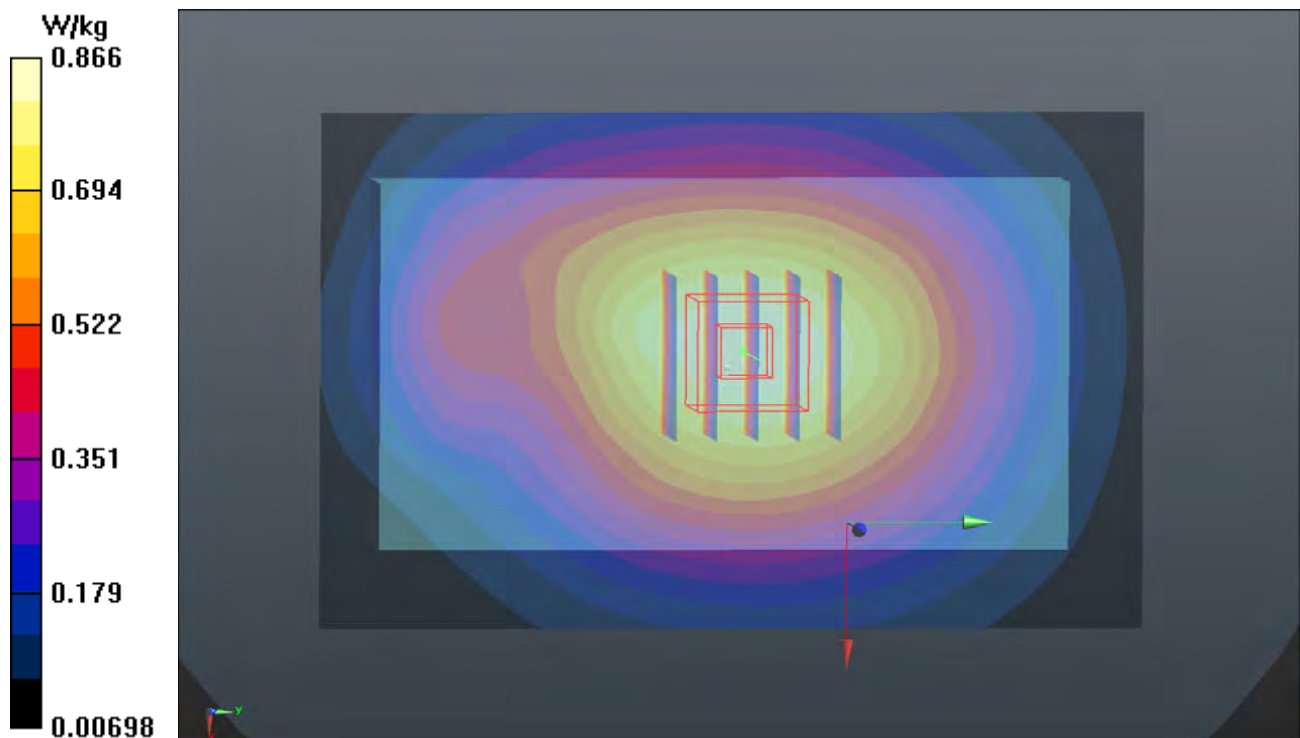

P23 LTE 12_QPSK10M_Rear Face_1.5cm_Ch23095_Sample1_1RB_OS0

DUT: 170427C12

Communication System: LTE; Frequency: 707.5 MHz; Duty Cycle: 1:1

Medium: B06T09N1_0903 Medium parameters used: $f = 707.5$ MHz; $\sigma = 0.92$ S/m; $\epsilon_r = 55.882$; $\rho = 1000$ kg/m³

Ambient Temperature : 23.5 °C ; Liquid Temperature : 23.3 °C

DASY5 Configuration:

- Probe: EX3DV4 - SN3971; ConvF(10.61, 10.61, 10.61); Calibrated: 2017/03/24;
- Sensor-Surface: 1.4mm (Mechanical Surface Detection)
- Electronics: DAE4 Sn916; Calibrated: 2016/12/15
- Phantom: Twin SAM Phantom_1653; Type: QD000P40;
- Measurement SW: DASY52, Version 52.8 (8); SEMCAD X Version 14.6.10 (7373)

- **Area Scan (71x111x1):** Interpolated grid: dx=1.500 mm, dy=1.500 mm

Maximum value of SAR (interpolated) = 0.441 W/kg

- **Zoom Scan (5x5x7)/Cube 0:** Measurement grid: dx=8mm, dy=8mm, dz=5mm

Reference Value = 22.35 V/m; Power Drift = -0.02 dB

Peak SAR (extrapolated) = 0.494 W/kg

SAR(1 g) = 0.371 W/kg; SAR(10 g) = 0.282 W/kg

Maximum value of SAR (measured) = 0.448 W/kg

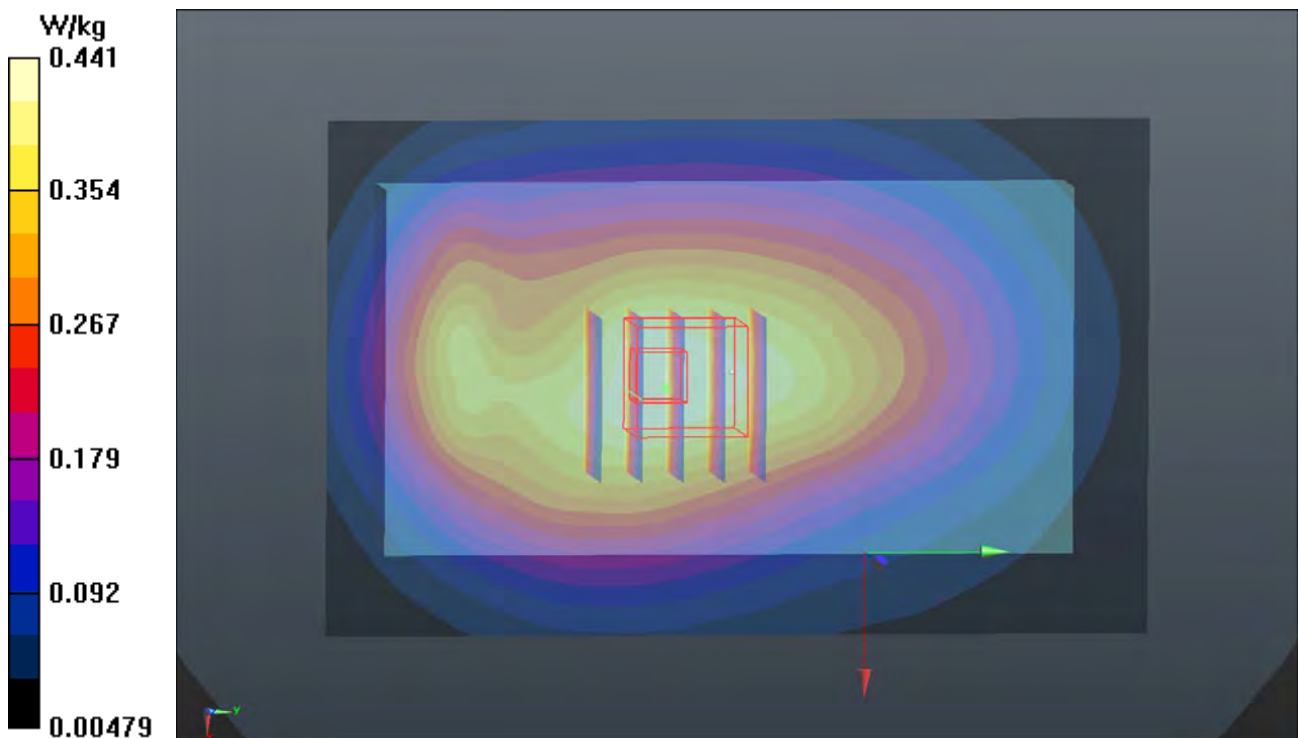

P24 LTE 17_QPSK10M_Rear Face_1.5cm_Ch23790_Sample1_1RB_OS0

DUT: 170427C12

Communication System: LTE; Frequency: 710 MHz; Duty Cycle: 1:1

Medium: B06T09N1_0903 Medium parameters used: $f = 710 \text{ MHz}$; $\sigma = 0.922 \text{ S/m}$; $\epsilon_r = 55.86$; $\rho = 1000 \text{ kg/m}^3$

Ambient Temperature : $23.5 \text{ }^\circ\text{C}$; Liquid Temperature : $23.3 \text{ }^\circ\text{C}$

DASY5 Configuration:

- Probe: EX3DV4 - SN3971; ConvF(10.61, 10.61, 10.61); Calibrated: 2017/03/24;
- Sensor-Surface: 1.4mm (Mechanical Surface Detection)
- Electronics: DAE4 Sn916; Calibrated: 2016/12/15
- Phantom: Twin SAM Phantom_1653; Type: QD000P40;
- Measurement SW: DASY52, Version 52.8 (8); SEMCAD X Version 14.6.10 (7373)

- **Area Scan (71x111x1):** Interpolated grid: $dx=1.500 \text{ mm}$, $dy=1.500 \text{ mm}$

Maximum value of SAR (interpolated) = 0.438 W/kg

- **Zoom Scan (5x5x7)/Cube 0:** Measurement grid: $dx=8\text{mm}$, $dy=8\text{mm}$, $dz=5\text{mm}$

Reference Value = 22.37 V/m ; Power Drift = 0.06 dB

Peak SAR (extrapolated) = 0.488 W/kg

SAR(1 g) = 0.358 W/kg ; SAR(10 g) = 0.270 W/kg

Maximum value of SAR (measured) = 0.439 W/kg

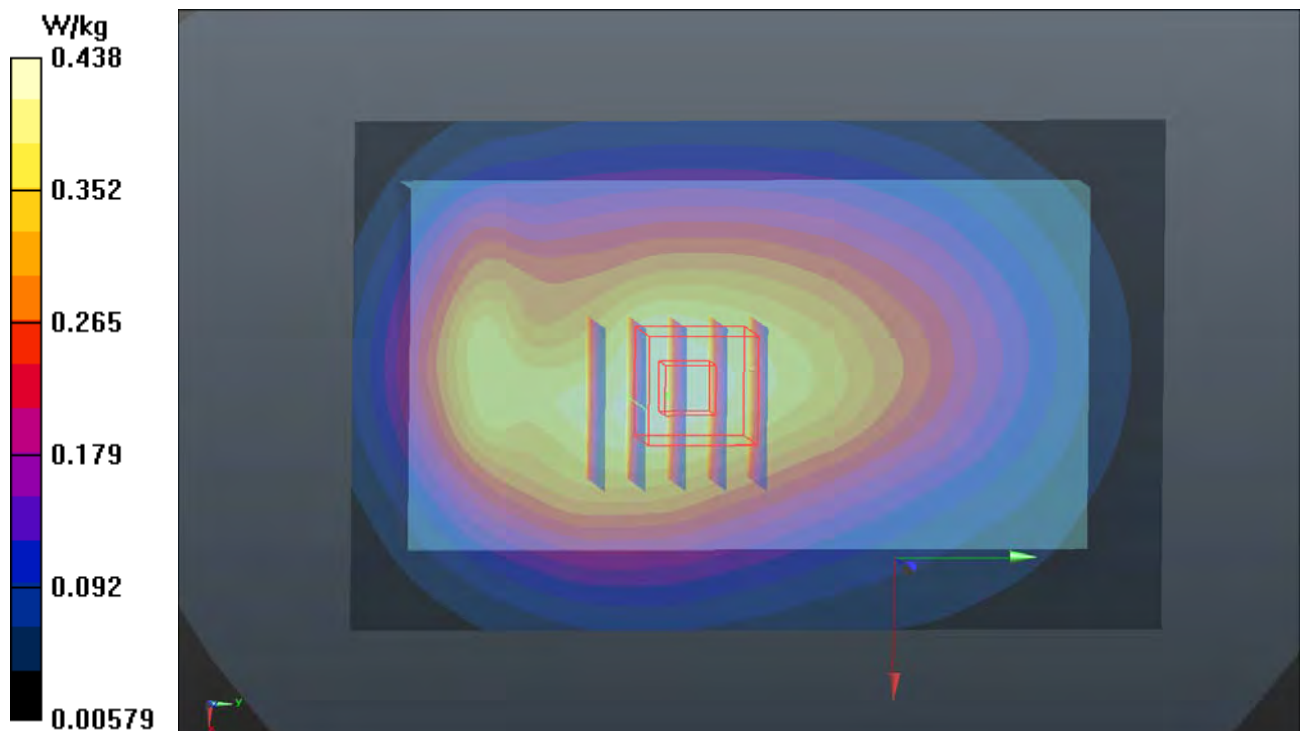

P25 2.4G WLAN_802.11b_Rear Face_1.5cm_Ch6_Sample1

DUT: 170427C12

Communication System: WLAN_2.4G; Frequency: 2437 MHz; Duty Cycle: 1:1

Medium: B19T27N3_0903 Medium parameters used: $f = 2437$ MHz; $\sigma = 2.017$ S/m; $\epsilon_r = 51.932$; $\rho =$

1000 kg/m³

Ambient Temperature : 23.5 °C ; Liquid Temperature : 23.1 °C

DASY5 Configuration:

- Probe: EX3DV4 - SN3971; ConvF(7.67, 7.67, 7.67); Calibrated: 2017/03/24;
- Sensor-Surface: 1.4mm (Mechanical Surface Detection)
- Electronics: DAE4 Sn916; Calibrated: 2016/12/15
- Phantom: Twin SAM Phantom_1653; Type: QD000P40;
- Measurement SW: DASY52, Version 52.8 (8); SEMCAD X Version 14.6.10 (7373)

- **Area Scan (91x141x1):** Interpolated grid: dx=1.200 mm, dy=1.200 mm

Maximum value of SAR (interpolated) = 0.559 W/kg

- **Zoom Scan (5x5x7)/Cube 0:** Measurement grid: dx=8mm, dy=8mm, dz=5mm

Reference Value = 15.91 V/m; Power Drift = 0.03 dB

Peak SAR (extrapolated) = 0.720 W/kg

SAR(1 g) = 0.379 W/kg; SAR(10 g) = 0.207 W/kg

Maximum value of SAR (measured) = 0.584 W/kg

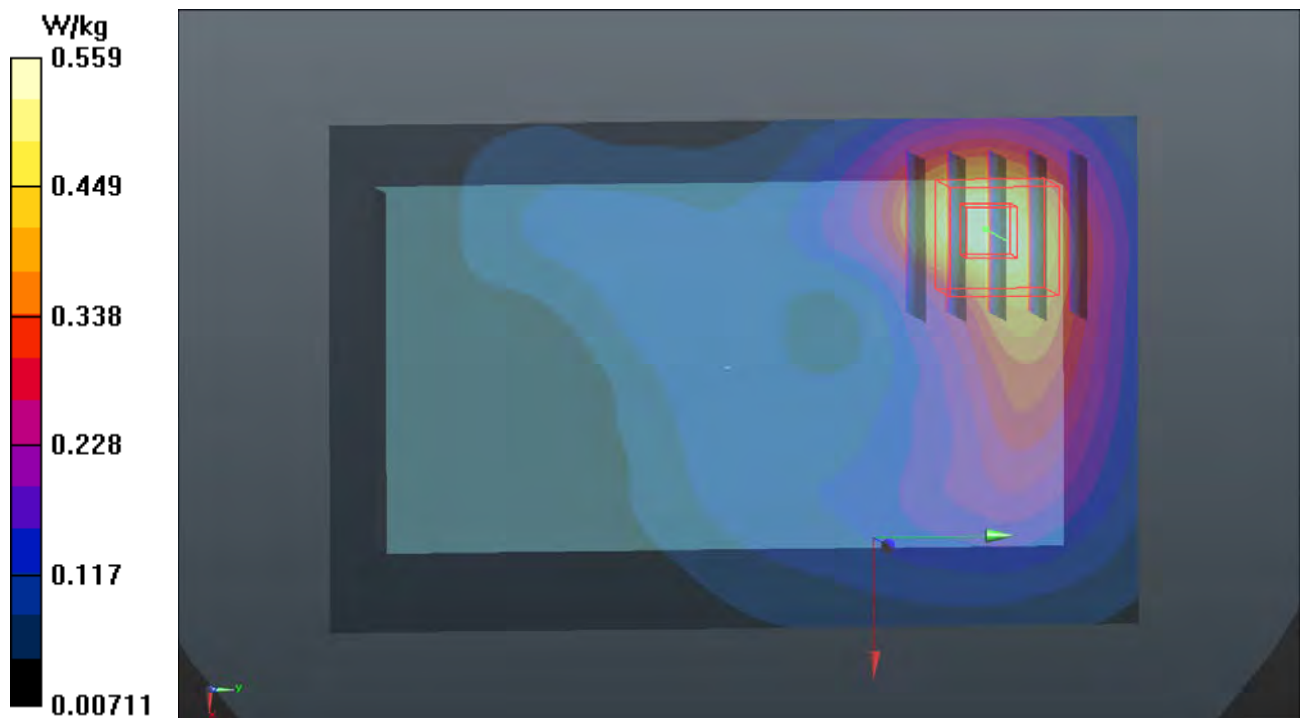

P26 5.3G WLAN_802.11n HT40_Rear Face_1.5cm_Ch54_Sample1

DUT: 170427C12

Communication System: WLAN_5G; Frequency: 5270 MHz; Duty Cycle: 1:1

Medium: B34T60N2_0928 Medium parameters used: $f = 5270$ MHz; $\sigma = 5.497$ S/m; $\epsilon_r = 47.85$; $\rho = 1000$ kg/m³

Ambient Temperature : 23.6 °C ; Liquid Temperature : 23.3 °C

DASY5 Configuration:

- Probe: EX3DV4 - SN3971; ConvF(4.7, 4.7, 4.7); Calibrated: 2017/03/24;
- Sensor-Surface: 1.4mm (Mechanical Surface Detection)
- Electronics: DAE4 Sn1431; Calibrated: 2017/03/20
- Phantom: Twin SAM Phantom_1127; Type: QD000P40CA;
- Measurement SW: DASY52, Version 52.8 (8); SEMCAD X Version 14.6.10 (7373)

- **Area Scan (101x181x1)**: Interpolated grid: dx=1.000 mm, dy=1.000 mm

Maximum value of SAR (interpolated) = 2.07 W/kg

- **Zoom Scan (6x6x12)/Cube 0**: Measurement grid: dx=5mm, dy=5mm, dz=2mm

Reference Value = 21.69 V/m; Power Drift = 0.02 dB

Peak SAR (extrapolated) = 3.63 W/kg

SAR(1 g) = 1.04 W/kg; SAR(10 g) = 0.430 W/kg

Maximum value of SAR (measured) = 2.22 W/kg

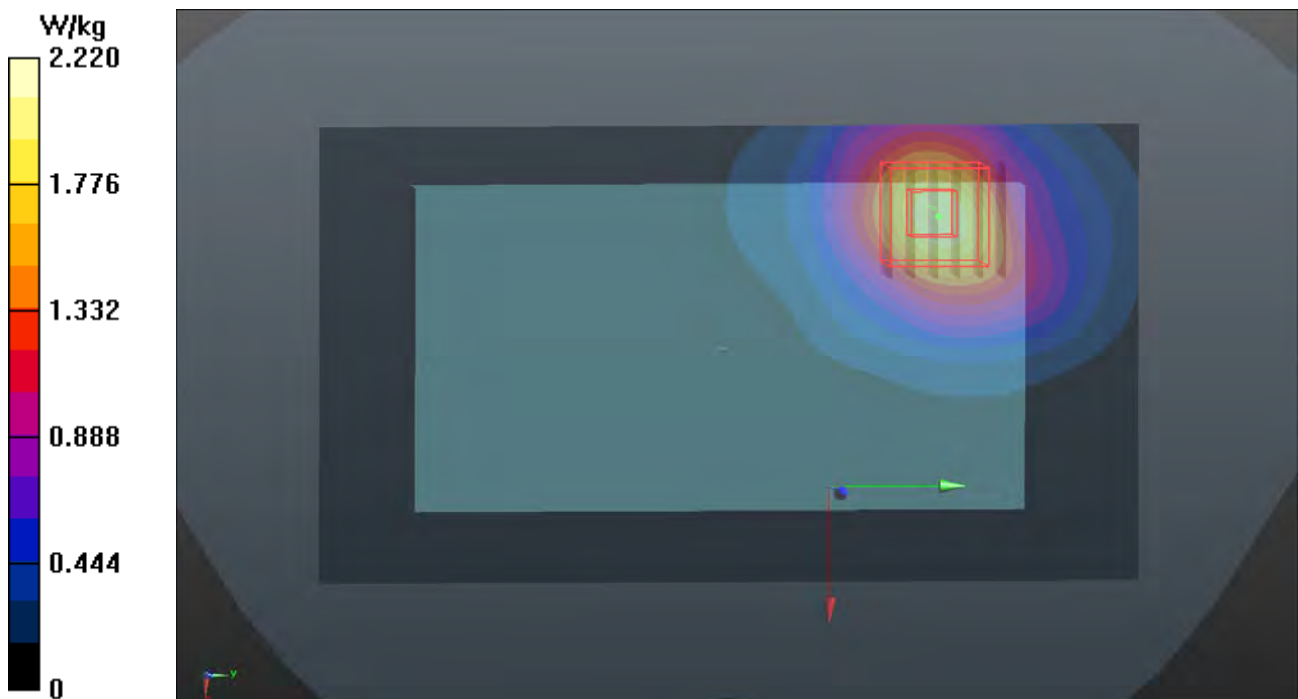

P27 5.6G WLAN_802.11ac VH80_Rear Face_1.5cm_Ch138_Sample1

DUT: 170427C12

Communication System: WLAN_5G; Frequency: 5690 MHz; Duty Cycle: 1:1

Medium: B34T60N1_0823 Medium parameters used: $f = 5690$ MHz; $\sigma = 6.056$ S/m; $\epsilon_r = 46.816$; $\rho = 1000$ kg/m³

Ambient Temperature : 23.9 °C ; Liquid Temperature : 23.5 °C

DASY5 Configuration:

- Probe: EX3DV4 - SN7375; ConvF(3.99, 3.99, 3.99); Calibrated: 2016/12/08;
- Sensor-Surface: 1.4mm (Mechanical Surface Detection)
- Electronics: DAE4 Sn1431; Calibrated: 2017/03/20
- Phantom: Twin SAM Phantom_1822; Type: QD000P40;
- Measurement SW: DASY52, Version 52.8 (8); SEMCAD X Version 14.6.10 (7373)

- **Area Scan (101x181x1):** Interpolated grid: dx=1.000 mm, dy=1.000 mm

Maximum value of SAR (interpolated) = 2.20 W/kg

- **Zoom Scan (6x6x12)/Cube 0:** Measurement grid: dx=5mm, dy=5mm, dz=2mm

Reference Value = 21.54 V/m; Power Drift = -0.17 dB

Peak SAR (extrapolated) = 3.57 W/kg

SAR(1 g) = 1.24 W/kg; SAR(10 g) = 0.607 W/kg

Maximum value of SAR (measured) = 2.23 W/kg

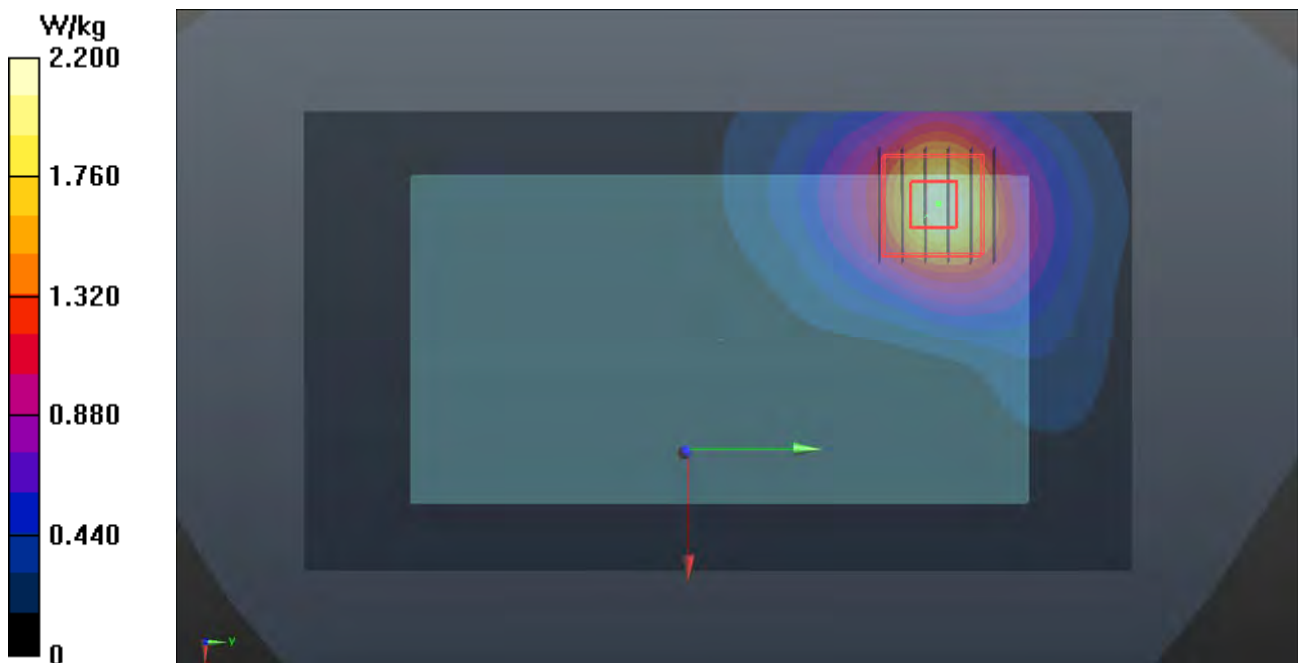

P28 5.8G WLAN_802.11ac VH80_Rear Face_1.5cm_Ch155_Sample1

DUT: 170427C12

Communication System: WLAN_5G; Frequency: 5775 MHz; Duty Cycle: 1:1

Medium: B34T60N1_0823 Medium parameters used: $f = 5775$ MHz; $\sigma = 6.169$ S/m; $\epsilon_r = 46.63$; $\rho = 1000$ kg/m³

Ambient Temperature : 23.8 °C ; Liquid Temperature : 23.6 °C

DASY5 Configuration:

- Probe: EX3DV4 - SN7375; ConvF(4.08, 4.08, 4.08); Calibrated: 2016/12/08;
- Sensor-Surface: 1.4mm (Mechanical Surface Detection)
- Electronics: DAE4 Sn1431; Calibrated: 2017/03/20
- Phantom: Twin SAM Phantom_1822; Type: QD000P40;
- Measurement SW: DASY52, Version 52.8 (8); SEMCAD X Version 14.6.10 (7373)

- **Area Scan (101x181x1)**: Interpolated grid: dx=1.000 mm, dy=1.000 mm
Maximum value of SAR (interpolated) = 1.77 W/kg

- **Zoom Scan (6x6x12)/Cube 0**: Measurement grid: dx=5mm, dy=5mm, dz=2mm
Reference Value = 18.11 V/m; Power Drift = -0.09 dB
Peak SAR (extrapolated) = 2.61 W/kg
SAR(1 g) = 0.938 W/kg; SAR(10 g) = 0.388 W/kg
Maximum value of SAR (measured) = 1.81 W/kg

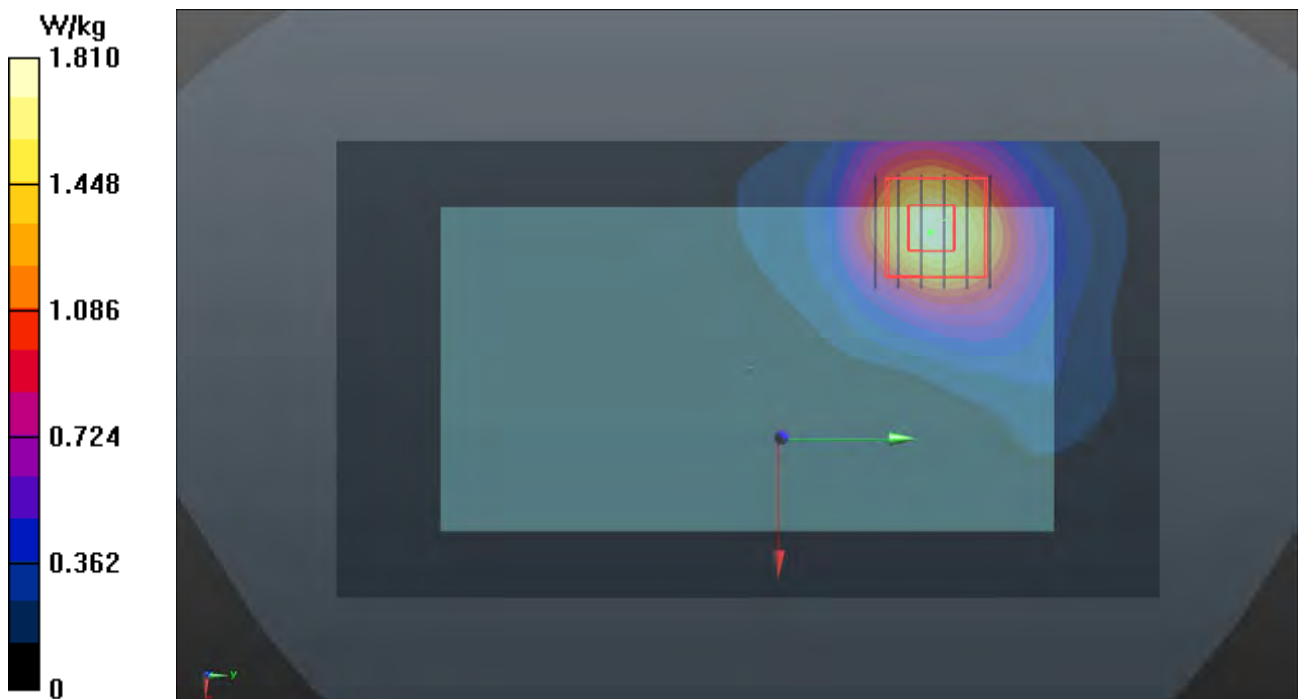

P29 GSM850_GPRS10_Rear Face_1cm_Ch251_Sample1

DUT: 170427C12

Communication System: GPRS10; Frequency: 848.8 MHz; Duty Cycle: 1:4

Medium: B07T10N1_0822 Medium parameters used: $f = 849$ MHz; $\sigma = 1.015$ S/m; $\epsilon_r = 54.112$; $\rho = 1000$ kg/m³

Ambient Temperature : 23.5 °C ; Liquid Temperature : 23.3 °C

DASY5 Configuration:

- Probe: EX3DV4 - SN7375; ConvF(9.94, 9.94, 9.94); Calibrated: 2016/12/08;
- Sensor-Surface: 1.4mm (Mechanical Surface Detection)
- Electronics: DAE4 Sn1431; Calibrated: 2017/03/20
- Phantom: Twin SAM Phantom_1822; Type: QD000P40;
- Measurement SW: DASY52, Version 52.8 (8); SEMCAD X Version 14.6.10 (7373)

- **Area Scan (71x111x1):** Interpolated grid: dx=1.500 mm, dy=1.500 mm

Maximum value of SAR (interpolated) = 1.24 W/kg

- **Zoom Scan (5x5x7)/Cube 0:** Measurement grid: dx=8mm, dy=8mm, dz=5mm

Reference Value = 35.62 V/m; Power Drift = -0.10 dB

Peak SAR (extrapolated) = 1.36 W/kg

SAR(1 g) = 0.999 W/kg; SAR(10 g) = 0.753 W/kg

Maximum value of SAR (measured) = 1.22 W/kg

- **Zoom Scan (5x5x7)/Cube 1:** Measurement grid: dx=8mm, dy=8mm, dz=5mm

Reference Value = 35.62 V/m; Power Drift = -0.10 dB

Peak SAR (extrapolated) = 1.21 W/kg

SAR(1 g) = 0.757 W/kg; SAR(10 g) = 0.487 W/kg

Maximum value of SAR (measured) = 1.08 W/kg

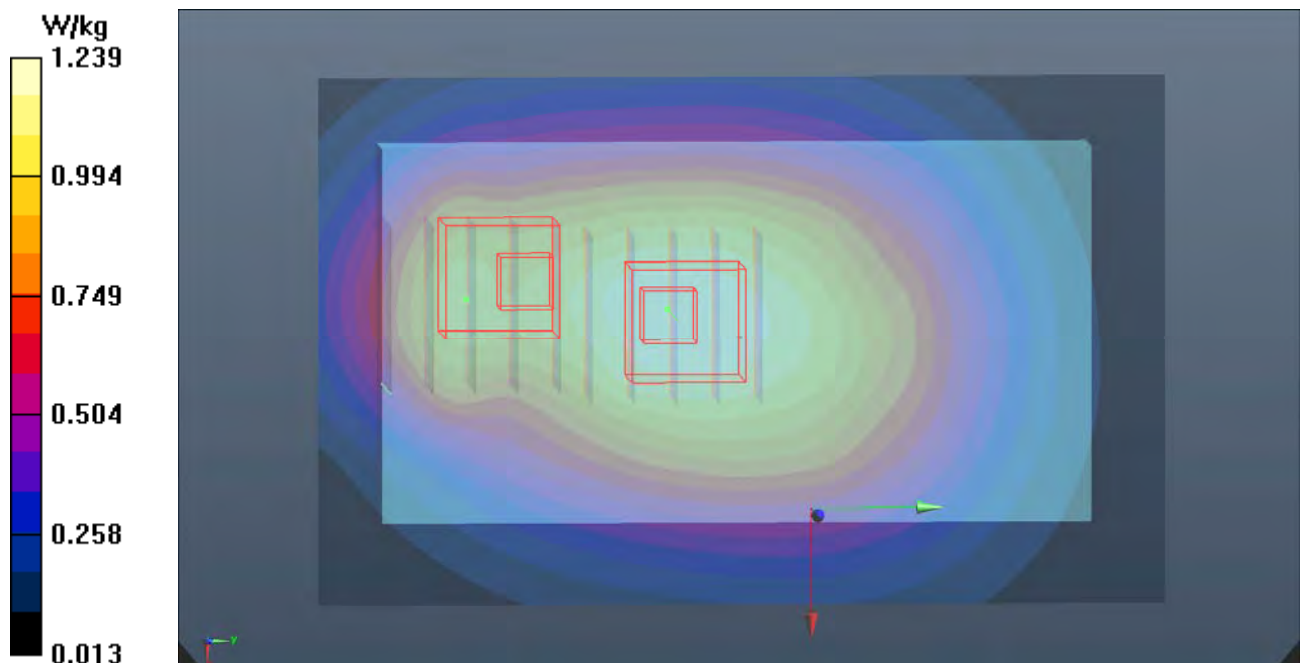

P30 GSM1900_GPRS10_Front Face_1cm_Ch810_Sample1

DUT: 170427C12

Communication System: GPRS10; Frequency: 1909.8 MHz; Duty Cycle: 1:4

Medium: B16T20N2_0812 Medium parameters used: $f = 1910$ MHz; $\sigma = 1.572$ S/m; $\epsilon_r = 50.964$; $\rho = 1000$ kg/m³

Ambient Temperature : 23.7 °C ; Liquid Temperature : 23.3 °C

DASY5 Configuration:

- Probe: EX3DV4 - SN3650; ConvF(8, 8, 8); Calibrated: 2017/07/24;
- Sensor-Surface: 1.4mm (Mechanical Surface Detection)
- Electronics: DAE4 Sn1277; Calibrated: 2017/07/20
- Phantom: Twin SAM Phantom_1822; Type: QD000P40;
- Measurement SW: DASY52, Version 52.8 (8); SEMCAD X Version 14.6.10 (7373)

- **Area Scan (71x111x1):** Interpolated grid: dx=1.500 mm, dy=1.500 mm

Maximum value of SAR (interpolated) = 1.23 W/kg

- **Zoom Scan (5x5x7)/Cube 0:** Measurement grid: dx=8mm, dy=8mm, dz=5mm

Reference Value = 27.66 V/m; Power Drift = -0.07 dB

Peak SAR (extrapolated) = 1.46 W/kg

SAR(1 g) = 0.852 W/kg; SAR(10 g) = 0.532 W/kg

Maximum value of SAR (measured) = 1.21 W/kg

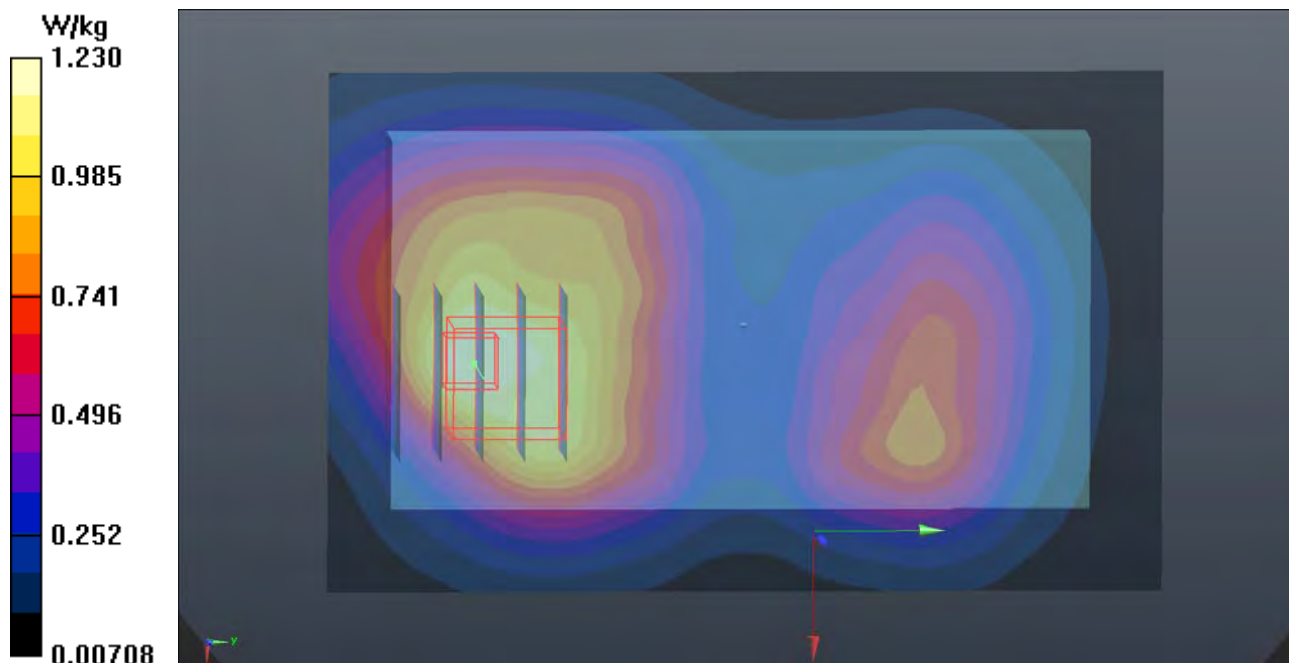

P31 WCDMA II_RMC12.2K_Rear Face_1cm_Ch9400_Sample1

DUT: 170427C12

Communication System: WCDMA; Frequency: 1880 MHz; Duty Cycle: 1:1

Medium: B16T20N1_0822 Medium parameters used: $f = 1880$ MHz; $\sigma = 1.552$ S/m; $\epsilon_r = 51.039$; $\rho = 1000$ kg/m³

Ambient Temperature : 23.4 °C ; Liquid Temperature : 23.1 °C

DASY5 Configuration:

- Probe: EX3DV4 - SN7375; ConvF(7.62, 7.62, 7.62); Calibrated: 2016/12/08;
- Sensor-Surface: 1.4mm (Mechanical Surface Detection)
- Electronics: DAE4 Sn1431; Calibrated: 2017/03/20
- Phantom: Twin SAM Phantom_1822; Type: QD000P40;
- Measurement SW: DASY52, Version 52.8 (8); SEMCAD X Version 14.6.10 (7373)

- **Area Scan (71x111x1):** Interpolated grid: dx=1.500 mm, dy=1.500 mm

Maximum value of SAR (interpolated) = 1.05 W/kg

- **Zoom Scan (5x5x7)/Cube 0:** Measurement grid: dx=8mm, dy=8mm, dz=5mm

Reference Value = 26.07 V/m; Power Drift = -0.14 dB

Peak SAR (extrapolated) = 1.30 W/kg

SAR(1 g) = 0.687 W/kg; SAR(10 g) = 0.342 W/kg

Maximum value of SAR (measured) = 0.999 W/kg

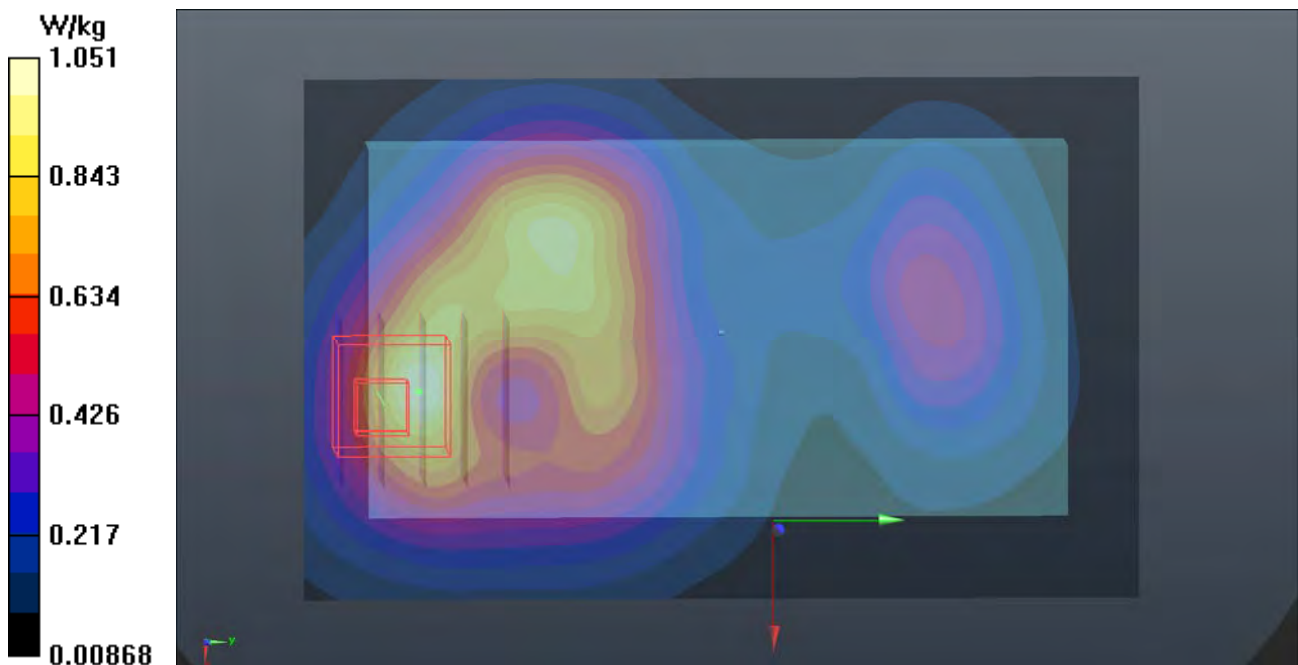

P32 WCDMA IV_RMC12.2K_Rear Face_1cm_Ch1513_Sample1

DUT: 170427C12

Communication System: WCDMA; Frequency: 1752.6 MHz; Duty Cycle: 1:1

Medium: B16T20N1_0822 Medium parameters used: $f = 1753$ MHz; $\sigma = 1.437$ S/m; $\epsilon_r = 51.395$; $\rho = 1000$ kg/m³

Ambient Temperature : 23.6 °C ; Liquid Temperature : 23.4 °C

DASY5 Configuration:

- Probe: EX3DV4 - SN7375; ConvF(8.22, 8.22, 8.22); Calibrated: 2016/12/08;
- Sensor-Surface: 1.4mm (Mechanical Surface Detection)
- Electronics: DAE4 Sn1431; Calibrated: 2017/03/20
- Phantom: Twin SAM Phantom_1822; Type: QD000P40;
- Measurement SW: DASY52, Version 52.8 (8); SEMCAD X Version 14.6.10 (7373)

- **Area Scan (71x111x1):** Interpolated grid: dx=1.500 mm, dy=1.500 mm

Maximum value of SAR (interpolated) = 2.05 W/kg

- **Zoom Scan (5x5x7)/Cube 0:** Measurement grid: dx=8mm, dy=8mm, dz=5mm

Reference Value = 35.97 V/m; Power Drift = -0.04 dB

Peak SAR (extrapolated) = 2.18 W/kg

SAR(1 g) = 1.28 W/kg; SAR(10 g) = 0.726 W/kg

Maximum value of SAR (measured) = 1.73 W/kg

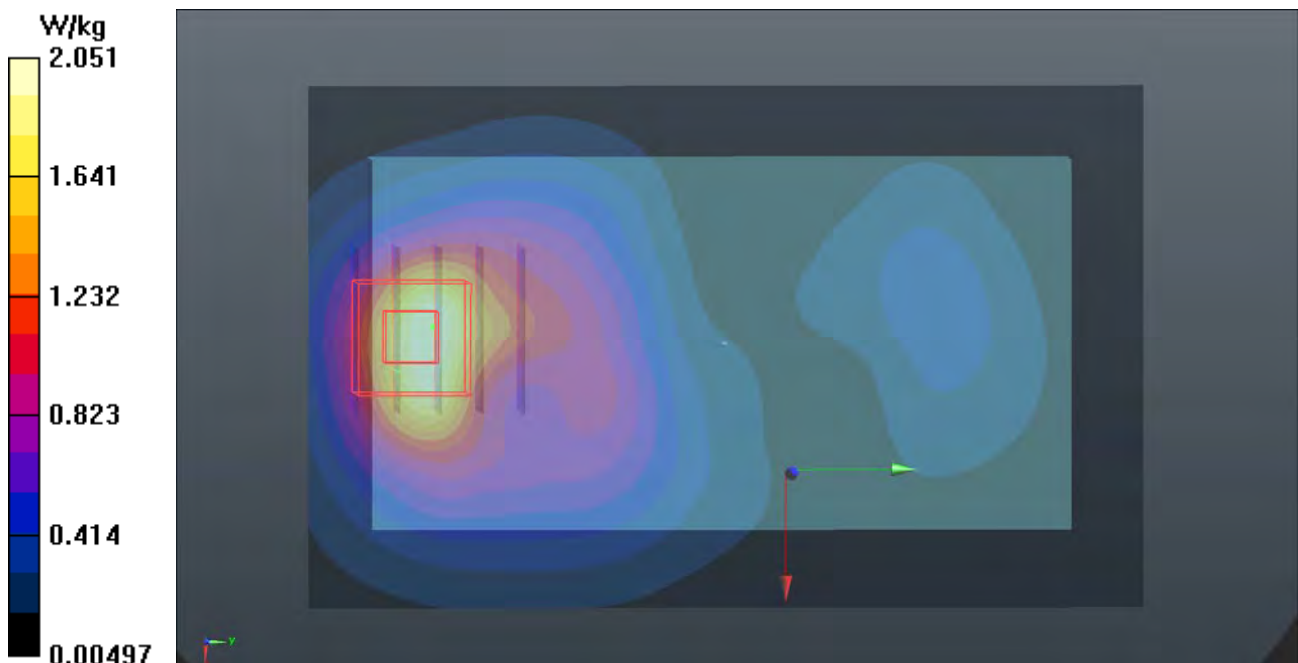

P33 WCDMA V_RMC12.2K_Rear Face_1cm_Ch4233_Sample1

DUT: 170427C12

Communication System: WCDMA; Frequency: 846.6 MHz; Duty Cycle: 1:1

Medium: B07T10N1_0822 Medium parameters used: $f = 847$ MHz; $\sigma = 1.013$ S/m; $\epsilon_r = 54.127$; $\rho = 1000$ kg/m³

Ambient Temperature : 23.5 °C ; Liquid Temperature : 23.3 °C

DASY5 Configuration:

- Probe: EX3DV4 - SN7375; ConvF(9.94, 9.94, 9.94); Calibrated: 2016/12/08;
- Sensor-Surface: 1.4mm (Mechanical Surface Detection)
- Electronics: DAE4 Sn1431; Calibrated: 2017/03/20
- Phantom: Twin SAM Phantom_1822; Type: QD000P40;
- Measurement SW: DASY52, Version 52.8 (8); SEMCAD X Version 14.6.10 (7373)

- **Area Scan (71x111x1):** Interpolated grid: dx=1.500 mm, dy=1.500 mm

Maximum value of SAR (interpolated) = 0.919 W/kg

- **Zoom Scan (5x5x7)/Cube 0:** Measurement grid: dx=8mm, dy=8mm, dz=5mm

Reference Value = 30.61 V/m; Power Drift = -0.14 dB

Peak SAR (extrapolated) = 0.995 W/kg

SAR(1 g) = 0.727 W/kg; SAR(10 g) = 0.545 W/kg

Maximum value of SAR (measured) = 0.897 W/kg

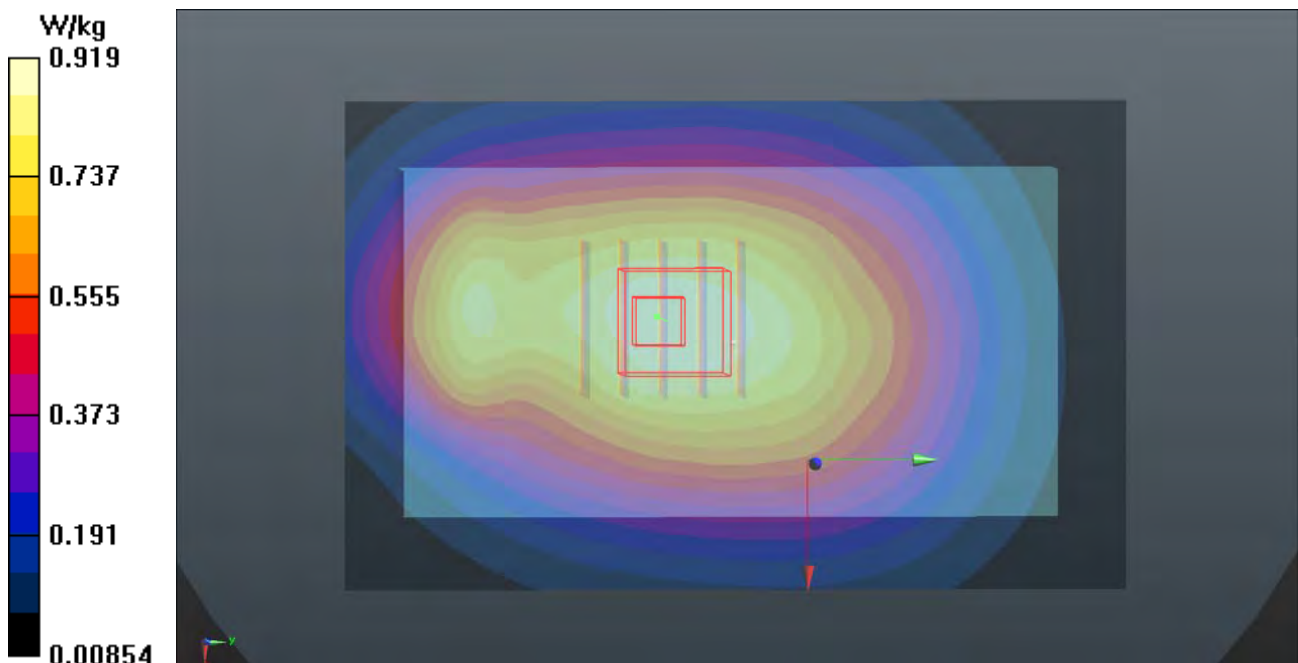

P34 LTE 2_QPSK20M_Front Face_1cm_Ch18900_Sample1_1RB_OS0

DUT: 170427C12

Communication System: LTE; Frequency: 1880 MHz; Duty Cycle: 1:1

Medium: B16T20N2_0812 Medium parameters used: $f = 1880$ MHz; $\sigma = 1.539$ S/m; $\epsilon_r = 51.023$; $\rho = 1000$ kg/m³

Ambient Temperature : 23.7 °C ; Liquid Temperature : 23.3 °C

DASY5 Configuration:

- Probe: EX3DV4 - SN3650; ConvF(8, 8, 8); Calibrated: 2017/07/24;
- Sensor-Surface: 1.4mm (Mechanical Surface Detection)
- Electronics: DAE4 Sn1277; Calibrated: 2017/07/20
- Phantom: Twin SAM Phantom_1822; Type: QD000P40;
- Measurement SW: DASY52, Version 52.8 (8); SEMCAD X Version 14.6.10 (7373)

- **Area Scan (71x111x1):** Interpolated grid: dx=1.500 mm, dy=1.500 mm

Maximum value of SAR (interpolated) = 1.02 W/kg

- **Zoom Scan (5x5x7)/Cube 0:** Measurement grid: dx=8mm, dy=8mm, dz=5mm

Reference Value = 25.52 V/m; Power Drift = -0.12 dB

Peak SAR (extrapolated) = 1.19 W/kg

SAR(1 g) = 0.714 W/kg; SAR(10 g) = 0.449 W/kg

Maximum value of SAR (measured) = 1.01 W/kg

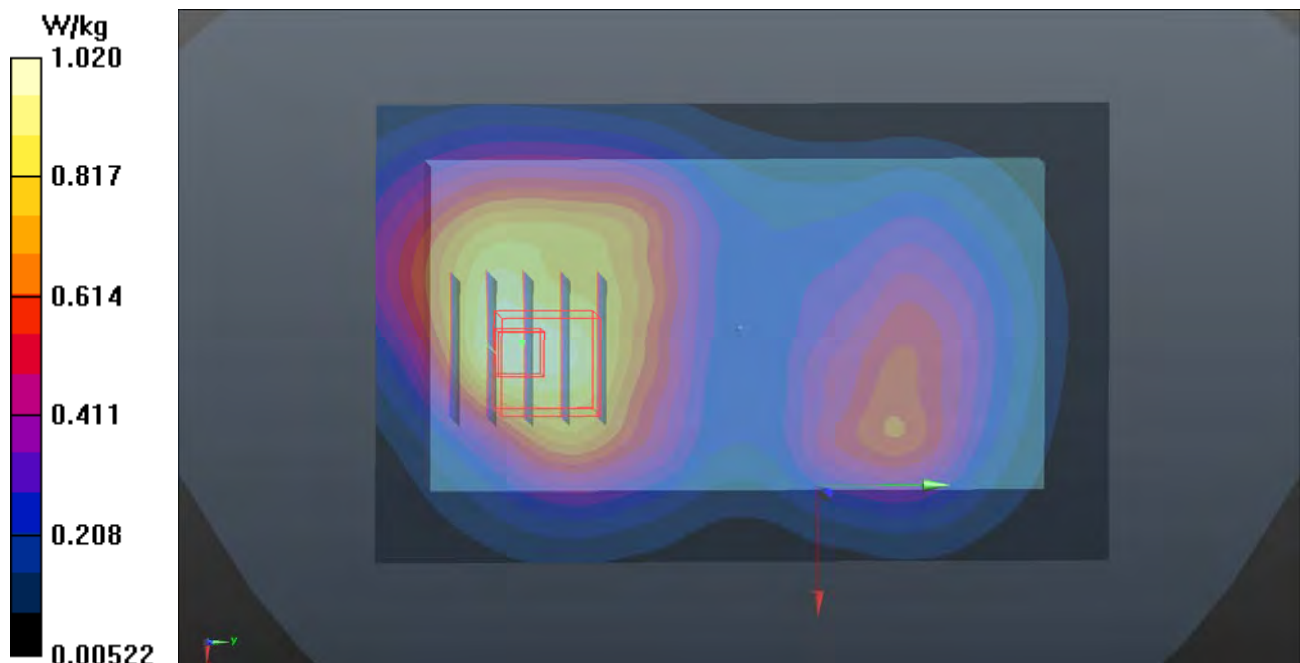

P35 LTE 4_QPSK20M_Rear Face_1cm_Ch20300_Sample1_1RB_OS0

DUT: 170427C12

Communication System: LTE; Frequency: 1745 MHz; Duty Cycle: 1:1

Medium: B16T20N2_0812 Medium parameters used: $f = 1745$ MHz; $\sigma = 1.424$ S/m; $\epsilon_r = 51.436$; $\rho = 1000$ kg/m³

Ambient Temperature : 23.7 °C ; Liquid Temperature : 23.3 °C

DASY5 Configuration:

- Probe: EX3DV4 - SN3650; ConvF(8.27, 8.27, 8.27); Calibrated: 2017/07/24;
- Sensor-Surface: 1.4mm (Mechanical Surface Detection)
- Electronics: DAE4 Sn1277; Calibrated: 2017/07/20
- Phantom: Twin SAM Phantom_1822; Type: QD000P40;
- Measurement SW: DASY52, Version 52.8 (8); SEMCAD X Version 14.6.10 (7373)

- **Area Scan (71x111x1):** Interpolated grid: dx=1.500 mm, dy=1.500 mm

Maximum value of SAR (interpolated) = 1.89 W/kg

- **Zoom Scan (5x5x7)/Cube 0:** Measurement grid: dx=8mm, dy=8mm, dz=5mm

Reference Value = 36.48 V/m; Power Drift = -0.11 dB

Peak SAR (extrapolated) = 2.05 W/kg

SAR(1 g) = 1.22 W/kg; SAR(10 g) = 0.681 W/kg

Maximum value of SAR (measured) = 1.70 W/kg

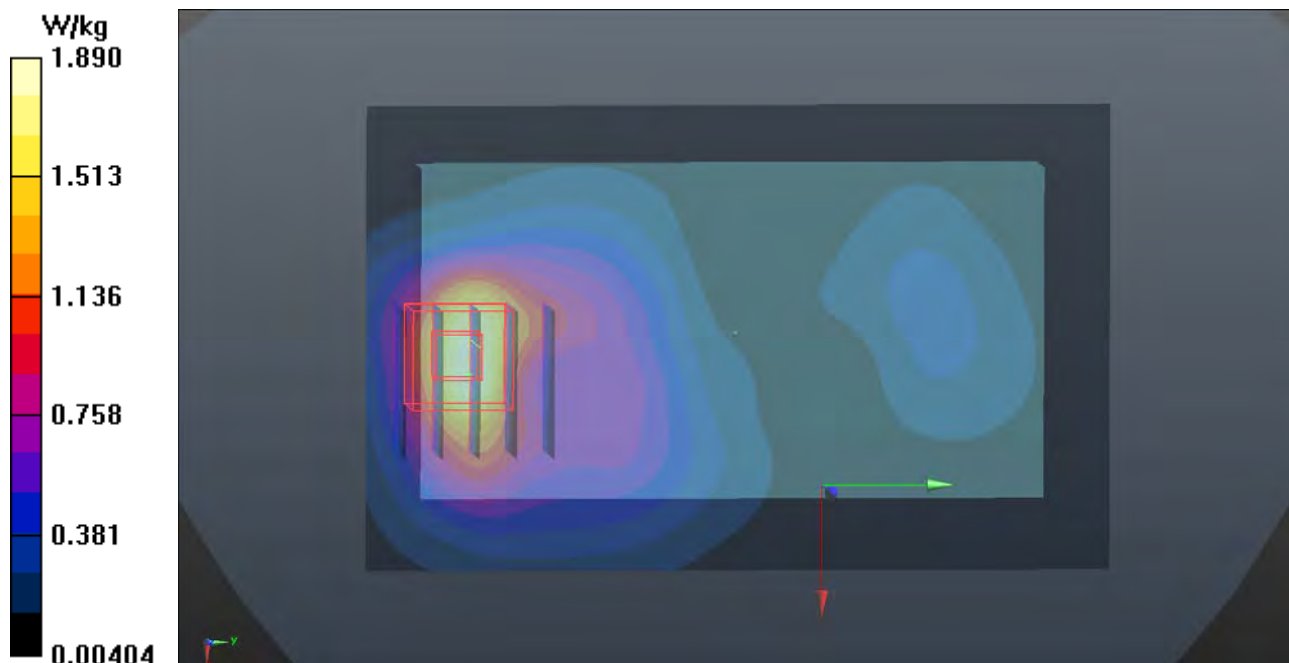

P36 LTE5_QPSK10M_Rear Face_1cm_Ch20525_Sample1_1RB_OS24

DUT: 170427C12

Communication System: LTE; Frequency: 836.5 MHz; Duty Cycle: 1:1

Medium: B07T10N1_0822 Medium parameters used: $f = 836.5$ MHz; $\sigma = 1.004$ S/m; $\epsilon_r = 54.21$; $\rho = 1000$ kg/m³

Ambient Temperature : 23.5 °C ; Liquid Temperature : 23.3 °C

DASY5 Configuration:

- Probe: EX3DV4 - SN7375; ConvF(9.94, 9.94, 9.94); Calibrated: 2016/12/08;
- Sensor-Surface: 1.4mm (Mechanical Surface Detection)
- Electronics: DAE4 Sn1431; Calibrated: 2017/03/20
- Phantom: Twin SAM Phantom_1822; Type: QD000P40;
- Measurement SW: DASY52, Version 52.8 (8); SEMCAD X Version 14.6.10 (7373)

- **Area Scan (71x111x1):** Interpolated grid: dx=1.500 mm, dy=1.500 mm

Maximum value of SAR (interpolated) = 1.04 W/kg

- **Zoom Scan (5x5x7)/Cube 0:** Measurement grid: dx=8mm, dy=8mm, dz=5mm

Reference Value = 32.55 V/m; Power Drift = -0.04 dB

Peak SAR (extrapolated) = 1.17 W/kg

SAR(1 g) = 0.843 W/kg; SAR(10 g) = 0.635 W/kg

Maximum value of SAR (measured) = 1.04 W/kg

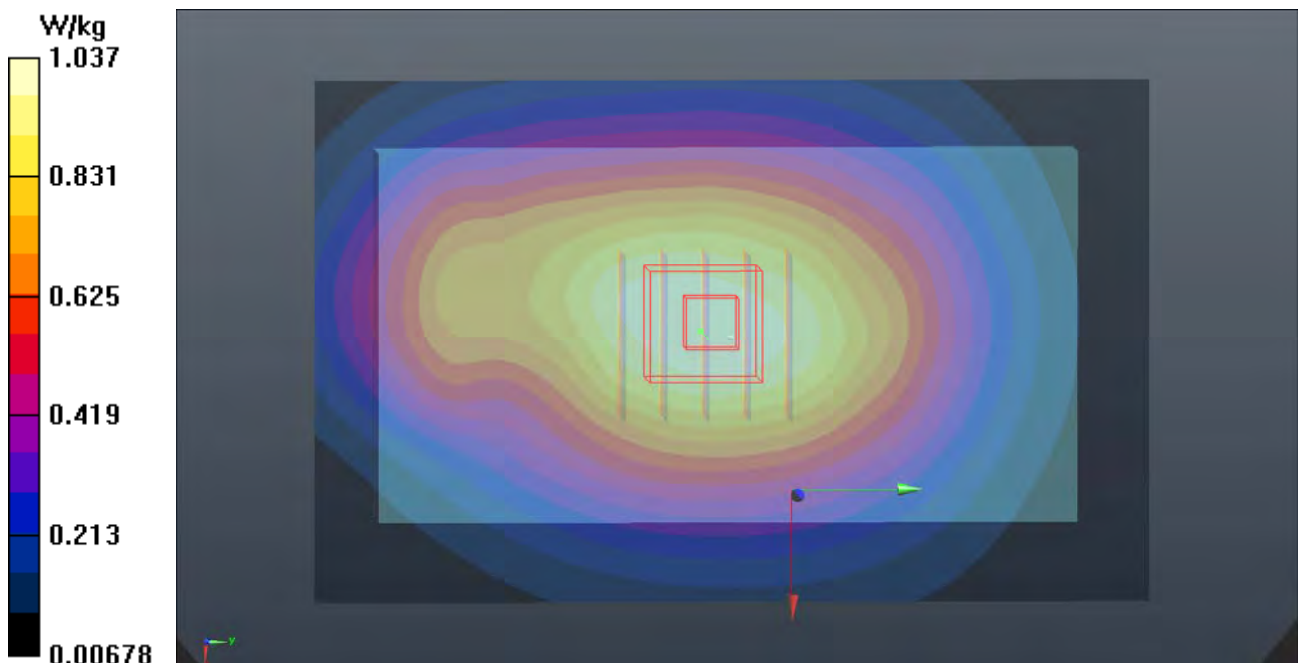

P37 LTE 12_QPSK10M_Rear Face_1cm_Ch23095_Sample1_1RB_OS0

DUT: 170427C12

Communication System: LTE; Frequency: 707.5 MHz; Duty Cycle: 1:1

Medium: B06T09N1_0813 Medium parameters used: $f = 707.5 \text{ MHz}$; $\sigma = 0.92 \text{ S/m}$; ϵ_r

$= 56.834$; $\rho = 1000 \text{ kg/m}^3$

Ambient Temperature : $23.9 \text{ }^\circ\text{C}$; Liquid Temperature : $23.6 \text{ }^\circ\text{C}$

DASY5 Configuration:

- Probe: EX3DV4 - SN7375; ConvF(9.94, 9.94, 9.94); Calibrated: 2016/12/08;
- Sensor-Surface: 1.4mm (Mechanical Surface Detection)
- Electronics: DAE4 Sn1431; Calibrated: 2017/03/20
- Phantom: Twin SAM Phantom_1653; Type: QD000P40;
- Measurement SW: DASY52, Version 52.8 (8); SEMCAD X Version 14.6.10 (7373)

- **Area Scan (71x111x1):** Interpolated grid: $dx=1.500 \text{ mm}$, $dy=1.500 \text{ mm}$

Maximum value of SAR (interpolated) = 0.711 W/kg

- **Zoom Scan (5x5x7)/Cube 0:** Measurement grid: $dx=8\text{mm}$, $dy=8\text{mm}$, $dz=5\text{mm}$

Reference Value = 26.84 V/m ; Power Drift = -0.05 dB

Peak SAR (extrapolated) = 0.773 W/kg

SAR(1 g) = 0.426 W/kg ; SAR(10 g) = 0.280 W/kg

Maximum value of SAR (measured) = 0.632 W/kg

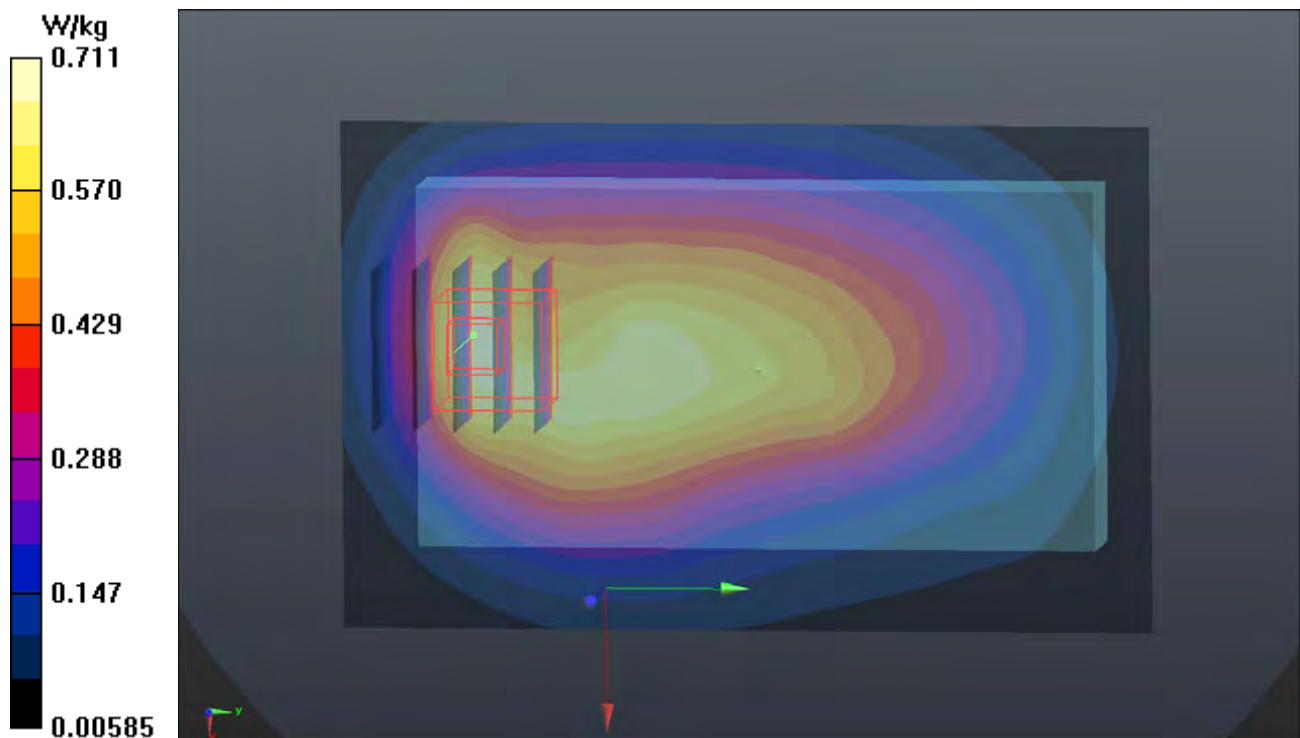

P38 LTE 17_QPSK10M_Rear Face_1cm_Ch23790_Sample1_1RB_OS0

DUT: 170427C12

Communication System: LTE; Frequency: 710 MHz; Duty Cycle: 1:1

Medium: B06T09N1_0813 Medium parameters used: $f = 710 \text{ MHz}$; $\sigma = 0.923 \text{ S/m}$; $\epsilon_r = 56.822$; $\rho = 1000 \text{ kg/m}^3$

Ambient Temperature : $23.9 \text{ }^\circ\text{C}$; Liquid Temperature : $23.6 \text{ }^\circ\text{C}$

DASY5 Configuration:

- Probe: EX3DV4 - SN7375; ConvF(9.94, 9.94, 9.94); Calibrated: 2016/12/08;
- Sensor-Surface: 1.4mm (Mechanical Surface Detection)
- Electronics: DAE4 Sn1431; Calibrated: 2017/03/20
- Phantom: Twin SAM Phantom_1653; Type: QD000P40;
- Measurement SW: DASY52, Version 52.8 (8); SEMCAD X Version 14.6.10 (7373)

- **Area Scan (71x111x1):** Interpolated grid: $dx=1.500 \text{ mm}$, $dy=1.500 \text{ mm}$

Maximum value of SAR (interpolated) = 0.722 W/kg

- **Zoom Scan (5x5x7)/Cube 0:** Measurement grid: $dx=8\text{mm}$, $dy=8\text{mm}$, $dz=5\text{mm}$

Reference Value = 26.82 V/m ; Power Drift = 0.03 dB

Peak SAR (extrapolated) = 0.783 W/kg

SAR(1 g) = 0.438 W/kg ; SAR(10 g) = 0.285 W/kg

Maximum value of SAR (measured) = 0.654 W/kg

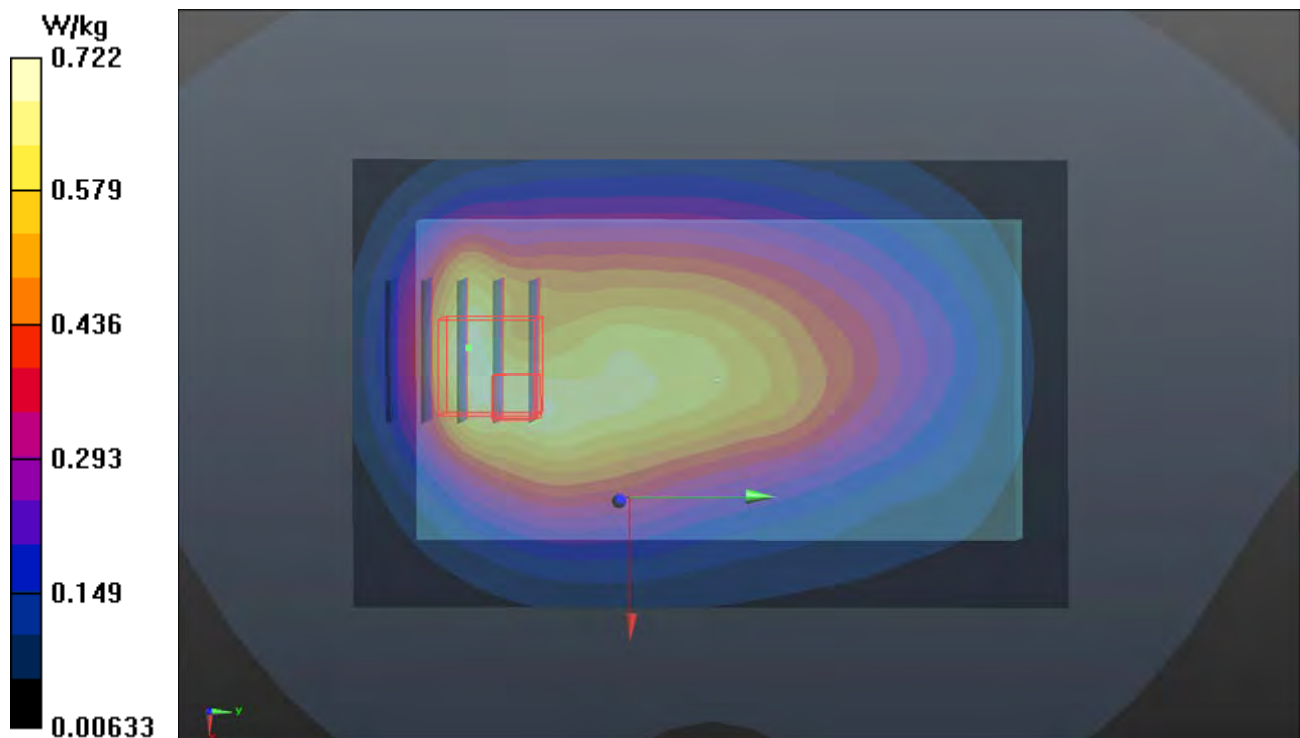

P39 2.4G WLAN_802.11b_Right Side_1cm_Ch6_Sample1

DUT: 170427C12

Communication System: WLAN_2.4G; Frequency: 2437 MHz; Duty Cycle: 1:1

Medium: B19T27N1_0817 Medium parameters used: $f = 2437$ MHz; $\sigma = 2.009$ S/m; $\epsilon_r = 51.451$; $\rho =$

1000 kg/m³

Ambient Temperature : 23.8 °C ; Liquid Temperature : 23.2 °C

DASY5 Configuration:

- Probe: EX3DV4 - SN7375; ConvF(7.33, 7.33, 7.33); Calibrated: 2016/12/08;
- Sensor-Surface: 1.4mm (Mechanical Surface Detection)
- Electronics: DAE4 Sn1431; Calibrated: 2017/03/20
- Phantom: Twin SAM Phantom_1652; Type: QD000P40;
- Measurement SW: DASY52, Version 52.8 (8); SEMCAD X Version 14.6.10 (7373)

- **Area Scan (71x141x1):** Interpolated grid: dx=1.200 mm, dy=1.200 mm

Maximum value of SAR (interpolated) = 1.21 W/kg

- **Zoom Scan (5x5x7)/Cube 0:** Measurement grid: dx=8mm, dy=8mm, dz=5mm

Reference Value = 25.31 V/m; Power Drift = 0.13 dB

Peak SAR (extrapolated) = 1.85 W/kg

SAR(1 g) = 0.934 W/kg; SAR(10 g) = 0.445 W/kg

Maximum value of SAR (measured) = 1.47 W/kg

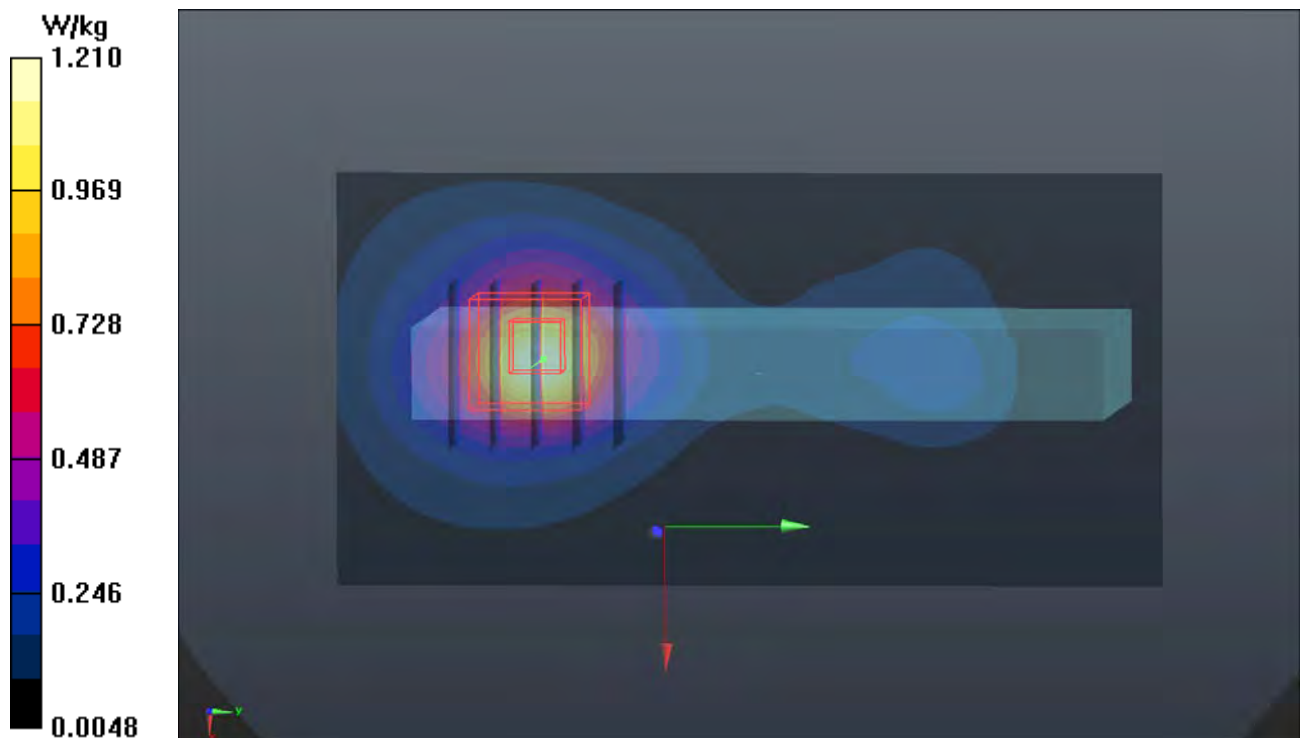

P40 GSM850_GPRS10_EUT(Front)_Top join_0cm_Ch251_Sample2

DUT: 170427C12

Communication System: GPRS10; Frequency: 848.8 MHz; Duty Cycle: 1:4

Medium: B07T10N2_0813 Medium parameters used: $f = 849$ MHz; $\sigma = 0.981$ S/m; $\epsilon_r = 54.884$; $\rho = 1000$ kg/m³

Ambient Temperature : 23.9 °C ; Liquid Temperature : 23.6 °C

DASY5 Configuration:

- Probe: EX3DV4 - SN7375; ConvF(9.94, 9.94, 9.94); Calibrated: 2016/12/08;
- Sensor-Surface: 1.4mm (Mechanical Surface Detection)
- Electronics: DAE4 Sn1431; Calibrated: 2017/03/20
- Phantom: Twin SAM Phantom_1653; Type: QD000P40;
- Measurement SW: DASY52, Version 52.8 (8); SEMCAD X Version 14.6.10 (7373)

- **Area Scan (71x111x1):** Interpolated grid: dx=1.500 mm, dy=1.500 mm

Maximum value of SAR (interpolated) = 0.628 W/kg

- **Zoom Scan (5x5x7)/Cube 0:** Measurement grid: dx=8mm, dy=8mm, dz=5mm

Reference Value = 25.86 V/m; Power Drift = -0.16 dB

Peak SAR (extrapolated) = 1.12 W/kg

SAR(1 g) = 0.395 W/kg; SAR(10 g) = 0.189 W/kg

Maximum value of SAR (measured) = 0.705 W/kg

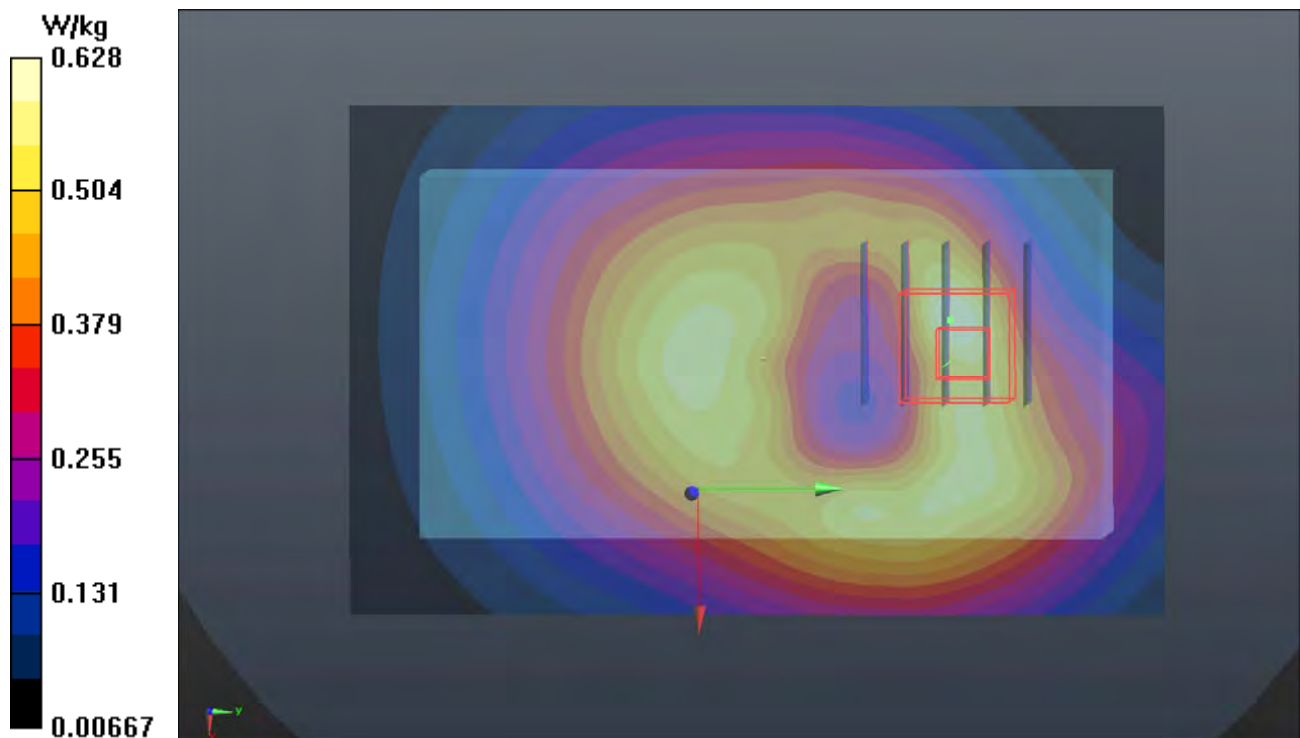

P41 GSM1900_GPRS10_EUT(Front)_Top join_0cm_Ch512_Sample1

DUT: 170427C12

Communication System: GPRS10; Frequency: 1850.2 MHz; Duty Cycle: 1:4

Medium: B16T20N2_0814 Medium parameters used: $f = 1850.2$ MHz; $\sigma = 1.569$ S/m; $\epsilon_r = 52.098$; $\rho = 1000$ kg/m³

Ambient Temperature : 23.8 °C ; Liquid Temperature : 23.6 °C

DASY5 Configuration:

- Probe: EX3DV4 - SN7375; ConvF(7.62, 7.62, 7.62); Calibrated: 2016/12/08;
- Sensor-Surface: 1.4mm (Mechanical Surface Detection)
- Electronics: DAE4 Sn1431; Calibrated: 2017/03/20
- Phantom: Twin SAM Phantom_1652; Type: QD000P40;
- Measurement SW: DASY52, Version 52.8 (8); SEMCAD X Version 14.6.10 (7373)

- **Area Scan (71x121x1):** Interpolated grid: dx=1.500 mm, dy=1.500 mm

Maximum value of SAR (interpolated) = 0.593 W/kg

- **Zoom Scan (5x5x7)/Cube 0:** Measurement grid: dx=8mm, dy=8mm, dz=5mm

Reference Value = 19.26 V/m; Power Drift = 0.13 dB

Peak SAR (extrapolated) = 0.675 W/kg

SAR(1 g) = 0.565 W/kg; SAR(10 g) = 0.333 W/kg

Maximum value of SAR (measured) = 0.580 W/kg

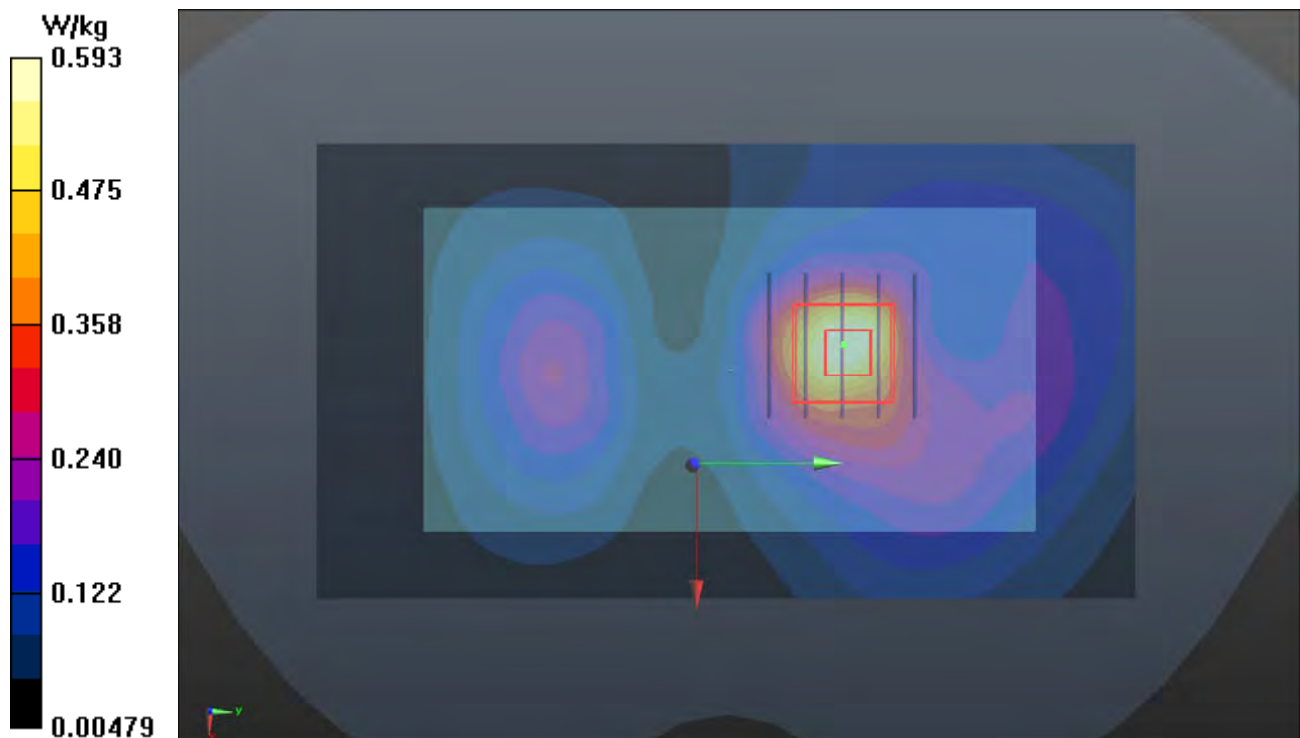

P42 WCDMA II_RMC12.2K_EUT(Front)_Top join_0cm_Ch9400_Sample1_Power Pack_w

DUT: 170427C12

Communication System: WCDMA; Frequency: 1880 MHz; Duty Cycle: 1:1

Medium: B16T20N2_0812 Medium parameters used: $f = 1880$ MHz; $\sigma = 1.539$ S/m; $\epsilon_r = 51.023$; $\rho = 1000$ kg/m³

Ambient Temperature : 23.7 °C ; Liquid Temperature : 23.3 °C

DASY5 Configuration:

- Probe: EX3DV4 - SN3650; ConvF(8, 8, 8); Calibrated: 2017/07/24;
- Sensor-Surface: 1.4mm (Mechanical Surface Detection)
- Electronics: DAE4 Sn1277; Calibrated: 2017/07/20
- Phantom: Twin SAM Phantom_1822; Type: QD000P40;
- Measurement SW: DASY52, Version 52.8 (8); SEMCAD X Version 14.6.10 (7373)

- **Area Scan (71x111x1):** Interpolated grid: dx=1.500 mm, dy=1.500 mm
Maximum value of SAR (interpolated) = 1.26 W/kg

- **Zoom Scan (5x5x7)/Cube 0:** Measurement grid: dx=8mm, dy=8mm, dz=5mm
Reference Value = 26.10 V/m; Power Drift = -0.03 dB
Peak SAR (extrapolated) = 1.27 W/kg
SAR(1 g) = 0.838 W/kg; SAR(10 g) = 0.535 W/kg
Maximum value of SAR (measured) = 1.10 W/kg

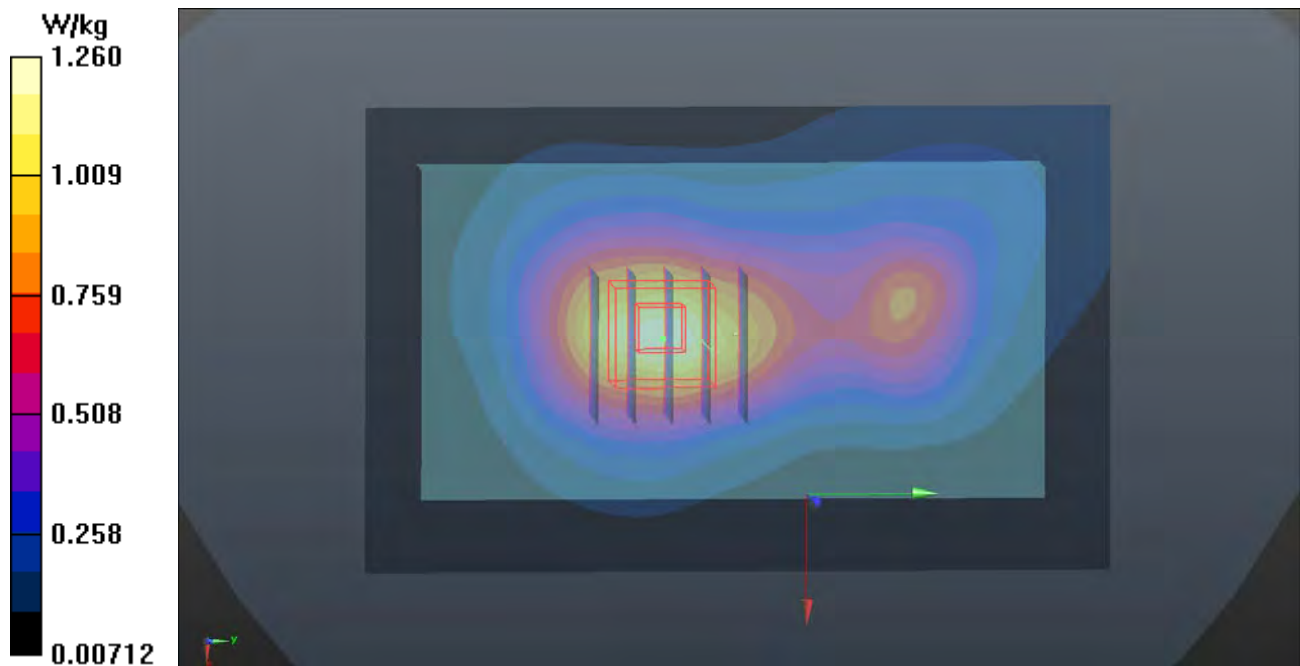

P43 WCDMA IV_RMC12.2K_EUT(Front)_Top join_0cm_Ch1513_Sample1

DUT: 170427C12

Communication System: WCDMA; Frequency: 1752.6 MHz; Duty Cycle: 1:1

Medium: B16T20N1_0814 Medium parameters used: $f = 1753$ MHz; $\sigma = 1.455$ S/m; $\epsilon_r = 52.464$; $\rho = 1000$ kg/m³

Ambient Temperature : 23.8 °C ; Liquid Temperature : 23.6 °C

DASY5 Configuration:

- Probe: EX3DV4 - SN7375; ConvF(8.22, 8.22, 8.22); Calibrated: 2016/12/08;
- Sensor-Surface: 1.4mm (Mechanical Surface Detection)
- Electronics: DAE4 Sn1431; Calibrated: 2017/03/20
- Phantom: Twin SAM Phantom_1652; Type: QD000P40;
- Measurement SW: DASY52, Version 52.8 (8); SEMCAD X Version 14.6.10 (7373)

- **Area Scan (71x121x1):** Interpolated grid: dx=1.500 mm, dy=1.500 mm

Maximum value of SAR (interpolated) = 0.942 W/kg

- **Zoom Scan (5x5x7)/Cube 0:** Measurement grid: dx=8mm, dy=8mm, dz=5mm

Reference Value = 25.20 V/m; Power Drift = -0.12 dB

Peak SAR (extrapolated) = 1.11 W/kg

SAR(1 g) = 0.739 W/kg; SAR(10 g) = 0.453 W/kg

Maximum value of SAR (measured) = 0.971 W/kg

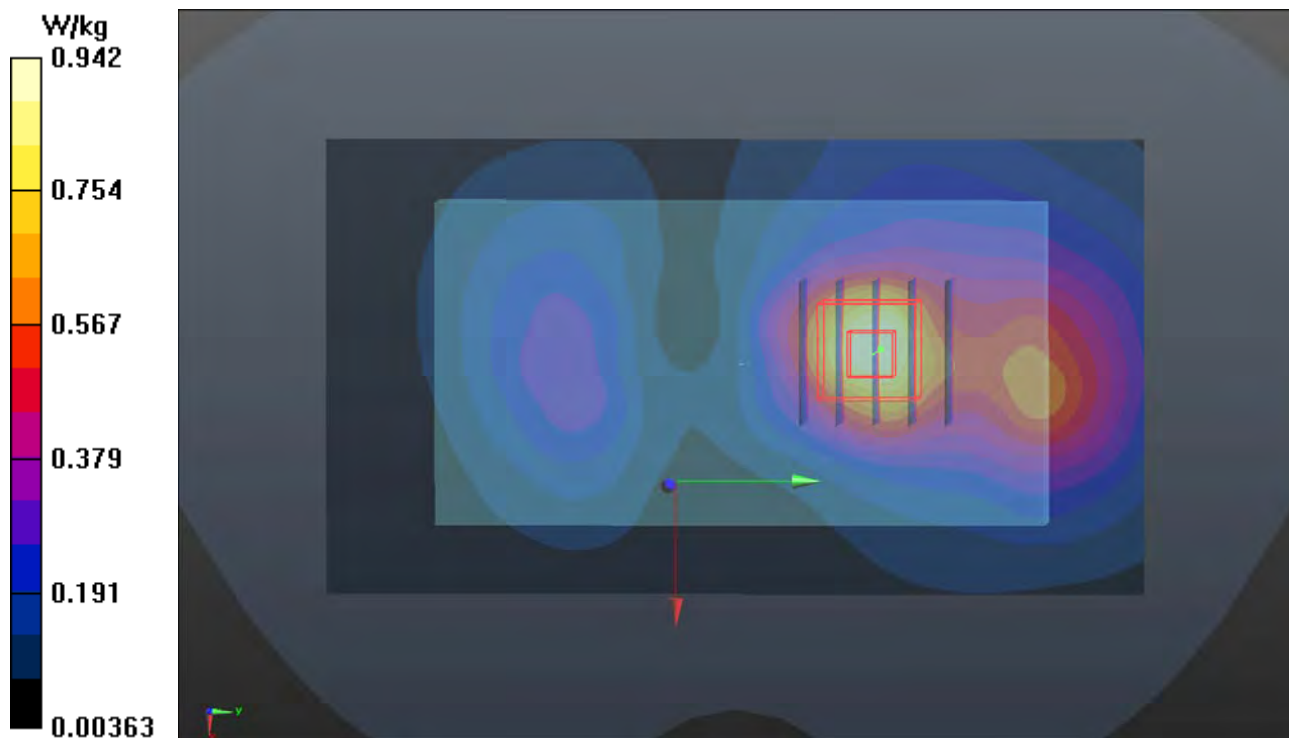

P44 WCDMA V_RMC12.2K_EUT(Front)_Top join_0cm_Ch4233_Sample1

DUT: 170427C12

Communication System: WCDMA; Frequency: 846.6 MHz; Duty Cycle: 1:1

Medium: B07T10N2_0813 Medium parameters used: $f = 847$ MHz; $\sigma = 0.979$ S/m; $\epsilon_r = 54.908$; $\rho = 1000$ kg/m³

Ambient Temperature : 23.9 °C ; Liquid Temperature : 23.6 °C

DASY5 Configuration:

- Probe: EX3DV4 - SN7375; ConvF(9.94, 9.94, 9.94); Calibrated: 2016/12/08;
- Sensor-Surface: 1.4mm (Mechanical Surface Detection)
- Electronics: DAE4 Sn1431; Calibrated: 2017/03/20
- Phantom: Twin SAM Phantom_1653; Type: QD000P40;
- Measurement SW: DASY52, Version 52.8 (8); SEMCAD X Version 14.6.10 (7373)

- **Area Scan (71x111x1):** Interpolated grid: dx=1.500 mm, dy=1.500 mm

Maximum value of SAR (interpolated) = 0.484 W/kg

- **Zoom Scan (5x5x7)/Cube 0:** Measurement grid: dx=8mm, dy=8mm, dz=5mm

Reference Value = 22.59 V/m; Power Drift = -0.12 dB

Peak SAR (extrapolated) = 0.720 W/kg

SAR(1 g) = 0.247 W/kg; SAR(10 g) = 0.111 W/kg

Maximum value of SAR (measured) = 0.460 W/kg

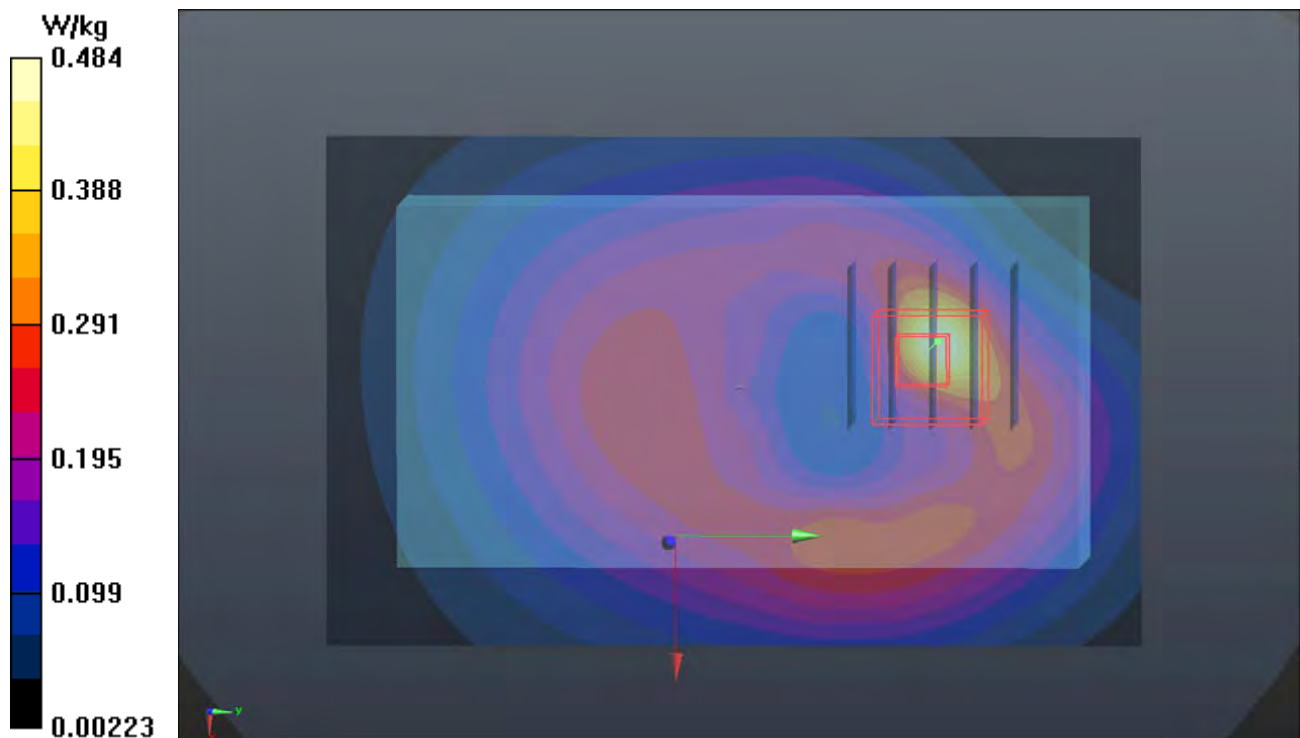

P45 LTE 2_QPSK20M_EUT(Front)_Top join_0cm_Ch18900_Sample1_1RB_OS0

DUT: 170427C12

Communication System: LTE; Frequency: 1880 MHz; Duty Cycle: 1:1

Medium: B16T20N1_0814 Medium parameters used: $f = 1880$ MHz; $\sigma = 1.569$ S/m; $\epsilon_r = 52.098$; $\rho = 1000$ kg/m³

Ambient Temperature : 23.8 °C ; Liquid Temperature : 23.6 °C

DASY5 Configuration:

- Probe: EX3DV4 - SN7375; ConvF(7.62, 7.62, 7.62); Calibrated: 2016/12/08;
- Sensor-Surface: 1.4mm (Mechanical Surface Detection)
- Electronics: DAE4 Sn1431; Calibrated: 2017/03/20
- Phantom: Twin SAM Phantom_1652; Type: QD000P40;
- Measurement SW: DASY52, Version 52.8 (8); SEMCAD X Version 14.6.10 (7373)

- **Area Scan (71x121x1):** Interpolated grid: dx=1.500 mm, dy=1.500 mm

Maximum value of SAR (interpolated) = 0.593 W/kg

- **Zoom Scan (5x5x7)/Cube 0:** Measurement grid: dx=8mm, dy=8mm, dz=5mm

Reference Value = 19.26 V/m; Power Drift = -0.17 dB

Peak SAR (extrapolated) = 0.675 W/kg

SAR(1 g) = 0.441 W/kg; SAR(10 g) = 0.262 W/kg

Maximum value of SAR (measured) = 0.580 W/kg

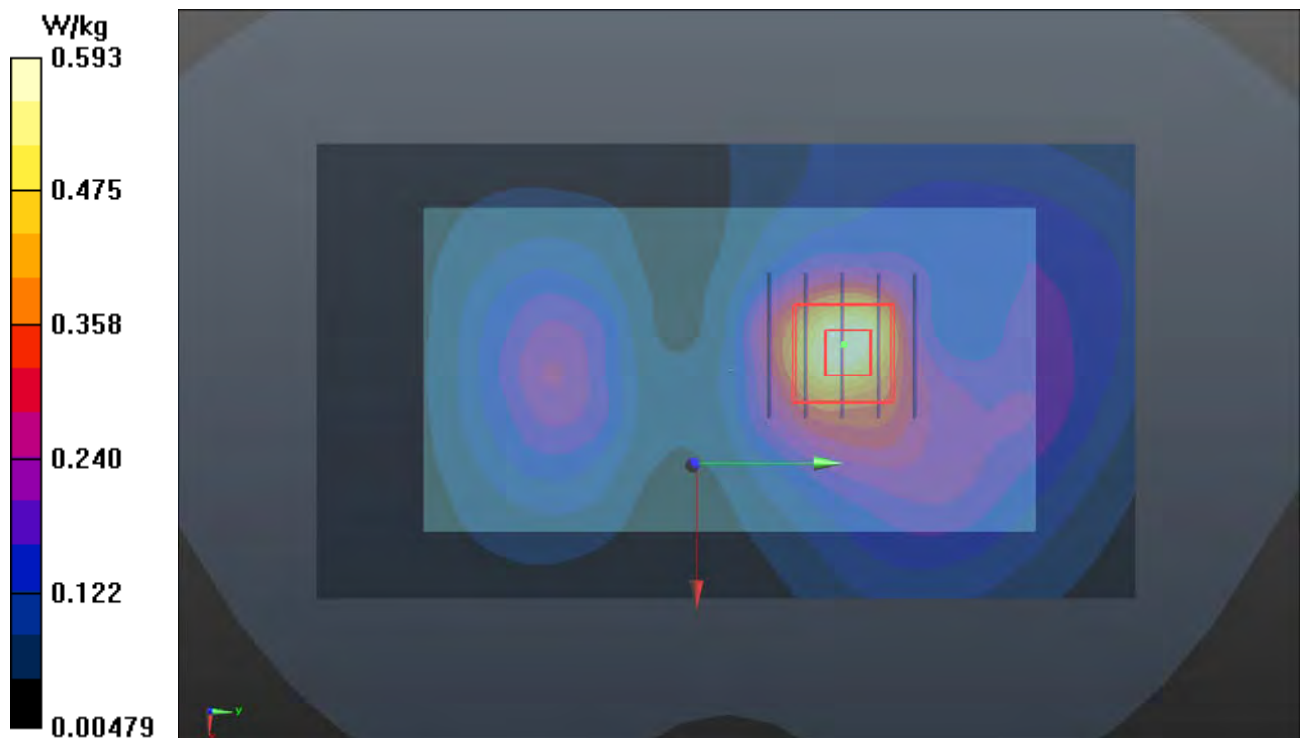

P46 LTE 4_QPSK20M_EUT(Front)_Top join_0cm_Ch20175_Sample1_1RB_OS0

DUT: 170427C12

Communication System: LTE; Frequency: 1732.5 MHz; Duty Cycle: 1:1

Medium: B16T20N1_0814 Medium parameters used: $f = 1732.5$ MHz; $\sigma = 1.436$ S/m; $\epsilon_r = 52.524$; $\rho = 1000$ kg/m³

Ambient Temperature : 23.8 °C ; Liquid Temperature : 23.6 °C

DASY5 Configuration:

- Probe: EX3DV4 - SN7375; ConvF(8.22, 8.22, 8.22); Calibrated: 2016/12/08;
- Sensor-Surface: 1.4mm (Mechanical Surface Detection)
- Electronics: DAE4 Sn1431; Calibrated: 2017/03/20
- Phantom: Twin SAM Phantom_1652; Type: QD000P40;
- Measurement SW: DASY52, Version 52.8 (8); SEMCAD X Version 14.6.10 (7373)

- **Area Scan (71x121x1):** Interpolated grid: dx=1.500 mm, dy=1.500 mm

Maximum value of SAR (interpolated) = 0.517 W/kg

- **Zoom Scan (5x5x7)/Cube 0:** Measurement grid: dx=8mm, dy=8mm, dz=5mm

Reference Value = 18.94 V/m; Power Drift = -0.17 dB

Peak SAR (extrapolated) = 0.605 W/kg

SAR(1 g) = 0.406 W/kg; SAR(10 g) = 0.250 W/kg

Maximum value of SAR (measured) = 0.530 W/kg

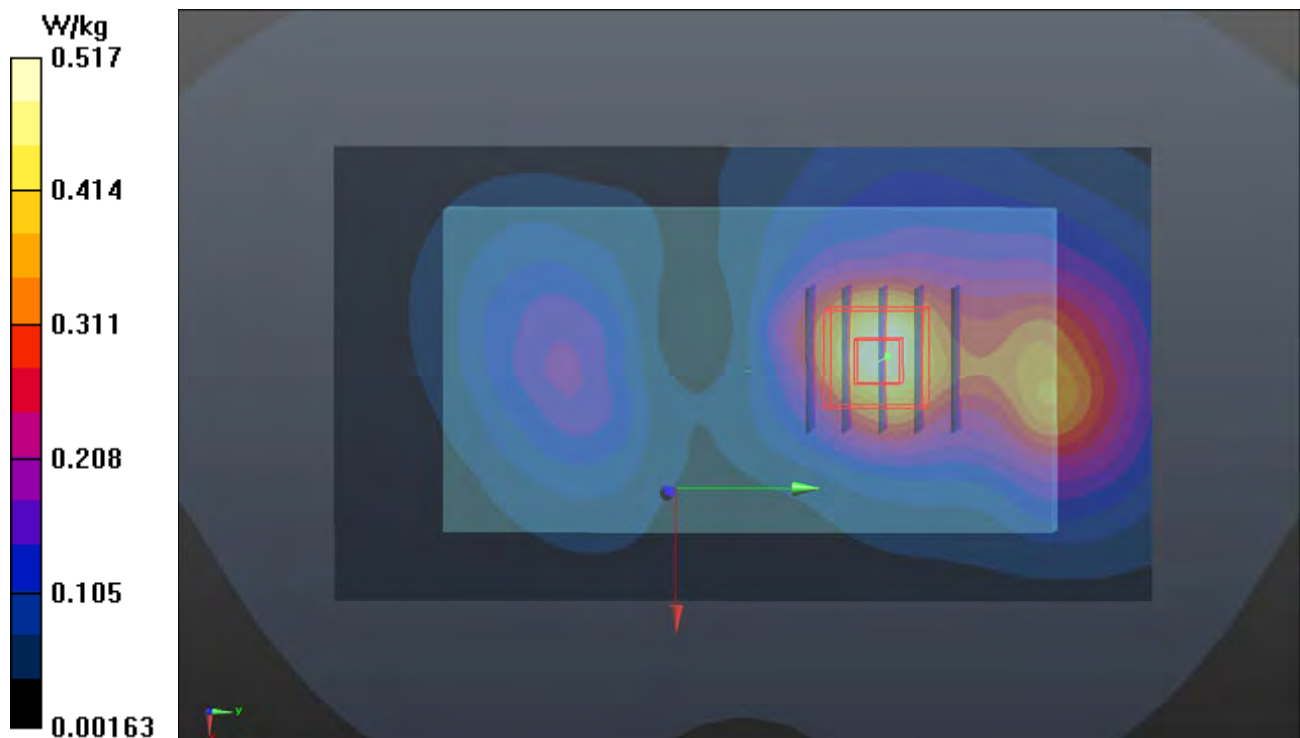

P47 LTE 5_QPSK10M_EUT(Front)_Bottom join_0cm_Ch20525_Sample1_1RB_OS24

DUT: 170427C12

Communication System: LTE; Frequency: 836.5 MHz; Duty Cycle: 1:1

Medium: B07T10N2_0813 Medium parameters used: $f = 836.5$ MHz; $\sigma = 0.97$ S/m; $\epsilon_r = 54.99$; $\rho =$

1000 kg/m³

Ambient Temperature : 23.9 °C ; Liquid Temperature : 23.6 °C

DASY5 Configuration:

- Probe: EX3DV4 - SN7375; ConvF(9.94, 9.94, 9.94); Calibrated: 2016/12/08;
- Sensor-Surface: 1.4mm (Mechanical Surface Detection)
- Electronics: DAE4 Sn1431; Calibrated: 2017/03/20
- Phantom: Twin SAM Phantom_1653; Type: QD000P40;
- Measurement SW: DASY52, Version 52.8 (8); SEMCAD X Version 14.6.10 (7373)

- **Area Scan (71x111x1):** Interpolated grid: dx=1.500 mm, dy=1.500 mm

Maximum value of SAR (interpolated) = 0.293 W/kg

- **Zoom Scan (5x5x7)/Cube 0:** Measurement grid: dx=8mm, dy=8mm, dz=5mm

Reference Value = 18.43 V/m; Power Drift = 0.00 dB

Peak SAR (extrapolated) = 0.369 W/kg

SAR(1 g) = 0.223 W/kg; SAR(10 g) = 0.135 W/kg

Maximum value of SAR (measured) = 0.305 W/kg

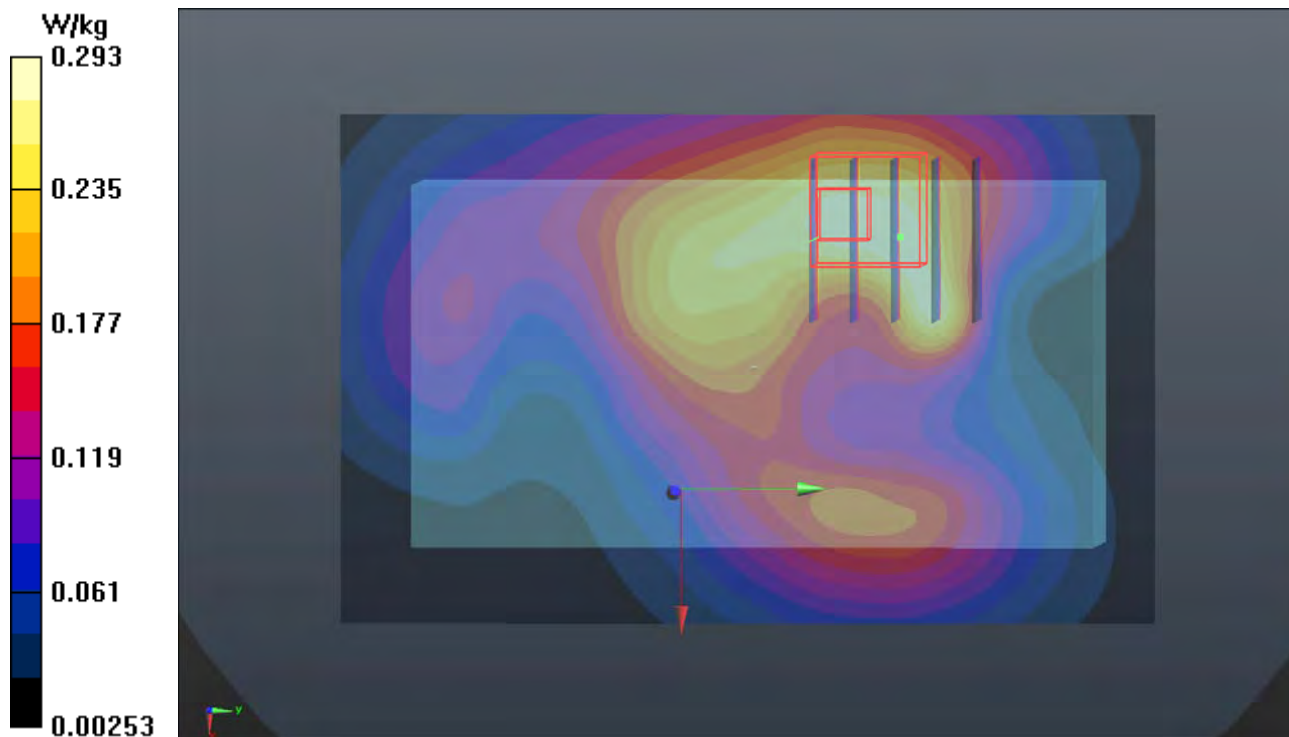

P48 LTE 12_QPSK10M_EUT(Front)_Bottom join_0cm_Ch23095_Sample1_1RB_OS0

DUT: 170427C12

Communication System: LTE; Frequency: 707.5 MHz; Duty Cycle: 1:1

Medium: B06T09N1_0813 Medium parameters used: $f = 707.5$ MHz; $\sigma = 0.92$ S/m; $\epsilon_r = 56.834$; $\rho = 1000$ kg/m³

Ambient Temperature : 23.9 °C ; Liquid Temperature : 23.6 °C

DASY5 Configuration:

- Probe: EX3DV4 - SN7375; ConvF(9.94, 9.94, 9.94); Calibrated: 2016/12/08;
- Sensor-Surface: 1.4mm (Mechanical Surface Detection)
- Electronics: DAE4 Sn1431; Calibrated: 2017/03/20
- Phantom: Twin SAM Phantom_1653; Type: QD000P40;
- Measurement SW: DASY52, Version 52.8 (8); SEMCAD X Version 14.6.10 (7373)

- **Area Scan (71x111x1):** Interpolated grid: dx=1.500 mm, dy=1.500 mm

Maximum value of SAR (interpolated) = 0.471 W/kg

- **Zoom Scan (5x5x7)/Cube 0:** Measurement grid: dx=8mm, dy=8mm, dz=5mm

Reference Value = 22.94 V/m; Power Drift = -0.01 dB

Peak SAR (extrapolated) = 0.569 W/kg

SAR(1 g) = 0.384 W/kg; SAR(10 g) = 0.274 W/kg

Maximum value of SAR (measured) = 0.500 W/kg

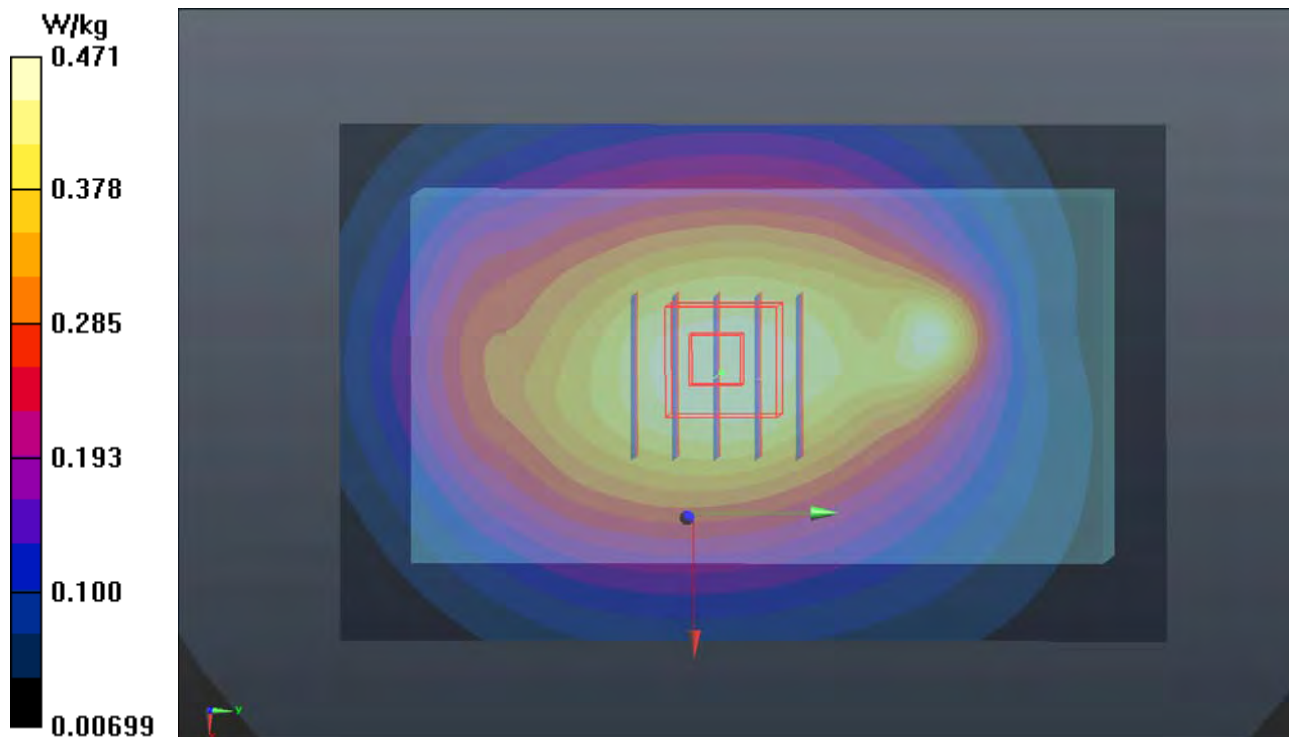

P49 LTE 17_QPSK10M_EUT(Front)_Bottom join_0cm_Ch23790_Sample1_1RB_OS0

DUT: 170427C12

Communication System: LTE; Frequency: 710 MHz; Duty Cycle: 1:1

Medium: B06T09N1_0813 Medium parameters used: $f = 710 \text{ MHz}$; $\sigma = 0.923 \text{ S/m}$; $\epsilon_r = 56.822$; $\rho = 1000 \text{ kg/m}^3$

Ambient Temperature : $23.9 \text{ }^\circ\text{C}$; Liquid Temperature : $23.6 \text{ }^\circ\text{C}$

DASY5 Configuration:

- Probe: EX3DV4 - SN7375; ConvF(9.94, 9.94, 9.94); Calibrated: 2016/12/08;
- Sensor-Surface: 1.4mm (Mechanical Surface Detection)
- Electronics: DAE4 Sn1431; Calibrated: 2017/03/20
- Phantom: Twin SAM Phantom_1653; Type: QD000P40;
- Measurement SW: DASY52, Version 52.8 (8); SEMCAD X Version 14.6.10 (7373)

- **Area Scan (71x111x1):** Interpolated grid: $dx=1.500 \text{ mm}$, $dy=1.500 \text{ mm}$
Maximum value of SAR (interpolated) = 0.504 W/kg

- **Zoom Scan (5x5x7)/Cube 0:** Measurement grid: $dx=8\text{mm}$, $dy=8\text{mm}$, $dz=5\text{mm}$
Reference Value = 22.51 V/m ; Power Drift = 0.15 dB
Peak SAR (extrapolated) = 0.587 W/kg
SAR(1 g) = 0.399 W/kg ; SAR(10 g) = 0.282 W/kg
Maximum value of SAR (measured) = 0.518 W/kg

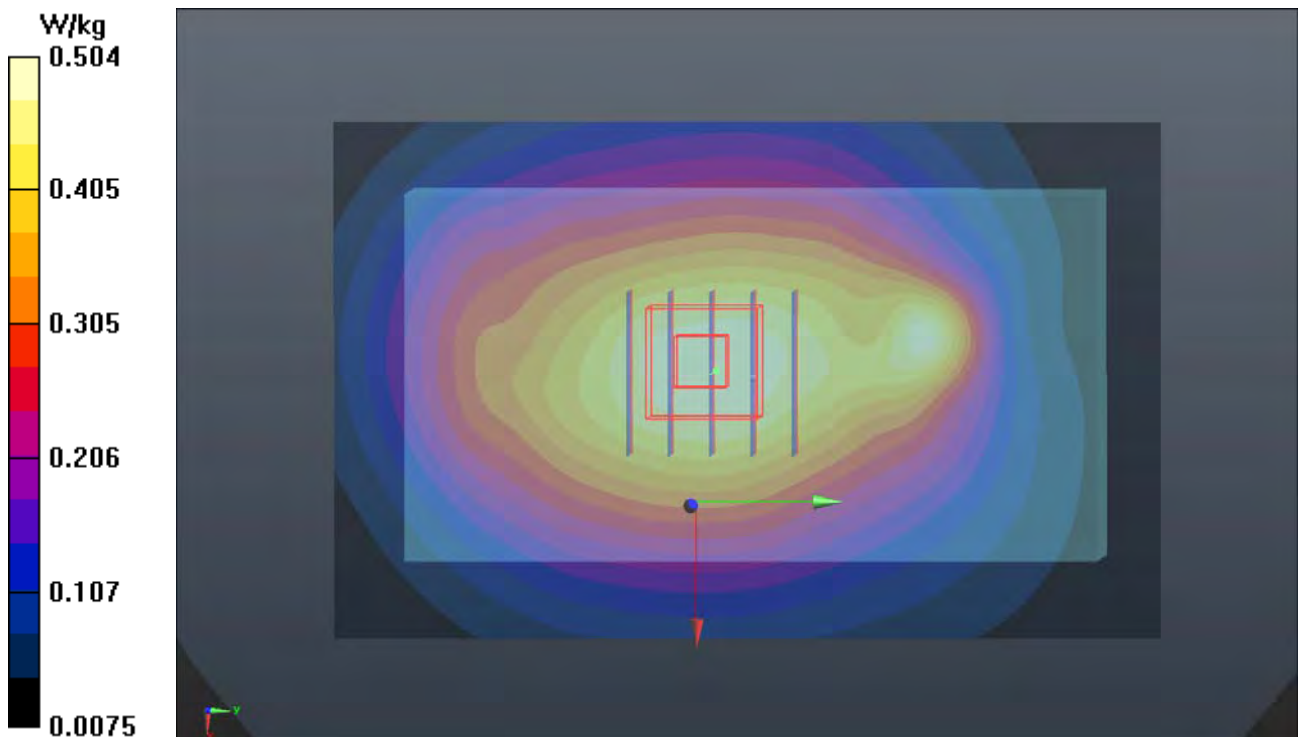

P50 2.4G WLAN_802.11b_EUT(Front)_Top join_0cm_Ch6_Sample1

DUT: 170427C12

Communication System: WLAN_2.4G; Frequency: 2437 MHz; Duty Cycle: 1:1

Medium: B19T27N5_0824 Medium parameters used: $f = 2437$ MHz; $\sigma = 1.982$ S/m; $\epsilon_r = 51.361$; $\rho = 1000$ kg/m³

Ambient Temperature : 23.6 °C ; Liquid Temperature : 23.4 °C

DASY5 Configuration:

- Probe: EX3DV4 - SN7375; ConvF(7.33, 7.33, 7.33); Calibrated: 2016/12/08;
- Sensor-Surface: 1.4mm (Mechanical Surface Detection)
- Electronics: DAE4 Sn1431; Calibrated: 2017/03/20
- Phantom: Twin SAM Phantom_1822; Type: QD000P40;
- Measurement SW: DASY52, Version 52.8 (8); SEMCAD X Version 14.6.10 (7373)

- **Area Scan (91x151x1):** Interpolated grid: dx=1.200 mm, dy=1.200 mm

Maximum value of SAR (interpolated) = 0.440 W/kg

- **Zoom Scan (5x5x7)/Cube 0:** Measurement grid: dx=8mm, dy=8mm, dz=5mm

Reference Value = 15.50 V/m; Power Drift = -0.06 dB

Peak SAR (extrapolated) = 0.518 W/kg

SAR(1 g) = 0.292 W/kg; SAR(10 g) = 0.165 W/kg

Maximum value of SAR (measured) = 0.433 W/kg

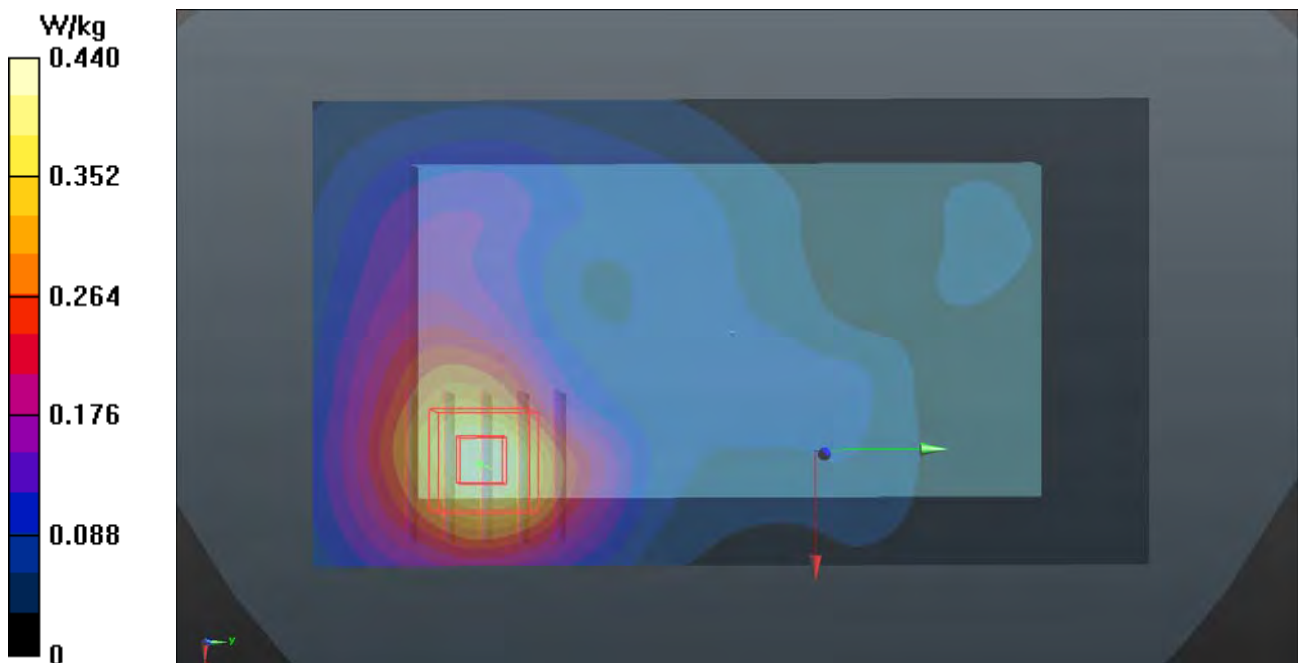

P51 5.3G WLAN_802.11n HT40_EUT(Front)_Top join_0cm_Ch54_Sample1

DUT: 170427C12

Communication System: WLAN_5G; Frequency: 5270 MHz; Duty Cycle: 1:1

Medium: B34T60N2_0928 Medium parameters used: $f = 5270$ MHz; $\sigma = 5.497$ S/m; $\epsilon_r = 47.85$; $\rho = 1000$ kg/m³

Ambient Temperature : 23.6 °C ; Liquid Temperature : 23.3 °C

DASY5 Configuration:

- Probe: EX3DV4 - SN3971; ConvF(4.7, 4.7, 4.7); Calibrated: 2017/03/24;
- Sensor-Surface: 1.4mm (Mechanical Surface Detection)
- Electronics: DAE4 Sn1431; Calibrated: 2017/03/20
- Phantom: Twin SAM Phantom_1127; Type: QD000P40CA;
- Measurement SW: DASY52, Version 52.8 (8); SEMCAD X Version 14.6.10 (7373)

- **Area Scan (101x181x1)**: Interpolated grid: dx=1.000 mm, dy=1.000 mm

Maximum value of SAR (interpolated) = 1.28 W/kg

- **Zoom Scan (6x6x12)/Cube 0**: Measurement grid: dx=5mm, dy=5mm, dz=2mm

Reference Value = 17.51 V/m; Power Drift = -0.11 dB

Peak SAR (extrapolated) = 2.21 W/kg

SAR(1 g) = 0.616 W/kg; SAR(10 g) = 0.256 W/kg

Maximum value of SAR (measured) = 1.35 W/kg

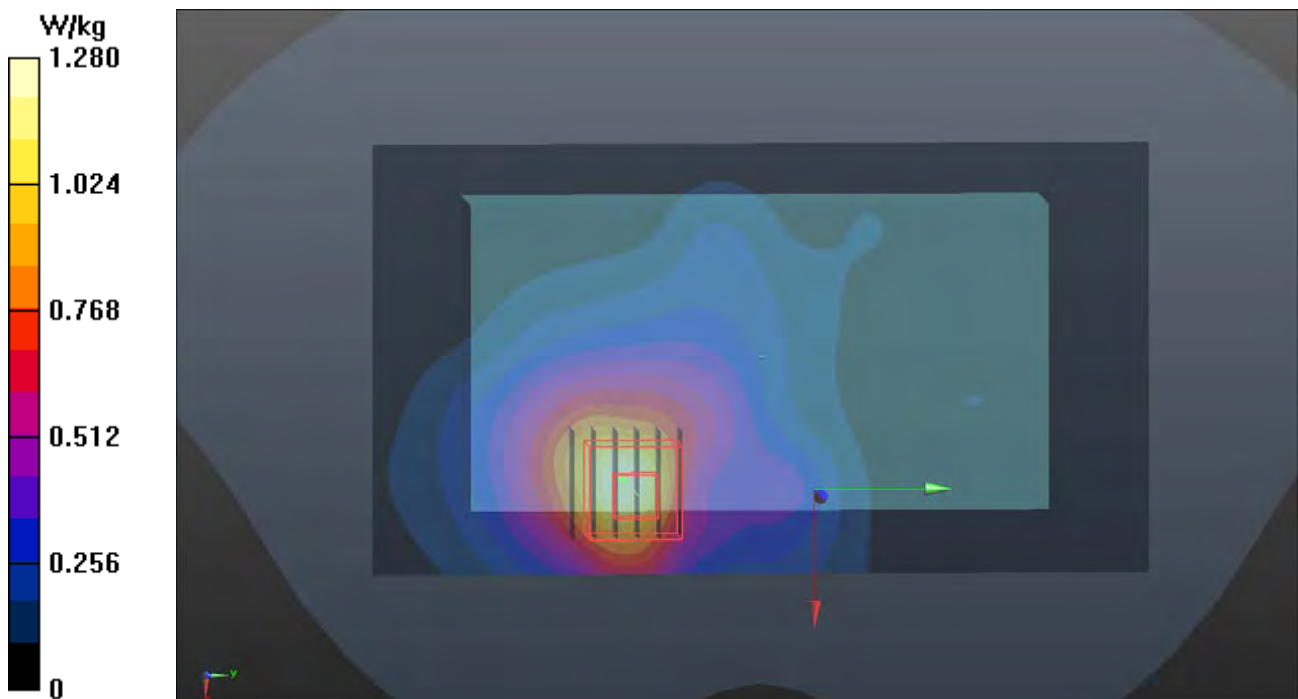

P52 5.6G WLAN_802.11ac VH80_EUT(Front)_Top join_0cm_Ch138_Sample1

DUT: 170427C12

Communication System: WLAN_5G; Frequency: 5690 MHz; Duty Cycle: 1:1

Medium: B34T60N1_0823 Medium parameters used: $f = 5690$ MHz; $\sigma = 6.056$ S/m; $\epsilon_r = 46.816$; $\rho = 1000$ kg/m³

Ambient Temperature : 23.5 °C ; Liquid Temperature : 23.3 °C

DASY5 Configuration:

- Probe: EX3DV4 - SN7375; ConvF(3.99, 3.99, 3.99); Calibrated: 2016/12/08;
- Sensor-Surface: 1.4mm (Mechanical Surface Detection)
- Electronics: DAE4 Sn1431; Calibrated: 2017/03/20
- Phantom: Twin SAM Phantom_1822; Type: QD000P40;
- Measurement SW: DASY52, Version 52.8 (8); SEMCAD X Version 14.6.10 (7373)

- **Area Scan (101x181x1):** Interpolated grid: dx=1.000 mm, dy=1.000 mm

Maximum value of SAR (interpolated) = 1.66 W/kg

- **Zoom Scan (6x6x12)/Cube 0:** Measurement grid: dx=5mm, dy=5mm, dz=2mm

Reference Value = 18.05 V/m; Power Drift = 0.04 dB

Peak SAR (extrapolated) = 2.55 W/kg

SAR(1 g) = 0.798 W/kg; SAR(10 g) = 0.335 W/kg

Maximum value of SAR (measured) = 1.66 W/kg

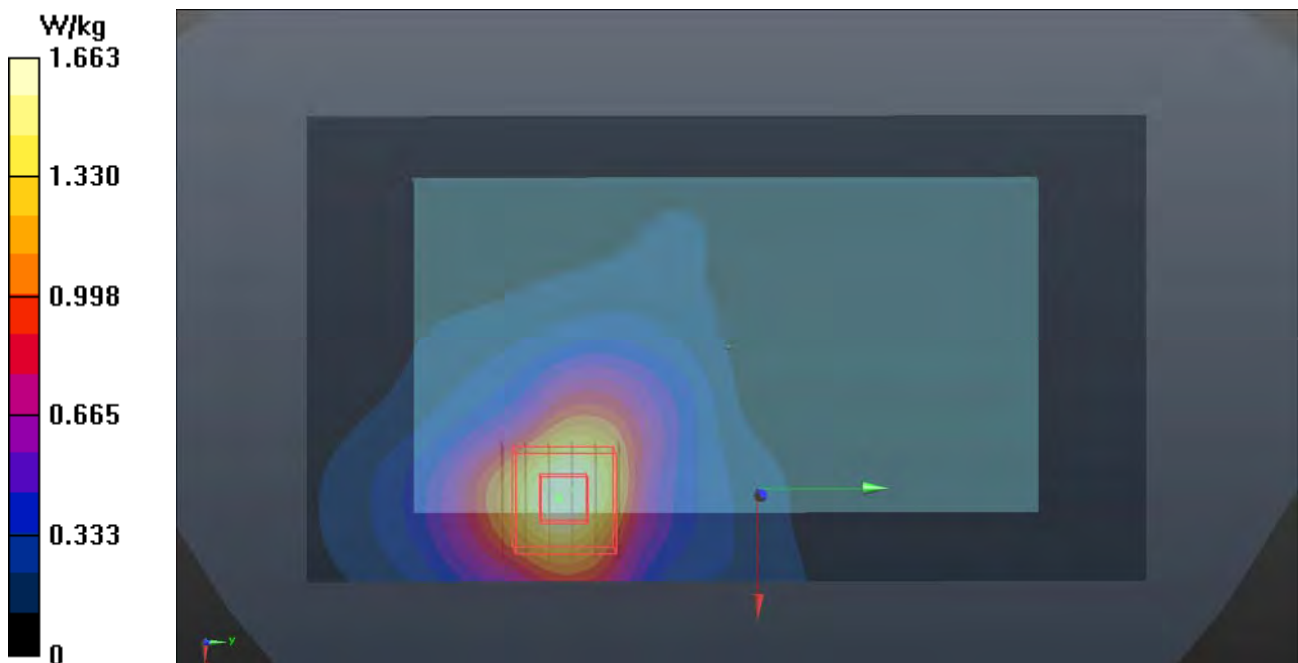

P53 5.8G WLAN_802.11ac VH80_EUT(Front)_Top join_0cm_Ch155_Sample1

DUT: 170427C12

Communication System: WLAN_5G; Frequency: 5775 MHz; Duty Cycle: 1:1

Medium: B34T60N1_0823 Medium parameters used: $f = 5775$ MHz; $\sigma = 6.169$ S/m; $\epsilon_r = 46.63$; $\rho = 1000$ kg/m³

Ambient Temperature : 23.5 °C ; Liquid Temperature : 23.3 °C

DASY5 Configuration:

- Probe: EX3DV4 - SN7375; ConvF(4.08, 4.08, 4.08); Calibrated: 2016/12/08;
- Sensor-Surface: 1.4mm (Mechanical Surface Detection)
- Electronics: DAE4 Sn1431; Calibrated: 2017/03/20
- Phantom: Twin SAM Phantom_1822; Type: QD000P40;
- Measurement SW: DASY52, Version 52.8 (8); SEMCAD X Version 14.6.10 (7373)

- **Area Scan (121x181x1):** Interpolated grid: dx=1.000 mm, dy=1.000 mm

Maximum value of SAR (interpolated) = 0.951 W/kg

- **Zoom Scan (6x6x12)/Cube 0:** Measurement grid: dx=5mm, dy=5mm, dz=2mm

Reference Value = 13.73 V/m; Power Drift = -0.13 dB

Peak SAR (extrapolated) = 1.41 W/kg

SAR(1 g) = 0.465 W/kg; SAR(10 g) = 0.195 W/kg

Maximum value of SAR (measured) = 0.943 W/kg

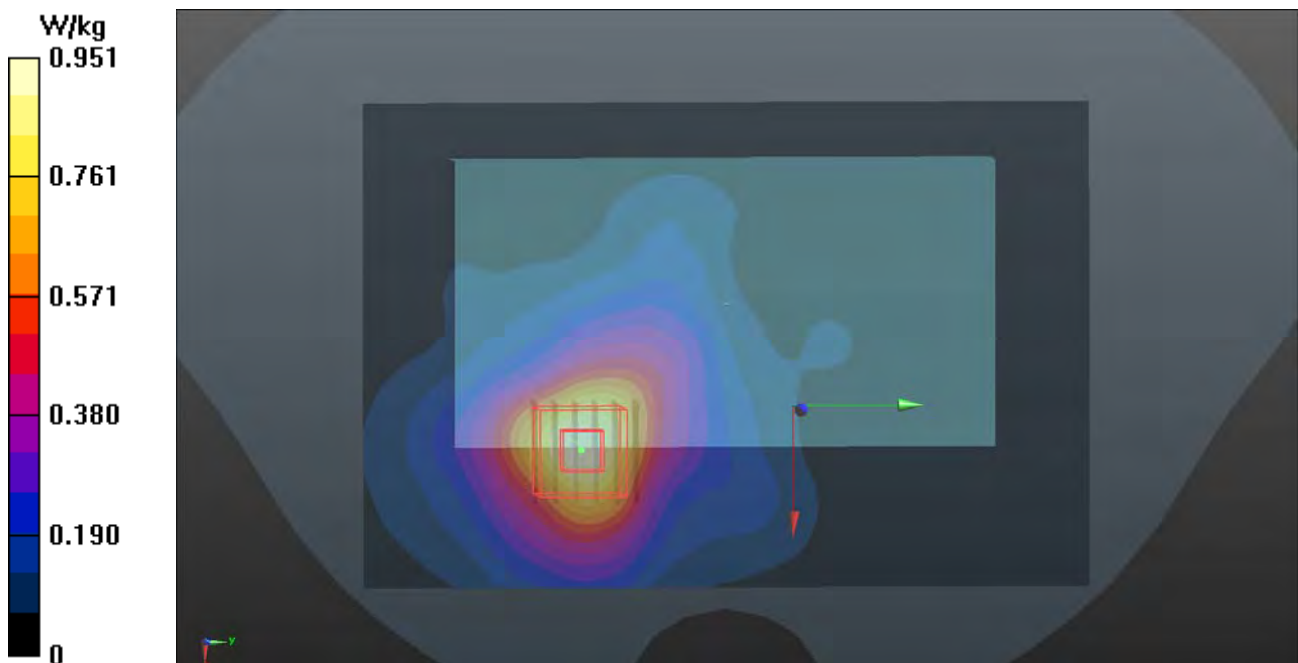

P54 GSM850_GPRS10_Rear Face_0cm_Ch251_Sample1

DUT: 170427C12

Communication System: GPRS10; Frequency: 848.8 MHz; Duty Cycle: 1:4

Medium: B07T10N2_0813 Medium parameters used: $f = 849$ MHz; $\sigma = 0.981$ S/m; $\epsilon_r = 54.884$; $\rho = 1000$ kg/m³

Ambient Temperature : 23.9 °C ; Liquid Temperature : 23.6 °C

DASY5 Configuration:

- Probe: EX3DV4 - SN7375; ConvF(9.94, 9.94, 9.94); Calibrated: 2016/12/08;
- Sensor-Surface: 1.4mm (Mechanical Surface Detection)
- Electronics: DAE4 Sn1431; Calibrated: 2017/03/20
- Phantom: Twin SAM Phantom_1653; Type: QD000P40;
- Measurement SW: DASY52, Version 52.8 (8); SEMCAD X Version 14.6.10 (7373)

- **Area Scan (71x111x1):** Interpolated grid: dx=1.500 mm, dy=1.500 mm

Maximum value of SAR (interpolated) = 0.878 W/kg

- **Zoom Scan (5x5x7)/Cube 0:** Measurement grid: dx=8mm, dy=8mm, dz=5mm

Reference Value = 30.58 V/m; Power Drift = 0.15 dB

Peak SAR (extrapolated) = 2.50 W/kg

SAR(1 g) = 1.02 W/kg; SAR(10 g) = 0.351 W/kg

Maximum value of SAR (measured) = 0.830 W/kg

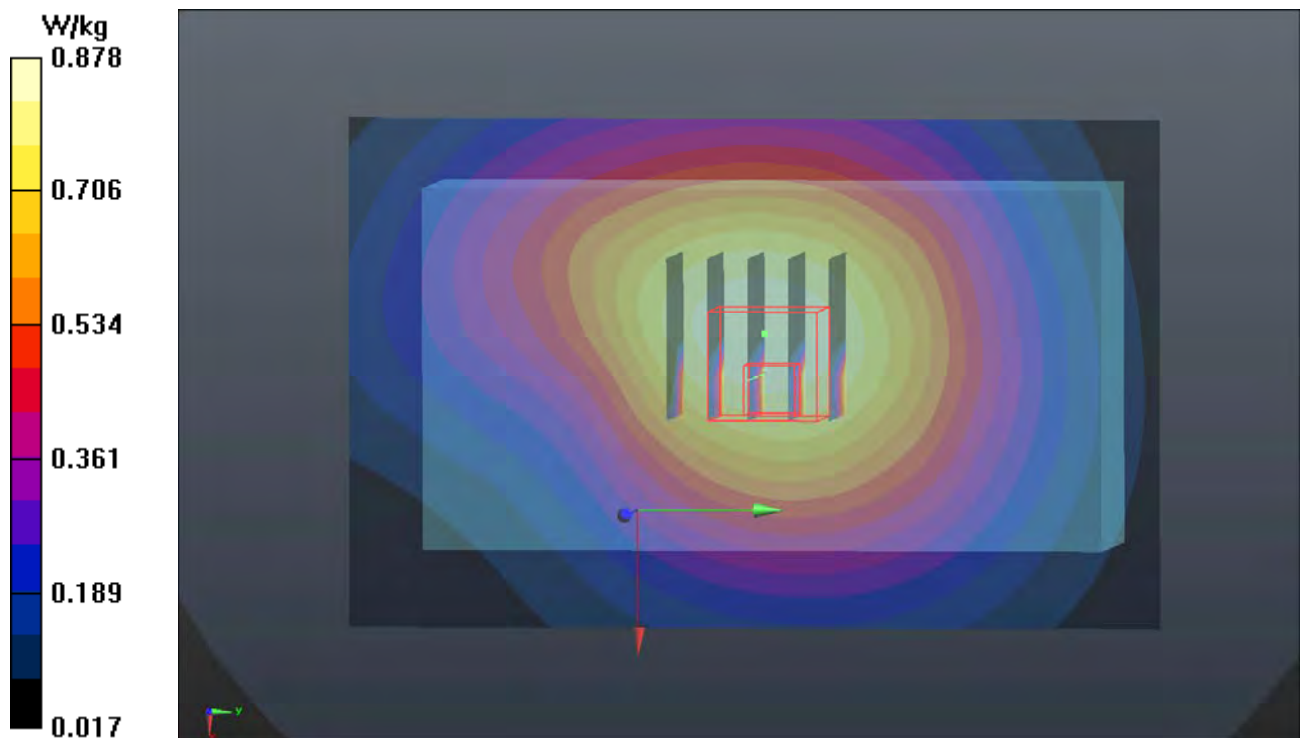

P55 GSM1900_GPRS10_Rear Face_0cm_Ch512_Sample1

DUT: 170427C12

Communication System: GPRS10; Frequency: 1850.2 MHz; Duty Cycle: 1:4

Medium: B16T20N2_0814 Medium parameters used: $f = 1850.2$ MHz; $\sigma = 1.569$ S/m; $\epsilon_r = 52.098$; $\rho = 1000$ kg/m³

Ambient Temperature : 23.7 °C ; Liquid Temperature : 23.5 °C

DASY5 Configuration:

- Probe: EX3DV4 - SN7375; ConvF(7.62, 7.62, 7.62); Calibrated: 2016/12/08;
- Sensor-Surface: 1.4mm (Mechanical Surface Detection)
- Electronics: DAE4 Sn1431; Calibrated: 2017/03/20
- Phantom: Twin SAM Phantom_1654; Type: QD000P40;
- Measurement SW: DASY52, Version 52.8 (8); SEMCAD X Version 14.6.10 (7373)

- **Area Scan (71x121x1):** Interpolated grid: dx=1.500 mm, dy=1.500 mm

Maximum value of SAR (interpolated) = 0.364 W/kg

- **Zoom Scan (5x5x7)/Cube 0:** Measurement grid: dx=8mm, dy=8mm, dz=5mm

Reference Value = 15.52 V/m; Power Drift = -0.14 dB

Peak SAR (extrapolated) = 0.420 W/kg

SAR(1 g) = 0.263 W/kg; SAR(10 g) = 0.166 W/kg

Maximum value of SAR (measured) = 0.363 W/kg

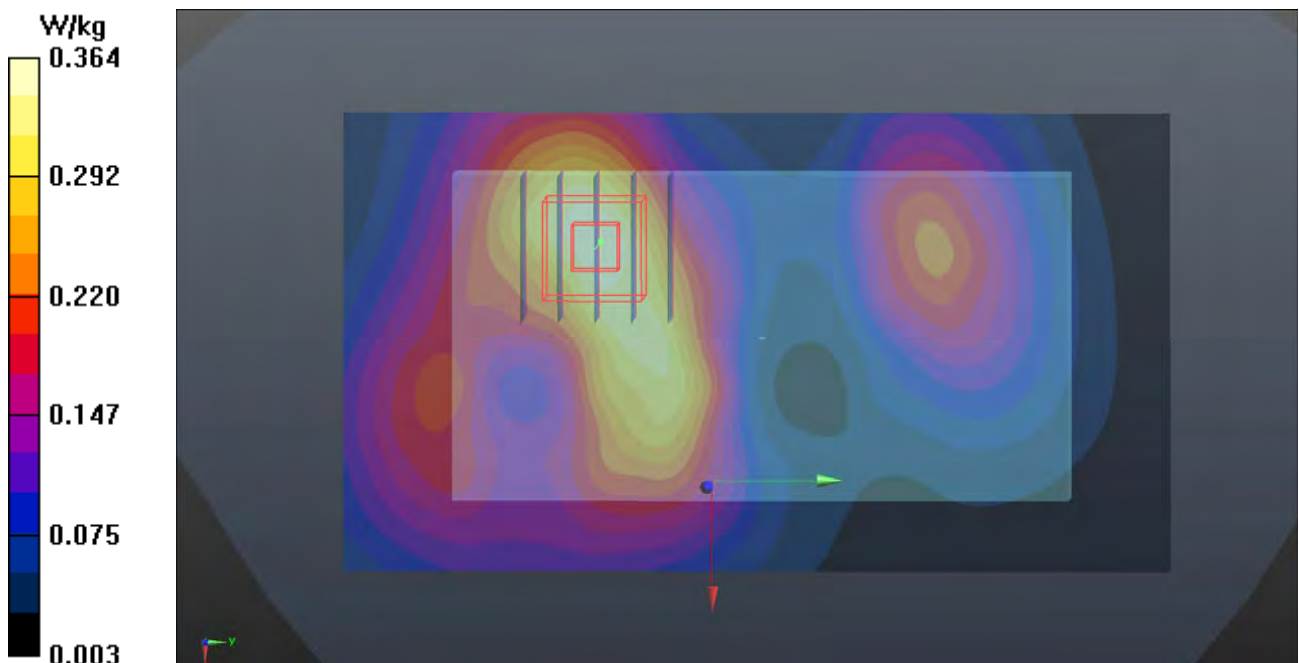

P56 WCDMA II_RMC12.2K_Rear Face_0cm_Ch9400_Sample1

DUT: 170427C12

Communication System: WCDMA; Frequency: 1880 MHz; Duty Cycle: 1:1

Medium: B16T20N1_0814 Medium parameters used: $f = 1880$ MHz; $\sigma = 1.569$ S/m; $\epsilon_r = 52.098$; $\rho = 1000$ kg/m³

Ambient Temperature : 23.8 °C ; Liquid Temperature : 23.6 °C

DASY5 Configuration:

- Probe: EX3DV4 - SN7375; ConvF(7.62, 7.62, 7.62); Calibrated: 2016/12/08;
- Sensor-Surface: 1.4mm (Mechanical Surface Detection)
- Electronics: DAE4 Sn1431; Calibrated: 2017/03/20
- Phantom: Twin SAM Phantom_1652; Type: QD000P40;
- Measurement SW: DASY52, Version 52.8 (8); SEMCAD X Version 14.6.10 (7373)

- **Area Scan (71x121x1):** Interpolated grid: dx=1.500 mm, dy=1.500 mm

Maximum value of SAR (interpolated) = 0.503 W/kg

- **Zoom Scan (5x5x7)/Cube 0:** Measurement grid: dx=8mm, dy=8mm, dz=5mm

Reference Value = 17.72 V/m; Power Drift = -0.15 dB

Peak SAR (extrapolated) = 0.566 W/kg

SAR(1 g) = 0.351 W/kg; SAR(10 g) = 0.222 W/kg

Maximum value of SAR (measured) = 0.486 W/kg

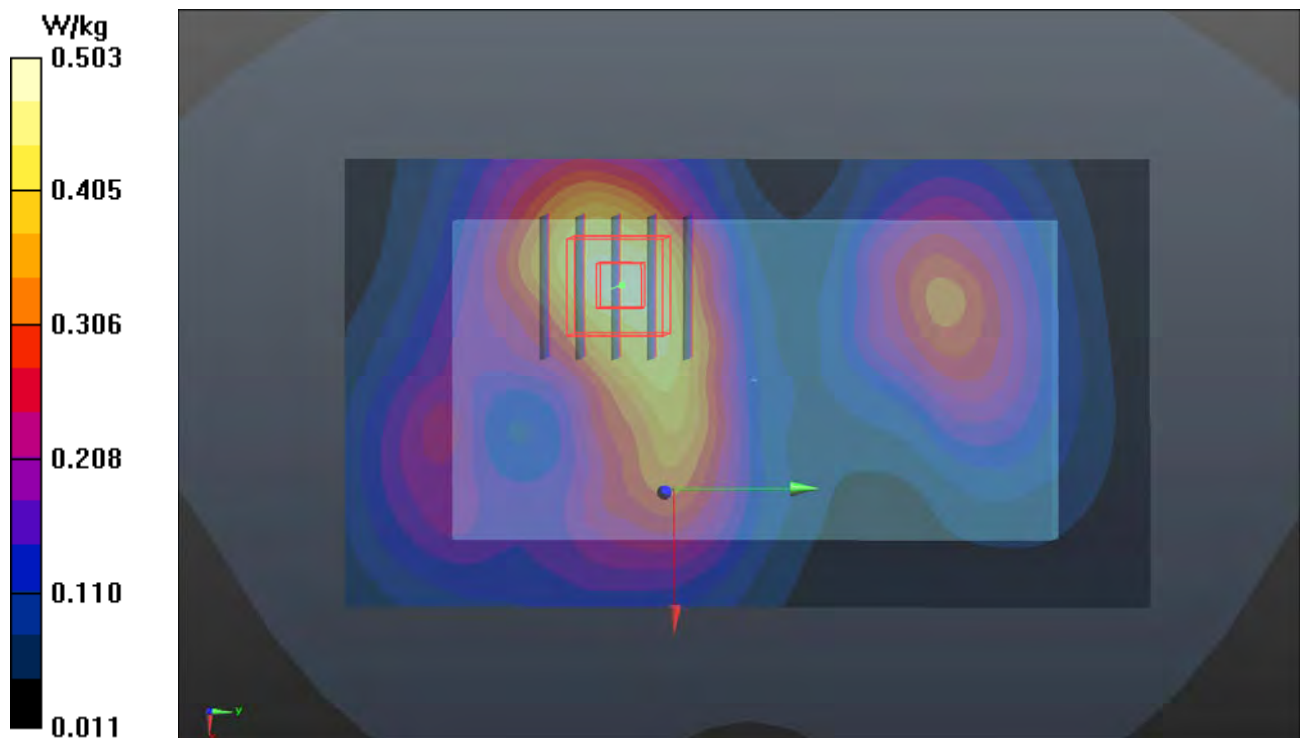

P57 WCDMA IV_RMC12.2K_Rear Face_0cm_Ch1513_Sample1

DUT: 170427C12

Communication System: WCDMA; Frequency: 1752.6 MHz; Duty Cycle: 1:1

Medium: B16T20N1_0814 Medium parameters used: $f = 1753$ MHz; $\sigma = 1.455$ S/m; $\epsilon_r = 52.464$; $\rho = 1000$ kg/m³

Ambient Temperature : 23.8 °C ; Liquid Temperature : 23.6 °C

DASY5 Configuration:

- Probe: EX3DV4 - SN7375; ConvF(8.22, 8.22, 8.22); Calibrated: 2016/12/08;
- Sensor-Surface: 1.4mm (Mechanical Surface Detection)
- Electronics: DAE4 Sn1431; Calibrated: 2017/03/20
- Phantom: Twin SAM Phantom_1652; Type: QD000P40;
- Measurement SW: DASY52, Version 52.8 (8); SEMCAD X Version 14.6.10 (7373)

- **Area Scan (71x121x1):** Interpolated grid: dx=1.500 mm, dy=1.500 mm

Maximum value of SAR (interpolated) = 0.451 W/kg

- **Zoom Scan (5x5x7)/Cube 0:** Measurement grid: dx=8mm, dy=8mm, dz=5mm

Reference Value = 17.75 V/m; Power Drift = -0.04 dB

Peak SAR (extrapolated) = 0.494 W/kg

SAR(1 g) = 0.320 W/kg; SAR(10 g) = 0.211 W/kg

Maximum value of SAR (measured) = 0.430 W/kg

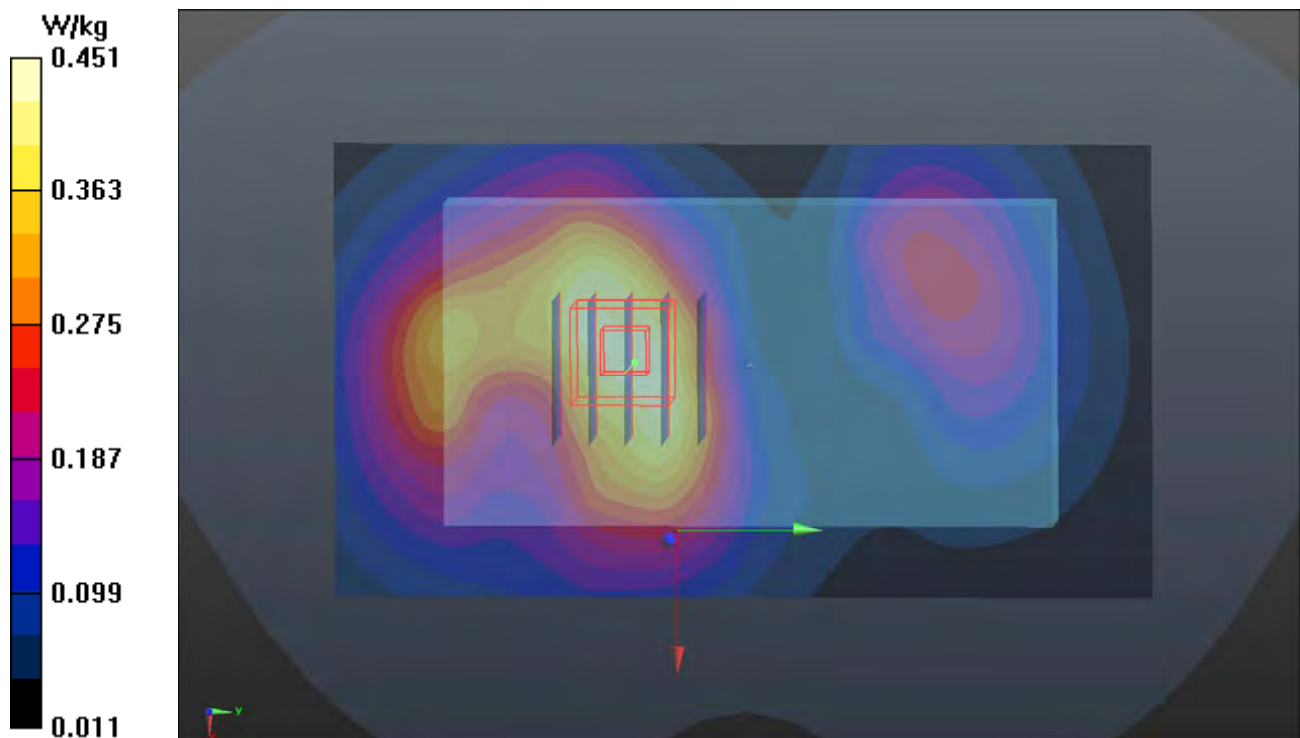

P58 WCDMA V_RMC12.2K_Rear Face_0cm_Ch4233_Sample1

DUT: 170427C12

Communication System: WCDMA; Frequency: 846.6 MHz; Duty Cycle: 1:1

Medium: B07T10N2_0813 Medium parameters used: $f = 847$ MHz; $\sigma = 0.979$ S/m; $\epsilon_r = 54.908$; $\rho = 1000$ kg/m³

Ambient Temperature : 23.9 °C ; Liquid Temperature : 23.6 °C

DASY5 Configuration:

- Probe: EX3DV4 - SN7375; ConvF(9.94, 9.94, 9.94); Calibrated: 2016/12/08;
- Sensor-Surface: 1.4mm (Mechanical Surface Detection)
- Electronics: DAE4 Sn1431; Calibrated: 2017/03/20
- Phantom: Twin SAM Phantom_1653; Type: QD000P40;
- Measurement SW: DASY52, Version 52.8 (8); SEMCAD X Version 14.6.10 (7373)

- **Area Scan (71x111x1):** Interpolated grid: dx=1.500 mm, dy=1.500 mm

Maximum value of SAR (interpolated) = 0.476 W/kg

- **Zoom Scan (5x5x7)/Cube 0:** Measurement grid: dx=8mm, dy=8mm, dz=5mm

Reference Value = 22.44 V/m; Power Drift = -0.07 dB

Peak SAR (extrapolated) = 0.525 W/kg

SAR(1 g) = 0.368 W/kg; SAR(10 g) = 0.267 W/kg

Maximum value of SAR (measured) = 0.467 W/kg

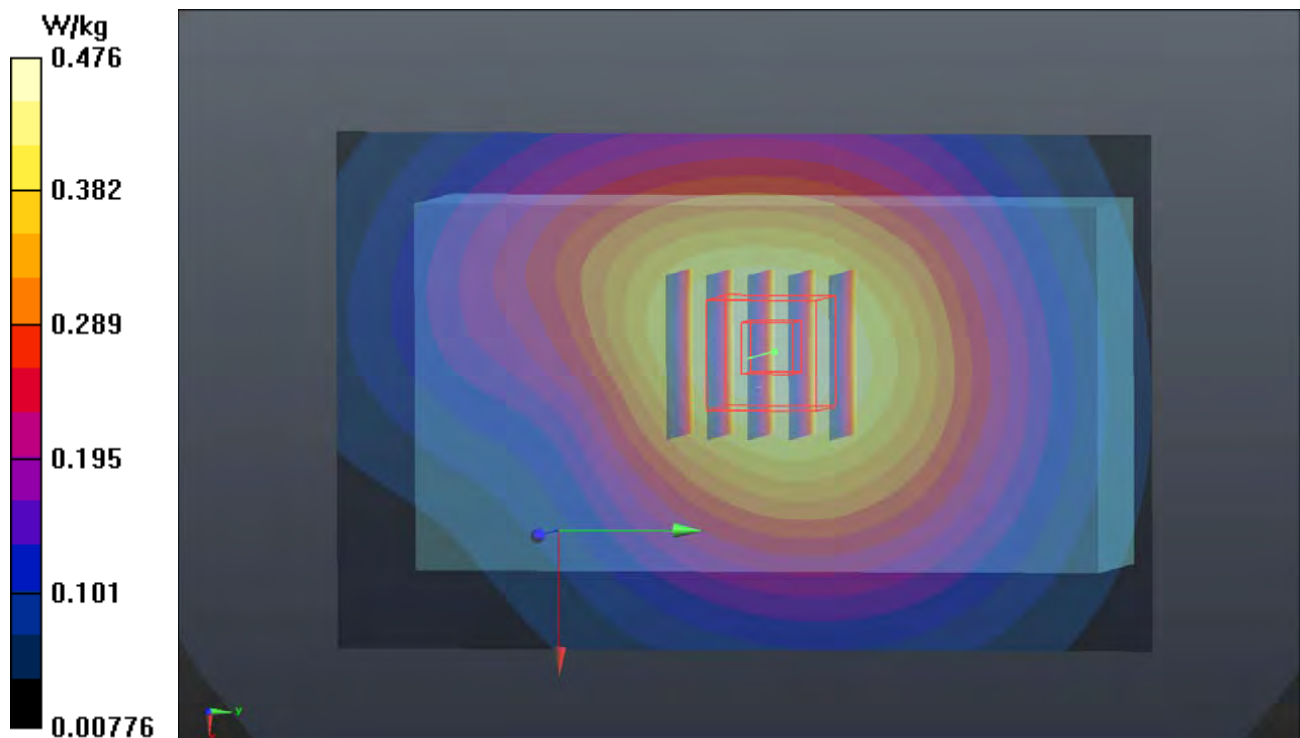

P59 LTE 2_QPSK20M_Rear Face_0cm_Ch18900_Sample1_1RB_OS0

DUT: 170427C12

Communication System: LTE; Frequency: 1880 MHz; Duty Cycle: 1:1

Medium: B16T20N1_0814 Medium parameters used: $f = 1880$ MHz; $\sigma = 1.569$ S/m; $\epsilon_r = 52.098$; $\rho = 1000$ kg/m³

Ambient Temperature : 23.8 °C ; Liquid Temperature : 23.6 °C

DASY5 Configuration:

- Probe: EX3DV4 - SN7375; ConvF(7.62, 7.62, 7.62); Calibrated: 2016/12/08;
- Sensor-Surface: 1.4mm (Mechanical Surface Detection)
- Electronics: DAE4 Sn1431; Calibrated: 2017/03/20
- Phantom: Twin SAM Phantom_1652; Type: QD000P40;
- Measurement SW: DASY52, Version 52.8 (8); SEMCAD X Version 14.6.10 (7373)

- **Area Scan (71x121x1):** Interpolated grid: dx=1.500 mm, dy=1.500 mm

Maximum value of SAR (interpolated) = 0.288 W/kg

- **Zoom Scan (5x5x7)/Cube 0:** Measurement grid: dx=8mm, dy=8mm, dz=5mm

Reference Value = 13.31 V/m; Power Drift = -0.11 dB

Peak SAR (extrapolated) = 0.321 W/kg

SAR(1 g) = 0.200 W/kg; SAR(10 g) = 0.127 W/kg

Maximum value of SAR (measured) = 0.275 W/kg

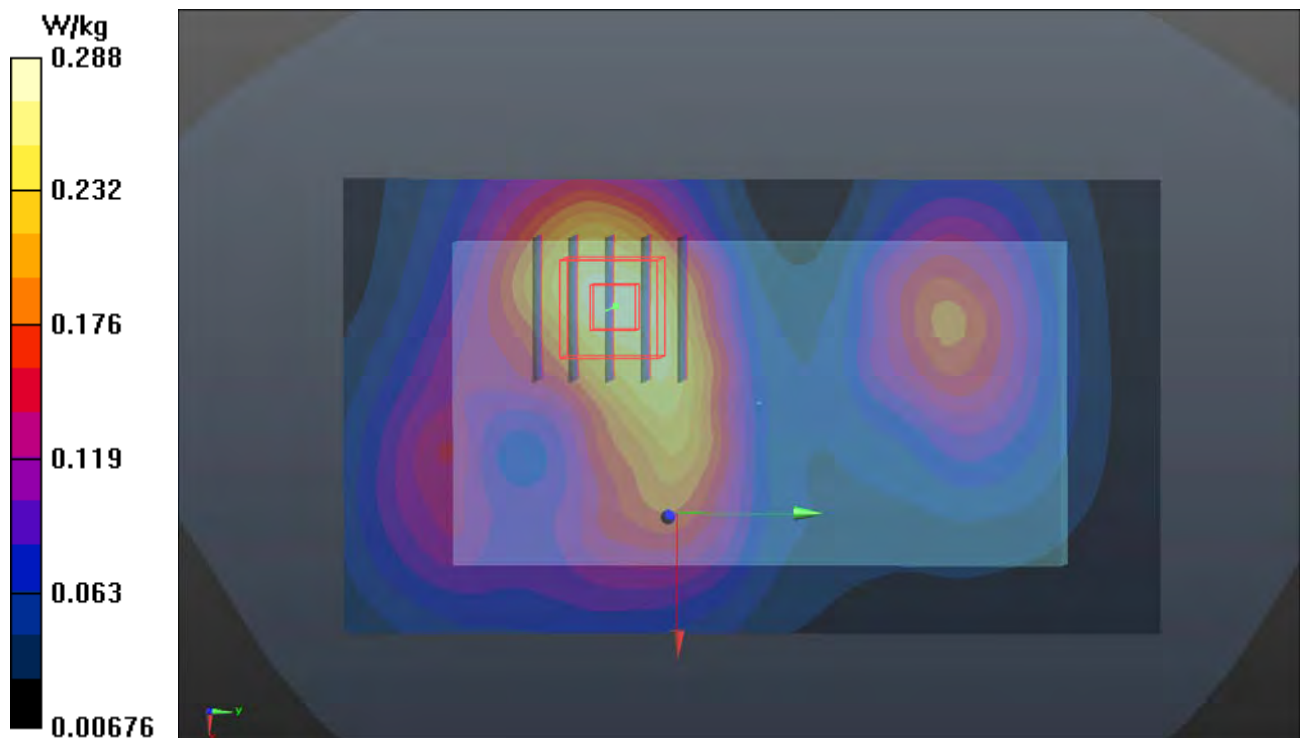

P60 LTE 4_QPSK20M_Rear Face_0cm_Ch20175_Sample1_1RB_OS0

DUT: 170427C12

Communication System: LTE; Frequency: 1732.5 MHz; Duty Cycle: 1:1

Medium: B16T20N1_0814 Medium parameters used: $f = 1732.5$ MHz; $\sigma = 1.436$ S/m; $\epsilon_r = 52.524$; $\rho = 1000$ kg/m³

Ambient Temperature : 23.8 °C ; Liquid Temperature : 23.6 °C

DASY5 Configuration:

- Probe: EX3DV4 - SN7375; ConvF(8.22, 8.22, 8.22); Calibrated: 2016/12/08;
- Sensor-Surface: 1.4mm (Mechanical Surface Detection)
- Electronics: DAE4 Sn1431; Calibrated: 2017/03/20
- Phantom: Twin SAM Phantom_1652; Type: QD000P40;
- Measurement SW: DASY52, Version 52.8 (8); SEMCAD X Version 14.6.10 (7373)

- **Area Scan (71x121x1):** Interpolated grid: dx=1.500 mm, dy=1.500 mm

Maximum value of SAR (interpolated) = 0.229 W/kg

- **Zoom Scan (5x5x7)/Cube 0:** Measurement grid: dx=8mm, dy=8mm, dz=5mm

Reference Value = 12.76 V/m; Power Drift = -0.08 dB

Peak SAR (extrapolated) = 0.252 W/kg

SAR(1 g) = 0.164 W/kg; SAR(10 g) = 0.108 W/kg

Maximum value of SAR (measured) = 0.220 W/kg

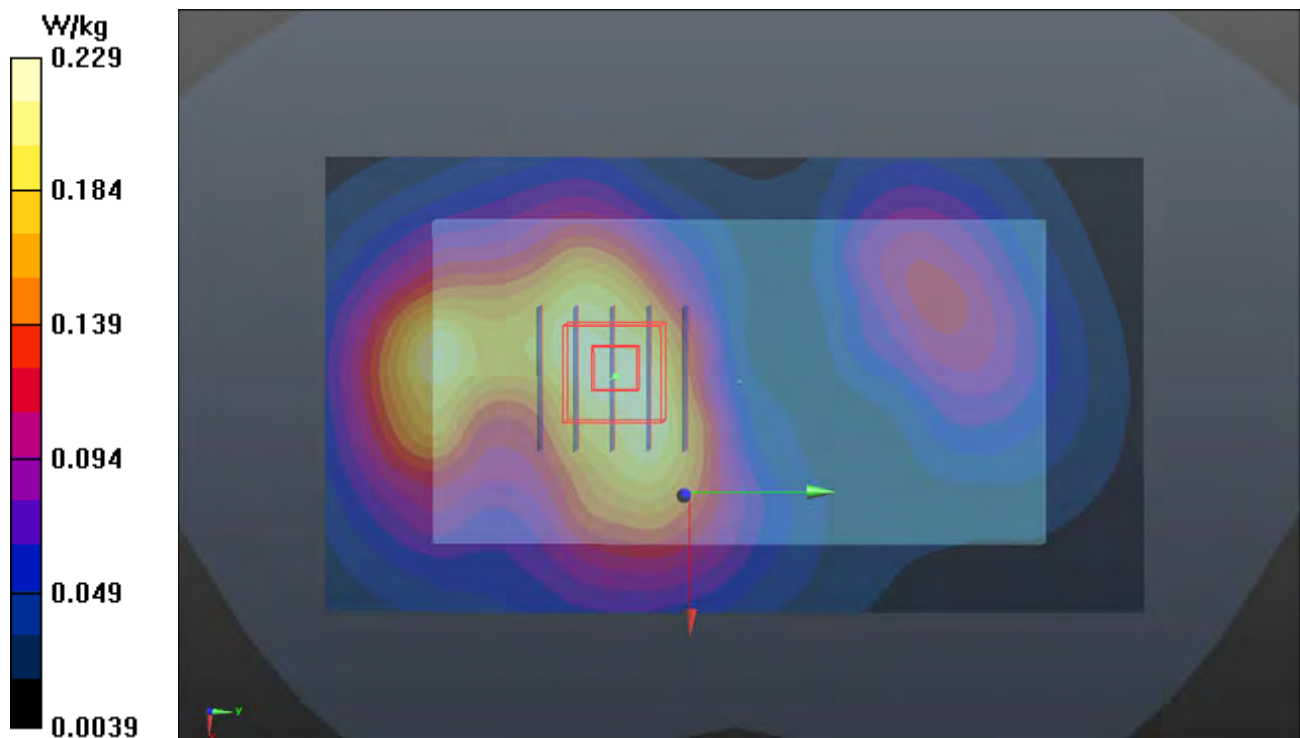

P61 LTE 5_QPSK10M_Rear Face_0cm_Ch20525_Sample1_1RB_OS24

DUT: 170427C12

Communication System: LTE; Frequency: 836.5 MHz; Duty Cycle: 1:1

Medium: B07T10N2_0813 Medium parameters used: $f = 836.5$ MHz; $\sigma = 0.97$ S/m; $\epsilon_r = 54.99$; $\rho = 1000$ kg/m³

Ambient Temperature : 23.9 °C ; Liquid Temperature : 23.6 °C

DASY5 Configuration:

- Probe: EX3DV4 - SN7375; ConvF(9.94, 9.94, 9.94); Calibrated: 2016/12/08;
- Sensor-Surface: 1.4mm (Mechanical Surface Detection)
- Electronics: DAE4 Sn1431; Calibrated: 2017/03/20
- Phantom: Twin SAM Phantom_1653; Type: QD000P40;
- Measurement SW: DASY52, Version 52.8 (8); SEMCAD X Version 14.6.10 (7373)

- **Area Scan (71x111x1):** Interpolated grid: dx=1.500 mm, dy=1.500 mm

Maximum value of SAR (interpolated) = 0.408 W/kg

- **Zoom Scan (5x5x7)/Cube 0:** Measurement grid: dx=8mm, dy=8mm, dz=5mm

Reference Value = 21.79 V/m; Power Drift = -0.11 dB

Peak SAR (extrapolated) = 0.483 W/kg

SAR(1 g) = 0.331 W/kg; SAR(10 g) = 0.241 W/kg

Maximum value of SAR (measured) = 0.420 W/kg

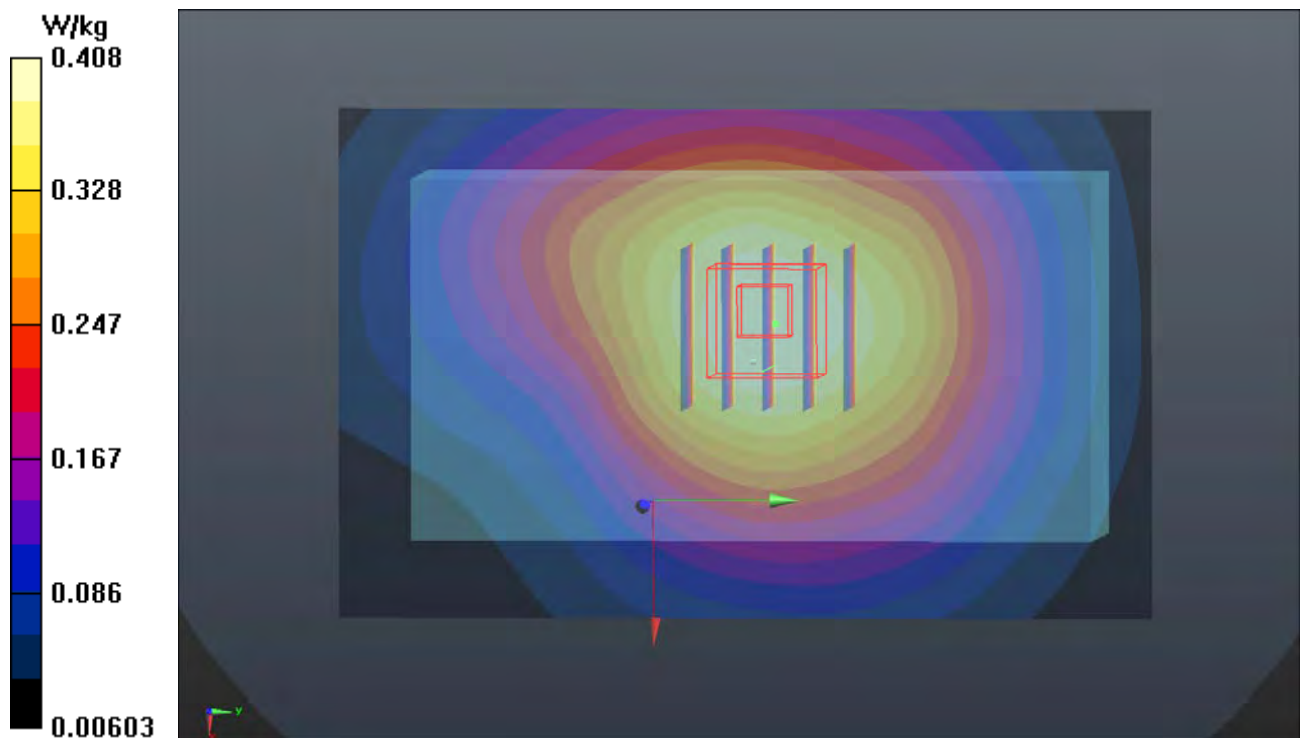

P62 LTE 12_QPSK10M_Rear Face_0cm_Ch23095_Sample1_1RB_OS0

DUT: 170427C12

Communication System: LTE; Frequency: 707.5 MHz; Duty Cycle: 1:1

Medium: B06T09N1_0813 Medium parameters used: $f = 707.5 \text{ MHz}$; $\sigma = 0.92 \text{ S/m}$; ϵ_r

$= 56.834$; $\rho = 1000 \text{ kg/m}^3$

Ambient Temperature : $23.9 \text{ }^\circ\text{C}$; Liquid Temperature : $23.6 \text{ }^\circ\text{C}$

DASY5 Configuration:

- Probe: EX3DV4 - SN7375; ConvF(9.94, 9.94, 9.94); Calibrated: 2016/12/08;
- Sensor-Surface: 1.4mm (Mechanical Surface Detection)
- Electronics: DAE4 Sn1431; Calibrated: 2017/03/20
- Phantom: Twin SAM Phantom_1653; Type: QD000P40;
- Measurement SW: DASY52, Version 52.8 (8); SEMCAD X Version 14.6.10 (7373)

- Area Scan (71x111x1): Interpolated grid: $dx=1.500 \text{ mm}$, $dy=1.500 \text{ mm}$

Maximum value of SAR (interpolated) = 0.389 W/kg

- Zoom Scan (5x5x7)/Cube 0: Measurement grid: $dx=8\text{mm}$, $dy=8\text{mm}$, $dz=5\text{mm}$

Reference Value = 20.36 V/m ; Power Drift = -0.06 dB

Peak SAR (extrapolated) = 0.441 W/kg

SAR(1 g) = 0.306 W/kg ; SAR(10 g) = 0.223 W/kg

Maximum value of SAR (measured) = 0.391 W/kg

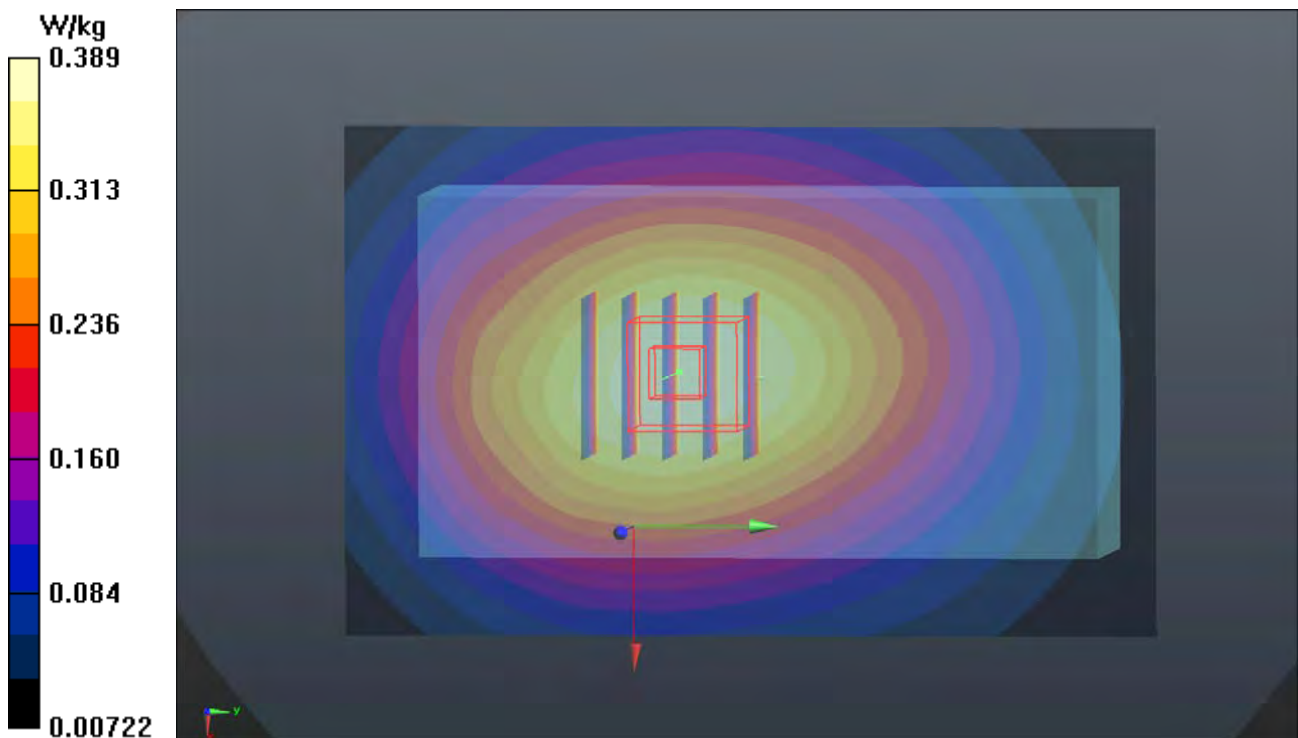

P63 LTE 17_QPSK10M_Rear Face_0cm_Ch23790_Sample1_1RB_OS0

DUT: 170427C12

Communication System: LTE; Frequency: 710 MHz; Duty Cycle: 1:1

Medium: B06T09N1_0813 Medium parameters used: $f = 710 \text{ MHz}$; $\sigma = 0.923 \text{ S/m}$; $\epsilon_r = 56.822$; $\rho = 1000 \text{ kg/m}^3$

Ambient Temperature : $23.9 \text{ }^\circ\text{C}$; Liquid Temperature : $23.6 \text{ }^\circ\text{C}$

DASY5 Configuration:

- Probe: EX3DV4 - SN7375; ConvF(9.94, 9.94, 9.94); Calibrated: 2016/12/08;
- Sensor-Surface: 1.4mm (Mechanical Surface Detection)
- Electronics: DAE4 Sn1431; Calibrated: 2017/03/20
- Phantom: Twin SAM Phantom_1653; Type: QD000P40;
- Measurement SW: DASY52, Version 52.8 (8); SEMCAD X Version 14.6.10 (7373)

- **Area Scan (71x111x1):** Interpolated grid: $dx=1.500 \text{ mm}$, $dy=1.500 \text{ mm}$

Maximum value of SAR (interpolated) = 0.388 W/kg

- **Zoom Scan (5x5x7)/Cube 0:** Measurement grid: $dx=8\text{mm}$, $dy=8\text{mm}$, $dz=5\text{mm}$

Reference Value = 20.40 V/m ; Power Drift = 0.01 dB

Peak SAR (extrapolated) = 0.442 W/kg

SAR(1 g) = 0.310 W/kg ; SAR(10 g) = 0.222 W/kg

Maximum value of SAR (measured) = 0.396 W/kg

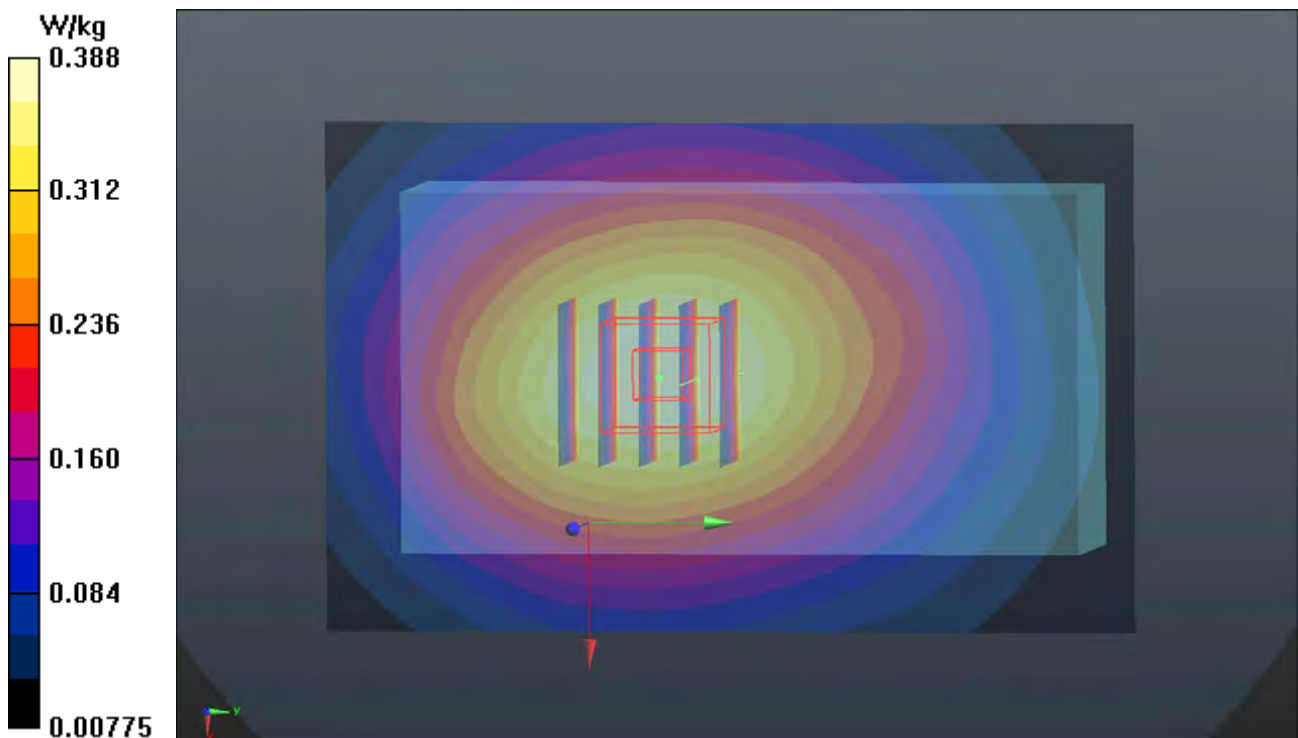

P64 2.4G WLAN_802.11b_Rear Face_0cm_Ch6_Sample1

DUT: 170427C12

Communication System: WLAN_2.4G; Frequency: 2437 MHz; Duty Cycle: 1:1

Medium: B19T27N5_0824 Medium parameters used: $f = 2437$ MHz; $\sigma = 1.982$ S/m; $\epsilon_r = 51.361$; $\rho = 1000$ kg/m³

Ambient Temperature : 23.6 °C ; Liquid Temperature : 23.4 °C

DASY5 Configuration:

- Probe: EX3DV4 - SN7375; ConvF(7.33, 7.33, 7.33); Calibrated: 2016/12/08;
- Sensor-Surface: 1.4mm (Mechanical Surface Detection)
- Electronics: DAE4 Sn1431; Calibrated: 2017/03/20
- Phantom: Twin SAM Phantom_1822; Type: QD000P40;
- Measurement SW: DASY52, Version 52.8 (8); SEMCAD X Version 14.6.10 (7373)

- **Area Scan (91x151x1):** Interpolated grid: dx=1.200 mm, dy=1.200 mm

Maximum value of SAR (interpolated) = 0.445 W/kg

- **Zoom Scan (5x5x7)/Cube 0:** Measurement grid: dx=8mm, dy=8mm, dz=5mm

Reference Value = 15.33 V/m; Power Drift = -0.19 dB

Peak SAR (extrapolated) = 0.545 W/kg

SAR(1 g) = 0.309 W/kg; SAR(10 g) = 0.174 W/kg

Maximum value of SAR (measured) = 0.456 W/kg

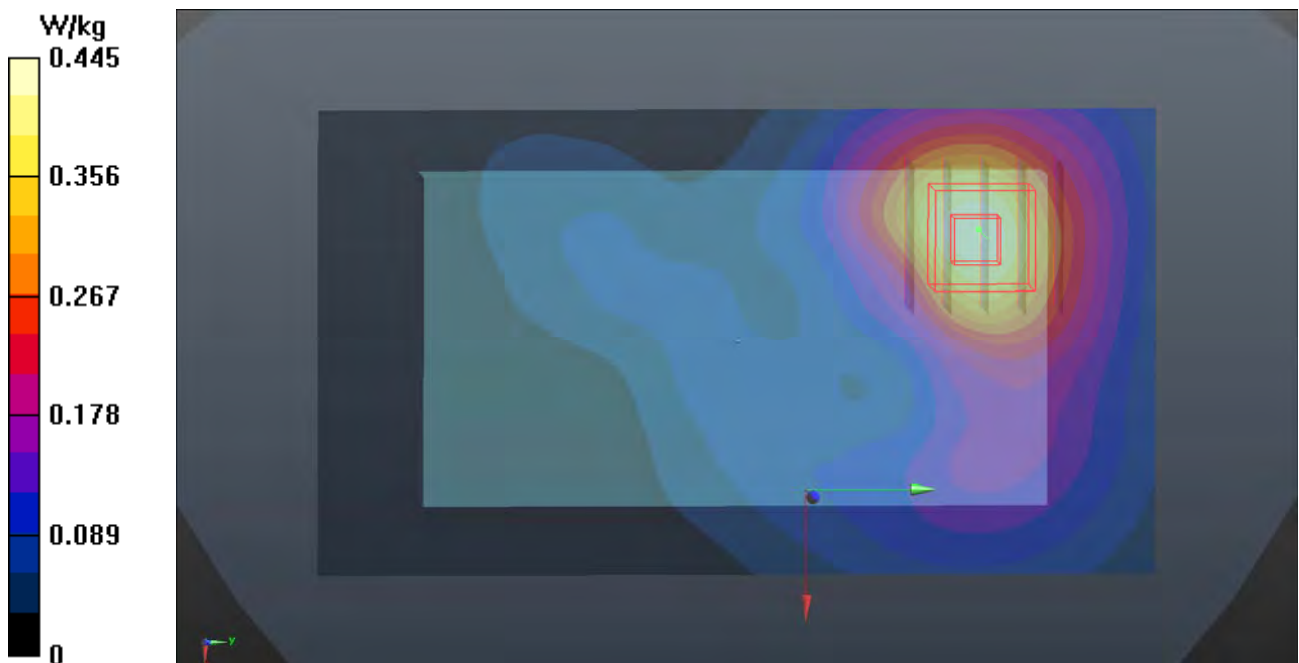

P65 5.3G WLAN_802.11n HT40_Rear Face_0cm_Ch54_Sample1

DUT: 170427C12

Communication System: WLAN_5G; Frequency: 5270 MHz; Duty Cycle: 1:1

Medium: B34T60N2_0928 Medium parameters used: $f = 5270$ MHz; $\sigma = 5.497$ S/m; $\epsilon_r = 47.85$; $\rho = 1000$ kg/m³

Ambient Temperature : 23.6 °C ; Liquid Temperature : 23.3 °C

DASY5 Configuration:

- Probe: EX3DV4 - SN3971; ConvF(4.7, 4.7, 4.7); Calibrated: 2017/03/24;
- Sensor-Surface: 1.4mm (Mechanical Surface Detection)
- Electronics: DAE4 Sn1431; Calibrated: 2017/03/20
- Phantom: Twin SAM Phantom_1127; Type: QD000P40CA;
- Measurement SW: DASY52, Version 52.8 (8); SEMCAD X Version 14.6.10 (7373)

- **Area Scan (101x181x1):** Interpolated grid: dx=1.000 mm, dy=1.000 mm
Maximum value of SAR (interpolated) = 1.01 W/kg

- **Zoom Scan (6x6x12)/Cube 0:** Measurement grid: dx=5mm, dy=5mm, dz=2mm

Reference Value = 13.88 V/m; Power Drift = 0.08 dB

Peak SAR (extrapolated) = 1.57 W/kg

SAR(1 g) = 0.442 W/kg; SAR(10 g) = 0.173 W/kg

Maximum value of SAR (measured) = 1.00 W/kg



P66 5.6G WLAN_802.11ac VH80_Rear Face_0cm_Ch138_Sample1

DUT: 170427C12

Communication System: WLAN_5G; Frequency: 5690 MHz; Duty Cycle: 1:1

Medium: B34T60N1_0824 Medium parameters used: $f = 5690$ MHz; $\sigma = 6.014$ S/m; $\epsilon_r = 46.684$; $\rho = 1000$ kg/m³

Ambient Temperature : 23.7 °C ; Liquid Temperature : 23.5 °C

DASY5 Configuration:

- Probe: EX3DV4 - SN7375; ConvF(3.99, 3.99, 3.99); Calibrated: 2016/12/08;
- Sensor-Surface: 1.4mm (Mechanical Surface Detection)
- Electronics: DAE4 Sn1431; Calibrated: 2017/03/20
- Phantom: Twin SAM Phantom_1822; Type: QD000P40;
- Measurement SW: DASY52, Version 52.8 (8); SEMCAD X Version 14.6.10 (7373)

- **Area Scan (101x181x1):** Interpolated grid: dx=1.000 mm, dy=1.000 mm

Maximum value of SAR (interpolated) = 1.89 W/kg

- **Zoom Scan (6x6x12)/Cube 0:** Measurement grid: dx=5mm, dy=5mm, dz=2mm

Reference Value = 19.97 V/m; Power Drift = -0.04 dB

Peak SAR (extrapolated) = 3.13 W/kg

SAR(1 g) = 0.834 W/kg; SAR(10 g) = 0.322 W/kg

Maximum value of SAR (measured) = 1.87 W/kg

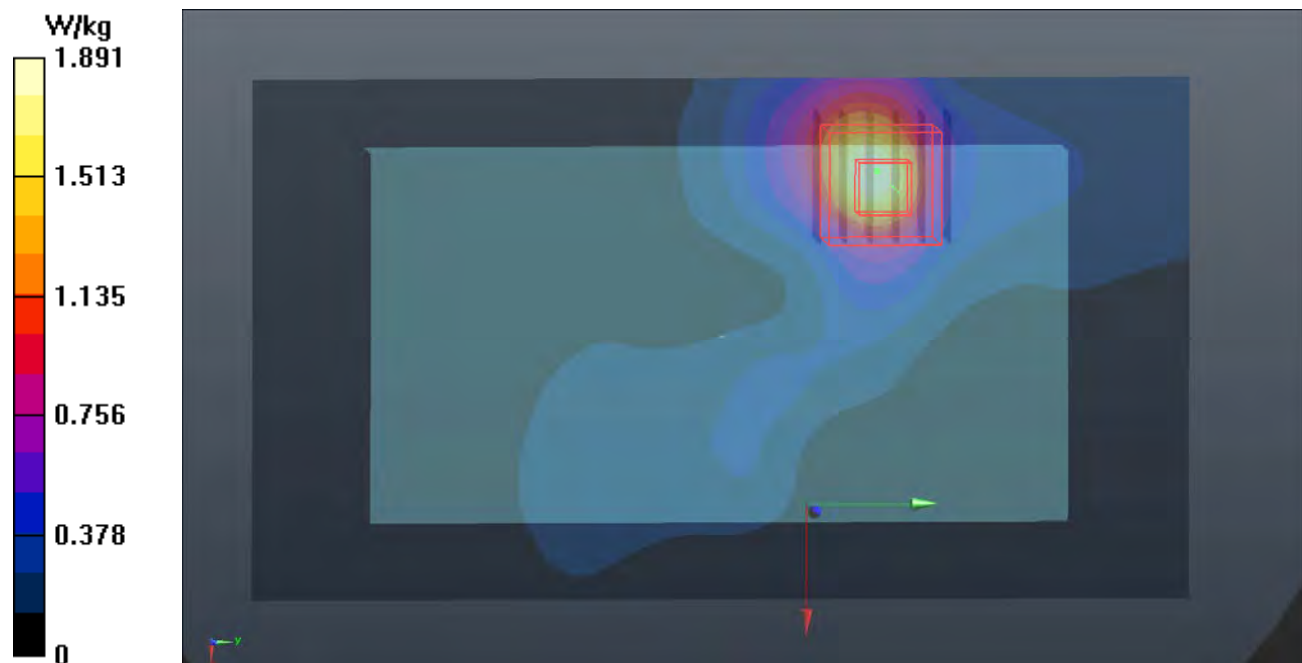

P67 5.8G WLAN_802.11ac VH80_Rear Face_0cm_Ch155_Sample1

DUT: 170427C12

Communication System: WLAN_5G; Frequency: 5775 MHz; Duty Cycle: 1:1

Medium: B34T60N1_0824 Medium parameters used: $f = 5775$ MHz; $\sigma = 6.15$ S/m; $\epsilon_r = 46.565$; $\rho = 1000$ kg/m³

Ambient Temperature : 23.7 °C ; Liquid Temperature : 23.5 °C

DASY5 Configuration:

- Probe: EX3DV4 - SN7375; ConvF(4.08, 4.08, 4.08); Calibrated: 2016/12/08;
- Sensor-Surface: 1.4mm (Mechanical Surface Detection)
- Electronics: DAE4 Sn1431; Calibrated: 2017/03/20
- Phantom: Twin SAM Phantom_1822; Type: QD000P40;
- Measurement SW: DASY52, Version 52.8 (8); SEMCAD X Version 14.6.10 (7373)

- **Area Scan (101x181x1)**: Interpolated grid: dx=1.000 mm, dy=1.000 mm
Maximum value of SAR (interpolated) = 1.30 W/kg

- **Zoom Scan (6x6x12)/Cube 0**: Measurement grid: dx=5mm, dy=5mm, dz=2mm

Reference Value = 16.99 V/m; Power Drift = -0.14 dB

Peak SAR (extrapolated) = 2.25 W/kg

SAR(1 g) = 0.601 W/kg; SAR(10 g) = 0.227 W/kg

Maximum value of SAR (measured) = 1.38 W/kg

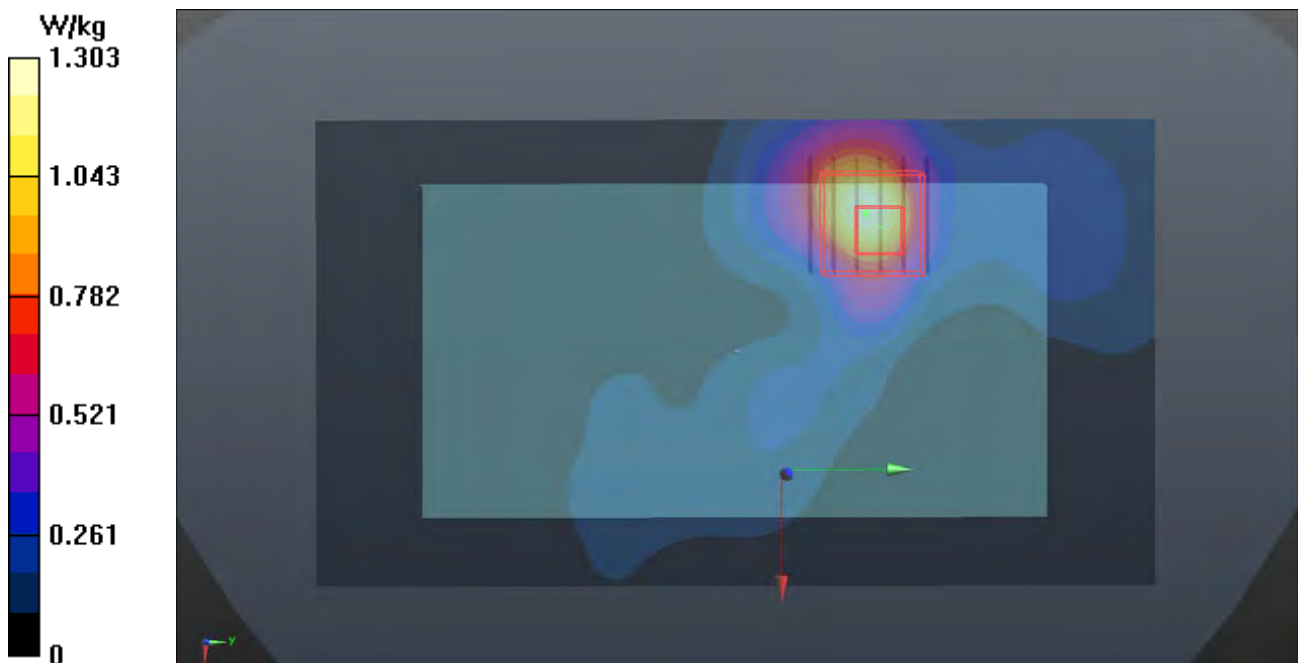



Appendix C. Calibration Certificate for Probe and Dipole

The SPEAG calibration certificates are shown as follows.



Accredited by the Swiss Accreditation Service (SAS)

Accreditation No.: **SCS 0108**

The Swiss Accreditation Service is one of the signatories to the EA Multilateral Agreement for the recognition of calibration certificates

Client **Auden**

Certificate No: **D750V3-1132_Dec16**

CALIBRATION CERTIFICATE

Object **D750V3 - SN:1132**

Calibration procedure(s) **QA CAL-05.v9**
Calibration procedure for dipole validation kits above 700 MHz

Calibration date: **December 28, 2016**

This calibration certificate documents the traceability to national standards, which realize the physical units of measurements (SI). The measurements and the uncertainties with confidence probability are given on the following pages and are part of the certificate.

All calibrations have been conducted in the closed laboratory facility: environment temperature (22 ± 3)°C and humidity < 70%.

Calibration Equipment used (M&TE critical for calibration)

Primary Standards	ID #	Cal Date (Certificate No.)	Scheduled Calibration
Power meter NRP	SN: 104778	06-Apr-16 (No. 217-02288/02289)	Apr-17
Power sensor NRP-Z91	SN: 103244	06-Apr-16 (No. 217-02288)	Apr-17
Power sensor NRP-Z91	SN: 103245	06-Apr-16 (No. 217-02289)	Apr-17
Reference 20 dB Attenuator	SN: 5058 (20k)	05-Apr-16 (No. 217-02292)	Apr-17
Type-N mismatch combination	SN: 5047.2 / 06327	05-Apr-16 (No. 217-02295)	Apr-17
Reference Probe EX3DV4	SN: 7349	15-Jun-16 (No. EX3-7349_Jun16)	Jun-17
DAE4	SN: 601	30-Dec-15 (No. DAE4-601_Dec15)	Dec-16

Secondary Standards	ID #	Check Date (in house)	Scheduled Check
Power meter EPM-442A	SN: GB37480704	07-Oct-15 (in house check Oct-16)	In house check: Oct-18
Power sensor HP 8481A	SN: US37292783	07-Oct-15 (in house check Oct-16)	In house check: Oct-18
Power sensor HP 8481A	SN: MY41092317	07-Oct-15 (in house check Oct-16)	In house check: Oct-18
RF generator R&S SMT-06	SN: 100972	15-Jun-15 (in house check Oct-16)	In house check: Oct-18
Network Analyzer HP 8753E	SN: US37390585	18-Oct-01 (in house check Oct-16)	In house check: Oct-17

Calibrated by: **Jeton Kastrati** Name: **Jeton Kastrati** Function: **Laboratory Technician**

Approved by: **Katja Pokovic** Name: **Katja Pokovic** Technical Manager

Signature

Issued: December 28, 2016

This calibration certificate shall not be reproduced except in full without written approval of the laboratory.



Accredited by the Swiss Accreditation Service (SAS)

Accreditation No.: **SCS 0108**

The Swiss Accreditation Service is one of the signatories to the EA Multilateral Agreement for the recognition of calibration certificates

Glossary:

TSL	tissue simulating liquid
ConvF	sensitivity in TSL / NORM x,y,z
N/A	not applicable or not measured

Calibration is Performed According to the Following Standards:

- IEEE Std 1528-2013, "IEEE Recommended Practice for Determining the Peak Spatial-Averaged Specific Absorption Rate (SAR) in the Human Head from Wireless Communications Devices: Measurement Techniques", June 2013
- IEC 62209-1, "Procedure to measure the Specific Absorption Rate (SAR) for hand-held devices used in close proximity to the ear (frequency range of 300 MHz to 3 GHz)", February 2005
- IEC 62209-2, "Procedure to determine the Specific Absorption Rate (SAR) for wireless communication devices used in close proximity to the human body (frequency range of 30 MHz to 6 GHz)", March 2010
- KDB 865664, "SAR Measurement Requirements for 100 MHz to 6 GHz"

Additional Documentation:

- DASY4/5 System Handbook

Methods Applied and Interpretation of Parameters:

- Measurement Conditions:* Further details are available from the Validation Report at the end of the certificate. All figures stated in the certificate are valid at the frequency indicated.
- Antenna Parameters with TSL:* The dipole is mounted with the spacer to position its feed point exactly below the center marking of the flat phantom section, with the arms oriented parallel to the body axis.
- Feed Point Impedance and Return Loss:* These parameters are measured with the dipole positioned under the liquid filled phantom. The impedance stated is transformed from the measurement at the SMA connector to the feed point. The Return Loss ensures low reflected power. No uncertainty required.
- Electrical Delay:* One-way delay between the SMA connector and the antenna feed point. No uncertainty required.
- SAR measured:* SAR measured at the stated antenna input power.
- SAR normalized:* SAR as measured, normalized to an input power of 1 W at the antenna connector.
- SAR for nominal TSL parameters:* The measured TSL parameters are used to calculate the nominal SAR result.

The reported uncertainty of measurement is stated as the standard uncertainty of measurement multiplied by the coverage factor $k=2$, which for a normal distribution corresponds to a coverage probability of approximately 95%.

Measurement Conditions

DASY system configuration, as far as not given on page 1.

DASY Version	DASY5	V52.8.8
Extrapolation	Advanced Extrapolation	
Phantom	Modular Flat Phantom	
Distance Dipole Center - TSL	15 mm	with Spacer
Zoom Scan Resolution	dx, dy, dz = 5 mm	
Frequency	750 MHz ± 1 MHz	

Head TSL parameters

The following parameters and calculations were applied.

	Temperature	Permittivity	Conductivity
Nominal Head TSL parameters	22.0 °C	41.9	0.89 mho/m
Measured Head TSL parameters	(22.0 ± 0.2) °C	40.7 ± 6 %	0.91 mho/m ± 6 %
Head TSL temperature change during test	< 0.5 °C	----	----

SAR result with Head TSL

SAR averaged over 1 cm ³ (1 g) of Head TSL	Condition	
SAR measured	250 mW input power	2.09 W/kg
SAR for nominal Head TSL parameters	normalized to 1W	8.17 W/kg ± 17.0 % (k=2)

SAR averaged over 10 cm ³ (10 g) of Head TSL	condition	
SAR measured	250 mW input power	1.36 W/kg
SAR for nominal Head TSL parameters	normalized to 1W	5.34 W/kg ± 16.5 % (k=2)

Body TSL parameters

The following parameters and calculations were applied.

	Temperature	Permittivity	Conductivity
Nominal Body TSL parameters	22.0 °C	55.5	0.96 mho/m
Measured Body TSL parameters	(22.0 ± 0.2) °C	54.7 ± 6 %	0.97 mho/m ± 6 %
Body TSL temperature change during test	< 0.5 °C	----	----

SAR result with Body TSL

SAR averaged over 1 cm ³ (1 g) of Body TSL	Condition	
SAR measured	250 mW input power	2.17 W/kg
SAR for nominal Body TSL parameters	normalized to 1W	8.58 W/kg ± 17.0 % (k=2)

SAR averaged over 10 cm ³ (10 g) of Body TSL	condition	
SAR measured	250 mW input power	1.43 W/kg
SAR for nominal Body TSL parameters	normalized to 1W	5.67 W/kg ± 16.5 % (k=2)

Appendix (Additional assessments outside the scope of SCS 0108)

Antenna Parameters with Head TSL

Impedance, transformed to feed point	50.3 Ω - 3.2 j Ω
Return Loss	- 30.0 dB

Antenna Parameters with Body TSL

Impedance, transformed to feed point	51.2 Ω - 1.5 j Ω
Return Loss	- 34.5 dB

General Antenna Parameters and Design

Electrical Delay (one direction)	1.034 ns
----------------------------------	----------

After long term use with 100W radiated power, only a slight warming of the dipole near the feedpoint can be measured.

The dipole is made of standard semirigid coaxial cable. The center conductor of the feeding line is directly connected to the second arm of the dipole. The antenna is therefore short-circuited for DC-signals. On some of the dipoles, small end caps are added to the dipole arms in order to improve matching when loaded according to the position as explained in the "Measurement Conditions" paragraph. The SAR data are not affected by this change. The overall dipole length is still according to the Standard.

No excessive force must be applied to the dipole arms, because they might bend or the soldered connections near the feedpoint may be damaged.

Additional EUT Data

Manufactured by	SPEAG
Manufactured on	October 20, 2014

DASY5 Validation Report for Head TSL

Date: 28.12.2016

Test Laboratory: SPEAG, Zurich, Switzerland

DUT: Dipole 750 MHz; Type: D750V3; Serial: D750V3 - SN:1132

Communication System: UID 0 - CW; Frequency: 750 MHz

Medium parameters used: $f = 750$ MHz; $\sigma = 0.91$ S/m; $\epsilon_r = 40.7$; $\rho = 1000$ kg/m³

Phantom section: Flat Section

Measurement Standard: DASY5 (IEEE/IEC/ANSI C63.19-2011)

DASY52 Configuration:

- Probe: EX3DV4 - SN7349; ConvF(10.07, 10.07, 10.07); Calibrated: 15.06.2016;
- Sensor-Surface: 1.4mm (Mechanical Surface Detection)
- Electronics: DAE4 Sn601; Calibrated: 30.12.2015
- Phantom: Flat Phantom 4.9 (front); Type: QD 00L P49 AA; Serial: 1001
- DASY52 52.8.8(1258); SEMCAD X 14.6.10(7372)

Dipole Calibration for Head Tissue/Pin=250 mW, d=15mm/Zoom Scan (7x7x7)/Cube 0:

Measurement grid: dx=5mm, dy=5mm, dz=5mm

Reference Value = 58.00 V/m; Power Drift = 0.01 dB

Peak SAR (extrapolated) = 3.11 W/kg

SAR(1 g) = 2.09 W/kg; SAR(10 g) = 1.36 W/kg

Maximum value of SAR (measured) = 2.78 W/kg

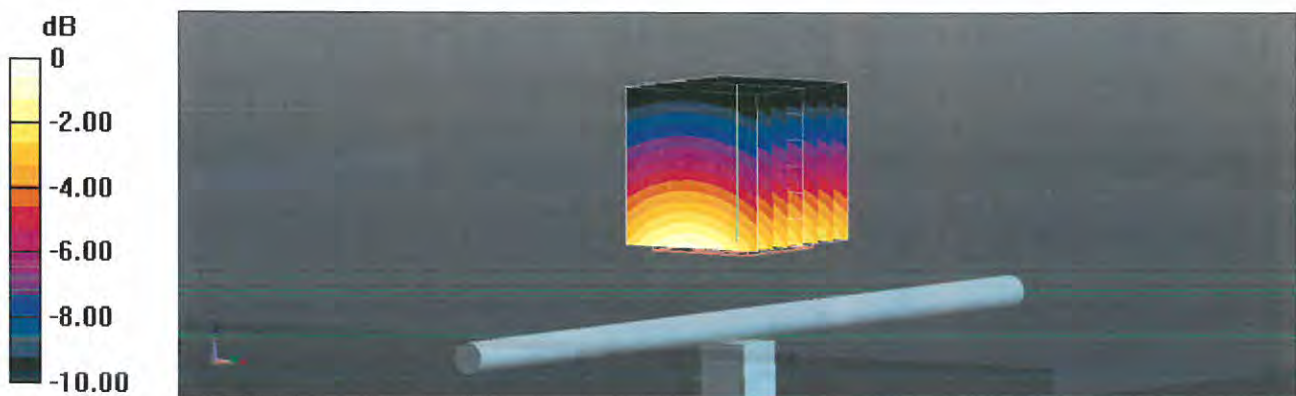

0 dB = 2.78 W/kg = 4.44 dBW/kg

Impedance Measurement Plot for Head TSL

28 Dec 2016 17:03:34
CH1 S11 1 U FS 1: 50.330 Ω -3.1855 Ω 66.615 μF 750.000 000 MHz

*
De1
CA

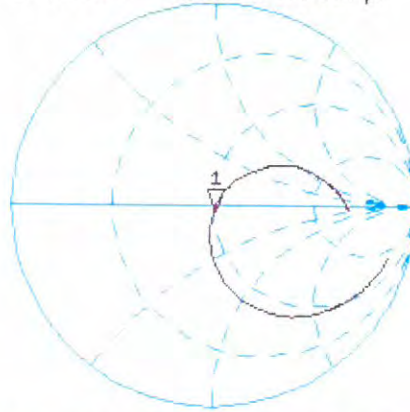

Avg
16

H1d

CH2 S11 LOG 5 dB/REF -20 dB 1: -29.968 dB 750.000 000 MHz

CA

Avg
16

H1d



DASY5 Validation Report for Body TSL

Date: 28.12.2016

Test Laboratory: SPEAG, Zurich, Switzerland

DUT: Dipole 750 MHz; Type: D750V3; Serial: D750V3 - SN:1132

Communication System: UID 0 - CW; Frequency: 750 MHz

Medium parameters used: $f = 750 \text{ MHz}$; $\sigma = 0.97 \text{ S/m}$; $\epsilon_r = 54.7$; $\rho = 1000 \text{ kg/m}^3$

Phantom section: Flat Section

Measurement Standard: DASY5 (IEEE/IEC/ANSI C63.19-2011)

DASY52 Configuration:

- Probe: EX3DV4 - SN7349; ConvF(9.99, 9.99, 9.99); Calibrated: 15.06.2016;
- Sensor-Surface: 1.4mm (Mechanical Surface Detection)
- Electronics: DAE4 Sn601; Calibrated: 30.12.2015
- Phantom: Flat Phantom 4.9 (Back); Type: QD 00R P49 AA; Serial: 1005
- DASY52 52.8.8(1258); SEMCAD X 14.6.10(7372)

Dipole Calibration for Body Tissue/Pin=250 mW, d=15mm/Zoom Scan (7x7x7)/Cube 0:

Measurement grid: $dx=5\text{mm}$, $dy=5\text{mm}$, $dz=5\text{mm}$

Reference Value = 57.05 V/m; Power Drift = -0.01 dB

Peak SAR (extrapolated) = 3.20 W/kg

SAR(1 g) = 2.17 W/kg; SAR(10 g) = 1.43 W/kg

Maximum value of SAR (measured) = 2.86 W/kg

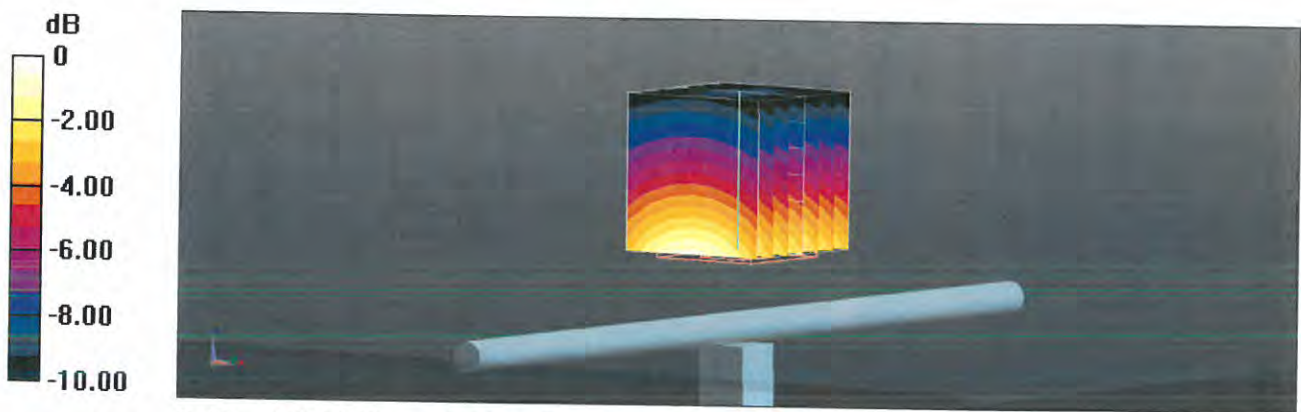

Impedance Measurement Plot for Body TSL

28 Dec 2016 10:24:37
CH1 S11 1 U FS 1: 51.150 Ω -1.5137 Ω 140.19 pF 750.000 000 MHz

*
De1
Cor

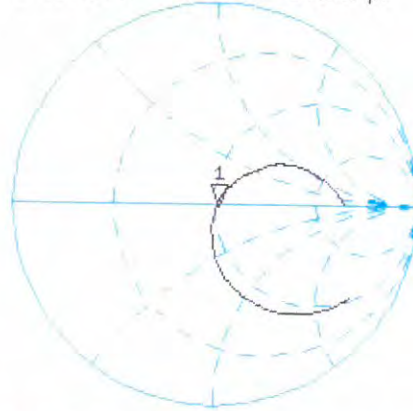

Avg
16

H1d

CH2 S11 LOG 5 dB/ REF -20 dB 1: -34.515 dB 750.000 000 MHz

Cor

Avg
16

H1d

