

FCC Test Report (Part 27)

Report No.: RF170427C12-2

FCC ID: UZ7TC25AJ

Test Model: TC25AJ

Received Date: Apr. 27, 2017

Test Date: May 15 ~ Oct. 23, 2017

Issued Date: Oct. 24, 2017

Applicant: Zebra Technologies Corporation

Address: 1 Zebra Plaza Holtsville New York United States 11742

Manufacturer: Zebra Technologies Corporation

Address: 1 Zebra Plaza Holtsville New York United States 11742

Issued By: Bureau Veritas Consumer Products Services (H.K.) Ltd., Taoyuan Branch

Lab Address: No. 47-2, 14th Ling, Chia Pau Vil., Lin Kou Dist., New Taipei City, Taiwan, R.O.C.

Test Location: No. 19, Hwa Ya 2nd Rd., Wen Hwa Vil., Kwei Shan Dist., Taoyuan City 33383, TAIWAN (R.O.C.)



This report is for your exclusive use. Any copying or replication of this report to or for any other person or entity, or use of our name or trademark, is permitted only with our prior written permission. This report sets forth our findings solely with respect to the test samples identified herein. The results set forth in this report are not indicative or representative of the quality or characteristics of the lot from which a test sample was taken or any similar or identical product unless specifically and expressly noted. Our report includes all of the tests requested by you and the results thereof based upon the information that you provided to us. You have 60 days from date of issuance of this report to notify us of any material error or omission caused by our negligence, provided, however, that such notice shall be in writing and shall specifically address the issue you wish to raise. A failure to raise such issue within the prescribed time shall constitute your unqualified acceptance of the completeness of this report, the tests conducted and the correctness of the report contents. Unless specific mention, the uncertainty of measurement has been explicitly taken into account to declare the compliance or non-compliance to the specification. The report must not be used by the client to claim product certification, approval, or endorsement by TAF or any government agency

Table of Contents

Release Control Record	4
1 Certificate of Conformity	5
2 Summary of Test Results	6
2.1 Measurement Uncertainty.....	6
2.2 Test Site and Instruments.....	7
3 General Information	8
3.1 General Description of EUT.....	8
3.2 Configuration of System under Test.....	11
3.2.1 Description of Support Units.....	12
3.3 Test Mode Applicability and Tested Channel Detail.....	13
3.4 EUT Operating Conditions.....	20
3.5 General Description of Applied Standards.....	20
4 Test Types and Results	21
4.1 Output Power Measurement.....	21
4.1.1 Limits of Output Power Measurement.....	21
4.1.2 Test Procedures.....	21
4.1.3 Test Setup.....	22
4.1.4 Test Results.....	23
4.2 Modulation Characteristics Measurement.....	41
4.2.1 Limits of Modulation Characteristics.....	41
4.2.2 Test Procedure.....	41
4.2.3 Test Setup.....	41
4.2.4 Test Results.....	42
4.3 Frequency Stability Measurement.....	45
4.3.1 Limits of Frequency Stability Measurement.....	45
4.3.2 Test Procedure.....	45
4.3.3 Test Setup.....	45
4.3.4 Test Results.....	46
4.4 Emission Bandwidth Measurement.....	47
4.4.1 Limits of Emission Bandwidth Measurement.....	47
4.4.2 Test Procedure.....	47
4.4.3 Test Setup.....	47
4.4.4 Test Result.....	48
4.5 Channel Edge Measurement.....	62
4.5.1 Limits of Band Edge Measurement.....	62
4.5.2 Test Setup.....	62
4.5.3 Test Procedures.....	62
4.5.4 Test Results.....	63
4.6 Peak to Average Ratio.....	76
4.6.1 Limits of Peak to Average Ratio Measurement.....	76
4.6.2 Test Setup.....	76
4.6.3 Test Procedures.....	76
4.6.4 Test Results.....	77
4.7 Conducted Spurious Emissions.....	90
4.7.1 Limits of Conducted Spurious Emissions Measurement.....	90
4.7.2 Test Setup.....	90
4.7.3 Test Procedure.....	90
4.7.4 Test Results.....	91
4.8 Radiated Emission Measurement.....	136
4.8.1 Limits of Radiated Emission Measurement.....	136
4.8.2 Test Procedure.....	136
4.8.3 Deviation from Test Standard.....	136
4.8.4 Test Setup.....	137

4.8.5 Test Results	138
5 Pictures of Test Arrangements.....	193
Appendix – Information on the Testing Laboratories	194

Release Control Record

Issue No.	Description	Date Issued
RF170427C12-2	Original release	Oct. 24, 2017

1 Certificate of Conformity

Product: Touch Computer

Brand: ZEBRA

Test Model: TC25AJ

Sample Status: Engineering sample

Applicant: Zebra Technologies Corporation

Test Date: May 15 ~ Oct. 23, 2017

Standards: FCC Part 27, Subpart L, H, F

The above equipment has been tested by **Bureau Veritas Consumer Products Services (H.K.) Ltd., Taoyuan Branch**, and found compliance with the requirement of the above standards. The test record, data evaluation & Equipment Under Test (EUT) configurations represented herein are true and accurate accounts of the measurements of the sample's EMC characteristics under the conditions specified in this report.

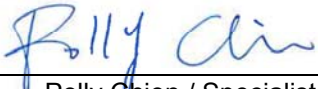
Prepared by : , **Date:** Oct. 24, 2017
Polly Chien / Specialist

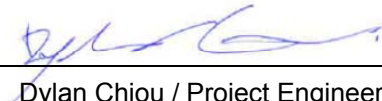
Approved by : , **Date:** Oct. 24, 2017
Dylan Chiou / Project Engineer

2 Summary of Test Results

Applied Standard: FCC Part 27 & Part 2					
FCC Clause			Test Item	Result	Remarks
WCDMA Band 4 / LTE Band 4	LTE Band 12	LTE Band 17			
2.1046 27.50(d)(4)	2.1046 27.50(b)(10)	2.1046 27.50(c)(10)	Equivalent Isotropically Radiated Power	Pass	Meet the requirement of limit.
----	----	----	Peak To Average Ratio	Pass	Meet the requirement of limit.
2.1055 27.54	2.1055 27.54	2.1055 27.54	Frequency Stability Stay with the authorized bands of operation	Pass	Meet the requirement of limit.
2.1049 27.53(m)(6)	2.1049 27.53(m)(6)	2.1049 27.53(m)(6)	Emission Bandwidth	Pass	Meet the requirement of limit.
2.1051 27.53(h)	2.1051 27.53(c)	2.1051 27.53(g)	Band Edge Measurements	Pass	Meet the requirement of limit.
2.1051 27.53(h)	2.1051 27.53(c)	2.1051 27.53(g)	Conducted Spurious Emissions	Pass	Meet the requirement of limit.
2.1051 27.53(h)	2.1051 27.53(c)	2.1051 27.53(g)	Radiated Spurious Emissions	Pass	Meet the requirement of limit. Minimum passing margin is -21.6dB at 2133.00MHz.

2.1 Measurement Uncertainty

Where relevant, the following measurement uncertainty levels have been estimated for tests performed on the EUT as specified in CISPR 16-4-2:

Measurement	Frequency	Expanded Uncertainty (k=2) (±)
Radiated Emissions up to 1 GHz	30MHz ~ 200MHz	3.63 dB
	200MHz ~1000MHz	3.64 dB
Radiated Emissions above 1 GHz	1GHz ~ 18GHz	2.29 dB
	18GHz ~ 40GHz	2.29 dB

2.2 Test Site and Instruments

Description & Manufacturer	Model No.	Serial No.	Cal. Date	Cal. Due
Test Receiver ROHDE & SCHWARZ	ESCI	100424	Oct. 24, 2016	Oct. 23, 2017
Spectrum Analyzer ROHDE & SCHWARZ	FSP40	100040	Aug. 16, 2016	Aug. 15, 2017
			Aug. 18, 2017	Aug. 17, 2018
BILOG Antenna SCHWARZBECK	VULB9168	9168-155	Dec. 28, 2016	Dec. 27, 2017
HORN Antenna SCHWARZBECK	BBHA 9120D	9120D-1170	Dec. 15, 2016	Dec. 14, 2017
HORN Antenna SCHWARZBECK	BBHA 9170	BBHA9170241	Dec. 14, 2016	Dec. 13, 2017
Loop Antenna	EM-6879	269	Aug. 11, 2016	Aug. 10, 2017
			Aug. 10, 2017	Aug. 09, 2018
Preamplifier Agilent	8447D	2944A10738	Aug. 22, 2016	Aug. 21, 2017
			Aug. 21, 2017	Aug. 20, 2018
Preamplifier Agilent	8449B	3008A01922	Sep. 18, 2016	Sep. 17, 2017
			Sep. 15, 2017	Sep. 14, 2018
RF signal cable HUBER+SUHNER	SUCOFLEX 104	MY 13380+295012/04	Aug. 09, 2016	Aug. 08, 2017
			Aug. 08, 2017	Aug. 07, 2018
RF signal cable HUBER+SUHNER	SUCOFLEX 104	Cable-CH4-03 (250724)	Aug. 09, 2016	Aug. 08, 2017
			Aug. 08, 2017	Aug. 07, 2018
Software BV ADT	ADT_Radiated_ V7.6.15.9.4	NA	NA	NA
Antenna Tower inn-co GmbH	MA 4000	013303	NA	NA
Antenna Tower Controller BV ADT	AT100	AT93021702	NA	NA
Turn Table BV ADT	TT100	TT93021702	NA	NA
Turn Table Controller BV ADT	SC100	SC93021702	NA	NA
WIT Standard Temperature And Humidity Chamber	TH-4S-C	W981030	Jun. 08, 2016	Jun. 07, 2017
			Jun. 07, 2017	Jun. 06, 2018
JFW 20dB attenuation	50HF-020-SMA	NA	NA	NA

- Note:
1. The calibration interval of the above test instruments is 12 months and the calibrations are traceable to NML/ROC and NIST/USA.
 2. The test was performed in HwaYa Chamber 4.
 3. The horn antenna and preamplifier (model: 8449B) are used only for the measurement of emission frequency above 1GHz if tested.
 4. The FCC Designation Number is TW0003. The number will be varied with the Lab location and scope as attached.
 5. The IC Site Registration No. is IC7450F-4.

3 General Information

3.1 General Description of EUT

Product	Touch Computer		
Brand	ZEBRA		
Test Model	TC25AJ		
Status of EUT	Engineering sample		
MFD	11JUL17		
HW Version	DV		
SW Version	90-06-05-N-00-E1		
Power Supply Rating	5Vdc (adapter or host equipment) 12 or 24Vdc (vehicle cigarette adaptor) 3.85Vdc (battery or power pack)		
Modulation Type	WCDMA: BPSK, QPSK HSDPA: BPSK HSUPA: QPSK LTE: QPSK, 16QAM		
Operating Frequency	WCDMA Band 4		1712.4MHz ~ 1752.6MHz
	LTE Band 4	Channel Bandwidth 1.4MHz	1710.7MHz ~ 1754.3MHz
		Channel Bandwidth 3MHz	1711.5MHz ~ 1753.5MHz
		Channel Bandwidth 5MHz	1712.5MHz ~ 1752.5MHz
		Channel Bandwidth 10MHz	1715MHz ~ 1750MHz
		Channel Bandwidth 15MHz	1717.5MHz ~ 1747.5MHz
		Channel Bandwidth 20MHz	1720MHz ~ 1745MHz
	LTE Band 12	Channel Bandwidth 1.4MHz	699.7MHz ~ 715.3MHz
		Channel Bandwidth 3MHz	700.5MHz ~ 714.5MHz
		Channel Bandwidth 5MHz	701.5MHz ~ 713.5MHz
		Channel Bandwidth 10MHz	704MHz ~ 711MHz
	LTE Band 17	Channel Bandwidth 5MHz	706.5MHz ~ 713.5MHz
		Channel Bandwidth 10MHz	709MHz ~ 711MHz
	Max. EIRP Power	WCDMA Band 4	
LTE Band 4		Channel Bandwidth 1.4MHz	308.319mW (24.89dBm)
		Channel Bandwidth 3MHz	311.889mW (24.94dBm)
		Channel Bandwidth 5MHz	316.957mW (25.01dBm)
		Channel Bandwidth 10MHz	324.340mW (25.11dBm)
		Channel Bandwidth 15MHz	330.370mW (25.19dBm)
		Channel Bandwidth 20MHz	336.512mW (25.27dBm)
LTE Band 12		Channel Bandwidth 1.4MHz	235.505mW (23.72dBm)
		Channel Bandwidth 3MHz	236.592mW (23.74dBm)
		Channel Bandwidth 5MHz	186.209mW (22.70dBm)
		Channel Bandwidth 10MHz	246.604mW (23.92dBm)
LTE Band 17		Channel Bandwidth 5MHz	250.035mW (23.98dBm)
		Channel Bandwidth 10MHz	254.683mW (24.06dBm)

Antenna Connector	Refer to Note
Antenna Connector	Refer to Note
Accessory Device	Adapter, Gun Handle, Arm Mount, Holster , Vehicle Cigarette Adaptor, Power pack (Refer to note 3 for more details)
Data Cable Supplied	1.5m shielded USB Type C to Type A cable without core (Refer to note 3 for more details)

Note:

1. The EUT has two types for sale.

Brand	Model	Difference
ZEBRA	TC25AJ	Scanner SE4710 with camera
	TC25AJ	Scanner SE2100 without camera

2. The EUT consumes power from the following adapter, Vehicle Cigarette Adaptor, battery and power pack.

Adapter	
Brand	ZEBRA
Model	SAWA-65-20005A
Input Power	100-240Vac, 0.5A, 50-60Hz
Output Power	5Vdc, 2.5A

Vehicle Cigarette Adaptor	
Brand	ZEBRA
Model	SAWA-68-25005A
Input Power	12-24V(3.5A)
Output Power	5V(2.5A)

Battery	
Brand	ZEBRA
Model	BT-000334
Rate capacity	3000mAh
Min capacity	2800mAh
Rate Voltage	3.85Vdc

Power Pack	
Brand	ZEBRA
Model	BT-000343
Rate capacity	2900mAh
Min capacity	2800mAh
Rate Voltage	3.85Vdc

3. Accessory devices of EUT are list as below:

Specification of Accessory		
AC Adapter	Brand Name	ZEBRA
	Model Name	SAWA-65-20005A
USB Type C cable	Brand Name	ZEBRA
	P/N Number	CBL-MPM-USB1-01
Gun Handle	Brand Name	ZEBRA
	P/N Number	TRG-TC2X-SNP1-01
Arm Mount	Brand Name	ZEBRA
	P/N Number	SG-TC2X-ARMNT-01
Holster	Brand Name	ZEBRA
	P/N Number	SG-TC2X-HLSTR1-01
Vehicle Cigarette Adaptor	Brand Name	ZEBRA
	Model Name	SAWA-68-25005A
Power pack	Brand Name	ZEBRA
	Model Name	BT-000343

4. The EUT uses following antennas.

Antenna	Brand	Frequency Range (MHz)	Antenna Gain (dBi)	Antenna Type	Antenna Connector
WWAN	WCDMA Band 4	1710	1.04	PIFA	NA
		1733	1.1		
		1755	1.29		
LTE	Band 4	1710	1.04	PIFA	NA
		1733	1.1		
		1755	1.29		
LTE	Band 12	698	1.04	PIFA	NA
		707	1.99		
		716	2.34		
LTE	Band 17	704	1.38	PIFA	NA
		710	2.02		
		716	2.30		

3.2 Configuration of System under Test

Mode A, E

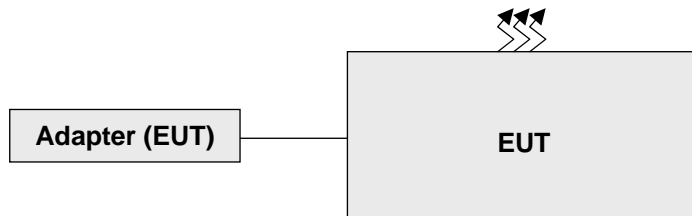

Remote site



Mode B

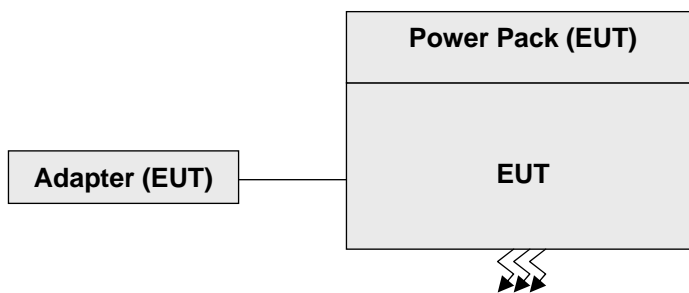

Remote site



Mode C

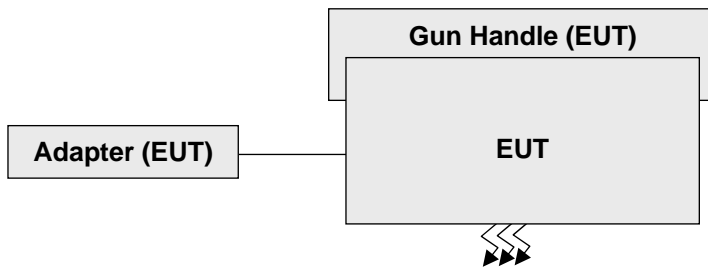

Remote site

Mode D

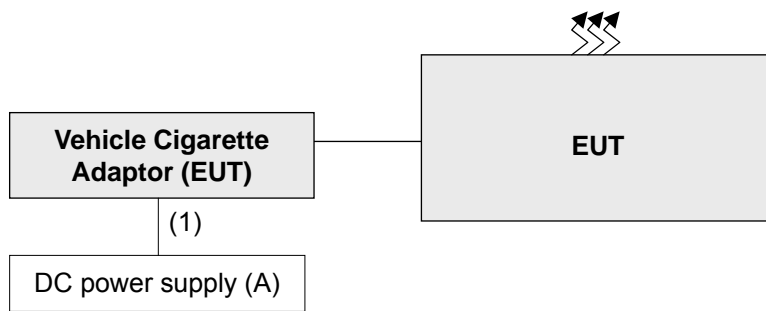

Remote site

3.2.1 Description of Support Units

The EUT has been tested as an independent unit together with other necessary accessories or support units. The following support units or accessories were used to form a representative test configuration during the tests.

ID	Product	Brand	Model No.	Serial No.	FCC ID	Remarks
A.	Radio Communication Tester	R&S	CMU200	123112	NA	-
B.	DC power supply	Keysight	U8002A	MY56330015	NA	-

Note:

1. All power cords of the above support units are non-shielded (1.8m).
2. Item A acted as a communication partner to transfer data.

ID	Descriptions	Qty.	Length (m)	Shielding (Yes/No)	Cores (Qty.)	Remarks
1.	DC cable	1	1.0	N	0	-

3.3 Test Mode Applicability and Tested Channel Detail

Pre-Scan has been conducted to determine the worst-case mode from all possible combinations between available modulations, data rates, XYZ axis and antenna ports. The worst case was found when positioned on Y-plane. Following channel(s) was (were) selected for the final test as listed below:

Test results are presented in the report as below.

Test Mode	Test Condition
A	Scanner SE4710, EUT+USB cable+adapter
B	Scanner SE4710, EUT+USB cable+adapter+power pack
C	Scanner SE4710, EUT+USB cable+adapter+Gun Handle
D	Scanner SE4710, EUT+USB cable+Vehicle Cigarette Adaptor
E	Scanner SE2100, EUT+USB cable+adapter

WCDMA Band 4 Mode

EUT Configure Mode	Test Item	Available Channel	Tested Channel	Mode
A	EIRP	1312 to 1513	1312(1712.4MHz), 1413(1732.6MHz), 1513(1752.6MHz)	WCDMA
A	Modulation Characteristics	1312 to 1513	1413(1732.6MHz)	WCDMA, HSDPA, HSUPA
A	Frequency Stability	1312 to 1513	1413(1732.6MHz)	WCDMA
A	Occupied Bandwidth	1312 to 1513	1312(1712.4MHz), 1413(1732.6MHz), 1513(1752.6MHz)	WCDMA, HSDPA, HSUPA
A	Band Edge	1312 to 1513	1312(1712.4MHz), 1513(1752.6MHz)	WCDMA, HSDPA, HSUPA
A	Peak To Average Ratio	1312 to 1513	1312(1712.4MHz), 1413(1732.6MHz), 1513(1752.6MHz)	WCDMA, HSDPA, HSUPA
A	Conducted Emission	1312 to 1513	1312(1712.4MHz), 1413(1732.6MHz), 1513(1752.6MHz)	WCDMA, HSDPA, HSUPA
A, B, C, D, E	Radiated Emission Below 1GHz	1312 to 1513	1312(1712.4MHz)	WCDMA
A	Radiated Emission Above 1GHz	1312 to 1513	1312(1712.4MHz), 1413(1732.6MHz), 1513(1752.6MHz)	WCDMA

LTE Band 4

EUT Configure Mode	Test Item	Available Channel	Tested Channel	Channel Bandwidth	Modulation	Mode
A	Output Power	19957 to 20393	19957(1710.7MHz), 20175(1732.5MHz), 20393(1754.3MHz)	1.4MHz	QPSK	1 RB / 0 RB Offset
		19965 to 20385	19965(1711.5MHz), 20175(1732.5MHz), 20385(1753.5MHz)	3MHz	QPSK	1 RB / 0 RB Offset
		19975 to 20375	19975(1712.5MHz), 20175(1732.5MHz), 20375(1752.5MHz)	5MHz	QPSK	1 RB / 0 RB Offset
		20000 to 20350	20000(1715.0MHz), 20175(1732.5MHz), 20350(1750.0MHz)	10MHz	QPSK	1 RB / 0 RB Offset
		20025 to 20325	20025(1717.5MHz), 20175(1732.5MHz), 20325(1747.5MHz)	15MHz	QPSK	1 RB / 0 RB Offset
		20050 to 20300	20050(1720.0MHz), 20175(1732.5MHz), 20300(1745.0MHz)	20MHz	QPSK	1 RB / 0 RB Offset
A	Modulation Characteristics	20050 to 20300	20175(1732.5MHz)	20MHz	QPSK, 16QAM	100 RB / 0 RB Offset
A	Frequency Stability	19957 to 20393	20175(1732.5MHz)	1.4MHz	QPSK	1 RB / 0 RB Offset
A	Emission Bandwidth	19957 to 20393	19957(1710.7MHz), 20175(1732.5MHz), 20393(1754.3MHz)	1.4MHz	QPSK, 16QAM	6 RB / 0 RB Offset
		19965 to 20385	19965(1711.5MHz), 20175(1732.5MHz), 20385(1753.5MHz)	3MHz	QPSK, 16QAM	15 RB / 0 RB Offset
		19975 to 20375	19975(1712.5MHz), 20175(1732.5MHz), 20375(1752.5MHz)	5MHz	QPSK, 16QAM	25 RB / 0 RB Offset
		20000 to 20350	20000(1715.0MHz), 20175(1732.5MHz), 20350(1750.0MHz)	10MHz	QPSK, 16QAM	50 RB / 0 RB Offset
		20025 to 20325	20025(1717.5MHz), 20175(1732.5MHz), 20325(1747.5MHz)	15MHz	QPSK, 16QAM	75 RB / 0 RB Offset
		20050 to 20300	20050(1720.0MHz), 20175(1732.5MHz), 20300(1745.0MHz)	20MHz	QPSK, 16QAM	100 RB / 0 RB Offset
A	Channel Edge	19957 to 20393	19957(1710.7MHz), 20393(1754.3MHz)	1.4MHz	QPSK	1 RB / 0 RB Offset 1 RB / 5 RB Offset 6 RB / 0 RB Offset
		19965 to 20385	19965(1711.5MHz), 20385(1753.5MHz)	3MHz	QPSK	1 RB / 0 RB Offset 1 RB / 14 RB Offset 15 RB / 0 RB Offset
		19975 to 20375	19975(1712.5MHz), 20375(1752.5MHz)	5MHz	QPSK	1 RB / 0 RB Offset 1 RB / 24 RB Offset 25 RB / 0 RB Offset
		20000 to 20350	20000(1715.0MHz), 20350(1750.0MHz)	10MHz	QPSK	1 RB / 0 RB Offset 1 RB / 49 RB Offset 50 RB / 0 RB Offset
		20025 to 20325	20025(1717.5MHz), 20325(1747.5MHz)	15MHz	QPSK	1 RB / 0 RB Offset 1 RB / 74 RB Offset 75 RB / 0 RB Offset
		20050 to 20300	20050(1720.0MHz), 20300(1745.0MHz)	20MHz	QPSK	1 RB / 0 RB Offset 1 RB / 99 RB Offset 100 RB / 0 RB Offset

EUT Configure Mode	Test Item	Available Channel	Tested Channel	Channel Bandwidth	Modulation	Mode
A	Conducted Emission	19957 to 20393	19957(1710.7MHz), 20175(1732.5MHz), 20393(1754.3MHz)	1.4MHz	QPSK	1 RB / 0 RB Offset
		19965 to 20385	19965(1711.5MHz), 20175(1732.5MHz), 20385(1753.5MHz)	3MHz	QPSK	1 RB / 0 RB Offset
		19975 to 20375	19975(1712.5MHz), 20175(1732.5MHz), 20375(1752.5MHz)	5MHz	QPSK	1 RB / 0 RB Offset
		20000 to 20350	20000(1715.0MHz), 20175(1732.5MHz), 20350(1750.0MHz)	10MHz	QPSK	1 RB / 0 RB Offset
		20025 to 20325	20025(1717.5MHz), 20175(1732.5MHz), 20325(1747.5MHz)	15MHz	QPSK	1 RB / 0 RB Offset
		20050 to 20300	20050(1720.0MHz), 20175(1732.5MHz), 20300(1745.0MHz)	20MHz	QPSK	1 RB / 0 RB Offset
A, B, C, D, E	Radiated Emission Below 1GHz	19957 to 20393	19957(1710.7MHz)	1.4MHz	QPSK	1 RB / 0 RB Offset
A		19965 to 20385	19965(1711.5MHz)	3MHz	QPSK	1 RB / 0 RB Offset
A		19975 to 20375	19975(1712.5MHz)	5MHz	QPSK	1 RB / 0 RB Offset
A		20000 to 20350	20000(1715.0MHz)	10MHz	QPSK	1 RB / 0 RB Offset
A		20025 to 20325	20025(1717.5MHz)	15MHz	QPSK	1 RB / 0 RB Offset
A		20050 to 20300	20050(1720.0MHz)	20MHz	QPSK	1 RB / 0 RB Offset
A	Radiated Emission Above 1GHz	19957 to 20393	19957(1710.7MHz), 20175(1732.5MHz), 20393(1754.3MHz)	1.4MHz	QPSK	1 RB / 0 RB Offset
		19965 to 20385	19965(1711.5MHz), 20175(1732.5MHz), 20385(1753.5MHz)	3MHz	QPSK	1 RB / 0 RB Offset
		19975 to 20375	19975(1712.5MHz), 20175(1732.5MHz), 20375(1752.5MHz)	5MHz	QPSK	1 RB / 0 RB Offset
		20000 to 20350	20000(1715.0MHz), 20175(1732.5MHz), 20350(1750.0MHz)	10MHz	QPSK	1 RB / 0 RB Offset
		20025 to 20325	20025(1717.5MHz), 20175(1732.5MHz), 20325(1747.5MHz)	15MHz	QPSK	1 RB / 0 RB Offset
		20050 to 20300	20050(1720.0MHz), 20175(1732.5MHz), 20300(1745.0MHz)	20MHz	QPSK	1 RB / 0 RB Offset

LTE Band 12

EUT Configure Mode	Test item	Available channel	Tested channel	Channel Bandwidth	Modulation	Mode
A	Output Power	23017 to 23171	23017 (699.7MHz) 23095(707.5MHz) 23173 (715.3MHz)	1.4MHz	QPSK	1 RB / 0 RB Offset
		23025 to 23165	23025 (700.5MHz) 23095(707.5 MHz) 23165(714.5MHz)	3MHz	QPSK	1 RB / 0 RB Offset
		23035 to 23155	23035(701.5MHz) 23095(707.5MHz) 23155(713.5MHz)	5MHz	QPSK	1 RB / 0 RB Offset
		23060 to 23130	23060(704MHz) 23095(707.5 MHz) 23130(711.0 MHz)	10MHz	QPSK	1 RB / 0 RB Offset
A	Modulation Characteristics	23060 to 23130	23095(707.5 MHz)	10MHz	QPSK / 16QAM	1 RB / 0 RB Offset
A	Frequency Stability	23017 to 23171	23017 (699.7MHz) 23095(707.5MHz) 23173 (715.3MHz)	1.4MHz	QPSK	1 RB / 0 RB Offset
		23025 to 23165	23025 (700.5MHz) 23095(707.5 MHz) 23165(714.5MHz)	3MHz	QPSK	1 RB / 0 RB Offset
		23035 to 23155	23035(701.5MHz) 23095(707.5MHz) 23155(713.5MHz)	5MHz	QPSK	1 RB / 0 RB Offset
		23060 to 23130	23060(704MHz) 23095(707.5 MHz) 23130(711.0 MHz)	10MHz	QPSK	1 RB / 0 RB Offset
A	Emission Bandwidth	23017 to 23171	23017 (699.7MHz) 23095(707.5MHz) 23173 (715.3MHz)	1.4MHz	QPSK / 16QAM	1 RB / 0 RB Offset
		23025 to 23165	23025 (700.5MHz) 23095(707.5 MHz) 23165(714.5MHz)	3MHz	QPSK / 16QAM	1 RB / 0 RB Offset
		23035 to 23155	23035(701.5MHz) 23095(707.5MHz) 23155(713.5MHz)	5MHz	QPSK / 16QAM	1 RB / 0 RB Offset
		23060 to 23130	23060(704MHz) 23095(707.5 MHz) 23130(711.0 MHz)	10MHz	QPSK / 16QAM	1 RB / 0 RB Offset
A	Band Edge	23017 to 23171	23017 (699.7MHz)	1.4MHz	QPSK	1 RB / 0 RB Offset 6 RB / 0 RB Offset
			23173 (715.3MHz)	1.4MHz	QPSK	1 RB / 5 RB Offset 6 RB / 0 RB Offset
		23025 to 23165	23025 (700.5MHz)	3MHz	QPSK	1 RB / 0 RB Offset 15 RB / 0 RB Offset
			23165(714.5MHz)	3MHz	QPSK	1 RB / 14 RB Offset 15 RB / 0 RB Offset
		23035 to 23155	23035(701.5MHz)	5MHz	QPSK	1 RB / 0 RB Offset 25 RB / 0 RB Offset
			23155(713.5MHz)	5MHz	QPSK	1 RB / 24 RB Offset 25 RB / 0 RB Offset
		23060 to 23130	23060(704MHz)	10MHz	QPSK	1 RB / 0 RB Offset 50 RB / 0 RB Offset
			23130(711.0 MHz)	10MHz	QPSK	1 RB / 49 RB Offset 50 RB / 0 RB Offset

EUT Configure Mode	Test item	Available channel	Tested channel	Channel Bandwidth	Modulation	Mode
A	Peak to Average Ratio	23017 to 23171	23017 (699.7MHz) 23095(707.5MHz) 23173 (715.3MHz)	1.4MHz	QPSK / 16QAM	1 RB / 0 RB Offset
		23025 to 23165	23025 (700.5MHz) 23095(707.5 MHz) 23165(714.5MHz)	3MHz	QPSK / 16QAM	1 RB / 0 RB Offset
		23035 to 23155	23035(701.5MHz) 23095(707.5MHz) 23155(713.5MHz)	5MHz	QPSK / 16QAM	1 RB / 0 RB Offset
		23060 to 23130	23060(704MHz) 23095(707.5 MHz) 23130(711.0 MHz)	10MHz	QPSK / 16QAM	1 RB / 0 RB Offset
A	Conducuted Emission	23017 to 23171	23017 (699.7MHz) 23095(707.5MHz) 23173 (715.3MHz)	1.4MHz	QPSK	1 RB / 0 RB Offset
		23025 to 23165	23025 (700.5MHz) 23095(707.5 MHz) 23165(714.5MHz)	3MHz	QPSK	1 RB / 0 RB Offset
		23035 to 23155	23035(701.5MHz) 23095(707.5MHz) 23155(713.5MHz)	5MHz	QPSK	1 RB / 0 RB Offset
		23060 to 23130	23060(704MHz) 23095(707.5 MHz) 23130(711.0 MHz)	10MHz	QPSK	1 RB / 0 RB Offset
A, B, C, D, E	Radiated Emission Below 1GHz	23017 to 23171	23017 (699.7MHz)	1.4MHz	QPSK	1 RB / 0 RB Offset
A		23025 to 23165	23025 (700.5MHz)	3MHz	QPSK	1 RB / 0 RB Offset
A		23035 to 23155	23035(701.5MHz)	5MHz	QPSK	1 RB / 0 RB Offset
A		23060 to 23130	23060(704MHz)	10MHz	QPSK	1 RB / 0 RB Offset
A	Radiated Emission Above 1GHz	23017 to 23171	23017 (699.7MHz) 23095(707.5MHz) 23173 (715.3MHz)	1.4MHz	QPSK	1 RB / 0 RB Offset
		23025 to 23165	23025 (700.5MHz) 23095(707.5 MHz) 23165(714.5MHz)	3MHz	QPSK	1 RB / 0 RB Offset
		23035 to 23155	23035(701.5MHz) 23095(707.5MHz) 23155(713.5MHz)	5MHz	QPSK	1 RB / 0 RB Offset
		23060 to 23130	23060(704MHz) 23095(707.5 MHz) 23130(711.0 MHz)	10MHz	QPSK	1 RB / 0 RB Offset

LTE Band 17

EUT Configure Mode	Test Item	Available Channel	Tested Channel	Channel Bandwidth	Modulation	Mode
A	Output Power	23755 to 23825	23755(706.5MHz), 23790(710.0MHz), 23825(713.5MHz)	5MHz	QPSK	1 RB / 0 RB Offset
		23780 to 23800	23780(709.0MHz), 23790(710.0MHz), 23800(711.0MHz)	10MHz	QPSK	1 RB / 0 RB Offset
A	Modulation Characteristics	23780 to 23800	23790(710.0MHz)	10MHz	QPSK, 16QAM	50 RB / 0 RB Offset
A	Frequency Stability	23755 to 23825	23790(710.0MHz)	5MHz	QPSK	1 RB / 0 RB Offset
A	Emission Bandwidth	23755 to 23825	23755(706.5MHz), 23790(710.0MHz), 23825(713.5MHz)	5MHz	QPSK, 16QAM	25 RB / 0 RB Offset
		23780 to 23800	23780(709.0MHz), 23790(710.0MHz), 23800(711.0MHz)	10MHz	QPSK, 16QAM	50 RB / 0 RB Offset
A	Channel Edge	23755 to 23825	23755(706.5MHz), 23825(713.5MHz)	5MHz	QPSK	1 RB / 0 RB Offset 1 RB / 24 RB Offset 25 RB / 0 RB Offset
		23780 to 23800	23780(709.0MHz), 23800(711.0MHz)	10MHz	QPSK	1 RB / 0 RB Offset 1 RB / 49 RB Offset 50 RB / 0 RB Offset
A	Conducted Emission	23755 to 23825	23755(706.5MHz), 23790(710.0MHz), 23825(713.5MHz)	5MHz	QPSK	1 RB / 0 RB Offset
		23780 to 23800	23780(709.0MHz), 23790(710.0MHz), 23800(711.0MHz)	10MHz	QPSK	1 RB / 0 RB Offset
A, B, C, D, E	Radiated Emission Below 1GHz	23755 to 23825	23755(706.5MHz)	5MHz	QPSK	1 RB / 0 RB Offset
A		23780 to 23800	23780(710.0MHz)	10MHz	QPSK	1 RB / 0 RB Offset
A	Radiated Emission Above 1GHz	23755 to 23825	23755(706.5MHz), 23790(710.0MHz), 23825(713.5MHz)	5MHz	QPSK	1 RB / 0 RB Offset
		23780 to 23800	23780(709.0MHz), 23790(710.0MHz), 23800(711.0MHz)	10MHz	QPSK	1 RB / 0 RB Offset

Note:

- For radiated emission below 1GHz, low, mid and high channels were pre-tested in chamber with 1.4MHz mode. Low channel on mode A was found to be the worst case and therefore had been chosen for all final tests.
- The conducted output power for QPSK and 16QAM, measured value of QPSK is higher than 16QAM mode. Therefore, only Emission Bandwidth had been tested under QPSK and 16QAM modes, the others test items were performed under QPSK mode only.

Test Condition:

Test Item	Environmental Conditions	Input Power	Tested By
Output Power	24deg. C, 64%RH	120Vac, 60Hz	Match Tsui
Modulation characteristics	24deg. C, 64%RH	120Vac, 60Hz	Match Tsui
Frequency Stability	24deg. C, 64%RH	120Vac, 60Hz	Match Tsui
Emission Bandwidth	24deg. C, 64%RH	120Vac, 60Hz	Match Tsui
Channel Edge	24deg. C, 64%RH	120Vac, 60Hz	Match Tsui
Conducted Emission	24deg. C, 64%RH	120Vac, 60Hz	Match Tsui
Radiated Emission	20deg. C, 69%RH 25deg. C, 70%RH	120Vac, 60Hz	Bond Tseng Luis Lee Matthew Yang

3.4 EUT Operating Conditions

The EUT makes a call to the communication simulator. The communication simulator station system controlled a EUT to export maximum output power under transmission mode and specific channel frequency

3.5 General Description of Applied Standards

The EUT is a RF Product. According to the specifications of the manufacturer, it must comply with the requirements of the following standards:

FCC 47 CFR Part 2

FCC 47 CFR Part 27

KDB 971168 D01 Power Meas License Digital Systems v02r02

ANSI/TIA/EIA-603-E 2016

ANSI 63.26-2015

Note: All test items have been performed and recorded as per the above standards.

Note: The EUT has been verified to comply with the requirements of FCC Part 15, Subpart B, Class B (DoC).
The test report has been issued separately.

4 Test Types and Results

4.1 Output Power Measurement

4.1.1 Limits of Output Power Measurement

Mobile / Portable station are limited to 2 watts e.r.p. for WCDMA, 1 watts e.i.r.p for LTE Band 4 and 3 watts e.r.p for LTE Band 13 & 17.

4.1.2 Test Procedures

EIRP / ERP Measurement:

- All measurements were done at low, middle and high operational frequency range. RWB and VBW is 5MHz for WCDMA, HSDPA, HSUPA mode and 5MHz for LTE Mode.
- Substitution method is used for E.I.R.P measurement. In the semi-anechoic chamber, EUT placed on the 0.8m(below or equal 1GHz) and/or 1.5m(above 1GHz) height of Turn Table, rotated the table around 360 degrees to search the maximum radiation power and receiver antenna shall be rotated vertical and horizontal polarization and moved height from 1m to 4m to find the maximum polar radiated power. The "Read Value" is the spectrum reading the maximum power value.
- The substitution horn antenna is substituted for EUT at the same position and signals generator export the CW signal to the substitution antenna via a TX cable. Rotated the Turn Table and moved receiving antenna to find the maximum radiation power. Adjust output power level of S.G to get a Value of spectrum reading equal to "Read Value" of step b. Record the power level of S.G
- $EIRP = \text{Output power level of S.G} - \text{TX cable loss} + \text{Antenna gain of substitution horn}$. E.R.P power can be calculated form E.I.R.P power by subtracting the gain of dipole, $E.R.P \text{ power} = E.I.R.P \text{ power} - 2.15\text{dBi}$.

Where:

$$ERP/EIRP = P_{Meas} + G_T - L_C$$

P_{Meas} : Measure transmitter output power.

G_T : Gain of the transmitting antenna.

L_C : signal attenuation in the connecting cable between the transmitter and antenna.

Conducted Power Measurement:

A power sensor was used on the output port of the EUT. A power meter was used to read the response of the power sensor. Record the power level.

4.1.3 Test Setup

EIRP / ERP MEASUREMENT:

For Radiated Emission below or equal 1GHz

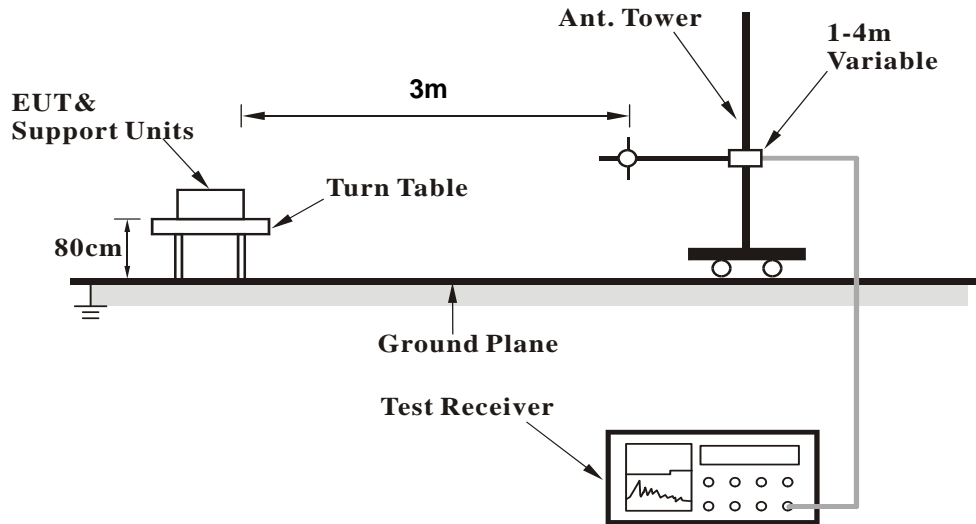

For Radiated Emission above 1GHz

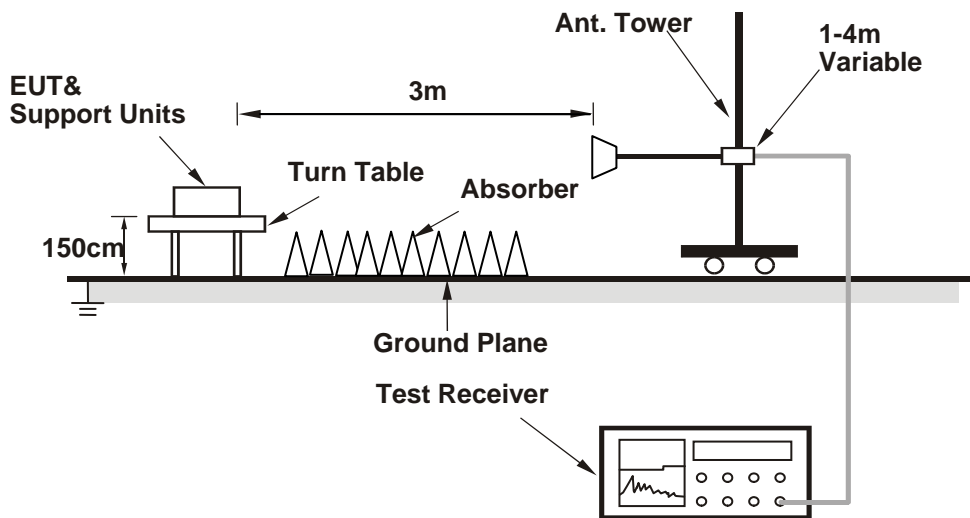

For the actual test configuration, please refer to the attached file (Test Setup Photo).

CONDUCTED POWER MEASUREMENT:



For the actual test configuration, please refer to the attached file (Test Setup Photo).

4.1.4 Test Results

CONDUCTED OUTPUT POWER (dBm)

Band	WCDMA IV		
Channel	1312	1413	1513
Frequency (MHz)	1712.4	1732.6	1752.6
RMC 12.2K	24.15	24.25	24.39
HSDPA Subtest-1	23.96	23.73	23.89
HSDPA Subtest-2	23.91	23.68	23.86
HSDPA Subtest-3	23.43	23.20	23.88
HSDPA Subtest-4	23.42	23.19	23.87
HSUPA Subtest-1	23.87	23.64	23.92
HSUPA Subtest-2	22.86	22.63	22.78
HSUPA Subtest-3	22.87	22.64	22.96
HSUPA Subtest-4	22.86	22.63	22.88
HSUPA Subtest-5	23.94	23.71	23.86

Conducted Output Power (dBm)

LTE Band 4

Band / BW	RB Size	RB Offset	QPSK			16QAM		
			Low CH 19957	Mid CH 20175	High CH 20393	Low CH 19957	Mid CH 20175	High CH 20393
			1710.7 MHz	1732.5 MHz	1754.3 MHz	1710.7 MHz	1732.5 MHz	1754.3 MHz
4 / 1.4M	1	0	22.85	23.60	22.89	21.84	22.59	21.88
	1	2	22.83	23.31	22.80	21.82	22.30	21.79
	1	5	22.15	22.33	22.12	21.14	21.32	21.11
	3	0	22.24	22.42	22.21	21.23	21.41	21.30
	3	1	22.17	22.05	22.14	21.21	21.04	21.13
	3	3	22.03	22.07	22.20	21.02	21.07	21.09
	6	0	21.40	21.88	21.37	20.39	20.87	20.36
Band / BW	RB Size	RB Offset	QPSK			16QAM		
			Low CH 19965	Mid CH 20175	High CH 20385	Low CH 19965	Mid CH 20175	High CH 20385
			1711.5 MHz	1732.5 MHz	1753.5 MHz	1711.5 MHz	1732.5 MHz	1753.5 MHz
4 / 3M	1	0	22.90	23.65	22.94	21.89	22.64	21.93
	1	7	22.88	23.36	22.85	21.87	22.35	21.84
	1	14	22.20	22.38	22.17	21.19	21.37	21.16
	8	0	21.99	22.47	21.96	20.98	21.46	20.95
	8	3	21.62	22.10	21.59	20.61	21.09	20.58
	8	7	21.28	21.76	21.25	20.27	20.75	20.24
	15	0	21.45	21.93	21.42	20.44	20.92	20.41
Band / BW	RB Size	RB Offset	QPSK			16QAM		
			Low CH 19975	Mid CH 20175	High CH 20375	Low CH 19975	Mid CH 20175	High CH 20375
			1712.5 MHz	1732.5 MHz	1752.5 MHz	1712.5 MHz	1732.5 MHz	1752.5 MHz
4 / 5M	1	0	22.97	23.72	23.01	21.96	22.71	22.00
	1	12	22.95	23.43	22.92	21.94	22.42	21.91
	1	24	22.27	22.45	22.24	21.26	21.44	21.23
	12	0	22.06	22.54	22.03	21.05	21.53	21.02
	12	6	21.69	22.17	21.66	20.68	21.16	20.65
	12	13	21.35	21.83	21.32	20.34	20.82	20.31
	25	0	21.52	22.00	21.49	20.51	20.99	20.48

Band / BW	RB Size	RB Offset	QPSK			16QAM		
			Low CH 20000	Mid CH 20175	High CH 20350	Low CH 20000	Mid CH 20175	High CH 20350
			1715 MHz	1732.5 MHz	1750 MHz	1715 MHz	1732.5 MHz	1750 MHz
4 / 10M	1	0	23.07	23.82	23.11	22.06	22.81	22.10
	1	24	23.05	23.53	23.02	22.04	22.52	22.01
	1	49	22.07	22.55	22.04	21.06	21.54	21.03
	25	0	22.16	22.64	22.13	21.15	21.63	21.12
	25	12	21.79	22.27	21.76	20.78	21.26	20.75
	25	25	21.45	21.93	21.42	20.44	20.92	20.41
	50	0	21.62	22.10	21.59	20.61	21.09	20.58
Band / BW	RB Size	RB Offset	QPSK			16QAM		
			Low CH 20025	Mid CH 20175	High CH 20325	Low CH 20025	Mid CH 20175	High CH 20325
			1717.5 MHz	1732.5 MHz	1747.5 MHz	1717.5 MHz	1732.5 MHz	1747.5 MHz
4 / 15M	1	0	23.15	23.90	23.19	22.14	22.89	22.18
	1	37	23.13	23.61	23.10	22.12	22.60	22.09
	1	74	22.15	22.63	22.12	21.14	21.62	21.11
	36	0	22.24	22.72	22.21	21.23	21.71	21.20
	36	19	21.87	22.35	21.84	20.86	21.34	20.83
	36	39	21.53	22.01	21.50	20.52	21.00	20.49
	75	0	21.70	22.18	21.67	20.69	21.17	20.66
Band / BW	RB Size	RB Offset	QPSK			16QAM		
			Low CH 20050	Mid CH 20175	High CH 20300	Low CH 20050	Mid CH 20175	High CH 20300
			1720 MHz	1732.5 MHz	1745 MHz	1720 MHz	1732.5 MHz	1745 MHz
4 / 20M	1	0	23.88	23.98	23.78	22.22	22.97	22.26
	1	50	23.21	23.69	23.18	22.20	22.68	22.17
	1	99	22.23	22.71	22.20	21.22	21.70	21.19
	50	0	22.32	22.80	22.29	21.31	21.79	21.28
	50	25	21.95	22.43	21.92	20.94	21.42	20.91
	50	50	21.61	22.09	21.58	20.60	21.08	20.57
	100	0	21.78	22.26	21.75	20.77	21.25	20.74

LTE Band 12

Band / BW	RB Size	RB Offset	QPSK			16QAM		
			Low CH 23017	Mid CH 23095	High CH 23173	Low CH 23017	Mid CH 23095	High CH 23173
			699.7 MHz	707.5 MHz	715.3 MHz	699.7 MHz	707.5 MHz	715.3 MHz
12 / 1.4M	1	0	23.25	23.53	23.22	22.23	22.50	22.18
	1	2	23.20	23.47	23.12	22.15	22.46	22.09
	1	5	23.15	23.43	23.03	22.09	22.41	22.02
	3	0	23.14	23.41	23.04	22.20	22.46	22.07
	3	1	23.00	23.31	22.93	22.03	22.38	21.98
	3	3	23.10	23.33	22.96	22.16	22.41	21.99
6	0	22.10	22.41	22.03	21.06	21.41	20.98	
Band / BW	RB Size	RB Offset	QPSK			16QAM		
			Low CH 23025	Mid CH 23095	High CH 23165	Low CH 23025	Mid CH 23095	High CH 23165
			700.5 MHz	707.5 MHz	714.5 MHz	700.5 MHz	707.5 MHz	714.5 MHz
12 / 3M	1	0	23.31	23.55	23.29	22.27	22.51	22.25
	1	7	23.27	23.51	23.25	22.23	22.47	22.21
	1	14	23.24	23.48	23.22	22.20	22.44	22.18
	8	0	22.30	22.54	22.28	21.26	21.50	21.24
	8	3	22.36	22.60	22.34	21.32	21.56	21.30
	8	7	22.31	22.55	22.29	21.27	21.51	21.25
15	0	22.30	22.54	22.28	21.26	21.50	21.24	
Band / BW	RB Size	RB Offset	QPSK			16QAM		
			Low CH 23035	Mid CH 23095	High CH 23155	Low CH 23035	Mid CH 23095	High CH 23155
			701.5 MHz	707.5 MHz	713.5 MHz	701.5 MHz	707.5 MHz	713.5 MHz
12 / 5M	1	0	22.27	22.51	22.25	22.38	22.62	22.36
	1	12	22.23	22.47	22.21	22.34	22.58	22.32
	1	24	22.20	22.44	22.18	22.31	22.55	22.29
	12	0	21.26	21.50	21.24	21.37	21.61	21.35
	12	6	21.32	21.56	21.30	21.43	21.67	21.41
	12	13	21.27	21.51	21.25	21.38	21.62	21.36
25	0	21.26	21.50	21.24	21.37	21.61	21.35	
Band / BW	RB Size	RB Offset	QPSK			16QAM		
			Low CH 23060	Mid CH 23095	High CH 23130	Low CH 23060	Mid CH 23095	High CH 23130
			704 MHz	707.5 MHz	711 MHz	704 MHz	707.5 MHz	711 MHz
12 / 10M	1	0	23.49	23.73	23.47	22.45	22.69	22.43
	1	24	23.45	23.69	23.43	22.41	22.65	22.39
	1	49	23.42	23.66	23.40	22.38	22.62	22.36
	25	0	22.54	22.78	22.52	21.44	21.68	21.42
	25	12	22.48	22.72	22.46	21.50	21.74	21.48
	25	25	22.49	22.73	22.47	21.45	21.69	21.43
50	0	22.48	22.72	22.46	21.44	21.68	21.42	

LTE Band 17

Band / BW	RB Size	RB Offset	QPSK			16QAM		
			Low CH 23755	Mid CH 23790	High CH 23825	Low CH 23755	Mid CH 23790	High CH 23825
			706.5 MHz	710 MHz	713.5 MHz	706.5 MHz	710 MHz	713.5 MHz
17 / 5M	1	0	23.74	23.83	23.23	22.70	22.79	22.19
	1	12	23.29	23.38	22.78	22.25	22.34	21.74
	1	24	23.34	23.43	22.83	22.30	22.39	21.79
	12	0	22.50	22.59	21.99	21.46	21.55	20.95
	12	6	22.55	22.64	22.04	21.51	21.60	21.00
	12	13	22.63	22.72	22.12	21.59	21.68	21.08
	25	0	22.48	22.57	21.97	21.44	21.53	20.93
Band / BW	RB Size	RB Offset	QPSK			16QAM		
			Low CH 23780	Mid CH 23790	High CH 23800	Low CH 23780	Mid CH 23790	High CH 23800
			709 MHz	710 MHz	711 MHz	709 MHz	710 MHz	711 MHz
17 / 10M	1	0	23.82	23.91	23.31	22.78	22.87	22.27
	1	24	23.37	23.46	22.86	22.33	22.42	21.82
	1	49	23.42	23.51	22.91	22.38	22.47	21.87
	25	0	22.71	22.81	22.20	21.54	21.63	21.03
	25	12	22.63	22.72	22.12	21.59	21.68	21.08
	25	25	22.58	22.71	22.09	21.67	21.76	21.16
	50	0	22.56	22.65	22.05	21.52	21.61	21.01

EIRP Power (dBm)

WCDMA Band 4 Mode

MODE		TX channel 1312					
Antenna Polarity & Test Distance: Horizontal at 3 M							
No.	Freq. (MHz)	Reading (dBm)	S.G Power Value (dBm)	Correction Factor (dB)	EIRP (dBm)	Limit (dBm)	Margin (dB)
1	1712.40	-18.34	19.73	0.68	20.41	30.00	-9.59
Antenna Polarity & Test Distance: Vertical at 3 M							
No.	Freq. (MHz)	Reading (dBm)	S.G Power Value (dBm)	Correction Factor (dB)	EIRP (dBm)	Limit (dBm)	Margin (dB)
1	1712.40	-13.11	24.76	0.68	25.44	30.00	-4.56

MODE		TX channel 1413					
Antenna Polarity & Test Distance: Horizontal at 3 M							
No.	Freq. (MHz)	Reading (dBm)	S.G Power Value (dBm)	Correction Factor (dB)	EIRP (dBm)	Limit (dBm)	Margin (dB)
1	1732.60	-18.53	19.90	0.59	20.49	30.00	-9.51
Antenna Polarity & Test Distance: Vertical at 3 M							
No.	Freq. (MHz)	Reading (dBm)	S.G Power Value (dBm)	Correction Factor (dB)	EIRP (dBm)	Limit (dBm)	Margin (dB)
1	1732.60	-13.41	24.95	0.59	25.54	30.00	-4.46

MODE		TX channel 1513					
Antenna Polarity & Test Distance: Horizontal at 3 M							
No.	Freq. (MHz)	Reading (dBm)	S.G Power Value (dBm)	Correction Factor (dB)	EIRP (dBm)	Limit (dBm)	Margin (dB)
1	1752.60	-19.10	19.69	0.50	20.19	30.00	-9.81
Antenna Polarity & Test Distance: Vertical at 3 M							
No.	Freq. (MHz)	Reading (dBm)	S.G Power Value (dBm)	Correction Factor (dB)	EIRP (dBm)	Limit (dBm)	Margin (dB)
1	1752.60	-13.67	25.18	0.50	25.68	30.00	-4.32

Note: EIRP (dBm) = S.G Power Value (dBm) + Correction Factor (dB).

LTE Band 4

Channel Bandwidth: 1.4MHz

MODE		TX channel 19957					
Antenna Polarity & Test Distance: Horizontal at 3 M							
No.	Freq. (MHz)	Reading (dBm)	S.G Power Value (dBm)	Correction Factor (dB)	EIRP (dBm)	Limit (dBm)	Margin (dB)
1	1710.70	-20.29	17.75	0.69	18.44	30.00	-11.56
Antenna Polarity & Test Distance: Vertical at 3 M							
No.	Freq. (MHz)	Reading (dBm)	S.G Power Value (dBm)	Correction Factor (dB)	EIRP (dBm)	Limit (dBm)	Margin (dB)
1	1710.70	-14.38	23.45	0.69	24.14	30.00	-5.86

MODE		TX channel 20175					
Antenna Polarity & Test Distance: Horizontal at 3 M							
No.	Freq. (MHz)	Reading (dBm)	S.G Power Value (dBm)	Correction Factor (dB)	EIRP (dBm)	Limit (dBm)	Margin (dB)
1	1732.50	-20.34	18.09	0.59	18.68	30.00	-11.32
Antenna Polarity & Test Distance: Vertical at 3 M							
No.	Freq. (MHz)	Reading (dBm)	S.G Power Value (dBm)	Correction Factor (dB)	EIRP (dBm)	Limit (dBm)	Margin (dB)
1	1732.50	-14.06	24.30	0.59	24.89	30.00	-5.11

MODE		TX channel 20393					
Antenna Polarity & Test Distance: Horizontal at 3 M							
No.	Freq. (MHz)	Reading (dBm)	S.G Power Value (dBm)	Correction Factor (dB)	EIRP (dBm)	Limit (dBm)	Margin (dB)
1	1754.30	-21.17	17.64	0.50	18.14	30.00	-11.86
Antenna Polarity & Test Distance: Vertical at 3 M							
No.	Freq. (MHz)	Reading (dBm)	S.G Power Value (dBm)	Correction Factor (dB)	EIRP (dBm)	Limit (dBm)	Margin (dB)
1	1754.30	-15.20	23.68	0.50	24.18	30.00	-5.82

Note: EIRP (dBm) = S.G Power Value (dBm) + Correction Factor (dB).

Channel Bandwidth: 3MHz

MODE		TX channel 19965					
Antenna Polarity & Test Distance: Horizontal at 3 M							
No.	Freq. (MHz)	Reading (dBm)	S.G Power Value (dBm)	Correction Factor (dB)	EIRP (dBm)	Limit (dBm)	Margin (dB)
1	1711.50	-19.88	18.18	0.68	18.86	30.00	-11.14
Antenna Polarity & Test Distance: Vertical at 3 M							
No.	Freq. (MHz)	Reading (dBm)	S.G Power Value (dBm)	Correction Factor (dB)	EIRP (dBm)	Limit (dBm)	Margin (dB)
1	1711.50	-14.34	23.51	0.68	24.19	30.00	-5.81

MODE		TX channel 20175					
Antenna Polarity & Test Distance: Horizontal at 3 M							
No.	Freq. (MHz)	Reading (dBm)	S.G Power Value (dBm)	Correction Factor (dB)	EIRP (dBm)	Limit (dBm)	Margin (dB)
1	1732.50	-20.49	17.94	0.59	18.53	30.00	-11.47
Antenna Polarity & Test Distance: Vertical at 3 M							
No.	Freq. (MHz)	Reading (dBm)	S.G Power Value (dBm)	Correction Factor (dB)	EIRP (dBm)	Limit (dBm)	Margin (dB)
1	1732.50	-14.01	24.35	0.59	24.94	30.00	-5.06

MODE		TX channel 20385					
Antenna Polarity & Test Distance: Horizontal at 3 M							
No.	Freq. (MHz)	Reading (dBm)	S.G Power Value (dBm)	Correction Factor (dB)	EIRP (dBm)	Limit (dBm)	Margin (dB)
1	1753.50	-20.88	17.92	0.50	18.42	30.00	-11.58
Antenna Polarity & Test Distance: Vertical at 3 M							
No.	Freq. (MHz)	Reading (dBm)	S.G Power Value (dBm)	Correction Factor (dB)	EIRP (dBm)	Limit (dBm)	Margin (dB)
1	1753.50	-15.14	23.73	0.50	24.23	30.00	-5.77

Note: EIRP (dBm) = S.G Power Value (dBm) + Correction Factor (dB).

Channel Bandwidth: 5MHz

MODE		TX channel 19975					
Antenna Polarity & Test Distance: Horizontal at 3 M							
No.	Freq. (MHz)	Reading (dBm)	S.G Power Value (dBm)	Correction Factor (dB)	EIRP (dBm)	Limit (dBm)	Margin (dB)
1	1712.50	-19.77	18.30	0.68	18.98	30.00	-11.02
Antenna Polarity & Test Distance: Vertical at 3 M							
No.	Freq. (MHz)	Reading (dBm)	S.G Power Value (dBm)	Correction Factor (dB)	EIRP (dBm)	Limit (dBm)	Margin (dB)
1	1712.50	-14.29	23.58	0.68	24.26	30.00	-5.74

MODE		TX channel 20175					
Antenna Polarity & Test Distance: Horizontal at 3 M							
No.	Freq. (MHz)	Reading (dBm)	S.G Power Value (dBm)	Correction Factor (dB)	EIRP (dBm)	Limit (dBm)	Margin (dB)
1	1732.50	-19.33	19.10	0.59	19.69	30.00	-10.31
Antenna Polarity & Test Distance: Vertical at 3 M							
No.	Freq. (MHz)	Reading (dBm)	S.G Power Value (dBm)	Correction Factor (dB)	EIRP (dBm)	Limit (dBm)	Margin (dB)
1	1732.50	-13.94	24.42	0.59	25.01	30.00	-4.99

MODE		TX channel 20375					
Antenna Polarity & Test Distance: Horizontal at 3 M							
No.	Freq. (MHz)	Reading (dBm)	S.G Power Value (dBm)	Correction Factor (dB)	EIRP (dBm)	Limit (dBm)	Margin (dB)
1	1752.50	-21.49	17.30	0.50	17.80	30.00	-12.20
Antenna Polarity & Test Distance: Vertical at 3 M							
No.	Freq. (MHz)	Reading (dBm)	S.G Power Value (dBm)	Correction Factor (dB)	EIRP (dBm)	Limit (dBm)	Margin (dB)
1	1752.50	-15.05	23.80	0.50	24.30	30.00	-5.70

Note: EIRP (dBm) = S.G Power Value (dBm) + Correction Factor (dB).

Channel Bandwidth: 10MHz

MODE		TX channel 20000					
Antenna Polarity & Test Distance: Horizontal at 3 M							
No.	Freq. (MHz)	Reading (dBm)	S.G Power Value (dBm)	Correction Factor (dB)	EIRP (dBm)	Limit (dBm)	Margin (dB)
1	1715.00	-20.14	17.97	0.67	18.64	30.00	-11.36
Antenna Polarity & Test Distance: Vertical at 3 M							
No.	Freq. (MHz)	Reading (dBm)	S.G Power Value (dBm)	Correction Factor (dB)	EIRP (dBm)	Limit (dBm)	Margin (dB)
1	1715.00	-14.24	23.69	0.67	24.36	30.00	-5.64

MODE		TX channel 20175					
Antenna Polarity & Test Distance: Horizontal at 3 M							
No.	Freq. (MHz)	Reading (dBm)	S.G Power Value (dBm)	Correction Factor (dB)	EIRP (dBm)	Limit (dBm)	Margin (dB)
1	1732.50	-19.07	19.36	0.59	19.95	30.00	-10.05
Antenna Polarity & Test Distance: Vertical at 3 M							
No.	Freq. (MHz)	Reading (dBm)	S.G Power Value (dBm)	Correction Factor (dB)	EIRP (dBm)	Limit (dBm)	Margin (dB)
1	1732.50	-13.84	24.52	0.59	25.11	30.00	-4.89

MODE		TX channel 20350					
Antenna Polarity & Test Distance: Horizontal at 3 M							
No.	Freq. (MHz)	Reading (dBm)	S.G Power Value (dBm)	Correction Factor (dB)	EIRP (dBm)	Limit (dBm)	Margin (dB)
1	1750.00	-21.20	17.54	0.52	18.06	30.00	-11.94
Antenna Polarity & Test Distance: Vertical at 3 M							
No.	Freq. (MHz)	Reading (dBm)	S.G Power Value (dBm)	Correction Factor (dB)	EIRP (dBm)	Limit (dBm)	Margin (dB)
1	1750.00	-14.90	23.88	0.52	24.40	30.00	-5.60

Note: EIRP (dBm) = S.G Power Value (dBm) + Correction Factor (dB).

Channel Bandwidth: 15MHz

MODE		TX channel 20025					
Antenna Polarity & Test Distance: Horizontal at 3 M							
No.	Freq. (MHz)	Reading (dBm)	S.G Power Value (dBm)	Correction Factor (dB)	EIRP (dBm)	Limit (dBm)	Margin (dB)
1	1717.50	-21.30	16.86	0.66	17.52	30.00	-12.48
Antenna Polarity & Test Distance: Vertical at 3 M							
No.	Freq. (MHz)	Reading (dBm)	S.G Power Value (dBm)	Correction Factor (dB)	EIRP (dBm)	Limit (dBm)	Margin (dB)
1	1717.50	-14.21	23.78	0.66	24.44	30.00	-5.56

MODE		TX channel 20175					
Antenna Polarity & Test Distance: Horizontal at 3 M							
No.	Freq. (MHz)	Reading (dBm)	S.G Power Value (dBm)	Correction Factor (dB)	EIRP (dBm)	Limit (dBm)	Margin (dB)
1	1732.50	-18.88	19.55	0.59	20.14	30.00	-9.86
Antenna Polarity & Test Distance: Vertical at 3 M							
No.	Freq. (MHz)	Reading (dBm)	S.G Power Value (dBm)	Correction Factor (dB)	EIRP (dBm)	Limit (dBm)	Margin (dB)
1	1732.50	-13.76	24.60	0.59	25.19	30.00	-4.81

MODE		TX channel 20325					
Antenna Polarity & Test Distance: Horizontal at 3 M							
No.	Freq. (MHz)	Reading (dBm)	S.G Power Value (dBm)	Correction Factor (dB)	EIRP (dBm)	Limit (dBm)	Margin (dB)
1	1747.50	-21.06	17.63	0.53	18.16	30.00	-11.84
Antenna Polarity & Test Distance: Vertical at 3 M							
No.	Freq. (MHz)	Reading (dBm)	S.G Power Value (dBm)	Correction Factor (dB)	EIRP (dBm)	Limit (dBm)	Margin (dB)
1	1747.50	-14.77	23.95	0.53	24.48	30.00	-5.52

Note: EIRP (dBm) = S.G Power Value (dBm) + Correction Factor (dB).

Channel Bandwidth: 20MHz

MODE		TX channel 20050					
Antenna Polarity & Test Distance: Horizontal at 3 M							
No.	Freq. (MHz)	Reading (dBm)	S.G Power Value (dBm)	Correction Factor (dB)	EIRP (dBm)	Limit (dBm)	Margin (dB)
1	1720.00	-20.07	18.13	0.65	18.78	30.00	-11.22
Antenna Polarity & Test Distance: Vertical at 3 M							
No.	Freq. (MHz)	Reading (dBm)	S.G Power Value (dBm)	Correction Factor (dB)	EIRP (dBm)	Limit (dBm)	Margin (dB)
1	1720.00	-13.53	24.52	0.65	25.17	30.00	-4.83

MODE		TX channel 20175					
Antenna Polarity & Test Distance: Horizontal at 3 M							
No.	Freq. (MHz)	Reading (dBm)	S.G Power Value (dBm)	Correction Factor (dB)	EIRP (dBm)	Limit (dBm)	Margin (dB)
1	1732.50	-18.94	19.49	0.59	20.08	30.00	-9.92
Antenna Polarity & Test Distance: Vertical at 3 M							
No.	Freq. (MHz)	Reading (dBm)	S.G Power Value (dBm)	Correction Factor (dB)	EIRP (dBm)	Limit (dBm)	Margin (dB)
1	1732.50	-13.68	24.68	0.59	25.27	30.00	-4.73

MODE		TX channel 20300					
Antenna Polarity & Test Distance: Horizontal at 3 M							
No.	Freq. (MHz)	Reading (dBm)	S.G Power Value (dBm)	Correction Factor (dB)	EIRP (dBm)	Limit (dBm)	Margin (dB)
1	1745.00	-19.15	19.50	0.54	20.04	30.00	-9.96
Antenna Polarity & Test Distance: Vertical at 3 M							
No.	Freq. (MHz)	Reading (dBm)	S.G Power Value (dBm)	Correction Factor (dB)	EIRP (dBm)	Limit (dBm)	Margin (dB)
1	1745.00	-14.13	24.53	0.54	25.07	30.00	-4.93

Note: EIRP (dBm) = S.G Power Value (dBm) + Correction Factor (dB).

LTE Band 12

Channel Bandwidth: 1.4MHz

MODE		TX channel 23017					
Antenna Polarity & Test Distance: Horizontal at 3 M							
No.	Freq. (MHz)	Reading (dBm)	S.G Power Value (dBm)	Correction Factor (dB)	EIRP (dBm)	Limit (dBm)	Margin (dB)
1	699.70	-4.51	20.02	3.42	23.44	34.77	-11.33
Antenna Polarity & Test Distance: Vertical at 3 M							
No.	Freq. (MHz)	Reading (dBm)	S.G Power Value (dBm)	Correction Factor (dB)	EIRP (dBm)	Limit (dBm)	Margin (dB)
1	699.70	-9.40	18.15	3.42	21.57	34.77	-13.20

MODE		TX channel 23095					
Antenna Polarity & Test Distance: Horizontal at 3 M							
No.	Freq. (MHz)	Reading (dBm)	S.G Power Value (dBm)	Correction Factor (dB)	EIRP (dBm)	Limit (dBm)	Margin (dB)
1	707.50	-4.52	20.22	3.50	23.72	34.77	-11.05
Antenna Polarity & Test Distance: Vertical at 3 M							
No.	Freq. (MHz)	Reading (dBm)	S.G Power Value (dBm)	Correction Factor (dB)	EIRP (dBm)	Limit (dBm)	Margin (dB)
1	707.50	-8.65	19.05	3.50	22.55	34.77	-12.22

MODE		TX channel 23173					
Antenna Polarity & Test Distance: Horizontal at 3 M							
No.	Freq. (MHz)	Reading (dBm)	S.G Power Value (dBm)	Correction Factor (dB)	EIRP (dBm)	Limit (dBm)	Margin (dB)
1	715.30	-5.00	19.92	3.49	23.41	34.77	-11.36
Antenna Polarity & Test Distance: Vertical at 3 M							
No.	Freq. (MHz)	Reading (dBm)	S.G Power Value (dBm)	Correction Factor (dB)	EIRP (dBm)	Limit (dBm)	Margin (dB)
1	715.30	-9.52	18.06	3.49	21.55	34.77	-13.22

Note: EIRP (dBm) = S.G Power Value (dBm) + Correction Factor (dB).

Channel Bandwidth: 3MHz

MODE		TX channel 23025					
Antenna Polarity & Test Distance: Horizontal at 3 M							
No.	Freq. (MHz)	Reading (dBm)	S.G Power Value (dBm)	Correction Factor (dB)	EIRP (dBm)	Limit (dBm)	Margin (dB)
1	700.50	-4.47	20.08	3.42	23.50	34.77	-11.27
Antenna Polarity & Test Distance: Vertical at 3 M							
No.	Freq. (MHz)	Reading (dBm)	S.G Power Value (dBm)	Correction Factor (dB)	EIRP (dBm)	Limit (dBm)	Margin (dB)
1	700.50	-9.31	18.27	3.42	21.69	34.77	-13.08

MODE		TX channel 23095					
Antenna Polarity & Test Distance: Horizontal at 3 M							
No.	Freq. (MHz)	Reading (dBm)	S.G Power Value (dBm)	Correction Factor (dB)	EIRP (dBm)	Limit (dBm)	Margin (dB)
1	707.50	-4.50	20.24	3.50	23.74	34.77	-11.03
Antenna Polarity & Test Distance: Vertical at 3 M							
No.	Freq. (MHz)	Reading (dBm)	S.G Power Value (dBm)	Correction Factor (dB)	EIRP (dBm)	Limit (dBm)	Margin (dB)
1	707.50	-9.25	18.45	3.50	21.95	34.77	-12.82

MODE		TX channel 23165					
Antenna Polarity & Test Distance: Horizontal at 3 M							
No.	Freq. (MHz)	Reading (dBm)	S.G Power Value (dBm)	Correction Factor (dB)	EIRP (dBm)	Limit (dBm)	Margin (dB)
1	714.50	-4.99	19.98	3.50	23.48	34.77	-11.29
Antenna Polarity & Test Distance: Vertical at 3 M							
No.	Freq. (MHz)	Reading (dBm)	S.G Power Value (dBm)	Correction Factor (dB)	EIRP (dBm)	Limit (dBm)	Margin (dB)
1	714.50	-9.64	18.04	3.50	21.54	34.77	-13.23

Note: EIRP (dBm) = S.G Power Value (dBm) + Correction Factor (dB).

Channel Bandwidth: 5MHz

MODE		TX channel 23035					
Antenna Polarity & Test Distance: Horizontal at 3 M							
No.	Freq. (MHz)	Reading (dBm)	S.G Power Value (dBm)	Correction Factor (dB)	EIRP (dBm)	Limit (dBm)	Margin (dB)
1	701.50	-5.50	19.03	3.43	22.46	34.77	-12.31
Antenna Polarity & Test Distance: Vertical at 3 M							
No.	Freq. (MHz)	Reading (dBm)	S.G Power Value (dBm)	Correction Factor (dB)	EIRP (dBm)	Limit (dBm)	Margin (dB)
1	701.50	-10.24	17.34	3.43	20.77	34.77	-14.00

MODE		TX channel 23095					
Antenna Polarity & Test Distance: Horizontal at 3 M							
No.	Freq. (MHz)	Reading (dBm)	S.G Power Value (dBm)	Correction Factor (dB)	EIRP (dBm)	Limit (dBm)	Margin (dB)
1	707.50	-5.54	19.20	3.50	22.70	34.77	-12.07
Antenna Polarity & Test Distance: Vertical at 3 M							
No.	Freq. (MHz)	Reading (dBm)	S.G Power Value (dBm)	Correction Factor (dB)	EIRP (dBm)	Limit (dBm)	Margin (dB)
1	707.50	-9.70	18.00	3.50	21.50	34.77	-13.27

MODE		TX channel 23155					
Antenna Polarity & Test Distance: Horizontal at 3 M							
No.	Freq. (MHz)	Reading (dBm)	S.G Power Value (dBm)	Correction Factor (dB)	EIRP (dBm)	Limit (dBm)	Margin (dB)
1	713.50	-6.06	18.95	3.49	22.44	34.77	-12.33
Antenna Polarity & Test Distance: Vertical at 3 M							
No.	Freq. (MHz)	Reading (dBm)	S.G Power Value (dBm)	Correction Factor (dB)	EIRP (dBm)	Limit (dBm)	Margin (dB)
1	713.50	-10.76	16.98	3.49	20.47	34.77	-14.30

Note: EIRP (dBm) = S.G Power Value (dBm) + Correction Factor (dB).

Channel Bandwidth: 10MHz

MODE		TX channel 23060					
Antenna Polarity & Test Distance: Horizontal at 3 M							
No.	Freq. (MHz)	Reading (dBm)	S.G Power Value (dBm)	Correction Factor (dB)	EIRP (dBm)	Limit (dBm)	Margin (dB)
1	704.00	-4.43	20.16	3.52	23.68	34.77	-11.09
Antenna Polarity & Test Distance: Vertical at 3 M							
No.	Freq. (MHz)	Reading (dBm)	S.G Power Value (dBm)	Correction Factor (dB)	EIRP (dBm)	Limit (dBm)	Margin (dB)
1	704.00	-9.04	18.60	3.52	22.12	34.77	-12.65

MODE		TX channel 23095					
Antenna Polarity & Test Distance: Horizontal at 3 M							
No.	Freq. (MHz)	Reading (dBm)	S.G Power Value (dBm)	Correction Factor (dB)	EIRP (dBm)	Limit (dBm)	Margin (dB)
1	707.50	-4.32	20.42	3.50	23.92	34.77	-10.85
Antenna Polarity & Test Distance: Vertical at 3 M							
No.	Freq. (MHz)	Reading (dBm)	S.G Power Value (dBm)	Correction Factor (dB)	EIRP (dBm)	Limit (dBm)	Margin (dB)
1	707.50	-9.20	18.50	3.50	22.00	34.77	-12.77

MODE		TX channel 23130					
Antenna Polarity & Test Distance: Horizontal at 3 M							
No.	Freq. (MHz)	Reading (dBm)	S.G Power Value (dBm)	Correction Factor (dB)	EIRP (dBm)	Limit (dBm)	Margin (dB)
1	711.00	-4.74	20.19	3.47	23.66	34.77	-11.11
Antenna Polarity & Test Distance: Vertical at 3 M							
No.	Freq. (MHz)	Reading (dBm)	S.G Power Value (dBm)	Correction Factor (dB)	EIRP (dBm)	Limit (dBm)	Margin (dB)
1	711.00	-8.60	19.03	3.47	22.50	34.77	-12.27

Note: EIRP (dBm) = S.G Power Value (dBm) + Correction Factor (dB).

LTE Band 17

Channel Bandwidth: 5MHz

MODE		TX channel 23755					
Antenna Polarity & Test Distance: Horizontal at 3 M							
No.	Freq. (MHz)	Reading (dBm)	S.G Power Value (dBm)	Correction Factor (dB)	ERP (dBm)	Limit (dBm)	Margin (dB)
1	706.50	-4.34	20.38	3.51	23.89	34.77	-10.88
Antenna Polarity & Test Distance: Vertical at 3 M							
No.	Freq. (MHz)	Reading (dBm)	S.G Power Value (dBm)	Correction Factor (dB)	ERP (dBm)	Limit (dBm)	Margin (dB)
1	706.50	-9.30	18.38	3.51	21.89	34.77	-12.88

MODE		TX channel 23790					
Antenna Polarity & Test Distance: Horizontal at 3 M							
No.	Freq. (MHz)	Reading (dBm)	S.G Power Value (dBm)	Correction Factor (dB)	ERP (dBm)	Limit (dBm)	Margin (dB)
1	710.00	-4.37	20.50	3.48	23.98	34.77	-10.79
Antenna Polarity & Test Distance: Vertical at 3 M							
No.	Freq. (MHz)	Reading (dBm)	S.G Power Value (dBm)	Correction Factor (dB)	ERP (dBm)	Limit (dBm)	Margin (dB)
1	710.00	-8.58	18.97	3.48	22.45	34.77	-12.32

MODE		TX channel 23825					
Antenna Polarity & Test Distance: Horizontal at 3 M							
No.	Freq. (MHz)	Reading (dBm)	S.G Power Value (dBm)	Correction Factor (dB)	ERP (dBm)	Limit (dBm)	Margin (dB)
1	713.50	-5.12	19.89	3.49	23.38	34.77	-11.39
Antenna Polarity & Test Distance: Vertical at 3 M							
No.	Freq. (MHz)	Reading (dBm)	S.G Power Value (dBm)	Correction Factor (dB)	ERP (dBm)	Limit (dBm)	Margin (dB)
1	713.50	-9.66	18.08	3.49	21.57	34.77	-13.20

Note: ERP (dBm) = S.G Power Value (dBm) + Correction Factor (dB).

Channel Bandwidth: 10MHz

MODE		TX channel 23780					
Antenna Polarity & Test Distance: Horizontal at 3 M							
No.	Freq. (MHz)	Reading (dBm)	S.G Power Value (dBm)	Correction Factor (dB)	ERP (dBm)	Limit (dBm)	Margin (dB)
1	709.00	-4.33	20.49	3.48	23.97	34.77	-10.80
Antenna Polarity & Test Distance: Vertical at 3 M							
No.	Freq. (MHz)	Reading (dBm)	S.G Power Value (dBm)	Correction Factor (dB)	ERP (dBm)	Limit (dBm)	Margin (dB)
1	709.00	-8.96	18.68	3.48	22.16	34.77	-12.61

MODE		TX channel 23790					
Antenna Polarity & Test Distance: Horizontal at 3 M							
No.	Freq. (MHz)	Reading (dBm)	S.G Power Value (dBm)	Correction Factor (dB)	ERP (dBm)	Limit (dBm)	Margin (dB)
1	710.00	-4.29	20.58	3.48	24.06	34.77	-10.71
Antenna Polarity & Test Distance: Vertical at 3 M							
No.	Freq. (MHz)	Reading (dBm)	S.G Power Value (dBm)	Correction Factor (dB)	ERP (dBm)	Limit (dBm)	Margin (dB)
1	710.00	-8.54	19.01	3.48	22.49	34.77	-12.28

MODE		TX channel 23800					
Antenna Polarity & Test Distance: Horizontal at 3 M							
No.	Freq. (MHz)	Reading (dBm)	S.G Power Value (dBm)	Correction Factor (dB)	ERP (dBm)	Limit (dBm)	Margin (dB)
1	711.00	-4.94	19.99	3.47	23.46	34.77	-11.31
Antenna Polarity & Test Distance: Vertical at 3 M							
No.	Freq. (MHz)	Reading (dBm)	S.G Power Value (dBm)	Correction Factor (dB)	ERP (dBm)	Limit (dBm)	Margin (dB)
1	711.00	-9.73	17.90	3.47	21.37	34.77	-13.40

Note: ERP (dBm) = S.G Power Value (dBm) + Correction Factor (dB).

4.2 Modulation Characteristics Measurement

4.2.1 Limits of Modulation Characteristics

N/A

4.2.2 Test Procedure

Connect the EUT to Communication Simulator via the antenna connector, The frequency band is set as EUT supported Modulation and Channels, the EUT output is matched with 50 ohm load, the waveform quality and constellation of the EUT was tested.

4.2.3 Test Setup



4.2.4 Test Results

WCDMA Band 4

Spectrum Plot of Measurement Value

Channel: 1413 / Frequency (MHz): 1732.6MHz

WCDMA

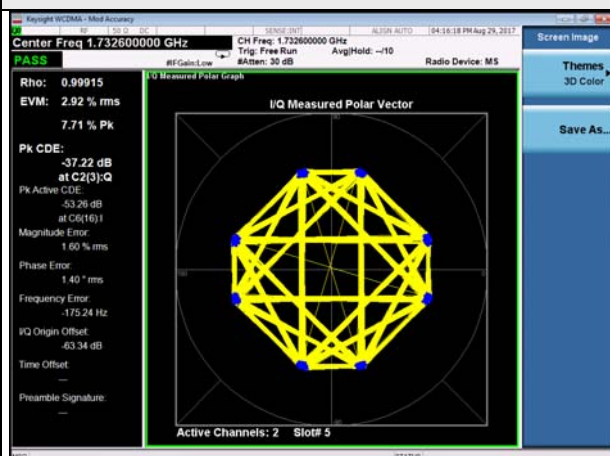

HSDPA

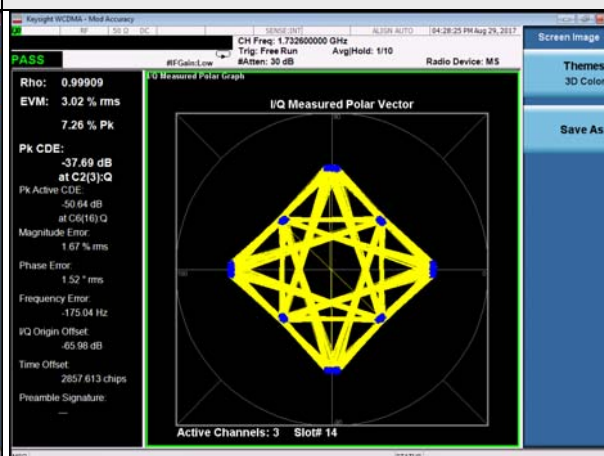

HSUPA

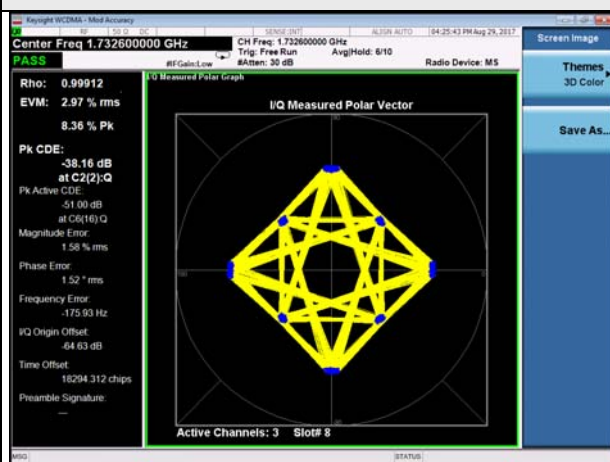

LTE Band 4

Spectrum Plot of Measurement Value

Channel: 20175 / Frequency (MHz): 1732.5MHz

Channel Bandwidth: 20MHz / QPSK

Channel Bandwidth: 20MHz / 16QAM

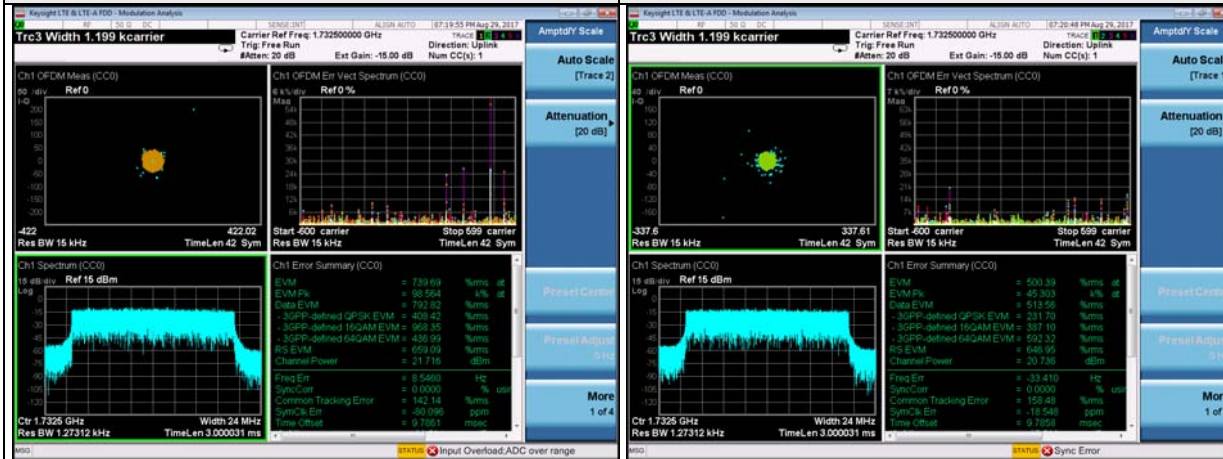

LTE Band 12

Spectrum Plot of Measurement Value

Channel: 23095 / Frequency (MHz): 707.5 MHz

Channel Bandwidth: 10MHz / QPSK

Channel Bandwidth: 10MHz / 16QAM

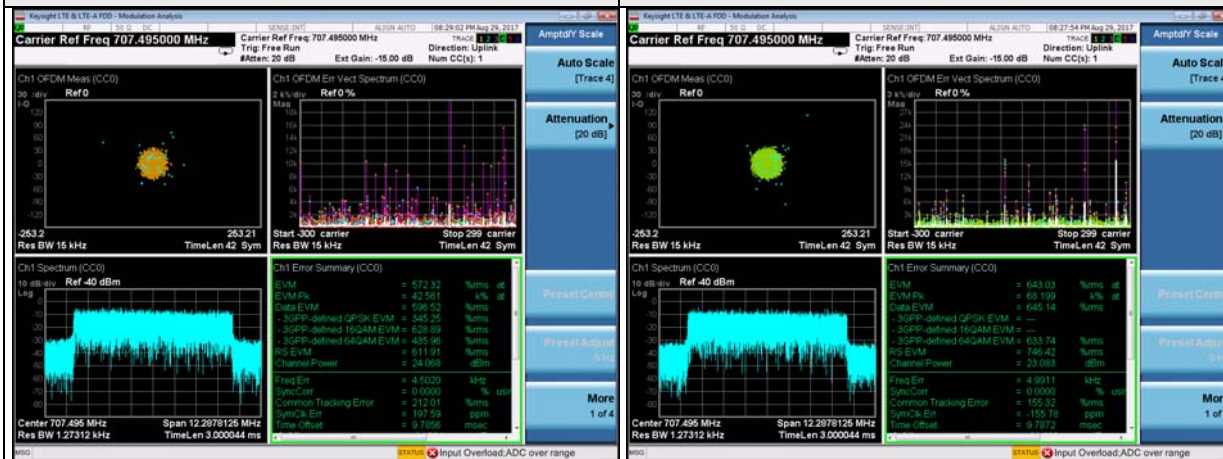

LTE Band 17

Spectrum Plot of Measurement Value

Channel: 23790 / Frequency (MHz): 710 MHz

Channel Bandwidth: 10MHz / QPSK

Channel Bandwidth: 10MHz / 16QAM

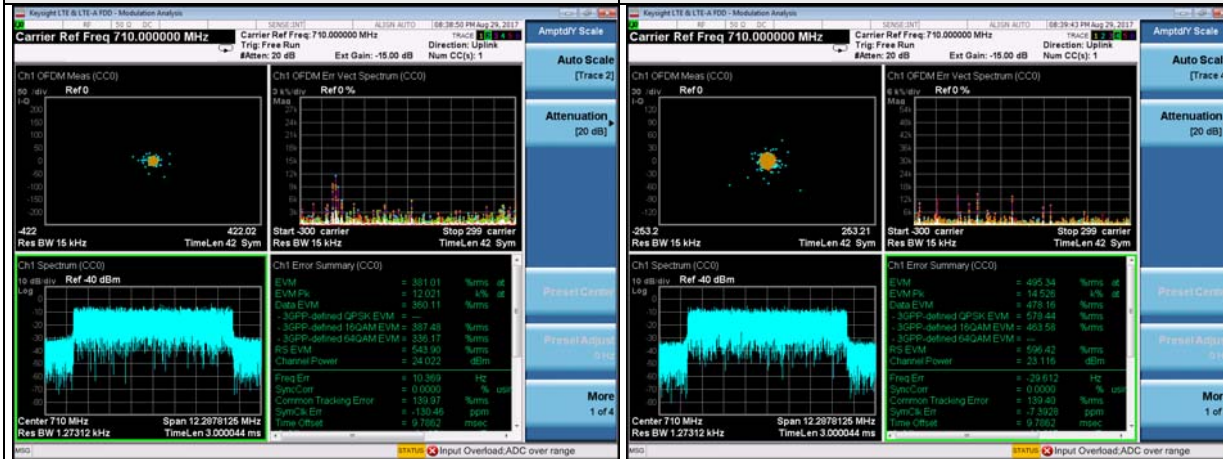

4.3 Frequency Stability Measurement

4.3.1 Limits of Frequency Stability Measurement

According to the FCC part 2.1055 shall be tested the frequency stability. The rule is defined that "The frequency stability shall be sufficient to ensure that the fundamental emission stays within the authorized frequency block." The test extreme voltage is according to the 2.1055(d)(1) Vary primary supply voltage from 85 to 115 percent of the nominal value for other than hand carried battery equipment and the extreme temperature rule is comply with specification of EUT $-30^{\circ}\text{C} \sim 50^{\circ}\text{C}$.

4.3.2 Test Procedure

- Device is placed at the oven room. The oven room could control the temperatures and humidity. Power warm up is at least 15 min and power applied should perform before recording frequency error.
- EUT is connected the external power supply to control the AC input power. The test voltage range is from minimum to maximum working voltage. Each step shall be record the frequency error rate.
- The temperature range step is 10 degrees in this test items. All temperature levels shall be hold the $\pm 0.5^{\circ}\text{C}$ during the measurement testing. The each temperature step shall be at least 0.5 hours, consider the EUT could be test under the stability condition.

Note: The frequency error was recorded frequency error from the communication simulator.

4.3.3 Test Setup

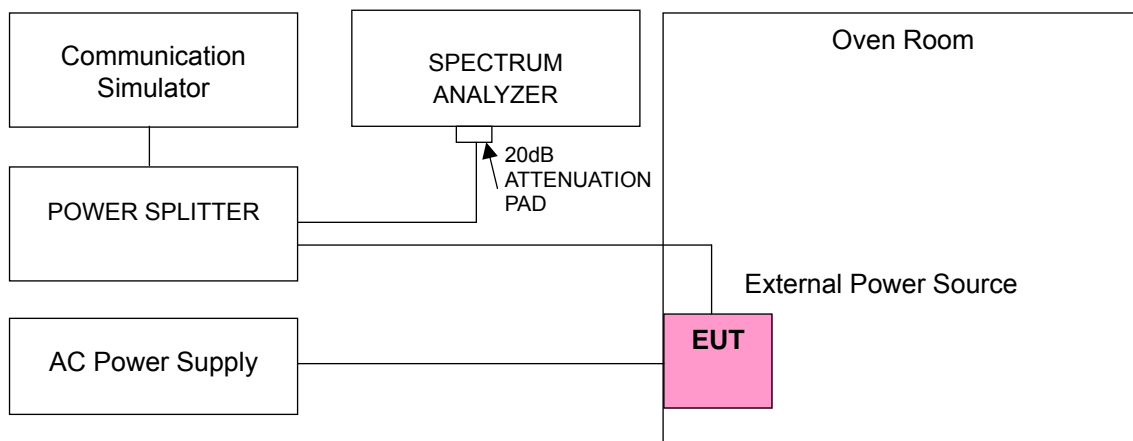

4.3.4 Test Results

Frequency Error vs. Voltage

Voltage (Volts)	Frequency Error (ppm)				Limit (ppm)
	WCDMA Band 4	LTE Band 4	LTE Band 12	LTE Band 17	
138	-0.005	-0.005	-0.012	-0.011	2.5
120	-0.005	-0.004	-0.011	-0.010	2.5
102	-0.004	-0.004	-0.010	-0.009	2.5

Note: The applicant defined the normal working voltage is from 102Vac to 138Vac.

Frequency Error vs. Temperature

Voltage (Volts)	Frequency Error (ppm)				Limit (ppm)
	WCDMA Band 4	LTE Band 4	LTE Band 12	LTE Band 17	
50	-0.006	-0.006	-0.014	-0.013	2.5
40	-0.005	-0.005	-0.013	-0.012	2.5
30	-0.005	-0.005	-0.012	-0.011	2.5
20	-0.005	-0.004	-0.011	-0.010	2.5
10	-0.005	-0.005	-0.012	-0.012	2.5
0	-0.006	-0.007	-0.015	-0.016	2.5
-10	-0.006	-0.008	-0.017	-0.019	2.5
-20	-0.007	-0.009	-0.019	-0.018	2.5
-30	-0.007	-0.008	-0.018	-0.020	2.5

4.4 Emission Bandwidth Measurement

4.4.1 Limits of Emission Bandwidth Measurement

According to FCC 27.53(m)(6) specified that emission bandwidth is defined as the width of the signal between two points, one below the carrier center frequency and one above the carrier center frequency, outside of which all emissions are attenuated at least 26dB below the transmitter power.

4.4.2 Test Procedure

The transmitter output was connected to the spectrum analyzer through an attenuator. The bandwidth of the fundamental frequency was measured by spectrum analyzer with RBW = 30kHz and VBW = 100kHz (Channel Bandwidth: 1.4MHz), RBW = 51kHz and VBW = 150kHz (Channel Bandwidth: 3MHz and 5MHz), RBW = 100kHz and VBW = 300kHz (Channel Bandwidth: 10MHz), RBW = 200kHz and VBW = 620kHz (Channel Bandwidth: 15MHz) and RBW = 430kHz and VBW = 1.2MHz (Channel Bandwidth: 20MHz). The 26dB bandwidth is defined as the total spectrum the power of which is higher than peak power minus 26dB.

4.4.3 Test Setup

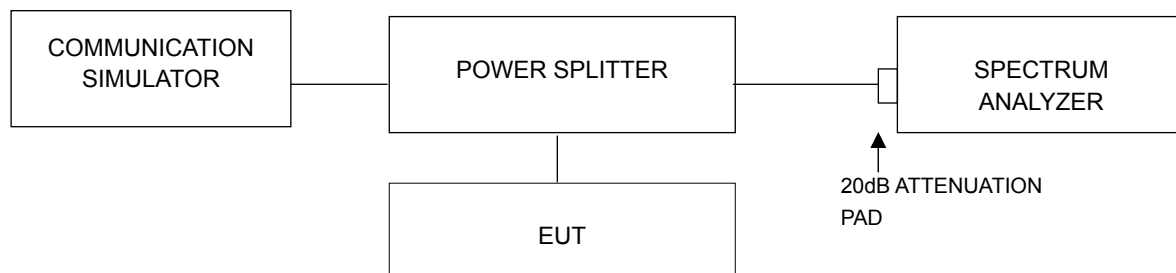

4.4.4 Test Result

WCDMA Band 4

Channel	Frequency (MHz)	26dBc Bandwidth (MHz)			Occupied Bandwidth (MHz)		
		WCDMA	HSDPA	HSUPA	WCDMA	HSDPA	HSUPA
1312	1712.4	4.67	4.71	4.71	4.13	4.14	4.14
1413	1732.6	4.69	4.68	4.71	4.13	4.14	4.14
1513	1752.6	4.70	4.71	4.70	4.13	4.12	4.14

Spectrum Plot of Worst Value

26dBc Bandwidth

WCDMA

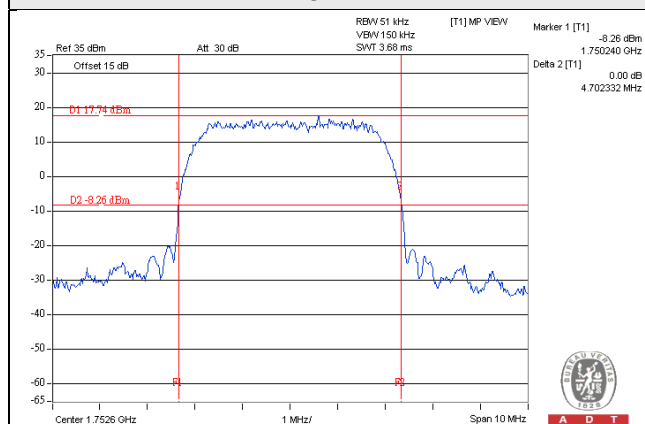

HSDPA

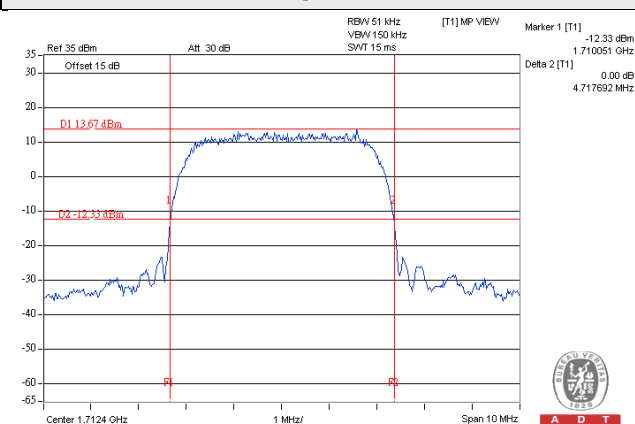

HSUPA

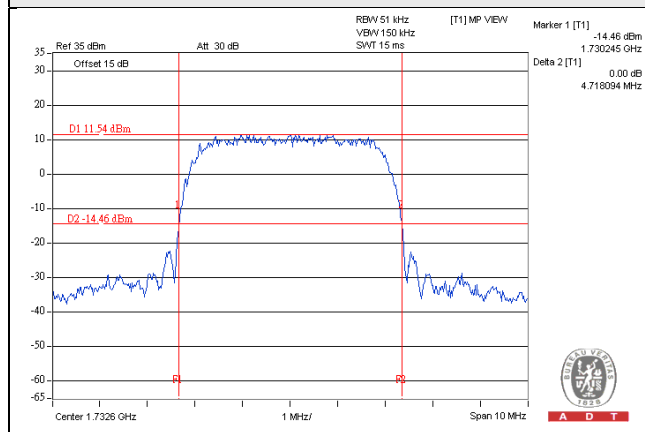

Occupied Bandwidth

WCDMA

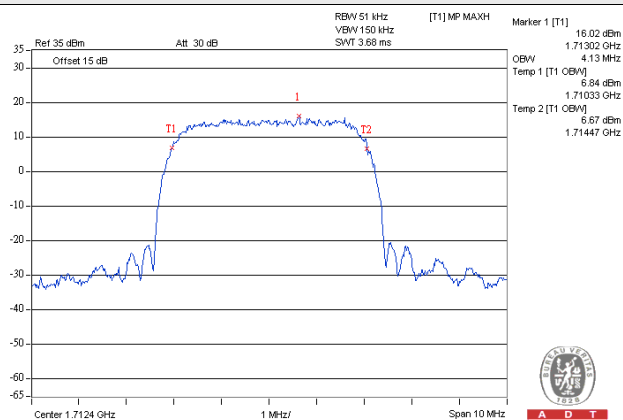

HSDPA

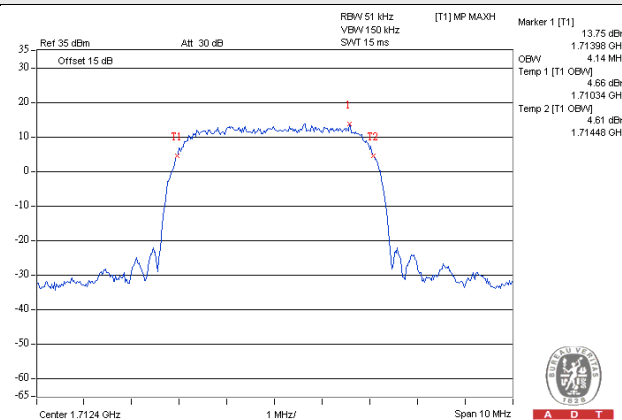

HSUPA

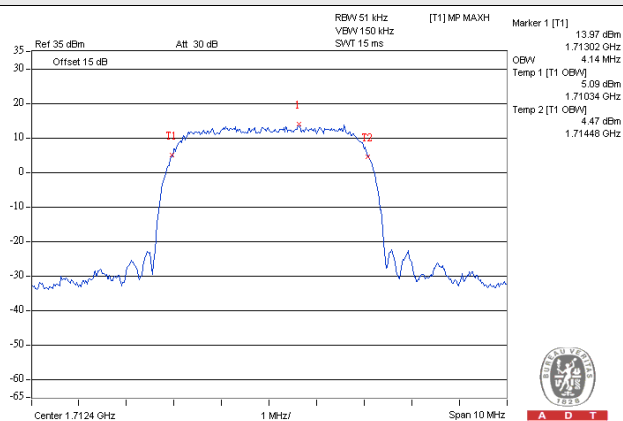

LTE Band 4

Channel Bandwidth: 1.4MHz					
Channel	Frequency (MHz)	26dBc Bandwidth (MHz)		Occupied Bandwidth (MHz)	
		QPSK	16QAM	QPSK	16QAM
19957	1710.7	1.274	1.246	1.09	1.09
20175	1732.5	1.279	1.279	1.09	1.09
20393	1754.3	1.275	1.280	1.09	1.09

Spectrum Plot of Worst Value
26dBc Bandwidth

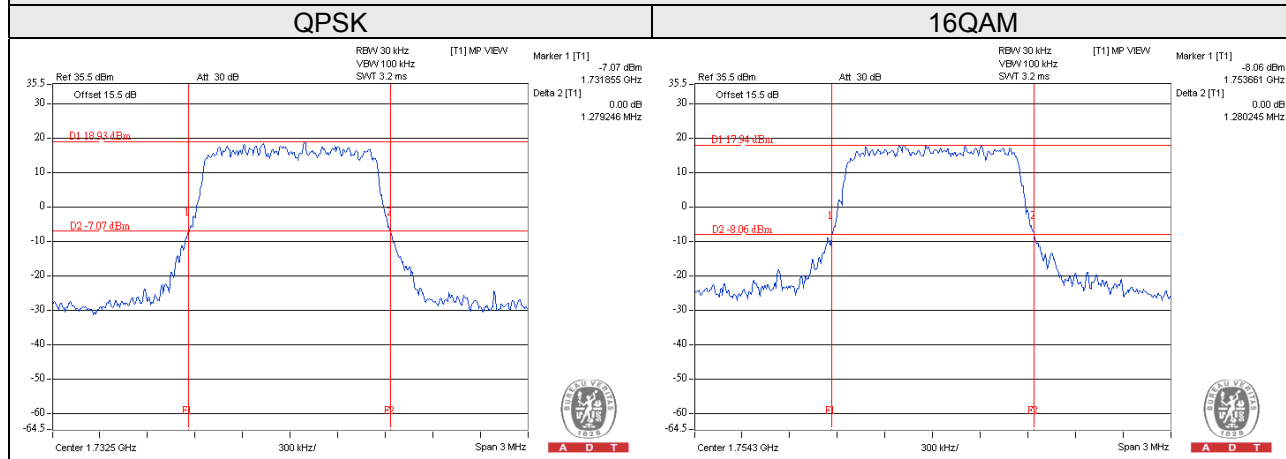

Occupied Bandwidth

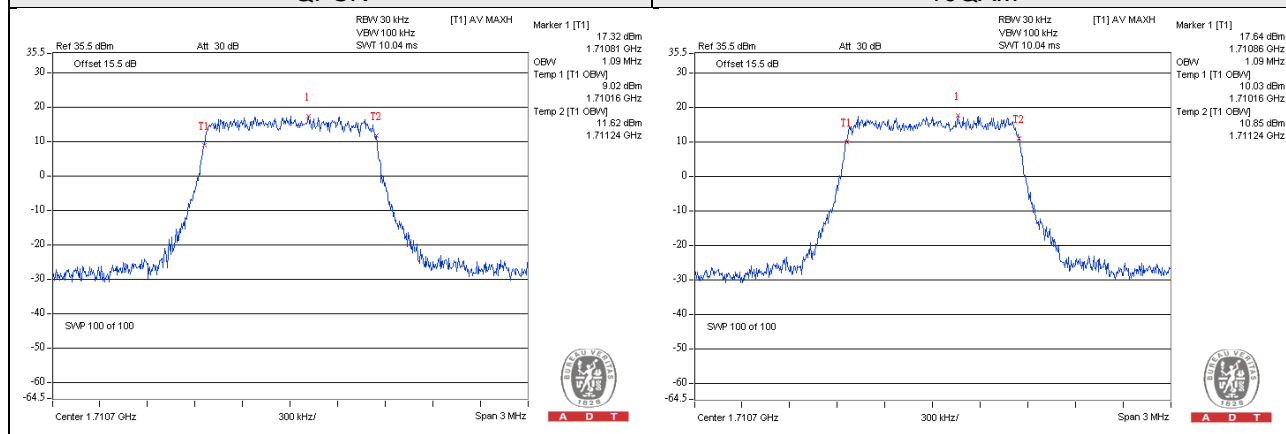

Channel Bandwidth: 3MHz					
Channel	Frequency (MHz)	26dBc Bandwidth (MHz)		Occupied Bandwidth (MHz)	
		QPSK	16QAM	QPSK	16QAM
19965	1711.5	2.944	2.942	2.67	2.69
20175	1732.5	2.987	2.930	2.68	2.69
20385	1753.5	2.959	2.964	2.69	2.68

Spectrum Plot of Worst Value
26dBc Bandwidth

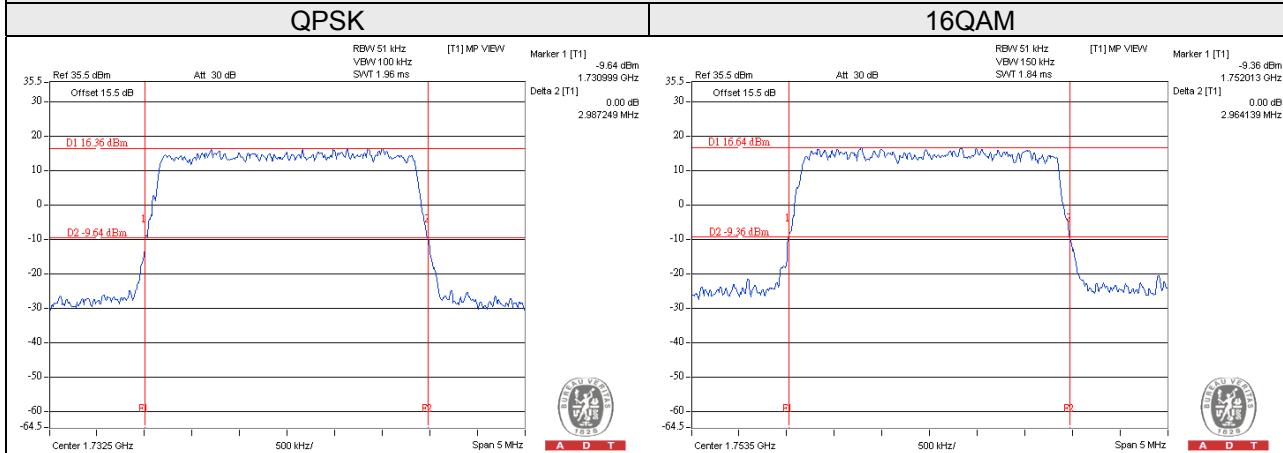

Occupied Bandwidth

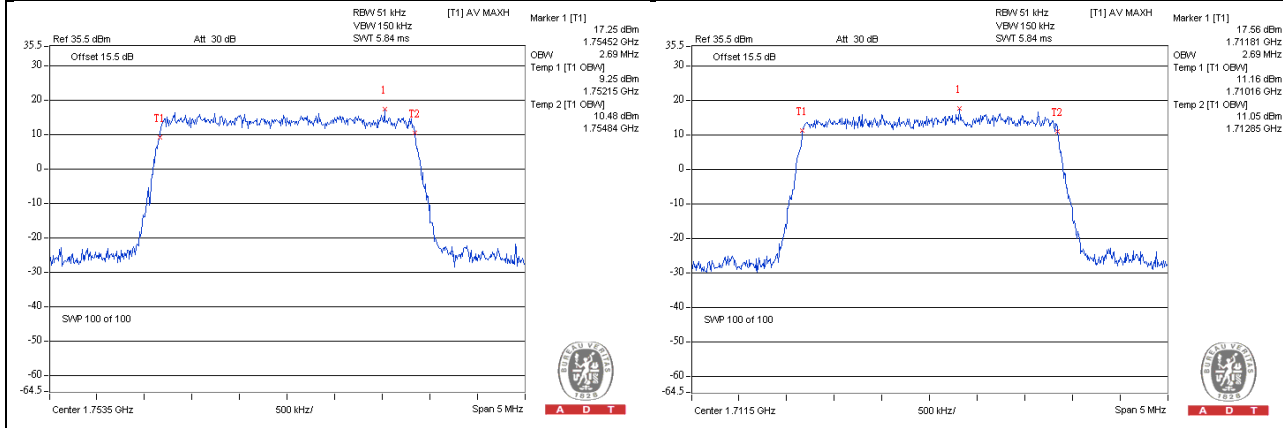

Channel Bandwidth: 5MHz					
Channel	Frequency (MHz)	26dBc Bandwidth (MHz)		Occupied Bandwidth (MHz)	
		QPSK	16QAM	QPSK	16QAM
19975	1712.5	4.929	4.940	4.47	4.47
20175	1732.5	4.925	4.889	4.47	4.47
20375	1752.5	4.917	4.938	4.47	4.48

Spectrum Plot of Worst Value
26dBc Bandwidth

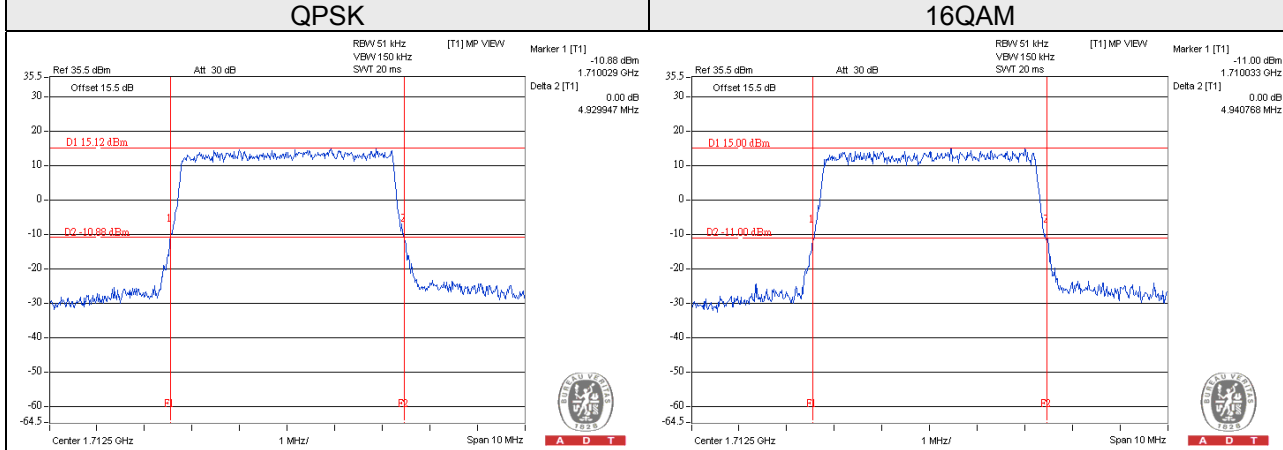

Occupied Bandwidth

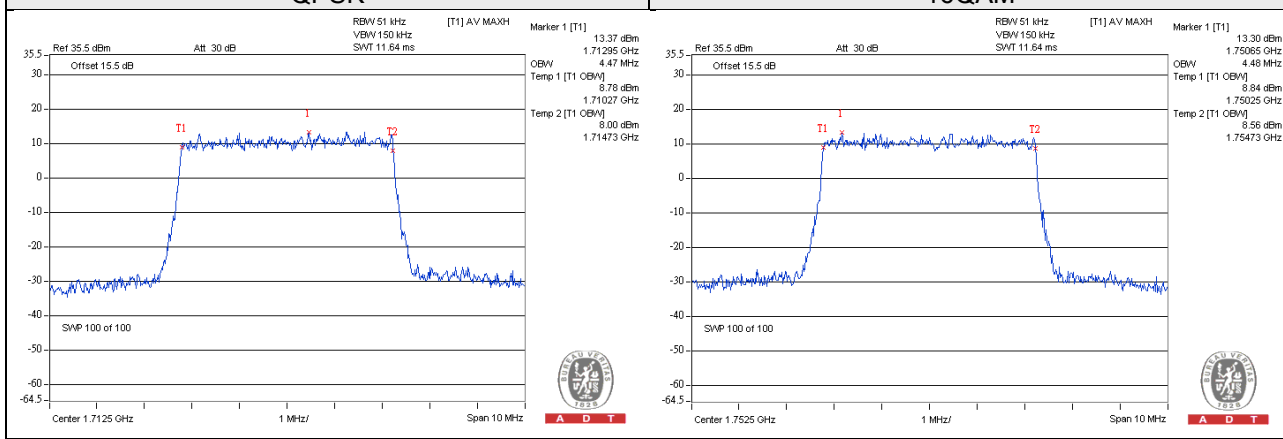

Channel Bandwidth: 10MHz					
Channel	Frequency (MHz)	26dBc Bandwidth (MHz)		Occupied Bandwidth (MHz)	
		QPSK	16QAM	QPSK	16QAM
20000	1715.0	9.554	9.579	8.90	8.93
20175	1732.5	9.644	9.584	8.93	8.93
20350	1750.0	9.572	9.646	8.93	8.90

Spectrum Plot of Worst Value
26dBc Bandwidth

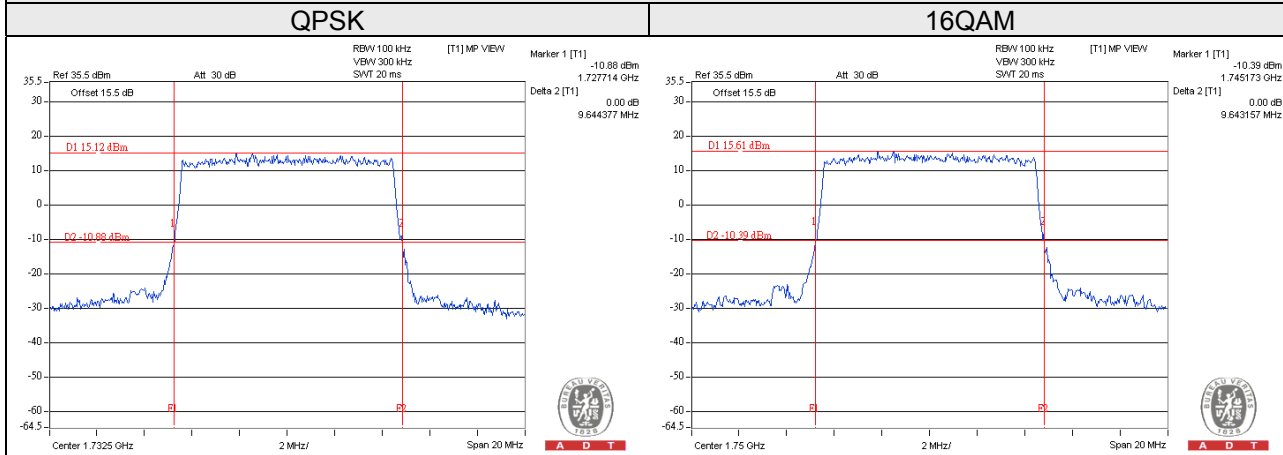

Occupied Bandwidth

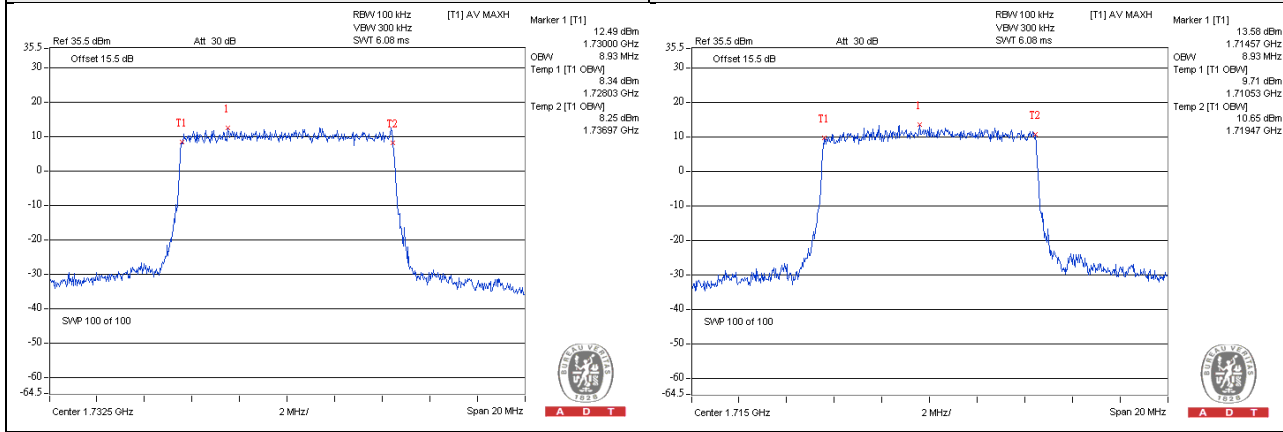

Channel Bandwidth: 15MHz					
Channel	Frequency (MHz)	26dBc Bandwidth (MHz)		Occupied Bandwidth (MHz)	
		QPSK	16QAM	QPSK	16QAM
20025	1717.5	14.435	14.424	13.37	13.33
20175	1732.5	14.461	14.491	13.37	13.33
20325	1747.5	14.390	14.465	13.33	13.37

Spectrum Plot of Worst Value
26dBc Bandwidth

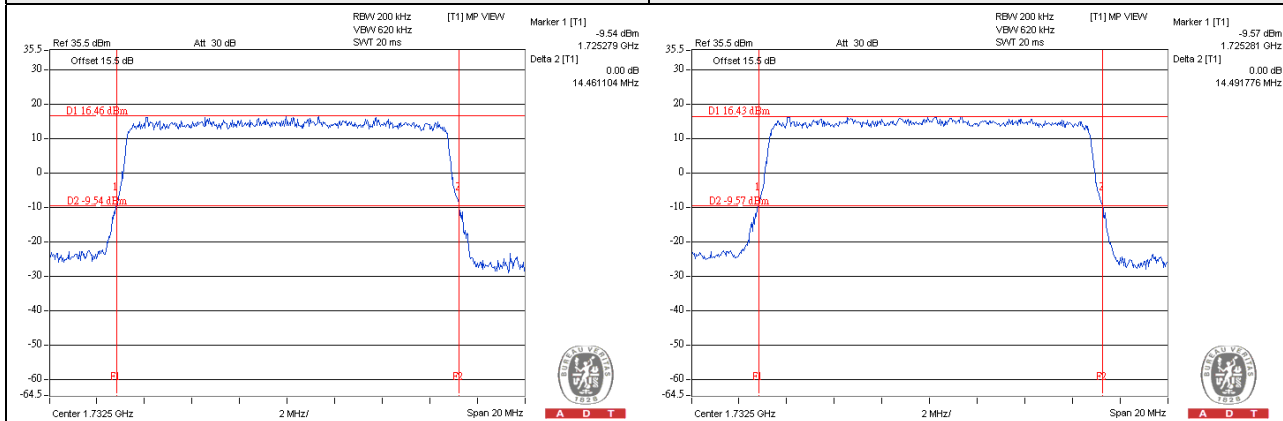

Occupied Bandwidth

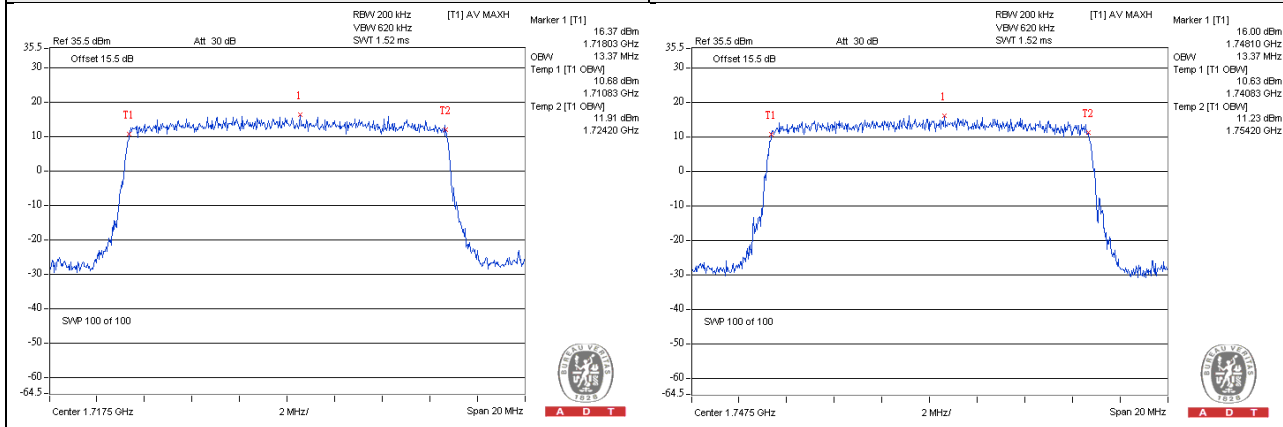

Channel Bandwidth: 20MHz

Channel	Frequency (MHz)	26dBc Bandwidth (MHz)		Occupied Bandwidth (MHz)	
		QPSK	16QAM	QPSK	16QAM
20050	1720.0	19.409	19.326	17.80	17.80
20175	1732.5	19.518	19.530	17.93	17.87
20300	1745.0	19.439	19.422	17.87	17.87

Spectrum Plot of Worst Value

26dBc Bandwidth

QPSK

16QAM

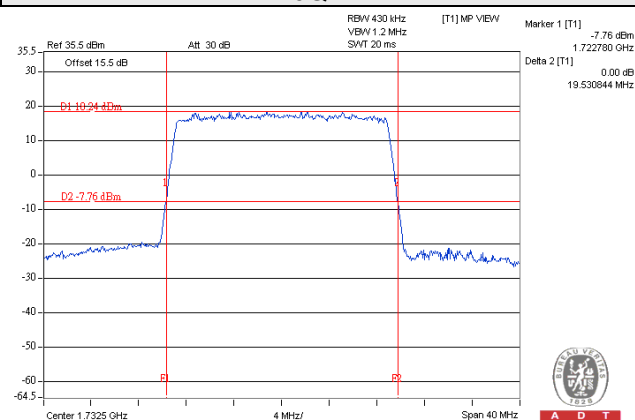
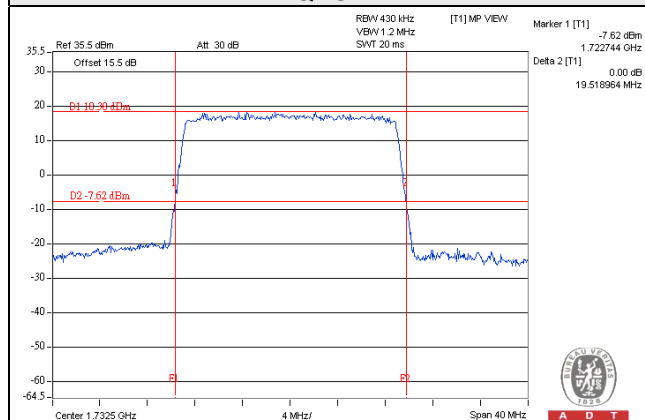

Occupied Bandwidth

QPSK

16QAM

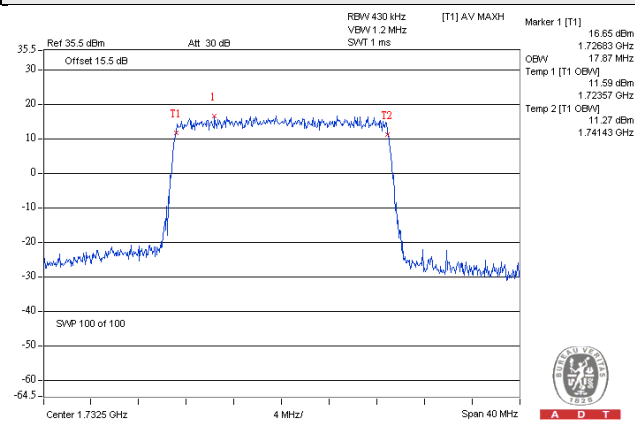
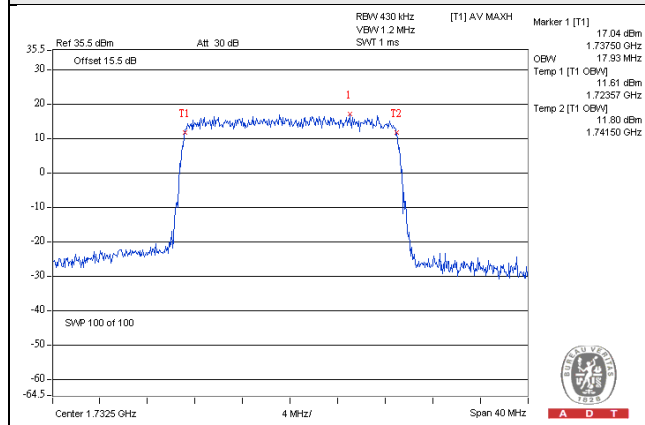

LTE Band 12

Channel Bandwidth: 1.4MHz					
Channel	Frequency (MHz)	26dBc Bandwidth (MHz)		Occupied Bandwidth (MHz)	
		QPSK	16QAM	QPSK	16QAM
23017	699.7	1.295	1.295	1.10	1.09
23095	707.5	1.276	1.299	1.09	1.09
23173	715.3	1.279	1.274	1.09	1.09

Spectrum Plot of Worst Value
26dBc Bandwidth

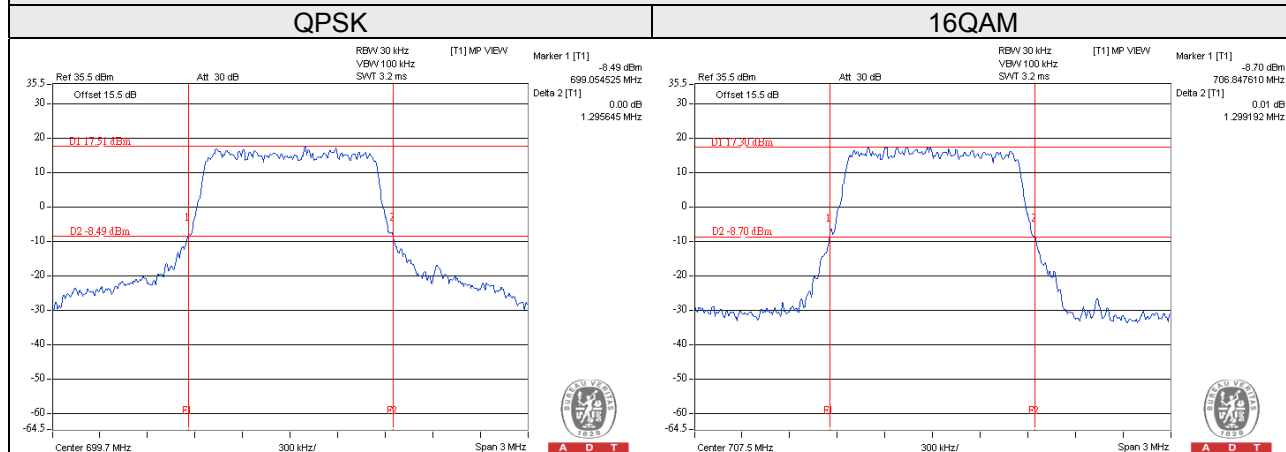

Occupied Bandwidth

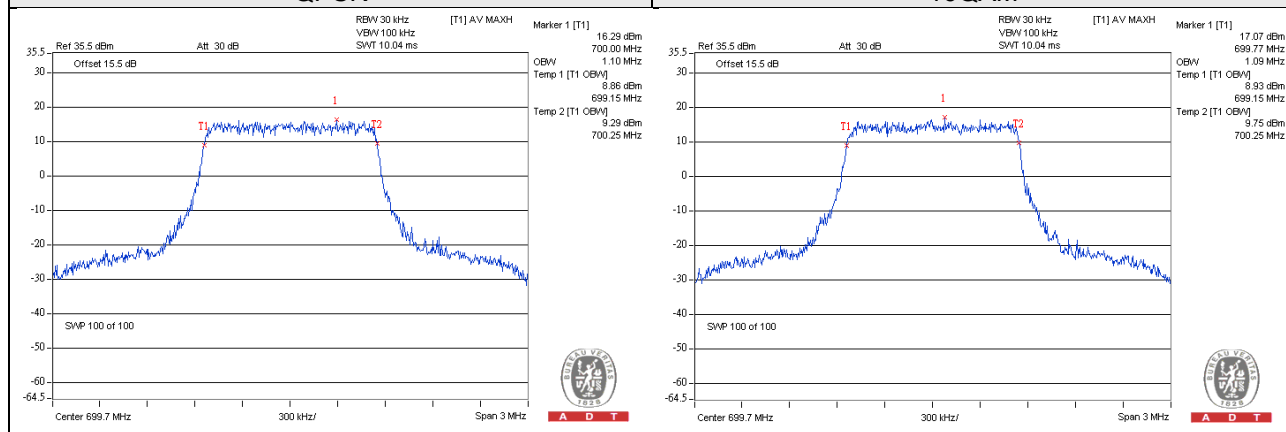

Channel Bandwidth: 3MHz

Channel	Frequency (MHz)	26dBc Bandwidth (MHz)		Occupied Bandwidth (MHz)	
		QPSK	16QAM	QPSK	16QAM
23025	700.5	2.965	2.966	2.68	2.68
23095	707.5	2.931	2.931	2.69	2.68
23165	714.5	2.972	2.941	2.68	2.68

Spectrum Plot of Worst Value

26dBc Bandwidth

QPSK

16QAM

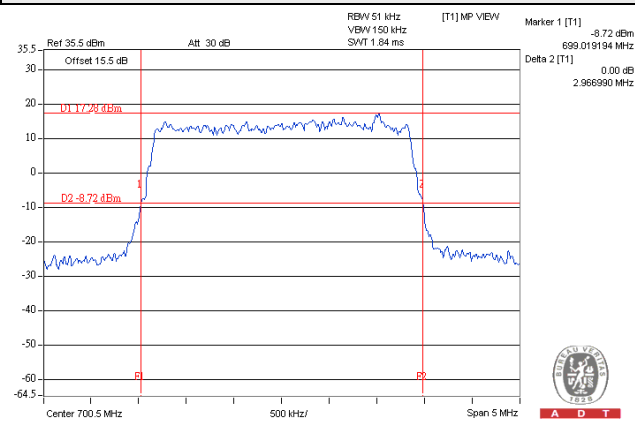
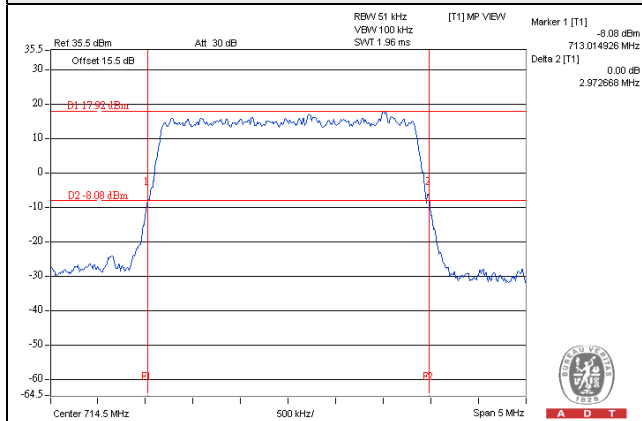

Occupied Bandwidth

QPSK

16QAM

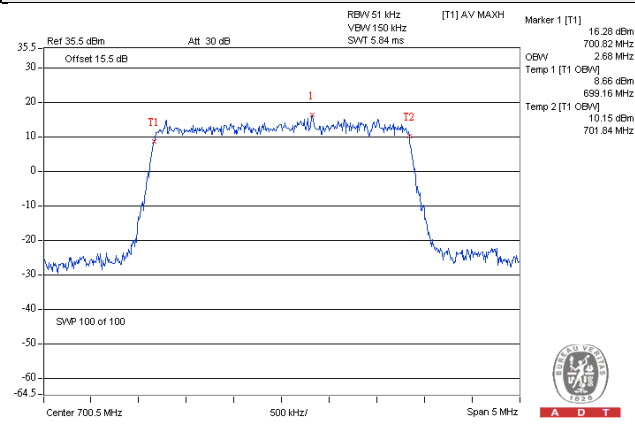
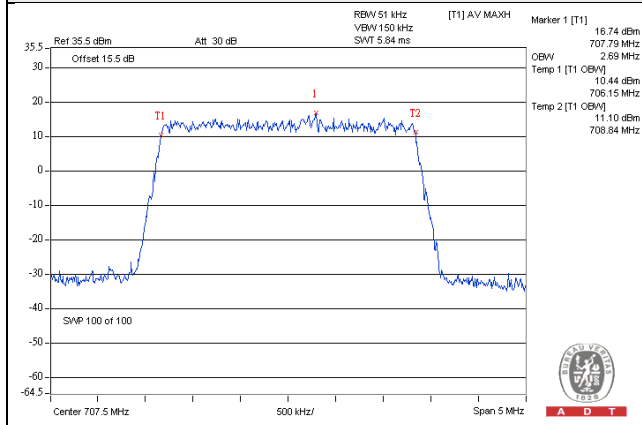

Channel Bandwidth: 5MHz					
Channel	Frequency (MHz)	26dBc Bandwidth (MHz)		Occupied Bandwidth (MHz)	
		QPSK	16QAM	QPSK	16QAM
23035	701.5	4.908	4.893	4.47	4.48
23095	707.5	4.904	4.921	4.48	4.48
23155	713.5	4.890	4.934	4.48	4.48

Spectrum Plot of Worst Value
26dBc Bandwidth

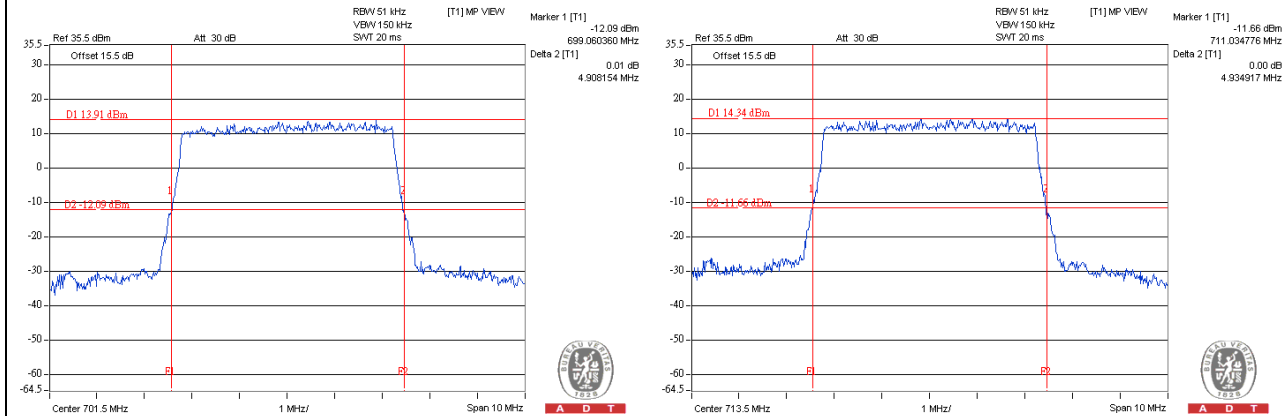

Occupied Bandwidth

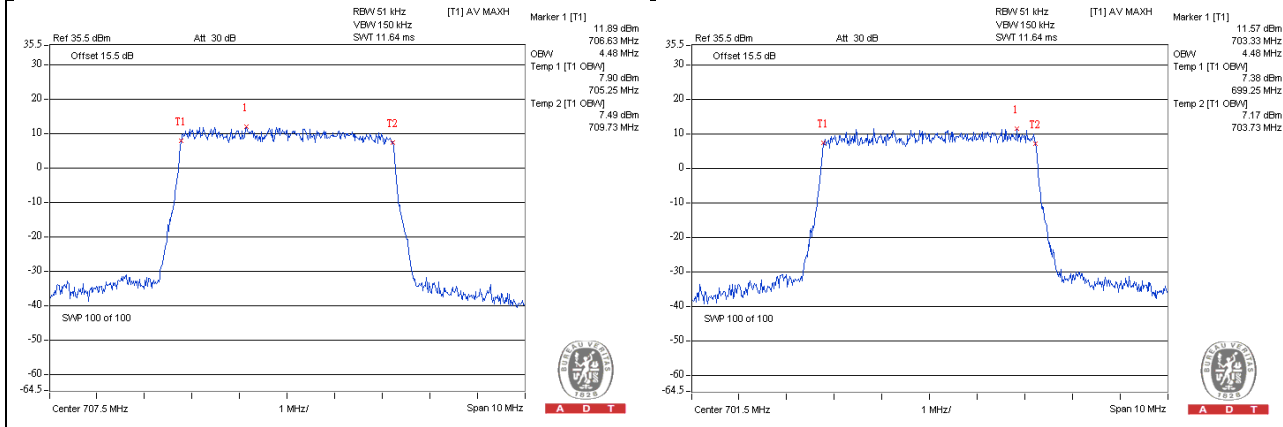

Channel Bandwidth: 10MHz

Channel	Frequency (MHz)	26dBc Bandwidth (MHz)		Occupied Bandwidth (MHz)	
		QPSK	16QAM	QPSK	16QAM
23060	704	9.577	9.558	8.90	8.90
23095	707.5	9.677	9.601	8.90	8.93
23130	711	9.662	9.651	8.93	8.93

Spectrum Plot of Worst Value

26dBc Bandwidth

QPSK

16QAM

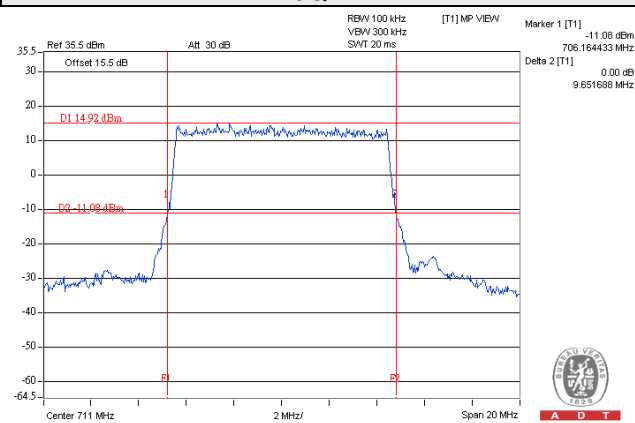
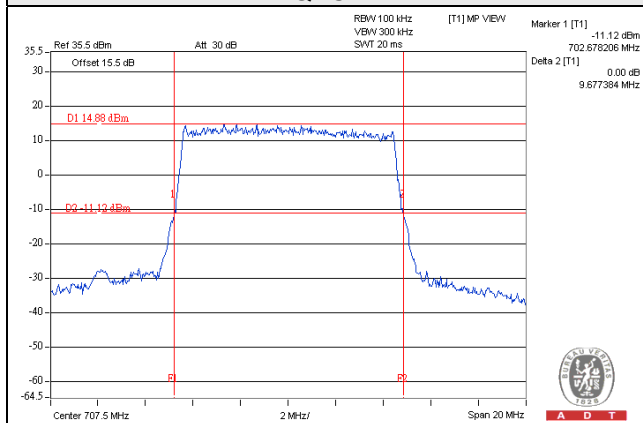

Occupied Bandwidth

QPSK

16QAM

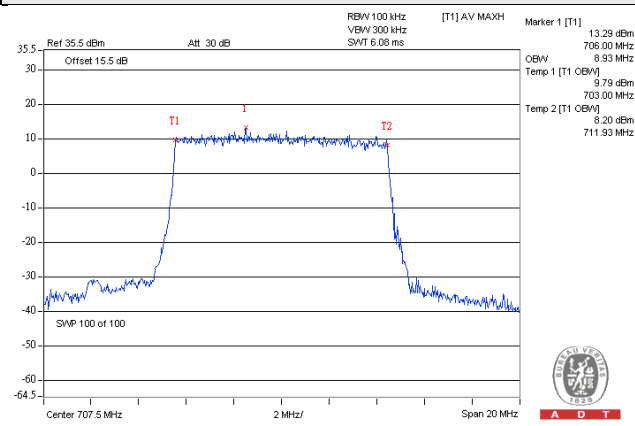
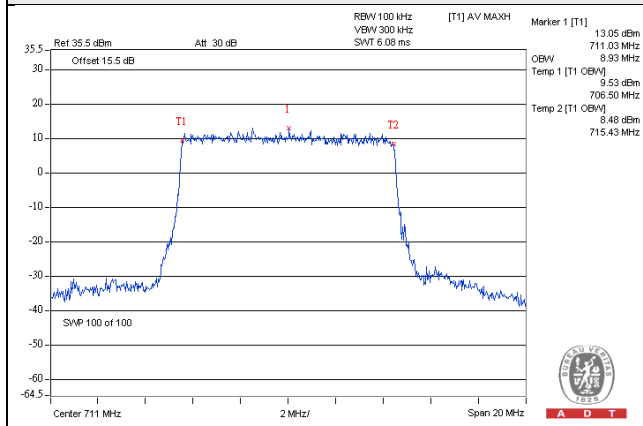

LTE Band 17

Channel Bandwidth: 5MHz					
Channel	Frequency (MHz)	26dBc Bandwidth (MHz)		Occupied Bandwidth (MHz)	
		QPSK	16QAM	QPSK	16QAM
23755	706.5	4.917	4.943	4.48	4.48
23790	710.0	4.935	4.945	4.48	4.48
23825	713.5	4.918	4.916	4.48	4.48

Spectrum Plot of Worst Value
26dBc Bandwidth

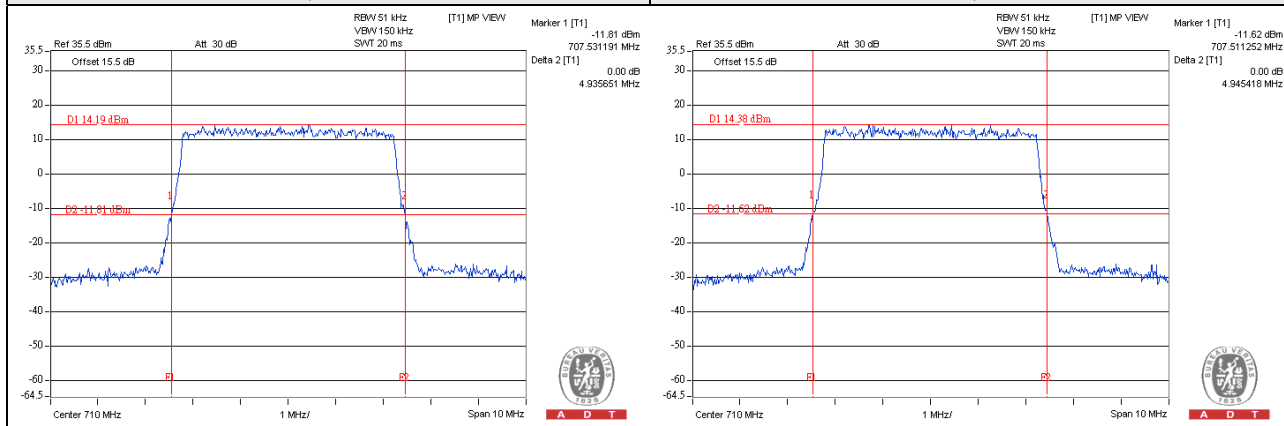

Occupied Bandwidth

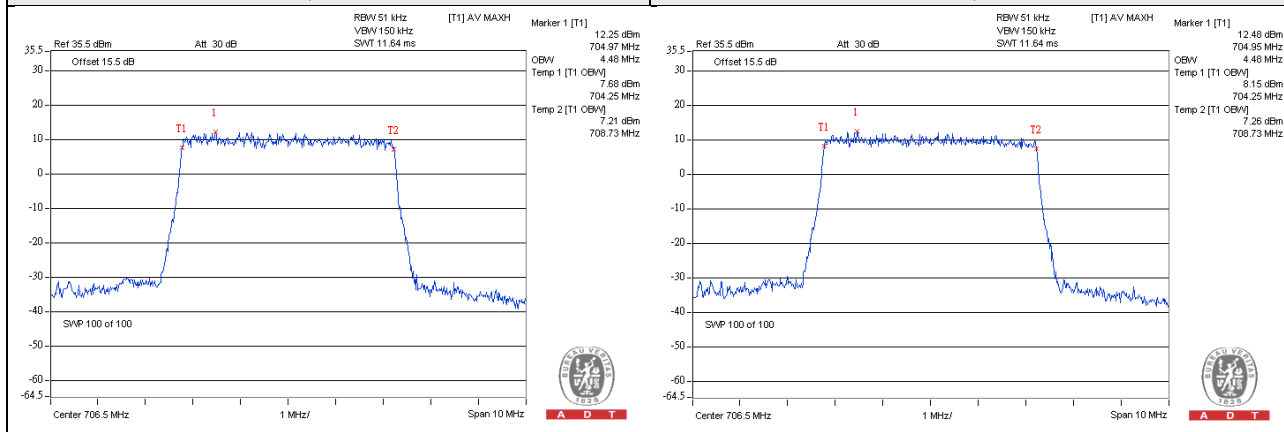

Channel Bandwidth: 10MHz					
Channel	Frequency (MHz)	26dBc Bandwidth (MHz)		Occupied Bandwidth (MHz)	
		QPSK	16QAM	QPSK	16QAM
23780	709.0	9.656	9.644	8.93	8.93
23790	710.0	9.656	9.633	8.93	8.90
23800	711.0	9.660	9.640	8.93	8.93

Spectrum Plot of Worst Value
26dBc Bandwidth

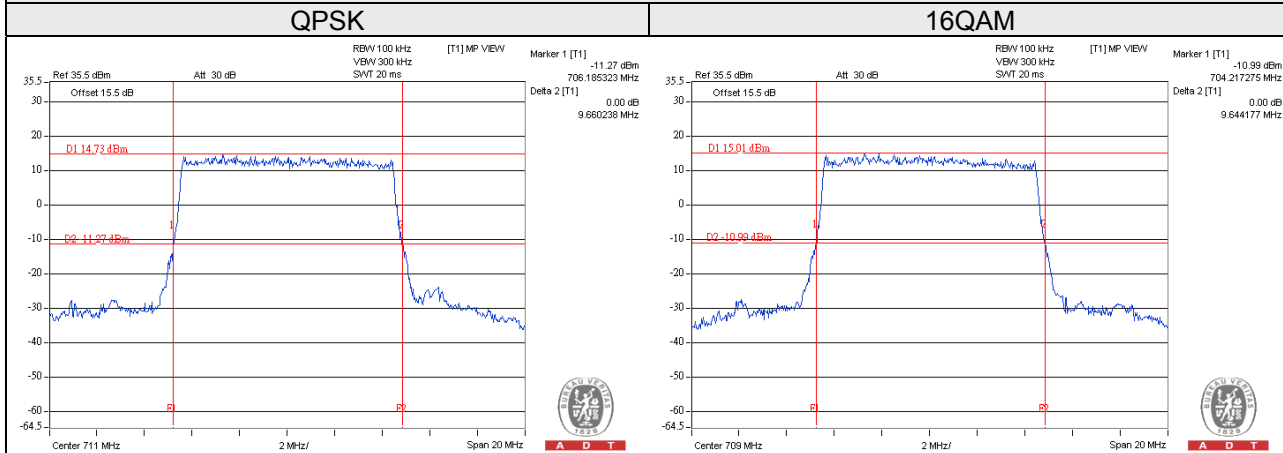

Occupied Bandwidth

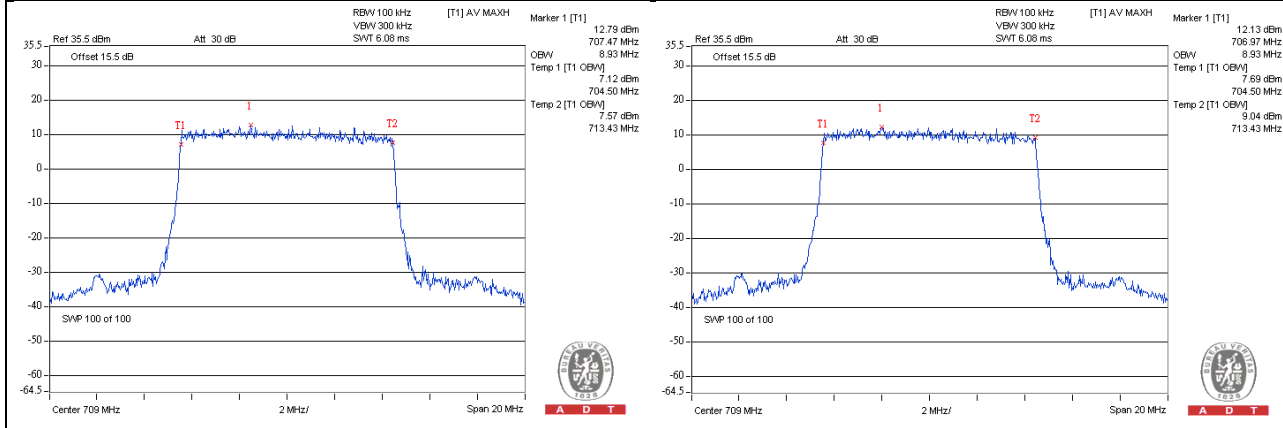

4.5 Channel Edge Measurement

4.5.1 Limits of Band Edge Measurement

For WCDMA Band 4, LTE Band 4

According to FCC 27.53(h) for operations in the 1695-1710 MHz, 1710-1755 MHz, 1755-1780 MHz, 1915-1920 MHz, 1995-2000 MHz, 2000-2020 MHz, 2110-2155 MHz, 2155-2180 MHz, and 2180-2200 bands, the power of any emission outside a licensee's frequency block shall be attenuated below the transmitter power (P) in watts by at least $43 + 10 \log_{10}(P)$ dB.

For LTE Band 12 and LTE Band 17

According to FCC 27.53(g) for operations in the 600 MHz band and the 698-746 MHz band, the power of any emission outside a licensee's frequency band(s) of operation shall be attenuated below the transmitter power (P) within the licensed band(s) of operation, measured in watts, by at least $43 + 10 \log(P)$ dB. Compliance with this provision is based on the use of measurement instrumentation employing a resolution bandwidth of 100 kilohertz or greater.

4.5.2 Test Setup

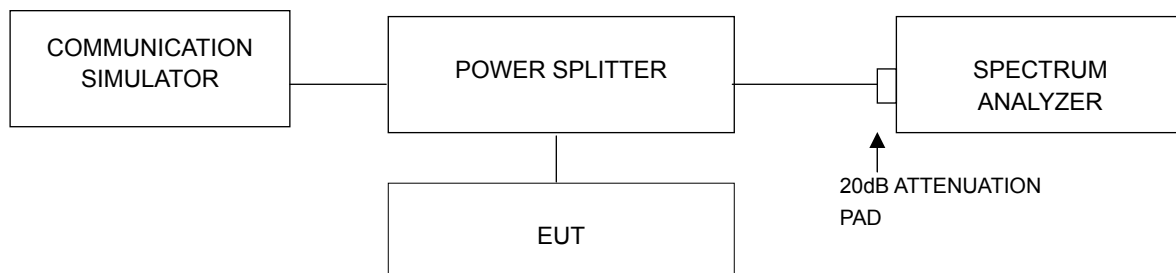

4.5.3 Test Procedures

- The EUT was set up for the rated peak power. The power was measured with Spectrum Analyzer. All measurements were done at 3 channels: low, middle and high operational frequency range.
- The center frequency of spectrum is the band edge frequency and span is 1.5MHz. RBW = 30kHz and VBW = 100kHz (Channel Bandwidth: 1.4MHz and 3MHz), RBW = 51kHz and VBW = 150kHz (Channel Bandwidth: 5MHz), RBW = 100kHz and VBW = 300kHz (Channel Bandwidth: 10MHz), RBW = 200kHz and VBW = 620kHz (Channel Bandwidth: 15MHz) and RBW = 430kHz and VBW = 1.2MHz (Channel Bandwidth: 20MHz).
- Record the max trace plot into the test report.

4.5.4 Test Results

WCDMA Band 4

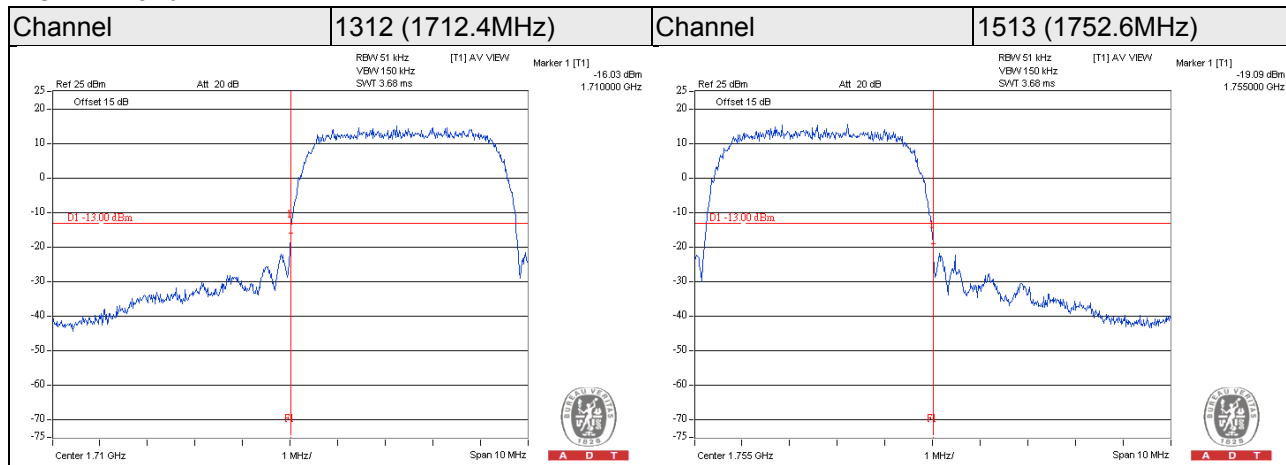

HSDPA

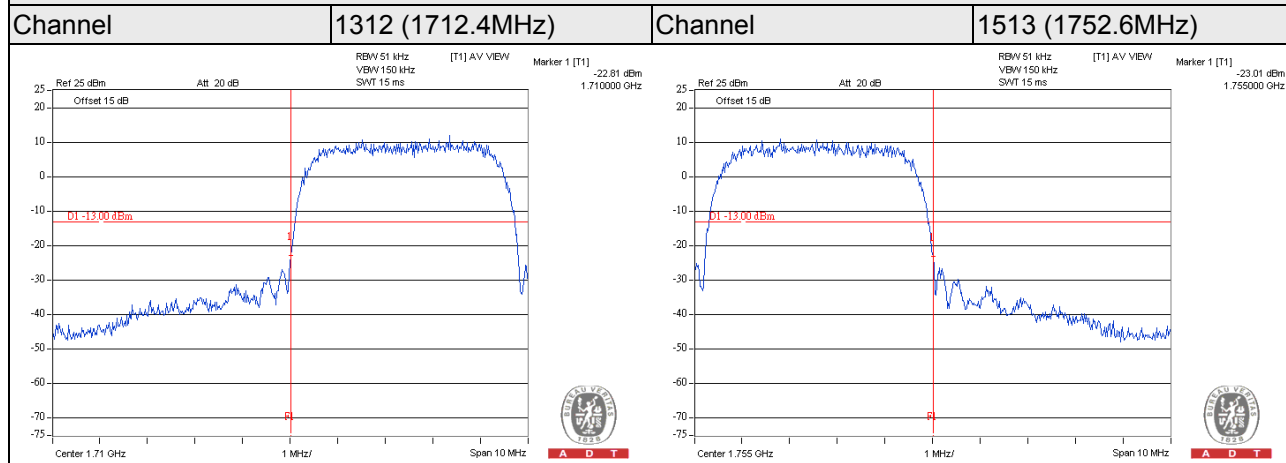

HSUPA

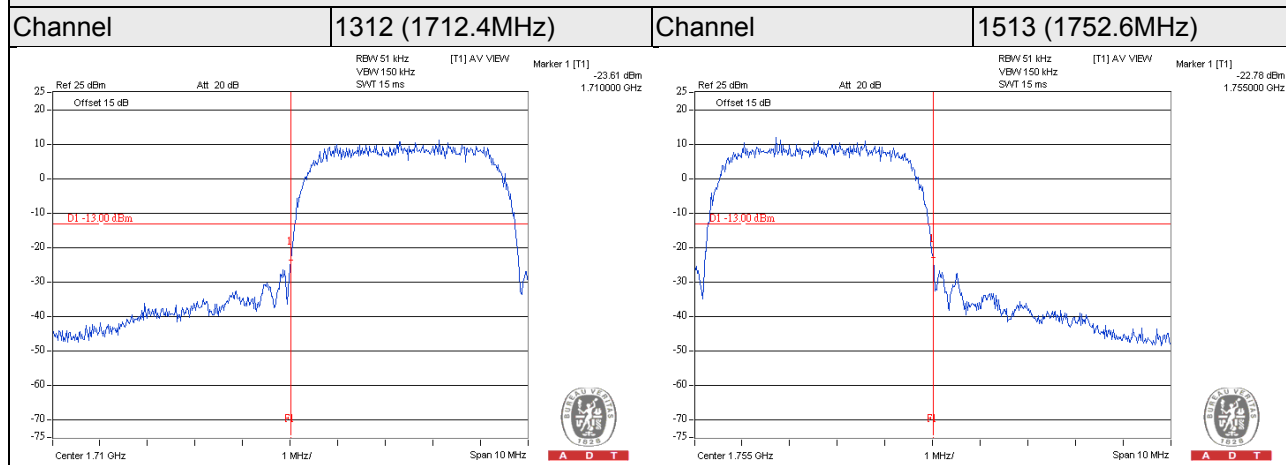

LTE Band 4

Channel Bandwidth: 1.4MHz

Channel 19957 (1710.7MHz)	QPSK	1 RB / 0 RB Offset	Channel 20393 (1754.3MHz)	QPSK	1 RB / 5 RB Offset
------------------------------	------	--------------------	------------------------------	------	--------------------

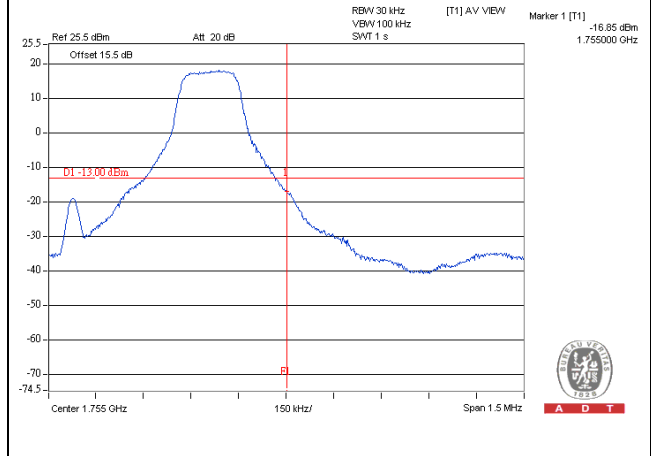
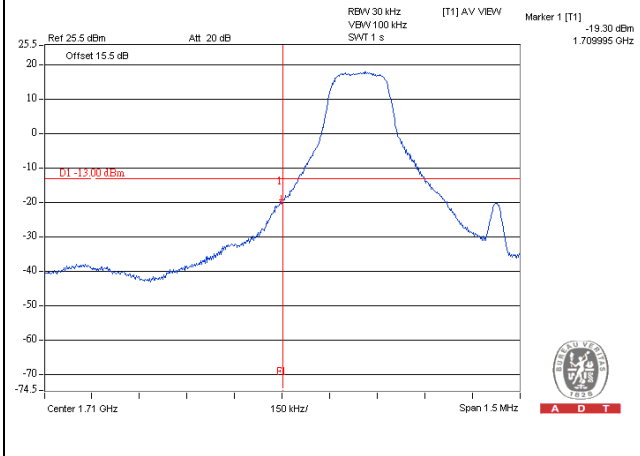

Channel 19957 (1710.7MHz)	QPSK	6 RB / 0 RB Offset	Channel 20393 (1754.3MHz)	QPSK	6 RB / 0 RB Offset
------------------------------	------	--------------------	------------------------------	------	--------------------

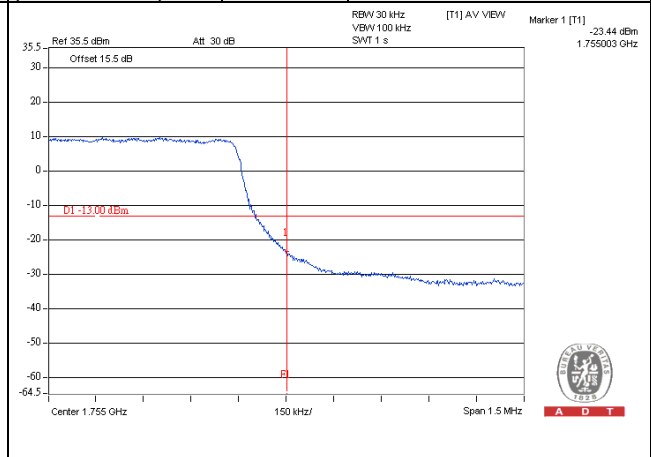
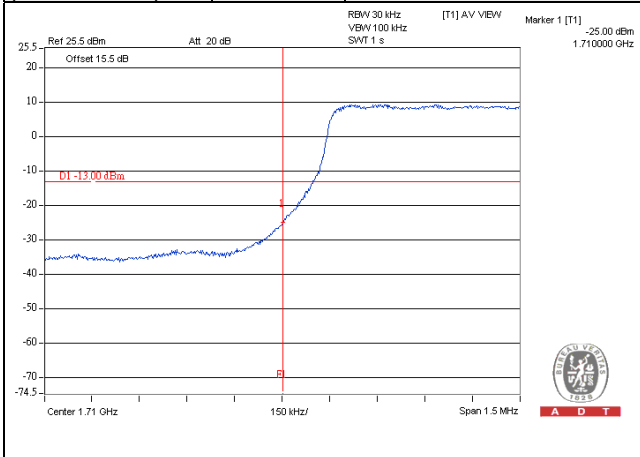

Channel Bandwidth: 3MHz

Channel 19965
(1711.5MHz)

QPSK

1 RB / 0 RB Offset

Channel 20385
(1753.5MHz)

QPSK

1 RB / 14 RB Offset

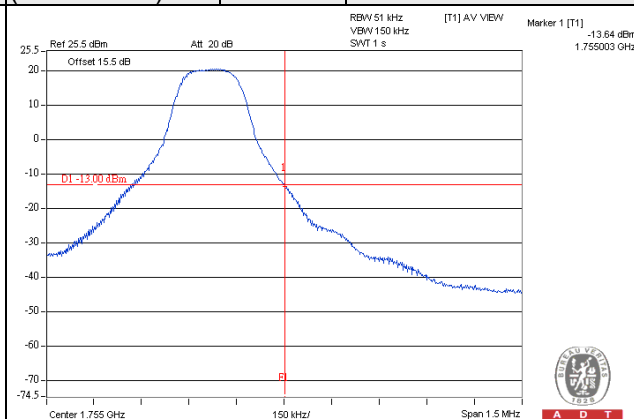
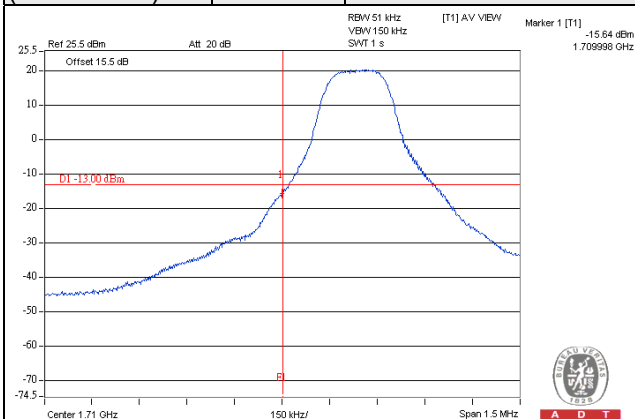

Channel 19965
(1711.5MHz)

QPSK

15 RB / 0 RB Offset

Channel 20385
(1753.5MHz)

QPSK

15 RB / 0 RB Offset

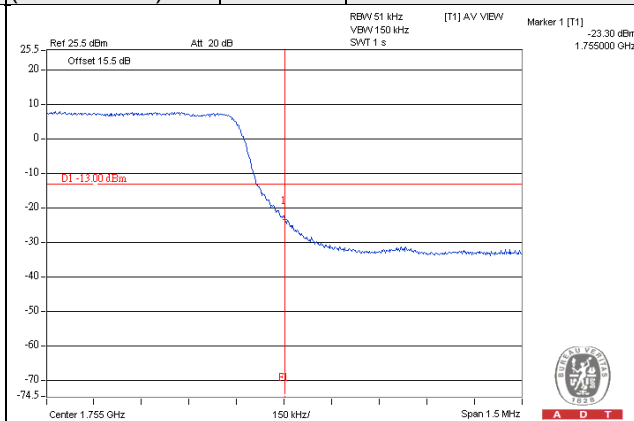
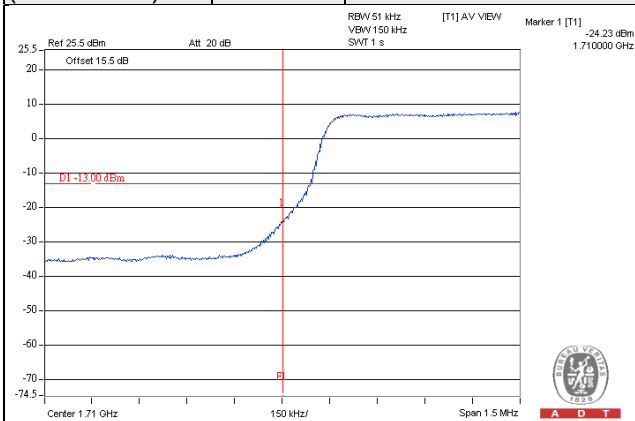

Channel Bandwidth: 5MHz

**Channel 19975
(1712.5MHz)**

QPSK

1 RB / 0 RB Offset

**Channel 20375
(1752.5MHz)**

QPSK

1 RB / 24 RB Offset

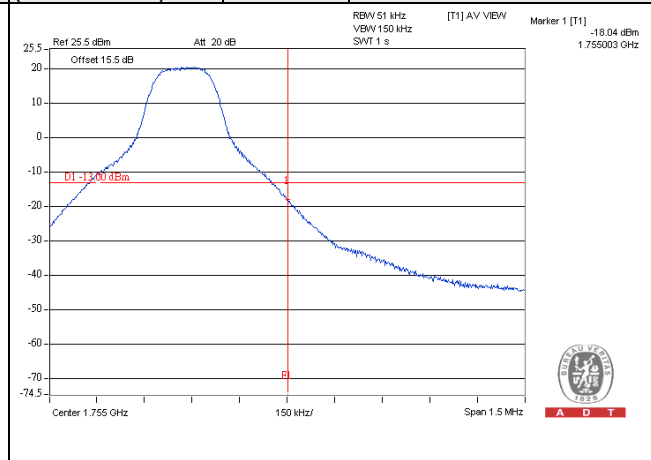
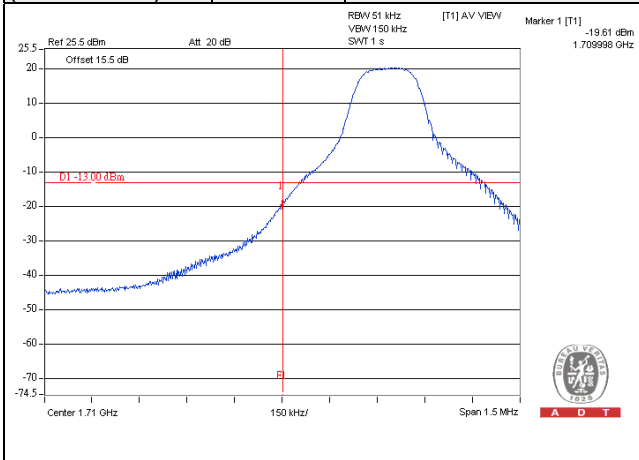

**Channel 19975
(1712.5MHz)**

QPSK

25 RB / 0 RB Offset

**Channel 20375
(1752.5MHz)**

QPSK

25 RB / 0 RB Offset

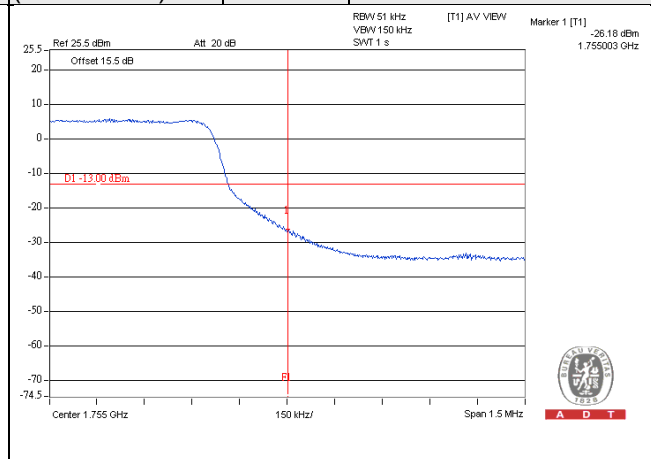
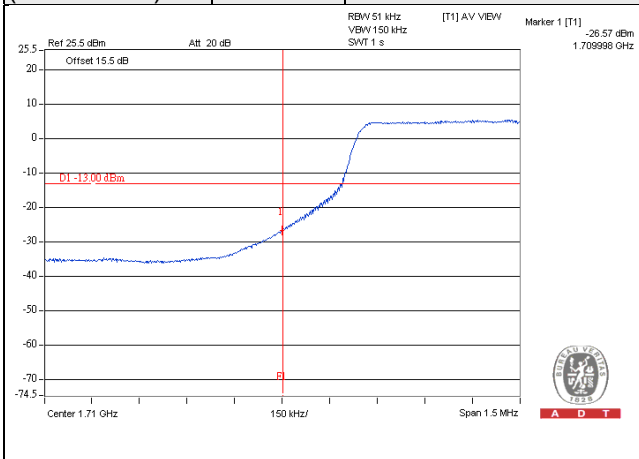

Channel Bandwidth: 10MHz

**Channel 20000
(1715.0MHz)**

QPSK

1 RB / 0 RB Offset

**Channel 20350
(1750.0MHz)**

QPSK

1 RB / 49 RB Offset

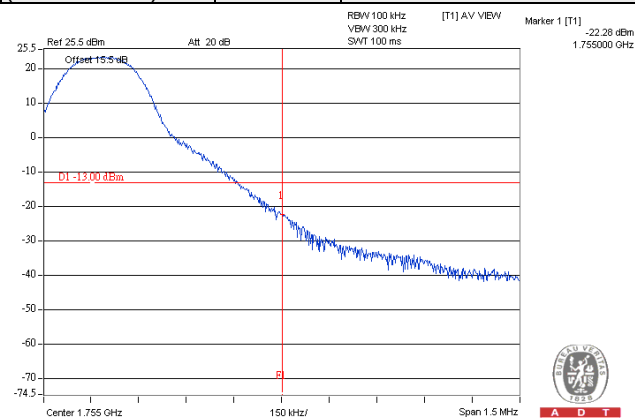
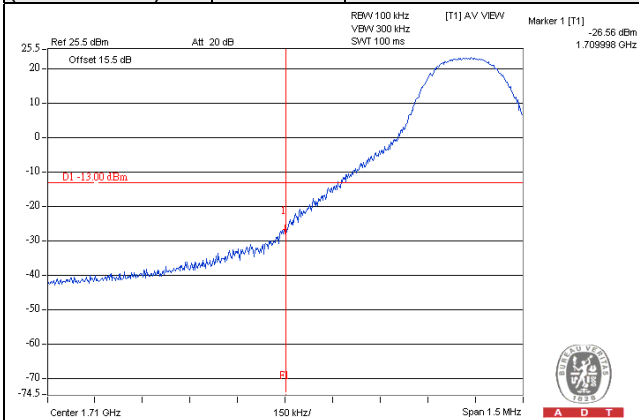

**Channel 20000
(1715.0MHz)**

QPSK

50 RB / 0 RB Offset

**Channel 20350
(1750.0MHz)**

QPSK

50 RB / 0 RB Offset

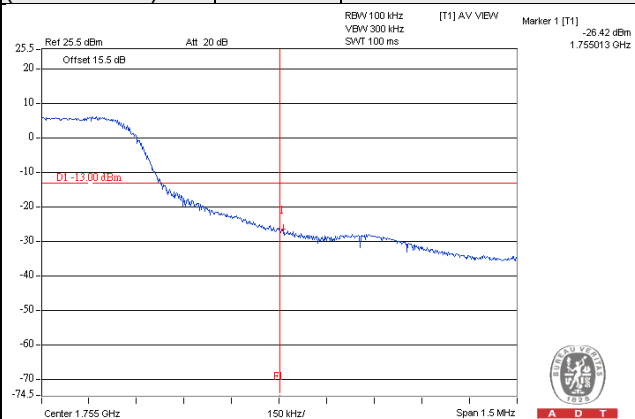
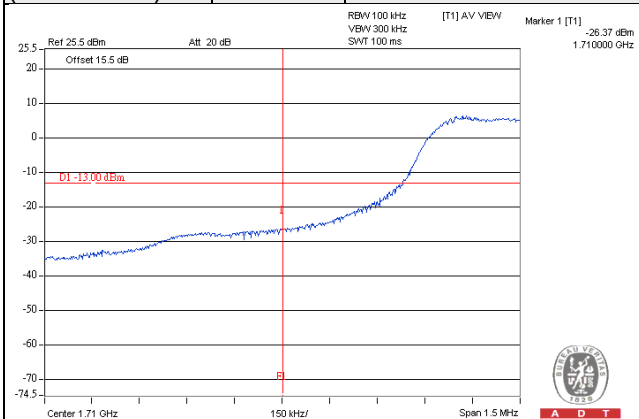

Channel Bandwidth: 15MHz

Channel 20025
(1717.5MHz)

QPSK

1 RB / 0 RB Offset

Channel 20325
(1747.5MHz)

QPSK

1 RB / 74 RB Offset

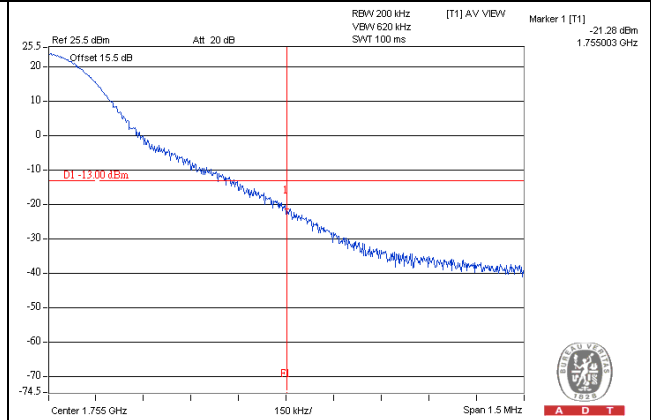
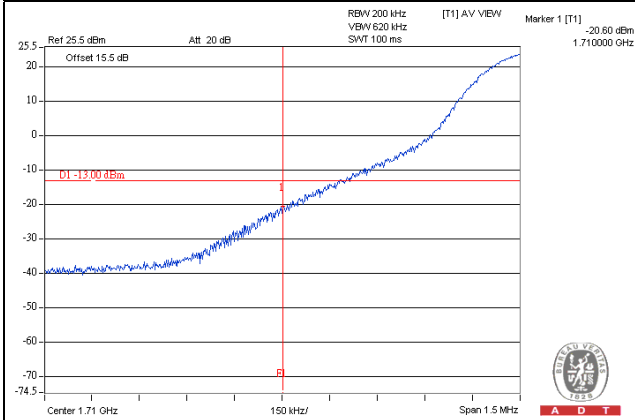

Channel 20025
(1717.5MHz)

QPSK

75 RB / 0 RB Offset

Channel 20325
(1747.5MHz)

QPSK

75 RB / 0 RB Offset

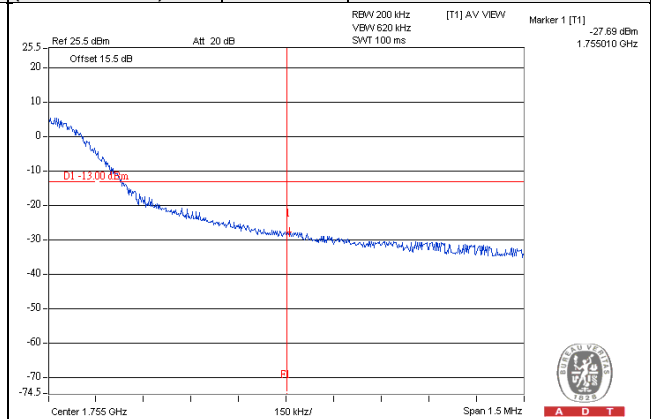
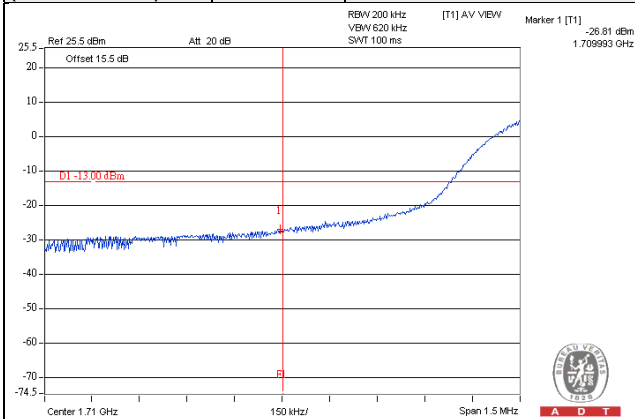

Channel Bandwidth: 20MHz

Channel 20050
(1720.0MHz)

QPSK

1 RB / 0 RB Offset

Channel 20300
(1745.0MHz)

QPSK

1 RB / 99 RB Offset

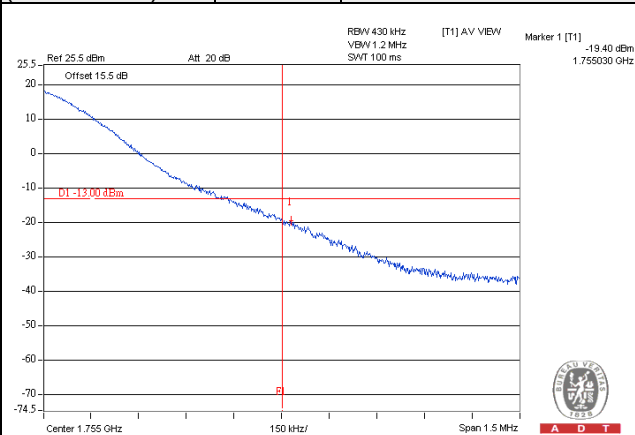
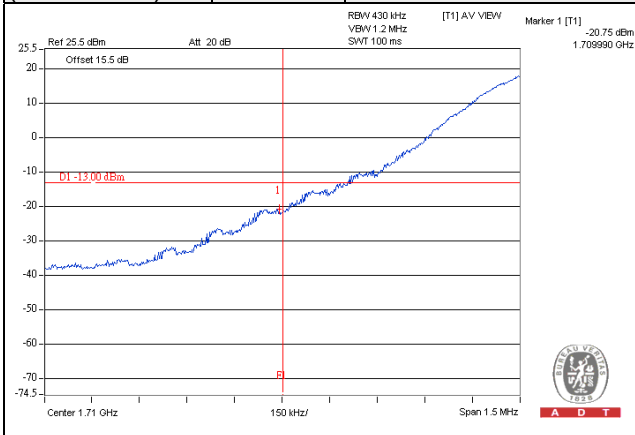

Channel 20050
(1720.0MHz)

QPSK

100 RB / 0 RB Offset

Channel 20300
(1745.0MHz)

QPSK

100 RB / 0 RB Offset

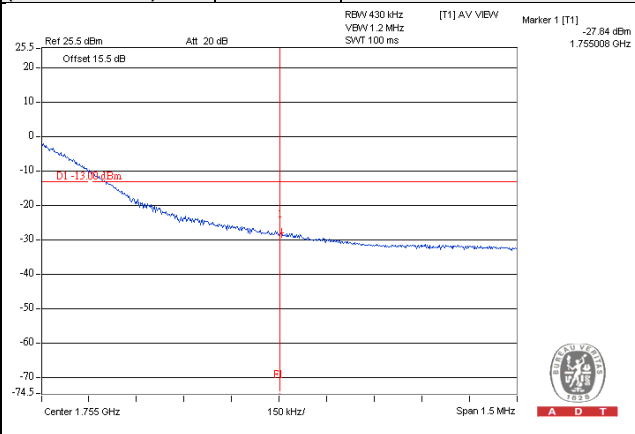
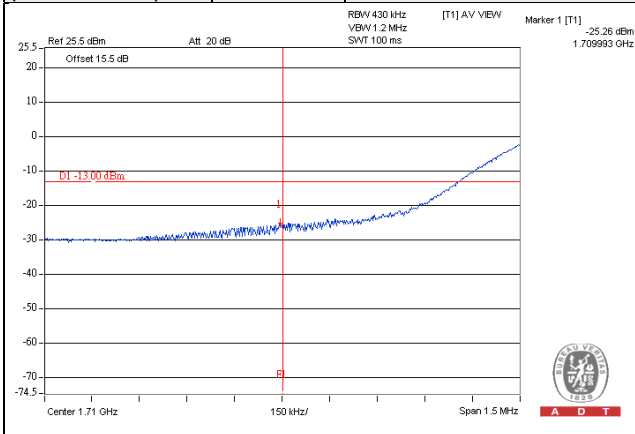

LTE Band 12

Channel Bandwidth: 1.4MHz

Channel 23017 (699.7MHz)	QPSK	1 RB / 0 RB Offset	Channel 23171 (715.3MHz)	QPSK	1 RB / 5 RB Offset
-----------------------------	------	--------------------	-----------------------------	------	--------------------

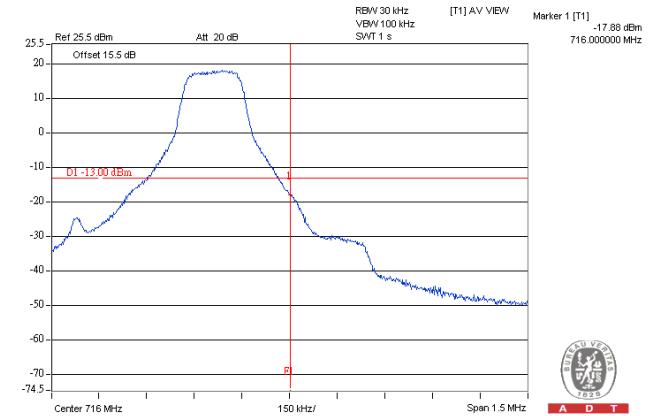
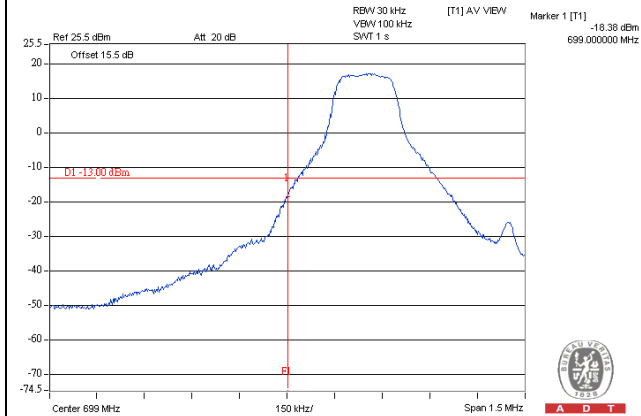

Channel 23017 (699.7MHz)	QPSK	6 RB / 0 RB Offset	Channel 23171 (715.3MHz)	QPSK	6 RB / 0 RB Offset
-----------------------------	------	--------------------	-----------------------------	------	--------------------

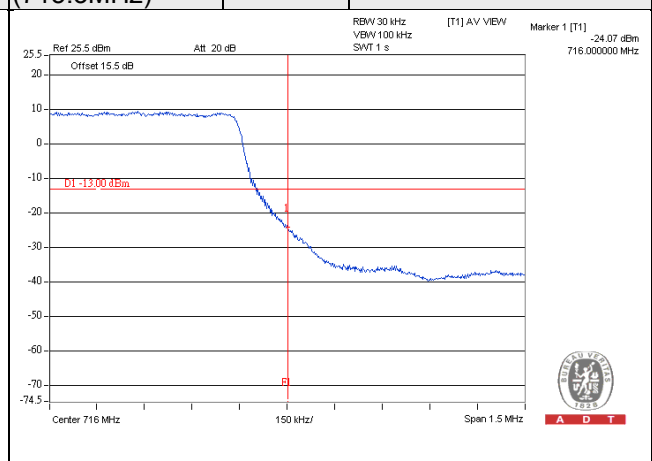
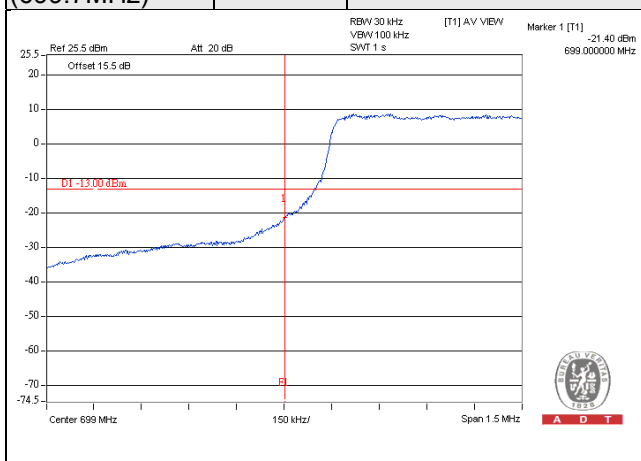

Channel Bandwidth: 3MHz

Channel 23025
(700.5MHz)

QPSK

1 RB / 0 RB Offset

Channel 23165
(714.5MHz)

QPSK

1 RB / 14RB Offset

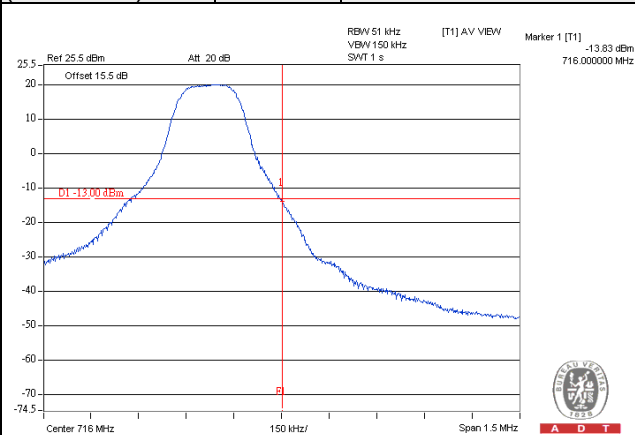
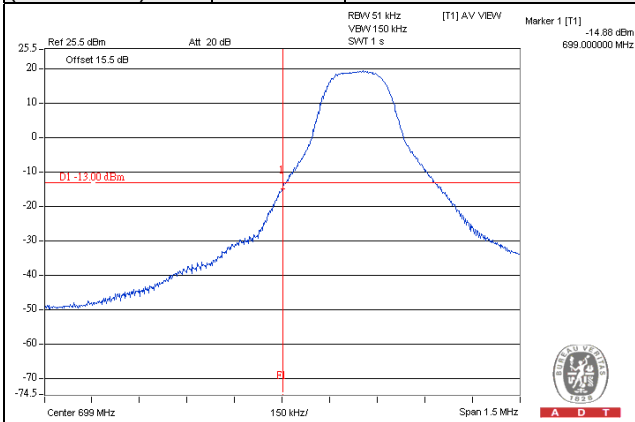

Channel 23025
(700.5MHz)

QPSK

15 RB / 0 RB Offset

Channel 23165
(714.5MHz)

QPSK

15 RB / 0 RB Offset

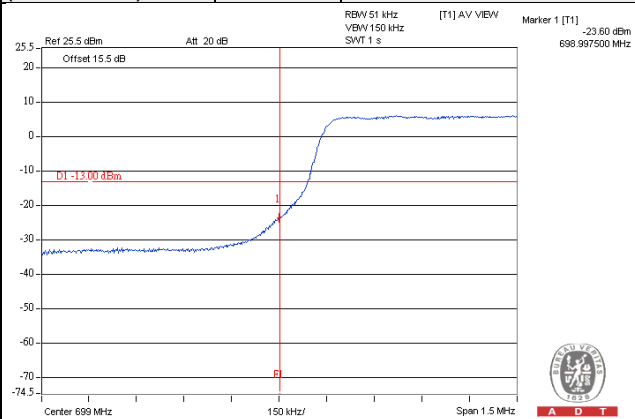
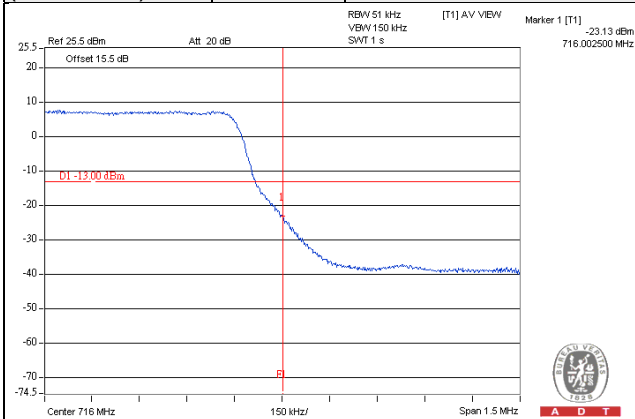

Channel Bandwidth: 5MHz

**Channel 23035
(701.5MHz)**

QPSK

1 RB / 0 RB Offset

**Channel 23155
(713.5MHz)**

QPSK

1 RB / 24RB Offset

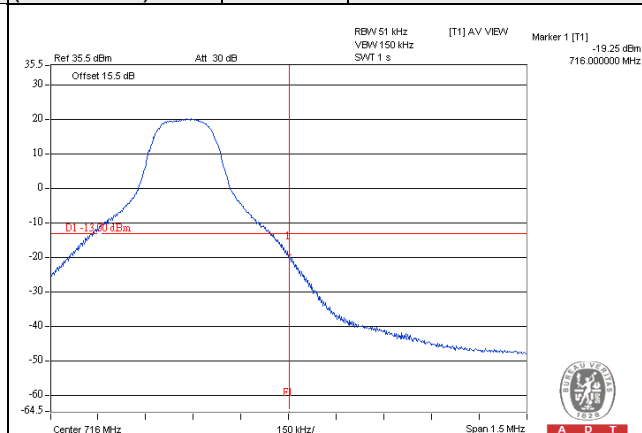
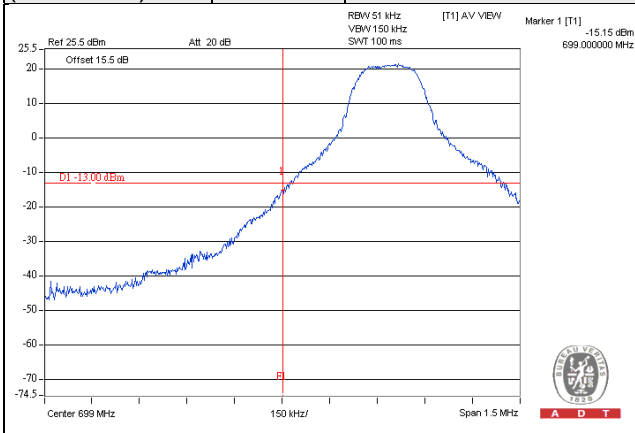

**Channel 23035
(701.5MHz)**

QPSK

25 RB / 0 RB Offset

**Channel 23155
(713.5MHz)**

QPSK

25 RB / 0 RB Offset

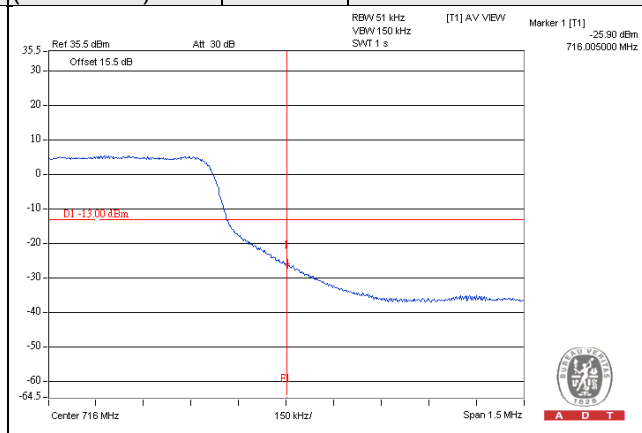
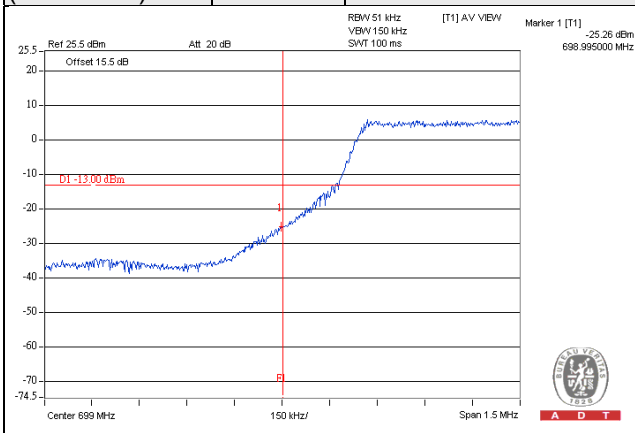

Channel Bandwidth: 10MHz

Channel 23060
(704MHz)

QPSK

1 RB / 0 RB Offset

Channel 23130
(711MHz)

QPSK

1 RB / 24RB Offset

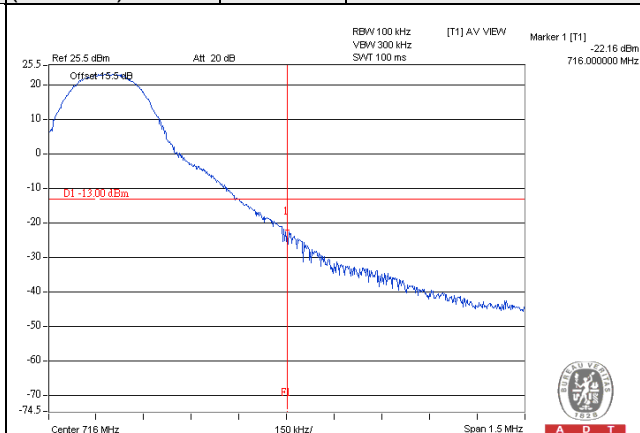
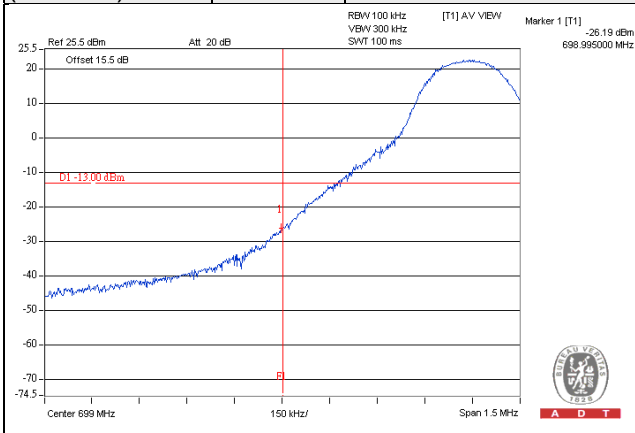

Channel 23060
(704MHz)

QPSK

50 RB / 0 RB Offset

Channel 23130
(711MHz)

QPSK

25 RB / 0 RB Offset

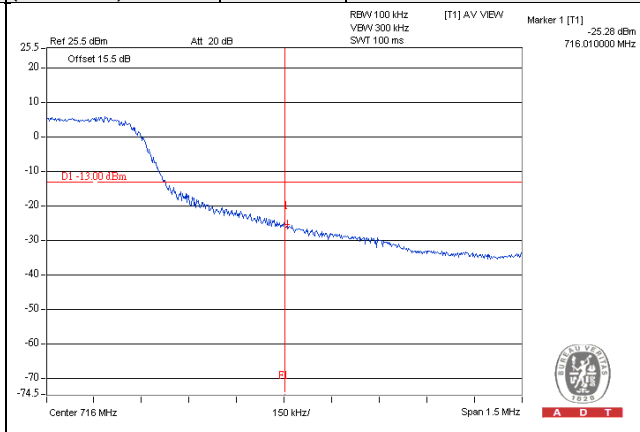
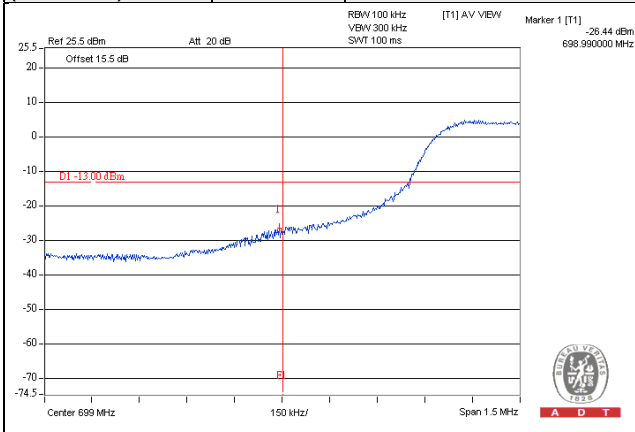

LTE Band 17

Channel Bandwidth: 5MHz

Channel 23755 (706.5MHz)	QPSK	1 RB / 0 RB Offset	Channel 23825 (713.5MHz)	QPSK	1 RB / 24 RB Offset
-----------------------------	------	--------------------	-----------------------------	------	---------------------

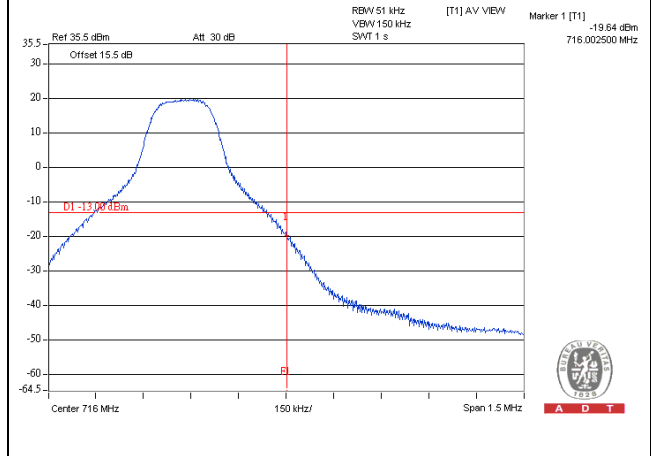
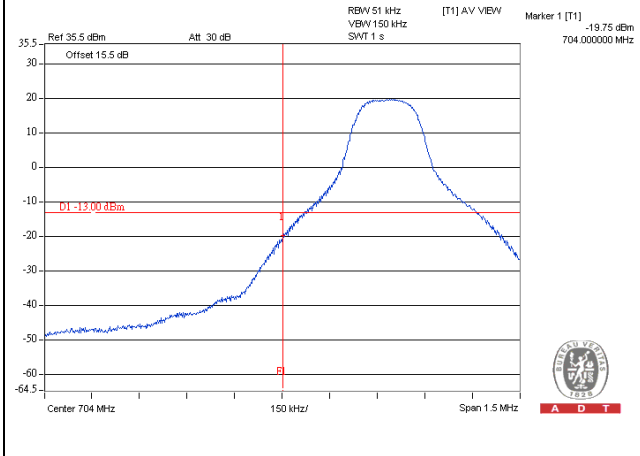

Channel 23755 (706.5MHz)	QPSK	25 RB / 0 RB Offset	Channel 23825 (713.5MHz)	QPSK	25 RB / 0 RB Offset
-----------------------------	------	---------------------	-----------------------------	------	---------------------

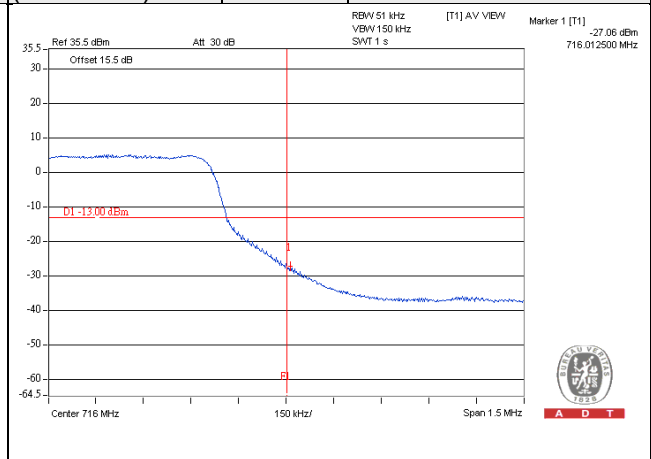
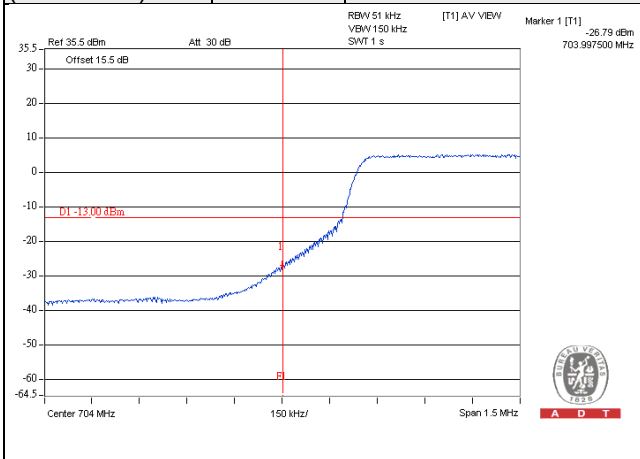

Channel Bandwidth: 10MHz

Channel 23780
(709.0MHz)

QPSK

1 RB / 0 RB Offset

Channel 23790
(711.0MHz)

QPSK

1 RB / 49 RB Offset

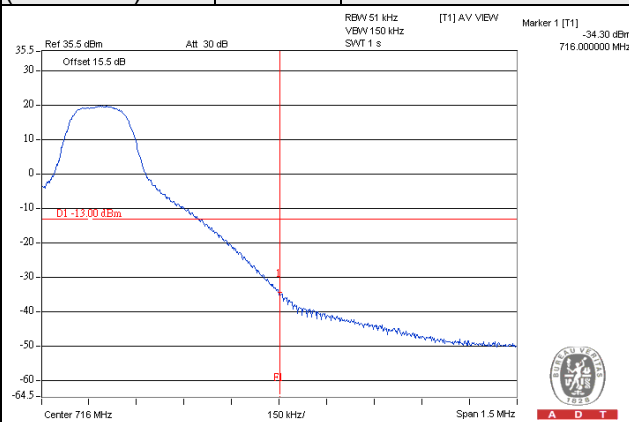
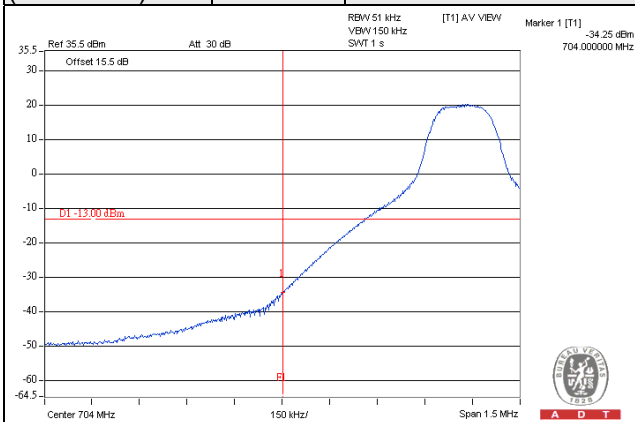

Channel 23780
(709.0MHz)

QPSK

50 RB / 0 RB Offset

Channel 23790
(711.0MHz)

QPSK

50 RB / 0 RB Offset

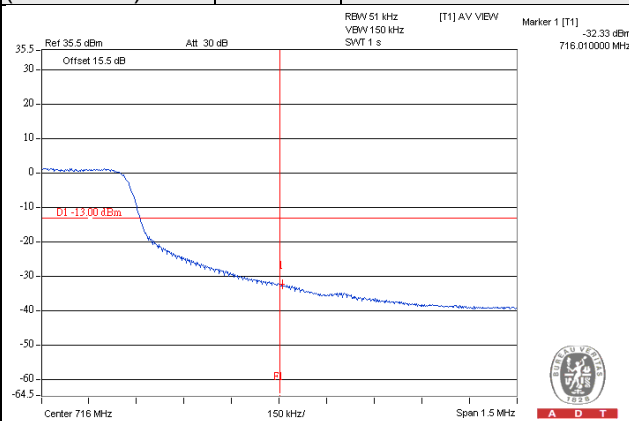
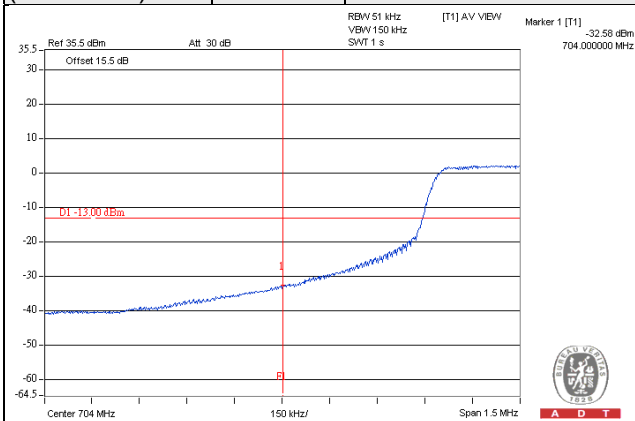

4.6 Peak to Average Ratio

4.6.1 Limits of Peak to Average Ratio Measurement

In measuring transmissions in this band using an average power technique, the peak to-average ratio (PAR) of the transmission may not exceed 13 dB

4.6.2 Test Setup

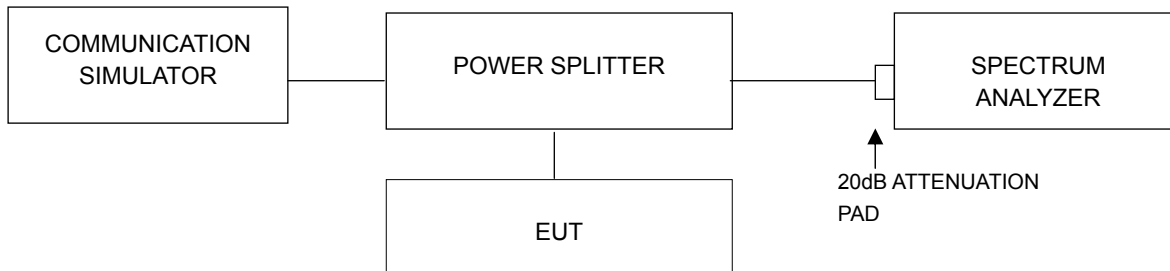

4.6.3 Test Procedures

- Set resolution/measurement bandwidth \geq signal's occupied bandwidth;
- Set the number of counts to a value that stabilizes the measured CCDF curve;
- Record the maximum PAPR level associated with a probability of 0.1%.

4.6.4 Test Results

WCDMA Band 4

Channel	Frequency (MHz)	Peak To Average Ratio (dB)		
		WCDMA	HSDPA	HSUPA
1312	1712.4	2.81	2.82	2.82
1413	1732.6	2.97	2.98	2.95
1513	1752.6	2.81	2.80	2.79

Spectrum Plot of Worst Value

WCDMA Band 4

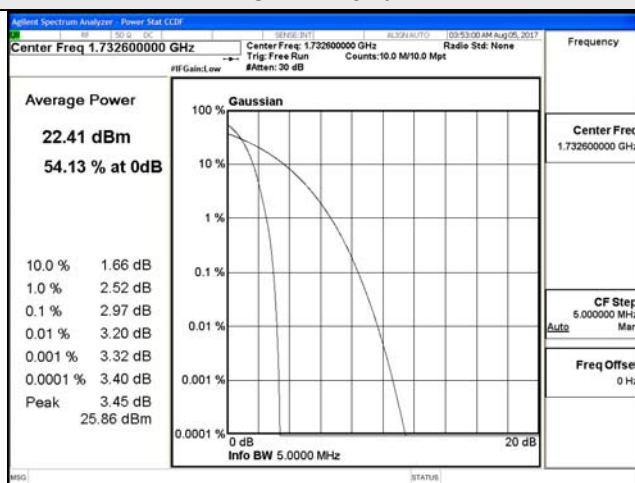

HSDPA

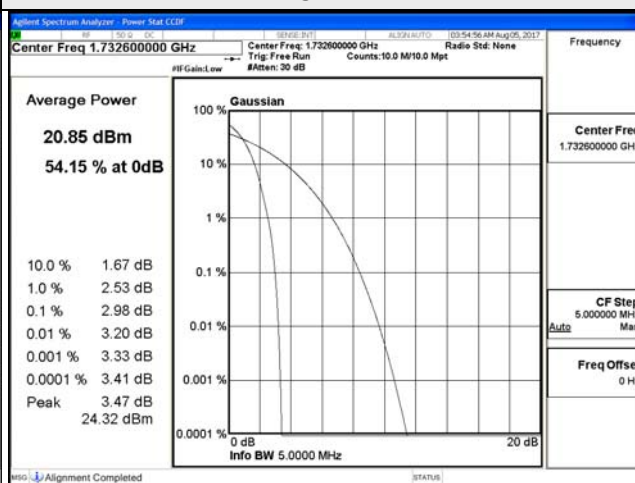

HSUPA

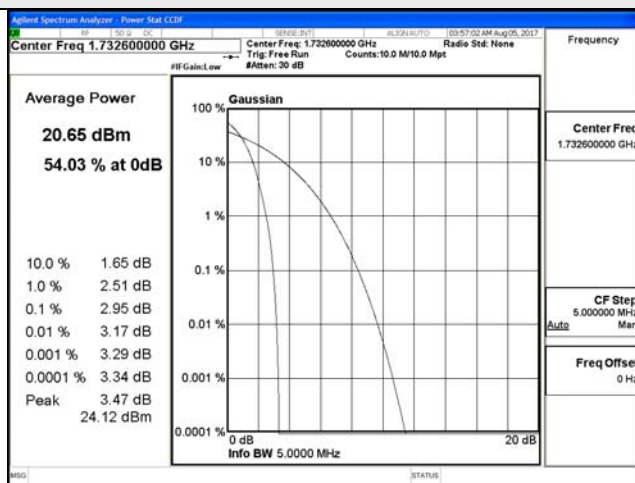

LTE Band 4

Channel Bandwidth: 1.4MHz

Channel	Frequency (MHz)	Peak To Average Ratio (dB)	
		QPSK	16QAM
19957	1710.7	4.09	4.09
20175	1732.5	4.44	4.45
20393	1754.3	3.97	3.97

Spectrum Plot of Worst Value

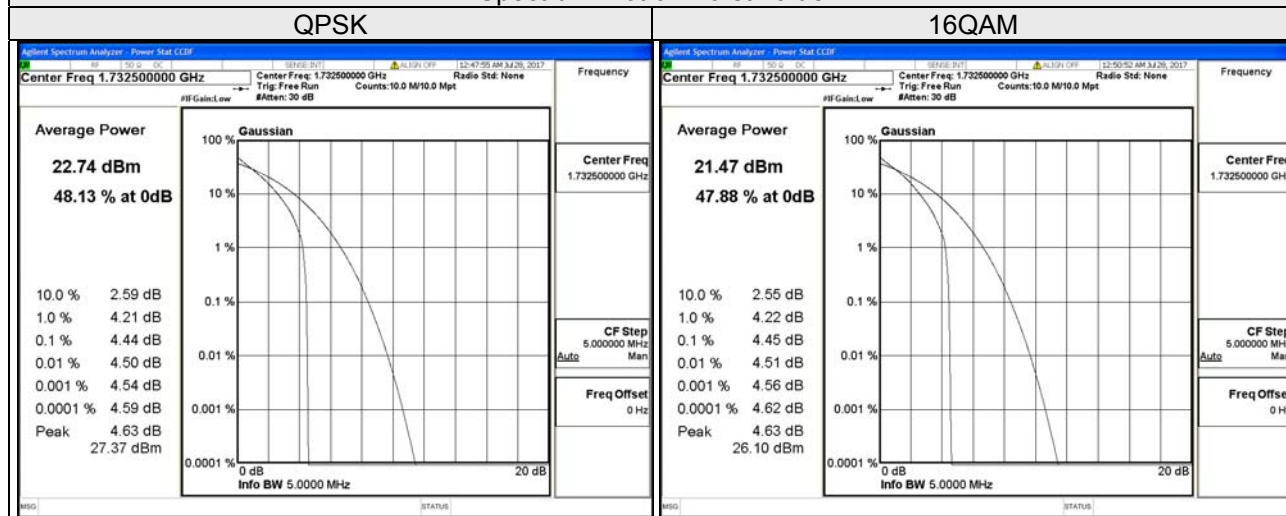

Channel Bandwidth: 3MHz

Channel	Frequency (MHz)	Peak To Average Ratio (dB)	
		QPSK	16QAM
19965	1711.5	3.98	3.97
20175	1732.5	4.36	4.38
20385	1753.5	3.86	3.86

Spectrum Plot of Worst Value

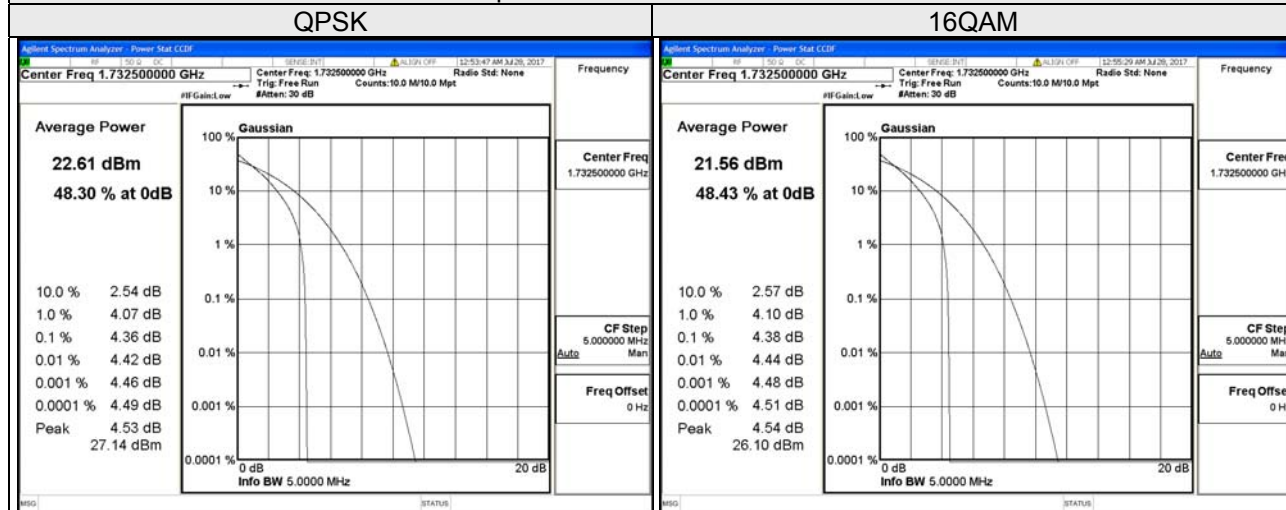

Channel Bandwidth: 5MHz

Channel	Frequency (MHz)	Peak To Average Ratio (dB)	
		QPSK	16QAM
19975	1712.5	3.93	3.93
20175	1732.5	4.33	4.34
20375	1752.5	3.78	3.90

Spectrum Plot of Worst Value

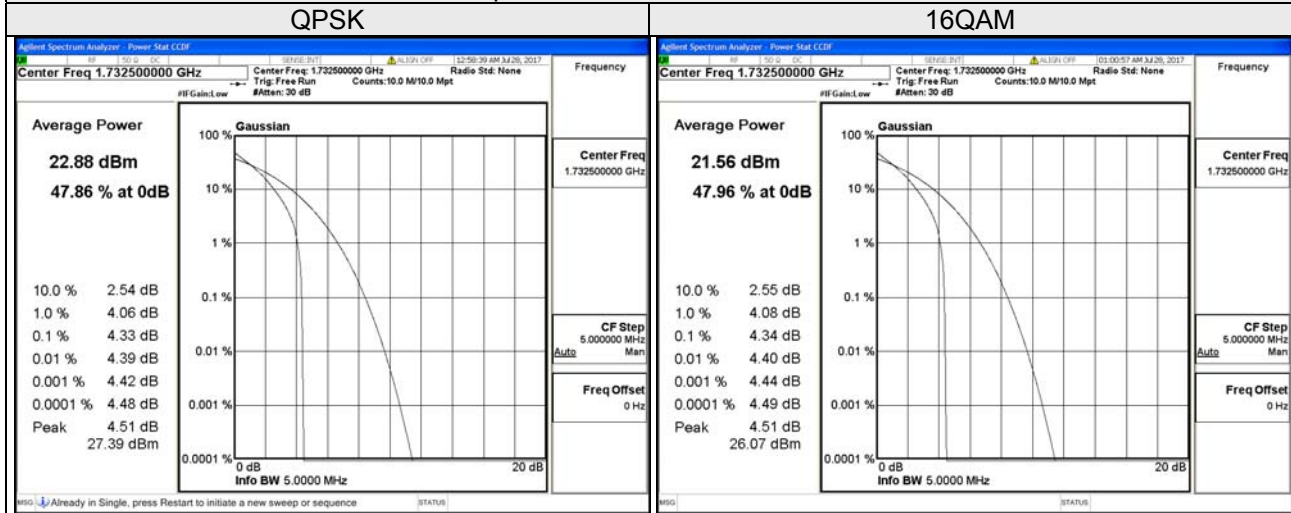

Channel Bandwidth: 10MHz

Channel	Frequency (MHz)	Peak To Average Ratio (dB)	
		QPSK	16QAM
20000	1715.0	4.10	4.09
20175	1732.5	4.43	4.44
20350	1750.0	4.22	4.22

Spectrum Plot of Worst Value

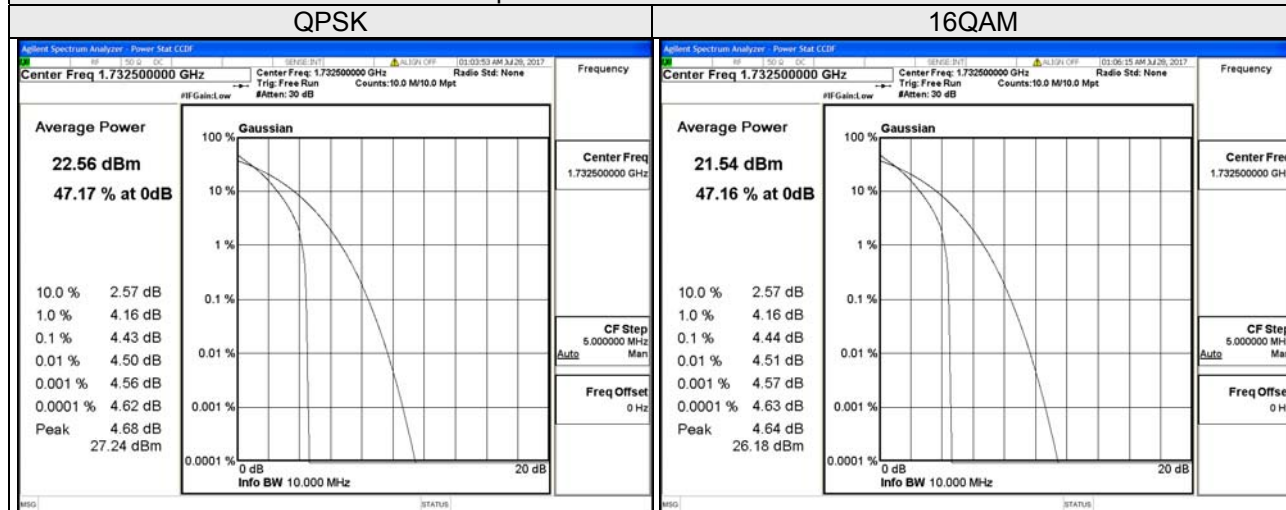

Channel Bandwidth: 15MHz

Channel	Frequency (MHz)	Peak To Average Ratio (dB)	
		QPSK	16QAM
20025	1717.5	4.04	4.06
20175	1732.5	4.26	4.30
20325	1747.5	4.26	4.31

Spectrum Plot of Worst Value

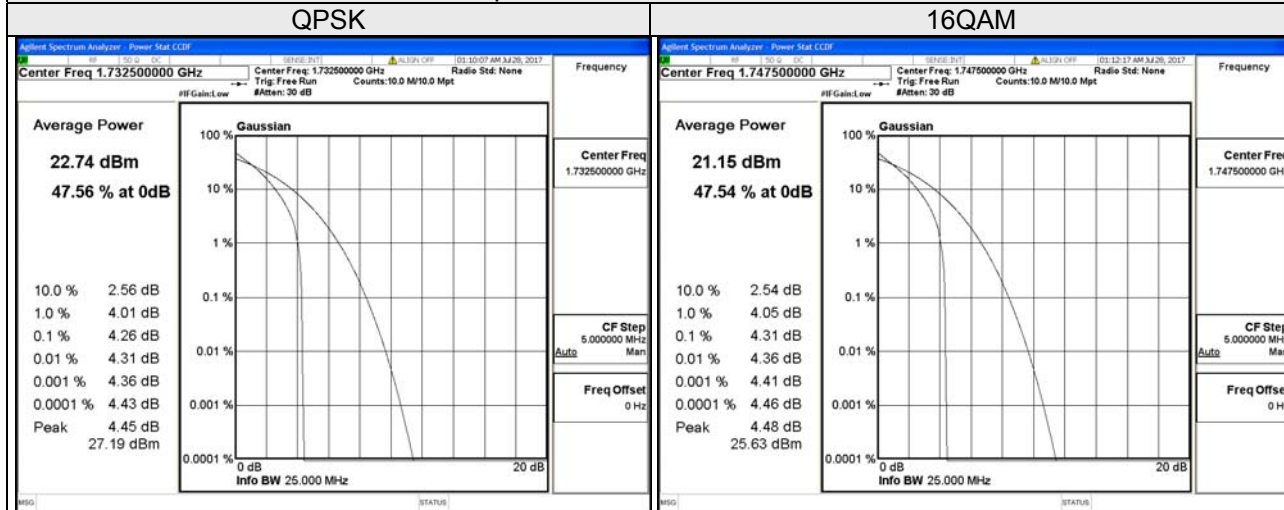

Channel Bandwidth: 20MHz

Channel	Frequency (MHz)	Peak To Average Ratio (dB)	
		QPSK	16QAM
20050	1720.0	4.09	4.08
20175	1732.5	4.18	4.09
20300	1745.0	4.46	4.44

Spectrum Plot of Worst Value

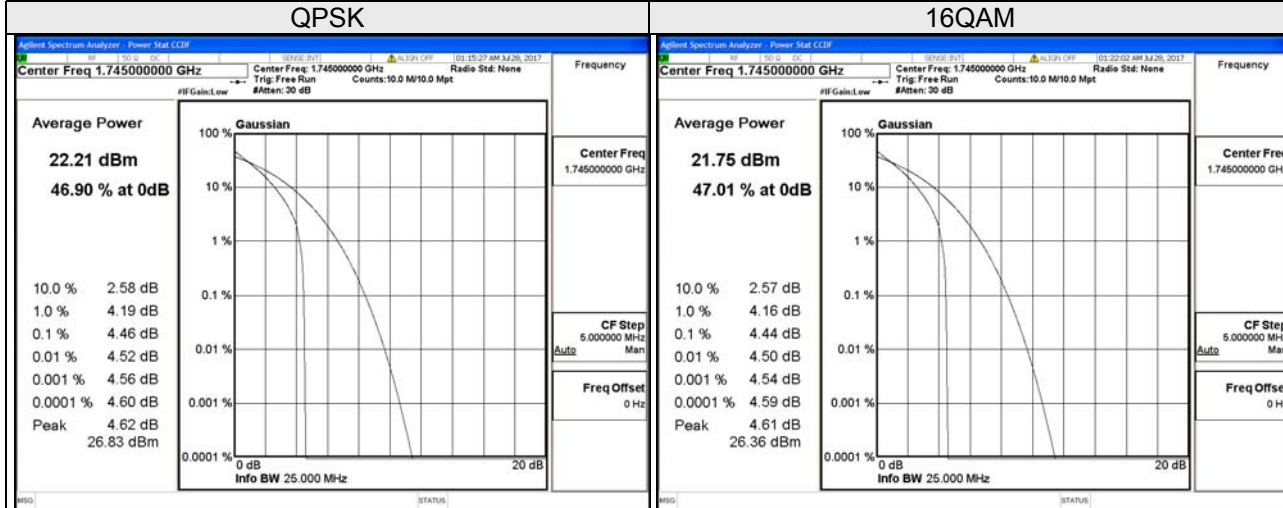

LTE Band 12

Channel Bandwidth: 1.4MHz			
Channel	Frequency (MHz)	Peak To Average Ratio (dB)	
		QPSK	16QAM
23017	699.7	2.86	2.80
23095	707.5	3.65	3.69
23173	715.3	3.45	3.43

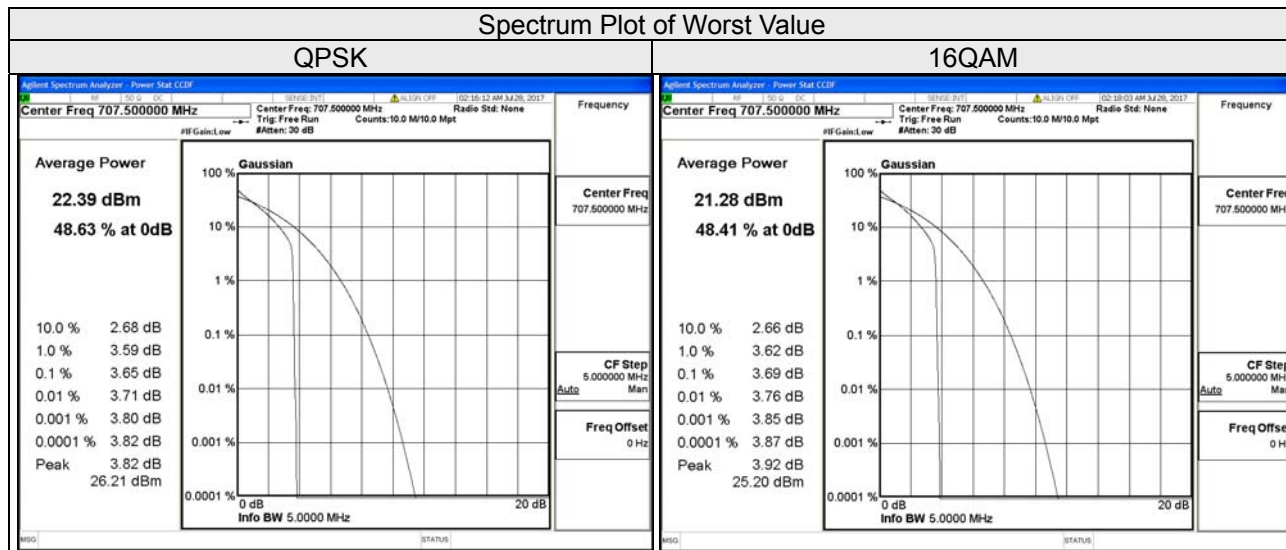

Channel Bandwidth: 3MHz

Channel	Frequency (MHz)	Peak To Average Ratio (dB)	
		QPSK	16QAM
23025	700.5	3.00	2.85
23095	707.5	3.77	3.76
23165	714.5	3.25	3.25

Spectrum Plot of Worst Value

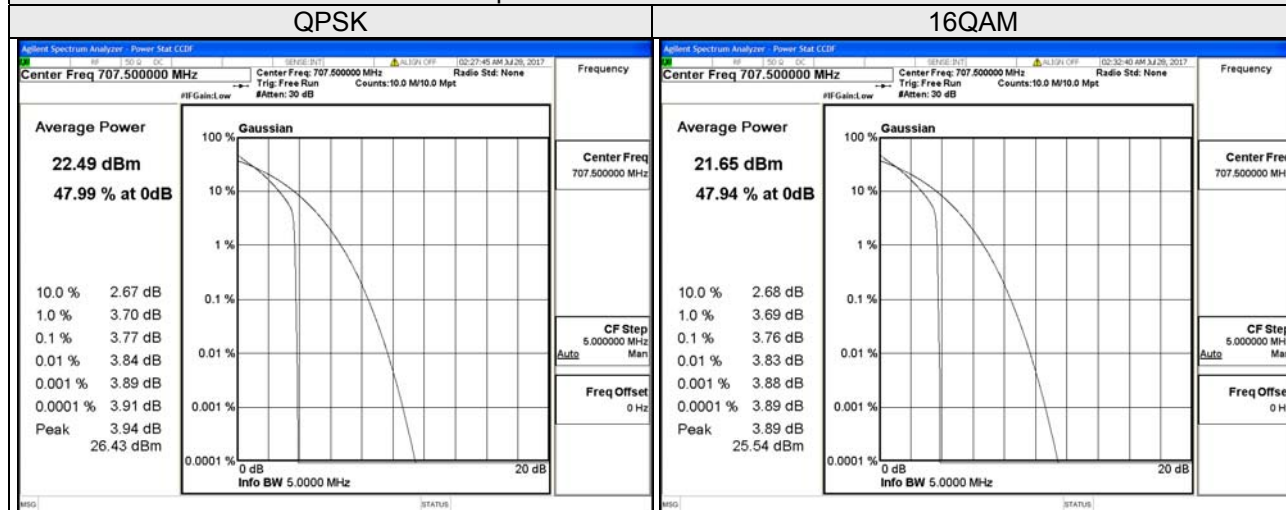

Channel Bandwidth: 5MHz

Channel	Frequency (MHz)	Peak To Average Ratio (dB)	
		QPSK	16QAM
23035	701.5	2.91	2.86
23095	707.5	3.74	3.72
23155	713.5	3.01	2.99

Spectrum Plot of Worst Value

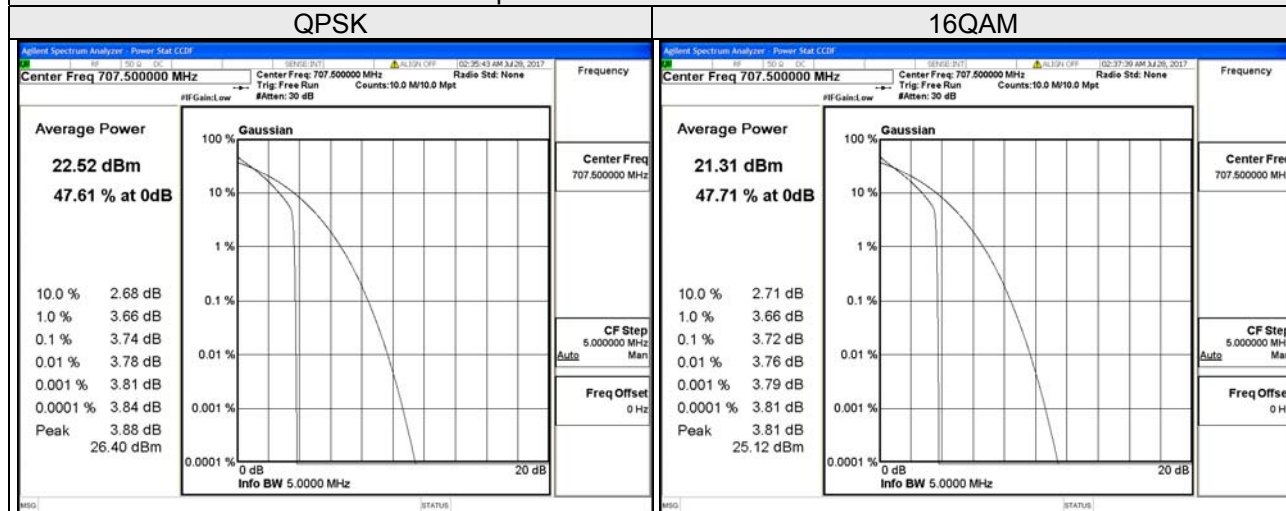

Channel Bandwidth: 10MHz

Channel	Frequency (MHz)	Peak To Average Ratio (dB)	
		QPSK	16QAM
23060	704	2.91	2.86
23095	707.5	3.57	3.59
23130	711	3.69	3.65

Spectrum Plot of Worst Value

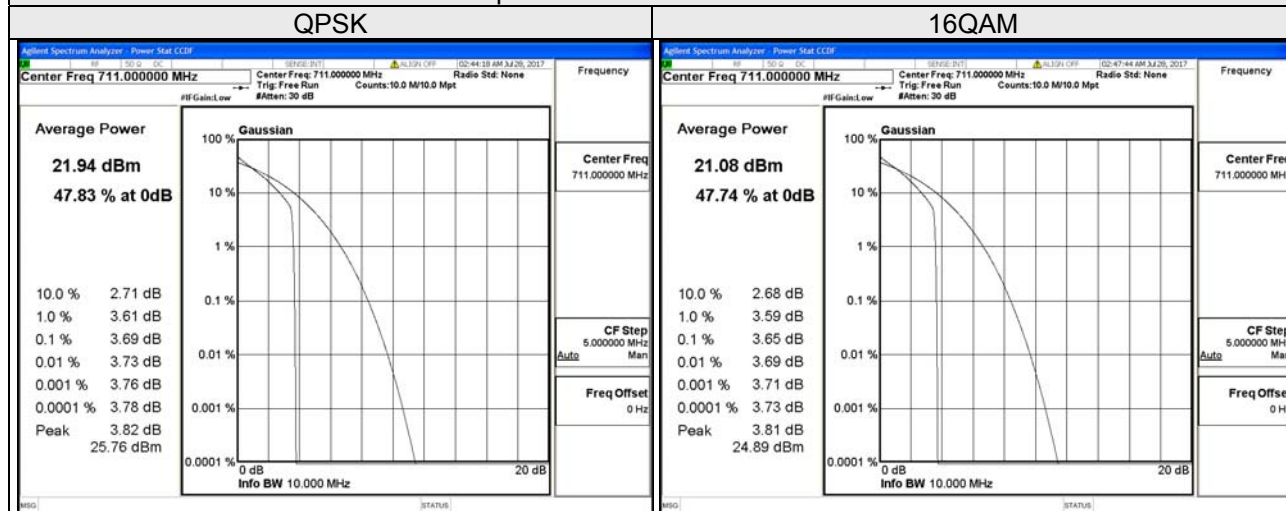

LTE Band 17

Channel Bandwidth: 5MHz			
Channel	Frequency (MHz)	Peak To Average Ratio (dB)	
		QPSK	16QAM
23755	706.5	4.52	4.20
23790	710.0	4.24	4.26
23825	713.5	3.65	3.62

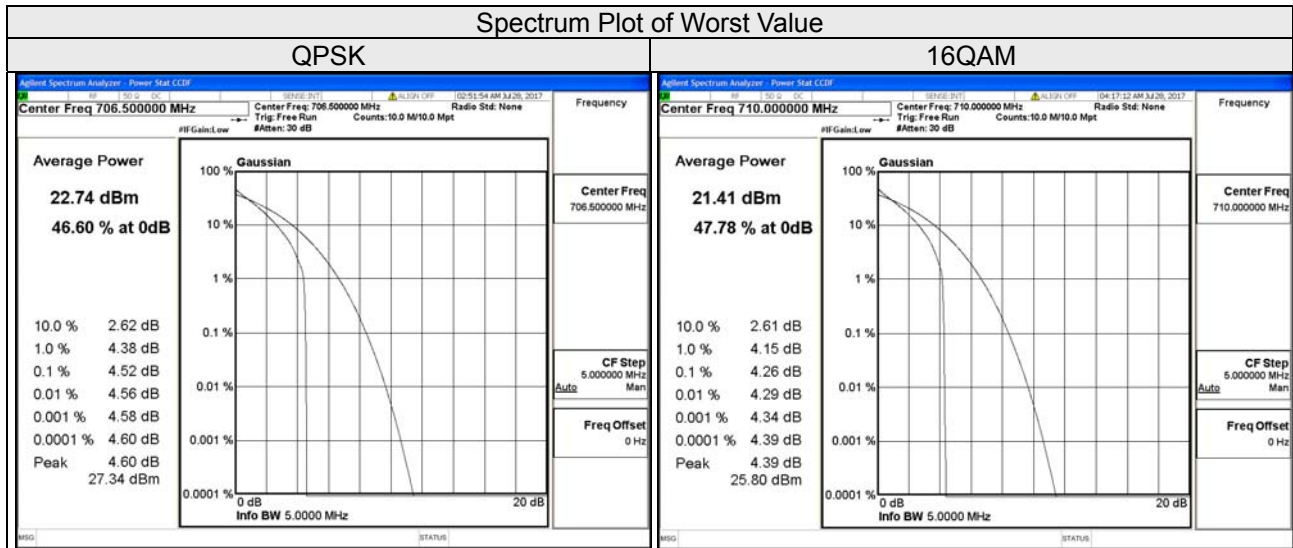

Channel Bandwidth: 10MHz

Channel	Frequency (MHz)	Peak To Average Ratio (dB)	
		QPSK	16QAM
23780	709.0	5.15	5.13
23790	710.0	5.17	5.18
23800	711.0	5.19	5.19

Spectrum Plot of Worst Value

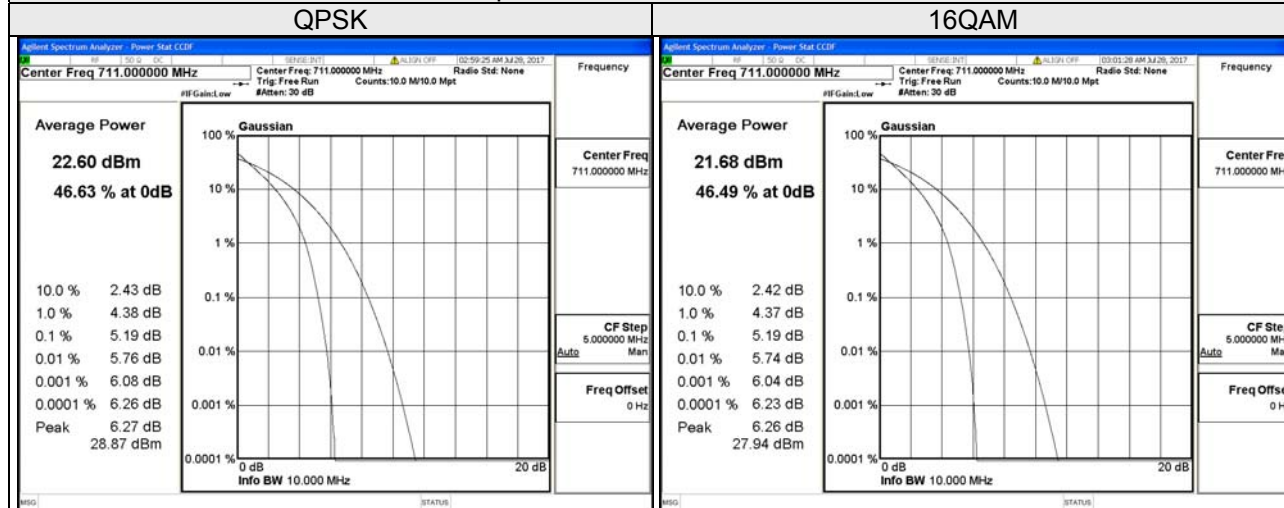

4.7 Conducted Spurious Emissions

4.7.1 Limits of Conducted Spurious Emissions Measurement

For WCDMA Band 4, LTE Band 4

According to FCC 27.53(h) for operations in the 1695-1710 MHz, 1710-1755 MHz, 1755-1780 MHz, 1915-1920 MHz, 1995-2000 MHz, 2000-2020 MHz, 2110-2155 MHz, 2155-2180 MHz, and 2180-2200 bands, the power of any emission outside a licensee's frequency block shall be attenuated below the transmitter power (P) in watts by at least $43 + 10 \log_{10}(P)$ dB.

For LTE Band 12, LTE Band 17

According to FCC 27.53(g) for operations in the 600 MHz band and the 698-746 MHz band, the power of any emission outside a licensee's frequency band(s) of operation shall be attenuated below the transmitter power (P) within the licensed band(s) of operation, measured in watts, by at least $43 + 10 \log(P)$ dB. Compliance with this provision is based on the use of measurement instrumentation employing a resolution bandwidth of 100 kilohertz or greater.

4.7.2 Test Setup

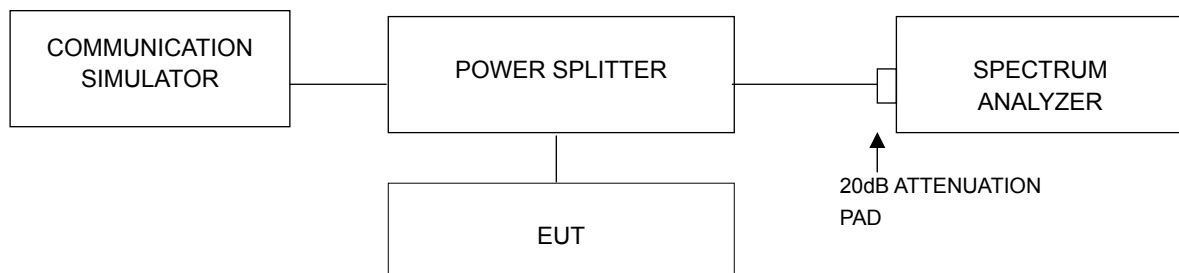

4.7.3 Test Procedure

- All measurements were done at 3 channels: low, middle and high operational frequency range.
- When the spectrum scanned from 9kHz to 26.5GHz for WCDMA Band 4, LTE Band 4, LTE Band 12, it shall be connected to the 20dB pad attenuated the carried frequency. The spectrum set RB = 1MHz, VB = 3MHz.
- When the spectrum scanned from 9kHz to 9GHz for LTE Band 17, it shall be connected to the 20dB pad attenuated the carried frequency. The spectrum set RB = 1MHz, VB = 3MHz.

4.7.4 Test Results

WCDMA Band 4

WCDMA

Channel 1312 (1712.4MHz)

Frequency Range : 9kHz~3GHz

Frequency Range : 3GHz~10GHz

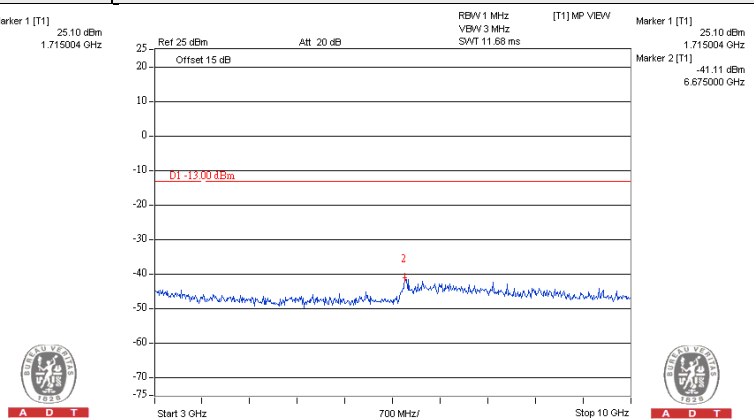
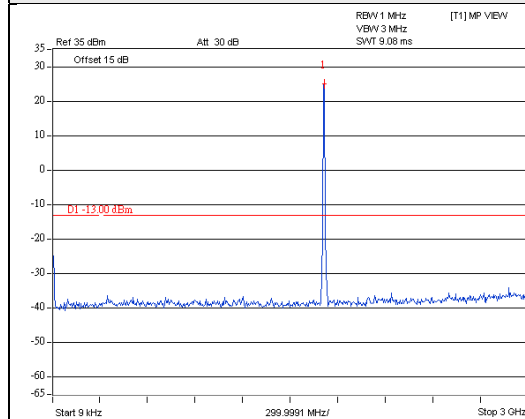

Frequency Range : 10GHz~26.5GHz

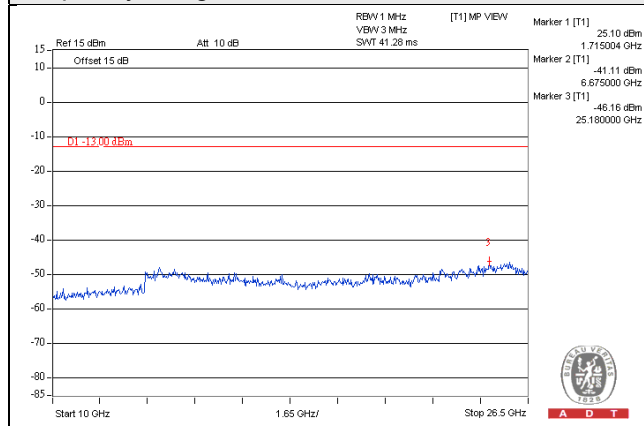

WCDMA

Channel 1413 (1732.6MHz)

Frequency Range : 9kHz~3GHz

Frequency Range : 3GHz~10GHz

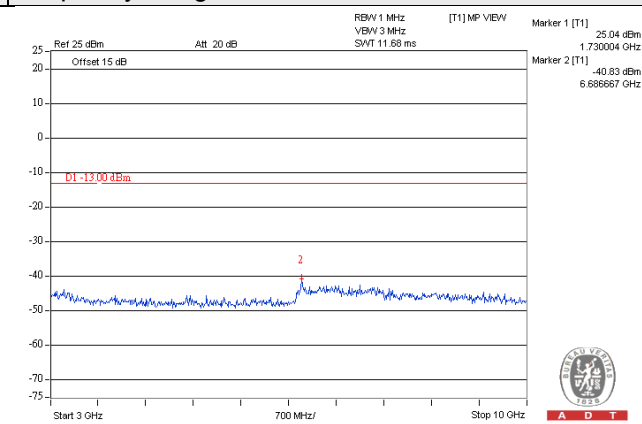
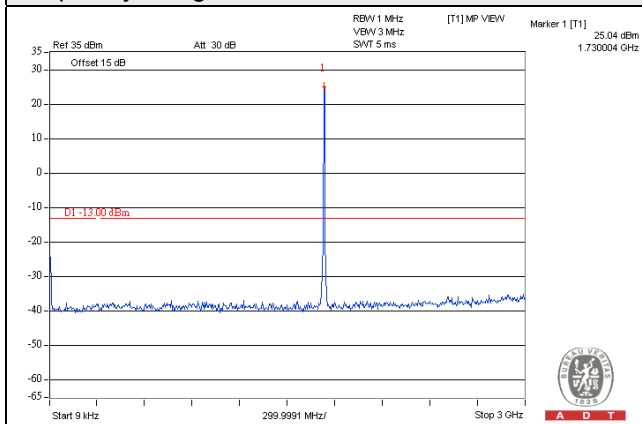

Frequency Range : 10GHz~26.5GHz

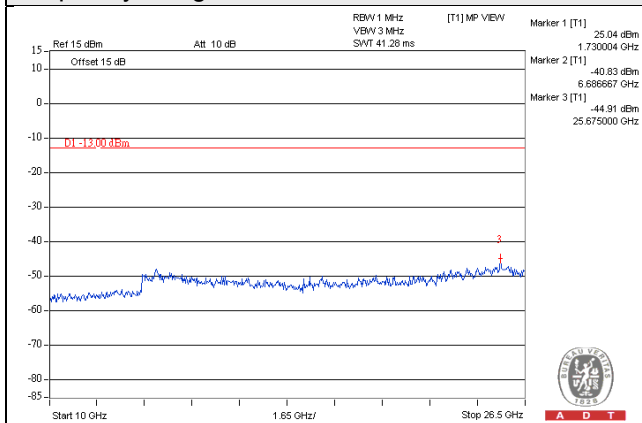

WCDMA

Channel 1513 (1752.6MHz)

Frequency Range : 9kHz~3GHz

Frequency Range : 3GHz~10GHz

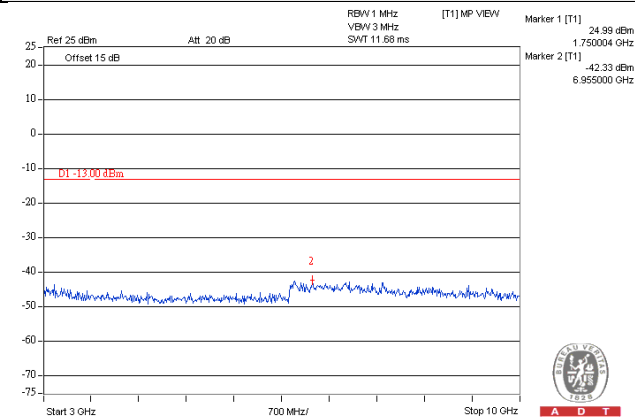
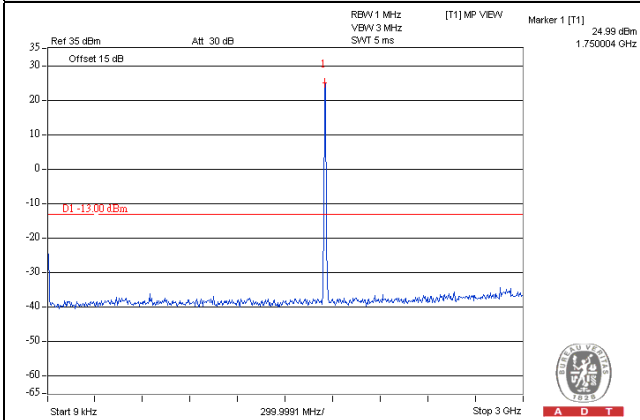

Frequency Range : 10GHz~26.5GHz

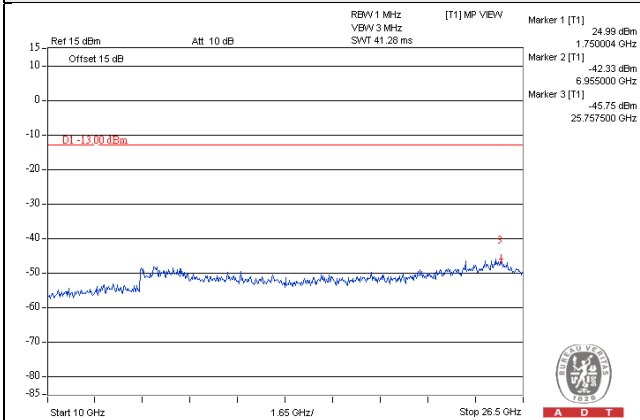

HSDPA

Channel 1312 (1712.4MHz)

Frequency Range : 9kHz~3GHz

Frequency Range : 3GHz~10GHz

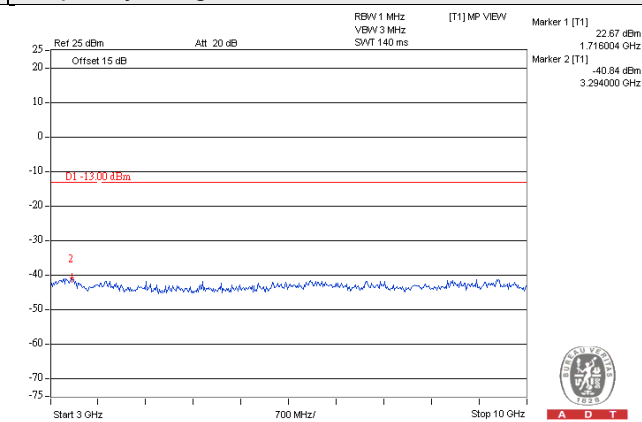
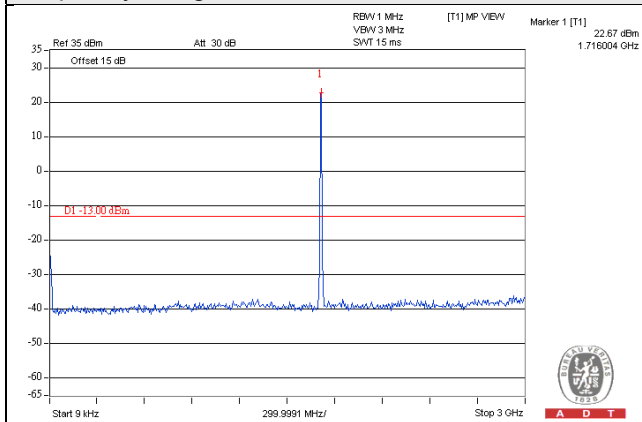

Frequency Range : 10GHz~26.5GHz

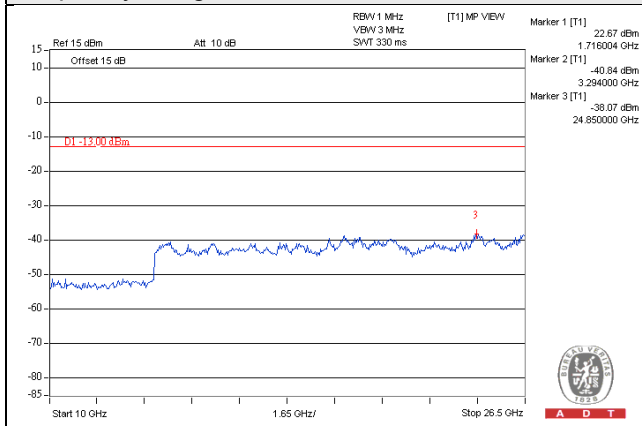

HSDPA

Channel 1413 (1732.6MHz)

Frequency Range : 9kHz~3GHz

Frequency Range : 3GHz~10GHz

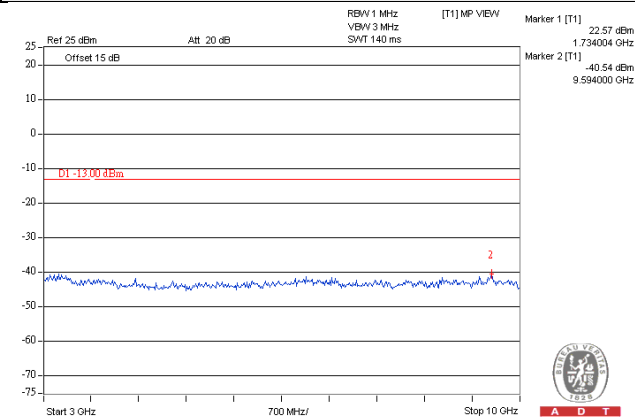
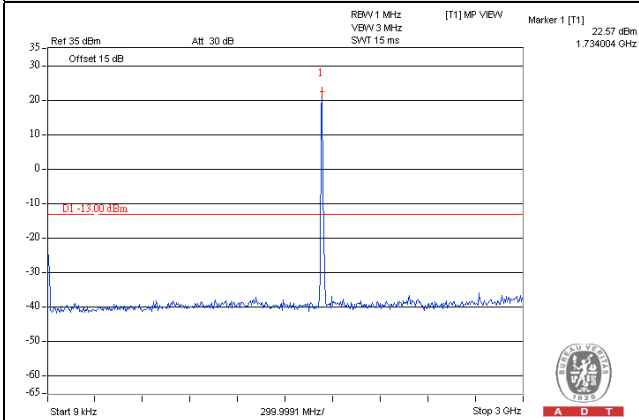

Frequency Range : 10GHz~26.5GHz

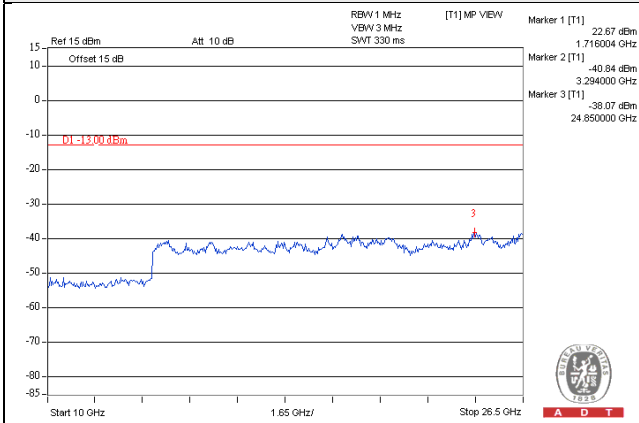

HSDPA

Channel 1513 (1752.6MHz)

Frequency Range : 9kHz~3GHz

Frequency Range : 3GHz~10GHz

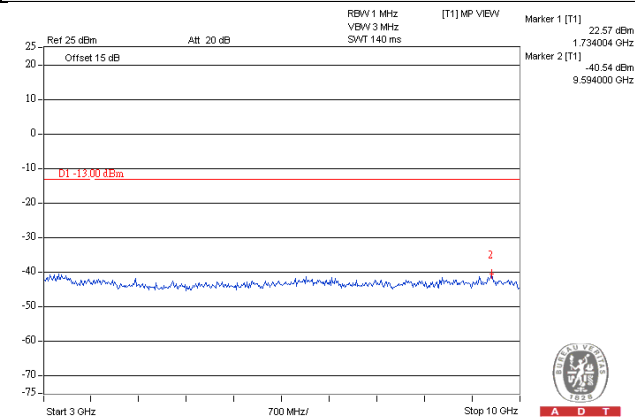
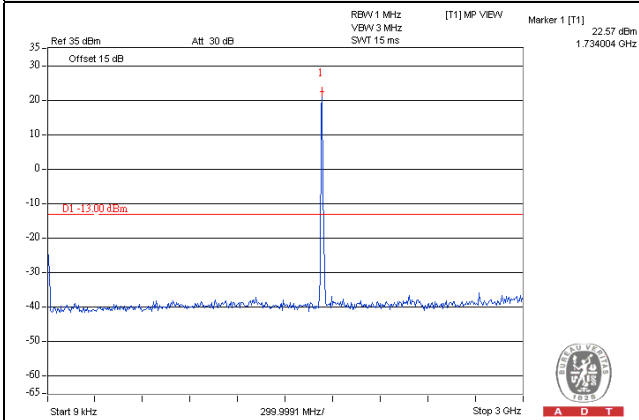

Frequency Range : 10GHz~26.5GHz

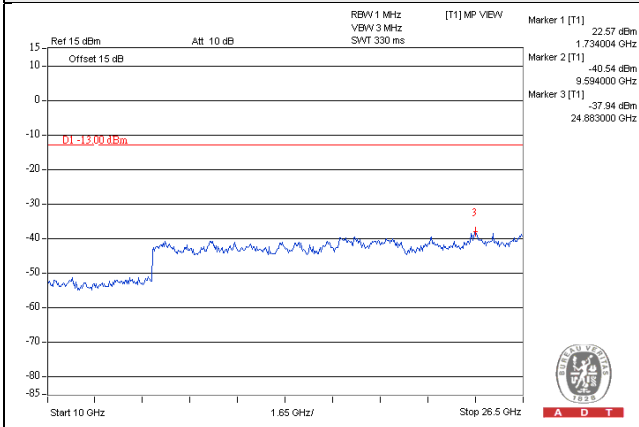

HSUPA

Channel 1312 (1712.4MHz)

Frequency Range : 9kHz~3GHz

Frequency Range : 3GHz~10GHz

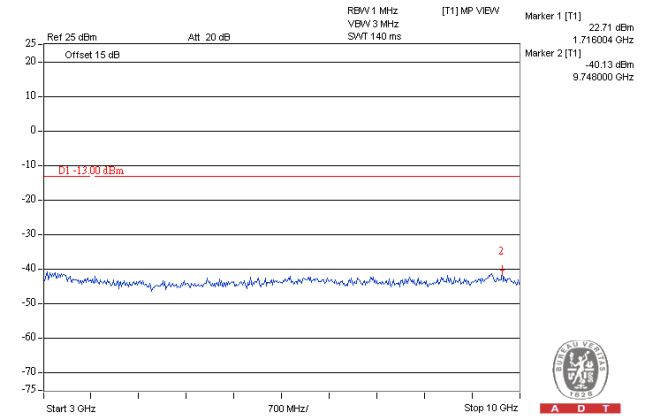
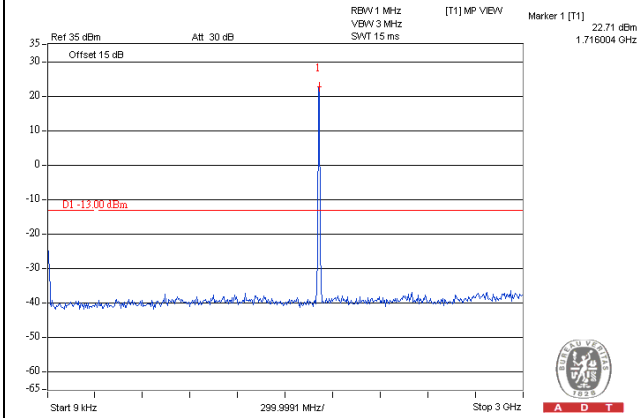

Frequency Range : 10GHz~26.5GHz

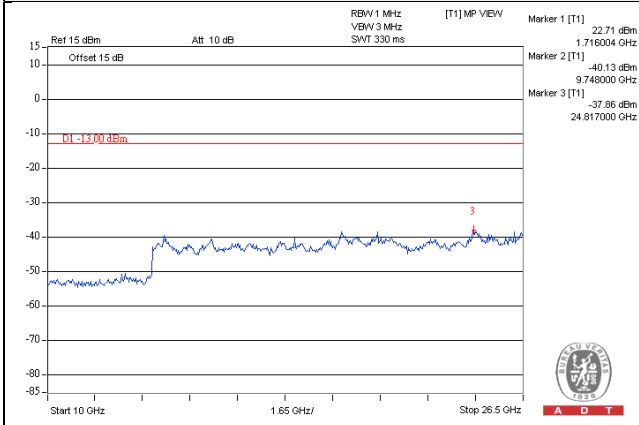

HSUPA

Channel 1413 (1732.6MHz)

Frequency Range : 9kHz~3GHz

Frequency Range : 3GHz~10GHz

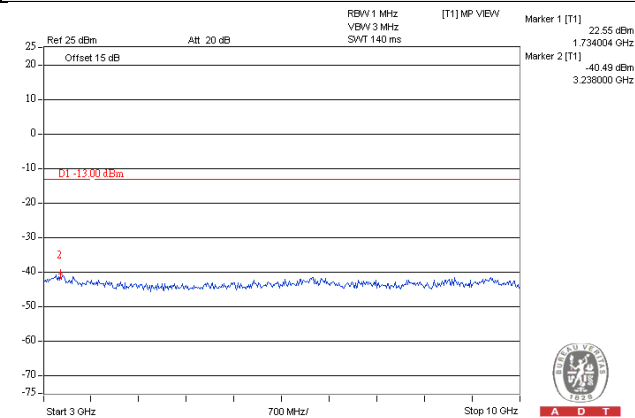
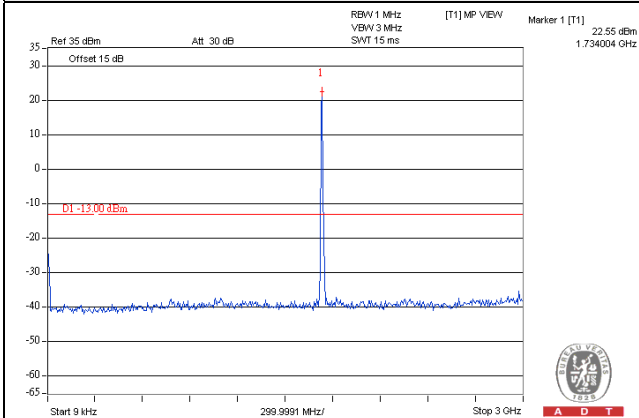

Frequency Range : 10GHz~26.5GHz

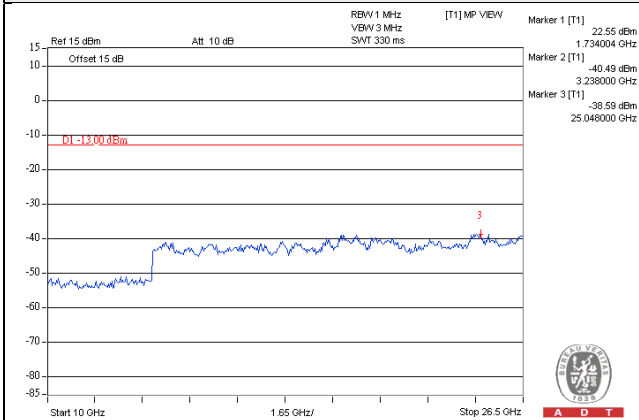

HSUPA

Channel 1513 (1752.6MHz)

Frequency Range : 9kHz~3GHz

Frequency Range : 3GHz~10GHz

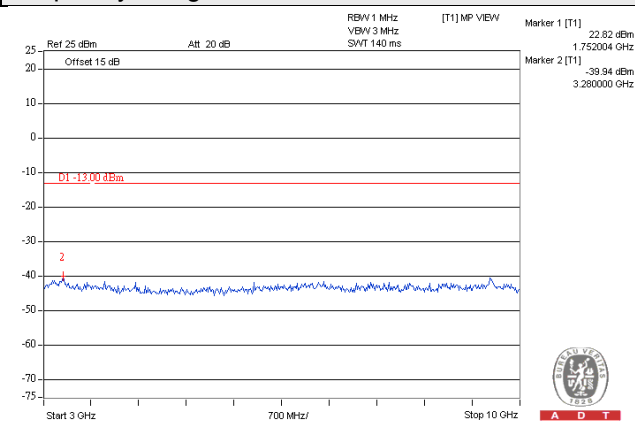
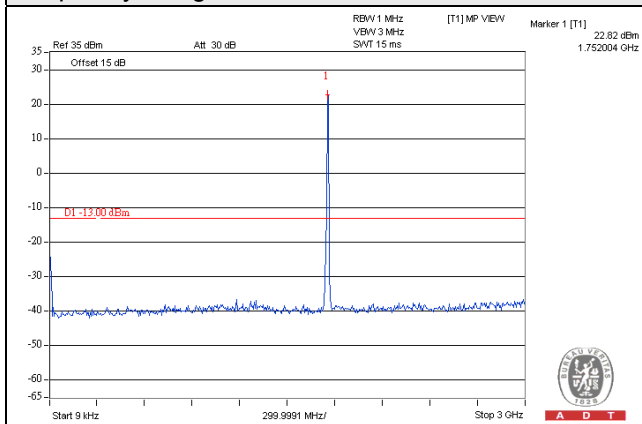

Frequency Range : 10GHz~26.5GHz

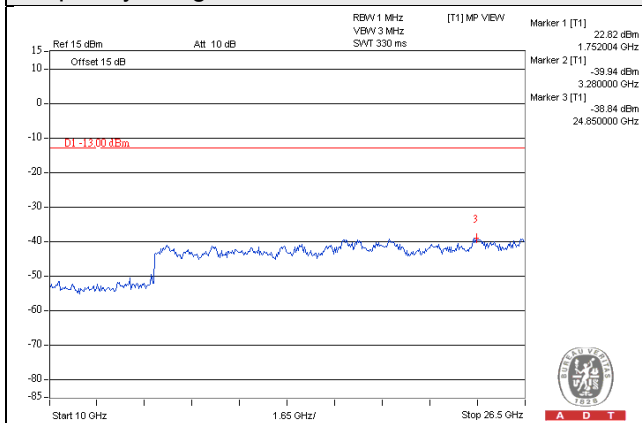

LTE Band 4

Channel Bandwidth: 1.4MHz

Channel 19957 (1710.7MHz)

Frequency Range : 9kHz~1GHz

Frequency Range : 1GHz~10GHz

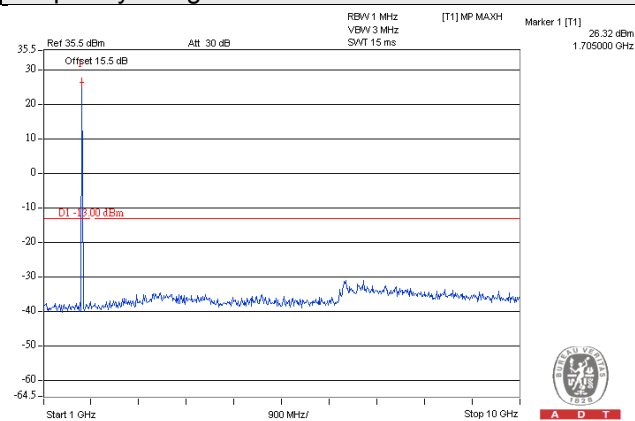
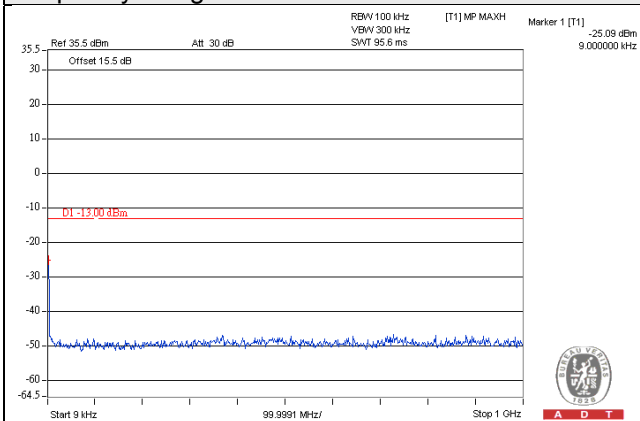

Frequency Range : 10GHz~26.5GHz

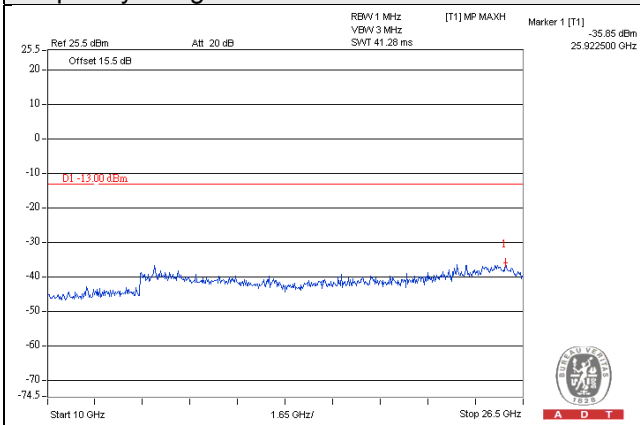

Channel Bandwidth: 1.4MHz

Channel 20175 (1732.5MHz)

Frequency Range : 9kHz~1GHz

Frequency Range : 1GHz~10GHz

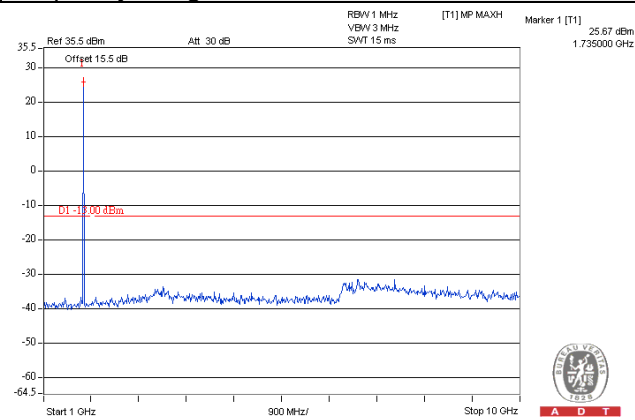
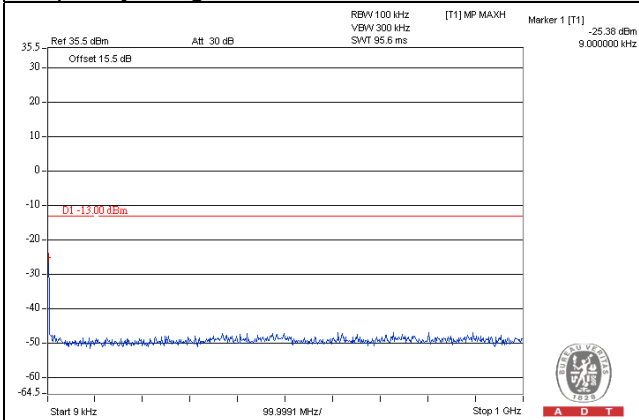

Frequency Range : 10GHz~26.5GHz

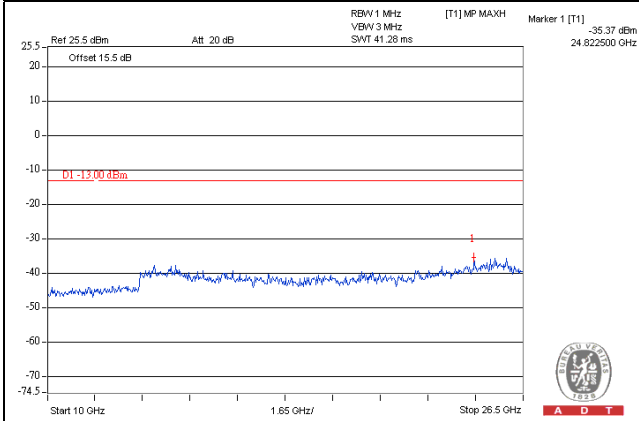

Channel Bandwidth: 1.4MHz

Channel 20393 (1754.3MHz)

Frequency Range : 9kHz~1GHz

Frequency Range : 1GHz~10GHz

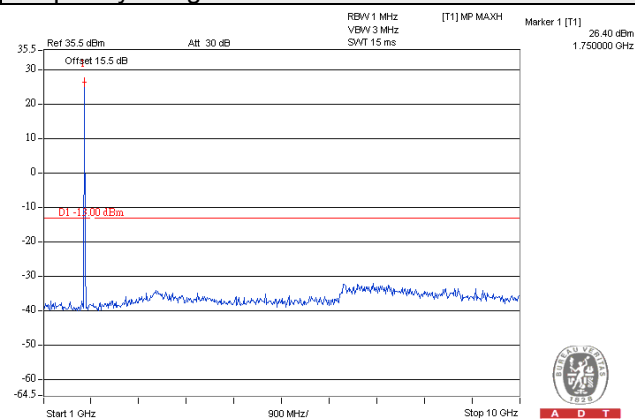
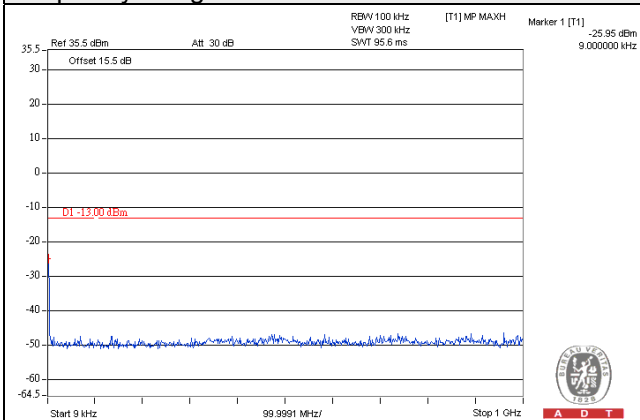

Frequency Range : 10GHz~26.5GHz

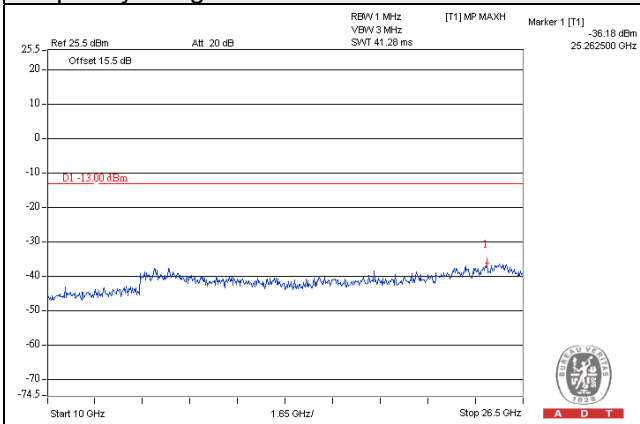

Channel Bandwidth: 3MHz
 Channel 19965 (1711.5MHz)

Frequency Range : 9kHz~1GHz

Frequency Range : 1GHz~10GHz

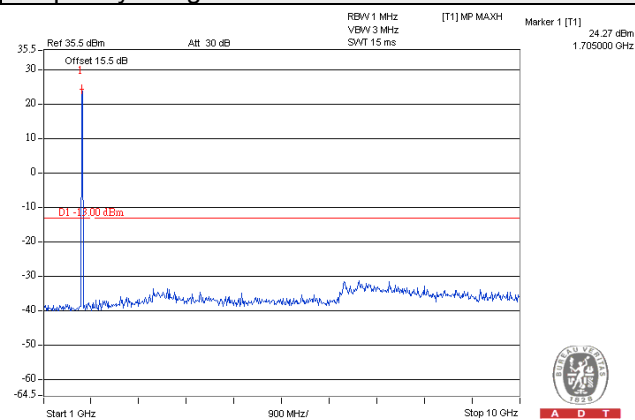
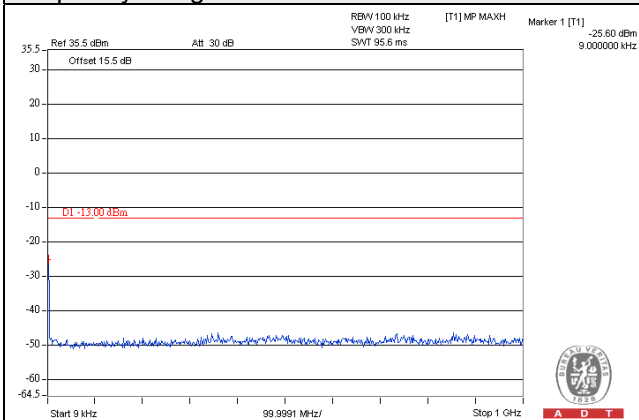

Frequency Range : 10GHz~26.5GHz

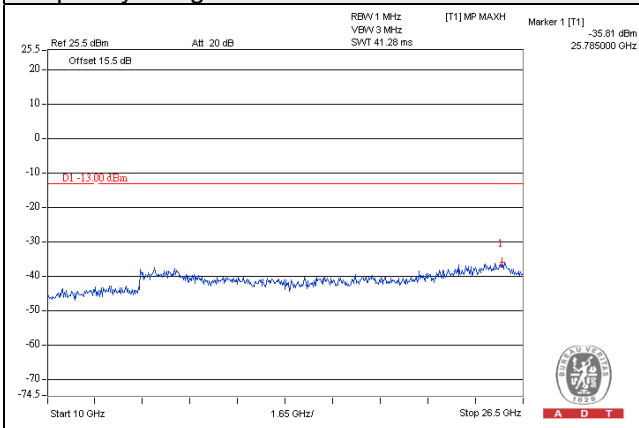

Channel Bandwidth: 3MHz
 Channel 20175 (1732.5MHz)
 Frequency Range : 9kHz~1GHz Frequency Range : 1GHz~10GHz

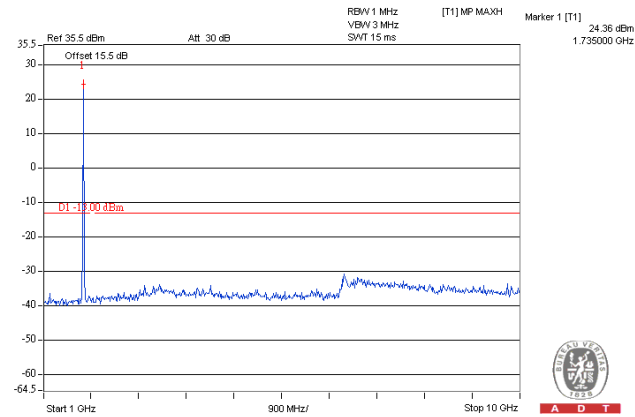
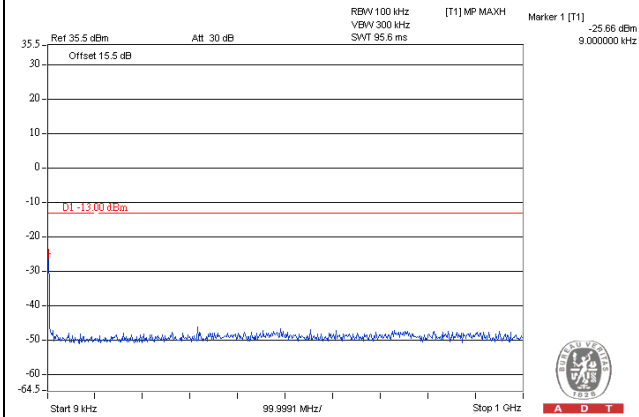

Frequency Range : 10GHz~26.5GHz

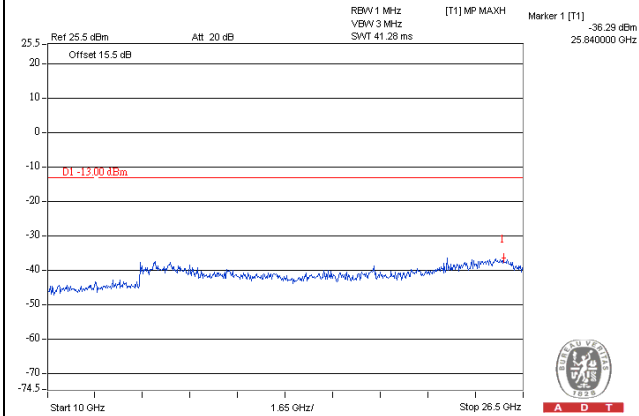

Channel Bandwidth: 3MHz

Channel 20385 (1753.5MHz)

Frequency Range : 9kHz~1GHz

Frequency Range : 1GHz~10GHz

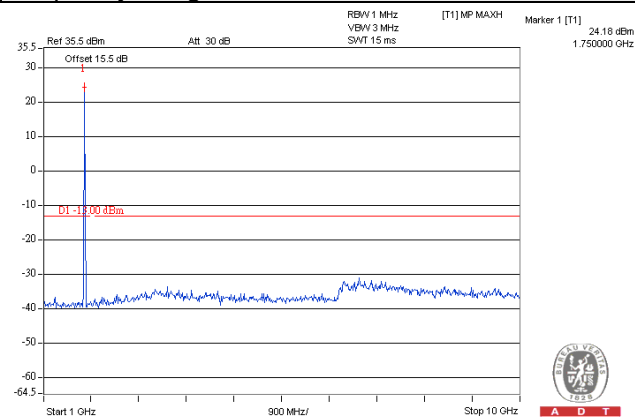
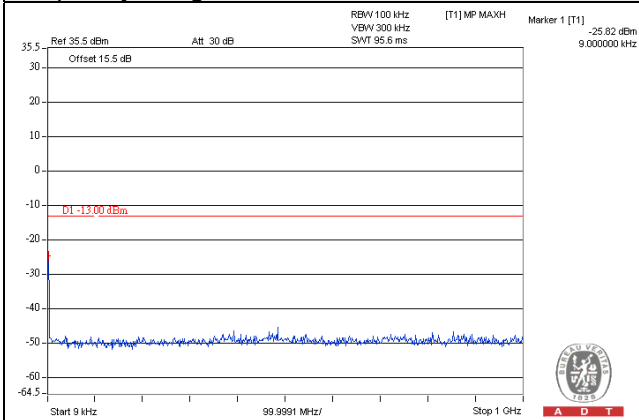

Frequency Range : 10GHz~26.5GHz

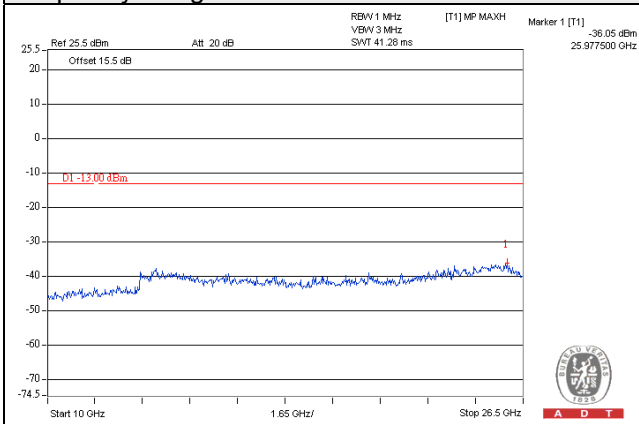

Channel Bandwidth: 5MHz

Channel 19975 (1712.5MHz)

Frequency Range : 9kHz~1GHz

Frequency Range : 1GHz~10GHz

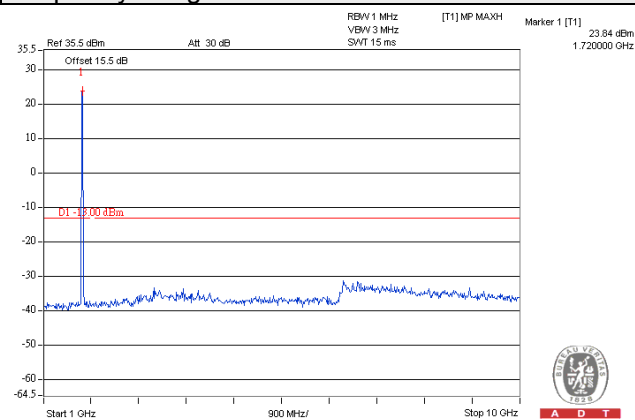
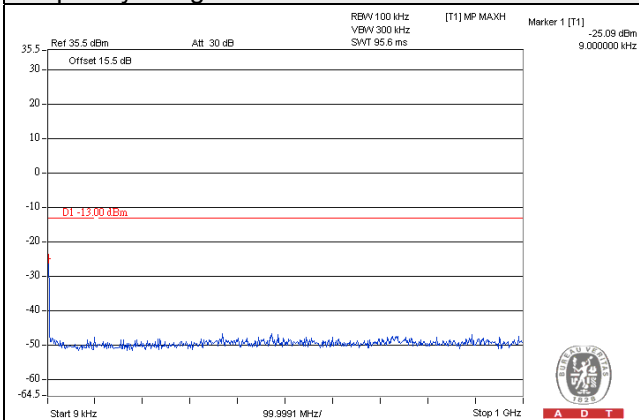

Frequency Range : 10GHz~26.5GHz

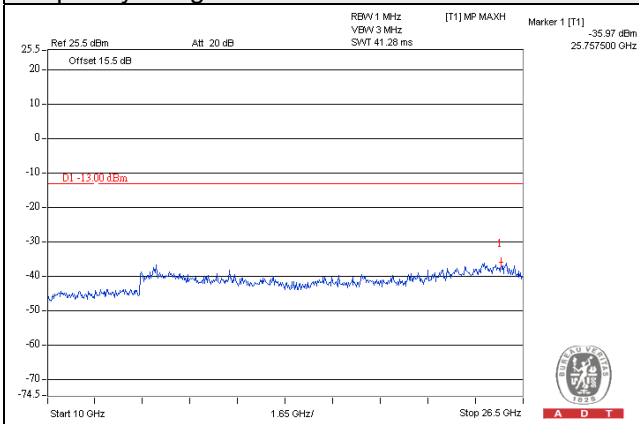

Channel Bandwidth: 5MHz
 Channel 20175 (1732.5MHz)
 Frequency Range : 9kHz~1GHz Frequency Range : 1GHz~10GHz

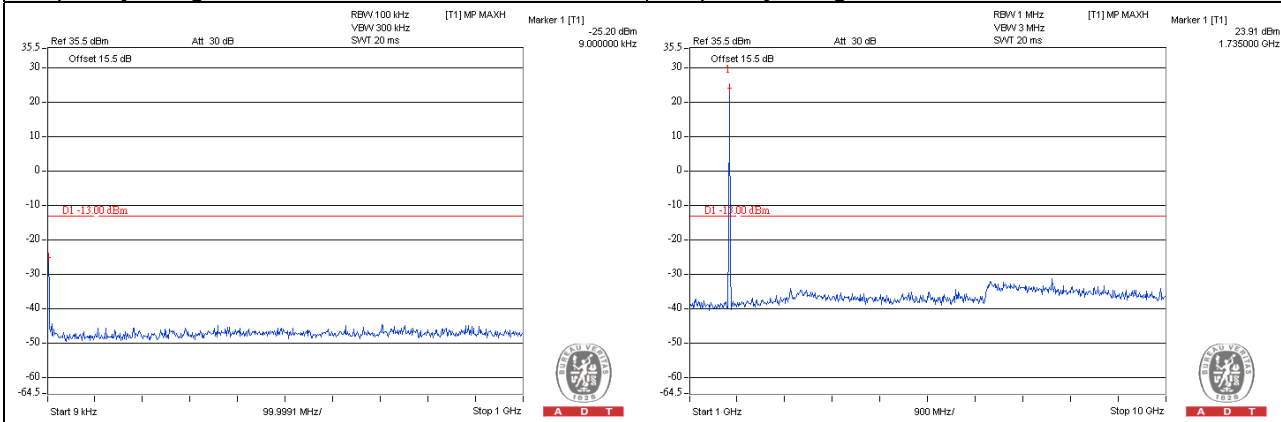

Frequency Range : 10GHz~26.5GHz

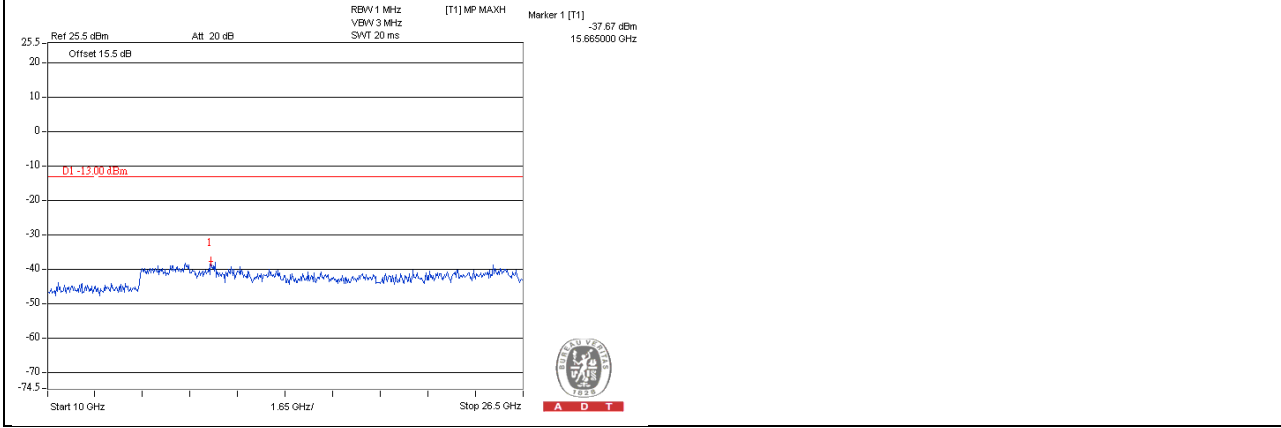

Channel Bandwidth: 5MHz
 Channel 20375 (1752.5MHz)
 Frequency Range : 9kHz~1GHz Frequency Range : 1GHz~10GHz

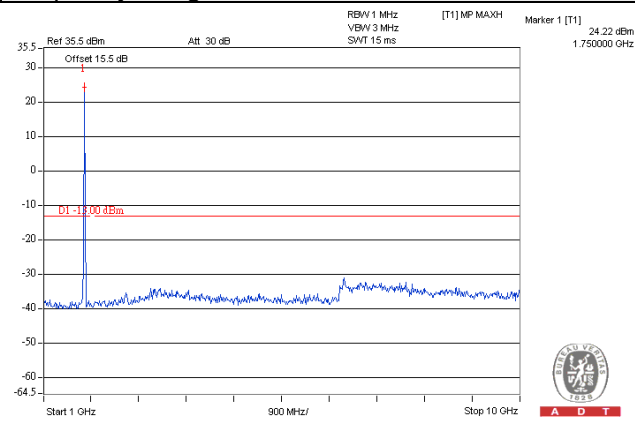
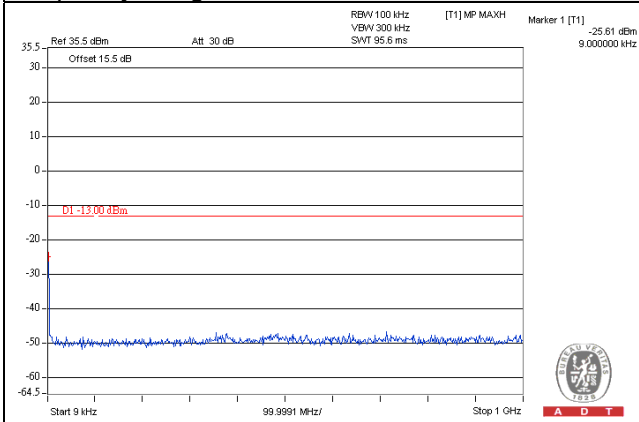

Frequency Range : 10GHz~26.5GHz

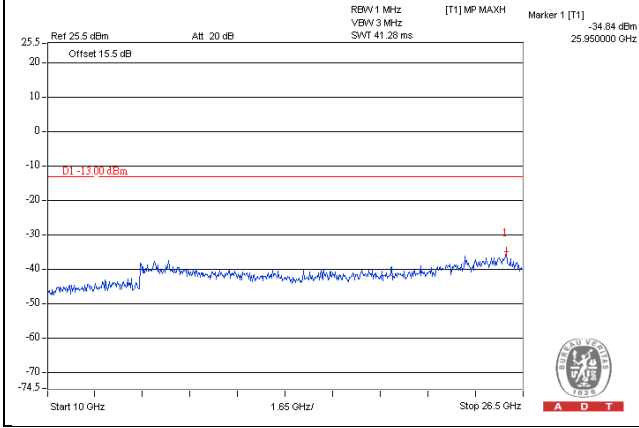

Channel Bandwidth: 10MHz
 Channel 20000 (1715.0MHz)
 Frequency Range : 9kHz~1GHz Frequency Range : 1GHz~10GHz

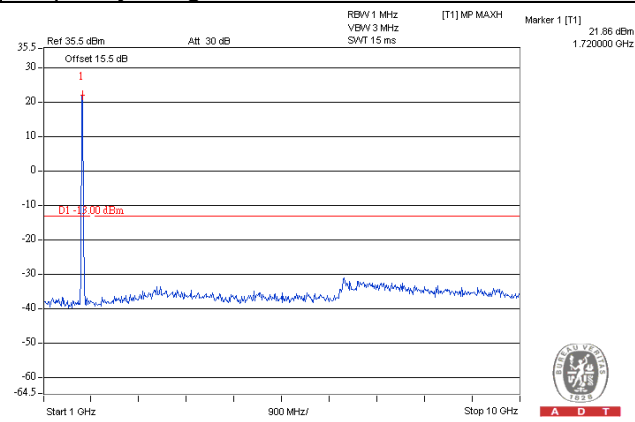
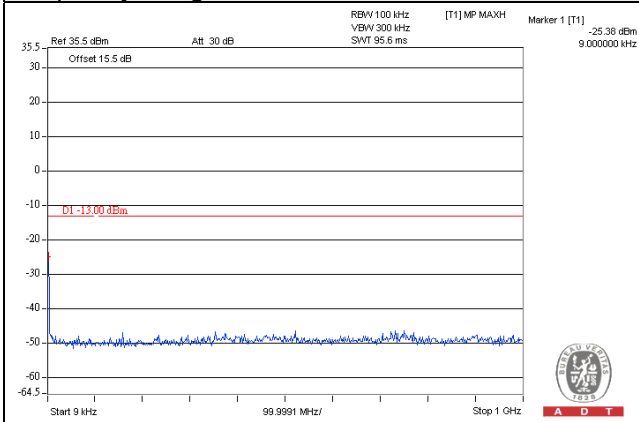

Frequency Range : 10GHz~26.5GHz

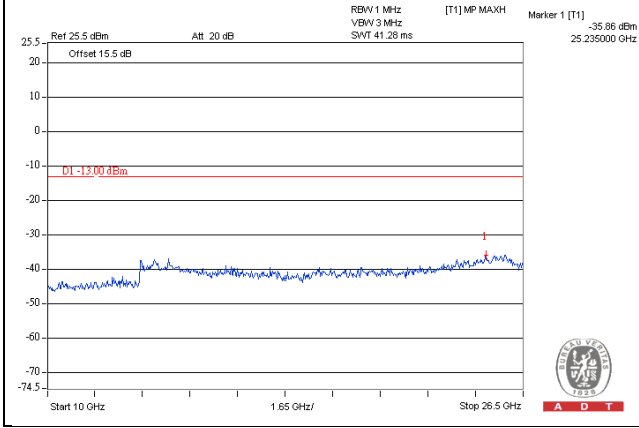

Channel Bandwidth: 10MHz
 Channel 20175 (1732.5MHz)
 Frequency Range : 9kHz~1GHz Frequency Range : 1GHz~10GHz

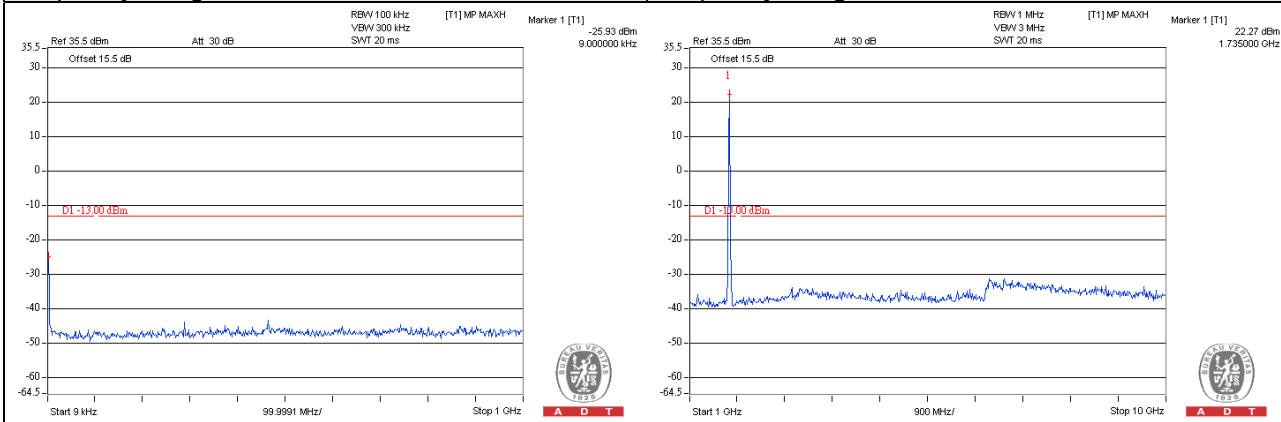

Frequency Range : 10GHz~26.5GHz

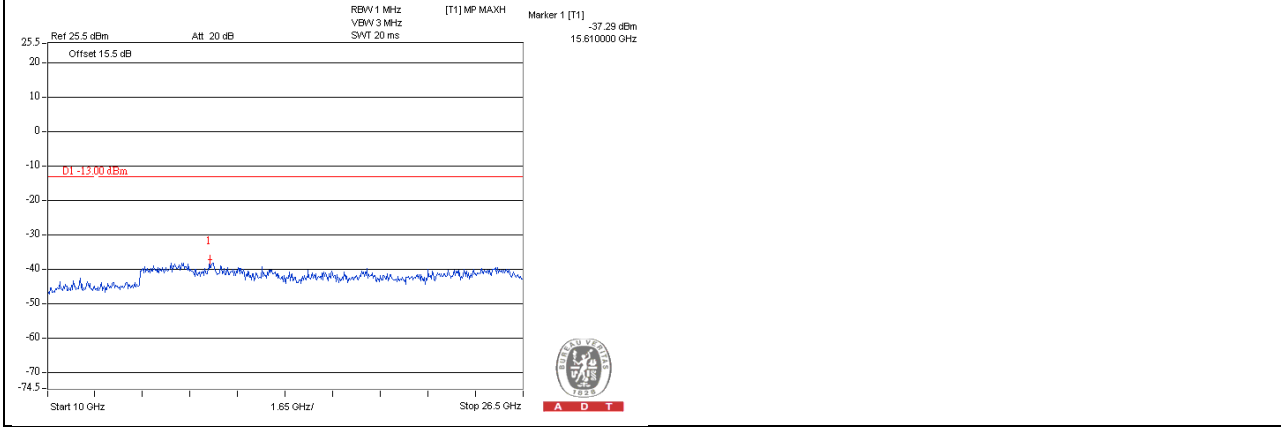

Channel Bandwidth: 10MHz
 Channel 20350 (1750.0MHz)
 Frequency Range : 9kHz~1GHz Frequency Range : 1GHz~10GHz

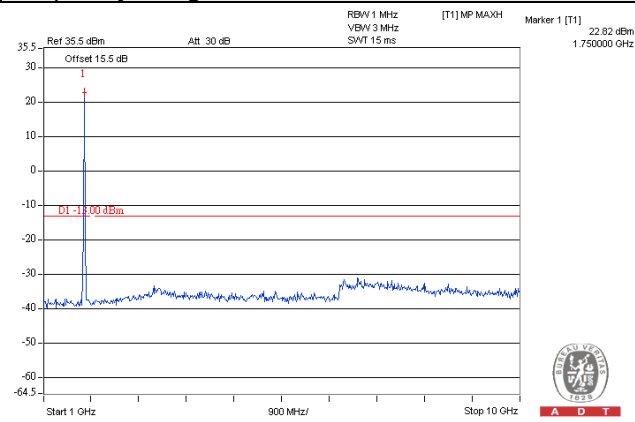
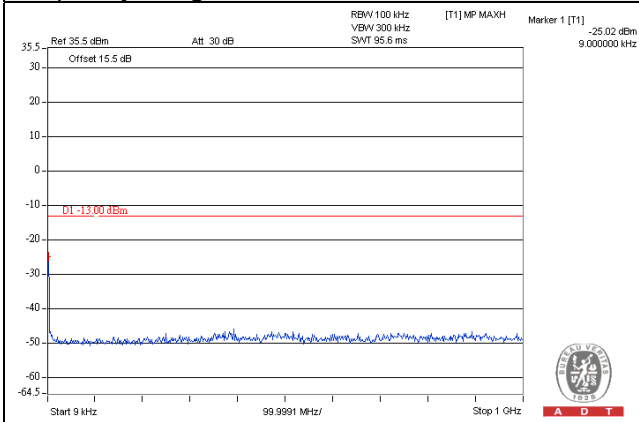

Frequency Range : 10GHz~26.5GHz

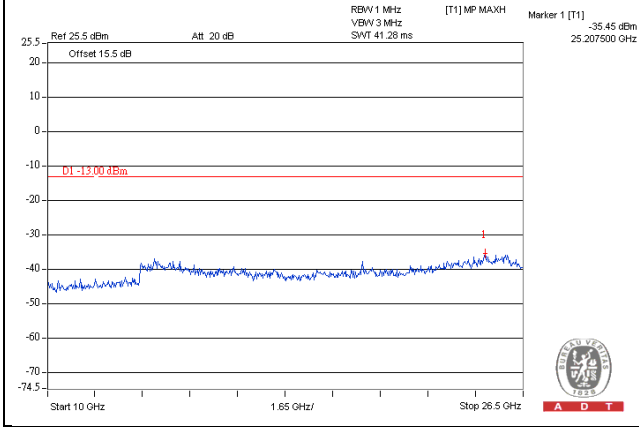

Channel Bandwidth: 15MHz
 Channel 20025 (1717.5MHz)
 Frequency Range : 9kHz~1GHz Frequency Range : 1GHz~10GHz

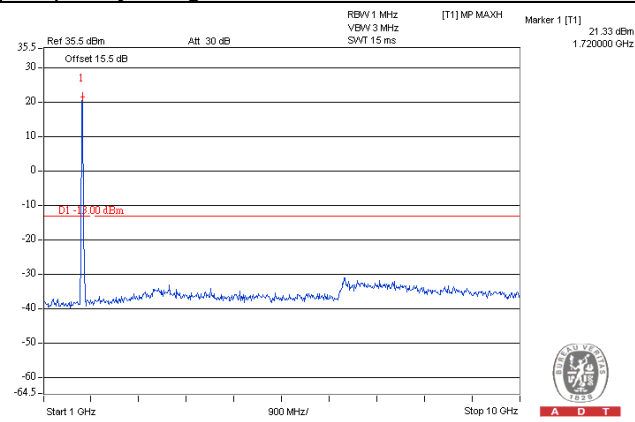
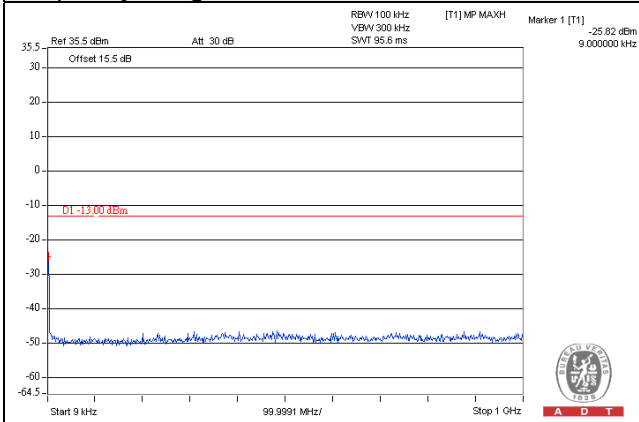

Frequency Range : 10GHz~26.5GHz

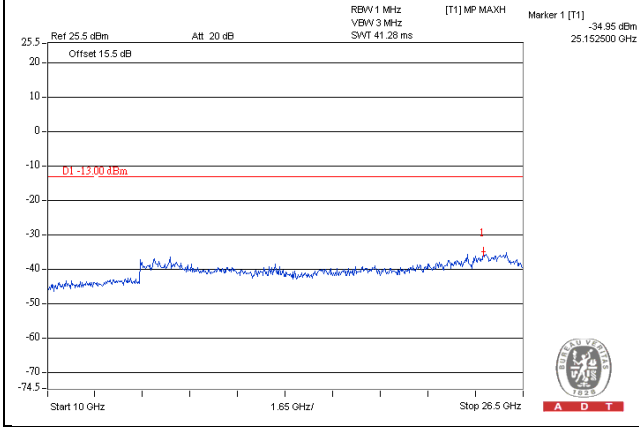

Channel Bandwidth: 15MHz

Channel 20175 (1732.5MHz)

Frequency Range : 9kHz~1GHz Frequency Range : 1GHz~10GHz

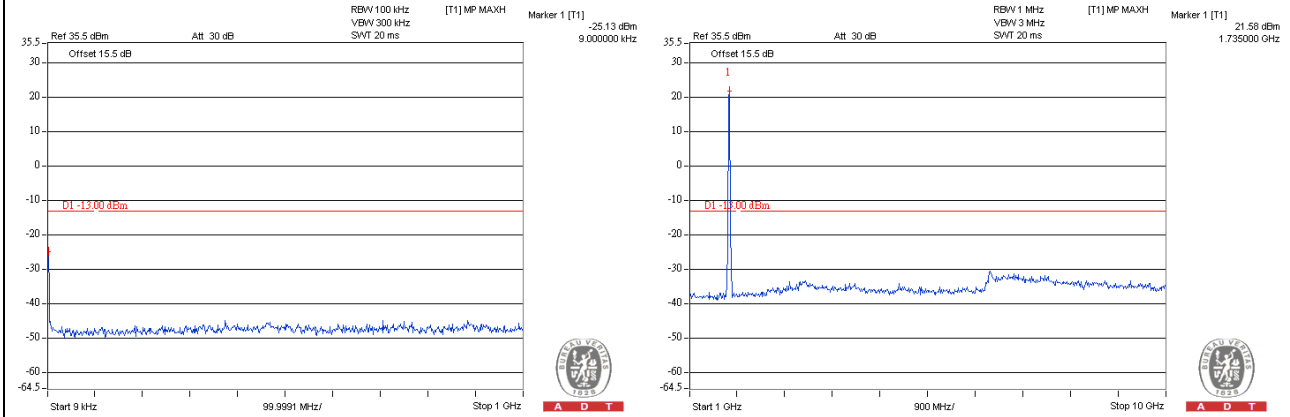

Frequency Range : 10GHz~26.5GHz

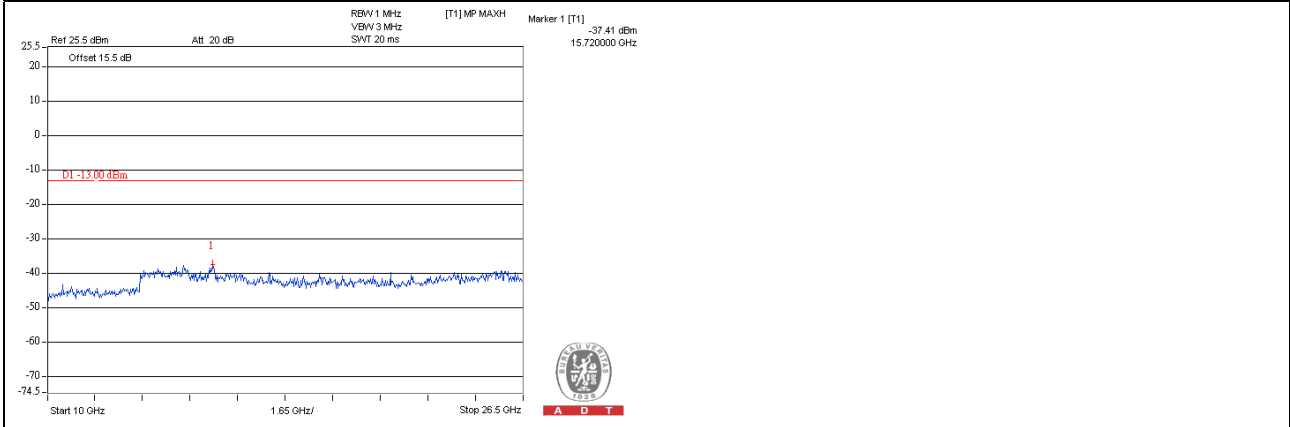

Channel Bandwidth: 15MHz

Channel 20325 (1747.5MHz)

Frequency Range : 9kHz~1GHz

Frequency Range : 1GHz~10GHz

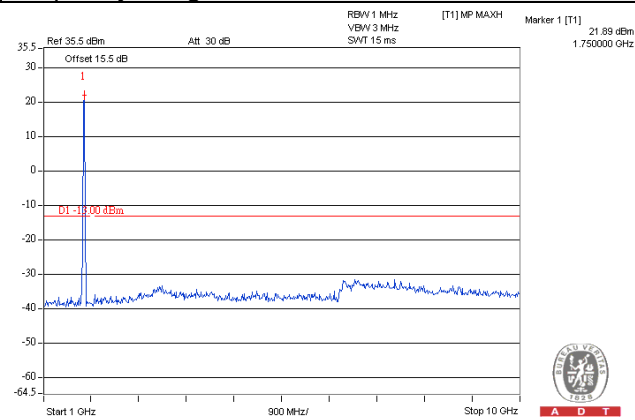
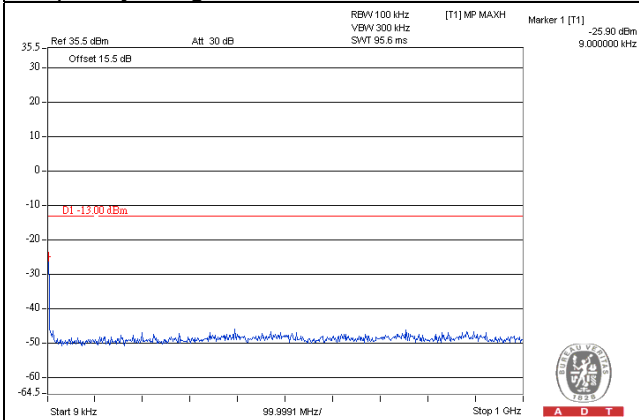

Frequency Range : 10GHz~26.5GHz

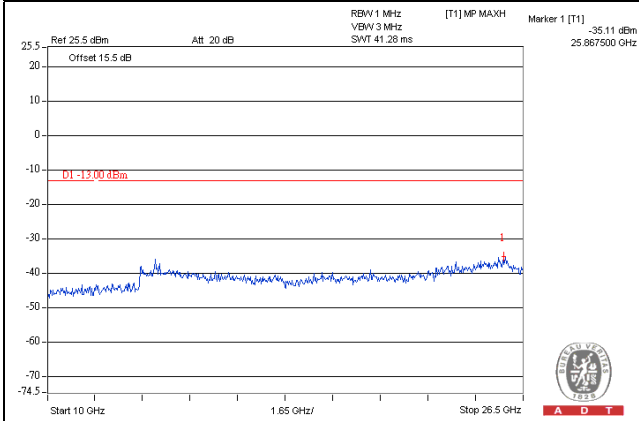

Channel Bandwidth: 20MHz

Channel 20050 (1720.0MHz)

Frequency Range : 9kHz~1GHz

Frequency Range : 1GHz~10GHz

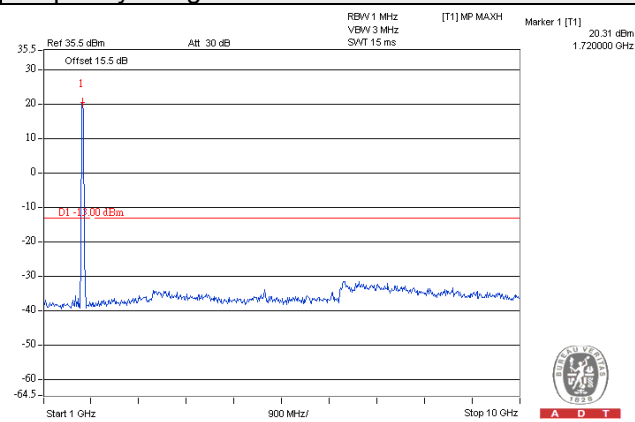
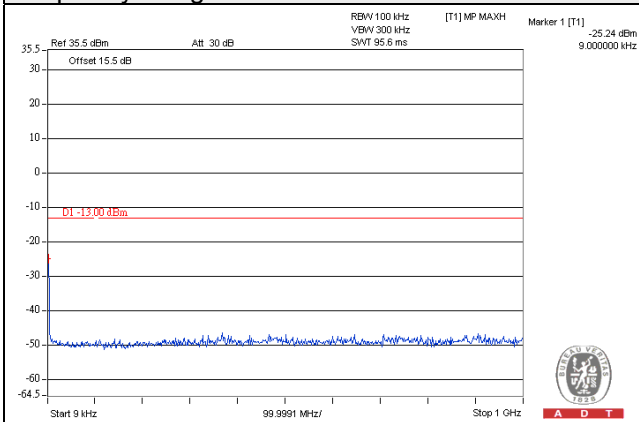

Frequency Range : 10GHz~26.5GHz

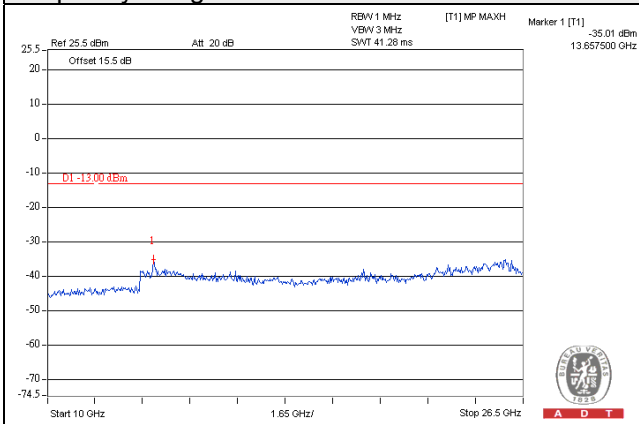

Channel Bandwidth: 20MHz

Channel 20175 (1732.5MHz)

Frequency Range : 9kHz~1GHz

Frequency Range : 1GHz~10GHz

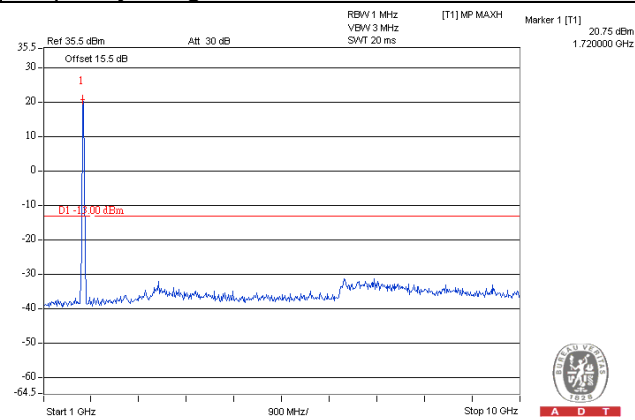
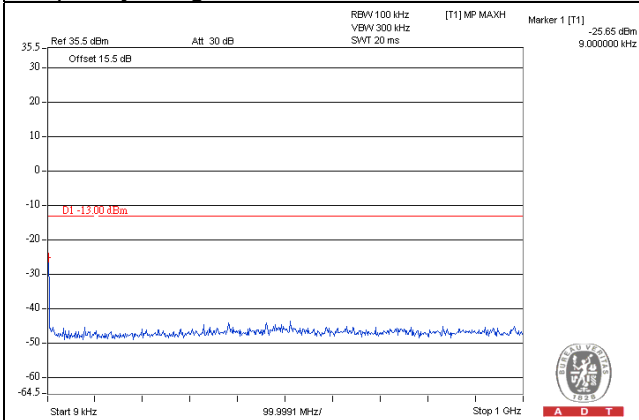

Frequency Range : 10GHz~26.5GHz

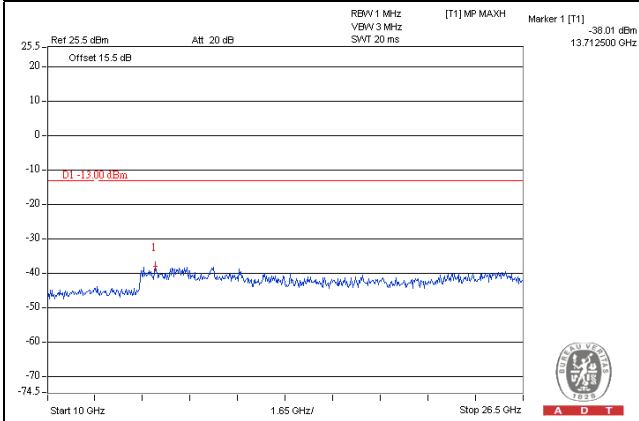

Channel Bandwidth: 20MHz
 Channel 20300 (1745.0MHz)
 Frequency Range : 9kHz~1GHz Frequency Range : 1GHz~10GHz

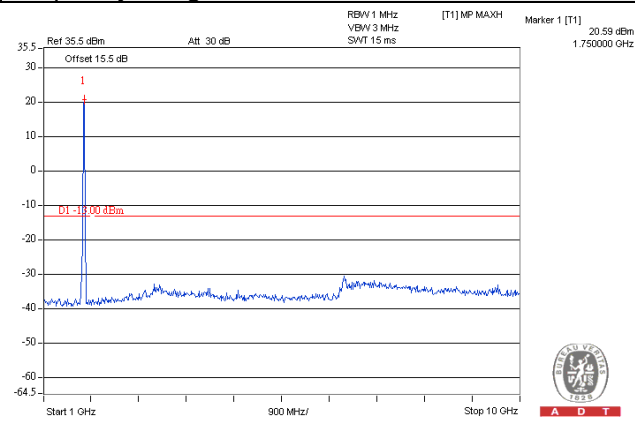
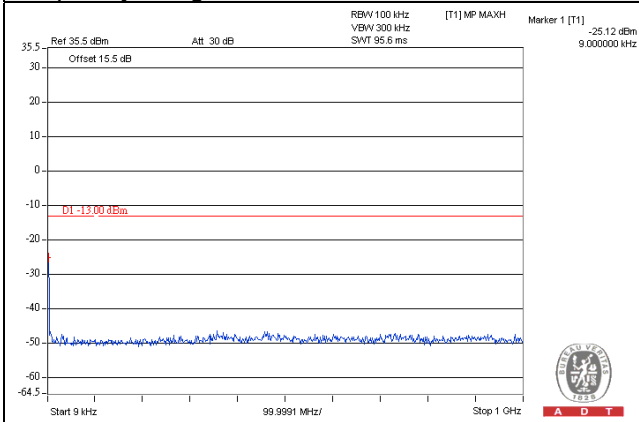

Frequency Range : 10GHz~26.5GHz

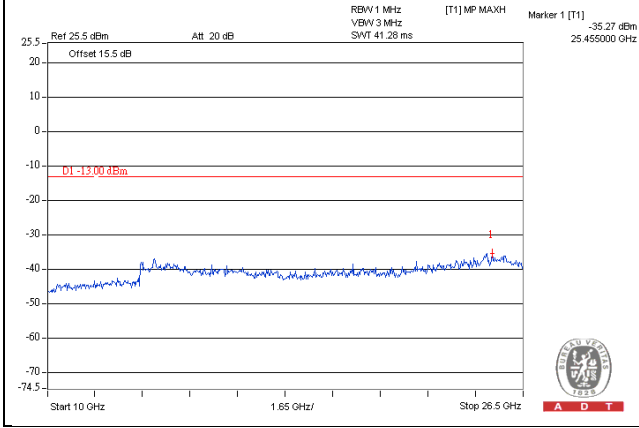

LTE Band 12

Channel Band width: 1.4MHz

Channel 23017 (699.7MHz)

Frequency Range : 9kHz~1GHz

Frequency Range : 1GHz~10GHz

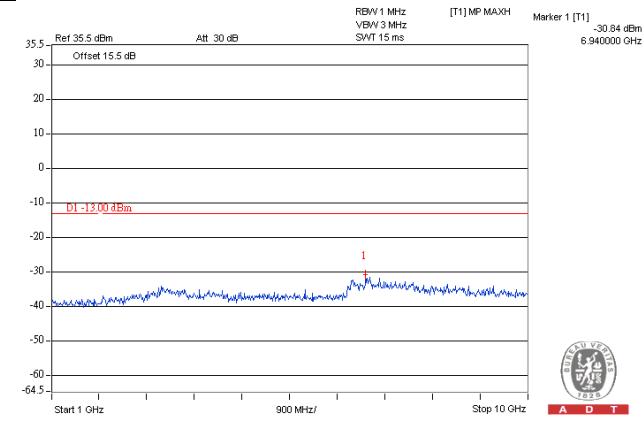
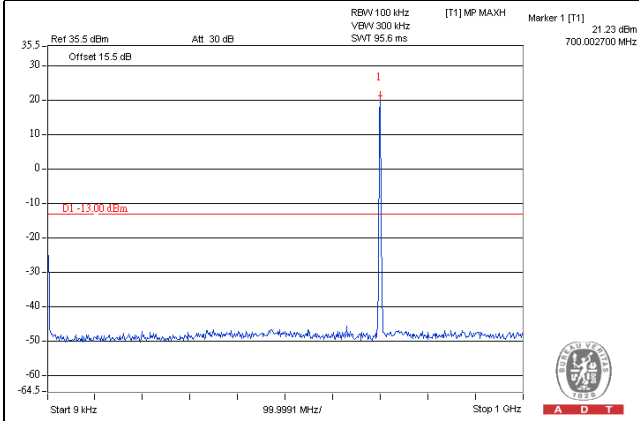

Frequency Range : 10GHz~26.5GHz

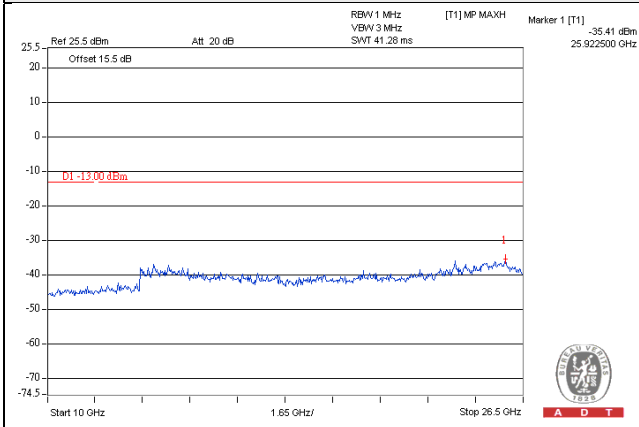

Channel Band width: 1.4MHz

Channel 23095 (707.5MHz)

Frequency Range : 9kHz~1GHz

Frequency Range : 1GHz~10GHz

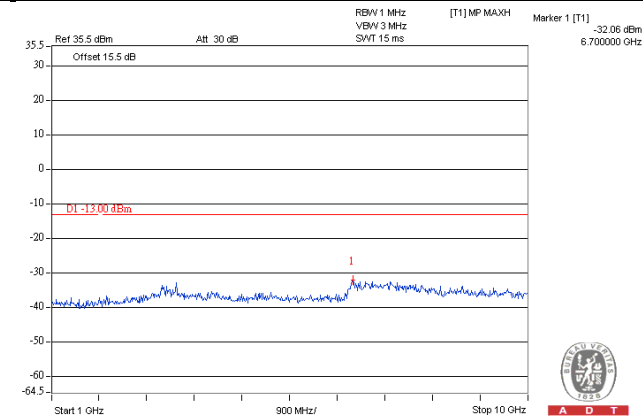
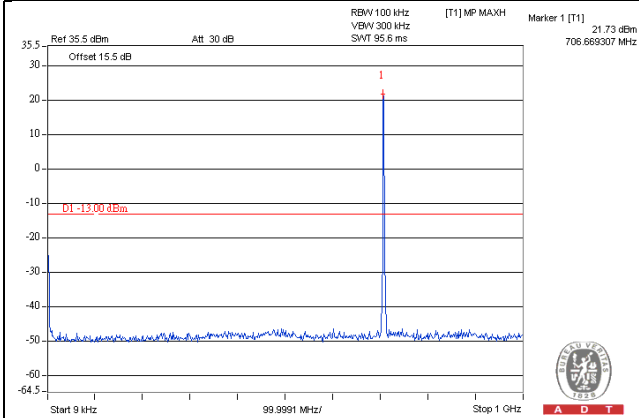

Frequency Range : 10GHz~26.5GHz

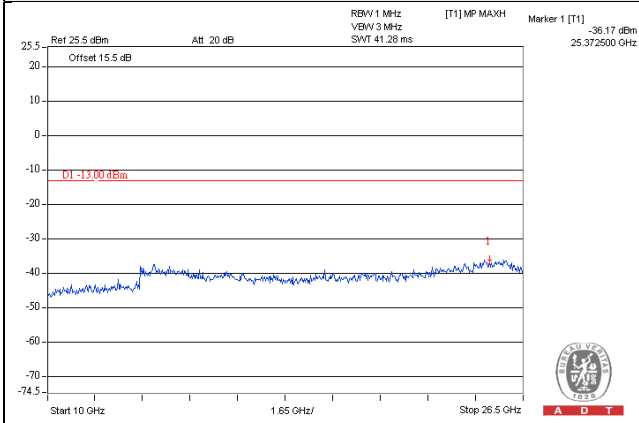

Channel Band width: 1.4MHz

Channel 23173 (715.3MHz)

Frequency Range : 9kHz~1GHz

Frequency Range : 1GHz~10GHz

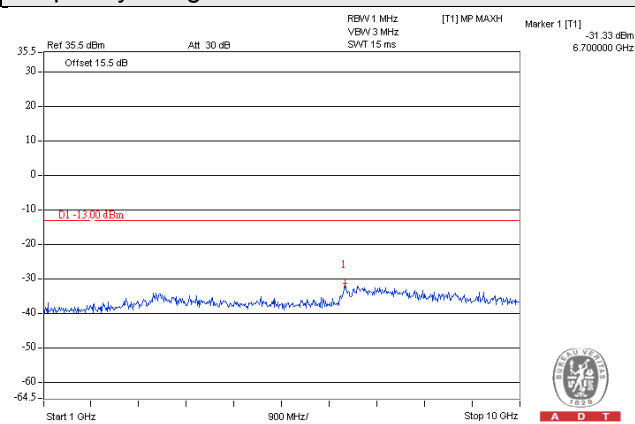
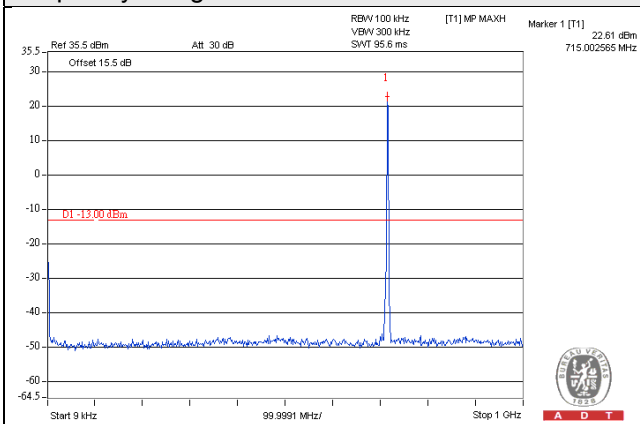

Frequency Range : 10GHz~26.5GHz

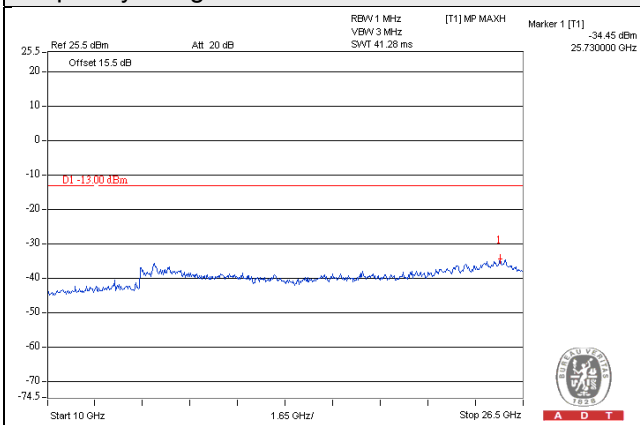

Channel Band width: 3MHz

Channel 23025 (700.5MHz)

Frequency Range : 9kHz~1GHz

Frequency Range : 1GHz~10GHz

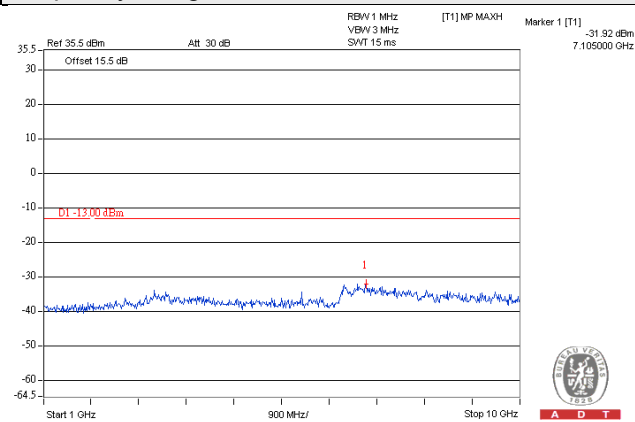
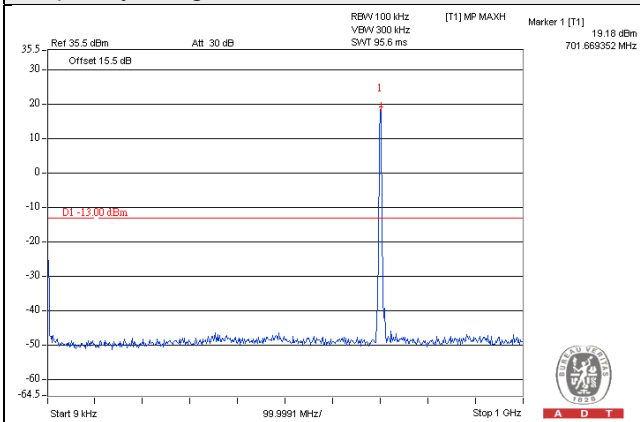

Frequency Range : 10GHz~26.5GHz

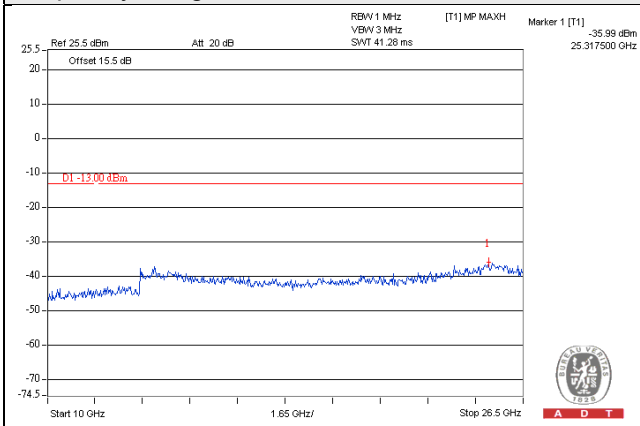

Channel Band width: 3MHz

Channel 23095 (707.5MHz)

Frequency Range : 9kHz~1GHz

Frequency Range : 1GHz~10GHz

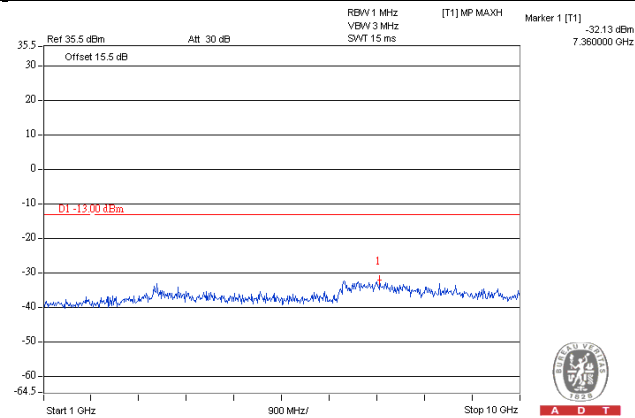
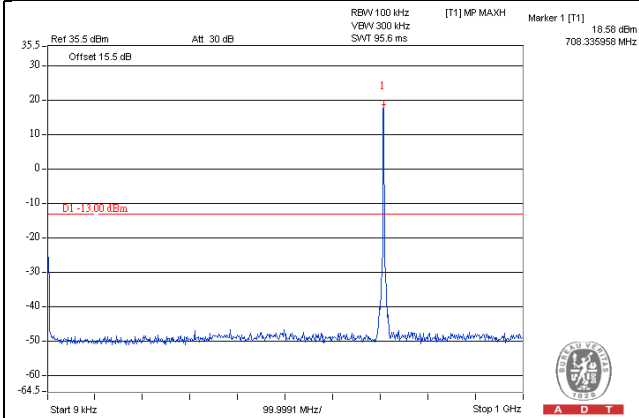

Frequency Range : 10GHz~26.5GHz

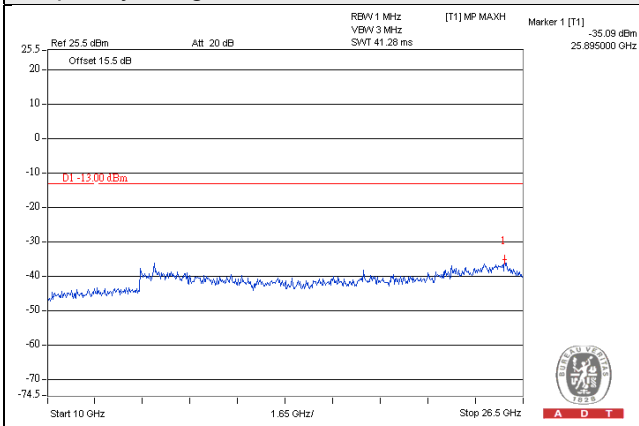

Channel Band width: 3MHz

Channel 23165 (714.5MHz)

Frequency Range : 9kHz~1GHz

Frequency Range : 1GHz~10GHz

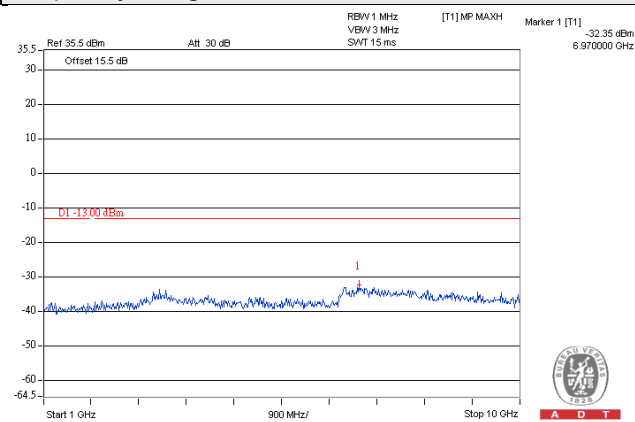
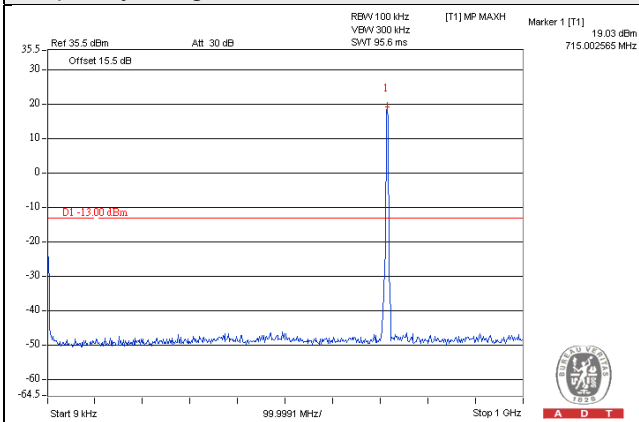

Frequency Range : 10GHz~26.5GHz

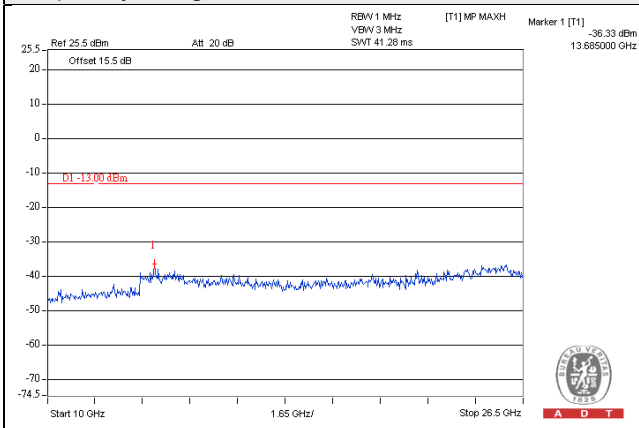

Channel Band width: 5MHz

Channel 23035 (701.5MHz)

Frequency Range : 9kHz~1GHz

Frequency Range : 1GHz~10GHz

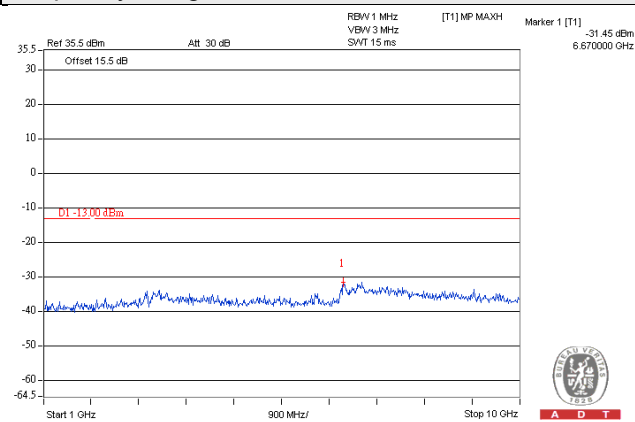
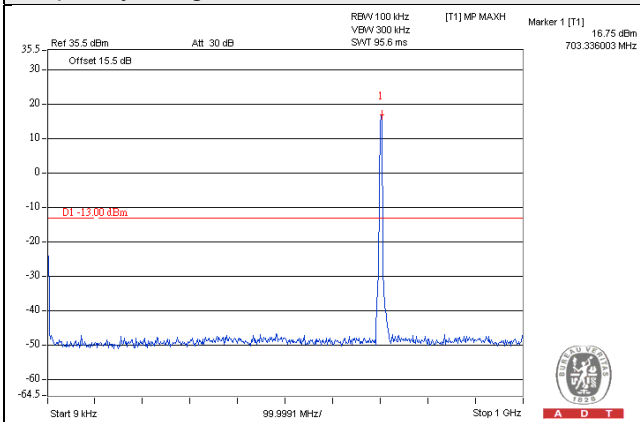

Frequency Range : 10GHz~26.5GHz

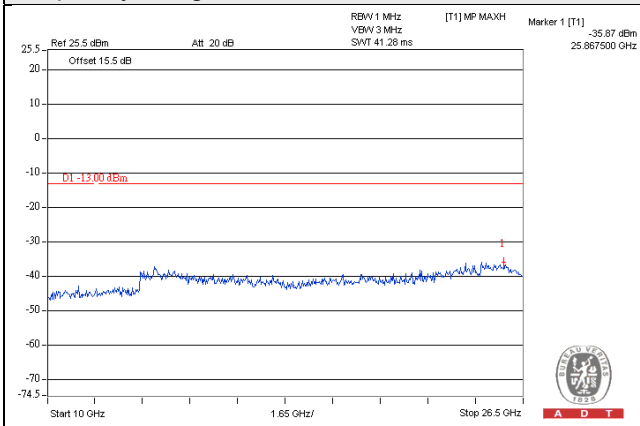

Channel Band width: 5MHz

Channel 23095 (707.5MHz)

Frequency Range : 9kHz~1GHz

Frequency Range : 1GHz~10GHz

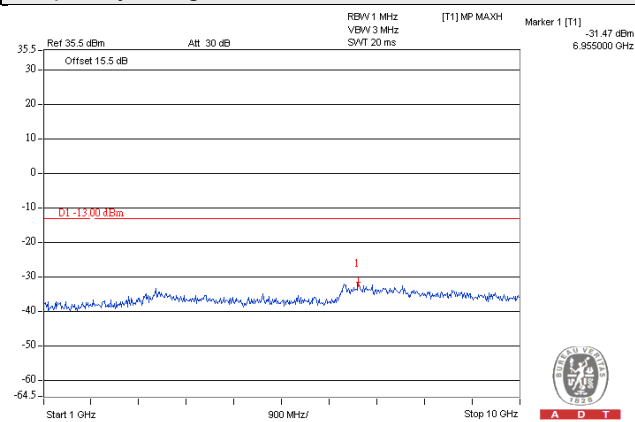
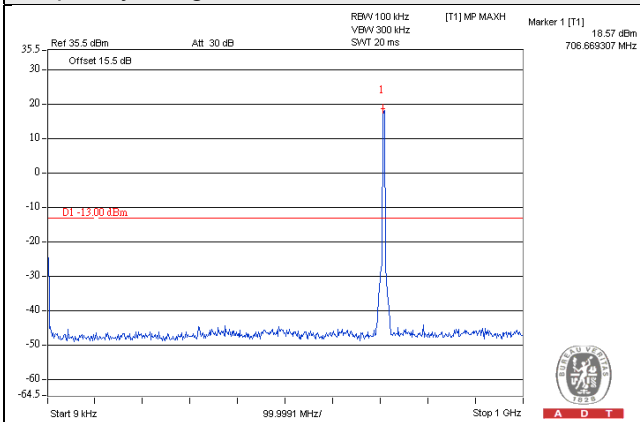

Frequency Range : 10GHz~26.5GHz

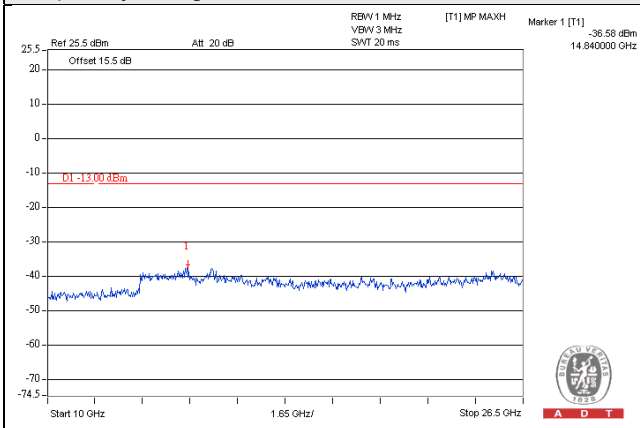

Channel Band width: 5MHz

Channel 23155 (713.5MHz)

Frequency Range : 9kHz~1GHz

Frequency Range : 1GHz~10GHz

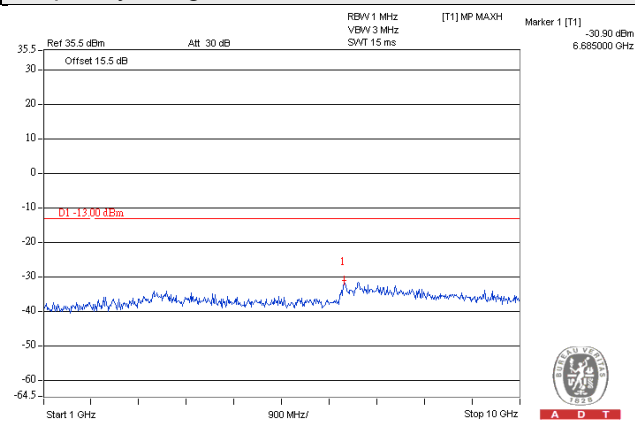
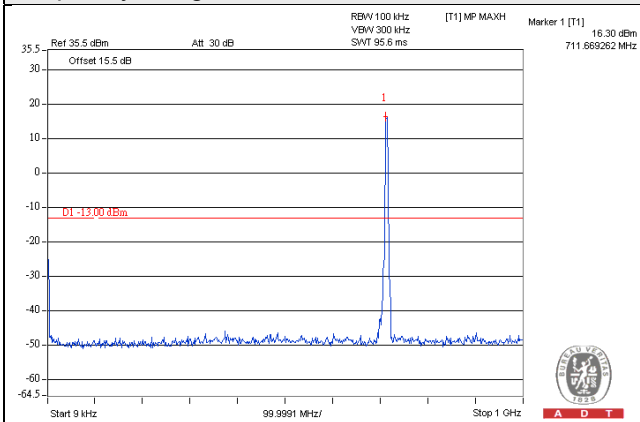

Frequency Range : 10GHz~26.5GHz

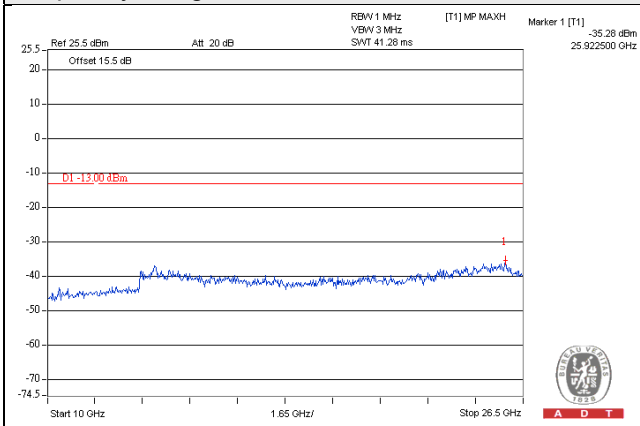

Channel Band width: 10MHz

Channel 23060 (704MHz)

Frequency Range : 9kHz~1GHz

Frequency Range : 1GHz~10GHz

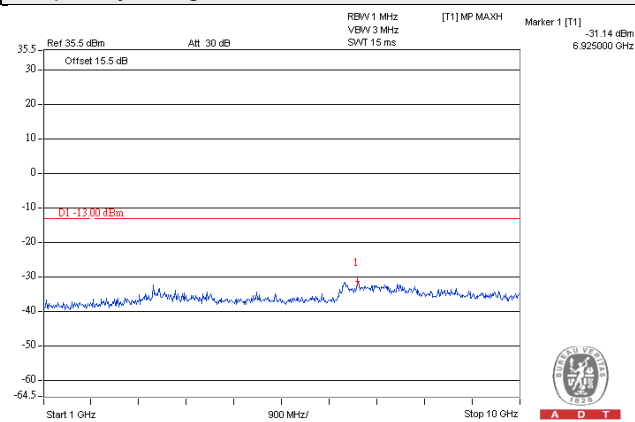
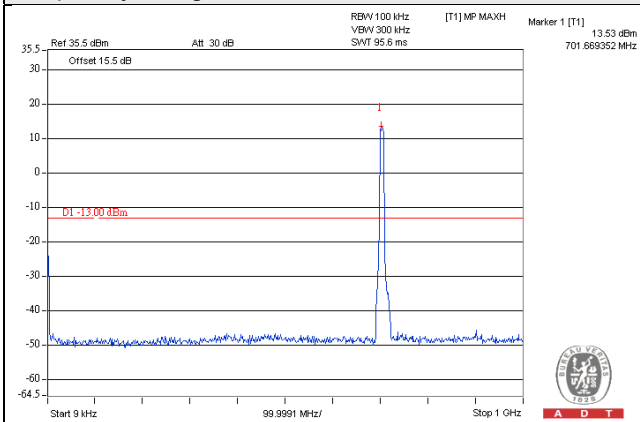

Frequency Range : 10GHz~26.5GHz

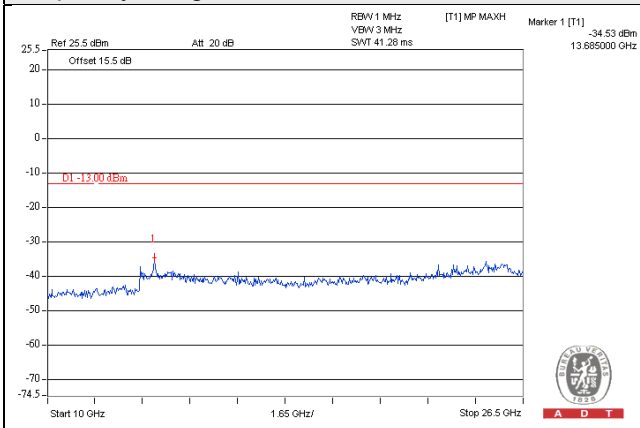

Channel Band width: 10MHz

Channel 23095 (707.5MHz)

Frequency Range : 9kHz~1GHz

Frequency Range : 1GHz~10GHz

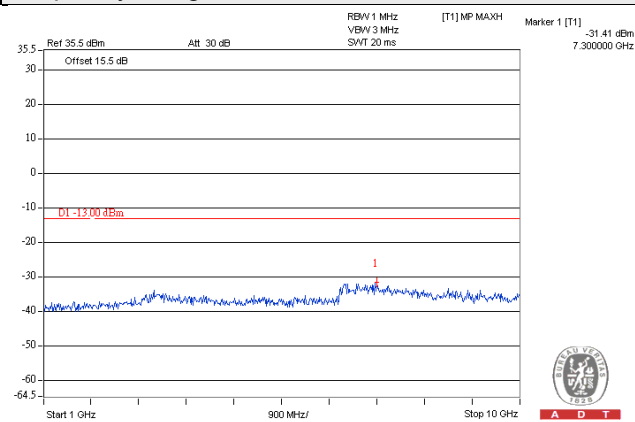
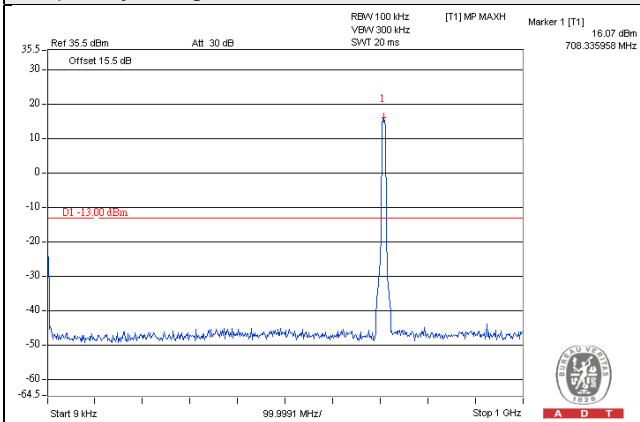

Frequency Range : 10GHz~26.5GHz

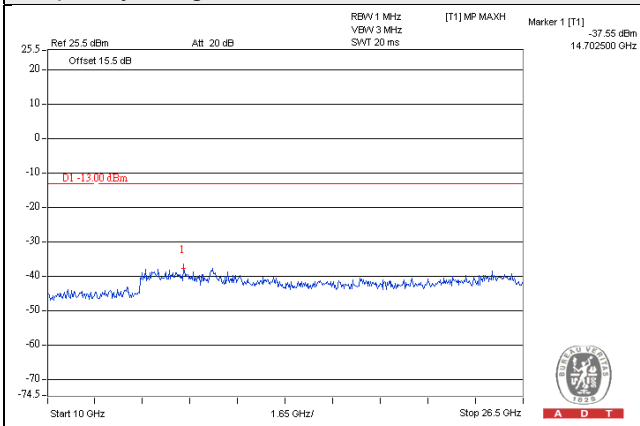

Channel Band width: 10MHz

Channel 23130 (711MHz)

Frequency Range : 9kHz~1GHz

Frequency Range : 1GHz~10GHz

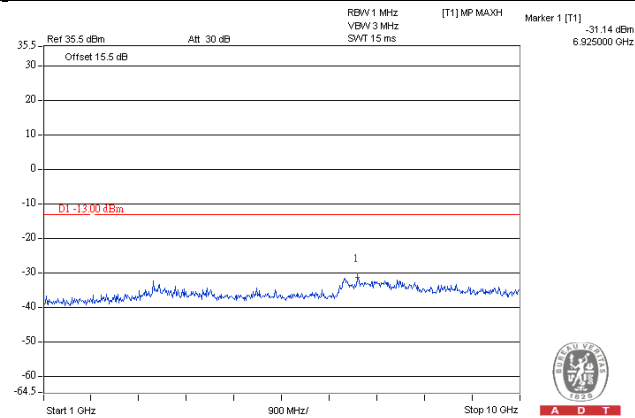
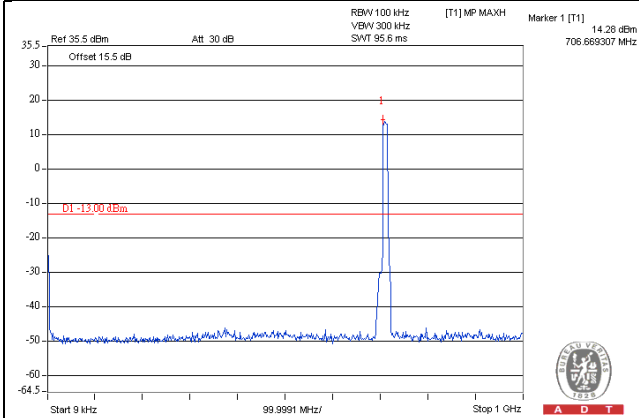

Frequency Range : 10GHz~26.5GHz

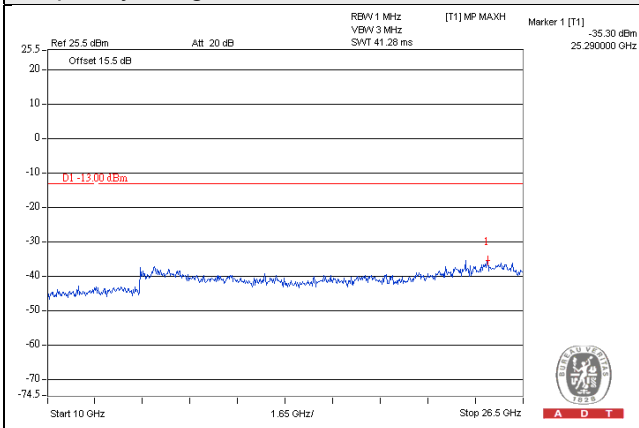

LTE Band 17

Channel Bandwidth: 5MHz

Channel 23775 (706.5MHz)

Frequency Range : 9kHz~1GHz

Frequency Range : 1GHz~4GHz

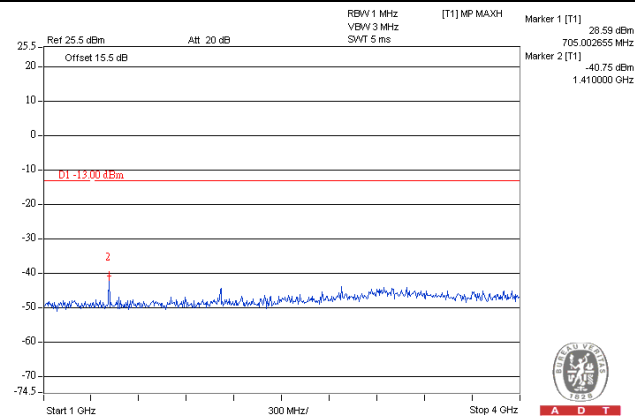
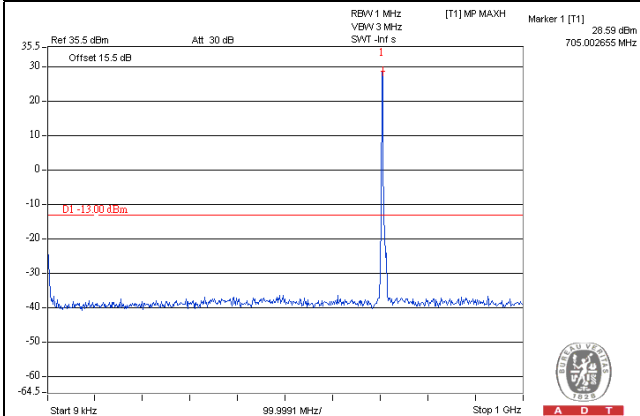

Frequency Range : 4GHz~7GHz

Frequency Range : 7GHz~9GHz

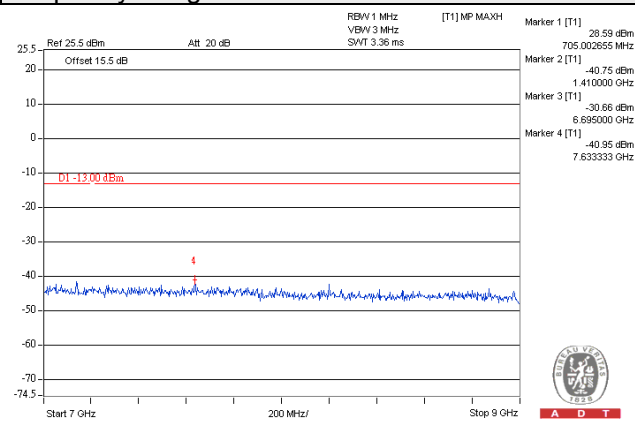
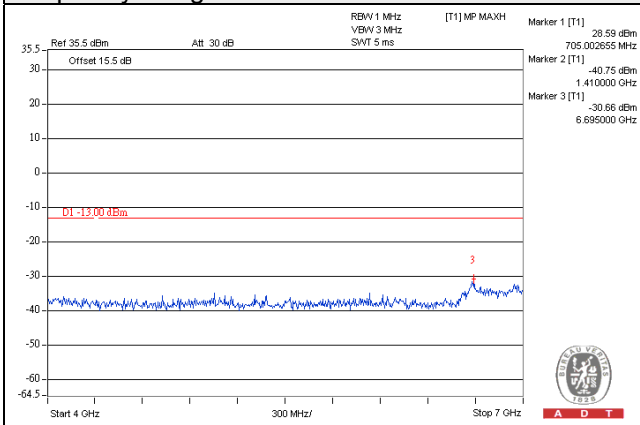

Channel Bandwidth: 5MHz
 Channel 23790 (710.0MHz)
 Frequency Range : 9kHz~1GHz

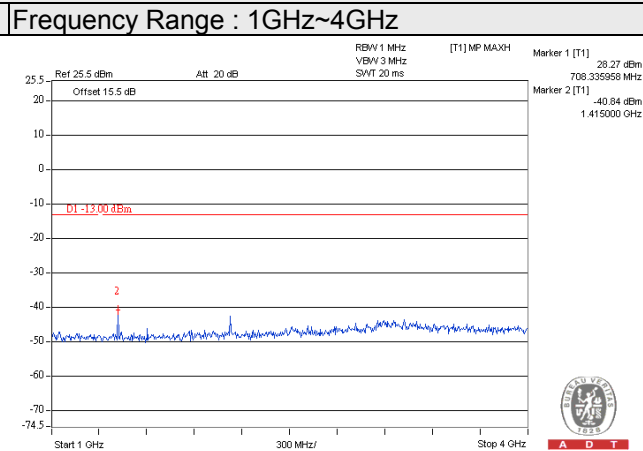
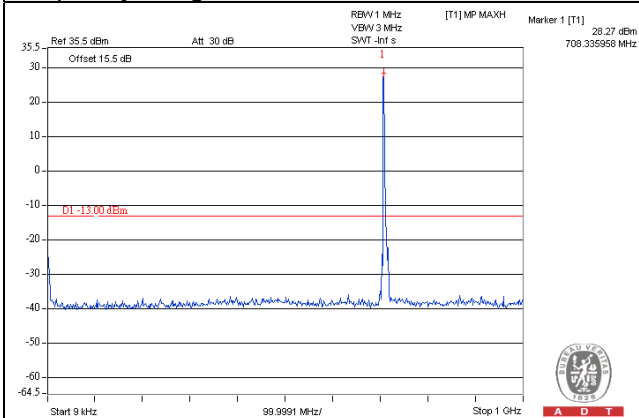

Frequency Range : 4GHz~7GHz

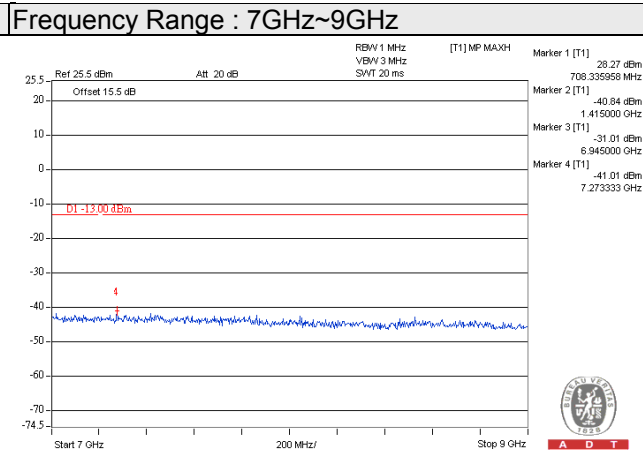
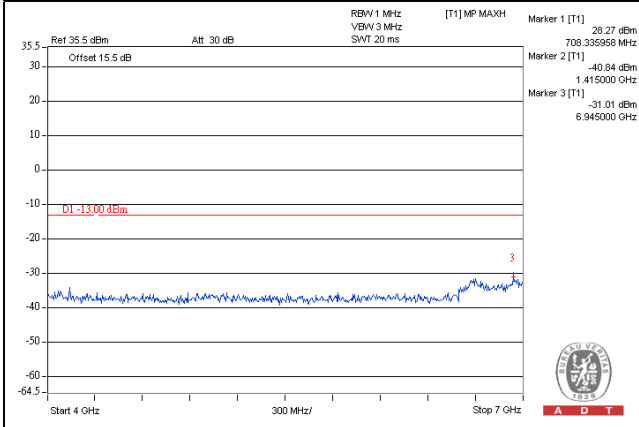

Channel Bandwidth: 5MHz
 Channel 23825 (713.5MHz)
 Frequency Range : 9kHz~1GHz Frequency Range : 1GHz~4GHz

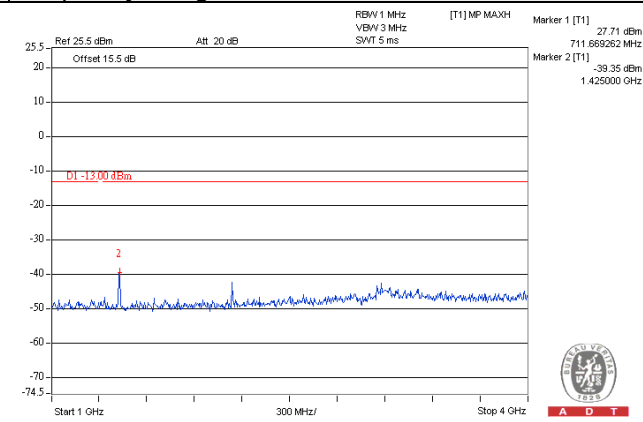
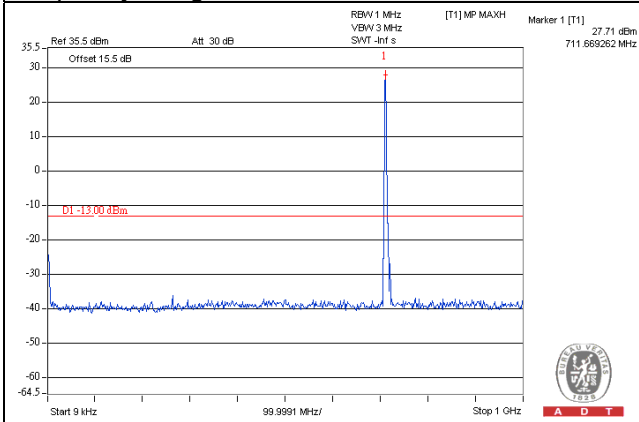

Frequency Range : 4GHz~7GHz

Frequency Range : 7GHz~9GHz

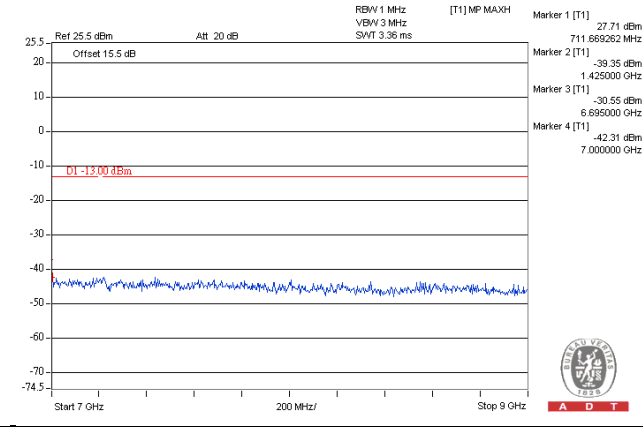
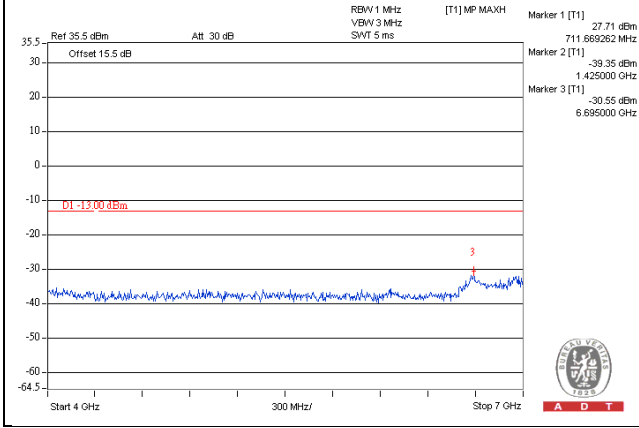

Channel Bandwidth: 10MHz

Channel 23780 (709.0MHz)

Frequency Range : 9kHz~1GHz

Frequency Range : 1GHz~4GHz

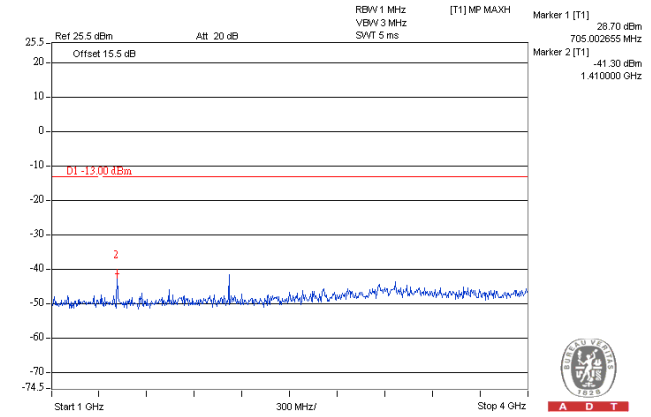
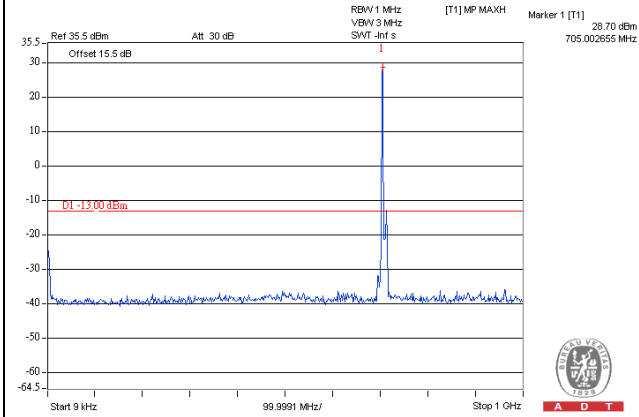

Frequency Range : 4GHz~7GHz

Frequency Range : 7GHz~9GHz

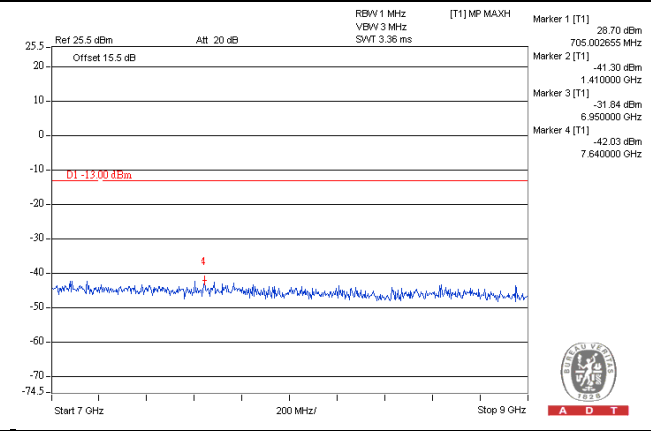
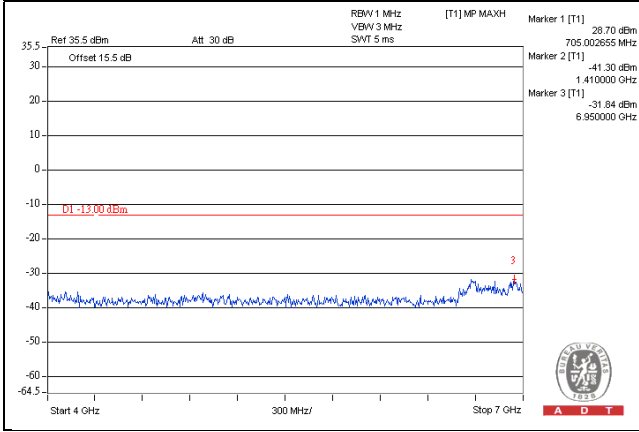

Channel Bandwidth: 10MHz
 Channel 23790 (710.0MHz)
 Frequency Range : 9kHz~1GHz Frequency Range : 1GHz~4GHz

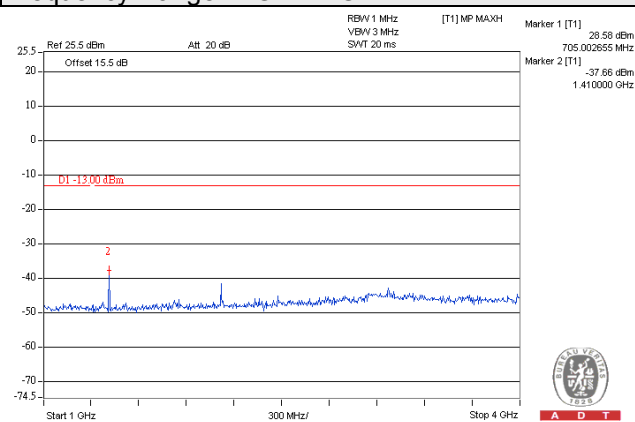
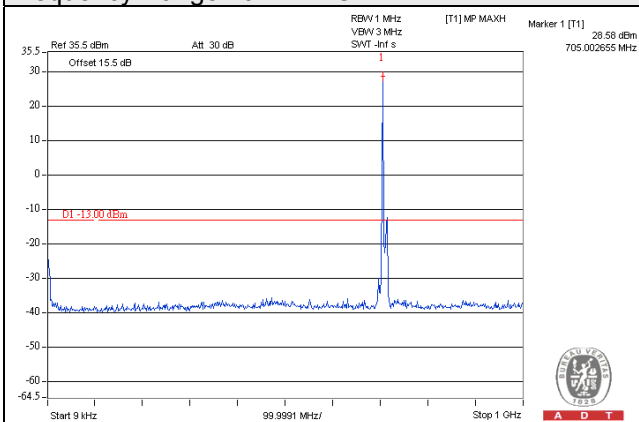

Frequency Range : 4GHz~7GHz Frequency Range : 7GHz~9GHz

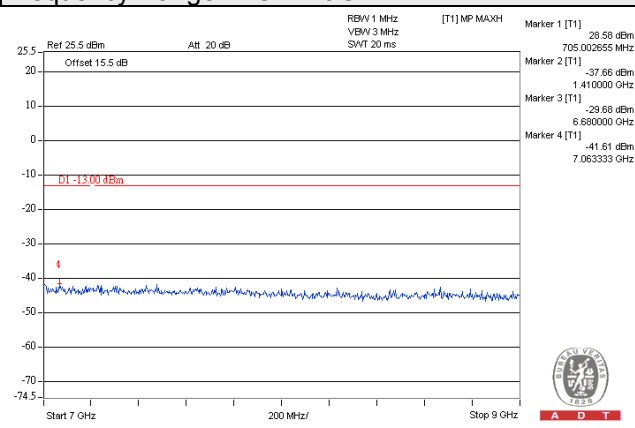
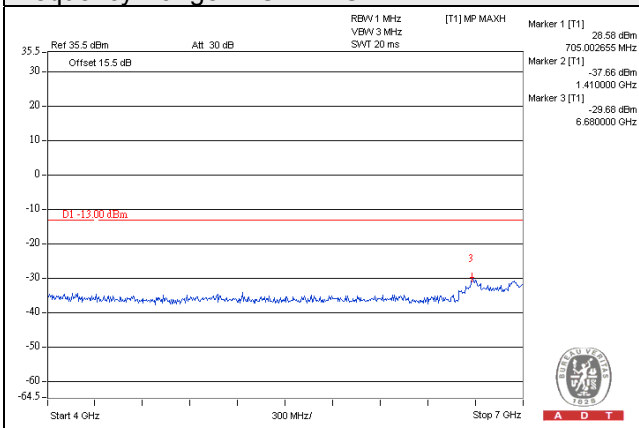

Channel Bandwidth: 10MHz
 Channel 23800 (711.0MHz)
 Frequency Range : 9kHz~1GHz

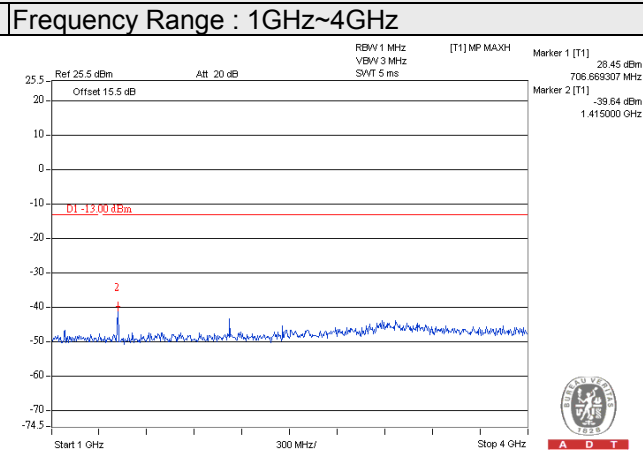
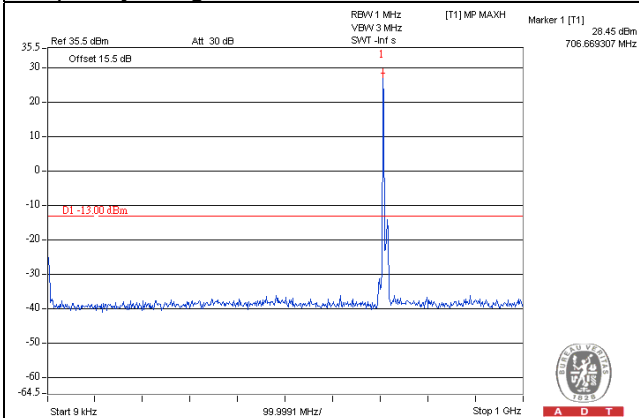

Frequency Range : 4GHz~7GHz

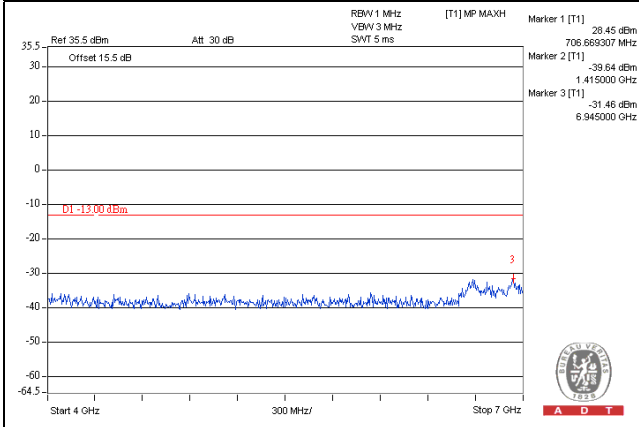

Frequency Range : 7GHz~9GHz

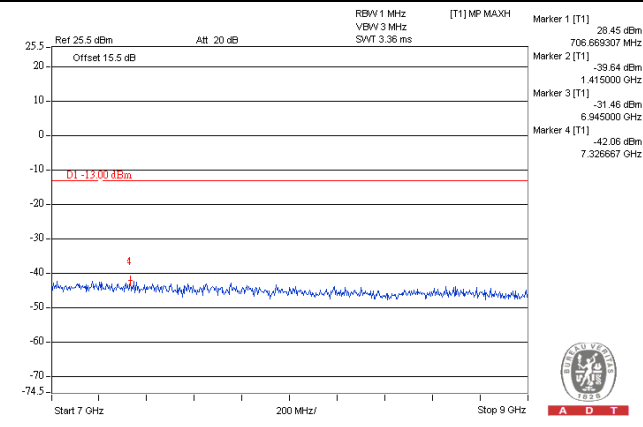

4.8 Radiated Emission Measurement

4.8.1 Limits of Radiated Emission Measurement

For WCDMA Band 4, LTE Band 4

According to FCC 27.53(h) for operations in the 1695-1710 MHz, 1710-1755 MHz, 1755-1780 MHz, 1915-1920 MHz, 1995-2000 MHz, 2000-2020 MHz, 2110-2155 MHz, 2155-2180 MHz, and 2180-2200 bands, the power of any emission outside a licensee's frequency block shall be attenuated below the transmitter power (P) in watts by at least $43 + 10 \log_{10}(P)$ dB.

For LTE Band 12 and LTE Band 17

According to FCC 27.53(g) for operations in the 600 MHz band and the 698-746 MHz band, the power of any emission outside a licensee's frequency band(s) of operation shall be attenuated below the transmitter power (P) within the licensed band(s) of operation, measured in watts, by at least $43 + 10 \log(P)$ dB. Compliance with this provision is based on the use of measurement instrumentation employing a resolution bandwidth of 100 kilohertz or greater.

4.8.2 Test Procedure

- a. The power was measured with R&S Spectrum Analyzer. All measurements were done at 3 channels (low, middle and high channel of operational frequency range.)
- b. Substitution method is used for E.I.R.P measurement. In the semi-anechoic chamber, EUT placed on the 0.8m height of Turn Table, rotated the table around 360 degrees to search the maximum radiation power and receiver antenna shall be rotated vertical and horizontal polarization and moved height from 1m to 4m to find the maximum polar radiated power. The "Read Value" is the spectrum reading the maximum power value.
- c. The substitution antenna is substituted for EUT at the same position and signals generator export the CW signal to the substitution antenna via a TX cable. Rotated the Turn Table and moved receiving antenna to find the maximum radiation power. Adjust output power level of S.G to get a Value of spectrum reading equal to "Read Value" of step b. Record the power level of S.G
- d. $EIRP = \text{Output power level of S.G} - \text{TX cable loss} + \text{Antenna gain of substitution antenna}$.

Note: The resolution bandwidth and video bandwidth of test receiver/spectrum analyzer is 1MHz/3MHz.

4.8.3 Deviation from Test Standard

No deviation.

4.8.4 Test Setup

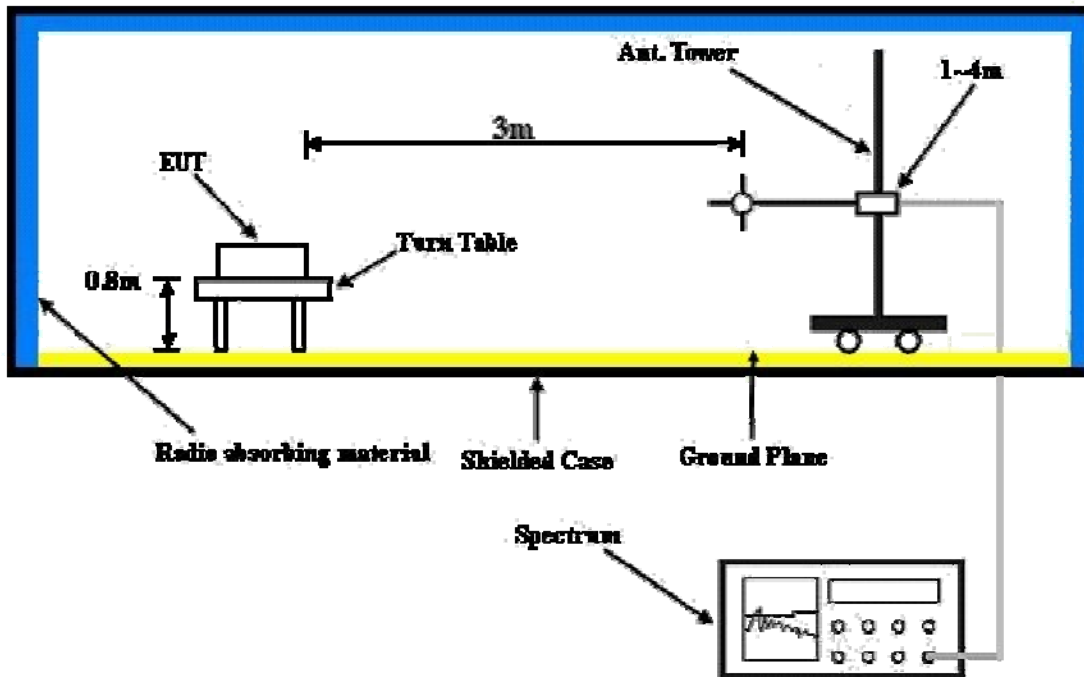

For the actual test configuration, please refer to the attached file (Test Setup Photo).

4.8.5 Test Results

Below 1GHz

WCDMA Band 4

Mode	TX channel 1312 (1712.4MHz)	Frequency Range	Below 1000 MHz
Environmental Conditions	25deg. C, 70%RH	Input Power	120Vac, 60Hz
Tested By	Luis Lee	Test Mode	A

Antenna Polarity & Test Distance: Horizontal at 3 M							
No.	Freq. (MHz)	Reading (dBm)	S.G Power Value (dBm)	Correction Factor (dB)	EIRP (dBm)	Limit (dBm)	Margin (dB)
1	43.58	-52.7	-39.9	-10.3	-50.2	-13.0	-37.2
2	72.68	-42.0	-43.7	-4.1	-47.8	-13.0	-34.8
3	125.06	-44.1	-51.2	0.0	-51.2	-13.0	-38.2
4	264.74	-44.5	-55.0	5.3	-49.7	-13.0	-36.7
5	730.34	-58.5	-60.1	4.9	-55.2	-13.0	-42.2
6	935.98	-55.0	-51.9	3.9	-48.0	-13.0	-35.0
Antenna Polarity & Test Distance: Vertical at 3 M							
No.	Freq. (MHz)	Reading (dBm)	S.G Power Value (dBm)	Correction Factor (dB)	EIRP (dBm)	Limit (dBm)	Margin (dB)
1	43.58	-39.1	-35.0	-10.3	-45.3	-13.0	-32.3
2	70.74	-35.5	-36.6	-4.7	-41.3	-13.0	-28.3
3	156.10	-50.5	-51.5	0.2	-51.3	-13.0	-38.3
4	173.56	-52.1	-54.3	2.1	-52.2	-13.0	-39.2
5	747.80	-62.5	-61.6	4.7	-56.9	-13.0	-43.9
6	935.98	-57.1	-52.3	3.9	-48.4	-13.0	-35.4

Remarks:

1. Output Power (dBm) = S.G Value (dBm) + Correction Factor (dB).
2. Correction Factor (dB) = Substitution Antenna Gain (dB) + Cable Loss (dB).

Mode	TX channel 1312 (1712.4MHz)	Frequency Range	Below 1000 MHz
Environmental Conditions	25deg. C, 70%RH	Input Power	120Vac, 60Hz
Tested By	Luis Lee	Test Mode	B

Antenna Polarity & Test Distance: Horizontal at 3 M							
No.	Freq. (MHz)	Reading (dBm)	S.G Power Value (dBm)	Correction Factor (dB)	EIRP (dBm)	Limit (dBm)	Margin (dB)
1	37.76	-53.1	-40.9	-11.2	-52.1	-13.0	-39.1
2	66.86	-47.0	-49.3	-5.8	-55.1	-13.0	-42.1
3	119.24	-38.6	-48.5	0.1	-48.4	-13.0	-35.4
4	130.88	-47.2	-56.4	-0.1	-56.5	-13.0	-43.5
5	745.86	-60.2	-63.5	4.7	-58.8	-13.0	-45.8
6	935.98	-57.2	-56.3	3.9	-52.4	-13.0	-39.4

Antenna Polarity & Test Distance: Vertical at 3 M							
No.	Freq. (MHz)	Reading (dBm)	S.G Power Value (dBm)	Correction Factor (dB)	EIRP (dBm)	Limit (dBm)	Margin (dB)
1	37.76	-39.6	-39.1	-11.2	-50.3	-13.0	-37.3
2	66.86	-42.8	-45.6	-5.8	-51.4	-13.0	-38.4
3	119.24	-49.2	-57.8	0.1	-57.7	-13.0	-44.7
4	379.20	-57.2	-66.0	5.3	-60.7	-13.0	-47.7
5	743.92	-62.0	-63.2	4.7	-58.5	-13.0	-45.5
6	937.92	-55.8	-53.0	3.9	-49.1	-13.0	-36.1

Remarks:

1. Output Power (dBm) = S.G Value (dBm) + Correction Factor (dB).
2. Correction Factor (dB) = Substitution Antenna Gain (dB) + Cable Loss (dB).

Mode	TX channel 1312 (1712.4MHz)	Frequency Range	Below 1000 MHz
Environmental Conditions	25deg. C, 70%RH	Input Power	120Vac, 60Hz
Tested By	Luis Lee	Test Mode	C

Antenna Polarity & Test Distance: Horizontal at 3 M							
No.	Freq. (MHz)	Reading (dBm)	S.G Power Value (dBm)	Correction Factor (dB)	EIRP (dBm)	Limit (dBm)	Margin (dB)
1	45.52	-57.4	-46.0	-10.0	-56.0	-13.0	-43.0
2	66.86	-46.0	-46.2	-5.8	-52.0	-13.0	-39.0
3	111.48	-41.2	-49.0	0.4	-48.6	-13.0	-35.6
4	249.22	-53.6	-65.7	5.4	-60.3	-13.0	-47.3
5	792.42	-68.0	-66.7	4.1	-62.6	-13.0	-49.6
6	937.92	-55.2	-52.0	3.9	-48.1	-13.0	-35.1

Antenna Polarity & Test Distance: Vertical at 3 M							
No.	Freq. (MHz)	Reading (dBm)	S.G Power Value (dBm)	Correction Factor (dB)	EIRP (dBm)	Limit (dBm)	Margin (dB)
1	43.58	-40.0	-35.9	-10.3	-46.2	-13.0	-33.2
2	68.80	-37.0	-37.8	-5.3	-43.1	-13.0	-30.1
3	107.60	-42.8	-49.7	0.5	-49.2	-13.0	-36.2
4	251.16	-57.1	-62.1	5.4	-56.7	-13.0	-43.7
5	745.86	-58.3	-57.4	4.7	-52.7	-13.0	-39.7
6	935.98	-57.1	-52.3	3.9	-48.4	-13.0	-35.4

Remarks:

1. Output Power (dBm) = S.G Value (dBm) + Correction Factor (dB).
2. Correction Factor (dB) = Substitution Antenna Gain (dB) + Cable Loss (dB).

Mode	TX channel 1312 (1712.4MHz)	Frequency Range	Below 1000 MHz
Environmental Conditions	25deg. C, 70%RH	Input Power	120Vac, 60Hz
Tested By	Luis Lee	Test Mode	D

Antenna Polarity & Test Distance: Horizontal at 3 M							
No.	Freq. (MHz)	Reading (dBm)	S.G Power Value (dBm)	Correction Factor (dB)	EIRP (dBm)	Limit (dBm)	Margin (dB)
1	30.00	-56.8	-43.4	-12.2	-55.6	-13.0	-42.6
2	307.42	-50.4	-62.4	5.2	-57.3	-13.0	-44.3
3	388.90	-55.8	-64.2	5.2	-59.0	-13.0	-46.0
4	406.36	-51.6	-60.0	5.3	-54.7	-13.0	-41.7
5	602.30	-56.7	-62.8	4.5	-58.4	-13.0	-45.4
6	935.98	-56.7	-55.7	3.9	-51.8	-13.0	-38.8

Antenna Polarity & Test Distance: Vertical at 3 M							
No.	Freq. (MHz)	Reading (dBm)	S.G Power Value (dBm)	Correction Factor (dB)	EIRP (dBm)	Limit (dBm)	Margin (dB)
1	76.56	-51.0	-54.8	-2.8	-57.6	-13.0	-44.6
2	136.70	-51.5	-57.6	-0.3	-57.9	-13.0	-44.9
3	214.30	-54.4	-63.0	5.5	-57.6	-13.0	-44.6
4	613.94	-60.1	-61.9	4.5	-57.4	-13.0	-44.4
5	668.26	-59.8	-61.9	5.0	-56.9	-13.0	-43.9
6	935.98	-56.3	-53.7	3.9	-49.8	-13.0	-36.8

Remarks:

1. Output Power (dBm) = S.G Value (dBm) + Correction Factor (dB).
2. Correction Factor (dB) = Substitution Antenna Gain (dB) + Cable Loss (dB).

Mode	TX channel 1312 (1712.4MHz)	Frequency Range	Below 1000 MHz
Environmental Conditions	25deg. C, 70%RH	Input Power	120Vac, 60Hz
Tested By	Matthew Yang	Test Mode	E

Antenna Polarity & Test Distance: Horizontal at 3 M

No.	Freq. (MHz)	Reading (dBm)	S.G Power Value (dBm)	Correction Factor (dB)	EIRP (dBm)	Limit (dBm)	Margin (dB)
1	45.54	-48.1	-36.8	-10.0	-46.8	-13.0	-33.8
2	110.83	-40.1	-48.0	0.4	-47.6	-13.0	-34.6
3	213.43	-56.7	-70.5	5.4	-65.1	-13.0	-52.1
4	281.83	-58.0	-67.4	5.3	-62.1	-13.0	-49.1
5	746.62	-55.7	-56.8	4.7	-52.1	-13.0	-39.1
6	888.08	-53.0	-50.3	3.9	-46.4	-13.0	-33.4

Antenna Polarity & Test Distance: Vertical at 3 M

No.	Freq. (MHz)	Reading (dBm)	S.G Power Value (dBm)	Correction Factor (dB)	EIRP (dBm)	Limit (dBm)	Margin (dB)
1	67.31	-41.2	-41.9	-5.7	-47.6	-13.0	-34.6
2	110.83	-42.9	-50.0	0.4	-49.6	-13.0	-36.6
3	281.83	-54.6	-58.7	5.3	-53.4	-13.0	-40.4
4	530.54	-63.6	-67.9	4.7	-63.2	-13.0	-50.2
5	729.52	-58.0	-57.2	4.9	-52.3	-13.0	-39.3
6	891.19	-50.8	-47.9	3.9	-44.0	-13.0	-31.0

Remarks:

1. Output Power (dBm) = S.G Value (dBm) + Correction Factor (dB).
2. Correction Factor (dB) = Substitution Antenna Gain (dB) + Cable Loss (dB).

LTE Band 4

Channel Bandwidth: 1.4MHz

Mode	TX channel 19957 (1710.7MHz)	Frequency Range	Below 1000 MHz
Environmental Conditions	20deg. C, 69%RH	Input Power	120Vac, 60Hz
Tested By	Bond Tseng	Test Mode	A

Antenna Polarity & Test Distance: Horizontal at 3 M

No.	Freq. (MHz)	Reading (dBm)	S.G Power Value (dBm)	Correction Factor (dB)	EIRP (dBm)	Limit (dBm)	Margin (dB)
1	30.00	-47.7	-24.3	-19.4	-43.7	-13.0	-30.7
2	103.72	-47.1	-53.5	-2.0	-55.5	-13.0	-42.5
3	179.38	-43.1	-48.1	-2.9	-51.0	-13.0	-38.0
4	297.72	-63.9	-64.9	-1.7	-66.6	-13.0	-53.6
5	579.02	-62.8	-65.5	3.7	-61.8	-13.0	-48.8
6	941.80	-55.1	-50.5	3.8	-46.7	-13.0	-33.7

Antenna Polarity & Test Distance: Vertical at 3 M

No.	Freq. (MHz)	Reading (dBm)	S.G Power Value (dBm)	Correction Factor (dB)	EIRP (dBm)	Limit (dBm)	Margin (dB)
1	61.04	-33.8	-37.4	-3.2	-40.6	-13.0	-27.6
2	97.90	-40.4	-47.1	-1.4	-48.5	-13.0	-35.5
3	189.08	-51.7	-51.1	-2.8	-53.9	-13.0	-40.9
4	297.72	-56.9	-55.5	-1.7	-57.2	-13.0	-44.2
5	363.68	-58.2	-62.4	3.9	-58.5	-13.0	-45.5
6	943.74	-55.6	-50.2	3.7	-46.5	-13.0	-33.5

Remarks:

1. Output Power (dBm) = S.G Value (dBm) + Correction Factor (dB).
2. Correction Factor (dB) = Substitution Antenna Gain (dB) + Cable Loss (dB).

Mode	TX channel 19957 (1710.7MHz)	Frequency Range	Below 1000 MHz
Environmental Conditions	25deg. C, 70%RH	Input Power	120Vac, 60Hz
Tested By	Luis Lee	Test Mode	B

Antenna Polarity & Test Distance: Horizontal at 3 M							
No.	Freq. (MHz)	Reading (dBm)	S.G Power Value (dBm)	Correction Factor (dB)	EIRP (dBm)	Limit (dBm)	Margin (dB)
1	37.76	-52.4	-40.2	-11.2	-51.4	-13.0	-38.4
2	66.86	-47.1	-49.5	-5.8	-55.3	-13.0	-42.3
3	117.30	-38.8	-48.6	0.2	-48.4	-13.0	-35.4
4	130.88	-47.5	-56.7	-0.1	-56.8	-13.0	-43.8
5	745.86	-60.7	-63.9	4.7	-59.2	-13.0	-46.2
6	937.92	-56.3	-55.3	3.9	-51.4	-13.0	-38.4
Antenna Polarity & Test Distance: Vertical at 3 M							
No.	Freq. (MHz)	Reading (dBm)	S.G Power Value (dBm)	Correction Factor (dB)	EIRP (dBm)	Limit (dBm)	Margin (dB)
1	39.70	-42.0	-41.2	-10.9	-52.1	-13.0	-39.1
2	66.86	-43.2	-46.1	-5.8	-51.9	-13.0	-38.9
3	119.24	-49.0	-57.7	0.1	-57.6	-13.0	-44.6
4	282.20	-58.9	-65.2	5.3	-59.9	-13.0	-46.9
5	730.34	-60.1	-61.5	4.9	-56.6	-13.0	-43.6
6	935.98	-57.2	-54.6	3.9	-50.7	-13.0	-37.7

Remarks:

1. Output Power (dBm) = S.G Value (dBm) + Correction Factor (dB).
2. Correction Factor (dB) = Substitution Antenna Gain (dB) + Cable Loss (dB).

Mode	TX channel 19957 (1710.7MHz)	Frequency Range	Below 1000 MHz
Environmental Conditions	25deg. C, 70%RH	Input Power	120Vac, 60Hz
Tested By	Luis Lee	Test Mode	C

Antenna Polarity & Test Distance: Horizontal at 3 M

No.	Freq. (MHz)	Reading (dBm)	S.G Power Value (dBm)	Correction Factor (dB)	EIRP (dBm)	Limit (dBm)	Margin (dB)
1	41.64	-57.8	-44.2	-10.6	-54.8	-13.0	-41.8
2	64.92	-48.1	-47.8	-6.3	-54.1	-13.0	-41.1
3	107.60	-41.0	-49.2	0.5	-48.7	-13.0	-35.7
4	262.80	-56.4	-66.8	5.3	-61.5	-13.0	-48.5
5	771.08	-67.7	-67.0	4.3	-62.7	-13.0	-49.7
6	937.92	-55.9	-52.7	3.9	-48.8	-13.0	-35.8

Antenna Polarity & Test Distance: Vertical at 3 M

No.	Freq. (MHz)	Reading (dBm)	S.G Power Value (dBm)	Correction Factor (dB)	EIRP (dBm)	Limit (dBm)	Margin (dB)
1	41.64	-38.9	-35.0	-10.6	-45.6	-13.0	-32.6
2	64.92	-38.4	-39.1	-6.3	-45.4	-13.0	-32.4
3	107.60	-44.9	-51.8	0.5	-51.3	-13.0	-38.3
4	264.74	-59.4	-62.1	5.3	-56.8	-13.0	-43.8
5	792.42	-68.0	-65.8	4.1	-61.7	-13.0	-48.7
6	932.10	-61.0	-56.4	3.9	-52.5	-13.0	-39.5

Remarks:

1. Output Power (dBm) = S.G Value (dBm) + Correction Factor (dB).
2. Correction Factor (dB) = Substitution Antenna Gain (dB) + Cable Loss (dB).

Mode	TX channel 19957 (1710.7MHz)	Frequency Range	Below 1000 MHz
Environmental Conditions	25deg. C, 70%RH	Input Power	120Vac, 60Hz
Tested By	Luis Lee	Test Mode	D

Antenna Polarity & Test Distance: Horizontal at 3 M							
No.	Freq. (MHz)	Reading (dBm)	S.G Power Value (dBm)	Correction Factor (dB)	EIRP (dBm)	Limit (dBm)	Margin (dB)
1	47.46	-54.3	-45.2	-10.2	-55.3	-13.0	-42.3
2	299.66	-51.8	-62.5	5.1	-57.4	-13.0	-44.4
3	365.62	-49.3	-59.4	5.2	-54.1	-13.0	-41.1
4	416.06	-52.6	-61.0	5.2	-55.8	-13.0	-42.8
5	602.30	-56.6	-62.7	4.5	-58.3	-13.0	-45.3
6	935.98	-57.9	-57.0	3.9	-53.1	-13.0	-40.1

Antenna Polarity & Test Distance: Vertical at 3 M							
No.	Freq. (MHz)	Reading (dBm)	S.G Power Value (dBm)	Correction Factor (dB)	EIRP (dBm)	Limit (dBm)	Margin (dB)
1	41.64	-47.3	-45.6	-10.6	-56.2	-13.0	-43.2
2	76.56	-48.4	-52.2	-2.8	-55.0	-13.0	-42.0
3	214.30	-54.6	-63.2	5.5	-57.7	-13.0	-44.7
4	617.82	-57.5	-59.2	4.6	-54.6	-13.0	-41.6
5	658.56	-59.1	-61.4	4.9	-56.5	-13.0	-43.5
6	935.98	-56.6	-54.0	3.9	-50.1	-13.0	-37.1

Remarks:

1. Output Power (dBm) = S.G Value (dBm) + Correction Factor (dB).
2. Correction Factor (dB) = Substitution Antenna Gain (dB) + Cable Loss (dB).

Mode	TX channel 19957 (1710.7MHz)	Frequency Range	Below 1000 MHz
Environmental Conditions	25deg. C, 70%RH	Input Power	120Vac, 60Hz
Tested By	Matthew Yang	Test Mode	E

Antenna Polarity & Test Distance: Horizontal at 3 M							
No.	Freq. (MHz)	Reading (dBm)	S.G Power Value (dBm)	Correction Factor (dB)	EIRP (dBm)	Limit (dBm)	Margin (dB)
1	45.54	-48.2	-36.9	-10.0	-46.9	-13.0	-33.9
2	110.83	-40.0	-47.9	0.4	-47.5	-13.0	-34.5
3	216.54	-55.6	-69.1	5.4	-63.7	-13.0	-50.7
4	289.60	-58.5	-66.9	5.2	-61.7	-13.0	-48.7
5	362.66	-57.1	-65.0	5.2	-59.8	-13.0	-46.8
6	729.52	-56.6	-58.3	4.9	-53.4	-13.0	-40.4

Antenna Polarity & Test Distance: Vertical at 3 M							
No.	Freq. (MHz)	Reading (dBm)	S.G Power Value (dBm)	Correction Factor (dB)	EIRP (dBm)	Limit (dBm)	Margin (dB)
1	47.10	-46.3	-42.7	-9.7	-52.4	-13.0	-39.4
2	67.31	-42.8	-43.5	-5.7	-49.2	-13.0	-36.2
3	110.83	-43.1	-50.2	0.4	-49.8	-13.0	-36.8
4	260.06	-58.0	-61.8	5.3	-56.5	-13.0	-43.5
5	378.21	-59.1	-65.7	5.3	-60.4	-13.0	-47.4
6	746.62	-56.0	-55.1	4.7	-50.4	-13.0	-37.4

Remarks:

1. Output Power (dBm) = S.G Value (dBm) + Correction Factor (dB).
2. Correction Factor (dB) = Substitution Antenna Gain (dB) + Cable Loss (dB).

Channel Bandwidth: 3MHz

Mode	TX channel 19965 (1711.5MHz)	Frequency Range	Below 1000 MHz
Environmental Conditions	20deg. C, 69%RH	Input Power	120Vac, 60Hz
Tested By	Bond Tseng	Test Mode	A

Antenna Polarity & Test Distance: Horizontal at 3 M

No.	Freq. (MHz)	Reading (dBm)	S.G Power Value (dBm)	Correction Factor (dB)	EIRP (dBm)	Limit (dBm)	Margin (dB)
1	30.00	-54.0	-30.6	-19.4	-50.0	-13.0	-37.0
2	59.10	-50.3	-51.0	-3.8	-54.8	-13.0	-41.8
3	97.90	-53.3	-60.6	-1.4	-62.0	-13.0	-49.0
4	192.96	-53.2	-59.0	-2.6	-61.6	-13.0	-48.6
5	363.68	-63.8	-70.2	3.9	-66.3	-13.0	-53.3
6	951.50	-59.0	-54.5	3.8	-50.7	-13.0	-37.7

Antenna Polarity & Test Distance: Vertical at 3 M

No.	Freq. (MHz)	Reading (dBm)	S.G Power Value (dBm)	Correction Factor (dB)	EIRP (dBm)	Limit (dBm)	Margin (dB)
1	57.16	-42.9	-45.1	-4.7	-49.8	-13.0	-36.8
2	97.90	-43.4	-50.1	-1.4	-51.5	-13.0	-38.5
3	192.96	-56.2	-55.1	-2.6	-57.7	-13.0	-44.7
4	297.72	-57.3	-55.9	-1.7	-57.6	-13.0	-44.6
5	429.64	-58.4	-62.3	3.5	-58.8	-13.0	-45.8
6	947.62	-58.7	-53.2	3.8	-49.4	-13.0	-36.4

Remarks:

1. Output Power (dBm) = S.G Value (dBm) + Correction Factor (dB).
2. Correction Factor (dB) = Substitution Antenna Gain (dB) + Cable Loss (dB).

Channel Bandwidth: 5MHz

Mode	TX channel 19975 (1712.5MHz)	Frequency Range	Below 1000 MHz
Environmental Conditions	20deg. C, 69%RH	Input Power	120Vac, 60Hz
Tested By	Bond Tseng	Test Mode	A

Antenna Polarity & Test Distance: Horizontal at 3 M							
No.	Freq. (MHz)	Reading (dBm)	S.G Power Value (dBm)	Correction Factor (dB)	EIRP (dBm)	Limit (dBm)	Margin (dB)
1	31.94	-49.9	-28.2	-18.3	-46.5	-13.0	-33.5
2	84.32	-43.4	-49.8	0.4	-49.4	-13.0	-36.4
3	142.52	-44.6	-46.7	-3.1	-49.8	-13.0	-36.8
4	429.64	-63.7	-67.7	3.5	-64.2	-13.0	-51.2
5	579.02	-65.4	-68.1	3.7	-64.4	-13.0	-51.4
6	945.68	-58.8	-54.3	3.8	-50.5	-13.0	-37.5
Antenna Polarity & Test Distance: Vertical at 3 M							
No.	Freq. (MHz)	Reading (dBm)	S.G Power Value (dBm)	Correction Factor (dB)	EIRP (dBm)	Limit (dBm)	Margin (dB)
1	61.04	-34.8	-38.4	-3.2	-41.6	-13.0	-28.6
2	185.20	-51.5	-51.6	-2.8	-54.4	-13.0	-41.4
3	297.72	-57.3	-55.9	-1.7	-57.6	-13.0	-44.6
4	429.64	-58.3	-62.2	3.5	-58.7	-13.0	-45.7
5	547.98	-58.7	-60.9	3.8	-57.1	-13.0	-44.1
6	934.04	-55.2	-50.0	3.7	-46.3	-13.0	-33.3

Remarks:

1. Output Power (dBm) = S.G Value (dBm) + Correction Factor (dB).
2. Correction Factor (dB) = Substitution Antenna Gain (dB) + Cable Loss (dB).

Channel Bandwidth: 10MHz

Mode	TX channel 20000 (1715.0MHz)	Frequency Range	Below 1000 MHz
Environmental Conditions	20deg. C, 69%RH	Input Power	120Vac, 60Hz
Tested By	Bond Tseng	Test Mode	A

Antenna Polarity & Test Distance: Horizontal at 3 M							
No.	Freq. (MHz)	Reading (dBm)	S.G Power Value (dBm)	Correction Factor (dB)	EIRP (dBm)	Limit (dBm)	Margin (dB)
1	33.88	-49.5	-29.5	-17.1	-46.6	-13.0	-33.6
2	84.32	-43.3	-49.7	0.4	-49.3	-13.0	-36.3
3	185.20	-45.7	-51.2	-2.8	-54.0	-13.0	-41.0
4	297.72	-61.5	-62.5	-1.7	-64.2	-13.0	-51.2
5	765.26	-64.3	-63.8	3.8	-60.0	-13.0	-47.0
6	949.56	-59.2	-54.6	3.7	-50.9	-13.0	-37.9
Antenna Polarity & Test Distance: Vertical at 3 M							
No.	Freq. (MHz)	Reading (dBm)	S.G Power Value (dBm)	Correction Factor (dB)	EIRP (dBm)	Limit (dBm)	Margin (dB)
1	59.10	-41.7	-44.7	-3.8	-48.5	-13.0	-35.5
2	97.90	-42.3	-49.0	-1.4	-50.4	-13.0	-37.4
3	192.96	-59.3	-58.2	-2.6	-60.8	-13.0	-47.8
4	297.72	-55.9	-54.5	-1.7	-56.2	-13.0	-43.2
5	429.64	-58.7	-62.6	3.5	-59.1	-13.0	-46.1
6	941.80	-56.2	-50.9	3.8	-47.1	-13.0	-34.1

Remarks:

1. Output Power (dBm) = S.G Value (dBm) + Correction Factor (dB).
2. Correction Factor (dB) = Substitution Antenna Gain (dB) + Cable Loss (dB).

Channel Bandwidth: 15MHz

Mode	TX channel 20025 (1717.5MHz)	Frequency Range	Below 1000 MHz
Environmental Conditions	20deg. C, 69%RH	Input Power	120Vac, 60Hz
Tested By	Bond Tseng	Test Mode	A

Antenna Polarity & Test Distance: Horizontal at 3 M							
No.	Freq. (MHz)	Reading (dBm)	S.G Power Value (dBm)	Correction Factor (dB)	EIRP (dBm)	Limit (dBm)	Margin (dB)
1	31.94	-50.2	-28.5	-18.3	-46.8	-13.0	-33.8
2	84.32	-51.7	-58.1	0.4	-57.7	-13.0	-44.7
3	181.32	-50.5	-55.7	-3.0	-58.7	-13.0	-45.7
4	410.24	-70.0	-73.5	3.3	-70.2	-13.0	-57.2
5	579.02	-64.6	-67.3	3.7	-63.6	-13.0	-50.6
6	941.80	-55.0	-50.4	3.8	-46.6	-13.0	-33.6
Antenna Polarity & Test Distance: Vertical at 3 M							
No.	Freq. (MHz)	Reading (dBm)	S.G Power Value (dBm)	Correction Factor (dB)	EIRP (dBm)	Limit (dBm)	Margin (dB)
1	59.10	-34.4	-37.4	-3.8	-41.2	-13.0	-28.2
2	101.78	-42.3	-49.1	-1.6	-50.7	-13.0	-37.7
3	175.50	-52.4	-53.3	-2.8	-56.1	-13.0	-43.1
4	297.72	-57.4	-56.0	-1.7	-57.7	-13.0	-44.7
5	429.64	-58.4	-62.3	3.5	-58.8	-13.0	-45.8
6	943.74	-55.6	-50.2	3.7	-46.5	-13.0	-33.5

Remarks:

1. Output Power (dBm) = S.G Value (dBm) + Correction Factor (dB).
2. Correction Factor (dB) = Substitution Antenna Gain (dB) + Cable Loss (dB).

Channel Bandwidth: 20MHz

Mode	TX channel 20050 (1720.0MHz)	Frequency Range	Below 1000 MHz
Environmental Conditions	20deg. C, 69%RH	Input Power	120Vac, 60Hz
Tested By	Bond Tseng	Test Mode	A

Antenna Polarity & Test Distance: Horizontal at 3 M							
No.	Freq. (MHz)	Reading (dBm)	S.G Power Value (dBm)	Correction Factor (dB)	EIRP (dBm)	Limit (dBm)	Margin (dB)
1	33.88	-49.9	-29.9	-17.1	-47.0	-13.0	-34.0
2	82.38	-44.4	-50.2	0.4	-49.8	-13.0	-36.8
3	171.62	-46.4	-50.6	-2.9	-53.5	-13.0	-40.5
4	297.72	-62.9	-63.9	-1.7	-65.6	-13.0	-52.6
5	579.02	-62.6	-65.3	3.7	-61.6	-13.0	-48.6
6	943.74	-54.7	-50.1	3.7	-46.4	-13.0	-33.4

Antenna Polarity & Test Distance: Vertical at 3 M							
No.	Freq. (MHz)	Reading (dBm)	S.G Power Value (dBm)	Correction Factor (dB)	EIRP (dBm)	Limit (dBm)	Margin (dB)
1	61.04	-34.8	-38.4	-3.2	-41.6	-13.0	-28.6
2	86.26	-40.6	-46.6	0.1	-46.5	-13.0	-33.5
3	185.20	-51.2	-51.3	-2.8	-54.1	-13.0	-41.1
4	297.72	-56.4	-55.0	-1.7	-56.7	-13.0	-43.7
5	429.64	-58.3	-62.2	3.5	-58.7	-13.0	-45.7
6	941.80	-55.4	-50.1	3.8	-46.3	-13.0	-33.3

Remarks:

1. Output Power (dBm) = S.G Value (dBm) + Correction Factor (dB).
2. Correction Factor (dB) = Substitution Antenna Gain (dB) + Cable Loss (dB).

LTE Band 12

Channel Bandwidth: 1.4MHz

Mode	TX channel 23017 (699.7MHz)	Frequency Range	Below 1000 MHz
Environmental Conditions	20deg. C, 69%RH	Input Power	120Vac, 60Hz
Tested By	Bond Tseng	Test Mode	A

Antenna Polarity & Test Distance: Horizontal at 3 M							
No.	Freq. (MHz)	Reading (dBm)	S.G Power Value (dBm)	Correction Factor (dB)	EIRP (dBm)	Limit (dBm)	Margin (dB)
1	30.00	-51.4	-30.1	-19.4	-49.5	-13.0	-36.5
2	84.32	-37.5	-46.0	0.4	-45.6	-13.0	-32.6
3	134.76	-43.1	-48.0	-3.2	-51.2	-13.0	-38.2
4	187.14	-45.4	-53.1	-2.7	-55.8	-13.0	-42.8
5	297.72	-62.9	-66.1	-1.7	-67.8	-13.0	-54.8
6	949.56	-60.2	-57.8	3.7	-54.1	-13.0	-41.1
Antenna Polarity & Test Distance: Vertical at 3 M							
No.	Freq. (MHz)	Reading (dBm)	S.G Power Value (dBm)	Correction Factor (dB)	EIRP (dBm)	Limit (dBm)	Margin (dB)
1	53.28	-35.5	-38.4	-6.2	-44.6	-13.0	-31.6
2	86.26	-33.7	-41.8	0.1	-41.7	-13.0	-28.7
3	142.52	-49.6	-50.9	-3.1	-54.0	-13.0	-41.0
4	187.14	-52.5	-54.3	-2.7	-57.0	-13.0	-44.0
5	295.78	-58.5	-58.8	-1.8	-60.6	-13.0	-47.6
6	947.62	-57.9	-54.6	3.8	-50.8	-13.0	-37.8

Remarks:

1. Output Power (dBm) = S.G Value (dBm) + Correction Factor (dB).
2. Correction Factor (dB) = Substitution Antenna Gain (dB) + Cable Loss (dB).

Mode	TX channel 23017 (699.7MHz)	Frequency Range	Below 1000 MHz
Environmental Conditions	25deg. C, 70%RH	Input Power	120Vac, 60Hz
Tested By	Luis Lee	Test Mode	B

Antenna Polarity & Test Distance: Horizontal at 3 M

No.	Freq. (MHz)	Reading (dBm)	S.G Power Value (dBm)	Correction Factor (dB)	EIRP (dBm)	Limit (dBm)	Margin (dB)
1	37.76	-50.9	-38.7	-11.2	-49.9	-13.0	-36.9
2	68.80	-46.5	-49.4	-5.3	-54.7	-13.0	-41.7
3	117.30	-38.9	-48.7	0.2	-48.5	-13.0	-35.5
4	128.94	-45.4	-54.5	-0.1	-54.6	-13.0	-41.6
5	745.86	-58.2	-61.4	4.7	-56.7	-13.0	-43.7
6	935.98	-56.4	-55.4	3.9	-51.5	-13.0	-38.5

Antenna Polarity & Test Distance: Vertical at 3 M

No.	Freq. (MHz)	Reading (dBm)	S.G Power Value (dBm)	Correction Factor (dB)	EIRP (dBm)	Limit (dBm)	Margin (dB)
1	41.64	-43.4	-41.6	-10.6	-52.2	-13.0	-39.2
2	64.92	-42.1	-44.9	-6.3	-51.2	-13.0	-38.2
3	119.24	-48.8	-57.4	0.1	-57.3	-13.0	-44.3
4	132.82	-54.5	-61.6	-0.1	-61.7	-13.0	-48.7
5	745.86	-58.5	-59.7	4.7	-55.0	-13.0	-42.0
6	937.92	-56.9	-54.1	3.9	-50.2	-13.0	-37.2

Remarks:

1. Output Power (dBm) = S.G Value (dBm) + Correction Factor (dB).
2. Correction Factor (dB) = Substitution Antenna Gain (dB) + Cable Loss (dB).

Mode	TX channel 23017 (699.7MHz)	Frequency Range	Below 1000 MHz
Environmental Conditions	25deg. C, 70%RH	Input Power	120Vac, 60Hz
Tested By	Luis Lee	Test Mode	C

Antenna Polarity & Test Distance: Horizontal at 3 M

No.	Freq. (MHz)	Reading (dBm)	S.G Power Value (dBm)	Correction Factor (dB)	EIRP (dBm)	Limit (dBm)	Margin (dB)
1	41.64	-56.7	-43.1	-10.6	-53.7	-13.0	-40.7
2	68.80	-48.4	-49.2	-5.3	-54.5	-13.0	-41.5
3	107.60	-41.2	-49.4	0.5	-48.9	-13.0	-35.9
4	134.76	-51.0	-57.3	-0.3	-57.6	-13.0	-44.6
5	268.62	-56.8	-67.5	5.3	-62.2	-13.0	-49.2
6	935.98	-57.4	-54.3	3.9	-50.4	-13.0	-37.4

Antenna Polarity & Test Distance: Vertical at 3 M

No.	Freq. (MHz)	Reading (dBm)	S.G Power Value (dBm)	Correction Factor (dB)	EIRP (dBm)	Limit (dBm)	Margin (dB)
1	43.58	-41.4	-37.3	-10.3	-47.6	-13.0	-34.6
2	68.80	-40.9	-41.7	-5.3	-47.0	-13.0	-34.0
3	107.60	-44.7	-51.6	0.5	-51.1	-13.0	-38.1
4	270.56	-61.5	-63.6	5.3	-58.3	-13.0	-45.3
5	388.90	-62.6	-69.0	5.2	-63.8	-13.0	-50.8
6	937.92	-57.9	-53.0	3.9	-49.1	-13.0	-36.1

Remarks:

1. Output Power (dBm) = S.G Value (dBm) + Correction Factor (dB).
2. Correction Factor (dB) = Substitution Antenna Gain (dB) + Cable Loss (dB).

Mode	TX channel 23017 (699.7MHz)	Frequency Range	Below 1000 MHz
Environmental Conditions	25deg. C, 70%RH	Input Power	120Vac, 60Hz
Tested By	Luis Lee	Test Mode	D

Antenna Polarity & Test Distance: Horizontal at 3 M							
No.	Freq. (MHz)	Reading (dBm)	S.G Power Value (dBm)	Correction Factor (dB)	EIRP (dBm)	Limit (dBm)	Margin (dB)
1	30.00	-56.8	-43.4	-12.2	-55.5	-13.0	-42.5
2	297.72	-51.4	-62.2	5.1	-57.0	-13.0	-44.0
3	377.26	-52.3	-61.2	5.2	-55.9	-13.0	-42.9
4	396.66	-53.3	-62.2	5.3	-56.9	-13.0	-43.9
5	602.30	-56.6	-62.7	4.5	-58.3	-13.0	-45.3
6	935.98	-58.5	-57.5	3.9	-53.6	-13.0	-40.6
Antenna Polarity & Test Distance: Vertical at 3 M							
No.	Freq. (MHz)	Reading (dBm)	S.G Power Value (dBm)	Correction Factor (dB)	EIRP (dBm)	Limit (dBm)	Margin (dB)
1	45.52	-49.4	-48.0	-10.0	-58.0	-13.0	-45.0
2	136.70	-51.4	-57.4	-0.3	-57.7	-13.0	-44.7
3	214.30	-54.2	-62.8	5.5	-57.3	-13.0	-44.3
4	619.76	-58.1	-59.9	4.6	-55.3	-13.0	-42.3
5	668.26	-60.0	-62.1	5.0	-57.1	-13.0	-44.1
6	937.92	-58.3	-55.5	3.9	-51.6	-13.0	-38.6

Remarks:

1. Output Power (dBm) = S.G Value (dBm) + Correction Factor (dB).
2. Correction Factor (dB) = Substitution Antenna Gain (dB) + Cable Loss (dB).

Mode	TX channel 23017 (699.7MHz)	Frequency Range	Below 1000 MHz
Environmental Conditions	25deg. C, 70%RH	Input Power	120Vac, 60Hz
Tested By	Matthew Yang	Test Mode	E

Antenna Polarity & Test Distance: Horizontal at 3 M							
No.	Freq. (MHz)	Reading (dBm)	S.G Power Value (dBm)	Correction Factor (dB)	EIRP (dBm)	Limit (dBm)	Margin (dB)
1	47.10	-46.4	-35.6	-9.7	-45.3	-13.0	-32.3
2	117.05	-45.7	-53.4	0.2	-53.2	-13.0	-40.2
3	214.98	-56.1	-69.8	5.4	-64.4	-13.0	-51.4
4	267.84	-57.1	-67.8	5.3	-62.5	-13.0	-49.5
5	729.52	-63.1	-64.8	4.9	-59.9	-13.0	-46.9
6	936.27	-55.9	-52.8	3.9	-48.9	-13.0	-35.9

Antenna Polarity & Test Distance: Vertical at 3 M							
No.	Freq. (MHz)	Reading (dBm)	S.G Power Value (dBm)	Correction Factor (dB)	EIRP (dBm)	Limit (dBm)	Margin (dB)
1	67.31	-42.9	-43.6	-5.7	-49.3	-13.0	-36.3
2	110.83	-42.7	-49.8	0.4	-49.4	-13.0	-36.4
3	171.46	-55.7	-57.1	1.8	-55.3	-13.0	-42.3
4	269.39	-59.9	-62.0	5.3	-56.7	-13.0	-43.7
5	435.72	-58.2	-64.9	5.2	-59.7	-13.0	-46.7
6	936.27	-55.1	-50.3	3.9	-46.4	-13.0	-33.4

Remarks:

1. Output Power (dBm) = S.G Value (dBm) + Correction Factor (dB).
2. Correction Factor (dB) = Substitution Antenna Gain (dB) + Cable Loss (dB).

Channel Bandwidth: 3MHz

Mode	TX channel 23025 (700.5MHz)	Frequency Range	Below 1000 MHz
Environmental Conditions	20deg. C, 69%RH	Input Power	120Vac, 60Hz
Tested By	Bond Tseng	Test Mode	A

Antenna Polarity & Test Distance: Horizontal at 3 M

No.	Freq. (MHz)	Reading (dBm)	S.G Power Value (dBm)	Correction Factor (dB)	EIRP (dBm)	Limit (dBm)	Margin (dB)
1	33.88	-50.8	-32.9	-17.1	-50.0	-13.0	-37.0
2	88.20	-38.6	-48.2	-0.2	-48.4	-13.0	-35.4
3	150.28	-45.9	-49.8	-3.0	-52.8	-13.0	-39.8
4	192.96	-50.0	-57.9	-2.6	-60.5	-13.0	-47.5
5	429.64	-62.9	-69.0	3.5	-65.5	-13.0	-52.5
6	951.50	-59.5	-57.2	3.8	-53.4	-13.0	-40.4

Antenna Polarity & Test Distance: Vertical at 3 M

No.	Freq. (MHz)	Reading (dBm)	S.G Power Value (dBm)	Correction Factor (dB)	EIRP (dBm)	Limit (dBm)	Margin (dB)
1	53.28	-36.5	-39.3	-6.2	-45.5	-13.0	-32.5
2	84.32	-35.6	-43.1	0.4	-42.7	-13.0	-29.7
3	138.64	-46.9	-48.8	-3.2	-52.0	-13.0	-39.0
4	185.20	-50.7	-52.9	-2.8	-55.7	-13.0	-42.7
5	297.72	-55.8	-56.6	-1.7	-58.3	-13.0	-45.3
6	947.62	-59.0	-55.7	3.8	-51.9	-13.0	-38.9

Remarks:

1. Output Power (dBm) = S.G Value (dBm) + Correction Factor (dB).
2. Correction Factor (dB) = Substitution Antenna Gain (dB) + Cable Loss (dB).

Channel Bandwidth: 5MHz

Mode	TX channel 23035 (701.5MHz)	Frequency Range	Below 1000 MHz
Environmental Conditions	20deg. C, 69%RH	Input Power	120Vac, 60Hz
Tested By	Bond Tseng	Test Mode	A

Antenna Polarity & Test Distance: Horizontal at 3 M							
No.	Freq. (MHz)	Reading (dBm)	S.G Power Value (dBm)	Correction Factor (dB)	EIRP (dBm)	Limit (dBm)	Margin (dB)
1	33.88	-49.6	-31.8	-17.1	-48.9	-13.0	-35.9
2	84.32	-37.1	-45.6	0.4	-45.2	-13.0	-32.2
3	138.64	-42.8	-47.7	-3.2	-50.9	-13.0	-37.9
4	185.20	-43.8	-51.5	-2.8	-54.3	-13.0	-41.3
5	260.86	-60.1	-65.5	-1.5	-67.0	-13.0	-54.0
6	947.62	-58.5	-56.2	3.8	-52.4	-13.0	-39.4

Antenna Polarity & Test Distance: Vertical at 3 M							
No.	Freq. (MHz)	Reading (dBm)	S.G Power Value (dBm)	Correction Factor (dB)	EIRP (dBm)	Limit (dBm)	Margin (dB)
1	53.28	-35.5	-38.3	-6.2	-44.5	-13.0	-31.5
2	90.14	-37.5	-45.8	-0.2	-46.0	-13.0	-33.0
3	181.32	-50.5	-53.0	-3.0	-56.0	-13.0	-43.0
4	305.48	-61.4	-67.2	3.8	-63.4	-13.0	-50.4
5	429.64	-57.5	-63.5	3.5	-60.0	-13.0	-47.0
6	949.56	-55.9	-52.5	3.7	-48.8	-13.0	-35.8

Remarks:

1. Output Power (dBm) = S.G Value (dBm) + Correction Factor (dB).
2. Correction Factor (dB) = Substitution Antenna Gain (dB) + Cable Loss (dB).

Channel Bandwidth: 10MHz

Mode	TX channel 23060 (704MHz)	Frequency Range	Below 1000 MHz
Environmental Conditions	20deg. C, 69%RH	Input Power	120Vac, 60Hz
Tested By	Bond Tseng	Test Mode	A

Antenna Polarity & Test Distance: Horizontal at 3 M

No.	Freq. (MHz)	Reading (dBm)	S.G Power Value (dBm)	Correction Factor (dB)	EIRP (dBm)	Limit (dBm)	Margin (dB)
1	53.28	-49.0	-46.7	-6.2	-52.9	-13.0	-39.9
2	97.90	-42.6	-52.1	-1.4	-53.5	-13.0	-40.5
3	152.22	-47.2	-50.8	-2.8	-53.6	-13.0	-40.6
4	189.08	-48.8	-56.6	-2.8	-59.4	-13.0	-46.4
5	268.62	-63.8	-68.6	-1.5	-70.1	-13.0	-57.1
6	951.50	-57.5	-55.2	3.8	-51.4	-13.0	-38.4

Antenna Polarity & Test Distance: Vertical at 3 M

No.	Freq. (MHz)	Reading (dBm)	S.G Power Value (dBm)	Correction Factor (dB)	EIRP (dBm)	Limit (dBm)	Margin (dB)
1	53.28	-36.2	-39.0	-6.2	-45.2	-13.0	-32.2
2	92.08	-41.5	-49.9	-0.6	-50.5	-13.0	-37.5
3	144.46	-51.2	-52.4	-3.2	-55.6	-13.0	-42.6
4	191.02	-54.5	-55.8	-2.7	-58.5	-13.0	-45.5
5	299.66	-61.0	-65.5	2.5	-63.0	-13.0	-50.0
6	955.38	-64.8	-61.4	3.8	-57.6	-13.0	-44.6

Remarks:

1. Output Power (dBm) = S.G Value (dBm) + Correction Factor (dB).
2. Correction Factor (dB) = Substitution Antenna Gain (dB) + Cable Loss (dB).

LTE Band 17

Channel Bandwidth: 5MHz

Mode	TX channel 23755 (706.5MHz)	Frequency Range	Below 1000 MHz
Environmental Conditions	20deg. C, 69%RH	Input Power	120Vac, 60Hz
Tested By	Bond Tseng	Test Mode	A

Antenna Polarity & Test Distance: Horizontal at 3 M

No.	Freq. (MHz)	Reading (dBm)	S.G Power Value (dBm)	Correction Factor (dB)	ERP (dBm)	Limit (dBm)	Margin (dB)
1	33.88	-49.9	-32.0	-17.1	-49.1	-13.0	-36.1
2	53.28	-49.6	-47.3	-6.2	-53.5	-13.0	-40.5
3	86.26	-37.7	-46.7	0.1	-46.6	-13.0	-33.6
4	146.40	-41.5	-45.4	-3.0	-48.4	-13.0	-35.4
5	429.64	-63.4	-69.5	3.5	-66.0	-13.0	-53.0
6	949.56	-56.9	-54.4	3.7	-50.7	-13.0	-37.7

Antenna Polarity & Test Distance: Vertical at 3 M

No.	Freq. (MHz)	Reading (dBm)	S.G Power Value (dBm)	Correction Factor (dB)	ERP (dBm)	Limit (dBm)	Margin (dB)
1	53.28	-36.2	-39.0	-6.2	-45.2	-13.0	-32.2
2	86.26	-34.0	-42.2	0.1	-42.1	-13.0	-29.1
3	185.20	-51.0	-53.2	-2.8	-56.0	-13.0	-43.0
4	363.68	-56.9	-63.3	3.9	-59.4	-13.0	-46.4
5	429.64	-57.6	-63.6	3.5	-60.1	-13.0	-47.1
6	935.98	-57.2	-54.2	3.7	-50.5	-13.0	-37.5

Remarks:

1. Output Power (dBm) = S.G Value (dBm) + Correction Factor (dB).
2. Correction Factor (dB) = Substitution Antenna Gain (dB) + Cable Loss (dB).

Mode	TX channel 23755 (706.5MHz)	Frequency Range	Below 1000 MHz
Environmental Conditions	25deg. C, 70%RH	Input Power	120Vac, 60Hz
Tested By	Luis Lee	Test Mode	B

Antenna Polarity & Test Distance: Horizontal at 3 M

No.	Freq. (MHz)	Reading (dBm)	S.G Power Value (dBm)	Correction Factor (dB)	ERP (dBm)	Limit (dBm)	Margin (dB)
1	37.76	-50.9	-38.7	-11.2	-49.9	-13.0	-36.9
2	68.80	-46.5	-49.4	-5.3	-54.7	-13.0	-41.7
3	117.30	-38.9	-48.7	0.2	-48.5	-13.0	-35.5
4	128.94	-45.4	-54.5	-0.1	-54.6	-13.0	-41.6
5	745.86	-58.2	-61.4	4.7	-56.7	-13.0	-43.7
6	935.98	-56.4	-55.4	3.9	-51.5	-13.0	-38.5

Antenna Polarity & Test Distance: Vertical at 3 M

No.	Freq. (MHz)	Reading (dBm)	S.G Power Value (dBm)	Correction Factor (dB)	ERP (dBm)	Limit (dBm)	Margin (dB)
1	41.64	-43.4	-41.6	-10.6	-52.2	-13.0	-39.2
2	64.92	-42.1	-44.9	-6.3	-51.2	-13.0	-38.2
3	119.24	-48.8	-57.4	0.1	-57.3	-13.0	-44.3
4	132.82	-54.5	-61.6	-0.1	-61.7	-13.0	-48.7
5	745.86	-58.5	-59.7	4.7	-55.0	-13.0	-42.0
6	937.92	-56.9	-54.1	3.9	-50.2	-13.0	-37.2

Remarks:

1. Output Power (dBm) = S.G Value (dBm) + Correction Factor (dB).
2. Correction Factor (dB) = Substitution Antenna Gain (dB) + Cable Loss (dB).

Mode	TX channel 23755 (706.5MHz)	Frequency Range	Below 1000 MHz
Environmental Conditions	25deg. C, 70%RH	Input Power	120Vac, 60Hz
Tested By	Luis Lee	Test Mode	C

Antenna Polarity & Test Distance: Horizontal at 3 M

No.	Freq. (MHz)	Reading (dBm)	S.G Power Value (dBm)	Correction Factor (dB)	ERP (dBm)	Limit (dBm)	Margin (dB)
1	41.64	-55.2	-41.6	-10.6	-52.2	-13.0	-39.2
2	68.80	-46.0	-46.8	-5.3	-52.1	-13.0	-39.1
3	117.30	-33.6	-41.3	0.2	-41.1	-13.0	-28.1
4	210.42	-55.8	-69.9	5.4	-64.5	-13.0	-51.5
5	266.68	-57.0	-67.7	5.3	-62.4	-13.0	-49.4
6	935.98	-57.0	-53.9	3.9	-50.0	-13.0	-37.0

Antenna Polarity & Test Distance: Vertical at 3 M

No.	Freq. (MHz)	Reading (dBm)	S.G Power Value (dBm)	Correction Factor (dB)	ERP (dBm)	Limit (dBm)	Margin (dB)
1	37.76	-39.1	-36.4	-11.2	-47.6	-13.0	-34.6
2	64.92	-37.7	-38.4	-6.3	-44.7	-13.0	-31.7
3	115.36	-45.0	-52.0	0.3	-51.7	-13.0	-38.7
4	220.12	-57.2	-63.0	5.4	-57.6	-13.0	-44.6
5	272.50	-59.1	-61.3	5.3	-56.0	-13.0	-43.0
6	935.98	-54.4	-49.6	3.9	-45.7	-13.0	-32.7

Remarks:

1. Output Power (dBm) = S.G Value (dBm) + Correction Factor (dB).
2. Correction Factor (dB) = Substitution Antenna Gain (dB) + Cable Loss (dB).

Mode	TX channel 23755 (706.5MHz)	Frequency Range	Below 1000 MHz
Environmental Conditions	25deg. C, 70%RH	Input Power	120Vac, 60Hz
Tested By	Luis Lee	Test Mode	D

Antenna Polarity & Test Distance: Horizontal at 3 M							
No.	Freq. (MHz)	Reading (dBm)	S.G Power Value (dBm)	Correction Factor (dB)	ERP (dBm)	Limit (dBm)	Margin (dB)
1	39.70	-55.6	-44.5	-10.9	-55.4	-13.0	-42.4
2	132.82	-49.6	-58.6	-0.2	-58.8	-13.0	-45.8
3	297.72	-49.9	-60.7	5.1	-55.5	-13.0	-42.5
4	386.96	-52.3	-60.7	5.2	-55.4	-13.0	-42.4
5	602.30	-56.8	-62.9	4.5	-58.4	-13.0	-45.4
6	935.98	-58.1	-57.2	3.9	-53.3	-13.0	-40.3
Antenna Polarity & Test Distance: Vertical at 3 M							
No.	Freq. (MHz)	Reading (dBm)	S.G Power Value (dBm)	Correction Factor (dB)	ERP (dBm)	Limit (dBm)	Margin (dB)
1	80.44	-50.5	-54.7	-1.5	-56.2	-13.0	-43.2
2	214.30	-54.3	-62.9	5.5	-57.4	-13.0	-44.4
3	613.94	-59.5	-61.4	4.5	-56.8	-13.0	-43.8
4	625.58	-60.3	-62.3	4.6	-57.6	-13.0	-44.6
5	668.26	-59.5	-61.6	5.0	-56.6	-13.0	-43.6
6	935.98	-60.9	-58.2	3.9	-54.3	-13.0	-41.3

Remarks:

1. Output Power (dBm) = S.G Value (dBm) + Correction Factor (dB).
2. Correction Factor (dB) = Substitution Antenna Gain (dB) + Cable Loss (dB).

Mode	TX channel 23755 (706.5MHz)	Frequency Range	Below 1000 MHz
Environmental Conditions	25deg. C, 70%RH	Input Power	120Vac, 60Hz
Tested By	Matthew Yang	Test Mode	E

Antenna Polarity & Test Distance: Horizontal at 3 M							
No.	Freq. (MHz)	Reading (dBm)	S.G Power Value (dBm)	Correction Factor (dB)	ERP (dBm)	Limit (dBm)	Margin (dB)
1	47.10	-47.3	-36.5	-9.7	-46.2	-13.0	-33.2
2	110.83	-39.8	-47.7	0.4	-47.3	-13.0	-34.3
3	288.04	-59.4	-67.9	5.2	-62.7	-13.0	-49.7
4	381.31	-62.8	-69.0	5.3	-63.7	-13.0	-50.7
5	902.07	-55.8	-52.9	3.9	-49.0	-13.0	-36.0
6	931.60	-57.1	-53.9	3.9	-50.0	-13.0	-37.0

Antenna Polarity & Test Distance: Vertical at 3 M							
No.	Freq. (MHz)	Reading (dBm)	S.G Power Value (dBm)	Correction Factor (dB)	ERP (dBm)	Limit (dBm)	Margin (dB)
1	67.31	-41.7	-42.4	-5.7	-48.1	-13.0	-35.1
2	110.83	-42.9	-50.0	0.4	-49.6	-13.0	-36.6
3	235.19	-57.6	-62.8	5.4	-57.4	-13.0	-44.4
4	280.27	-57.8	-61.6	5.3	-56.3	-13.0	-43.3
5	729.52	-59.9	-59.1	4.9	-54.2	-13.0	-41.2
6	936.27	-56.2	-51.4	3.9	-47.5	-13.0	-34.5

Remarks:

1. Output Power (dBm) = S.G Value (dBm) + Correction Factor (dB).
2. Correction Factor (dB) = Substitution Antenna Gain (dB) + Cable Loss (dB).

Channel Bandwidth: 10MHz

Mode	TX channel 23780 (710.0MHz)	Frequency Range	Below 1000 MHz
Environmental Conditions	20deg. C, 69%RH	Input Power	120Vac, 60Hz
Tested By	Bond Tseng	Test Mode	A

Antenna Polarity & Test Distance: Horizontal at 3 M							
No.	Freq. (MHz)	Reading (dBm)	S.G Power Value (dBm)	Correction Factor (dB)	ERP (dBm)	Limit (dBm)	Margin (dB)
1	33.88	-48.9	-31.0	-17.1	-48.1	-13.0	-35.1
2	97.90	-41.4	-50.8	-1.4	-52.2	-13.0	-39.2
3	152.22	-47.1	-50.7	-2.8	-53.5	-13.0	-40.5
4	189.08	-47.0	-54.8	-2.8	-57.6	-13.0	-44.6
5	429.64	-63.1	-69.3	3.5	-65.8	-13.0	-52.8
6	955.38	-63.9	-61.3	3.8	-57.5	-13.0	-44.5
Antenna Polarity & Test Distance: Vertical at 3 M							
No.	Freq. (MHz)	Reading (dBm)	S.G Power Value (dBm)	Correction Factor (dB)	ERP (dBm)	Limit (dBm)	Margin (dB)
1	88.20	-31.2	-39.6	-0.2	-39.8	-13.0	-26.8
2	138.64	-46.5	-48.4	-3.2	-51.6	-13.0	-38.6
3	191.02	-54.9	-56.2	-2.7	-58.9	-13.0	-45.9
4	297.72	-56.5	-57.3	-1.7	-59.0	-13.0	-46.0
5	429.64	-57.7	-63.7	3.5	-60.2	-13.0	-47.2
6	951.50	-58.1	-54.8	3.8	-51.0	-13.0	-38.0

Remarks:

1. Output Power (dBm) = S.G Value (dBm) + Correction Factor (dB).
2. Correction Factor (dB) = Substitution Antenna Gain (dB) + Cable Loss (dB).

Above 1GHz
 WCDMA Band 4

Mode	TX channel 1312 (1712.4MHz)	Frequency Range	Above 1000MHz
Environmental Conditions	20deg. C, 69%RH	Input Power	120Vac, 60Hz
Tested By	Bond Tseng		

Antenna Polarity & Test Distance: Horizontal at 3 M							
No.	Freq. (MHz)	Reading (dBm)	S.G Power Value (dBm)	Correction Factor (dB)	EIRP (dBm)	Limit (dBm)	Margin (dB)
1	3424.80	-56.5	-47.9	1.3	-46.6	-13.0	-33.6
2	5137.20	-61.0	-48.8	1.4	-47.4	-13.0	-34.4
Antenna Polarity & Test Distance: Vertical at 3 M							
No.	Freq. (MHz)	Reading (dBm)	S.G Power Value (dBm)	Correction Factor (dB)	EIRP (dBm)	Limit (dBm)	Margin (dB)
1	3424.80	-57.2	-49.1	1.3	-47.8	-13.0	-34.8
2	5137.20	-61.2	-49.3	1.4	-47.9	-13.0	-34.9

Remarks:

1. Output Power (dBm) = S.G Value (dBm) + Correction Factor (dB).
2. Correction Factor (dB) = Substitution Antenna Gain (dB) + Cable Loss (dB).

Mode	TX channel 1413 (1732.6MHz)	Frequency Range	Above 1000MHz
Environmental Conditions	20deg. C, 69%RH	Input Power	120Vac, 60Hz
Tested By	Bond Tseng		

Antenna Polarity & Test Distance: Horizontal at 3 M							
No.	Freq. (MHz)	Reading (dBm)	S.G Power Value (dBm)	Correction Factor (dB)	EIRP (dBm)	Limit (dBm)	Margin (dB)
1	3465.20	-56.7	-48.3	1.4	-46.9	-13.0	-33.9
2	5197.80	-61.1	-49.5	1.4	-48.1	-13.0	-35.1
Antenna Polarity & Test Distance: Vertical at 3 M							
No.	Freq. (MHz)	Reading (dBm)	S.G Power Value (dBm)	Correction Factor (dB)	EIRP (dBm)	Limit (dBm)	Margin (dB)
1	3465.20	-56.9	-49.1	1.4	-47.7	-13.0	-34.7
2	5197.80	-60.8	-48.6	1.4	-47.2	-13.0	-34.2

Remarks:

1. Output Power (dBm) = S.G Value (dBm) + Correction Factor (dB).
2. Correction Factor (dB) = Substitution Antenna Gain (dB) + Cable Loss (dB).

Mode	TX channel 1513 (1752.6MHz)	Frequency Range	Above 1000MHz
Environmental Conditions	20deg. C, 69%RH	Input Power	120Vac, 60Hz
Tested By	Bond Tseng		

Antenna Polarity & Test Distance: Horizontal at 3 M							
No.	Freq. (MHz)	Reading (dBm)	S.G Power Value (dBm)	Correction Factor (dB)	EIRP (dBm)	Limit (dBm)	Margin (dB)
1	5257.80	-56.8	-45.0	1.5	-43.5	-13.0	-30.5
2	7010.40	-60.9	-43.0	0.6	-42.4	-13.0	-29.4
Antenna Polarity & Test Distance: Vertical at 3 M							
No.	Freq. (MHz)	Reading (dBm)	S.G Power Value (dBm)	Correction Factor (dB)	EIRP (dBm)	Limit (dBm)	Margin (dB)
1	3505.20	-57.3	-49.7	1.5	-48.2	-13.0	-35.2
2	7010.40	-60.9	-44.0	0.6	-43.4	-13.0	-30.4

Remarks:

1. Output Power (dBm) = S.G Value (dBm) + Correction Factor (dB).
2. Correction Factor (dB) = Substitution Antenna Gain (dB) + Cable Loss (dB).

LTE Band 4

Channel Bandwidth: 1.4MHz

Mode	TX channel 19957 (1710.7MHz)	Frequency Range	Above 1000MHz
Environmental Conditions	20deg. C, 69%RH	Input Power	120Vac, 60Hz
Tested By	Bond Tseng		

Antenna Polarity & Test Distance: Horizontal at 3 M							
No.	Freq. (MHz)	Reading (dBm)	S.G Power Value (dBm)	Correction Factor (dB)	EIRP (dBm)	Limit (dBm)	Margin (dB)
1	3421.40	-54.2	-45.6	1.3	-44.3	-13.0	-31.3
2	5132.10	-53.4	-41.2	1.4	-39.8	-13.0	-26.8
Antenna Polarity & Test Distance: Vertical at 3 M							
No.	Freq. (MHz)	Reading (dBm)	S.G Power Value (dBm)	Correction Factor (dB)	EIRP (dBm)	Limit (dBm)	Margin (dB)
1	3421.40	-53.0	-44.9	1.3	-43.6	-13.0	-30.6
2	5132.10	-54.5	-42.7	1.4	-41.3	-13.0	-28.3

Remarks:

1. Output Power (dBm) = S.G Value (dBm) + Correction Factor (dB).
2. Correction Factor (dB) = Substitution Antenna Gain (dB) + Cable Loss (dB).

Mode	TX channel 20175 (1732.5MHz)	Frequency Range	Above 1000MHz
Environmental Conditions	20deg. C, 69%RH	Input Power	120Vac, 60Hz
Tested By	Bond Tseng		

Antenna Polarity & Test Distance: Horizontal at 3 M							
No.	Freq. (MHz)	Reading (dBm)	S.G Power Value (dBm)	Correction Factor (dB)	EIRP (dBm)	Limit (dBm)	Margin (dB)
1	3465.00	-54.9	-46.5	1.4	-45.1	-13.0	-32.1
2	5197.50	-53.7	-42.1	1.4	-40.7	-13.0	-27.7
Antenna Polarity & Test Distance: Vertical at 3 M							
No.	Freq. (MHz)	Reading (dBm)	S.G Power Value (dBm)	Correction Factor (dB)	EIRP (dBm)	Limit (dBm)	Margin (dB)
1	3465.00	-54.6	-46.8	1.4	-45.4	-13.0	-32.4
2	5197.50	-54.8	-42.6	1.4	-41.2	-13.0	-28.2

Remarks:

1. Output Power (dBm) = S.G Value (dBm) + Correction Factor (dB).
2. Correction Factor (dB) = Substitution Antenna Gain (dB) + Cable Loss (dB).

Mode	TX channel 20393 (1754.3MHz)	Frequency Range	Above 1000MHz
Environmental Conditions	20deg. C, 69%RH	Input Power	120Vac, 60Hz
Tested By	Bond Tseng		

Antenna Polarity & Test Distance: Horizontal at 3 M							
No.	Freq. (MHz)	Reading (dBm)	S.G Power Value (dBm)	Correction Factor (dB)	EIRP (dBm)	Limit (dBm)	Margin (dB)
1	3508.60	-53.9	-45.6	1.4	-44.2	-13.0	-31.2
2	5262.90	-53.7	-41.9	1.5	-40.4	-13.0	-27.4
Antenna Polarity & Test Distance: Vertical at 3 M							
No.	Freq. (MHz)	Reading (dBm)	S.G Power Value (dBm)	Correction Factor (dB)	EIRP (dBm)	Limit (dBm)	Margin (dB)
1	3508.60	-54.3	-46.6	1.4	-45.2	-13.0	-32.2
2	5262.90	-54.3	-42.7	1.5	-41.2	-13.0	-28.2

Remarks:

1. Output Power (dBm) = S.G Value (dBm) + Correction Factor (dB).
2. Correction Factor (dB) = Substitution Antenna Gain (dB) + Cable Loss (dB).

Channel Bandwidth: 3MHz

Mode	TX channel 19965 (1711.5MHz)	Frequency Range	Above 1000MHz
Environmental Conditions	20deg. C, 69%RH	Input Power	120Vac, 60Hz
Tested By	Bond Tseng		

Antenna Polarity & Test Distance: Horizontal at 3 M							
No.	Freq. (MHz)	Reading (dBm)	S.G Power Value (dBm)	Correction Factor (dB)	EIRP (dBm)	Limit (dBm)	Margin (dB)
1	3423.00	-54.5	-45.9	1.3	-44.6	-13.0	-31.6
2	5134.50	-52.9	-40.7	1.4	-39.3	-13.0	-26.3
Antenna Polarity & Test Distance: Vertical at 3 M							
No.	Freq. (MHz)	Reading (dBm)	S.G Power Value (dBm)	Correction Factor (dB)	EIRP (dBm)	Limit (dBm)	Margin (dB)
1	3423.00	-53.5	-45.4	1.3	-44.1	-13.0	-31.1
2	5134.50	-54.8	-43.0	1.4	-41.6	-13.0	-28.6

Remarks:

1. Output Power (dBm) = S.G Value (dBm) + Correction Factor (dB).
2. Correction Factor (dB) = Substitution Antenna Gain (dB) + Cable Loss (dB).

Mode	TX channel 20175 (1732.5MHz)	Frequency Range	Above 1000MHz
Environmental Conditions	20deg. C, 69%RH	Input Power	120Vac, 60Hz
Tested By	Bond Tseng		

Antenna Polarity & Test Distance: Horizontal at 3 M							
No.	Freq. (MHz)	Reading (dBm)	S.G Power Value (dBm)	Correction Factor (dB)	EIRP (dBm)	Limit (dBm)	Margin (dB)
1	3465.00	-54.1	-45.7	1.4	-44.3	-13.0	-31.3
2	5197.50	-54.3	-42.7	1.4	-41.3	-13.0	-28.3
Antenna Polarity & Test Distance: Vertical at 3 M							
No.	Freq. (MHz)	Reading (dBm)	S.G Power Value (dBm)	Correction Factor (dB)	EIRP (dBm)	Limit (dBm)	Margin (dB)
1	3465.00	-54.8	-47.0	1.4	-45.6	-13.0	-32.6
2	5197.50	-54.3	-42.1	1.4	-40.7	-13.0	-27.7

Remarks:

1. Output Power (dBm) = S.G Value (dBm) + Correction Factor (dB).
2. Correction Factor (dB) = Substitution Antenna Gain (dB) + Cable Loss (dB).

Mode	TX channel 20385 (1753.5MHz)	Frequency Range	Above 1000MHz
Environmental Conditions	20deg. C, 69%RH	Input Power	120Vac, 60Hz
Tested By	Bond Tseng		

Antenna Polarity & Test Distance: Horizontal at 3 M							
No.	Freq. (MHz)	Reading (dBm)	S.G Power Value (dBm)	Correction Factor (dB)	EIRP (dBm)	Limit (dBm)	Margin (dB)
1	3507.00	-54.3	-46.0	1.4	-44.6	-13.0	-31.6
2	5260.50	-54.3	-42.5	1.5	-41.0	-13.0	-28.0
Antenna Polarity & Test Distance: Vertical at 3 M							
No.	Freq. (MHz)	Reading (dBm)	S.G Power Value (dBm)	Correction Factor (dB)	EIRP (dBm)	Limit (dBm)	Margin (dB)
1	3507.00	-54.9	-47.2	1.4	-45.8	-13.0	-32.8
2	5260.50	-54.7	-43.1	1.5	-41.6	-13.0	-28.6

Remarks:

1. Output Power (dBm) = S.G Value (dBm) + Correction Factor (dB).
2. Correction Factor (dB) = Substitution Antenna Gain (dB) + Cable Loss (dB).

Channel Bandwidth: 5MHz

Mode	TX channel 19975 (1712.5MHz)	Frequency Range	Above 1000MHz
Environmental Conditions	20deg. C, 69%RH	Input Power	120Vac, 60Hz
Tested By	Bond Tseng		

Antenna Polarity & Test Distance: Horizontal at 3 M							
No.	Freq. (MHz)	Reading (dBm)	S.G Power Value (dBm)	Correction Factor (dB)	EIRP (dBm)	Limit (dBm)	Margin (dB)
1	3425.00	-54.7	-46.1	1.3	-44.8	-13.0	-31.8
2	5137.50	-53.8	-41.6	1.4	-40.2	-13.0	-27.2
Antenna Polarity & Test Distance: Vertical at 3 M							
No.	Freq. (MHz)	Reading (dBm)	S.G Power Value (dBm)	Correction Factor (dB)	EIRP (dBm)	Limit (dBm)	Margin (dB)
1	3425.00	-53.7	-45.6	1.3	-44.3	-13.0	-31.3
2	5137.50	-54.9	-43.0	1.4	-41.6	-13.0	-28.6

Remarks:

1. Output Power (dBm) = S.G Value (dBm) + Correction Factor (dB).
2. Correction Factor (dB) = Substitution Antenna Gain (dB) + Cable Loss (dB).

Mode	TX channel 20175 (1732.5MHz)	Frequency Range	Above 1000MHz
Environmental Conditions	20deg. C, 69%RH	Input Power	120Vac, 60Hz
Tested By	Bond Tseng		

Antenna Polarity & Test Distance: Horizontal at 3 M							
No.	Freq. (MHz)	Reading (dBm)	S.G Power Value (dBm)	Correction Factor (dB)	EIRP (dBm)	Limit (dBm)	Margin (dB)
1	3465.00	-54.2	-45.8	1.4	-44.4	-13.0	-31.4
2	5197.50	-53.4	-41.8	1.4	-40.4	-13.0	-27.4
Antenna Polarity & Test Distance: Vertical at 3 M							
No.	Freq. (MHz)	Reading (dBm)	S.G Power Value (dBm)	Correction Factor (dB)	EIRP (dBm)	Limit (dBm)	Margin (dB)
1	3465.00	-54.2	-46.4	1.4	-45.0	-13.0	-32.0
2	5197.50	-54.2	-42.0	1.4	-40.6	-13.0	-27.6

Remarks:

1. Output Power (dBm) = S.G Value (dBm) + Correction Factor (dB).
2. Correction Factor (dB) = Substitution Antenna Gain (dB) + Cable Loss (dB).

Mode	TX channel 20375 (1752.5MHz)	Frequency Range	Above 1000MHz
Environmental Conditions	20deg. C, 69%RH	Input Power	120Vac, 60Hz
Tested By	Bond Tseng		

Antenna Polarity & Test Distance: Horizontal at 3 M							
No.	Freq. (MHz)	Reading (dBm)	S.G Power Value (dBm)	Correction Factor (dB)	EIRP (dBm)	Limit (dBm)	Margin (dB)
1	3505.00	-54.2	-46.0	1.5	-44.5	-13.0	-31.5
2	5257.50	-53.4	-41.6	1.5	-40.1	-13.0	-27.1
Antenna Polarity & Test Distance: Vertical at 3 M							
No.	Freq. (MHz)	Reading (dBm)	S.G Power Value (dBm)	Correction Factor (dB)	EIRP (dBm)	Limit (dBm)	Margin (dB)
1	3505.00	-54.8	-47.2	1.5	-45.7	-13.0	-32.7
2	5257.50	-54.9	-43.3	1.5	-41.8	-13.0	-28.8

Remarks:

1. Output Power (dBm) = S.G Value (dBm) + Correction Factor (dB).
2. Correction Factor (dB) = Substitution Antenna Gain (dB) + Cable Loss (dB).

Channel Bandwidth: 10MHz

Mode	TX channel 20000 (1715.0MHz)	Frequency Range	Above 1000MHz
Environmental Conditions	20deg. C, 69%RH	Input Power	120Vac, 60Hz
Tested By	Bond Tseng		

Antenna Polarity & Test Distance: Horizontal at 3 M							
No.	Freq. (MHz)	Reading (dBm)	S.G Power Value (dBm)	Correction Factor (dB)	EIRP (dBm)	Limit (dBm)	Margin (dB)
1	3430.00	-53.2	-44.7	1.4	-43.3	-13.0	-30.3
2	5145.00	-55.1	-43.0	1.4	-41.6	-13.0	-28.6
Antenna Polarity & Test Distance: Vertical at 3 M							
No.	Freq. (MHz)	Reading (dBm)	S.G Power Value (dBm)	Correction Factor (dB)	EIRP (dBm)	Limit (dBm)	Margin (dB)
1	3430.00	-54.2	-46.2	1.4	-44.8	-13.0	-31.8
2	5145.00	-54.3	-42.4	1.4	-41.0	-13.0	-28.0

Remarks:

1. Output Power (dBm) = S.G Value (dBm) + Correction Factor (dB).
2. Correction Factor (dB) = Substitution Antenna Gain (dB) + Cable Loss (dB).

Mode	TX channel 20175 (1732.5MHz)	Frequency Range	Above 1000MHz
Environmental Conditions	20deg. C, 69%RH	Input Power	120Vac, 60Hz
Tested By	Bond Tseng		

Antenna Polarity & Test Distance: Horizontal at 3 M							
No.	Freq. (MHz)	Reading (dBm)	S.G Power Value (dBm)	Correction Factor (dB)	EIRP (dBm)	Limit (dBm)	Margin (dB)
1	3465.00	-53.8	-45.4	1.4	-44.0	-13.0	-31.0
2	5197.50	-53.9	-42.3	1.4	-40.9	-13.0	-27.9
Antenna Polarity & Test Distance: Vertical at 3 M							
No.	Freq. (MHz)	Reading (dBm)	S.G Power Value (dBm)	Correction Factor (dB)	EIRP (dBm)	Limit (dBm)	Margin (dB)
1	3465.00	-54.6	-46.8	1.4	-45.4	-13.0	-32.4
2	5197.50	-54.9	-42.7	1.4	-41.3	-13.0	-28.3

Remarks:

1. Output Power (dBm) = S.G Value (dBm) + Correction Factor (dB).
2. Correction Factor (dB) = Substitution Antenna Gain (dB) + Cable Loss (dB).

Mode	TX channel 20350 (1750.0MHz)	Frequency Range	Above 1000MHz
Environmental Conditions	20deg. C, 69%RH	Input Power	120Vac, 60Hz
Tested By	Bond Tseng		

Antenna Polarity & Test Distance: Horizontal at 3 M							
No.	Freq. (MHz)	Reading (dBm)	S.G Power Value (dBm)	Correction Factor (dB)	EIRP (dBm)	Limit (dBm)	Margin (dB)
1	3500.00	-53.7	-45.5	1.5	-44.0	-13.0	-31.0
2	5250.00	-53.1	-41.4	1.5	-39.9	-13.0	-26.9
Antenna Polarity & Test Distance: Vertical at 3 M							
No.	Freq. (MHz)	Reading (dBm)	S.G Power Value (dBm)	Correction Factor (dB)	EIRP (dBm)	Limit (dBm)	Margin (dB)
1	3500.00	-54.6	-47.0	1.5	-45.5	-13.0	-32.5
2	5250.00	-54.4	-42.7	1.5	-41.2	-13.0	-28.2

Remarks:

1. Output Power (dBm) = S.G Value (dBm) + Correction Factor (dB).
2. Correction Factor (dB) = Substitution Antenna Gain (dB) + Cable Loss (dB).

Channel Bandwidth: 15MHz

Mode	TX channel 20025 (1717.5MHz)	Frequency Range	Above 1000MHz
Environmental Conditions	20deg. C, 69%RH	Input Power	120Vac, 60Hz
Tested By	Bond Tseng		

Antenna Polarity & Test Distance: Horizontal at 3 M							
No.	Freq. (MHz)	Reading (dBm)	S.G Power Value (dBm)	Correction Factor (dB)	EIRP (dBm)	Limit (dBm)	Margin (dB)
1	3435.00	-54.8	-46.2	1.3	-44.9	-13.0	-31.9
2	5152.50	-54.2	-42.2	1.4	-40.8	-13.0	-27.8
Antenna Polarity & Test Distance: Vertical at 3 M							
No.	Freq. (MHz)	Reading (dBm)	S.G Power Value (dBm)	Correction Factor (dB)	EIRP (dBm)	Limit (dBm)	Margin (dB)
1	3435.00	-53.6	-45.5	1.3	-44.2	-13.0	-31.2
2	5152.50	-54.2	-42.2	1.4	-40.8	-13.0	-27.8

Remarks:

1. Output Power (dBm) = S.G Value (dBm) + Correction Factor (dB).
2. Correction Factor (dB) = Substitution Antenna Gain (dB) + Cable Loss (dB).

Mode	TX channel 20175 (1732.5MHz)	Frequency Range	Above 1000MHz
Environmental Conditions	20deg. C, 69%RH	Input Power	120Vac, 60Hz
Tested By	Bond Tseng		

Antenna Polarity & Test Distance: Horizontal at 3 M							
No.	Freq. (MHz)	Reading (dBm)	S.G Power Value (dBm)	Correction Factor (dB)	EIRP (dBm)	Limit (dBm)	Margin (dB)
1	3465.00	-54.2	-45.8	1.4	-44.4	-13.0	-31.4
2	5197.50	-54.2	-42.6	1.4	-41.2	-13.0	-28.2
Antenna Polarity & Test Distance: Vertical at 3 M							
No.	Freq. (MHz)	Reading (dBm)	S.G Power Value (dBm)	Correction Factor (dB)	EIRP (dBm)	Limit (dBm)	Margin (dB)
1	3465.00	-55.1	-47.3	1.4	-45.9	-13.0	-32.9
2	5197.50	-54.2	-42.0	1.4	-40.6	-13.0	-27.6

Remarks:

1. Output Power (dBm) = S.G Value (dBm) + Correction Factor (dB).
2. Correction Factor (dB) = Substitution Antenna Gain (dB) + Cable Loss (dB).

Mode	TX channel 20325 (1747.5MHz)	Frequency Range	Above 1000MHz
Environmental Conditions	20deg. C, 69%RH	Input Power	120Vac, 60Hz
Tested By	Bond Tseng		

Antenna Polarity & Test Distance: Horizontal at 3 M							
No.	Freq. (MHz)	Reading (dBm)	S.G Power Value (dBm)	Correction Factor (dB)	EIRP (dBm)	Limit (dBm)	Margin (dB)
1	3495.00	-53.6	-45.4	1.5	-43.9	-13.0	-30.9
2	5242.50	-54.2	-42.4	1.4	-41.0	-13.0	-28.0
Antenna Polarity & Test Distance: Vertical at 3 M							
No.	Freq. (MHz)	Reading (dBm)	S.G Power Value (dBm)	Correction Factor (dB)	EIRP (dBm)	Limit (dBm)	Margin (dB)
1	3495.00	-54.8	-47.2	1.5	-45.7	-13.0	-32.7
2	5242.50	-54.6	-42.7	1.4	-41.3	-13.0	-28.3

Remarks:

1. Output Power (dBm) = S.G Value (dBm) + Correction Factor (dB).
2. Correction Factor (dB) = Substitution Antenna Gain (dB) + Cable Loss (dB).

Channel Bandwidth: 20MHz

Mode	TX channel 20050 (1720.0MHz)	Frequency Range	Above 1000MHz
Environmental Conditions	20deg. C, 69%RH	Input Power	120Vac, 60Hz
Tested By	Bond Tseng		

Antenna Polarity & Test Distance: Horizontal at 3 M							
No.	Freq. (MHz)	Reading (dBm)	S.G Power Value (dBm)	Correction Factor (dB)	EIRP (dBm)	Limit (dBm)	Margin (dB)
1	3440.00	-54.6	-46.1	1.3	-44.8	-13.0	-31.8
2	5160.00	-53.9	-41.9	1.4	-40.5	-13.0	-27.5
Antenna Polarity & Test Distance: Vertical at 3 M							
No.	Freq. (MHz)	Reading (dBm)	S.G Power Value (dBm)	Correction Factor (dB)	EIRP (dBm)	Limit (dBm)	Margin (dB)
1	3440.00	-53.3	-45.3	1.3	-44.0	-13.0	-31.0
2	5160.00	-54.2	-42.2	1.4	-40.8	-13.0	-27.8

Remarks:

1. Output Power (dBm) = S.G Value (dBm) + Correction Factor (dB).
2. Correction Factor (dB) = Substitution Antenna Gain (dB) + Cable Loss (dB).

Mode	TX channel 20175 (1732.5MHz)	Frequency Range	Above 1000MHz
Environmental Conditions	20deg. C, 69%RH	Input Power	120Vac, 60Hz
Tested By	Bond Tseng		

Antenna Polarity & Test Distance: Horizontal at 3 M							
No.	Freq. (MHz)	Reading (dBm)	S.G Power Value (dBm)	Correction Factor (dB)	EIRP (dBm)	Limit (dBm)	Margin (dB)
1	3465.00	-54.3	-45.9	1.4	-44.5	-13.0	-31.5
2	5197.50	-54.6	-43.0	1.4	-41.6	-13.0	-28.6
Antenna Polarity & Test Distance: Vertical at 3 M							
No.	Freq. (MHz)	Reading (dBm)	S.G Power Value (dBm)	Correction Factor (dB)	EIRP (dBm)	Limit (dBm)	Margin (dB)
1	3465.00	-54.7	-46.9	1.4	-45.5	-13.0	-32.5
2	5197.50	-54.5	-42.3	1.4	-40.9	-13.0	-27.9

Remarks:

1. Output Power (dBm) = S.G Value (dBm) + Correction Factor (dB).
2. Correction Factor (dB) = Substitution Antenna Gain (dB) + Cable Loss (dB).

Mode	TX channel 20300 (1745.0MHz)	Frequency Range	Above 1000MHz
Environmental Conditions	20deg. C, 69%RH	Input Power	120Vac, 60Hz
Tested By	Bond Tseng		

Antenna Polarity & Test Distance: Horizontal at 3 M							
No.	Freq. (MHz)	Reading (dBm)	S.G Power Value (dBm)	Correction Factor (dB)	EIRP (dBm)	Limit (dBm)	Margin (dB)
1	3490.00	-53.8	-45.6	1.5	-44.1	-13.0	-31.1
2	5235.00	-54.1	-42.3	1.4	-40.9	-13.0	-27.9
Antenna Polarity & Test Distance: Vertical at 3 M							
No.	Freq. (MHz)	Reading (dBm)	S.G Power Value (dBm)	Correction Factor (dB)	EIRP (dBm)	Limit (dBm)	Margin (dB)
1	3490.00	-54.7	-47.1	1.5	-45.6	-13.0	-32.6
2	5235.00	-53.8	-41.9	1.4	-40.5	-13.0	-27.5

Remarks:

1. Output Power (dBm) = S.G Value (dBm) + Correction Factor (dB).
2. Correction Factor (dB) = Substitution Antenna Gain (dB) + Cable Loss (dB).

LTE Band 12

Channel Bandwidth: 1.4MHz

Mode	TX channel 23017 (699.7MHz)	Frequency Range	Above 1000MHz
Environmental Conditions	20deg. C, 69%RH	Input Power	120Vac, 60Hz
Tested By	Bayu Chen		

Antenna Polarity & Test Distance: Horizontal at 3 M							
No.	Freq. (MHz)	Reading (dBm)	S.G Power Value (dBm)	Correction Factor (dB)	ERP (dBm)	Limit (dBm)	Margin (dB)
1	1399.40	-52.2	-46.0	0.9	-45.1	-13.0	-32.1
2	2099.10	-44.1	-39.2	-0.3	-39.5	-13.0	-26.5
3	3498.50	-50.3	-44.3	1.5	-42.8	-13.0	-29.8
Antenna Polarity & Test Distance: Vertical at 3 M							
No.	Freq. (MHz)	Reading (dBm)	S.G Power Value (dBm)	Correction Factor (dB)	ERP (dBm)	Limit (dBm)	Margin (dB)
1	1399.40	-52.0	-46.9	0.9	-46.0	-13.0	-33.0
2	2099.10	-38.8	-35.2	-0.3	-35.5	-13.0	-22.5
3	3498.50	-55.0	-49.5	1.5	-48.0	-13.0	-35.0

Remarks:

1. Output Power (dBm) = S.G Value (dBm) + Correction Factor (dB).
2. Correction Factor (dB) = Substitution Antenna Gain (dB) + Cable Loss (dB).

Mode	TX channel 23095 (707.5MHz)	Frequency Range	Above 1000MHz
Environmental Conditions	20deg. C, 69%RH	Input Power	120Vac, 60Hz
Tested By	Bayu Chen		

Antenna Polarity & Test Distance: Horizontal at 3 M							
No.	Freq. (MHz)	Reading (dBm)	S.G Power Value (dBm)	Correction Factor (dB)	ERP (dBm)	Limit (dBm)	Margin (dB)
1	1415.00	-52.3	-45.8	0.9	-44.9	-13.0	-31.9
2	2122.50	-43.4	-38.5	-0.3	-38.8	-13.0	-25.8
3	3537.50	-49.8	-43.5	1.4	-42.1	-13.0	-29.1
Antenna Polarity & Test Distance: Vertical at 3 M							
No.	Freq. (MHz)	Reading (dBm)	S.G Power Value (dBm)	Correction Factor (dB)	ERP (dBm)	Limit (dBm)	Margin (dB)
1	1415.00	-54.2	-48.9	0.9	-48.0	-13.0	-35.0
2	2122.50	-38.2	-34.5	-0.3	-34.8	-13.0	-21.8
3	3537.50	-54.3	-48.7	1.4	-47.3	-13.0	-34.3

Remarks:

1. Output Power (dBm) = S.G Value (dBm) + Correction Factor (dB).
2. Correction Factor (dB) = Substitution Antenna Gain (dB) + Cable Loss (dB).

Mode	TX channel 23173 (715.3MHz)	Frequency Range	Above 1000MHz
Environmental Conditions	20deg. C, 69%RH	Input Power	120Vac, 60Hz
Tested By	Bayu Chen		

Antenna Polarity & Test Distance: Horizontal at 3 M							
No.	Freq. (MHz)	Reading (dBm)	S.G Power Value (dBm)	Correction Factor (dB)	ERP (dBm)	Limit (dBm)	Margin (dB)
1	1430.60	-54.0	-47.3	1.0	-46.3	-13.0	-33.3
2	2145.90	-44.2	-39.3	-0.3	-39.6	-13.0	-26.6
3	3576.50	-51.2	-44.9	1.4	-43.5	-13.0	-30.5
Antenna Polarity & Test Distance: Vertical at 3 M							
No.	Freq. (MHz)	Reading (dBm)	S.G Power Value (dBm)	Correction Factor (dB)	ERP (dBm)	Limit (dBm)	Margin (dB)
1	1430.60	-57.3	-51.8	1.0	-50.8	-13.0	-37.8
2	2145.90	-39.0	-35.1	-0.3	-35.4	-13.0	-22.4
3	3576.50	-55.4	-49.7	1.4	-48.3	-13.0	-35.3

Remarks:

1. Output Power (dBm) = S.G Value (dBm) + Correction Factor (dB).
2. Correction Factor (dB) = Substitution Antenna Gain (dB) + Cable Loss (dB).

Channel Bandwidth: 3MHz

Mode	TX channel 23025 (700.5MHz)	Frequency Range	Above 1000MHz
Environmental Conditions	20deg. C, 69%RH	Input Power	120Vac, 60Hz
Tested By	Bayu Chen		

Antenna Polarity & Test Distance: Horizontal at 3 M							
No.	Freq. (MHz)	Reading (dBm)	S.G Power Value (dBm)	Correction Factor (dB)	ERP (dBm)	Limit (dBm)	Margin (dB)
1	1401.00	-51.4	-45.2	0.9	-44.3	-13.0	-31.3
2	2101.50	-44.9	-40.0	-0.3	-40.3	-13.0	-27.3
3	3502.50	-49.8	-43.7	1.5	-42.2	-13.0	-29.2
Antenna Polarity & Test Distance: Vertical at 3 M							
No.	Freq. (MHz)	Reading (dBm)	S.G Power Value (dBm)	Correction Factor (dB)	ERP (dBm)	Limit (dBm)	Margin (dB)
1	1401.00	-53.8	-48.6	0.9	-47.7	-13.0	-34.7
2	2101.50	-38.5	-35.0	-0.3	-35.3	-13.0	-22.3
3	3502.50	-55.2	-49.7	1.5	-48.2	-13.0	-35.2

Remarks:

- Output Power (dBm) = S.G Value (dBm) + Correction Factor (dB).
- Correction Factor (dB) = Substitution Antenna Gain (dB) + Cable Loss (dB).

Mode	TX channel 23095 (707.5MHz)	Frequency Range	Above 1000MHz
Environmental Conditions	20deg. C, 69%RH	Input Power	120Vac, 60Hz
Tested By	Bayu Chen		

Antenna Polarity & Test Distance: Horizontal at 3 M							
No.	Freq. (MHz)	Reading (dBm)	S.G Power Value (dBm)	Correction Factor (dB)	ERP (dBm)	Limit (dBm)	Margin (dB)
1	1415.00	-52.5	-45.9	0.9	-45.0	-13.0	-32.0
2	2122.50	-44.0	-39.1	-0.3	-39.4	-13.0	-26.4
3	3537.50	-50.4	-44.2	1.4	-42.8	-13.0	-29.8
Antenna Polarity & Test Distance: Vertical at 3 M							
No.	Freq. (MHz)	Reading (dBm)	S.G Power Value (dBm)	Correction Factor (dB)	ERP (dBm)	Limit (dBm)	Margin (dB)
1	1415.00	-54.5	-49.2	0.9	-48.3	-13.0	-35.3
2	2122.50	-39.1	-35.3	-0.3	-35.6	-13.0	-22.6
3	3537.50	-54.9	-49.3	1.4	-47.9	-13.0	-34.9

Remarks:

- Output Power (dBm) = S.G Value (dBm) + Correction Factor (dB).
- Correction Factor (dB) = Substitution Antenna Gain (dB) + Cable Loss (dB).

Mode	TX channel 23165 (714.5MHz)	Frequency Range	Above 1000MHz
Environmental Conditions	20deg. C, 69%RH	Input Power	120Vac, 60Hz
Tested By	Bayu Chen		

Antenna Polarity & Test Distance: Horizontal at 3 M							
No.	Freq. (MHz)	Reading (dBm)	S.G Power Value (dBm)	Correction Factor (dB)	ERP (dBm)	Limit (dBm)	Margin (dB)
1	1429.00	-52.4	-45.8	1.0	-44.8	-13.0	-31.8
2	2143.50	-45.4	-40.4	-0.3	-40.7	-13.0	-27.7
3	3572.50	-50.9	-44.5	1.4	-43.1	-13.0	-30.1
Antenna Polarity & Test Distance: Vertical at 3 M							
No.	Freq. (MHz)	Reading (dBm)	S.G Power Value (dBm)	Correction Factor (dB)	ERP (dBm)	Limit (dBm)	Margin (dB)
1	1429.00	-52.9	-47.4	1.0	-46.4	-13.0	-33.4
2	2143.50	-38.3	-34.5	-0.3	-34.8	-13.0	-21.8
3	3572.50	-55.9	-50.1	1.4	-48.7	-13.0	-35.7

Remarks:

1. Output Power (dBm) = S.G Value (dBm) + Correction Factor (dB).
2. Correction Factor (dB) = Substitution Antenna Gain (dB) + Cable Loss (dB).

Channel Bandwidth: 5MHz

Mode	TX channel 23035 (701.5MHz)	Frequency Range	Above 1000MHz
Environmental Conditions	20deg. C, 69%RH	Input Power	120Vac, 60Hz
Tested By	Bayu Chen		

Antenna Polarity & Test Distance: Horizontal at 3 M							
No.	Freq. (MHz)	Reading (dBm)	S.G Power Value (dBm)	Correction Factor (dB)	ERP (dBm)	Limit (dBm)	Margin (dB)
1	1403.00	-51.5	-45.1	0.9	-44.2	-13.0	-31.2
2	2104.50	-44.4	-39.5	-0.3	-39.8	-13.0	-26.8
3	3507.50	-50.8	-44.7	1.4	-43.3	-13.0	-30.3
Antenna Polarity & Test Distance: Vertical at 3 M							
No.	Freq. (MHz)	Reading (dBm)	S.G Power Value (dBm)	Correction Factor (dB)	ERP (dBm)	Limit (dBm)	Margin (dB)
1	1403.00	-51.2	-46.1	0.9	-45.2	-13.0	-32.2
2	2104.50	-38.5	-34.9	-0.3	-35.2	-13.0	-22.2
3	3507.50	-55.3	-49.8	1.4	-48.4	-13.0	-35.4

Remarks:

1. Output Power (dBm) = S.G Value (dBm) + Correction Factor (dB).
2. Correction Factor (dB) = Substitution Antenna Gain (dB) + Cable Loss (dB).

Mode	TX channel 23095 (707.5MHz)	Frequency Range	Above 1000MHz
Environmental Conditions	20deg. C, 69%RH	Input Power	120Vac, 60Hz
Tested By	Bayu Chen		

Antenna Polarity & Test Distance: Horizontal at 3 M							
No.	Freq. (MHz)	Reading (dBm)	S.G Power Value (dBm)	Correction Factor (dB)	ERP (dBm)	Limit (dBm)	Margin (dB)
1	1415.00	-51.8	-45.2	0.9	-44.3	-13.0	-31.3
2	2122.50	-44.6	-39.7	-0.3	-40.0	-13.0	-27.0
3	3537.50	-51.1	-44.9	1.4	-43.5	-13.0	-30.5
Antenna Polarity & Test Distance: Vertical at 3 M							
No.	Freq. (MHz)	Reading (dBm)	S.G Power Value (dBm)	Correction Factor (dB)	ERP (dBm)	Limit (dBm)	Margin (dB)
1	1415.00	-52.0	-46.7	0.9	-45.8	-13.0	-32.8
2	2122.50	-39.2	-35.4	-0.3	-35.7	-13.0	-22.7
3	3537.50	-54.8	-49.2	1.4	-47.8	-13.0	-34.8

Remarks:

1. Output Power (dBm) = S.G Value (dBm) + Correction Factor (dB).
2. Correction Factor (dB) = Substitution Antenna Gain (dB) + Cable Loss (dB).

Mode	TX channel 23155 (713.5MHz)	Frequency Range	Above 1000MHz
Environmental Conditions	20deg. C, 69%RH	Input Power	120Vac, 60Hz
Tested By	Bayu Chen		

Antenna Polarity & Test Distance: Horizontal at 3 M							
No.	Freq. (MHz)	Reading (dBm)	S.G Power Value (dBm)	Correction Factor (dB)	ERP (dBm)	Limit (dBm)	Margin (dB)
1	1427.00	-51.5	-44.9	1.0	-43.9	-13.0	-30.9
2	2140.50	-43.6	-38.7	-0.3	-39.0	-13.0	-26.0
3	3567.50	-51.2	-45.0	1.5	-43.5	-13.0	-30.5
Antenna Polarity & Test Distance: Vertical at 3 M							
No.	Freq. (MHz)	Reading (dBm)	S.G Power Value (dBm)	Correction Factor (dB)	ERP (dBm)	Limit (dBm)	Margin (dB)
1	1427.00	-51.1	-45.6	1.0	-44.6	-13.0	-31.6
2	2140.50	-38.9	-35.1	-0.3	-35.4	-13.0	-22.4
3	3567.50	-55.0	-49.4	1.5	-47.9	-13.0	-34.9

Remarks:

1. Output Power (dBm) = S.G Value (dBm) + Correction Factor (dB).
2. Correction Factor (dB) = Substitution Antenna Gain (dB) + Cable Loss (dB).

Channel Bandwidth: 10MHz

Mode	TX channel 23060 (704MHz)	Frequency Range	Above 1000MHz
Environmental Conditions	20deg. C, 69%RH	Input Power	120Vac, 60Hz
Tested By	Bayu Chen		

Antenna Polarity & Test Distance: Horizontal at 3 M							
No.	Freq. (MHz)	Reading (dBm)	S.G Power Value (dBm)	Correction Factor (dB)	ERP (dBm)	Limit (dBm)	Margin (dB)
1	1408.00	-51.1	-44.6	0.9	-43.7	-13.0	-30.7
2	2112.00	-43.4	-38.5	-0.3	-38.8	-13.0	-25.8
3	3520.00	-52.9	-46.8	1.4	-45.4	-13.0	-32.4
Antenna Polarity & Test Distance: Vertical at 3 M							
No.	Freq. (MHz)	Reading (dBm)	S.G Power Value (dBm)	Correction Factor (dB)	ERP (dBm)	Limit (dBm)	Margin (dB)
1	1408.00	-51.4	-46.2	0.9	-45.3	-13.0	-32.3
2	2112.00	-38.6	-34.9	-0.3	-35.2	-13.0	-22.2
3	3520.00	-54.8	-49.2	1.4	-47.8	-13.0	-34.8

Remarks:

- Output Power (dBm) = S.G Value (dBm) + Correction Factor (dB).
- Correction Factor (dB) = Substitution Antenna Gain (dB) + Cable Loss (dB).

Mode	TX channel 23095 (707.5MHz)	Frequency Range	Above 1000MHz
Environmental Conditions	20deg. C, 69%RH	Input Power	120Vac, 60Hz
Tested By	Bayu Chen		

Antenna Polarity & Test Distance: Horizontal at 3 M							
No.	Freq. (MHz)	Reading (dBm)	S.G Power Value (dBm)	Correction Factor (dB)	ERP (dBm)	Limit (dBm)	Margin (dB)
1	1415.00	-51.8	-45.3	0.9	-44.4	-13.0	-31.4
2	2122.50	-43.9	-39.0	-0.3	-39.3	-13.0	-26.3
3	3537.50	-51.9	-45.6	1.4	-44.2	-13.0	-31.2
Antenna Polarity & Test Distance: Vertical at 3 M							
No.	Freq. (MHz)	Reading (dBm)	S.G Power Value (dBm)	Correction Factor (dB)	ERP (dBm)	Limit (dBm)	Margin (dB)
1	1415.00	-51.2	-45.9	0.9	-45.0	-13.0	-32.0
2	2122.50	-39.2	-35.4	-0.3	-35.7	-13.0	-22.7
3	3537.50	-55.4	-49.8	1.4	-48.4	-13.0	-35.4

Remarks:

- Output Power (dBm) = S.G Value (dBm) + Correction Factor (dB).
- Correction Factor (dB) = Substitution Antenna Gain (dB) + Cable Loss (dB).

Mode	TX channel 23130 (711MHz)	Frequency Range	Above 1000MHz
Environmental Conditions	20deg. C, 69%RH	Input Power	120Vac, 60Hz
Tested By	Bayu Chen		

Antenna Polarity & Test Distance: Horizontal at 3 M							
No.	Freq. (MHz)	Reading (dBm)	S.G Power Value (dBm)	Correction Factor (dB)	ERP (dBm)	Limit (dBm)	Margin (dB)
1	1422.00	-50.0	-43.5	1.0	-42.5	-13.0	-29.5
2	2133.00	-43.9	-38.9	-0.4	-39.3	-13.0	-26.3
3	3555.00	-52.5	-46.3	1.4	-44.9	-13.0	-31.9
Antenna Polarity & Test Distance: Vertical at 3 M							
No.	Freq. (MHz)	Reading (dBm)	S.G Power Value (dBm)	Correction Factor (dB)	ERP (dBm)	Limit (dBm)	Margin (dB)
1	1422.00	-51.2	-45.7	1.0	-44.7	-13.0	-31.7
2	2133.00	-38.1	-34.2	-0.4	-34.6	-13.0	-21.6
3	3555.00	-54.2	-48.6	1.4	-47.2	-13.0	-34.2

Remarks:

1. Output Power (dBm) = S.G Value (dBm) + Correction Factor (dB).
2. Correction Factor (dB) = Substitution Antenna Gain (dB) + Cable Loss (dB).

LTE Band 17

Channel Bandwidth: 5MHz

Mode	TX channel 23755 (706.5MHz)	Frequency Range	Above 1000MHz
Environmental Conditions	20deg. C, 69%RH	Input Power	120Vac, 60Hz
Tested By	Bayu Chen		

Antenna Polarity & Test Distance: Horizontal at 3 M							
No.	Freq. (MHz)	Reading (dBm)	S.G Power Value (dBm)	Correction Factor (dB)	ERP (dBm)	Limit (dBm)	Margin (dB)
1	1413.00	-50.6	-44.1	0.9	-43.2	-13.0	-30.2
2	2119.50	-61.2	-56.3	-0.3	-56.6	-13.0	-43.6
Antenna Polarity & Test Distance: Vertical at 3 M							
No.	Freq. (MHz)	Reading (dBm)	S.G Power Value (dBm)	Correction Factor (dB)	ERP (dBm)	Limit (dBm)	Margin (dB)
1	1413.00	-52.8	-47.4	0.9	-46.5	-13.0	-33.5
2	2119.50	-60.9	-57.2	-0.3	-57.5	-13.0	-44.5

Remarks:

1. Output Power (dBm) = S.G Value (dBm) + Correction Factor (dB).
2. Correction Factor (dB) = Substitution Antenna Gain (dB) + Cable Loss (dB).

Mode	TX channel 23790 (710.0MHz)	Frequency Range	Above 1000MHz
Environmental Conditions	20deg. C, 69%RH	Input Power	120Vac, 60Hz
Tested By	Bayu Chen		

Antenna Polarity & Test Distance: Horizontal at 3 M							
No.	Freq. (MHz)	Reading (dBm)	S.G Power Value (dBm)	Correction Factor (dB)	ERP (dBm)	Limit (dBm)	Margin (dB)
1	1420.00	-50.8	-44.1	0.9	-43.2	-13.0	-30.2
2	2130.00	-59.9	-54.8	-0.4	-55.2	-13.0	-42.2
Antenna Polarity & Test Distance: Vertical at 3 M							
No.	Freq. (MHz)	Reading (dBm)	S.G Power Value (dBm)	Correction Factor (dB)	ERP (dBm)	Limit (dBm)	Margin (dB)
1	1420.00	-53.6	-48.1	0.9	-47.2	-13.0	-34.2
2	2130.00	-40.9	-37.0	-0.4	-37.4	-13.0	-24.4

Remarks:

1. Output Power (dBm) = S.G Value (dBm) + Correction Factor (dB).
2. Correction Factor (dB) = Substitution Antenna Gain (dB) + Cable Loss (dB).

Mode	TX channel 23825 (713.5MHz)	Frequency Range	Above 1000MHz
Environmental Conditions	20deg. C, 69%RH	Input Power	120Vac, 60Hz
Tested By	Bayu Chen		

Antenna Polarity & Test Distance: Horizontal at 3 M							
No.	Freq. (MHz)	Reading (dBm)	S.G Power Value (dBm)	Correction Factor (dB)	ERP (dBm)	Limit (dBm)	Margin (dB)
1	1427.00	-49.4	-42.8	1.0	-41.8	-13.0	-28.8
2	2140.50	-57.5	-52.6	-0.3	-52.9	-13.0	-39.9
Antenna Polarity & Test Distance: Vertical at 3 M							
No.	Freq. (MHz)	Reading (dBm)	S.G Power Value (dBm)	Correction Factor (dB)	ERP (dBm)	Limit (dBm)	Margin (dB)
1	1427.00	-54.3	-48.8	1.0	-47.8	-13.0	-34.8
2	2140.50	-41.6	-37.8	-0.3	-38.1	-13.0	-25.1

Remarks:

1. Output Power (dBm) = S.G Value (dBm) + Correction Factor (dB).
2. Correction Factor (dB) = Substitution Antenna Gain (dB) + Cable Loss (dB).

Channel Bandwidth: 10MHz

Mode	TX channel 23780 (709.0MHz)	Frequency Range	Above 1000MHz
Environmental Conditions	20deg. C, 69%RH	Input Power	120Vac, 60Hz
Tested By	Bayu Chen		

Antenna Polarity & Test Distance: Horizontal at 3 M							
No.	Freq. (MHz)	Reading (dBm)	S.G Power Value (dBm)	Correction Factor (dB)	ERP (dBm)	Limit (dBm)	Margin (dB)
1	1418.00	-50.0	-43.4	0.9	-42.5	-13.0	-29.5
2	2127.00	-58.4	-53.3	-0.4	-53.7	-13.0	-40.7
Antenna Polarity & Test Distance: Vertical at 3 M							
No.	Freq. (MHz)	Reading (dBm)	S.G Power Value (dBm)	Correction Factor (dB)	ERP (dBm)	Limit (dBm)	Margin (dB)
1	1418.00	-53.2	-47.8	0.9	-46.9	-13.0	-33.9
2	2127.00	-38.7	-34.8	-0.4	-35.2	-13.0	-22.2

Remarks:

1. Output Power (dBm) = S.G Value (dBm) + Correction Factor (dB).
2. Correction Factor (dB) = Substitution Antenna Gain (dB) + Cable Loss (dB).

Mode	TX channel 23790 (710.0MHz)	Frequency Range	Above 1000MHz
Environmental Conditions	20deg. C, 69%RH	Input Power	120Vac, 60Hz
Tested By	Bayu Chen		

Antenna Polarity & Test Distance: Horizontal at 3 M							
No.	Freq. (MHz)	Reading (dBm)	S.G Power Value (dBm)	Correction Factor (dB)	ERP (dBm)	Limit (dBm)	Margin (dB)
1	1420.00	-50.4	-43.8	0.9	-42.9	-13.0	-29.9
2	2130.00	-60.9	-55.9	-0.4	-56.3	-13.0	-43.3
Antenna Polarity & Test Distance: Vertical at 3 M							
No.	Freq. (MHz)	Reading (dBm)	S.G Power Value (dBm)	Correction Factor (dB)	ERP (dBm)	Limit (dBm)	Margin (dB)
1	1420.00	-54.0	-48.5	0.9	-47.6	-13.0	-34.6
2	2130.00	-39.1	-35.2	-0.4	-35.6	-13.0	-22.6

Remarks:

1. Output Power (dBm) = S.G Value (dBm) + Correction Factor (dB).
2. Correction Factor (dB) = Substitution Antenna Gain (dB) + Cable Loss (dB).

Mode	TX channel 23800 (711.0MHz)	Frequency Range	Above 1000MHz
Environmental Conditions	20deg. C, 69%RH	Input Power	120Vac, 60Hz
Tested By	Bayu Chen		

Antenna Polarity & Test Distance: Horizontal at 3 M							
No.	Freq. (MHz)	Reading (dBm)	S.G Power Value (dBm)	Correction Factor (dB)	ERP (dBm)	Limit (dBm)	Margin (dB)
1	1422.00	-51.5	-45.0	1.0	-44.0	-13.0	-31.0
2	2133.00	-59.1	-54.1	-0.4	-54.5	-13.0	-41.5
Antenna Polarity & Test Distance: Vertical at 3 M							
No.	Freq. (MHz)	Reading (dBm)	S.G Power Value (dBm)	Correction Factor (dB)	ERP (dBm)	Limit (dBm)	Margin (dB)
1	1422.00	-53.2	-47.8	1.0	-46.8	-13.0	-33.8
2	2133.00	-39.6	-35.7	-0.4	-36.1	-13.0	-23.1

Remarks:

1. Output Power (dBm) = S.G Value (dBm) + Correction Factor (dB).
2. Correction Factor (dB) = Substitution Antenna Gain (dB) + Cable Loss (dB).

5 Pictures of Test Arrangements

Please refer to the attached file (Test Setup Photo).

Appendix – Information on the Testing Laboratories

We, Bureau Veritas Consumer Products Services (H.K.) Ltd., Taoyuan Branch, were founded in 1988 to provide our best service in EMC, Radio, Telecom and Safety consultation. Our laboratories are FCC recognized accredited test firms and accredited and approved according to ISO/IEC 17025.

If you have any comments, please feel free to contact us at the following:

Linko EMC/RF Lab

Tel: 886-2-26052180

Fax: 886-2-26051924

Hsin Chu EMC/RF/Telecom Lab

Tel: 886-3-6668565

Fax: 886-3-6668323

Hwa Ya EMC/RF/Safety Lab

Tel: 886-3-3183232

Fax: 886-3-3270892

Email: service.adt@tw.bureauveritas.com

Web Site: www.bureauveritas-adt.com

The address and road map of all our labs can be found in our web site also.

--- END ---