

## FCC Test Report

**Report No.:** RF170421C58A-1

**FCC ID:** UZ7TC200J

**Test Model:** TC200J

**Received Date:** Jun. 28, 2017

**Test Date:** Jul. 05 ~ Aug. 18, 2017

**Issued Date:** Aug. 24, 2017

**Applicant:** Zebra Technologies Corporation

**Address:** 1 Zebra Plaza Holtsville New York United States 11742

**Manufacturer:** Zebra Technologies Corporation

**Address:** 1 Zebra Plaza Holtsville New York United States 11742

**Issued By:** Bureau Veritas Consumer Products Services (H.K.) Ltd., Taoyuan Branch

**Lab Address:** No. 47-2, 14th Ling, Chia Pau Vil., Lin Kou Dist., New Taipei City, Taiwan (R.O.C.)

**Test Location:** No. 19, Hwa Ya 2nd Rd., Wen Hwa Vil., Kwei Shan Dist., Taoyuan City 33383, TAIWAN (R.O.C.)



This report is for your exclusive use. Any copying or replication of this report to or for any other person or entity, or use of our name or trademark, is permitted only with our prior written permission. This report sets forth our findings solely with respect to the test samples identified herein. The results set forth in this report are not indicative or representative of the quality or characteristics of the lot from which a test sample was taken or any similar or identical product specifically and expressly noted. Our report includes all of the tests requested by you and the results thereof based upon the information that you provided to us. You have 60 days from date of issuance of this report to notify us of any material error or omission caused by our negligence, provided, however, that such notice shall be in writing and shall specifically address the issue you wish to raise. A failure to raise such issue within the prescribed time shall constitute your unqualified acceptance of the completeness of this report, the tests conducted and the correctness of the report contents. Unless specific mention, the uncertainty of measurement has been explicitly taken into account to declare the compliance or non-compliance to the specification. The report must not be used by the client to claim product certification, approval, or endorsement by TAF or any government agencies.

## Table of Contents

<b>Release Control Record</b> .....	<b>4</b>
<b>1 Certificate of Conformity</b> .....	<b>5</b>
<b>2 Summary of Test Results</b> .....	<b>6</b>
2.1 Measurement Uncertainty.....	6
2.2 Modification Record.....	6
<b>3 General Information</b> .....	<b>7</b>
3.1 General Description of EUT.....	7
3.2 Description of Test Modes.....	10
3.2.1 Test Mode Applicability and Tested Channel Detail.....	12
3.3 Duty Cycle of Test Signal.....	14
3.4 Conducted Output Power.....	15
3.5 Description of Support Units.....	18
3.5.1 Configuration of System under Test.....	18
3.6 General Description of Applied Standards.....	19
<b>4 Test Types and Results</b> .....	<b>20</b>
4.1 Radiated Emission and Bandedge Measurement.....	20
4.1.1 Limits of Radiated Emission and Bandedge Measurement.....	20
4.1.2 Test Instruments.....	21
4.1.3 Test Procedures.....	22
4.1.4 Deviation from Test Standard.....	23
4.1.5 Test Set Up.....	23
4.1.6 EUT Operating Conditions.....	24
4.1.7 Test Results.....	25
4.2 Conducted Emission Measurement.....	72
4.2.1 Limits of Conducted Emission Measurement.....	72
4.2.2 Test Instruments.....	72
4.2.3 Test Procedures.....	73
4.2.4 Deviation from Test Standard.....	73
4.2.5 Test Setup.....	73
4.2.6 EUT Operating Conditions.....	73
4.2.7 Test Results.....	74
4.3 Transmit Power Measurement.....	84
4.3.1 Limits of Transmit Power Measurement.....	84
4.3.2 Test Setup.....	84
4.3.3 Test Instruments.....	85
4.3.4 Test Procedure.....	85
4.3.5 Deviation from Test Standard.....	85
4.3.6 EUT Operating Conditions.....	85
4.3.7 Test Result.....	86
4.4 Occupied Bandwidth Measurement.....	94
4.4.1 Test Setup.....	94
4.4.2 Test Instruments.....	94
4.4.3 Test Procedure.....	94
4.4.4 Test Result.....	95
4.5 Peak Power Spectral Density Measurement.....	98
4.5.1 Limits of Peak Power Spectral Density Measurement.....	98
4.5.2 Test Setup.....	98
4.5.3 Test Instruments.....	98
4.5.4 Test Procedures.....	99
4.5.5 Deviation from Test Standard.....	99
4.5.6 EUT Operating Conditions.....	99
4.5.7 Test Results.....	100
4.6 Frequency Stability.....	105

4.6.1	Limits of Frequency Stability Measurement .....	105
4.6.2	Test Setup.....	105
4.6.3	Test Instruments .....	105
4.6.4	Test Procedure .....	105
4.6.5	Deviation from Test Standard .....	105
4.6.6	EUT Operating Condition .....	105
4.6.7	Test Results .....	106
4.7	6dB Bandwidth Measurement.....	107
4.7.1	Limits of 6dB Bandwidth Measurement.....	107
4.7.2	Test Setup.....	107
4.7.3	Test Instruments .....	107
4.7.4	Test Procedure .....	107
4.7.5	Deviation from Test Standard .....	107
4.7.6	EUT Operating Condition .....	107
4.7.7	Test Results .....	108
<b>5</b>	<b>Pictures of Test Arrangements.....</b>	<b>110</b>
	<b>Annex A- Radiated Out of Band Emission (OOBE) Measurement (For U-NII-3 band).....</b>	<b>111</b>
	<b>Appendix – Information on the Testing Laboratories .....</b>	<b>114</b>

### Release Control Record

Issue No.	Description	Date Issued
RF170421C58A-1	Original release.	Aug. 24, 2017

## 1 Certificate of Conformity

**Product:** Touch Computer  
**Brand:** ZEBRA  
**Test Model:** TC200J  
**Sample Status:** Engineering sample  
**Applicant:** Zebra Technologies Corporation  
**Test Date:** Jul. 05 ~ Aug. 18, 2017  
**Standards:** 47 CFR FCC Part 15, Subpart E (Section 15.407)  
ANSI C63.10:2013

The above equipment has been tested by **Bureau Veritas Consumer Products Services (H.K.) Ltd., Taoyuan Branch**, and found compliance with the requirement of the above standards. The test record, data evaluation & Equipment Under Test (EUT) configurations represented herein are true and accurate accounts of the measurements of the sample's EMC characteristics under the conditions specified in this report.

**Prepared by :**  , **Date:** Aug. 24, 2017  
Pettie Chen / Senior Specialist

**Approved by :**  , **Date:** Aug. 24, 2017  
Ken Liu / Senior Manager

## 2 Summary of Test Results

47 CFR FCC Part 15, Subpart E (Section 15.407)			
FCC Clause	Test Item	Result	Remarks
15.407(b)(6)	AC Power Conducted Emissions	Pass	Meet the requirement of limit. Minimum passing margin is -14.27dB at 0.29897MHz.
15.407(b)(1/2/3/4(i/ii)/6)	Radiated Emissions & Band Edge Measurement	Pass	Meet the requirement of limit. Minimum passing margin is -1.0dB at 5150.00, 5460.00, 5470.00, 5725.00MHz.
15.407(a)(1/2/3)	Max Average Transmit Power	Pass	Meet the requirement of limit.
---	Occupied Bandwidth Measurement	Pass	Meet the requirement of limit.
15.407(a)(1/2/3)	Peak Power Spectral Density	Pass	Meet the requirement of limit. (U-NII-3 Band only)
15.407(e)	6dB bandwidth	Pass	Meet the requirement of limit.
15.407(g)	Frequency Stability	Pass	Meet the requirement of limit.
15.203	Antenna Requirement	Pass	No antenna connector is used.

### 2.1 Measurement Uncertainty

Where relevant, the following measurement uncertainty levels have been estimated for tests performed on the EUT as specified in CISPR 16-4-2:

Measurement	Frequency	Expanded Uncertainty (k=2) ( $\pm$ )
Conducted Emissions at mains ports	150kHz ~ 30MHz	2.94 dB
Radiated Emissions up to 1 GHz	30MHz ~ 200MHz	3.59 dB
	200MHz ~ 1000MHz	3.60 dB
Radiated Emissions above 1 GHz	1GHz ~ 18GHz	2.29 dB
	18GHz ~ 40GHz	2.29 dB

### 2.2 Modification Record

There were no modifications required for compliance.

### 3 General Information

#### 3.1 General Description of EUT

Product	Touch Computer
Brand	ZEBRA
Test Model	TC200J
Sample Status	Engineering sample
MFD	28MAR17 (For TC200J without keypad using) 26MAY17 (For TC200J with keypad using)
HW Version	EV
SW Version	90-04-03-N-00-E1
Power Supply Rating	5Vdc from adapter or host equipment 12 or 24Vdc from Vehicle Cigarette Adaptor 5Vdc from power pack 3.85Vdc from battery
Modulation Type	256QAM, 64QAM, 16QAM, QPSK, BPSK
Modulation Technology	OFDM
Transfer Rate	802.11a: 54/48/36/24/18/12/9/6Mbps 802.11n: up to 150Mbps 802.11ac: up to 433.3Mbps
Operating Frequency	5180~5240MHz, 5260~5320MHz, 5500~5720MHz, 5745~5825MHz
Number of Channel	5180~5240MHz: 802.11a, 802.11n (HT20), 802.11ac (VHT20): 4 802.11n (HT40), 802.11ac (VHT40): 2 802.11ac (VHT80): 1 5260~5320MHz: 802.11a, 802.11n (HT20), 802.11ac (VHT20): 4 802.11n (HT40), 802.11ac (VHT40): 2 802.11ac (VHT80): 1 5500~5720MHz: 802.11a, 802.11n (HT20), 802.11ac (VHT20): 12 802.11n (HT40), 802.11ac (VHT40): 6 802.11ac (VHT80): 3 5745~5825MHz: 802.11a, 802.11n (HT20), 802.11ac (VHT20): 5 802.11n (HT40), 802.11ac (VHT40): 2 802.11ac (VHT80): 1
Output Power	5180~5240MHz: 58.076mW 5260~5320MHz: 57.148mW 5500~5720MHz: 49.431mW 5745~5825MHz: 65.163mW
Antenna Type	Refer to Note
Antenna Connector	Refer to Note
Accessory Device	Adapter, Gun Handle, Headset (1.25m non-shielded cable without core), Arm Mount, Holster, Vehicle Cigarette Adaptor, Power Pack (Refer to note 6 for more details)
Cable Supplied	1.5m shielded USB Type C to Type A cable without core (Refer to note 6 for more details)

Note:

1. This report is prepared for FCC class II permissive change. This report is issued as a supplementary report to the original report no. RF170421C58-1. The differences compared with the original design are adding power bank, Vehicle Cigarette Adaptor, Holster and sale type. All test data had been re-tested.
2. The EUT has four types for sale. (New sale type is marked in boldface.)

Brand	Model	Difference (sale type)
ZEBRA	TC200J	Scanner SE4710 with camera, with 2pin, without keypad
		Scanner SE4710 with camera, with 8pin (option), without keypad
		Scanner SE2100 without camera, with blank, without keypad
		<b>Scanner SE4710 with camera, with blank, with keypad</b>

3. The EUT provides 1 completed transmitter and 1 receiver.

Modulation Mode	TX Function
802.11a	1TX
802.11n (HT20)	1TX
802.11n (HT40)	1TX
802.11ac (VHT20)	1TX
802.11ac (VHT40)	1TX
802.11ac (VHT80)	1TX

\* The modulation and bandwidth are similar for 802.11n mode for HT20/HT40 and 802.11ac mode for VHT20/VHT40. After pre-testing, 802.11ac (VHT20/VHT40) power is lower than 802.11n (HT20/HT40), therefore 802.11n (HT20/HT40) is the worst case to representative mode in test report. (Final test mode refer section 3.2.1)

4. The EUT consumes power from the following adapter, Vehicle Cigarette Adaptor, power pack and battery.

Adapter	
Brand	ZEBRA
Model	SAWA-65-20005A
Input Power	100-240Vac, 0.5A, 50-60Hz
Output Power	5Vdc, 2.5A

Vehicle Cigarette Adaptor	
Brand	ZEBRA
Model	SAWA-68-25005A
Input Power	12-24V(3.5A)
Output Power	5V(2.5A)

Power Pack	
Brand	ZEBRA
Model	BT-000343
Rate capacity	2900mAh
Min capacity	2800mAh
Rate Voltage	3.85Vdc

Battery	
Brand	ZEBRA
Model	BT-000334
Rate capacity(mAh)	3000mAh
Min capacity(mAh)	2800mAh
Rate Voltage	3.85Vdc



5. The following antennas were provided to the EUT.

For TC200J without keypad using

Type	Connector	Gain (dBi)		
		2.4GHz	5GHz	BT
PIFA	NA	2.25	4.22	2.25

For TC200J with keypad using

Type	Connector	Gain (dBi)		
		WLAN (2.4GHz)	WLAN (5GHz)	BT
PIFA	NA	1.93	4.48	1.92

6. Accessory devices of EUT are list as below:

Specification of Accessory		
AC Adapter	Brand Name	ZEBRA
	Model Name	SAWA-65-20005A
USB Type C cable	Brand Name	ZEBRA
	P/N Number	CBL-MPM-USB1-01
Ear Headset	Brand Name	ZEBRA
	Model Name	HDST-35MM-PTVP-01
Headset Adapter Cable	Brand Name	ZEBRA
	Model Name	CBL-TC51-HDST35-01
Gun Handle	Brand Name	ZEBRA
	P/N Number	TRG-TC2X-SNP1-01
Vehicle Cigarette Adaptor	Brand Name	ZEBRA
	P/N Number	SAWA-68-25005A
Arm Mount for TC200J without keypad using	Brand Name	ZEBRA
	P/N Number	SG-TC2X-ARMNT-01
Holster for TC200J without keypad using	Brand Name	ZEBRA
	P/N Number	SG-TC2X-HLSTR1-01
Holster for TC200J with keypad using	Brand Name	ZEBRA
	P/N Number	SG-TC20K-HLST1-01
Power Pack	Brand Name	ZEBRA
	P/N Number	BT-000343

7. The above EUT information is declared by manufacturer and for more detailed features description, please refer to the manufacturer's specifications or user's manual.

### 3.2 Description of Test Modes

#### 5180~5240MHz:

4 channels are provided for 802.11a, 802.11n (HT20), 802.11ac (VHT20):

Channel	Frequency	Channel	Frequency
36	5180 MHz	44	5220 MHz
40	5200 MHz	48	5240 MHz

2 channels are provided for 802.11n (HT40), 802.11ac (VHT40):

Channel	Frequency	Channel	Frequency
38	5190 MHz	46	5230 MHz

1 channel is provided for 802.11ac (VHT80):

Channel	Frequency
42	5210MHz

#### 5260~5320MHz:

4 channels are provided for 802.11a, 802.11n (HT20), 802.11ac (VHT20):

Channel	Frequency	Channel	Frequency
52	5260 MHz	60	5300 MHz
56	5280 MHz	64	5320 MHz

2 channels are provided for 802.11n (HT40), 802.11ac (VHT40):

Channel	Frequency	Channel	Frequency
54	5270 MHz	62	5310 MHz

1 channel is provided for 802.11ac (VHT80):

Channel	Frequency
58	5290MHz

### 5500~5720MHz:

12 channels are provided for 802.11a, 802.11n (HT20), 802.11ac (VHT20):

Channel	Frequency	Channel	Frequency
100	5500 MHz	124	5620 MHz
104	5520 MHz	128	5640 MHz
108	5540 MHz	132	5660 MHz
112	5560 MHz	136	5680 MHz
116	5580 MHz	140	5700 MHz
120	5600 MHz	144	5720 MHz

6 channels are provided for 802.11n (HT40), 802.11ac (VHT40):

Channel	Frequency	Channel	Frequency
102	5510 MHz	126	5630 MHz
110	5550 MHz	134	5670 MHz
118	5590 MHz	142	5710 MHz

3 channels are provided for 802.11ac (VHT80):

Channel	Frequency	Channel	Frequency
106	5530 MHz	122	5610 MHz
138	5690 MHz		

### 5745~5825MHz:

5 channels are provided for 802.11a, 802.11n (HT20), 802.11ac (VHT20):

Channel	Frequency	Channel	Frequency
149	5745MHz	161	5805MHz
153	5765MHz	165	5825MHz
157	5785MHz		

2 channels are provided for 802.11n (HT40), 802.11ac (VHT40):

Channel	Frequency	Channel	Frequency
151	5755MHz	159	5795MHz

1 channel is provided for 802.11ac (VHT80):

Channel	Frequency
155	5775MHz

### 3.2.1 Test Mode Applicability and Tested Channel Detail

EUT Configure Mode	Applicable to				Description
	RE $\geq$ 1G	RE<1G	PLC	APCM	
A	-	√	√	-	Scanner SE4710 (8pin), EUT with adapter+USB+Power Pack
B	-	√	√	-	Scanner SE4710 (8pin), EUT with USB+ Vehicle Cigarette Adaptor
C	√	√	√	√	Scanner SE4710 (Blank), EUT with adapter+USB
D	-	√	√	-	Scanner SE4710 (Blank), EUT with adapter+USB+Power Pack
E	-	√	√	-	Scanner SE4710 (Blank), EUT with USB+ Vehicle Cigarette Adaptor

Where RE $\geq$ 1G: Radiated Emission above 1GHz & Bandedge Measurement  
 RE<1G: Radiated Emission below 1GHz  
 PLC: Power Line Conducted Emission  
 APCM: Antenna Port Conducted Measurement

Note:

1. The EUT had been pre-tested on the positioned of each 3 axis. The worst case was found when positioned on X-plane (For Test Mode A, B), Z-plane (For Test Mode C, D, E).
2. "-" means no effect.

#### Radiated Emission Test (Above 1GHz):

- Pre-Scan has been conducted to determine the worst-case mode from all possible combinations between available modulations, data rates and antenna ports (if EUT with antenna diversity architecture).
- Following channel(s) was (were) selected for the final test as listed below.

EUT Configure Mode	Mode	Frequency Band (MHz)	Available Channel	Tested Channel	Modulation Technology	Data Rate (Mbps)
C	802.11a	5180-5240	36 to 48	36, 40, 48	OFDM	6.0
	802.11n (HT20)		36 to 48	36, 40, 48	OFDM	6.5
	802.11n (HT40)		38 to 46	38, 46	OFDM	13.5
	802.11ac (VHT80)		42	42	OFDM	29.3
C	802.11a	5260-5320	52 to 64	52, 60, 64	OFDM	6.0
	802.11n (HT20)		52 to 64	52, 60, 64	OFDM	6.5
	802.11n (HT40)		54 to 62	54, 62	OFDM	13.5
	802.11ac (VHT80)		58	58	OFDM	29.3
C	802.11a	5500-5720	100 to 144	100, 116, 140, 144	OFDM	6.0
	802.11n (HT20)		100 to 144	100, 116, 140, 144	OFDM	6.5
	802.11n (HT40)		102 to 142	102, 110, 134, 142	OFDM	13.5
	802.11ac (VHT80)		106 to 138	106, 122, 138	OFDM	29.3
C	802.11a	5745-5825	149 to 165	149, 157, 165	OFDM	6.0
	802.11n (HT20)		149 to 165	149, 157, 165	OFDM	6.5
	802.11n (HT40)		151 to 159	151, 159	OFDM	13.5
	802.11ac (VHT80)		155	155	OFDM	29.3

#### Radiated Emission Test (Below 1GHz):

- Pre-Scan has been conducted to determine the worst-case mode from all possible combinations between available modulations, data rates and antenna ports (if EUT with antenna diversity architecture).
- Following channel(s) was (were) selected for the final test as listed below.

EUT Configure Mode	Mode	Frequency Band (MHz)	Available Channel	Tested Channel	Modulation Technology	Data Rate (Mbps)
A, B, C, D, E	802.11a	5180-5240	36 to 48	40	OFDM	6.0
		5260-5320	52 to 64		OFDM	6.0
		5500-5720	100 to 144		OFDM	6.0
		5745-5825	149 to 165		OFDM	6.0

### Power Line Conducted Emission Test:

- Pre-Scan has been conducted to determine the worst-case mode from all possible combinations between available modulations, data rates and antenna ports (if EUT with antenna diversity architecture).
- Following channel(s) was (were) selected for the final test as listed below.

EUT Configure Mode	Mode	Frequency Band (MHz)	Available Channel	Tested Channel	Modulation Technology	Data Rate (Mbps)
A, B, C, D, E	802.11a	5180-5240	36 to 48	40	OFDM	6.0
		5260-5320	52 to 64		OFDM	6.0
		5500-5720	100 to 144		OFDM	6.0
		5745-5825	149 to 165		OFDM	6.0

### Antenna Port Conducted Measurement:

- This item includes all test value of each mode, but only includes spectrum plot of worst value of each mode.
- Pre-Scan has been conducted to determine the worst-case mode from all possible combinations between available modulations, data rates and antenna ports (if EUT with antenna diversity architecture).
- Following channel(s) was (were) selected for the final test as listed below.

EUT Configure Mode	Mode	Frequency Band (MHz)	Available Channel	Tested Channel	Modulation Technology	Data Rate (Mbps)
C	802.11a	5180-5240	36 to 48	36, 40, 48	OFDM	6.0
	802.11n (HT20)		36 to 48	36, 40, 48	OFDM	6.5
	802.11n (HT40)		38 to 46	38, 46	OFDM	13.5
	802.11ac (VHT80)		42	42	OFDM	29.3
C	802.11a	5260-5320	52 to 64	52, 60, 64	OFDM	6.0
	802.11n (HT20)		52 to 64	52, 60, 64	OFDM	6.5
	802.11n (HT40)		54 to 62	54, 62	OFDM	13.5
	802.11ac (VHT80)		58	58	OFDM	29.3
C	802.11a	5500-5720	100 to 144	100, 116, 140, 144	OFDM	6.0
	802.11n (HT20)		100 to 144	100, 116, 140, 144	OFDM	6.5
	802.11n (HT40)		102 to 142	102, 110, 134, 142	OFDM	13.5
	802.11ac (VHT80)		106 to 138	106, 122, 138	OFDM	29.3
C	802.11a	5745-5825	149 to 165	149, 157, 165	OFDM	6.0
	802.11n (HT20)		149 to 165	149, 157, 165	OFDM	6.5
	802.11n (HT40)		151 to 159	151, 159	OFDM	13.5
	802.11ac (VHT80)		155	155	OFDM	29.3

### Test Condition:

Applicable to	Environmental Conditions	Input Power	Tested by
RE $\geq$ 1G	20deg. C, 65%RH	120Vac, 60Hz	James Yang Matthew Yang
RE<1G	25deg. C, 70%RH	120Vac, 60Hz	Frank Liu
PLC	25deg. C, 75%RH	120Vac, 60Hz	Luis Lee
APCM	25deg. C, 60%RH	120Vac, 60Hz	Edward Lin

### 3.3 Duty Cycle of Test Signal

Duty cycle of test signal is > 98%, duty factor is not required.

Duty cycle of test signal is < 98 %, duty factor is required.

802.11a: Duty cycle =  $10.975/10.99 = 0.999$

802.11n (HT20): Duty cycle =  $5.075/5.115 = 0.992$

802.11n (HT40): Duty cycle =  $2.465/2.486 = 0.992$

802.11ac (VHT80): Duty cycle =  $0.249/0.26 = 0.958$ , Duty factor =  $10 * \log(1/0.958) = 0.19$

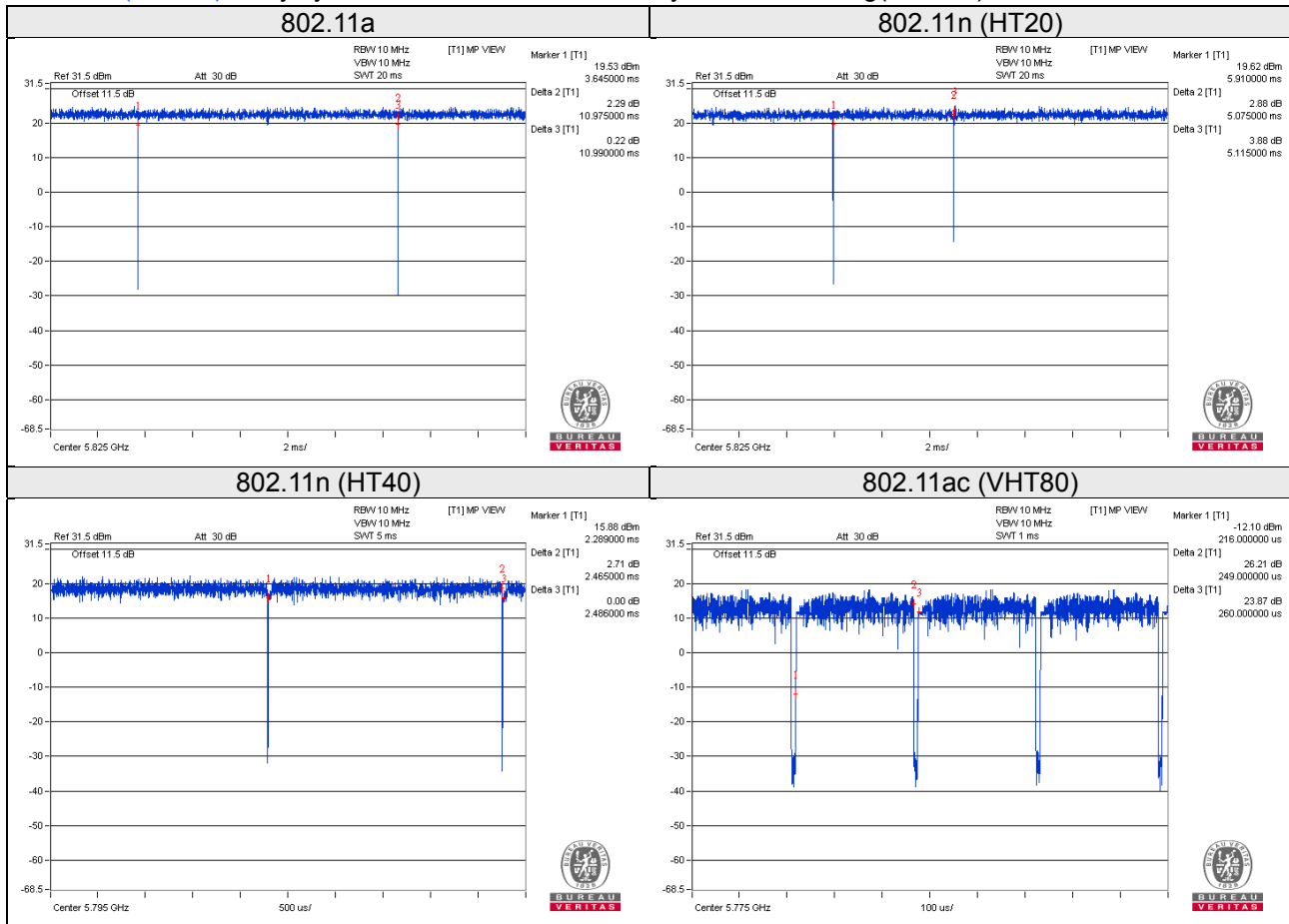

### 3.4 Conducted Output Power

		802.11a Real Average Power							
		6Mbps	9Mbps	12Mbps	18Mbps	24Mbps	36Mbps	48Mbps	54Mbps
Band 1	Ch36	17.58	-	-	-	-	-	-	-
	Ch40	17.64	17.62	17.58	17.47	17.47	17.54	17.48	17.52
	Ch48	17.54	-	-	-	-	-	-	-
Band 2	Ch52	17.49	-	-	-	-	-	-	-
	Ch60	17.33	-	-	-	-	-	-	-
	Ch64	17.57	17.37	17.49	17.54	17.48	17.53	17.46	17.46
Band 3	Ch100	16.61	-	-	-	-	-	-	-
	Ch116	16.45	-	-	-	-	-	-	-
	Ch140	16.63	-	-	-	-	-	-	-
	Ch144	16.65	16.46	16.59	16.51	16.62	16.58	16.44	16.55
Band 4	Ch149	16.92	-	-	-	-	-	-	-
	Ch157	16.96	-	-	-	-	-	-	-
	Ch165	16.98	16.87	16.80	16.96	16.89	16.88	16.81	16.91

		802.11n(HT20) Real Average Power									
		MCS0	MCS1	MCS2	MCS3	MCS4	MCS5	MCS6	MCS7	MCS8	MCS9
Band 1	Ch36	17.48	-	-	-	-	-	-	-	-	-
	Ch40	17.48	17.44	17.38	17.45	17.34	17.35	17.33	17.37	17.34	17.30
	Ch48	17.41	-	-	-	-	-	-	-	-	-
Band 2	Ch52	17.34	-	-	-	-	-	-	-	-	-
	Ch60	17.46	17.38	17.42	17.32	17.35	17.26	17.27	17.32	17.25	17.43
	Ch64	17.45	-	-	-	-	-	-	-	-	-
Band 3	Ch100	16.46	-	-	-	-	-	-	-	-	-
	Ch116	16.19	-	-	-	-	-	-	-	-	-
	Ch140	16.50	-	-	-	-	-	-	-	-	-
Band 4	Ch144	16.51	16.48	16.46	16.47	16.37	16.38	16.41	16.48	16.33	16.49
	Ch149	17.04	-	-	-	-	-	-	-	-	-
	Ch157	17.09	17.01	17.04	17.07	17.06	17.05	17.01	16.98	16.98	17.03
	Ch165	17.08	-	-	-	-	-	-	-	-	-

		802.11ac (VHT20) Real Average Power									
		MCS0	MCS1	MCS2	MCS3	MCS4	MCS5	MCS6	MCS7	MCS8	MCS9
Band 1	Ch36	17.24	-	-	-	-	-	-	-	-	-
	Ch40	17.37	17.22	17.33	17.18	17.28	17.18	17.33	17.25	17.17	17.15
	Ch48	17.27	-	-	-	-	-	-	-	-	-
Band 2	Ch52	17.16	-	-	-	-	-	-	-	-	-
	Ch60	17.32	-	-	-	-	-	-	-	-	-
	Ch64	17.43	17.27	17.28	17.40	17.27	17.30	17.31	17.28	17.40	17.24
Band 3	Ch100	16.31	-	-	-	-	-	-	-	-	-
	Ch116	16.24	-	-	-	-	-	-	-	-	-
	Ch140	16.56	16.48	16.49	16.52	16.40	16.51	16.44	16.49	16.40	16.49
Band 4	Ch144	16.40	-	-	-	-	-	-	-	-	-
	Ch149	16.91	-	-	-	-	-	-	-	-	-
	Ch157	16.93	16.82	16.84	16.86	16.73	16.89	16.90	16.86	16.80	16.74
	Ch165	16.92	-	-	-	-	-	-	-	-	-



		802.11n(HT40) Real Average Power									
		MCS0	MCS1	MCS2	MCS3	MCS4	MCS5	MCS6	MCS7	MCS8	MCS9
Band 1	Ch38	16.78	-	-	-	-	-	-	-	-	-
	Ch46	17.42	17.33	17.38	17.22	17.25	17.22	17.36	17.21	17.35	17.29
Band 2	Ch54	17.34	17.19	17.27	17.15	17.17	17.13	17.30	17.29	17.15	17.23
	Ch62	15.94	-	-	-	-	-	-	-	-	-
Band 3	Ch102	15.35	-	-	-	-	-	-	-	-	-
	Ch110	16.24	-	-	-	-	-	-	-	-	-
	Ch134	16.25	-	-	-	-	-	-	-	-	-
Band 4	Ch142	16.44	16.33	16.30	16.41	16.37	16.39	16.25	16.41	16.35	16.41
	Ch151	18.06	-	-	-	-	-	-	-	-	-
	Ch159	18.14	18.05	18.11	18.12	17.94	18.11	18.09	18.10	18.03	17.98

		802.11ac (VHT40) Real Average Power									
		MCS0	MCS1	MCS2	MCS3	MCS4	MCS5	MCS6	MCS7	MCS8	MCS9
Band 1	Ch38	16.68	-	-	-	-	-	-	-	-	-
	Ch46	17.33	17.30	17.19	17.29	17.27	17.24	17.25	17.19	17.30	17.23
Band 2	Ch54	17.21	17.14	17.02	17.08	17.05	17.10	17.18	17.08	17.17	17.06
	Ch62	15.83	-	-	-	-	-	-	-	-	-
Band 3	Ch102	15.26	-	-	-	-	-	-	-	-	-
	Ch110	16.12	-	-	-	-	-	-	-	-	-
	Ch134	16.18	-	-	-	-	-	-	-	-	-
Band 4	Ch142	16.28	16.23	16.14	16.10	16.11	16.18	16.10	16.13	16.13	16.19
	Ch151	17.85	-	-	-	-	-	-	-	-	-
	Ch159	17.89	17.72	17.71	17.81	17.74	17.71	17.70	17.86	17.83	17.74

		802.11ac (VHT80) Real Average Power									
		MCS0	MCS1	MCS2	MCS3	MCS4	MCS5	MCS6	MCS7	MCS8	MCS9
Band 1	Ch42	17.18	16.99	17.03	17.11	17.08	17.13	16.98	17.01	17.00	17.05
Band 2	Ch58	17.06	16.87	16.88	17.02	16.91	16.86	16.90	16.99	16.98	16.91
Band 3	Ch106	16.14	-	-	-	-	-	-	-	-	-
	Ch122	16.94	-	-	-	-	-	-	-	-	-
	Ch138	17.07	17.02	16.88	16.97	17.02	17.01	16.90	16.94	16.88	17.01
Band 4	Ch155	17.40	17.33	17.22	17.31	17.20	17.23	17.28	17.36	17.26	17.25

### 3.5 Description of Support Units

The EUT has been tested as an independent unit together with other necessary accessories or support units. The following support units or accessories were used to form a representative test configuration during the tests.

ID	Product	Brand	Model No.	Serial No.	FCC ID	Remarks
A.	DC power supply	Keysight	U8002A	MY56330015	NA	-

Note: All power cords of the above support units are non-shielded (1.8m).

ID	Descriptions	Qty.	Length (m)	Shielding (Yes/No)	Cores (Qty.)	Remarks
1.	USB Type C	1	1.5	Y	1	Accessory of EUT
2.	DC cable	1	1.0	N	0	-

#### 3.5.1 Configuration of System under Test

Test Mode A, D

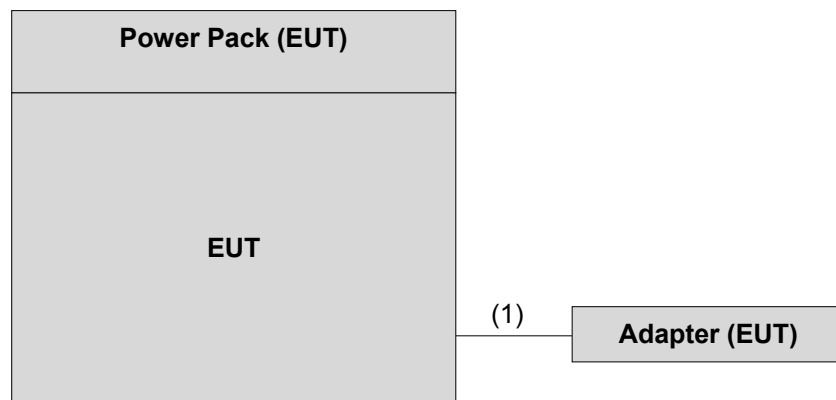

Test Mode B, E

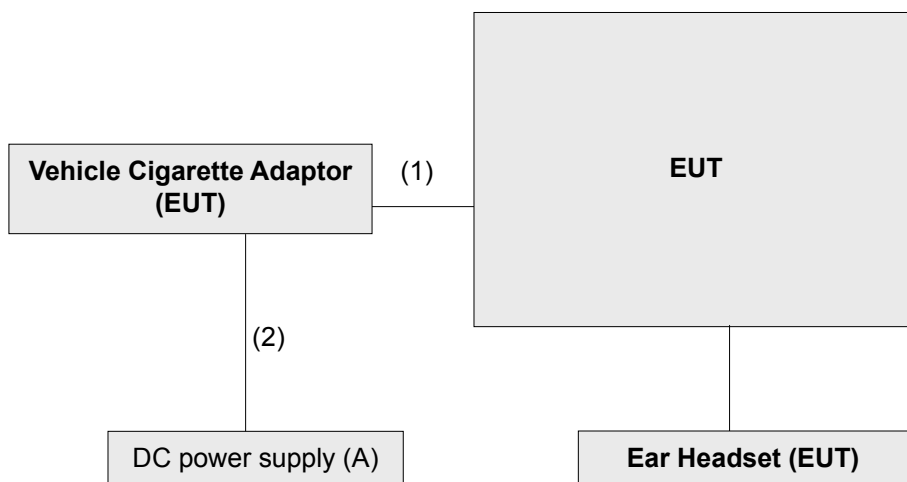

Test Mode C

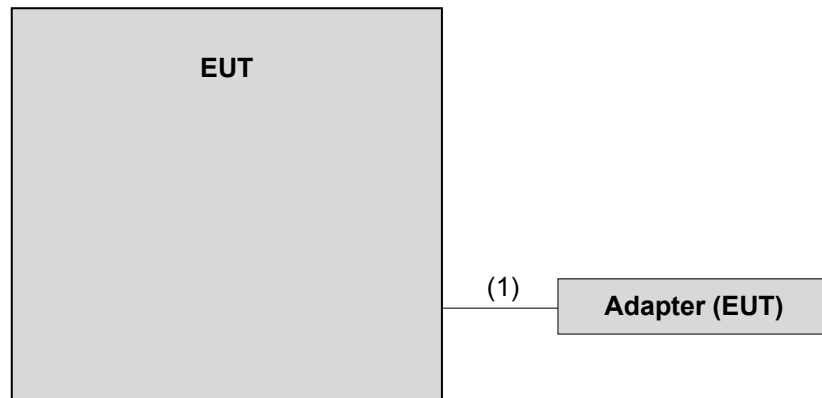

### 3.6 General Description of Applied Standards

The EUT is a RF Product. According to the specifications of the manufacturer, it must comply with the requirements of the following standards:

**FCC Part 15, Subpart E (15.407)**

**KDB 789033 D02 General UNII Test Procedure New Rules v01r04**

**KDB 662911 D01 Multiple Transmitter Output v02r01**

**ANSI C63.10:2013**

All test items have been performed and recorded as per the above standards.

Note: The EUT has been verified to comply with the requirements of FCC Part 15, Subpart B, Class B (DoC).  
The test report has been issued separately.

## 4 Test Types and Results

### 4.1 Radiated Emission and Bandedge Measurement

#### 4.1.1 Limits of Radiated Emission and Bandedge Measurement

Radiated emissions which fall in the restricted bands must comply with the radiated emission limits specified as below table.

Frequencies (MHz)	Field Strength (microvolts/meter)	Measurement Distance (meters)
0.009 ~ 0.490	2400/F(kHz)	300
0.490 ~ 1.705	24000/F(kHz)	30
1.705 ~ 30.0	30	30
30 ~ 88	100	3
88 ~ 216	150	3
216 ~ 960	200	3
Above 960	500	3

**NOTE:**

- The lower limit shall apply at the transition frequencies.
- Emission level (dBuV/m) = 20 log Emission level (uV/m).
- For frequencies above 1000MHz, the field strength limits are based on average detector, however, the peak field strength of any emission shall not exceed the maximum permitted average limits, specified above by more than 20dB under any condition of modulation.

Limits of unwanted emission out of the restricted bands

Applicable To		Limit	
789033 D02 General UNII Test Procedure New Rules v01r04		Field Strength at 3m	
		PK: 74 (dBµV/m)	AV: 54 (dBµV/m)
Frequency Band	Applicable To	EIRP Limit	Equivalent Field Strength at 3m
5150~5250 MHz	15.407(b)(1)	PK: -27 (dBm/MHz)	PK: 68.2(dBµV/m)
5250~5350 MHz	15.407(b)(2)		
5470~5725 MHz	15.407(b)(3)		
5725~5850 MHz	<input checked="" type="checkbox"/> 15.407(b)(4)(i)	PK: -27 (dBm/MHz) <sup>*1</sup> PK: 10 (dBm/MHz) <sup>*2</sup> PK: 15.6 (dBm/MHz) <sup>*3</sup> PK: 27 (dBm/MHz) <sup>*4</sup>	PK: 68.2(dBµV/m) <sup>*1</sup> PK: 105.2 (dBµV/m) <sup>*2</sup> PK: 110.8(dBµV/m) <sup>*3</sup> PK: 122.2 (dBµV/m) <sup>*4</sup>
	<input type="checkbox"/> 15.407(b)(4)(ii)	Emission limits in section 15.247(d)	
<sup>*1</sup> beyond 75 MHz or more above of the band edge.		<sup>*2</sup> below the band edge increasing linearly to 10 dBm/MHz at 25 MHz above.	
<sup>*3</sup> below the band edge increasing linearly to a level of 15.6 dBm/MHz at 5 MHz above.		<sup>*4</sup> from 5 MHz above or below the band edge increasing linearly to a level of 27 dBm/MHz at the band edge.	

**Note:** The following formula is used to convert the equipment isotropic radiated power (eirp) to field strength:

$$E = \frac{1000000 \sqrt{30 P}}{3} \mu\text{V/m, where P is the eirp (Watts).}$$

#### 4.1.2 Test Instruments

Description & Manufacturer	Model No.	Serial No.	Cal. Date	Cal. Due
Test Receiver KEYSIGHT	N9038A	MY55420137	Mar. 27, 2017	Mar. 26, 2018
Spectrum Analyzer ROHDE & SCHWARZ	FSP40	100269	May. 11, 2017	May. 10, 2018
BILOG Antenna SCHWARZBECK	VULB9168	9168-148	Dec. 28, 2016	Dec. 27, 2017
HORN Antenna SCHWARZBECK	BBHA 9120 D	9120D-1169	Dec. 27, 2016	Dec. 26, 2017
HORN Antenna SCHWARZBECK	BBHA 9170	BBHA9170241	Dec. 14, 2016	Dec. 13, 2017
Loop Antenna TESEQ	HLA 6121	45745	May 19, 2017	May 18, 2018
Preamplifier Agilent	8449B	3008A01638	Feb. 22, 2017	Feb. 21, 2018
Preamplifier Agilent	8447D	2944A10638	Aug. 09, 2016	Aug. 08, 2017
			Aug. 08, 2017	Aug. 07, 2018
RF signal cable HUBER+SUHNER	SUCOFLEX 104	CABLE-CH9-02 (248780+MY13377)	Aug. 09, 2016	Aug. 08, 2017
			Aug. 08, 2017	Aug. 07, 2018
RF signal cable HUBER+SUHNER	SUCOFLEX 104	CABLE-CH9-(250795/ 4)	Aug. 09, 2016	Aug. 08, 2017
			Aug. 08, 2017	Aug. 07, 2018
RF signal cable Woken	8D-FB	Cable-CH9-01	Aug. 01, 2017	Jul. 31, 2018
Software BV ADT	ADT_Radiated_ V7.6.15.9.4	NA	NA	NA
Antenna Tower EMCO	2070/2080	512.835.4684	NA	NA
Turn Table EMCO	2087-2.03	NA	NA	NA
Antenna Tower & Turn BV ADT	AT100	AT93021705	NA	NA
Turn Table BV ADT	TT100	TT93021705	NA	NA
Turn Table Controller BV ADT	SC100	SC93021705	NA	NA
26GHz ~ 40GHz Amplifier	EM26400	815221	Oct. 17, 2016	Oct. 16, 2017
High Speed Peak Power Meter	ML2495A	0842014	Apr. 24, 2017	Apr. 23, 2018
Power Sensor	MA2411B	0738404	Apr. 24, 2017	Apr. 23, 2018

- Note:
1. The calibration interval of the above test instruments is 12 months and the calibrations are traceable to NML/ROC and NIST/USA.
  2. The test was performed in HwaYa Chamber 9.
  3. The horn antenna and preamplifier (model: 8449B) are used only for the measurement of emission frequency above 1GHz if tested.
  4. The IC Site Registration No. is IC 7450F-9.

### 4.1.3 Test Procedures

#### For Radiated emission below 30MHz

- a. The EUT was placed on the top of a rotating table 0.8 meters above the ground at a 3 meter chamber room. The table was rotated 360 degrees to determine the position of the highest radiation.
- b. The EUT was set 3 meters away from the interference-receiving antenna, which was mounted on the top of a variable-height antenna tower.
- c. Both X and Y axes of the antenna are set to make the measurement.
- d. For each suspected emission, the EUT was arranged to its worst case and the rotatable table was turned from 0 degrees to 360 degrees to find the maximum reading.
- e. The test-receiver system was set to Quasi-Peak Detect Function and Specified Bandwidth with Maximum Hold Mode.

**Note:**

1. The resolution bandwidth and video bandwidth of test receiver/spectrum analyzer is 9kHz at frequency below 30MHz.

#### For Radiated emission above 30MHz

- a. The EUT was placed on the top of a rotating table 0.8 meters (for 30MHz ~ 1GHz) / 1.5 meters (for above 1GHz) above the ground at 3 meter chamber room for test. The table was rotated 360 degrees to determine the position of the highest radiation.
- b. The EUT was set 3 meters away from the interference-receiving antenna, which was mounted on the top of a variable-height antenna tower.
- c. The height of antenna is varied from one meter to four meters above the ground to determine the maximum value of the field strength. Both horizontal and vertical polarizations of the antenna are set to make the measurement.
- d. For each suspected emission, the EUT was arranged to its worst case and then the antenna was tuned to heights from 1 meter to 4 meters and the rotatable table was turned from 0 degrees to 360 degrees to find the maximum reading.
- e. The test-receiver system was set to quasi-peak detect function and specified bandwidth with maximum hold mode when the test frequency is below 1 GHz.
- f. The test-receiver system was set to peak and average detect function and specified bandwidth with maximum hold mode when the test frequency is above 1 GHz. If the peak reading value also meets average limit, measurement with the average detector is unnecessary.

**Note:**

1. The resolution bandwidth and video bandwidth of test receiver/spectrum analyzer is 120kHz for Quasi-peak detection (QP) at frequency below 1GHz.
2. The resolution bandwidth of test receiver/spectrum analyzer is 1 MHz and the video bandwidth is 3 MHz for Peak detection (PK) at frequency above 1GHz.
3. The resolution bandwidth of test receiver/spectrum analyzer is 1MHz and the video bandwidth is  $\geq 1/T$  (Duty cycle < 98%) or 10Hz (Duty cycle  $\geq 98\%$ ) for Average detection (AV) at frequency above 1GHz.
4. All modes of operation were investigated and the worst-case emissions are reported.

#### 4.1.4 Deviation from Test Standard

No deviation.

#### 4.1.5 Test Set Up

##### For Radiated emission below 30MHz

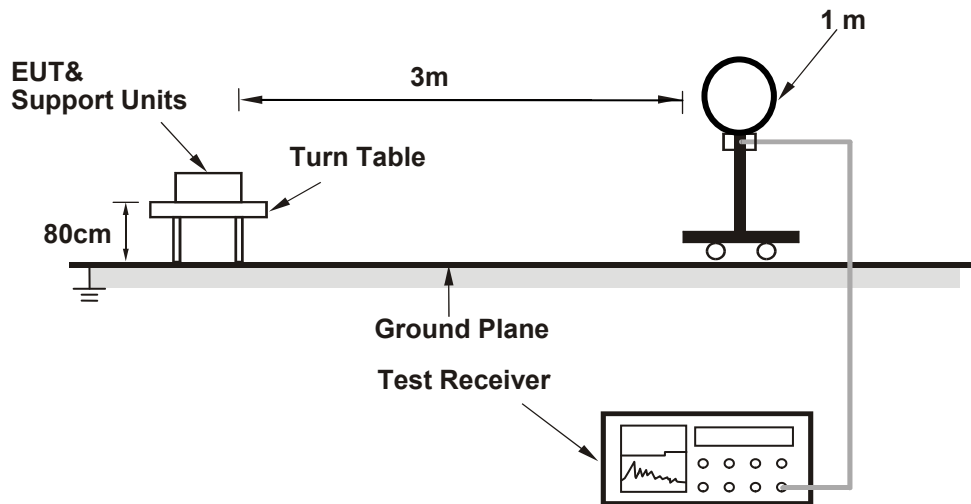

##### For Radiated emission 30MHz to 1GHz

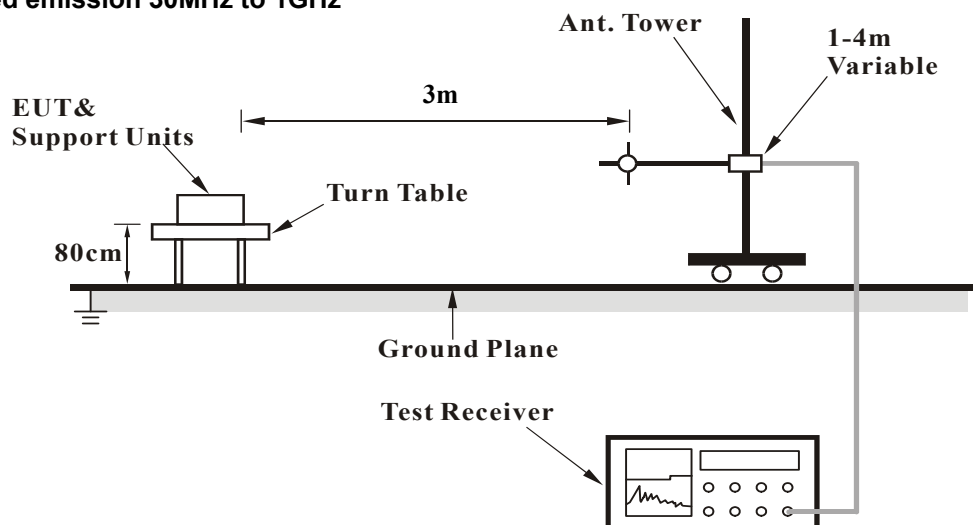

### For Radiated emission above 1GHz

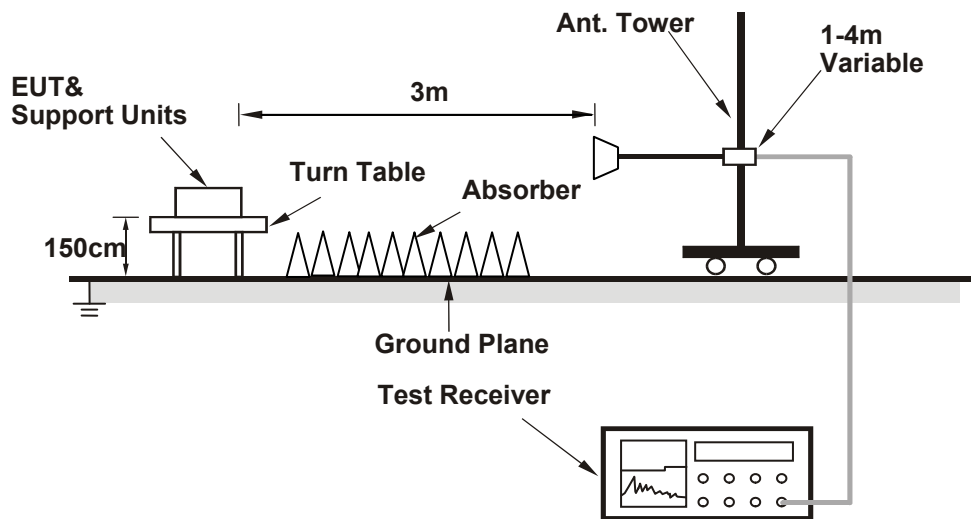

For the actual test configuration, please refer to the attached file (Test Setup Photo).

#### 4.1.6 EUT Operating Conditions

The EUT has been tested as an independent unit together with other necessary accessories or support units.



#### 4.1.7 Test Results

Above 1GHz data:

802.11a

CHANNEL	TX Channel 36	DETECTOR	Peak (PK)
FREQUENCY RANGE	1GHz ~ 40GHz	FUNCTION	Average (AV)

ANTENNA POLARITY & TEST DISTANCE: HORIZONTAL AT 3 M								
NO.	FREQ. (MHz)	EMISSION LEVEL (dBuV/m)	LIMIT (dBuV/m)	MARGIN (dB)	ANTENNA HEIGHT (m)	TABLE ANGLE (Degree)	RAW VALUE (dBuV)	CORRECTION FACTOR (dB/m)
1	5150.00	70.7 PK	74.0	-3.3	1.53 H	91	68.6	2.1
2	5150.00	50.1 AV	54.0	-3.9	1.53 H	91	48.0	2.1
3	*5180.00	113.1 PK			1.43 H	90	74.2	38.9
4	*5180.00	102.0 AV			1.43 H	90	63.1	38.9
5	#10360.00	57.4 PK	74.0	-16.6	2.08 H	169	43.0	14.4
6	#10360.00	44.5 AV	54.0	-9.5	2.08 H	169	30.1	14.4
ANTENNA POLARITY & TEST DISTANCE: VERTICAL AT 3 M								
NO.	FREQ. (MHz)	EMISSION LEVEL (dBuV/m)	LIMIT (dBuV/m)	MARGIN (dB)	ANTENNA HEIGHT (m)	TABLE ANGLE (Degree)	RAW VALUE (dBuV)	CORRECTION FACTOR (dB/m)
1	5150.00	72.7 PK	74.0	-1.3	1.74 V	80	70.6	2.1
2	5150.00	52.8 AV	54.0	-1.2	1.74 V	80	50.7	2.1
3	*5180.00	115.9 PK			1.74 V	81	77.0	38.9
4	*5180.00	104.8 AV			1.74 V	81	65.9	38.9
5	#10360.00	59.3 PK	74.0	-14.7	2.08 V	294	44.9	14.4
6	#10360.00	45.2 AV	54.0	-8.8	2.08 V	294	30.8	14.4

Remarks:

1. Emission Level(dBuV/m) = Raw Value(dBuV) + Correction Factor(dB/m)
2. Correction Factor(dB/m) = Antenna Factor(dB/m) + Cable Factor(dB) – Pre-Amplifier Factor(dB)
3. The other emission levels were very low against the limit.
4. Margin value = Emission Level – Limit value
5. " \* ": Fundamental frequency.
6. " # ": The radiated frequency is out of the restricted band.

CHANNEL	TX Channel 40	DETECTOR FUNCTION	Peak (PK)
FREQUENCY RANGE	1GHz ~ 40GHz		Average (AV)

**ANTENNA POLARITY & TEST DISTANCE: HORIZONTAL AT 3 M**

NO.	FREQ. (MHz)	EMISSION LEVEL (dBuV/m)	LIMIT (dBuV/m)	MARGIN (dB)	ANTENNA HEIGHT (m)	TABLE ANGLE (Degree)	RAW VALUE (dBuV)	CORRECTION FACTOR (dB/m)
1	5150.00	58.4 PK	74.0	-15.6	1.31 H	139	56.3	2.1
2	5150.00	45.3 AV	54.0	-8.7	1.31 H	139	43.2	2.1
3	*5200.00	109.5 PK			1.38 H	140	70.5	39.0
4	*5200.00	99.0 AV			1.38 H	140	60.0	39.0
5	#10400.00	55.7 PK	74.0	-18.3	2.41 H	6	41.1	14.6
6	#10400.00	43.3 AV	54.0	-10.7	2.41 H	6	28.7	14.6

**ANTENNA POLARITY & TEST DISTANCE: VERTICAL AT 3 M**

NO.	FREQ. (MHz)	EMISSION LEVEL (dBuV/m)	LIMIT (dBuV/m)	MARGIN (dB)	ANTENNA HEIGHT (m)	TABLE ANGLE (Degree)	RAW VALUE (dBuV)	CORRECTION FACTOR (dB/m)
1	5150.00	66.6 PK	74.0	-7.4	2.12 V	199	64.5	2.1
2	5150.00	51.2 AV	54.0	-2.8	2.12 V	199	49.1	2.1
3	*5200.00	117.5 PK			2.13 V	197	78.5	39.0
4	*5200.00	106.9 AV			2.13 V	197	67.9	39.0
5	#10400.00	57.5 PK	74.0	-16.5	1.86 V	342	42.9	14.6
6	#10400.00	44.3 AV	54.0	-9.7	1.86 V	342	29.7	14.6

**Remarks:**

1. Emission Level(dBuV/m) = Raw Value(dBuV) + Correction Factor(dB/m)
2. Correction Factor(dB/m) = Antenna Factor(dB/m) + Cable Factor(dB) – Pre-Amplifier Factor(dB)
3. The other emission levels were very low against the limit.
4. Margin value = Emission Level – Limit value
5. " \* ": Fundamental frequency.
6. " # ": The radiated frequency is out of the restricted band.

CHANNEL	TX Channel 48	DETECTOR FUNCTION	Peak (PK)
FREQUENCY RANGE	1GHz ~ 40GHz		Average (AV)

ANTENNA POLARITY & TEST DISTANCE: HORIZONTAL AT 3 M								
NO.	FREQ. (MHz)	EMISSION LEVEL (dBuV/m)	LIMIT (dBuV/m)	MARGIN (dB)	ANTENNA HEIGHT (m)	TABLE ANGLE (Degree)	RAW VALUE (dBuV)	CORRECTION FACTOR (dB/m)
1	*5240.00	109.4 PK			1.26 H	138	70.4	39.0
2	*5240.00	99.0 AV			1.26 H	138	60.0	39.0
3	5350.00	54.4 PK	74.0	-19.6	1.61 H	195	51.8	2.6
4	5350.00	41.4 AV	54.0	-12.6	1.61 H	195	38.8	2.6
5	#10480.00	54.4 PK	74.0	-19.6	1.69 H	311	40.2	14.2
6	#10480.00	42.0 AV	54.0	-12.0	1.69 H	311	27.8	14.2

ANTENNA POLARITY & TEST DISTANCE: VERTICAL AT 3 M								
NO.	FREQ. (MHz)	EMISSION LEVEL (dBuV/m)	LIMIT (dBuV/m)	MARGIN (dB)	ANTENNA HEIGHT (m)	TABLE ANGLE (Degree)	RAW VALUE (dBuV)	CORRECTION FACTOR (dB/m)
1	*5240.00	118.3 PK			2.11 V	198	79.3	39.0
2	*5240.00	107.1 AV			2.11 V	198	68.1	39.0
3	5350.00	54.8 PK	74.0	-19.2	2.05 V	199	52.2	2.6
4	5350.00	42.5 AV	54.0	-11.5	2.05 V	199	39.9	2.6
5	#10480.00	56.4 PK	74.0	-17.6	1.41 V	193	42.2	14.2
6	#10480.00	42.7 AV	54.0	-11.3	1.41 V	193	28.5	14.2

Remarks:

1. Emission Level(dBuV/m) = Raw Value(dBuV) + Correction Factor(dB/m)
2. Correction Factor(dB/m) = Antenna Factor(dB/m) + Cable Factor(dB) – Pre-Amplifier Factor(dB)
3. The other emission levels were very low against the limit.
4. Margin value = Emission Level – Limit value
5. " \* ": Fundamental frequency.
6. " # ": The radiated frequency is out of the restricted band.

CHANNEL	TX Channel 52	DETECTOR FUNCTION	Peak (PK)
FREQUENCY RANGE	1GHz ~ 40GHz		Average (AV)

**ANTENNA POLARITY & TEST DISTANCE: HORIZONTAL AT 3 M**

NO.	FREQ. (MHz)	EMISSION LEVEL (dBuV/m)	LIMIT (dBuV/m)	MARGIN (dB)	ANTENNA HEIGHT (m)	TABLE ANGLE (Degree)	RAW VALUE (dBuV)	CORRECTION FACTOR (dB/m)
1	5150.00	53.5 PK	74.0	-20.5	1.50 H	94	51.4	2.1
2	5150.00	40.8 AV	54.0	-13.2	1.50 H	94	38.7	2.1
3	*5260.00	110.4 PK			1.54 H	92	71.3	39.1
4	*5260.00	99.7 AV			1.54 H	92	60.6	39.1
5	#10520.00	55.4 PK	74.0	-18.6	1.67 H	243	41.2	14.2
6	#10520.00	42.5 AV	54.0	-11.5	1.67 H	243	28.3	14.2

**ANTENNA POLARITY & TEST DISTANCE: VERTICAL AT 3 M**

NO.	FREQ. (MHz)	EMISSION LEVEL (dBuV/m)	LIMIT (dBuV/m)	MARGIN (dB)	ANTENNA HEIGHT (m)	TABLE ANGLE (Degree)	RAW VALUE (dBuV)	CORRECTION FACTOR (dB/m)
1	5150.00	54.5 PK	74.0	-19.5	1.92 V	204	52.4	2.1
2	5150.00	41.7 AV	54.0	-12.3	1.92 V	204	39.6	2.1
3	*5260.00	115.1 PK			1.96 V	197	76.0	39.1
4	*5260.00	105.3 AV			1.96 V	197	66.2	39.1
5	#10520.00	56.1 PK	74.0	-17.9	1.65 V	91	41.9	14.2
6	#10520.00	43.1 AV	54.0	-10.9	1.65 V	91	28.9	14.2

**Remarks:**

1. Emission Level(dBuV/m) = Raw Value(dBuV) + Correction Factor(dB/m)
2. Correction Factor(dB/m) = Antenna Factor(dB/m) + Cable Factor(dB) – Pre-Amplifier Factor(dB)
3. The other emission levels were very low against the limit.
4. Margin value = Emission Level – Limit value
5. " \* ": Fundamental frequency.
6. " # ": The radiated frequency is out of the restricted band.

CHANNEL	TX Channel 60	DETECTOR FUNCTION	Peak (PK)
FREQUENCY RANGE	1GHz ~ 40GHz		Average (AV)

ANTENNA POLARITY & TEST DISTANCE: HORIZONTAL AT 3 M								
NO.	FREQ. (MHz)	EMISSION LEVEL (dBuV/m)	LIMIT (dBuV/m)	MARGIN (dB)	ANTENNA HEIGHT (m)	TABLE ANGLE (Degree)	RAW VALUE (dBuV)	CORRECTION FACTOR (dB/m)
1	*5300.00	109.5 PK			1.49 H	92	70.3	39.2
2	*5300.00	99.1 AV			1.49 H	92	59.9	39.2
3	5350.00	58.0 PK	74.0	-16.0	1.47 H	93	55.4	2.6
4	5350.00	45.4 AV	54.0	-8.6	1.47 H	93	42.8	2.6
5	10600.00	56.0 PK	74.0	-18.0	2.02 H	195	41.3	14.7
6	10600.00	42.2 AV	54.0	-11.8	2.02 H	195	27.5	14.7
ANTENNA POLARITY & TEST DISTANCE: VERTICAL AT 3 M								
NO.	FREQ. (MHz)	EMISSION LEVEL (dBuV/m)	LIMIT (dBuV/m)	MARGIN (dB)	ANTENNA HEIGHT (m)	TABLE ANGLE (Degree)	RAW VALUE (dBuV)	CORRECTION FACTOR (dB/m)
1	*5300.00	114.5 PK			2.03 V	197	75.3	39.2
2	*5300.00	103.6 AV			2.03 V	197	64.4	39.2
3	5350.00	62.3 PK	74.0	-11.7	2.02 V	196	59.7	2.6
4	5350.00	48.8 AV	54.0	-5.2	2.02 V	196	46.2	2.6
5	10600.00	56.8 PK	74.0	-17.2	1.69 V	96	42.1	14.7
6	10600.00	43.7 AV	54.0	-10.3	1.69 V	96	29.0	14.7

Remarks:

1. Emission Level(dBuV/m) = Raw Value(dBuV) + Correction Factor(dB/m)
2. Correction Factor(dB/m) = Antenna Factor(dB/m) + Cable Factor(dB) – Pre-Amplifier Factor(dB)
3. The other emission levels were very low against the limit.
4. Margin value = Emission Level – Limit value
5. " \* ": Fundamental frequency.
6. " # ": The radiated frequency is out of the restricted band.

CHANNEL	TX Channel 64	DETECTOR FUNCTION	Peak (PK)
FREQUENCY RANGE	1GHz ~ 40GHz		Average (AV)

ANTENNA POLARITY & TEST DISTANCE: HORIZONTAL AT 3 M								
NO.	FREQ. (MHz)	EMISSION LEVEL (dBuV/m)	LIMIT (dBuV/m)	MARGIN (dB)	ANTENNA HEIGHT (m)	TABLE ANGLE (Degree)	RAW VALUE (dBuV)	CORRECTION FACTOR (dB/m)
1	*5320.00	108.6 PK			1.53 H	92	69.4	39.2
2	*5320.00	98.2 AV			1.53 H	92	59.0	39.2
3	5350.00	66.9 PK	74.0	-7.1	1.46 H	94	64.3	2.6
4	5350.00	48.4 AV	54.0	-5.6	1.46 H	94	45.8	2.6
5	10640.00	54.9 PK	74.0	-19.1	2.55 H	173	40.2	14.7
6	10640.00	42.0 AV	54.0	-12.0	2.55 H	173	27.3	14.7
ANTENNA POLARITY & TEST DISTANCE: VERTICAL AT 3 M								
NO.	FREQ. (MHz)	EMISSION LEVEL (dBuV/m)	LIMIT (dBuV/m)	MARGIN (dB)	ANTENNA HEIGHT (m)	TABLE ANGLE (Degree)	RAW VALUE (dBuV)	CORRECTION FACTOR (dB/m)
1	*5320.00	113.8 PK			2.00 V	196	74.6	39.2
2	*5320.00	103.1 AV			2.00 V	196	63.9	39.2
3	5350.00	70.5 PK	74.0	-3.5	2.01 V	204	67.9	2.6
4	5350.00	52.9 AV	54.0	-1.1	2.01 V	204	50.3	2.6
5	10640.00	56.4 PK	74.0	-17.6	1.72 V	100	41.7	14.7
6	10640.00	43.4 AV	54.0	-10.6	1.72 V	100	28.7	14.7

Remarks:

1. Emission Level(dBuV/m) = Raw Value(dBuV) + Correction Factor(dB/m)
2. Correction Factor(dB/m) = Antenna Factor(dB/m) + Cable Factor(dB) – Pre-Amplifier Factor(dB)
3. The other emission levels were very low against the limit.
4. Margin value = Emission Level – Limit value
5. " \* ": Fundamental frequency.
6. " # ": The radiated frequency is out of the restricted band.

CHANNEL	TX Channel 100	DETECTOR FUNCTION	Peak (PK)
FREQUENCY RANGE	1GHz ~ 40GHz		Average (AV)

## ANTENNA POLARITY &amp; TEST DISTANCE: HORIZONTAL AT 3 M

NO.	FREQ. (MHz)	EMISSION LEVEL (dBuV/m)	LIMIT (dBuV/m)	MARGIN (dB)	ANTENNA HEIGHT (m)	TABLE ANGLE (Degree)	RAW VALUE (dBuV)	CORRECTION FACTOR (dB/m)
1	5460.00	63.2 PK	74.0	-10.8	2.26 H	113	56.5	6.7
2	5460.00	47.2 AV	54.0	-6.8	2.26 H	113	40.5	6.7
3	#5470.00	65.2 PK	74.0	-8.8	2.23 H	115	58.5	6.7
4	#5470.00	51.4 AV	54.0	-2.6	2.23 H	115	44.7	6.7
5	*5500.00	112.3 PK			2.23 H	112	71.4	40.9
6	*5500.00	101.8 AV			2.23 H	112	60.9	40.9
7	11000.00	60.5 PK	74.0	-13.5	1.72 H	106	41.2	19.3
8	11000.00	48.1 AV	54.0	-5.9	1.72 H	106	28.8	19.3

## ANTENNA POLARITY &amp; TEST DISTANCE: VERTICAL AT 3 M

NO.	FREQ. (MHz)	EMISSION LEVEL (dBuV/m)	LIMIT (dBuV/m)	MARGIN (dB)	ANTENNA HEIGHT (m)	TABLE ANGLE (Degree)	RAW VALUE (dBuV)	CORRECTION FACTOR (dB/m)
1	5460.00	63.7 PK	74.0	-10.3	1.85 V	178	61.0	2.7
2	5460.00	45.2 AV	54.0	-8.8	1.85 V	178	42.5	2.7
3	#5470.00	70.2 PK	74.0	-3.8	1.87 V	174	67.5	2.7
4	#5470.00	52.5 AV	54.0	-1.5	1.87 V	174	49.8	2.7
5	*5500.00	113.4 PK			1.87 V	174	73.9	39.5
6	*5500.00	103.3 AV			1.87 V	174	63.8	39.5
7	11000.00	58.7 PK	74.0	-15.3	1.47 V	56	42.6	16.1
8	11000.00	46.7 AV	54.0	-7.3	1.47 V	56	30.6	16.1

## Remarks:

1. Emission Level(dBuV/m) = Raw Value(dBuV) + Correction Factor(dB/m)
2. Correction Factor(dB/m) = Antenna Factor(dB/m) + Cable Factor(dB) – Pre-Amplifier Factor(dB)
3. The other emission levels were very low against the limit.
4. Margin value = Emission Level – Limit value
5. " \* ": Fundamental frequency.
6. " # ": The radiated frequency is out of the restricted band.

CHANNEL	TX Channel 116	DETECTOR FUNCTION	Peak (PK)
FREQUENCY RANGE	1GHz ~ 40GHz		Average (AV)

ANTENNA POLARITY & TEST DISTANCE: HORIZONTAL AT 3 M								
NO.	FREQ. (MHz)	EMISSION LEVEL (dBuV/m)	LIMIT (dBuV/m)	MARGIN (dB)	ANTENNA HEIGHT (m)	TABLE ANGLE (Degree)	RAW VALUE (dBuV)	CORRECTION FACTOR (dB/m)
1	*5580.00	113.5 PK			2.23 H	46	72.5	41.0
2	*5580.00	102.8 AV			2.23 H	46	61.8	41.0
3	11160.00	61.4 PK	74.0	-12.6	1.75 H	104	41.6	19.8
4	11160.00	48.9 AV	54.0	-5.1	1.75 H	104	29.1	19.8
ANTENNA POLARITY & TEST DISTANCE: VERTICAL AT 3 M								
NO.	FREQ. (MHz)	EMISSION LEVEL (dBuV/m)	LIMIT (dBuV/m)	MARGIN (dB)	ANTENNA HEIGHT (m)	TABLE ANGLE (Degree)	RAW VALUE (dBuV)	CORRECTION FACTOR (dB/m)
1	*5580.00	114.0 PK			1.91 V	173	74.3	39.7
2	*5580.00	104.1 AV			1.91 V	173	64.4	39.7
3	11160.00	57.9 PK	74.0	-16.1	1.05 V	87	42.6	15.3
4	11160.00	45.7 AV	54.0	-8.3	1.05 V	87	30.4	15.3

Remarks:

1. Emission Level(dBuV/m) = Raw Value(dBuV) + Correction Factor(dB/m)
2. Correction Factor(dB/m) = Antenna Factor(dB/m) + Cable Factor(dB) – Pre-Amplifier Factor(dB)
3. The other emission levels were very low against the limit.
4. Margin value = Emission Level – Limit value
5. " \* ": Fundamental frequency.
6. " # ": The radiated frequency is out of the restricted band.



CHANNEL	TX Channel 140	DETECTOR FUNCTION	Peak (PK)
FREQUENCY RANGE	1GHz ~ 40GHz		Average (AV)

## ANTENNA POLARITY &amp; TEST DISTANCE: HORIZONTAL AT 3 M

NO.	FREQ. (MHz)	EMISSION LEVEL (dBuV/m)	LIMIT (dBuV/m)	MARGIN (dB)	ANTENNA HEIGHT (m)	TABLE ANGLE (Degree)	RAW VALUE (dBuV)	CORRECTION FACTOR (dB/m)
1	*5700.00	108.7 PK			2.27 H	29	67.2	41.5
2	*5700.00	98.3 AV			2.27 H	29	56.8	41.5
3	#5725.00	65.5 PK	74.0	-8.5	2.29 H	41	58.2	7.3
4	#5725.00	50.8 AV	54.0	-3.2	2.29 H	41	43.5	7.3
5	11400.00	62.2 PK	74.0	-11.8	1.65 H	101	41.8	20.4
6	11400.00	49.6 AV	54.0	-4.4	1.65 H	101	29.2	20.4

## ANTENNA POLARITY &amp; TEST DISTANCE: VERTICAL AT 3 M

NO.	FREQ. (MHz)	EMISSION LEVEL (dBuV/m)	LIMIT (dBuV/m)	MARGIN (dB)	ANTENNA HEIGHT (m)	TABLE ANGLE (Degree)	RAW VALUE (dBuV)	CORRECTION FACTOR (dB/m)
1	*5700.00	112.3 PK			1.58 V	198	72.4	39.9
2	*5700.00	102.1 AV			1.58 V	198	62.2	39.9
3	#5725.00	71.3 PK	74.0	-2.7	1.58 V	198	68.2	3.1
<b>4</b>	<b>#5725.00</b>	<b>53.0 AV</b>	<b>54.0</b>	<b>-1.0</b>	<b>1.58 V</b>	<b>198</b>	<b>49.9</b>	<b>3.1</b>
5	11400.00	57.5 PK	74.0	-16.5	1.02 V	54	42.2	15.3
6	11400.00	44.9 AV	54.0	-9.1	1.02 V	54	29.6	15.3

## Remarks:

1. Emission Level(dBuV/m) = Raw Value(dBuV) + Correction Factor(dB/m)
2. Correction Factor(dB/m) = Antenna Factor(dB/m) + Cable Factor(dB) – Pre-Amplifier Factor(dB)
3. The other emission levels were very low against the limit.
4. Margin value = Emission Level – Limit value
5. " \* ": Fundamental frequency.
6. " # ": The radiated frequency is out of the restricted band.

CHANNEL	TX Channel 144	DETECTOR FUNCTION	Peak (PK)
FREQUENCY RANGE	1GHz ~ 40GHz		Average (AV)

ANTENNA POLARITY & TEST DISTANCE: HORIZONTAL AT 3 M								
NO.	FREQ. (MHz)	EMISSION LEVEL (dBuV/m)	LIMIT (dBuV/m)	MARGIN (dB)	ANTENNA HEIGHT (m)	TABLE ANGLE (Degree)	RAW VALUE (dBuV)	CORRECTION FACTOR (dB/m)
1	#5470.00	59.1 PK	74.0	-14.9	2.13 H	55	52.4	6.7
2	#5470.00	44.9 AV	54.0	-9.1	2.13 H	55	38.2	6.7
3	*5720.00	112.2 PK			2.11 H	53	70.7	41.5
4	*5720.00	101.7 AV			2.11 H	53	60.2	41.5
5	#5850.00	58.6 PK	74.0	-15.4	2.09 H	47	50.9	7.7
6	#5850.00	45.8 AV	54.0	-8.2	2.09 H	47	38.1	7.7
7	11440.00	62.1 PK	74.0	-11.9	1.68 H	98	41.8	20.3
8	11440.00	48.8 AV	54.0	-5.2	1.68 H	98	28.5	20.3

ANTENNA POLARITY & TEST DISTANCE: VERTICAL AT 3 M								
NO.	FREQ. (MHz)	EMISSION LEVEL (dBuV/m)	LIMIT (dBuV/m)	MARGIN (dB)	ANTENNA HEIGHT (m)	TABLE ANGLE (Degree)	RAW VALUE (dBuV)	CORRECTION FACTOR (dB/m)
1	#5470.00	55.6 PK	74.0	-18.4	1.65 V	180	52.9	2.7
2	#5470.00	43.4 AV	54.0	-10.6	1.65 V	180	40.7	2.7
3	*5720.00	116.1 PK			1.70 V	174	76.2	39.9
4	*5720.00	105.0 AV			1.70 V	174	65.1	39.9
5	#5850.00	55.6 PK	74.0	-18.4	1.65 V	178	52.4	3.2
6	#5850.00	43.7 AV	54.0	-10.3	1.65 V	178	40.5	3.2
7	11440.00	57.1 PK	74.0	-16.9	1.05 V	21	42.1	15.0
8	11440.00	44.1 AV	54.0	-9.9	1.05 V	21	29.1	15.0

**REMARKS:**

1. Emission Level(dBuV/m) = Raw Value(dBuV) + Correction Factor(dB/m)
2. Correction Factor(dB/m) = Antenna Factor(dB/m) + Cable Factor(dB) – Pre-Amplifier Factor(dB)
3. The other emission levels were very low against the limit.
4. Margin value = Emission Level – Limit value
5. " \* " : Fundamental frequency.
6. " # " : The radiated frequency is out of the restricted band.

CHANNEL	TX Channel 149	DETECTOR FUNCTION	Peak (PK)
FREQUENCY RANGE	1GHz ~ 40GHz		Average (AV)

**ANTENNA POLARITY & TEST DISTANCE: HORIZONTAL AT 3 M**

NO.	FREQ. (MHz)	EMISSION LEVEL (dBuV/m)	LIMIT (dBuV/m)	MARGIN (dB)	ANTENNA HEIGHT (m)	TABLE ANGLE (Degree)	RAW VALUE (dBuV)	CORRECTION FACTOR (dB/m)
1	#5616.00	59.1 PK	68.2	-9.1	1.96 H	57	52.2	6.9
2	*5745.00	113.2 PK			1.96 H	57	71.6	41.6
3	*5745.00	102.7 AV			1.96 H	57	61.1	41.6
4	#5971.20	60.3 PK	68.2	-7.9	1.96 H	57	52.4	7.9
5	11490.00	62.7 PK	74.0	-11.3	1.69 H	74	42.4	20.3
6	11490.00	49.4 AV	54.0	-4.6	1.69 H	74	29.1	20.3

**ANTENNA POLARITY & TEST DISTANCE: VERTICAL AT 3 M**

NO.	FREQ. (MHz)	EMISSION LEVEL (dBuV/m)	LIMIT (dBuV/m)	MARGIN (dB)	ANTENNA HEIGHT (m)	TABLE ANGLE (Degree)	RAW VALUE (dBuV)	CORRECTION FACTOR (dB/m)
1	#5619.20	63.8 PK	68.2	-4.4	1.62 V	198	60.9	2.9
2	*5745.00	114.5 PK			1.63 V	198	74.6	39.9
3	*5745.00	104.2 AV			1.63 V	198	64.3	39.9
4	#5948.00	64.4 PK	68.2	-3.8	1.62 V	198	61.2	3.2
5	11490.00	56.9 PK	74.0	-17.1	1.05 V	47	42.3	14.6
6	11490.00	44.2 AV	54.0	-9.8	1.05 V	47	29.6	14.6

**Remarks:**

1. Emission Level(dBuV/m) = Raw Value(dBuV) + Correction Factor(dB/m)
2. Correction Factor(dB/m) = Antenna Factor(dB/m) + Cable Factor(dB) – Pre-Amplifier Factor(dB)
3. The other emission levels were very low against the limit.
4. Margin value = Emission Level – Limit value
5. " \* ": Fundamental frequency.
6. " # ": The radiated frequency is out of the restricted band.

CHANNEL	TX Channel 157	DETECTOR FUNCTION	Peak (PK)
FREQUENCY RANGE	1GHz ~ 40GHz		Average (AV)

**ANTENNA POLARITY & TEST DISTANCE: HORIZONTAL AT 3 M**

NO.	FREQ. (MHz)	EMISSION LEVEL (dBuV/m)	LIMIT (dBuV/m)	MARGIN (dB)	ANTENNA HEIGHT (m)	TABLE ANGLE (Degree)	RAW VALUE (dBuV)	CORRECTION FACTOR (dB/m)
1	#5640.80	59.5 PK	68.2	-8.7	1.99 H	33	52.4	7.1
2	*5785.00	113.0 PK			1.99 H	33	71.4	41.6
3	*5785.00	102.8 AV			1.99 H	33	61.2	41.6
4	#5978.40	59.3 PK	68.2	-8.9	1.99 H	33	51.4	7.9
5	11570.00	62.3 PK	74.0	-11.7	1.66 H	103	42.2	20.1
6	11570.00	49.3 AV	54.0	-4.7	1.66 H	103	29.2	20.1

**ANTENNA POLARITY & TEST DISTANCE: VERTICAL AT 3 M**

NO.	FREQ. (MHz)	EMISSION LEVEL (dBuV/m)	LIMIT (dBuV/m)	MARGIN (dB)	ANTENNA HEIGHT (m)	TABLE ANGLE (Degree)	RAW VALUE (dBuV)	CORRECTION FACTOR (dB/m)
1	#5606.40	58.1 PK	68.2	-10.1	1.50 V	197	55.2	2.9
2	*5785.00	116.7 PK			1.50 V	197	76.8	39.9
3	*5785.00	106.2 AV			1.50 V	197	66.3	39.9
4	#5979.20	58.5 PK	68.2	-9.7	1.50 V	197	55.2	3.3
5	11570.00	57.1 PK	74.0	-16.9	1.05 V	28	42.6	14.5
6	11570.00	44.1 AV	54.0	-9.9	1.05 V	28	29.6	14.5

**Remarks:**

1. Emission Level(dBuV/m) = Raw Value(dBuV) + Correction Factor(dB/m)
2. Correction Factor(dB/m) = Antenna Factor(dB/m) + Cable Factor(dB) – Pre-Amplifier Factor(dB)
3. The other emission levels were very low against the limit.
4. Margin value = Emission Level – Limit value
5. " \* ": Fundamental frequency.
6. " # ": The radiated frequency is out of the restricted band.

CHANNEL	TX Channel 165	DETECTOR FUNCTION	Peak (PK)
FREQUENCY RANGE	1GHz ~ 40GHz		Average (AV)

**ANTENNA POLARITY & TEST DISTANCE: HORIZONTAL AT 3 M**

NO.	FREQ. (MHz)	EMISSION LEVEL (dBuV/m)	LIMIT (dBuV/m)	MARGIN (dB)	ANTENNA HEIGHT (m)	TABLE ANGLE (Degree)	RAW VALUE (dBuV)	CORRECTION FACTOR (dB/m)
1	#5608.80	58.3 PK	68.2	-9.9	2.25 H	115	51.4	6.9
2	*5825.00	113.2 PK			2.25 H	115	71.4	41.8
3	*5825.00	102.6 AV			2.25 H	115	60.8	41.8
4	#5988.80	60.7 PK	68.2	-7.5	2.25 H	115	52.8	7.9
5	11650.00	61.5 PK	74.0	-12.5	1.96 H	71	41.7	19.8
6	11650.00	48.8 AV	54.0	-5.2	1.96 H	71	29.0	19.8

**ANTENNA POLARITY & TEST DISTANCE: VERTICAL AT 3 M**

NO.	FREQ. (MHz)	EMISSION LEVEL (dBuV/m)	LIMIT (dBuV/m)	MARGIN (dB)	ANTENNA HEIGHT (m)	TABLE ANGLE (Degree)	RAW VALUE (dBuV)	CORRECTION FACTOR (dB/m)
1	#5633.60	57.9 PK	68.2	-10.3	1.58 V	198	55.0	2.9
2	*5825.00	116.2 PK			1.58 V	198	76.2	40.0
3	*5825.00	105.8 AV			1.58 V	198	65.8	40.0
4	#5980.80	58.9 PK	68.2	-9.3	1.58 V	198	55.6	3.3
5	11650.00	56.8 PK	74.0	-17.2	1.07 V	48	42.1	14.7
6	11650.00	44.0 AV	54.0	-10.0	1.07 V	48	29.3	14.7

**Remarks:**

1. Emission Level(dBuV/m) = Raw Value(dBuV) + Correction Factor(dB/m)
2. Correction Factor(dB/m) = Antenna Factor(dB/m) + Cable Factor(dB) – Pre-Amplifier Factor(dB)
3. The other emission levels were very low against the limit.
4. Margin value = Emission Level – Limit value
5. " \* ": Fundamental frequency.
6. " # ": The radiated frequency is out of the restricted band.

802.11n (HT20)

CHANNEL	TX Channel 36	DETECTOR	Peak (PK)
FREQUENCY RANGE	1GHz ~ 40GHz	FUNCTION	Average (AV)

ANTENNA POLARITY & TEST DISTANCE: HORIZONTAL AT 3 M								
NO.	FREQ. (MHz)	EMISSION LEVEL (dBuV/m)	LIMIT (dBuV/m)	MARGIN (dB)	ANTENNA HEIGHT (m)	TABLE ANGLE (Degree)	RAW VALUE (dBuV)	CORRECTION FACTOR (dB/m)
1	5150.00	63.5 PK	74.0	-10.5	1.70 H	90	61.4	2.1
2	5150.00	45.6 AV	54.0	-8.4	1.70 H	90	43.5	2.1
3	*5180.00	107.5 PK			1.49 H	90	68.6	38.9
4	*5180.00	97.1 AV			1.49 H	90	58.2	38.9
5	#10360.00	55.7 PK	74.0	-18.3	1.97 H	283	41.3	14.4
6	#10360.00	42.9 AV	54.0	-11.1	1.97 H	283	28.5	14.4
ANTENNA POLARITY & TEST DISTANCE: VERTICAL AT 3 M								
NO.	FREQ. (MHz)	EMISSION LEVEL (dBuV/m)	LIMIT (dBuV/m)	MARGIN (dB)	ANTENNA HEIGHT (m)	TABLE ANGLE (Degree)	RAW VALUE (dBuV)	CORRECTION FACTOR (dB/m)
<b>1</b>	<b>5150.00</b>	<b>73.0 PK</b>	<b>74.0</b>	<b>-1.0</b>	<b>2.23 V</b>	<b>205</b>	<b>70.9</b>	<b>2.1</b>
2	5150.00	51.5 AV	54.0	-2.5	2.23 V	205	49.4	2.1
3	*5180.00	115.1 PK			2.20 V	199	76.2	38.9
4	*5180.00	103.5 AV			2.20 V	199	64.6	38.9
5	#10360.00	56.2 PK	74.0	-17.8	1.67 V	155	41.8	14.4
6	#10360.00	43.6 AV	54.0	-10.4	1.67 V	155	29.2	14.4

Remarks:

1. Emission Level(dBuV/m) = Raw Value(dBuV) + Correction Factor(dB/m)
2. Correction Factor(dB/m) = Antenna Factor(dB/m) + Cable Factor(dB) – Pre-Amplifier Factor(dB)
3. The other emission levels were very low against the limit.
4. Margin value = Emission Level – Limit value
5. " \* ": Fundamental frequency.
6. " # ": The radiated frequency is out of the restricted band.

CHANNEL	TX Channel 40	DETECTOR FUNCTION	Peak (PK)
FREQUENCY RANGE	1GHz ~ 40GHz		Average (AV)

ANTENNA POLARITY & TEST DISTANCE: HORIZONTAL AT 3 M								
NO.	FREQ. (MHz)	EMISSION LEVEL (dBuV/m)	LIMIT (dBuV/m)	MARGIN (dB)	ANTENNA HEIGHT (m)	TABLE ANGLE (Degree)	RAW VALUE (dBuV)	CORRECTION FACTOR (dB/m)
1	5150.00	62.0 PK	74.0	-12.0	1.55 H	91	59.9	2.1
2	5150.00	46.3 AV	54.0	-7.7	1.55 H	91	44.2	2.1
3	*5200.00	110.2 PK			1.54 H	90	71.2	39.0
4	*5200.00	99.2 AV			1.54 H	90	60.2	39.0
5	#10400.00	56.4 PK	74.0	-17.6	1.63 H	77	41.8	14.6
6	#10400.00	43.8 AV	54.0	-10.2	1.63 H	77	29.2	14.6

ANTENNA POLARITY & TEST DISTANCE: VERTICAL AT 3 M								
NO.	FREQ. (MHz)	EMISSION LEVEL (dBuV/m)	LIMIT (dBuV/m)	MARGIN (dB)	ANTENNA HEIGHT (m)	TABLE ANGLE (Degree)	RAW VALUE (dBuV)	CORRECTION FACTOR (dB/m)
1	5150.00	69.9 PK	74.0	-4.1	2.12 V	198	67.8	2.1
2	5150.00	52.8 AV	54.0	-1.2	2.12 V	198	50.7	2.1
3	*5200.00	117.8 PK			2.12 V	198	78.8	39.0
4	*5200.00	106.6 AV			2.12 V	198	67.6	39.0
5	#10400.00	56.2 PK	74.0	-17.8	1.70 V	142	41.6	14.6
6	#10400.00	43.6 AV	54.0	-10.4	1.70 V	142	29.0	14.6

Remarks:

1. Emission Level(dBuV/m) = Raw Value(dBuV) + Correction Factor(dB/m)
2. Correction Factor(dB/m) = Antenna Factor(dB/m) + Cable Factor(dB) – Pre-Amplifier Factor(dB)
3. The other emission levels were very low against the limit.
4. Margin value = Emission Level – Limit value
5. " \* ": Fundamental frequency.
6. " # ": The radiated frequency is out of the restricted band.

CHANNEL	TX Channel 48	DETECTOR FUNCTION	Peak (PK)
FREQUENCY RANGE	1GHz ~ 40GHz		Average (AV)

**ANTENNA POLARITY & TEST DISTANCE: HORIZONTAL AT 3 M**

NO.	FREQ. (MHz)	EMISSION LEVEL (dBuV/m)	LIMIT (dBuV/m)	MARGIN (dB)	ANTENNA HEIGHT (m)	TABLE ANGLE (Degree)	RAW VALUE (dBuV)	CORRECTION FACTOR (dB/m)
1	*5240.00	110.3 PK			1.57 H	90	71.3	39.0
2	*5240.00	99.4 AV			1.57 H	90	60.4	39.0
3	5380.00	54.9 PK	74.0	-19.1	1.55 H	86	52.3	2.6
4	5380.00	41.7 AV	54.0	-12.3	1.55 H	86	39.1	2.6
5	#10480.00	55.1 PK	74.0	-18.9	1.87 H	333	40.9	14.2
6	#10480.00	43.0 AV	54.0	-11.0	1.87 H	333	28.8	14.2

**ANTENNA POLARITY & TEST DISTANCE: VERTICAL AT 3 M**

NO.	FREQ. (MHz)	EMISSION LEVEL (dBuV/m)	LIMIT (dBuV/m)	MARGIN (dB)	ANTENNA HEIGHT (m)	TABLE ANGLE (Degree)	RAW VALUE (dBuV)	CORRECTION FACTOR (dB/m)
1	*5240.00	118.1 PK			2.08 V	197	79.1	39.0
2	*5240.00	106.8 AV			2.08 V	197	67.8	39.0
3	5380.00	58.7 PK	74.0	-15.3	2.05 V	195	56.1	2.6
4	5380.00	45.4 AV	54.0	-8.6	2.05 V	195	42.8	2.6
5	#10480.00	56.1 PK	74.0	-17.9	1.66 V	139	41.9	14.2
6	#10480.00	43.5 AV	54.0	-10.5	1.66 V	139	29.3	14.2

Remarks:

1. Emission Level(dBuV/m) = Raw Value(dBuV) + Correction Factor(dB/m)
2. Correction Factor(dB/m) = Antenna Factor(dB/m) + Cable Factor(dB) – Pre-Amplifier Factor(dB)
3. The other emission levels were very low against the limit.
4. Margin value = Emission Level – Limit value
5. " \* ": Fundamental frequency.
6. " # ": The radiated frequency is out of the restricted band.



CHANNEL	TX Channel 52	DETECTOR FUNCTION	Peak (PK)
FREQUENCY RANGE	1GHz ~ 40GHz		Average (AV)

**ANTENNA POLARITY & TEST DISTANCE: HORIZONTAL AT 3 M**

NO.	FREQ. (MHz)	EMISSION LEVEL (dBuV/m)	LIMIT (dBuV/m)	MARGIN (dB)	ANTENNA HEIGHT (m)	TABLE ANGLE (Degree)	RAW VALUE (dBuV)	CORRECTION FACTOR (dB/m)
1	5150.00	54.2 PK	74.0	-19.8	1.51 H	87	52.1	2.1
2	5150.00	40.7 AV	54.0	-13.3	1.51 H	87	38.6	2.1
3	*5260.00	110.7 PK			1.52 H	92	71.6	39.1
4	*5260.00	99.9 AV			1.52 H	92	60.8	39.1
5	#10520.00	55.9 PK	74.0	-18.1	1.68 H	164	41.7	14.2
6	#10520.00	42.3 AV	54.0	-11.7	1.68 H	164	28.1	14.2

**ANTENNA POLARITY & TEST DISTANCE: VERTICAL AT 3 M**

NO.	FREQ. (MHz)	EMISSION LEVEL (dBuV/m)	LIMIT (dBuV/m)	MARGIN (dB)	ANTENNA HEIGHT (m)	TABLE ANGLE (Degree)	RAW VALUE (dBuV)	CORRECTION FACTOR (dB/m)
1	5150.00	55.3 PK	74.0	-18.7	1.92 V	197	53.2	2.1
2	5150.00	42.4 AV	54.0	-11.6	1.92 V	197	40.3	2.1
3	*5260.00	115.8 PK			1.96 V	198	76.7	39.1
4	*5260.00	105.1 AV			1.96 V	198	66.0	39.1
5	#10520.00	56.4 PK	74.0	-17.6	1.73 V	166	42.2	14.2
6	#10520.00	43.3 AV	54.0	-10.7	1.73 V	166	29.1	14.2

**Remarks:**

1. Emission Level(dBuV/m) = Raw Value(dBuV) + Correction Factor(dB/m)
2. Correction Factor(dB/m) = Antenna Factor(dB/m) + Cable Factor(dB) – Pre-Amplifier Factor(dB)
3. The other emission levels were very low against the limit.
4. Margin value = Emission Level – Limit value
5. " \* ": Fundamental frequency.
6. " # ": The radiated frequency is out of the restricted band.

CHANNEL	TX Channel 60	DETECTOR FUNCTION	Peak (PK)
FREQUENCY RANGE	1GHz ~ 40GHz		Average (AV)

**ANTENNA POLARITY & TEST DISTANCE: HORIZONTAL AT 3 M**

NO.	FREQ. (MHz)	EMISSION LEVEL (dBuV/m)	LIMIT (dBuV/m)	MARGIN (dB)	ANTENNA HEIGHT (m)	TABLE ANGLE (Degree)	RAW VALUE (dBuV)	CORRECTION FACTOR (dB/m)
1	*5300.00	109.4 PK			1.51 H	92	70.2	39.2
2	*5300.00	98.9 AV			1.51 H	92	59.7	39.2
3	5350.00	60.4 PK	74.0	-13.6	1.47 H	91	57.8	2.6
4	5350.00	46.0 AV	54.0	-8.0	1.47 H	91	43.4	2.6
5	10600.00	56.4 PK	74.0	-17.6	2.91 H	177	41.7	14.7
6	10600.00	42.8 AV	54.0	-11.2	2.91 H	177	28.1	14.7

**ANTENNA POLARITY & TEST DISTANCE: VERTICAL AT 3 M**

NO.	FREQ. (MHz)	EMISSION LEVEL (dBuV/m)	LIMIT (dBuV/m)	MARGIN (dB)	ANTENNA HEIGHT (m)	TABLE ANGLE (Degree)	RAW VALUE (dBuV)	CORRECTION FACTOR (dB/m)
1	*5300.00	114.3 PK			1.94 V	197	75.1	39.2
2	*5300.00	103.8 AV			1.94 V	197	64.6	39.2
3	5350.00	65.0 PK	74.0	-9.0	1.91 V	197	62.4	2.6
4	5350.00	49.8 AV	54.0	-4.2	1.91 V	197	47.2	2.6
5	10600.00	56.9 PK	74.0	-17.1	1.74 V	151	42.2	14.7
6	10600.00	43.8 AV	54.0	-10.2	1.74 V	151	29.1	14.7

**Remarks:**

1. Emission Level(dBuV/m) = Raw Value(dBuV) + Correction Factor(dB/m)
2. Correction Factor(dB/m) = Antenna Factor(dB/m) + Cable Factor(dB) – Pre-Amplifier Factor(dB)
3. The other emission levels were very low against the limit.
4. Margin value = Emission Level – Limit value
5. " \* ": Fundamental frequency.
6. " # ": The radiated frequency is out of the restricted band.

CHANNEL	TX Channel 64	DETECTOR FUNCTION	Peak (PK)
FREQUENCY RANGE	1GHz ~ 40GHz		Average (AV)

**ANTENNA POLARITY & TEST DISTANCE: HORIZONTAL AT 3 M**

NO.	FREQ. (MHz)	EMISSION LEVEL (dBuV/m)	LIMIT (dBuV/m)	MARGIN (dB)	ANTENNA HEIGHT (m)	TABLE ANGLE (Degree)	RAW VALUE (dBuV)	CORRECTION FACTOR (dB/m)
1	*5320.00	109.2 PK			1.41 H	93	70.0	39.2
2	*5320.00	98.0 AV			1.41 H	93	58.8	39.2
3	5350.00	65.9 PK	74.0	-8.1	1.48 H	93	63.3	2.6
4	5350.00	48.9 AV	54.0	-5.1	1.48 H	93	46.3	2.6
5	10640.00	55.5 PK	74.0	-18.5	2.56 H	312	40.8	14.7
6	10640.00	42.5 AV	54.0	-11.5	2.56 H	312	27.8	14.7

**ANTENNA POLARITY & TEST DISTANCE: VERTICAL AT 3 M**

NO.	FREQ. (MHz)	EMISSION LEVEL (dBuV/m)	LIMIT (dBuV/m)	MARGIN (dB)	ANTENNA HEIGHT (m)	TABLE ANGLE (Degree)	RAW VALUE (dBuV)	CORRECTION FACTOR (dB/m)
1	*5320.00	113.7 PK			1.91 V	197	74.5	39.2
2	*5320.00	102.9 AV			1.91 V	197	63.7	39.2
3	5350.00	71.3 PK	74.0	-2.7	1.77 V	197	68.7	2.6
4	5350.00	52.7 AV	54.0	-1.3	1.77 V	197	50.1	2.6
5	10640.00	57.1 PK	74.0	-16.9	1.82 V	144	42.4	14.7
6	10640.00	44.0 AV	54.0	-10.0	1.82 V	144	29.3	14.7

**Remarks:**

1. Emission Level(dBuV/m) = Raw Value(dBuV) + Correction Factor(dB/m)
2. Correction Factor(dB/m) = Antenna Factor(dB/m) + Cable Factor(dB) – Pre-Amplifier Factor(dB)
3. The other emission levels were very low against the limit.
4. Margin value = Emission Level – Limit value
5. " \* ": Fundamental frequency.
6. " # ": The radiated frequency is out of the restricted band.

CHANNEL	TX Channel 100	DETECTOR FUNCTION	Peak (PK)
FREQUENCY RANGE	1GHz ~ 40GHz		Average (AV)

**ANTENNA POLARITY & TEST DISTANCE: HORIZONTAL AT 3 M**

NO.	FREQ. (MHz)	EMISSION LEVEL (dBuV/m)	LIMIT (dBuV/m)	MARGIN (dB)	ANTENNA HEIGHT (m)	TABLE ANGLE (Degree)	RAW VALUE (dBuV)	CORRECTION FACTOR (dB/m)
1	5448.00	59.6 PK	74.0	-14.4	2.10 H	111	52.9	6.7
2	5448.00	48.9 AV	54.0	-5.1	2.10 H	111	42.2	6.7
3	#5470.00	66.2 PK	74.0	-7.8	2.18 H	118	59.5	6.7
4	#5470.00	51.9 AV	54.0	-2.1	2.18 H	118	45.2	6.7
5	*5500.00	111.7 PK			2.14 H	116	70.8	40.9
6	*5500.00	101.1 AV			2.14 H	116	60.2	40.9
7	11000.00	60.8 PK	74.0	-13.2	1.82 H	105	41.5	19.3
8	11000.00	47.9 AV	54.0	-6.1	1.82 H	105	28.6	19.3

**ANTENNA POLARITY & TEST DISTANCE: VERTICAL AT 3 M**

NO.	FREQ. (MHz)	EMISSION LEVEL (dBuV/m)	LIMIT (dBuV/m)	MARGIN (dB)	ANTENNA HEIGHT (m)	TABLE ANGLE (Degree)	RAW VALUE (dBuV)	CORRECTION FACTOR (dB/m)
1	5448.00	65.9 PK	74.0	-8.1	1.78 V	195	63.2	2.7
2	5448.00	49.4 AV	54.0	-4.6	1.78 V	195	46.7	2.7
3	#5470.00	70.5 PK	74.0	-3.5	1.79 V	195	67.8	2.7
4	#5470.00	52.8 AV	54.0	-1.2	1.79 V	195	50.1	2.7
5	*5500.00	112.7 PK			1.87 V	194	73.2	39.5
6	*5500.00	102.0 AV			1.87 V	194	62.5	39.5
7	11000.00	55.0 PK	74.0	-19.0	1.07 V	94	38.9	16.1
8	11000.00	41.1 AV	54.0	-12.9	1.07 V	94	25.0	16.1

Remarks:

1. Emission Level(dBuV/m) = Raw Value(dBuV) + Correction Factor(dB/m)
2. Correction Factor(dB/m) = Antenna Factor(dB/m) + Cable Factor(dB) – Pre-Amplifier Factor(dB)
3. The other emission levels were very low against the limit.
4. Margin value = Emission Level – Limit value
5. " \* ": Fundamental frequency.
6. " # ": The radiated frequency is out of the restricted band.

CHANNEL	TX Channel 116	DETECTOR	Peak (PK)
FREQUENCY RANGE	1GHz ~ 40GHz	FUNCTION	Average (AV)

**ANTENNA POLARITY & TEST DISTANCE: HORIZONTAL AT 3 M**

NO.	FREQ. (MHz)	EMISSION LEVEL (dBuV/m)	LIMIT (dBuV/m)	MARGIN (dB)	ANTENNA HEIGHT (m)	TABLE ANGLE (Degree)	RAW VALUE (dBuV)	CORRECTION FACTOR (dB/m)
1	*5580.00	113.2 PK			2.19 H	55	72.2	41.0
2	*5580.00	102.2 AV			2.19 H	55	61.2	41.0
3	11160.00	61.1 PK	74.0	-12.9	1.77 H	91	41.3	19.8
4	11160.00	48.2 AV	54.0	-5.8	1.77 H	91	28.4	19.8

**ANTENNA POLARITY & TEST DISTANCE: VERTICAL AT 3 M**

NO.	FREQ. (MHz)	EMISSION LEVEL (dBuV/m)	LIMIT (dBuV/m)	MARGIN (dB)	ANTENNA HEIGHT (m)	TABLE ANGLE (Degree)	RAW VALUE (dBuV)	CORRECTION FACTOR (dB/m)
1	*5580.00	114.2 PK			1.92 V	163	74.5	39.7
2	*5580.00	103.8 AV			1.92 V	163	64.1	39.7
3	11160.00	56.2 PK	74.0	-17.8	3.42 V	105	40.9	15.3
4	11160.00	43.4 AV	54.0	-10.6	3.42 V	105	28.1	15.3

**Remarks:**

1. Emission Level(dBuV/m) = Raw Value(dBuV) + Correction Factor(dB/m)
2. Correction Factor(dB/m) = Antenna Factor(dB/m) + Cable Factor(dB) – Pre-Amplifier Factor(dB)
3. The other emission levels were very low against the limit.
4. Margin value = Emission Level – Limit value
5. " \* ": Fundamental frequency.
6. " # ": The radiated frequency is out of the restricted band.

CHANNEL	TX Channel 140	DETECTOR FUNCTION	Peak (PK)
FREQUENCY RANGE	1GHz ~ 40GHz		Average (AV)

## ANTENNA POLARITY &amp; TEST DISTANCE: HORIZONTAL AT 3 M

NO.	FREQ. (MHz)	EMISSION LEVEL (dBuV/m)	LIMIT (dBuV/m)	MARGIN (dB)	ANTENNA HEIGHT (m)	TABLE ANGLE (Degree)	RAW VALUE (dBuV)	CORRECTION FACTOR (dB/m)
1	*5700.00	108.9 PK			2.00 H	45	67.4	41.5
2	*5700.00	98.6 AV			2.00 H	45	57.1	41.5
3	#5725.00	67.8 PK	74.0	-6.2	2.08 H	51	60.5	7.3
4	#5725.00	50.5 AV	54.0	-3.5	2.08 H	51	43.2	7.3
5	11400.00	61.5 PK	74.0	-12.5	1.88 H	83	41.1	20.4
6	11400.00	48.6 AV	54.0	-5.4	1.88 H	83	28.2	20.4

## ANTENNA POLARITY &amp; TEST DISTANCE: VERTICAL AT 3 M

NO.	FREQ. (MHz)	EMISSION LEVEL (dBuV/m)	LIMIT (dBuV/m)	MARGIN (dB)	ANTENNA HEIGHT (m)	TABLE ANGLE (Degree)	RAW VALUE (dBuV)	CORRECTION FACTOR (dB/m)
1	*5700.00	111.4 PK			1.84 V	198	71.5	39.9
2	*5700.00	100.4 AV			1.84 V	198	60.5	39.9
3	#5725.00	71.2 PK	74.0	-2.8	1.83 V	197	68.1	3.1
4	#5725.00	52.8 AV	54.0	-1.2	1.83 V	197	49.7	3.1
5	11400.00	55.7 PK	74.0	-18.3	1.65 V	274	40.4	15.3
6	11400.00	42.6 AV	54.0	-11.4	1.65 V	274	27.3	15.3

## Remarks:

1. Emission Level(dBuV/m) = Raw Value(dBuV) + Correction Factor(dB/m)
2. Correction Factor(dB/m) = Antenna Factor(dB/m) + Cable Factor(dB) – Pre-Amplifier Factor(dB)
3. The other emission levels were very low against the limit.
4. Margin value = Emission Level – Limit value
5. " \* ": Fundamental frequency.
6. " # ": The radiated frequency is out of the restricted band.

CHANNEL	TX Channel 144	DETECTOR FUNCTION	Peak (PK)
FREQUENCY RANGE	1GHz ~ 40GHz		Average (AV)

**ANTENNA POLARITY & TEST DISTANCE: HORIZONTAL AT 3 M**

NO.	FREQ. (MHz)	EMISSION LEVEL (dBuV/m)	LIMIT (dBuV/m)	MARGIN (dB)	ANTENNA HEIGHT (m)	TABLE ANGLE (Degree)	RAW VALUE (dBuV)	CORRECTION FACTOR (dB/m)
1	#5470.00	57.8 PK	74.0	-16.2	1.98 H	50	51.1	6.7
2	#5470.00	45.6 AV	54.0	-8.4	1.98 H	50	38.9	6.7
3	*5720.00	113.0 PK			1.96 H	46	71.5	41.5
4	*5720.00	101.8 AV			1.96 H	46	60.3	41.5
5	#5850.00	58.3 PK	74.0	-15.7	1.99 H	41	50.6	7.7
6	#5850.00	45.6 AV	54.0	-8.4	1.99 H	41	37.9	7.7
7	11400.00	61.7 PK	74.0	-12.3	1.79 H	81	41.3	20.4
8	11400.00	49.1 AV	54.0	-4.9	1.79 H	81	28.7	20.4

**ANTENNA POLARITY & TEST DISTANCE: VERTICAL AT 3 M**

NO.	FREQ. (MHz)	EMISSION LEVEL (dBuV/m)	LIMIT (dBuV/m)	MARGIN (dB)	ANTENNA HEIGHT (m)	TABLE ANGLE (Degree)	RAW VALUE (dBuV)	CORRECTION FACTOR (dB/m)
1	#5470.00	55.6 PK	74.0	-18.4	1.88 V	164	52.9	2.7
2	#5470.00	42.4 AV	54.0	-11.6	1.88 V	164	39.7	2.7
3	*5720.00	114.8 PK			1.84 V	166	74.9	39.9
4	*5720.00	104.7 AV			1.84 V	166	64.8	39.9
5	#5825.00	56.2 PK	74.0	-17.8	1.85 V	160	53.1	3.1
6	#5825.00	43.0 AV	54.0	-11.0	1.85 V	160	39.9	3.1
7	11400.00	56.2 PK	74.0	-17.8	2.98 V	310	40.9	15.3
8	11400.00	43.8 AV	54.0	-10.2	2.98 V	310	28.5	15.3

**REMARKS:**

1. Emission Level(dBuV/m) = Raw Value(dBuV) + Correction Factor(dB/m)
2. Correction Factor(dB/m) = Antenna Factor(dB/m) + Cable Factor(dB) – Pre-Amplifier Factor(dB)
3. The other emission levels were very low against the limit.
4. Margin value = Emission Level – Limit value
5. " \* " : Fundamental frequency.
6. " # " : The radiated frequency is out of the restricted band.

CHANNEL	TX Channel 149	DETECTOR FUNCTION	Peak (PK)
FREQUENCY RANGE	1GHz ~ 40GHz		Average (AV)

**ANTENNA POLARITY & TEST DISTANCE: HORIZONTAL AT 3 M**

NO.	FREQ. (MHz)	EMISSION LEVEL (dBuV/m)	LIMIT (dBuV/m)	MARGIN (dB)	ANTENNA HEIGHT (m)	TABLE ANGLE (Degree)	RAW VALUE (dBuV)	CORRECTION FACTOR (dB/m)
1	#5601.60	58.2 PK	68.2	-10.0	2.04 H	34	51.3	6.9
2	*5745.00	112.5 PK			2.04 H	34	70.9	41.6
3	*5745.00	102.1 AV			2.04 H	34	60.5	41.6
4	#5967.20	60.3 PK	68.2	-7.9	2.04 H	34	52.4	7.9
5	11490.00	62.0 PK	74.0	-12.0	1.80 H	80	41.7	20.3
6	11490.00	49.8 AV	54.0	-4.2	1.80 H	80	29.5	20.3

**ANTENNA POLARITY & TEST DISTANCE: VERTICAL AT 3 M**

NO.	FREQ. (MHz)	EMISSION LEVEL (dBuV/m)	LIMIT (dBuV/m)	MARGIN (dB)	ANTENNA HEIGHT (m)	TABLE ANGLE (Degree)	RAW VALUE (dBuV)	CORRECTION FACTOR (dB/m)
1	#5648.00	52.4 PK	68.2	-15.8	1.73 V	186	49.5	2.9
2	*5745.00	114.5 PK			1.73 V	186	74.6	39.9
3	*5745.00	104.4 AV			1.73 V	186	64.5	39.9
4	#5932.80	52.0 PK	68.2	-16.2	1.73 V	186	48.8	3.2
5	11490.00	56.8 PK	74.0	-17.2	1.05 V	87	42.2	14.6
6	11490.00	44.7 AV	54.0	-9.3	1.05 V	87	30.1	14.6

**Remarks:**

1. Emission Level(dBuV/m) = Raw Value(dBuV) + Correction Factor(dB/m)
2. Correction Factor(dB/m) = Antenna Factor(dB/m) + Cable Factor(dB) – Pre-Amplifier Factor(dB)
3. The other emission levels were very low against the limit.
4. Margin value = Emission Level – Limit value
5. " \* ": Fundamental frequency.
6. " # ": The radiated frequency is out of the restricted band.



CHANNEL	TX Channel 157	DETECTOR FUNCTION	Peak (PK)
FREQUENCY RANGE	1GHz ~ 40GHz		Average (AV)

**ANTENNA POLARITY & TEST DISTANCE: HORIZONTAL AT 3 M**

NO.	FREQ. (MHz)	EMISSION LEVEL (dBuV/m)	LIMIT (dBuV/m)	MARGIN (dB)	ANTENNA HEIGHT (m)	TABLE ANGLE (Degree)	RAW VALUE (dBuV)	CORRECTION FACTOR (dB/m)
1	#5603.20	59.5 PK	68.2	-8.7	1.98 H	54	52.6	6.9
2	*5785.00	112.9 PK			1.98 H	54	71.3	41.6
3	*5785.00	101.8 AV			1.98 H	54	60.2	41.6
4	#5996.00	59.8 PK	68.2	-8.4	1.98 H	54	51.9	7.9
5	11570.00	62.0 PK	74.0	-12.0	1.81 H	69	41.9	20.1
6	11570.00	49.7 AV	54.0	-4.3	1.81 H	69	29.6	20.1

**ANTENNA POLARITY & TEST DISTANCE: VERTICAL AT 3 M**

NO.	FREQ. (MHz)	EMISSION LEVEL (dBuV/m)	LIMIT (dBuV/m)	MARGIN (dB)	ANTENNA HEIGHT (m)	TABLE ANGLE (Degree)	RAW VALUE (dBuV)	CORRECTION FACTOR (dB/m)
1	#5608.80	55.7 PK	68.2	-12.5	1.62 V	201	52.8	2.9
2	*5785.00	114.2 PK			1.62 V	201	74.3	39.9
3	*5785.00	104.4 AV			1.62 V	201	64.5	39.9
4	#5971.20	56.2 PK	68.2	-12.0	1.62 V	201	52.9	3.3
5	11570.00	56.7 PK	74.0	-17.3	1.47 V	87	42.2	14.5
6	11570.00	44.6 AV	54.0	-9.4	1.47 V	87	30.1	14.5

**Remarks:**

1. Emission Level(dBuV/m) = Raw Value(dBuV) + Correction Factor(dB/m)
2. Correction Factor(dB/m) = Antenna Factor(dB/m) + Cable Factor(dB) – Pre-Amplifier Factor(dB)
3. The other emission levels were very low against the limit.
4. Margin value = Emission Level – Limit value
5. " \* ": Fundamental frequency.
6. " # ": The radiated frequency is out of the restricted band.

CHANNEL	TX Channel 165	DETECTOR FUNCTION	Peak (PK)
FREQUENCY RANGE	1GHz ~ 40GHz		Average (AV)

**ANTENNA POLARITY & TEST DISTANCE: HORIZONTAL AT 3 M**

NO.	FREQ. (MHz)	EMISSION LEVEL (dBuV/m)	LIMIT (dBuV/m)	MARGIN (dB)	ANTENNA HEIGHT (m)	TABLE ANGLE (Degree)	RAW VALUE (dBuV)	CORRECTION FACTOR (dB/m)
1	#5644.00	59.0 PK	68.2	-9.2	1.97 H	47	51.9	7.1
2	*5825.00	112.9 PK			1.97 H	47	71.1	41.8
3	*5825.00	102.2 AV			1.97 H	47	60.4	41.8
4	#5939.20	59.8 PK	68.2	-8.4	1.97 H	47	52.0	7.8
5	11650.00	61.5 PK	74.0	-12.5	1.67 H	77	41.7	19.8
6	11650.00	49.2 AV	54.0	-4.8	1.67 H	77	29.4	19.8

**ANTENNA POLARITY & TEST DISTANCE: VERTICAL AT 3 M**

NO.	FREQ. (MHz)	EMISSION LEVEL (dBuV/m)	LIMIT (dBuV/m)	MARGIN (dB)	ANTENNA HEIGHT (m)	TABLE ANGLE (Degree)	RAW VALUE (dBuV)	CORRECTION FACTOR (dB/m)
1	#5636.80	56.1 PK	68.2	-12.1	1.59 V	166	53.2	2.9
2	*5825.00	114.9 PK			1.59 V	166	74.9	40.0
3	*5825.00	104.2 AV			1.59 V	166	64.2	40.0
4	#5948.00	55.9 PK	68.2	-12.3	1.59 V	166	52.7	3.2
5	11650.00	56.6 PK	74.0	-17.4	1.02 V	47	41.9	14.7
6	11650.00	44.3 AV	54.0	-9.7	1.02 V	47	29.6	14.7

**Remarks:**

1. Emission Level(dBuV/m) = Raw Value(dBuV) + Correction Factor(dB/m)
2. Correction Factor(dB/m) = Antenna Factor(dB/m) + Cable Factor(dB) – Pre-Amplifier Factor(dB)
3. The other emission levels were very low against the limit.
4. Margin value = Emission Level – Limit value
5. " \* ": Fundamental frequency.
6. " # ": The radiated frequency is out of the restricted band.

802.11n (HT40)

CHANNEL	TX Channel 38	DETECTOR FUNCTION	Peak (PK) Average (AV)
FREQUENCY RANGE	1GHz ~ 40GHz		

ANTENNA POLARITY & TEST DISTANCE: HORIZONTAL AT 3 M								
NO.	FREQ. (MHz)	EMISSION LEVEL (dBuV/m)	LIMIT (dBuV/m)	MARGIN (dB)	ANTENNA HEIGHT (m)	TABLE ANGLE (Degree)	RAW VALUE (dBuV)	CORRECTION FACTOR (dB/m)
1	5150.00	64.8 PK	74.0	-9.2	1.55 H	90	62.7	2.1
2	5150.00	46.8 AV	54.0	-7.2	1.55 H	90	44.7	2.1
3	*5190.00	103.1 PK			1.54 H	92	64.1	39.0
4	*5190.00	92.5 AV			1.54 H	92	53.5	39.0
5	#10380.00	55.3 PK	74.0	-18.7	2.73 H	278	40.7	14.6
6	#10380.00	42.8 AV	54.0	-11.2	2.73 H	278	28.2	14.6
ANTENNA POLARITY & TEST DISTANCE: VERTICAL AT 3 M								
NO.	FREQ. (MHz)	EMISSION LEVEL (dBuV/m)	LIMIT (dBuV/m)	MARGIN (dB)	ANTENNA HEIGHT (m)	TABLE ANGLE (Degree)	RAW VALUE (dBuV)	CORRECTION FACTOR (dB/m)
1	5150.00	71.6 PK	74.0	-2.4	2.24 V	5	65.5	6.1
2	5150.00	52.3 AV	54.0	-1.7	2.24 V	5	46.2	6.1
3	*5190.00	107.7 PK			2.12 V	6	67.5	40.2
4	*5190.00	97.1 AV			2.12 V	6	56.9	40.2
5	#10380.00	60.4 PK	74.0	-13.6	1.78 V	125	42.4	18.0
6	#10380.00	47.2 AV	54.0	-6.8	1.78 V	125	29.2	18.0

Remarks:

1. Emission Level(dBuV/m) = Raw Value(dBuV) + Correction Factor(dB/m)
2. Correction Factor(dB/m) = Antenna Factor(dB/m) + Cable Factor(dB) – Pre-Amplifier Factor(dB)
3. The other emission levels were very low against the limit.
4. Margin value = Emission Level – Limit value
5. " \* ": Fundamental frequency.
6. " # ": The radiated frequency is out of the restricted band.

CHANNEL	TX Channel 46	DETECTOR FUNCTION	Peak (PK)
FREQUENCY RANGE	1GHz ~ 40GHz		Average (AV)

**ANTENNA POLARITY & TEST DISTANCE: HORIZONTAL AT 3 M**

NO.	FREQ. (MHz)	EMISSION LEVEL (dBuV/m)	LIMIT (dBuV/m)	MARGIN (dB)	ANTENNA HEIGHT (m)	TABLE ANGLE (Degree)	RAW VALUE (dBuV)	CORRECTION FACTOR (dB/m)
1	*5230.00	107.1 PK			1.66 H	90	68.1	39.0
2	*5230.00	96.5 AV			1.66 H	90	57.5	39.0
3	5350.00	54.2 PK	74.0	-19.8	1.64 H	93	51.6	2.6
4	5350.00	41.6 AV	54.0	-12.4	1.64 H	93	39.0	2.6
5	#10460.00	53.1 PK	74.0	-20.9	3.43 H	208	38.9	14.2
6	#10460.00	40.6 AV	54.0	-13.4	3.43 H	208	26.4	14.2

**ANTENNA POLARITY & TEST DISTANCE: VERTICAL AT 3 M**

NO.	FREQ. (MHz)	EMISSION LEVEL (dBuV/m)	LIMIT (dBuV/m)	MARGIN (dB)	ANTENNA HEIGHT (m)	TABLE ANGLE (Degree)	RAW VALUE (dBuV)	CORRECTION FACTOR (dB/m)
1	*5230.00	112.2 PK			1.98 V	198	73.2	39.0
2	*5230.00	101.8 AV			1.98 V	198	62.8	39.0
3	5350.00	55.9 PK	74.0	-18.1	1.95 V	199	53.3	2.6
4	5350.00	42.8 AV	54.0	-11.2	1.95 V	199	40.2	2.6
5	#10460.00	56.8 PK	74.0	-17.2	1.75 V	118	42.6	14.2
6	#10460.00	43.6 AV	54.0	-10.4	1.75 V	118	29.4	14.2

**Remarks:**

1. Emission Level(dBuV/m) = Raw Value(dBuV) + Correction Factor(dB/m)
2. Correction Factor(dB/m) = Antenna Factor(dB/m) + Cable Factor(dB) – Pre-Amplifier Factor(dB)
3. The other emission levels were very low against the limit.
4. Margin value = Emission Level – Limit value
5. " \* ": Fundamental frequency.
6. " # ": The radiated frequency is out of the restricted band.

CHANNEL	TX Channel 54	DETECTOR FUNCTION	Peak (PK)
FREQUENCY RANGE	1GHz ~ 40GHz		Average (AV)

**ANTENNA POLARITY & TEST DISTANCE: HORIZONTAL AT 3 M**

NO.	FREQ. (MHz)	EMISSION LEVEL (dBuV/m)	LIMIT (dBuV/m)	MARGIN (dB)	ANTENNA HEIGHT (m)	TABLE ANGLE (Degree)	RAW VALUE (dBuV)	CORRECTION FACTOR (dB/m)
1	5150.00	54.4 PK	74.0	-19.6	1.55 H	90	52.3	2.1
2	5150.00	41.3 AV	54.0	-12.7	1.55 H	90	39.2	2.1
3	*5270.00	106.9 PK			1.54 H	92	67.7	39.2
4	*5270.00	96.1 AV			1.54 H	92	56.9	39.2
5	#10540.00	55.0 PK	74.0	-19.0	1.43 H	6	40.7	14.3
6	#10540.00	43.1 AV	54.0	-10.9	1.43 H	6	28.8	14.3

**ANTENNA POLARITY & TEST DISTANCE: VERTICAL AT 3 M**

NO.	FREQ. (MHz)	EMISSION LEVEL (dBuV/m)	LIMIT (dBuV/m)	MARGIN (dB)	ANTENNA HEIGHT (m)	TABLE ANGLE (Degree)	RAW VALUE (dBuV)	CORRECTION FACTOR (dB/m)
1	5150.00	54.5 PK	74.0	-19.5	1.95 V	203	52.4	2.1
2	5150.00	41.9 AV	54.0	-12.1	1.95 V	203	39.8	2.1
3	*5270.00	112.2 PK			1.96 V	197	73.0	39.2
4	*5270.00	101.1 AV			1.96 V	197	61.9	39.2
5	#10540.00	56.0 PK	74.0	-18.0	1.59 V	123	41.7	14.3
6	#10540.00	42.9 AV	54.0	-11.1	1.59 V	123	28.6	14.3

**Remarks:**

1. Emission Level(dBuV/m) = Raw Value(dBuV) + Correction Factor(dB/m)
2. Correction Factor(dB/m) = Antenna Factor(dB/m) + Cable Factor(dB) – Pre-Amplifier Factor(dB)
3. The other emission levels were very low against the limit.
4. Margin value = Emission Level – Limit value
5. " \* ": Fundamental frequency.
6. " # ": The radiated frequency is out of the restricted band.

CHANNEL	TX Channel 62	DETECTOR FUNCTION	Peak (PK)
FREQUENCY RANGE	1GHz ~ 40GHz		Average (AV)

**ANTENNA POLARITY & TEST DISTANCE: HORIZONTAL AT 3 M**

NO.	FREQ. (MHz)	EMISSION LEVEL (dBuV/m)	LIMIT (dBuV/m)	MARGIN (dB)	ANTENNA HEIGHT (m)	TABLE ANGLE (Degree)	RAW VALUE (dBuV)	CORRECTION FACTOR (dB/m)
1	*5310.00	102.9 PK			1.60 H	91	63.7	39.2
2	*5310.00	92.0 AV			1.60 H	91	52.8	39.2
3	5350.00	61.5 PK	74.0	-12.5	1.55 H	95	58.9	2.6
4	5350.00	44.8 AV	54.0	-9.2	1.55 H	95	42.2	2.6
5	5358.00	65.3 PK	74.0	-8.7	1.59 H	94	62.7	2.6
6	5358.00	47.1 AV	54.0	-6.9	1.59 H	94	44.5	2.6
7	10620.00	55.5 PK	74.0	-18.5	2.46 H	15	40.8	14.7
8	10620.00	42.8 AV	54.0	-11.2	2.46 H	15	28.1	14.7

**ANTENNA POLARITY & TEST DISTANCE: VERTICAL AT 3 M**

NO.	FREQ. (MHz)	EMISSION LEVEL (dBuV/m)	LIMIT (dBuV/m)	MARGIN (dB)	ANTENNA HEIGHT (m)	TABLE ANGLE (Degree)	RAW VALUE (dBuV)	CORRECTION FACTOR (dB/m)
1	*5310.00	108.3 PK			2.19 V	13	67.8	40.5
2	*5310.00	97.9 AV			2.19 V	13	57.4	40.5
3	5350.00	68.5 PK	74.0	-5.5	2.15 V	13	62.0	6.5
4	5350.00	51.7 AV	54.0	-2.3	2.15 V	13	45.2	6.5
5	5358.00	69.3 PK	74.0	-4.7	2.17 V	11	62.8	6.5
6	5358.00	52.3 AV	54.0	-1.7	2.17 V	11	45.8	6.5
7	10620.00	60.8 PK	74.0	-13.2	1.61 V	120	41.9	18.9
8	10620.00	47.8 AV	54.0	-6.2	1.61 V	120	28.9	18.9

**Remarks:**

1. Emission Level(dBuV/m) = Raw Value(dBuV) + Correction Factor(dB/m)
2. Correction Factor(dB/m) = Antenna Factor(dB/m) + Cable Factor(dB) – Pre-Amplifier Factor(dB)
3. The other emission levels were very low against the limit.
4. Margin value = Emission Level – Limit value
5. " \* ": Fundamental frequency.
6. " # ": The radiated frequency is out of the restricted band.

CHANNEL	TX Channel 102	DETECTOR FUNCTION	Peak (PK)
FREQUENCY RANGE	1GHz ~ 40GHz		Average (AV)

**ANTENNA POLARITY & TEST DISTANCE: HORIZONTAL AT 3 M**

NO.	FREQ. (MHz)	EMISSION LEVEL (dBuV/m)	LIMIT (dBuV/m)	MARGIN (dB)	ANTENNA HEIGHT (m)	TABLE ANGLE (Degree)	RAW VALUE (dBuV)	CORRECTION FACTOR (dB/m)
1	5460.00	61.8 PK	74.0	-12.2	2.04 H	52	55.1	6.7
2	5460.00	49.6 AV	54.0	-4.4	2.04 H	52	42.9	6.7
3	#5470.00	72.8 PK	74.0	-1.2	2.08 H	42	66.1	6.7
4	#5470.00	52.9 AV	54.0	-1.1	2.08 H	42	46.2	6.7
5	*5510.00	106.1 PK			2.03 H	48	65.2	40.9
6	*5510.00	96.1 AV			2.03 H	48	55.2	40.9
7	11020.00	61.1 PK	74.0	-12.9	1.91 H	90	41.8	19.3
8	11020.00	48.4 AV	54.0	-5.6	1.91 H	90	29.1	19.3

**ANTENNA POLARITY & TEST DISTANCE: VERTICAL AT 3 M**

NO.	FREQ. (MHz)	EMISSION LEVEL (dBuV/m)	LIMIT (dBuV/m)	MARGIN (dB)	ANTENNA HEIGHT (m)	TABLE ANGLE (Degree)	RAW VALUE (dBuV)	CORRECTION FACTOR (dB/m)
1	5460.00	64.4 PK	74.0	-9.6	2.08 V	145	61.7	2.7
2	5460.00	48.6 AV	54.0	-5.4	2.08 V	145	45.9	2.7
3	#5470.00	72.7 PK	74.0	-1.3	2.04 V	141	70.0	2.7
4	#5470.00	52.8 AV	54.0	-1.2	2.04 V	141	50.1	2.7
5	*5510.00	107.4 PK			2.10 V	148	67.9	39.5
6	*5510.00	96.6 AV			2.10 V	148	57.1	39.5
7	11020.00	57.4 PK	74.0	-16.6	1.20 V	56	41.5	15.9
8	11020.00	45.5 AV	54.0	-8.5	1.20 V	56	29.6	15.9

Remarks:

1. Emission Level(dBuV/m) = Raw Value(dBuV) + Correction Factor(dB/m)
2. Correction Factor(dB/m) = Antenna Factor(dB/m) + Cable Factor(dB) – Pre-Amplifier Factor(dB)
3. The other emission levels were very low against the limit.
4. Margin value = Emission Level – Limit value
5. " \* ": Fundamental frequency.
6. " # ": The radiated frequency is out of the restricted band.

CHANNEL	TX Channel 110	DETECTOR FUNCTION	Peak (PK)
FREQUENCY RANGE	1GHz ~ 40GHz		Average (AV)

ANTENNA POLARITY & TEST DISTANCE: HORIZONTAL AT 3 M								
NO.	FREQ. (MHz)	EMISSION LEVEL (dBuV/m)	LIMIT (dBuV/m)	MARGIN (dB)	ANTENNA HEIGHT (m)	TABLE ANGLE (Degree)	RAW VALUE (dBuV)	CORRECTION FACTOR (dB/m)
1	*5550.00	108.8 PK			2.04 H	48	67.8	41.0
2	*5550.00	98.1 AV			2.04 H	48	57.1	41.0
3	11100.00	61.3 PK	74.0	-12.7	1.76 H	96	41.5	19.8
4	11100.00	48.7 AV	54.0	-5.3	1.76 H	96	28.9	19.8
ANTENNA POLARITY & TEST DISTANCE: VERTICAL AT 3 M								
NO.	FREQ. (MHz)	EMISSION LEVEL (dBuV/m)	LIMIT (dBuV/m)	MARGIN (dB)	ANTENNA HEIGHT (m)	TABLE ANGLE (Degree)	RAW VALUE (dBuV)	CORRECTION FACTOR (dB/m)
1	*5550.00	110.1 PK			1.93 V	191	70.5	39.6
2	*5550.00	99.2 AV			1.93 V	191	59.6	39.6
3	11100.00	56.5 PK	74.0	-17.5	1.55 V	226	41.2	15.3
4	11100.00	44.9 AV	54.0	-9.1	1.55 V	226	29.6	15.3

Remarks:

1. Emission Level(dBuV/m) = Raw Value(dBuV) + Correction Factor(dB/m)
2. Correction Factor(dB/m) = Antenna Factor(dB/m) + Cable Factor(dB) – Pre-Amplifier Factor(dB)
3. The other emission levels were very low against the limit.
4. Margin value = Emission Level – Limit value
5. " \* ": Fundamental frequency.
6. " # ": The radiated frequency is out of the restricted band.



CHANNEL	TX Channel 134	DETECTOR FUNCTION	Peak (PK)
FREQUENCY RANGE	1GHz ~ 40GHz		Average (AV)

## ANTENNA POLARITY &amp; TEST DISTANCE: HORIZONTAL AT 3 M

NO.	FREQ. (MHz)	EMISSION LEVEL (dBuV/m)	LIMIT (dBuV/m)	MARGIN (dB)	ANTENNA HEIGHT (m)	TABLE ANGLE (Degree)	RAW VALUE (dBuV)	CORRECTION FACTOR (dB/m)
1	*5670.00	109.0 PK			2.13 H	55	67.7	41.3
2	*5670.00	98.5 AV			2.13 H	55	57.2	41.3
3	#5725.00	68.9 PK	74.0	-5.1	2.16 H	59	61.6	7.3
4	#5725.00	51.5 AV	54.0	-2.5	2.16 H	59	44.2	7.3
5	11340.00	61.5 PK	74.0	-12.5	1.85 H	98	41.3	20.2
6	11340.00	49.3 AV	54.0	-4.7	1.85 H	98	29.1	20.2

## ANTENNA POLARITY &amp; TEST DISTANCE: VERTICAL AT 3 M

NO.	FREQ. (MHz)	EMISSION LEVEL (dBuV/m)	LIMIT (dBuV/m)	MARGIN (dB)	ANTENNA HEIGHT (m)	TABLE ANGLE (Degree)	RAW VALUE (dBuV)	CORRECTION FACTOR (dB/m)
1	*5670.00	110.7 PK			1.79 V	206	70.9	39.8
2	*5670.00	100.0 AV			1.79 V	206	60.2	39.8
3	#5725.00	71.1 PK	74.0	-2.9	1.81 V	210	68.0	3.1
<b>4</b>	<b>#5725.00</b>	<b>53.0 AV</b>	<b>54.0</b>	<b>-1.0</b>	<b>1.81 V</b>	<b>210</b>	<b>49.9</b>	<b>3.1</b>
5	11340.00	57.0 PK	74.0	-17.0	1.00 V	15	41.2	15.8
6	11340.00	45.3 AV	54.0	-8.7	1.00 V	15	29.5	15.8

## Remarks:

1. Emission Level(dBuV/m) = Raw Value(dBuV) + Correction Factor(dB/m)
2. Correction Factor(dB/m) = Antenna Factor(dB/m) + Cable Factor(dB) – Pre-Amplifier Factor(dB)
3. The other emission levels were very low against the limit.
4. Margin value = Emission Level – Limit value
5. " \* ": Fundamental frequency.
6. " # ": The radiated frequency is out of the restricted band.

CHANNEL	TX Channel 142	DETECTOR FUNCTION	Peak (PK)
FREQUENCY RANGE	1GHz ~ 40GHz		Average (AV)

**ANTENNA POLARITY & TEST DISTANCE: HORIZONTAL AT 3 M**

NO.	FREQ. (MHz)	EMISSION LEVEL (dBuV/m)	LIMIT (dBuV/m)	MARGIN (dB)	ANTENNA HEIGHT (m)	TABLE ANGLE (Degree)	RAW VALUE (dBuV)	CORRECTION FACTOR (dB/m)
1	#5470.00	57.8 PK	74.0	-16.2	2.19 H	113	51.1	6.7
2	#5470.00	44.6 AV	54.0	-9.4	2.19 H	113	37.9	6.7
3	*5710.00	108.8 PK			2.27 H	115	67.3	41.5
4	*5710.00	99.4 AV			2.27 H	115	57.9	41.5
5	#5850.00	58.5 PK	74.0	-15.5	2.22 H	119	50.8	7.7
6	#5850.00	45.8 AV	54.0	-8.2	2.22 H	119	38.1	7.7
7	11420.00	61.8 PK	74.0	-12.2	1.88 H	100	41.4	20.4
8	11420.00	48.6 AV	54.0	-5.4	1.88 H	100	28.2	20.4

**ANTENNA POLARITY & TEST DISTANCE: VERTICAL AT 3 M**

NO.	FREQ. (MHz)	EMISSION LEVEL (dBuV/m)	LIMIT (dBuV/m)	MARGIN (dB)	ANTENNA HEIGHT (m)	TABLE ANGLE (Degree)	RAW VALUE (dBuV)	CORRECTION FACTOR (dB/m)
1	#5470.00	54.3 PK	74.0	-19.7	1.81 V	216	51.6	2.7
2	#5470.00	43.2 AV	54.0	-10.8	1.81 V	216	40.5	2.7
3	*5710.00	110.2 PK			1.82 V	211	70.3	39.9
4	*5710.00	100.4 AV			1.82 V	211	60.5	39.9
5	#5850.00	55.2 PK	74.0	-18.8	1.82 V	217	52.0	3.2
6	#5850.00	43.8 AV	54.0	-10.2	1.82 V	217	40.6	3.2
7	11420.00	56.4 PK	74.0	-17.6	1.20 V	63	41.2	15.2
8	11420.00	44.8 AV	54.0	-9.2	1.20 V	63	29.6	15.2

**REMARKS:**

1. Emission Level(dBuV/m) = Raw Value(dBuV) + Correction Factor(dB/m)
2. Correction Factor(dB/m) = Antenna Factor(dB/m) + Cable Factor(dB) – Pre-Amplifier Factor(dB)
3. The other emission levels were very low against the limit.
4. Margin value = Emission Level – Limit value
5. " \* " : Fundamental frequency.
6. " # " : The radiated frequency is out of the restricted band.

CHANNEL	TX Channel 151	DETECTOR FUNCTION	Peak (PK)
FREQUENCY RANGE	1GHz ~ 40GHz		Average (AV)

**ANTENNA POLARITY & TEST DISTANCE: HORIZONTAL AT 3 M**

NO.	FREQ. (MHz)	EMISSION LEVEL (dBuV/m)	LIMIT (dBuV/m)	MARGIN (dB)	ANTENNA HEIGHT (m)	TABLE ANGLE (Degree)	RAW VALUE (dBuV)	CORRECTION FACTOR (dB/m)
1	#5608.00	59.6 PK	68.2	-8.6	2.16 H	49	52.7	6.9
2	*5755.00	109.5 PK			2.16 H	49	67.9	41.6
3	*5755.00	98.7 AV			2.16 H	49	57.1	41.6
4	#5953.60	59.3 PK	68.2	-8.9	2.16 H	49	51.4	7.9
5	11510.00	61.3 PK	74.0	-12.7	1.89 H	94	41.1	20.2
6	11510.00	49.5 AV	54.0	-4.5	1.89 H	94	29.3	20.2

**ANTENNA POLARITY & TEST DISTANCE: VERTICAL AT 3 M**

NO.	FREQ. (MHz)	EMISSION LEVEL (dBuV/m)	LIMIT (dBuV/m)	MARGIN (dB)	ANTENNA HEIGHT (m)	TABLE ANGLE (Degree)	RAW VALUE (dBuV)	CORRECTION FACTOR (dB/m)
1	#5649.60	57.8 PK	68.2	-10.4	1.84 V	186	54.9	2.9
2	*5755.00	111.0 PK			1.84 V	186	71.1	39.9
3	*5755.00	100.8 AV			1.84 V	186	60.9	39.9
4	#5984.00	55.9 PK	68.2	-12.3	1.84 V	186	52.6	3.3
5	11510.00	55.0 PK	74.0	-19.0	1.06 V	35	40.5	14.5
6	11510.00	44.1 AV	54.0	-9.9	1.06 V	35	29.6	14.5

Remarks:

1. Emission Level(dBuV/m) = Raw Value(dBuV) + Correction Factor(dB/m)
2. Correction Factor(dB/m) = Antenna Factor(dB/m) + Cable Factor(dB) – Pre-Amplifier Factor(dB)
3. The other emission levels were very low against the limit.
4. Margin value = Emission Level – Limit value
5. " \* ": Fundamental frequency.
6. " # ": The radiated frequency is out of the restricted band.

CHANNEL	TX Channel 159	DETECTOR FUNCTION	Peak (PK)
FREQUENCY RANGE	1GHz ~ 40GHz		Average (AV)

**ANTENNA POLARITY & TEST DISTANCE: HORIZONTAL AT 3 M**

NO.	FREQ. (MHz)	EMISSION LEVEL (dBuV/m)	LIMIT (dBuV/m)	MARGIN (dB)	ANTENNA HEIGHT (m)	TABLE ANGLE (Degree)	RAW VALUE (dBuV)	CORRECTION FACTOR (dB/m)
1	#5608.00	59.0 PK	68.2	-9.2	2.12 H	32	52.1	6.9
2	*5795.00	109.1 PK			2.12 H	32	67.4	41.7
3	*5795.00	98.9 AV			2.12 H	32	57.2	41.7
4	#5984.00	60.1 PK	68.2	-8.1	2.12 H	32	52.2	7.9
5	11590.00	61.8 PK	74.0	-12.2	1.88 H	81	41.7	20.1
6	11590.00	49.2 AV	54.0	-4.8	1.88 H	81	29.1	20.1

**ANTENNA POLARITY & TEST DISTANCE: VERTICAL AT 3 M**

NO.	FREQ. (MHz)	EMISSION LEVEL (dBuV/m)	LIMIT (dBuV/m)	MARGIN (dB)	ANTENNA HEIGHT (m)	TABLE ANGLE (Degree)	RAW VALUE (dBuV)	CORRECTION FACTOR (dB/m)
1	#5640.80	55.1 PK	68.2	-13.1	1.82 V	180	52.2	2.9
2	*5795.00	110.4 PK			1.82 V	180	70.5	39.9
3	*5795.00	100.1 AV			1.82 V	180	60.2	39.9
4	#5984.00	55.5 PK	68.2	-12.7	1.82 V	180	52.2	3.3
5	11590.00	55.9 PK	74.0	-18.1	1.05 V	78	41.5	14.4
6	11590.00	44.0 AV	54.0	-10.0	1.05 V	78	29.6	14.4

**Remarks:**

1. Emission Level(dBuV/m) = Raw Value(dBuV) + Correction Factor(dB/m)
2. Correction Factor(dB/m) = Antenna Factor(dB/m) + Cable Factor(dB) – Pre-Amplifier Factor(dB)
3. The other emission levels were very low against the limit.
4. Margin value = Emission Level – Limit value
5. " \* ": Fundamental frequency.
6. " # ": The radiated frequency is out of the restricted band.

802.11ac (VHT80)

CHANNEL	TX Channel 42	DETECTOR FUNCTION	Peak (PK)
FREQUENCY RANGE	1GHz ~ 40GHz		Average (AV)

ANTENNA POLARITY & TEST DISTANCE: HORIZONTAL AT 3 M								
NO.	FREQ. (MHz)	EMISSION LEVEL (dBuV/m)	LIMIT (dBuV/m)	MARGIN (dB)	ANTENNA HEIGHT (m)	TABLE ANGLE (Degree)	RAW VALUE (dBuV)	CORRECTION FACTOR (dB/m)
1	5150.00	63.7 PK	74.0	-10.3	1.53 H	91	61.6	2.1
2	5150.00	46.7 AV	54.0	-7.3	1.53 H	91	44.6	2.1
3	*5210.00	101.2 PK			1.56 H	92	62.2	39.0
4	*5210.00	89.6 AV			1.56 H	92	50.6	39.0
5	5350.00	54.7 PK	74.0	-19.3	1.55 H	96	52.1	2.6
6	5350.00	41.8 AV	54.0	-12.2	1.55 H	96	39.2	2.6
7	#10420.00	53.9 PK	74.0	-20.1	1.18 H	105	39.5	14.4
8	#10420.00	41.9 AV	54.0	-12.1	1.18 H	105	27.5	14.4
ANTENNA POLARITY & TEST DISTANCE: VERTICAL AT 3 M								
NO.	FREQ. (MHz)	EMISSION LEVEL (dBuV/m)	LIMIT (dBuV/m)	MARGIN (dB)	ANTENNA HEIGHT (m)	TABLE ANGLE (Degree)	RAW VALUE (dBuV)	CORRECTION FACTOR (dB/m)
1	5150.00	69.3 PK	74.0	-4.7	2.21 V	7	63.2	6.1
2	5150.00	52.6 AV	54.0	-1.4	2.21 V	7	46.5	6.1
3	*5210.00	104.9 PK			2.06 V	5	64.6	40.3
4	*5210.00	94.4 AV			2.06 V	5	54.1	40.3
5	5350.00	58.8 PK	74.0	-15.2	2.38 V	11	52.3	6.5
6	5350.00	45.8 AV	54.0	-8.2	2.38 V	11	39.3	6.5
7	#10420.00	60.3 PK	74.0	-13.7	1.69 V	115	42.2	18.1
8	#10420.00	47.0 AV	54.0	-7.0	1.69 V	115	28.9	18.1

Remarks:

1. Emission Level(dBuV/m) = Raw Value(dBuV) + Correction Factor(dB/m)
2. Correction Factor(dB/m) = Antenna Factor(dB/m) + Cable Factor(dB) – Pre-Amplifier Factor(dB)
3. The other emission levels were very low against the limit.
4. Margin value = Emission Level – Limit value
5. " \* ": Fundamental frequency.
6. " # ": The radiated frequency is out of the restricted band.

CHANNEL	TX Channel 58	DETECTOR FUNCTION	Peak (PK)
FREQUENCY RANGE	1GHz ~ 40GHz		Average (AV)

**ANTENNA POLARITY & TEST DISTANCE: HORIZONTAL AT 3 M**

NO.	FREQ. (MHz)	EMISSION LEVEL (dBuV/m)	LIMIT (dBuV/m)	MARGIN (dB)	ANTENNA HEIGHT (m)	TABLE ANGLE (Degree)	RAW VALUE (dBuV)	CORRECTION FACTOR (dB/m)
1	5150.00	54.9 PK	74.0	-19.1	1.60 H	87	52.8	2.1
2	5150.00	41.2 AV	54.0	-12.8	1.60 H	87	39.1	2.1
3	*5290.00	101.8 PK			1.52 H	93	62.6	39.2
4	*5290.00	90.4 AV			1.52 H	93	51.2	39.2
5	5350.00	63.3 PK	74.0	-10.7	1.56 H	94	60.7	2.6
6	5350.00	46.6 AV	54.0	-7.4	1.56 H	94	44.0	2.6
7	#10580.00	55.1 PK	74.0	-18.9	2.29 H	357	40.5	14.6
8	#10580.00	43.5 AV	54.0	-10.5	2.29 H	357	28.9	14.6

**ANTENNA POLARITY & TEST DISTANCE: VERTICAL AT 3 M**

NO.	FREQ. (MHz)	EMISSION LEVEL (dBuV/m)	LIMIT (dBuV/m)	MARGIN (dB)	ANTENNA HEIGHT (m)	TABLE ANGLE (Degree)	RAW VALUE (dBuV)	CORRECTION FACTOR (dB/m)
1	5150.00	59.4 PK	74.0	-14.6	2.32 V	18	53.3	6.1
2	5150.00	46.0 AV	54.0	-8.0	2.32 V	18	39.9	6.1
3	*5290.00	105.8 PK			2.25 V	12	65.4	40.4
4	*5290.00	95.2 AV			2.25 V	12	54.8	40.4
5	5350.00	68.9 PK	74.0	-5.1	2.14 V	14	62.4	6.5
6	5350.00	52.6 AV	54.0	-1.4	2.14 V	14	46.1	6.5
7	#10580.00	60.7 PK	74.0	-13.3	1.67 V	129	42.0	18.7
8	#10580.00	47.3 AV	54.0	-6.7	1.67 V	129	28.6	18.7

**Remarks:**

1. Emission Level(dBuV/m) = Raw Value(dBuV) + Correction Factor(dB/m)
2. Correction Factor(dB/m) = Antenna Factor(dB/m) + Cable Factor(dB) – Pre-Amplifier Factor(dB)
3. The other emission levels were very low against the limit.
4. Margin value = Emission Level – Limit value
5. " \* ": Fundamental frequency.
6. " # ": The radiated frequency is out of the restricted band.

CHANNEL	TX Channel 106	DETECTOR FUNCTION	Peak (PK)
FREQUENCY RANGE	1GHz ~ 40GHz		Average (AV)

## ANTENNA POLARITY &amp; TEST DISTANCE: HORIZONTAL AT 3 M

NO.	FREQ. (MHz)	EMISSION LEVEL (dBuV/m)	LIMIT (dBuV/m)	MARGIN (dB)	ANTENNA HEIGHT (m)	TABLE ANGLE (Degree)	RAW VALUE (dBuV)	CORRECTION FACTOR (dB/m)
1	5460.00	67.4 PK	74.0	-6.6	2.29 H	110	60.7	6.7
2	5460.00	51.7 AV	54.0	-2.3	2.29 H	110	45.0	6.7
3	#5470.00	69.9 PK	74.0	-4.1	2.24 H	116	63.2	6.7
4	#5470.00	52.3 AV	54.0	-1.7	2.24 H	116	45.6	6.7
5	*5530.00	104.2 PK			2.24 H	113	63.3	40.9
6	*5530.00	93.7 AV			2.24 H	113	52.8	40.9
7	11060.00	61.1 PK	74.0	-12.9	1.70 H	72	41.5	19.6
8	11060.00	48.6 AV	54.0	-5.4	1.70 H	72	29.0	19.6

## ANTENNA POLARITY &amp; TEST DISTANCE: VERTICAL AT 3 M

NO.	FREQ. (MHz)	EMISSION LEVEL (dBuV/m)	LIMIT (dBuV/m)	MARGIN (dB)	ANTENNA HEIGHT (m)	TABLE ANGLE (Degree)	RAW VALUE (dBuV)	CORRECTION FACTOR (dB/m)
1	5460.00	68.2 PK	74.0	-5.8	1.93 V	208	65.5	2.7
2	<b>5460.00</b>	<b>53.0 AV</b>	<b>54.0</b>	<b>-1.0</b>	<b>1.93 V</b>	<b>208</b>	<b>50.3</b>	<b>2.7</b>
3	#5470.00	69.8 PK	74.0	-4.2	1.93 V	208	67.1	2.7
4	<b>#5470.00</b>	<b>53.0 AV</b>	<b>54.0</b>	<b>-1.0</b>	<b>1.93 V</b>	<b>208</b>	<b>50.3</b>	<b>2.7</b>
5	*5530.00	105.3 PK			1.98 V	215	65.8	39.5
6	*5530.00	94.4 AV			1.98 V	215	54.9	39.5
7	11060.00	56.9 PK	74.0	-17.1	1.05 V	74	41.2	15.7
8	11060.00	45.3 AV	54.0	-8.7	1.05 V	74	29.6	15.7

## Remarks:

1. Emission Level(dBuV/m) = Raw Value(dBuV) + Correction Factor(dB/m)
2. Correction Factor(dB/m) = Antenna Factor(dB/m) + Cable Factor(dB) – Pre-Amplifier Factor(dB)
3. The other emission levels were very low against the limit.
4. Margin value = Emission Level – Limit value
5. " \* ": Fundamental frequency.
6. " # ": The radiated frequency is out of the restricted band.

CHANNEL	TX Channel 122	DETECTOR FUNCTION	Peak (PK)
FREQUENCY RANGE	1GHz ~ 40GHz		Average (AV)

**ANTENNA POLARITY & TEST DISTANCE: HORIZONTAL AT 3 M**

NO.	FREQ. (MHz)	EMISSION LEVEL (dBuV/m)	LIMIT (dBuV/m)	MARGIN (dB)	ANTENNA HEIGHT (m)	TABLE ANGLE (Degree)	RAW VALUE (dBuV)	CORRECTION FACTOR (dB/m)
1	#5470.00	59.0 PK	74.0	-15.0	2.01 H	39	52.3	6.7
2	#5470.00	46.1 AV	54.0	-7.9	2.01 H	39	39.4	6.7
3	*5610.00	105.8 PK			2.04 H	44	64.7	41.1
4	*5610.00	95.2 AV			2.04 H	44	54.1	41.1
5	11220.00	61.1 PK	74.0	-12.9	1.85 H	87	41.2	19.9
6	11220.00	49.1 AV	54.0	-4.9	1.85 H	87	29.2	19.9

**ANTENNA POLARITY & TEST DISTANCE: VERTICAL AT 3 M**

NO.	FREQ. (MHz)	EMISSION LEVEL (dBuV/m)	LIMIT (dBuV/m)	MARGIN (dB)	ANTENNA HEIGHT (m)	TABLE ANGLE (Degree)	RAW VALUE (dBuV)	CORRECTION FACTOR (dB/m)
1	#5470.00	60.3 PK	74.0	-13.7	1.90 V	222	57.6	2.7
2	#5470.00	45.7 AV	54.0	-8.3	1.90 V	222	43.0	2.7
3	*5610.00	107.5 PK			1.87 V	219	67.8	39.7
4	*5610.00	96.4 AV			1.87 V	219	56.7	39.7
5	11220.00	57.0 PK	74.0	-17.0	1.06 V	35	41.5	15.5
6	11220.00	45.1 AV	54.0	-8.9	1.06 V	35	29.6	15.5

Remarks:

1. Emission Level(dBuV/m) = Raw Value(dBuV) + Correction Factor(dB/m)
2. Correction Factor(dB/m) = Antenna Factor(dB/m) + Cable Factor(dB) – Pre-Amplifier Factor(dB)
3. The other emission levels were very low against the limit.
4. Margin value = Emission Level – Limit value
5. " \* ": Fundamental frequency.
6. " # ": The radiated frequency is out of the restricted band.



CHANNEL	TX Channel 138	DETECTOR	Peak (PK)
FREQUENCY RANGE	1GHz ~ 40GHz	FUNCTION	Average (AV)

ANTENNA POLARITY & TEST DISTANCE: HORIZONTAL AT 3 M								
NO.	FREQ. (MHz)	EMISSION LEVEL (dBuV/m)	LIMIT (dBuV/m)	MARGIN (dB)	ANTENNA HEIGHT (m)	TABLE ANGLE (Degree)	RAW VALUE (dBuV)	CORRECTION FACTOR (dB/m)
1	#5470.00	56.9 PK	74.0	-17.1	2.00 H	61	50.2	6.7
2	#5470.00	45.5 AV	54.0	-8.5	2.00 H	61	38.8	6.7
3	*5690.00	106.2 PK			1.99 H	58	64.9	41.3
4	*5690.00	95.5 AV			1.99 H	58	54.2	41.3
5	#5850.00	59.3 PK	74.0	-14.7	2.03 H	66	51.6	7.7
6	#5850.00	47.4 AV	54.0	-6.6	2.03 H	66	39.7	7.7
7	11380.00	61.8 PK	74.0	-12.2	1.67 H	73	41.5	20.3
8	11380.00	49.2 AV	54.0	-4.8	1.67 H	73	28.9	20.3

ANTENNA POLARITY & TEST DISTANCE: VERTICAL AT 3 M								
NO.	FREQ. (MHz)	EMISSION LEVEL (dBuV/m)	LIMIT (dBuV/m)	MARGIN (dB)	ANTENNA HEIGHT (m)	TABLE ANGLE (Degree)	RAW VALUE (dBuV)	CORRECTION FACTOR (dB/m)
1	#5470.00	54.3 PK	74.0	-19.7	1.91 V	212	51.6	2.7
2	#5470.00	43.3 AV	54.0	-10.7	1.91 V	212	40.6	2.7
3	*5690.00	117.5 PK			1.90 V	214	77.6	39.9
4	*5690.00	96.8 AV			1.90 V	214	56.9	39.9
5	#5850.00	54.8 PK	74.0	-19.2	1.85 V	211	51.6	3.2
6	#5850.00	43.8 AV	54.0	-10.2	1.85 V	211	40.6	3.2
7	11380.00	56.7 PK	74.0	-17.3	1.25 V	47	41.2	15.5
8	11380.00	45.1 AV	54.0	-8.9	1.25 V	47	29.6	15.5

Remarks:

1. Emission Level(dBuV/m) = Raw Value(dBuV) + Correction Factor(dB/m)
2. Correction Factor(dB/m) = Antenna Factor(dB/m) + Cable Factor(dB) – Pre-Amplifier Factor(dB)
3. The other emission levels were very low against the limit.
4. Margin value = Emission Level – Limit value
5. " \* ": Fundamental frequency.
6. " # ": The radiated frequency is out of the restricted band.

CHANNEL	TX Channel 155	DETECTOR FUNCTION	Peak (PK)
FREQUENCY RANGE	1GHz ~ 40GHz		Average (AV)

ANTENNA POLARITY & TEST DISTANCE: HORIZONTAL AT 3 M								
NO.	FREQ. (MHz)	EMISSION LEVEL (dBuV/m)	LIMIT (dBuV/m)	MARGIN (dB)	ANTENNA HEIGHT (m)	TABLE ANGLE (Degree)	RAW VALUE (dBuV)	CORRECTION FACTOR (dB/m)
1	#5650.40	61.3 PK	68.5	-7.2	2.19 H	115	54.2	7.1
2	*5775.00	106.1 PK			2.19 H	115	64.5	41.6
3	*5775.00	95.7 AV			2.19 H	115	54.1	41.6
4	#6000.00	61.1 PK	68.2	-7.1	2.19 H	115	53.2	7.9
5	11550.00	61.7 PK	74.0	-12.3	2.06 H	108	41.5	20.2
6	11550.00	49.4 AV	54.0	-4.6	2.06 H	108	29.2	20.2

ANTENNA POLARITY & TEST DISTANCE: VERTICAL AT 3 M								
NO.	FREQ. (MHz)	EMISSION LEVEL (dBuV/m)	LIMIT (dBuV/m)	MARGIN (dB)	ANTENNA HEIGHT (m)	TABLE ANGLE (Degree)	RAW VALUE (dBuV)	CORRECTION FACTOR (dB/m)
1	#5644.80	62.3 PK	68.2	-5.9	1.80 V	200	59.4	2.9
2	*5775.00	107.5 PK			1.80 V	200	67.6	39.9
3	*5775.00	97.3 AV			1.80 V	200	57.4	39.9
4	#5924.00	59.5 PK	68.9	-9.4	1.80 V	200	56.3	3.2
5	11550.00	55.7 PK	74.0	-18.3	1.04 V	18	41.2	14.5
6	11550.00	44.1 AV	54.0	-9.9	1.04 V	18	29.6	14.5

Remarks:

1. Emission Level(dBuV/m) = Raw Value(dBuV) + Correction Factor(dB/m)
2. Correction Factor(dB/m) = Antenna Factor(dB/m) + Cable Factor(dB) – Pre-Amplifier Factor(dB)
3. The other emission levels were very low against the limit.
4. Margin value = Emission Level – Limit value
5. " \* ": Fundamental frequency.
6. " # ": The radiated frequency is out of the restricted band.

Below 1GHz Worst-Case Data: 802.11a

CHANNEL	TX Channel 40	DETECTOR FUNCTION	Quasi-Peak (QP)
FREQUENCY RANGE	30MHz ~ 1GHz	TEST MODE	A

ANTENNA POLARITY & TEST DISTANCE: HORIZONTAL AT 3 M

NO.	FREQ. (MHz)	EMISSION LEVEL (dBuV/m)	LIMIT (dBuV/m)	MARGIN (dB)	ANTENNA HEIGHT (m)	TABLE ANGLE (Degree)	RAW VALUE (dBuV)	CORRECTION FACTOR (dB/m)
1	64.11	22.6 QP	40.0	-17.4	2.00 H	205	37.8	-15.2
2	110.75	23.3 QP	43.5	-20.2	1.51 H	335	40.4	-17.1
3	193.15	31.1 QP	43.5	-12.4	2.00 H	280	47.1	-16.0
4	242.91	29.8 QP	46.0	-16.2	2.00 H	242	44.1	-14.3
5	250.68	31.5 QP	46.0	-14.5	2.00 H	280	45.5	-14.0
6	298.88	30.4 QP	46.0	-15.6	1.51 H	340	42.5	-12.1

ANTENNA POLARITY & TEST DISTANCE: VERTICAL AT 3 M

NO.	FREQ. (MHz)	EMISSION LEVEL (dBuV/m)	LIMIT (dBuV/m)	MARGIN (dB)	ANTENNA HEIGHT (m)	TABLE ANGLE (Degree)	RAW VALUE (dBuV)	CORRECTION FACTOR (dB/m)
1	40.78	25.6 QP	40.0	-14.4	1.00 V	12	40.6	-15.0
2	61.00	25.9 QP	40.0	-14.1	1.00 V	326	40.9	-15.0
3	62.55	28.6 QP	40.0	-11.4	1.00 V	337	43.8	-15.2
4	110.75	21.6 QP	43.5	-21.9	1.00 V	133	38.7	-17.1
5	193.15	22.4 QP	43.5	-21.1	1.00 V	12	38.4	-16.0
6	252.24	26.8 QP	46.0	-19.2	1.00 V	276	40.7	-13.9

Remarks:

1. Emission Level(dBuV/m) = Raw Value(dBuV) + Correction Factor(dB/m)
2. Correction Factor(dB/m) = Antenna Factor(dB/m) + Cable Factor(dB) – Pre-Amplifier Factor(dB)
3. The other emission levels were very low against the limit.
4. Margin value = Emission Level – Limit value

CHANNEL	TX Channel 40	DETECTOR FUNCTION	Quasi-Peak (QP)
FREQUENCY RANGE	30MHz ~ 1GHz	TEST MODE	B

**ANTENNA POLARITY & TEST DISTANCE: HORIZONTAL AT 3 M**

NO.	FREQ. (MHz)	EMISSION LEVEL (dBuV/m)	LIMIT (dBuV/m)	MARGIN (dB)	ANTENNA HEIGHT (m)	TABLE ANGLE (Degree)	RAW VALUE (dBuV)	CORRECTION FACTOR (dB/m)
1	120.08	24.6 QP	43.5	-18.9	1.49 H	285	40.6	-16.0
2	137.18	28.3 QP	43.5	-15.2	2.00 H	69	42.7	-14.4
3	224.25	31.0 QP	46.0	-15.0	1.49 H	106	47.1	-16.1
4	314.43	28.7 QP	46.0	-17.3	1.00 H	57	40.3	-11.6
5	729.56	34.2 QP	46.0	-11.8	1.00 H	24	37.6	-3.4
6	746.67	36.1 QP	46.0	-9.9	1.00 H	227	38.9	-2.8

**ANTENNA POLARITY & TEST DISTANCE: VERTICAL AT 3 M**

NO.	FREQ. (MHz)	EMISSION LEVEL (dBuV/m)	LIMIT (dBuV/m)	MARGIN (dB)	ANTENNA HEIGHT (m)	TABLE ANGLE (Degree)	RAW VALUE (dBuV)	CORRECTION FACTOR (dB/m)
1	29.90	28.6 QP	40.0	-11.4	1.01 V	247	44.6	-16.0
2	137.18	28.1 QP	43.5	-15.4	1.01 V	222	42.5	-14.4
3	222.70	26.3 QP	46.0	-19.7	1.51 V	110	42.3	-16.0
4	314.43	29.2 QP	46.0	-16.8	2.00 V	33	40.8	-11.6
5	729.56	38.3 QP	46.0	-7.7	1.01 V	13	41.7	-3.4
6	746.67	40.3 QP	46.0	-5.7	1.01 V	230	43.1	-2.8

**Remarks:**

1. Emission Level(dBuV/m) = Raw Value(dBuV) + Correction Factor(dB/m)
2. Correction Factor(dB/m) = Antenna Factor(dB/m) + Cable Factor(dB) – Pre-Amplifier Factor(dB)
3. The other emission levels were very low against the limit.
4. Margin value = Emission Level – Limit value

CHANNEL	TX Channel 40	DETECTOR FUNCTION	Quasi-Peak (QP)
FREQUENCY RANGE	30MHz ~ 1GHz	TEST MODE	C

**ANTENNA POLARITY & TEST DISTANCE: HORIZONTAL AT 3 M**

NO.	FREQ. (MHz)	EMISSION LEVEL (dBuV/m)	LIMIT (dBuV/m)	MARGIN (dB)	ANTENNA HEIGHT (m)	TABLE ANGLE (Degree)	RAW VALUE (dBuV)	CORRECTION FACTOR (dB/m)
1	30.00	26.2 QP	40.0	-13.8	1.99 H	330	42.2	-16.0
2	138.64	22.1 QP	43.5	-21.4	1.00 H	191	36.1	-14.0
3	274.44	21.2 QP	46.0	-24.8	1.49 H	12	33.1	-11.9
4	447.10	24.4 QP	46.0	-21.6	1.00 H	9	32.0	-7.6
5	747.80	33.7 QP	46.0	-12.3	1.00 H	103	34.2	-0.5
6	922.40	34.6 QP	46.0	-11.4	1.99 H	18	31.1	3.5

**ANTENNA POLARITY & TEST DISTANCE: VERTICAL AT 3 M**

NO.	FREQ. (MHz)	EMISSION LEVEL (dBuV/m)	LIMIT (dBuV/m)	MARGIN (dB)	ANTENNA HEIGHT (m)	TABLE ANGLE (Degree)	RAW VALUE (dBuV)	CORRECTION FACTOR (dB/m)
1	33.27	30.0 QP	40.0	-10.0	1.00 V	258	45.7	-15.7
2	51.34	28.5 QP	40.0	-11.5	1.00 V	117	42.4	-13.9
3	86.26	18.9 QP	40.0	-21.1	1.00 V	174	38.0	-19.1
4	158.04	18.0 QP	43.5	-25.5	1.99 V	315	31.0	-13.0
5	439.34	23.2 QP	46.0	-22.8	1.49 V	148	30.9	-7.7
6	941.80	33.8 QP	46.0	-12.2	1.99 V	61	30.1	3.7

**Remarks:**

1. Emission Level(dBuV/m) = Raw Value(dBuV) + Correction Factor(dB/m)
2. Correction Factor(dB/m) = Antenna Factor(dB/m) + Cable Factor(dB) – Pre-Amplifier Factor(dB)
3. The other emission levels were very low against the limit.
4. Margin value = Emission Level – Limit value

CHANNEL	TX Channel 40	DETECTOR FUNCTION	Quasi-Peak (QP)
FREQUENCY RANGE	30MHz ~ 1GHz	TEST MODE	D

**ANTENNA POLARITY & TEST DISTANCE: HORIZONTAL AT 3 M**

NO.	FREQ. (MHz)	EMISSION LEVEL (dBuV/m)	LIMIT (dBuV/m)	MARGIN (dB)	ANTENNA HEIGHT (m)	TABLE ANGLE (Degree)	RAW VALUE (dBuV)	CORRECTION FACTOR (dB/m)
1	115.41	26.7 QP	43.5	-16.8	2.00 H	282	43.3	-16.6
2	191.60	30.7 QP	43.5	-12.8	1.00 H	275	46.7	-16.0
3	214.92	32.3 QP	43.5	-11.2	1.00 H	275	48.4	-16.1
4	250.68	38.7 QP	46.0	-7.3	1.00 H	239	52.7	-14.0
5	263.12	37.7 QP	46.0	-8.3	1.00 H	243	51.1	-13.4
6	745.11	37.0 QP	46.0	-9.0	2.00 H	7	39.9	-2.9

**ANTENNA POLARITY & TEST DISTANCE: VERTICAL AT 3 M**

NO.	FREQ. (MHz)	EMISSION LEVEL (dBuV/m)	LIMIT (dBuV/m)	MARGIN (dB)	ANTENNA HEIGHT (m)	TABLE ANGLE (Degree)	RAW VALUE (dBuV)	CORRECTION FACTOR (dB/m)
1	45.45	29.6 QP	40.0	-10.4	1.00 V	26	44.3	-14.7
2	68.77	30.5 QP	40.0	-9.5	1.50 V	19	46.4	-15.9
3	121.63	26.2 QP	43.5	-17.3	1.00 V	197	42.1	-15.9
4	197.82	31.9 QP	43.5	-11.6	1.00 V	237	48.1	-16.2
5	263.12	33.8 QP	46.0	-12.2	1.50 V	178	47.2	-13.4
6	420.16	22.7 QP	46.0	-23.3	1.00 V	178	32.6	-9.9

**Remarks:**

1. Emission Level(dBuV/m) = Raw Value(dBuV) + Correction Factor(dB/m)
2. Correction Factor(dB/m) = Antenna Factor(dB/m) + Cable Factor(dB) – Pre-Amplifier Factor(dB)
3. The other emission levels were very low against the limit.
4. Margin value = Emission Level – Limit value

CHANNEL	TX Channel 40	DETECTOR FUNCTION	Quasi-Peak (QP)
FREQUENCY RANGE	30MHz ~ 1GHz	TEST MODE	E

**ANTENNA POLARITY & TEST DISTANCE: HORIZONTAL AT 3 M**

NO.	FREQ. (MHz)	EMISSION LEVEL (dBuV/m)	LIMIT (dBuV/m)	MARGIN (dB)	ANTENNA HEIGHT (m)	TABLE ANGLE (Degree)	RAW VALUE (dBuV)	CORRECTION FACTOR (dB/m)
1	135.63	25.3 QP	43.5	-18.2	2.00 H	284	40.0	-14.7
2	222.70	25.9 QP	46.0	-20.1	1.01 H	106	41.9	-16.0
3	232.02	23.9 QP	46.0	-22.1	1.51 H	266	39.5	-15.6
4	314.43	28.3 QP	46.0	-17.7	1.01 H	47	39.9	-11.6
5	586.52	26.8 QP	46.0	-19.2	1.51 H	312	33.2	-6.4
6	746.67	31.4 QP	46.0	-14.6	2.00 H	81	34.2	-2.8

**ANTENNA POLARITY & TEST DISTANCE: VERTICAL AT 3 M**

NO.	FREQ. (MHz)	EMISSION LEVEL (dBuV/m)	LIMIT (dBuV/m)	MARGIN (dB)	ANTENNA HEIGHT (m)	TABLE ANGLE (Degree)	RAW VALUE (dBuV)	CORRECTION FACTOR (dB/m)
1	135.63	24.4 QP	43.5	-19.1	1.50 V	66	39.1	-14.7
2	176.05	21.5 QP	43.5	-22.0	1.50 V	269	36.0	-14.5
3	222.70	27.0 QP	46.0	-19.0	1.50 V	273	43.0	-16.0
4	305.10	25.6 QP	46.0	-20.4	1.00 V	39	37.6	-12.0
5	746.67	33.4 QP	46.0	-12.6	1.00 V	7	36.2	-2.8
6	829.07	27.4 QP	46.0	-18.6	1.50 V	180	29.0	-1.6

**Remarks:**

1. Emission Level(dBuV/m) = Raw Value(dBuV) + Correction Factor(dB/m)
2. Correction Factor(dB/m) = Antenna Factor(dB/m) + Cable Factor(dB) – Pre-Amplifier Factor(dB)
3. The other emission levels were very low against the limit.
4. Margin value = Emission Level – Limit value

## 4.2 Conducted Emission Measurement

### 4.2.1 Limits of Conducted Emission Measurement

Frequency (MHz)	Conducted Limit (dBuV)	
	Quasi-peak	Average
0.15 - 0.5	66 - 56	56 - 46
0.50 - 5.0	56	46
5.0 - 30.0	60	50

Note: 1. The lower limit shall apply at the transition frequencies.

2. The limit decreases in line with the logarithm of the frequency in the range of 0.15 to 0.50MHz.

### 4.2.2 Test Instruments

Description & Manufacturer	Model No.	Serial No.	Cal. Date	Cal. Due
Test Receiver ROHDE & SCHWARZ	ESCI	100613	Nov. 21, 2016	Nov. 20, 2017
RF signal cable (with 10dB PAD) Woken	5D-FB	Cable-cond1-01	Dec. 22, 2016	Dec. 21, 2017
LISN ROHDE & SCHWARZ (EUT)	ESH3-Z5	835239/001	Mar. 10, 2017	Mar. 09, 2018
LISN ROHDE & SCHWARZ (Peripheral)	ESH3-Z5	835239/001	Mar. 10, 2017	Mar. 09, 2018
Software ADT	BV ADT_Cond_ V7.3.7.3	NA	NA	NA

Note: 1. The calibration interval of the above test instruments is 12 months and the calibrations are traceable to NML/ROC and NIST/USA.

2. The test was performed in HwaYa Shielded Room 1.

3. The VCCI Site Registration No. is C-2040.



#### 4.2.3 Test Procedures

- The EUT was placed 0.4 meters from the conducting wall of the shielded room with EUT being connected to the power mains through a line impedance stabilization network (LISN). Other support units were connected to the power mains through another LISN. The two LISNs provide 50 ohm/ 50uH of coupling impedance for the measuring instrument.
- Both lines of the power mains connected to the EUT were checked for maximum conducted interference.
- The frequency range from 150kHz to 30MHz was searched. Emission levels under (Limit - 20dB) was not recorded.

NOTE: The resolution bandwidth and video bandwidth of test receiver is 9kHz for quasi-peak detection (QP) and average detection (AV) at frequency 0.15MHz-30MHz.

#### 4.2.4 Deviation from Test Standard

No deviation.

#### 4.2.5 Test Setup

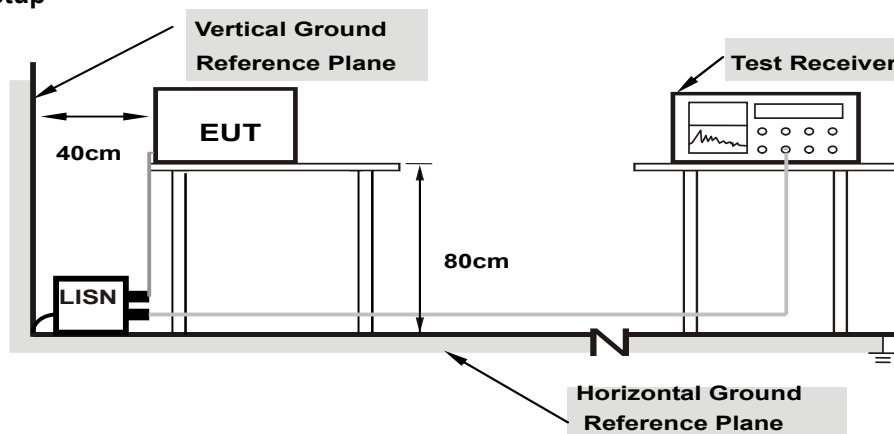

Note: 1.Support units were connected to second LISN.

For the actual test configuration, please refer to the attached file (Test Setup Photo).

#### 4.2.6 EUT Operating Conditions

Same as 4.1.6.

#### 4.2.7 Test Results

Phase	Line (L)	Detector Function	Quasi-Peak (QP) / Average (AV)
Test Mode	A		

No	Freq. [MHz]	Corr. Factor (dB)	Reading Value		Emission Level		Limit		Margin	
			[dB (uV)]		[dB (uV)]		[dB (uV)]		(dB)	
			Q.P.	AV.	Q.P.	AV.	Q.P.	AV.	Q.P.	AV.
1	0.15391	10.41	31.51	16.20	41.92	26.61	65.79	55.79	-23.87	-29.18
2	0.16967	10.41	29.60	14.70	40.01	25.11	64.98	54.98	-24.97	-29.87
3	0.18508	10.42	26.88	12.03	37.30	22.45	64.25	54.25	-26.95	-31.80
4	0.20511	10.43	24.67	11.06	35.10	21.49	63.40	53.40	-28.30	-31.91
5	0.23586	10.44	20.08	6.14	30.52	16.58	62.24	52.24	-31.72	-35.66
6	0.41233	10.51	19.66	10.18	30.17	20.69	57.60	47.60	-27.43	-26.91

#### REMARKS:

1. Q.P. and AV. are abbreviations of quasi-peak and average individually.
2. The emission levels of other frequencies were very low against the limit.
3. Margin value = Emission level - Limit value
4. Correction factor = Insertion loss + Cable loss
5. Emission Level = Correction Factor + Reading Value.

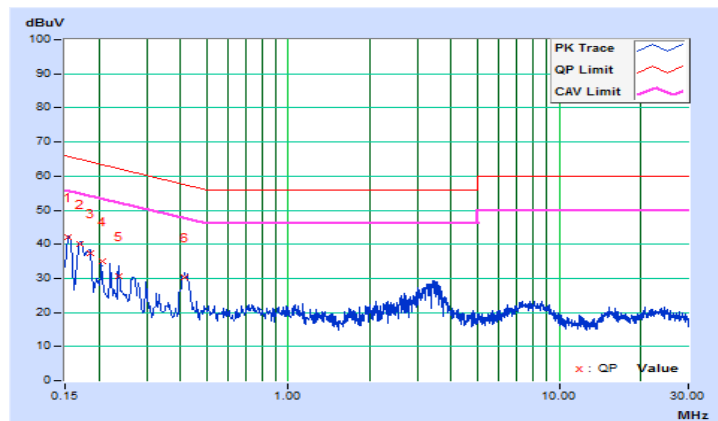

Phase	Neutral (N)	Detector Function	Quasi-Peak (QP) / Average (AV)
Test Mode	A		

No	Freq. [MHz]	Corr. Factor (dB)	Reading Value [dB (uV)]		Emission Level [dB (uV)]		Limit [dB (uV)]		Margin (dB)	
			Q.P.	AV.	Q.P.	AV.	Q.P.	AV.	Q.P.	AV.
			1	0.15719	10.16	30.84	16.32	41.00	26.48	65.61
2	0.19978	10.20	24.90	13.19	35.10	23.39	63.62	53.62	-28.52	-30.23
3	0.21851	10.20	22.62	11.06	32.82	21.26	62.88	52.88	-30.06	-31.62
4	0.23586	10.21	20.36	9.16	30.57	19.37	62.24	52.24	-31.67	-32.87
5	0.42334	10.23	25.99	18.85	36.22	29.08	57.38	47.38	-21.16	-18.30
6	3.35229	10.38	14.08	4.92	24.46	15.30	56.00	46.00	-31.54	-30.70

REMARKS:

1. Q.P. and AV. are abbreviations of quasi-peak and average individually.
2. The emission levels of other frequencies were very low against the limit.
3. Margin value = Emission level - Limit value
4. Correction factor = Insertion loss + Cable loss
5. Emission Level = Correction Factor + Reading Value.

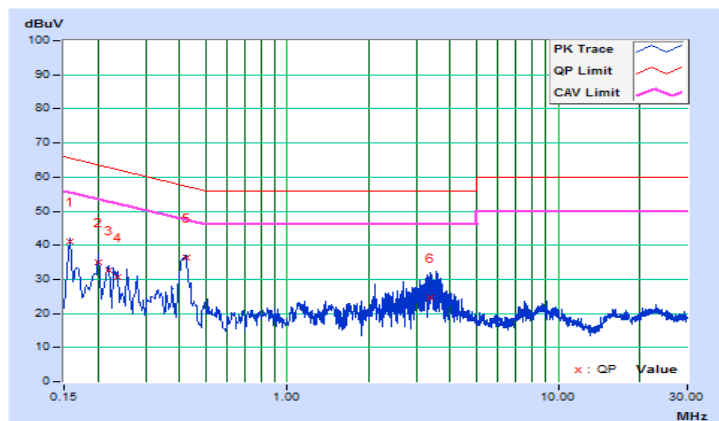

Phase	Line (L)	Detector Function	Quasi-Peak (QP) / Average (AV)
Test Mode	B		

No	Freq. [MHz]	Corr. Factor (dB)	Reading Value [dB (uV)]		Emission Level [dB (uV)]		Limit [dB (uV)]		Margin (dB)	
			Q.P.	AV.	Q.P.	AV.	Q.P.	AV.	Q.P.	AV.
			1	0.16564	10.41	26.14	2.10	36.55	12.51	65.18
2	0.17374	10.42	23.13	1.99	33.55	12.41	64.78	54.78	-31.23	-42.37
3	0.20474	10.43	16.05	-0.14	26.48	10.29	63.42	53.42	-36.94	-43.13
4	0.23277	10.44	10.63	0.36	21.07	10.80	62.35	52.35	-41.28	-41.55
5	17.73327	11.31	25.44	18.99	36.75	30.30	60.00	50.00	-23.25	-19.70
6	20.65404	11.45	23.33	17.12	34.78	28.57	60.00	50.00	-25.22	-21.43

REMARKS:

1. Q.P. and AV. are abbreviations of quasi-peak and average individually.
2. The emission levels of other frequencies were very low against the limit.
3. Margin value = Emission level - Limit value
4. Correction factor = Insertion loss + Cable loss
5. Emission Level = Correction Factor + Reading Value.

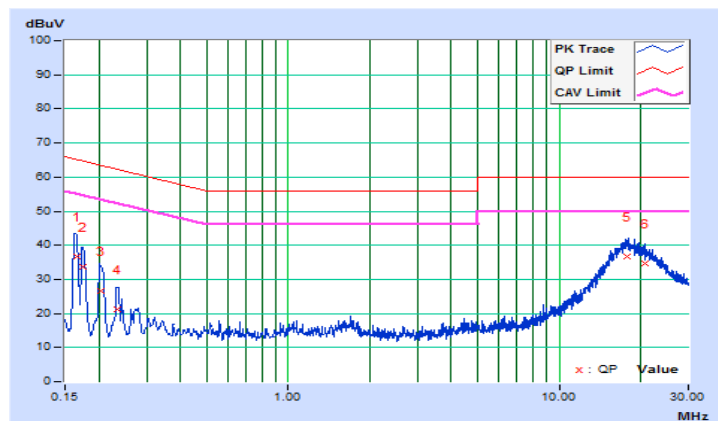

Phase	Neutral (N)	Detector Function	Quasi-Peak (QP) / Average (AV)
Test Mode	B		

No	Freq. [MHz]	Corr. Factor (dB)	Reading Value [dB (uV)]		Emission Level [dB (uV)]		Limit [dB (uV)]		Margin (dB)	
			Q.P.	AV.	Q.P.	AV.	Q.P.	AV.	Q.P.	AV.
			1	0.15391	10.16	28.46	3.83	38.62	13.99	65.79
2	0.17838	10.18	22.10	2.56	32.28	12.74	64.56	54.56	-32.28	-41.82
3	0.19717	10.20	18.98	-0.46	29.18	9.74	63.73	53.73	-34.55	-43.99
4	0.22434	10.20	13.13	-1.29	23.33	8.91	62.66	52.66	-39.33	-43.75
5	0.25125	10.21	7.35	-2.38	17.56	7.83	61.72	51.72	-44.16	-43.89
6	19.11741	11.02	25.21	18.85	36.23	29.87	60.00	50.00	-23.77	-20.13

REMARKS:

1. Q.P. and AV. are abbreviations of quasi-peak and average individually.
2. The emission levels of other frequencies were very low against the limit.
3. Margin value = Emission level - Limit value
4. Correction factor = Insertion loss + Cable loss
5. Emission Level = Correction Factor + Reading Value.

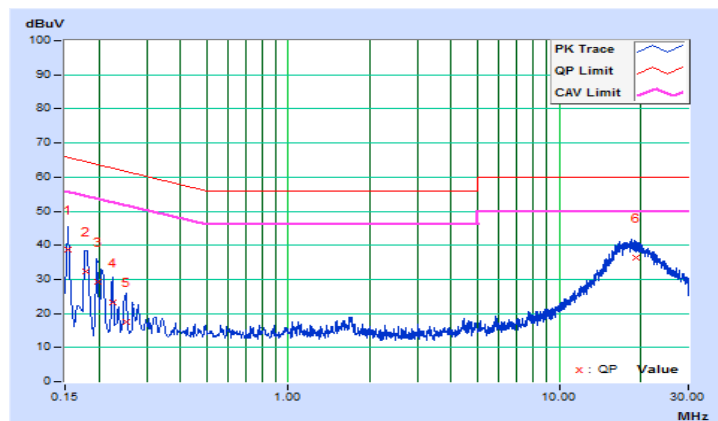

Phase	Line (L)	Detector Function	Quasi-Peak (QP) / Average (AV)
Test Mode	C		

No	Freq. [MHz]	Corr. Factor (dB)	Reading Value [dB (uV)]		Emission Level [dB (uV)]		Limit [dB (uV)]		Margin (dB)	
			Q.P.	AV.	Q.P.	AV.	Q.P.	AV.	Q.P.	AV.
			1	0.18128	10.42	36.17	25.99	46.59	36.41	64.43
<b>2</b>	<b>0.29897</b>	<b>10.47</b>	<b>31.19</b>	<b>25.53</b>	<b>41.66</b>	<b>36.00</b>	<b>60.27</b>	<b>50.27</b>	<b>-18.61</b>	<b>-14.27</b>
3	0.41560	10.51	25.95	20.68	36.46	31.19	57.54	47.54	-21.08	-16.35
4	0.88899	10.47	18.90	5.13	29.37	15.60	56.00	46.00	-26.63	-30.40
5	3.30146	10.61	18.45	4.91	29.06	15.52	56.00	46.00	-26.94	-30.48
6	8.52913	10.84	12.41	4.44	23.25	15.28	60.00	50.00	-36.75	-34.72

REMARKS:

1. Q.P. and AV. are abbreviations of quasi-peak and average individually.
2. The emission levels of other frequencies were very low against the limit.
3. Margin value = Emission level - Limit value
4. Correction factor = Insertion loss + Cable loss
5. Emission Level = Correction Factor + Reading Value.

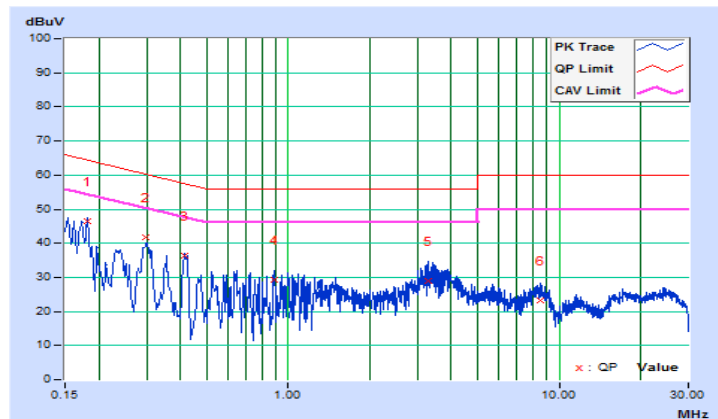

Phase	Neutral (N)	Detector Function	Quasi-Peak (QP) / Average (AV)
Test Mode	C		

No	Freq. [MHz]	Corr. Factor (dB)	Reading Value [dB (uV)]		Emission Level [dB (uV)]		Limit [dB (uV)]		Margin (dB)	
			Q.P.	AV.	Q.P.	AV.	Q.P.	AV.	Q.P.	AV.
			1	0.16967	10.17	35.89	22.12	46.06	32.29	64.98
2	0.23993	10.21	26.17	15.79	36.38	26.00	62.10	52.10	-25.72	-26.10
3	0.29858	10.21	24.73	15.27	34.94	25.48	60.28	50.28	-25.34	-24.80
4	1.45594	10.27	16.93	4.46	27.20	14.73	56.00	46.00	-28.80	-31.27
5	3.32492	10.38	19.43	4.84	29.81	15.22	56.00	46.00	-26.19	-30.78
6	8.30235	10.58	16.85	8.95	27.43	19.53	60.00	50.00	-32.57	-30.47

REMARKS:

1. Q.P. and AV. are abbreviations of quasi-peak and average individually.
2. The emission levels of other frequencies were very low against the limit.
3. Margin value = Emission level - Limit value
4. Correction factor = Insertion loss + Cable loss
5. Emission Level = Correction Factor + Reading Value.

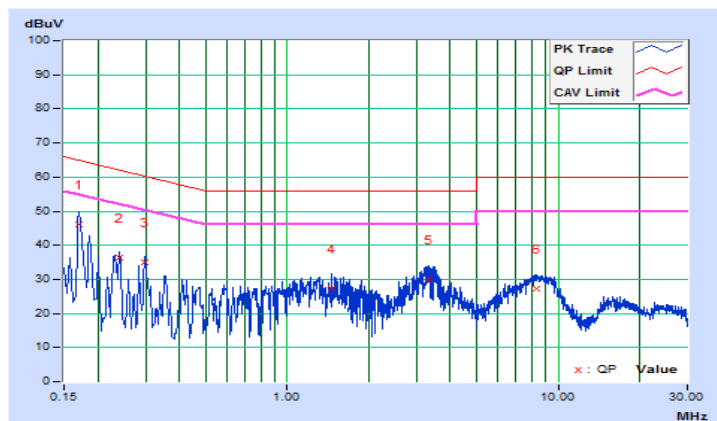

Phase	Line (L)	Detector Function	Quasi-Peak (QP) / Average (AV)
Test Mode	D		

No	Freq. [MHz]	Corr. Factor (dB)	Reading Value [dB (uV)]		Emission Level [dB (uV)]		Limit [dB (uV)]		Margin (dB)	
			Q.P.	AV.	Q.P.	AV.	Q.P.	AV.	Q.P.	AV.
			1	0.18128	10.42	34.60	21.32	45.02	31.74	64.43
2	0.20031	10.43	33.16	18.26	43.59	28.69	63.60	53.60	-20.01	-24.91
3	0.25526	10.45	31.70	17.75	42.15	28.20	61.58	51.58	-19.43	-23.38
4	0.57228	10.50	19.57	3.91	30.07	14.41	56.00	46.00	-25.93	-31.59
5	3.28191	10.61	20.48	8.56	31.09	19.17	56.00	46.00	-24.91	-26.83
6	10.53496	10.93	9.65	2.68	20.58	13.61	60.00	50.00	-39.42	-36.39

REMARKS:

1. Q.P. and AV. are abbreviations of quasi-peak and average individually.
2. The emission levels of other frequencies were very low against the limit.
3. Margin value = Emission level - Limit value
4. Correction factor = Insertion loss + Cable loss
5. Emission Level = Correction Factor + Reading Value.

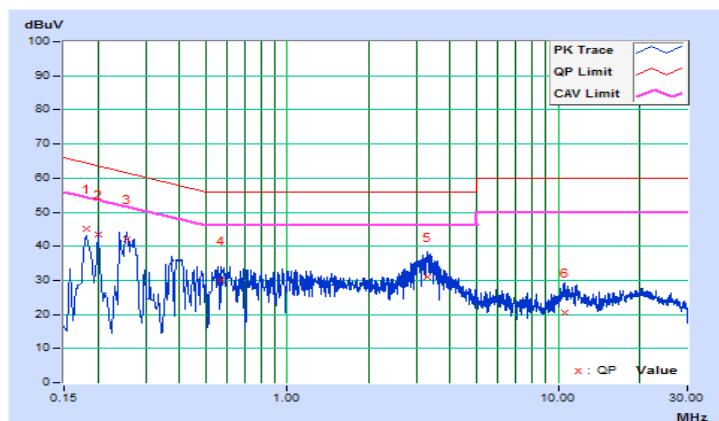



Phase	Neutral (N)	Detector Function	Quasi-Peak (QP) / Average (AV)
Test Mode	D		

No	Freq. [MHz]	Corr. Factor (dB)	Reading Value [dB (uV)]		Emission Level [dB (uV)]		Limit [dB (uV)]		Margin (dB)	
			Q.P.	AV.	Q.P.	AV.	Q.P.	AV.	Q.P.	AV.
			1	0.15000	10.15	25.21	4.64	35.36	14.79	66.00
2	0.17737	10.18	32.71	17.19	42.89	27.37	64.61	54.61	-21.72	-27.24
3	0.24384	10.21	29.71	18.47	39.92	28.68	61.96	51.96	-22.04	-23.28
4	1.35819	10.27	17.08	5.75	27.35	16.02	56.00	46.00	-28.65	-29.98
5	3.11378	10.37	20.43	8.43	30.80	18.80	56.00	46.00	-25.20	-27.20
6	8.05993	10.57	16.60	10.91	27.17	21.48	60.00	50.00	-32.83	-28.52

REMARKS:

1. Q.P. and AV. are abbreviations of quasi-peak and average individually.
2. The emission levels of other frequencies were very low against the limit.
3. Margin value = Emission level - Limit value
4. Correction factor = Insertion loss + Cable loss
5. Emission Level = Correction Factor + Reading Value.

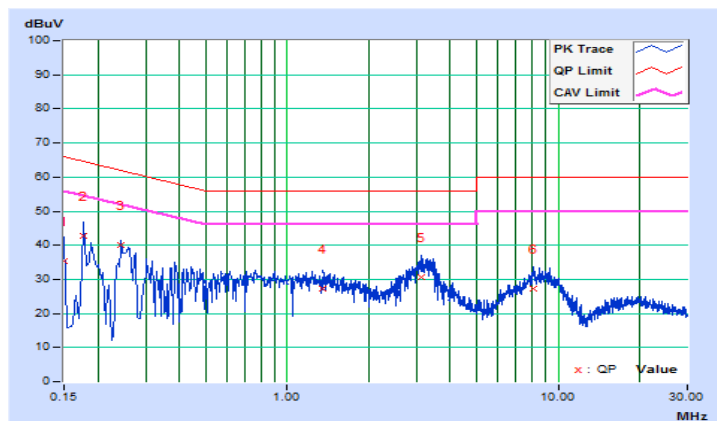

Phase	Line (L)	Detector Function	Quasi-Peak (QP) / Average (AV)
Test Mode	E		

No	Freq. [MHz]	Corr. Factor (dB)	Reading Value		Emission Level		Limit		Margin	
			[dB (uV)]		[dB (uV)]		[dB (uV)]		(dB)	
			Q.P.	AV.	Q.P.	AV.	Q.P.	AV.	Q.P.	AV.
1	0.15391	10.41	32.48	7.98	42.89	18.39	65.79	55.79	-22.90	-37.40
2	0.16955	10.41	28.66	5.09	39.07	15.50	64.98	54.98	-25.91	-39.48
3	0.19305	10.43	27.63	4.35	38.06	14.78	63.90	53.90	-25.84	-39.12
4	0.22434	10.44	26.37	2.76	36.81	13.20	62.66	52.66	-25.85	-39.46
5	1.60061	10.50	5.17	1.00	15.67	11.50	56.00	46.00	-40.33	-34.50
6	15.80564	11.20	23.45	14.41	34.65	25.61	60.00	50.00	-25.35	-24.39

REMARKS:

1. Q.P. and AV. are abbreviations of quasi-peak and average individually.
2. The emission levels of other frequencies were very low against the limit.
3. Margin value = Emission level - Limit value
4. Correction factor = Insertion loss + Cable loss
5. Emission Level = Correction Factor + Reading Value.

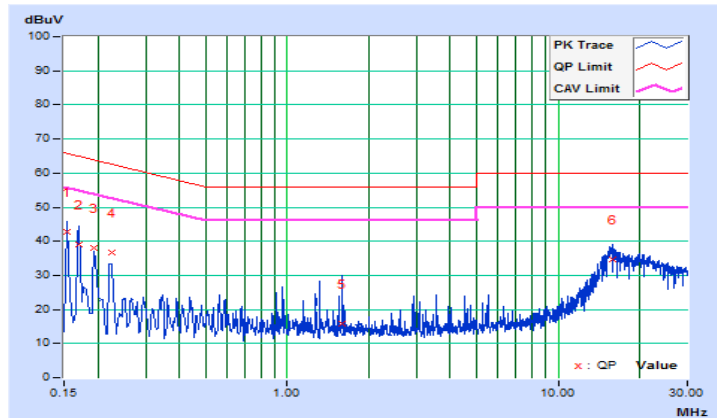

Phase	Neutral (N)	Detector Function	Quasi-Peak (QP) / Average (AV)
Test Mode	E		

No	Freq. [MHz]	Corr. Factor (dB)	Reading Value [dB (uV)]		Emission Level [dB (uV)]		Limit [dB (uV)]		Margin (dB)	
			Q.P.	AV.	Q.P.	AV.	Q.P.	AV.	Q.P.	AV.
			1	0.16955	10.17	25.16	1.29	35.33	11.46	64.98
2	0.19692	10.20	18.61	1.22	28.81	11.42	63.74	53.74	-34.93	-42.32
3	0.21256	10.20	13.48	2.37	23.68	12.57	63.10	53.10	-39.42	-40.53
4	0.23993	10.21	8.99	3.07	19.20	13.28	62.10	52.10	-42.90	-38.82
5	0.26730	10.21	4.32	0.60	14.53	10.81	61.20	51.20	-46.67	-40.39
6	15.79000	10.87	25.14	16.73	36.01	27.60	60.00	50.00	-23.99	-22.40

REMARKS:

1. Q.P. and AV. are abbreviations of quasi-peak and average individually.
2. The emission levels of other frequencies were very low against the limit.
3. Margin value = Emission level - Limit value
4. Correction factor = Insertion loss + Cable loss
5. Emission Level = Correction Factor + Reading Value.

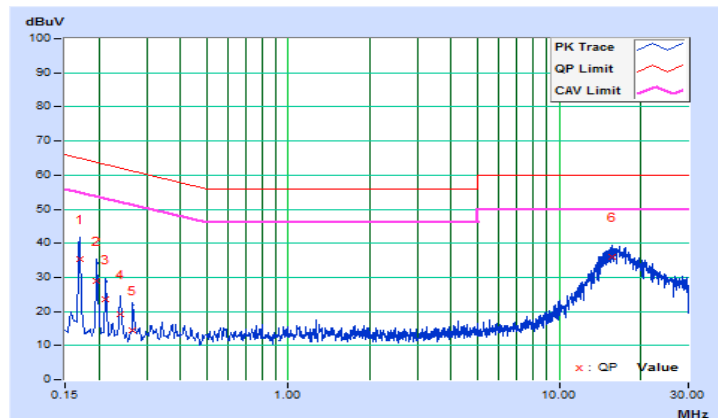

### 4.3 Transmit Power Measurement

#### 4.3.1 Limits of Transmit Power Measurement

Operation Band	EUT Category		LIMIT
U-NII-1		Outdoor Access Point	1 Watt (30 dBm) (Max. e.i.r.p $\leq$ 125mW(21 dBm) at any elevation angle above 30 degrees as measured from the horizon)
		Fixed point-to-point Access Point	1 Watt (30 dBm)
		Indoor Access Point	1 Watt (30 dBm)
	√	Mobile and Portable client device	250mW (24 dBm)
U-NII-2A		√	250mW (24 dBm) or 11 dBm+10 log B*
U-NII-2C		√	250mW (24 dBm) or 11 dBm+10 log B*
U-NII-3		√	1 Watt (30 dBm)

\*B is the 26 dB emission bandwidth in megahertz

Per KDB 662911 Method of conducted output power measurement on IEEE 802.11 devices,

Array Gain = 0 dB (i.e., no array gain) for  $N_{ANT} \leq 4$ ;

Array Gain = 0 dB (i.e., no array gain) for channel widths  $\geq 40$  MHz for any  $N_{ANT}$ ;

Array Gain =  $5 \log(N_{ANT}/N_{SS})$  dB or 3 dB, whichever is less for 20-MHz channel widths with  $N_{ANT} \geq 5$ .

For power measurements on all other devices: Array Gain =  $10 \log(N_{ANT}/N_{SS})$  dB.

#### 4.3.2 Test Setup

For Power Output

802.11a, 802.11n (HT20), 802.11n (HT40)

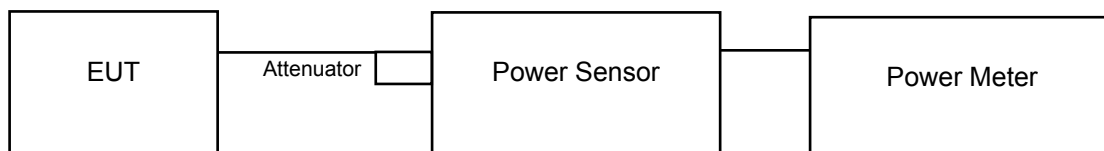

802.11ac (VHT80)

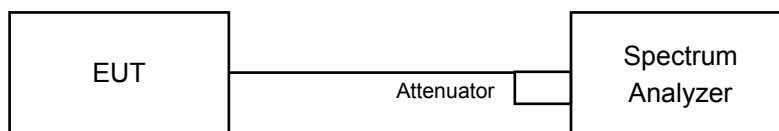

For 26dB and Occupied Bandwidth

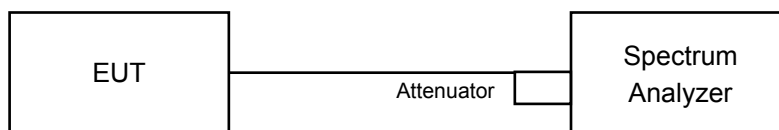

### 4.3.3 Test Instruments

Refer to section 4.1.2 to get information of above instrument.

### 4.3.4 Test Procedure

#### For Average Power Measurement

##### For 802.11a, 802.11n (HT20), 802.11n (HT40)

Method PM is used to perform output power measurement, trigger and gating function of wide band power meter is enabled to measure max output power of TX on burst. Duty factor is not added to measured value.

##### For 802.11ac (VHT80)

- Set span to encompass the entire 26 dB EBW (or, alternatively, the entire 99% occupied bandwidth) of the signal.
- Set sweep trigger to "free run".
- Set RBW = 1 MHz
- Set VBW  $\geq$  3 MHz
- Number of points in sweep  $\geq$  2 Span / RBW
- Sweep time  $\leq$  (number of points in sweep) \* T
- Using emission bandwidth to determine the frequency span for integration the channel bandwidth.
- Detector = RMS
- Trace mode = max hold
- Allow max hold to run for at least 60 seconds, or longer as needed to allow the trace to stabilize.
- Compute power by integrating the spectrum across the EBW (or, alternatively, the entire 99% occupied bandwidth) of the signal using the instrument's band power measurement function with band limits set equal to the EBW (or occupied bandwidth) band edges. If the instrument does not have a band power function, sum the spectrum levels (in power units) at 1 MHz intervals extending across the EBW (or, alternatively, the entire 99% occupied bandwidth) of the spectrum.

##### For 26dB Bandwidth

- Set RBW = approximately 1% of the emission bandwidth.
- Set the VBW > RBW.
- Detector = Peak.
- Trace mode = max hold.
- Measure the maximum width of the emission that is 26 dB down from the peak of the emission. Compare this with the RBW setting of the analyzer. Readjust RBW and repeat measurement as needed until the RBW/EBW ratio is approximately 1%.

##### For Occupied Bandwidth

The transmitter output was connected to the spectrum analyzer through an attenuator. The bandwidth of the fundamental frequency was measured by spectrum analyzer with resolution bandwidth in the range of 1% to 5% of the anticipated emission bandwidth, and a video bandwidth at least 3x the resolution bandwidth and set the detector to Sampling. The width of a frequency band such that, below the lower and above the upper frequency limits, the mean powers emitted are each equal to a specified percentage 0.5 % of the total mean power of a given emission.

### 4.3.5 Deviation from Test Standard

No deviation.

### 4.3.6 EUT Operating Conditions

The software provided by client to enable the EUT under transmission condition continuously at lowest, middle and highest channel frequencies individually.

### 4.3.7 Test Result

Power Output:

802.11a

Chan.	Freq. (MHz)	Conducted Power (mW)	Conducted Power (dBm)	Power Limit (dBm)	Pass / Fail
36	5180	57.280	17.58	24.00	Pass
40	5200	<b>58.076</b>	17.64	24.00	Pass
48	5240	56.754	17.54	24.00	Pass
52	5260	56.105	17.49	24.00	Pass
60	5300	54.075	17.33	24.00	Pass
64	5320	<b>57.148</b>	17.57	24.00	Pass
100	5500	45.814	16.61	24.00	Pass
116	5580	44.157	16.45	24.00	Pass
140	5700	46.026	16.63	24.00	Pass
144	5720 For U-NII-2C	18.664	12.71	23.22	Pass
144	5720 For U-NII-3	4.808	6.82	30.00	Pass
149	5745	49.204	16.92	30.00	Pass
157	5785	49.659	16.96	30.00	Pass
165	5825	49.888	16.98	30.00	Pass

Note:

For U-NII-2A, U-NII-2C Band:

- $11\text{dBm} + 10\log(22.66) = 24.55\text{ dBm} > 24\text{dBm}$
- $11\text{dBm} + 10\log(23.10) = 24.64\text{ dBm} > 24\text{dBm}$
- $11\text{dBm} + 10\log(22.53) = 24.53\text{ dBm} > 24\text{dBm}$
- $11\text{dBm} + 10\log(22.93) = 24.60\text{ dBm} > 24\text{dBm}$
- $11\text{dBm} + 10\log(22.53) = 24.53\text{ dBm} > 24\text{dBm}$
- $11\text{dBm} + 10\log(25.95) = 25.14\text{ dBm} > 24\text{dBm}$
- $11\text{dBm} + 10\log(5725.00 - 5708.30) = 23.22\text{ dBm} < 24\text{dBm}$ .

For Reference only-Power meter value

The power value was measured by power meter with average sensor

Chan.	Freq. (MHz)	Conducted Power (mW)	Conducted Power (dBm)
144	5720	23.472	13.71

802.11n (HT20)

Chan.	Freq. (MHz)	Conducted Power (mW)	Conducted Power (dBm)	Power Limit (dBm)	Pass / Fail
36	5180	55.976	17.48	24.00	Pass
40	5200	55.976	17.48	24.00	Pass
48	5240	55.081	17.41	24.00	Pass
52	5260	54.200	17.34	24.00	Pass
60	5300	55.719	17.46	24.00	Pass
64	5320	55.590	17.45	24.00	Pass
100	5500	44.259	16.46	24.00	Pass
116	5580	41.591	16.19	24.00	Pass
140	5700	44.668	16.50	24.00	Pass
144	5720 For U-NII-2C	16.181	12.09	23.41	Pass
144	5720 For U-NII-3	5.559	7.45	30.00	Pass
149	5745	50.582	17.04	30.00	Pass
157	5785	51.168	17.09	30.00	Pass
165	5825	51.050	17.08	30.00	Pass

Note:

For U-NII-2A, U-NII-2C Band:

- $11\text{dBm} + 10\log(24.32) = 24.86\text{ dBm} > 24\text{dBm}$
- $11\text{dBm} + 10\log(23.33) = 24.68\text{ dBm} > 24\text{dBm}$
- $11\text{dBm} + 10\log(22.86) = 24.59\text{ dBm} > 24\text{dBm}$
- $11\text{dBm} + 10\log(24.07) = 24.81\text{ dBm} > 24\text{dBm}$
- $11\text{dBm} + 10\log(22.72) = 24.56\text{ dBm} > 24\text{dBm}$
- $11\text{dBm} + 10\log(24.50) = 24.89\text{ dBm} > 24\text{dBm}$
- $11\text{dBm} + 10\log(5725.00 - 5707.57) = 23.41\text{ dBm} < 24\text{dBm}$ .

For Reference only-Power meter value

The power value was measured by power meter with average sensor

Chan.	Freq. (MHz)	Conducted Power (mW)	Conducted Power (dBm)
144	5720	21.74	13.37

## 802.11n (HT40)

Chan.	Freq. (MHz)	Conducted Power (mW)	Conducted Power (dBm)	Power Limit (dBm)	Pass / Fail
38	5190	47.643	16.78	24.00	Pass
46	5230	55.208	17.42	24.00	Pass
54	5270	54.200	17.34	24.00	Pass
62	5310	39.264	15.94	24.00	Pass
102	5510	34.277	15.35	24.00	Pass
110	5550	42.073	16.24	24.00	Pass
134	5670	42.170	16.25	24.00	Pass
142	5710 For U-NII-2C	33.420	15.24	24.00	Pass
142	5710 For U-NII-3	2.999	4.77	30.00	Pass
151	5755	63.973	18.06	30.00	Pass
159	5795	<b>65.163</b>	18.14	30.00	Pass

## Note:

For U-NII-2A, U-NII-2C Band:

- $11\text{dBm} + 10\log(45.60) = 27.59\text{ dBm} > 24\text{dBm}$
- $11\text{dBm} + 10\log(46.43) = 27.67\text{ dBm} > 24\text{dBm}$
- $11\text{dBm} + 10\log(45.28) = 27.56\text{ dBm} > 24\text{dBm}$
- $11\text{dBm} + 10\log(45.42) = 27.57\text{ dBm} > 24\text{dBm}$
- $11\text{dBm} + 10\log(48.47) = 27.85\text{ dBm} > 24\text{dBm}$
- $11\text{dBm} + 10\log(5725.00 - 5687.14) = 26.78\text{ dBm} > 24\text{dBm}$ .

For Reference only-Power meter value

The power value was measured by power meter with average sensor

Chan.	Freq. (MHz)	Conducted Power (mW)	Conducted Power (dBm)
142	5710	36.419	15.61



## 802.11ac (VHT80)

Chan.	Freq. (MHz)	Conducted Power (mW)	Conducted Power (dBm)	Power Limit (dBm)	Pass / Fail
42	5210	52.240	17.18	24.00	Pass
58	5290	50.816	17.06	24.00	Pass
106	5530	41.115	16.14	24.00	Pass
122	5610	<b>49.431</b>	16.94	24.00	Pass
138	5690 For U-NII-2C	28.576	14.56	24.00	Pass
138	5690 For U-NII-3	0.8184	-0.87	30.00	Pass
155	5775	54.954	17.40	30.00	Pass

## Note:

For U-NII-2A, U-NII-2C Band:

1.  $11\text{dBm} + 10\log(84.80) = 30.28\text{ dBm} > 24\text{dBm}$
2.  $11\text{dBm} + 10\log(84.56) = 30.27\text{ dBm} > 24\text{dBm}$
3.  $11\text{dBm} + 10\log(84.67) = 30.28\text{ dBm} > 24\text{dBm}$
4.  $11\text{dBm} + 10\log(5725.00 - 5647.86) = 29.87\text{ dBm} > 24\text{dBm}$ .

For Reference only-Power meter value

The power value was measured by power meter with average sensor

Chan.	Freq. (MHz)	Conducted Power (mW)	Conducted Power (dBm)
138	5690	29.394	14.68

26dB Bandwidth:  
802.11a

Channel	Frequency (MHz)	26dBc Bandwidth (MHz)
36	5180	22.96
40	5200	22.55
48	5240	22.47
52	5260	22.66
60	5300	23.10
64	5320	22.53
100	5500	22.93
116	5580	22.53
140	5700	25.95
144	5720 For U-NII-2C	16.70

802.11n (HT20)

Channel	Frequency (MHz)	26dBc Bandwidth (MHz)
36	5180	22.64
40	5200	23.32
48	5240	23.06
52	5260	24.32
60	5300	23.33
64	5320	22.86
100	5500	24.07
116	5580	22.72
140	5700	24.50
144	5720 For U-NII-2C	17.43

### 802.11n (HT40)

Channel	Frequency (MHz)	26dBc Bandwidth (MHz)
38	5190	45.63
46	5230	45.19
54	5270	45.60
62	5310	46.43
102	5510	45.28
110	5550	45.42
134	5670	48.47
142	5710 For U-NII-2C	37.86

### 802.11ac (VHT80)

Channel	Frequency (MHz)	26dBc Bandwidth (MHz)
42	5210	84.75
58	5290	84.80
106	5530	84.56
122	5610	84.67
138	5690 For U-NII-2C	77.14

### Spectrum Plot of Worst Value

#### 802.11a

#### 802.11n (HT20)

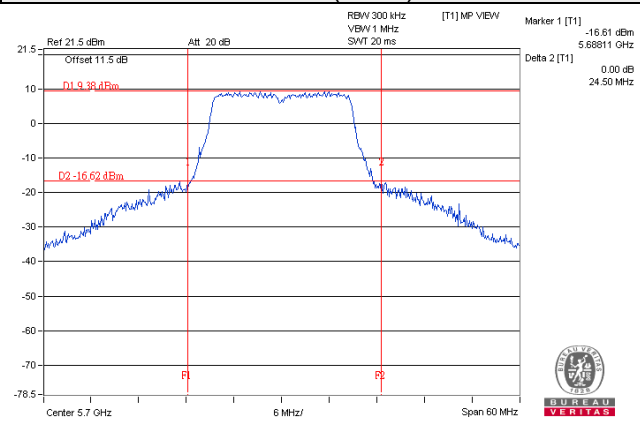
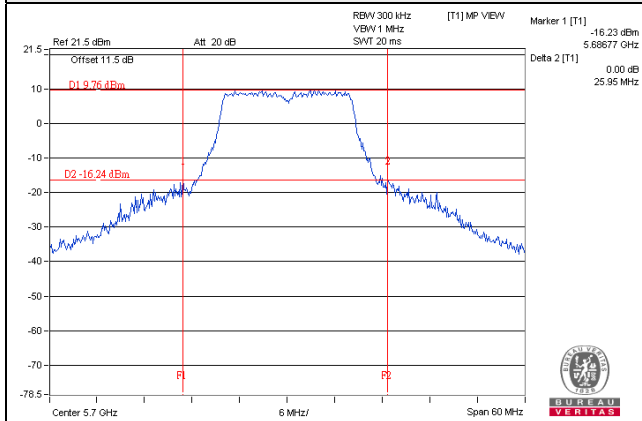

#### 802.11n (HT40)

#### 802.11ac (VHT80)

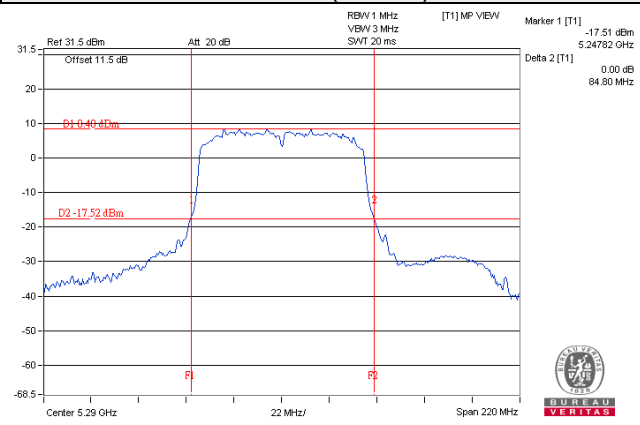
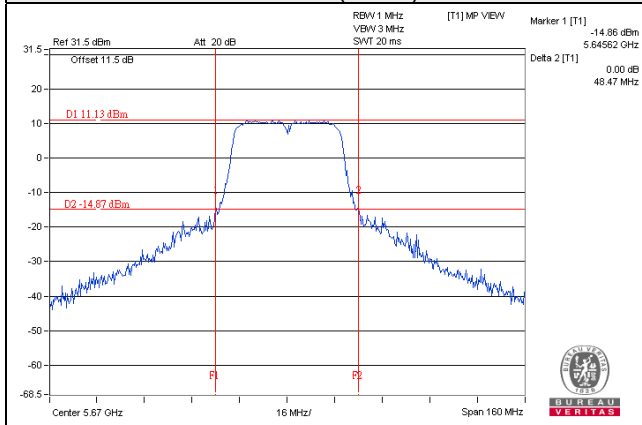

## EUT Maximum Conducted Power

### 802.11a

Frequency Band (MHz)	Max. Power	
	Output Power (mW)	Output Power (dBm)
5250~5350	57.148	17.57
5470~5725	46.881	16.71

Note: Manufacturer provides Transmit Power Control description to meet this requirement.

### 802.11n (HT20)

Frequency Band (MHz)	Max. Power	
	Output Power (mW)	Output Power (dBm)
5250~5350	55.719	17.46
5470~5725	44.668	16.50

Note: Manufacturer provides Transmit Power Control description to meet this requirement.

### 802.11n (HT40)

Frequency Band (MHz)	Max. Power	
	Output Power (mW)	Output Power (dBm)
5250~5350	54.200	17.34
5470~5725	42.170	16.25

Note: Manufacturer provides Transmit Power Control description to meet this requirement.

### 802.11ac (VHT80)

Frequency Band (MHz)	Max. Power	
	Output Power (mW)	Output Power (dBm)
5250~5350	50.816	17.06
5470~5725	49.431	16.94

Note: Manufacturer provides Transmit Power Control description to meet this requirement.

## 4.4 Occupied Bandwidth Measurement

### 4.4.1 Test Setup

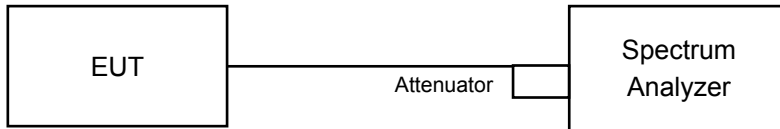

### 4.4.2 Test Instruments

Refer to section 4.1.2 to get information of above instrument.

### 4.4.3 Test Procedure

The transmitter output was connected to the spectrum analyzer through an attenuator. The bandwidth of the fundamental frequency was measured by spectrum analyzer with resolution bandwidth in the range of 1% to 5% of the anticipated emission bandwidth, and a video bandwidth at least 3x the resolution bandwidth and set the detector to sampling. The width of a frequency band such that, below the lower and above the upper frequency limits, the mean powers emitted are each equal to a specified percentage 0.5 %of the total mean power of a given emission.

#### 4.4.4 Test Result

##### 802.11a

Channel	Frequency (MHz)	Occupied Bandwidth (MHz)
36	5180	17.16
40	5200	17.44
48	5240	17.04
52	5260	17.16
60	5300	17.16
64	5320	17.16
100	5500	17.16
116	5580	17.16
140	5700	17.16
144	5720 For U-NII-2C	13.28
144	5720 For U-NII-3	3.28
149	5745	17.16
157	5785	17.28
165	5825	17.16

##### 802.11n (HT20)

Channel	Frequency (MHz)	Occupied Bandwidth (MHz)
36	5180	18.12
40	5200	18.12
48	5240	18.12
52	5260	18.12
60	5300	18.12
64	5320	18.12
100	5500	18.12
116	5580	18.12
140	5700	18.24
144	5720 For U-NII-2C	13.88
144	5720 For U-NII-3	3.88
149	5745	18.24
157	5785	18.24
165	5825	18.24

### 802.11n (HT40)

Channel	Frequency (MHz)	Occupied Bandwidth (MHz)
38	5190	36.60
46	5230	36.72
54	5270	36.60
62	5310	36.72
102	5510	36.60
110	5550	36.72
134	5670	36.84
142	5710 For U-NII-2C	33.36
142	5710 For U-NII-3	3.36
151	5755	36.84
159	5795	36.78

### 802.11ac (VHT80)

Channel	Frequency (MHz)	Occupied Bandwidth (MHz)
42	5210	74.88
58	5290	74.88
106	5530	74.88
122	5610	74.88
138	5690 For U-NII-2C	72.44
138	5690 For U-NII-3	2.44
155	5775	74.88



Spectrum Plot of Worst Value

802.11a

802.11n (HT20)

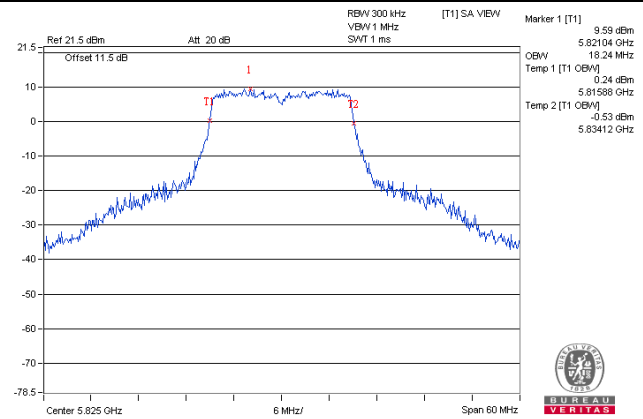
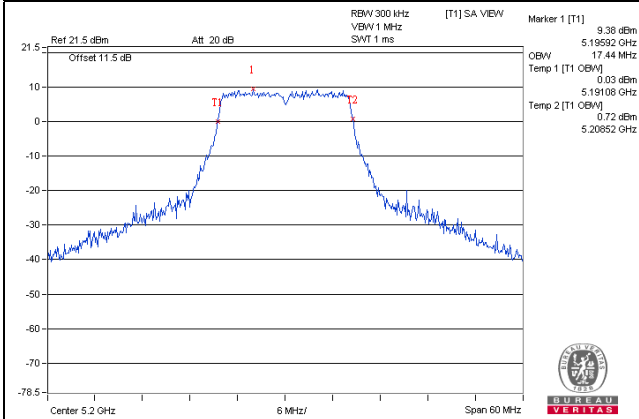

802.11n (HT40)

802.11ac (VHT80)

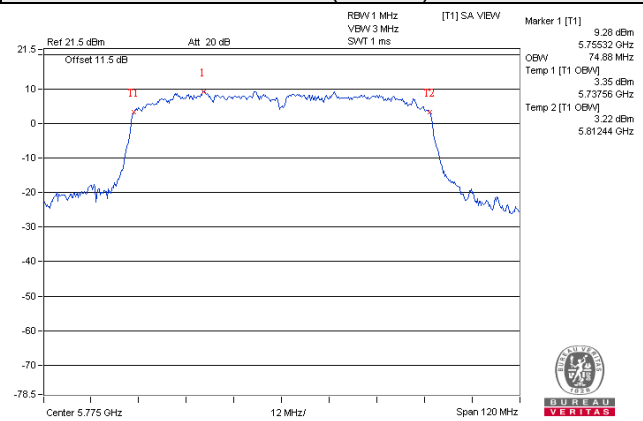
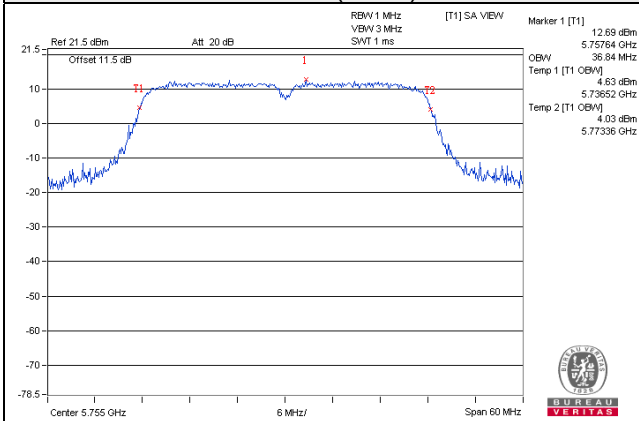

## 4.5 Peak Power Spectral Density Measurement

### 4.5.1 Limits of Peak Power Spectral Density Measurement

Operation Band	EUT Category		LIMIT
U-NII-1		Outdoor Access Point	17dBm/ MHz
		Fixed point-to-point Access Point	
		Indoor Access Point	
	√	Mobile and Portable client device	11dBm/ MHz
U-NII-2A		√	11dBm/ MHz
U-NII-2C		√	11dBm/ MHz
U-NII-3		√	30dBm/ 500kHz

### 4.5.2 Test Setup

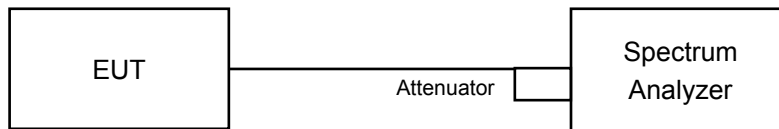

### 4.5.3 Test Instruments

Refer to section 4.1.2 to get information of above instrument.

#### 4.5.4 Test Procedures

##### For U-NII-1, U-NII-2A, U-NII-2C band:

Duty cycle of test signal is  $\geq 98\%$

Using method SA-1

- 1) Set span to encompass the entire emission bandwidth (EBW) of the signal.
- 2) Set RBW = 1MHz, Set VBW  $\geq 3$  MHz, Detector = RMS
- 3) Set Channel power measure = 1MHz
- 4) Sweep time = auto, trigger set to "free run".
- 5) Trace average at least 100 traces in power averaging mode.
- 6) Record the max value

Duty cycle of test signal is  $< 98\%$

Using method SA-2

- 1) Set span to encompass the entire emission bandwidth (EBW) of the signal.
- 2) Set RBW = 1MHz, Set VBW  $\geq 3$  MHz, Detector = RMS
- 3) Set Channel power measure = 1MHz
- 4) Sweep time = auto, trigger set to "free run".
- 5) Trace average at least 100 traces in power averaging mode.
- 6) Record the max value and add  $10 \log (1/\text{duty cycle})$

##### For U-NII-3 band:

Duty cycle of test signal is  $\geq 98\%$

Using method SA-1

- 1) Set span to encompass the entire emission bandwidth (EBW) of the signal.
- 2) Set RBW = 300 kHz, Set VBW  $\geq 1$  MHz, Detector = RMS.
- 3) Use the peak marker function to determine the maximum power level in any 300 kHz band segment within the fundamental EBW.
- 4) Scale the observed power level to an equivalent value in 500 kHz by adjusting (reducing) the measured power by a bandwidth correction factor (BWCF) where  $BWCF = 10 \log(500 \text{ kHz} / 300 \text{ kHz})$ .
- 5) Sweep time = auto, trigger set to "free run".
- 6) Trace average at least 100 traces in power averaging mode.
- 7) Record the max value.

Duty cycle of test signal is  $< 98\%$

- 1) Set span to encompass the entire emission bandwidth (EBW) of the signal.
- 2) Set RBW = 300 kHz, Set VBW  $\geq 1$  MHz, Detector = RMS
- 3) Use the peak marker function to determine the maximum power level in any 300 kHz band segment within the fundamental EBW.
- 4) Scale the observed power level to an equivalent value in 500 kHz by adjusting (reducing) the measured power by a bandwidth correction factor (BWCF) where  $BWCF = 10 \log(500 \text{ kHz}/300 \text{ kHz})$
- 5) Sweep time = auto, trigger set to "free run".
- 6) Trace average at least 100 traces in power averaging mode.
- 7) Record the max value and add  $10 \log (1/\text{duty cycle})$

#### 4.5.5 Deviation from Test Standard

No deviation.

#### 4.5.6 EUT Operating Conditions

Same as 4.3.6.

#### 4.5.7 Test Results

For U-NII-1, U-NII-2A, U-NII-2C band

802.11a

Chan.	Freq. (MHz)	PSD (dBm/MHz)	Max. Limit (dBm/MHz)	Pass / Fail
36	5180	5.20	11	Pass
40	5200	5.29	11	Pass
48	5240	5.20	11	Pass
52	5260	5.17	11	Pass
60	5300	4.69	11	Pass
64	5320	5.07	11	Pass
100	5500	4.86	11	Pass
116	5580	5.17	11	Pass
140	5700	5.09	11	Pass
144	5720 For U-NII-2C	5.07	11	Pass

802.11n (HT20)

Chan.	Freq. (MHz)	PSD (dBm/MHz)	Max. Limit (dBm/MHz)	Pass / Fail
36	5180	4.99	11	Pass
40	5200	4.59	11	Pass
48	5240	4.53	11	Pass
52	5260	4.77	11	Pass
60	5300	4.76	11	Pass
64	5320	4.39	11	Pass
100	5500	4.68	11	Pass
116	5580	4.53	11	Pass
140	5700	4.80	11	Pass
144	5720 For U-NII-2C	4.79	11	Pass

## 802.11n (HT40)

Chan.	Freq. (MHz)	PSD (dBm/MHz)	Max. Limit (dBm/MHz)	Pass / Fail
38	5190	0.60	11	Pass
46	5230	0.56	11	Pass
54	5270	0.81	11	Pass
62	5310	0.40	11	Pass
102	5510	-0.16	11	Pass
110	5550	0.80	11	Pass
134	5670	0.85	11	Pass
142	5710 For U-NII-2C	0.86	11	Pass

## 802.11ac (VHT80)

Chan.	Freq. (MHz)	PSD without Duty Factor (dBm/MHz)	Duty Factor	PSD with Duty Factor (dBm/MHz)	Max. Limit (dBm/MHz)	Pass / Fail
42	5210	-1.71	0.19	-1.52	11	Pass
58	5290	-1.77	0.19	-1.58	11	Pass
106	5530	-1.56	0.19	-1.37	11	Pass
122	5610	-1.33	0.19	-1.14	11	Pass
138	5690 For U-NII-2C	-1.42	0.19	-1.23	11	Pass

### Spectrum Plot of Worst Value

802.11a / CH 40

802.11n (HT20) / CH 36

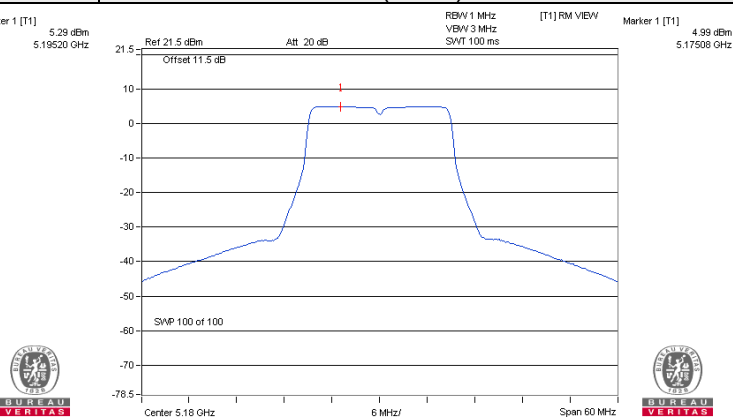
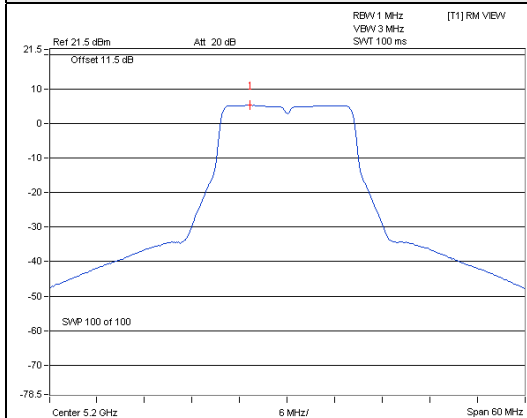

802.11n (HT40) / CH 142

802.11ac (VHT80) / CH 122

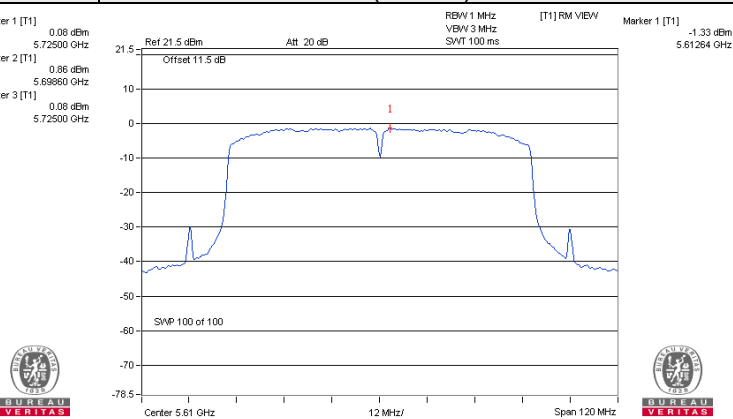
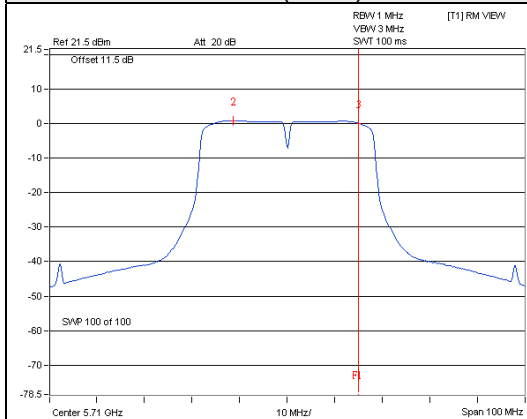

For U-NII-3 band:  
802.11a

Chan.	Freq. (MHz)	PSD		Limit (dBm/500kHz)	Pass / Fail
		(dBm/300kHz)	(dBm/500kHz)		
144	5720 For U-NII-3	-3.36	-1.14	30.00	Pass
149	5745	-3.09	-0.87	30.00	Pass
157	5785	-2.82	-0.60	30.00	Pass
165	5825	-2.66	-0.44	30.00	Pass

802.11n (HT20)

Chan.	Freq. (MHz)	PSD		Limit (dBm/500kHz)	Pass / Fail
		(dBm/300kHz)	(dBm/500kHz)		
144	5720 For U-NII-3	-3.58	-1.36	30.00	Pass
149	5745	-3.13	-0.91	30.00	Pass
157	5785	-3.12	-0.90	30.00	Pass
165	5825	-3.04	-0.82	30.00	Pass

802.11n (HT40)

Chan.	Freq. (MHz)	PSD		Limit (dBm/500kHz)	Pass / Fail
		(dBm/300kHz)	(dBm/500kHz)		
142	5710 For U-NII-3	-8.80	-6.58	30.00	Pass
151	5755	-6.43	-4.21	30.00	Pass
159	5795	-6.39	-4.17	30.00	Pass

### 802.11ac (VHT80)

Chan.	Freq. (MHz)	PSD		Duty factor	Total PSD (dBm /500kHz)	Limit (dBm /500kHz)	Pass / Fail
		(dBm/300kHz)	(dBm/500kHz)				
138	5690 For U-NII-3	-13.37	-11.15	0.19	-10.97	30.00	Pass
151	5755	-9.30	-7.08	0.19	-6.90	30.00	Pass

### Spectrum Plot of Worst Value

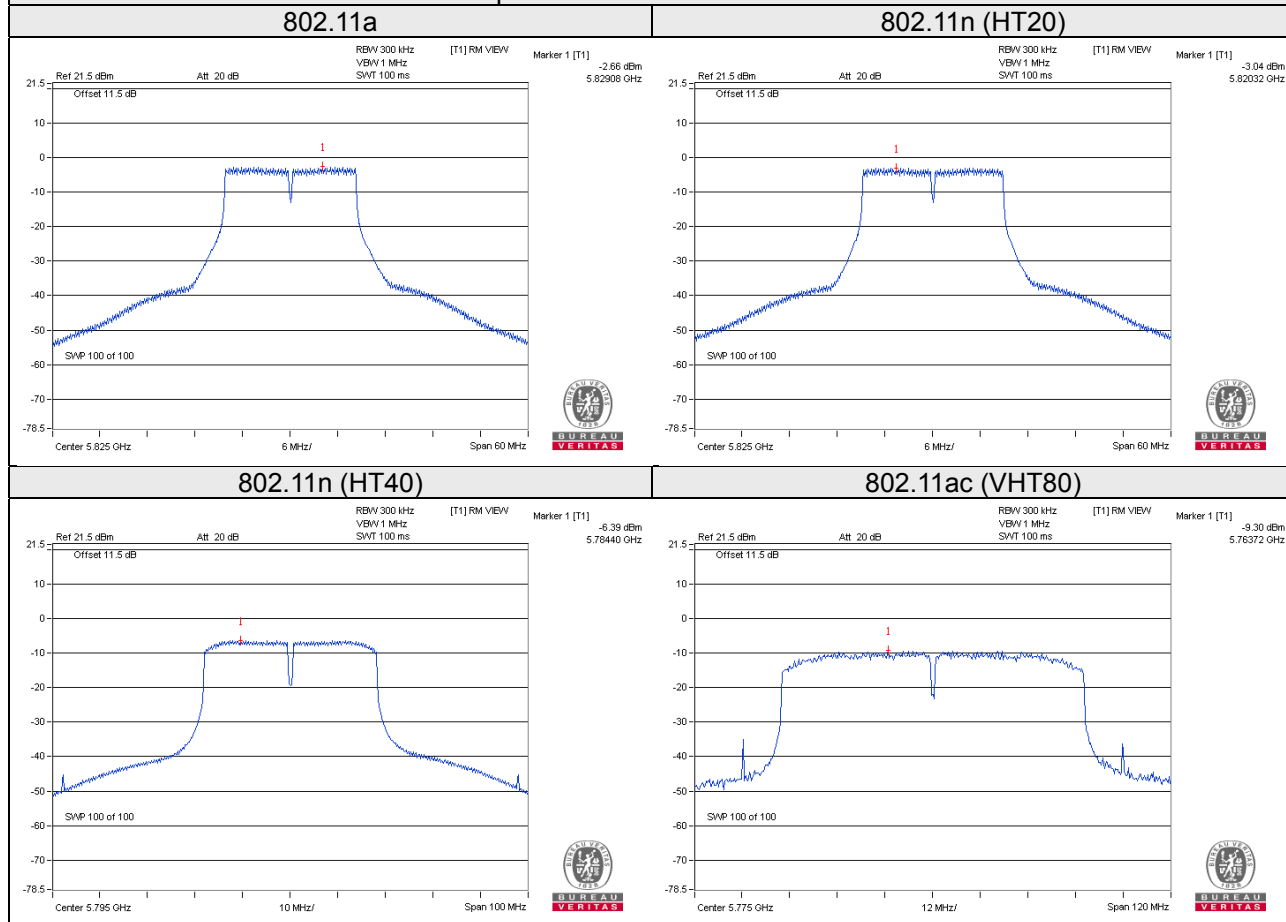



## 4.6 Frequency Stability

### 4.6.1 Limits of Frequency Stability Measurement

The frequency of the carrier signal shall be maintained within band of operation

### 4.6.2 Test Setup

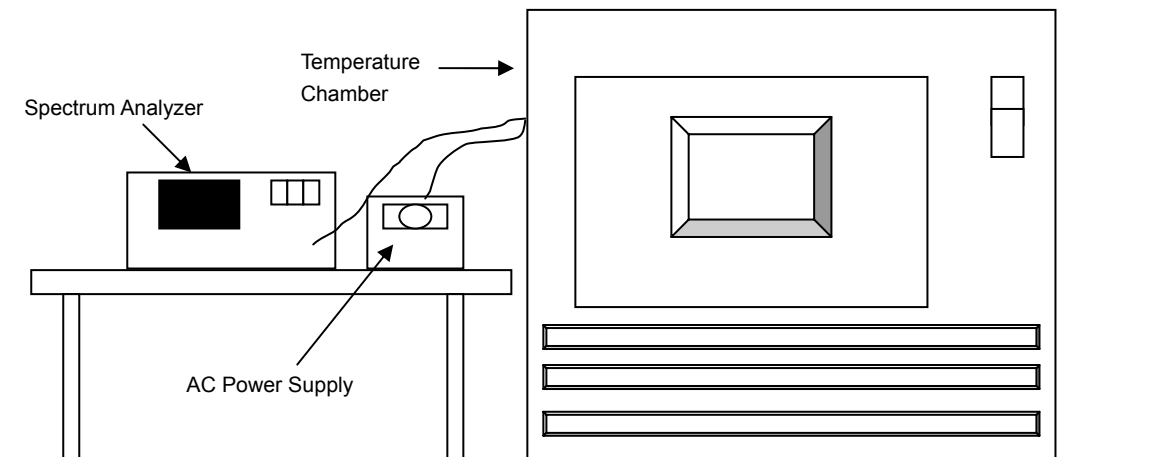

### 4.6.3 Test Instruments

Refer to section 4.1.2 to get information of above instrument.

### 4.6.4 Test Procedure

- The EUT was placed inside the environmental test chamber and powered by nominal AC voltage.
- Turn the EUT on and couple its output to a spectrum analyzer.
- Turn the EUT off and set the chamber to the highest temperature specified.
- Allow sufficient time (approximately 30 min) for the temperature of the chamber to stabilize, turn the EUT on and measure the operating frequency after 2, 5, and 10 minutes.
- Repeat step 2 and 3 with the temperature chamber set to the lowest temperature.
- The test chamber was allowed to stabilize at +20 degree C for a minimum of 30 minutes. The supply voltage was then adjusted on the EUT from 85% to 115% and the frequency record.

### 4.6.5 Deviation from Test Standard

No deviation.

### 4.6.6 EUT Operating Condition

Set the EUT transmit at un-modulation mode to test frequency stability.

#### 4.6.7 Test Results

Frequency Stability Versus Temp.									
Operating Frequency: 5180MHz									
Temp. (°C)	Power Supply (Vac)	0 Minute		2 Minute		5 Minute		10 Minute	
		Measured Frequency (MHz)	Frequency Drift (%)	Measured Frequency (MHz)	Frequency Drift (%)	Measured Frequency (MHz)	Frequency Drift (%)	Measured Frequency (MHz)	Frequency Drift (%)
50	120	5179.9931	-0.00013	5179.9906	-0.00018	5179.9923	-0.00015	5179.9886	-0.00022
40	120	5180.0042	0.00008	5180.0073	0.00014	5180.0085	0.00016	5180.0053	0.00010
30	120	5179.9982	-0.00003	5179.9973	-0.00005	5179.9971	-0.00006	5179.9980	-0.00004
20	120	5180.0158	0.00031	5180.0147	0.00028	5180.0151	0.00029	5180.0159	0.00031
10	120	5179.9780	-0.00042	5179.9778	-0.00043	5179.9803	-0.00038	5179.9775	-0.00043
0	120	5179.9858	-0.00027	5179.9873	-0.00025	5179.9840	-0.00031	5179.9854	-0.00028
-10	120	5179.9725	-0.00053	5179.9762	-0.00046	5179.9737	-0.00051	5179.9728	-0.00053
-20	120	5179.9820	-0.00035	5179.9804	-0.00038	5179.9837	-0.00031	5179.9815	-0.00036
-30	120	5179.9745	-0.00049	5179.9721	-0.00054	5179.9757	-0.00047	5179.9755	-0.00047

Frequency Stability Versus Voltage									
Operating Frequency: 5180MHz									
Temp. (°C)	Power Supply (Vac)	0 Minute		2 Minute		5 Minute		10 Minute	
		Measured Frequency (MHz)	Frequency Drift (%)	Measured Frequency (MHz)	Frequency Drift (%)	Measured Frequency (MHz)	Frequency Drift (%)	Measured Frequency (MHz)	Frequency Drift (%)
20	138	5180.0166	0.00032	5180.0157	0.00030	5180.0154	0.00030	5180.0162	0.00031
	120	5180.0158	0.00031	5180.0147	0.00028	5180.0151	0.00029	5180.0159	0.00031
	102	5180.0162	0.00031	5180.0137	0.00026	5180.0159	0.00031	5180.0166	0.00032

## 4.7 6dB Bandwidth Measurement

### 4.7.1 Limits of 6dB Bandwidth Measurement

The minimum of 6dB Bandwidth Measurement is 0.5MHz.

### 4.7.2 Test Setup

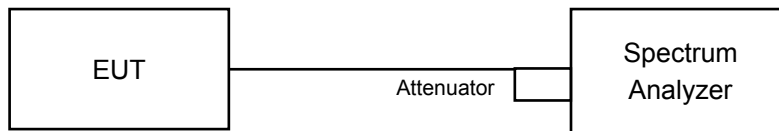

### 4.7.3 Test Instruments

Refer to section 4.1.2 to get information of above instrument.

### 4.7.4 Test Procedure

#### Measurement Procedure REF

- Set resolution bandwidth (RBW) = 100kHz
- Set the video bandwidth (VBW)  $\geq 3 \times$  RBW, Detector = Peak.
- Trace mode = max hold.
- Sweep = auto couple.
- Measure the maximum width of the emission that is constrained by the frequencies associated with the two amplitude points (upper and lower) that are attenuated by 6 dB relative to the maximum level measured in the fundamental emission

### 4.7.5 Deviation from Test Standard

No deviation.

### 4.7.6 EUT Operating Condition

The software provided by client to enable the EUT under transmission condition continuously at lowest, middle and highest channel frequencies individually.

#### 4.7.7 Test Results

##### 802.11a

Channel	Frequency (MHz)	6dB Bandwidth (MHz)	Minimum Limit (MHz)	Pass / Fail
144	5720 For U-NII-3	3.23	0.5	Pass
149	5745	16.44	0.5	Pass
157	5785	16.43	0.5	Pass
165	5825	16.44	0.5	Pass

##### 802.11n (HT20)

Channel	Frequency (MHz)	6dB Bandwidth (MHz)	Minimum Limit (MHz)	Pass / Fail
144	5720 For U-NII-3	3.83	0.5	Pass
149	5745	17.65	0.5	Pass
157	5785	17.65	0.5	Pass
165	5825	17.65	0.5	Pass

##### 802.11n (HT40)

Channel	Frequency (MHz)	6dB Bandwidth (MHz)	Minimum Limit (MHz)	Pass / Fail
142	5710 For U-NII-3	2.66	0.5	Pass
151	5755	35.61	0.5	Pass
159	5795	35.28	0.5	Pass

##### 802.11ac (VHT80)

Channel	Frequency (MHz)	6dB Bandwidth (MHz)	Minimum Limit (MHz)	Pass / Fail
138	5690 For U-NII-3	2.64	0.5	Pass
155	5775	75.29	0.5	Pass

### Spectrum Plot of Worst Value

#### 802.11a

#### 802.11n (HT20)

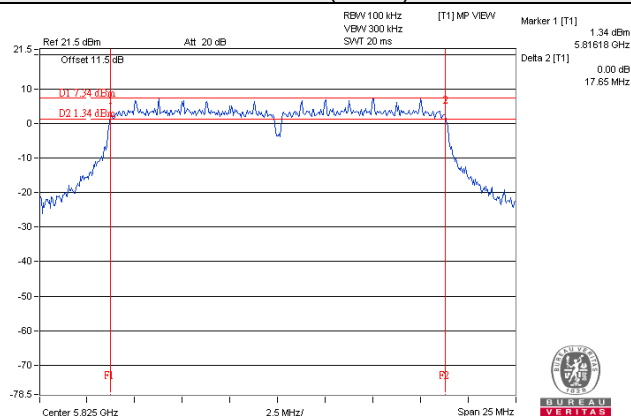
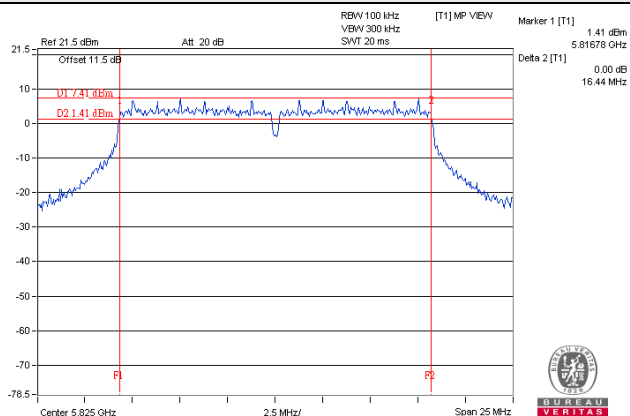

#### 802.11n (HT40)

#### 802.11ac (VHT80)

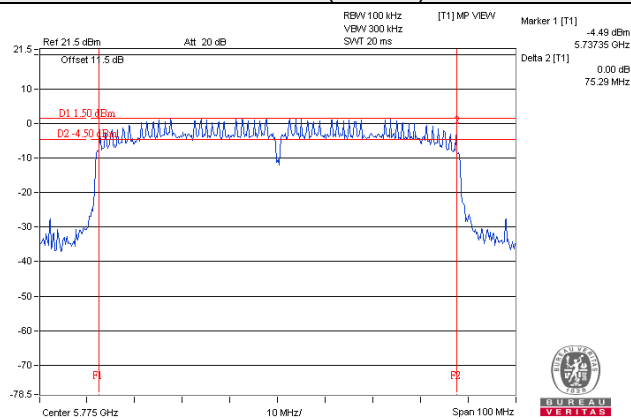
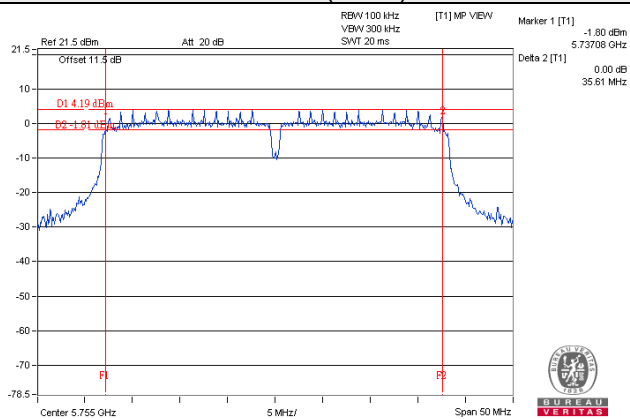

## 5 Pictures of Test Arrangements

Please refer to the attached file (Test Setup Photo).

### Annex A- Radiated Out of Band Emission (OOBE) Measurement (For U-NII-3 band)

802.11a

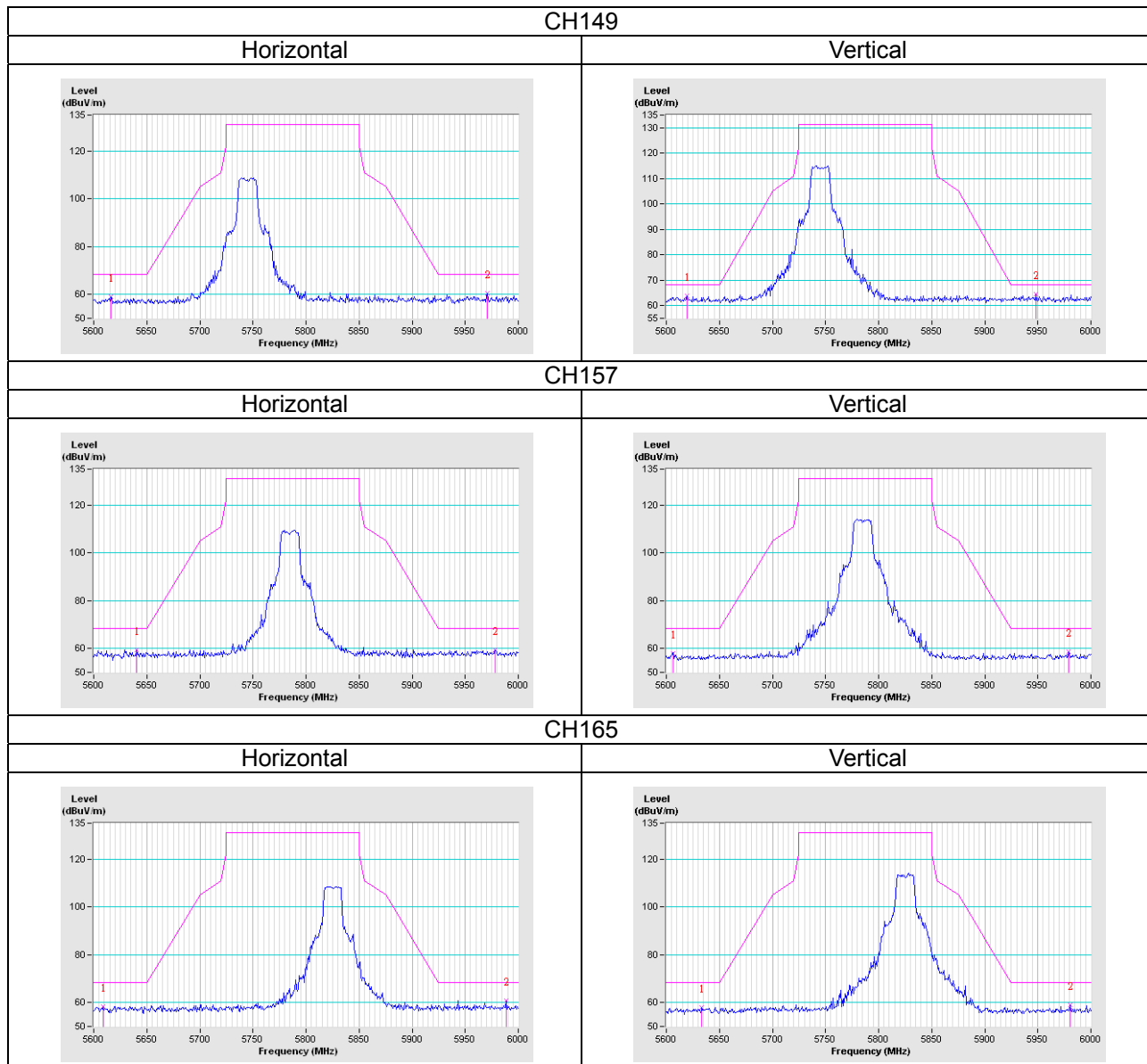

802.11n (HT20)

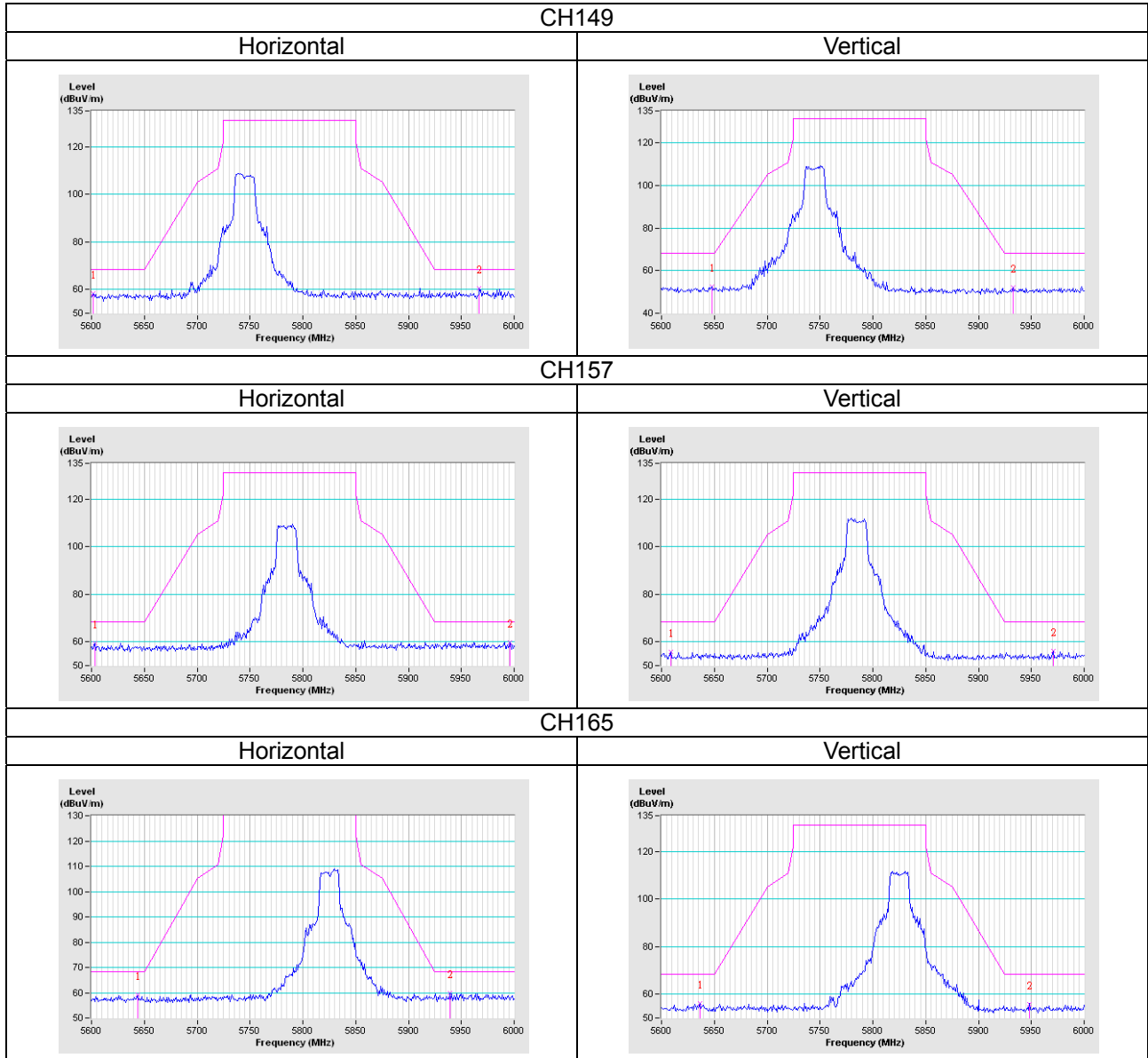



802.11n (HT40)

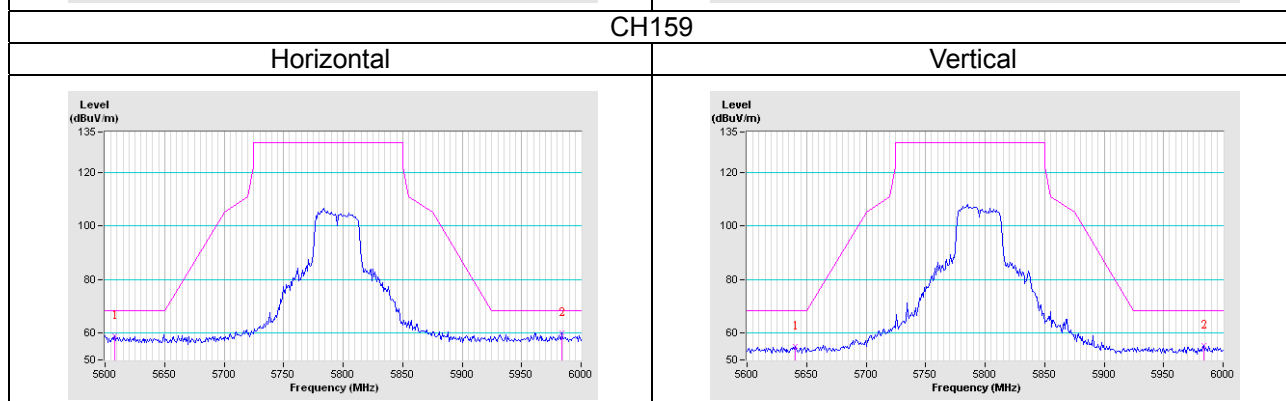
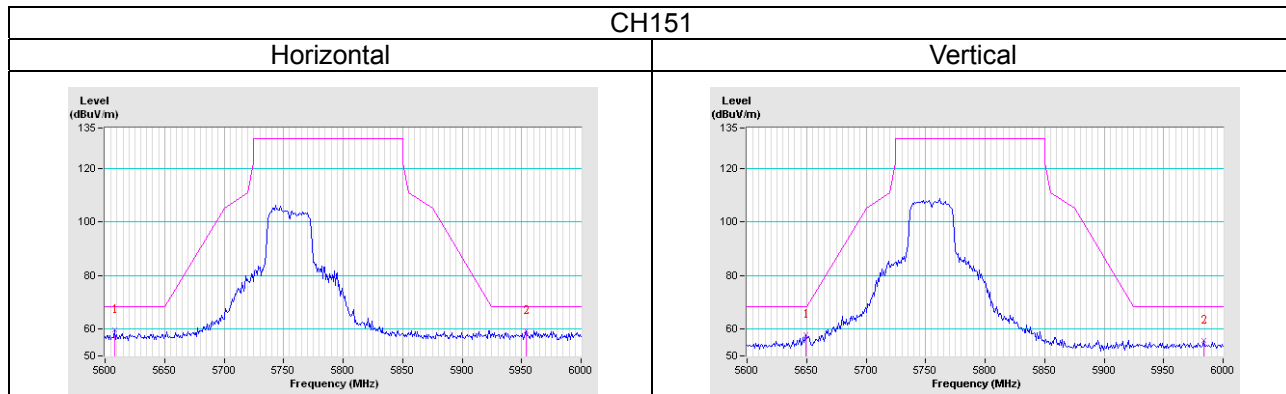

802.11ac (VHT80)

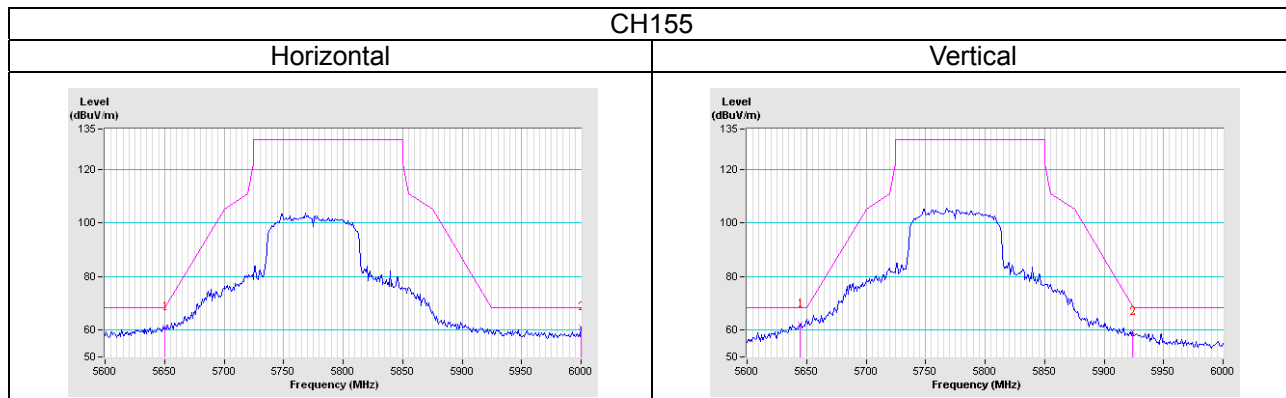

## Appendix – Information on the Testing Laboratories

We, Bureau Veritas Consumer Products Services (H.K.) Ltd., Taoyuan Branch, were founded in 1988 to provide our best service in EMC, Radio, Telecom and Safety consultation. Our laboratories are accredited and approved according to ISO/IEC 17025.

If you have any comments, please feel free to contact us at the following:

**Linko EMC/RF Lab**

Tel: 886-2-26052180

Fax: 886-2-26051924

**Hsin Chu EMC/RF/Telecom Lab**

Tel: 886-3-6668565

Fax: 886-3-6668323

**Hwa Ya EMC/RF/Safety**

Tel: 886-3-3183232

Fax: 886-3-3270892

**Email:** [service.adt@tw.bureauveritas.com](mailto:service.adt@tw.bureauveritas.com)

**Web Site:** [www.bureauveritas-adt.com](http://www.bureauveritas-adt.com)

The address and road map of all our labs can be found in our web site also.

--- END ---