

FCC Test Report

Report No.: RF170421C58-1

FCC ID: UZ7TC200J

Test Model: TC200J

Received Date: Apr. 21, 2017

Test Date: Apr. 25 ~ Jun. 29, 2017

Issued Date: Jul. 04, 2017

Applicant: Zebra Technologies Corporation

Address: 1 Zebra Plaza Holtsville New York United States 11742

Manufacturer: Zebra Technologies Corporation

Address: 1 Zebra Plaza Holtsville New York United States 11742

Issued By: Bureau Veritas Consumer Products Services (H.K.) Ltd., Taoyuan Branch

Lab Address: No. 47-2, 14th Ling, Chia Pau Vil., Lin Kou Dist., New Taipei City, Taiwan (R.O.C.)

Test Location: No. 19, Hwa Ya 2nd Rd., Wen Hwa Vil., Kwei Shan Dist., Taoyuan City 33383, TAIWAN (R.O.C.)



This report is for your exclusive use. Any copying or replication of this report to or for any other person or entity, or use of our name or trademark, is permitted only with our prior written permission. This report sets forth our findings solely with respect to the test samples identified herein. The results set forth in this report are not indicative or representative of the quality or characteristics of the lot from which a test sample was taken or any similar or identical product unless specifically and expressly noted. Our report includes all of the tests requested by you and the results thereof based upon the information that you provided to us. You have 60 days from date of issuance of this report to notify us of any material error or omission caused by our negligence, provided, however, that such notice shall be in writing and shall specifically address the issue you wish to raise. A failure to raise such issue within the prescribed time shall constitute your unqualified acceptance of the completeness of this report, the tests conducted and the correctness of the report contents. Unless specific mention, the uncertainty of measurement has been explicitly taken into account to declare the compliance or non-compliance to the specification. The report must not be used by the client to claim product certification, approval, or endorsement by TAF or any government agencies.

Table of Contents

Release Control Record	4
1 Certificate of Conformity	5
2 Summary of Test Results	6
2.1 Measurement Uncertainty.....	6
2.2 Modification Record.....	6
3 General Information	7
3.1 General Description of EUT.....	7
3.2 Description of Test Modes.....	9
3.2.1 Test Mode Applicability and Tested Channel Detail.....	11
3.3 Duty Cycle of Test Signal.....	13
3.4 Conducted Output Power.....	14
3.5 Description of Support Units.....	17
3.5.1 Configuration of System under Test.....	17
3.6 General Description of Applied Standards.....	17
4 Test Types and Results	18
4.1 Radiated Emission and Bandedge Measurement.....	18
4.1.1 Limits of Radiated Emission and Bandedge Measurement.....	18
4.1.2 Test Instruments.....	19
4.1.3 Test Procedures.....	20
4.1.4 Deviation from Test Standard.....	21
4.1.5 Test Set Up.....	21
4.1.6 EUT Operating Conditions.....	22
4.1.7 Test Results.....	23
4.2 Conducted Emission Measurement.....	68
4.2.1 Limits of Conducted Emission Measurement.....	68
4.2.2 Test Instruments.....	68
4.2.3 Test Procedures.....	69
4.2.4 Deviation from Test Standard.....	69
4.2.5 Test Setup.....	69
4.2.6 EUT Operating Conditions.....	69
4.2.7 Test Results.....	70
4.3 Transmit Power Measurement.....	78
4.3.1 Limits of Transmit Power Measurement.....	78
4.3.2 Test Setup.....	78
4.3.3 Test Instruments.....	79
4.3.4 Test Procedure.....	79
4.3.5 Deviation from Test Standard.....	79
4.3.6 EUT Operating Conditions.....	79
4.3.7 Test Result.....	80
4.4 Occupied Bandwidth Measurement.....	88
4.4.1 Test Setup.....	88
4.4.2 Test Instruments.....	88
4.4.3 Test Procedure.....	88
4.4.4 Test Result.....	89
4.5 Peak Power Spectral Density Measurement.....	92
4.5.1 Limits of Peak Power Spectral Density Measurement.....	92
4.5.2 Test Setup.....	92
4.5.3 Test Instruments.....	92
4.5.4 Test Procedures.....	93
4.5.5 Deviation from Test Standard.....	93
4.5.6 EUT Operating Conditions.....	93
4.5.7 Test Results.....	94
4.6 Frequency Stability.....	99

4.6.1	Limits of Frequency Stability Measurement	99
4.6.2	Test Setup.....	99
4.6.3	Test Instruments	99
4.6.4	Test Procedure	99
4.6.5	Deviation from Test Standard	99
4.6.6	EUT Operating Condition	99
4.6.7	Test Results	100
4.7	6dB Bandwidth Measurement.....	101
4.7.1	Limits of 6dB Bandwidth Measurement.....	101
4.7.2	Test Setup.....	101
4.7.3	Test Instruments	101
4.7.4	Test Procedure	101
4.7.5	Deviation from Test Standard	101
4.7.6	EUT Operating Condition	101
4.7.7	Test Results	102
5	Pictures of Test Arrangements.....	104
	Annex A- Radiated Out of Band Emission (OOBE) Measurement (For U-NII-3 band).....	105
	Appendix – Information on the Testing Laboratories	108

Release Control Record

Issue No.	Description	Date Issued
RF170421C58-1	Original release.	Jul. 04, 2017

1 Certificate of Conformity

Product: Touch Computer

Brand: ZEBRA

Test Model: TC200J

Sample Status: Engineering sample

Applicant: Zebra Technologies Corporation

Test Date: Apr. 25 ~ Jun. 29, 2017

Standards: 47 CFR FCC Part 15, Subpart E (Section 15.407)
ANSI C63.10:2013

The above equipment has been tested by **Bureau Veritas Consumer Products Services (H.K.) Ltd., Taoyuan Branch**, and found compliance with the requirement of the above standards. The test record, data evaluation & Equipment Under Test (EUT) configurations represented herein are true and accurate accounts of the measurements of the sample's EMC characteristics under the conditions specified in this report.

Prepared by :  , **Date:** Jul. 04, 2017
Pettie Chen / Senior Specialist

Approved by :  , **Date:** Jul. 04, 2017
Ken Liu / Senior Manager

2 Summary of Test Results

47 CFR FCC Part 15, Subpart E (Section 15.407)			
FCC Clause	Test Item	Result	Remarks
15.407(b)(6)	AC Power Conducted Emissions	Pass	Meet the requirement of limit. Minimum passing margin is -15.55dB at 0.41400MHz.
15.407(b)(1/2/3/4(i/ii)/6)	Radiated Emissions & Band Edge Measurement	Pass	Meet the requirement of limit. Minimum passing margin is -1.0dB at 5470.00, 5725.00MHz.
15.407(a)(1/2/3)	Max Average Transmit Power	Pass	Meet the requirement of limit.
---	Occupied Bandwidth Measurement	Pass	Meet the requirement of limit.
15.407(a)(1/2/3)	Peak Power Spectral Density	Pass	Meet the requirement of limit. (U-NII-3 Band only)
15.407(e)	6dB bandwidth	Pass	Meet the requirement of limit.
15.407(g)	Frequency Stability	Pass	Meet the requirement of limit.
15.203	Antenna Requirement	Pass	No antenna connector is used.

2.1 Measurement Uncertainty

Where relevant, the following measurement uncertainty levels have been estimated for tests performed on the EUT as specified in CISPR 16-4-2:

Measurement	Frequency	Expanded Uncertainty (k=2) (\pm)
Conducted Emissions at mains ports	150kHz ~ 30MHz	2.94 dB
Radiated Emissions up to 1 GHz	30MHz ~ 200MHz	3.63 dB
	200MHz ~ 1000MHz	3.64 dB
Radiated Emissions above 1 GHz	1GHz ~ 18GHz	2.29 dB
	18GHz ~ 40GHz	2.29 dB

2.2 Modification Record

There were no modifications required for compliance.

3 General Information

3.1 General Description of EUT

Product	Touch Computer
Brand	ZEBRA
Test Model	TC200J
Sample Status	Engineering sample
MFD	28MAR17
HW Version	EV
SW Version	90-04-03-N-00-E1
Power Supply Rating	5.0Vdc from adapter or host equipment 3.85Vdc from battery
Modulation Type	256QAM, 64QAM, 16QAM, QPSK, BPSK
Modulation Technology	OFDM
Transfer Rate	802.11a: 54/48/36/24/18/12/9/6Mbps 802.11n: up to 150Mbps 802.11ac: up to 433.3Mbps
Operating Frequency	5180~5240MHz, 5260~5320MHz, 5500~5720MHz, 5745~5825MHz
Number of Channel	5180~5240MHz: 802.11a, 802.11n (HT20), 802.11ac (VHT20): 4 802.11n (HT40), 802.11ac (VHT40): 2 802.11ac (VHT80): 1 5260~5320MHz: 802.11a, 802.11n (HT20), 802.11ac (VHT20): 4 802.11n (HT40), 802.11ac (VHT40): 2 802.11ac (VHT80): 1 5500~5720MHz: 802.11a, 802.11n (HT20), 802.11ac (VHT20): 12 802.11n (HT40), 802.11ac (VHT40): 6 802.11ac (VHT80): 3 5745~5825MHz: 802.11a, 802.11n (HT20), 802.11ac (VHT20): 5 802.11n (HT40), 802.11ac (VHT40): 2 802.11ac (VHT80): 1
Output Power	5180~5240MHz: 65.013mW 5260~5320MHz: 70.469mW 5500~5700MHz: 49.659mW 5745~5825MHz: 68.077mW
Antenna Type	Refer to Note
Antenna Connector	Refer to Note
Accessory Device	Adapter, Gun Handle, Headset (1.25m non-shielded cable without core), Arm Mount, Holster (Refer to note 6 for more details)
Cable Supplied	1.5m shielded USB Type C to Type A cable without core (Refer to note 6 for more details)

Note:

1. The EUT has three types for sale.

Brand	Model	Difference
ZEBRA	TC200J	Scanner SE4710 with camera, with 2pin
		Scanner SE4710 with camera, with 8pin (option)
		Scanner SE2100 without camera, blank

2. The EUT provides 1 completed transmitter and 1 receiver.

Modulation Mode	TX Function
802.11a	1TX
802.11n (HT20)	1TX
802.11n (HT40)	1TX
802.11ac (VHT20)	1TX
802.11ac (VHT40)	1TX
802.11ac (VHT80)	1TX

* The modulation and bandwidth are similar for 802.11n mode for HT20/HT40 and 802.11ac mode for VHT20/VHT40. After pre-testing, 802.11ac (VHT20/VHT40) power is lower than 802.11n (HT20/HT40), therefore 802.11n (HT20/HT40) is the worst case to representative mode in test report. (Final test mode refer section 3.2.1)

3. The EUT consumes power from the following adapter and battery.

Adapter	
Brand	ZEBRA
Model	SAWA-65-20005A
Input Power	100-240Vac, 0.5A, 50-60Hz
Output Power	5Vdc, 2.5A

Battery	
Brand	ZEBRA
Model	BT-000334
Rate capacity(mAh)	3000mAh
Min capacity(mAh)	2800mAh
Rate Voltage	3.85Vdc

4. The 5GHz & BT EDR or 5GHz & BT LE can transmit simultaneously.

5. The following antennas were provided to the EUT.

Type	Connector	Gain (dBi)	
		2.4GHz	5GHz
PIFA	NA	2.25	4.22

6. Accessory devices of EUT are list as below:

Specification of Accessory		
AC Adapter	Brand Name	ZEBRA
	Model Name	SAWA-65-20005A
USB Type C cable	Brand Name	ZEBRA
	P/N Number	CBL-MPM-USB1-01
Ear Headset	Brand Name	ZEBRA
	Model Name	HDST-25MM-PTVP-01
Headset Adapter Cable	Brand Name	ZEBRA
	Model Name	CBL-TC51-HDST35-01
Gun Handle	Brand Name	ZEBRA
	P/N Number	TRG-TC2X-SNP1-01
Arm Mount	Brand Name	ZEBRA
	P/N Number	SG-TC2X-ARMNT-01
Holster	Brand Name	ZEBRA
	P/N Number	SG-TC2X-HLSTR1-01

3.2 Description of Test Modes

5180~5240MHz:

4 channels are provided for 802.11a, 802.11n (HT20), 802.11ac (VHT20):

Channel	Frequency	Channel	Frequency
36	5180 MHz	44	5220 MHz
40	5200 MHz	48	5240 MHz

2 channels are provided for 802.11n (HT40), 802.11ac (VHT40):

Channel	Frequency	Channel	Frequency
38	5190 MHz	46	5230 MHz

1 channel is provided for 802.11ac (VHT80):

Channel	Frequency
42	5210MHz

5260~5320MHz:

4 channels are provided for 802.11a, 802.11n (HT20), 802.11ac (VHT20):

Channel	Frequency	Channel	Frequency
52	5260 MHz	60	5300 MHz
56	5280 MHz	64	5320 MHz

2 channels are provided for 802.11n (HT40), 802.11ac (VHT40):

Channel	Frequency	Channel	Frequency
54	5270 MHz	62	5310 MHz

1 channel is provided for 802.11ac (VHT80):

Channel	Frequency
58	5290MHz

5500~5720MHz:

12 channels are provided for 802.11a, 802.11n (HT20), 802.11ac (VHT20):

Channel	Frequency	Channel	Frequency
100	5500 MHz	124	5620 MHz
104	5520 MHz	128	5640 MHz
108	5540 MHz	132	5660 MHz
112	5560 MHz	136	5680 MHz
116	5580 MHz	140	5700 MHz
120	5600 MHz	144	5720 MHz

6 channels are provided for 802.11n (HT40), 802.11ac (VHT40):

Channel	Frequency	Channel	Frequency
102	5510 MHz	126	5630 MHz
110	5550 MHz	134	5670 MHz
118	5590 MHz	142	5710 MHz

3 channels are provided for 802.11ac (VHT80):

Channel	Frequency	Channel	Frequency
106	5530 MHz	122	5610 MHz
138	5690 MHz		

5745~5825MHz:

5 channels are provided for 802.11a, 802.11n (HT20), 802.11ac (VHT20):

Channel	Frequency	Channel	Frequency
149	5745MHz	161	5805MHz
153	5765MHz	165	5825MHz
157	5785MHz		

2 channels are provided for 802.11n (HT40), 802.11ac (VHT40):

Channel	Frequency	Channel	Frequency
151	5755MHz	159	5795MHz

1 channel is provided for 802.11ac (VHT80):

Channel	Frequency
155	5775MHz

3.2.1 Test Mode Applicability and Tested Channel Detail

EUT Configure Mode	Applicable to				Description
	RE \geq 1G	RE<1G	PLC	APCM	
A	√	√	√	√	Scanner SE4710 (2pin), EUT with Headset
B	-	√	√	-	Scanner SE4710 (2pin), EUT with Gun Handle
C	-	√	√	-	Scanner SE4710 (8pin), EUT with Headset
D	-	√	√	-	Scanner SE2100 (2pin), EUT with Headset

Where RE \geq 1G: Radiated Emission above 1GHz & Bandedge Measurement
 RE<1G: Radiated Emission below 1GHz
 PLC: Power Line Conducted Emission
 APCM: Antenna Port Conducted Measurement

Note:

1. The EUT had been pre-tested on the positioned of each 3 axis. The worst case was found when positioned on X-plane.
2. "-" means no effect.

Radiated Emission Test (Above 1GHz):

- Pre-Scan has been conducted to determine the worst-case mode from all possible combinations between available modulations, data rates and antenna ports (if EUT with antenna diversity architecture).
- Following channel(s) was (were) selected for the final test as listed below.

EUT Configure Mode	Mode	Frequency Band (MHz)	Available Channel	Tested Channel	Modulation Technology	Data Rate (Mbps)
A	802.11a	5180-5240	36 to 48	36, 40, 48	OFDM	6.0
	802.11n (HT20)		36 to 48	36, 40, 48	OFDM	6.5
	802.11n (HT40)		38 to 46	38, 46	OFDM	13.5
	802.11ac (VHT80)		42	42	OFDM	29.3
A	802.11a	5260-5320	52 to 64	52, 60, 64	OFDM	6.0
	802.11n (HT20)		52 to 64	52, 60, 64	OFDM	6.5
	802.11n (HT40)		54 to 62	54, 62	OFDM	13.5
	802.11ac (VHT80)		58	58	OFDM	29.3
A	802.11a	5500-5720	100 to 144	100, 116, 140, 144	OFDM	6.0
	802.11n (HT20)		100 to 144	100, 116, 140, 144	OFDM	6.5
	802.11n (HT40)		102 to 142	102, 110, 134, 142	OFDM	13.5
	802.11ac (VHT80)		106 to 138	106, 138	OFDM	29.3
A	802.11a	5745-5825	149 to 165	149, 157, 165	OFDM	6.0
	802.11n (HT20)		149 to 165	149, 157, 165	OFDM	6.5
	802.11n (HT40)		151 to 159	151, 159	OFDM	13.5
	802.11ac (VHT80)		155	155	OFDM	29.3

Radiated Emission Test (Below 1GHz):

- Pre-Scan has been conducted to determine the worst-case mode from all possible combinations between available modulations, data rates and antenna ports (if EUT with antenna diversity architecture).
- Following channel(s) was (were) selected for the final test as listed below.

EUT Configure Mode	Mode	Frequency Band (MHz)	Available Channel	Tested Channel	Modulation Technology	Data Rate (Mbps)
A, B, C, D	802.11a	5180-5240	36 to 48	40	OFDM	6.0
		5260-5320	52 to 64		OFDM	6.0
		5500-5720	100 to 144		OFDM	6.0
		5745-5825	149 to 165		OFDM	6.0

Power Line Conducted Emission Test:

- Pre-Scan has been conducted to determine the worst-case mode from all possible combinations between available modulations, data rates and antenna ports (if EUT with antenna diversity architecture).
- Following channel(s) was (were) selected for the final test as listed below.

EUT Configure Mode	Mode	Frequency Band (MHz)	Available Channel	Tested Channel	Modulation Technology	Data Rate (Mbps)
A, B, C, D	802.11a	5180-5240	36 to 48	40	OFDM	6.0
		5260-5320	52 to 64		OFDM	6.0
		5500-5720	100 to 144		OFDM	6.0
		5745-5825	149 to 165		OFDM	6.0

Antenna Port Conducted Measurement:

- This item includes all test value of each mode, but only includes spectrum plot of worst value of each mode.
- Pre-Scan has been conducted to determine the worst-case mode from all possible combinations between available modulations, data rates and antenna ports (if EUT with antenna diversity architecture).
- Following channel(s) was (were) selected for the final test as listed below.

EUT Configure Mode	Mode	Frequency Band (MHz)	Available Channel	Tested Channel	Modulation Technology	Data Rate (Mbps)
A	802.11a	5180-5240	36 to 48	36, 40, 48	OFDM	6.0
	802.11n (HT20)		36 to 48	36, 40, 48	OFDM	6.5
	802.11n (HT40)		38 to 46	38, 46	OFDM	13.5
	802.11ac (VHT80)		42	42	OFDM	29.3
A	802.11a	5260-5320	52 to 64	52, 60, 64	OFDM	6.0
	802.11n (HT20)		52 to 64	52, 60, 64	OFDM	6.5
	802.11n (HT40)		54 to 62	54, 62	OFDM	13.5
	802.11ac (VHT80)		58	58	OFDM	29.3
A	802.11a	5500-5720	100 to 144	100, 116, 140, 144	OFDM	6.0
	802.11n (HT20)		100 to 144	100, 116, 140, 144	OFDM	6.5
	802.11n (HT40)		102 to 142	102, 110, 134, 142	OFDM	13.5
	802.11ac (VHT80)		106 to 138	106, 138	OFDM	29.3
A	802.11a	5745-5825	149 to 165	149, 157, 165	OFDM	6.0
	802.11n (HT20)		149 to 165	149, 157, 165	OFDM	6.5
	802.11n (HT40)		151 to 159	151, 159	OFDM	13.5
	802.11ac (VHT80)		155	155	OFDM	29.3

Test Condition:

Applicable to	Environmental Conditions	Input Power	Tested by
RE \geq 1G	20deg. C, 69%RH	120Vac, 60Hz	Chris Lin
RE<1G	20deg. C, 69%RH	120Vac, 60Hz	Bayu Chen
PLC	25deg. C, 75%RH	120Vac, 60Hz	Chris Lin
APCM	25deg. C, 60%RH	120Vac, 60Hz	Ted Chang

3.3 Duty Cycle of Test Signal

Duty cycle = 100%

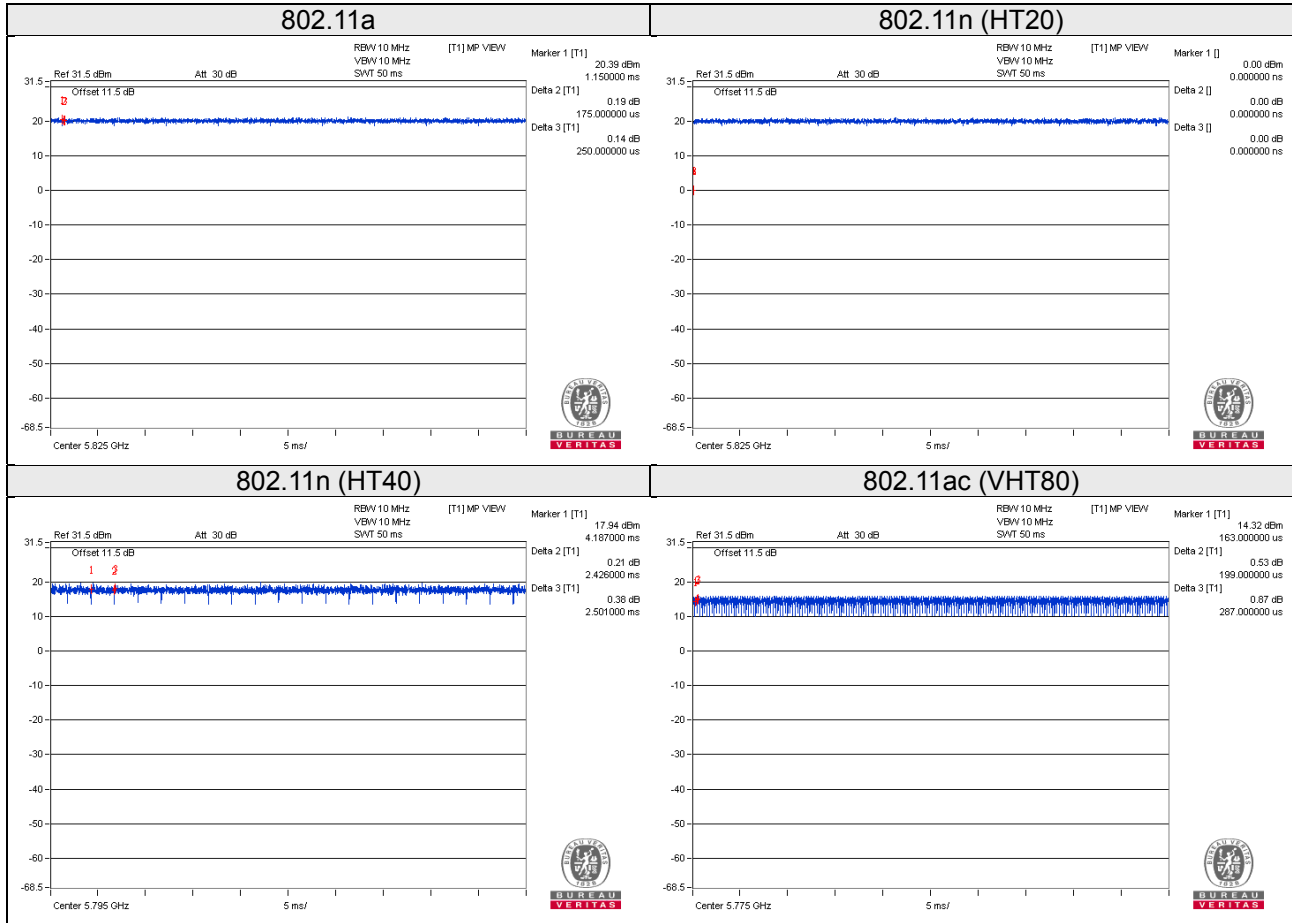

3.4 Conducted Output Power

		802.11a Real Average Power							
		6Mbps	9Mbps	12Mbps	18Mbps	24Mbps	36Mbps	48Mbps	54Mbps
Band 1	Ch36	17.85	-	-	-	-	-	-	-
	Ch40	17.92	17.74	17.7	17.82	17.62	17.77	17.68	17.75
	Ch48	17.83	-	-	-	-	-	-	-
Band 2	Ch52	18.44	-	-	-	-	-	-	-
	Ch60	18.48	18.26	18.24	18.23	18.36	18.35	18.38	18.21
	Ch64	18.41	-	-	-	-	-	-	-
Band 3	Ch100	16.89	-	-	-	-	-	-	-
	Ch116	16.96	16.7	16.71	16.81	16.8	16.75	16.7	16.71
	Ch140	16.9	-	-	-	-	-	-	-
Band 4	Ch144	16.92	-	-	-	-	-	-	-
	Ch149	16.94	-	-	-	-	-	-	-
	Ch157	17.45	-	-	-	-	-	-	-
	Ch165	17.47	17.29	17.32	17.26	17.26	17.28	17.21	17.32

		802.11n(HT20) Real Average Power									
		MCS0	MCS1	MCS2	MCS3	MCS4	MCS5	MCS6	MCS7	MCS8	MCS9
Band 1	Ch36	17.77	-	-	-	-	-	-	-	-	-
	Ch40	17.81	17.62	17.70	17.58	17.63	17.63	17.62	17.70	17.69	17.59
	Ch48	17.75	-	-	-	-	-	-	-	-	-
Band 2	Ch52	17.63	-	-	-	-	-	-	-	-	-
	Ch60	17.74	17.51	17.61	17.45	17.58	17.62	17.60	17.62	17.63	17.47
	Ch64	18.22	-	-	-	-	-	-	-	-	-
Band 3	Ch100	16.75	-	-	-	-	-	-	-	-	-
	Ch116	16.47	-	-	-	-	-	-	-	-	-
	Ch140	16.77	-	-	-	-	-	-	-	-	-
Band 4	Ch144	16.79	16.67	16.62	16.52	16.59	16.58	16.66	16.51	16.51	16.57
	Ch149	17.33	-	-	-	-	-	-	-	-	-
	Ch157	17.36	17.21	17.18	17.15	17.10	17.23	17.17	17.11	17.11	17.24
	Ch165	17.35	-	-	-	-	-	-	-	-	-

		802.11ac (VHT20) Real Average Power									
		MCS0	MCS1	MCS2	MCS3	MCS4	MCS5	MCS6	MCS7	MCS8	MCS9
Band 1	Ch36	17.59	-	-	-	-	-	-	-	-	-
	Ch40	17.75	17.52	17.55	17.49	17.49	17.57	17.56	17.55	17.64	17.4
	Ch48	17.64	-	-	-	-	-	-	-	-	-
Band 2	Ch52	17.44	-	-	-	-	-	-	-	-	-
	Ch60	17.61	17.43	17.49	17.3	17.52	17.44	17.42	17.52	17.52	17.33
	Ch64	18.08	-	-	-	-	-	-	-	-	-
Band 3	Ch100	16.59	-	-	-	-	-	-	-	-	-
	Ch116	16.41	-	-	-	-	-	-	-	-	-
	Ch140	16.65	-	-	-	-	-	-	-	-	-
Band 4	Ch144	16.69	16.49	16.51	16.42	16.41	16.52	16.53	16.44	16.32	16.45
	Ch149	17.19	-	-	-	-	-	-	-	-	-
	Ch157	17.22	17.07	17.04	17.03	16.96	17.14	17.01	17.03	16.93	17.17
	Ch165	17.2	-	-	-	-	-	-	-	-	-

		802.11n(HT40) Real Average Power									
		MCS0	MCS1	MCS2	MCS3	MCS4	MCS5	MCS6	MCS7	MCS8	MCS9
Band 1	Ch38	17.06	-	-	-	-	-	-	-	-	-
	Ch46	18.13	17.95	17.84	17.84	18.00	18.00	17.88	17.89	17.89	17.96
Band 2	Ch54	17.61	17.32	17.34	17.48	17.32	17.37	17.38	17.47	17.46	17.51
	Ch62	16.23	-	-	-	-	-	-	-	-	-
Band 3	Ch102	15.63	-	-	-	-	-	-	-	-	-
	Ch110	16.52	-	-	-	-	-	-	-	-	-
	Ch134	16.54	-	-	-	-	-	-	-	-	-
Band 4	Ch142	16.73	16.50	16.46	16.43	16.49	16.61	16.48	16.50	16.57	16.53
	Ch151	18.23	-	-	-	-	-	-	-	-	-
	Ch159	18.33	18.11	18.06	18.16	18.21	18.08	18.06	18.05	18.10	18.15

		802.11ac (VHT40) Real Average Power									
		MCS0	MCS1	MCS2	MCS3	MCS4	MCS5	MCS6	MCS7	MCS8	MCS9
Band 1	Ch38	16.97	-	-	-	-	-	-	-	-	-
	Ch46	18.04	17.78	17.73	17.68	17.91	17.82	17.70	17.82	17.78	17.89
Band 2	Ch54	17.50	17.27	17.26	17.43	17.20	17.21	17.27	17.38	17.37	17.43
	Ch62	16.11	-	-	-	-	-	-	-	-	-
Band 3	Ch102	15.55	-	-	-	-	-	-	-	-	-
	Ch110	16.39	-	-	-	-	-	-	-	-	-
	Ch134	16.45	-	-	-	-	-	-	-	-	-
Band 4	Ch142	16.57	16.33	16.31	16.32	16.33	16.48	16.35	16.44	16.41	16.42
	Ch151	18.12	-	-	-	-	-	-	-	-	-
	Ch159	18.17	17.96	17.94	18.01	18.06	17.93	17.91	17.95	17.92	17.97

		802.11ac (VHT80) Real Average Power									
		MCS0	MCS1	MCS2	MCS3	MCS4	MCS5	MCS6	MCS7	MCS8	MCS9
Band 1	Ch42	17.46	17.34	17.32	17.28	17.25	17.27	17.36	17.37	17.30	17.23
Band 2	Ch58	17.35	17.18	17.17	17.13	17.16	17.19	17.22	17.19	17.15	17.12
Band 3	Ch106	16.41	-	-	-	-	-	-	-	-	-
	Ch122	17.47	-	-	-	-	-	-	-	-	-
	Ch138	17.62	17.46	17.42	17.34	17.52	17.48	17.44	17.34	17.33	17.48
Band 4	Ch155	18.16	17.87	17.86	18.05	17.99	17.92	18.06	17.92	17.96	17.97

3.5 Description of Support Units

The EUT has been tested as an independent unit together with other necessary accessories or support units.

3.5.1 Configuration of System under Test

Test Mode A, C, D

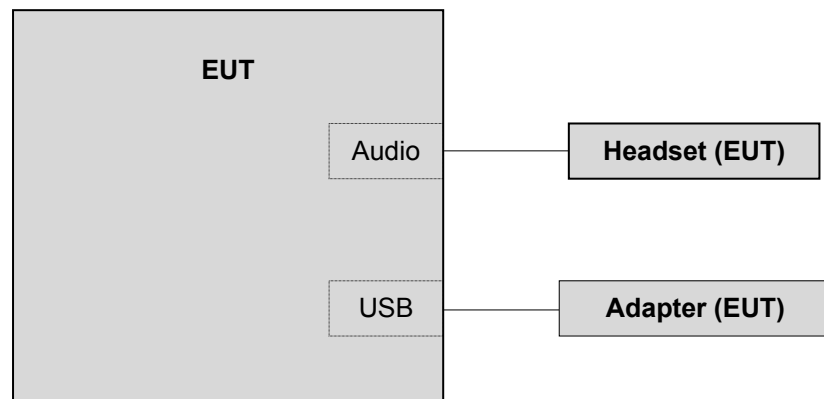

Test Mode B

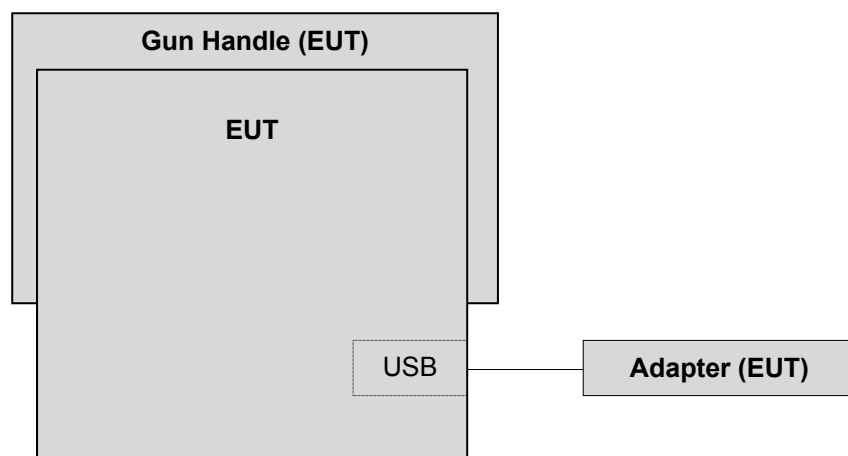

3.6 General Description of Applied Standards

The EUT is a RF Product. According to the specifications of the manufacturer, it must comply with the requirements of the following standards:

FCC Part 15, Subpart E (15.407)

KDB 789033 D02 General UNII Test Procedure New Rules v01r04

KDB 662911 D01 Multiple Transmitter Output v02r01

ANSI C63.10:2013

All test items have been performed and recorded as per the above standards.

Note: The EUT has been verified to comply with the requirements of FCC Part 15, Subpart B, Class B (DoC).
The test report has been issued separately.

4 Test Types and Results

4.1 Radiated Emission and Bandedge Measurement

4.1.1 Limits of Radiated Emission and Bandedge Measurement

Radiated emissions which fall in the restricted bands must comply with the radiated emission limits specified as below table.

Frequencies (MHz)	Field Strength (microvolts/meter)	Measurement Distance (meters)
0.009 ~ 0.490	2400/F(kHz)	300
0.490 ~ 1.705	24000/F(kHz)	30
1.705 ~ 30.0	30	30
30 ~ 88	100	3
88 ~ 216	150	3
216 ~ 960	200	3
Above 960	500	3

NOTE:

- The lower limit shall apply at the transition frequencies.
- Emission level (dBuV/m) = 20 log Emission level (uV/m).
- For frequencies above 1000MHz, the field strength limits are based on average detector, however, the peak field strength of any emission shall not exceed the maximum permitted average limits, specified above by more than 20dB under any condition of modulation.

Limits of unwanted emission out of the restricted bands

Applicable To		Limit	
789033 D02 General UNII Test Procedure New Rules v01r04		Field Strength at 3m	
		PK: 74 (dBµV/m)	AV: 54 (dBµV/m)
Frequency Band	Applicable To	EIRP Limit	Equivalent Field Strength at 3m
5150~5250 MHz	15.407(b)(1)	PK: -27 (dBm/MHz)	PK: 68.2(dBµV/m)
5250~5350 MHz	15.407(b)(2)		
5470~5725 MHz	15.407(b)(3)		
5725~5850 MHz	<input checked="" type="checkbox"/> 15.407(b)(4)(i)	PK: -27 (dBm/MHz) ^{*1} PK: 10 (dBm/MHz) ^{*2} PK: 15.6 (dBm/MHz) ^{*3} PK: 27 (dBm/MHz) ^{*4}	PK: 68.2(dBµV/m) ^{*1} PK: 105.2 (dBµV/m) ^{*2} PK: 110.8(dBµV/m) ^{*3} PK: 122.2 (dBµV/m) ^{*4}
	<input type="checkbox"/> 15.407(b)(4)(ii)	Emission limits in section 15.247(d)	
^{*1} beyond 75 MHz or more above of the band edge.		^{*2} below the band edge increasing linearly to 10 dBm/MHz at 25 MHz above.	
^{*3} below the band edge increasing linearly to a level of 15.6 dBm/MHz at 5 MHz above.		^{*4} from 5 MHz above or below the band edge increasing linearly to a level of 27 dBm/MHz at the band edge.	

Note: The following formula is used to convert the equipment isotropic radiated power (eirp) to field strength:

$$E = \frac{1000000 \sqrt{30P}}{3} \mu\text{V/m, where P is the eirp (Watts).}$$

4.1.2 Test Instruments

Description & Manufacturer	Model No.	Serial No.	Cal. Date	Cal. Due
Test Receiver ROHDE & SCHWARZ	ESCI	100424	Oct. 24, 2016	Oct. 23, 2017
Spectrum Analyzer ROHDE & SCHWARZ	FSP40	100040	Aug. 16, 2016	Aug. 15, 2017
BILOG Antenna SCHWARZBECK	VULB9168	9168-155	Dec. 28, 2016	Dec. 27, 2017
HORN Antenna SCHWARZBECK	BBHA 9120D	9120D-1170	Dec. 15, 2016	Dec. 14, 2017
HORN Antenna SCHWARZBECK	BBHA 9170	BBHA9170241	Dec. 14, 2016	Dec. 13, 2017
Loop Antenna	EM-6879	269	Aug. 11, 2016	Aug. 10, 2017
Preamplifier Agilent	8449B	3008A01960	Aug. 09, 2016	Aug. 08, 2017
Preamplifier Agilent	8447D	2944A10631	Aug. 09, 2016	Aug. 08, 2017
RF signal cable HUBER+SUHNER	SUCOFLEX 104	MY 13380+295012/04	Aug. 09, 2016	Aug. 08, 2017
RF signal cable HUBER+SUHNER	SUCOFLEX 104	Cable-CH4-03 (250724)	Aug. 09, 2016	Aug. 08, 2017
Software BV ADT	ADT_Radiated_ V7.6.15.9.4	NA	NA	NA
Antenna Tower inn-co GmbH	MA 4000	010303	NA	NA
Antenna Tower Controller BV ADT	AT100	AT93021703	NA	NA
Turn Table BV ADT	TT100	TT93021703	NA	NA
Turn Table Controller BV ADT	SC100	SC93021703	NA	NA
High Speed Peak Power Meter	ML2495A	0824012	Aug. 11, 2016	Aug. 10, 2017
Power Sensor	MA2411B	0738171	Aug. 11, 2016	Aug. 10, 2017
26GHz ~ 40GHz Amplifier	EM26400	815221	Oct. 17, 2016	Oct. 16, 2017

- Note:
1. The calibration interval of the above test instruments is 12 months and the calibrations are traceable to NML/ROC and NIST/USA.
 2. The test was performed in HwaYa Chamber 4.
 3. The horn antenna and preamplifier (model: 8449B) are used only for the measurement of emission frequency above 1GHz if tested.
 4. The FCC Site Registration No. is 460141.
 5. The IC Site Registration No. is IC7450F-4.

4.1.3 Test Procedures

For Radiated emission below 30MHz

- a. The EUT was placed on the top of a rotating table 0.8 meters above the ground at a 3 meter chamber room. The table was rotated 360 degrees to determine the position of the highest radiation.
- b. The EUT was set 3 meters away from the interference-receiving antenna, which was mounted on the top of a variable-height antenna tower.
- c. Both X and Y axes of the antenna are set to make the measurement.
- d. For each suspected emission, the EUT was arranged to its worst case and the rotatable table was turned from 0 degrees to 360 degrees to find the maximum reading.
- e. The test-receiver system was set to Quasi-Peak Detect Function and Specified Bandwidth with Maximum Hold Mode.

Note:

1. The resolution bandwidth and video bandwidth of test receiver/spectrum analyzer is 9kHz at frequency below 30MHz.

For Radiated emission above 30MHz

- a. The EUT was placed on the top of a rotating table 0.8 meters (for 30MHz ~ 1GHz) / 1.5 meters (for above 1GHz) above the ground at 3 meter chamber room for test. The table was rotated 360 degrees to determine the position of the highest radiation.
- b. The EUT was set 3 meters away from the interference-receiving antenna, which was mounted on the top of a variable-height antenna tower.
- c. The height of antenna is varied from one meter to four meters above the ground to determine the maximum value of the field strength. Both horizontal and vertical polarizations of the antenna are set to make the measurement.
- d. For each suspected emission, the EUT was arranged to its worst case and then the antenna was tuned to heights from 1 meter to 4 meters and the rotatable table was turned from 0 degrees to 360 degrees to find the maximum reading.
- e. The test-receiver system was set to quasi-peak detect function and specified bandwidth with maximum hold mode when the test frequency is below 1 GHz.
- f. The test-receiver system was set to peak and average detect function and specified bandwidth with maximum hold mode when the test frequency is above 1 GHz. If the peak reading value also meets average limit, measurement with the average detector is unnecessary.

Note:

1. The resolution bandwidth and video bandwidth of test receiver/spectrum analyzer is 120kHz for Quasi-peak detection (QP) at frequency below 1GHz.
2. The resolution bandwidth of test receiver/spectrum analyzer is 1 MHz and the video bandwidth is 3 MHz for Peak detection (PK) at frequency above 1GHz.
3. The resolution bandwidth of test receiver/spectrum analyzer is 1MHz and the video bandwidth is $\geq 1/T$ (Duty cycle < 98%) or 10Hz (Duty cycle $\geq 98\%$) for Average detection (AV) at frequency above 1GHz.
4. All modes of operation were investigated and the worst-case emissions are reported.

4.1.4 Deviation from Test Standard

No deviation.

4.1.5 Test Set Up

For Radiated emission below 30MHz

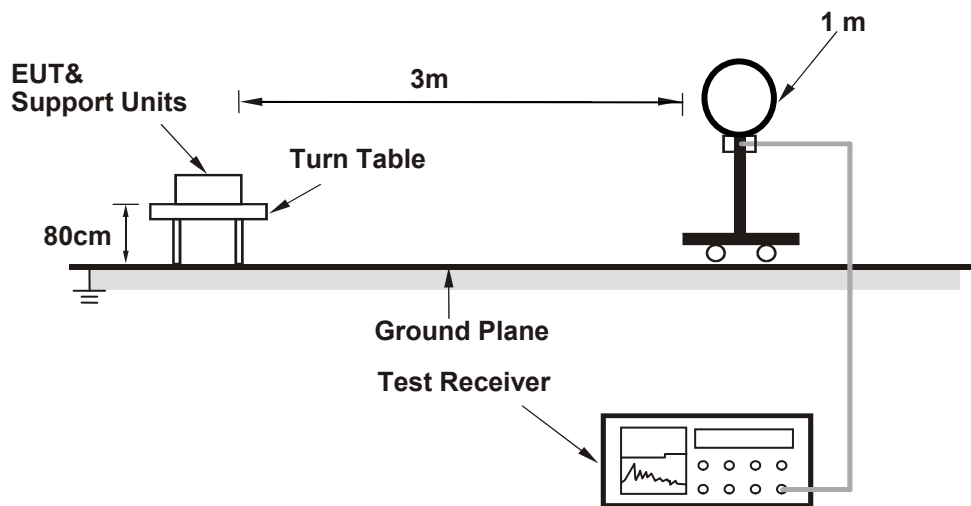

For Radiated emission 30MHz to 1GHz

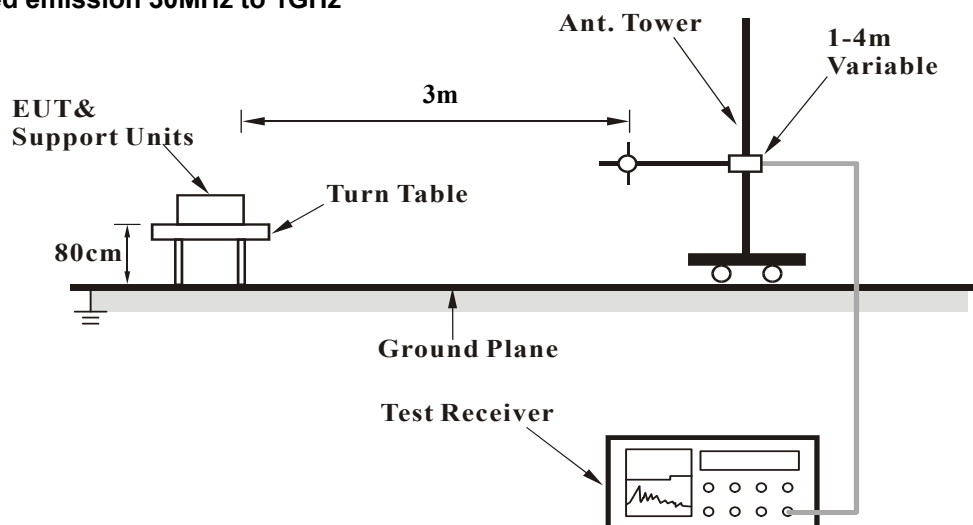

For Radiated emission above 1GHz

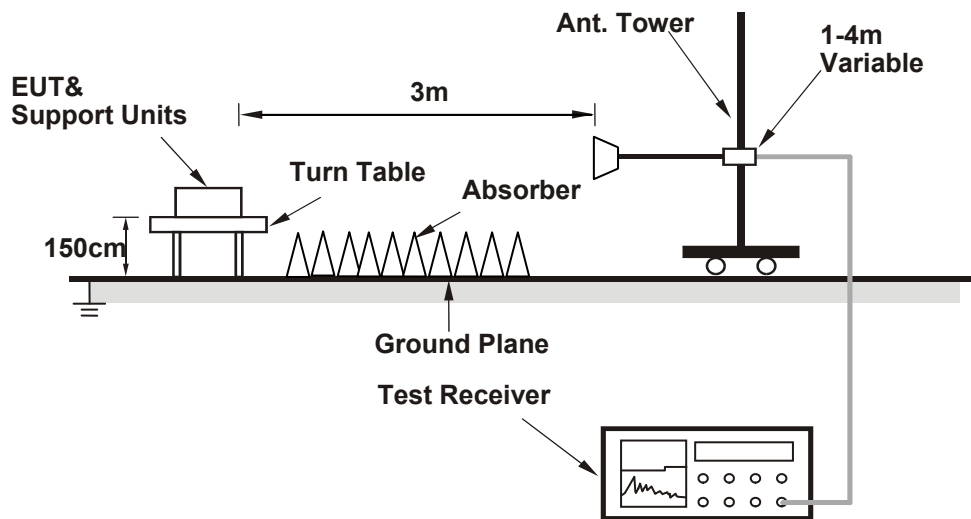

For the actual test configuration, please refer to the attached file (Test Setup Photo).

4.1.6 EUT Operating Conditions

The EUT has been tested as an independent unit together with other necessary accessories or support units.

4.1.7 Test Results

Above 1GHz data:

802.11a

CHANNEL	TX Channel 36	DETECTOR	Peak (PK)
FREQUENCY RANGE	1GHz ~ 40GHz	FUNCTION	Average (AV)

ANTENNA POLARITY & TEST DISTANCE: HORIZONTAL AT 3 M								
NO.	FREQ. (MHz)	EMISSION LEVEL (dBuV/m)	LIMIT (dBuV/m)	MARGIN (dB)	ANTENNA HEIGHT (m)	TABLE ANGLE (Degree)	RAW VALUE (dBuV)	CORRECTION FACTOR (dB/m)
1	5150.00	70.1 PK	74.0	-3.9	1.20 H	215	68.0	2.1
2	5150.00	52.8 AV	54.0	-1.2	1.20 H	215	50.7	2.1
3	*5180.00	112.5 PK			1.20 H	215	73.6	38.9
4	*5180.00	101.7 AV			1.20 H	215	62.8	38.9
5	#10360.00	59.1 PK	74.0	-14.9	1.55 H	224	44.7	14.4
6	#10360.00	46.6 AV	54.0	-7.4	1.55 H	224	32.2	14.4
ANTENNA POLARITY & TEST DISTANCE: VERTICAL AT 3 M								
NO.	FREQ. (MHz)	EMISSION LEVEL (dBuV/m)	LIMIT (dBuV/m)	MARGIN (dB)	ANTENNA HEIGHT (m)	TABLE ANGLE (Degree)	RAW VALUE (dBuV)	CORRECTION FACTOR (dB/m)
1	5150.00	67.2 PK	74.0	-6.8	1.00 V	175	65.1	2.1
2	5150.00	50.9 AV	54.0	-3.1	1.00 V	175	48.8	2.1
3	*5180.00	110.8 PK			1.00 V	175	71.9	38.9
4	*5180.00	100.9 AV			1.00 V	175	62.0	38.9
5	#10360.00	58.1 PK	74.0	-15.9	1.33 V	45	43.7	14.4
6	#10360.00	45.0 AV	54.0	-9.0	1.33 V	45	30.6	14.4

Remarks:

1. Emission Level(dBuV/m) = Raw Value(dBuV) + Correction Factor(dB/m)
2. Correction Factor(dB/m) = Antenna Factor(dB/m) + Cable Factor(dB) – Pre-Amplifier Factor(dB)
3. The other emission levels were very low against the limit.
4. Margin value = Emission Level – Limit value
5. " * ": Fundamental frequency.
6. " # ": The radiated frequency is out of the restricted band.

CHANNEL	TX Channel 40	DETECTOR FUNCTION	Peak (PK)
FREQUENCY RANGE	1GHz ~ 40GHz		Average (AV)

ANTENNA POLARITY & TEST DISTANCE: HORIZONTAL AT 3 M

NO.	FREQ. (MHz)	EMISSION LEVEL (dBuV/m)	LIMIT (dBuV/m)	MARGIN (dB)	ANTENNA HEIGHT (m)	TABLE ANGLE (Degree)	RAW VALUE (dBuV)	CORRECTION FACTOR (dB/m)
1	*5200.00	111.7 PK			1.36 H	216	72.7	39.0
2	*5200.00	101.5 AV			1.36 H	216	62.5	39.0
3	#10400.00	58.9 PK	74.0	-15.1	1.39 H	226	44.3	14.6
4	#10400.00	47.0 AV	54.0	-7.0	1.39 H	226	32.4	14.6

ANTENNA POLARITY & TEST DISTANCE: VERTICAL AT 3 M

NO.	FREQ. (MHz)	EMISSION LEVEL (dBuV/m)	LIMIT (dBuV/m)	MARGIN (dB)	ANTENNA HEIGHT (m)	TABLE ANGLE (Degree)	RAW VALUE (dBuV)	CORRECTION FACTOR (dB/m)
1	*5200.00	110.5 PK			1.00 V	192	71.5	39.0
2	*5200.00	100.7 AV			1.00 V	192	61.7	39.0
3	#10400.00	57.9 PK	74.0	-16.1	1.21 V	11	43.3	14.6
4	#10400.00	45.5 AV	54.0	-8.5	1.21 V	11	30.9	14.6

Remarks:

1. Emission Level(dBuV/m) = Raw Value(dBuV) + Correction Factor(dB/m)
2. Correction Factor(dB/m) = Antenna Factor(dB/m) + Cable Factor(dB) – Pre-Amplifier Factor(dB)
3. The other emission levels were very low against the limit.
4. Margin value = Emission Level – Limit value
5. " * ": Fundamental frequency.
6. " # ": The radiated frequency is out of the restricted band.

CHANNEL	TX Channel 48	DETECTOR FUNCTION	Peak (PK)
FREQUENCY RANGE	1GHz ~ 40GHz		Average (AV)

ANTENNA POLARITY & TEST DISTANCE: HORIZONTAL AT 3 M

NO.	FREQ. (MHz)	EMISSION LEVEL (dBuV/m)	LIMIT (dBuV/m)	MARGIN (dB)	ANTENNA HEIGHT (m)	TABLE ANGLE (Degree)	RAW VALUE (dBuV)	CORRECTION FACTOR (dB/m)
1	*5240.00	112.5 PK			1.53 H	218	73.5	39.0
2	*5240.00	102.3 AV			1.53 H	218	63.3	39.0
3	5350.00	55.5 PK	74.0	-18.5	1.53 H	218	52.9	2.6
4	5350.00	44.3 AV	54.0	-9.7	1.53 H	218	41.7	2.6
5	#10480.00	59.9 PK	74.0	-14.1	1.19 H	245	45.7	14.2
6	#10480.00	46.5 AV	54.0	-7.5	1.19 H	245	32.3	14.2

ANTENNA POLARITY & TEST DISTANCE: VERTICAL AT 3 M

NO.	FREQ. (MHz)	EMISSION LEVEL (dBuV/m)	LIMIT (dBuV/m)	MARGIN (dB)	ANTENNA HEIGHT (m)	TABLE ANGLE (Degree)	RAW VALUE (dBuV)	CORRECTION FACTOR (dB/m)
1	*5240.00	110.6 PK			1.22 V	230	71.6	39.0
2	*5240.00	100.4 AV			1.22 V	230	61.4	39.0
3	5350.00	54.0 PK	74.0	-20.0	1.22 V	230	51.4	2.6
4	5350.00	43.3 AV	54.0	-10.7	1.22 V	230	40.7	2.6
5	#10480.00	58.4 PK	74.0	-15.6	1.73 V	221	44.2	14.2
6	#10480.00	45.0 AV	54.0	-9.0	1.73 V	221	30.8	14.2

Remarks:

1. Emission Level(dBuV/m) = Raw Value(dBuV) + Correction Factor(dB/m)
2. Correction Factor(dB/m) = Antenna Factor(dB/m) + Cable Factor(dB) – Pre-Amplifier Factor(dB)
3. The other emission levels were very low against the limit.
4. Margin value = Emission Level – Limit value
5. " * ": Fundamental frequency.
6. " # ": The radiated frequency is out of the restricted band.

CHANNEL	TX Channel 52	DETECTOR FUNCTION	Peak (PK)
FREQUENCY RANGE	1GHz ~ 40GHz		Average (AV)

ANTENNA POLARITY & TEST DISTANCE: HORIZONTAL AT 3 M

NO.	FREQ. (MHz)	EMISSION LEVEL (dBuV/m)	LIMIT (dBuV/m)	MARGIN (dB)	ANTENNA HEIGHT (m)	TABLE ANGLE (Degree)	RAW VALUE (dBuV)	CORRECTION FACTOR (dB/m)
1	5150.00	57.4 PK	74.0	-16.6	1.22 H	215	55.3	2.1
2	5150.00	44.3 AV	54.0	-9.7	1.22 H	215	42.2	2.1
3	*5260.00	114.2 PK			1.22 H	215	75.2	39.0
4	*5260.00	103.1 AV			1.22 H	215	64.1	39.0
5	#10520.00	59.2 PK	74.0	-14.8	1.28 H	152	45.0	14.2
6	#10520.00	45.9 AV	54.0	-8.1	1.28 H	152	31.7	14.2

ANTENNA POLARITY & TEST DISTANCE: VERTICAL AT 3 M

NO.	FREQ. (MHz)	EMISSION LEVEL (dBuV/m)	LIMIT (dBuV/m)	MARGIN (dB)	ANTENNA HEIGHT (m)	TABLE ANGLE (Degree)	RAW VALUE (dBuV)	CORRECTION FACTOR (dB/m)
1	5150.00	56.2 PK	74.0	-17.8	3.53 V	195	54.1	2.1
2	5150.00	43.3 AV	54.0	-10.7	3.53 V	195	41.2	2.1
3	*5260.00	111.7 PK			3.53 V	195	72.6	39.1
4	*5260.00	101.1 AV			3.53 V	195	62.0	39.1
5	#10520.00	58.8 PK	74.0	-15.2	1.38 V	97	44.6	14.2
6	#10520.00	45.7 AV	54.0	-8.3	1.38 V	97	31.5	14.2

Remarks:

1. Emission Level(dBuV/m) = Raw Value(dBuV) + Correction Factor(dB/m)
2. Correction Factor(dB/m) = Antenna Factor(dB/m) + Cable Factor(dB) – Pre-Amplifier Factor(dB)
3. The other emission levels were very low against the limit.
4. Margin value = Emission Level – Limit value
5. " * ": Fundamental frequency.
6. " # ": The radiated frequency is out of the restricted band.

CHANNEL	TX Channel 60	DETECTOR FUNCTION	Peak (PK)
FREQUENCY RANGE	1GHz ~ 40GHz		Average (AV)

ANTENNA POLARITY & TEST DISTANCE: HORIZONTAL AT 3 M

NO.	FREQ. (MHz)	EMISSION LEVEL (dBuV/m)	LIMIT (dBuV/m)	MARGIN (dB)	ANTENNA HEIGHT (m)	TABLE ANGLE (Degree)	RAW VALUE (dBuV)	CORRECTION FACTOR (dB/m)
1	*5300.00	113.5 PK			1.26 H	218	74.3	39.2
2	*5300.00	102.8 AV			1.26 H	218	63.6	39.2
3	5352.00	65.7 PK	74.0	-8.3	1.26 H	218	63.1	2.6
4	5352.00	49.2 AV	54.0	-4.8	1.26 H	218	46.6	2.6
5	10600.00	60.0 PK	74.0	-14.0	1.25 H	158	45.3	14.7
6	10600.00	46.5 AV	54.0	-7.5	1.25 H	158	31.8	14.7

ANTENNA POLARITY & TEST DISTANCE: VERTICAL AT 3 M

NO.	FREQ. (MHz)	EMISSION LEVEL (dBuV/m)	LIMIT (dBuV/m)	MARGIN (dB)	ANTENNA HEIGHT (m)	TABLE ANGLE (Degree)	RAW VALUE (dBuV)	CORRECTION FACTOR (dB/m)
1	*5300.00	112.0 PK			3.65 V	201	72.8	39.2
2	*5300.00	101.7 AV			3.65 V	201	62.5	39.2
3	5352.00	64.7 PK	74.0	-9.3	3.65 V	201	62.1	2.6
4	5352.00	47.9 AV	54.0	-6.1	3.65 V	201	45.3	2.6
5	10600.00	59.5 PK	74.0	-14.5	1.32 V	100	44.8	14.7
6	10600.00	46.1 AV	54.0	-7.9	1.32 V	100	31.4	14.7

Remarks:

1. Emission Level(dBuV/m) = Raw Value(dBuV) + Correction Factor(dB/m)
2. Correction Factor(dB/m) = Antenna Factor(dB/m) + Cable Factor(dB) – Pre-Amplifier Factor(dB)
3. The other emission levels were very low against the limit.
4. Margin value = Emission Level – Limit value
5. " * ": Fundamental frequency.
6. " # ": The radiated frequency is out of the restricted band.

CHANNEL	TX Channel 64	DETECTOR FUNCTION	Peak (PK)
FREQUENCY RANGE	1GHz ~ 40GHz		Average (AV)

ANTENNA POLARITY & TEST DISTANCE: HORIZONTAL AT 3 M

NO.	FREQ. (MHz)	EMISSION LEVEL (dBuV/m)	LIMIT (dBuV/m)	MARGIN (dB)	ANTENNA HEIGHT (m)	TABLE ANGLE (Degree)	RAW VALUE (dBuV)	CORRECTION FACTOR (dB/m)
1	*5320.00	111.5 PK			1.18 H	215	72.3	39.2
2	*5320.00	100.6 AV			1.18 H	215	61.4	39.2
3	5350.00	71.1 PK	74.0	-2.9	1.18 H	215	68.5	2.6
4	5350.00	52.8 AV	54.0	-1.2	1.18 H	215	50.2	2.6
5	10640.00	60.2 PK	74.0	-13.8	1.30 H	162	45.5	14.7
6	10640.00	46.7 AV	54.0	-7.3	1.30 H	162	32.0	14.7

ANTENNA POLARITY & TEST DISTANCE: VERTICAL AT 3 M

NO.	FREQ. (MHz)	EMISSION LEVEL (dBuV/m)	LIMIT (dBuV/m)	MARGIN (dB)	ANTENNA HEIGHT (m)	TABLE ANGLE (Degree)	RAW VALUE (dBuV)	CORRECTION FACTOR (dB/m)
1	*5320.00	110.4 PK			3.72 V	212	71.2	39.2
2	*5320.00	99.7 AV			3.72 V	212	60.5	39.2
3	5350.00	69.9 PK	74.0	-4.1	3.72 V	212	67.3	2.6
4	5350.00	50.4 AV	54.0	-3.6	3.72 V	212	47.8	2.6
5	10640.00	59.5 PK	74.0	-14.5	1.25 V	83	44.8	14.7
6	10640.00	46.1 AV	54.0	-7.9	1.25 V	83	31.4	14.7

Remarks:

1. Emission Level(dBuV/m) = Raw Value(dBuV) + Correction Factor(dB/m)
2. Correction Factor(dB/m) = Antenna Factor(dB/m) + Cable Factor(dB) – Pre-Amplifier Factor(dB)
3. The other emission levels were very low against the limit.
4. Margin value = Emission Level – Limit value
5. " * ": Fundamental frequency.
6. " # ": The radiated frequency is out of the restricted band.

CHANNEL	TX Channel 100	DETECTOR FUNCTION	Peak (PK)
FREQUENCY RANGE	1GHz ~ 40GHz		Average (AV)

ANTENNA POLARITY & TEST DISTANCE: HORIZONTAL AT 3 M

NO.	FREQ. (MHz)	EMISSION LEVEL (dBuV/m)	LIMIT (dBuV/m)	MARGIN (dB)	ANTENNA HEIGHT (m)	TABLE ANGLE (Degree)	RAW VALUE (dBuV)	CORRECTION FACTOR (dB/m)
1	5460.00	63.1 PK	74.0	-10.9	1.77 H	216	60.4	2.7
2	5460.00	46.5 AV	54.0	-7.5	1.77 H	216	43.8	2.7
3	#5470.00	71.4 PK	74.0	-2.6	1.77 H	216	68.7	2.7
4	#5470.00	52.5 AV	54.0	-1.5	1.77 H	216	49.8	2.7
5	*5500.00	111.2 PK			1.77 H	216	71.7	39.5
6	*5500.00	100.7 AV			1.77 H	216	61.2	39.5
7	11000.00	60.6 PK	74.0	-13.4	2.24 H	236	44.5	16.1
8	11000.00	47.9 AV	54.0	-6.1	2.24 H	236	31.8	16.1

ANTENNA POLARITY & TEST DISTANCE: VERTICAL AT 3 M

NO.	FREQ. (MHz)	EMISSION LEVEL (dBuV/m)	LIMIT (dBuV/m)	MARGIN (dB)	ANTENNA HEIGHT (m)	TABLE ANGLE (Degree)	RAW VALUE (dBuV)	CORRECTION FACTOR (dB/m)
1	5460.00	63.3 PK	74.0	-10.7	1.02 V	173	60.6	2.7
2	5460.00	46.4 AV	54.0	-7.6	1.02 V	173	43.7	2.7
3	#5470.00	68.6 PK	74.0	-5.4	1.02 V	173	65.9	2.7
4	#5470.00	51.9 AV	54.0	-2.1	1.02 V	173	49.2	2.7
5	*5500.00	109.5 PK			1.02 V	173	70.0	39.5
6	*5500.00	99.5 AV			1.02 V	173	60.0	39.5
7	11000.00	59.3 PK	74.0	-14.7	1.32 V	225	43.2	16.1
8	11000.00	46.5 AV	54.0	-7.5	1.32 V	225	30.4	16.1

Remarks:

1. Emission Level(dBuV/m) = Raw Value(dBuV) + Correction Factor(dB/m)
2. Correction Factor(dB/m) = Antenna Factor(dB/m) + Cable Factor(dB) – Pre-Amplifier Factor(dB)
3. The other emission levels were very low against the limit.
4. Margin value = Emission Level – Limit value
5. " * ": Fundamental frequency.
6. " # ": The radiated frequency is out of the restricted band.

CHANNEL	TX Channel 116	DETECTOR	Peak (PK)
FREQUENCY RANGE	1GHz ~ 40GHz	FUNCTION	Average (AV)

ANTENNA POLARITY & TEST DISTANCE: HORIZONTAL AT 3 M

NO.	FREQ. (MHz)	EMISSION LEVEL (dBuV/m)	LIMIT (dBuV/m)	MARGIN (dB)	ANTENNA HEIGHT (m)	TABLE ANGLE (Degree)	RAW VALUE (dBuV)	CORRECTION FACTOR (dB/m)
1	*5580.00	111.5 PK			1.30 H	250	71.8	39.7
2	*5580.00	101.3 AV			1.30 H	250	61.6	39.7
3	11160.00	59.8 PK	74.0	-14.2	1.13 H	242	44.5	15.3
4	11160.00	46.7 AV	54.0	-7.3	1.13 H	242	31.4	15.3

ANTENNA POLARITY & TEST DISTANCE: VERTICAL AT 3 M

NO.	FREQ. (MHz)	EMISSION LEVEL (dBuV/m)	LIMIT (dBuV/m)	MARGIN (dB)	ANTENNA HEIGHT (m)	TABLE ANGLE (Degree)	RAW VALUE (dBuV)	CORRECTION FACTOR (dB/m)
1	*5580.00	109.4 PK			1.05 V	179	69.7	39.7
2	*5580.00	99.2 AV			1.05 V	179	59.5	39.7
3	11160.00	59.1 PK	74.0	-14.9	2.23 V	248	43.8	15.3
4	11160.00	45.9 AV	54.0	-8.1	2.23 V	248	30.6	15.3

Remarks:

1. Emission Level(dBuV/m) = Raw Value(dBuV) + Correction Factor(dB/m)
2. Correction Factor(dB/m) = Antenna Factor(dB/m) + Cable Factor(dB) – Pre-Amplifier Factor(dB)
3. The other emission levels were very low against the limit.
4. Margin value = Emission Level – Limit value
5. " * ": Fundamental frequency.
6. " # ": The radiated frequency is out of the restricted band.

CHANNEL	TX Channel 140	DETECTOR FUNCTION	Peak (PK)
FREQUENCY RANGE	1GHz ~ 40GHz		Average (AV)

ANTENNA POLARITY & TEST DISTANCE: HORIZONTAL AT 3 M

NO.	FREQ. (MHz)	EMISSION LEVEL (dBuV/m)	LIMIT (dBuV/m)	MARGIN (dB)	ANTENNA HEIGHT (m)	TABLE ANGLE (Degree)	RAW VALUE (dBuV)	CORRECTION FACTOR (dB/m)
1	*5700.00	110.4 PK			1.24 H	250	70.5	39.9
2	*5700.00	98.9 AV			1.24 H	250	59.0	39.9
3	#5725.00	71.2 PK	74.0	-2.8	1.24 H	250	68.1	3.1
4	#5725.00	52.7 AV	54.0	-1.3	1.24 H	250	49.6	3.1
5	11400.00	59.6 PK	74.0	-14.4	1.28 H	155	44.3	15.3
6	11400.00	46.8 AV	54.0	-7.2	1.28 H	155	31.5	15.3

ANTENNA POLARITY & TEST DISTANCE: VERTICAL AT 3 M

NO.	FREQ. (MHz)	EMISSION LEVEL (dBuV/m)	LIMIT (dBuV/m)	MARGIN (dB)	ANTENNA HEIGHT (m)	TABLE ANGLE (Degree)	RAW VALUE (dBuV)	CORRECTION FACTOR (dB/m)
1	*5700.00	108.5 PK			1.04 V	177	68.6	39.9
2	*5700.00	98.4 AV			1.04 V	177	58.5	39.9
3	#5725.00	69.7 PK	74.0	-4.3	1.04 V	177	66.6	3.1
4	#5725.00	51.4 AV	54.0	-2.6	1.04 V	177	48.3	3.1
5	11400.00	58.9 PK	74.0	-15.1	2.27 V	185	43.6	15.3
6	11400.00	46.0 AV	54.0	-8.0	2.27 V	185	30.7	15.3

Remarks:

1. Emission Level(dBuV/m) = Raw Value(dBuV) + Correction Factor(dB/m)
2. Correction Factor(dB/m) = Antenna Factor(dB/m) + Cable Factor(dB) – Pre-Amplifier Factor(dB)
3. The other emission levels were very low against the limit.
4. Margin value = Emission Level – Limit value
5. " * ": Fundamental frequency.
6. " # ": The radiated frequency is out of the restricted band.

CHANNEL	TX Channel 144	DETECTOR FUNCTION	Peak (PK)
FREQUENCY RANGE	1GHz ~ 40GHz		Average (AV)

ANTENNA POLARITY & TEST DISTANCE: HORIZONTAL AT 3 M								
NO.	FREQ. (MHz)	EMISSION LEVEL (dBuV/m)	LIMIT (dBuV/m)	MARGIN (dB)	ANTENNA HEIGHT (m)	TABLE ANGLE (Degree)	RAW VALUE (dBuV)	CORRECTION FACTOR (dB/m)
1	5460.00	54.5 PK	74.0	-19.5	1.40 H	215	51.8	2.7
2	5460.00	43.0 AV	54.0	-11.0	1.40 H	215	40.3	2.7
3	#5470.00	55.2 PK	74.0	-18.8	1.40 H	215	52.5	2.7
4	#5470.00	44.1 AV	54.0	-9.9	1.40 H	215	41.4	2.7
5	*5720.00	111.4 PK			1.44 H	215	71.5	39.9
6	*5720.00	101.8 AV			1.44 H	215	61.9	39.9
7	#5850.00	55.9 PK	74.0	-18.1	1.40 H	215	52.7	3.2
8	#5850.00	44.7 AV	54.0	-9.3	1.40 H	215	41.5	3.2
9	11440.00	59.6 PK	74.0	-14.4	1.32 H	59	44.6	15.0
10	11440.00	46.5 AV	54.0	-7.5	1.32 H	59	31.5	15.0

ANTENNA POLARITY & TEST DISTANCE: VERTICAL AT 3 M								
NO.	FREQ. (MHz)	EMISSION LEVEL (dBuV/m)	LIMIT (dBuV/m)	MARGIN (dB)	ANTENNA HEIGHT (m)	TABLE ANGLE (Degree)	RAW VALUE (dBuV)	CORRECTION FACTOR (dB/m)
1	5460.00	52.9 PK	74.0	-21.1	1.10 V	195	50.2	2.7
2	5460.00	42.4 AV	54.0	-11.6	1.10 V	195	39.7	2.7
3	#5470.00	53.0 PK	74.0	-21.0	1.10 V	195	50.3	2.7
4	#5470.00	42.9 AV	54.0	-11.1	1.10 V	195	40.2	2.7
5	*5720.00	110.3 PK			1.10 V	195	70.4	39.9
6	*5720.00	100.1 AV			1.10 V	195	60.2	39.9
7	#5850.00	54.9 PK	74.0	-19.1	1.10 V	195	51.7	3.2
8	#5850.00	43.8 AV	54.0	-10.2	1.10 V	195	40.6	3.2
9	11440.00	58.6 PK	74.0	-15.4	2.12 V	185	43.6	15.0
10	11440.00	45.2 AV	54.0	-8.8	2.12 V	185	30.2	15.0

REMARKS:

1. Emission Level(dBuV/m) = Raw Value(dBuV) + Correction Factor(dB/m)
2. Correction Factor(dB/m) = Antenna Factor(dB/m) + Cable Factor(dB) – Pre-Amplifier Factor(dB)
3. The other emission levels were very low against the limit.
4. Margin value = Emission Level – Limit value
5. " * ": Fundamental frequency.
6. " # ": The radiated frequency is out of the restricted band.

CHANNEL	TX Channel 149	DETECTOR FUNCTION	Peak (PK)
FREQUENCY RANGE	1GHz ~ 40GHz		Average (AV)

ANTENNA POLARITY & TEST DISTANCE: HORIZONTAL AT 3 M

NO.	FREQ. (MHz)	EMISSION LEVEL (dBuV/m)	LIMIT (dBuV/m)	MARGIN (dB)	ANTENNA HEIGHT (m)	TABLE ANGLE (Degree)	RAW VALUE (dBuV)	CORRECTION FACTOR (dB/m)
1	#5628.00	56.3 PK	68.2	-11.9	2.11 H	216	53.4	2.9
2	*5745.00	111.0 PK			2.11 H	216	71.1	39.9
3	*5745.00	100.7 AV			2.11 H	216	60.8	39.9
4	#5934.40	56.8 PK	68.2	-11.4	2.11 H	216	53.6	3.2
5	11490.00	59.5 PK	74.0	-14.5	1.35 H	148	44.9	14.6
6	11490.00	45.7 AV	54.0	-8.3	1.35 H	148	31.1	14.6

ANTENNA POLARITY & TEST DISTANCE: VERTICAL AT 3 M

NO.	FREQ. (MHz)	EMISSION LEVEL (dBuV/m)	LIMIT (dBuV/m)	MARGIN (dB)	ANTENNA HEIGHT (m)	TABLE ANGLE (Degree)	RAW VALUE (dBuV)	CORRECTION FACTOR (dB/m)
1	#5604.00	55.5 PK	68.2	-12.7	3.67 V	178	52.6	2.9
2	*5745.00	111.5 PK			3.67 V	178	71.6	39.9
3	*5745.00	101.3 AV			3.67 V	178	61.4	39.9
4	#5946.40	56.1 PK	68.2	-12.1	3.67 V	178	52.9	3.2
5	11490.00	59.2 PK	74.0	-14.8	1.45 V	84	44.6	14.6
6	11490.00	45.6 AV	54.0	-8.4	1.45 V	84	31.0	14.6

Remarks:

1. Emission Level(dBuV/m) = Raw Value(dBuV) + Correction Factor(dB/m)
2. Correction Factor(dB/m) = Antenna Factor(dB/m) + Cable Factor(dB) – Pre-Amplifier Factor(dB)
3. The other emission levels were very low against the limit.
4. Margin value = Emission Level – Limit value
5. " * ": Fundamental frequency.
6. " # ": The radiated frequency is out of the restricted band.

CHANNEL	TX Channel 157	DETECTOR FUNCTION	Peak (PK)
FREQUENCY RANGE	1GHz ~ 40GHz		Average (AV)

ANTENNA POLARITY & TEST DISTANCE: HORIZONTAL AT 3 M

NO.	FREQ. (MHz)	EMISSION LEVEL (dBuV/m)	LIMIT (dBuV/m)	MARGIN (dB)	ANTENNA HEIGHT (m)	TABLE ANGLE (Degree)	RAW VALUE (dBuV)	CORRECTION FACTOR (dB/m)
1	#5604.00	56.1 PK	68.2	-12.1	1.26 H	246	53.2	2.9
2	*5785.00	110.7 PK			1.26 H	246	70.8	39.9
3	*5785.00	99.6 AV			1.26 H	246	59.7	39.9
4	#5984.00	56.9 PK	68.2	-11.3	1.26 H	246	53.6	3.3
5	11570.00	60.0 PK	74.0	-14.0	1.26 H	159	45.5	14.5
6	11570.00	45.9 AV	54.0	-8.1	1.26 H	159	31.4	14.5

ANTENNA POLARITY & TEST DISTANCE: VERTICAL AT 3 M

NO.	FREQ. (MHz)	EMISSION LEVEL (dBuV/m)	LIMIT (dBuV/m)	MARGIN (dB)	ANTENNA HEIGHT (m)	TABLE ANGLE (Degree)	RAW VALUE (dBuV)	CORRECTION FACTOR (dB/m)
1	#5617.60	55.8 PK	68.2	-12.4	3.81 V	179	52.9	2.9
2	*5785.00	112.2 PK			3.81 V	179	72.3	39.9
3	*5785.00	101.6 AV			3.81 V	179	61.7	39.9
4	#5996.80	56.7 PK	68.2	-11.5	3.81 V	179	53.4	3.3
5	11570.00	59.6 PK	74.0	-14.4	1.53 V	90	45.1	14.5
6	11570.00	45.8 AV	54.0	-8.2	1.53 V	90	31.3	14.5

Remarks:

1. Emission Level(dBuV/m) = Raw Value(dBuV) + Correction Factor(dB/m)
2. Correction Factor(dB/m) = Antenna Factor(dB/m) + Cable Factor(dB) – Pre-Amplifier Factor(dB)
3. The other emission levels were very low against the limit.
4. Margin value = Emission Level – Limit value
5. " * ": Fundamental frequency.
6. " # ": The radiated frequency is out of the restricted band.

CHANNEL	TX Channel 165	DETECTOR FUNCTION	Peak (PK)
FREQUENCY RANGE	1GHz ~ 40GHz		Average (AV)

ANTENNA POLARITY & TEST DISTANCE: HORIZONTAL AT 3 M

NO.	FREQ. (MHz)	EMISSION LEVEL (dBuV/m)	LIMIT (dBuV/m)	MARGIN (dB)	ANTENNA HEIGHT (m)	TABLE ANGLE (Degree)	RAW VALUE (dBuV)	CORRECTION FACTOR (dB/m)
1	#5644.00	55.8 PK	68.2	-12.4	1.27 H	247	52.9	2.9
2	*5825.00	110.5 PK			1.27 H	247	70.5	40.0
3	*5825.00	100.5 AV			1.27 H	247	60.5	40.0
4	#5977.60	56.3 PK	68.2	-11.9	1.27 H	247	53.0	3.3
5	11650.00	60.1 PK	74.0	-13.9	1.36 H	168	45.4	14.7
6	11650.00	47.0 AV	54.0	-7.0	1.36 H	168	32.3	14.7

ANTENNA POLARITY & TEST DISTANCE: VERTICAL AT 3 M

NO.	FREQ. (MHz)	EMISSION LEVEL (dBuV/m)	LIMIT (dBuV/m)	MARGIN (dB)	ANTENNA HEIGHT (m)	TABLE ANGLE (Degree)	RAW VALUE (dBuV)	CORRECTION FACTOR (dB/m)
1	#5640.80	57.3 PK	68.2	-10.9	3.71 V	179	54.4	2.9
2	*5825.00	111.9 PK			3.71 V	179	71.9	40.0
3	*5825.00	100.8 AV			3.71 V	179	60.8	40.0
4	#5979.20	56.3 PK	68.2	-11.9	3.71 V	179	53.0	3.3
5	11650.00	59.9 PK	74.0	-14.1	1.50 V	90	45.2	14.7
6	11650.00	46.9 AV	54.0	-7.1	1.50 V	90	32.2	14.7

Remarks:

1. Emission Level(dBuV/m) = Raw Value(dBuV) + Correction Factor(dB/m)
2. Correction Factor(dB/m) = Antenna Factor(dB/m) + Cable Factor(dB) – Pre-Amplifier Factor(dB)
3. The other emission levels were very low against the limit.
4. Margin value = Emission Level – Limit value
5. " * ": Fundamental frequency.
6. " # ": The radiated frequency is out of the restricted band.

802.11n (HT20)

CHANNEL	TX Channel 36	DETECTOR	Peak (PK)
FREQUENCY RANGE	1GHz ~ 40GHz	FUNCTION	Average (AV)

ANTENNA POLARITY & TEST DISTANCE: HORIZONTAL AT 3 M

NO.	FREQ. (MHz)	EMISSION LEVEL (dBuV/m)	LIMIT (dBuV/m)	MARGIN (dB)	ANTENNA HEIGHT (m)	TABLE ANGLE (Degree)	RAW VALUE (dBuV)	CORRECTION FACTOR (dB/m)
1	5150.00	68.0 PK	74.0	-6.0	1.89 H	216	65.9	2.1
2	5150.00	52.5 AV	54.0	-1.5	1.89 H	216	50.4	2.1
3	*5180.00	109.9 PK			1.89 H	216	71.0	38.9
4	*5180.00	100.0 AV			1.89 H	216	61.1	38.9
5	#10360.00	59.0 PK	74.0	-15.0	2.41 H	145	44.6	14.4
6	#10360.00	46.6 AV	54.0	-7.4	2.41 H	145	32.2	14.4

ANTENNA POLARITY & TEST DISTANCE: VERTICAL AT 3 M

NO.	FREQ. (MHz)	EMISSION LEVEL (dBuV/m)	LIMIT (dBuV/m)	MARGIN (dB)	ANTENNA HEIGHT (m)	TABLE ANGLE (Degree)	RAW VALUE (dBuV)	CORRECTION FACTOR (dB/m)
1	5150.00	65.7 PK	74.0	-8.3	1.06 V	224	63.6	2.1
2	5150.00	49.4 AV	54.0	-4.6	1.06 V	224	47.3	2.1
3	*5180.00	108.5 PK			1.06 V	224	69.6	38.9
4	*5180.00	98.4 AV			1.06 V	224	59.5	38.9
5	#10360.00	58.2 PK	74.0	-15.8	1.75 V	115	43.8	14.4
6	#10360.00	45.2 AV	54.0	-8.8	1.75 V	115	30.8	14.4

Remarks:

1. Emission Level(dBuV/m) = Raw Value(dBuV) + Correction Factor(dB/m)
2. Correction Factor(dB/m) = Antenna Factor(dB/m) + Cable Factor(dB) – Pre-Amplifier Factor(dB)
3. The other emission levels were very low against the limit.
4. Margin value = Emission Level – Limit value
5. " * ": Fundamental frequency.
6. " # ": The radiated frequency is out of the restricted band.

CHANNEL	TX Channel 40	DETECTOR	Peak (PK)
FREQUENCY RANGE	1GHz ~ 40GHz	FUNCTION	Average (AV)

ANTENNA POLARITY & TEST DISTANCE: HORIZONTAL AT 3 M

NO.	FREQ. (MHz)	EMISSION LEVEL (dBuV/m)	LIMIT (dBuV/m)	MARGIN (dB)	ANTENNA HEIGHT (m)	TABLE ANGLE (Degree)	RAW VALUE (dBuV)	CORRECTION FACTOR (dB/m)
1	*5200.00	110.8 PK			1.76 H	200	71.8	39.0
2	*5200.00	100.8 AV			1.76 H	200	61.8	39.0
3	#10400.00	58.9 PK	74.0	-15.1	2.45 H	185	44.3	14.6
4	#10400.00	46.8 AV	54.0	-7.2	2.45 H	185	32.2	14.6

ANTENNA POLARITY & TEST DISTANCE: VERTICAL AT 3 M

NO.	FREQ. (MHz)	EMISSION LEVEL (dBuV/m)	LIMIT (dBuV/m)	MARGIN (dB)	ANTENNA HEIGHT (m)	TABLE ANGLE (Degree)	RAW VALUE (dBuV)	CORRECTION FACTOR (dB/m)
1	*5200.00	108.8 PK			1.04 V	251	69.8	39.0
2	*5200.00	98.6 AV			1.04 V	251	59.6	39.0
3	#10400.00	57.7 PK	74.0	-16.3	1.32 V	144	43.1	14.6
4	#10400.00	45.1 AV	54.0	-8.9	1.32 V	144	30.5	14.6

Remarks:

1. Emission Level(dBuV/m) = Raw Value(dBuV) + Correction Factor(dB/m)
2. Correction Factor(dB/m) = Antenna Factor(dB/m) + Cable Factor(dB) – Pre-Amplifier Factor(dB)
3. The other emission levels were very low against the limit.
4. Margin value = Emission Level – Limit value
5. " * ": Fundamental frequency.
6. " # ": The radiated frequency is out of the restricted band.

CHANNEL	TX Channel 48	DETECTOR FUNCTION	Peak (PK)
FREQUENCY RANGE	1GHz ~ 40GHz		Average (AV)

ANTENNA POLARITY & TEST DISTANCE: HORIZONTAL AT 3 M

NO.	FREQ. (MHz)	EMISSION LEVEL (dBuV/m)	LIMIT (dBuV/m)	MARGIN (dB)	ANTENNA HEIGHT (m)	TABLE ANGLE (Degree)	RAW VALUE (dBuV)	CORRECTION FACTOR (dB/m)
1	*5240.00	111.7 PK			1.56 H	214	72.7	39.0
2	*5240.00	101.5 AV			1.56 H	214	62.5	39.0
3	5350.00	55.3 PK	74.0	-18.7	1.56 H	214	52.7	2.6
4	5350.00	44.5 AV	54.0	-9.5	1.56 H	214	41.9	2.6
5	#10480.00	59.0 PK	74.0	-15.0	1.77 H	165	44.8	14.2
6	#10480.00	46.3 AV	54.0	-7.7	1.77 H	165	32.1	14.2

ANTENNA POLARITY & TEST DISTANCE: VERTICAL AT 3 M

NO.	FREQ. (MHz)	EMISSION LEVEL (dBuV/m)	LIMIT (dBuV/m)	MARGIN (dB)	ANTENNA HEIGHT (m)	TABLE ANGLE (Degree)	RAW VALUE (dBuV)	CORRECTION FACTOR (dB/m)
1	*5240.00	109.6 PK			1.72 V	282	70.6	39.0
2	*5240.00	99.8 AV			1.72 V	282	60.8	39.0
3	5350.00	53.5 PK	74.0	-20.5	1.72 V	282	50.9	2.6
4	5350.00	42.3 AV	54.0	-11.7	1.72 V	282	39.7	2.6
5	#10480.00	57.8 PK	74.0	-16.2	2.25 V	13	43.6	14.2
6	#10480.00	44.8 AV	54.0	-9.2	2.25 V	13	30.6	14.2

Remarks:

1. Emission Level(dBuV/m) = Raw Value(dBuV) + Correction Factor(dB/m)
2. Correction Factor(dB/m) = Antenna Factor(dB/m) + Cable Factor(dB) – Pre-Amplifier Factor(dB)
3. The other emission levels were very low against the limit.
4. Margin value = Emission Level – Limit value
5. " * ": Fundamental frequency.
6. " # ": The radiated frequency is out of the restricted band.

CHANNEL	TX Channel 52	DETECTOR FUNCTION	Peak (PK)
FREQUENCY RANGE	1GHz ~ 40GHz		Average (AV)

ANTENNA POLARITY & TEST DISTANCE: HORIZONTAL AT 3 M

NO.	FREQ. (MHz)	EMISSION LEVEL (dBuV/m)	LIMIT (dBuV/m)	MARGIN (dB)	ANTENNA HEIGHT (m)	TABLE ANGLE (Degree)	RAW VALUE (dBuV)	CORRECTION FACTOR (dB/m)
1	5150.00	56.9 PK	74.0	-17.1	1.24 H	215	54.8	2.1
2	5150.00	44.4 AV	54.0	-9.6	1.24 H	215	42.3	2.1
3	*5260.00	113.3 PK			1.24 H	215	74.2	39.1
4	*5260.00	103.2 AV			1.24 H	215	64.1	39.1
5	#10520.00	59.8 PK	74.0	-14.2	1.22 H	154	45.6	14.2
6	#10520.00	46.1 AV	54.0	-7.9	1.22 H	154	31.9	14.2

ANTENNA POLARITY & TEST DISTANCE: VERTICAL AT 3 M

NO.	FREQ. (MHz)	EMISSION LEVEL (dBuV/m)	LIMIT (dBuV/m)	MARGIN (dB)	ANTENNA HEIGHT (m)	TABLE ANGLE (Degree)	RAW VALUE (dBuV)	CORRECTION FACTOR (dB/m)
1	5150.00	56.0 PK	74.0	-18.0	3.84 V	225	53.9	2.1
2	5150.00	43.9 AV	54.0	-10.1	3.84 V	225	41.8	2.1
3	*5260.00	111.7 PK			3.84 V	225	72.6	39.1
4	*5260.00	101.9 AV			3.84 V	225	62.8	39.1
5	#10520.00	59.3 PK	74.0	-14.7	1.19 V	78	45.1	14.2
6	#10520.00	45.6 AV	54.0	-8.4	1.19 V	78	31.4	14.2

Remarks:

1. Emission Level(dBuV/m) = Raw Value(dBuV) + Correction Factor(dB/m)
2. Correction Factor(dB/m) = Antenna Factor(dB/m) + Cable Factor(dB) – Pre-Amplifier Factor(dB)
3. The other emission levels were very low against the limit.
4. Margin value = Emission Level – Limit value
5. " * ": Fundamental frequency.
6. " # ": The radiated frequency is out of the restricted band.

CHANNEL	TX Channel 60	DETECTOR FUNCTION	Peak (PK)
FREQUENCY RANGE	1GHz ~ 40GHz		Average (AV)

ANTENNA POLARITY & TEST DISTANCE: HORIZONTAL AT 3 M								
NO.	FREQ. (MHz)	EMISSION LEVEL (dBuV/m)	LIMIT (dBuV/m)	MARGIN (dB)	ANTENNA HEIGHT (m)	TABLE ANGLE (Degree)	RAW VALUE (dBuV)	CORRECTION FACTOR (dB/m)
1	*5300.00	112.8 PK			1.17 H	216	73.6	39.2
2	*5300.00	102.4 AV			1.17 H	216	63.2	39.2
3	5352.00	64.4 PK	74.0	-9.6	1.17 H	216	61.8	2.6
4	5352.00	50.1 AV	54.0	-3.9	1.17 H	216	47.5	2.6
5	10600.00	60.5 PK	74.0	-13.5	1.16 H	143	45.8	14.7
6	10600.00	46.7 AV	54.0	-7.3	1.16 H	143	32.0	14.7

ANTENNA POLARITY & TEST DISTANCE: VERTICAL AT 3 M								
NO.	FREQ. (MHz)	EMISSION LEVEL (dBuV/m)	LIMIT (dBuV/m)	MARGIN (dB)	ANTENNA HEIGHT (m)	TABLE ANGLE (Degree)	RAW VALUE (dBuV)	CORRECTION FACTOR (dB/m)
1	*5300.00	110.7 PK			3.78 V	214	71.5	39.2
2	*5300.00	100.7 AV			3.78 V	214	61.5	39.2
3	5352.00	62.5 PK	74.0	-11.5	3.78 V	214	59.9	2.6
4	5352.00	48.9 AV	54.0	-5.1	3.78 V	214	46.3	2.6
5	10600.00	60.2 PK	74.0	-13.8	1.23 V	84	45.5	14.7
6	10600.00	46.1 AV	54.0	-7.9	1.23 V	84	31.4	14.7

Remarks:

1. Emission Level(dBuV/m) = Raw Value(dBuV) + Correction Factor(dB/m)
2. Correction Factor(dB/m) = Antenna Factor(dB/m) + Cable Factor(dB) – Pre-Amplifier Factor(dB)
3. The other emission levels were very low against the limit.
4. Margin value = Emission Level – Limit value
5. " * ": Fundamental frequency.
6. " # ": The radiated frequency is out of the restricted band.

CHANNEL	TX Channel 64	DETECTOR FUNCTION	Peak (PK)
FREQUENCY RANGE	1GHz ~ 40GHz		Average (AV)

ANTENNA POLARITY & TEST DISTANCE: HORIZONTAL AT 3 M

NO.	FREQ. (MHz)	EMISSION LEVEL (dBuV/m)	LIMIT (dBuV/m)	MARGIN (dB)	ANTENNA HEIGHT (m)	TABLE ANGLE (Degree)	RAW VALUE (dBuV)	CORRECTION FACTOR (dB/m)
1	*5320.00	110.7 PK			1.22 H	215	71.5	39.2
2	*5320.00	99.6 AV			1.22 H	215	60.4	39.2
3	5350.00	70.1 PK	74.0	-3.9	1.22 H	215	67.5	2.6
4	5350.00	52.5 AV	54.0	-1.5	1.22 H	215	49.9	2.6
5	10640.00	60.7 PK	74.0	-13.3	1.09 H	154	46.0	14.7
6	10640.00	46.9 AV	54.0	-7.1	1.09 H	154	32.2	14.7

ANTENNA POLARITY & TEST DISTANCE: VERTICAL AT 3 M

NO.	FREQ. (MHz)	EMISSION LEVEL (dBuV/m)	LIMIT (dBuV/m)	MARGIN (dB)	ANTENNA HEIGHT (m)	TABLE ANGLE (Degree)	RAW VALUE (dBuV)	CORRECTION FACTOR (dB/m)
1	*5320.00	108.9 PK			3.84 V	225	69.7	39.2
2	*5320.00	97.8 AV			3.84 V	225	58.6	39.2
3	5350.00	67.6 PK	74.0	-6.4	3.84 V	225	65.0	2.6
4	5350.00	50.1 AV	54.0	-3.9	3.84 V	225	47.5	2.6
5	10640.00	59.9 PK	74.0	-14.1	1.14 V	92	45.2	14.7
6	10640.00	46.1 AV	54.0	-7.9	1.14 V	92	31.4	14.7

Remarks:

1. Emission Level(dBuV/m) = Raw Value(dBuV) + Correction Factor(dB/m)
2. Correction Factor(dB/m) = Antenna Factor(dB/m) + Cable Factor(dB) – Pre-Amplifier Factor(dB)
3. The other emission levels were very low against the limit.
4. Margin value = Emission Level – Limit value
5. " * ": Fundamental frequency.
6. " # ": The radiated frequency is out of the restricted band.

CHANNEL	TX Channel 100	DETECTOR FUNCTION	Peak (PK)
FREQUENCY RANGE	1GHz ~ 40GHz		Average (AV)

ANTENNA POLARITY & TEST DISTANCE: HORIZONTAL AT 3 M

NO.	FREQ. (MHz)	EMISSION LEVEL (dBuV/m)	LIMIT (dBuV/m)	MARGIN (dB)	ANTENNA HEIGHT (m)	TABLE ANGLE (Degree)	RAW VALUE (dBuV)	CORRECTION FACTOR (dB/m)
1	5449.00	64.8 PK	74.0	-9.2	1.19 H	303	62.1	2.7
2	5449.00	49.2 AV	54.0	-4.8	1.19 H	303	46.5	2.7
3	#5470.00	71.2 PK	74.0	-2.8	1.19 H	303	68.5	2.7
4	#5470.00	53.0 AV	54.0	-1.0	1.19 H	303	50.3	2.7
5	*5500.00	112.5 PK			1.19 H	303	73.0	39.5
6	*5500.00	101.8 AV			1.19 H	303	62.3	39.5
7	11000.00	61.9 PK	74.0	-12.1	2.13 H	284	45.8	16.1
8	11000.00	48.2 AV	54.0	-5.8	2.13 H	284	32.1	16.1

ANTENNA POLARITY & TEST DISTANCE: VERTICAL AT 3 M

NO.	FREQ. (MHz)	EMISSION LEVEL (dBuV/m)	LIMIT (dBuV/m)	MARGIN (dB)	ANTENNA HEIGHT (m)	TABLE ANGLE (Degree)	RAW VALUE (dBuV)	CORRECTION FACTOR (dB/m)
1	5449.00	64.0 PK	74.0	-10.0	1.04 V	278	61.3	2.7
2	5449.00	48.4 AV	54.0	-5.6	1.04 V	278	45.7	2.7
3	#5470.00	70.1 PK	74.0	-3.9	1.04 V	278	67.4	2.7
4	#5470.00	51.5 AV	54.0	-2.5	1.04 V	278	48.8	2.7
5	*5500.00	111.0 PK			1.04 V	278	71.5	39.5
6	*5500.00	100.9 AV			1.04 V	278	61.4	39.5
7	11000.00	61.4 PK	74.0	-12.6	1.34 V	206	45.3	16.1
8	11000.00	47.7 AV	54.0	-6.3	1.34 V	206	31.6	16.1

Remarks:

1. Emission Level(dBuV/m) = Raw Value(dBuV) + Correction Factor(dB/m)
2. Correction Factor(dB/m) = Antenna Factor(dB/m) + Cable Factor(dB) – Pre-Amplifier Factor(dB)
3. The other emission levels were very low against the limit.
4. Margin value = Emission Level – Limit value
5. " * ": Fundamental frequency.
6. " # ": The radiated frequency is out of the restricted band.

CHANNEL	TX Channel 116	DETECTOR FUNCTION	Peak (PK)
FREQUENCY RANGE	1GHz ~ 40GHz		Average (AV)

ANTENNA POLARITY & TEST DISTANCE: HORIZONTAL AT 3 M

NO.	FREQ. (MHz)	EMISSION LEVEL (dBuV/m)	LIMIT (dBuV/m)	MARGIN (dB)	ANTENNA HEIGHT (m)	TABLE ANGLE (Degree)	RAW VALUE (dBuV)	CORRECTION FACTOR (dB/m)
1	*5580.00	113.9 PK			1.26 H	302	74.2	39.7
2	*5580.00	103.3 AV			1.26 H	302	63.6	39.7
3	11160.00	61.0 PK	74.0	-13.0	2.05 H	295	45.7	15.3
4	11160.00	47.5 AV	54.0	-6.5	2.05 H	295	32.2	15.3

ANTENNA POLARITY & TEST DISTANCE: VERTICAL AT 3 M

NO.	FREQ. (MHz)	EMISSION LEVEL (dBuV/m)	LIMIT (dBuV/m)	MARGIN (dB)	ANTENNA HEIGHT (m)	TABLE ANGLE (Degree)	RAW VALUE (dBuV)	CORRECTION FACTOR (dB/m)
1	*5580.00	112.7 PK			1.13 V	278	73.0	39.7
2	*5580.00	102.1 AV			1.13 V	278	62.4	39.7
3	11160.00	60.6 PK	74.0	-13.4	1.26 V	193	45.3	15.3
4	11160.00	46.9 AV	54.0	-7.1	1.26 V	193	31.6	15.3

Remarks:

1. Emission Level(dBuV/m) = Raw Value(dBuV) + Correction Factor(dB/m)
2. Correction Factor(dB/m) = Antenna Factor(dB/m) + Cable Factor(dB) – Pre-Amplifier Factor(dB)
3. The other emission levels were very low against the limit.
4. Margin value = Emission Level – Limit value
5. " * ": Fundamental frequency.
6. " # ": The radiated frequency is out of the restricted band.

CHANNEL	TX Channel 140	DETECTOR FUNCTION	Peak (PK)
FREQUENCY RANGE	1GHz ~ 40GHz		Average (AV)

ANTENNA POLARITY & TEST DISTANCE: HORIZONTAL AT 3 M

NO.	FREQ. (MHz)	EMISSION LEVEL (dBuV/m)	LIMIT (dBuV/m)	MARGIN (dB)	ANTENNA HEIGHT (m)	TABLE ANGLE (Degree)	RAW VALUE (dBuV)	CORRECTION FACTOR (dB/m)
1	*5700.00	110.3 PK			1.29 H	303	70.4	39.9
2	*5700.00	99.3 AV			1.29 H	303	59.4	39.9
3	#5725.00	71.3 PK	74.0	-2.7	1.29 H	303	68.2	3.1
4	#5725.00	53.0 AV	54.0	-1.0	1.29 H	303	49.9	3.1
5	11400.00	60.8 PK	74.0	-13.2	2.13 H	286	45.5	15.3
6	11400.00	46.9 AV	54.0	-7.1	2.13 H	286	31.6	15.3

ANTENNA POLARITY & TEST DISTANCE: VERTICAL AT 3 M

NO.	FREQ. (MHz)	EMISSION LEVEL (dBuV/m)	LIMIT (dBuV/m)	MARGIN (dB)	ANTENNA HEIGHT (m)	TABLE ANGLE (Degree)	RAW VALUE (dBuV)	CORRECTION FACTOR (dB/m)
1	*5700.00	108.4 PK			1.04 V	270	68.5	39.9
2	*5700.00	98.2 AV			1.04 V	270	58.3	39.9
3	#5725.00	70.4 PK	74.0	-3.6	1.04 V	270	67.3	3.1
4	#5725.00	51.7 AV	54.0	-2.3	1.04 V	270	48.6	3.1
5	11400.00	60.6 PK	74.0	-13.4	1.32 V	200	45.3	15.3
6	11400.00	46.7 AV	54.0	-7.3	1.32 V	200	31.4	15.3

Remarks:

1. Emission Level(dBuV/m) = Raw Value(dBuV) + Correction Factor(dB/m)
2. Correction Factor(dB/m) = Antenna Factor(dB/m) + Cable Factor(dB) – Pre-Amplifier Factor(dB)
3. The other emission levels were very low against the limit.
4. Margin value = Emission Level – Limit value
5. " * ": Fundamental frequency.
6. " # ": The radiated frequency is out of the restricted band.

CHANNEL	TX Channel 144	DETECTOR FUNCTION	Peak (PK)
FREQUENCY RANGE	1GHz ~ 40GHz		Average (AV)

ANTENNA POLARITY & TEST DISTANCE: HORIZONTAL AT 3 M

NO.	FREQ. (MHz)	EMISSION LEVEL (dBuV/m)	LIMIT (dBuV/m)	MARGIN (dB)	ANTENNA HEIGHT (m)	TABLE ANGLE (Degree)	RAW VALUE (dBuV)	CORRECTION FACTOR (dB/m)
1	5460.00	56.8 PK	74.0	-17.2	1.23 H	321	54.1	2.7
2	5460.00	43.7 AV	54.0	-10.3	1.23 H	321	41.0	2.7
3	#5470.00	57.2 PK	74.0	-16.8	1.23 H	312	54.5	2.7
4	#5470.00	44.0 AV	54.0	-10.0	1.23 H	312	41.3	2.7
5	*5720.00	111.7 PK			1.23 H	312	71.8	39.9
6	*5720.00	101.9 AV			1.23 H	312	62.0	39.9
7	#5850.00	57.4 PK	74.0	-16.6	1.23 H	321	54.2	3.2
8	#5850.00	44.4 AV	54.0	-9.6	1.23 H	321	41.2	3.2
9	11440.00	60.9 PK	74.0	-13.1	2.23 H	284	45.9	15.0
10	11440.00	47.1 AV	54.0	-6.9	2.23 H	284	32.1	15.0

ANTENNA POLARITY & TEST DISTANCE: VERTICAL AT 3 M

NO.	FREQ. (MHz)	EMISSION LEVEL (dBuV/m)	LIMIT (dBuV/m)	MARGIN (dB)	ANTENNA HEIGHT (m)	TABLE ANGLE (Degree)	RAW VALUE (dBuV)	CORRECTION FACTOR (dB/m)
1	5460.00	56.5 PK	74.0	-17.5	1.10 V	296	53.8	2.7
2	5460.00	43.3 AV	54.0	-10.7	1.10 V	296	40.6	2.7
3	#5470.00	56.9 PK	74.0	-17.1	1.10 V	296	54.2	2.7
4	#5470.00	43.6 AV	54.0	-10.4	1.10 V	296	40.9	2.7
5	*5720.00	110.2 PK			1.10 V	296	70.3	39.9
6	*5720.00	100.7 AV			1.10 V	296	60.8	39.9
7	#5850.00	57.0 PK	74.0	-17.0	1.10 V	296	53.8	3.2
8	#5850.00	44.1 AV	54.0	-9.9	1.10 V	296	40.9	3.2
9	11440.00	60.3 PK	74.0	-13.7	1.26 V	194	45.3	15.0
10	11440.00	46.7 AV	54.0	-7.3	1.26 V	194	31.7	15.0

REMARKS:

1. Emission Level(dBuV/m) = Raw Value(dBuV) + Correction Factor(dB/m)
2. Correction Factor(dB/m) = Antenna Factor(dB/m) + Cable Factor(dB) – Pre-Amplifier Factor(dB)
3. The other emission levels were very low against the limit.
4. Margin value = Emission Level – Limit value
5. " * ": Fundamental frequency.
6. " # ": The radiated frequency is out of the restricted band.

CHANNEL	TX Channel 149	DETECTOR FUNCTION	Peak (PK)
FREQUENCY RANGE	1GHz ~ 40GHz		Average (AV)

ANTENNA POLARITY & TEST DISTANCE: HORIZONTAL AT 3 M

NO.	FREQ. (MHz)	EMISSION LEVEL (dBuV/m)	LIMIT (dBuV/m)	MARGIN (dB)	ANTENNA HEIGHT (m)	TABLE ANGLE (Degree)	RAW VALUE (dBuV)	CORRECTION FACTOR (dB/m)
1	#5613.60	56.2 PK	68.2	-12.0	1.08 H	244	53.3	2.9
2	*5745.00	111.6 PK			1.08 H	244	71.7	39.9
3	*5745.00	100.4 AV			1.08 H	244	60.5	39.9
4	#5941.60	56.4 PK	68.2	-11.8	1.08 H	244	53.2	3.2
5	11490.00	60.2 PK	74.0	-13.8	1.24 H	155	45.6	14.6
6	11490.00	46.3 AV	54.0	-7.7	1.24 H	155	31.7	14.6

ANTENNA POLARITY & TEST DISTANCE: VERTICAL AT 3 M

NO.	FREQ. (MHz)	EMISSION LEVEL (dBuV/m)	LIMIT (dBuV/m)	MARGIN (dB)	ANTENNA HEIGHT (m)	TABLE ANGLE (Degree)	RAW VALUE (dBuV)	CORRECTION FACTOR (dB/m)
1	#5627.20	55.9 PK	68.2	-12.3	3.82 V	189	53.0	2.9
2	*5745.00	111.4 PK			3.82 V	189	71.5	39.9
3	*5745.00	100.7 AV			3.82 V	189	60.8	39.9
4	#5953.60	55.9 PK	68.2	-12.3	3.82 V	189	52.6	3.3
5	11490.00	59.9 PK	74.0	-14.1	1.38 V	95	45.3	14.6
6	11490.00	45.9 AV	54.0	-8.1	1.38 V	95	31.3	14.6

Remarks:

1. Emission Level(dBuV/m) = Raw Value(dBuV) + Correction Factor(dB/m)
2. Correction Factor(dB/m) = Antenna Factor(dB/m) + Cable Factor(dB) – Pre-Amplifier Factor(dB)
3. The other emission levels were very low against the limit.
4. Margin value = Emission Level – Limit value
5. " * ": Fundamental frequency.
6. " # ": The radiated frequency is out of the restricted band.

CHANNEL	TX Channel 157	DETECTOR FUNCTION	Peak (PK)
FREQUENCY RANGE	1GHz ~ 40GHz		Average (AV)

ANTENNA POLARITY & TEST DISTANCE: HORIZONTAL AT 3 M

NO.	FREQ. (MHz)	EMISSION LEVEL (dBuV/m)	LIMIT (dBuV/m)	MARGIN (dB)	ANTENNA HEIGHT (m)	TABLE ANGLE (Degree)	RAW VALUE (dBuV)	CORRECTION FACTOR (dB/m)
1	#5601.60	57.3 PK	68.2	-10.9	1.14 H	242	54.4	2.9
2	*5785.00	110.8 PK			1.14 H	242	70.9	39.9
3	*5785.00	100.2 AV			1.14 H	242	60.3	39.9
4	#5992.80	56.1 PK	68.2	-12.1	1.14 H	242	52.8	3.3
5	11570.00	60.3 PK	74.0	-13.7	1.40 H	156	45.8	14.5
6	11570.00	46.3 AV	54.0	-7.7	1.40 H	156	31.8	14.5

ANTENNA POLARITY & TEST DISTANCE: VERTICAL AT 3 M

NO.	FREQ. (MHz)	EMISSION LEVEL (dBuV/m)	LIMIT (dBuV/m)	MARGIN (dB)	ANTENNA HEIGHT (m)	TABLE ANGLE (Degree)	RAW VALUE (dBuV)	CORRECTION FACTOR (dB/m)
1	#5619.20	55.8 PK	68.2	-12.4	3.79 V	185	52.9	2.9
2	*5785.00	111.4 PK			3.79 V	185	71.5	39.9
3	*5785.00	100.8 AV			3.79 V	185	60.9	39.9
4	#5954.40	56.6 PK	68.2	-11.6	3.79 V	185	53.3	3.3
5	11570.00	60.0 PK	74.0	-14.0	1.53 V	87	45.5	14.5
6	11570.00	45.9 AV	54.0	-8.1	1.53 V	87	31.4	14.5

Remarks:

1. Emission Level(dBuV/m) = Raw Value(dBuV) + Correction Factor(dB/m)
2. Correction Factor(dB/m) = Antenna Factor(dB/m) + Cable Factor(dB) – Pre-Amplifier Factor(dB)
3. The other emission levels were very low against the limit.
4. Margin value = Emission Level – Limit value
5. " * ": Fundamental frequency.
6. " # ": The radiated frequency is out of the restricted band.

CHANNEL	TX Channel 165	DETECTOR FUNCTION	Peak (PK)
FREQUENCY RANGE	1GHz ~ 40GHz		Average (AV)

ANTENNA POLARITY & TEST DISTANCE: HORIZONTAL AT 3 M

NO.	FREQ. (MHz)	EMISSION LEVEL (dBuV/m)	LIMIT (dBuV/m)	MARGIN (dB)	ANTENNA HEIGHT (m)	TABLE ANGLE (Degree)	RAW VALUE (dBuV)	CORRECTION FACTOR (dB/m)
1	#5632.80	57.1 PK	68.2	-11.1	1.05 H	252	54.2	2.9
2	*5825.00	110.8 PK			1.05 H	252	70.8	40.0
3	*5825.00	100.0 AV			1.05 H	252	60.0	40.0
4	#5970.40	56.0 PK	68.2	-12.2	1.05 H	252	52.7	3.3
5	11650.00	60.6 PK	74.0	-13.4	1.30 H	168	45.9	14.7
6	11650.00	46.5 AV	54.0	-7.5	1.30 H	168	31.8	14.7

ANTENNA POLARITY & TEST DISTANCE: VERTICAL AT 3 M

NO.	FREQ. (MHz)	EMISSION LEVEL (dBuV/m)	LIMIT (dBuV/m)	MARGIN (dB)	ANTENNA HEIGHT (m)	TABLE ANGLE (Degree)	RAW VALUE (dBuV)	CORRECTION FACTOR (dB/m)
1	#5644.00	56.1 PK	68.2	-12.1	3.72 V	180	53.2	2.9
2	*5825.00	111.1 PK			3.72 V	180	71.1	40.0
3	*5825.00	100.5 AV			3.72 V	180	60.5	40.0
4	#5997.60	56.3 PK	68.2	-11.9	3.72 V	180	53.0	3.3
5	11650.00	60.3 PK	74.0	-13.7	1.45 V	91	45.6	14.7
6	11650.00	46.3 AV	54.0	-7.7	1.45 V	91	31.6	14.7

Remarks:

1. Emission Level(dBuV/m) = Raw Value(dBuV) + Correction Factor(dB/m)
2. Correction Factor(dB/m) = Antenna Factor(dB/m) + Cable Factor(dB) – Pre-Amplifier Factor(dB)
3. The other emission levels were very low against the limit.
4. Margin value = Emission Level – Limit value
5. " * ": Fundamental frequency.
6. " # ": The radiated frequency is out of the restricted band.

802.11n (HT40)

CHANNEL	TX Channel 38	DETECTOR	Peak (PK)
FREQUENCY RANGE	1GHz ~ 40GHz	FUNCTION	Average (AV)

ANTENNA POLARITY & TEST DISTANCE: HORIZONTAL AT 3 M								
NO.	FREQ. (MHz)	EMISSION LEVEL (dBuV/m)	LIMIT (dBuV/m)	MARGIN (dB)	ANTENNA HEIGHT (m)	TABLE ANGLE (Degree)	RAW VALUE (dBuV)	CORRECTION FACTOR (dB/m)
1	5150.00	68.7 PK	74.0	-5.3	1.58 H	214	66.6	2.1
2	5150.00	52.7 AV	54.0	-1.3	1.58 H	214	50.6	2.1
3	*5190.00	106.4 PK			1.58 H	214	67.4	39.0
4	*5190.00	95.3 AV			1.58 H	214	56.3	39.0
5	#10380.00	59.5 PK	74.0	-14.5	1.99 H	251	44.9	14.6
6	#10380.00	46.4 AV	54.0	-7.6	1.99 H	251	31.8	14.6
ANTENNA POLARITY & TEST DISTANCE: VERTICAL AT 3 M								
NO.	FREQ. (MHz)	EMISSION LEVEL (dBuV/m)	LIMIT (dBuV/m)	MARGIN (dB)	ANTENNA HEIGHT (m)	TABLE ANGLE (Degree)	RAW VALUE (dBuV)	CORRECTION FACTOR (dB/m)
1	5150.00	68.3 PK	74.0	-5.7	1.26 V	247	66.2	2.1
2	5150.00	49.0 AV	54.0	-5.0	1.26 V	247	46.9	2.1
3	*5190.00	105.0 PK			1.26 V	247	66.0	39.0
4	*5190.00	95.8 AV			1.26 V	247	56.8	39.0
5	#10380.00	58.4 PK	74.0	-15.6	1.66 V	28	43.8	14.6
6	#10380.00	45.3 AV	54.0	-8.7	1.66 V	28	30.7	14.6

Remarks:

1. Emission Level(dBuV/m) = Raw Value(dBuV) + Correction Factor(dB/m)
2. Correction Factor(dB/m) = Antenna Factor(dB/m) + Cable Factor(dB) – Pre-Amplifier Factor(dB)
3. The other emission levels were very low against the limit.
4. Margin value = Emission Level – Limit value
5. " * ": Fundamental frequency.
6. " # ": The radiated frequency is out of the restricted band.

CHANNEL	TX Channel 46	DETECTOR FUNCTION	Peak (PK)
FREQUENCY RANGE	1GHz ~ 40GHz		Average (AV)

ANTENNA POLARITY & TEST DISTANCE: HORIZONTAL AT 3 M

NO.	FREQ. (MHz)	EMISSION LEVEL (dBuV/m)	LIMIT (dBuV/m)	MARGIN (dB)	ANTENNA HEIGHT (m)	TABLE ANGLE (Degree)	RAW VALUE (dBuV)	CORRECTION FACTOR (dB/m)
1	*5230.00	108.7 PK			1.55 H	215	69.7	39.0
2	*5230.00	99.0 AV			1.55 H	215	60.0	39.0
3	5350.00	55.2 PK	74.0	-18.8	1.55 H	215	52.6	2.6
4	5350.00	44.0 AV	54.0	-10.0	1.55 H	215	41.4	2.6
5	#10460.00	58.5 PK	74.0	-15.5	1.75 H	253	44.3	14.2
6	#10460.00	45.8 AV	54.0	-8.2	1.75 H	253	31.6	14.2

ANTENNA POLARITY & TEST DISTANCE: VERTICAL AT 3 M

NO.	FREQ. (MHz)	EMISSION LEVEL (dBuV/m)	LIMIT (dBuV/m)	MARGIN (dB)	ANTENNA HEIGHT (m)	TABLE ANGLE (Degree)	RAW VALUE (dBuV)	CORRECTION FACTOR (dB/m)
1	*5230.00	107.4 PK			1.87 V	204	68.4	39.0
2	*5230.00	97.7 AV			1.87 V	204	58.7	39.0
3	5350.00	52.9 PK	74.0	-21.1	1.87 V	204	50.3	2.6
4	5350.00	42.9 AV	54.0	-11.1	1.87 V	204	40.3	2.6
5	#10460.00	57.4 PK	74.0	-16.6	1.72 V	116	43.2	14.2
6	#10460.00	44.5 AV	54.0	-9.5	1.72 V	116	30.3	14.2

Remarks:

1. Emission Level(dBuV/m) = Raw Value(dBuV) + Correction Factor(dB/m)
2. Correction Factor(dB/m) = Antenna Factor(dB/m) + Cable Factor(dB) – Pre-Amplifier Factor(dB)
3. The other emission levels were very low against the limit.
4. Margin value = Emission Level – Limit value
5. " * ": Fundamental frequency.
6. " # ": The radiated frequency is out of the restricted band.

CHANNEL	TX Channel 54	DETECTOR FUNCTION	Peak (PK)
FREQUENCY RANGE	1GHz ~ 40GHz		Average (AV)

ANTENNA POLARITY & TEST DISTANCE: HORIZONTAL AT 3 M

NO.	FREQ. (MHz)	EMISSION LEVEL (dBuV/m)	LIMIT (dBuV/m)	MARGIN (dB)	ANTENNA HEIGHT (m)	TABLE ANGLE (Degree)	RAW VALUE (dBuV)	CORRECTION FACTOR (dB/m)
1	5150.00	57.3 PK	74.0	-16.7	1.24 H	217	55.2	2.1
2	5150.00	45.1 AV	54.0	-8.9	1.24 H	217	43.0	2.1
3	*5270.00	109.4 PK			1.24 H	217	70.2	39.2
4	*5270.00	99.3 AV			1.24 H	217	60.1	39.2
5	5350.00	63.6 PK	74.0	-10.4	1.24 H	217	61.0	2.6
6	5350.00	48.6 AV	54.0	-5.4	1.24 H	217	46.0	2.6
7	#10540.00	59.9 PK	74.0	-14.1	1.00 H	143	45.6	14.3
8	#10540.00	46.0 AV	54.0	-8.0	1.00 H	143	31.7	14.3

ANTENNA POLARITY & TEST DISTANCE: VERTICAL AT 3 M

NO.	FREQ. (MHz)	EMISSION LEVEL (dBuV/m)	LIMIT (dBuV/m)	MARGIN (dB)	ANTENNA HEIGHT (m)	TABLE ANGLE (Degree)	RAW VALUE (dBuV)	CORRECTION FACTOR (dB/m)
1	5150.00	56.9 PK	74.0	-17.1	3.92 V	214	54.8	2.1
2	5150.00	44.7 AV	54.0	-9.3	3.92 V	214	42.6	2.1
3	*5270.00	107.7 PK			3.92 V	214	68.5	39.2
4	*5270.00	97.8 AV			3.92 V	214	58.6	39.2
5	5350.00	62.4 PK	74.0	-11.6	3.92 V	214	59.8	2.6
6	5350.00	47.3 AV	54.0	-6.7	3.92 V	214	44.7	2.6
7	#10540.00	59.5 PK	74.0	-14.5	1.23 V	74	45.2	14.3
8	#10540.00	45.6 AV	54.0	-8.4	1.23 V	74	31.3	14.3

Remarks:

1. Emission Level(dBuV/m) = Raw Value(dBuV) + Correction Factor(dB/m)
2. Correction Factor(dB/m) = Antenna Factor(dB/m) + Cable Factor(dB) – Pre-Amplifier Factor(dB)
3. The other emission levels were very low against the limit.
4. Margin value = Emission Level – Limit value
5. " * ": Fundamental frequency.
6. " # ": The radiated frequency is out of the restricted band.

CHANNEL	TX Channel 62	DETECTOR FUNCTION	Peak (PK)
FREQUENCY RANGE	1GHz ~ 40GHz		Average (AV)

ANTENNA POLARITY & TEST DISTANCE: HORIZONTAL AT 3 M								
NO.	FREQ. (MHz)	EMISSION LEVEL (dBuV/m)	LIMIT (dBuV/m)	MARGIN (dB)	ANTENNA HEIGHT (m)	TABLE ANGLE (Degree)	RAW VALUE (dBuV)	CORRECTION FACTOR (dB/m)
1	*5310.00	105.4 PK			1.46 H	218	66.2	39.2
2	*5310.00	95.0 AV			1.46 H	218	55.8	39.2
3	5358.00	72.8 PK	74.0	-1.2	1.46 H	218	70.2	2.6
4	5358.00	52.8 AV	54.0	-1.2	1.46 H	218	50.2	2.6
5	10620.00	60.1 PK	74.0	-13.9	1.12 H	152	45.4	14.7
6	10620.00	46.2 AV	54.0	-7.8	1.12 H	152	31.5	14.7
ANTENNA POLARITY & TEST DISTANCE: VERTICAL AT 3 M								
NO.	FREQ. (MHz)	EMISSION LEVEL (dBuV/m)	LIMIT (dBuV/m)	MARGIN (dB)	ANTENNA HEIGHT (m)	TABLE ANGLE (Degree)	RAW VALUE (dBuV)	CORRECTION FACTOR (dB/m)
1	*5310.00	104.5 PK			3.86 V	204	65.3	39.2
2	*5310.00	93.7 AV			3.86 V	204	54.5	39.2
3	5358.00	71.0 PK	74.0	-3.0	3.86 V	204	68.4	2.6
4	5358.00	50.4 AV	54.0	-3.6	3.86 V	204	47.8	2.6
5	10620.00	59.5 PK	74.0	-14.5	1.17 V	87	44.8	14.7
6	10620.00	46.1 AV	54.0	-7.9	1.17 V	87	31.4	14.7

Remarks:

1. Emission Level(dBuV/m) = Raw Value(dBuV) + Correction Factor(dB/m)
2. Correction Factor(dB/m) = Antenna Factor(dB/m) + Cable Factor(dB) – Pre-Amplifier Factor(dB)
3. The other emission levels were very low against the limit.
4. Margin value = Emission Level – Limit value
5. " * ": Fundamental frequency.
6. " # ": The radiated frequency is out of the restricted band.

CHANNEL	TX Channel 102	DETECTOR FUNCTION	Peak (PK)
FREQUENCY RANGE	1GHz ~ 40GHz		Average (AV)

ANTENNA POLARITY & TEST DISTANCE: HORIZONTAL AT 3 M

NO.	FREQ. (MHz)	EMISSION LEVEL (dBuV/m)	LIMIT (dBuV/m)	MARGIN (dB)	ANTENNA HEIGHT (m)	TABLE ANGLE (Degree)	RAW VALUE (dBuV)	CORRECTION FACTOR (dB/m)
1	5460.00	60.3 PK	74.0	-13.7	1.28 H	304	57.6	2.7
2	5460.00	45.2 AV	54.0	-8.8	1.28 H	304	42.5	2.7
3	#5462.00	72.6 PK	74.0	-1.4	1.28 H	304	69.9	2.7
4	#5462.00	50.6 AV	54.0	-3.4	1.28 H	304	47.9	2.7
5	*5510.00	106.0 PK			1.28 H	304	66.5	39.5
6	*5510.00	95.1 AV			1.28 H	304	55.6	39.5
7	11020.00	60.7 PK	74.0	-13.3	2.10 H	243	44.8	15.9
8	11020.00	47.6 AV	54.0	-6.4	2.10 H	243	31.7	15.9

ANTENNA POLARITY & TEST DISTANCE: VERTICAL AT 3 M

NO.	FREQ. (MHz)	EMISSION LEVEL (dBuV/m)	LIMIT (dBuV/m)	MARGIN (dB)	ANTENNA HEIGHT (m)	TABLE ANGLE (Degree)	RAW VALUE (dBuV)	CORRECTION FACTOR (dB/m)
1	5460.00	59.5 PK	74.0	-14.5	1.00 V	284	56.8	2.7
2	5460.00	44.9 AV	54.0	-9.1	1.00 V	284	42.2	2.7
3	#5462.00	71.3 PK	74.0	-2.7	1.00 V	284	68.6	2.7
4	#5462.00	49.2 AV	54.0	-4.8	1.00 V	284	46.5	2.7
5	*5510.00	105.3 PK			1.00 V	284	65.8	39.5
6	*5510.00	94.3 AV			1.00 V	284	54.8	39.5
7	11020.00	60.4 PK	74.0	-13.6	1.42 V	213	44.5	15.9
8	11020.00	47.3 AV	54.0	-6.7	1.42 V	213	31.4	15.9

Remarks:

1. Emission Level(dBuV/m) = Raw Value(dBuV) + Correction Factor(dB/m)
2. Correction Factor(dB/m) = Antenna Factor(dB/m) + Cable Factor(dB) – Pre-Amplifier Factor(dB)
3. The other emission levels were very low against the limit.
4. Margin value = Emission Level – Limit value
5. " * ": Fundamental frequency.
6. " # ": The radiated frequency is out of the restricted band.

CHANNEL	TX Channel 110	DETECTOR FUNCTION	Peak (PK)
FREQUENCY RANGE	1GHz ~ 40GHz		Average (AV)

ANTENNA POLARITY & TEST DISTANCE: HORIZONTAL AT 3 M								
NO.	FREQ. (MHz)	EMISSION LEVEL (dBuV/m)	LIMIT (dBuV/m)	MARGIN (dB)	ANTENNA HEIGHT (m)	TABLE ANGLE (Degree)	RAW VALUE (dBuV)	CORRECTION FACTOR (dB/m)
1	*5550.00	110.4 PK			1.13 H	300	70.8	39.6
2	*5550.00	99.8 AV			1.13 H	300	60.2	39.6
3	11100.00	60.6 PK	74.0	-13.4	2.04 H	251	45.3	15.3
4	11100.00	47.3 AV	54.0	-6.7	2.04 H	251	32.0	15.3
ANTENNA POLARITY & TEST DISTANCE: VERTICAL AT 3 M								
NO.	FREQ. (MHz)	EMISSION LEVEL (dBuV/m)	LIMIT (dBuV/m)	MARGIN (dB)	ANTENNA HEIGHT (m)	TABLE ANGLE (Degree)	RAW VALUE (dBuV)	CORRECTION FACTOR (dB/m)
1	*5550.00	108.4 PK			1.03 V	291	68.8	39.6
2	*5550.00	98.6 AV			1.03 V	291	59.0	39.6
3	11100.00	60.4 PK	74.0	-13.6	1.54 V	204	45.1	15.3
4	11100.00	47.1 AV	54.0	-6.9	1.54 V	204	31.8	15.3

Remarks:

1. Emission Level(dBuV/m) = Raw Value(dBuV) + Correction Factor(dB/m)
2. Correction Factor(dB/m) = Antenna Factor(dB/m) + Cable Factor(dB) – Pre-Amplifier Factor(dB)
3. The other emission levels were very low against the limit.
4. Margin value = Emission Level – Limit value
5. " * ": Fundamental frequency.
6. " # ": The radiated frequency is out of the restricted band.

CHANNEL	TX Channel 134	DETECTOR FUNCTION	Peak (PK)
FREQUENCY RANGE	1GHz ~ 40GHz		Average (AV)

ANTENNA POLARITY & TEST DISTANCE: HORIZONTAL AT 3 M

NO.	FREQ. (MHz)	EMISSION LEVEL (dBuV/m)	LIMIT (dBuV/m)	MARGIN (dB)	ANTENNA HEIGHT (m)	TABLE ANGLE (Degree)	RAW VALUE (dBuV)	CORRECTION FACTOR (dB/m)
1	*5670.00	109.2 PK			1.31 H	302	69.4	39.8
2	*5670.00	98.4 AV			1.31 H	302	58.6	39.8
3	#5725.00	68.5 PK	74.0	-5.5	1.31 H	302	65.4	3.1
4	#5725.00	53.0 AV	54.0	-1.0	1.31 H	302	49.9	3.1
5	11340.00	61.3 PK	74.0	-12.7	2.13 H	265	45.5	15.8
6	11340.00	47.5 AV	54.0	-6.5	2.13 H	265	31.7	15.8

ANTENNA POLARITY & TEST DISTANCE: VERTICAL AT 3 M

NO.	FREQ. (MHz)	EMISSION LEVEL (dBuV/m)	LIMIT (dBuV/m)	MARGIN (dB)	ANTENNA HEIGHT (m)	TABLE ANGLE (Degree)	RAW VALUE (dBuV)	CORRECTION FACTOR (dB/m)
1	*5670.00	108.2 PK			1.12 V	284	68.4	39.8
2	*5670.00	97.3 AV			1.12 V	284	57.5	39.8
3	#5725.00	67.5 PK	74.0	-6.5	1.12 V	284	64.4	3.1
4	#5725.00	51.6 AV	54.0	-2.4	1.12 V	284	48.5	3.1
5	11340.00	61.0 PK	74.0	-13.0	1.35 V	204	45.2	15.8
6	11340.00	47.3 AV	54.0	-6.7	1.35 V	204	31.5	15.8

Remarks:

1. Emission Level(dBuV/m) = Raw Value(dBuV) + Correction Factor(dB/m)
2. Correction Factor(dB/m) = Antenna Factor(dB/m) + Cable Factor(dB) – Pre-Amplifier Factor(dB)
3. The other emission levels were very low against the limit.
4. Margin value = Emission Level – Limit value
5. " * ": Fundamental frequency.
6. " # ": The radiated frequency is out of the restricted band.

CHANNEL	TX Channel 142	DETECTOR FUNCTION	Peak (PK) Average (AV)
FREQUENCY RANGE	1GHz ~ 40GHz		

ANTENNA POLARITY & TEST DISTANCE: HORIZONTAL AT 3 M

NO.	FREQ. (MHz)	EMISSION LEVEL (dBuV/m)	LIMIT (dBuV/m)	MARGIN (dB)	ANTENNA HEIGHT (m)	TABLE ANGLE (Degree)	RAW VALUE (dBuV)	CORRECTION FACTOR (dB/m)
1	5460.00	56.5 PK	74.0	-17.5	1.24 H	302	53.8	2.7
2	5460.00	43.3 AV	54.0	-10.7	1.24 H	302	40.6	2.7
3	#5470.00	57.0 PK	74.0	-17.0	1.24 H	302	54.3	2.7
4	#5470.00	43.6 AV	54.0	-10.4	1.24 H	302	40.9	2.7
5	*5710.00	109.9 PK			1.24 H	302	70.0	39.9
6	*5710.00	99.1 AV			1.24 H	302	59.2	39.9
7	#5850.00	57.6 PK	74.0	-16.4	1.24 H	302	54.4	3.2
8	#5850.00	44.6 AV	54.0	-9.4	1.24 H	302	41.4	3.2
9	11420.00	61.0 PK	74.0	-13.0	2.21 H	271	45.8	15.2
10	11420.00	47.2 AV	54.0	-6.8	2.21 H	271	32.0	15.2

ANTENNA POLARITY & TEST DISTANCE: VERTICAL AT 3 M

NO.	FREQ. (MHz)	EMISSION LEVEL (dBuV/m)	LIMIT (dBuV/m)	MARGIN (dB)	ANTENNA HEIGHT (m)	TABLE ANGLE (Degree)	RAW VALUE (dBuV)	CORRECTION FACTOR (dB/m)
1	5460.00	56.5 PK	74.0	-17.5	1.06 V	291	53.8	2.7
2	5460.00	43.0 AV	54.0	-11.0	1.06 V	291	40.3	2.7
3	#5470.00	56.7 PK	74.0	-17.3	1.06 V	291	54.0	2.7
4	#5470.00	43.3 AV	54.0	-10.7	1.06 V	291	40.6	2.7
5	*5710.00	108.7 PK			1.06 V	291	68.8	39.9
6	*5710.00	98.2 AV			1.06 V	291	58.3	39.9
7	#5850.00	57.5 PK	74.0	-16.5	1.06 V	291	54.3	3.2
8	#5850.00	44.4 AV	54.0	-9.6	1.06 V	291	41.2	3.2
9	11420.00	60.5 PK	74.0	-13.5	1.28 V	211	45.3	15.2
10	11420.00	46.8 AV	54.0	-7.2	1.28 V	211	31.6	15.2

REMARKS:

1. Emission Level(dBuV/m) = Raw Value(dBuV) + Correction Factor(dB/m)
2. Correction Factor(dB/m) = Antenna Factor(dB/m) + Cable Factor(dB) – Pre-Amplifier Factor(dB)
3. The other emission levels were very low against the limit.
4. Margin value = Emission Level – Limit value
5. " * ": Fundamental frequency.
6. " # ": The radiated frequency is out of the restricted band.

CHANNEL	TX Channel 151	DETECTOR FUNCTION	Peak (PK)
FREQUENCY RANGE	1GHz ~ 40GHz		Average (AV)

ANTENNA POLARITY & TEST DISTANCE: HORIZONTAL AT 3 M

NO.	FREQ. (MHz)	EMISSION LEVEL (dBuV/m)	LIMIT (dBuV/m)	MARGIN (dB)	ANTENNA HEIGHT (m)	TABLE ANGLE (Degree)	RAW VALUE (dBuV)	CORRECTION FACTOR (dB/m)
1	#5648.80	58.5 PK	68.2	-9.7	1.17 H	245	55.6	2.9
2	*5755.00	107.7 PK			1.17 H	245	67.8	39.9
3	*5755.00	97.3 AV			1.17 H	245	57.4	39.9
4	#5931.20	56.3 PK	68.2	-11.9	1.17 H	245	53.1	3.2
5	11510.00	59.1 PK	74.0	-14.9	1.36 H	335	44.6	14.5
6	11510.00	46.2 AV	54.0	-7.8	1.36 H	335	31.7	14.5

ANTENNA POLARITY & TEST DISTANCE: VERTICAL AT 3 M

NO.	FREQ. (MHz)	EMISSION LEVEL (dBuV/m)	LIMIT (dBuV/m)	MARGIN (dB)	ANTENNA HEIGHT (m)	TABLE ANGLE (Degree)	RAW VALUE (dBuV)	CORRECTION FACTOR (dB/m)
1	#5641.60	57.4 PK	68.2	-10.8	3.84 V	183	54.5	2.9
2	*5755.00	107.3 PK			3.84 V	183	67.4	39.9
3	*5755.00	96.7 AV			3.84 V	183	56.8	39.9
4	#5965.60	55.8 PK	68.2	-12.4	3.84 V	183	52.5	3.3
5	11510.00	58.2 PK	74.0	-15.8	2.21 V	281	43.7	14.5
6	11510.00	45.2 AV	54.0	-8.8	2.21 V	281	30.7	14.5

Remarks:

1. Emission Level(dBuV/m) = Raw Value(dBuV) + Correction Factor(dB/m)
2. Correction Factor(dB/m) = Antenna Factor(dB/m) + Cable Factor(dB) – Pre-Amplifier Factor(dB)
3. The other emission levels were very low against the limit.
4. Margin value = Emission Level – Limit value
5. " * ": Fundamental frequency.
6. " # ": The radiated frequency is out of the restricted band.

CHANNEL	TX Channel 159	DETECTOR FUNCTION	Peak (PK)
FREQUENCY RANGE	1GHz ~ 40GHz		Average (AV)

ANTENNA POLARITY & TEST DISTANCE: HORIZONTAL AT 3 M

NO.	FREQ. (MHz)	EMISSION LEVEL (dBuV/m)	LIMIT (dBuV/m)	MARGIN (dB)	ANTENNA HEIGHT (m)	TABLE ANGLE (Degree)	RAW VALUE (dBuV)	CORRECTION FACTOR (dB/m)
1	#5643.20	56.1 PK	68.2	-12.1	1.28 H	245	53.2	2.9
2	*5795.00	109.4 PK			1.28 H	245	69.5	39.9
3	*5795.00	98.3 AV			1.28 H	245	58.4	39.9
4	#5933.60	57.0 PK	68.2	-11.2	1.28 H	245	53.8	3.2
5	11590.00	59.1 PK	74.0	-14.9	2.21 H	52	44.7	14.4
6	11590.00	45.9 AV	54.0	-8.1	2.21 H	52	31.5	14.4

ANTENNA POLARITY & TEST DISTANCE: VERTICAL AT 3 M

NO.	FREQ. (MHz)	EMISSION LEVEL (dBuV/m)	LIMIT (dBuV/m)	MARGIN (dB)	ANTENNA HEIGHT (m)	TABLE ANGLE (Degree)	RAW VALUE (dBuV)	CORRECTION FACTOR (dB/m)
1	#5648.80	56.1 PK	68.2	-12.1	3.78 V	186	53.2	2.9
2	*5795.00	108.3 PK			3.78 V	186	68.4	39.9
3	*5795.00	97.1 AV			3.78 V	186	57.2	39.9
4	#5925.60	58.0 PK	68.2	-10.2	3.78 V	186	54.8	3.2
5	11590.00	57.9 PK	74.0	-16.1	2.34 V	147	43.5	14.4
6	11590.00	45.1 AV	54.0	-8.9	2.34 V	147	30.7	14.4

Remarks:

1. Emission Level(dBuV/m) = Raw Value(dBuV) + Correction Factor(dB/m)
2. Correction Factor(dB/m) = Antenna Factor(dB/m) + Cable Factor(dB) – Pre-Amplifier Factor(dB)
3. The other emission levels were very low against the limit.
4. Margin value = Emission Level – Limit value
5. " * ": Fundamental frequency.
6. " # ": The radiated frequency is out of the restricted band.

802.11ac (VHT80)

CHANNEL	TX Channel 42	DETECTOR FUNCTION	Peak (PK)
FREQUENCY RANGE	1GHz ~ 40GHz		Average (AV)

ANTENNA POLARITY & TEST DISTANCE: HORIZONTAL AT 3 M								
NO.	FREQ. (MHz)	EMISSION LEVEL (dBuV/m)	LIMIT (dBuV/m)	MARGIN (dB)	ANTENNA HEIGHT (m)	TABLE ANGLE (Degree)	RAW VALUE (dBuV)	CORRECTION FACTOR (dB/m)
1	5150.00	67.0 PK	74.0	-7.0	1.55 H	222	64.9	2.1
2	5150.00	52.8 AV	54.0	-1.2	1.55 H	222	50.7	2.1
3	*5210.00	102.4 PK			1.55 H	222	63.4	39.0
4	*5210.00	92.6 AV			1.55 H	222	53.6	39.0
5	5350.00	55.3 PK	74.0	-18.7	1.55 H	222	52.7	2.6
6	5350.00	44.0 AV	54.0	-10.0	1.55 H	222	41.4	2.6
7	#10420.00	59.0 PK	74.0	-15.0	2.51 H	354	44.6	14.4
8	#10420.00	46.0 AV	54.0	-8.0	2.51 H	354	31.6	14.4

ANTENNA POLARITY & TEST DISTANCE: VERTICAL AT 3 M								
NO.	FREQ. (MHz)	EMISSION LEVEL (dBuV/m)	LIMIT (dBuV/m)	MARGIN (dB)	ANTENNA HEIGHT (m)	TABLE ANGLE (Degree)	RAW VALUE (dBuV)	CORRECTION FACTOR (dB/m)
1	5150.00	62.6 PK	74.0	-11.4	1.72 V	214	60.5	2.1
2	5150.00	50.6 AV	54.0	-3.4	1.72 V	214	48.5	2.1
3	*5210.00	99.5 PK			1.72 V	214	60.5	39.0
4	*5210.00	89.1 AV			1.72 V	214	50.1	39.0
5	5350.00	52.9 PK	74.0	-21.1	1.72 V	214	50.3	2.6
6	5350.00	42.8 AV	54.0	-11.2	1.72 V	214	40.2	2.6
7	#10420.00	57.7 PK	74.0	-16.3	2.22 V	144	43.3	14.4
8	#10420.00	45.0 AV	54.0	-9.0	2.22 V	144	30.6	14.4

Remarks:

1. Emission Level(dBuV/m) = Raw Value(dBuV) + Correction Factor(dB/m)
2. Correction Factor(dB/m) = Antenna Factor(dB/m) + Cable Factor(dB) – Pre-Amplifier Factor(dB)
3. The other emission levels were very low against the limit.
4. Margin value = Emission Level – Limit value
5. " * ": Fundamental frequency.
6. " # ": The radiated frequency is out of the restricted band.

CHANNEL	TX Channel 58	DETECTOR FUNCTION	Peak (PK)
FREQUENCY RANGE	1GHz ~ 40GHz		Average (AV)

ANTENNA POLARITY & TEST DISTANCE: HORIZONTAL AT 3 M

NO.	FREQ. (MHz)	EMISSION LEVEL (dBuV/m)	LIMIT (dBuV/m)	MARGIN (dB)	ANTENNA HEIGHT (m)	TABLE ANGLE (Degree)	RAW VALUE (dBuV)	CORRECTION FACTOR (dB/m)
1	5150.00	56.8 PK	74.0	-17.2	1.16 H	216	54.7	2.1
2	5150.00	46.2 AV	54.0	-7.8	1.16 H	216	44.1	2.1
3	*5290.00	101.9 PK			1.16 H	216	62.7	39.2
4	*5290.00	93.1 AV			1.16 H	216	53.9	39.2
5	5350.00	67.6 PK	74.0	-6.4	1.16 H	216	65.0	2.6
6	5350.00	52.5 AV	54.0	-1.5	1.16 H	216	49.9	2.6
7	#10580.00	60.1 PK	74.0	-13.9	1.03 H	147	45.5	14.6
8	#10580.00	46.2 AV	54.0	-7.8	1.03 H	147	31.6	14.6

ANTENNA POLARITY & TEST DISTANCE: VERTICAL AT 3 M

NO.	FREQ. (MHz)	EMISSION LEVEL (dBuV/m)	LIMIT (dBuV/m)	MARGIN (dB)	ANTENNA HEIGHT (m)	TABLE ANGLE (Degree)	RAW VALUE (dBuV)	CORRECTION FACTOR (dB/m)
1	5150.00	55.1 PK	74.0	-18.9	3.78 V	212	53.0	2.1
2	5150.00	45.6 AV	54.0	-8.4	3.78 V	212	43.5	2.1
3	*5290.00	100.4 PK			3.78 V	212	61.2	39.2
4	*5290.00	90.6 AV			3.78 V	212	51.4	39.2
5	5350.00	66.3 PK	74.0	-7.7	3.78 V	212	63.7	2.6
6	5350.00	50.9 AV	54.0	-3.1	3.78 V	212	48.3	2.6
7	#10580.00	59.8 PK	74.0	-14.2	1.20 V	92	45.2	14.6
8	#10580.00	46.0 AV	54.0	-8.0	1.20 V	92	31.4	14.6

Remarks:

1. Emission Level(dBuV/m) = Raw Value(dBuV) + Correction Factor(dB/m)
2. Correction Factor(dB/m) = Antenna Factor(dB/m) + Cable Factor(dB) – Pre-Amplifier Factor(dB)
3. The other emission levels were very low against the limit.
4. Margin value = Emission Level – Limit value
5. " * ": Fundamental frequency.
6. " # ": The radiated frequency is out of the restricted band.

CHANNEL	TX Channel 106	DETECTOR FUNCTION	Peak (PK)
FREQUENCY RANGE	1GHz ~ 40GHz		Average (AV)

ANTENNA POLARITY & TEST DISTANCE: HORIZONTAL AT 3 M

NO.	FREQ. (MHz)	EMISSION LEVEL (dBuV/m)	LIMIT (dBuV/m)	MARGIN (dB)	ANTENNA HEIGHT (m)	TABLE ANGLE (Degree)	RAW VALUE (dBuV)	CORRECTION FACTOR (dB/m)
1	5460.00	65.8 PK	74.0	-8.2	1.36 H	303	63.1	2.7
2	5460.00	50.7 AV	54.0	-3.3	1.36 H	303	48.0	2.7
3	#5470.00	69.1 PK	74.0	-4.9	1.36 H	303	66.4	2.7
4	#5470.00	52.5 AV	54.0	-1.5	1.36 H	303	49.8	2.7
5	*5530.00	103.7 PK			1.36 H	303	64.2	39.5
6	*5530.00	92.9 AV			1.36 H	303	53.4	39.5
7	11060.00	61.1 PK	74.0	-12.9	2.04 H	268	45.4	15.7
8	11060.00	47.2 AV	54.0	-6.8	2.04 H	268	31.5	15.7

ANTENNA POLARITY & TEST DISTANCE: VERTICAL AT 3 M

NO.	FREQ. (MHz)	EMISSION LEVEL (dBuV/m)	LIMIT (dBuV/m)	MARGIN (dB)	ANTENNA HEIGHT (m)	TABLE ANGLE (Degree)	RAW VALUE (dBuV)	CORRECTION FACTOR (dB/m)
1	5460.00	65.3 PK	74.0	-8.7	1.02 V	283	62.6	2.7
2	5460.00	49.9 AV	54.0	-4.1	1.02 V	283	47.2	2.7
3	#5470.00	68.5 PK	74.0	-5.5	1.02 V	283	65.8	2.7
4	#5470.00	51.2 AV	54.0	-2.8	1.02 V	283	48.5	2.7
5	*5530.00	102.9 PK			1.02 V	283	63.4	39.5
6	*5530.00	92.2 AV			1.02 V	283	52.7	39.5
7	11060.00	61.0 PK	74.0	-13.0	1.30 V	198	45.3	15.7
8	11060.00	47.0 AV	54.0	-7.0	1.30 V	198	31.3	15.7

Remarks:

1. Emission Level(dBuV/m) = Raw Value(dBuV) + Correction Factor(dB/m)
2. Correction Factor(dB/m) = Antenna Factor(dB/m) + Cable Factor(dB) – Pre-Amplifier Factor(dB)
3. The other emission levels were very low against the limit.
4. Margin value = Emission Level – Limit value
5. " * ": Fundamental frequency.
6. " # ": The radiated frequency is out of the restricted band.

CHANNEL	TX Channel 138	DETECTOR FUNCTION	Peak (PK)
FREQUENCY RANGE	1GHz ~ 40GHz		Average (AV)

ANTENNA POLARITY & TEST DISTANCE: HORIZONTAL AT 3 M								
NO.	FREQ. (MHz)	EMISSION LEVEL (dBuV/m)	LIMIT (dBuV/m)	MARGIN (dB)	ANTENNA HEIGHT (m)	TABLE ANGLE (Degree)	RAW VALUE (dBuV)	CORRECTION FACTOR (dB/m)
1	5460.00	56.9 PK	74.0	-17.1	1.22 H	303	54.2	2.7
2	5460.00	43.2 AV	54.0	-10.8	1.22 H	303	40.5	2.7
3	#5470.00	57.1 PK	74.0	-16.9	1.22 H	303	54.4	2.7
4	#5470.00	43.6 AV	54.0	-10.4	1.22 H	303	40.9	2.7
5	*5690.00	107.4 PK			1.22 H	303	67.6	39.8
6	*5690.00	96.0 AV			1.22 H	303	56.2	39.8
7	#5850.00	59.9 PK	74.0	-14.1	1.22 H	303	56.7	3.2
8	#5850.00	46.1 AV	54.0	-7.9	1.22 H	303	42.9	3.2
9	11380.00	60.9 PK	74.0	-13.1	2.30 H	267	45.4	15.5
10	11380.00	47.0 AV	54.0	-7.0	2.30 H	267	31.5	15.5

ANTENNA POLARITY & TEST DISTANCE: VERTICAL AT 3 M								
NO.	FREQ. (MHz)	EMISSION LEVEL (dBuV/m)	LIMIT (dBuV/m)	MARGIN (dB)	ANTENNA HEIGHT (m)	TABLE ANGLE (Degree)	RAW VALUE (dBuV)	CORRECTION FACTOR (dB/m)
1	5460.00	56.7 PK	74.0	-17.3	1.10 V	264	54.0	2.7
2	5460.00	43.5 AV	54.0	-10.5	1.10 V	264	40.8	2.7
3	#5470.00	56.8 PK	74.0	-17.2	1.10 V	264	54.1	2.7
4	#5470.00	43.5 AV	54.0	-10.5	1.10 V	264	40.8	2.7
5	*5690.00	105.6 PK			1.10 V	264	65.8	39.8
6	*5690.00	95.1 AV			1.10 V	264	55.3	39.8
7	#5850.00	59.0 PK	74.0	-15.0	1.10 V	264	55.8	3.2
8	#5850.00	45.5 AV	54.0	-8.5	1.10 V	264	42.3	3.2
9	11380.00	60.5 PK	74.0	-13.5	1.18 V	195	45.0	15.5
10	11380.00	46.7 AV	54.0	-7.3	1.18 V	195	31.2	15.5

Remarks:

1. Emission Level(dBuV/m) = Raw Value(dBuV) + Correction Factor(dB/m)
2. Correction Factor(dB/m) = Antenna Factor(dB/m) + Cable Factor(dB) – Pre-Amplifier Factor(dB)
3. The other emission levels were very low against the limit.
4. Margin value = Emission Level – Limit value
5. " * ": Fundamental frequency.
6. " # ": The radiated frequency is out of the restricted band.

CHANNEL	TX Channel 155	DETECTOR FUNCTION	Peak (PK)
FREQUENCY RANGE	1GHz ~ 40GHz		Average (AV)

ANTENNA POLARITY & TEST DISTANCE: HORIZONTAL AT 3 M								
NO.	FREQ. (MHz)	EMISSION LEVEL (dBuV/m)	LIMIT (dBuV/m)	MARGIN (dB)	ANTENNA HEIGHT (m)	TABLE ANGLE (Degree)	RAW VALUE (dBuV)	CORRECTION FACTOR (dB/m)
1	#5646.40	66.3 PK	68.2	-1.9	1.78 H	213	63.4	2.9
2	*5775.00	104.5 PK			1.78 H	213	64.6	39.9
3	*5775.00	94.3 AV			1.78 H	213	54.4	39.9
4	#5942.40	58.4 PK	68.2	-9.8	1.78 H	213	55.2	3.2
5	11550.00	59.4 PK	74.0	-14.6	2.21 H	23	44.9	14.5
6	11550.00	46.1 AV	54.0	-7.9	2.21 H	23	31.6	14.5

ANTENNA POLARITY & TEST DISTANCE: VERTICAL AT 3 M								
NO.	FREQ. (MHz)	EMISSION LEVEL (dBuV/m)	LIMIT (dBuV/m)	MARGIN (dB)	ANTENNA HEIGHT (m)	TABLE ANGLE (Degree)	RAW VALUE (dBuV)	CORRECTION FACTOR (dB/m)
1	#5646.40	65.8 PK	68.2	-2.4	3.63 V	176	62.9	2.9
2	*5775.00	104.4 PK			3.63 V	176	64.5	39.9
3	*5775.00	93.7 AV			3.63 V	176	53.8	39.9
4	#5924.80	58.1 PK	68.3	-10.2	3.63 V	176	54.9	3.2
5	11550.00	58.0 PK	74.0	-16.0	2.63 V	44	43.5	14.5
6	11550.00	45.2 AV	54.0	-8.8	2.63 V	44	30.7	14.5

Remarks:

1. Emission Level(dBuV/m) = Raw Value(dBuV) + Correction Factor(dB/m)
2. Correction Factor(dB/m) = Antenna Factor(dB/m) + Cable Factor(dB) – Pre-Amplifier Factor(dB)
3. The other emission levels were very low against the limit.
4. Margin value = Emission Level – Limit value
5. " * ": Fundamental frequency.
6. " # ": The radiated frequency is out of the restricted band.

Below 1GHz Worst-Case Data: 802.11a

CHANNEL	TX Channel 40	DETECTOR FUNCTION	Quasi-Peak (QP)
FREQUENCY RANGE	30MHz ~ 1GHz	TEST MODE	A

ANTENNA POLARITY & TEST DISTANCE: HORIZONTAL AT 3 M

NO.	FREQ. (MHz)	EMISSION LEVEL (dBuV/m)	LIMIT (dBuV/m)	MARGIN (dB)	ANTENNA HEIGHT (m)	TABLE ANGLE (Degree)	RAW VALUE (dBuV)	CORRECTION FACTOR (dB/m)
1	30.00	31.3 QP	40.0	-8.7	1.49 H	10	47.3	-16.0
2	107.60	29.5 QP	43.5	-14.0	1.49 H	101	46.6	-17.1
3	132.82	31.3 QP	43.5	-12.2	1.99 H	153	46.0	-14.7
4	322.94	26.2 QP	46.0	-19.8	1.99 H	149	36.6	-10.4
5	582.90	31.1 QP	46.0	-14.9	1.99 H	11	35.5	-4.4
6	794.36	40.6 QP	46.0	-5.4	1.99 H	9	40.3	0.3

ANTENNA POLARITY & TEST DISTANCE: VERTICAL AT 3 M

NO.	FREQ. (MHz)	EMISSION LEVEL (dBuV/m)	LIMIT (dBuV/m)	MARGIN (dB)	ANTENNA HEIGHT (m)	TABLE ANGLE (Degree)	RAW VALUE (dBuV)	CORRECTION FACTOR (dB/m)
1	30.00	34.4 QP	40.0	-5.6	1.25 V	31	50.4	-16.0
2	59.10	34.8 QP	40.0	-5.2	1.25 V	5	49.0	-14.2
3	107.60	28.3 QP	43.5	-15.2	1.00 V	305	45.4	-17.1
4	144.46	31.9 QP	43.5	-11.6	1.00 V	259	45.4	-13.5
5	441.28	28.6 QP	46.0	-17.4	1.00 V	247	36.3	-7.7
6	582.90	30.8 QP	46.0	-15.2	1.00 V	100	35.2	-4.4

Remarks:

1. Emission Level(dBuV/m) = Raw Value(dBuV) + Correction Factor(dB/m)
2. Correction Factor(dB/m) = Antenna Factor(dB/m) + Cable Factor(dB) – Pre-Amplifier Factor(dB)
3. The other emission levels were very low against the limit.
4. Margin value = Emission Level – Limit value

CHANNEL	TX Channel 40	DETECTOR FUNCTION	Quasi-Peak (QP)
FREQUENCY RANGE	30MHz ~ 1GHz	TEST MODE	B

ANTENNA POLARITY & TEST DISTANCE: HORIZONTAL AT 3 M

NO.	FREQ. (MHz)	EMISSION LEVEL (dBuV/m)	LIMIT (dBuV/m)	MARGIN (dB)	ANTENNA HEIGHT (m)	TABLE ANGLE (Degree)	RAW VALUE (dBuV)	CORRECTION FACTOR (dB/m)
1	30.00	26.1 QP	40.0	-13.9	1.26 H	246	42.1	-16.0
2	57.16	26.2 QP	40.0	-13.8	1.50 H	6	40.2	-14.0
3	111.48	14.8 QP	43.5	-28.7	1.50 H	98	31.5	-16.7
4	258.92	24.2 QP	46.0	-21.8	1.00 H	243	37.0	-12.8
5	385.02	23.2 QP	46.0	-22.8	1.00 H	31	32.3	-9.1
6	544.10	26.3 QP	46.0	-19.7	1.26 H	118	31.8	-5.5

ANTENNA POLARITY & TEST DISTANCE: VERTICAL AT 3 M

NO.	FREQ. (MHz)	EMISSION LEVEL (dBuV/m)	LIMIT (dBuV/m)	MARGIN (dB)	ANTENNA HEIGHT (m)	TABLE ANGLE (Degree)	RAW VALUE (dBuV)	CORRECTION FACTOR (dB/m)
1	30.00	31.8 QP	40.0	-8.2	1.00 V	348	47.8	-16.0
2	59.10	32.8 QP	40.0	-7.2	1.49 V	332	47.0	-14.2
3	86.26	22.2 QP	40.0	-17.8	1.49 V	233	41.3	-19.1
4	109.54	22.2 QP	43.5	-21.3	1.00 V	293	39.1	-16.9
5	503.36	25.8 QP	46.0	-20.2	1.00 V	286	32.2	-6.4
6	889.42	34.7 QP	46.0	-11.3	1.24 V	106	32.3	2.4

Remarks:

1. Emission Level(dBuV/m) = Raw Value(dBuV) + Correction Factor(dB/m)
2. Correction Factor(dB/m) = Antenna Factor(dB/m) + Cable Factor(dB) – Pre-Amplifier Factor(dB)
3. The other emission levels were very low against the limit.
4. Margin value = Emission Level – Limit value

CHANNEL	TX Channel 40	DETECTOR FUNCTION	Quasi-Peak (QP)
FREQUENCY RANGE	30MHz ~ 1GHz	TEST MODE	C

ANTENNA POLARITY & TEST DISTANCE: HORIZONTAL AT 3 M

NO.	FREQ. (MHz)	EMISSION LEVEL (dBuV/m)	LIMIT (dBuV/m)	MARGIN (dB)	ANTENNA HEIGHT (m)	TABLE ANGLE (Degree)	RAW VALUE (dBuV)	CORRECTION FACTOR (dB/m)
1	31.94	27.7 QP	40.0	-12.3	1.26 H	15	43.7	-16.0
2	51.34	25.3 QP	40.0	-14.7	1.50 H	251	39.2	-13.9
3	88.20	19.2 QP	43.5	-24.3	1.50 H	51	38.6	-19.4
4	128.94	23.4 QP	43.5	-20.1	1.50 H	323	38.6	-15.2
5	181.32	19.3 QP	43.5	-24.2	1.01 H	111	33.8	-14.5
6	421.88	24.8 QP	46.0	-21.2	1.50 H	123	33.1	-8.3

ANTENNA POLARITY & TEST DISTANCE: VERTICAL AT 3 M

NO.	FREQ. (MHz)	EMISSION LEVEL (dBuV/m)	LIMIT (dBuV/m)	MARGIN (dB)	ANTENNA HEIGHT (m)	TABLE ANGLE (Degree)	RAW VALUE (dBuV)	CORRECTION FACTOR (dB/m)
1	30.00	32.4 QP	40.0	-7.6	1.00 V	351	48.4	-16.0
2	53.28	30.6 QP	40.0	-9.4	1.00 V	24	44.5	-13.9
3	88.20	26.7 QP	43.5	-16.8	1.49 V	229	46.1	-19.4
4	192.96	23.9 QP	43.5	-19.6	1.00 V	203	39.4	-15.5
5	582.90	28.3 QP	46.0	-17.7	1.49 V	126	32.7	-4.4
6	968.96	37.0 QP	54.0	-17.0	1.49 V	248	32.5	4.5

Remarks:

1. Emission Level(dBuV/m) = Raw Value(dBuV) + Correction Factor(dB/m)
2. Correction Factor(dB/m) = Antenna Factor(dB/m) + Cable Factor(dB) – Pre-Amplifier Factor(dB)
3. The other emission levels were very low against the limit.
4. Margin value = Emission Level – Limit value

CHANNEL	TX Channel 40	DETECTOR FUNCTION	Quasi-Peak (QP)
FREQUENCY RANGE	30MHz ~ 1GHz	TEST MODE	D

ANTENNA POLARITY & TEST DISTANCE: HORIZONTAL AT 3 M

NO.	FREQ. (MHz)	EMISSION LEVEL (dBuV/m)	LIMIT (dBuV/m)	MARGIN (dB)	ANTENNA HEIGHT (m)	TABLE ANGLE (Degree)	RAW VALUE (dBuV)	CORRECTION FACTOR (dB/m)
1	30.00	25.9 QP	40.0	-14.1	1.26 H	56	41.9	-16.0
2	53.28	29.3 QP	40.0	-10.7	1.26 H	235	43.2	-13.9
3	125.06	21.1 QP	43.5	-22.4	1.50 H	263	36.5	-15.4
4	321.00	23.1 QP	46.0	-22.9	1.50 H	203	33.6	-10.5
5	831.22	33.9 QP	46.0	-12.1	1.50 H	273	32.7	1.2
6	939.86	36.0 QP	46.0	-10.0	1.00 H	15	32.3	3.7

ANTENNA POLARITY & TEST DISTANCE: VERTICAL AT 3 M

NO.	FREQ. (MHz)	EMISSION LEVEL (dBuV/m)	LIMIT (dBuV/m)	MARGIN (dB)	ANTENNA HEIGHT (m)	TABLE ANGLE (Degree)	RAW VALUE (dBuV)	CORRECTION FACTOR (dB/m)
1	30.00	31.1 QP	40.0	-8.9	1.00 V	210	47.1	-16.0
2	53.28	32.8 QP	40.0	-7.2	1.00 V	9	46.7	-13.9
3	86.26	23.7 QP	40.0	-16.3	1.00 V	262	42.8	-19.1
4	493.66	25.7 QP	46.0	-20.3	1.00 V	6	32.3	-6.6
5	660.50	29.7 QP	46.0	-16.3	1.49 V	97	32.3	-2.6
6	906.88	36.1 QP	46.0	-9.9	1.24 V	55	33.2	2.9

Remarks:

1. Emission Level(dBuV/m) = Raw Value(dBuV) + Correction Factor(dB/m)
2. Correction Factor(dB/m) = Antenna Factor(dB/m) + Cable Factor(dB) – Pre-Amplifier Factor(dB)
3. The other emission levels were very low against the limit.
4. Margin value = Emission Level – Limit value

4.2 Conducted Emission Measurement

4.2.1 Limits of Conducted Emission Measurement

Frequency (MHz)	Conducted Limit (dBuV)	
	Quasi-peak	Average
0.15 - 0.5	66 - 56	56 - 46
0.50 - 5.0	56	46
5.0 - 30.0	60	50

Note: 1. The lower limit shall apply at the transition frequencies.

2. The limit decreases in line with the logarithm of the frequency in the range of 0.15 to 0.50MHz.

4.2.2 Test Instruments

Description & Manufacturer	Model No.	Serial No.	Cal. Date	Cal. Due
Test Receiver ROHDE & SCHWARZ	ESCI	100613	Nov. 21, 2016	Nov. 20, 2017
RF signal cable (with 10dB PAD) Woken	5D-FB	Cable-cond1-01	Dec. 22, 2016	Dec. 21, 2017
LISN ROHDE & SCHWARZ (EUT)	ESH3-Z5	835239/001	Mar. 10, 2017	Mar. 09, 2018
LISN ROHDE & SCHWARZ (Peripheral)	ESH3-Z5	100311	Jul. 28, 2016	Jul. 27, 2017
Software ADT	BV ADT_Cond_ V7.3.7.3	NA	NA	NA

Note: 1. The calibration interval of the above test instruments is 12 months and the calibrations are traceable to NML/ROC and NIST/USA.

2. The test was performed in HwaYa Shielded Room 1.

3. The VCCI Site Registration No. is C-2040.

4.2.3 Test Procedures

- The EUT was placed 0.4 meters from the conducting wall of the shielded room with EUT being connected to the power mains through a line impedance stabilization network (LISN). Other support units were connected to the power mains through another LISN. The two LISNs provide 50 ohm/ 50uH of coupling impedance for the measuring instrument.
- Both lines of the power mains connected to the EUT were checked for maximum conducted interference.
- The frequency range from 150kHz to 30MHz was searched. Emission levels under (Limit - 20dB) was not recorded.

NOTE: The resolution bandwidth and video bandwidth of test receiver is 9kHz for quasi-peak detection (QP) and average detection (AV) at frequency 0.15MHz-30MHz.

4.2.4 Deviation from Test Standard

No deviation.

4.2.5 Test Setup

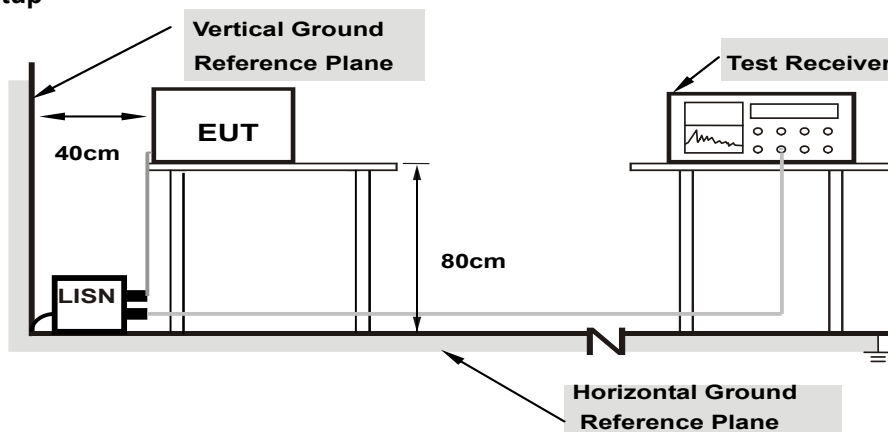

Note: 1.Support units were connected to second LISN.

For the actual test configuration, please refer to the attached file (Test Setup Photo).

4.2.6 EUT Operating Conditions

Same as 4.1.6.

4.2.7 Test Results

Phase	Line (L)	Detector Function	Quasi-Peak (QP) / Average (AV)
Test Mode	A		

No	Freq. [MHz]	Corr. Factor (dB)	Reading Value [dB (uV)]		Emission Level [dB (uV)]		Limit [dB (uV)]		Margin (dB)	
			Q.P.	AV.	Q.P.	AV.	Q.P.	AV.	Q.P.	AV.
			1	0.17430	10.36	26.13	14.36	36.49	24.72	64.75
2	0.41799	10.40	28.20	18.50	38.60	28.90	57.49	47.49	-18.89	-18.59
3	1.09800	10.41	3.67	-1.97	14.08	8.44	56.00	46.00	-41.92	-37.56
4	3.48200	10.54	14.19	1.73	24.73	12.27	56.00	46.00	-31.27	-33.73
5	9.17400	10.79	4.58	-3.05	15.37	7.74	60.00	50.00	-44.63	-42.26
6	18.31000	11.27	4.26	-2.65	15.53	8.62	60.00	50.00	-44.47	-41.38

REMARKS:

1. Q.P. and AV. are abbreviations of quasi-peak and average individually.
2. The emission levels of other frequencies were very low against the limit.
3. Margin value = Emission level - Limit value
4. Correction factor = Insertion loss + Cable loss
5. Emission Level = Correction Factor + Reading Value.

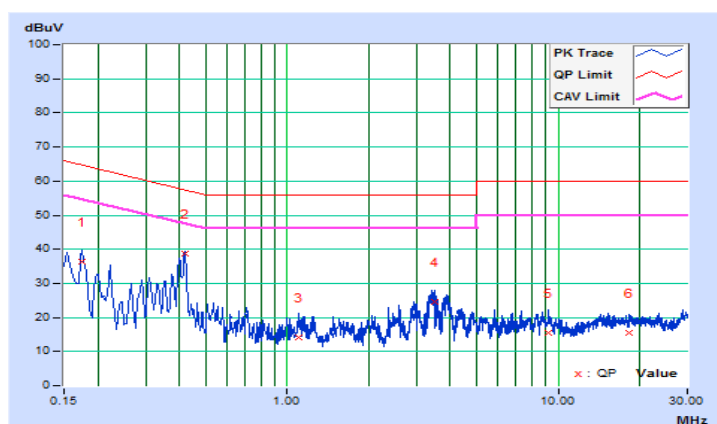

Phase	Neutral (N)	Detector Function	Quasi-Peak (QP) / Average (AV)
Test Mode	A		

No	Freq. [MHz]	Corr. Factor (dB)	Reading Value [dB (uV)]		Emission Level [dB (uV)]		Limit [dB (uV)]		Margin (dB)	
			Q.P.	AV.	Q.P.	AV.	Q.P.	AV.	Q.P.	AV.
			1	0.15800	10.11	27.21	15.75	37.32	25.86	65.57
2	0.42200	10.16	22.82	12.84	32.98	23.00	57.41	47.41	-24.43	-24.41
3	1.12600	10.18	9.79	-0.21	19.97	9.97	56.00	46.00	-36.03	-36.03
4	3.43800	10.31	15.05	1.61	25.36	11.92	56.00	46.00	-30.64	-34.08
5	9.18200	10.52	6.34	-1.71	16.86	8.81	60.00	50.00	-43.14	-41.19
6	18.22600	10.89	5.64	-1.91	16.53	8.98	60.00	50.00	-43.47	-41.02

REMARKS:

1. Q.P. and AV. are abbreviations of quasi-peak and average individually.
2. The emission levels of other frequencies were very low against the limit.
3. Margin value = Emission level - Limit value
4. Correction factor = Insertion loss + Cable loss
5. Emission Level = Correction Factor + Reading Value.

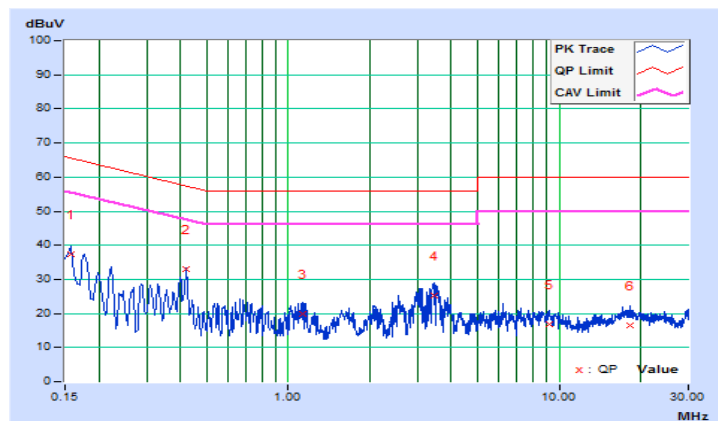

Phase	Line (L)	Detector Function	Quasi-Peak (QP) / Average (AV)
Test Mode	B		

No	Freq. [MHz]	Corr. Factor (dB)	Reading Value [dB (uV)]		Emission Level [dB (uV)]		Limit [dB (uV)]		Margin (dB)	
			Q.P.	AV.	Q.P.	AV.	Q.P.	AV.	Q.P.	AV.
			1	0.15400	10.35	29.66	19.69	40.01	30.04	65.78
2	0.25000	10.38	20.33	12.79	30.71	23.17	61.76	51.76	-31.05	-28.59
3	0.41400	10.40	28.64	21.62	39.04	32.02	57.57	47.57	-18.53	-15.55
4	1.45800	10.43	7.41	0.84	17.84	11.27	56.00	46.00	-38.16	-34.73
5	3.69800	10.55	12.82	4.28	23.37	14.83	56.00	46.00	-32.63	-31.17
6	9.27400	10.80	3.67	-1.56	14.47	9.24	60.00	50.00	-45.53	-40.76

REMARKS:

1. Q.P. and AV. are abbreviations of quasi-peak and average individually.
2. The emission levels of other frequencies were very low against the limit.
3. Margin value = Emission level - Limit value
4. Correction factor = Insertion loss + Cable loss
5. Emission Level = Correction Factor + Reading Value.

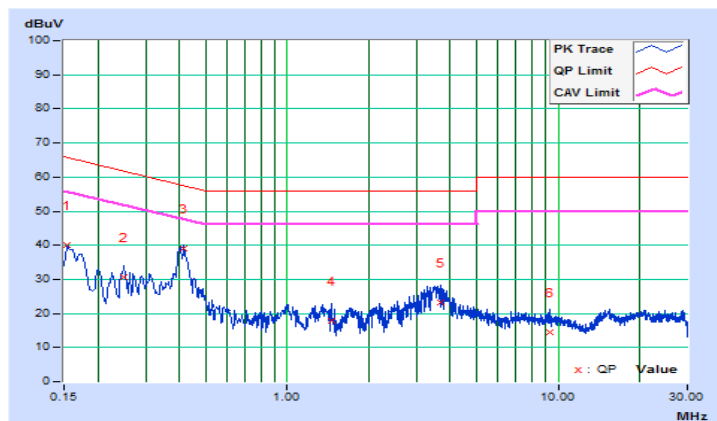

Phase	Neutral (N)	Detector Function	Quasi-Peak (QP) / Average (AV)
Test Mode	B		

No	Freq. [MHz]	Corr. Factor (dB)	Reading Value [dB (uV)]		Emission Level [dB (uV)]		Limit [dB (uV)]		Margin (dB)	
			Q.P.	AV.	Q.P.	AV.	Q.P.	AV.	Q.P.	AV.
			1	0.15000	10.10	28.49	18.11	38.59	28.21	66.00
2	0.19000	10.13	23.24	14.78	33.37	24.91	64.04	54.04	-30.67	-29.13
3	0.27800	10.15	16.78	8.89	26.93	19.04	60.88	50.88	-33.95	-31.84
4	0.41000	10.16	22.93	13.55	33.09	23.71	57.65	47.65	-24.56	-23.94
5	3.37400	10.31	13.98	4.61	24.29	14.92	56.00	46.00	-31.71	-31.08
6	19.44600	10.95	4.76	0.51	15.71	11.46	60.00	50.00	-44.29	-38.54

REMARKS:

1. Q.P. and AV. are abbreviations of quasi-peak and average individually.
2. The emission levels of other frequencies were very low against the limit.
3. Margin value = Emission level - Limit value
4. Correction factor = Insertion loss + Cable loss
5. Emission Level = Correction Factor + Reading Value.

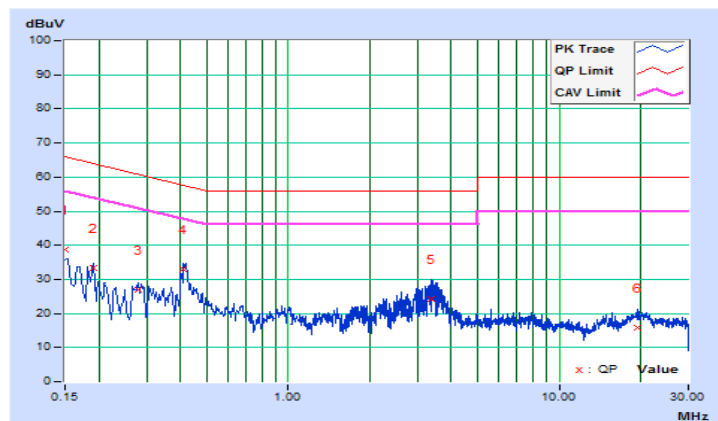

Phase	Line (L)	Detector Function	Quasi-Peak (QP) / Average (AV)
Test Mode	C		

No	Freq. [MHz]	Corr. Factor (dB)	Reading Value [dB (uV)]		Emission Level [dB (uV)]		Limit [dB (uV)]		Margin (dB)	
			Q.P.	AV.	Q.P.	AV.	Q.P.	AV.	Q.P.	AV.
			1	0.17801	10.36	27.17	14.94	37.53	25.30	64.58
2	0.41799	10.40	22.12	13.20	32.52	23.60	57.49	47.49	-24.97	-23.89
3	1.12600	10.41	10.00	-0.34	20.41	10.07	56.00	46.00	-35.59	-35.93
4	3.48200	10.54	13.84	0.64	24.38	11.18	56.00	46.00	-31.62	-34.82
5	8.62600	10.77	6.47	-2.26	17.24	8.51	60.00	50.00	-42.76	-41.49
6	18.61817	11.28	5.72	-1.73	17.00	9.55	60.00	50.00	-43.00	-40.45

REMARKS:

1. Q.P. and AV. are abbreviations of quasi-peak and average individually.
2. The emission levels of other frequencies were very low against the limit.
3. Margin value = Emission level - Limit value
4. Correction factor = Insertion loss + Cable loss
5. Emission Level = Correction Factor + Reading Value.

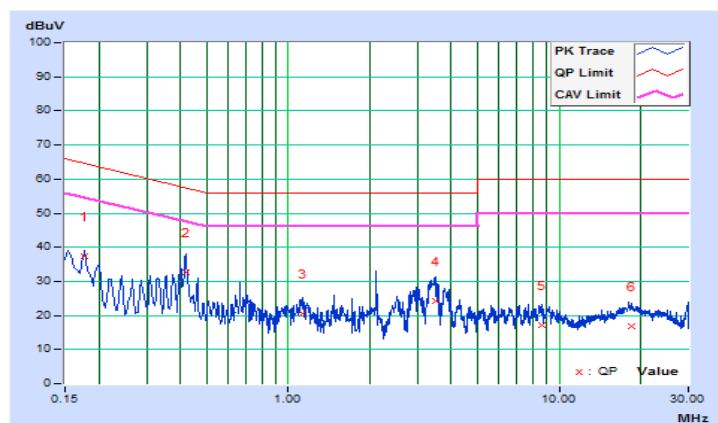

Phase	Neutral (N)	Detector Function	Quasi-Peak (QP) / Average (AV)
Test Mode	C		

No	Freq. [MHz]	Corr. Factor (dB)	Reading Value [dB (uV)]		Emission Level [dB (uV)]		Limit [dB (uV)]		Margin (dB)	
			Q.P.	AV.	Q.P.	AV.	Q.P.	AV.	Q.P.	AV.
			1	0.15400	10.11	31.51	20.20	41.62	30.31	65.78
2	0.41799	10.16	30.24	20.74	40.40	30.90	57.49	47.49	-17.09	-16.59
3	0.70982	10.17	10.80	0.98	20.97	11.15	56.00	46.00	-35.03	-34.85
4	3.43800	10.31	14.43	2.22	24.74	12.53	56.00	46.00	-31.26	-33.47
5	9.26600	10.52	7.04	-1.28	17.56	9.24	60.00	50.00	-42.44	-40.76
6	21.72600	11.00	5.14	-2.04	16.14	8.96	60.00	50.00	-43.86	-41.04

REMARKS:

1. Q.P. and AV. are abbreviations of quasi-peak and average individually.
2. The emission levels of other frequencies were very low against the limit.
3. Margin value = Emission level - Limit value
4. Correction factor = Insertion loss + Cable loss
5. Emission Level = Correction Factor + Reading Value.

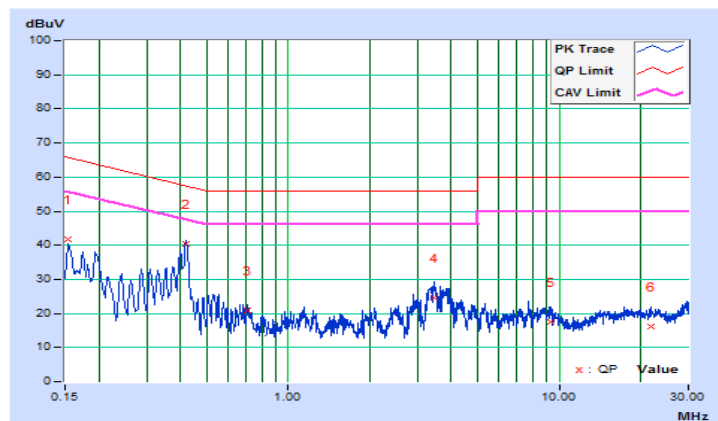

Phase	Line (L)	Detector Function	Quasi-Peak (QP) / Average (AV)
Test Mode	D		

No	Freq. [MHz]	Corr. Factor (dB)	Reading Value [dB (uV)]		Emission Level [dB (uV)]		Limit [dB (uV)]		Margin (dB)	
			Q.P.	AV.	Q.P.	AV.	Q.P.	AV.	Q.P.	AV.
			1	0.16148	10.35	30.70	17.86	41.05	28.21	65.39
2	0.23000	10.37	23.85	15.17	34.22	25.54	62.45	52.45	-28.23	-26.91
3	0.40605	10.40	29.38	21.46	39.78	31.86	57.73	47.73	-17.95	-15.87
4	1.61800	10.44	5.61	0.82	16.05	11.26	56.00	46.00	-39.95	-34.74
5	3.49400	10.54	13.52	4.35	24.06	14.89	56.00	46.00	-31.94	-31.11
6	22.97400	11.45	5.36	1.18	16.81	12.63	60.00	50.00	-43.19	-37.37

REMARKS:

1. Q.P. and AV. are abbreviations of quasi-peak and average individually.
2. The emission levels of other frequencies were very low against the limit.
3. Margin value = Emission level - Limit value
4. Correction factor = Insertion loss + Cable loss
5. Emission Level = Correction Factor + Reading Value.

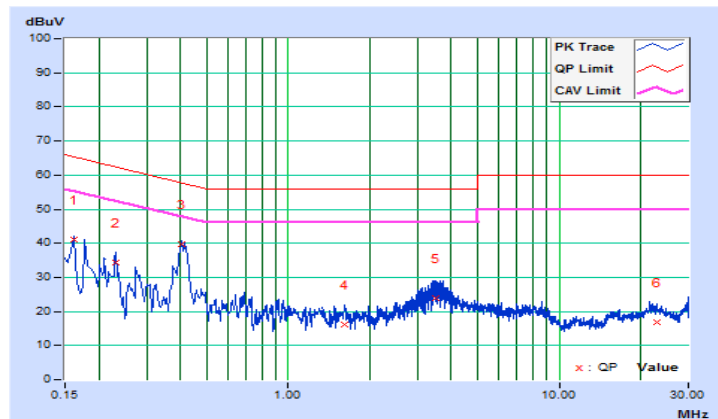

Phase	Neutral (N)	Detector Function	Quasi-Peak (QP) / Average (AV)
Test Mode	D		

No	Freq. [MHz]	Corr. Factor (dB)	Reading Value [dB (uV)]		Emission Level [dB (uV)]		Limit [dB (uV)]		Margin (dB)	
			Q.P.	AV.	Q.P.	AV.	Q.P.	AV.	Q.P.	AV.
			1	0.15979	10.11	31.37	18.09	41.48	28.20	65.47
2	0.41799	10.16	27.56	21.44	37.72	31.60	57.49	47.49	-19.77	-15.89
3	0.65800	10.16	12.35	4.07	22.51	14.23	56.00	46.00	-33.49	-31.77
4	3.44600	10.31	13.90	5.20	24.21	15.51	56.00	46.00	-31.79	-30.49
5	7.41800	10.46	6.99	0.41	17.45	10.87	60.00	50.00	-42.55	-39.13
6	23.05000	11.03	5.99	1.80	17.02	12.83	60.00	50.00	-42.98	-37.17

REMARKS:

1. Q.P. and AV. are abbreviations of quasi-peak and average individually.
2. The emission levels of other frequencies were very low against the limit.
3. Margin value = Emission level - Limit value
4. Correction factor = Insertion loss + Cable loss
5. Emission Level = Correction Factor + Reading Value.

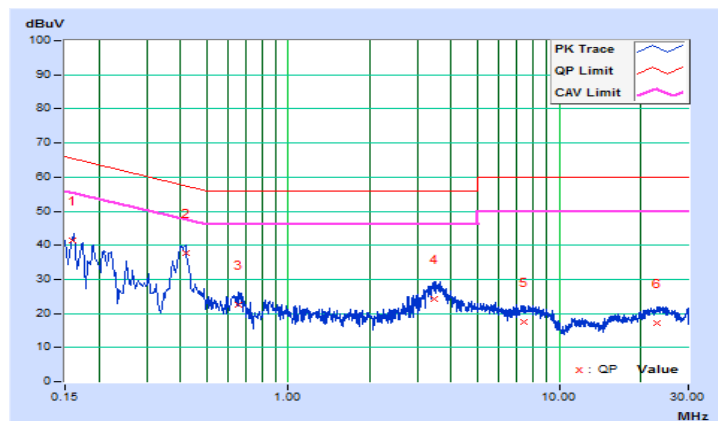

4.3 Transmit Power Measurement

4.3.1 Limits of Transmit Power Measurement

Operation Band	EUT Category		LIMIT
U-NII-1		Outdoor Access Point	1 Watt (30 dBm) (Max. e.i.r.p \leq 125mW(21 dBm) at any elevation angle above 30 degrees as measured from the horizon)
		Fixed point-to-point Access Point	1 Watt (30 dBm)
		Indoor Access Point	1 Watt (30 dBm)
	√	Mobile and Portable client device	250mW (24 dBm)
U-NII-2A		√	250mW (24 dBm) or 11 dBm+10 log B*
U-NII-2C		√	250mW (24 dBm) or 11 dBm+10 log B*
U-NII-3		√	1 Watt (30 dBm)

*B is the 26 dB emission bandwidth in megahertz

Per KDB 662911 Method of conducted output power measurement on IEEE 802.11 devices,

Array Gain = 0 dB (i.e., no array gain) for $N_{ANT} \leq 4$;

Array Gain = 0 dB (i.e., no array gain) for channel widths ≥ 40 MHz for any N_{ANT} ;

Array Gain = $5 \log(N_{ANT}/N_{SS})$ dB or 3 dB, whichever is less for 20-MHz channel widths with $N_{ANT} \geq 5$.

For power measurements on all other devices: Array Gain = $10 \log(N_{ANT}/N_{SS})$ dB.

4.3.2 Test Setup

For Power Output

802.11a, 802.11n (HT20), 802.11n (HT40)

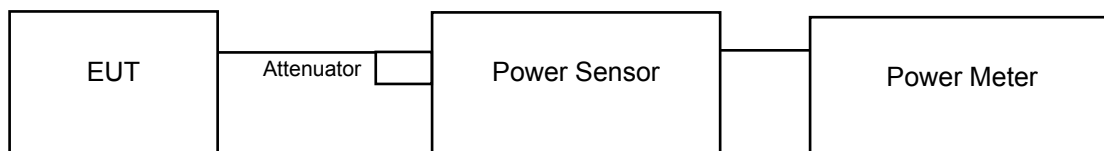

802.11ac (VHT80)

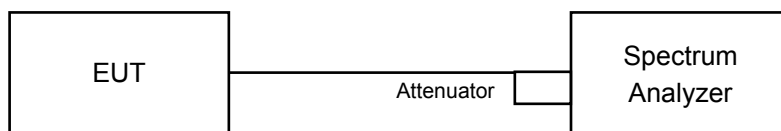

For 26dB and Occupied Bandwidth

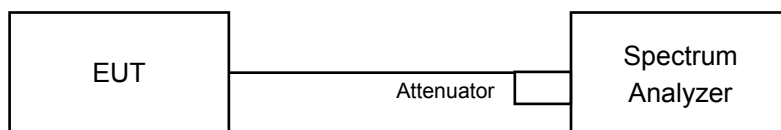

4.3.3 Test Instruments

Refer to section 4.1.2 to get information of above instrument.

4.3.4 Test Procedure

For Average Power Measurement

For 802.11a, 802.11n (HT20), 802.11n (HT40)

Method PM is used to perform output power measurement, trigger and gating function of wide band power meter is enabled to measure max output power of TX on burst. Duty factor is not added to measured value.

For 802.11ac (VHT80)

- Set span to encompass the entire 26 dB EBW (or, alternatively, the entire 99% occupied bandwidth) of the signal.
- Set sweep trigger to "free run".
- Set RBW = 1 MHz
- Set VBW \geq 3 MHz
- Number of points in sweep \geq 2 Span / RBW
- Sweep time \leq (number of points in sweep) * T
- Using emission bandwidth to determine the frequency span for integration the channel bandwidth.
- Detector = RMS
- Trace mode = max hold
- Allow max hold to run for at least 60 seconds, or longer as needed to allow the trace to stabilize.
- Compute power by integrating the spectrum across the EBW (or, alternatively, the entire 99% occupied bandwidth) of the signal using the instrument's band power measurement function with band limits set equal to the EBW (or occupied bandwidth) band edges. If the instrument does not have a band power function, sum the spectrum levels (in power units) at 1 MHz intervals extending across the EBW (or, alternatively, the entire 99% occupied bandwidth) of the spectrum.

For 26dB Bandwidth

- Set RBW = approximately 1% of the emission bandwidth.
- Set the VBW > RBW.
- Detector = Peak.
- Trace mode = max hold.
- Measure the maximum width of the emission that is 26 dB down from the peak of the emission. Compare this with the RBW setting of the analyzer. Readjust RBW and repeat measurement as needed until the RBW/EBW ratio is approximately 1%.

For Occupied Bandwidth

The transmitter output was connected to the spectrum analyzer through an attenuator. The bandwidth of the fundamental frequency was measured by spectrum analyzer with resolution bandwidth in the range of 1% to 5% of the anticipated emission bandwidth, and a video bandwidth at least 3x the resolution bandwidth and set the detector to Sampling. The width of a frequency band such that, below the lower and above the upper frequency limits, the mean powers emitted are each equal to a specified percentage 0.5 % of the total mean power of a given emission.

4.3.5 Deviation from Test Standard

No deviation.

4.3.6 EUT Operating Conditions

The software provided by client to enable the EUT under transmission condition continuously at lowest, middle and highest channel frequencies individually.

4.3.7 Test Result

Power Output:

802.11a

Chan.	Freq. (MHz)	Conducted Power (mW)	Conducted Power (dBm)	Power Limit (dBm)	Pass / Fail
36	5180	60.954	17.85	24.00	Pass
40	5200	61.944	17.92	24.00	Pass
48	5240	60.674	17.83	24.00	Pass
52	5260	69.823	18.44	24.00	Pass
60	5300	70.469	18.48	24.00	Pass
64	5320	69.343	18.41	24.00	Pass
100	5500	48.865	16.89	24.00	Pass
116	5580	49.659	16.96	24.00	Pass
140	5700	48.978	16.90	24.00	Pass
144	5720 For U-NII-2C	31.550	14.99	24.00	Pass
144	5720 For U-NII-3	8.551	9.32	30.00	Pass
149	5745	49.431	16.94	30.00	Pass
157	5785	55.590	17.45	30.00	Pass
165	5825	55.847	17.47	30.00	Pass

Note:

For U-NII-2A, U-NII-2C Band:

- $11\text{dBm} + 10\log(25.51) = 25.07\text{ dBm} > 24\text{dBm}$
- $11\text{dBm} + 10\log(30.40) = 25.83\text{ dBm} > 24\text{dBm}$
- $11\text{dBm} + 10\log(22.94) = 24.61\text{ dBm} > 24\text{dBm}$
- $11\text{dBm} + 10\log(27.99) = 25.47\text{ dBm} > 24\text{dBm}$
- $11\text{dBm} + 10\log(36.91) = 26.67\text{ dBm} > 24\text{dBm}$
- $11\text{dBm} + 10\log(28.40) = 25.53\text{ dBm} > 24\text{dBm}$
- $11\text{dBm} + 10\log(5725.00 - 5700.44) = 24.90\text{ dBm} > 24\text{dBm}$.

For Reference only-Power meter value

The power value was measured by power meter with average sensor

Chan.	Freq. (MHz)	Conducted Power (mW)	Conducted Power (dBm)
144	5720	40.101	16.03

802.11n (HT20)

Chan.	Freq. (MHz)	Conducted Power (mW)	Conducted Power (dBm)	Power Limit (dBm)	Pass / Fail
36	5180	59.841	17.77	24.00	Pass
40	5200	60.395	17.81	24.00	Pass
48	5240	59.566	17.75	24.00	Pass
52	5260	57.943	17.63	24.00	Pass
60	5300	59.429	17.74	24.00	Pass
64	5320	66.374	18.22	24.00	Pass
100	5500	47.315	16.75	24.00	Pass
116	5580	44.361	16.47	24.00	Pass
140	5700	47.534	16.77	24.00	Pass
144	5720 For U-NII-2C	30.549	14.85	24.00	Pass
144	5720 For U-NII-3	9.162	9.62	30.00	Pass
149	5745	54.075	17.33	30.00	Pass
157	5785	54.450	17.36	30.00	Pass
165	5825	54.325	17.35	30.00	Pass

Note:

For U-NII-2A, U-NII-2C Band:

- $11\text{dBm} + 10\log(27.54) = 25.40\text{ dBm} > 24\text{dBm}$
- $11\text{dBm} + 10\log(29.59) = 25.71\text{ dBm} > 24\text{dBm}$
- $11\text{dBm} + 10\log(22.72) = 24.56\text{ dBm} > 24\text{dBm}$
- $11\text{dBm} + 10\log(24.33) = 24.86\text{ dBm} > 24\text{dBm}$
- $11\text{dBm} + 10\log(39.59) = 26.98\text{ dBm} > 24\text{dBm}$
- $11\text{dBm} + 10\log(23.05) = 24.63\text{ dBm} > 24\text{dBm}$
- $11\text{dBm} + 10\log(5725.00 - 5698.36) = 25.26\text{ dBm} > 24\text{dBm}$.

For Reference only-Power meter value

The power value was measured by power meter with average sensor

Chan.	Freq. (MHz)	Conducted Power (mW)	Conducted Power (dBm)
144	5720	47.753	16.79

802.11n (HT40)

Chan.	Freq. (MHz)	Conducted Power (mW)	Conducted Power (dBm)	Power Limit (dBm)	Pass / Fail
38	5190	50.816	17.06	24.00	Pass
46	5230	65.013	18.13	24.00	Pass
54	5270	57.677	17.61	24.00	Pass
62	5310	41.976	16.23	24.00	Pass
102	5510	36.559	15.63	24.00	Pass
110	5550	44.875	16.52	24.00	Pass
134	5670	45.082	16.54	24.00	Pass
142	5710 For U-NII-2C	28.576	14.56	24.00	Pass
142	5710 For U-NII-3	2.296	3.61	30.00	Pass
151	5755	66.527	18.23	30.00	Pass
159	5795	68.077	18.33	30.00	Pass

Note:

For U-NII-2A, U-NII-2C Band:

- $11\text{dBm} + 10\log(47.54) = 27.77\text{ dBm} > 24\text{dBm}$
- $11\text{dBm} + 10\log(45.49) = 27.58\text{ dBm} > 24\text{dBm}$
- $11\text{dBm} + 10\log(46.45) = 27.67\text{ dBm} > 24\text{dBm}$
- $11\text{dBm} + 10\log(69.81) = 29.44\text{ dBm} > 24\text{dBm}$
- $11\text{dBm} + 10\log(82.96) = 30.19\text{ dBm} > 24\text{dBm}$
- $11\text{dBm} + 10\log(5725.00 - 5667.57) = 28.59\text{ dBm} > 24\text{dBm}$.

For Reference only-Power meter value

The power value was measured by power meter with average sensor

Chan.	Freq. (MHz)	Conducted Power (mW)	Conducted Power (dBm)
142	5710	47.098	16.73

802.11ac (VHT80)

Chan.	Freq. (MHz)	Conducted Power (mW)	Conducted Power (dBm)	Power Limit (dBm)	Pass / Fail
42	5210	55.719	17.46	24.00	Pass
58	5290	54.325	17.35	24.00	Pass
106	5530	43.752	16.41	24.00	Pass
138	5690 For U-NII-2C	27.669	14.42	24.00	Pass
138	5690 For U-NII-3	0.6026	-2.20	24.00	Pass
155	5775	65.464	18.16	30.00	Pass

Note:

For U-NII-2A, U-NII-2C Band:

1. $11\text{dBm} + 10\log(84.60) = 30.27\text{ dBm} > 24\text{dBm}$
2. $11\text{dBm} + 10\log(84.94) = 30.29\text{ dBm} > 24\text{dBm}$
3. $11\text{dBm} + 10\log(5725.00 - 5619.58) = 31.23\text{ dBm} > 24\text{dBm}$.

For Reference only-Power meter value

The power value was measured by power meter with average sensor

Chan.	Freq. (MHz)	Conducted Power (mW)	Conducted Power (dBm)
138	5690	57.810	17.62

26dB Bandwidth:

802.11a

Channel	Frequency (MHz)	26dBc Bandwidth (MHz)
36	5180	25.13
40	5200	28.95
48	5240	26.72
52	5260	25.51
60	5300	30.40
64	5320	22.94
100	5500	27.99
116	5580	36.91
140	5700	28.40
144	5720 For U-NII-2C	24.56

802.11n (HT20)

Channel	Frequency (MHz)	26dBc Bandwidth (MHz)
36	5180	28.20
40	5200	28.38
48	5240	28.84
52	5260	27.54
60	5300	29.59
64	5320	22.72
100	5500	24.33
116	5580	39.59
140	5700	23.05
144	5720 For U-NII-2C	26.64

802.11n (HT40)

Channel	Frequency (MHz)	26dBc Bandwidth (MHz)
38	5190	45.98
46	5230	56.04
54	5270	47.54
62	5310	45.49
102	5510	46.45
110	5550	69.81
134	5670	82.96
142	5710 For U-NII-2C	57.43

802.11ac (VHT80)

Channel	Frequency (MHz)	26dBc Bandwidth (MHz)
42	5210	84.62
58	5290	84.60
106	5530	84.94
138	5690 For U-NII-2C	105.42

Spectrum Plot of Worst Value

802.11a

802.11n (HT20)

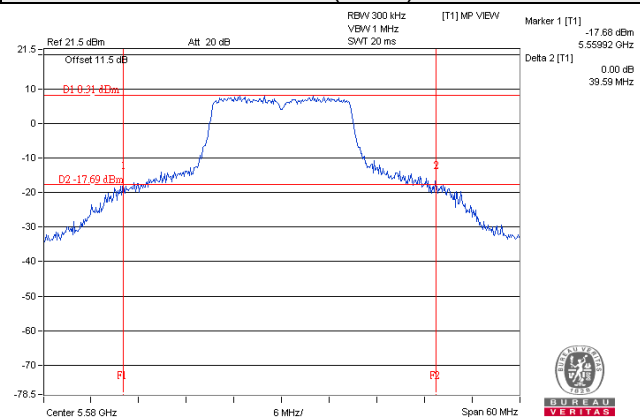
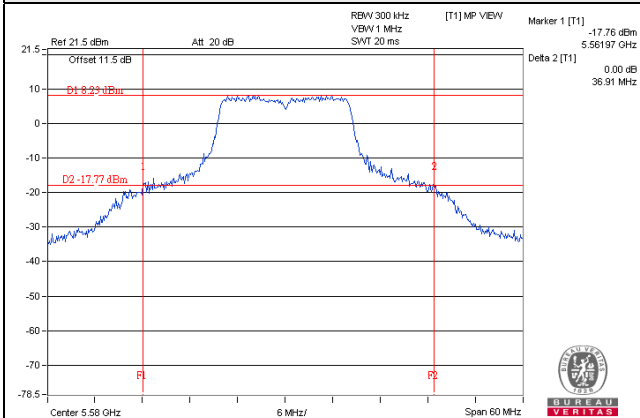

802.11n (HT40)

802.11ac (VHT80)

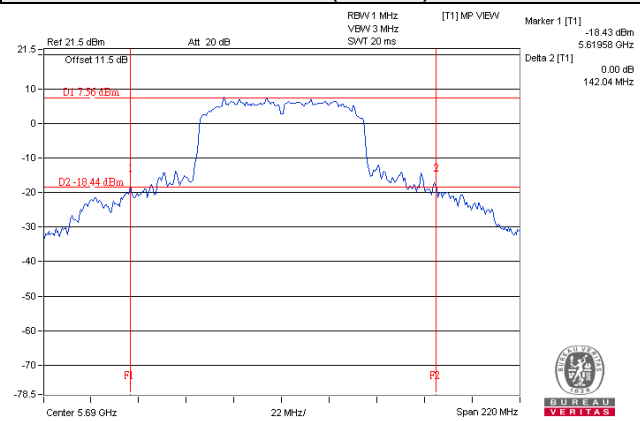
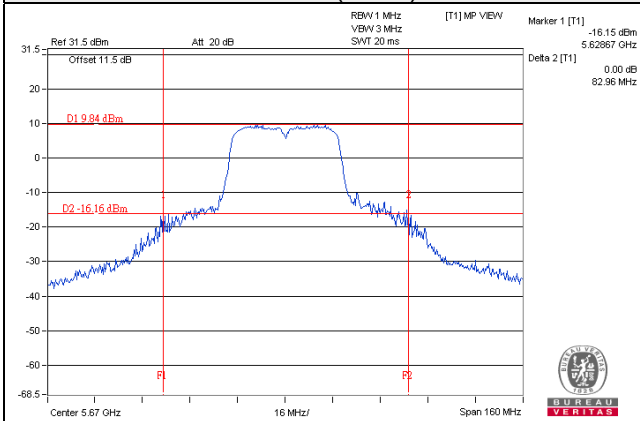

EUT Maximum Conducted Power

802.11a

Frequency Band (MHz)	Max. Power	
	Output Power (mW)	Output Power (dBm)
5250~5350	70.469	18.48
5470~5725	49.659	16.96

Note: Manufacturer provides Transmit Power Control description to meet this requirement.

802.11n (HT20)

Frequency Band (MHz)	Max. Power	
	Output Power (mW)	Output Power (dBm)
5250~5350	66.374	18.22
5470~5725	47.534	16.77

Note: Manufacturer provides Transmit Power Control description to meet this requirement.

802.11n (HT40)

Frequency Band (MHz)	Max. Power	
	Output Power (mW)	Output Power (dBm)
5250~5350	57.677	17.61
5470~5725	45.082	16.54

Note: Manufacturer provides Transmit Power Control description to meet this requirement.

802.11ac (VHT80)

Frequency Band (MHz)	Max. Power	
	Output Power (mW)	Output Power (dBm)
5250~5350	54.325	17.35
5470~5725	43.752	16.41

Note: Manufacturer provides Transmit Power Control description to meet this requirement.

4.4 Occupied Bandwidth Measurement

4.4.1 Test Setup

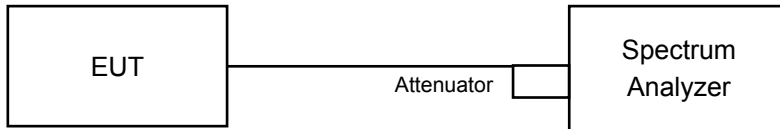

4.4.2 Test Instruments

Refer to section 4.1.2 to get information of above instrument.

4.4.3 Test Procedure

The transmitter output was connected to the spectrum analyzer through an attenuator. The bandwidth of the fundamental frequency was measured by spectrum analyzer with resolution bandwidth in the range of 1% to 5% of the anticipated emission bandwidth, and a video bandwidth at least 3x the resolution bandwidth and set the detector to sampling. The width of a frequency band such that, below the lower and above the upper frequency limits, the mean powers emitted are each equal to a specified percentage 0.5 %of the total mean power of a given emission.

4.4.4 Test Result

802.11a

Channel	Frequency (MHz)	Occupied Bandwidth (MHz)
36	5180	17.40
40	5200	17.40
48	5240	17.40
52	5260	17.40
60	5300	17.40
64	5320	17.28
100	5500	17.40
116	5580	18.12
140	5700	17.40
144	5720 For U-NII-2C	14.72
144	5720 For U-NII-3	4.96
149	5745	20.44
157	5785	22.92
165	5825	24.48

802.11n (HT20)

Channel	Frequency (MHz)	Occupied Bandwidth (MHz)
36	5180	18.24
40	5200	18.36
48	5240	18.36
52	5260	17.40
60	5300	18.36
64	5320	18.12
100	5500	18.24
116	5580	19.08
140	5700	17.28
144	5720 For U-NII-2C	15.20
144	5720 For U-NII-3	5.32
149	5745	24.00
157	5785	25.68
165	5825	26.76

802.11n (HT40)

Channel	Frequency (MHz)	Occupied Bandwidth (MHz)
38	5190	36.60
46	5230	36.84
54	5270	36.72
62	5310	36.60
102	5510	36.72
110	5550	36.84
134	5670	36.96
142	5710 For U-NII-2C	33.72
142	5710 For U-NII-3	3.72
151	5755	37.56
159	5795	37.92

802.11ac (VHT80)

Channel	Frequency (MHz)	Occupied Bandwidth (MHz)
42	5210	74.64
58	5290	74.64
106	5530	74.64
138	5690 For U-NII-2C	72.68
138	5690 For U-NII-3	2.68
155	5775	75.60

Spectrum Plot of Worst Value

802.11a

802.11n (HT20)

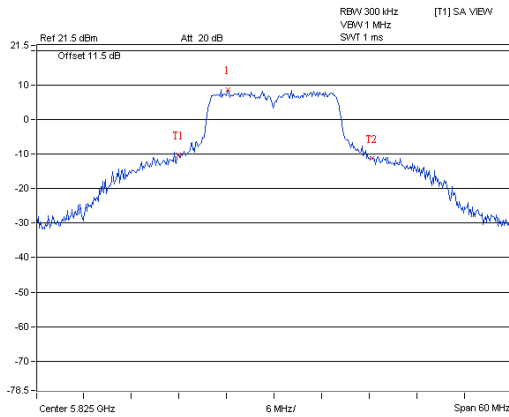

Marker 1 [T1]
8.63 dBm
5.81912 GHz
OBW 24.48 MHz
Temp 1 [T1] OBW -13.23 dBm
5.81288 GHz
Temp 2 [T1] OBW -11.19 dBm
5.83736 GHz

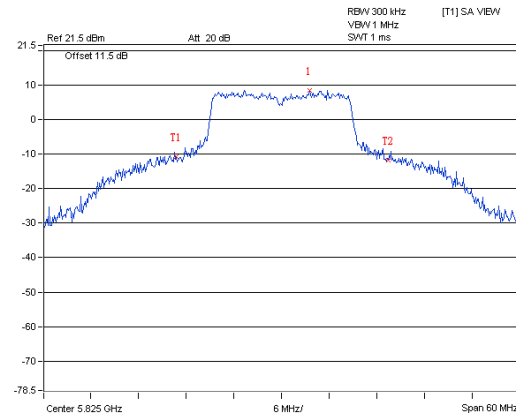

Marker 1 [T1]
8.45 dBm
5.82948 GHz
OBW 26.76 MHz
Temp 1 [T1] OBW -10.89 dBm
5.81168 GHz
Temp 2 [T1] OBW -11.78 dBm
5.83844 GHz

802.11n (HT40)

802.11ac (VHT80)

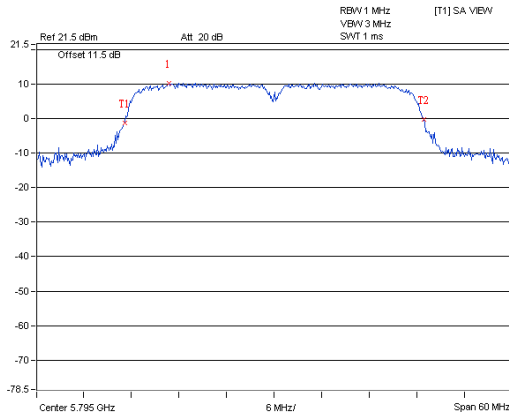

Marker 1 [T1]
10.31 dBm
5.78168 GHz
OBW 37.92 MHz
Temp 1 [T1] OBW -1.15 dBm
5.77604 GHz
Temp 2 [T1] OBW -3.38 dBm
5.81386 GHz

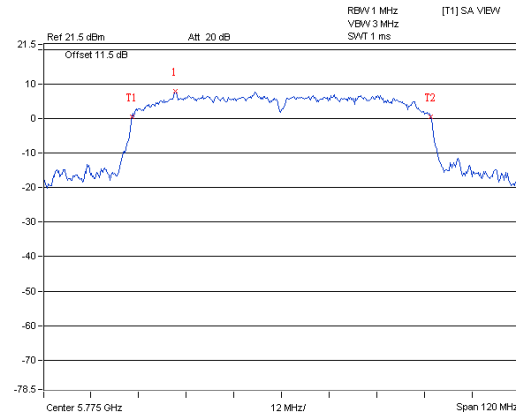

Marker 1 [T1]
7.93 dBm
5.74812 GHz
OBW 75.60 MHz
Temp 1 [T1] OBW 0.83 dBm
5.73708 GHz
Temp 2 [T1] OBW 0.57 dBm
5.81286 GHz

4.5 Peak Power Spectral Density Measurement

4.5.1 Limits of Peak Power Spectral Density Measurement

Operation Band	EUT Category		LIMIT
U-NII-1		Outdoor Access Point	17dBm/ MHz
		Fixed point-to-point Access Point	
		Indoor Access Point	
	√	Mobile and Portable client device	11dBm/ MHz
U-NII-2A		√	11dBm/ MHz
U-NII-2C		√	11dBm/ MHz
U-NII-3		√	30dBm/ 500kHz

4.5.2 Test Setup

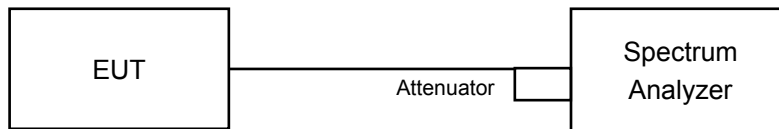

4.5.3 Test Instruments

Refer to section 4.1.2 to get information of above instrument.

4.5.4 Test Procedures

For U-NII-1, U-NII-2A, U-NII-2C band:

Duty cycle of test signal is $\geq 98\%$

Using method SA-1

- 1) Set span to encompass the entire emission bandwidth (EBW) of the signal.
- 2) Set RBW = 1MHz, Set VBW ≥ 3 MHz, Detector = RMS
- 3) Set Channel power measure = 1MHz
- 4) Sweep time = auto, trigger set to "free run".
- 5) Trace average at least 100 traces in power averaging mode.
- 6) Record the max value

For U-NII-3 band:

Duty cycle of test signal is $\geq 98\%$

Using method SA-1

- 1) Set span to encompass the entire emission bandwidth (EBW) of the signal.
- 2) Set RBW = 300 kHz, Set VBW ≥ 1 MHz, Detector = RMS.
- 3) Use the peak marker function to determine the maximum power level in any 300 kHz band segment within the fundamental EBW.
- 4) Scale the observed power level to an equivalent value in 500 kHz by adjusting (reducing) the measured 1) power by a bandwidth correction factor (BWCF) where $BWCF = 10\log(500 \text{ kHz} / 300 \text{ kHz})$.
- 5) Sweep time = auto, trigger set to "free run".
- 6) Trace average at least 100 traces in power averaging mode.
- 7) Record the max value.

4.5.5 Deviation from Test Standard

No deviation.

4.5.6 EUT Operating Conditions

Same as 4.3.6.

4.5.7 Test Results

For U-NII-1, U-NII-2A, U-NII-2C band

802.11a

Chan.	Freq. (MHz)	PSD (dBm/MHz)	Max. Limit (dBm/MHz)	Pass / Fail
36	5180	3.63	11	Pass
40	5200	3.97	11	Pass
48	5240	4.00	11	Pass
52	5260	4.00	11	Pass
60	5300	3.68	11	Pass
64	5320	1.83	11	Pass
100	5500	1.79	11	Pass
116	5580	3.61	11	Pass
140	5700	2.00	11	Pass
144	5720 For U-NII-2C	3.31	11	Pass

802.11n (HT20)

Chan.	Freq. (MHz)	PSD (dBm/MHz)	Max. Limit (dBm/MHz)	Pass / Fail
36	5180	3.32	11	Pass
40	5200	3.86	11	Pass
48	5240	4.01	11	Pass
52	5260	4.16	11	Pass
60	5300	3.75	11	Pass
64	5320	1.46	11	Pass
100	5500	0.72	11	Pass
116	5580	3.26	11	Pass
140	5700	1.09	11	Pass
144	5720 For U-NII-2C	3.04	11	Pass

802.11n (HT40)

Chan.	Freq. (MHz)	PSD (dBm/MHz)	Max. Limit (dBm/MHz)	Pass / Fail
38	5190	-2.36	11	Pass
46	5230	0.03	11	Pass
54	5270	0.11	11	Pass
62	5310	-4.06	11	Pass
102	5510	-6.28	11	Pass
110	5550	-0.94	11	Pass
134	5670	-0.89	11	Pass
142	5710 For U-NII-2C	-0.70	11	Pass

802.11ac (VHT80)

Chan.	Freq. (MHz)	PSD (dBm/MHz)	Max. Limit (dBm/MHz)	Pass / Fail
42	5210	-5.53	11	Pass
58	5290	-5.68	11	Pass
106	5530	-7.04	11	Pass
138	5690 For U-NII-2C	-3.13	11	Pass

Spectrum Plot of Worst Value

802.11a / CH 48

802.11n (HT20) / CH 52

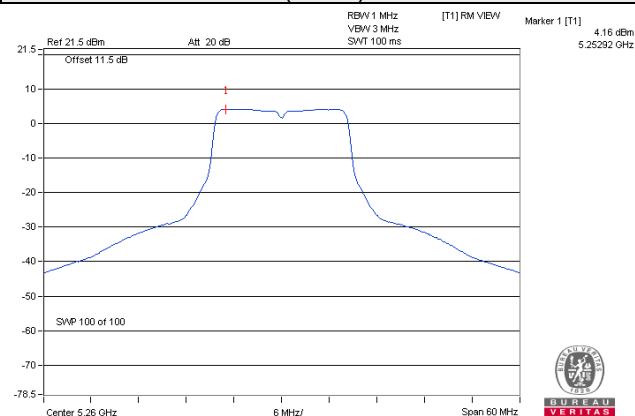
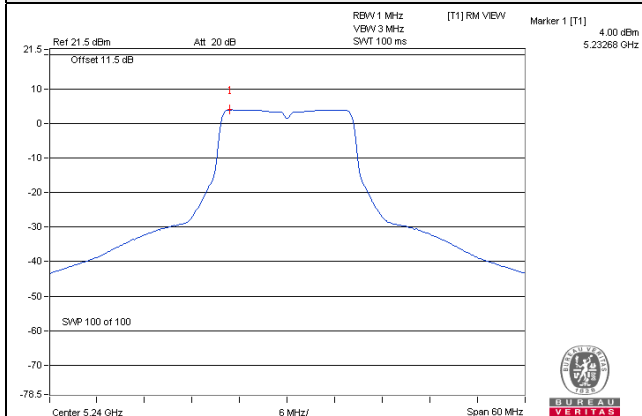

802.11n (HT40) / CH 54

802.11ac (VHT80) / CH 138

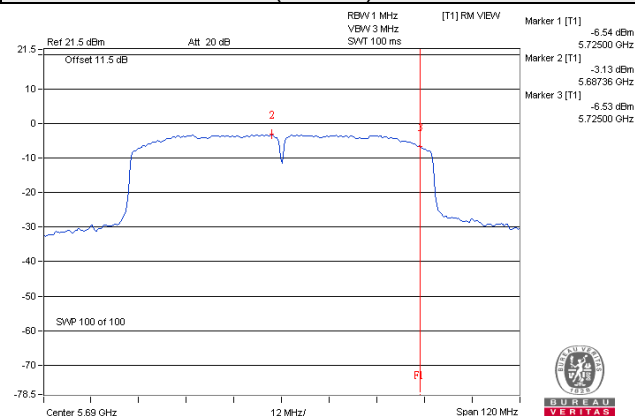
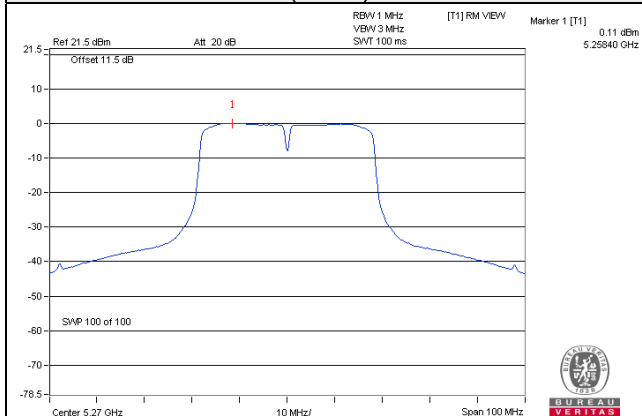

For U-NII-3 band:

802.11a

Chan.	Freq. (MHz)	PSD		Limit (dBm/500kHz)	Pass / Fail
		(dBm/300kHz)	(dBm/500kHz)		
144	5720 For U-NII-3	-5.11	-2.89	30.00	Pass
149	5745	-4.05	-1.83	30.00	Pass
157	5785	-3.85	-1.63	30.00	Pass
165	5825	-3.78	-1.56	30.00	Pass

802.11n (HT20)

Chan.	Freq. (MHz)	PSD		Limit (dBm/500kHz)	Pass / Fail
		(dBm/300kHz)	(dBm/500kHz)		
144	5720 For U-NII-3	-5.30	-3.08	30.00	Pass
149	5745	-4.17	-1.95	30.00	Pass
157	5785	-4.04	-1.82	30.00	Pass
165	5825	-4.17	-1.95	30.00	Pass

802.11n (HT40)

Chan.	Freq. (MHz)	PSD		Limit (dBm/500kHz)	Pass / Fail
		(dBm/300kHz)	(dBm/500kHz)		
142	5710 For U-NII-3	-9.90	-7.68	30.00	Pass
151	5755	-8.27	-6.05	30.00	Pass
159	5795	-8.14	-5.92	30.00	Pass

802.11ac (VHT80)

Chan.	Freq. (MHz)	PSD		Limit (dBm/500kHz)	Pass / Fail
		(dBm/300kHz)	(dBm/500kHz)		
138	5690 For U-NII-3	-14.73	-12.51	30.00	Pass
151	5755	-10.92	-8.70	30.00	Pass

Spectrum Plot of Worst Value

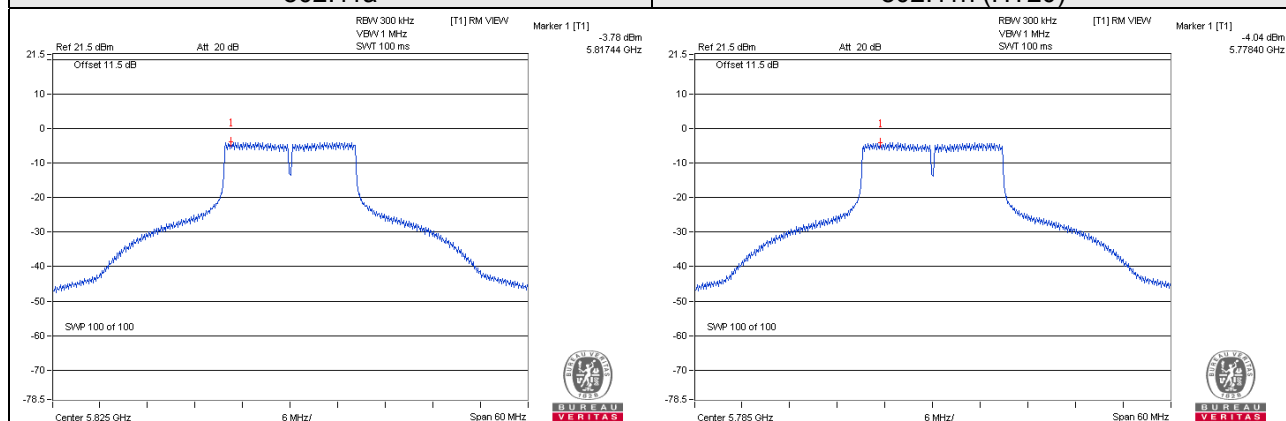

802.11n (HT40) and 802.11ac (VHT80)

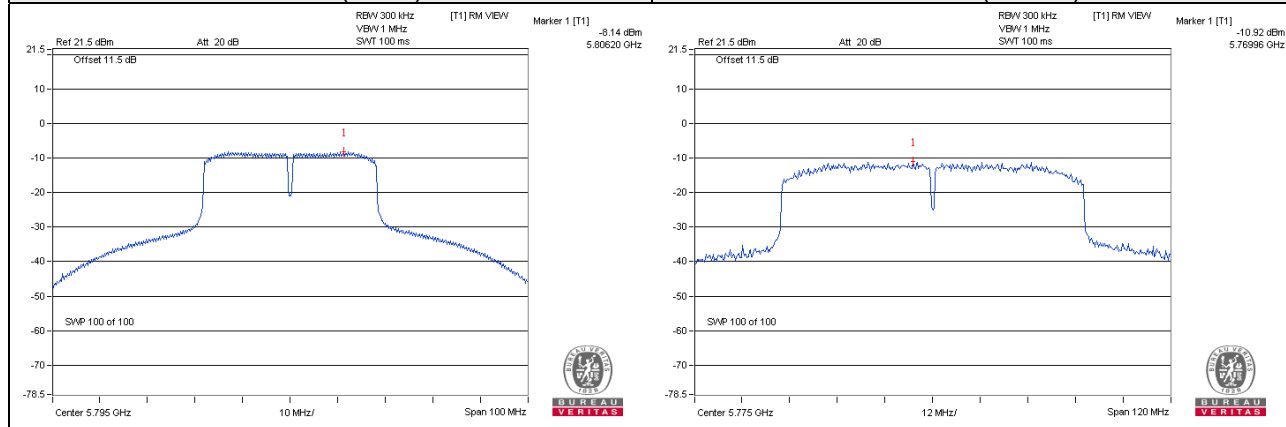

4.6 Frequency Stability

4.6.1 Limits of Frequency Stability Measurement

The frequency of the carrier signal shall be maintained within band of operation

4.6.2 Test Setup

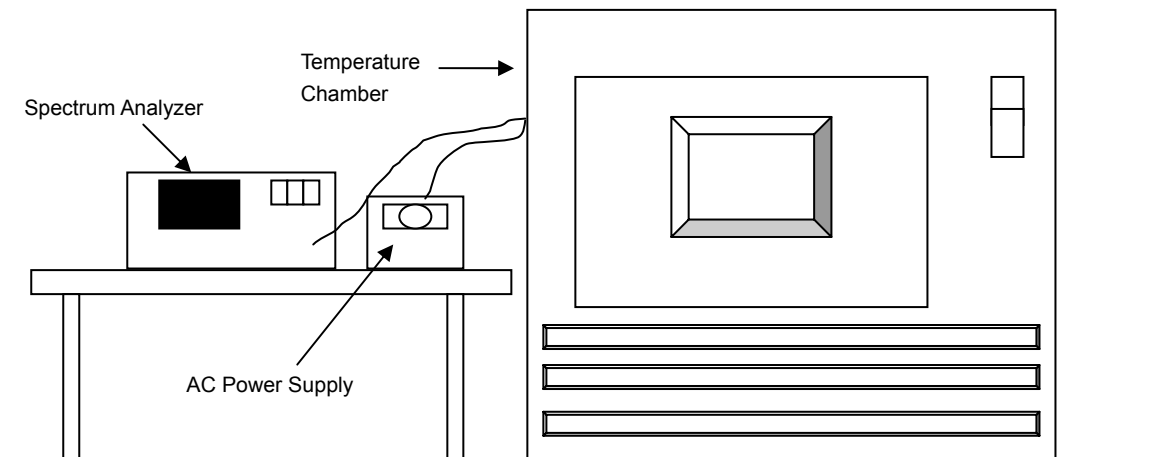

4.6.3 Test Instruments

Refer to section 4.1.2 to get information of above instrument.

4.6.4 Test Procedure

- The EUT was placed inside the environmental test chamber and powered by nominal AC voltage.
- Turn the EUT on and couple its output to a spectrum analyzer.
- Turn the EUT off and set the chamber to the highest temperature specified.
- Allow sufficient time (approximately 30 min) for the temperature of the chamber to stabilize, turn the EUT on and measure the operating frequency after 2, 5, and 10 minutes.
- Repeat step 2 and 3 with the temperature chamber set to the lowest temperature.
- The test chamber was allowed to stabilize at +20 degree C for a minimum of 30 minutes. The supply voltage was then adjusted on the EUT from 85% to 115% and the frequency record.

4.6.5 Deviation from Test Standard

No deviation.

4.6.6 EUT Operating Condition

Set the EUT transmit at un-modulation mode to test frequency stability.

4.6.7 Test Results

Frequency Stability Versus Temp.									
Operating Frequency: 5180MHz									
Temp. (°C)	Power Supply (Vac)	0 Minute		2 Minute		5 Minute		10 Minute	
		Measured Frequency (MHz)	Frequency Drift (%)	Measured Frequency (MHz)	Frequency Drift (%)	Measured Frequency (MHz)	Frequency Drift (%)	Measured Frequency (MHz)	Frequency Drift (%)
50	120	5179.9758	-0.00047	5179.9738	-0.00051	5179.9757	-0.00047	5179.9753	-0.00048
40	120	5180.0095	0.00018	5180.0068	0.00013	5180.0055	0.00011	5180.0064	0.00012
30	120	5180.0009	0.00002	5180.0037	0.00007	5180.0039	0.00008	5180.0046	0.00009
20	120	5179.9873	-0.00025	5179.9865	-0.00026	5179.9853	-0.00028	5179.9862	-0.00027
10	120	5179.9921	-0.00015	5179.9913	-0.00017	5179.9873	-0.00025	5179.9909	-0.00018
0	120	5180.0023	0.00004	5179.9977	-0.00004	5179.9987	-0.00003	5180.0021	0.00004
-10	120	5179.9971	-0.00006	5179.9929	-0.00014	5179.9953	-0.00009	5179.9933	-0.00013
-20	120	5180.0134	0.00026	5180.0134	0.00026	5180.0134	0.00026	5180.0157	0.00030
-30	120	5180.0052	0.00010	5180.0069	0.00013	5180.0057	0.00011	5180.0064	0.00012

Frequency Stability Versus Voltage									
Operating Frequency: 5180MHz									
Temp. (°C)	Power Supply (Vac)	0 Minute		2 Minute		5 Minute		10 Minute	
		Measured Frequency (MHz)	Frequency Drift (%)	Measured Frequency (MHz)	Frequency Drift (%)	Measured Frequency (MHz)	Frequency Drift (%)	Measured Frequency (MHz)	Frequency Drift (%)
20	138	5179.9883	-0.00023	5179.986	-0.00027	5179.9848	-0.00029	5179.9852	-0.00029
	120	5179.9873	-0.00025	5179.9865	-0.00026	5179.9853	-0.00028	5179.9862	-0.00027
	102	5179.9881	-0.00023	5179.9866	-0.00026	5179.9853	-0.00028	5179.9863	-0.00026

4.7 6dB Bandwidth Measurement

4.7.1 Limits of 6dB Bandwidth Measurement

The minimum of 6dB Bandwidth Measurement is 0.5MHz.

4.7.2 Test Setup

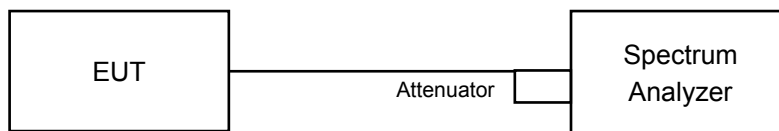

4.7.3 Test Instruments

Refer to section 4.1.2 to get information of above instrument.

4.7.4 Test Procedure

Measurement Procedure REF

- Set resolution bandwidth (RBW) = 100kHz
- Set the video bandwidth (VBW) $\geq 3 \times$ RBW, Detector = Peak.
- Trace mode = max hold.
- Sweep = auto couple.
- Measure the maximum width of the emission that is constrained by the frequencies associated with the two amplitude points (upper and lower) that are attenuated by 6 dB relative to the maximum level measured in the fundamental emission

4.7.5 Deviation from Test Standard

No deviation.

4.7.6 EUT Operating Condition

The software provided by client to enable the EUT under transmission condition continuously at lowest, middle and highest channel frequencies individually.

4.7.7 Test Results

802.11a

Channel	Frequency (MHz)	6dB Bandwidth (MHz)	Minimum Limit (MHz)	Pass / Fail
144	5720 For U-NII-3	3.17	0.5	Pass
149	5745	16.40	0.5	Pass
157	5785	16.41	0.5	Pass
165	5825	16.41	0.5	Pass

802.11n (HT20)

Channel	Frequency (MHz)	6dB Bandwidth (MHz)	Minimum Limit (MHz)	Pass / Fail
144	5720 For U-NII-3	3.78	0.5	Pass
149	5745	17.64	0.5	Pass
157	5785	17.62	0.5	Pass
165	5825	17.62	0.5	Pass

802.11n (HT40)

Channel	Frequency (MHz)	6dB Bandwidth (MHz)	Minimum Limit (MHz)	Pass / Fail
142	5710 For U-NII-3	2.67	0.5	Pass
151	5755	35.25	0.5	Pass
159	5795	35.34	0.5	Pass

802.11ac (VHT80)

Channel	Frequency (MHz)	6dB Bandwidth (MHz)	Minimum Limit (MHz)	Pass / Fail
138	5690 For U-NII-3	2.63	0.5	Pass
155	5775	75.26	0.5	Pass

Spectrum Plot of Worst Value

802.11a

802.11n (HT20)

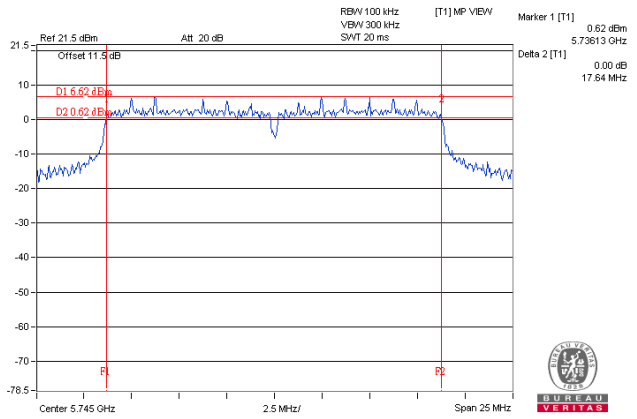
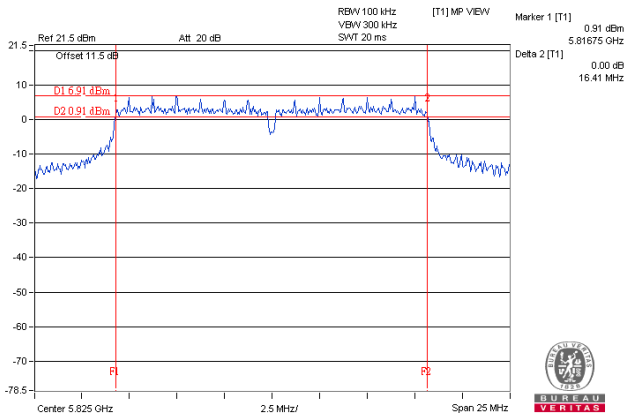

802.11n (HT40)

802.11ac (VHT80)

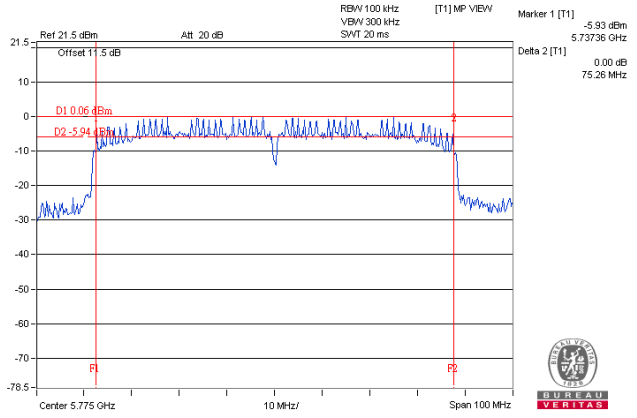
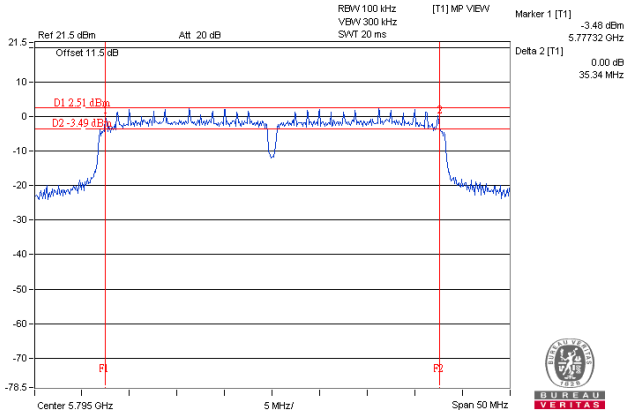

5 Pictures of Test Arrangements

Please refer to the attached file (Test Setup Photo).

Annex A- Radiated Out of Band Emission (OOBE) Measurement (For U-NII-3 band)

802.11a

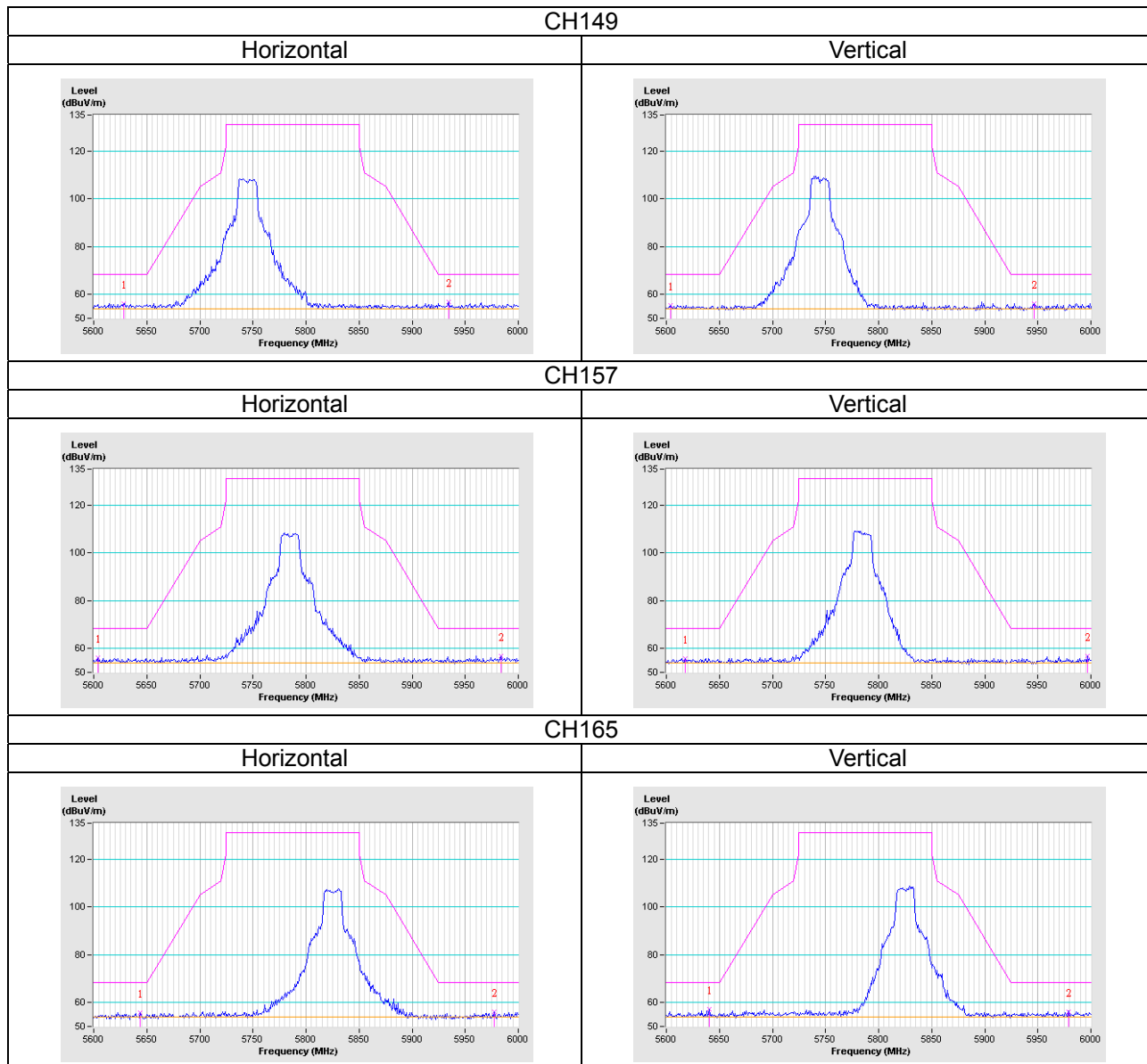

802.11n (HT20)

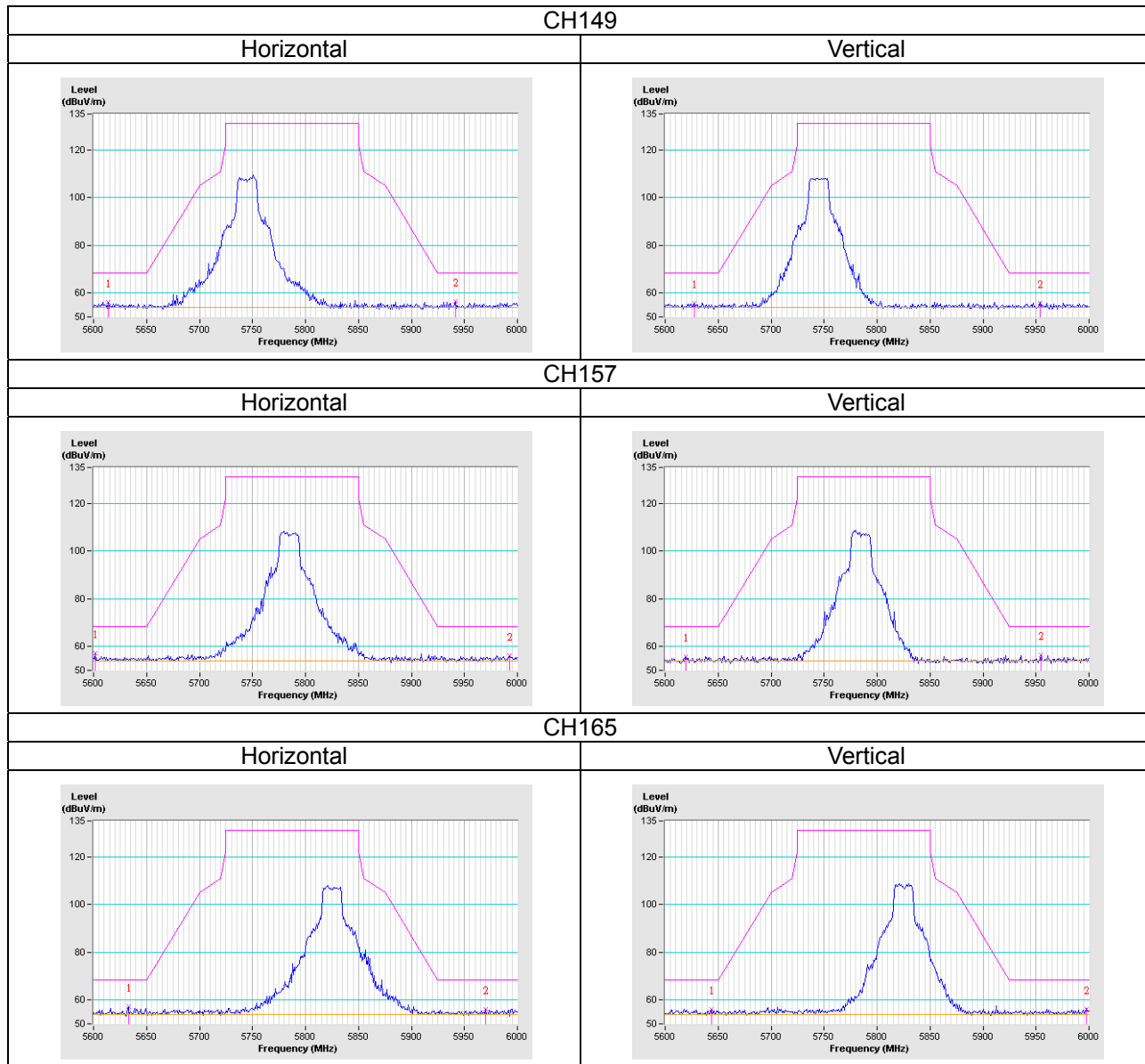

802.11n (HT40)

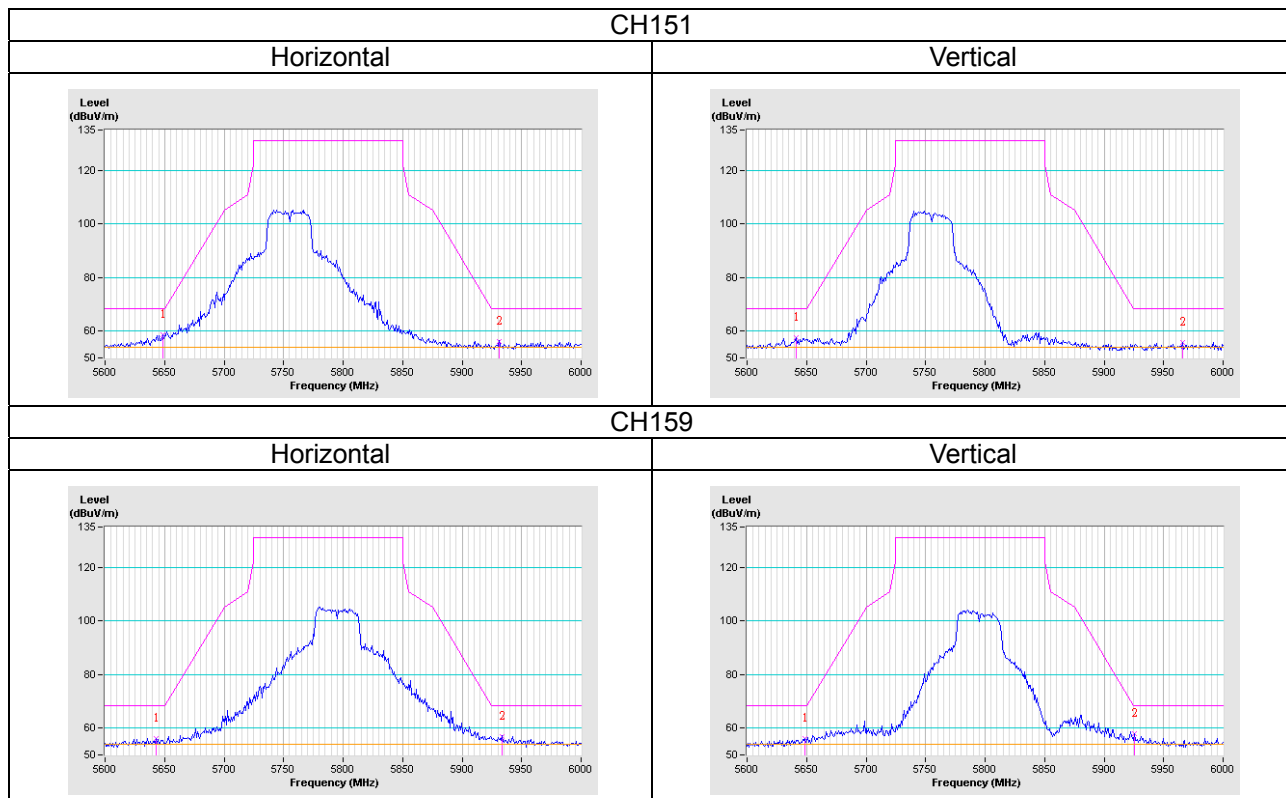

802.11ac (VHT80)

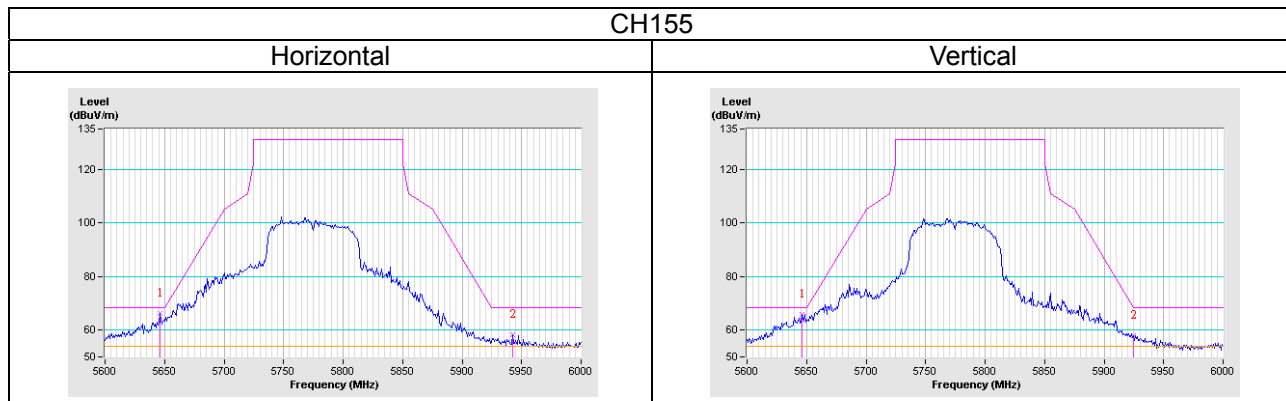

Appendix – Information on the Testing Laboratories

We, Bureau Veritas Consumer Products Services (H.K.) Ltd., Taoyuan Branch, were founded in 1988 to provide our best service in EMC, Radio, Telecom and Safety consultation. Our laboratories are accredited and approved according to ISO/IEC 17025.

If you have any comments, please feel free to contact us at the following:

Linko EMC/RF Lab

Tel: 886-2-26052180

Fax: 886-2-26051924

Hsin Chu EMC/RF/Telecom Lab

Tel: 886-3-6668565

Fax: 886-3-6668323

Hwa Ya EMC/RF/Safety

Tel: 886-3-3183232

Fax: 886-3-3270892

Email: service.adt@tw.bureauveritas.com

Web Site: www.bureauveritas-adt.com

The address and road map of all our labs can be found in our web site also.

--- END ---