

FCC SAR Test Report

Report No. : SA170421C58
Applicant : Zebra Technologies Corporation
Address : 1 Zebra Plaza Holtsville New York United States 11742
Manufacturer : Zebra Technologies Corporation
Address : 1 Zebra Plaza Holtsville New York United States 11742
Product : Touch Computer
FCC ID : UZ7TC200J
Brand : ZEBRA
Model No. : TC200J
Standards : FCC 47 CFR PART 2 (2.1093), IEEE C95.1:1992, IEEE STD 1528:2013
KDB 865664 D01 v01r04, KDB 865664 D02 v01r02
KDB 248227 D01 v02r02, KDB 447498 D01 v06
Sample Received Date : Apr. 21, 2017
Date of Testing : Jun. 14, 2017 ~ Jul. 02, 2017
Lab Address : No. 47-2, 14th Ling, Chia Pau Vil., Lin Kou Dist., New Taipei City, Taiwan, R.O.C.
Test Location : No. 19, Hwa Ya 2nd Rd, Wen Hwa Vil, Kwei Shan Dist., Taoyuan City 33383, Taiwan (R.O.C)

CERTIFICATION: The above equipment have been tested by **Bureau Veritas Consumer Products Services (H.K.) Ltd., Taoyuan Branch – Lin Kou Laboratories**, and found compliance with the requirement of the above standards. The test record, data evaluation & Equipment Under Test (EUT) configurations represented herein are true and accurate accounts of the measurements of the sample's SAR characteristics under the conditions specified in this report. It should not be reproduced except in full, without the written approval of our laboratory. The client should not use it to claim product certification, approval, or endorsement by TAF or any government agencies.

Prepared By : Evonne Liu
Evonne Liu / Specialist

Approved By : Gordon Lin
Gordon Lin / Assistant Manager



This report is for your exclusive use. Any copying or replication of this report to or for any other person or entity, or use of our name or trademark, is permitted only with our prior written permission. This report sets forth our findings solely with respect to the test samples identified herein. The results set forth in this report are not indicative or representative of the quality or characteristics of the lot from which a test sample was taken or any similar or identical product unless specifically and expressly noted. Our report includes all of the tests requested by you and the results thereof based upon the information that you provided to us. You have 60 days from date of issuance of this report to notify us of any material error or omission caused by our negligence, provided, however, that such notice shall be in writing and shall specifically address the issue you wish to raise. A failure to raise such issue within the prescribed time shall constitute your unqualified acceptance of the completeness of this report, the tests conducted and the correctness of the report contents. Unless specific mention, the uncertainty of measurement has been explicitly taken into account to declare the compliance or non-compliance to the specification.

Table of Contents

Release Control Record	3
1. Summary of Maximum SAR Value	4
2. Description of Equipment Under Test	5
3. SAR Measurement System	6
3.1 Definition of Specific Absorption Rate (SAR)	6
3.2 SPEAG DASY52 System	6
3.2.1 Robot.....	7
3.2.2 Probes.....	8
3.2.3 Data Acquisition Electronics (DAE)	9
3.2.4 Phantoms	9
3.2.5 Device Holder.....	10
3.2.6 System Validation Dipoles.....	10
3.2.7 Tissue Simulating Liquids.....	11
3.3 SAR System Verification	14
3.4 SAR Measurement Procedure	15
3.4.1 Area & Zoom Scan Procedure	15
3.4.2 Volume Scan Procedure.....	15
3.4.3 Power Drift Monitoring.....	16
3.4.4 Spatial Peak SAR Evaluation	16
3.4.5 SAR Averaged Methods	16
4. SAR Measurement Evaluation	17
4.1 EUT Configuration and Setting.....	17
4.2 EUT Testing Position	18
4.2.1 Head Exposure Conditions.....	18
4.2.2 Body-worn Accessory Exposure Conditions	20
4.2.3 Extremity Exposure Conditions	21
4.2.4 SAR Test Exclusion Evaluations	22
4.3 Tissue Verification	23
4.4 System Validation.....	24
4.5 System Verification.....	25
4.6 Maximum Output Power.....	26
4.6.1 Maximum Target Conducted Power	26
4.6.2 Measured Conducted Power Result.....	27
4.7 SAR Testing Results	31
4.7.1 SAR Test Reduction Considerations	31
4.7.2 SAR Results for Head Exposure Condition	32
4.7.3 SAR Results for Body-worn Exposure Condition (Test Separation Distance is 15 mm)	33
4.7.4 SAR Results for Holster Exposure Condition (Test Separation Distance is 0 mm).....	34
4.7.5 SAR Results for Arm Mount Exposure Condition (Test Separation Distance is 0 mm).....	35
4.7.6 SAR Results for Gun Exposure Condition (Test Separation Distance is 0 mm)	35
4.7.7 Simultaneous Multi-band Transmission Evaluation	35
4.7.8 SAR Measurement Variability.....	36
5. Calibration of Test Equipment.....	37
6. Measurement Uncertainty.....	38
7. Information on the Testing Laboratories.....	42
Appendix A. SAR Plots of System Verification	
Appendix B. SAR Plots of SAR Measurement	
Appendix C. Calibration Certificate for Probe and Dipole	
Appendix D. Photographs of EUT and Setup	

1. Summary of Maximum SAR Value

Equipment Class	Mode	Highest SAR-1g Head (W/kg)	Highest SAR-1g Body-worn (15 mm Gap) (W/kg)	Highest SAR-1g Holster (0 mm Gap) (W/kg)	Highest SAR-10g Arm Mount (0 mm Gap) (W/kg)	Highest SAR-10g Gun (0 mm Gap) (W/kg)
DTS	2.4G WLAN	1.28	0.59	0.68	0.18	2.46
NII	5.2G WLAN	N/A	1.25	N/A	N/A	N/A
	5.3G WLAN	0.67	1.37	1.19	0.56	1.98
	5.6G WLAN	0.45	1.39	0.97	0.27	1.08
	5.8G WLAN	0.46	1.34	0.9	0.21	0.85
DSS	Bluetooth	N/A	N/A	N/A	N/A	N/A

Note:

1. The SAR criteria (**Head & Body: SAR-1g 1.6 W/kg, and Extremity: SAR-10g 4.0 W/kg**) for general population / uncontrolled exposure is specified in FCC 47 CFR part 2 (2.1093) and ANSI/IEEE C95.1-1992.

2. Description of Equipment Under Test

EUT Type	Touch Computer
FCC ID	UZ7TC200J
Brand Name	ZEBRA
Model Name	TC200J
HW Version	EV
SW Version	90-04-03-N-00-E1
EUT Configuration	EUT1: Scanner SE4710 EUT2: Scanner SE2100
Tx Frequency Bands (Unit: MHz)	WLAN : 2412 ~ 2462, 5180 ~ 5240, 5260 ~ 5320, 5500 ~ 5580, 5660 ~ 5720, 5745 ~ 5825 Bluetooth : 2402 ~ 2480
Uplink Modulations	802.11b : DSSS 802.11a/g/n/ac : OFDM Bluetooth : GFSK, $\pi/4$ -DQPSK, 8-DPSK
Maximum Tune-up Conducted Power (Unit: dBm)	WLAN 2.4G : 21.0 WLAN 5.2G : 18.5 WLAN 5.3G : 18.5 WLAN 5.6G : 18.0 WLAN 5.8G : 18.5 Bluetooth : 3.5
Antenna Type	PIFA Antenna (Peak Antenna Gain : 2.25 dBi for 2.4GHz, 4.22 dBi for 5GHz)
EUT Stage	Engineering sample

Note:

- The EUT has following types.

Brand	Model	Difference
ZEBRA	TC200J	Scanner SE4710 with camera, with 2pin
		Scanner SE4710 with camera, with 8pin (option)
		Scanner SE2100 without camera, blank

- The above EUT information is declared by manufacturer and for more detailed features description please refers to the manufacturer's specifications or User's Manual.

List of Accessory:

Battery	Brand Name	ZEBRA
	Model Name	BT-000334
	Power Rating	3.85Vdc, 3000mAh
	Type	Li-ion
Ear Headset	Brand Name	ZEBRA
	Model Name	HDST-25MM-PTVP-01
	Signal Line Type	1.25 meter non-shielded cable without ferrite core
Headset Adapter Cable	Brand Name	ZEBRA
	Model Name	CBL-TC51-HDST35-01
Gun Handle	Brand Name	ZEBRA
	P/N Number	TRG-TC2X-SNP1-01
BT Ring scanner	Brand Name	ZEBRA
	P/N Number	RS6000
AC Adapter	Brand Name	ZEBRA
	P/N Number	SAWA-65-20005A
USB Type C cable	Brand Name	ZEBRA
	P/N Number	CBL-MPM-USB1-01
Arm Mount	Brand Name	ZEBRA
	P/N Number	SG-TC2X-ARMNT-01
Holster	Brand Name	ZEBRA
	P/N Number	SG-TC2X-HLSTR1-01

3. SAR Measurement System

3.1 Definition of Specific Absorption Rate (SAR)

SAR is related to the rate at which energy is absorbed per unit mass in an object exposed to a radio field. The SAR distribution in a biological body is complicated and is usually carried out by experimental techniques or numerical modeling. The standard recommends limits for two tiers of groups, occupational/controlled and general population/uncontrolled, based on a person’s awareness and ability to exercise control over his or her exposure. In general, occupational/controlled exposure limits are higher than the limits for general population/uncontrolled.

The SAR definition is the time derivative (rate) of the incremental energy (dW) absorbed by (dissipated in) an incremental mass (dm) contained in a volume element (dv) of a given density (ρ). The equation description is as below:

$$SAR = \frac{d}{dt} \left(\frac{dW}{dm} \right) = \frac{d}{dt} \left(\frac{dW}{\rho dv} \right)$$

SAR is expressed in units of Watts per kilogram (W/kg)

SAR measurement can be related to the electrical field in the tissue by

$$SAR = \frac{\sigma |E|^2}{\rho}$$

Where: σ is the conductivity of the tissue, ρ is the mass density of the tissue and E is the RMS electrical field strength.

3.2 SPEAG DASY52 System

DASY52 system consists of high precision robot, probe alignment sensor, phantom, robot controller, controlled measurement server and near-field probe. The robot includes six axes that can move to the precision position of the DASY52 software defined. The DASY52 software can define the area that is detected by the probe. The robot is connected to controlled box. Controlled measurement server is connected to the controlled robot box. The DAE includes amplifier, signal multiplexing, AD converter, offset measurement and surface detection. It is connected to the Electro-optical coupler (ECO). The ECO performs the conversion form the optical into digital electric signal of the DAE and transfers data to the PC.



Fig-3.1 SPEAG DASY52 System Setup

3.2.1 Robot

The DASY52 system uses the high precision robots from Stäubli SA (France). For the 6-axis controller system, the robot controller version of CS8c from Stäubli is used. The Stäubli robot series have many features that are important for our application:

- High precision (repeatability ± 0.035 mm)
- High reliability (industrial design)
- Jerk-free straight movements
- Low ELF interference (the closed metallic construction shields against motor control fields)





Fig-3.2 SPEAG DASY52 System

FCC SAR Test Report

3.2.2 Probes

The SAR measurement is conducted with the dosimetric probe. The probe is specially designed and calibrated for use in liquid with high permittivity. The dosimetric probe has special calibration in liquid at different frequency.

Model	EX3DV4	
Construction	Symmetrical design with triangular core. Built-in shielding against static charges. PEEK enclosure material (resistant to organic solvents, e.g., DGBE).	
Frequency	10 MHz to 6 GHz Linearity: ± 0.2 dB	
Directivity	± 0.3 dB in HSL (rotation around probe axis) ± 0.5 dB in tissue material (rotation normal to probe axis)	
Dynamic Range	10 μ W/g to 100 mW/g Linearity: ± 0.2 dB (noise: typically < 1 μ W/g)	
Dimensions	Overall length: 337 mm (Tip: 20 mm) Tip diameter: 2.5 mm (Body: 12 mm) Typical distance from probe tip to dipole centers: 1 mm	

Model	ES3DV3	
Construction	Symmetrical design with triangular core. Interleaved sensors. Built-in shielding against static charges. PEEK enclosure material (resistant to organic solvents, e.g., DGBE).	
Frequency	10 MHz to 4 GHz Linearity: ± 0.2 dB	
Directivity	± 0.2 dB in HSL (rotation around probe axis) ± 0.3 dB in tissue material (rotation normal to probe axis)	
Dynamic Range	5 μ W/g to 100 mW/g Linearity: ± 0.2 dB	
Dimensions	Overall length: 337 mm (Tip: 20 mm) Tip diameter: 3.9 mm (Body: 12 mm) Distance from probe tip to dipole centers: 2.0 mm	

Model	ET3DV6	
Construction	Symmetrical design with triangular core Built-in optical fiber for surface detection system. Built-in shielding against static charges. PEEK enclosure material (resistant to organic solvents, e.g., DGBE)	
Frequency	10 MHz to 2.3 GHz; Linearity: ± 0.2 dB	
Directivity	± 0.2 dB in TSL (rotation around probe axis) ± 0.4 dB in TSL (rotation normal to probe axis)	
Dynamic Range	5 μ W/g to 100 mW/g; Linearity: ± 0.2 dB	
Dimensions	Overall length: 337 mm (Tip: 16 mm) Tip diameter: 6.8 mm (Body: 12 mm) Distance from probe tip to dipole centers: 2.7 mm	

FCC SAR Test Report

3.2.3 Data Acquisition Electronics (DAE)

Model	DAE3, DAE4	
Construction	Signal amplifier, multiplexer, A/D converter and control logic. Serial optical link for communication with DASY embedded system (fully remote controlled). Two step probe touch detector for mechanical surface detection and emergency robot stop.	
Measurement Range	-100 to +300 mV (16 bit resolution and two range settings: 4mV, 400mV)	
Input Offset Voltage	< 5µV (with auto zero)	
Input Bias Current	< 50 fA	
Dimensions	60 x 60 x 68 mm	

3.2.4 Phantoms

Model	Twin SAM	
Construction	The shell corresponds to the specifications of the Specific Anthropomorphic Mannequin (SAM) phantom defined in IEEE 1528 and IEC 62209-1. It enables the dosimetric evaluation of left and right hand phone usage as well as body mounted usage at the flat phantom region. A cover prevents evaporation of the liquid. Reference markings on the phantom allow the complete setup of all predefined phantom positions and measurement grids by teaching three points with the robot.	
Material	Vinylester, glass fiber reinforced (VE-GF)	
Shell Thickness	2 ± 0.2 mm (6 ± 0.2 mm at ear point)	
Dimensions	Length: 1000 mm Width: 500 mm Height: adjustable feet	
Filling Volume	approx. 25 liters	

Model	ELI	
Construction	Phantom for compliance testing of handheld and body-mounted wireless devices in the frequency range of 30 MHz to 6 GHz. ELI is fully compatible with the IEC 62209-2 standard and all known tissue simulating liquids. ELI has been optimized regarding its performance and can be integrated into our standard phantom tables. A cover prevents evaporation of the liquid. Reference markings on the phantom allow installation of the complete setup, including all predefined phantom positions and measurement grids, by teaching three points. The phantom is compatible with all SPEAG dosimetric probes and dipoles.	
Material	Vinylester, glass fiber reinforced (VE-GF)	
Shell Thickness	2.0 ± 0.2 mm (bottom plate)	
Dimensions	Major axis: 600 mm Minor axis: 400 mm	
Filling Volume	approx. 30 liters	

FCC SAR Test Report

3.2.5 Device Holder

Model	Mounting Device	
Construction	In combination with the Twin SAM Phantom or ELI4, the Mounting Device enables the rotation of the mounted transmitter device in spherical coordinates. Rotation point is the ear opening point. Transmitter devices can be easily and accurately positioned according to IEC, IEEE, FCC or other specifications. The device holder can be locked for positioning at different phantom sections (left head, right head, flat).	
Material	POM	

Model	Laptop Extensions Kit	
Construction	Simple but effective and easy-to-use extension for Mounting Device that facilitates the testing of larger devices according to IEC 62209-2 (e.g., laptops, cameras, etc.). It is lightweight and fits easily on the upper part of the Mounting Device in place of the phone positioner.	
Material	POM, Acrylic glass, Foam	

3.2.6 System Validation Dipoles

Model	D-Serial	
Construction	Symmetrical dipole with 1/4 balun. Enables measurement of feed point impedance with NWA. Matched for use near flat phantoms filled with tissue simulating solutions.	
Frequency	750 MHz to 5800 MHz	
Return Loss	> 20 dB	
Power Capability	> 100 W (f < 1GHz), > 40 W (f > 1GHz)	

3.2.7 Tissue Simulating Liquids

For SAR measurement of the field distribution inside the phantom, the phantom must be filled with homogeneous tissue simulating liquid to a depth of at least 15 cm. For head SAR testing, the liquid height from the ear reference point (ERP) of the phantom to the liquid top surface is larger than 15 cm. For body SAR testing, the liquid height from the center of the flat phantom to the liquid top surface is larger than 15 cm. The nominal dielectric values of the tissue simulating liquids in the phantom and the tolerance of 5% are listed in Table-3.1.

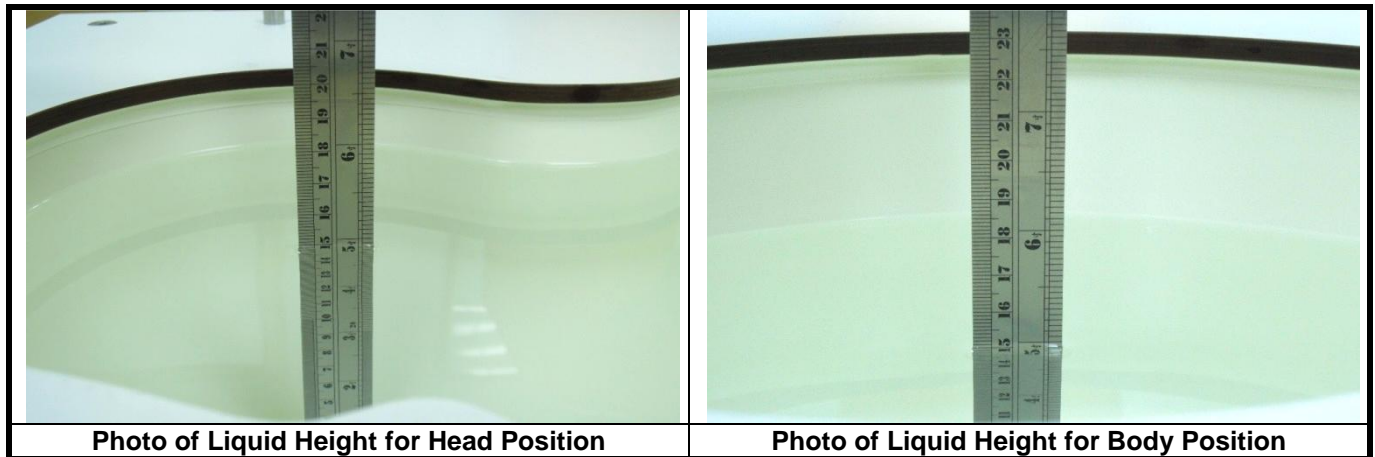

The dielectric properties of the head tissue simulating liquids are defined in IEEE 1528, and KDB 865664 D01 Appendix A. For the body tissue simulating liquids, the dielectric properties are defined in KDB 865664 D01 Appendix A. The dielectric properties of the tissue simulating liquids were verified prior to the SAR evaluation using a dielectric assessment kit and a network analyzer.

Table-3.1 Targets of Tissue Simulating Liquid

Frequency (MHz)	Target Permittivity	Range of $\pm 5\%$	Target Conductivity	Range of $\pm 5\%$
For Head				
750	41.9	39.8 ~ 44.0	0.89	0.85 ~ 0.93
835	41.5	39.4 ~ 43.6	0.90	0.86 ~ 0.95
900	41.5	39.4 ~ 43.6	0.97	0.92 ~ 1.02
1450	40.5	38.5 ~ 42.5	1.20	1.14 ~ 1.26
1640	40.3	38.3 ~ 42.3	1.29	1.23 ~ 1.35
1750	40.1	38.1 ~ 42.1	1.37	1.30 ~ 1.44
1800	40.0	38.0 ~ 42.0	1.40	1.33 ~ 1.47
1900	40.0	38.0 ~ 42.0	1.40	1.33 ~ 1.47
2000	40.0	38.0 ~ 42.0	1.40	1.33 ~ 1.47
2300	39.5	37.5 ~ 41.5	1.67	1.59 ~ 1.75
2450	39.2	37.2 ~ 41.2	1.80	1.71 ~ 1.89
2600	39.0	37.1 ~ 41.0	1.96	1.86 ~ 2.06
3500	37.9	36.0 ~ 39.8	2.91	2.76 ~ 3.06
5200	36.0	34.2 ~ 37.8	4.66	4.43 ~ 4.89
5300	35.9	34.1 ~ 37.7	4.76	4.52 ~ 5.00
5500	35.6	33.8 ~ 37.4	4.96	4.71 ~ 5.21
5600	35.5	33.7 ~ 37.3	5.07	4.82 ~ 5.32
5800	35.3	33.5 ~ 37.1	5.27	5.01 ~ 5.53
For Body				
750	55.5	52.7 ~ 58.3	0.96	0.91 ~ 1.01
835	55.2	52.4 ~ 58.0	0.97	0.92 ~ 1.02
900	55.0	52.3 ~ 57.8	1.05	1.00 ~ 1.10
1450	54.0	51.3 ~ 56.7	1.30	1.24 ~ 1.37
1640	53.8	51.1 ~ 56.5	1.40	1.33 ~ 1.47
1750	53.4	50.7 ~ 56.1	1.49	1.42 ~ 1.56
1800	53.3	50.6 ~ 56.0	1.52	1.44 ~ 1.60
1900	53.3	50.6 ~ 56.0	1.52	1.44 ~ 1.60
2000	53.3	50.6 ~ 56.0	1.52	1.44 ~ 1.60
2300	52.9	50.3 ~ 55.5	1.81	1.72 ~ 1.90
2450	52.7	50.1 ~ 55.3	1.95	1.85 ~ 2.05
2600	52.5	49.9 ~ 55.1	2.16	2.05 ~ 2.27
3500	51.3	48.7 ~ 53.9	3.31	3.14 ~ 3.48
5200	49.0	46.6 ~ 51.5	5.30	5.04 ~ 5.57
5300	48.9	46.5 ~ 51.3	5.42	5.15 ~ 5.69
5500	48.6	46.2 ~ 51.0	5.65	5.37 ~ 5.93
5600	48.5	46.1 ~ 50.9	5.77	5.48 ~ 6.06
5800	48.2	45.8 ~ 50.6	6.00	5.70 ~ 6.30

FCC SAR Test Report

The following table gives the recipes for tissue simulating liquids.

Table-3.2 Recipes of Tissue Simulating Liquid

Tissue Type	Bactericide	DGBE	HEC	NaCl	Sucrose	Triton X-100	Water	Diethylene Glycol Mono-hexylether
H750	0.2	-	0.2	1.5	56.0	-	42.1	-
H835	0.2	-	0.2	1.5	57.0	-	41.1	-
H900	0.2	-	0.2	1.4	58.0	-	40.2	-
H1450	-	43.3	-	0.6	-	-	56.1	-
H1640	-	45.8	-	0.5	-	-	53.7	-
H1750	-	47.0	-	0.4	-	-	52.6	-
H1800	-	44.5	-	0.3	-	-	55.2	-
H1900	-	44.5	-	0.2	-	-	55.3	-
H2000	-	44.5	-	0.1	-	-	55.4	-
H2300	-	44.9	-	0.1	-	-	55.0	-
H2450	-	45.0	-	0.1	-	-	54.9	-
H2600	-	45.1	-	0.1	-	-	54.8	-
H3500	-	8.0	-	0.2	-	20.0	71.8	-
H5G	-	-	-	-	-	17.2	65.5	17.3
B750	0.2	-	0.2	0.8	48.8	-	50.0	-
B835	0.2	-	0.2	0.9	48.5	-	50.2	-
B900	0.2	-	0.2	0.9	48.2	-	50.5	-
B1450	-	34.0	-	0.3	-	-	65.7	-
B1640	-	32.5	-	0.3	-	-	67.2	-
B1750	-	31.0	-	0.2	-	-	68.8	-
B1800	-	29.5	-	0.4	-	-	70.1	-
B1900	-	29.5	-	0.3	-	-	70.2	-
B2000	-	30.0	-	0.2	-	-	69.8	-
B2300	-	31.0	-	0.1	-	-	68.9	-
B2450	-	31.4	-	0.1	-	-	68.5	-
B2600	-	31.8	-	0.1	-	-	68.1	-
B3500	-	28.8	-	0.1	-	-	71.1	-
B5G	-	-	-	-	-	10.7	78.6	10.7

3.3 SAR System Verification

The system check verifies that the system operates within its specifications. It is performed daily or before every SAR measurement. The system check uses normal SAR measurements in the flat section of the phantom with a matched dipole at a specified distance. The system verification setup is shown as below.

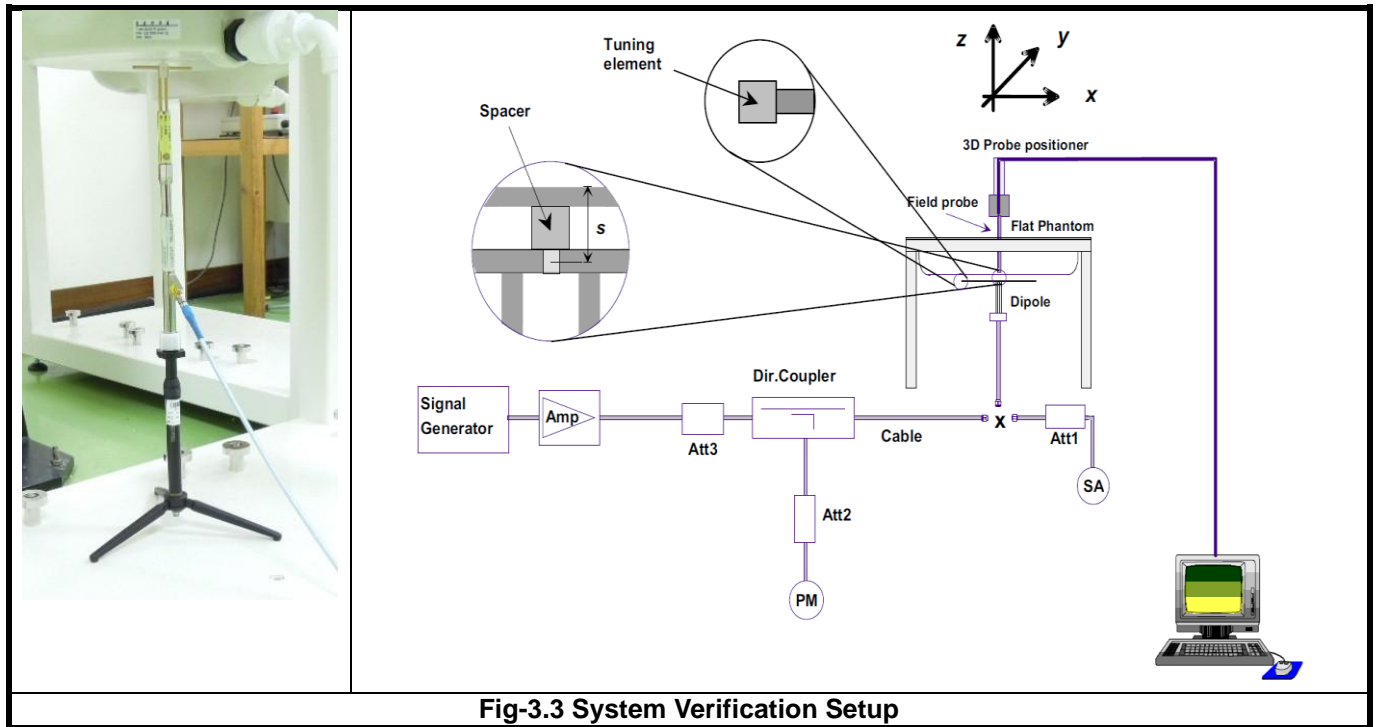

Fig-3.3 System Verification Setup

The validation dipole is placed beneath the flat phantom with the specific spacer in place. The distance spacer is touch the phantom surface with a light pressure at the reference marking and be oriented parallel to the long side of the phantom. The spectrum analyzer measures the forward power at the location of the system check dipole connector. The signal generator is adjusted for the desired forward power (250 mW is used for 700 MHz to 3 GHz, 100 mW is used for 3.5 GHz to 6 GHz) at the dipole connector and the power meter is read at that level. After connecting the cable to the dipole, the signal generator is readjusted for the same reading at power meter.

After system check testing, the SAR result will be normalized to 1W forward input power and compared with the reference SAR value derived from validation dipole certificate report. The deviation of system check should be within 10 %.

3.4 SAR Measurement Procedure

According to the SAR test standard, the recommended procedure for assessing the peak spatial-average SAR value consists of the following steps:

- (a) Power reference measurement
- (b) Area scan
- (c) Zoom scan
- (d) Power drift measurement

The SAR measurement procedures for each of test conditions are as follows:

- (a) Make EUT to transmit maximum output power
- (b) Measure conducted output power through RF cable
- (c) Place the EUT in the specific position of phantom
- (d) Perform SAR testing steps on the DASY system
- (e) Record the SAR value

3.4.1 Area & Zoom Scan Procedure

First Area Scan is used to locate the approximate location(s) of the local peak SAR value(s). The measurement grid within an Area Scan is defined by the grid extent, grid step size and grid offset. Next, in order to determine the EM field distribution in a three-dimensional spatial extension, Zoom Scan is required. The Zoom Scan is performed around the highest E-field value to determine the averaged SAR-distribution over 10 g. According to KDB 865664 D01, the resolution for Area and Zoom scan is specified in the table below.

Items	<= 2 GHz	2-3 GHz	3-4 GHz	4-5 GHz	5-6 GHz
Area Scan ($\Delta x, \Delta y$)	<= 15 mm	<= 12 mm	<= 12 mm	<= 10 mm	<= 10 mm
Zoom Scan ($\Delta x, \Delta y$)	<= 8 mm	<= 5 mm	<= 5 mm	<= 4 mm	<= 4 mm
Zoom Scan (Δz)	<= 5 mm	<= 5 mm	<= 4 mm	<= 3 mm	<= 2 mm
Zoom Scan Volume	>= 30 mm	>= 30 mm	>= 28 mm	>= 25 mm	>= 22 mm

Note:

When zoom scan is required and report SAR is <= 1.4 W/kg, the zoom scan resolution of $\Delta x / \Delta y$ (2-3GHz: <= 8 mm, 3-4GHz: <= 7 mm, 4-6GHz: <= 5 mm) may be applied.

3.4.2 Volume Scan Procedure

The volume scan is used for assess overlapping SAR distributions for antennas transmitting in different frequency bands. It is equivalent to an oversized zoom scan used in standalone measurements. The measurement volume will be used to enclose all the simultaneous transmitting antennas. For antennas transmitting simultaneously in different frequency bands, the volume scan is measured separately in each frequency band. In order to sum correctly to compute the 1g aggregate SAR, the EUT remain in the same test position for all measurements and all volume scan use the same spatial resolution and grid spacing. When all volume scan were completed, the software, SEMCAD postprocessor can combine and subsequently superpose these measurement data to calculating the multiband SAR.

3.4.3 Power Drift Monitoring

All SAR testing is under the EUT install full charged battery and transmit maximum output power. In DASY measurement software, the power reference measurement and power drift measurement procedures are used for monitoring the power drift of EUT during SAR test. Both these procedures measure the field at a specified reference position before and after the SAR testing. The software will calculate the field difference in dB. If the power drift more than 5%, the SAR will be retested.

3.4.4 Spatial Peak SAR Evaluation

The procedure for spatial peak SAR evaluation has been implemented according to the test standard. It can be conducted for 1g and 10g, as well as for user-specific masses. The DASY software includes all numerical procedures necessary to evaluate the spatial peak SAR value.

The base for the evaluation is a "cube" measurement. The measured volume must include the 1g and 10g cubes with the highest averaged SAR values. For that purpose, the center of the measured volume is aligned to the interpolated peak SAR value of a previously performed area scan.

The entire evaluation of the spatial peak values is performed within the post-processing engine (SEMCAD). The system always gives the maximum values for the 1g and 10g cubes. The algorithm to find the cube with highest averaged SAR is divided into the following stages:

- (a) Extraction of the measured data (grid and values) from the Zoom Scan
- (b) Calculation of the SAR value at every measurement point based on all stored data (A/D values and measurement parameters)
- (c) Generation of a high-resolution mesh within the measured volume
- (d) Interpolation of all measured values from the measurement grid to the high-resolution grid
- (e) Extrapolation of the entire 3-D field distribution to the phantom surface over the distance from sensor to surface
- (f) Calculation of the averaged SAR within masses of 1g and 10g

3.4.5 SAR Averaged Methods

In DASY, the interpolation and extrapolation are both based on the modified Quadratic Shepard's method. The interpolation scheme combines a least-square fitted function method and a weighted average method which are the two basic types of computational interpolation and approximation.

Extrapolation routines are used to obtain SAR values between the lowest measurement points and the inner phantom surface. The extrapolation distance is determined by the surface detection distance and the probe sensor offset. The uncertainty increases with the extrapolation distance. To keep the uncertainty within 1% for the 1 g and 10 g cubes, the extrapolation distance should not be larger than 5 mm.

4. SAR Measurement Evaluation

4.1 EUT Configuration and Setting

<Considerations Related to WLAN for Setup and Testing>

In general, various vendor specific external test software and chipset based internal test modes are typically used for SAR measurement. These chipset based test mode utilities are generally hardware and manufacturer dependent, and often include substantial flexibility to reconfigure or reprogram a device. A Wi-Fi device must be configured to transmit continuously at the required data rate, channel bandwidth and signal modulation, using the highest transmission duty factor supported by the test mode tools for SAR measurement. The test frequencies established using test mode must correspond to the actual channel frequencies. When 802.11 frame gaps are accounted for in the transmission, a maximum transmission duty factor of 92 - 96% is typically achievable in most test mode configurations. A minimum transmission duty factor of 85% is required to avoid certain hardware and device implementation issues related to wide range SAR scaling. In addition, a periodic transmission duty factor is required for current generation SAR systems to measure SAR correctly. The reported SAR must be scaled to 100% transmission duty factor to determine compliance at the maximum tune-up tolerance limit.

According to KDB 248227 D01, this device has installed WLAN engineering testing software which can provide continuous transmitting RF signal. During WLAN SAR testing, this device was operated to transmit continuously at the maximum transmission duty with specified transmission mode, operating frequency, lowest data rate, and maximum output power.

Initial Test Configuration

An initial test configuration is determined for OFDM transmission modes in 2.4 GHz and 5 GHz bands according to the channel bandwidth, modulation and data rate combination(s) with the highest maximum output power specified for production units in each standalone and aggregated frequency band. When the same maximum power is specified for multiple transmission modes in a frequency band, the largest channel bandwidth, lowest order modulation, lowest data rate and lowest order 802.11a/g/n/ac mode is used for SAR measurement, on the highest measured output power channel in the initial test configuration, for each frequency band.

Subsequent Test Configuration

SAR measurement requirements for the remaining 802.11 transmission mode configurations that have not been tested in the initial test configuration are determined separately for each standalone and aggregated frequency band, in each exposure condition, according to the maximum output power specified for production units. Additional power measurements may be required to determine if SAR measurements are required for subsequent highest output power channels in a subsequent test configuration. When the highest reported SAR for the initial test configuration according to the initial test position or fixed exposure position requirements, is adjusted by the ratio of the subsequent test configuration to initial test configuration specified maximum output power and the adjusted SAR is ≤ 1.2 W/kg, SAR is not required for that subsequent test configuration.

SAR Test Configuration and Channel Selection

When multiple channel bandwidth configurations in a frequency band have the same specified maximum output power, the initial test configuration is using largest channel bandwidth, lowest order modulation, lowest data rate, and lowest order 802.11 mode (i.e., 802.11a is chosen over 802.11n then 802.11ac or 802.11g is chosen over 802.11n). After an initial test configuration is determined, if multiple test channels have the same measured maximum output power, the channel chosen for SAR measurement is determined according to the following.

- 1) The channel closest to mid-band frequency is selected for SAR measurement.
- 2) For channels with equal separation from mid-band frequency; for example, high and low channels or two mid-band channels, the higher frequency (number) channel is selected for SAR measurement.

Test Reduction for U-NII-1 (5.2 GHz) and U-NII-2A (5.3 GHz) Bands

For devices that operate in both U-NII bands using the same transmitter and antenna(s), SAR test reduction is determined according to the following.

- 1) When the same maximum output power is specified for both bands, begin SAR measurement in U-NII-2A band by applying the OFDM SAR requirements. If the highest reported SAR for a test configuration is ≤ 1.2 W/kg, SAR is not required for U-NII-1 band for that configuration (802.11 mode and exposure condition).
- 2) When different maximum output power is specified for the bands, begin SAR measurement in the band with higher specified maximum output power. The highest reported SAR for the tested configuration is adjusted by the ratio of lower to higher specified maximum output power for the two bands. When the adjusted SAR is ≤ 1.2 W/kg, SAR is not required for the band with lower maximum output power in that test configuration.

4.2 EUT Testing Position

According to KDB 648474 D04, handsets are tested for SAR compliance in head, body-worn accessory and other use configurations described in the following subsections.

4.2.1 Head Exposure Conditions

Head exposure is limited to next to the ear voice mode operations. Head SAR compliance is tested according to the test positions defined in IEEE Std 1528-2003 using the SAM phantom illustrated as below.

1. Define two imaginary lines on the handset
 - (a) The vertical centerline passes through two points on the front side of the handset - the midpoint of the width w_t of the handset at the level of the acoustic output, and the midpoint of the width w_b of the bottom of the handset.
 - (b) The horizontal line is perpendicular to the vertical centerline and passes through the center of the acoustic output. The horizontal line is also tangential to the face of the handset at point A.
 - (c) The two lines intersect at point A. Note that for many handsets, point A coincides with the center of the acoustic output; however, the acoustic output may be located elsewhere on the horizontal line. Also note that the vertical centerline is not necessarily parallel to the front face of the handset, especially for clamshell handsets, handsets with flip covers, and other irregularly shaped handsets.

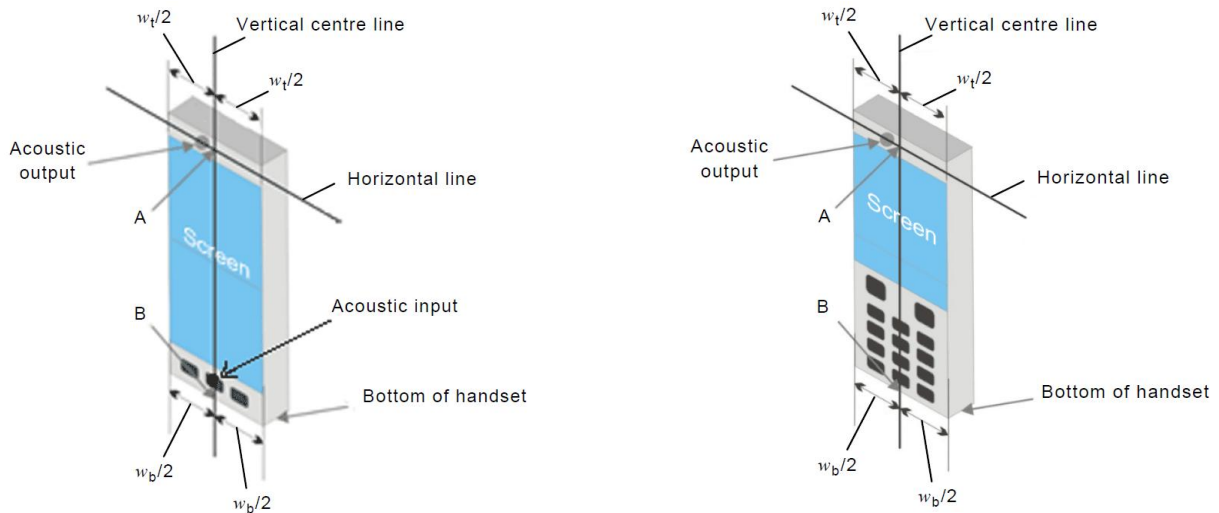

Fig-4.1 Illustration for Handset Vertical and Horizontal Reference Lines

2. Cheek Position

- (a) To position the device with the vertical center line of the body of the device and the horizontal line crossing the center piece in a plane parallel to the sagittal plane of the phantom. While maintaining the device in this plane, align the vertical center line with the reference plane containing the three ear and mouth reference point (M: Mouth, RE: Right Ear, and LE: Left Ear) and align the center of the ear piece with the line RE-LE.
- (b) To move the device towards the phantom with the ear piece aligned with the line LE-RE until the phone touched the ear. While maintaining the device in the reference plane and maintaining the phone contact with the ear, move the bottom of the phone until any point on the front side is in contact with the cheek of the phantom or until contact with the ear is lost (see Fig-4.2).

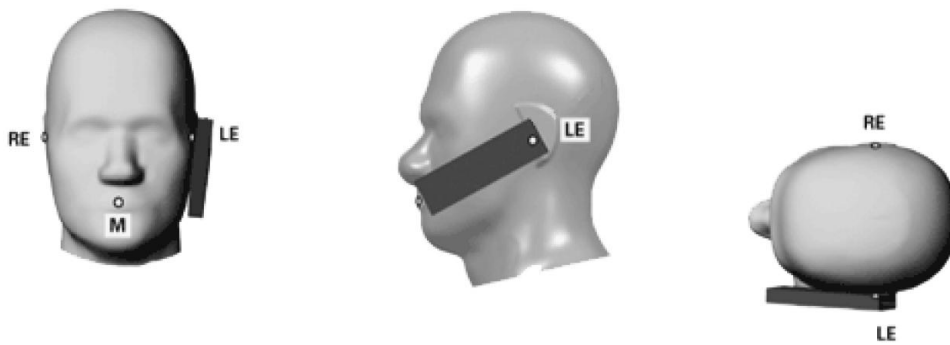

Fig-4.2 Illustration for Cheek Position

3. Tilted Position

- (a) To position the device in the “cheek” position described above.
- (b) While maintaining the device the reference plane described above and pivoting against the ear, moves it outward away from the mouth by an angle of 15 degrees or until contact with the ear is lost (see Fig-4.3).

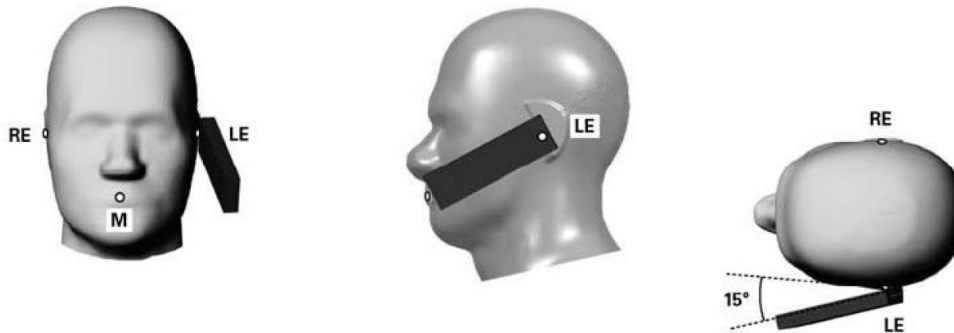

Fig-4.3 Illustration for Tilted Position

4.2.2 Body-worn Accessory Exposure Conditions

Body-worn accessory exposure is typically related to voice mode operations when handsets are carried in body-worn accessories. The body-worn accessory procedures in KDB 447498 are used to test for body-worn accessory SAR compliance, without a headset connected to it. This enables the test results for such configuration to be compatible with that required for hotspot mode when the body-worn accessory test separation distance is greater than or equal to that required for hotspot mode. When the reported SAR for a body-worn accessory, measured without a headset connected to the handset, is > 1.2 W/kg, the highest reported SAR configuration for that wireless mode and frequency band should be repeated for that body-worn accessory with a headset attached to the handset.

Body-worn accessories that do not contain metallic or conductive components may be tested according to worst-case exposure configurations, typically according to the smallest test separation distance required for the group of body-worn accessories with similar operating and exposure characteristics. All body-worn accessories containing metallic components are tested in conjunction with the host device.

Body-worn accessory SAR compliance is based on a single minimum test separation distance for all wireless and operating modes applicable to each body-worn accessory used by the host, and according to the relevant voice and/or data mode transmissions and operations. If a body-worn accessory supports voice only operations in its normal and expected use conditions, testing of data mode for body-worn compliance is not required.

A conservative minimum test separation distance for supporting off-the-shelf body-worn accessories that may be acquired by users of consumer handsets is used to test for body-worn accessory SAR compliance. This distance is determined by the handset manufacturer, according to the requirements of Supplement C 01-01. Devices that are designed to operate on the body of users using lanyards and straps, or without requiring additional body-worn accessories, will be tested using a conservative minimum test separation distance ≤ 5 mm to support compliance.

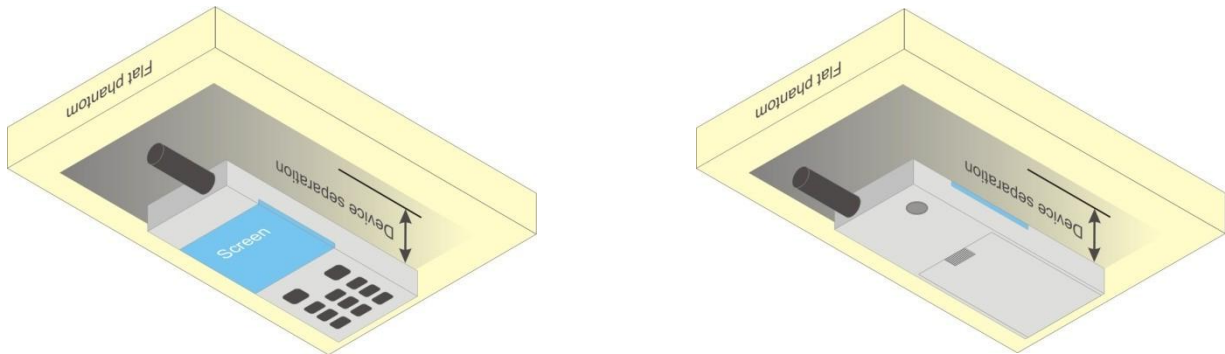

Fig-4.4 Illustration for Body Worn Position

4.2.3 Extremity Exposure Conditions

Transmitters that are built-in within a wrist watch or similar wrist-worn devices typically operate in speaker mode for voice communication, with the device worn on the wrist and positioned next to the mouth. Next to the mouth exposure requires 1-g SAR, and the wrist-worn condition requires 10-g extremity SAR. The 10-g extremity and 1-g SAR test exclusions may be applied to the wrist and face exposure conditions. When SAR evaluation is required, next to the mouth use is evaluated with the front of the device positioned at 10 mm from a flat phantom filled with head tissue-equivalent medium. The wrist bands should be strapped together to represent normal use conditions. SAR for wrist exposure is evaluated with the back of the devices positioned in direct contact against a flat phantom fill with body tissue-equivalent medium. The wrist bands should be unstrapped and touching the phantom. The space introduced by the watch or wrist bands and the phantom must be representative of actual use conditions.

FCC SAR Test Report

4.2.4 SAR Test Exclusion Evaluations

According to KDB 447498 D01, the SAR test exclusion condition is based on source-based time-averaged maximum conducted output power, adjusted for tune-up tolerance, and the minimum test separation distance required for the exposure conditions. The SAR exclusion threshold is determined by the following formula.

$$\frac{\text{Max. Tune up Power}_{(mW)}}{\text{Min. Test Separation Distance}_{(mm)}} \times \sqrt{f_{(GHz)}} \leq 3.0 \text{ for SAR-1g, } \leq 7.5 \text{ for SAR-10g}$$

When the minimum test separation distance is < 5 mm, a distance of 5 mm is applied to determine SAR test exclusion.

< For Body-Worn >

Mode	Max. Tune-up Power (dBm)	Max. Tune-up Power (mW)	Body-Worn		
			Ant. to Surface (mm)	Calculated Result	Require SAR Testing?
BT (2.48 GHz)	3.5	2.24	0	0.7	No

< For Limbs >

Mode	Max. Tune-up Power (dBm)	Max. Tune-up Power (mW)	Limbs		
			Ant. to Surface (mm)	Calculated Result	Require SAR Testing?
WLAN 2.4G	21.0	125.89	385	0.51	No
WLAN 5.2G	18.5	70.79	385	0.42	No
WLAN 5.3G	18.5	70.79	385	0.43	No
WLAN 5.6G	18.0	63.1	385	0.39	No
WLAN 5.8G	18.5	70.79	385	0.45	No
BT	3.5	2.24	385	0.01	No

Note:

1. When separation distance <= 50 mm and the calculated result shown in above table is <= 3.0 for SAR-1g exposure condition, or <= 7.5 for SAR-10g exposure condition, the SAR testing exclusion is applied.

4.3 Tissue Verification

The measuring results for tissue simulating liquid are shown as below.

Test Date	Tissue Type	Frequency (MHz)	Liquid Temp. (°C)	Measured Conductivity (σ)	Measured Permittivity (ε _r)	Target Conductivity (σ)	Target Permittivity (ε _r)	Conductivity Deviation (%)	Permittivity Deviation (%)
Jun. 15, 2017	Head	2450	23.4	1.885	38.286	1.80	39.2	4.72	-2.33
Jun. 16, 2017	Head	2450	23.4	1.886	39.637	1.80	39.2	4.78	1.11
Jun. 19, 2017	Head	2450	23.5	1.837	38.526	1.80	39.2	2.06	-1.72
Jun. 20, 2017	Head	5250	23.5	4.851	35.598	4.71	35.9	2.99	-0.84
Jun. 28, 2017	Head	5250	23.5	4.646	34.510	4.71	35.9	-1.36	-3.87
Jun. 20, 2017	Head	5600	23.5	5.174	35.068	5.07	35.5	2.05	-1.22
Jun. 28, 2017	Head	5600	23.5	4.981	34.013	5.07	35.5	-1.76	-4.19
Jun. 20, 2017	Head	5800	23.5	5.373	34.767	5.27	35.3	1.95	-1.51
Jun. 28, 2017	Head	5800	23.5	5.178	33.717	5.27	35.3	-1.75	-4.48
Jun. 19, 2017	Body	2450	23.6	1.997	51.524	1.95	52.7	2.41	-2.23
Jun. 13, 2017	Body	5250	23.4	5.456	47.688	5.36	48.9	1.79	-2.48
Jun. 16, 2017	Body	5250	23.4	5.505	48.100	5.30	48.0	3.87	0.21
Jun. 18, 2017	Body	5250	23.5	5.290	50.125	5.30	48.0	-0.19	4.43
Jun. 19, 2017	Body	5250	23.4	5.514	47.389	5.36	48.9	2.87	-3.09
Jun. 23, 2017	Body	5250	23.5	5.458	47.083	5.36	48.9	1.83	-3.72
Jun. 24, 2017	Body	5250	23.4	5.254	47.081	5.36	48.9	-1.98	-3.72
Jun. 26, 2017	Body	5250	23.4	5.519	47.407	5.36	48.9	2.97	-3.05
Jun. 28, 2017	Body	5250	23.5	5.514	47.389	5.36	48.9	2.87	-3.09
Jun. 29, 2017	Body	5250	23.5	5.514	47.389	5.36	48.9	2.87	-3.09
Jun. 30, 2017	Body	5250	23.4	5.497	47.921	5.36	48.9	2.56	-2.00
Jul. 02, 2017	Body	5250	23.5	5.514	47.389	5.36	48.9	2.87	-3.09
Jun. 14, 2017	Body	5600	23.4	5.788	47.080	5.77	48.5	0.31	-2.93
Jun. 15, 2017	Body	5600	23.3	5.822	46.671	5.77	48.5	0.90	-3.77
Jun. 16, 2017	Body	5600	23.4	5.939	47.583	5.77	48.5	2.93	-1.89
Jun. 19, 2017	Body	5600	23.5	5.970	46.776	5.77	48.5	3.47	-3.55
Jun. 23, 2017	Body	5600	23.5	5.919	46.511	5.77	48.5	2.58	-4.10
Jun. 27, 2017	Body	5600	23.4	5.615	46.772	5.77	48.5	-2.69	-3.56
Jun. 19, 2017	Body	5800	23.5	6.258	46.422	6.00	48.2	4.30	-3.69
Jun. 23, 2017	Body	5800	23.5	6.186	46.116	6.00	48.2	3.10	-4.32
Jun. 14, 2017	Body	5800	23.4	6.190	46.112	6.00	48.2	3.17	-4.33
Jun. 27, 2017	Body	5800	23.4	5.897	46.424	6.00	48.2	-1.72	-3.68

Note:

The dielectric properties of the tissue simulating liquid must be measured within 24 hours before the SAR testing and within ±5% of the target values. Liquid temperature during the SAR testing must be within ±2 °C.

4.4 System Validation

The SAR measurement system was validated according to procedures in KDB 865664 D01. The validation status in tabulated summary is as below.

Test Date	Probe S/N	Calibration Point		Measured Conductivity (σ)	Measured Permittivity (ϵ_r)	Validation for CW			Validation for Modulation		
						Sensitivity Range	Probe Linearity	Probe Isotropy	Modulation Type	Duty Factor	PAR
Jun. 15, 2017	3650	Head	2450	1.885	38.286	Pass	Pass	Pass	OFDM	N/A	Pass
Jun. 16, 2017	3650	Head	2450	1.886	39.637	Pass	Pass	Pass	OFDM	N/A	Pass
Jun. 19, 2017	3650	Head	2450	1.837	38.526	Pass	Pass	Pass	OFDM	N/A	Pass
Jun. 20, 2017	3650	Head	5250	4.851	35.598	Pass	Pass	Pass	OFDM	N/A	Pass
Jun. 28, 2017	3650	Head	5250	4.646	34.510	Pass	Pass	Pass	OFDM	N/A	Pass
Jun. 20, 2017	3650	Head	5600	5.174	35.068	Pass	Pass	Pass	OFDM	N/A	Pass
Jun. 28, 2017	3650	Head	5600	4.981	34.013	Pass	Pass	Pass	OFDM	N/A	Pass
Jun. 20, 2017	3650	Head	5800	5.373	34.767	Pass	Pass	Pass	OFDM	N/A	Pass
Jun. 28, 2017	3650	Head	5800	5.178	33.717	Pass	Pass	Pass	OFDM	N/A	Pass
Jun. 19, 2017	3650	Body	2450	1.997	51.524	Pass	Pass	Pass	OFDM	N/A	Pass
Jun. 13, 2017	3650	Body	5250	5.456	47.688	Pass	Pass	Pass	OFDM	N/A	Pass
Jun. 16, 2017	3650	Body	5250	5.505	48.100	Pass	Pass	Pass	OFDM	N/A	Pass
Jun. 18, 2017	3650	Body	5250	5.290	50.125	Pass	Pass	Pass	OFDM	N/A	Pass
Jun. 19, 2017	3650	Body	5250	5.514	47.389	Pass	Pass	Pass	OFDM	N/A	Pass
Jun. 23, 2017	3650	Body	5250	5.458	47.083	Pass	Pass	Pass	OFDM	N/A	Pass
Jun. 24, 2017	3650	Body	5250	5.254	47.081	Pass	Pass	Pass	OFDM	N/A	Pass
Jun. 26, 2017	3650	Body	5250	5.519	47.407	Pass	Pass	Pass	OFDM	N/A	Pass
Jun. 28, 2017	3650	Body	5250	5.514	47.389	Pass	Pass	Pass	OFDM	N/A	Pass
Jun. 29, 2017	3650	Body	5250	5.514	47.389	Pass	Pass	Pass	OFDM	N/A	Pass
Jun. 30, 2017	3650	Body	5250	5.497	47.921	Pass	Pass	Pass	OFDM	N/A	Pass
Jul. 02, 2017	3650	Body	5250	5.514	47.389	Pass	Pass	Pass	OFDM	N/A	Pass
Jun. 14, 2017	3650	Body	5600	5.788	47.080	Pass	Pass	Pass	OFDM	N/A	Pass
Jun. 15, 2017	3650	Body	5600	5.822	46.671	Pass	Pass	Pass	OFDM	N/A	Pass
Jun. 16, 2017	3650	Body	5600	5.939	47.583	Pass	Pass	Pass	OFDM	N/A	Pass
Jun. 19, 2017	3650	Body	5600	5.970	46.776	Pass	Pass	Pass	OFDM	N/A	Pass
Jun. 23, 2017	3650	Body	5600	5.919	46.511	Pass	Pass	Pass	OFDM	N/A	Pass
Jun. 27, 2017	3650	Body	5600	5.615	46.772	Pass	Pass	Pass	OFDM	N/A	Pass
Jun. 19, 2017	3650	Body	5800	6.258	46.422	Pass	Pass	Pass	OFDM	N/A	Pass
Jun. 23, 2017	3650	Body	5800	6.186	46.116	Pass	Pass	Pass	OFDM	N/A	Pass
Jun. 14, 2017	3650	Body	5800	6.190	46.112	Pass	Pass	Pass	OFDM	N/A	Pass
Jun. 27, 2017	3650	Body	5800	5.897	46.424	Pass	Pass	Pass	OFDM	N/A	Pass

4.5 System Verification

The measuring result for system verification is tabulated as below.

Test Date	Mode	Frequency (MHz)	1W Target SAR-1g (W/kg)	Measured SAR-1g (W/kg)	Normalized to 1W SAR-1g (W/kg)	Deviation (%)	Dipole S/N	Probe S/N	DAE S/N
Jun. 15, 2017	Head	2450	52.60	13.30	53.20	1.14	737	3650	917
Jun. 16, 2017	Head	2450	52.60	13.20	52.80	0.38	737	3650	917
Jun. 19, 2017	Head	2450	52.60	12.30	49.20	-6.46	737	3650	917
Jun. 20, 2017	Head	5250	79.60	8.05	80.50	1.13	1019	3650	917
Jun. 28, 2017	Head	5250	79.60	7.64	76.40	-4.02	1019	3650	917
Jun. 20, 2017	Head	5600	82.40	7.95	79.50	-3.52	1019	3650	917
Jun. 28, 2017	Head	5600	82.40	8.03	80.30	-2.55	1019	3650	917
Jun. 20, 2017	Head	5800	79.40	7.87	78.70	-0.88	1019	3650	917
Jun. 28, 2017	Head	5800	79.40	8.07	80.70	1.64	1019	3650	917
Jun. 19, 2017	Body	2450	51.10	12.30	49.20	-3.72	737	3650	917
Jun. 13, 2017	Body	5250	77.60	7.23	72.30	-6.83	1019	3650	917
Jun. 16, 2017	Body	5250	75.30	7.34	73.40	-2.52	1019	3650	917
Jun. 18, 2017	Body	5250	75.30	7.85	78.50	4.25	1019	3650	917
Jun. 19, 2017	Body	5250	77.60	7.31	73.10	-5.80	1019	3650	917
Jun. 23, 2017	Body	5250	77.60	7.64	76.40	-1.55	1019	3650	917
Jun. 24, 2017	Body	5250	77.60	7.72	77.20	-0.52	1019	3650	917
Jun. 26, 2017	Body	5250	77.60	7.55	75.50	-2.71	1019	3650	917
Jun. 28, 2017	Body	5250	77.60	7.52	75.20	-3.09	1019	3650	917
Jun. 29, 2017	Body	5250	77.60	7.35	73.50	-5.28	1019	3650	917
Jun. 30, 2017	Body	5250	77.60	7.53	75.30	-2.96	1019	3650	917
Jul. 02, 2017	Body	5250	77.60	7.52	75.20	-3.09	1019	3650	917
Jun. 14, 2017	Body	5600	79.60	7.75	77.50	-2.64	1019	3650	917
Jun. 15, 2017	Body	5600	79.60	7.89	78.90	-0.88	1019	3650	917
Jun. 16, 2017	Body	5600	79.60	7.90	79.00	-0.75	1019	3650	917
Jun. 19, 2017	Body	5600	79.60	7.70	77.00	-3.27	1019	3650	917
Jun. 23, 2017	Body	5600	79.60	7.68	76.80	-3.52	1019	3650	917
Jun. 27, 2017	Body	5600	79.60	8.02	80.20	0.75	1019	3650	917
Jun. 19, 2017	Body	5800	77.30	8.04	80.40	4.01	1019	3650	917
Jun. 23, 2017	Body	5800	77.30	7.89	78.90	2.07	1019	3650	917
Jun. 14, 2017	Body	5800	77.30	7.72	77.20	-0.13	1019	3650	917
Jun. 27, 2017	Body	5800	77.30	7.12	71.20	-7.89	1019	3650	917

Note:

Comparing to the reference SAR value provided by SPEAG, the validation data should be within its specification of 10 %. The result indicates the system check can meet the variation criterion and the plots can be referred to Appendix A of this report.

FCC SAR Test Report

4.6 Maximum Output Power

4.6.1 Maximum Target Conducted Power

The maximum conducted average power (Unit: dBm) including tune-up tolerance is shown as below.

Mode	2.4G WLAN	5.2G WLAN	5.3G WLAN	5.6G WLAN	5.8G WLAN
802.11b	20.0	N/A	N/A	N/A	N/A
802.11g	Ch1 : 17.0 Ch6 : 20.0 Ch11 : 15.0	N/A	N/A	N/A	N/A
802.11a	N/A	18.0	18.5	17.0	17.5
802.11n HT20	Ch1 : 16.0 Ch6 : 21.0 Ch11 : 14.5	18.0	18.5	17.0	17.5
802.11n HT40	Ch3 : 15.0 Ch6 : 16.0 Ch9 : 13.0	Ch38 : 17.5 Ch46 : 18.5	Ch54 : 18.0 Ch62 : 16.5	Ch102 : 16.0 Ch110~Ch142 : 17.0	18.5
802.11ac VHT80	N/A	17.5	17.5	Ch106 : 16.5 Ch122 : 17.5 Ch138 : 18.0	18.5

Mode	2.4G Bluetooth
Bluetooth	Ch0 : 2.0 Ch39 : 3.5 Ch78 : 1.0

4.6.2 Measured Conducted Power Result

The measuring conducted average power (Unit: dBm) is shown as below.

<WLAN 2.4G>

	802.11b Real Average Power			
	1Mbps	2Mbps	5.5Mb	11Mbps
Ch1	19.60	-	-	-
Ch6	19.69	19.52	19.43	19.51
Ch11	19.58	-	-	-

	802.11g Real Average Power							
	6Mbps	9Mbps	12Mbps	18Mbps	24Mbps	36Mbps	48Mbps	54Mbps
Ch1	16.57	-	-	-	-	-	-	-
Ch6	19.60	19.33	19.35	19.32	19.48	19.43	19.31	19.38
Ch11	14.61	-	-	-	-	-	-	-

	802.11n(HT20) Real Average Power							
	MCS0	MCS1	MCS2	MCS3	MCS4	MCS5	MCS6	MCS7
Ch1	15.68	-	-	-	-	-	-	-
Ch6	20.51	20.22	20.39	20.40	20.38	20.32	20.25	20.35
Ch11	14.15	-	-	-	-	-	-	-

	802.11n(HT40) Real Average Power							
	MCS0	MCS1	MCS2	MCS3	MCS4	MCS5	MCS6	MCS7
Ch3	14.65	-	-	-	-	-	-	-
Ch6	15.52	15.24	15.38	15.22	15.37	15.41	15.32	15.23
Ch9	12.75	-	-	-	-	-	-	-

FCC SAR Test Report

<WLAN 5G>

		802.11a Real Average Power							
		6Mbps	9Mbps	12Mbps	18Mbps	24Mbps	36Mbps	48Mbps	54Mbps
Band 1	Ch36	17.85	-	-	-	-	-	-	-
	Ch40	17.92	17.74	17.7	17.82	17.62	17.77	17.68	17.75
	Ch48	17.83	-	-	-	-	-	-	-
Band 2	Ch52	18.44	-	-	-	-	-	-	-
	Ch60	18.48	18.26	18.24	18.23	18.36	18.35	18.38	18.21
	Ch64	18.41	-	-	-	-	-	-	-
Band 3	Ch100	16.89	-	-	-	-	-	-	-
	Ch116	16.96	16.7	16.71	16.81	16.8	16.75	16.7	16.71
	Ch140	16.9	-	-	-	-	-	-	-
	Ch144	16.92	-	-	-	-	-	-	-
Band 4	Ch149	16.94	-	-	-	-	-	-	-
	Ch157	17.45	-	-	-	-	-	-	-
	Ch165	17.47	17.29	17.32	17.26	17.26	17.28	17.21	17.32

		802.11n(HT20) Real Average Power									
		MCS0	MCS1	MCS2	MCS3	MCS4	MCS5	MCS6	MCS7	MCS8	MCS9
Band 1	Ch36	17.77	-	-	-	-	-	-	-	-	-
	Ch40	17.81	17.62	17.70	17.58	17.63	17.63	17.62	17.70	17.69	17.59
	Ch48	17.75	-	-	-	-	-	-	-	-	-
Band 2	Ch52	17.63	-	-	-	-	-	-	-	-	-
	Ch60	17.74	17.51	17.61	17.45	17.58	17.62	17.60	17.62	17.63	17.47
	Ch64	18.22	-	-	-	-	-	-	-	-	-
Band 3	Ch100	16.75	-	-	-	-	-	-	-	-	-
	Ch116	16.47	-	-	-	-	-	-	-	-	-
	Ch140	16.77	-	-	-	-	-	-	-	-	-
	Ch144	16.79	16.67	16.62	16.52	16.59	16.58	16.66	16.51	16.51	16.57
Band 4	Ch149	17.33	-	-	-	-	-	-	-	-	-
	Ch157	17.36	17.21	17.18	17.15	17.10	17.23	17.17	17.11	17.11	17.24
	Ch165	17.35	-	-	-	-	-	-	-	-	-

FCC SAR Test Report

		802.11ac (VHT20) Real Average Power									
		MCS0	MCS1	MCS2	MCS3	MCS4	MCS5	MCS6	MCS7	MCS8	MCS9
Band 1	Ch36	17.59	-	-	-	-	-	-	-	-	-
	Ch40	17.75	17.52	17.55	17.49	17.49	17.57	17.56	17.55	17.64	17.4
	Ch48	17.64	-	-	-	-	-	-	-	-	-
Band 2	Ch52	17.44	-	-	-	-	-	-	-	-	-
	Ch60	17.61	17.43	17.49	17.3	17.52	17.44	17.42	17.52	17.52	17.33
	Ch64	18.08	-	-	-	-	-	-	-	-	-
Band 3	Ch100	16.59	-	-	-	-	-	-	-	-	-
	Ch116	16.41	-	-	-	-	-	-	-	-	-
	Ch140	16.65	-	-	-	-	-	-	-	-	-
	Ch144	16.69	16.49	16.51	16.42	16.41	16.52	16.53	16.44	16.32	16.45
Band 4	Ch149	17.19	-	-	-	-	-	-	-	-	-
	Ch157	17.22	17.07	17.04	17.03	16.96	17.14	17.01	17.03	16.93	17.17
	Ch165	17.2	-	-	-	-	-	-	-	-	-

		802.11n(HT40) Real Average Power									
		MCS0	MCS1	MCS2	MCS3	MCS4	MCS5	MCS6	MCS7	MCS8	MCS9
Band 1	Ch38	17.06	-	-	-	-	-	-	-	-	-
	Ch46	18.13	17.95	17.84	17.84	18.00	18.00	17.88	17.89	17.89	17.96
Band 2	Ch54	17.61	17.32	17.34	17.48	17.32	17.37	17.38	17.47	17.46	17.51
	Ch62	16.23	-	-	-	-	-	-	-	-	-
Band 3	Ch102	15.63	-	-	-	-	-	-	-	-	-
	Ch110	16.52	-	-	-	-	-	-	-	-	-
	Ch134	16.54	-	-	-	-	-	-	-	-	-
	Ch142	16.73	16.50	16.46	16.43	16.49	16.61	16.48	16.50	16.57	16.53
Band 4	Ch151	18.23	-	-	-	-	-	-	-	-	-
	Ch159	18.33	18.11	18.06	18.16	18.21	18.08	18.06	18.05	18.10	18.15

FCC SAR Test Report

		802.11ac (VHT40) Real Average Power									
		MCS0	MCS1	MCS2	MCS3	MCS4	MCS5	MCS6	MCS7	MCS8	MCS9
Band 1	Ch38	16.97	-	-	-	-	-	-	-	-	-
	Ch46	18.04	17.78	17.73	17.68	17.91	17.82	17.70	17.82	17.78	17.89
Band 2	Ch54	17.50	17.27	17.26	17.43	17.20	17.21	17.27	17.38	17.37	17.43
	Ch62	16.11	-	-	-	-	-	-	-	-	-
Band 3	Ch102	15.55	-	-	-	-	-	-	-	-	-
	Ch110	16.39	-	-	-	-	-	-	-	-	-
	Ch134	16.45	-	-	-	-	-	-	-	-	-
	Ch142	16.57	16.33	16.31	16.32	16.33	16.48	16.35	16.44	16.41	16.42
Band 4	Ch151	18.12	-	-	-	-	-	-	-	-	-
	Ch159	18.17	17.96	17.94	18.01	18.06	17.93	17.91	17.95	17.92	17.97

		802.11ac (VHT80) Real Average Power									
		MCS0	MCS1	MCS2	MCS3	MCS4	MCS5	MCS6	MCS7	MCS8	MCS9
Band 1	Ch42	17.46	17.34	17.32	17.28	17.25	17.27	17.36	17.37	17.30	17.23
Band 2	Ch58	17.35	17.18	17.17	17.13	17.16	17.19	17.22	17.19	17.15	17.12
Band 3	Ch106	16.41	-	-	-	-	-	-	-	-	-
	Ch122	17.47	-	-	-	-	-	-	-	-	-
	Ch138	17.62	17.46	17.42	17.34	17.52	17.48	17.44	17.34	17.33	17.48
Band 4	Ch155	18.16	17.87	17.86	18.05	17.99	17.92	18.06	17.92	17.96	17.97

<Bluetooth>

Mode	Bluetooth		
Channel / Frequency (MHz)	0 (2402)	39 (2441)	78 (2480)
Average Power	1.57	3.20	0.90

<Bluetooth LE>

Mode	Bluetooth		
Channel / Frequency (MHz)	37 (2402)	17 (2440)	39 (2480)
Average Power	1.50	3.14	0.88

4.7 SAR Testing Results

4.7.1 SAR Test Reduction Considerations

<KDB 447498 D01, General RF Exposure Guidance>

Testing of other required channels within the operating mode of a frequency band is not required when the reported SAR for the mid-band or highest output power channel is:

- (1) ≤ 0.8 W/kg or 2.0 W/kg, for 1-g or 10-g respectively, when the transmission band is ≤ 100 MHz
- (2) ≤ 0.6 W/kg or 1.5 W/kg, for 1-g or 10-g respectively, when the transmission band is between 100 MHz and 200 MHz
- (3) ≤ 0.4 W/kg or 1.0 W/kg, for 1-g or 10-g respectively, when the transmission band is ≥ 200 MHz

<KDB 248227 D01, SAR Guidance for Wi-Fi Transmitters>

- (1) For handsets operating next to ear, hotspot mode or mini-tablet configurations, the initial test position procedures were applied. The test position with the highest extrapolated peak SAR will be used as the initial test position. When the reported SAR of initial test position is ≤ 0.4 W/kg, SAR testing for remaining test positions is not required. Otherwise, SAR is evaluated at the subsequent highest peak SAR positions until the reported SAR result is ≤ 0.8 W/kg or all test positions are measured.
- (2) For WLAN 2.4 GHz, the highest measured maximum output power channel for DSSS was selected for SAR measurement. When the reported SAR is ≤ 0.8 W/kg, no further SAR testing is required. Otherwise, SAR is evaluated at the next highest measured output power channel. When any reported SAR is > 1.2 W/kg, SAR is required for the third channel. For OFDM modes (802.11g/n), SAR is not required when the highest reported SAR for DSSS is adjusted by the ratio of OFDM to DSSS specified maximum output power and it is ≤ 1.2 W/kg.
- (3) For WLAN 5 GHz, the initial test configuration was selected according to the transmission mode with the highest maximum output power. When the reported SAR of initial test configuration is > 0.8 W/kg, SAR is required for the subsequent highest measured output power channel until the reported SAR result is ≤ 1.2 W/kg or all required channels are measured. For other transmission modes, SAR is not required when the highest reported SAR for initial test configuration is adjusted by the ratio of subsequent test configuration to initial test configuration specified maximum output power and it is ≤ 1.2 W/kg.

FCC SAR Test Report

4.7.2 SAR Results for Head Exposure Condition

Plot No.	Band	Mode	Test Position	Ch.	EUT Config.	PIN	Power Pack	Max. Tune-up Power (dBm)	Measured Conducted Power (dBm)	Scaling Factor	Power Drift (dB)	Measured SAR-1g (W/kg)	Scaled SAR-1g (W/kg)
	2.4G WLAN	802.11b	Right Check	6	1	2	-	20.0	19.69	1.07	-0.05	0.449	0.48
	2.4G WLAN	802.11b	Right Tilted	6	1	2	-	20.0	19.69	1.07	-0.05	0.343	0.37
	2.4G WLAN	802.11b	Left Check	6	1	2	-	20.0	19.69	1.07	0.06	1.07	1.15
	2.4G WLAN	802.11b	Left Tilted	6	1	2	-	20.0	19.69	1.07	-0.04	0.413	0.44
01	2.4G WLAN	802.11b	Left Check	1	1	2	-	20.0	19.60	1.10	0.05	1.17	1.28
	2.4G WLAN	802.11b	Left Check	11	1	2	-	20.0	19.58	1.10	0.06	0.915	1.01
	2.4G WLAN	802.11b	Left Check	6	2	2	-	20.0	19.69	1.07	0.04	1.12	1.20
	2.4G WLAN	802.11b	Left Check	1	2	2	-	20.0	19.60	1.10	0.16	1.05	1.15
	2.4G WLAN	802.11n HT20	Left Check	6	1	2	-	21.0	20.51	1.12	0.06	0.866	0.97
	2.4G WLAN	802.11n HT20	Left Check	1	1	2	-	16.0	15.68	1.08	0.03	0.298	0.32
	2.4G WLAN	802.11n HT20	Left Check	6	2	2	-	21.0	20.51	1.12	0.12	0.912	1.02
	2.4G WLAN	802.11n HT20	Left Check	1	2	2	-	16.0	15.68	1.08	-0.01	0.175	0.19
	2.4G WLAN	802.11b	Left Check	1	1	8	-	20.0	19.60	1.10	0.03	0.942	1.03
	2.4G WLAN	802.11b	Left Check	6	1	8	-	20.0	19.69	1.07	0.13	0.899	0.97
	2.4G WLAN	802.11b	Left Check	1	1	2	w/	20.0	19.60	1.10	0.15	0.989	1.08
	2.4G WLAN	802.11b	Left Check	1	1	2	-	20.0	19.60	1.10	0.01	1.15	1.26
	5.3G WLAN	802.11a	Right Check	60	1	2	-	18.5	18.48	1.00	0.18	0.237	0.24
	5.3G WLAN	802.11a	Right Tilted	60	1	2	-	18.5	18.48	1.00	0.02	0.245	0.25
	5.3G WLAN	802.11a	Left Check	60	1	2	-	18.5	18.48	1.00	-0.1	0.591	0.59
	5.3G WLAN	802.11a	Left Tilted	60	1	2	-	18.5	18.48	1.00	-0.01	0.33	0.33
	5.3G WLAN	802.11a	Left Check	60	2	2	-	18.5	18.48	1.00	-0.08	0.632	0.63
02	5.3G WLAN	802.11a	Left Check	60	2	8	-	18.5	18.48	1.00	0.01	0.671	0.67
	5.3G WLAN	802.11a	Left Check	60	2	8	w/	18.5	18.48	1.00	0.13	0.652	0.66
	5.6G WLAN	802.11ac VH80	Right Check	138	1	2	-	18.0	17.62	1.09	0.07	0.215	0.23
	5.6G WLAN	802.11ac VH80	Right Tilted	138	1	2	-	18.0	17.62	1.09	0.18	0.239	0.26
	5.6G WLAN	802.11ac VH80	Left Check	138	1	2	-	18.0	17.62	1.09	0.11	0.308	0.34
	5.6G WLAN	802.11ac VH80	Left Tilted	138	1	2	-	18.0	17.62	1.09	-0.07	0.277	0.30
	5.6G WLAN	802.11ac VH80	Left Check	138	2	2	-	18.0	17.62	1.09	0.17	0.363	0.40
03	5.6G WLAN	802.11ac VH80	Left Check	138	2	8	-	18.0	17.62	1.09	0.12	0.408	0.45
	5.6G WLAN	802.11ac VH80	Left Check	138	2	8	w/	18.0	17.62	1.09	0.01	0.382	0.42
	5.8G WLAN	802.11ac VH80	Right Check	155	1	2	-	18.5	18.16	1.08	-0.09	0.212	0.23
	5.8G WLAN	802.11ac VH80	Right Tilted	155	1	2	-	18.5	18.16	1.08	-0.12	0.259	0.28
	5.8G WLAN	802.11ac VH80	Left Check	155	1	2	-	18.5	18.16	1.08	-0.04	0.319	0.34
	5.8G WLAN	802.11ac VH80	Left Tilted	155	1	2	-	18.5	18.16	1.08	0.15	0.308	0.33
	5.8G WLAN	802.11ac VH80	Left Check	155	2	2	-	18.5	18.16	1.08	-0.05	0.398	0.43
04	5.8G WLAN	802.11ac VH80	Left Check	155	2	8	-	18.5	18.16	1.08	0.14	0.423	0.46
	5.8G WLAN	802.11ac VH80	Left Check	155	2	8	w/	18.5	18.16	1.08	0.02	0.396	0.43

FCC SAR Test Report

4.7.3 SAR Results for Body-worn Exposure Condition (Test Separation Distance is 15 mm)

Plot No.	Band	Mode	Test Position	Ch.	EUT Config.	PIN	Power Pack	Max. Tune-up Power (dBm)	Measured Conducted Power (dBm)	Scaling Factor	Power Drift (dB)	Measured SAR-1g (W/kg)	Scaled SAR-1g (W/kg)
	2.4G WLAN	802.11b	Front Face	6	1	2	-	20.0	19.69	1.07	-0.1	0.176	0.19
	2.4G WLAN	802.11b	Rear Face	6	1	2	-	20.0	19.69	1.07	0.19	0.526	0.56
	2.4G WLAN	802.11b	Rear Face	6	2	2	-	20.0	19.69	1.07	-0.15	0.449	0.48
05	2.4G WLAN	802.11b	Rear Face	6	1	8	-	20.0	19.69	1.07	0.14	0.548	0.59
	2.4G WLAN	802.11b	Rear Face	6	1	8	w/	20.0	19.69	1.07	0.13	0.088	0.09
	5.2G WLAN	802.11n HT40	Front Face	46	1	2	-	18.5	18.13	1.09	0.00	0.031	0.03
21	5.2G WLAN	802.11n HT40	Rear Face	46	1	2	-	18.5	18.13	1.09	-0.07	1.15	1.25
	5.2G WLAN	802.11n HT40	Rear Face	38	1	2	-	17.5	17.48	1.00	-0.11	0.841	0.84
	5.3G WLAN	802.11n HT40	Rear Face	46	2	2	-	18.5	18.13	1.09	0.07	1.09	1.19
	5.2G WLAN	802.11n HT40	Rear Face	38	2	2	-	17.5	17.48	1.00	-0.03	0.819	0.82
	5.2G WLAN	802.11n HT40	Rear Face	46	1	8	-	18.5	18.13	1.09	0.01	1.03	1.12
	5.2G WLAN	802.11n HT40	Rear Face	38	1	2	-	17.5	17.48	1.00	0.04	0.756	0.76
	5.2G WLAN	802.11n HT40	Rear Face	46	1	2	w/	18.5	18.13	1.09	-0.11	0.317	0.35
	5.2G WLAN	802.11n HT40	Rear Face	46	1	2	-	18.5	18.13	1.09	0.03	1.11	1.21
	5.3G WLAN	802.11a	Front Face	60	1	2	-	18.5	18.48	1.00	0.09	0.085	0.09
	5.3G WLAN	802.11a	Rear Face	60	1	2	-	18.5	18.48	1.00	0.13	1.27	1.28
	5.3G WLAN	802.11a	Rear Face	52	1	2	-	18.5	18.44	1.01	0.07	1.27	1.29
06	5.3G WLAN	802.11a	Rear Face	64	1	2	-	18.5	18.41	1.02	0.12	1.34	1.37
	5.3G WLAN	802.11a	Rear Face	56	1	2	-	18.5	18.33	1.04	0.07	1.28	1.33
	5.3G WLAN	802.11a	Rear Face	60	2	2	-	18.5	18.48	1.00	-0.09	1.28	1.29
	5.3G WLAN	802.11a	Rear Face	52	2	2	-	18.5	18.44	1.01	0.13	1.29	1.31
	5.3G WLAN	802.11a	Rear Face	64	2	2	-	18.5	18.41	1.02	0.07	1.28	1.31
	5.3G WLAN	802.11a	Rear Face	56	2	2	-	18.5	18.33	1.04	-0.14	1.26	1.31
	5.3G WLAN	802.11a	Rear Face	64	1	8	-	18.5	18.41	1.02	-0.05	1.24	1.27
	5.3G WLAN	802.11a	Rear Face	60	1	8	-	18.5	18.48	1.00	-0.12	1.27	1.28
	5.3G WLAN	802.11a	Rear Face	52	1	8	-	18.5	18.44	1.01	-0.12	1.26	1.28
	5.3G WLAN	802.11a	Rear Face	56	1	8	-	18.5	18.33	1.04	0.11	1.18	1.23
	5.3G WLAN	802.11a	Rear Face	64	1	2	w/	18.5	18.41	1.02	0.11	0.424	0.43
	5.3G WLAN	802.11a	Rear Face	64	1	2	-	18.5	18.41	1.02	-0.01	1.29	1.32
	5.6G WLAN	802.11ac VH80	Front Face	138	1	2	-	18.0	17.62	1.09	0.15	0.089	0.10
07	5.6G WLAN	802.11ac VH80	Rear Face	138	1	2	-	18.0	17.62	1.09	0.12	1.27	1.39
	5.6G WLAN	802.11ac VH80	Rear Face	122	1	2	-	17.5	17.47	1.01	-0.11	1.12	1.13
	5.6G WLAN	802.11ac VH80	Rear Face	138	2	2	-	18.0	17.62	1.09	0.15	1.19	1.30
	5.6G WLAN	802.11ac VH80	Rear Face	122	2	2	-	17.5	17.47	1.01	-0.02	1.04	1.05
	5.6G WLAN	802.11ac VH80	Rear Face	138	1	8	-	18.0	17.62	1.09	0.13	1.21	1.32
	5.6G WLAN	802.11ac VH80	Rear Face	138	1	2	w/	18.0	17.62	1.09	0.11	0.301	0.33
	5.6G WLAN	802.11ac VH80	Rear Face	138	1	2	-	18.0	17.62	1.09	0.02	1.21	1.32
	5.8G WLAN	802.11ac VH80	Front Face	155	1	2	-	18.5	18.16	1.08	0.06	0.045	0.05
08	5.8G WLAN	802.11ac VH80	Rear Face	155	1	2	-	18.5	18.16	1.08	0.07	1.24	1.34
	5.8G WLAN	802.11ac VH80	Rear Face	155	2	2	-	18.5	18.16	1.08	0.13	1.18	1.28
	5.8G WLAN	802.11ac VH80	Rear Face	155	1	8	-	18.5	18.16	1.08	0.12	1.19	1.29
	5.8G WLAN	802.11ac VH80	Rear Face	155	1	2	w/	18.5	18.16	1.08	0.13	0.35	0.38
	5.8G WLAN	802.11ac VH80	Rear Face	155	1	2	-	18.5	18.16	1.08	0.09	1.19	1.29

FCC SAR Test Report

4.7.4 SAR Results for Holster Exposure Condition (Test Separation Distance is 0 mm)

Plot No.	Band	Mode	Test Position	Ch.	EUT Config.	PIN	Power Pack	Max. Tune-up Power (dBm)	Measured Conducted Power (dBm)	Scaling Factor	Power Drift (dB)	Measured SAR-1g (W/kg)	Scaled SAR-1g (W/kg)
	2.4G WLAN	802.11b	(Front)_Bottom join	6	1	2	-	20.0	19.69	1.07	-0.13	0.345	0.37
	2.4G WLAN	802.11b	(Front)_Top join	6	1	2	-	20.0	19.69	1.07	-0.05	0.594	0.64
	2.4G WLAN	802.11b	(Rear)_Bottom join	6	1	2	-	20.0	19.69	1.07	-0.05	0.103	0.11
	2.4G WLAN	802.11b	(Rear)_Top join	6	1	2	-	20.0	19.69	1.07	-0.07	0.187	0.20
	2.4G WLAN	802.11b	(Front)_Top join	6	2	2	-	20.0	19.69	1.07	-0.12	0.535	0.57
09	2.4G WLAN	802.11b	(Front)_Top join	6	1	8	-	20.0	19.69	1.07	-0.07	0.635	0.68
	2.4G WLAN	802.11b	(Front)_Top join	6	1	8	w/	20.0	19.69	1.07	0.13	0.035	0.04
	5.3G WLAN	802.11a	(Front)_Bottom join	60	1	2	-	18.5	18.48	1.00	0.11	0.351	0.35
10	5.3G WLAN	802.11a	(Front)_Top join	60	1	2	-	18.5	18.48	1.00	0.16	1.18	1.19
	5.3G WLAN	802.11a	(Rear)_Bottom join	60	1	2	-	18.5	18.48	1.00	0.12	0.105	0.11
	5.3G WLAN	802.11a	(Rear)_Top join	60	1	2	-	18.5	18.48	1.00	0.04	0.191	0.19
	5.3G WLAN	802.11a	(Front)_Top join	52	1	2	-	18.5	18.44	1.01	0.02	1.13	1.15
	5.3G WLAN	802.11a	(Front)_Top join	60	2	2	-	18.5	18.48	1.00	0.15	1.11	1.12
	5.3G WLAN	802.11a	(Front)_Top join	52	2	2	-	18.5	18.44	1.01	-0.04	1.08	1.10
	5.3G WLAN	802.11a	(Front)_Top join	60	1	8	-	18.5	18.48	1.00	0.15	0.996	1.00
	5.3G WLAN	802.11a	(Front)_Top join	60	1	2	w/	18.5	18.48	1.00	0.05	0.213	0.21
	5.3G WLAN	802.11a	(Front)_Top join	60	1	2	-	18.5	18.48	1.00	0.01	1.13	1.14
	5.6G WLAN	802.11ac VH80	(Front)_Bottom join	138	1	2	-	18.0	17.62	1.09	0.14	0.273	0.30
11	5.6G WLAN	802.11ac VH80	(Front)_Top join	138	1	2	-	18.0	17.62	1.09	0.11	0.893	0.97
	5.6G WLAN	802.11ac VH80	(Rear)_Bottom join	138	1	2	-	18.0	17.62	1.09	0.02	0.082	0.09
	5.6G WLAN	802.11ac VH80	(Rear)_Top join	138	1	2	-	18.0	17.62	1.09	0.11	0.148	0.16
	5.6G WLAN	802.11ac VH80	(Front)_Top join	122	1	2	-	17.5	17.47	1.01	0.03	0.716	0.72
	5.6G WLAN	802.11ac VH80	(Front)_Top join	138	2	2	-	18.0	17.62	1.09	0.15	0.862	0.94
	5.6G WLAN	802.11ac VH80	(Front)_Top join	122	1	2	-	17.5	17.47	1.01	0.11	0.689	0.69
	5.6G WLAN	802.11ac VH80	(Front)_Top join	138	1	8	-	18.0	17.62	1.09	0.08	0.773	0.84
	5.6G WLAN	802.11ac VH80	(Front)_Top join	138	1	2	w/	18.0	17.62	1.09	0.11	0.165	0.18
	5.6G WLAN	802.11ac VH80	(Front)_Top join	138	1	2	-	18.0	17.62	1.09	-0.13	0.816	0.89
	5.8G WLAN	802.11ac VH80	(Front)_Bottom join	155	1	2	-	18.5	18.16	1.08	0.11	0.253	0.27
12	5.8G WLAN	802.11ac VH80	(Front)_Top join	155	1	2	-	18.5	18.16	1.08	-0.04	0.828	0.90
	5.8G WLAN	802.11ac VH80	(Rear)_Bottom join	155	1	2	-	18.5	18.16	1.08	0.04	0.076	0.08
	5.8G WLAN	802.11ac VH80	(Rear)_Top join	155	1	2	-	18.5	18.16	1.08	0.15	0.138	0.15
	5.8G WLAN	802.11ac VH80	(Front)_Top join	155	2	2	-	18.5	18.16	1.08	0.15	0.799	0.86
	5.8G WLAN	802.11ac VH80	(Front)_Top join	155	1	8	-	18.5	18.16	1.08	0.12	0.717	0.78
	5.8G WLAN	802.11ac VH80	(Front)_Top join	155	1	2	w/	18.5	18.16	1.08	0.03	0.082	0.09
	5.8G WLAN	802.11ac VH80	(Front)_Top join	155	1	2	-	18.5	18.16	1.08	0.12	0.795	0.86

FCC SAR Test Report

4.7.5 SAR Results for Arm Mount Exposure Condition (Test Separation Distance is 0 mm)

Plot No.	Band	Mode	Test Position	Ch.	EUT Config.	PIN	Max. Tune-up Power (dBm)	Measured Conducted Power (dBm)	Scaling Factor	Power Drift (dB)	Measured SAR-10g (W/kg)	Scaled SAR-10g (W/kg)
	2.4G WLAN	802.11b	Rear Face	6	1	2	20.0	19.69	1.07	-0.05	0.152	0.16
	2.4G WLAN	802.11b	Rear Face	6	2	2	20.0	19.69	1.07	0.11	0.165	0.18
13	2.4G WLAN	802.11b	Rear Face	6	2	8	20.0	19.69	1.07	0.15	0.168	0.18
14	5.3G WLAN	802.11a	Rear Face	60	1	2	18.5	18.48	1.00	0.01	0.557	0.56
	5.3G WLAN	802.11a	Rear Face	60	2	2	18.5	18.48	1.00	0.13	0.543	0.55
	5.3G WLAN	802.11a	Rear Face	60	1	8	18.5	18.48	1.00	0.15	0.538	0.54
	5.6G WLAN	802.11ac VH80	Rear Face	138	1	2	18.0	17.62	1.09	0.11	0.221	0.24
15	5.6G WLAN	802.11ac VH80	Rear Face	138	2	2	18.0	17.62	1.09	0.02	0.249	0.27
	5.6G WLAN	802.11ac VH80	Rear Face	138	2	8	18.0	17.62	1.09	0.15	0.225	0.25
	5.8G WLAN	802.11ac VH80	Rear Face	155	1	2	18.5	18.16	1.08	0.11	0.215	0.23
	5.8G WLAN	802.11ac VH80	Rear Face	155	2	2	18.5	18.16	1.08	0.15	0.224	0.24
16	5.8G WLAN	802.11ac VH80	Rear Face	155	1	8	18.5	18.16	1.08	0.16	0.198	0.21

4.7.6 SAR Results for Gun Exposure Condition (Test Separation Distance is 0 mm)

Plot No.	Band	Mode	Test Position	Ch.	EUT Config.	PIN	Max. Tune-up Power (dBm)	Measured Conducted Power (dBm)	Scaling Factor	Power Drift (dB)	Measured SAR-10g (W/kg)	Scaled SAR-10g (W/kg)
	2.4G WLAN	802.11b	Right Side	6	1	2	20.0	19.69	1.07	0.16	2.03	2.18
	2.4G WLAN	802.11b	Right Side	1	1	2	20.0	19.60	1.10	-0.15	2.15	2.36
	2.4G WLAN	802.11b	Right Side	6	2	2	20.0	19.69	1.07	-0.16	2.2	2.36
17	2.4G WLAN	802.11b	Right Side	1	2	2	20.0	19.60	1.10	-0.14	2.24	2.46
	2.4G WLAN	802.11b	Right Side	1	2	2	20.0	19.60	1.10	0.01	2.19	2.40
	5.3G WLAN	802.11a	Right Side	60	1	2	18.5	18.48	1.00	0.15	1.93	1.94
18	5.3G WLAN	802.11a	Right Side	60	2	2	18.5	18.48	1.00	0.11	1.97	1.98
19	5.6G WLAN	802.11ac VH80	Right Side	138	1	2	18.0	17.62	1.09	0.05	0.99	1.08
	5.6G WLAN	802.11ac VH80	Right Side	138	2	2	18.0	17.62	1.09	0.13	0.97	1.06
	5.8G WLAN	802.11ac VH80	Right Side	155	1	2	18.5	18.16	1.08	0.11	0.773	0.84
20	5.8G WLAN	802.11ac VH80	Right Side	155	2	2	18.5	18.16	1.08	0.05	0.782	0.85

4.7.7 Simultaneous Multi-band Transmission Evaluation

<Possibilities of Simultaneous Transmission>

The simultaneous transmission possibilities for this device are listed as below.

Simultaneous TX Combination	Capable Transmit Configurations	Head Exposure Condition	Body Exposure Condition	Holster Exposure Condition	Arm Mount Exposure Condition	Gun Exposure Condition
1	WLAN 2.4G + BT	No	No	No	No	No
2	WLAN 5G + BT	No	No	No	No	No

Note :

1. The WLAN 2.4G and WLAN 5G cannot transmit simultaneously.
2. The WLAN and Bluetooth cannot transmit simultaneously.

4.7.8 SAR Measurement Variability

According to KDB 865664 D01, SAR measurement variability was assessed for each frequency band, which is determined by the SAR probe calibration point and tissue-equivalent medium used for the device measurements. When both head and body tissue-equivalent media are required for SAR measurements in a frequency band, the variability measurement procedures should be applied to the tissue medium with the highest measured SAR, using the highest measured SAR configuration for that tissue-equivalent medium. Alternatively, if the highest measured SAR for both head and body tissue-equivalent media are ≤ 1.45 W/kg and the ratio of these highest SAR values, i.e., largest divided by smallest value, is ≤ 1.10 , the highest SAR configuration for either head or body tissue-equivalent medium may be used to perform the repeated measurement. These additional measurements are repeated after the completion of all measurements requiring the same head or body tissue-equivalent medium in a frequency band. The test device should be returned to ambient conditions (normal room temperature) with the battery fully charged before it is re-mounted on the device holder for the repeated measurement(s) to minimize any unexpected variations in the repeated results.

SAR repeated measurement procedure:

1. When the highest measured SAR is < 0.80 W/kg, repeated measurement is not required.
2. When the highest measured SAR is ≥ 0.80 W/kg, repeat that measurement once.
3. If the ratio of largest to smallest SAR for the original and first repeated measurements is > 1.20 , or when the original or repeated measurement is ≥ 1.45 W/kg, perform a second repeated measurement.
4. If the ratio of largest to smallest SAR for the original, first and second repeated measurements is > 1.20 , and the original, first or second repeated measurement is ≥ 1.5 W/kg, perform a third repeated measurement.

Band	Mode	Test Position	Ch.	Original Measured SAR-1g (W/kg)	1st Repeated SAR-1g (W/kg)	L/S Ratio	2nd Repeated SAR-1g (W/kg)	L/S Ratio	3rd Repeated SAR-1g (W/kg)	L/S Ratio
2.4G WLAN	802.11b	Left Check	1	1.17	1.15	1.02	N/A	N/A	N/A	N/A
5.2G WLAN	802.11n HT40	Rear Face	46	1.15	1.11	1.04	N/A	N/A	N/A	N/A
5.3G WLAN	802.11a	Rear Face	64	1.34	1.29	1.04	N/A	N/A	N/A	N/A
5.6G WLAN	802.11ac VH80	Rear Face	138	1.27	1.21	1.04	N/A	N/A	N/A	N/A
5.8G WLAN	802.11ac VH80	Rear Face	155	1.24	1.19	1.04	N/A	N/A	N/A	N/A
5.3G WLAN	802.11a	(Front)_Top join	60	1.18	1.13	1.05	N/A	N/A	N/A	N/A
5.6G WLAN	802.11ac VH80	(Front)_Top join	138	0.893	0.816	1.10	N/A	N/A	N/A	N/A
5.8G WLAN	802.11ac VH80	(Front)_Top join	155	0.828	0.795	1.04	N/A	N/A	N/A	N/A

Band	Mode	Test Position	Ch.	Original Measured SAR-10g (W/kg)	1st Repeated SAR-10g (W/kg)	L/S Ratio	2nd Repeated SAR-1g (W/kg)	L/S Ratio	3rd Repeated SAR-1g (W/kg)	L/S Ratio
2.4G WLAN	802.11b	Right Side	1	2.24	2.19	1.03	N/A	N/A	N/A	N/A

Test Engineer : Austin Lin, and Blake Wang

5. Calibration of Test Equipment

Equipment	Manufacturer	Model	SN	Cal. Date	Cal. Interval
System Validation Dipole	SPEAG	D2450V2	737	Aug. 26, 2016	1 Year
System Validation Dipole	SPEAG	D5GHzV2	1019	Aug. 23, 2016	1 Year
Dosimetric E-Field Probe	SPEAG	EX3DV4	3650	Jul. 25, 2016	1 Year
Data Acquisition Electronics	SPEAG	DAE4	917	Jan. 06, 2017	1 Year
EXA Spectrum Analyzer	Agilent	N9010A	MY53470455	Feb. 26, 2015	N/A
Vector Signal Generator	Anritsu	MG3710A	6201599977	Mar. 27, 2017	1 Year
Thermometer	YFE	YF-160A	130504591	Mar. 24, 2017	1 Year
Power Amplifier	AR	5S1G4	0339656	Sep. 21, 2016	1 Year
Power Amplifier	mini-circuits	ZVE-8G	05770420A	Sep. 21, 2016	1 Year
Attenuator	MTJ	MTJ6011-03	N/A	Sep. 21, 2016	1 Year
Directional Coupler	Woken	0110A056020-10	11122702	Sep. 21, 2016	1 Year
Dielectric Assessment Kit	SPEAG	DAK-3.5	1151	Aug. 25, 2016	1 Year
Twin SAM Phantom	SPEAG	QD 000 P40 CD	1652	N/A	N/A
Twin SAM Phantom	SPEAG	QD 000 P40 CD	1653	N/A	N/A

FCC SAR Test Report

6. Measurement Uncertainty

Source of Uncertainty	Uncertainty (± %)	Probability Distribution	Divisor	Ci (1g)	Ci (10g)	Standard Uncertainty (± %, 1g)	Standard Uncertainty (± %, 10g)	Vi
Measurement System								
Probe Calibration	6.0	Normal	1	1	1	6.0	6.0	∞
Axial Isotropy	4.7	Rectangular	√3	√0.5	√0.5	1.9	1.9	∞
Hemispherical Isotropy	9.6	Rectangular	√3	√0.5	√0.5	3.9	3.9	∞
Boundary Effect	1.0	Rectangular	√3	1	1	0.6	0.6	∞
Linearity	4.7	Rectangular	√3	1	1	2.7	2.7	∞
Detection Limits	0.25	Rectangular	√3	1	1	0.14	0.14	∞
Probe Modulation Response	3.5	Rectangular	√3	1	1	2.0	2.0	∞
Readout Electronics	0.3	Normal	1	1	1	0.3	0.3	∞
Response Time	0.0	Rectangular	√3	1	1	0.0	0.0	∞
Integration Time	1.7	Rectangular	√3	1	1	1.0	1.0	∞
RF Ambient Conditions – Noise	3.0	Rectangular	√3	1	1	1.7	1.7	∞
RF Ambient Conditions – Reflections	3.0	Rectangular	√3	1	1	1.7	1.7	∞
Probe Positioner Mechanical Tolerance	0.4	Rectangular	√3	1	1	0.2	0.2	∞
Probe Positioning with Respect to Phantom	2.9	Rectangular	√3	1	1	1.7	1.7	∞
Post-processing	2.0	Rectangular	√3	1	1	1.2	1.2	∞
Test Sample Related								
Test Sample Positioning	3.9 / 2.06	Normal	1	1	1	3.9	2.1	35
Device Holder Uncertainty	2.9 / 4.1	Normal	1	1	1	2.9	4.1	11
Power Drift of Measurement	5.0	Rectangular	√3	1	1	2.9	2.9	∞
Power Scaling	0.0	Rectangular	√3	1	1	0.0	0.0	∞
Phantom and Setup								
Phantom Uncertainty (Shape and Thickness Tolerances)	6.1	Rectangular	√3	1	1	3.5	3.5	∞
Liquid Conductivity (Temperature Uncertainty)	3.24	Rectangular	√3	0.78	0.71	1.5	1.3	∞
Liquid Conductivity (Measured)	2.88	Normal	1	0.78	0.71	2.2	2.0	43
Liquid Permittivity (Temperature Uncertainty)	1.13	Rectangular	√3	0.23	0.26	0.2	0.2	∞
Liquid Permittivity (Measured)	2.50	Normal	1	0.23	0.26	0.6	0.7	54
Combined Standard Uncertainty						± 11.4 %	± 11.2 %	
Expanded Uncertainty (K=2)						± 22.8 %	± 22.4 %	

Head SAR Uncertainty Budget for Frequency Range of 300 MHz to 3 GHz

FCC SAR Test Report

Source of Uncertainty	Uncertainty (± %)	Probability Distribution	Divisor	Ci (1g)	Ci (10g)	Standard Uncertainty (± %, 1g)	Standard Uncertainty (± %, 10g)	Vi
Measurement System								
Probe Calibration	6.55	Normal	1	1	1	6.55	6.55	∞
Axial Isotropy	4.7	Rectangular	√3	0.7	0.7	1.9	1.9	∞
Hemispherical Isotropy	9.6	Rectangular	√3	0.7	0.7	3.9	3.9	∞
Boundary Effect	2.0	Rectangular	√3	1	1	1.2	1.2	∞
Linearity	4.7	Rectangular	√3	1	1	2.7	2.7	∞
Detection Limits	0.25	Rectangular	√3	1	1	0.14	0.14	∞
Probe Modulation Response	3.5	Rectangular	√3	1	1	2.0	2.0	∞
Readout Electronics	0.3	Normal	1	1	1	0.3	0.3	∞
Response Time	0.0	Rectangular	√3	1	1	0.0	0.0	∞
Integration Time	1.7	Rectangular	√3	1	1	1.0	1.0	∞
RF Ambient Conditions – Noise	3.0	Rectangular	√3	1	1	1.7	1.7	∞
RF Ambient Conditions – Reflections	3.0	Rectangular	√3	1	1	1.7	1.7	∞
Probe Positioner Mechanical Tolerance	0.4	Rectangular	√3	1	1	0.2	0.2	∞
Probe Positioning with Respect to Phantom	6.7	Rectangular	√3	1	1	3.9	3.9	∞
Post-processing	4.0	Rectangular	√3	1	1	2.3	2.3	∞
Test Sample Related								
Test Sample Positioning	3.9 / 2.06	Normal	1	1	1	3.9	2.1	35
Device Holder Uncertainty	2.9 / 4.1	Normal	1	1	1	2.9	4.1	11
Power Drift of Measurement	5.0	Rectangular	√3	1	1	2.9	2.9	∞
Power Scaling	0.0	Rectangular	√3	1	1	0.0	0.0	∞
Phantom and Setup								
Phantom Uncertainty (Shape and Thickness Tolerances)	6.6	Rectangular	√3	1	1	3.8	3.8	∞
Liquid Conductivity (Temperature Uncertainty)	3.24	Rectangular	√3	0.78	0.71	1.5	1.3	∞
Liquid Conductivity (Measured)	2.88	Normal	1	0.78	0.71	2.2	2.0	43
Liquid Permittivity (Temperature Uncertainty)	1.13	Rectangular	√3	0.23	0.26	0.2	0.2	∞
Liquid Permittivity (Measured)	2.50	Normal	1	0.23	0.26	0.6	0.7	54
Combined Standard Uncertainty						± 12.5 %	± 12.3 %	
Expanded Uncertainty (K=2)						± 25.0 %	± 24.6 %	

Head SAR Uncertainty Budget for Frequency Range of 3 GHz to 6 GHz

FCC SAR Test Report

Source of Uncertainty	Uncertainty (± %)	Probability Distribution	Divisor	Ci (1g)	Ci (10g)	Standard Uncertainty (± %, 1g)	Standard Uncertainty (± %, 10g)	Vi
Measurement System								
Probe Calibration	6.0	Normal	1	1	1	6.0	6.0	∞
Axial Isotropy	4.7	Rectangular	√3	√0.5	√0.5	1.9	1.9	∞
Hemispherical Isotropy	9.6	Rectangular	√3	√0.5	√0.5	3.9	3.9	∞
Boundary Effect	1.0	Rectangular	√3	1	1	0.6	0.6	∞
Linearity	4.7	Rectangular	√3	1	1	2.7	2.7	∞
Detection Limits	0.25	Rectangular	√3	1	1	0.14	0.14	∞
Probe Modulation Response	3.5	Rectangular	√3	1	1	2.0	2.0	∞
Readout Electronics	0.3	Normal	1	1	1	0.3	0.3	∞
Response Time	0.0	Rectangular	√3	1	1	0.0	0.0	∞
Integration Time	1.7	Rectangular	√3	1	1	1.0	1.0	∞
RF Ambient Conditions – Noise	3.0	Rectangular	√3	1	1	1.7	1.7	∞
RF Ambient Conditions – Reflections	3.0	Rectangular	√3	1	1	1.7	1.7	∞
Probe Positioner Mechanical Tolerance	0.4	Rectangular	√3	1	1	0.2	0.2	∞
Probe Positioning with Respect to Phantom	2.9	Rectangular	√3	1	1	1.7	1.7	∞
Post-processing	2.0	Rectangular	√3	1	1	1.2	1.2	∞
Test Sample Related								
Test Sample Positioning	4.38 / 1.35	Normal	1	1	1	4.4	1.4	29
Device Holder Uncertainty	2.9 / 4.1	Normal	1	1	1	2.9	4.1	11
Power Drift of Measurement	5.0	Rectangular	√3	1	1	2.9	2.9	∞
Power Scaling	0.0	Rectangular	√3	1	1	0.0	0.0	∞
Phantom and Setup								
Phantom Uncertainty (Shape and Thickness Tolerances)	7.2	Rectangular	√3	1	1	4.2	4.2	∞
Liquid Conductivity (Temperature Uncertainty)	3.24	Rectangular	√3	0.78	0.71	1.5	1.3	∞
Liquid Conductivity (Measured)	2.88	Normal	1	0.78	0.71	2.2	2.0	43
Liquid Permittivity (Temperature Uncertainty)	1.13	Rectangular	√3	0.23	0.26	0.2	0.2	∞
Liquid Permittivity (Measured)	2.50	Normal	1	0.23	0.26	0.6	0.7	54
Combined Standard Uncertainty						± 11.8 %	± 11.3 %	
Expanded Uncertainty (K=2)						± 23.6 %	± 22.6 %	

Body SAR Uncertainty Budget for Frequency Range of 300 MHz to 3 GHz

FCC SAR Test Report

Source of Uncertainty	Uncertainty (± %)	Probability Distribution	Divisor	Ci (1g)	Ci (10g)	Standard Uncertainty (± %, 1g)	Standard Uncertainty (± %, 10g)	Vi
Measurement System								
Probe Calibration	6.55	Normal	1	1	1	6.55	6.55	∞
Axial Isotropy	4.7	Rectangular	√3	0.7	0.7	1.9	1.9	∞
Hemispherical Isotropy	9.6	Rectangular	√3	0.7	0.7	3.9	3.9	∞
Boundary Effect	2.0	Rectangular	√3	1	1	1.2	1.2	∞
Linearity	4.7	Rectangular	√3	1	1	2.7	2.7	∞
Detection Limits	0.25	Rectangular	√3	1	1	0.14	0.14	∞
Probe Modulation Response	3.5	Rectangular	√3	1	1	2.0	2.0	∞
Readout Electronics	0.3	Normal	1	1	1	0.3	0.3	∞
Response Time	0.0	Rectangular	√3	1	1	0.0	0.0	∞
Integration Time	1.7	Rectangular	√3	1	1	1.0	1.0	∞
RF Ambient Conditions – Noise	3.0	Rectangular	√3	1	1	1.7	1.7	∞
RF Ambient Conditions – Reflections	3.0	Rectangular	√3	1	1	1.7	1.7	∞
Probe Positioner Mechanical Tolerance	0.4	Rectangular	√3	1	1	0.2	0.2	∞
Probe Positioning with Respect to Phantom	6.7	Rectangular	√3	1	1	3.9	3.9	∞
Post-processing	4.0	Rectangular	√3	1	1	2.3	2.3	∞
Test Sample Related								
Test Sample Positioning	4.38 / 1.35	Normal	1	1	1	4.4	1.4	29
Device Holder Uncertainty	2.9 / 4.1	Normal	1	1	1	2.9	4.1	11
Power Drift of Measurement	5.0	Rectangular	√3	1	1	2.9	2.9	∞
Power Scaling	0.0	Rectangular	√3	1	1	0.0	0.0	∞
Phantom and Setup								
Phantom Uncertainty (Shape and Thickness Tolerances)	7.6	Rectangular	√3	1	1	4.4	4.4	∞
Liquid Conductivity (Temperature Uncertainty)	3.24	Rectangular	√3	0.78	0.71	1.5	1.3	∞
Liquid Conductivity (Measured)	2.88	Normal	1	0.78	0.71	2.2	2.0	43
Liquid Permittivity (Temperature Uncertainty)	1.13	Rectangular	√3	0.23	0.26	0.2	0.2	∞
Liquid Permittivity (Measured)	2.50	Normal	1	0.23	0.26	0.6	0.7	54
Combined Standard Uncertainty						± 12.8 %	± 12.4 %	
Expanded Uncertainty (K=2)						± 25.6 %	± 24.8 %	

Body SAR Uncertainty Budget for Frequency Range of 3 GHz to 6 GHz

7. Information on the Testing Laboratories

We, Bureau Veritas Consumer Products Services (H.K.) Ltd., Taoyuan Branch, were founded in 1988 to provide our best service in EMC, Radio, Telecom and Safety consultation. Our laboratories are accredited and approved according to ISO/IEC 17025.

If you have any comments, please feel free to contact us at the following:

Taiwan HwaYa EMC/RF/Safety/Telecom Lab:

Add: No. 19, Hwa Ya 2nd Rd, Wen Hwa Vil., Kwei Shan Hsiang, Taoyuan Hsien 333, Taiwan, R.O.C.

Tel: 886-3-318-3232

Fax: 886-3-327-0892

Taiwan LinKo EMC/RF Lab:

Add: No. 47-2, 14th Ling, Chia Pau Vil., Linkou Dist., New Taipei City 244, Taiwan, R.O.C.

Tel: 886-2-2605-2180

Fax: 886-2-2605-1924

Taiwan HsinChu EMC/RF Lab:

Add: No. 81-1, Lu Liao Keng, 9th Ling, Wu Lung Vil., Chiung Lin Township, Hsinchu County 307, Taiwan, R.O.C.

Tel: 886-3-593-5343

Fax: 886-3-593-5342

Email: service.adt@tw.bureauveritas.com

Web Site: www.adt.com.tw

The road map of all our labs can be found in our web site also.

---END---

Appendix A. SAR Plots of System Verification

The plots for system verification with largest deviation for each SAR system combination are shown as follows.

System Check_H2450_170615

DUT: Dipole 2450 MHz; Type: D2450V2; SN: 737

Communication System: CW; Frequency: 2450 MHz; Duty Cycle: 1:1

Medium: H19T27N3_0615 Medium parameters used: $f = 2450$ MHz; $\sigma = 1.885$ S/m; $\epsilon_r = 38.286$; $\rho = 1000$ kg/m³

Ambient Temperature : 23.6 °C ; Liquid Temperature : 23.4 °C

DASY5 Configuration:

- Probe: EX3DV4 - SN3650; ConvF(7.51, 7.51, 7.51); Calibrated: 2016/07/25;
- Sensor-Surface: 1.4mm (Mechanical Surface Detection)
- Electronics: DAE4 Sn917; Calibrated: 2017/01/06
- Phantom: Twin SAM Phantom_1653; Type: QD000P40;
- Measurement SW: DASY52, Version 52.8 (8); SEMCAD X Version 14.6.10 (7373)

Pin=250mW/Area Scan (81x81x1): Interpolated grid: dx=1.200 mm, dy=1.200 mm
Maximum value of SAR (interpolated) = 22.7 W/kg

Pin=250mW/Zoom Scan (7x7x7)/Cube 0: Measurement grid: dx=5mm, dy=5mm, dz=5mm
Reference Value = 106.3 V/m; Power Drift = -0.02 dB
Peak SAR (extrapolated) = 28.2 W/kg
SAR(1 g) = 13.3 W/kg; SAR(10 g) = 6.04 W/kg
Maximum value of SAR (measured) = 22.7 W/kg

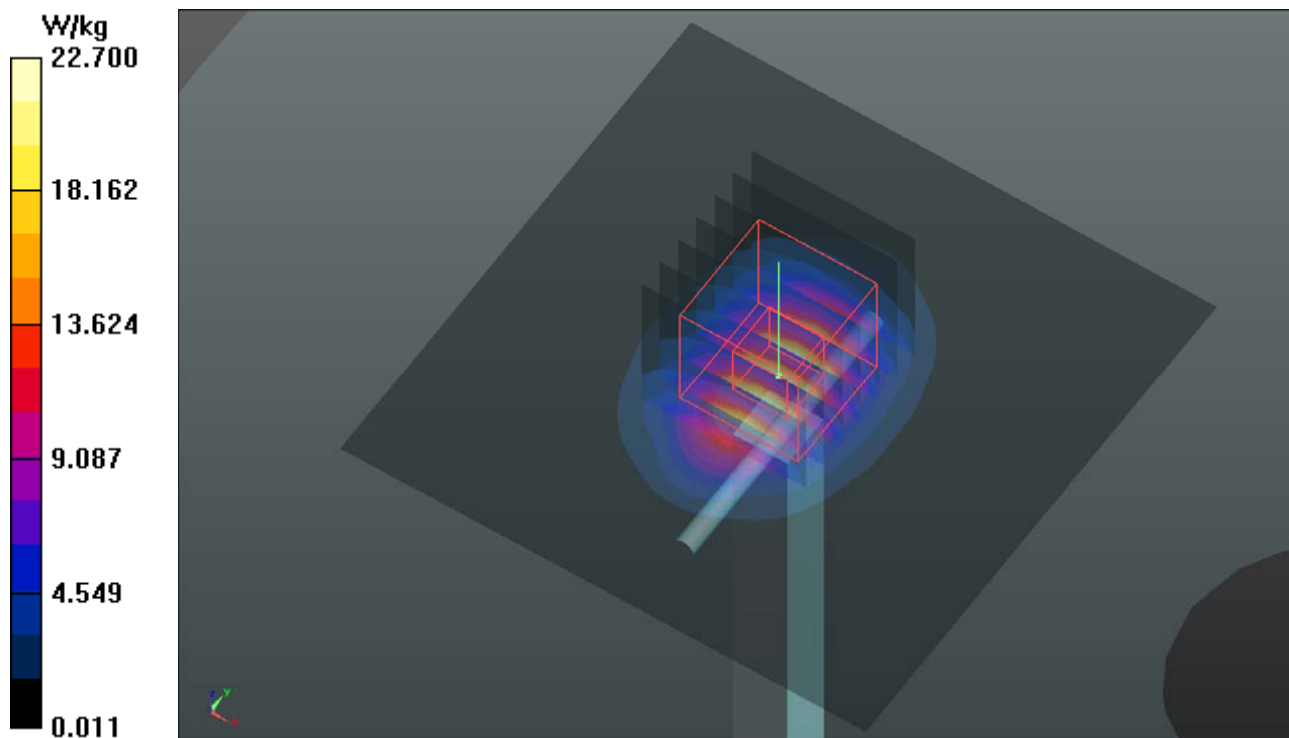

System Check_H5250_170628

DUT: Dipole 5 GHz; Type: D5GHzV2; SN: 1019

Communication System: CW; Frequency: 5250 MHz; Duty Cycle: 1:1

Medium: H34T60N3_0628 Medium parameters used: $f = 5250$ MHz; $\sigma = 4.646$ S/m; $\epsilon_r = 34.51$; $\rho = 1000$ kg/m³

Ambient Temperature : 23.7 °C ; Liquid Temperature : 23.5 °C

DASY5 Configuration:

- Probe: EX3DV4 - SN3650; ConvF(5.43, 5.43, 5.43); Calibrated: 2016/07/25;
- Sensor-Surface: 1.4mm (Mechanical Surface Detection)
- Electronics: DAE4 Sn917; Calibrated: 2017/01/06
- Phantom: Twin SAM Phantom_1652; Type: QD000P40;
- Measurement SW: DASY52, Version 52.8 (8); SEMCAD X Version 14.6.10 (7373)

Pin=100mW/Area Scan (91x91x1): Interpolated grid: dx=1.000 mm, dy=1.000 mm
Maximum value of SAR (interpolated) = 16.4 W/kg

Pin=100mW/Zoom Scan (7x7x12)/Cube 0: Measurement grid: dx=4mm, dy=4mm, dz=2mm
Reference Value = 59.88 V/m; Power Drift = 0.14 dB
Peak SAR (extrapolated) = 32.9 W/kg
SAR(1 g) = 7.64 W/kg; SAR(10 g) = 2.17 W/kg
Maximum value of SAR (measured) = 16.0 W/kg

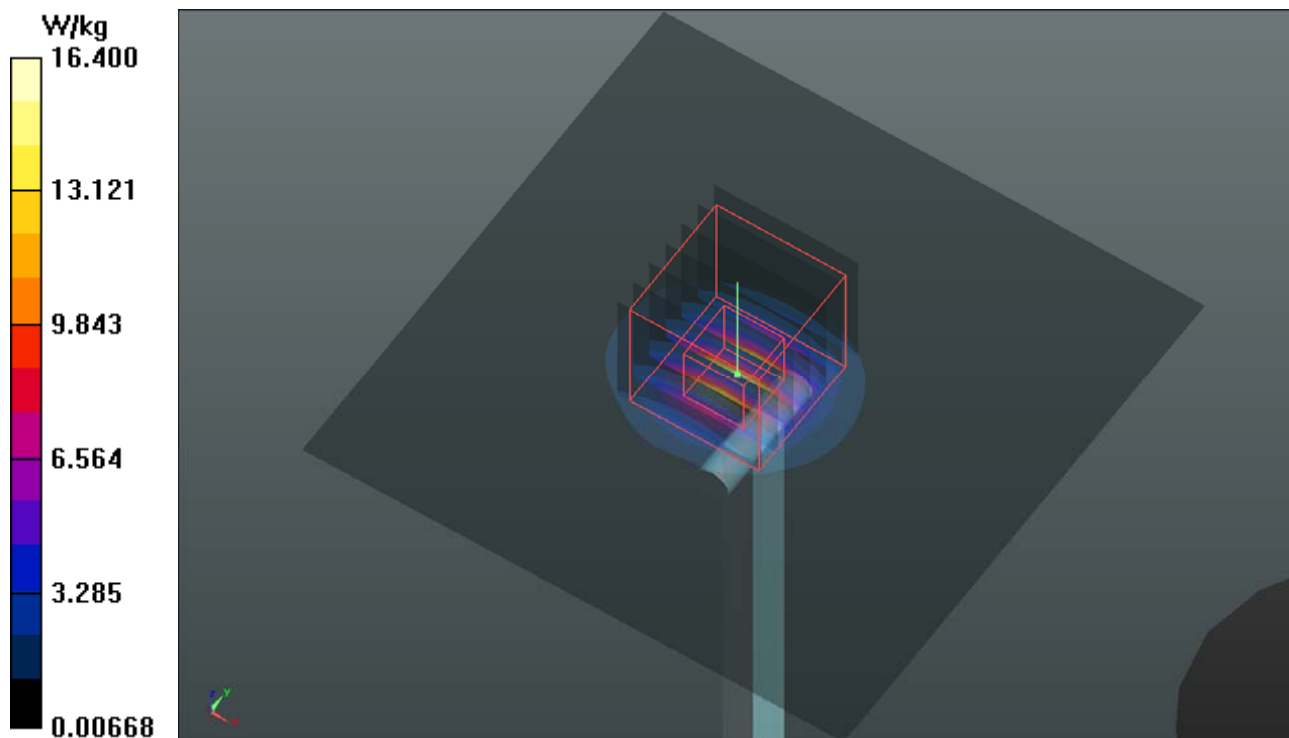

System Check_H5600_170620

DUT: Dipole 5 GHz; Type: D5GHzV2; SN: 1019

Communication System: CW; Frequency: 5600 MHz; Duty Cycle: 1:1

Medium: H34T60N2_0620 Medium parameters used: $f = 5600$ MHz; $\sigma = 5.174$ S/m; $\epsilon_r = 35.068$; $\rho = 1000$ kg/m³

Ambient Temperature : 23.6 °C ; Liquid Temperature : 23.5 °C

DASY5 Configuration:

- Probe: EX3DV4 - SN3650; ConvF(4.78, 4.78, 4.78); Calibrated: 2016/07/25;
- Sensor-Surface: 1.4mm (Mechanical Surface Detection)
- Electronics: DAE4 Sn917; Calibrated: 2017/01/06
- Phantom: Twin SAM Phantom_1653; Type: QD000P40;
- Measurement SW: DASY52, Version 52.8 (8); SEMCAD X Version 14.6.10 (7373)

Pin=100mW/Area Scan (91x91x1): Interpolated grid: dx=1.000 mm, dy=1.000 mm
Maximum value of SAR (interpolated) = 19.4 W/kg

Pin=100mW/Zoom Scan (7x7x12)/Cube 0: Measurement grid: dx=4mm, dy=4mm, dz=2mm
Reference Value = 70.14 V/m; Power Drift = -0.13 dB
Peak SAR (extrapolated) = 33.0 W/kg
SAR(1 g) = 7.95 W/kg; SAR(10 g) = 2.29 W/kg
Maximum value of SAR (measured) = 20.2 W/kg

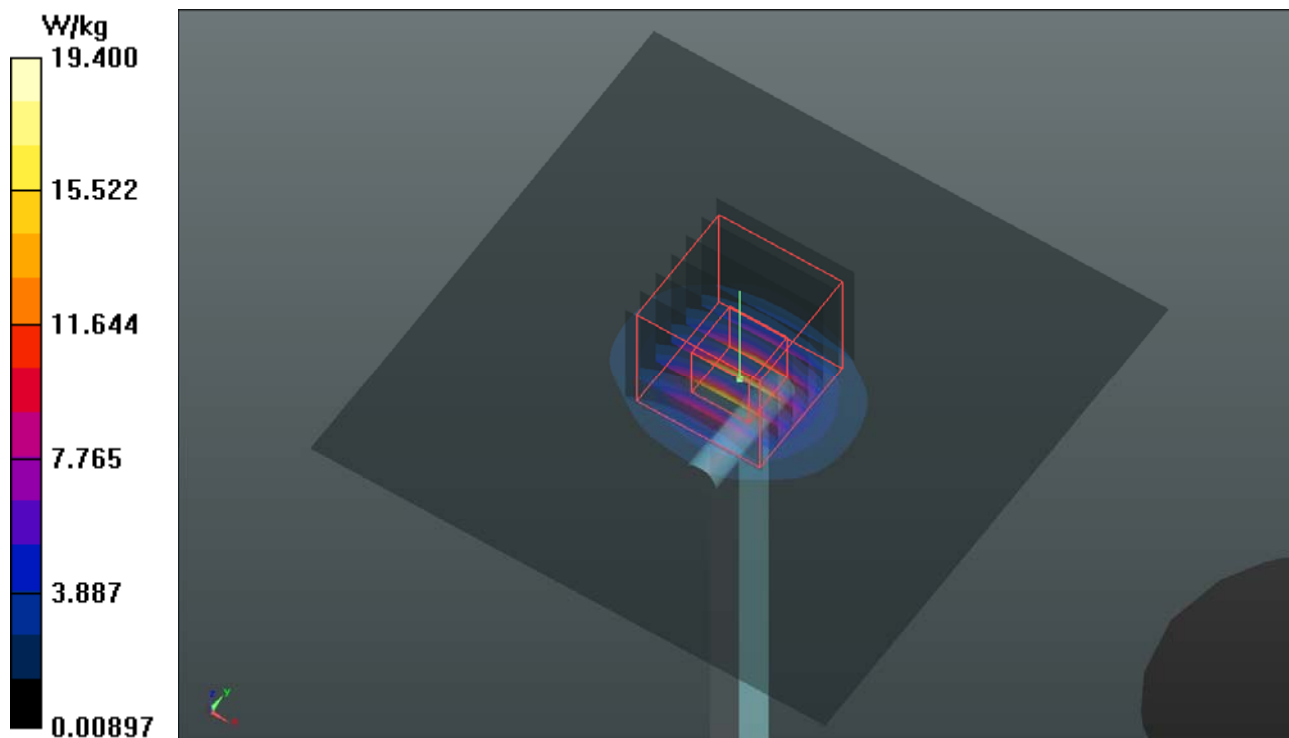

System Check_H5800_170620

DUT: Dipole 5 GHz; Type: D5GHzV2; SN: 1019

Communication System: CW; Frequency: 5800 MHz; Duty Cycle: 1:1

Medium: H34T60N2_0620 Medium parameters used: $f = 5800$ MHz; $\sigma = 5.373$ S/m; $\epsilon_r = 34.767$; $\rho = 1000$ kg/m³

Ambient Temperature : 23.6 °C ; Liquid Temperature : 23.5 °C

DASY5 Configuration:

- Probe: EX3DV4 - SN3650; ConvF(4.84, 4.84, 4.84); Calibrated: 2016/07/25;
- Sensor-Surface: 1.4mm (Mechanical Surface Detection)
- Electronics: DAE4 Sn917; Calibrated: 2017/01/06
- Phantom: Twin SAM Phantom_1653; Type: QD000P40;
- Measurement SW: DASY52, Version 52.8 (8); SEMCAD X Version 14.6.10 (7373)

Pin=100mW/Area Scan (91x91x1): Interpolated grid: dx=1.000 mm, dy=1.000 mm
Maximum value of SAR (interpolated) = 22.0 W/kg

Pin=100mW/Zoom Scan (7x7x12)/Cube 0: Measurement grid: dx=4mm, dy=4mm, dz=2mm
Reference Value = 72.81 V/m; Power Drift = -0.15 dB
Peak SAR (extrapolated) = 33.8 W/kg
SAR(1 g) = 7.87 W/kg; SAR(10 g) = 2.29 W/kg
Maximum value of SAR (measured) = 19.9 W/kg

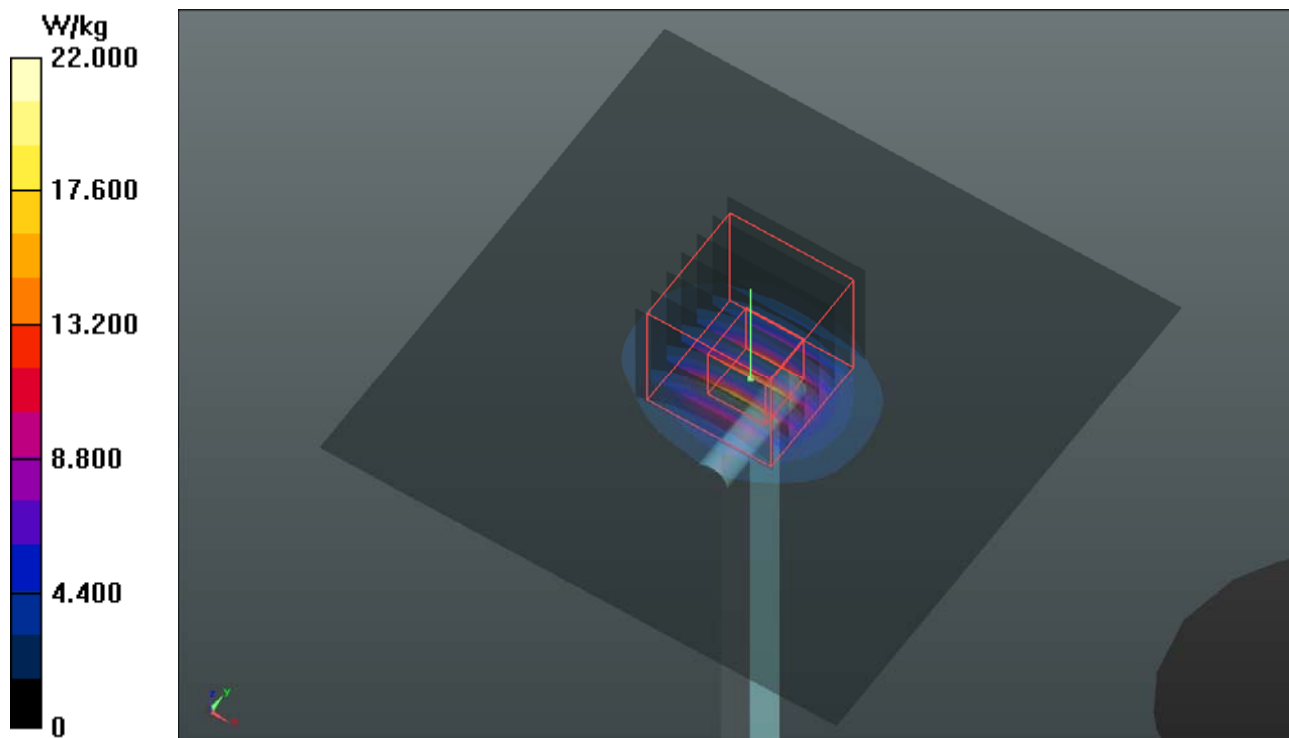

System Check_B2450_170619

DUT: Dipole 2450 MHz; Type: D2450V2; SN: 737

Communication System: CW; Frequency: 2450 MHz; Duty Cycle: 1:1

Medium: B19T27N4_0619 Medium parameters used: $f = 2450$ MHz; $\sigma = 1.997$ S/m; $\epsilon_r = 51.524$; $\rho = 1000$ kg/m³

Ambient Temperature : 23.8 °C ; Liquid Temperature : 23.6 °C

DASY5 Configuration:

- Probe: EX3DV4 - SN3650; ConvF(7.36, 7.36, 7.36); Calibrated: 2016/07/25;
- Sensor-Surface: 1.4mm (Mechanical Surface Detection)
- Electronics: DAE4 Sn917; Calibrated: 2017/01/06
- Phantom: Twin SAM Phantom_1653; Type: QD000P40;
- Measurement SW: DASY52, Version 52.8 (8); SEMCAD X Version 14.6.10 (7373)

Pin=250mW/Area Scan (81x81x1): Interpolated grid: dx=1.200 mm, dy=1.200 mm
Maximum value of SAR (interpolated) = 19.2 W/kg

Pin=250mW/Zoom Scan (7x7x7)/Cube 0: Measurement grid: dx=5mm, dy=5mm, dz=5mm
Reference Value = 97.02 V/m; Power Drift = 0.02 dB
Peak SAR (extrapolated) = 25.8 W/kg
SAR(1 g) = 12.3 W/kg; SAR(10 g) = 5.7 W/kg
Maximum value of SAR (measured) = 18.9 W/kg

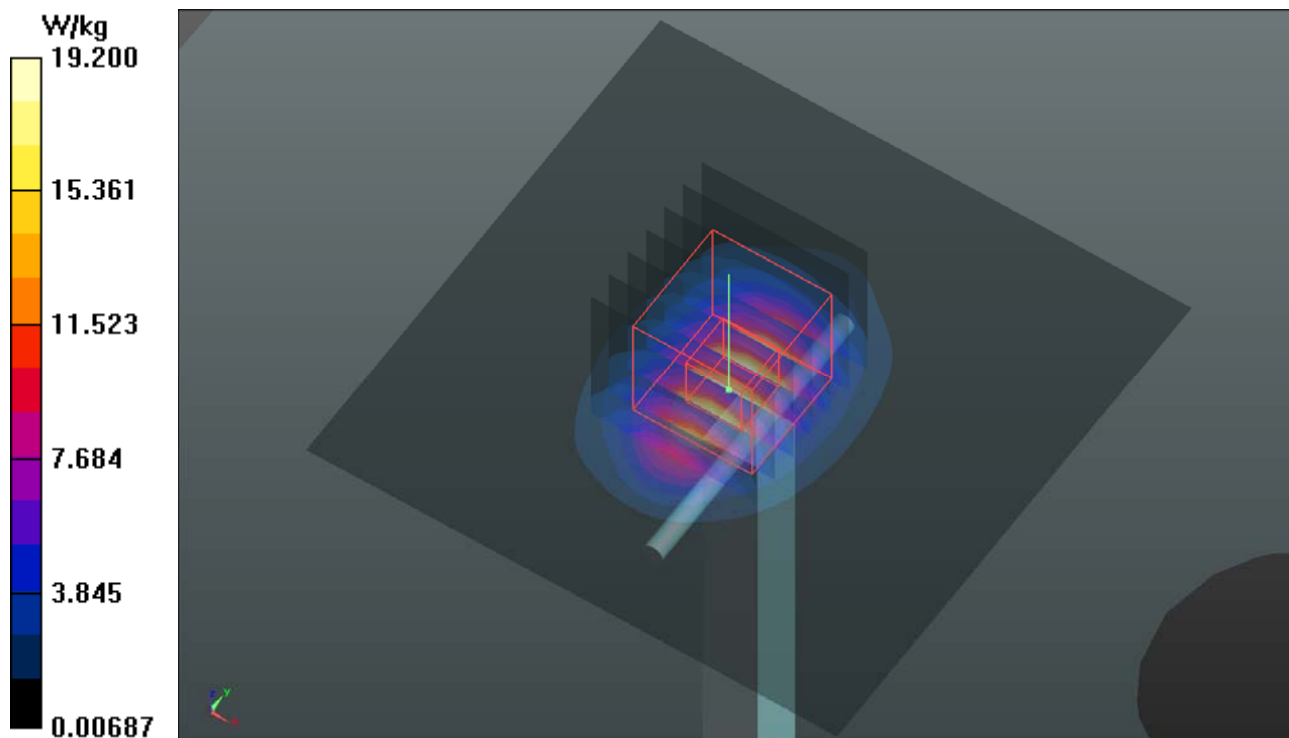

System Check_B5250_170702

DUT: Dipole 5 GHz; Type: D5GHzV2; SN: 1019

Communication System: CW; Frequency: 5250 MHz; Duty Cycle: 1:1

Medium: B34T60N1_0702 Medium parameters used: $f = 5250$ MHz; $\sigma = 5.514$ S/m; $\epsilon_r = 47.389$; $\rho = 1000$ kg/m³

Ambient Temperature : 23.8 °C ; Liquid Temperature : 23.5 °C

DASY5 Configuration:

- Probe: EX3DV4 - SN3650; ConvF(4.9, 4.9, 4.9); Calibrated: 2016/07/25;
- Sensor-Surface: 1.4mm (Mechanical Surface Detection)
- Electronics: DAE4 Sn917; Calibrated: 2017/01/06
- Phantom: Twin SAM Phantom_1653; Type: QD000P40;
- Measurement SW: DASY52, Version 52.8 (8); SEMCAD X Version 14.6.10 (7373)

Pin=100mW/Area Scan (91x91x1): Interpolated grid: dx=1.000 mm, dy=1.000 mm
Maximum value of SAR (interpolated) = 16.5 W/kg

Pin=100mW/Zoom Scan (7x7x12)/Cube 0: Measurement grid: dx=4mm, dy=4mm, dz=2mm
Reference Value = 56.42 V/m; Power Drift = -0.14 dB
Peak SAR (extrapolated) = 28.4 W/kg
SAR(1 g) = 7.52 W/kg; SAR(10 g) = 2.17 W/kg
Maximum value of SAR (measured) = 18.5 W/kg

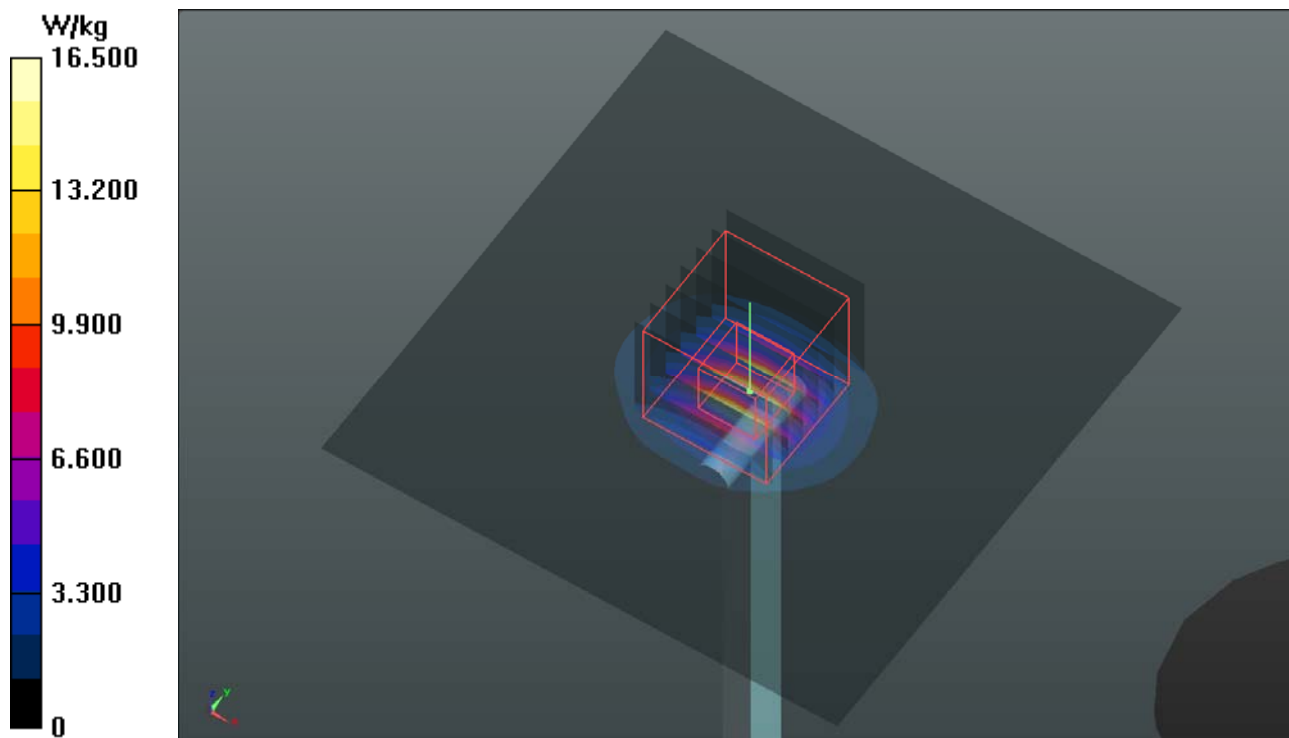

System Check_B5600_170623

DUT: Dipole 5 GHz; Type: D5GHzV2; SN: 1019

Communication System: CW; Frequency: 5600 MHz; Duty Cycle: 1:1

Medium: B34T60N2_0623 Medium parameters used: $f = 5600$ MHz; $\sigma = 5.919$ S/m; $\epsilon_r = 46.511$; $\rho = 1000$ kg/m³

Ambient Temperature : 23.6 °C ; Liquid Temperature : 23.5 °C

DASY5 Configuration:

- Probe: EX3DV4 - SN3650; ConvF(4.01, 4.01, 4.01); Calibrated: 2016/07/25;
- Sensor-Surface: 1.4mm (Mechanical Surface Detection)
- Electronics: DAE4 Sn917; Calibrated: 2017/01/06
- Phantom: Twin SAM Phantom_1652; Type: QD000P40;
- Measurement SW: DASY52, Version 52.8 (8); SEMCAD X Version 14.6.10 (7373)

Pin=100mW/Area Scan (91x91x1): Interpolated grid: dx=1.000 mm, dy=1.000 mm
Maximum value of SAR (interpolated) = 18.2 W/kg

Pin=100mW/Zoom Scan (7x7x12)/Cube 0: Measurement grid: dx=4mm, dy=4mm, dz=2mm
Reference Value = 59.90 V/m; Power Drift = -0.13 dB
Peak SAR (extrapolated) = 29.3 W/kg
SAR(1 g) = 7.68 W/kg; SAR(10 g) = 2.18 W/kg
Maximum value of SAR (measured) = 19.1 W/kg

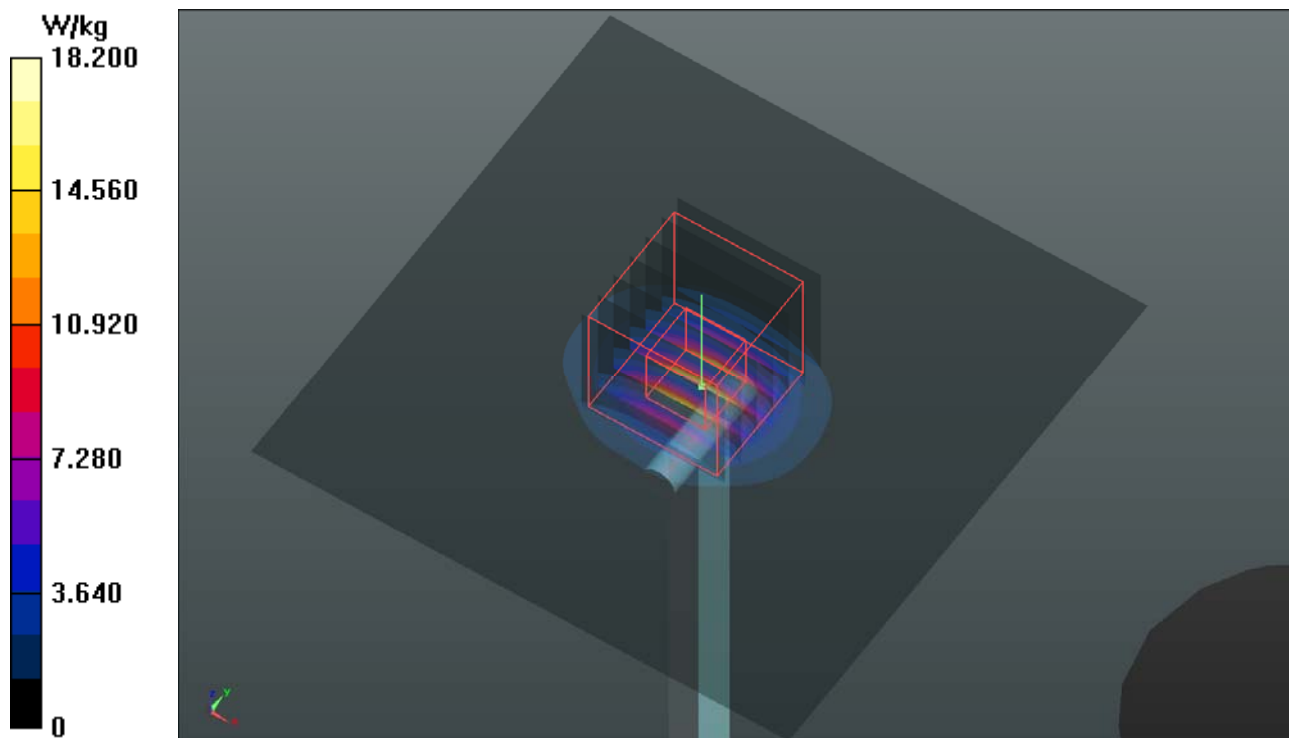

System Check_B5800_170627

DUT: Dipole 5 GHz; Type: D5GHzV2; SN: 1019

Communication System: CW; Frequency: 5800 MHz; Duty Cycle: 1:1

Medium: B34T60N2_0627 Medium parameters used: $f = 5800$ MHz; $\sigma = 5.897$ S/m; $\epsilon_r = 46.424$; $\rho = 1000$ kg/m³

Ambient Temperature : 23.6 °C ; Liquid Temperature : 23.4 °C

DASY5 Configuration:

- Probe: EX3DV4 - SN3650; ConvF(4.36, 4.36, 4.36); Calibrated: 2016/07/25;
- Sensor-Surface: 1.4mm (Mechanical Surface Detection)
- Electronics: DAE4 Sn917; Calibrated: 2017/01/06
- Phantom: Twin SAM Phantom_1653; Type: QD000P40;
- Measurement SW: DASY52, Version 52.8 (8); SEMCAD X Version 14.6.10 (7373)

Pin=100mW/Area Scan (91x91x1): Interpolated grid: dx=1.000 mm, dy=1.000 mm
Maximum value of SAR (interpolated) = 15.1 W/kg

Pin=100mW/Zoom Scan (7x7x12)/Cube 0: Measurement grid: dx=4mm, dy=4mm, dz=2mm
Reference Value = 56.23 V/m; Power Drift = 0.06 dB
Peak SAR (extrapolated) = 28.9 W/kg
SAR(1 g) = 7.12 W/kg; SAR(10 g) = 2.03 W/kg
Maximum value of SAR (measured) = 15.0 W/kg

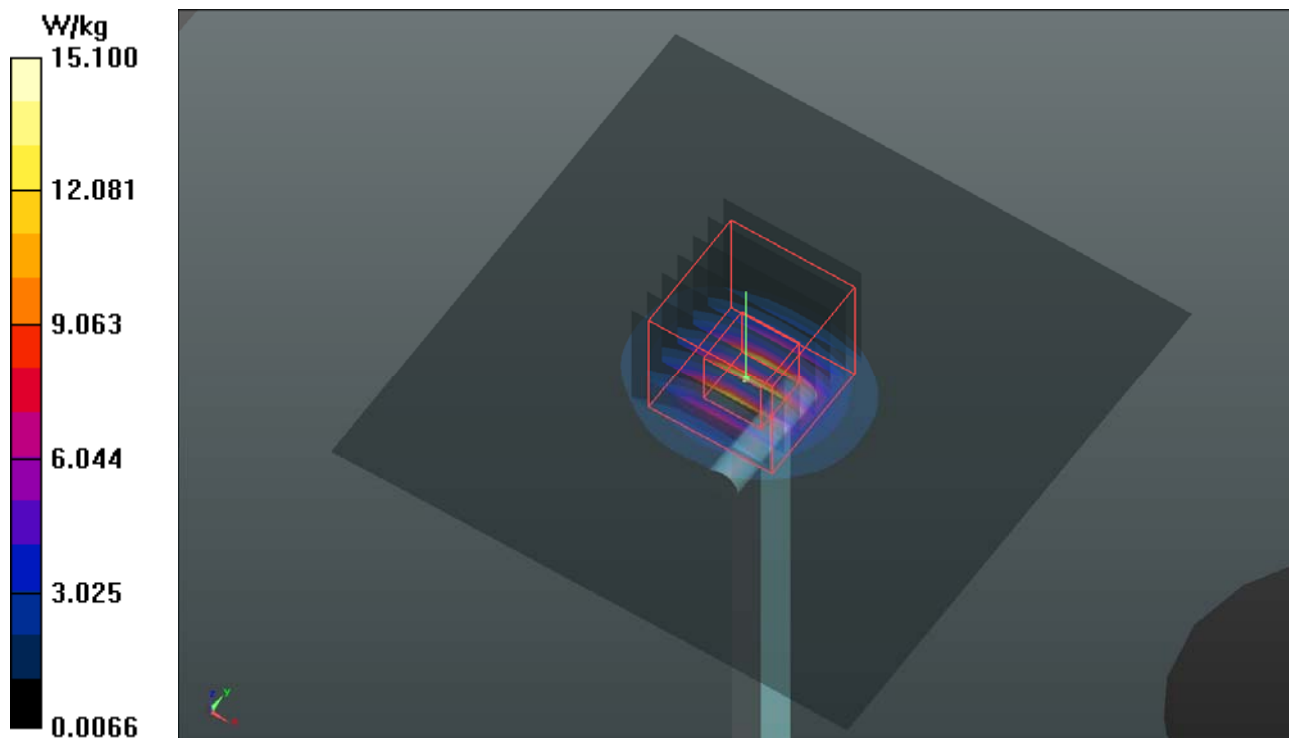



Appendix B. SAR Plots of SAR Measurement

The SAR plots for highest measured SAR in each exposure configuration, wireless mode and frequency band combination, and measured SAR > 1.5 W/kg are shown as follows.

P01 2.4G WLAN_802.11b_Left Cheek_Ch1_Sample1_PIN2

DUT: 170421C58

Communication System: WLAN_2.4G; Frequency: 2412 MHz; Duty Cycle: 1:1

Medium: H19T27N3_0615 Medium parameters used: $f = 2412$ MHz; $\sigma = 1.841$ S/m; $\epsilon_r = 38.459$; $\rho = 1000$ kg/m³

Ambient Temperature : 23.6 °C ; Liquid Temperature : 23.4 °C

DASY5 Configuration:

- Probe: EX3DV4 - SN3650; ConvF(7.51, 7.51, 7.51); Calibrated: 2016/07/25;
- Sensor-Surface: 1.4mm (Mechanical Surface Detection)
- Electronics: DAE4 Sn917; Calibrated: 2017/01/06
- Phantom: Twin SAM Phantom_1653; Type: QD000P40;
- Measurement SW: DASY52, Version 52.8 (8); SEMCAD X Version 14.6.10 (7373)

- **Area Scan (101x141x1):** Interpolated grid: dx=1.200 mm, dy=1.200 mm

Maximum value of SAR (interpolated) = 1.74 W/kg

- **Zoom Scan (5x5x7)/Cube 0:** Measurement grid: dx=8mm, dy=8mm, dz=5mm

Reference Value = 27.31 V/m; Power Drift = 0.05 dB

Peak SAR (extrapolated) = 2.47 W/kg

SAR(1 g) = 1.17 W/kg; SAR(10 g) = 0.567 W/kg

Maximum value of SAR (measured) = 1.95 W/kg

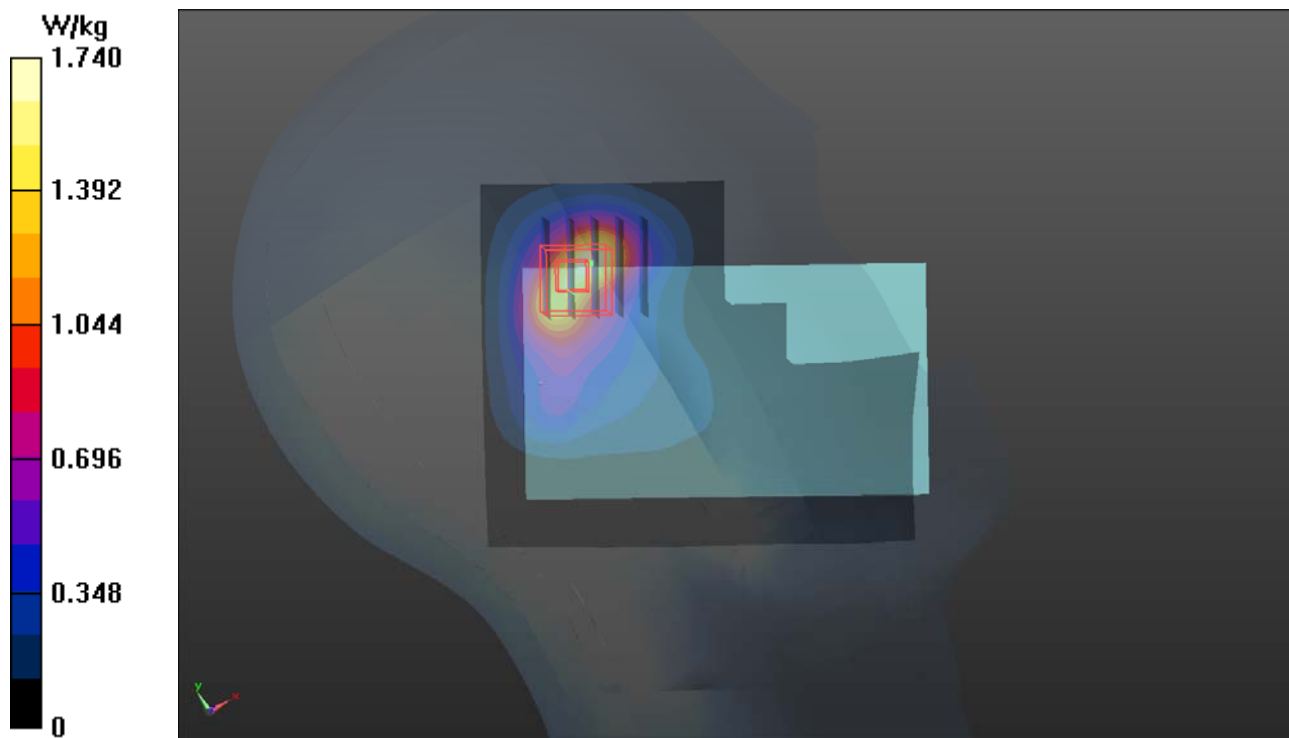

P02 5.3G WLAN_802.11a_Left Cheek_Ch60_Sample2_PIN8

DUT: 170421C58

Communication System: WLAN_5G; Frequency: 5300 MHz; Duty Cycle: 1:1

Medium: H34T60N3_0628 Medium parameters used: $f = 5300$ MHz; $\sigma = 4.692$ S/m; $\epsilon_r = 34.435$; $\rho = 1000$ kg/m³

Ambient Temperature : 23.7 °C ; Liquid Temperature : 23.5 °C

DASY5 Configuration:

- Probe: EX3DV4 - SN3650; ConvF(5.31, 5.31, 5.31); Calibrated: 2016/07/25;
- Sensor-Surface: 1.4mm (Mechanical Surface Detection)
- Electronics: DAE4 Sn917; Calibrated: 2017/01/06
- Phantom: Twin SAM Phantom_1652; Type: QD000P40;
- Measurement SW: DASY52, Version 52.8 (8); SEMCAD X Version 14.6.10 (7373)

- **Area Scan (121x161x1):** Interpolated grid: dx=1.000 mm, dy=1.000 mm
Maximum value of SAR (interpolated) = 1.01 W/kg

- **Zoom Scan (6x6x12)/Cube 0:** Measurement grid: dx=5mm, dy=5mm, dz=2mm
Reference Value = 14.99 V/m; Power Drift = 0.01 dB
Peak SAR (extrapolated) = 2.51 W/kg
SAR(1 g) = 0.671 W/kg; SAR(10 g) = 0.203 W/kg
Maximum value of SAR (measured) = 1.55 W/kg

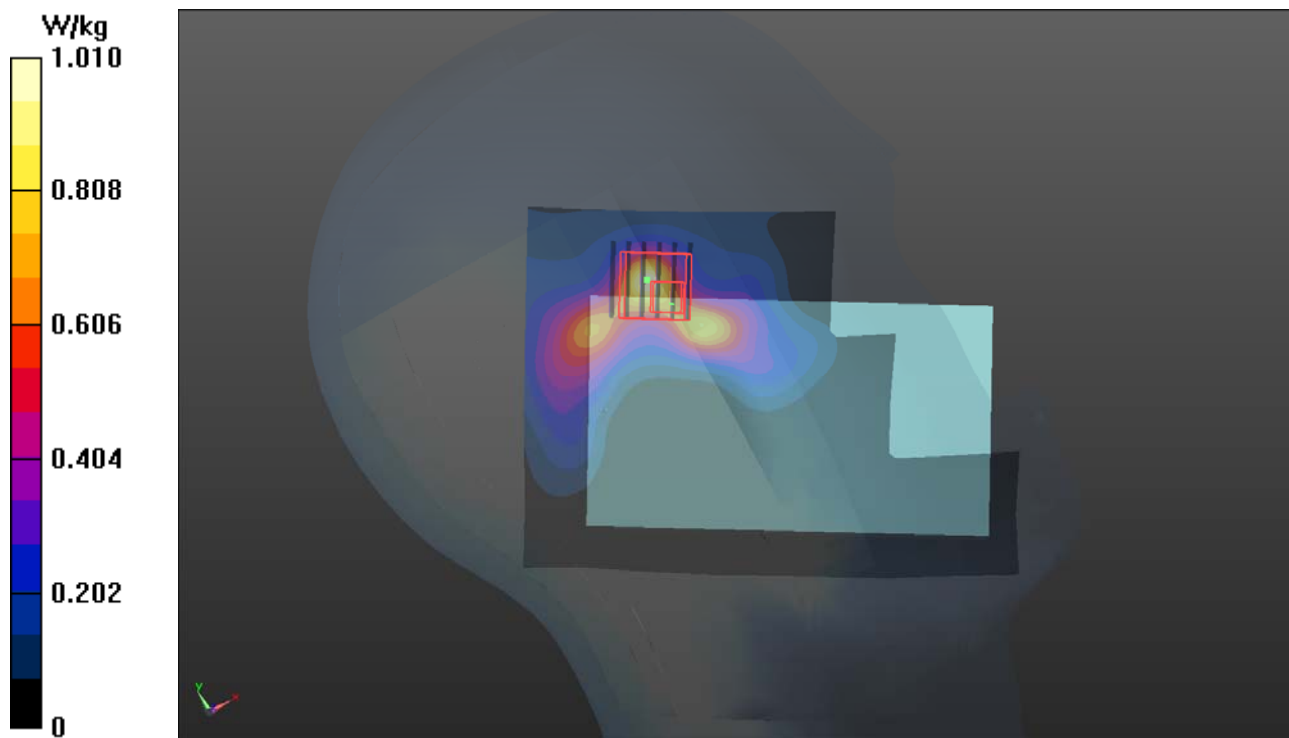

P03 5.6G WLAN_802.11ac VH80_Left Cheek_Ch138_Sample2_PIN8

DUT: 170421C58

Communication System: WLAN_5G; Frequency: 5690 MHz; Duty Cycle: 1:1

Medium: H34T60N2_0620 Medium parameters used: $f = 5690$ MHz; $\sigma = 5.267$ S/m; $\epsilon_r = 34.926$; $\rho = 1000$ kg/m³

Ambient Temperature : 23.6 °C ; Liquid Temperature : 23.5 °C

DASY5 Configuration:

- Probe: EX3DV4 - SN3650; ConvF(4.78, 4.78, 4.78); Calibrated: 2016/07/25;
- Sensor-Surface: 1.4mm (Mechanical Surface Detection)
- Electronics: DAE4 Sn917; Calibrated: 2017/01/06
- Phantom: Twin SAM Phantom_1653; Type: QD000P40;
- Measurement SW: DASY52, Version 52.8 (8); SEMCAD X Version 14.6.10 (7373)

- **Area Scan (121x161x1):** Interpolated grid: dx=1.000 mm, dy=1.000 mm

Maximum value of SAR (interpolated) = 0.657 W/kg

- **Zoom Scan (6x6x12)/Cube 0:** Measurement grid: dx=5mm, dy=5mm, dz=2mm

Reference Value = 11.65 V/m; Power Drift = 0.12 dB

Peak SAR (extrapolated) = 1.58 W/kg

SAR(1 g) = 0.408 W/kg; SAR(10 g) = 0.118 W/kg

Maximum value of SAR (measured) = 0.965 W/kg

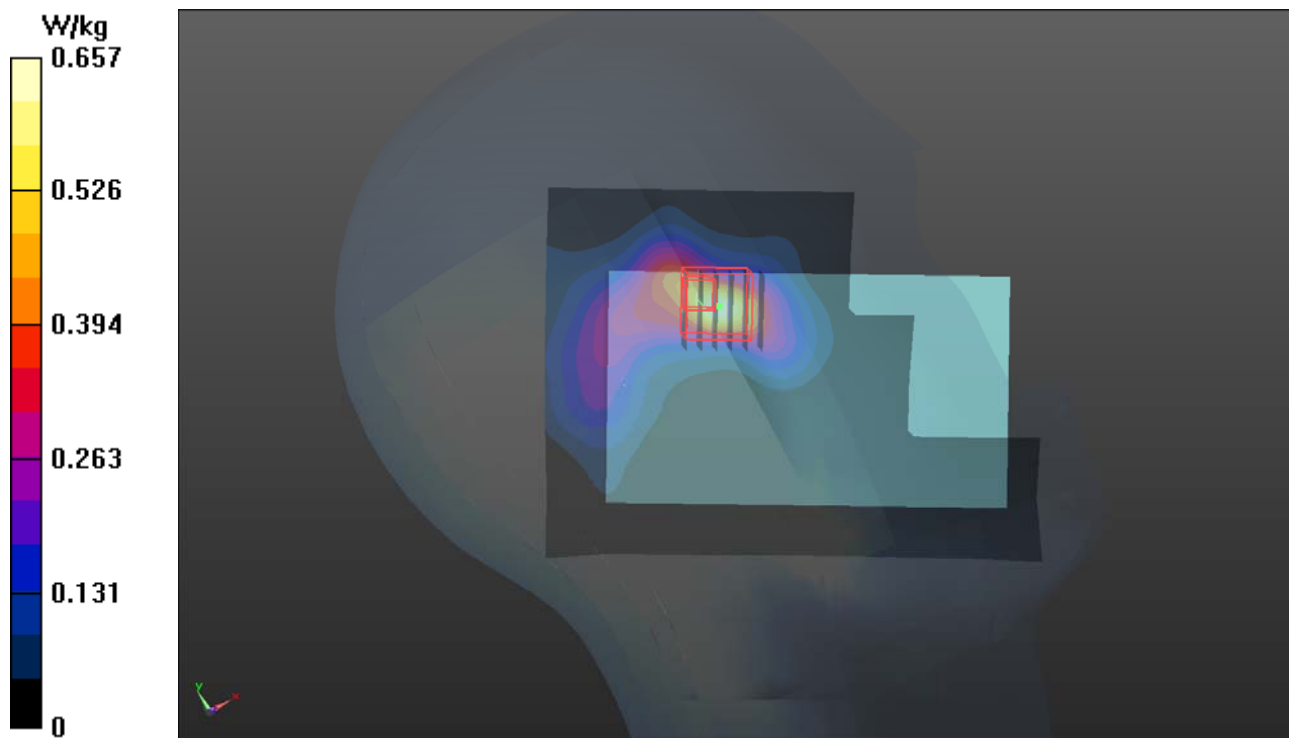

P04 5.8G WLAN_802.11ac VH80_Left Cheek_Ch155_Sample2_PIN8

DUT: 170421C58

Communication System: WLAN_5G; Frequency: 5775 MHz; Duty Cycle: 1:1

Medium: H34T60N2_0620 Medium parameters used: $f = 5775$ MHz; $\sigma = 5.348$ S/m; $\epsilon_r = 34.783$; $\rho = 1000$ kg/m³

Ambient Temperature : 23.6 °C ; Liquid Temperature : 23.5 °C

DASY5 Configuration:

- Probe: EX3DV4 - SN3650; ConvF(4.84, 4.84, 4.84); Calibrated: 2016/07/25;
- Sensor-Surface: 1.4mm (Mechanical Surface Detection)
- Electronics: DAE4 Sn917; Calibrated: 2017/01/06
- Phantom: Twin SAM Phantom_1653; Type: QD000P40;
- Measurement SW: DASY52, Version 52.8 (8); SEMCAD X Version 14.6.10 (7373)

- Area Scan (121x161x1): Interpolated grid: dx=1.000 mm, dy=1.000 mm

Maximum value of SAR (interpolated) = 0.700 W/kg

- Zoom Scan (6x6x12)/Cube 0: Measurement grid: dx=5mm, dy=5mm, dz=2mm

Reference Value = 11.98 V/m; Power Drift = 0.14 dB

Peak SAR (extrapolated) = 1.73 W/kg

SAR(1 g) = 0.423 W/kg; SAR(10 g) = 0.124 W/kg

Maximum value of SAR (measured) = 1.02 W/kg

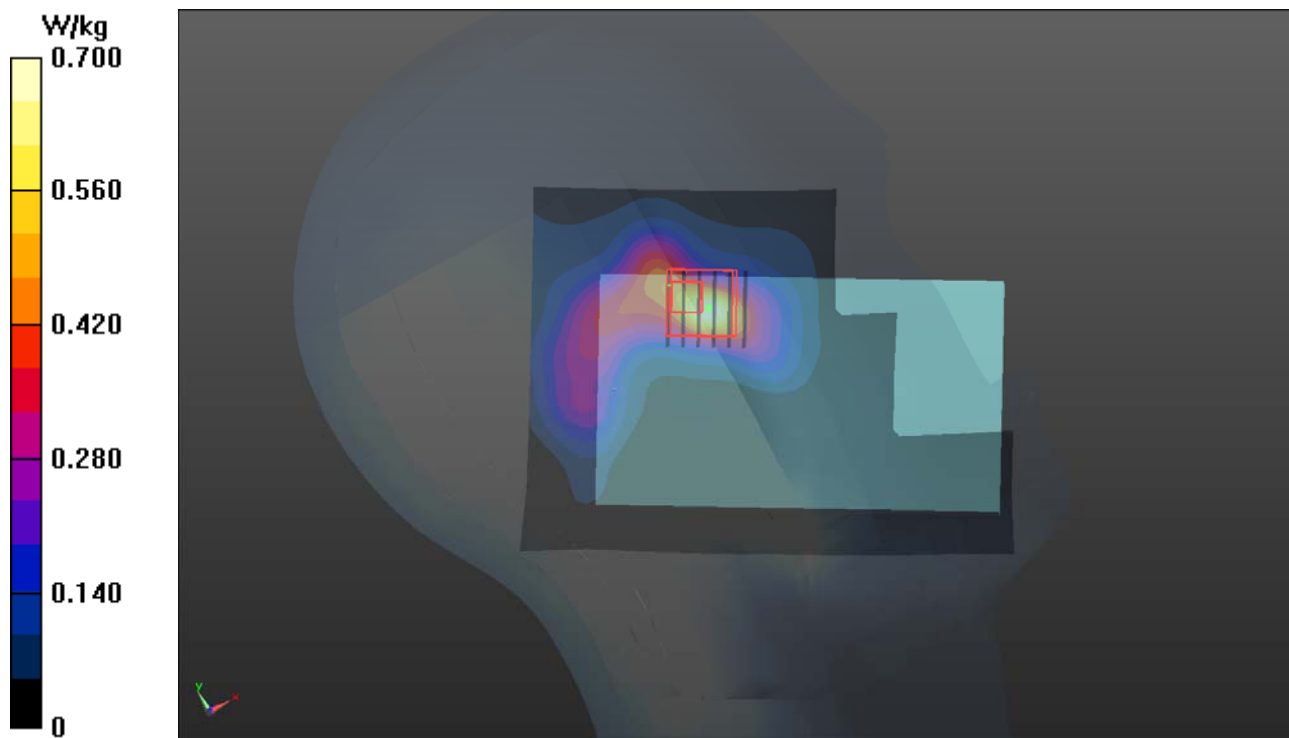

P05 2.4G WLAN_802.11b_Rear Face_1.5cm_Ch6_Sample1_PIN8

DUT: 170421C58

Communication System: WLAN_2.4G; Frequency: 2437 MHz; Duty Cycle: 1:1

Medium: B19T27N4_0619 Medium parameters used: $f = 2437$ MHz; $\sigma = 1.982$ S/m; $\epsilon_r = 51.552$; $\rho =$

1000 kg/m³

Ambient Temperature : 23.8 °C ; Liquid Temperature : 23.6 °C

DASY5 Configuration:

- Probe: EX3DV4 - SN3650; ConvF(7.36, 7.36, 7.36); Calibrated: 2016/07/25;
- Sensor-Surface: 1.4mm (Mechanical Surface Detection)
- Electronics: DAE4 Sn917; Calibrated: 2017/01/06
- Phantom: Twin SAM Phantom_1653; Type: QD000P40;
- Measurement SW: DASY52, Version 52.8 (8); SEMCAD X Version 14.6.10 (7373)

- **Area Scan (101x141x1):** Interpolated grid: dx=1.200 mm, dy=1.200 mm

Maximum value of SAR (interpolated) = 0.728 W/kg

- **Zoom Scan (5x5x7)/Cube 0:** Measurement grid: dx=8mm, dy=8mm, dz=5mm

Reference Value = 18.31 V/m; Power Drift = 0.14 dB

Peak SAR (extrapolated) = 1.01 W/kg

SAR(1 g) = 0.548 W/kg; SAR(10 g) = 0.293 W/kg

Maximum value of SAR (measured) = 0.831 W/kg

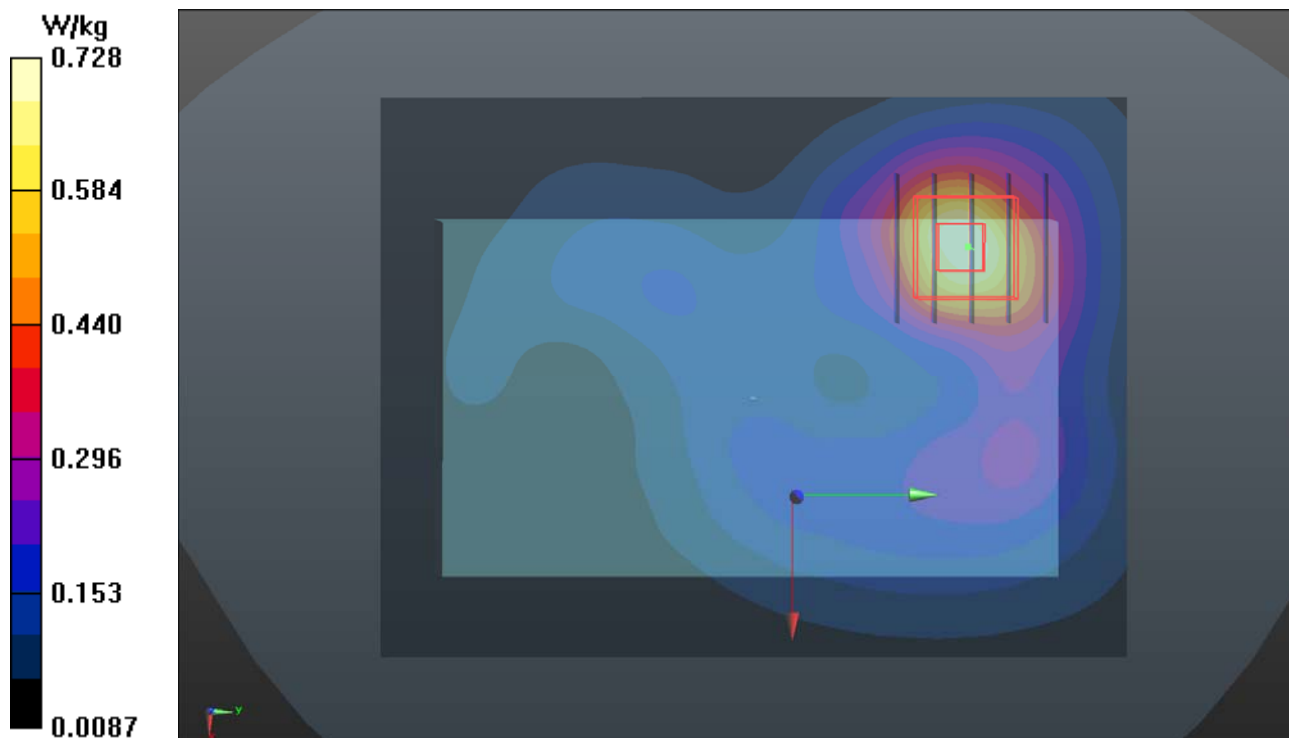

P21 5.2G WLAN_802.11n HT40_Rear Face_1.5cm_Ch46_Sample1_PIN2

DUT: 170421C58

Communication System: WLAN_5G; Frequency: 5230 MHz; Duty Cycle: 1:1

Medium: B34T60N2_0624 Medium parameters used: $f = 5230$ MHz; $\sigma = 5.225$ S/m; $\epsilon_r = 47.042$; $\rho = 1000$ kg/m³

Ambient Temperature : 23.6 °C ; Liquid Temperature : 23.5 °C

DASY5 Configuration:

- Probe: EX3DV4 - SN3650; ConvF(4.94, 4.94, 4.94); Calibrated: 2016/07/25;
- Sensor-Surface: 1.4mm (Mechanical Surface Detection)
- Electronics: DAE4 Sn917; Calibrated: 2017/01/06
- Phantom: Twin SAM Phantom_1653; Type: QD000P40;
- Measurement SW: DASY52, Version 52.8 (8); SEMCAD X Version 14.6.10 (7373)

- **Area Scan (121x161x1):** Interpolated grid: dx=1.000 mm, dy=1.000 mm

Maximum value of SAR (interpolated) = 2.36 W/kg

- **Zoom Scan (6x6x12)/Cube 0:** Measurement grid: dx=5mm, dy=5mm, dz=2mm

Reference Value = 22.18 V/m; Power Drift = -0.07 dB

Peak SAR (extrapolated) = 3.69 W/kg

SAR(1 g) = 1.15 W/kg; SAR(10 g) = 0.474 W/kg

Maximum value of SAR (measured) = 2.43 W/kg

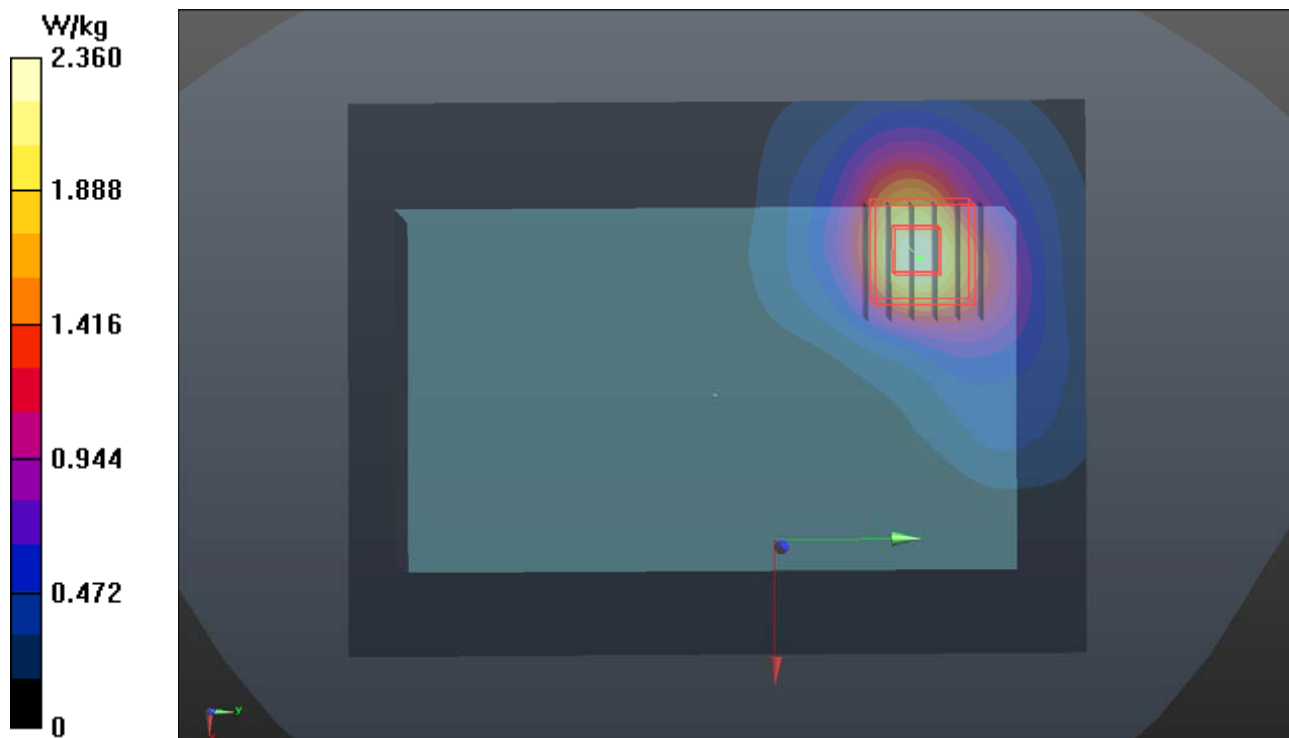

P06 5.3G WLAN_802.11a_Rear Face_1.5cm_Ch64_Sample1_PIN2

DUT: 170421C58

Communication System: WLAN_5G; Frequency: 5320 MHz; Duty Cycle: 1:1

Medium: B34T60N2_0624 Medium parameters used: $f = 5320$ MHz; $\sigma = 5.289$ S/m; $\epsilon_r = 46.886$; $\rho = 1000$ kg/m³

Ambient Temperature : 23.5 °C ; Liquid Temperature : 23.4 °C

DASY5 Configuration:

- Probe: EX3DV4 - SN3650; ConvF(4.75, 4.75, 4.75); Calibrated: 2016/07/25;
- Sensor-Surface: 1.4mm (Mechanical Surface Detection)
- Electronics: DAE4 Sn917; Calibrated: 2017/01/06
- Phantom: Twin SAM Phantom_1653; Type: QD000P40;
- Measurement SW: DASY52, Version 52.8 (8); SEMCAD X Version 14.6.10 (7373)

- **Area Scan (121x161x1):** Interpolated grid: dx=1.000 mm, dy=1.000 mm

Maximum value of SAR (interpolated) = 2.64 W/kg

- **Zoom Scan (6x6x12)/Cube 0:** Measurement grid: dx=5mm, dy=5mm, dz=2mm

Reference Value = 22.65 V/m; Power Drift = 0.12 dB

Peak SAR (extrapolated) = 4.39 W/kg

SAR(1 g) = 1.34 W/kg; SAR(10 g) = 0.551 W/kg

Maximum value of SAR (measured) = 2.79 W/kg

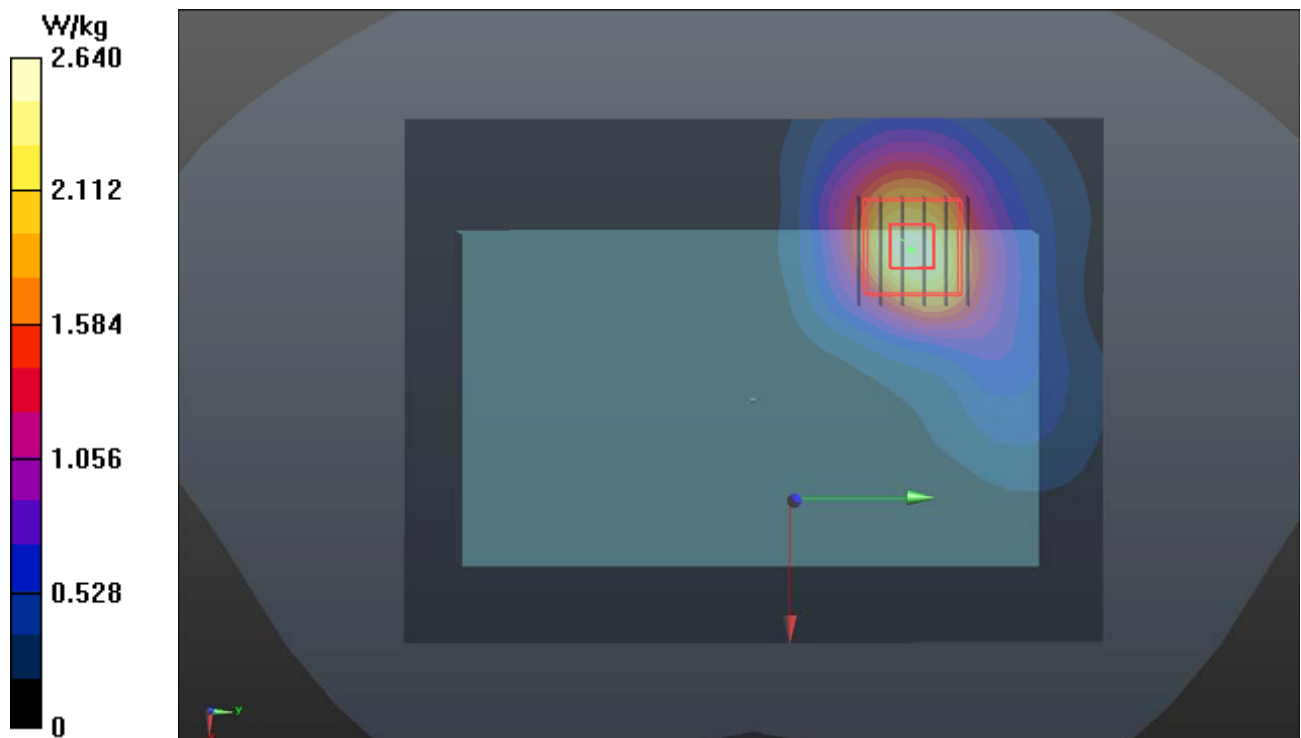

P07 5.6G WLAN_802.11ac VH80_Rear Face_1.5cm_Ch138_Sample1_PIN2

DUT: 170421C58

Communication System: WLAN_5G; Frequency: 5690 MHz; Duty Cycle: 1:1

Medium: B34T60N3_0615 Medium parameters used: $f = 5690$ MHz; $\sigma = 5.954$ S/m; $\epsilon_r = 46.568$; $\rho = 1000$ kg/m³

Ambient Temperature : 23.5 °C ; Liquid Temperature : 23.3 °C

DASY5 Configuration:

- Probe: EX3DV4 - SN3650; ConvF(4.01, 4.01, 4.01); Calibrated: 2016/07/25;
- Sensor-Surface: 1.4mm (Mechanical Surface Detection)
- Electronics: DAE4 Sn917; Calibrated: 2017/01/06
- Phantom: Twin SAM Phantom_1653; Type: QD000P40;
- Measurement SW: DASY52, Version 52.8 (8); SEMCAD X Version 14.6.10 (7373)

- **Area Scan (121x161x1):** Interpolated grid: dx=1.000 mm, dy=1.000 mm

Maximum value of SAR (interpolated) = 2.35 W/kg

- **Zoom Scan (6x6x12)/Cube 0:** Measurement grid: dx=5mm, dy=5mm, dz=2mm

Reference Value = 20.66 V/m; Power Drift = 0.12 dB

Peak SAR (extrapolated) = 4.32 W/kg

SAR(1 g) = 1.27 W/kg; SAR(10 g) = 0.491 W/kg

Maximum value of SAR (measured) = 2.81 W/kg

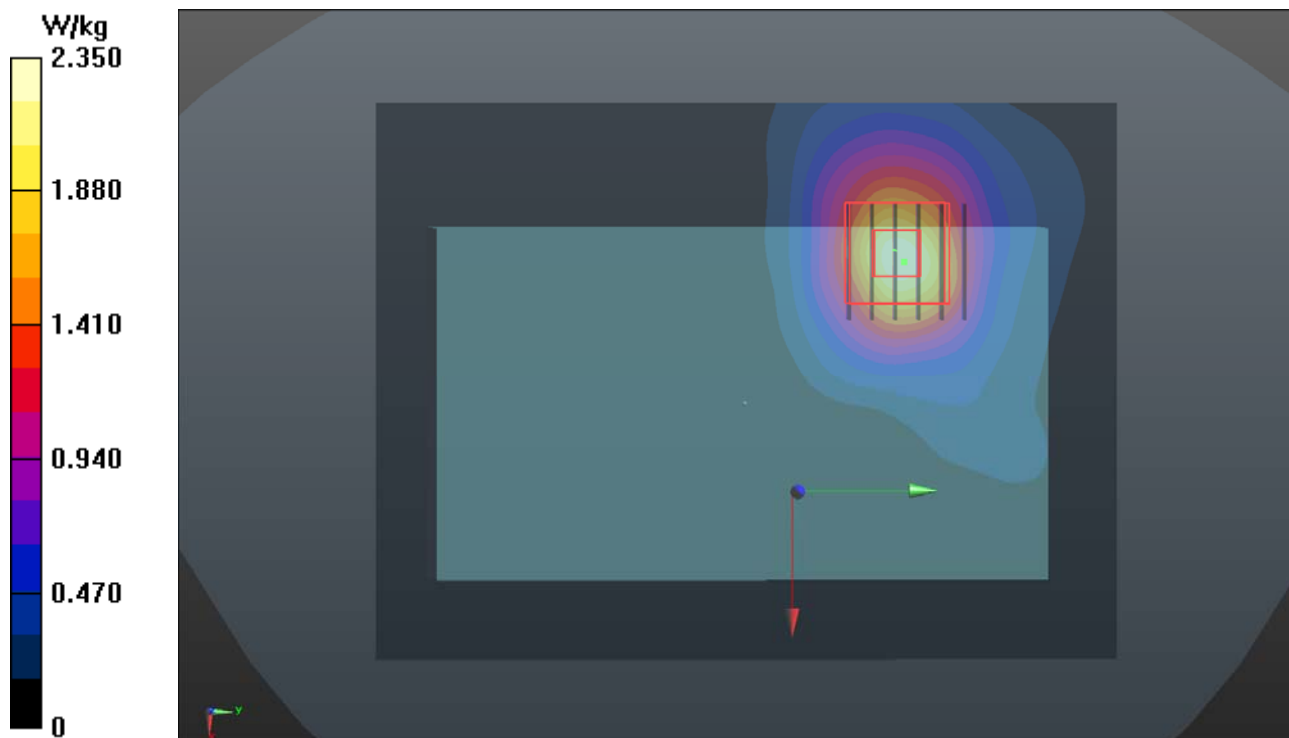

P08 5.8G WLAN_802.11ac VH80_Rear Face_1.5cm_Ch155_Sample1_PIN2

DUT: 170421C58

Communication System: WLAN_5G; Frequency: 5775 MHz; Duty Cycle: 1:1

Medium: B34T60N1_0614 Medium parameters used: $f = 5775$ MHz; $\sigma = 6.126$ S/m; $\epsilon_r = 46.16$; $\rho = 1000$ kg/m³

Ambient Temperature : 23.6 °C ; Liquid Temperature : 23.4 °C

DASY5 Configuration:

- Probe: EX3DV4 - SN3650; ConvF(4.36, 4.36, 4.36); Calibrated: 2016/07/25;
- Sensor-Surface: 1.4mm (Mechanical Surface Detection)
- Electronics: DAE4 Sn917; Calibrated: 2017/01/06
- Phantom: Twin SAM Phantom_1653; Type: QD000P40;
- Measurement SW: DASY52, Version 52.8 (8); SEMCAD X Version 14.6.10 (7373)

- **Area Scan (121x161x1):** Interpolated grid: dx=1.000 mm, dy=1.000 mm

Maximum value of SAR (interpolated) = 2.53 W/kg

- **Zoom Scan (6x6x12)/Cube 0:** Measurement grid: dx=5mm, dy=5mm, dz=2mm

Reference Value = 21.08 V/m; Power Drift = 0.07 dB

Peak SAR (extrapolated) = 4.32 W/kg

SAR(1 g) = 1.24 W/kg; SAR(10 g) = 0.478 W/kg

Maximum value of SAR (measured) = 2.72 W/kg

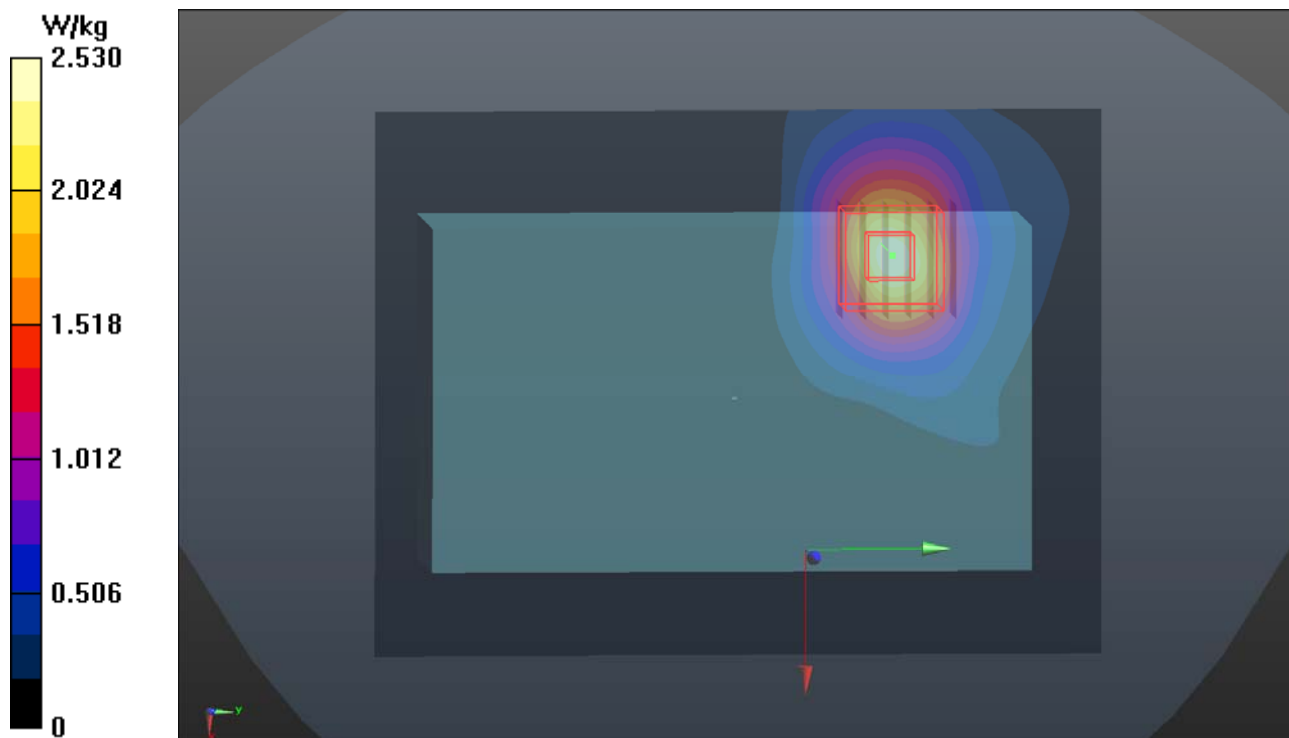

P09 2.4G WLAN_802.11b_EUT(Front)_Top join_0cm_Ch6_Sample1_PIN8

DUT: 170421C58

Communication System: WLAN_2.4G; Frequency: 2437 MHz; Duty Cycle: 1:1

Medium: B19T27N4_0619 Medium parameters used: $f = 2437$ MHz; $\sigma = 1.982$ S/m; $\epsilon_r = 51.552$; $\rho = 1000$ kg/m³

Ambient Temperature : 23.8 °C ; Liquid Temperature : 23.5 °C

DASY5 Configuration:

- Probe: EX3DV4 - SN3650; ConvF(7.36, 7.36, 7.36); Calibrated: 2016/07/25;
- Sensor-Surface: 1.4mm (Mechanical Surface Detection)
- Electronics: DAE4 Sn917; Calibrated: 2017/01/06
- Phantom: Twin SAM Phantom_1653; Type: QD000P40;
- Measurement SW: DASY52, Version 52.8 (8); SEMCAD X Version 14.6.10 (7373)

- **Area Scan (101x141x1):** Interpolated grid: dx=1.200 mm, dy=1.200 mm

Maximum value of SAR (interpolated) = 0.915 W/kg

- **Zoom Scan (5x5x7)/Cube 0:** Measurement grid: dx=8mm, dy=8mm, dz=5mm

Reference Value = 21.00 V/m; Power Drift = -0.07 dB

Peak SAR (extrapolated) = 1.18 W/kg

SAR(1 g) = 0.635 W/kg; SAR(10 g) = 0.339 W/kg

Maximum value of SAR (measured) = 0.970 W/kg

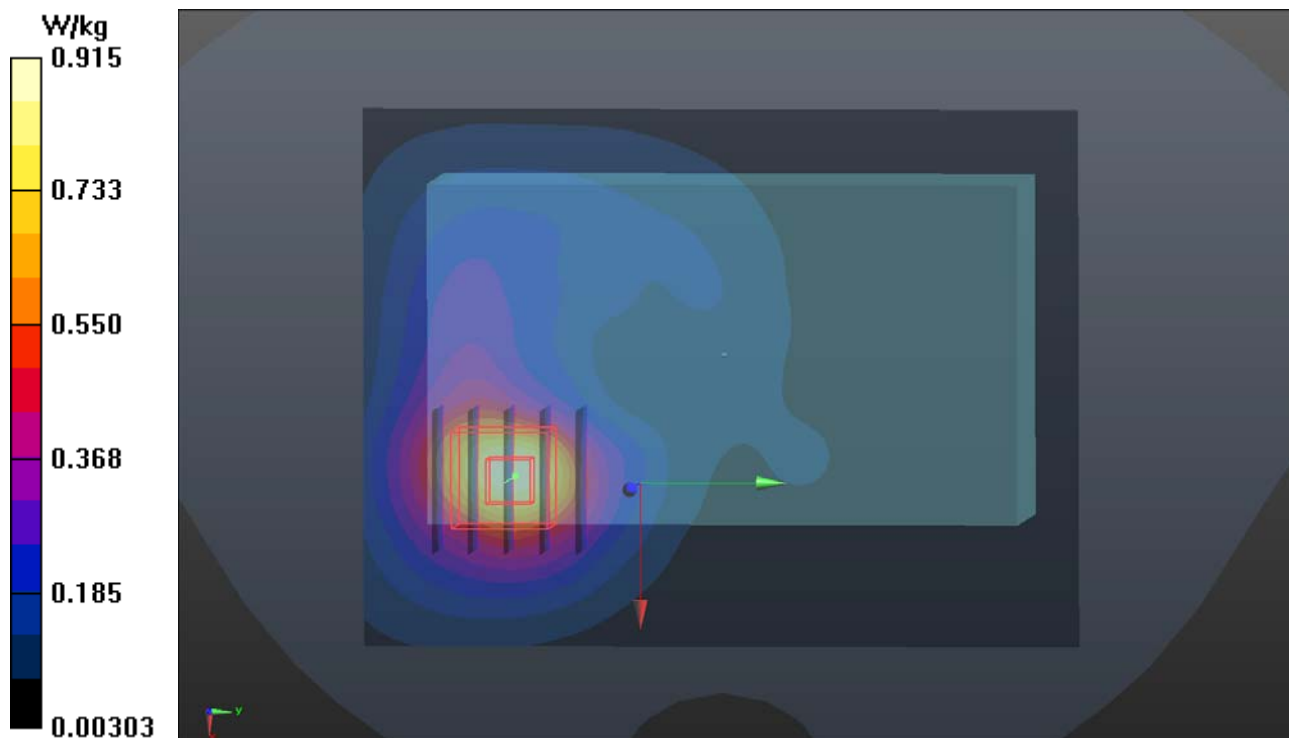

P10 5.3G WLAN_802.11a_EUT(Front)_Top join_0cm_Ch60_Sample1_PIN2

DUT: 170421C58

Communication System: WLAN_5G; Frequency: 5300 MHz; Duty Cycle: 1:1

Medium: B34T60N1_0702 Medium parameters used: $f = 5300$ MHz; $\sigma = 5.571$ S/m; $\epsilon_r = 47.255$; $\rho = 1000$ kg/m³

Ambient Temperature : 23.8 °C ; Liquid Temperature : 23.5 °C

DASY5 Configuration:

- Probe: EX3DV4 - SN3650; ConvF(4.75, 4.75, 4.75); Calibrated: 2016/07/25;
- Sensor-Surface: 1.4mm (Mechanical Surface Detection)
- Electronics: DAE4 Sn917; Calibrated: 2017/01/06
- Phantom: Twin SAM Phantom_1653; Type: QD000P40;
- Measurement SW: DASY52, Version 52.8 (8); SEMCAD X Version 14.6.10 (7373)

- **Area Scan (121x161x1):** Interpolated grid: dx=1.000 mm, dy=1.000 mm

Maximum value of SAR (interpolated) = 2.51 W/kg

- **Zoom Scan (6x6x12)/Cube 0:** Measurement grid: dx=5mm, dy=5mm, dz=2mm

Reference Value = 22.90 V/m; Power Drift = 0.16 dB

Peak SAR (extrapolated) = 4.01 W/kg

SAR(1 g) = 1.18 W/kg; SAR(10 g) = 0.507 W/kg

Maximum value of SAR (measured) = 2.56 W/kg

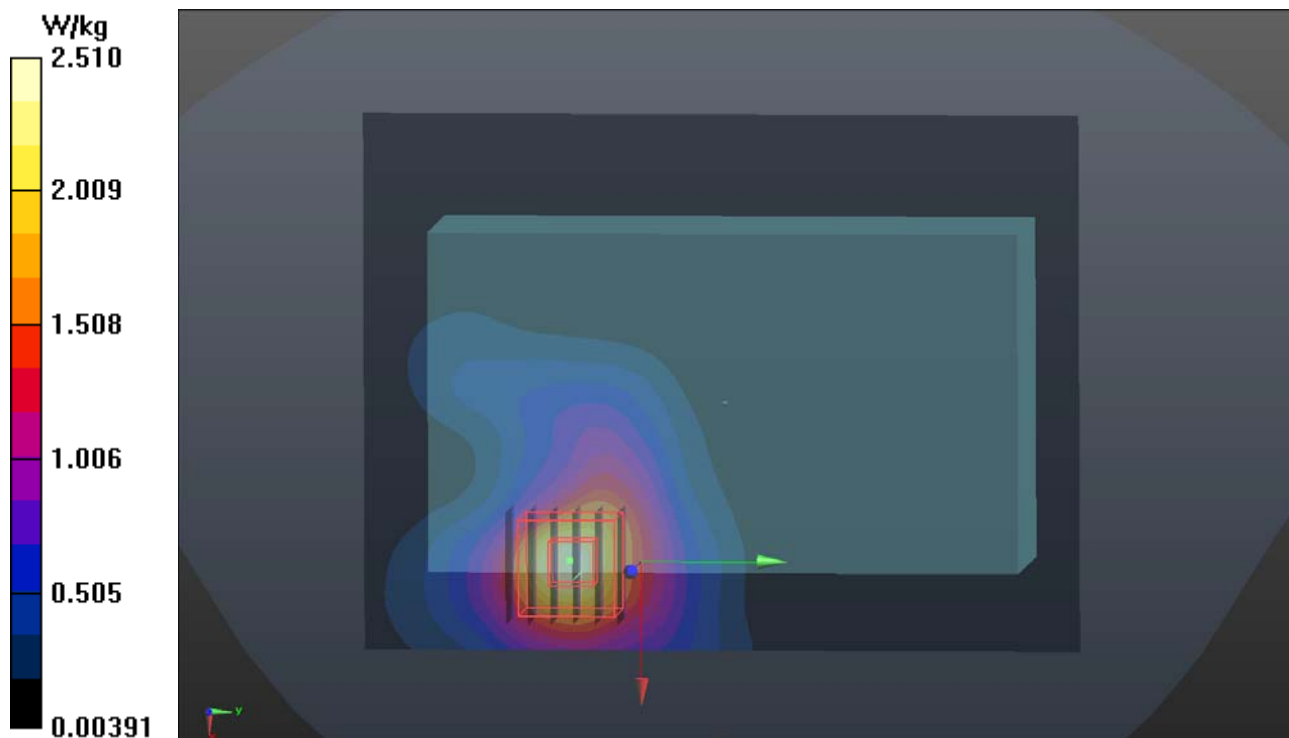

P11 5.6G WLAN_802.11ac VH80_EUT(Front)_Top join_0cm_Ch138_Sample1_PIN2

DUT: 170421C58

Communication System: WLAN_5G; Frequency: 5690 MHz; Duty Cycle: 1:1

Medium: B34T60N2_0623 Medium parameters used: $f = 5690$ MHz; $\sigma = 6.036$ S/m; $\epsilon_r = 46.308$; $\rho = 1000$ kg/m³

Ambient Temperature : 23.6 °C ; Liquid Temperature : 23.5 °C

DASY5 Configuration:

- Probe: EX3DV4 - SN3650; ConvF(4.01, 4.01, 4.01); Calibrated: 2016/07/25;
- Sensor-Surface: 1.4mm (Mechanical Surface Detection)
- Electronics: DAE4 Sn917; Calibrated: 2017/01/06
- Phantom: Twin SAM Phantom_1652; Type: QD000P40;
- Measurement SW: DASY52, Version 52.8 (8); SEMCAD X Version 14.6.10 (7373)

- **Area Scan (121x161x1)**: Interpolated grid: dx=1.000 mm, dy=1.000 mm
Maximum value of SAR (interpolated) = 1.52 W/kg

- **Zoom Scan (6x6x12)/Cube 0**: Measurement grid: dx=5mm, dy=5mm, dz=2mm

Reference Value = 17.16 V/m; Power Drift = 0.11 dB

Peak SAR (extrapolated) = 3.20 W/kg

SAR(1 g) = 0.893 W/kg; SAR(10 g) = 0.337 W/kg

Maximum value of SAR (measured) = 2.00 W/kg

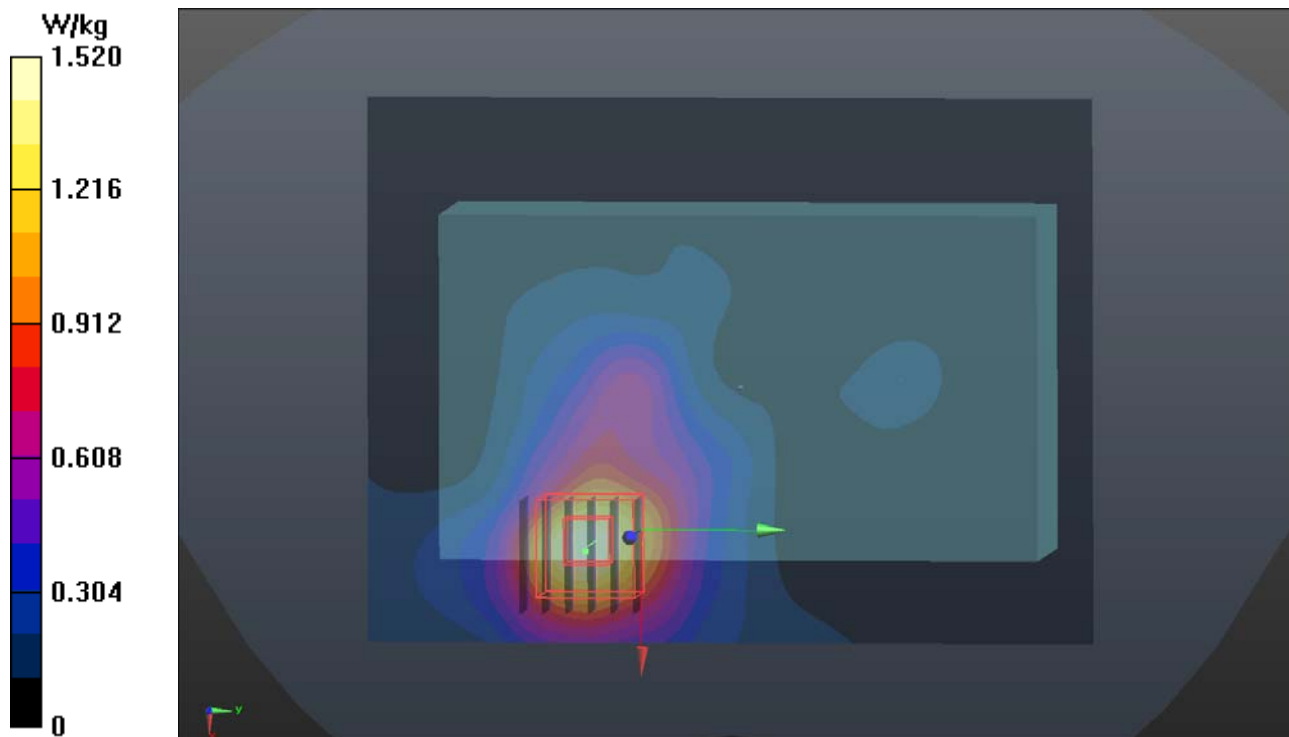

P12 5.8G WLAN_802.11ac VH80_EUT(Front)_Top join_0cm_Ch155_Sample1_PIN2

DUT: 170421C58

Communication System: WLAN_5G; Frequency: 5775 MHz; Duty Cycle: 1:1

Medium: B34T60N2_0623 Medium parameters used: $f = 5775$ MHz; $\sigma = 6.127$ S/m; $\epsilon_r = 46.169$; $\rho = 1000$ kg/m³

Ambient Temperature : 23.6 °C ; Liquid Temperature : 23.5 °C

DASY5 Configuration:

- Probe: EX3DV4 - SN3650; ConvF(4.36, 4.36, 4.36); Calibrated: 2016/07/25;
- Sensor-Surface: 1.4mm (Mechanical Surface Detection)
- Electronics: DAE4 Sn917; Calibrated: 2017/01/06
- Phantom: Twin SAM Phantom_1652; Type: QD000P40;
- Measurement SW: DASY52, Version 52.8 (8); SEMCAD X Version 14.6.10 (7373)

- **Area Scan (121x161x1):** Interpolated grid: dx=1.000 mm, dy=1.000 mm
Maximum value of SAR (interpolated) = 1.32 W/kg

- **Zoom Scan (6x6x12)/Cube 0:** Measurement grid: dx=5mm, dy=5mm, dz=2mm
Reference Value = 15.85 V/m; Power Drift = -0.04 dB
Peak SAR (extrapolated) = 3.00 W/kg
SAR(1 g) = 0.828 W/kg; SAR(10 g) = 0.312 W/kg
Maximum value of SAR (measured) = 1.82 W/kg

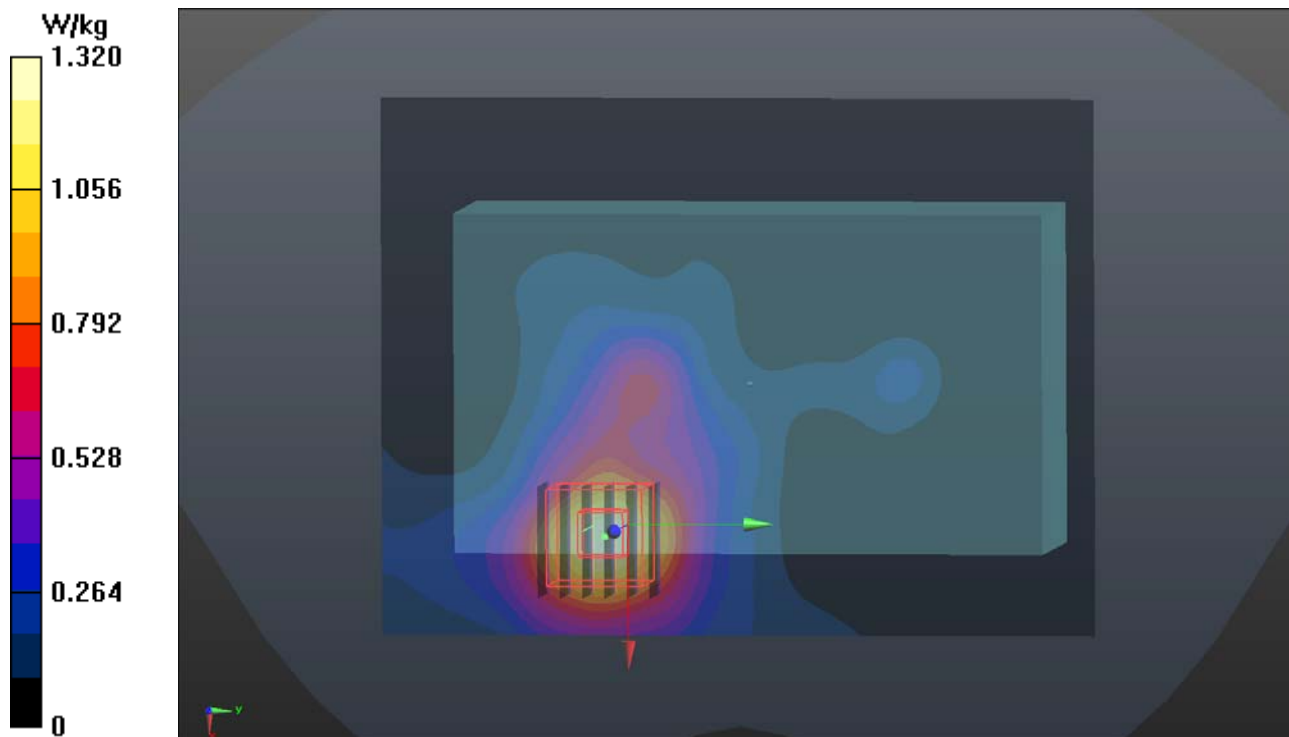

P13 2.4G WLAN_802.11b_Rear Face_0cm_Ch6_Sample2_PIN8

DUT: 170421C58

Communication System: WLAN_2.4G; Frequency: 2437 MHz; Duty Cycle: 1:1

Medium: B19T27N4_0619 Medium parameters used: $f = 2437$ MHz; $\sigma = 1.982$ S/m; $\epsilon_r = 51.552$; $\rho =$

1000 kg/m³

Ambient Temperature : 23.8 °C ; Liquid Temperature : 23.5 °C

DASY5 Configuration:

- Probe: EX3DV4 - SN3650; ConvF(7.36, 7.36, 7.36); Calibrated: 2016/07/25;
- Sensor-Surface: 1.4mm (Mechanical Surface Detection)
- Electronics: DAE4 Sn917; Calibrated: 2017/01/06
- Phantom: Twin SAM Phantom_1653; Type: QD000P40;
- Measurement SW: DASY52, Version 52.8 (8); SEMCAD X Version 14.6.10 (7373)

- **Area Scan (101x141x1):** Interpolated grid: dx=1.200 mm, dy=1.200 mm

Maximum value of SAR (interpolated) = 0.444 W/kg

- **Zoom Scan (5x5x7)/Cube 0:** Measurement grid: dx=8mm, dy=8mm, dz=5mm

Reference Value = 15.34 V/m; Power Drift = 0.15 dB

Peak SAR (extrapolated) = 0.531 W/kg

SAR(1 g) = 0.295 W/kg; SAR(10 g) = 0.168 W/kg

Maximum value of SAR (measured) = 0.441 W/kg

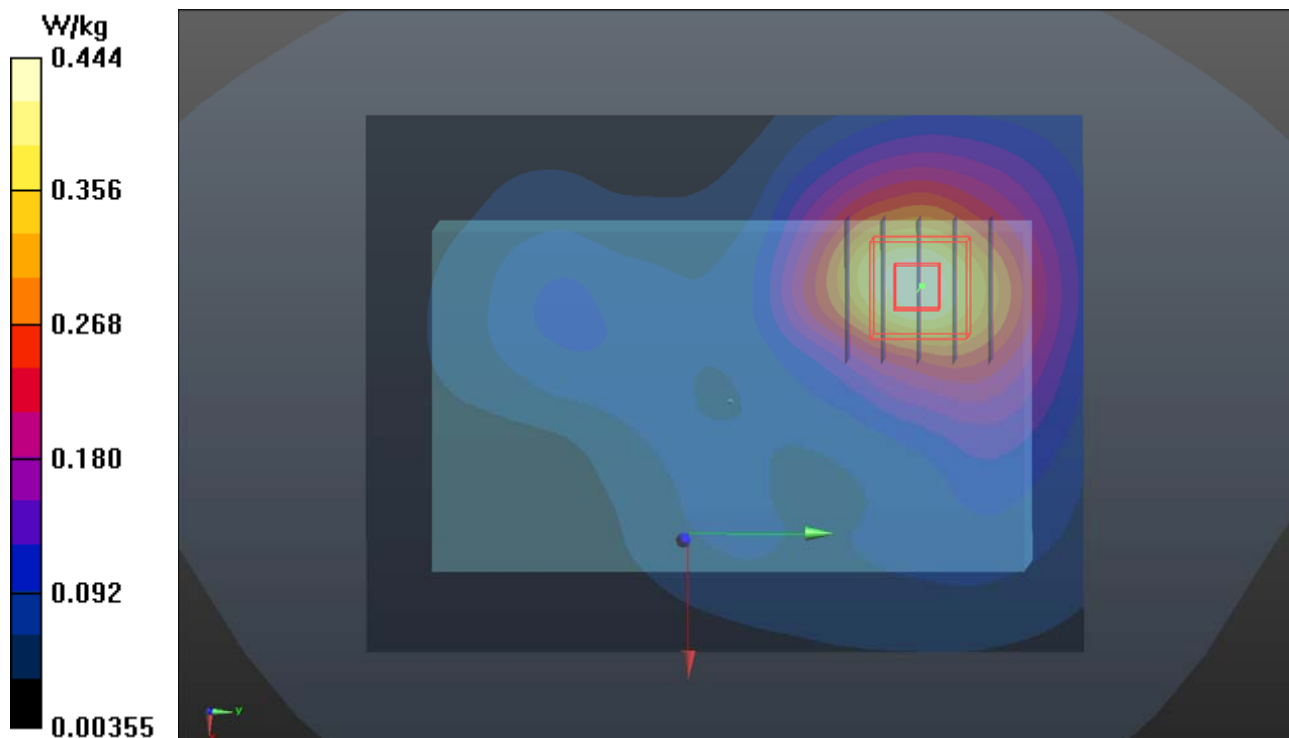

P14 5.3G WLAN_802.11a_Rear Face_0cm_Ch60_Sample1_PIN2

DUT: 170421C58

Communication System: WLAN_5G; Frequency: 5300 MHz; Duty Cycle: 1:1

Medium: B34T60N1_0702 Medium parameters used: $f = 5300$ MHz; $\sigma = 5.571$ S/m; $\epsilon_r = 47.255$; $\rho = 1000$ kg/m³

Ambient Temperature : 23.6 °C ; Liquid Temperature : 23.5 °C

DASY5 Configuration:

- Probe: EX3DV4 - SN3650; ConvF(4.75, 4.75, 4.75); Calibrated: 2016/07/25;
- Sensor-Surface: 1.4mm (Mechanical Surface Detection)
- Electronics: DAE4 Sn917; Calibrated: 2017/01/06
- Phantom: Twin SAM Phantom_1653; Type: QD000P40;
- Measurement SW: DASY52, Version 52.8 (8); SEMCAD X Version 14.6.10 (7373)

- **Area Scan (121x161x1):** Interpolated grid: dx=1.000 mm, dy=1.000 mm
Maximum value of SAR (interpolated) = 3.64 W/kg

- **Zoom Scan (6x6x12)/Cube 0:** Measurement grid: dx=5mm, dy=5mm, dz=2mm
Reference Value = 25.65 V/m; Power Drift = 0.01 dB
Peak SAR (extrapolated) = 4.82 W/kg
SAR(1 g) = 1.43 W/kg; SAR(10 g) = 0.557 W/kg
Maximum value of SAR (measured) = 3.00 W/kg

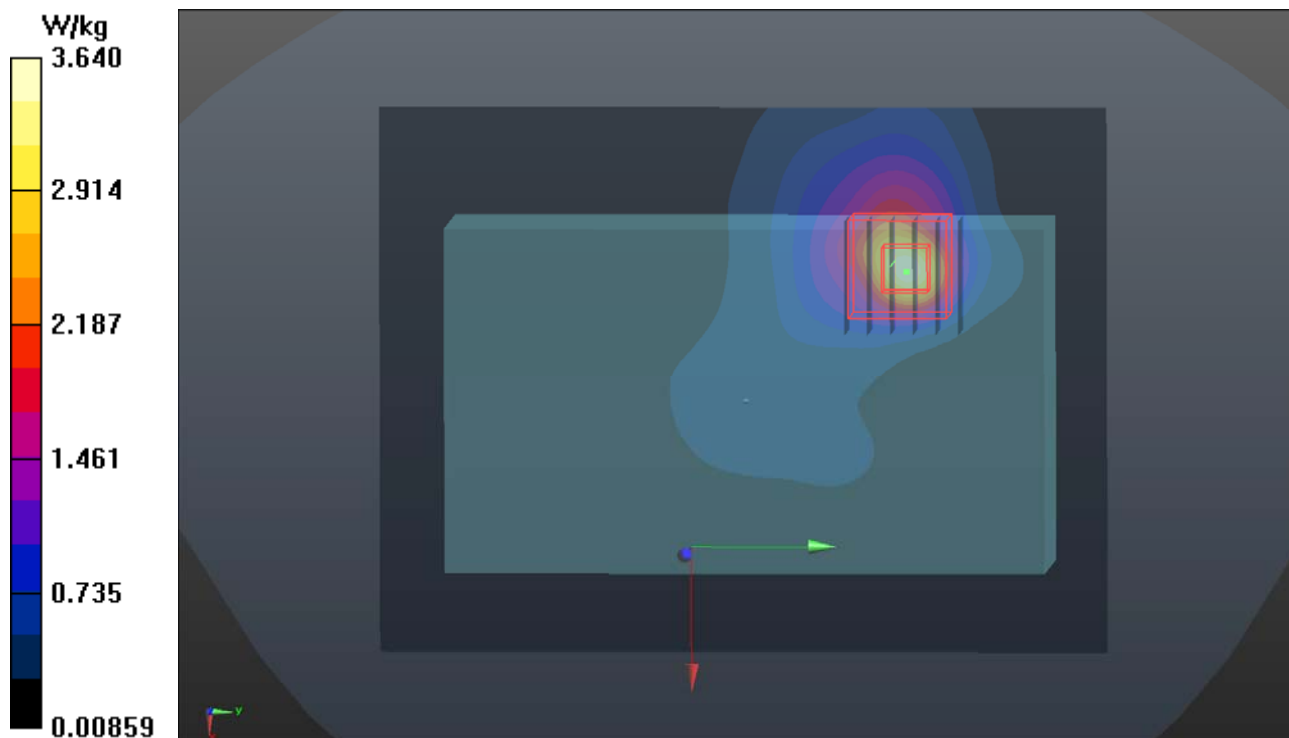

P15 5.6G WLAN_802.11ac VH80_Rear Face_0cm_Ch138_Sample2_PIN2_Arm Mount

DUT: 170421C58

Communication System: WLAN_5G; Frequency: 5690 MHz; Duty Cycle: 1:1

Medium: B34T60N2_0627 Medium parameters used: $f = 5690$ MHz; $\sigma = 5.76$ S/m; $\epsilon_r = 46.562$; $\rho = 1000$ kg/m³

Ambient Temperature : 23.6 °C ; Liquid Temperature : 23.4 °C

DASY5 Configuration:

- Probe: EX3DV4 - SN3650; ConvF(4.01, 4.01, 4.01); Calibrated: 2016/07/25;
- Sensor-Surface: 1.4mm (Mechanical Surface Detection)
- Electronics: DAE4 Sn917; Calibrated: 2017/01/06
- Phantom: Twin SAM Phantom_1653; Type: QD000P40;
- Measurement SW: DASY52, Version 52.8 (8); SEMCAD X Version 14.6.10 (7373)

- **Area Scan (121x161x1):** Interpolated grid: dx=1.000 mm, dy=1.000 mm
Maximum value of SAR (interpolated) = 1.31 W/kg

- **Zoom Scan (6x6x12)/Cube 0:** Measurement grid: dx=5mm, dy=5mm, dz=2mm
Reference Value = 16.48 V/m; Power Drift = 0.02 dB
Peak SAR (extrapolated) = 2.32 W/kg
SAR(1 g) = 0.670 W/kg; SAR(10 g) = 0.249 W/kg
Maximum value of SAR (measured) = 1.48 W/kg

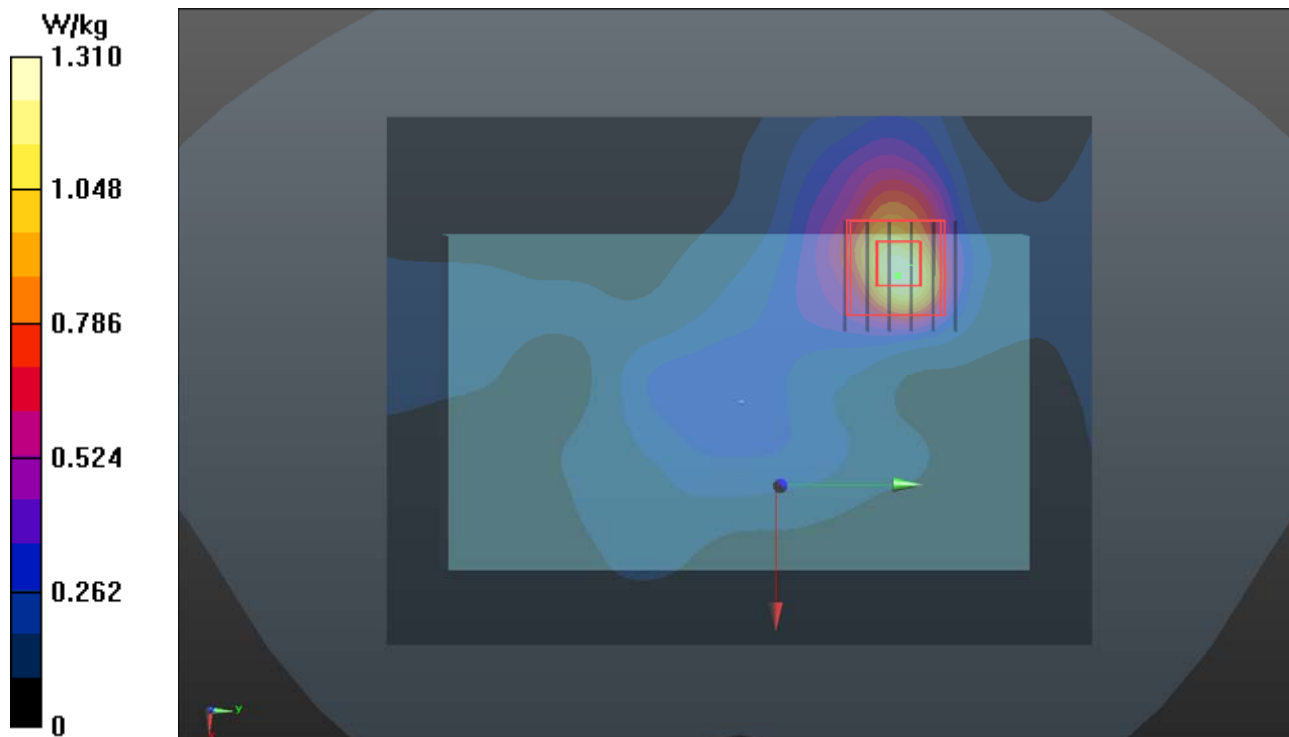

P16 5.8G WLAN_802.11ac VH80_Rear Face_0cm_Ch155_Sample1_PIN8_Arm Mount

DUT: 170421C58

Communication System: WLAN_5G; Frequency: 5775 MHz; Duty Cycle: 1:1

Medium: B34T60N2_0627 Medium parameters used: $f = 5775$ MHz; $\sigma = 5.804$ S/m; $\epsilon_r = 46.362$; $\rho = 1000$ kg/m³

Ambient Temperature : 23.6 °C ; Liquid Temperature : 23.4 °C

DASY5 Configuration:

- Probe: EX3DV4 - SN3650; ConvF(4.36, 4.36, 4.36); Calibrated: 2016/07/25;
- Sensor-Surface: 1.4mm (Mechanical Surface Detection)
- Electronics: DAE4 Sn917; Calibrated: 2017/01/06
- Phantom: Twin SAM Phantom_1653; Type: QD000P40;
- Measurement SW: DASY52, Version 52.8 (8); SEMCAD X Version 14.6.10 (7373)

- **Area Scan (121x161x1):** Interpolated grid: dx=1.000 mm, dy=1.000 mm
Maximum value of SAR (interpolated) = 0.881 W/kg

- **Zoom Scan (6x6x12)/Cube 0:** Measurement grid: dx=5mm, dy=5mm, dz=2mm
Reference Value = 12.96 V/m; Power Drift = 0.16 dB
Peak SAR (extrapolated) = 1.80 W/kg
SAR(1 g) = 0.523 W/kg; SAR(10 g) = 0.198 W/kg
Maximum value of SAR (measured) = 1.16 W/kg

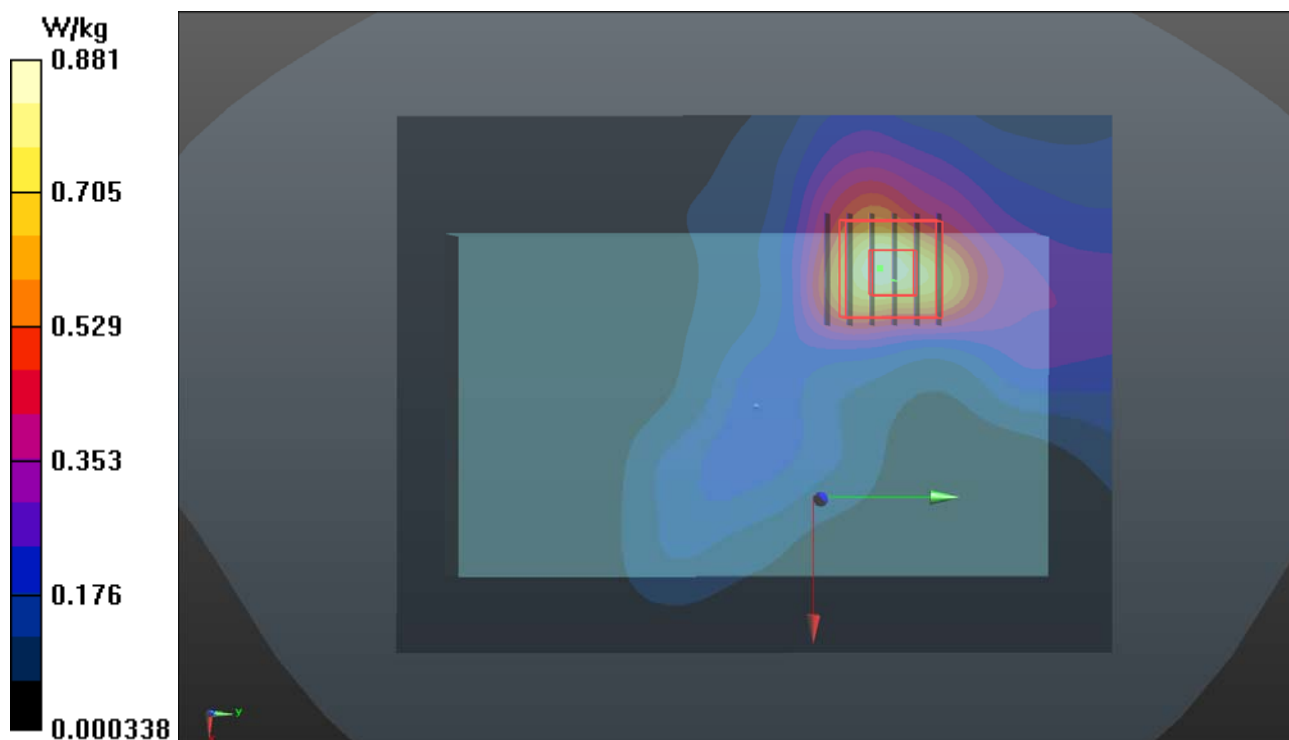

P17 2.4G WLAN_802.11b_Right Side_0cm_Ch1_Sample2_PIN2

DUT: 170421C58

Communication System: WLAN_2.4G; Frequency: 2412 MHz; Duty Cycle: 1:1

Medium: B19T27N4_0619 Medium parameters used: $f = 2412$ MHz; $\sigma = 1.954$ S/m; $\epsilon_r = 51.627$; $\rho =$

1000 kg/m³

Ambient Temperature : 23.8 °C ; Liquid Temperature : 23.5 °C

DASY5 Configuration:

- Probe: EX3DV4 - SN3650; ConvF(7.36, 7.36, 7.36); Calibrated: 2016/07/25;
- Sensor-Surface: 1.4mm (Mechanical Surface Detection)
- Electronics: DAE4 Sn917; Calibrated: 2017/01/06
- Phantom: Twin SAM Phantom_1653; Type: QD000P40;
- Measurement SW: DASY52, Version 52.8 (8); SEMCAD X Version 14.6.10 (7373)

- **Area Scan (71x141x1):** Interpolated grid: dx=1.200 mm, dy=1.200 mm

Maximum value of SAR (interpolated) = 9.04 W/kg

- **Zoom Scan (5x5x7)/Cube 0:** Measurement grid: dx=8mm, dy=8mm, dz=5mm

Reference Value = 68.93 V/m; Power Drift = -0.14 dB

Peak SAR (extrapolated) = 14.2 W/kg

SAR(1 g) = 5.81 W/kg; SAR(10 g) = 2.24 W/kg

Maximum value of SAR (measured) = 10.7 W/kg

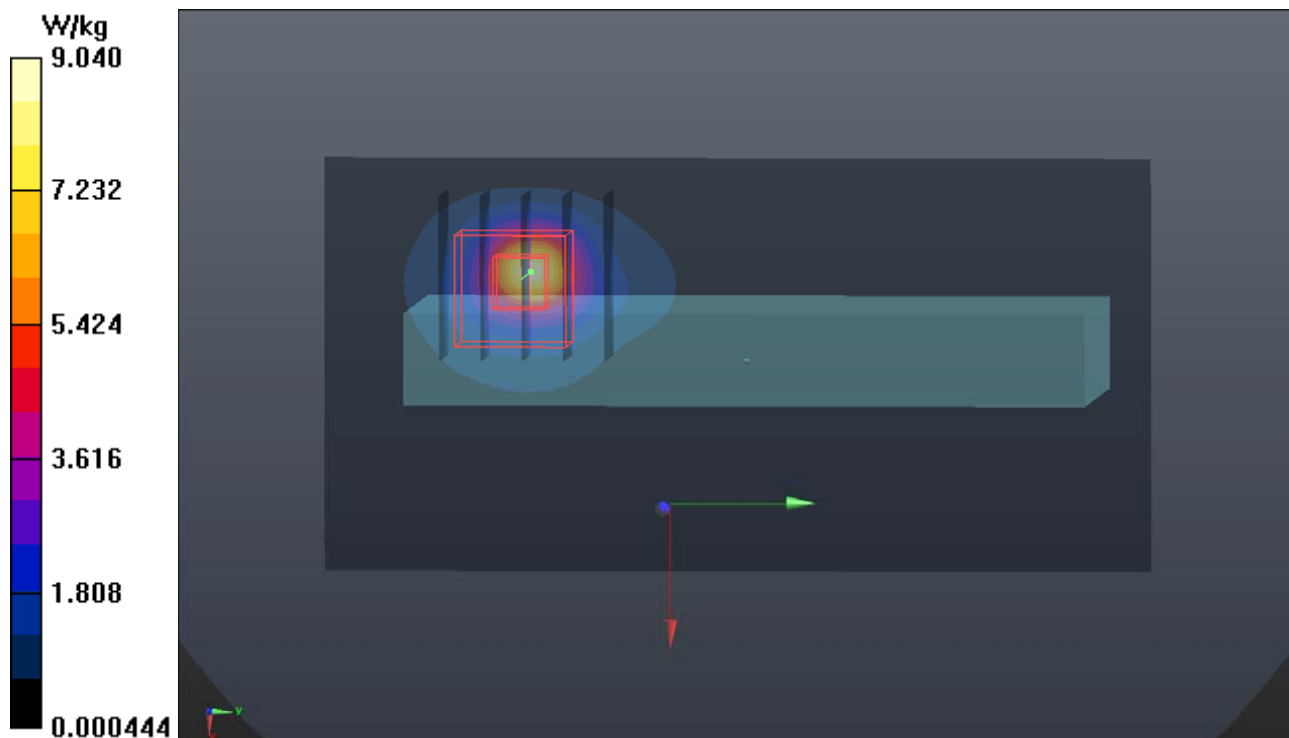

P18 5.3G WLAN_802.11a_Right Side_0cm_Ch60_Sample2_PIN2

DUT: 170421C58

Communication System: WLAN_5G; Frequency: 5300 MHz; Duty Cycle: 1:1

Medium: B34T60N1_0702 Medium parameters used: $f = 5300$ MHz; $\sigma = 5.571$ S/m; $\epsilon_r = 47.255$; $\rho = 1000$ kg/m³

Ambient Temperature : 23.8 °C ; Liquid Temperature : 23.5 °C

DASY5 Configuration:

- Probe: EX3DV4 - SN3650; ConvF(4.75, 4.75, 4.75); Calibrated: 2016/07/25;
- Sensor-Surface: 1.4mm (Mechanical Surface Detection)
- Electronics: DAE4 Sn917; Calibrated: 2017/01/06
- Phantom: Twin SAM Phantom_1653; Type: QD000P40;
- Measurement SW: DASY52, Version 52.8 (8); SEMCAD X Version 14.6.10 (7373)

- **Area Scan (81x161x1):** Interpolated grid: dx=1.000 mm, dy=1.000 mm

Maximum value of SAR (interpolated) = 6.69 W/kg

- **Zoom Scan (6x6x12)/Cube 0:** Measurement grid: dx=5mm, dy=5mm, dz=2mm

Reference Value = 34.82 V/m; Power Drift = 0.11 dB

Peak SAR (extrapolated) = 28.2 W/kg

SAR(1 g) = 6.88 W/kg; SAR(10 g) = 1.97 W/kg

Maximum value of SAR (measured) = 17.0 W/kg

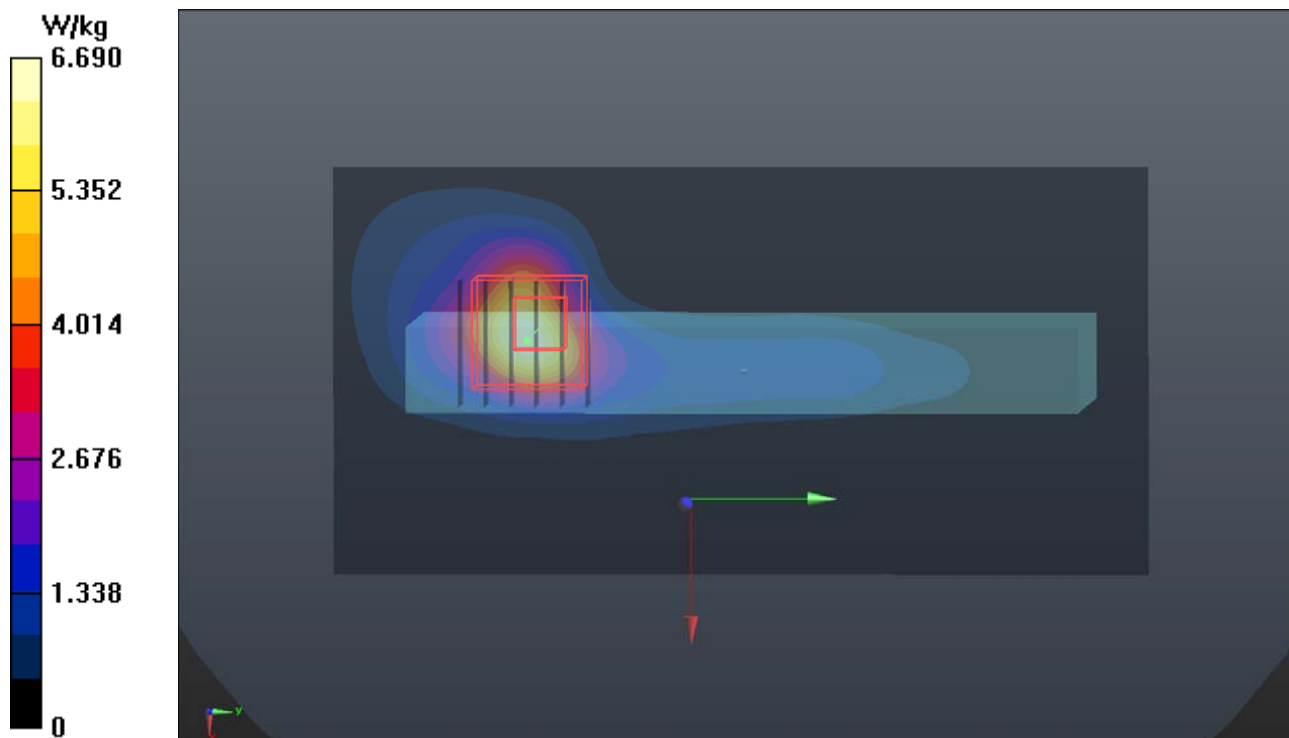

P19 5.6G WLAN_802.11ac VH80_Right Side_0cm_Ch138_Sample1_PIN2_Gun

DUT: 170421C58

Communication System: WLAN_5G; Frequency: 5690 MHz; Duty Cycle: 1:1

Medium: B34T60N2_0627 Medium parameters used: $f = 5690$ MHz; $\sigma = 5.76$ S/m; $\epsilon_r = 46.562$; $\rho = 1000$ kg/m³

Ambient Temperature : 23.6 °C ; Liquid Temperature : 23.4 °C

DASY5 Configuration:

- Probe: EX3DV4 - SN3650; ConvF(4.01, 4.01, 4.01); Calibrated: 2016/07/25;
- Sensor-Surface: 1.4mm (Mechanical Surface Detection)
- Electronics: DAE4 Sn917; Calibrated: 2017/01/06
- Phantom: Twin SAM Phantom_1653; Type: QD000P40;
- Measurement SW: DASY52, Version 52.8 (8); SEMCAD X Version 14.6.10 (7373)

- **Area Scan (81x161x1):** Interpolated grid: dx=1.000 mm, dy=1.000 mm

Maximum value of SAR (interpolated) = 5.26 W/kg

- **Zoom Scan (7x7x12)/Cube 0:** Measurement grid: dx=4mm, dy=4mm, dz=2mm

Reference Value = 33.11 V/m; Power Drift = 0.05 dB

Peak SAR (extrapolated) = 14.5 W/kg

SAR(1 g) = 3.32 W/kg; SAR(10 g) = 0.990 W/kg

Maximum value of SAR (measured) = 8.31 W/kg

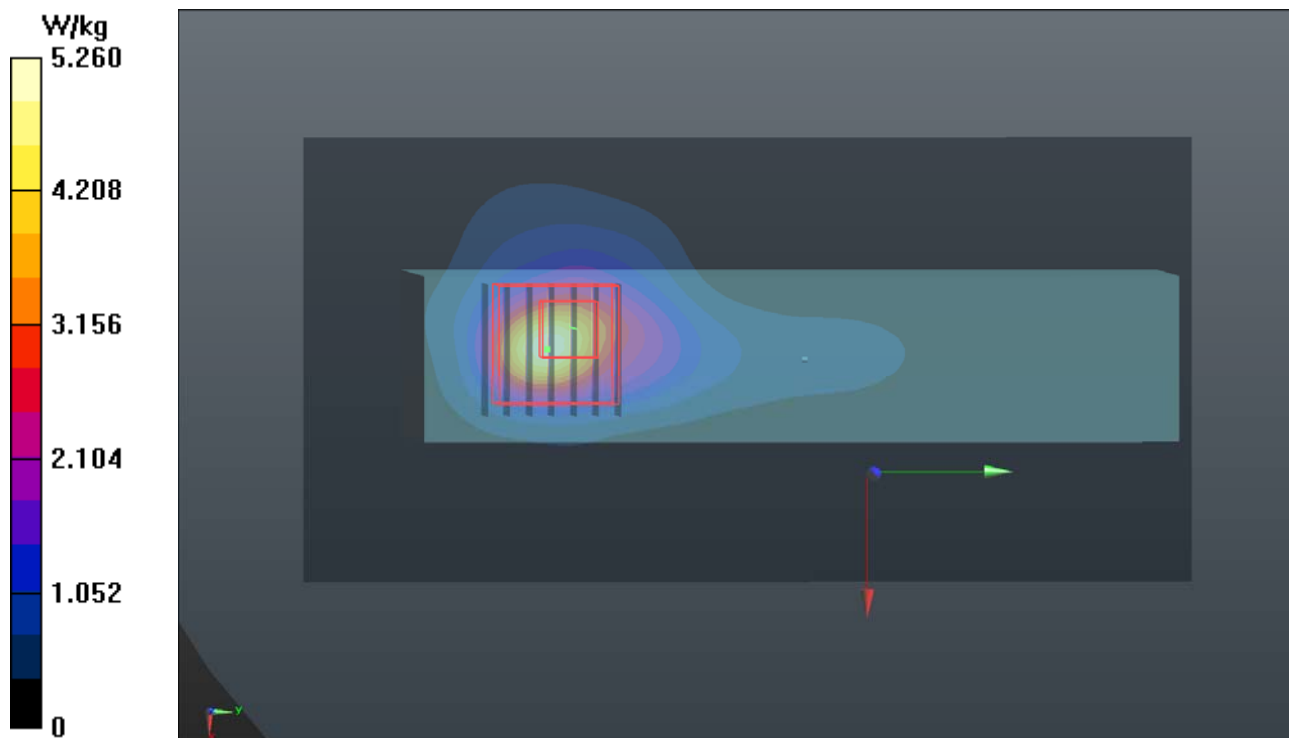

P20 5.8G WLAN_802.11ac VH80_Right Side_0cm_Ch155_Sample2_PIN2_Gun

DUT: 170421C58

Communication System: WLAN_5G; Frequency: 5775 MHz; Duty Cycle: 1:1

Medium: B34T60N2_0627 Medium parameters used: $f = 5775$ MHz; $\sigma = 5.804$ S/m; $\epsilon_r = 46.362$; $\rho = 1000$ kg/m³

Ambient Temperature : 23.6 °C ; Liquid Temperature : 23.4 °C

DASY5 Configuration:

- Probe: EX3DV4 - SN3650; ConvF(4.36, 4.36, 4.36); Calibrated: 2016/07/25;
- Sensor-Surface: 1.4mm (Mechanical Surface Detection)
- Electronics: DAE4 Sn917; Calibrated: 2017/01/06
- Phantom: Twin SAM Phantom_1653; Type: QD000P40;
- Measurement SW: DASY52, Version 52.8 (8); SEMCAD X Version 14.6.10 (7373)

- **Area Scan (81x161x1):** Interpolated grid: dx=1.000 mm, dy=1.000 mm

Maximum value of SAR (interpolated) = 4.25 W/kg

- **Zoom Scan (7x7x12)/Cube 0:** Measurement grid: dx=4mm, dy=4mm, dz=2mm

Reference Value = 29.58 V/m; Power Drift = 0.05 dB

Peak SAR (extrapolated) = 11.4 W/kg

SAR(1 g) = 2.55 W/kg; SAR(10 g) = 0.782 W/kg

Maximum value of SAR (measured) = 6.68 W/kg

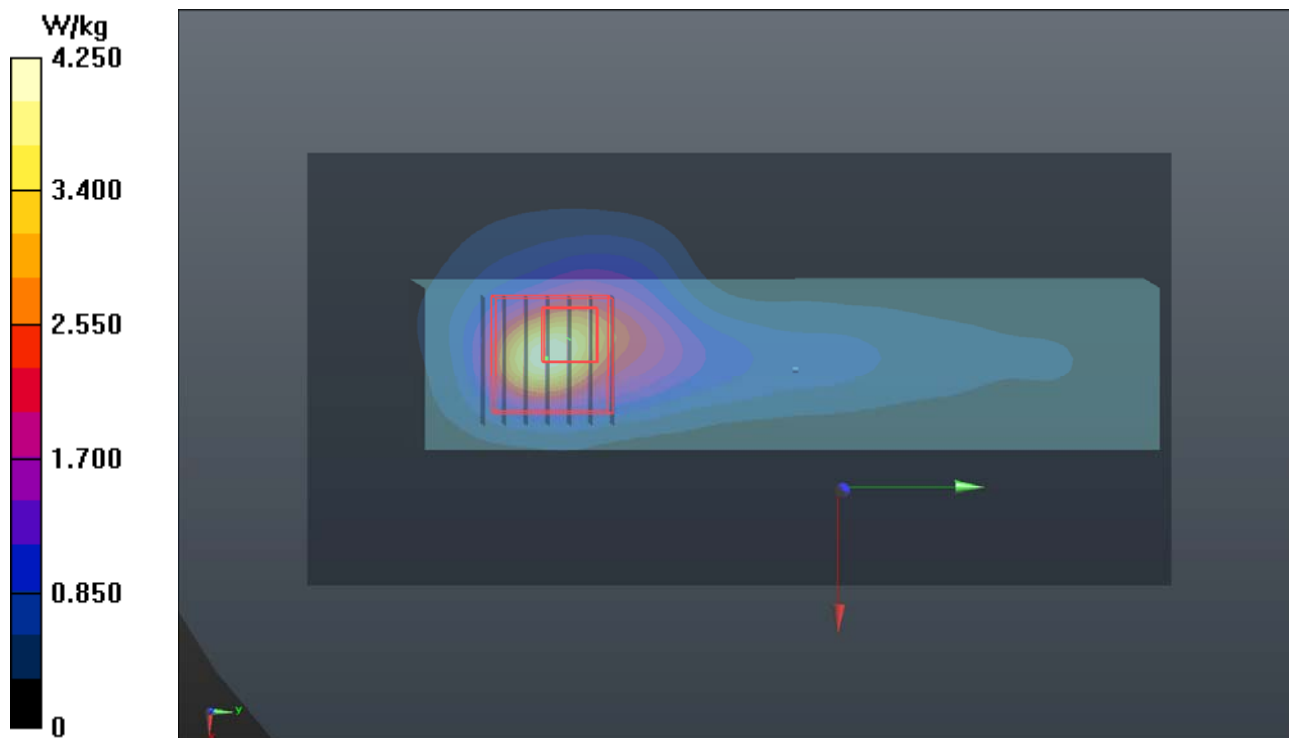



Appendix C. Calibration Certificate for Probe and Dipole

The SPEAG calibration certificates are shown as follows.



Accredited by the Swiss Accreditation Service (SAS)
The Swiss Accreditation Service is one of the signatories to the EA
Multilateral Agreement for the recognition of calibration certificates

Accreditation No.: **SCS 0108**

Client **B.V. ADT (Auden)**

Certificate No: **D2450V2-737_Aug16**

CALIBRATION CERTIFICATE

Object **D2450V2 - SN:737**

Calibration procedure(s) **QA CAL-05.v9
Calibration procedure for dipole validation kits above 700 MHz**

Calibration date: **August 26, 2016**

This calibration certificate documents the traceability to national standards, which realize the physical units of measurements (SI).
The measurements and the uncertainties with confidence probability are given on the following pages and are part of the certificate.

All calibrations have been conducted in the closed laboratory facility: environment temperature (22 ± 3)°C and humidity < 70%.

Calibration Equipment used (M&TE critical for calibration)

Primary Standards	ID #	Cal Date (Certificate No.)	Scheduled Calibration
Power meter NRP	SN: 104778	06-Apr-16 (No. 217-02288/02289)	Apr-17
Power sensor NRP-Z91	SN: 103244	06-Apr-16 (No. 217-02288)	Apr-17
Power sensor NRP-Z91	SN: 103245	06-Apr-16 (No. 217-02289)	Apr-17
Reference 20 dB Attenuator	SN: 5058 (20k)	05-Apr-16 (No. 217-02292)	Apr-17
Type-N mismatch combination	SN: 5047.2 / 06327	05-Apr-16 (No. 217-02295)	Apr-17
Reference Probe EX3DV4	SN: 7349	15-Jun-16 (No. EX3-7349_Jun16)	Jun-17
DAE4	SN: 601	30-Dec-15 (No. DAE4-601_Dec15)	Dec-16
Secondary Standards	ID #	Check Date (in house)	Scheduled Check
Power meter EPM-442A	SN: GB37480704	07-Oct-15 (No. 217-02222)	In house check: Oct-16
Power sensor HP 8481A	SN: US37292783	07-Oct-15 (No. 217-02222)	In house check: Oct-16
Power sensor HP 8481A	SN: MY41092317	07-Oct-15 (No. 217-02223)	In house check: Oct-16
RF generator R&S SMT-06	SN: 100972	15-Jun-15 (in house check Jun-15)	In house check: Oct-16
Network Analyzer HP 8753E	SN: US37390585	18-Oct-01 (in house check Oct-15)	In house check: Oct-16

Calibrated by: **Johannes Kurikka** **Laboratory Technician**

Approved by: **Katja Pokovic** **Technical Manager**

Johannes Kurikka

Katja Pokovic

Issued: August 29, 2016

This calibration certificate shall not be reproduced except in full without written approval of the laboratory.



Accredited by the Swiss Accreditation Service (SAS)

Accreditation No.: **SCS 0108**

The Swiss Accreditation Service is one of the signatories to the EA
Multilateral Agreement for the recognition of calibration certificates

Glossary:

TSL	tissue simulating liquid
ConvF	sensitivity in TSL / NORM x,y,z
N/A	not applicable or not measured

Calibration is Performed According to the Following Standards:

- IEEE Std 1528-2013, "IEEE Recommended Practice for Determining the Peak Spatial-Averaged Specific Absorption Rate (SAR) in the Human Head from Wireless Communications Devices: Measurement Techniques", June 2013
- IEC 62209-1, "Procedure to measure the Specific Absorption Rate (SAR) for hand-held devices used in close proximity to the ear (frequency range of 300 MHz to 3 GHz)", February 2005
- IEC 62209-2, "Procedure to determine the Specific Absorption Rate (SAR) for wireless communication devices used in close proximity to the human body (frequency range of 30 MHz to 6 GHz)", March 2010
- KDB 865664, "SAR Measurement Requirements for 100 MHz to 6 GHz"

Additional Documentation:

- DASY4/5 System Handbook

Methods Applied and Interpretation of Parameters:

- Measurement Conditions:* Further details are available from the Validation Report at the end of the certificate. All figures stated in the certificate are valid at the frequency indicated.
- Antenna Parameters with TSL:* The dipole is mounted with the spacer to position its feed point exactly below the center marking of the flat phantom section, with the arms oriented parallel to the body axis.
- Feed Point Impedance and Return Loss:* These parameters are measured with the dipole positioned under the liquid filled phantom. The impedance stated is transformed from the measurement at the SMA connector to the feed point. The Return Loss ensures low reflected power. No uncertainty required.
- Electrical Delay:* One-way delay between the SMA connector and the antenna feed point. No uncertainty required.
- SAR measured:* SAR measured at the stated antenna input power.
- SAR normalized:* SAR as measured, normalized to an input power of 1 W at the antenna connector.
- SAR for nominal TSL parameters:* The measured TSL parameters are used to calculate the nominal SAR result.

The reported uncertainty of measurement is stated as the standard uncertainty of measurement multiplied by the coverage factor $k=2$, which for a normal distribution corresponds to a coverage probability of approximately 95%.

Measurement Conditions

DASY system configuration, as far as not given on page 1.

DASY Version	DASY5	V52.8.8
Extrapolation	Advanced Extrapolation	
Phantom	Modular Flat Phantom	
Distance Dipole Center - TSL	10 mm	with Spacer
Zoom Scan Resolution	dx, dy, dz = 5 mm	
Frequency	2450 MHz \pm 1 MHz	

Head TSL parameters

The following parameters and calculations were applied.

	Temperature	Permittivity	Conductivity
Nominal Head TSL parameters	22.0 °C	39.2	1.80 mho/m
Measured Head TSL parameters	(22.0 \pm 0.2) °C	38.2 \pm 6 %	1.88 mho/m \pm 6 %
Head TSL temperature change during test	< 0.5 °C	----	----

SAR result with Head TSL

SAR averaged over 1 cm³ (1 g) of Head TSL	Condition	
SAR measured	250 mW input power	13.5 W/kg
SAR for nominal Head TSL parameters	normalized to 1W	52.6 W/kg \pm 17.0 % (k=2)

SAR averaged over 10 cm³ (10 g) of Head TSL	condition	
SAR measured	250 mW input power	6.29 W/kg
SAR for nominal Head TSL parameters	normalized to 1W	24.8 W/kg \pm 16.5 % (k=2)

Body TSL parameters

The following parameters and calculations were applied.

	Temperature	Permittivity	Conductivity
Nominal Body TSL parameters	22.0 °C	52.7	1.95 mho/m
Measured Body TSL parameters	(22.0 \pm 0.2) °C	52.0 \pm 6 %	2.04 mho/m \pm 6 %
Body TSL temperature change during test	< 0.5 °C	----	----

SAR result with Body TSL

SAR averaged over 1 cm³ (1 g) of Body TSL	Condition	
SAR measured	250 mW input power	13.1 W/kg
SAR for nominal Body TSL parameters	normalized to 1W	51.1 W/kg \pm 17.0 % (k=2)

SAR averaged over 10 cm³ (10 g) of Body TSL	condition	
SAR measured	250 mW input power	6.11 W/kg
SAR for nominal Body TSL parameters	normalized to 1W	24.1 W/kg \pm 16.5 % (k=2)

Appendix (Additional assessments outside the scope of SCS 0108)

Antenna Parameters with Head TSL

Impedance, transformed to feed point	54.4 Ω + 4.3 j Ω
Return Loss	- 24.6 dB

Antenna Parameters with Body TSL

Impedance, transformed to feed point	49.8 Ω + 6.4 j Ω
Return Loss	- 23.8 dB

General Antenna Parameters and Design

Electrical Delay (one direction)	1.161 ns
----------------------------------	----------

After long term use with 100W radiated power, only a slight warming of the dipole near the feedpoint can be measured.

The dipole is made of standard semirigid coaxial cable. The center conductor of the feeding line is directly connected to the second arm of the dipole. The antenna is therefore short-circuited for DC-signals. On some of the dipoles, small end caps are added to the dipole arms in order to improve matching when loaded according to the position as explained in the "Measurement Conditions" paragraph. The SAR data are not affected by this change. The overall dipole length is still according to the Standard.

No excessive force must be applied to the dipole arms, because they might bend or the soldered connections near the feedpoint may be damaged.

Additional EUT Data

Manufactured by	SPEAG
Manufactured on	August 26, 2003

DASY5 Validation Report for Head TSL

Date: 26.08.2016

Test Laboratory: SPEAG, Zurich, Switzerland

DUT: Dipole 2450 MHz; Type: D2450V2; Serial: D2450V2 - SN:737

Communication System: UID 0 - CW; Frequency: 2450 MHz

Medium parameters used: $f = 2450$ MHz; $\sigma = 1.88$ S/m; $\epsilon_r = 38.2$; $\rho = 1000$ kg/m³

Phantom section: Flat Section

Measurement Standard: DASY5 (IEEE/IEC/ANSI C63.19-2011)

DASY52 Configuration:

- Probe: EX3DV4 - SN7349; ConvF(7.72, 7.72, 7.72); Calibrated: 15.06.2016;
- Sensor-Surface: 1.4mm (Mechanical Surface Detection)
- Electronics: DAE4 Sn601; Calibrated: 30.12.2015
- Phantom: Flat Phantom 5.0 (front); Type: QD000P50AA; Serial: 1001
- DASY52 52.8.8(1258); SEMCAD X 14.6.10(7372)

Dipole Calibration for Head Tissue/Pin=250 mW, d=10mm/Zoom Scan (7x7x7)/Cube 0:

Measurement grid: dx=5mm, dy=5mm, dz=5mm

Reference Value = 114.2 V/m; Power Drift = -0.01 dB

Peak SAR (extrapolated) = 27.2 W/kg

SAR(1 g) = 13.5 W/kg; SAR(10 g) = 6.29 W/kg

Maximum value of SAR (measured) = 22.2 W/kg

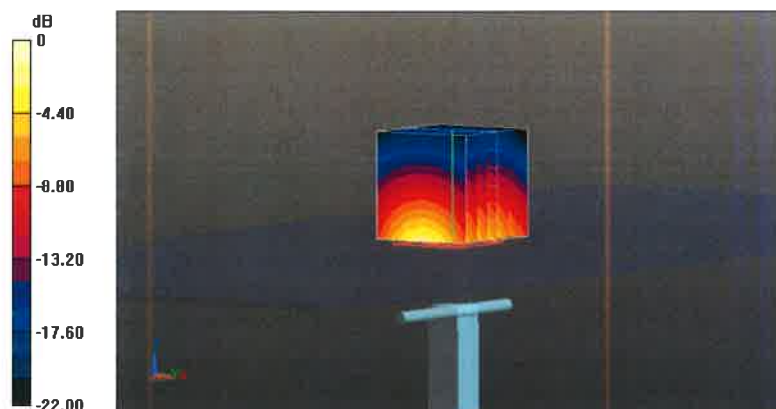

0 dB = 22.2 W/kg = 13.46 dBW/kg

Impedance Measurement Plot for Head TSL

26 Aug 2016 12:10:20

CH1 S11 1 U FS

1: 54.398 Ω 4.3457 Ω 282.30 pF

2 450.000 000 MHz

*
De1

CA

Avg
16

H1 d

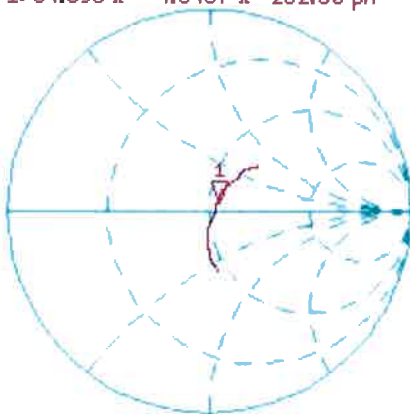

CH2 S11 LOG

5 dB/REF -20 dB

1: -24.554 dB 2 450.000 000 MHz

CA

Avg
16

H1 d

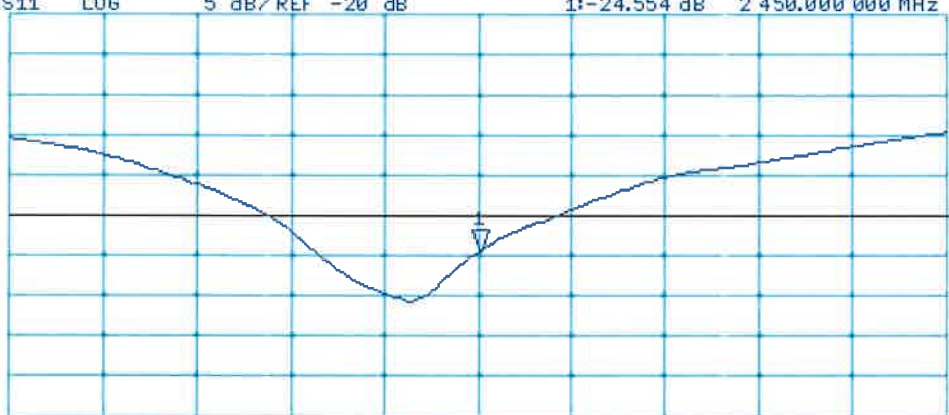

START 2 250.000 000 MHz

STOP 2 650.000 000 MHz

DASY5 Validation Report for Body TSL

Date: 24.08.2016

Test Laboratory: SPEAG, Zurich, Switzerland

DUT: Dipole 2450 MHz; Type: D2450V2; Serial: D2450V2 - SN:737

Communication System: UID 0 - CW; Frequency: 2450 MHz

Medium parameters used: $f = 2450$ MHz; $\sigma = 2.04$ S/m; $\epsilon_r = 52$; $\rho = 1000$ kg/m³

Phantom section: Flat Section

Measurement Standard: DASY5 (IEEE/IEC/ANSI C63.19-2011)

DASY52 Configuration:

- Probe: EX3DV4 - SN7349; ConvF(7.79, 7.79, 7.79); Calibrated: 15.06.2016;
- Sensor-Surface: 1.4mm (Mechanical Surface Detection)
- Electronics: DAE4 Sn601; Calibrated: 30.12.2015
- Phantom: Flat Phantom 5.0 (back); Type: QD000P50AA; Serial: 1002
- DASY52 52.8.8(1258); SEMCAD X 14.6.10(7372)

Dipole Calibration for Body Tissue/Pin=250 mW, d=10mm/Zoom Scan (7x7x7)/Cube 0:

Measurement grid: dx=5mm, dy=5mm, dz=5mm

Reference Value = 106.3 V/m; Power Drift = -0.01 dB

Peak SAR (extrapolated) = 26.3 W/kg

SAR(1 g) = 13.1 W/kg; SAR(10 g) = 6.11 W/kg

Maximum value of SAR (measured) = 21.3 W/kg



0 dB = 21.3 W/kg = 13.28 dBW/kg

Impedance Measurement Plot for Body TSL

24 Aug 2016 13:04:27

CH1 S11 1 U FS

1: 49.836 Ω 6.4453 Ω 418.70 pF

2 450.000 000 MHz

*
Del

CA

Avg
16

H1 d

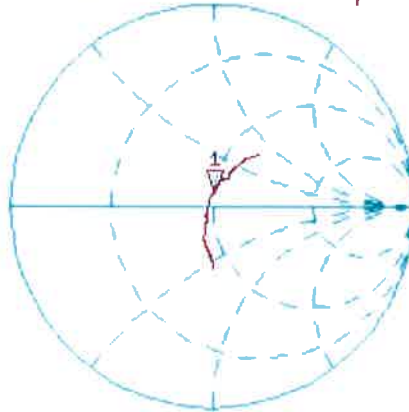

CH2 S11 LOG

5 dB/REF -20 dB

1: -23.810 dB

2 450.000 000 MHz

CA

Avg
16

H1 d





Accredited by the Swiss Accreditation Service (SAS)
The Swiss Accreditation Service is one of the signatories to the EA
Multilateral Agreement for the recognition of calibration certificates

Accreditation No.: **SCS 0108**

Client **B.V. ADT (Auden)**

Certificate No: **D5GHzV2-1019_Aug16**

CALIBRATION CERTIFICATE

Object **D5GHzV2 - SN:1019**

Calibration procedure(s) **QA CAL-22.v2
Calibration procedure for dipole validation kits between 3-6 GHz**

Calibration date: **August 23, 2016**

This calibration certificate documents the traceability to national standards, which realize the physical units of measurements (SI).
The measurements and the uncertainties with confidence probability are given on the following pages and are part of the certificate.

All calibrations have been conducted in the closed laboratory facility: environment temperature (22 ± 3)°C and humidity < 70%.

Calibration Equipment used (M&TE critical for calibration)

Primary Standards	ID #	Cal Date (Certificate No.)	Scheduled Calibration
Power meter NRP	SN: 104778	06-Apr-16 (No. 217-02288/02289)	Apr-17
Power sensor NRP-Z91	SN: 103244	06-Apr-16 (No. 217-02288)	Apr-17
Power sensor NRP-Z91	SN: 103245	06-Apr-16 (No. 217-02289)	Apr-17
Reference 20 dB Attenuator	SN: 5058 (20k)	05-Apr-16 (No. 217-02292)	Apr-17
Type-N mismatch combination	SN: 5047.2 / 06327	05-Apr-16 (No. 217-02295)	Apr-17
Reference Probe EX3DV4	SN: 3503	30-Jun-16 (No. EX3-3503_Jun16)	Jun-17
DAE4	SN: 601	30-Dec-15 (No. DAE4-601_Dec15)	Dec-16

Secondary Standards	ID #	Check Date (in house)	Scheduled Check
Power meter EPM-442A	SN: GB37480704	07-Oct-15 (No. 217-02222)	In house check: Oct-16
Power sensor HP 8481A	SN: US37292783	07-Oct-15 (No. 217-02222)	In house check: Oct-16
Power sensor HP 8481A	SN: MY41092317	07-Oct-15 (No. 217-02223)	In house check: Oct-16
RF generator R&S SMT-06	SN: 100972	15-Jun-15 (in house check Jun-15)	In house check: Oct-16
Network Analyzer HP 8753E	SN: US37390585	18-Oct-01 (in house check Oct-15)	In house check: Oct-16

Calibrated by: **Johannes Kurikka** Laboratory Technician

Approved by: **Katja Pokovic** Technical Manager

Signature

Issued: August 25, 2016

This calibration certificate shall not be reproduced except in full without written approval of the laboratory.



Accredited by the Swiss Accreditation Service (SAS)

The Swiss Accreditation Service is one of the signatories to the EA Multilateral Agreement for the recognition of calibration certificates

Accreditation No.: **SCS 0108**

Glossary:

TSL	tissue simulating liquid
ConvF	sensitivity in TSL / NORM x,y,z
N/A	not applicable or not measured

Calibration is Performed According to the Following Standards:

- IEEE Std 1528-2013, "IEEE Recommended Practice for Determining the Peak Spatial-Averaged Specific Absorption Rate (SAR) in the Human Head from Wireless Communications Devices: Measurement Techniques", June 2013
- IEC 62209-2, "Procedure to determine the Specific Absorption Rate (SAR) for wireless communication devices used in close proximity to the human body (frequency range of 30 MHz to 6 GHz)", March 2010
- KDB 865664, "SAR Measurement Requirements for 100 MHz to 6 GHz"

Additional Documentation:

- DASY4/5 System Handbook

Methods Applied and Interpretation of Parameters:

- Measurement Conditions:** Further details are available from the Validation Report at the end of the certificate. All figures stated in the certificate are valid at the frequency indicated.
- Antenna Parameters with TSL:** The dipole is mounted with the spacer to position its feed point exactly below the center marking of the flat phantom section, with the arms oriented parallel to the body axis.
- Feed Point Impedance and Return Loss:** These parameters are measured with the dipole positioned under the liquid filled phantom. The impedance stated is transformed from the measurement at the SMA connector to the feed point. The Return Loss ensures low reflected power. No uncertainty required.
- Electrical Delay:** One-way delay between the SMA connector and the antenna feed point. No uncertainty required.
- SAR measured:** SAR measured at the stated antenna input power.
- SAR normalized:** SAR as measured, normalized to an input power of 1 W at the antenna connector.
- SAR for nominal TSL parameters:** The measured TSL parameters are used to calculate the nominal SAR result.

The reported uncertainty of measurement is stated as the standard uncertainty of measurement multiplied by the coverage factor $k=2$, which for a normal distribution corresponds to a coverage probability of approximately 95%.

Measurement Conditions

DASY system configuration, as far as not given on page 1.

DASY Version	DASY5	V52.8.8
Extrapolation	Advanced Extrapolation	
Phantom	Modular Flat Phantom V5.0	
Distance Dipole Center - TSL	10 mm	with Spacer
Zoom Scan Resolution	dx, dy = 4.0 mm, dz = 1.4 mm	Graded Ratio = 1.4 (Z direction)
Frequency	5200 MHz ± 1 MHz 5250 MHz ± 1 MHz 5300 MHz ± 1 MHz 5600 MHz ± 1 MHz 5800 MHz ± 1 MHz	

Head TSL parameters at 5200 MHz

The following parameters and calculations were applied.

	Temperature	Permittivity	Conductivity
Nominal Head TSL parameters	22.0 °C	36.0	4.66 mho/m
Measured Head TSL parameters	(22.0 ± 0.2) °C	34.5 ± 6 %	4.52 mho/m ± 6 %
Head TSL temperature change during test	< 0.5 °C	----	----

SAR result with Head TSL at 5200 MHz

SAR averaged over 1 cm³ (1 g) of Head TSL	Condition	
SAR measured	100 mW input power	7.87 W/kg
SAR for nominal Head TSL parameters	normalized to 1W	78.0 W/kg ± 19.9 % (k=2)

SAR averaged over 10 cm³ (10 g) of Head TSL	condition	
SAR measured	100 mW input power	2.25 W/kg
SAR for nominal Head TSL parameters	normalized to 1W	22.2 W/kg ± 19.5 % (k=2)

Head TSL parameters at 5250 MHz

The following parameters and calculations were applied.

	Temperature	Permittivity	Conductivity
Nominal Head TSL parameters	22.0 °C	35.9	4.71 mho/m
Measured Head TSL parameters	(22.0 ± 0.2) °C	34.4 ± 6 %	4.57 mho/m ± 6 %
Head TSL temperature change during test	< 0.5 °C	----	----

SAR result with Head TSL at 5250 MHz

SAR averaged over 1 cm ³ (1 g) of Head TSL	Condition	
SAR measured	100 mW input power	8.04 W/kg
SAR for nominal Head TSL parameters	normalized to 1W	79.6 W / kg ± 19.9 % (k=2)

SAR averaged over 10 cm ³ (10 g) of Head TSL	condition	
SAR measured	100 mW input power	2.30 W/kg
SAR for nominal Head TSL parameters	normalized to 1W	22.7 W/kg ± 19.5 % (k=2)

Head TSL parameters at 5300 MHz

The following parameters and calculations were applied.

	Temperature	Permittivity	Conductivity
Nominal Head TSL parameters	22.0 °C	35.9	4.76 mho/m
Measured Head TSL parameters	(22.0 ± 0.2) °C	34.4 ± 6 %	4.62 mho/m ± 6 %
Head TSL temperature change during test	< 0.5 °C	----	----

SAR result with Head TSL at 5300 MHz

SAR averaged over 1 cm ³ (1 g) of Head TSL	Condition	
SAR measured	100 mW input power	8.44 W/kg
SAR for nominal Head TSL parameters	normalized to 1W	83.6 W/kg ± 19.9 % (k=2)

SAR averaged over 10 cm ³ (10 g) of Head TSL	condition	
SAR measured	100 mW input power	2.41 W/kg
SAR for nominal Head TSL parameters	normalized to 1W	23.8 W/kg ± 19.5 % (k=2)

Head TSL parameters at 5600 MHz

The following parameters and calculations were applied.

	Temperature	Permittivity	Conductivity
Nominal Head TSL parameters	22.0 °C	35.5	5.07 mho/m
Measured Head TSL parameters	(22.0 ± 0.2) °C	34.0 ± 6 %	4.91 mho/m ± 6 %
Head TSL temperature change during test	< 0.5 °C	----	----

SAR result with Head TSL at 5600 MHz

SAR averaged over 1 cm ³ (1 g) of Head TSL	Condition	
SAR measured	100 mW input power	8.33 W/kg
SAR for nominal Head TSL parameters	normalized to 1W	82.4 W/kg ± 19.9 % (k=2)

SAR averaged over 10 cm ³ (10 g) of Head TSL	condition	
SAR measured	100 mW input power	2.38 W/kg
SAR for nominal Head TSL parameters	normalized to 1W	23.5 W/kg ± 19.5 % (k=2)

Head TSL parameters at 5800 MHz

The following parameters and calculations were applied.

	Temperature	Permittivity	Conductivity
Nominal Head TSL parameters	22.0 °C	35.3	5.27 mho/m
Measured Head TSL parameters	(22.0 ± 0.2) °C	33.7 ± 6 %	5.11 mho/m ± 6 %
Head TSL temperature change during test	< 0.5 °C	----	----

SAR result with Head TSL at 5800 MHz

SAR averaged over 1 cm ³ (1 g) of Head TSL	Condition	
SAR measured	100 mW input power	8.03 W/kg
SAR for nominal Head TSL parameters	normalized to 1W	79.4 W/kg ± 19.9 % (k=2)

SAR averaged over 10 cm ³ (10 g) of Head TSL	condition	
SAR measured	100 mW input power	2.28 W/kg
SAR for nominal Head TSL parameters	normalized to 1W	22.5 W/kg ± 19.5 % (k=2)

Body TSL parameters at 5200 MHz

The following parameters and calculations were applied.

	Temperature	Permittivity	Conductivity
Nominal Body TSL parameters	22.0 °C	49.0	5.30 mho/m
Measured Body TSL parameters	(22.0 ± 0.2) °C	47.1 ± 6 %	5.43 mho/m ± 6 %
Body TSL temperature change during test	< 0.5 °C	----	----

SAR result with Body TSL at 5200 MHz

SAR averaged over 1 cm ³ (1 g) of Body TSL	Condition	
SAR measured	100 mW input power	7.59 W/kg
SAR for nominal Body TSL parameters	normalized to 1W	75.3 W/kg ± 19.9 % (k=2)

SAR averaged over 10 cm ³ (10 g) of Body TSL	condition	
SAR measured	100 mW input power	2.13 W/kg
SAR for nominal Body TSL parameters	normalized to 1W	21.1 W/kg ± 19.5 % (k=2)

Body TSL parameters at 5250 MHz

The following parameters and calculations were applied.

	Temperature	Permittivity	Conductivity
Nominal Body TSL parameters	22.0 °C	48.9	5.36 mho/m
Measured Body TSL parameters	(22.0 ± 0.2) °C	47.0 ± 6 %	5.50 mho/m ± 6 %
Body TSL temperature change during test	< 0.5 °C	----	----

SAR result with Body TSL at 5250 MHz

SAR averaged over 1 cm ³ (1 g) of Body TSL	Condition	
SAR measured	100 mW input power	7.82 W/kg
SAR for nominal Body TSL parameters	normalized to 1W	77.6 W/kg ± 19.9 % (k=2)

SAR averaged over 10 cm ³ (10 g) of Body TSL	condition	
SAR measured	100 mW input power	2.19 W/kg
SAR for nominal Body TSL parameters	normalized to 1W	21.7 W/kg ± 19.5 % (k=2)

Body TSL parameters at 5300 MHz

The following parameters and calculations were applied.

	Temperature	Permittivity	Conductivity
Nominal Body TSL parameters	22.0 °C	48.9	5.42 mho/m
Measured Body TSL parameters	(22.0 ± 0.2) °C	47.0 ± 6 %	5.57 mho/m ± 6 %
Body TSL temperature change during test	< 0.5 °C	----	----

SAR result with Body TSL at 5300 MHz

SAR averaged over 1 cm ³ (1 g) of Body TSL	Condition	
SAR measured	100 mW input power	7.85 W/kg
SAR for nominal Body TSL parameters	normalized to 1W	77.9 W/kg ± 19.9 % (k=2)

SAR averaged over 10 cm ³ (10 g) of Body TSL	condition	
SAR measured	100 mW input power	2.20 W/kg
SAR for nominal Body TSL parameters	normalized to 1W	21.8 W/kg ± 19.5 % (k=2)

Body TSL parameters at 5600 MHz

The following parameters and calculations were applied.

	Temperature	Permittivity	Conductivity
Nominal Body TSL parameters	22.0 °C	48.5	5.77 mho/m
Measured Body TSL parameters	(22.0 ± 0.2) °C	46.4 ± 6 %	5.96 mho/m ± 6 %
Body TSL temperature change during test	< 0.5 °C	----	----

SAR result with Body TSL at 5600 MHz

SAR averaged over 1 cm ³ (1 g) of Body TSL	Condition	
SAR measured	100 mW input power	8.02 W/kg
SAR for nominal Body TSL parameters	normalized to 1W	79.6 W/kg ± 19.9 % (k=2)

SAR averaged over 10 cm ³ (10 g) of Body TSL	condition	
SAR measured	100 mW input power	2.25 W/kg
SAR for nominal Body TSL parameters	normalized to 1W	22.3 W/kg ± 19.5 % (k=2)

Body TSL parameters at 5800 MHz

The following parameters and calculations were applied.

	Temperature	Permittivity	Conductivity
Nominal Body TSL parameters	22.0 °C	48.2	6.00 mho/m
Measured Body TSL parameters	(22.0 ± 0.2) °C	46.0 ± 6 %	6.25 mho/m ± 6 %
Body TSL temperature change during test	< 0.5 °C	----	----

SAR result with Body TSL at 5800 MHz

SAR averaged over 1 cm ³ (1 g) of Body TSL	Condition	
SAR measured	100 mW input power	7.79 W/kg
SAR for nominal Body TSL parameters	normalized to 1W	77.3 W/kg ± 19.9 % (k=2)

SAR averaged over 10 cm ³ (10 g) of Body TSL	condition	
SAR measured	100 mW input power	2.16 W/kg
SAR for nominal Body TSL parameters	normalized to 1W	21.4 W/kg ± 19.5 % (k=2)

Appendix (Additional assessments outside the scope of SCS 0108)

Antenna Parameters with Head TSL at 5200 MHz

Impedance, transformed to feed point	52.3 Ω - 9.9 j Ω
Return Loss	- 20.1 dB

Antenna Parameters with Head TSL at 5250 MHz

Impedance, transformed to feed point	52.9 Ω - 5.6 j Ω
Return Loss	- 24.2 dB

Antenna Parameters with Head TSL at 5300 MHz

Impedance, transformed to feed point	52.2 Ω - 1.2 j Ω
Return Loss	- 32.2 dB

Antenna Parameters with Head TSL at 5600 MHz

Impedance, transformed to feed point	57.8 Ω - 2.0 j Ω
Return Loss	- 22.5 dB

Antenna Parameters with Head TSL at 5800 MHz

Impedance, transformed to feed point	55.7 Ω + 1.7 j Ω
Return Loss	- 25.0 dB

Antenna Parameters with Body TSL at 5200 MHz

Impedance, transformed to feed point	54.1 Ω - 7.4 j Ω
Return Loss	- 21.8 dB

Antenna Parameters with Body TSL at 5250 MHz

Impedance, transformed to feed point	53.2 Ω - 3.9 j Ω
Return Loss	- 26.2 dB

Antenna Parameters with Body TSL at 5300 MHz

Impedance, transformed to feed point	53.1 Ω + 0.2 j Ω
Return Loss	- 30.5 dB

Antenna Parameters with Body TSL at 5600 MHz

Impedance, transformed to feed point	58.3 Ω - 0.1 j Ω
Return Loss	- 22.3 dB

Antenna Parameters with Body TSL at 5800 MHz

Impedance, transformed to feed point	55.5 Ω + 3.8 j Ω
Return Loss	- 24.0 dB

General Antenna Parameters and Design

Electrical Delay (one direction)	1.204 ns
----------------------------------	----------

After long term use with 100W radiated power, only a slight warming of the dipole near the feedpoint can be measured.

The dipole is made of standard semirigid coaxial cable. The center conductor of the feeding line is directly connected to the second arm of the dipole. The antenna is therefore short-circuited for DC-signals. On some of the dipoles, small end caps are added to the dipole arms in order to improve matching when loaded according to the position as explained in the "Measurement Conditions" paragraph. The SAR data are not affected by this change. The overall dipole length is still according to the Standard.

No excessive force must be applied to the dipole arms, because they might bend or the soldered connections near the feedpoint may be damaged.

Additional EUT Data

Manufactured by	SPEAG
Manufactured on	February 05, 2004

DASY5 Validation Report for Head TSL

Date: 22.08.2016

Test Laboratory: SPEAG, Zurich, Switzerland

DUT: Dipole D5GHzV2; Type: D5GHzV2; Serial: D5GHzV2 - SN:1019

Communication System: UID 0 - CW; Frequency: 5200 MHz, Frequency: 5250 MHz, Frequency: 5300 MHz, Frequency: 5600 MHz, Frequency: 5800 MHz

Medium parameters used: $f = 5200$ MHz; $\sigma = 4.52$ S/m; $\epsilon_r = 34.5$; $\rho = 1000$ kg/m³, Medium parameters used: $f = 5250$ MHz; $\sigma = 4.57$ S/m; $\epsilon_r = 34.4$; $\rho = 1000$ kg/m³, Medium parameters used: $f = 5300$ MHz; $\sigma = 4.62$ S/m; $\epsilon_r = 34.4$; $\rho = 1000$ kg/m³, Medium parameters used: $f = 5600$ MHz; $\sigma = 4.91$ S/m; $\epsilon_r = 34$; $\rho = 1000$ kg/m³, Medium parameters used: $f = 5800$ MHz; $\sigma = 5.11$ S/m; $\epsilon_r = 33.7$; $\rho = 1000$ kg/m³

Phantom section: Flat Section

Measurement Standard: DASY5 (IEEE/IEC/ANSI C63.19-2011)

DASY52 Configuration:

- Probe: EX3DV4 - SN3503; ConvF(5.59, 5.59, 5.59); Calibrated: 30.06.2016, ConvF(5.42, 5.42, 5.42); Calibrated: 30.06.2016, ConvF(5.14, 5.14, 5.14); Calibrated: 30.06.2016, ConvF(4.89, 4.89, 4.89); Calibrated: 30.06.2016, ConvF(4.85, 4.85, 4.85); Calibrated: 30.06.2016;
- Sensor-Surface: 1.4mm (Mechanical Surface Detection)
- Electronics: DAE4 Sn601; Calibrated: 30.12.2015
- Phantom: Flat Phantom 5.0 (front); Type: QD000P50AA; Serial: 1001
- DASY52 52.8.8(1258); SEMCAD X 14.6.10(7372)

Dipole Calibration for Head Tissue/Pin=100mW, dist=10mm, f=5200 MHz/Zoom Scan,

dist=1.4mm (8x8x7)/Cube 0: Measurement grid: dx=4mm, dy=4mm, dz=1.4mm

Reference Value = 67.34 V/m; Power Drift = 0.06 dB

Peak SAR (extrapolated) = 28.1 W/kg

SAR(1 g) = 7.87 W/kg; SAR(10 g) = 2.25 W/kg

Maximum value of SAR (measured) = 17.6 W/kg

Dipole Calibration for Head Tissue/Pin=100mW, dist=10mm, f=5250 MHz/Zoom Scan,

dist=1.4mm (8x8x7)/Cube 0: Measurement grid: dx=4mm, dy=4mm, dz=1.4mm

Reference Value = 68.23 V/m; Power Drift = 0.03 dB

Peak SAR (extrapolated) = 29.2 W/kg

SAR(1 g) = 8.04 W/kg; SAR(10 g) = 2.3 W/kg

Maximum value of SAR (measured) = 18.2 W/kg

Dipole Calibration for Head Tissue/Pin=100mW, dist=10mm, f=5300 MHz/Zoom Scan,

dist=1.4mm (8x8x7)/Cube 0: Measurement grid: dx=4mm, dy=4mm, dz=1.4mm

Reference Value = 69.27 V/m; Power Drift = 0.01 dB

Peak SAR (extrapolated) = 31.6 W/kg

SAR(1 g) = 8.44 W/kg; SAR(10 g) = 2.41 W/kg

Maximum value of SAR (measured) = 19.3 W/kg

Dipole Calibration for Head Tissue/Pin=100mW, dist=10mm, f=5600 MHz/Zoom Scan, dist=1.4mm (8x8x7)/Cube 0: Measurement grid: dx=4mm, dy=4mm, dz=1.4mm
Reference Value = 68.63 V/m; Power Drift = 0.03 dB
Peak SAR (extrapolated) = 32.7 W/kg
SAR(1 g) = 8.33 W/kg; SAR(10 g) = 2.38 W/kg
Maximum value of SAR (measured) = 19.4 W/kg

Dipole Calibration for Head Tissue/Pin=100mW, dist=10mm, f=5800 MHz/Zoom Scan, dist=1.4mm (8x8x7)/Cube 0: Measurement grid: dx=4mm, dy=4mm, dz=1.4mm
Reference Value = 66.11 V/m; Power Drift = -0.03 dB
Peak SAR (extrapolated) = 33.1 W/kg
SAR(1 g) = 8.03 W/kg; SAR(10 g) = 2.28 W/kg
Maximum value of SAR (measured) = 19.2 W/kg

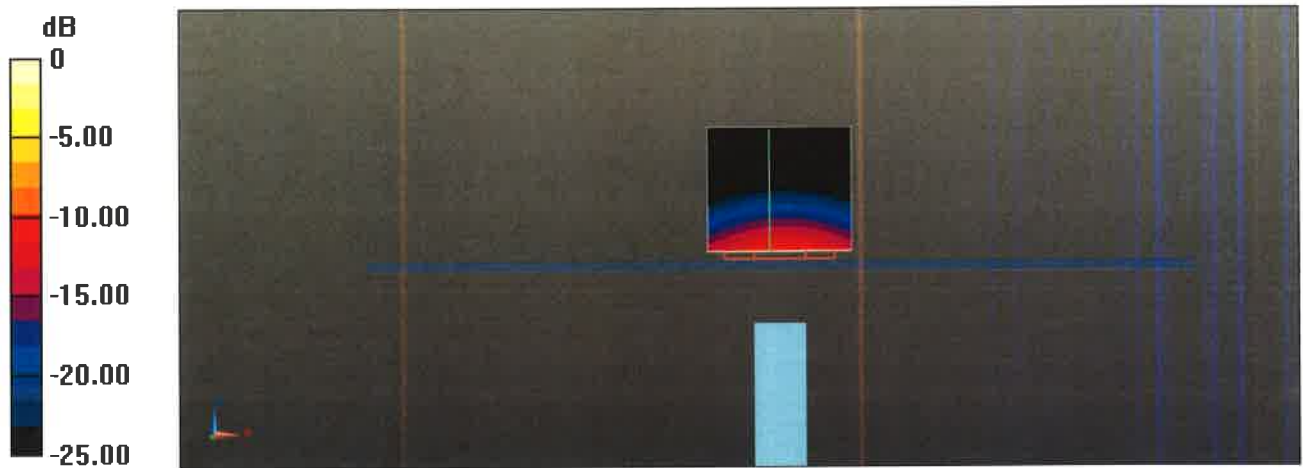

0 dB = 17.6 W/kg = 12.46 dBW/kg

Impedance Measurement Plot for Head TSL

22 Aug 2016 16:45:52

CH1 S11 1 U FS 1: 52.256 Ω -9.8965 Ω 3.0927 pF 5 200.000 000 MHz

*
De1
Cor
Avg
16
H1d

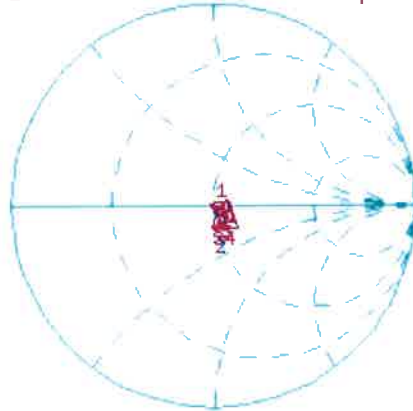

CH1 Markers
2: 52.869 Ω
-5.6309 Ω
5.25000 GHz
3: 52.188 Ω
-1.2441 Ω
5.30000 GHz
4: 57.813 Ω
-1.9902 Ω
5.60000 GHz
5: 55.680 Ω
1.6934 Ω
5.80000 GHz

CH2 S11 LOG 5 dB/REF -20 dB 1:-20.103 dB 5 200.000 000 MHz

Cor
Avg
16
H1d

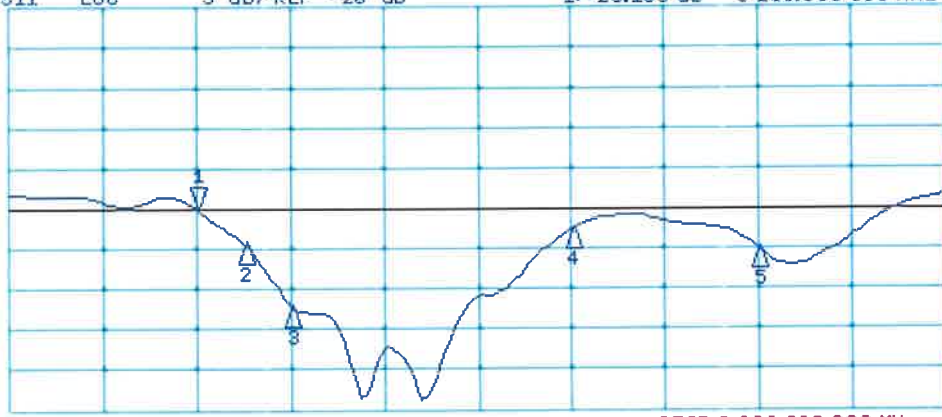

CH2 Markers
2:-24.243 dB
5.25000 GHz
3:-32.207 dB
5.30000 GHz
4:-22.528 dB
5.60000 GHz
5:-25.022 dB
5.80000 GHz

DASY5 Validation Report for Body TSL

Date: 23.08.2016

Test Laboratory: SPEAG, Zurich, Switzerland

DUT: Dipole D5GHzV2; Type: D5GHzV2; Serial: D5GHzV2 - SN:1019

Communication System: UID 0 - CW; Frequency: 5200 MHz, Frequency: 5250 MHz, Frequency: 5300 MHz, Frequency: 5600 MHz, Frequency: 5800 MHz

Medium parameters used: $f = 5200$ MHz; $\sigma = 5.43$ S/m; $\epsilon_r = 47.1$; $\rho = 1000$ kg/m³, Medium parameters used: $f = 5250$ MHz; $\sigma = 5.5$ S/m; $\epsilon_r = 47$; $\rho = 1000$ kg/m³, Medium parameters used: $f = 5300$ MHz; $\sigma = 5.57$ S/m; $\epsilon_r = 47$; $\rho = 1000$ kg/m³, Medium parameters used: $f = 5600$ MHz; $\sigma = 5.96$ S/m; $\epsilon_r = 46.4$; $\rho = 1000$ kg/m³, Medium parameters used: $f = 5800$ MHz; $\sigma = 6.25$ S/m; $\epsilon_r = 46$; $\rho = 1000$ kg/m³

Phantom section: Flat Section

Measurement Standard: DASY5 (IEEE/IEC/ANSI C63.19-2011)

DASY52 Configuration:

- Probe: EX3DV4 - SN3503; ConvF(4.99, 4.99, 4.99); Calibrated: 31.12.2015, ConvF(4.85, 4.85, 4.85); Calibrated: 31.12.2015, ConvF(4.75, 4.75, 4.75); Calibrated: 31.12.2015, ConvF(4.35, 4.35, 4.35); Calibrated: 31.12.2015, ConvF(4.27, 4.27, 4.27); Calibrated: 31.12.2015;
- Sensor-Surface: 1.4mm (Mechanical Surface Detection)
- Electronics: DAE4 Sn601; Calibrated: 30.12.2015
- Phantom: Flat Phantom 5.0 (back); Type: QD000P50AA; Serial: 1002
- DASY52 52.8.8(1258); SEMCAD X 14.6.10(7372)

Dipole Calibration for Body Tissue/Pin=100mW, dist=10mm, f=5200MHz/Zoom Scan, dist=1.4mm (8x8x7)/Cube 0: Measurement grid: dx=4mm, dy=4mm, dz=1.4mm

Reference Value = 67.96 V/m; Power Drift = -0.06 dB

Peak SAR (extrapolated) = 28.4 W/kg

SAR(1 g) = 7.59 W/kg; SAR(10 g) = 2.13 W/kg

Maximum value of SAR (measured) = 17.2 W/kg

Dipole Calibration for Body Tissue/Pin=100mW, dist=10mm, f=5250 MHz/Zoom Scan, dist=1.4mm (8x8x7)/Cube 0: Measurement grid: dx=4mm, dy=4mm, dz=1.4mm

Reference Value = 68.27 V/m; Power Drift = -0.02 dB

Peak SAR (extrapolated) = 29.6 W/kg

SAR(1 g) = 7.82 W/kg; SAR(10 g) = 2.19 W/kg

Maximum value of SAR (measured) = 17.8 W/kg

Dipole Calibration for Body Tissue/Pin=100mW, dist=10mm, f=5300 MHz/Zoom Scan, dist=1.4mm (8x8x7)/Cube 0: Measurement grid: dx=4mm, dy=4mm, dz=1.4mm

Reference Value = 68.45 V/m; Power Drift = -0.05 dB

Peak SAR (extrapolated) = 30.1 W/kg

SAR(1 g) = 7.85 W/kg; SAR(10 g) = 2.2 W/kg

Maximum value of SAR (measured) = 18.1 W/kg

Dipole Calibration for Body Tissue/Pin=100mW, dist=10mm, f=5600 MHz/Zoom Scan, dist=1.4mm (8x8x7)/Cube 0: Measurement grid: dx=4mm, dy=4mm, dz=1.4mm
Reference Value = 67.90 V/m; Power Drift = -0.04 dB
Peak SAR (extrapolated) = 33.0 W/kg
SAR(1 g) = 8.02 W/kg; SAR(10 g) = 2.25 W/kg
Maximum value of SAR (measured) = 18.9 W/kg

Dipole Calibration for Body Tissue/Pin=100mW, dist=10mm, f=5800 MHz/Zoom Scan, dist=1.4mm (8x8x7)/Cube 0: Measurement grid: dx=4mm, dy=4mm, dz=1.4mm
Reference Value = 65.71 V/m; Power Drift = -0.03 dB
Peak SAR (extrapolated) = 34.2 W/kg
SAR(1 g) = 7.79 W/kg; SAR(10 g) = 2.16 W/kg



0 dB = 17.2 W/kg = 12.36 dBW/kg

Impedance Measurement Plot for Body TSL

23 Aug 2016 13:49:09

CH1 S11 1 U FS 1: 54.064 Ω -7.4160 Ω 4.1271 pF 5 200.000 000 MHz

*
De1
CA
Avg
16
H1d

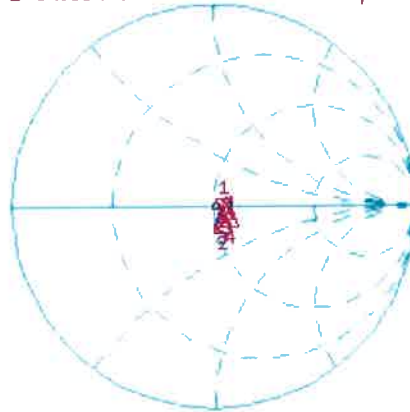

CH1 Markers
2: 53.195 Ω
-3.9160 Ω
5.25000 GHz
3: 53.080 Ω
0.1504 Ω
5.30000 GHz
4: 58.291 Ω
-93.750 m Ω
5.60000 GHz
5: 55.496 Ω
3.7637 Ω
5.80000 GHz

CH2 S11 LOG 5 dB/REF -20 dB 1:-21.826 dB 5 200.000 000 MHz

CA
Avg
16
H1d



CH2 Markers
2:-26.203 dB
5.25000 GHz
3:-30.480 dB
5.30000 GHz
4:-22.317 dB
5.60000 GHz
5:-24.002 dB
5.80000 GHz

START 5 000.000 000 MHz

STOP 6 000.000 000 MHz



Accredited by the Swiss Accreditation Service (SAS)
The Swiss Accreditation Service is one of the signatories to the EA
Multilateral Agreement for the recognition of calibration certificates

Accreditation No.: **SCS 0108**

Client **BV ADT (Auden)**

Certificate No: **EX3-3650_Jul16**

CALIBRATION CERTIFICATE

Object **EX3DV4 - SN:3650**

Calibration procedure(s) **QA CAL-01.v9, QA CAL-14.v4, QA CAL-23.v5, QA CAL-25.v6
Calibration procedure for dosimetric E-field probes**

Calibration date: **July 25, 2016**

This calibration certificate documents the traceability to national standards, which realize the physical units of measurements (SI).
The measurements and the uncertainties with confidence probability are given on the following pages and are part of the certificate.

All calibrations have been conducted in the closed laboratory facility: environment temperature (22 ± 3)°C and humidity < 70%.

Calibration Equipment used (M&TE critical for calibration)

Primary Standards	ID	Cal Date (Certificate No.)	Scheduled Calibration
Power meter NRP	SN: 104778	06-Apr-16 (No. 217-02288/02289)	Apr-17
Power sensor NRP-Z91	SN: 103244	06-Apr-16 (No. 217-02288)	Apr-17
Power sensor NRP-Z91	SN: 103245	06-Apr-16 (No. 217-02289)	Apr-17
Reference 20 dB Attenuator	SN: S5277 (20x)	05-Apr-16 (No. 217-02293)	Apr-17
Reference Probe ES3DV2	SN: 3013	31-Dec-15 (No. ES3-3013_Dec15)	Dec-16
DAE4	SN: 660	23-Dec-15 (No. DAE4-660_Dec15)	Dec-16
Secondary Standards	ID	Check Date (in house)	Scheduled Check
Power meter E4419B	SN: GB41293874	06-Apr-16 (in house check Jun-16)	In house check: Jun-18
Power sensor E4412A	SN: MY41498087	06-Apr-16 (in house check Jun-16)	In house check: Jun-18
Power sensor E4412A	SN: 000110210	06-Apr-16 (in house check Jun-16)	In house check: Jun-18
RF generator HP 8648C	SN: US3642U01700	04-Aug-99 (in house check Jun-16)	In house check: Jun-18
Network Analyzer HP 8753E	SN: US37390585	18-Oct-01 (in house check Oct-15)	In house check: Oct-16

	Name	Function	Signature
Calibrated by:	Michael Weber	Laboratory Technician	
Approved by:	Katja Pokovic	Technical Manager	
			Issued: July 27, 2016

This calibration certificate shall not be reproduced except in full without written approval of the laboratory.



Accredited by the Swiss Accreditation Service (SAS)

Accreditation No.: **SCS 0108**

The Swiss Accreditation Service is one of the signatories to the EA
Multilateral Agreement for the recognition of calibration certificates

Glossary:

TSL	tissue simulating liquid
NORM _{x,y,z}	sensitivity in free space
ConvF	sensitivity in TSL / NORM _{x,y,z}
DCP	diode compression point
CF	crest factor (1/duty_cycle) of the RF signal
A, B, C, D	modulation dependent linearization parameters
Polarization φ	φ rotation around probe axis
Polarization ϑ	ϑ rotation around an axis that is in the plane normal to probe axis (at measurement center), i.e., $\vartheta = 0$ is normal to probe axis
Connector Angle	information used in DASY system to align probe sensor X to the robot coordinate system

Calibration is Performed According to the Following Standards:

- IEEE Std 1528-2013, "IEEE Recommended Practice for Determining the Peak Spatial-Averaged Specific Absorption Rate (SAR) in the Human Head from Wireless Communications Devices: Measurement Techniques", June 2013
- IEC 62209-1, "Procedure to measure the Specific Absorption Rate (SAR) for hand-held devices used in close proximity to the ear (frequency range of 300 MHz to 3 GHz)", February 2005
- IEC 62209-2, "Procedure to determine the Specific Absorption Rate (SAR) for wireless communication devices used in close proximity to the human body (frequency range of 30 MHz to 6 GHz)", March 2010
- KDB 865664, "SAR Measurement Requirements for 100 MHz to 6 GHz"

Methods Applied and Interpretation of Parameters:

- NORM_{x,y,z}**: Assessed for E-field polarization $\vartheta = 0$ ($f \leq 900$ MHz in TEM-cell; $f > 1800$ MHz: R22 waveguide). NORM_{x,y,z} are only intermediate values, i.e., the uncertainties of NORM_{x,y,z} does not affect the E²-field uncertainty inside TSL (see below ConvF).
- NORM(f)_{x,y,z}** = NORM_{x,y,z} * frequency_response (see Frequency Response Chart). This linearization is implemented in DASY4 software versions later than 4.2. The uncertainty of the frequency response is included in the stated uncertainty of ConvF.
- DCP_{x,y,z}**: DCP are numerical linearization parameters assessed based on the data of power sweep with CW signal (no uncertainty required). DCP does not depend on frequency nor media.
- PAR**: PAR is the Peak to Average Ratio that is not calibrated but determined based on the signal characteristics
- A_{x,y,z}; B_{x,y,z}; C_{x,y,z}; D_{x,y,z}; VR_{x,y,z}**: A, B, C, D are numerical linearization parameters assessed based on the data of power sweep for specific modulation signal. The parameters do not depend on frequency nor media. VR is the maximum calibration range expressed in RMS voltage across the diode.
- ConvF and Boundary Effect Parameters**: Assessed in flat phantom using E-field (or Temperature Transfer Standard for $f \leq 800$ MHz) and inside waveguide using analytical field distributions based on power measurements for $f > 800$ MHz. The same setups are used for assessment of the parameters applied for boundary compensation (alpha, depth) of which typical uncertainty values are given. These parameters are used in DASY4 software to improve probe accuracy close to the boundary. The sensitivity in TSL corresponds to NORM_{x,y,z} * ConvF whereby the uncertainty corresponds to that given for ConvF. A frequency dependent ConvF is used in DASY version 4.4 and higher which allows extending the validity from ± 50 MHz to ± 100 MHz.
- Spherical isotropy (3D deviation from isotropy)**: in a field of low gradients realized using a flat phantom exposed by a patch antenna.
- Sensor Offset**: The sensor offset corresponds to the offset of virtual measurement center from the probe tip (on probe axis). No tolerance required.
- Connector Angle**: The angle is assessed using the information gained by determining the NORM_x (no uncertainty required).

Probe EX3DV4

SN:3650

Manufactured: March 18, 2008
Calibrated: July 25, 2016

Calibrated for DASY/EASY Systems
(Note: non-compatible with DASY2 system!)

DASY/EASY - Parameters of Probe: EX3DV4 - SN:3650

Basic Calibration Parameters

	Sensor X	Sensor Y	Sensor Z	Unc (k=2)
Norm ($\mu\text{V}/(\text{V}/\text{m})^2$) ^A	0.40	0.41	0.40	± 10.1 %
DCP (mV) ^B	100.2	97.0	98.5	

Modulation Calibration Parameters

UID	Communication System Name		A dB	B dB/ μV	C	D dB	VR mV	Unc ^E (k=2)
0	CW	X	0.0	0.0	1.0	0.00	130.7	±3.5 %
		Y	0.0	0.0	1.0		141.5	
		Z	0.0	0.0	1.0		129.4	

The reported uncertainty of measurement is stated as the standard uncertainty of measurement multiplied by the coverage factor k=2, which for a normal distribution corresponds to a coverage probability of approximately 95%.

^A The uncertainties of Norm X,Y,Z do not affect the E²-field uncertainty inside TSL (see Pages 5 and 6).

^B Numerical linearization parameter; uncertainty not required.

^E Uncertainty is determined using the max. deviation from linear response applying rectangular distribution and is expressed for the square of the field value.

DASY/EASY - Parameters of Probe: EX3DV4 - SN:3650

Calibration Parameter Determined in Head Tissue Simulating Media

f (MHz) ^C	Relative Permittivity ^F	Conductivity (S/m) ^F	ConvF X	ConvF Y	ConvF Z	Alpha ^G	Depth (mm) ^G	Unc (k=2)
750	41.9	0.89	10.29	10.29	10.29	0.60	0.85	± 12.0 %
835	41.5	0.90	10.01	10.01	10.01	0.55	0.85	± 12.0 %
900	41.5	0.97	9.90	9.90	9.90	0.50	0.90	± 12.0 %
1450	40.5	1.20	8.99	8.99	8.99	0.44	0.83	± 12.0 %
1640	40.3	1.29	8.73	8.73	8.73	0.34	0.88	± 12.0 %
1750	40.1	1.37	8.61	8.61	8.61	0.38	0.80	± 12.0 %
1900	40.0	1.40	8.29	8.29	8.29	0.33	0.80	± 12.0 %
2000	40.0	1.40	8.26	8.26	8.26	0.31	0.80	± 12.0 %
2300	39.5	1.67	8.02	8.02	8.02	0.31	0.80	± 12.0 %
2450	39.2	1.80	7.51	7.51	7.51	0.34	0.87	± 12.0 %
2600	39.0	1.96	7.32	7.32	7.32	0.35	0.85	± 12.0 %
3500	37.9	2.91	7.37	7.37	7.37	0.34	1.16	± 13.1 %
5200	36.0	4.66	5.65	5.65	5.65	0.35	1.80	± 13.1 %
5250	35.9	4.71	5.43	5.43	5.43	0.40	1.80	± 13.1 %
5300	35.9	4.76	5.31	5.31	5.31	0.40	1.80	± 13.1 %
5600	35.5	5.07	4.78	4.78	4.78	0.50	1.80	± 13.1 %
5800	35.3	5.27	4.84	4.84	4.84	0.50	1.80	± 13.1 %

^C Frequency validity above 300 MHz of ± 100 MHz only applies for DASY v4.4 and higher (see Page 2), else it is restricted to ± 50 MHz. The uncertainty is the RSS of the ConvF uncertainty at calibration frequency and the uncertainty for the indicated frequency band. Frequency validity below 300 MHz is ± 10, 25, 40, 50 and 70 MHz for ConvF assessments at 30, 64, 128, 150 and 220 MHz respectively. Above 5 GHz frequency validity can be extended to ± 110 MHz.

^F At frequencies below 3 GHz, the validity of tissue parameters (ϵ and σ) can be relaxed to ± 10% if liquid compensation formula is applied to measured SAR values. At frequencies above 3 GHz, the validity of tissue parameters (ϵ and σ) is restricted to ± 5%. The uncertainty is the RSS of the ConvF uncertainty for indicated target tissue parameters.

^G Alpha/Depth are determined during calibration. SPEAG warrants that the remaining deviation due to the boundary effect after compensation is always less than ± 1% for frequencies below 3 GHz and below ± 2% for frequencies between 3-6 GHz at any distance larger than half the probe tip diameter from the boundary.

DASY/EASY - Parameters of Probe: EX3DV4 - SN:3650

Calibration Parameter Determined in Body Tissue Simulating Media

f (MHz) ^C	Relative Permittivity ^F	Conductivity (S/m) ^F	ConvF X	ConvF Y	ConvF Z	Alpha ^G	Depth (mm) ^G	Unc (k=2)
750	55.5	0.96	9.61	9.61	9.61	0.47	0.88	± 12.0 %
835	55.2	0.97	9.73	9.73	9.73	0.35	0.92	± 12.0 %
900	55.0	1.05	9.49	9.49	9.49	0.48	0.80	± 12.0 %
1450	54.0	1.30	8.58	8.58	8.58	0.33	0.80	± 12.0 %
1640	53.8	1.40	8.59	8.59	8.59	0.47	0.80	± 12.0 %
1750	53.4	1.49	8.15	8.15	8.15	0.40	0.87	± 12.0 %
1900	53.3	1.52	7.89	7.89	7.89	0.33	1.01	± 12.0 %
2000	53.3	1.52	8.11	8.11	8.11	0.24	1.07	± 12.0 %
2300	52.9	1.81	7.73	7.73	7.73	0.46	0.80	± 12.0 %
2450	52.7	1.95	7.36	7.36	7.36	0.44	0.80	± 12.0 %
2600	52.5	2.16	7.14	7.14	7.14	0.38	0.80	± 12.0 %
3500	51.3	3.31	6.99	6.99	6.99	0.35	1.29	± 13.1 %
5200	49.0	5.30	4.94	4.94	4.94	0.50	1.90	± 13.1 %
5250	48.9	5.36	4.90	4.90	4.90	0.50	1.90	± 13.1 %
5300	48.9	5.42	4.75	4.75	4.75	0.50	1.90	± 13.1 %
5600	48.5	5.77	4.01	4.01	4.01	0.60	1.90	± 13.1 %
5800	48.2	6.00	4.36	4.36	4.36	0.60	1.90	± 13.1 %

^C Frequency validity above 300 MHz of ± 100 MHz only applies for DASY v4.4 and higher (see Page 2), else it is restricted to ± 50 MHz. The uncertainty is the RSS of the ConvF uncertainty at calibration frequency and the uncertainty for the indicated frequency band. Frequency validity below 300 MHz is ± 10, 25, 40, 50 and 70 MHz for ConvF assessments at 30, 64, 128, 150 and 220 MHz respectively. Above 5 GHz frequency validity can be extended to ± 110 MHz.

^F At frequencies below 3 GHz, the validity of tissue parameters (ϵ and σ) can be relaxed to ± 10% if liquid compensation formula is applied to measured SAR values. At frequencies above 3 GHz, the validity of tissue parameters (ϵ and σ) is restricted to ± 5%. The uncertainty is the RSS of the ConvF uncertainty for indicated target tissue parameters.

^G Alpha/Depth are determined during calibration. SPEAG warrants that the remaining deviation due to the boundary effect after compensation is always less than ± 1% for frequencies below 3 GHz and below ± 2% for frequencies between 3-6 GHz at any distance larger than half the probe tip diameter from the boundary.

Frequency Response of E-Field (TEM-Cell:ifi110 EXX, Waveguide: R22)

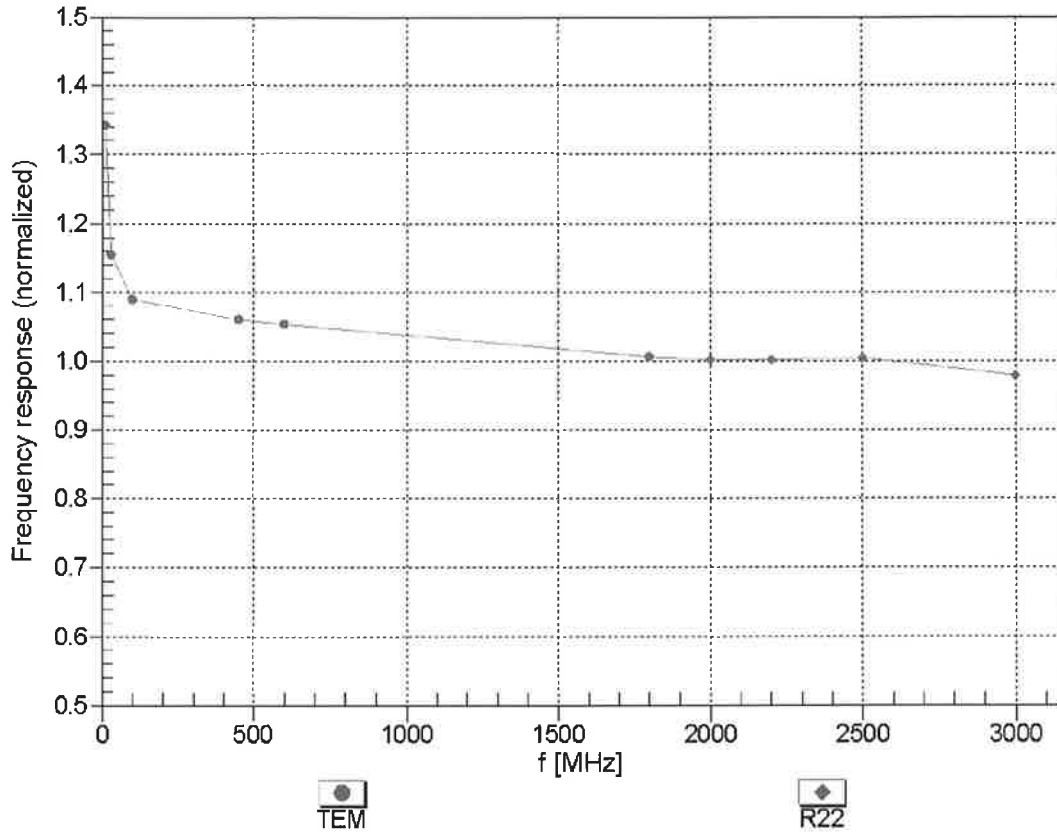

Uncertainty of Frequency Response of E-field: $\pm 6.3\%$ (k=2)

Receiving Pattern (ϕ), $\theta = 0^\circ$

f=600 MHz,TEM

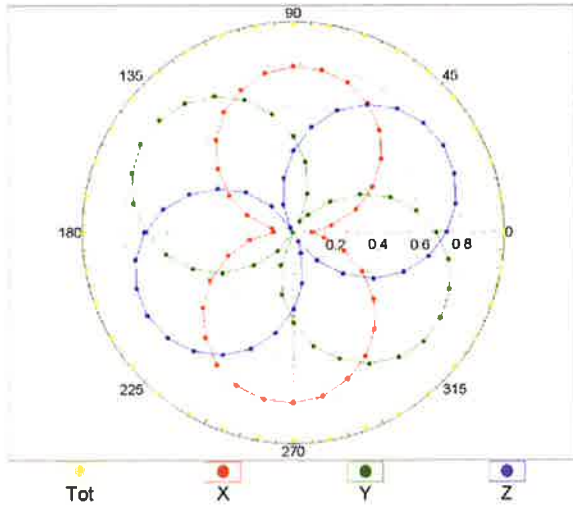

f=1800 MHz,R22

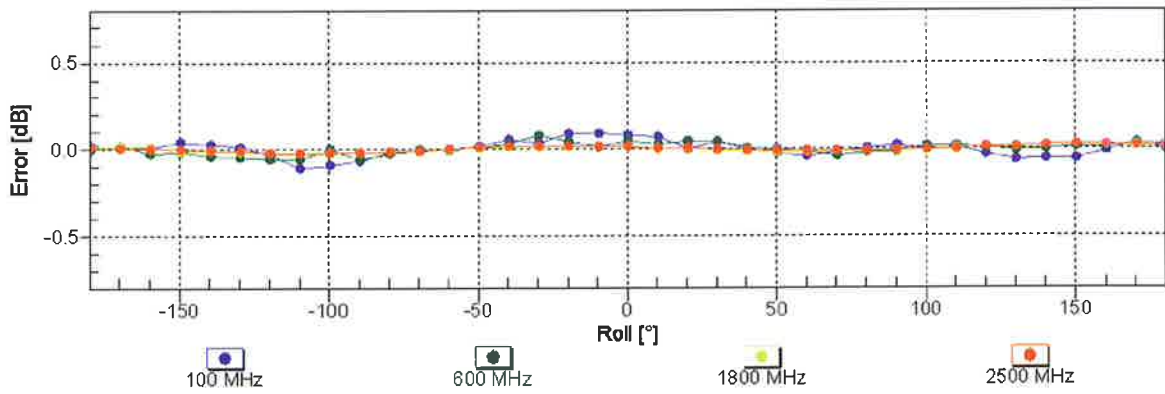
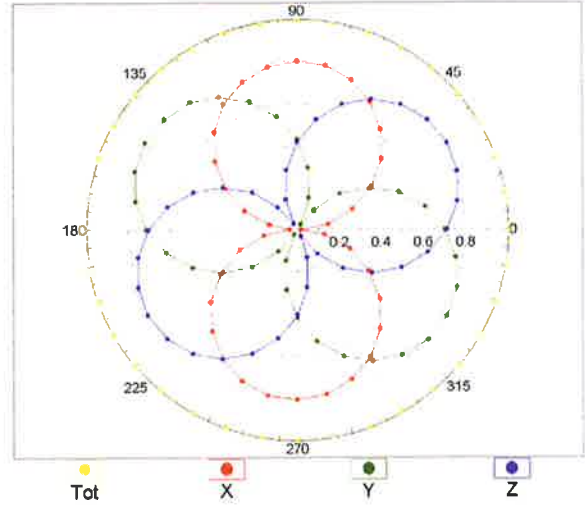

Uncertainty of Axial Isotropy Assessment: $\pm 0.5\%$ (k=2)

Dynamic Range $f(SAR_{head})$ (TEM cell , $f_{eval}= 1900$ MHz)

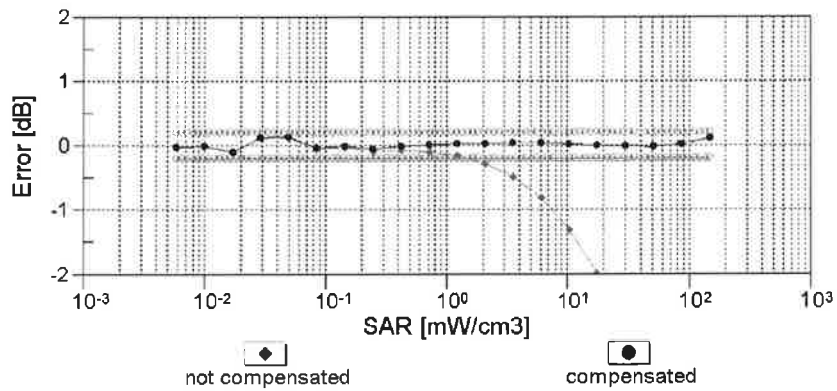
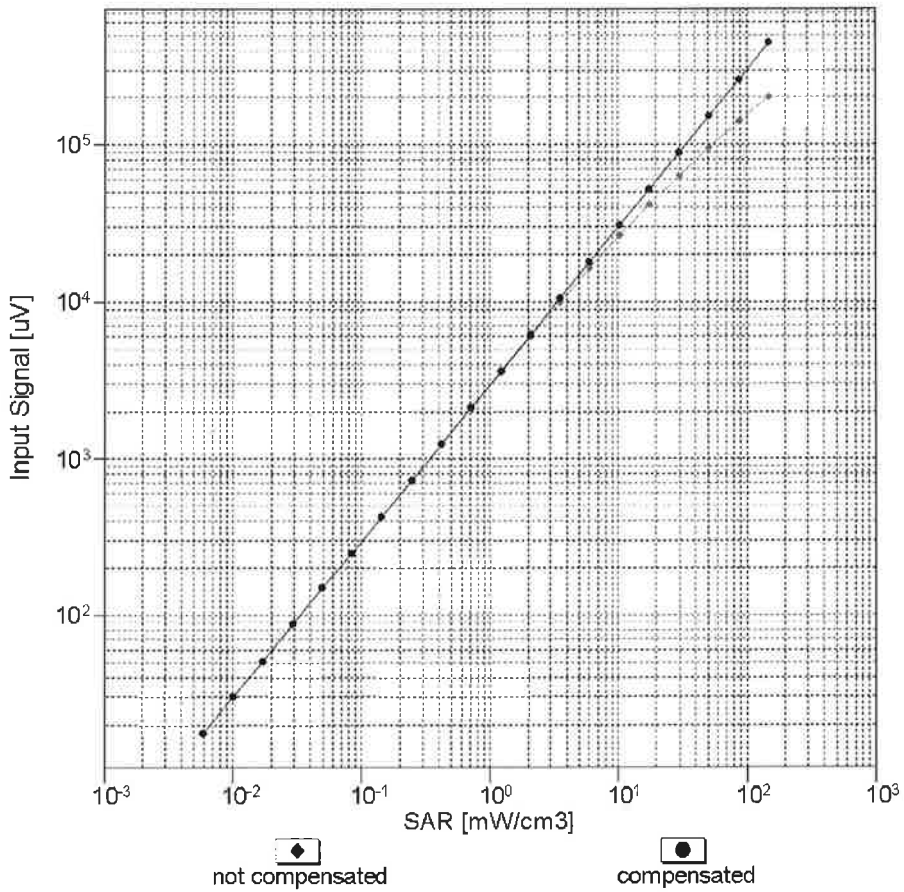

Uncertainty of Linearity Assessment: $\pm 0.6\%$ (k=2)

Conversion Factor Assessment

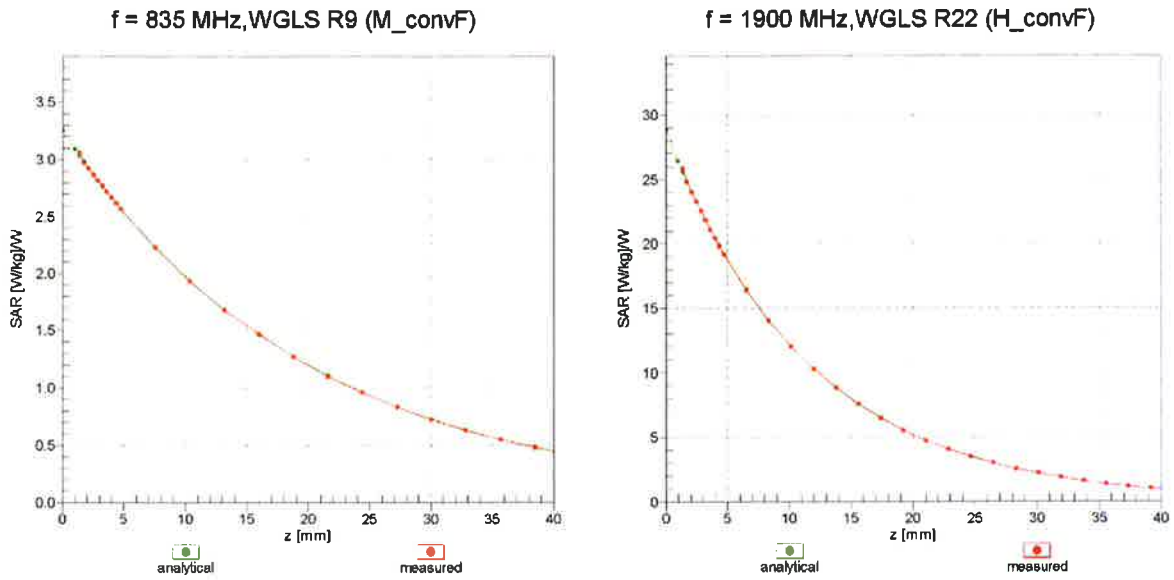

Deviation from Isotropy in Liquid Error (ϕ, θ), f = 900 MHz

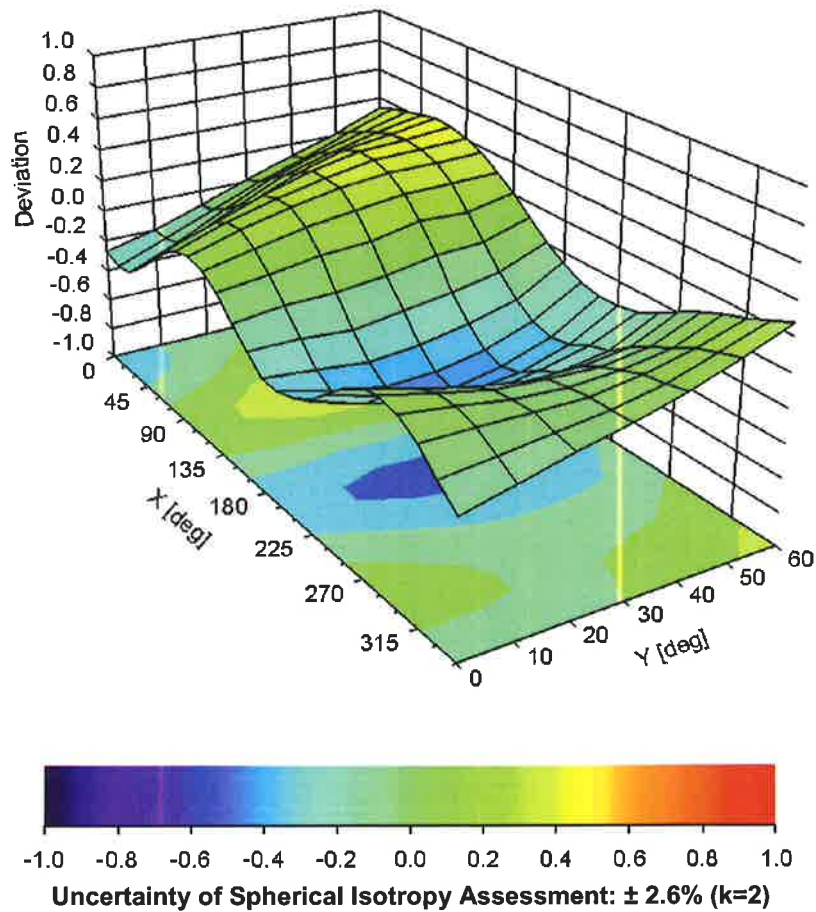

DASY/EASY - Parameters of Probe: EX3DV4 - SN:3650**Other Probe Parameters**

Sensor Arrangement	Triangular
Connector Angle (°)	-19.6
Mechanical Surface Detection Mode	enabled
Optical Surface Detection Mode	disabled
Probe Overall Length	337 mm
Probe Body Diameter	10 mm
Tip Length	9 mm
Tip Diameter	2.5 mm
Probe Tip to Sensor X Calibration Point	1 mm
Probe Tip to Sensor Y Calibration Point	1 mm
Probe Tip to Sensor Z Calibration Point	1 mm
Recommended Measurement Distance from Surface	1.4 mm