



# FCC RF Test Report

**FCC ID** : UZ7TC15BK  
**Equipment** : Touch computer  
**Brand Name** : Zebra  
**Model Name** : TC15BK  
**Applicant** : Zebra Technologies Corporation  
1 Zebra Plaza, Holtsville, NY 11742  
**Manufacturer** : Zebra Technologies Corporation  
1 Zebra Plaza, Holtsville, NY 11742  
**STANDARD** : 47 CFR Part 2, 270  
**Classification** : PCS Licensed Transmitter Held to Ear (PCE)  
**Test Date(s)** : Feb. 21, 2022 ~ Feb. 23, 2022

We, Sporton International Inc. (Kunshan), would like to declare that the tested sample has been evaluated in accordance with the procedures given in ANSI C63.26-2015 and shown compliance with the applicable technical standards.

This report contains data that were produced under subcontract by Sporton International Inc. (Shenzhen).

The test results in this report apply exclusively to the tested model / sample. Without written approval of Sporton International Inc. (Kunshan), the test report shall not be reproduced except in full.

Reviewed by: Jason Jia / Supervisor

Approved by: Alex Wang / Manager



**Sporton International Inc. (Kunshan)**

**No. 1098, Pengxi North Road, Kunshan Economic Development Zone Jiangsu Province 215300  
People's Republic of China**



## TABLE OF CONTENTS

REVISION HISTORY .....	3
SUMMARY OF TEST RESULT .....	4
<b>1 GENERAL DESCRIPTION .....</b>	<b>5</b>
1.1 Product Feature of Equipment Under Test.....	5
1.2 Product Specification of Equipment Under Test.....	6
1.3 Modification of EUT .....	6
1.4 Maximum EIRP Power and Emission Designator .....	7
1.5 Testing Location .....	8
1.6 Test Software.....	8
1.7 Applicable Standards.....	9
<b>2 TEST CONFIGURATION OF EQUIPMENT UNDER TEST .....</b>	<b>10</b>
2.1 Test Mode.....	10
2.2 Connection Diagram of Test System.....	11
2.3 Support Unit used in test configuration and system.....	11
2.4 Measurement Results Explanation Example.....	11
2.5 Frequency List of Low/Middle/High Channels .....	12
<b>3 CONDUCTED TEST ITEMS .....</b>	<b>13</b>
3.1 Measuring Instruments .....	13
3.2 Test Setup .....	13
3.3 Test Result of Conducted Test .....	13
3.4 Conducted Output Power and EIRP .....	14
3.5 Peak-to-Average Ratio .....	15
3.6 Occupied Bandwidth.....	16
3.7 Conducted Band Edge .....	17
3.8 Conducted Spurious Emission .....	18
3.9 Frequency Stability .....	19
<b>4 RADIATED TEST ITEMS .....</b>	<b>20</b>
4.1 Measuring Instruments .....	20
4.2 Test Setup .....	20
4.3 Test Result of Radiated Test .....	21
4.4 Radiated Spurious Emission .....	22
<b>5 LIST OF MEASURING EQUIPMENT .....</b>	<b>23</b>
<b>6 UNCERTAINTY OF EVALUATION .....</b>	<b>24</b>
<b>APPENDIX A. TEST RESULTS OF CONDUCTED TEST</b>	
<b>APPENDIX B. TEST RESULTS OF AND RADIATED TEST</b>	
<b>APPENDIX C. TEST SETUP PHOTOGRAPHS</b>	





## SUMMARY OF TEST RESULT

Report Section	FCC Rule	Description	Limit	Result	Remark
3.4	§2.1046	Conducted Output Power	-	Reporting Only	-
	§27.50(j)(3)	Equivalent Isotropic Radiated Power	EIRP < 1Watt		
3.5	§27.50(j)(4)	Peak-to-Average Ratio	<13 dB	PASS	-
3.6	§2.1049	Occupied Bandwidth	-	Reporting Only	-
3.7	§2.1051 §27.53(l)(2)	Conducted Band Edge Measurement	< 43+10log <sub>10</sub> (P[Watts])	PASS	-
3.8	§2.1051 §27.53(l)(2)	Conducted Spurious Emission	< 43+10log <sub>10</sub> (P[Watts])	PASS	-
3.9	§2.1055 §27.54	Frequency Stability Temperature & Voltage	Within Authorized Band	PASS	-
4.4	§2.1053 §27.53(l)(2)	Radiated Spurious Emission	< 43+10log <sub>10</sub> (P[Watts])	PASS	Under limit 46.37 dB at 15540.000 MHz

### Declaration of Conformity:

The test results with all measurement uncertainty excluded are presented in accordance with the regulation limits or requirements declared by manufacturers.

### Comments and Explanations:

The declared of product specification for EUT presented in the report are provided by the manufacturer, and the manufacturer takes all the responsibilities for the accuracy of product specification.



# 1 General Description

## 1.1 Product Feature of Equipment Under Test

Product Feature	
Equipment	Touch computer
Brand Name	Zebra
Model Name	TC15BK
FCC ID	UZ7TC15BK
Sample 1	Scanner(SE4710)
Sample 2	Scanner(SE4100)
HW Version	EV2.4
SW Version	Groot-userdebug11 11-06-29.00-RG-U000-PRD-GRT FX3
MFD	26JAN22
EUT Stage	Identical Prototype

Remark: The above EUT's information was declared by manufacturer.

Specification of Accessory				
AC Adapter	Brand Name	Zebra	Part Number	PWR-WUA5V12W0US
Battery 1	Brand Name	Zebra	Model Number	BT-000454
			Part Number	BT-000454-20
Battery 2	Brand Name	Zebra	Model Number	BT-000454
			Part Number	BT-000454-70
Earphone	Brand Name	Zebra	Part Number	HDST-35MM-PTVP-01
USB Cable (Type C to Type A)	Brand Name	Zebra	Part Number	CBL-TC5X-USBC2A-01
Type C-Audio Cable (Type C to 3.5mm)	Brand Name	Zebra	Part Number	ADP-USBC-35MM1-01

## 1.2 Product Specification of Equipment Under Test

Standards-related Product Specification	
<b>Tx Frequency</b>	5G NR n77: 3700 MHz ~ 3980 MHz 5G NR n78: 3700 MHz ~ 3800 MHz
<b>Rx Frequency</b>	5G NR n77: 3700 MHz ~ 3980 MHz 5G NR n78: 3700 MHz ~ 3800 MHz
<b>SCS</b>	30kHz
<b>Bandwidth</b>	5G NR n77: 20MHz / 30MHz / 40MHz / 60MHz / 80MHz / 100MHz 5G NR n78: 20MHz / 30MHz / 40MHz / 50MHz / 60MHz / 70MHz / 80MHz / 90MHz / 100MHz
<b>Antenna Type</b>	Fixed Internal Antenna
<b>Maximum Output Power to Antenna</b>	<Ant. 3> 5G NR n77 : 23.99 dBm 5G NR n78 : 26.99 dBm
<b>Antenna Gain</b>	<Ant. 1> 5G NR n77: -2.52 dBi 5G NR n78: -2.52 dBi <Ant. 3> 5G NR n77: -1.06 dBi 5G NR n78: -1.06 dBi <Ant. 4> 5G NR n77: -0.83 dBi 5G NR n78: -0.83 dBi <Ant. 5> 5G NR n77: 1.33 dBi 5G NR n78: 1.33 dBi
<b>Type of Modulation</b>	CP-OFDM: QPSK / 16QAM / 64QAM / 256QAM DFT-s-OFDM: PI/2 BPSK / QPSK / 16QAM / 64QAM / 256QAM

**Remark:**

1. The maximum EIRP is calculated from max output power and max antenna gain, only the maximum EIRP is shown in the report, 5G NR n77/n78 for Antenna 3.
2. 5G NR n77 support SA, n78 support SA & NSA. According to the maximum power between SA and NSA mode, SA covers NSA mode for 5G NR n78.
3. The device supports HPUE mode for 5G NR SA n78.
4. The EN-DC mode combination: DC\_2A\_n78A, DC\_5A\_n78A.
5. The device supports n78(1T4R) SRS resources on ant.1/4/5, only the test data of worst ant.3 is showed in the report according to the maximum power.

## 1.3 Modification of EUT

No modifications are made to the EUT during all test items.



### 1.4 Maximum EIRP Power and Emission Designator

5G NR n77 SA		PI/2 BPSK / QPSK		16QAM / 64QAM / 256QAM	
BW (MHz)	Frequency Range (MHz)	Maximum EIRP(W)	Emission Designator (99%OBW)	Maximum EIRP(W)	Emission Designator (99%OBW)
20	3710.01 ~ 3969.99	0.1854	18M2G7D	0.1531	18M2W7D
30	3715.02 ~ 3964.98	0.1892	27M8G7D	0.1556	27M9W7D
40	3720.00 ~ 3960.00	0.1963	37M8G7D	0.1578	37M8W7D
60	3730.02 ~ 3949.98	0.1791	57M9G7D	0.1483	57M8W7D
80	3740.01 ~ 3939.99	0.1758	77M4G7D	0.1416	77M5W7D
100	3750.00 ~ 3930.00	0.1738	97M4G7D	0.1455	97M5W7D

5G NR n78 SA		PI/2 BPSK / QPSK		16QAM / 64QAM / 256QAM	
BW (MHz)	Frequency Range (MHz)	Maximum EIRP(W)	Emission Designator (99%OBW)	Maximum EIRP(W)	Emission Designator (99%OBW)
20	3710.01 ~ 3789.99	0.3516	18M2G7D	0.2871	18M2W7D
30	3715.02 ~ 3984.98	0.3581	27M9G7D	0.3069	27M8W7D
40	3720.00 ~ 3780.00	0.3664	37M8G7D	0.3069	37M8W7D
50	3725.01 ~ 3774.99	0.3357	47M5G7D	0.2742	47M5W7D
60	3730.02 ~ 3769.98	0.3917	57M9G7D	0.3524	57M9W7D
70	3735.00 ~ 3765.00	0.3334	67M4G7D	0.2723	67M6W7D
80	3740.01 ~ 3759.99	0.3199	77M5G7D	0.2630	77M6W7D
90	3745.02 ~ 3754.98	0.3350	87M4G7D	0.2773	87M6W7D
100	3750.00	0.3221	97M3G7D	0.2649	97M7W7D

**Note:** All modulations have been tested, only the worst test results of PSK & QAM are shown in the report.



### 1.5 Testing Location

Sporton International Inc. (Kunshan) is accredited to ISO/IEC 17025:2017 by American Association for Laboratory Accreditation with Certificate Number 5145.02.

<b>Test Firm</b>	Sporton International Inc. (Kunshan)		
<b>Test Site Location</b>	No. 1098, Pengxi North Road, Kunshan Economic Development Zone Jiangsu Province 215300 People's Republic of China TEL : +86-512-57900158 FAX : +86-512-57900958		
<b>Test Site No.</b>	<b>Sporton Site No.</b>	<b>FCC Designation No.</b>	<b>FCC Test Firm Registration No.</b>
	03CH02-KS	CN1257	314309

Sporton International Inc. (Shenzhen) is accredited to ISO/IEC 17025:2017 by American Association for Laboratory Accreditation with Certificate Number 5145.01.

<b>Test Firm</b>	Sporton International Inc. (Shenzhen)		
<b>Test Site Location</b>	1/F, 2/F, Bldg 5, Shiling Industrial Zone, Xinwei Village, Xili, Nanshan, Shenzhen, 518055 People's Republic of China TEL: +86-755-86379589 FAX: +86-755-86379595		
<b>Test Site No.</b>	<b>Sporton Site No.</b>	<b>FCC Designation No.</b>	<b>FCC Test Firm Registration No.</b>
	TH01-SZ	CN1256	421272

Test data subcontracted: conducted test items in section 3.4~3.9 of this report.

### 1.6 Test Software

Item	Site	Manufacturer	Name	Version
1.	03CH02-KS	AUDIX	E3	6.2009-8-24a





## 1.7 Applicable Standards

According to the specifications of the manufacturer, the EUT must comply with the requirements of the following standards:

- ♦ 47 CFR Part 2, 270
- ♦ ANSI C63.26-2015
- ♦ FCC KDB 971168 D01 Power Meas License Digital Systems v03r01
- ♦ FCC KDB 412172 D01 Determining ERP and EIRP v01r01

**Remark:** All test items were verified and recorded according to the standards and without any deviation during the test.



## 2 Test Configuration of Equipment Under Test

### 2.1 Test Mode

Antenna port conducted and radiated test items are performed according to KDB 971168 D01 Power Meas License Digital Systems v03r01 with maximum output power.

For radiated measurement, pre-scanned in three orthogonal panels, X, Y, Z and accessory configurations. The worst-cases (Y Plane with adapter) were recorded in this report.

The device is investigated from 30MHz to 10 times of fundamental signal for radiated spurious emission test under different RB size/offset and modulations in exploratory test. Subsequently, only the worst case emissions are reported.

Test Items	5G NR	Bandwidth (MHz)									Modulation					RB #		Test Channel		
		20	30	40	50	60	70	80	90	100	PI/2 BPSK	QPSK	16QAM	64QAM	256 QAM	1	Full	L	M	H
Max. Output Power	n77	v	v	v	-	v	-	v	-	v	v	v	v	v	v	v	v	v	v	v
	n78	v	v	v	v	v	v	v	v	v	v	v	v	v	v	v	v	v	v	v
Peak-to-Average Ratio	n77	v	-	-	-	-	-	-	-	-	v	v	-	-	-	-	v	v	v	v
	n78	v	-	-	-	-	-	-	-	-	v	v	-	-	-	-	v	v	v	v
26dB and 99% Bandwidth	n77	v	v	v	-	v	-	v	-	v	v	v	v	v	v	-	v	-	v	-
	n78	v	v	v	v	v	v	v	v	v	v	v	v	v	v	-	v	-	v	-
Conducted Band Edge	n77	v	-	-	-	v	-	-	-	v	v	v	-	-	-	v	v	v	-	v
	n78	v	-	-	-	v	-	-	-	v	v	v	-	-	-	v	v	v	-	v
Conducted Spurious Emission	n77	v	-	-	-	v	-	-	-	v	v	v	-	-	-	v	-	v	v	v
	n78	v	-	-	-	v	-	-	-	v	v	v	-	-	-	v	-	v	v	v
Frequency Stability	n77	v	-	-	-	-	-	-	-	-	-	v	-	-	-	-	v	-	v	-
	n78	v	-	-	-	-	-	-	-	-	-	v	-	-	-	-	v	-	v	-
E.R.P / E.I.R.P	n77	v	v	v	-	v	-	v	-	v	v	v	v	v	v	v	v	v	v	v
	n78	v	v	v	v	v	v	v	v	v	v	v	v	v	v	v	v	v	v	v
Radiated Spurious Emission	n77	Worst Case																v	v	v
	n78	Worst Case																-	-	v
Note	1. The mark "v" means that this configuration is chosen for testing 2. The mark "-" means that this bandwidth is not supported. 3. The device is investigated from 30MHz to 10 times of fundamental signal for radiated spurious emission test under different RB size/offset and modulations in exploratory test. Subsequently, only the worst case emissions are reported. 4. Based on engineering evaluation, only the worst modulations test results are shown in the report. 5. Frequency Stability : Normal Voltage = 3.87V ; Low Voltage =3.65V. ; High Voltage =4.45V																			

## 2.2 Connection Diagram of Test System

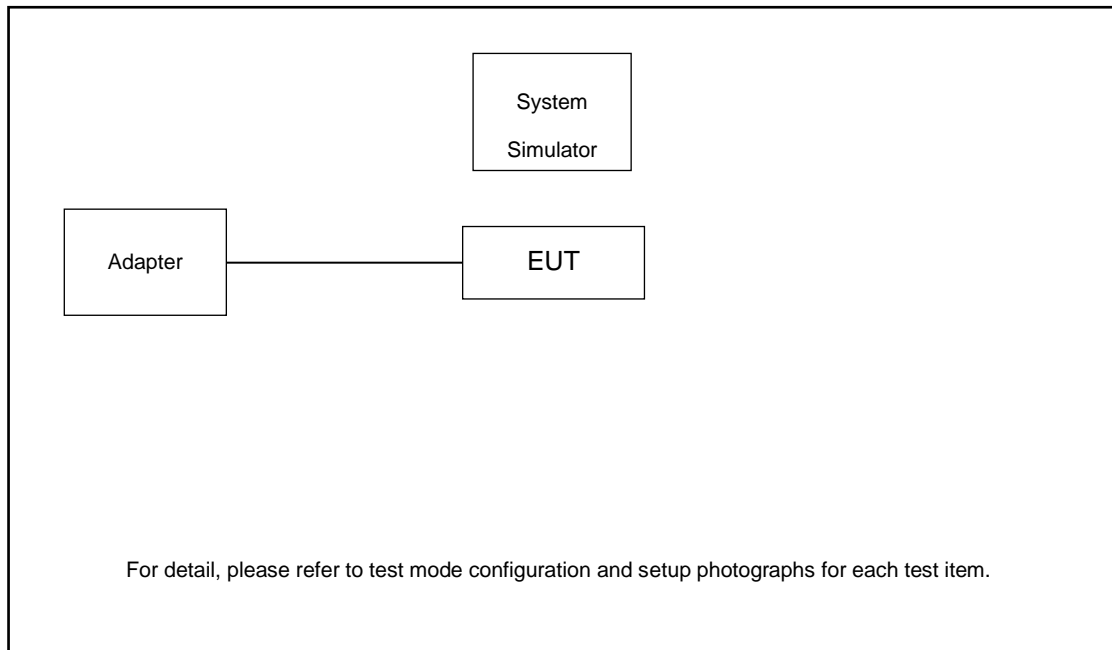

## 2.3 Support Unit used in test configuration and system

Item	Equipment	Trade Name	Model No.	FCC ID	Data Cable	Power Cord
1.	Power Supply	GWINSTEK	PSS-2002	N/A	N/A	Unshielded,1.8m
2.	Base Station	Anritsu	MT8821C	N/A	N/A	Unshielded,1.8m
3.	Base Station	Anritsu	MT8000A	N/A	N/A	Unshielded,1.8m

## 2.4 Measurement Results Explanation Example

### For all conducted test items:

The offset level is set in the spectrum analyzer to compensate the RF cable loss between EUT conducted output port and spectrum analyzer. With the offset compensation, the spectrum analyzer reading level is exactly the EUT RF output level.

The spectrum analyzer offset is derived from RF cable loss.

*Offset = RF cable loss.*

Following shows an offset computation example with cable loss 9.10 dB.

Example :

*Offset(dB) = RF cable loss(dB).*

*= 9.10 (dB)*



### 2.5 Frequency List of Low/Middle/High Channels

5G n77 Channel and Frequency List				
BW [MHz]	Channel/Frequency(MHz)	Lowest	Middle	Highest
100	Channel	650000	656000	662000
	Frequency	3750	3840	3930
80	Channel	649334	656000	662666
	Frequency	3740.01	3840	3939.99
60	Channel	648668	656000	663332
	Frequency	3730.02	3840	3949.98
40	Channel	648000	656000	664000
	Frequency	3720	3840	3960
30	Channel	647668	656000	664332
	Frequency	3715.02	3840	3964.98
20	Channel	647334	656000	664666
	Frequency	3710.01	3840	3969.99

5G n78 Channel and Frequency List				
BW [MHz]	Channel/Frequency(MHz)	Lowest	Middle	Highest
100	Channel	650000		
	Frequency	3750		
90	Channel	649668	650000	650332
	Frequency	3745.02	3750	3754.98
80	Channel	649334	650000	650666
	Frequency	3740.01	3750	3759.99
70	Channel	649000	650000	651000
	Frequency	3735	3750	3765
60	Channel	648668	650000	651332
	Frequency	3730.02	3750	3769.98
50	Channel	648334	650000	651666
	Frequency	3725.01	3750	3774.99
40	Channel	648000	650000	652000
	Frequency	3720	3750	3780
30	Channel	647668	650000	652332
	Frequency	3715.02	3750	3784.98
20	Channel	647334	650000	652666
	Frequency	3710.01	3750	3789.99

### 3 Conducted Test Items

#### 3.1 Measuring Instruments

See list of measuring instruments of this test report.

#### 3.2 Test Setup

##### 3.2.1 Conducted Output Power

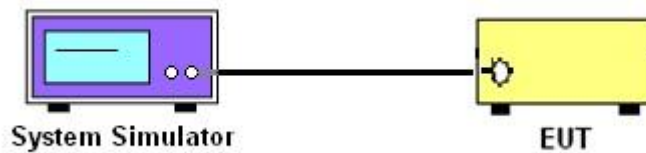

##### 3.2.2 Peak-to-Average Ratio, Occupied Bandwidth, Conducted Band-Edge and Conducted Spurious Emission

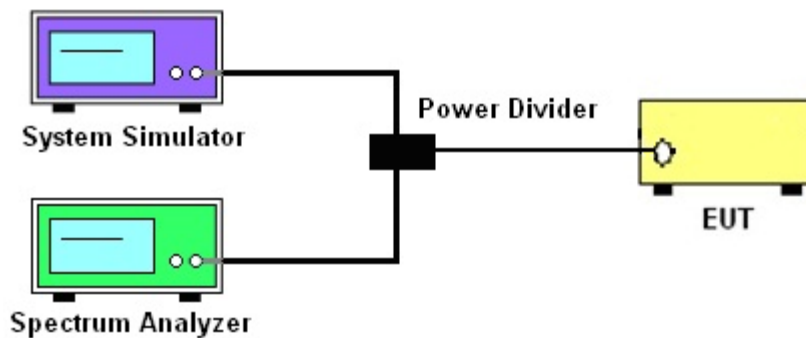

##### 3.2.3 Frequency Stability

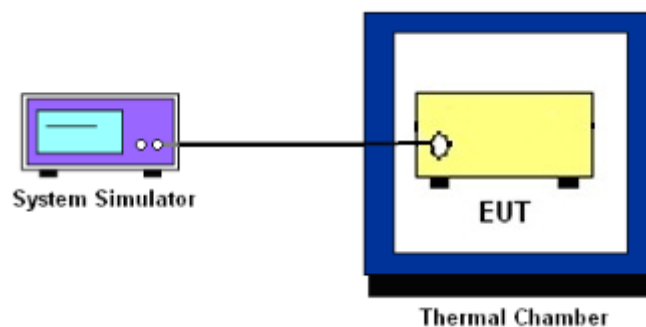

### 3.3 Test Result of Conducted Test

Please refer to Appendix A.



### 3.4 Conducted Output Power and EIRP

#### 3.4.1 Description of the Conducted Output Power Measurement and EIRP Measurement

A system simulator was used to establish communication with the EUT. Its parameters were set to force the EUT transmitting at maximum output power. The measured power in the radio frequency on the transmitter output terminals shall be reported.

The EIRP of mobile transmitters must not exceed 1 Watts for 5G NR n77, n78.

According to KDB 412172 D01 Power Approach,

$EIRP = P_T + G_T - L_C$ ,  $ERP = EIRP - 2.15$ , where

$P_T$  = transmitter output power in dBm

$G_T$  = gain of the transmitting antenna in dBi

$L_C$  = signal attenuation in the connecting cable between the transmitter and antenna in dB

#### 3.4.2 Test Procedures

1. The testing follows ANSI C63.26 Section 5.2
2. The transmitter output port was connected to the system simulator.
3. Set EUT at maximum power through the system simulator.
4. Select lowest, middle, and highest channels for each band and different modulation.
5. Measure and record the power level from the system simulator.



## **3.5 Peak-to-Average Ratio**

### **3.5.1 Description of the PAR Measurement**

Power Complementary Cumulative Distribution Function (CCDF) curves provide a means for characterizing the power peaks of a digitally modulated signal on a statistical basis. A CCDF curve depicts the probability of the peak signal amplitude exceeding the average power level. Most contemporary measurement instrumentation include the capability to produce CCDF curves for an input signal provided that the instrument's resolution bandwidth can be set wide enough to accommodate the entire input signal bandwidth. In measuring transmissions in this band using an average power technique, the peak-to-average ratio (PAR) of the transmission may not exceed 13 dB.

### **3.5.2 Test Procedures**

1. The testing follows ANSI C63.26 Section 5.2.3.4 (CCDF).
2. The EUT was connected to spectrum and system simulator via a power divider.
3. Set the CCDF (Complementary Cumulative Distribution Function) option in spectrum analyzer.
4. The highest RF powers were measured and recorded the maximum PAPR level associated with a probability of 0.1 %.
5. Record the deviation as Peak to Average Ratio.



## 3.6 Occupied Bandwidth

### 3.6.1 Description of Occupied Bandwidth Measurement

The occupied bandwidth is the width of a frequency band such that, below the lower and above the upper frequency limits, the mean powers emitted are each equal to a specified percentage 0.5% of the total mean transmitted power.

The 26 dB emission bandwidth is defined as the frequency range between two points, one above and one below the carrier frequency, at which the spectral density of the emission is attenuated 26 dB below the maximum in-band spectral density of the modulated signal. Spectral density (power per unit bandwidth) is to be measured with a detector of resolution bandwidth equal to approximately 1.0% of the emission bandwidth.

### 3.6.2 Test Procedures

1. The testing follows ANSI C63.26 Section 5.4
2. The EUT was connected to spectrum analyzer and system simulator via a power divider.
3. The spectrum analyzer center frequency is set to the nominal EUT channel center frequency. The span range for the spectrum analyzer shall be between two and five times the anticipated OBW.
4. The nominal resolution bandwidth (RBW) shall be in the range of 1 to 5 % of the anticipated OBW, and the VBW shall be at least 3 times the RBW.
5. Set the detection mode to peak, and the trace mode to max hold.
6. Determine the reference value: Set the EUT to transmit a modulated signal. Allow the trace to stabilize. Set the spectrum analyzer marker to the highest level of the displayed trace.  
(this is the reference value)
7. Determine the “-26 dB down amplitude” as equal to (Reference Value – X).
8. Place two markers, one at the lowest and the other at the highest frequency of the envelope of the spectral display such that each marker is at or slightly below the “-X dB down amplitude” determined in step 6. If a marker is below this “-X dB down amplitude” value it shall be placed as close as possible to this value. The OBW is the positive frequency difference between the two markers.
9. Use the 99 % power bandwidth function of the spectrum analyzer and report the measured bandwidth.





### 3.7 Conducted Band Edge

#### 3.7.1 Description of Conducted Band Edge Measurement

27.53(l)(2)

For mobile operations in the 3700-3980 MHz band, the conducted power of any emission outside the licensee's authorized bandwidth shall not exceed -13 dBm/MHz. Compliance with this paragraph is based on the use of measurement instrumentation employing a resolution bandwidth of 1 megahertz or greater. However, in the 1 megahertz bands immediately outside and adjacent to the licensee's frequency block, the minimum resolution bandwidth for the measurement shall be either one percent of the emission bandwidth of the fundamental emission of the transmitter or 350 kHz. In the bands between 1 and 5 MHz removed from the licensee's frequency block, the minimum resolution bandwidth for the measurement shall be 500 kHz.

#### 3.7.2 Test Procedures

1. The testing follows ANSI C63.26 section 5.7
2. The EUT was connected to spectrum analyzer and system simulator via a power divider.
3. The band edges of low and high channels for the highest RF powers were measured.
4. Set RBW  $\geq$  1% EBW in the 1MHz band immediately outside and adjacent to the band edge.
5. Beyond the 1 MHz band from the band edge, RBW=1MHz was used.
6. Set spectrum analyzer with RMS detector.
7. The RF fundamental frequency should be excluded against the limit line in the operating frequency band.
8. Checked that all the results comply with the emission limit line.

Example:

The limit line is derived from  $43 + 10\log(P)$  dB below the transmitter power P(Watts)  
 $= P(W) - [43 + 10\log(P)]$  (dB)  
 $= [30 + 10\log(P)]$  (dBm) -  $[43 + 10\log(P)]$  (dB) = -13dBm.

9. When using the integration method, the starting frequency of the integration shall be centered at one-half of the RBW away from the band edge.



## 3.8 Conducted Spurious Emission

### 3.8.1 Description of Conducted Spurious Emission Measurement

The power of any emission outside of the authorized operating frequency ranges must be lower than the transmitter power (P) by a factor of at least  $43 + 10 \log (P)$  dB.

It is measured by means of a calibrated spectrum analyzer and scanned from 30 MHz up to a frequency including its 10<sup>th</sup> harmonic.

### 3.8.2 Test Procedures

1. The testing follows ANSI C63.26 section 5.7
2. The EUT was connected to spectrum analyzer and system simulator via a power divider.
3. The RF output of EUT was connected to the spectrum analyzer by RF cable and attenuator. The path loss was compensated to the results for each measurement.
4. The middle channel for the highest RF power within the transmitting frequency was measured.
5. The conducted spurious emission for the whole frequency range was taken.
6. Make the measurement with the spectrum analyzer's RBW = 1MHz, VBW = 3MHz.
7. Set spectrum analyzer with RMS detector.
8. Taking the record of maximum spurious emission.
9. The RF fundamental frequency should be excluded against the limit line in the operating frequency band.
10. The limit line is derived from  $43 + 10\log(P)$ dB below the transmitter power P(Watts)  
=  $P(W) - [43 + 10\log(P)]$  (dB)  
=  $[30 + 10\log(P)]$  (dBm) -  $[43 + 10\log(P)]$  (dB)  
= -13dBm.



### 3.9 Frequency Stability

#### 3.9.1 Description of Frequency Stability Measurement

The frequency stability shall be measured by variation of ambient temperature and variation of primary supply voltage to ensure that the fundamental emission stays within the authorized frequency block. The frequency stability of the transmitter shall be maintained within  $\pm 0.00025\%$  ( $\pm 2.5\text{ppm}$ ) of the center frequency.

#### 3.9.2 Test Procedures for Temperature Variation

1. The testing follows ANSI C63.26 section 5.6.4
2. The EUT was set up in the thermal chamber and connected with the system simulator.
3. With power OFF, the temperature was decreased to  $-30^{\circ}\text{C}$  and the EUT was stabilized before testing. Power was applied and the maximum change in frequency was recorded within one minute.
4. With power OFF, the temperature was raised in  $10^{\circ}\text{C}$  step up to  $50^{\circ}\text{C}$ . The EUT was stabilized at each step for at least half an hour. Power was applied and the maximum frequency change was recorded within one minute.

#### 3.9.3 Test Procedures for Voltage Variation

1. The testing follows ANSI C63.26 section 5.6.5
2. The EUT was placed in a temperature chamber at  $20\pm 5^{\circ}\text{C}$  and connected with the system simulator.
3. The power supply voltage to the EUT was varied from 85% to 115% of the nominal value for other than hand carried battery equipment.
4. For hand carried, battery powered equipment, reduce the primary ac or dc supply voltage to the battery operating end point, which shall be specified by the manufacturer.
5. The variation in frequency was measured for the worst case.

## 4 Radiated Test Items

### 4.1 Measuring Instruments

See list of measuring instruments of this test report.

### 4.2 Test Setup

#### 4.2.1 For radiated test below 30MHz

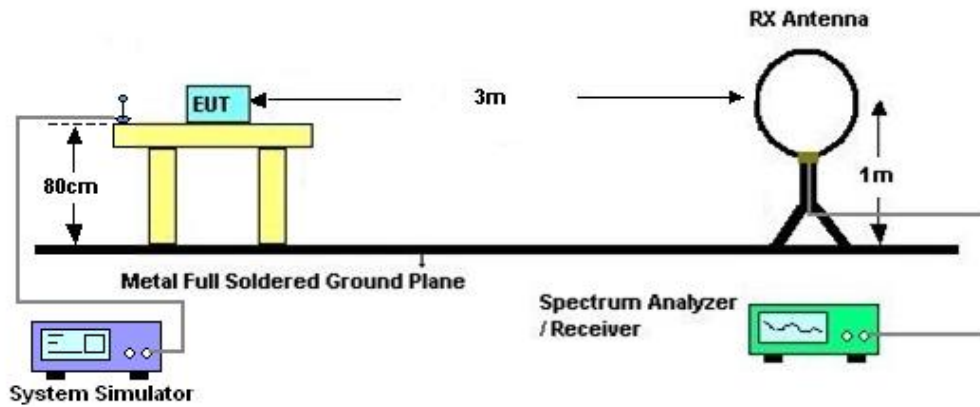

#### 4.2.2 For radiated test from 30MHz to 1GHz

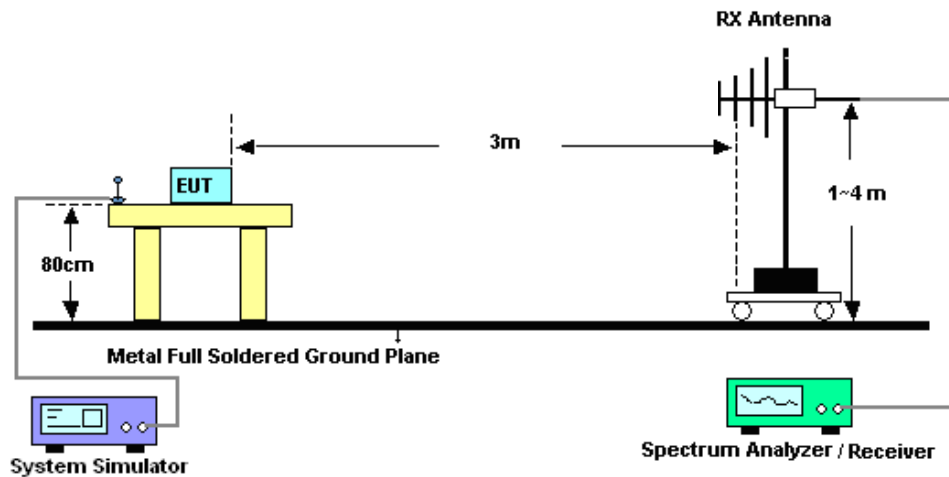

#### 4.2.3 For radiated test above 1GHz

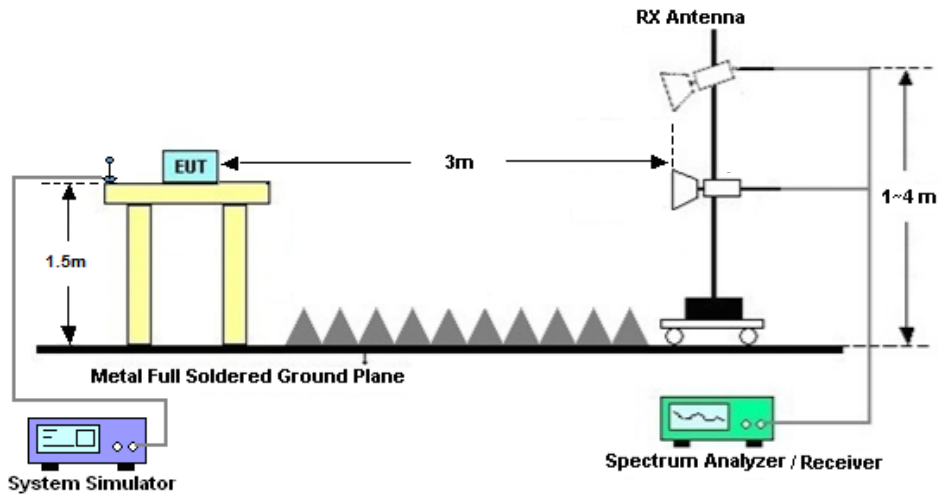

#### 4.3 Test Result of Radiated Test

The low frequency, which started from 9 kHz to 30MHz, was pre-scanned and the result which was 20dB lower than the limit line was not reported.

Please refer to Appendix B.



## 4.4 Radiated Spurious Emission

### 4.4.1 Description of Radiated Spurious Emission

The radiated spurious emission was measured by substitution method according to ANSI C63.26. The power of any emission outside of the authorized operating frequency ranges must be attenuated below the transmitter power (P) by a factor of at least  $43 + 10 \log (P)$  dB.

The spectrum is scanned from 30 MHz up to a frequency including its 10th harmonic.

### 4.4.2 Test Procedures

1. The testing follows ANSI C63.26 Section 5.5
2. The EUT was placed on a turntable with 0.8 meter height for frequency below 1GHz and 1.5 meter height for frequency above 1GHz respectively above ground.
3. The EUT was set 3 meters from the receiving antenna mounted on the antenna tower.
4. The table was rotated 360 degrees to determine the position of the highest spurious emission.
5. The height of the receiving antenna is varied between 1m to 4m to search the maximum spurious emission for both horizontal and vertical polarizations.
6. During the measurement, the system simulator parameters were set to force the EUT transmitting at maximum output power.
7. Make the measurement with the spectrum analyzer's RBW = 1MHz, VBW = 3MHz, taking the record of maximum spurious emission.
8. A horn antenna was substituted in place of the EUT and was driven by a signal generator.
9. Tune the output power of signal generator to the same emission level with EUT maximum spurious emission.
10.  $EIRP \text{ (dBm)} = S.G. \text{ Power} - Tx \text{ Cable Loss} + Tx \text{ Antenna Gain}$
11.  $ERP \text{ (dBm)} = EIRP - 2.15$
12. The RF fundamental frequency should be excluded against the limit line in the operating frequency band.

The limit line is derived from  $43 + 10\log(P)$ dB below the transmitter power P(Watts)  
=  $P(W) - [43 + 10\log(P)] \text{ (dB)}$   
=  $[30 + 10\log(P)] \text{ (dBm)} - [43 + 10\log(P)] \text{ (dB)}$   
= -13dBm.



## 5 List of Measuring Equipment

Instrument	Manufacturer	Model No.	Serial No.	Characteristics	Calibration Date	Test Date	Due Date	Remark
EXA Signal Analyzer	KEYSIGHT	N9010B	MY60240803	10Hz~44GHz	Apr. 03, 2021	Feb. 22, 2022~ Feb. 23, 2022	Apr. 02, 2022	Conducted (TH01-SZ)
Power divider	STI	STI08-0055	-	0.5~40GHz	Aug. 26, 2021	Feb. 22, 2022~ Feb. 23, 2022	Aug. 25, 2022	Conducted (TH01-SZ)
Thermal Chamber	Ten Billion Hongzhangroup	LP-150U	H2014081803	-40~+150°C	Jul. 14, 2021	Feb. 22, 2022~ Feb. 23, 2022	Jul. 13, 2022	Conducted (TH01-SZ)
EMI Test Receiver	R&S	ESR7	101403	9kHz~7GHz;Max 30dBm	Oct. 16, 2021	Feb. 21,2022	Oct. 15,2022	Radiation (03CH02-KS)
EXA Spectrum Analyzer	Keysight	N9010A	MY55370528	10Hz~44G,MAX 30dB	Oct. 16, 2021	Feb. 21,2022	Oct. 15,2022	Radiation (03CH02-KS)
Loop Antenna	R&S	HFH2-Z2	100321	9kHz~30MHz	Oct. 30, 2021	Feb. 21,2022	Oct. 29, 2022	Radiation (03CH02-KS)
Bilog Antenna	TeseQ	CBL6111D	44483	30MHz~1GHz	Dec. 22, 2021	Feb. 21,2022	Dec. 21, 2022	Radiation (03CH02-KS)
Double Ridge Horn Antenna	ETS-Lindgren	3117	75957	1GHz~18GHz	Oct. 30, 2021	Feb. 21,2022	Oct. 29, 2022	Radiation (03CH02-KS)
high gain Amplifier	MITEQ	AMF-7D-00 101800-30-1 0P	2025788	1Ghz~18Ghz	Jul. 30, 2021	Feb. 21,2022	Jul. 29, 2022	Radiation (03CH02-KS)
SHF-EHF Horn	Com-power	AH-840	101070	18GHz~40GHz	Jan. 05, 2022	Feb. 21,2022	Jan. 04, 2023	Radiation (03CH02-KS)
Amplifier	SONOMA	310N	187289	9KHz~1GHz	Apr. 13, 2021	Feb. 21,2022	Apr. 12, 2022	Radiation (03CH02-KS)
Amplifier	Keysight	83017A	MY53270316	500MHz~26.5GHz	Oct. 16, 2021	Feb. 21,2022	Oct. 15,2022	Radiation (03CH02-KS)
Amplifier	MITEQ	EM18G40G GA	060728	18~40GHz	Jan. 05, 2022	Feb. 21,2022	Jan. 04, 2023	Radiation (03CH02-KS)
AC Power Source	Chroma	61601	616010002473	N/A	NCR	Feb. 21,2022	NCR	Radiation (03CH02-KS)
Turn Table	MF	MF7802	N/A	0~360 degree	NCR	Feb. 21,2022	NCR	Radiation (03CH02-KS)
Antenna Mast	MF	MF7802	N/A	1 m~4 m	NCR	Feb. 21,2022	NCR	Radiation (03CH02-KS)

NCR: No Calibration Required



## 6 Uncertainty of Evaluation

The measurement uncertainties shown below were calculated in accordance with the requirements of ANSI 63.26-2015. All the measurement uncertainty value were shown with a coverage  $K=2$  to indicate 95% level of confidence. The measurement data show herein meets or exceeds the CISPR measurement uncertainty values specified in CISPR 16-4-2 and can be compared directly to specified limit to determine compliance.

### Uncertainty of Radiated Emission Measurement (30 MHz ~ 1000 MHz)

Measuring Uncertainty for a Level of Confidence of 95% ( $U = 2Uc(y)$ )	2.5dB
---	-------

### Uncertainty of Radiated Emission Measurement (1 GHz ~ 18 GHz)

Measuring Uncertainty for a Level of Confidence of 95% ( $U = 2Uc(y)$ )	2.1dB
---	-------

### Uncertainty of Radiated Emission Measurement (18 GHz ~ 40 GHz)

Measuring Uncertainty for a Level of Confidence of 95% ( $U = 2Uc(y)$ )	2.1dB
---	-------





## Appendix A. Test Results of Conducted Test

Test Engineer :	Jung Guo	Temperature :	21~23°C
		Relative Humidity :	45~51%

# FR1 N77

## Frequency Stability

NR Band	SCS (kHz)	Bandwidth (MHz)	Arfcn	Freq (MHz)	Modulation	RB	Deviation (ppm)	Verdict	Environment
77	30	20	656000	3840.0	DFT-s-OFDM QPSK	50@0	0.00384	PASS	NV
77	30	20	656000	3840.0	DFT-s-OFDM QPSK	50@0	0.00056	PASS	LV
77	30	20	656000	3840.0	DFT-s-OFDM QPSK	50@0	0.00452	PASS	HV
77	30	20	656000	3840.0	DFT-s-OFDM QPSK	50@0	0.00214	PASS	-30°C
77	30	20	656000	3840.0	DFT-s-OFDM QPSK	50@0	0.00441	PASS	-20°C
77	30	20	656000	3840.0	DFT-s-OFDM QPSK	50@0	0.00328	PASS	-10°C
77	30	20	656000	3840.0	DFT-s-OFDM QPSK	50@0	0.00508	PASS	0°C
77	30	20	656000	3840.0	DFT-s-OFDM QPSK	50@0	0.00429	PASS	10°C
77	30	20	656000	3840.0	DFT-s-OFDM QPSK	50@0	0.00615	PASS	20°C
77	30	20	656000	3840.0	DFT-s-OFDM QPSK	50@0	0.00475	PASS	30°C
77	30	20	656000	3840.0	DFT-s-OFDM QPSK	50@0	0.00669	PASS	40°C
77	30	20	656000	3840.0	DFT-s-OFDM QPSK	50@0	0.00046	PASS	50°C

## Peak to Average Ratio

NR Band	SCS (kHz)	Bandwidth (MHz)	Arfcn	Freq (MHz)	Modulation	RB	Result (dB)	Limit (dB)	Verdict
77	30	20	647334	3710.01	DFT-s-OFDM PI/2 BPSK	50@0	6.81	13	PASS
77	30	20	647334	3710.01	DFT-s-OFDM PI/2 BPSK	1@0	7.74	13	PASS
77	30	20	647334	3710.01	DFT-s-OFDM QPSK	50@0	7.87	13	PASS
77	30	20	647334	3710.01	DFT-s-OFDM QPSK	1@0	7.73	13	PASS
77	30	20	656000	3840.0	DFT-s-OFDM PI/2 BPSK	50@0	6.56	13	PASS
77	30	20	656000	3840.0	DFT-s-OFDM PI/2 BPSK	1@0	7.79	13	PASS
77	30	20	656000	3840.0	DFT-s-OFDM QPSK	50@0	7.51	13	PASS
77	30	20	656000	3840.0	DFT-s-OFDM QPSK	1@0	8.28	13	PASS
77	30	20	664666	3969.99	DFT-s-OFDM PI/2 BPSK	50@0	6.77	13	PASS
77	30	20	664666	3969.99	DFT-s-OFDM PI/2 BPSK	1@0	7.72	13	PASS
77	30	20	664666	3969.99	DFT-s-OFDM QPSK	50@0	7.68	13	PASS
77	30	20	664666	3969.99	DFT-s-OFDM QPSK	1@0	8.11	13	PASS

N77(20M)\_DFT-s-OFDM\_PI\_2-BPSK\_Outer\_Full\_Low\_CH

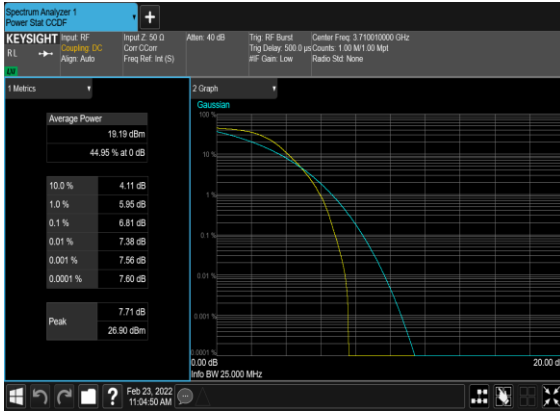

N77(20M)\_DFT-s-OFDM\_PI\_2-BPSK\_Edge\_1RB\_Left\_Low\_CH

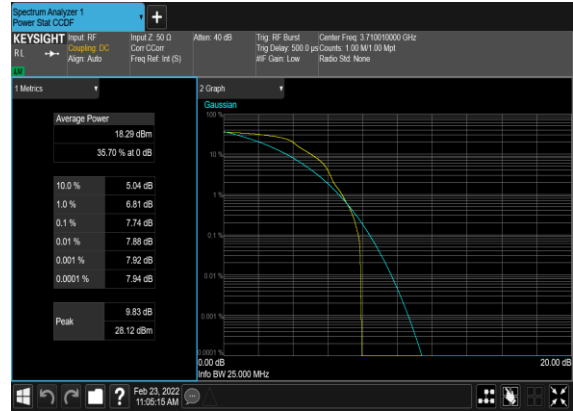

N77(20M)\_DFT-s-OFDM\_QPSK\_Outer\_Full\_Low\_CH

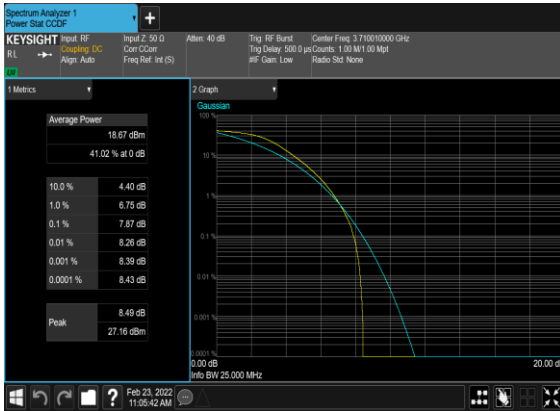

N77(20M)\_DFT-s-OFDM\_QPSK\_Edge\_1RB\_Left\_Low\_CH

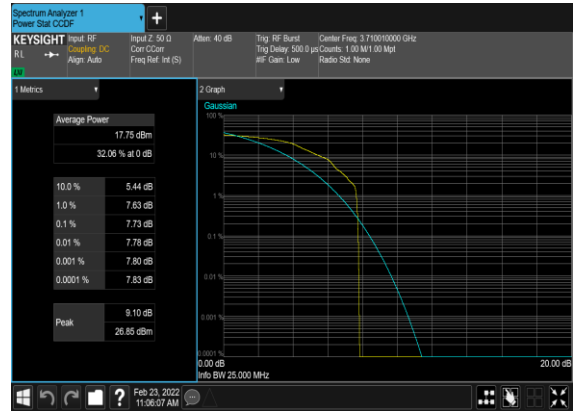

N77(20M)\_DFT-s-OFDM\_PI\_2-BPSK\_Outer\_Full\_Mid\_CH

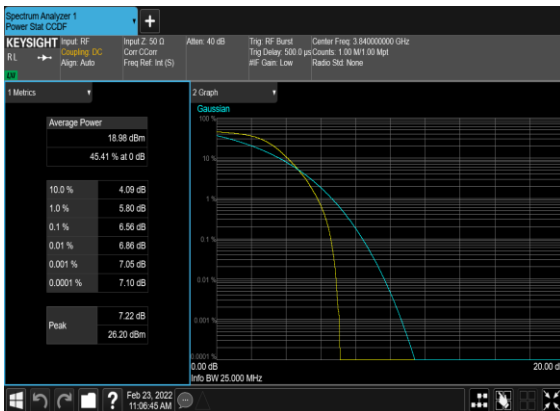

N77(20M)\_DFT-s-OFDM\_PI\_2-BPSK\_Edge\_1RB\_Left\_Mid\_CH



N77(20M)\_DFT-s-OFDM\_QPSK\_Outer\_Full\_Mid\_CH



N77(20M)\_DFT-s-OFDM\_QPSK\_Edge\_1RB\_Left\_Mid\_CH

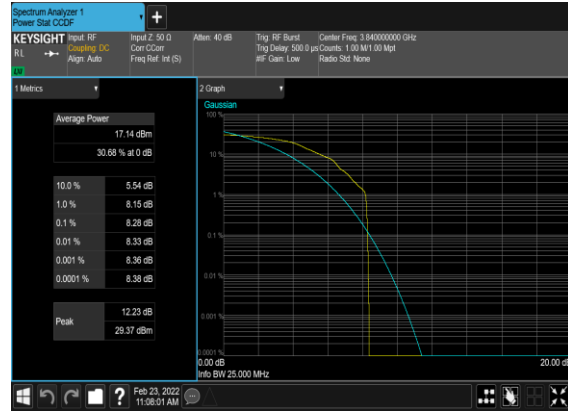

N77(20M)\_DFT-s-OFDM\_PI\_2-BPSK\_Outer\_Full\_High\_CH

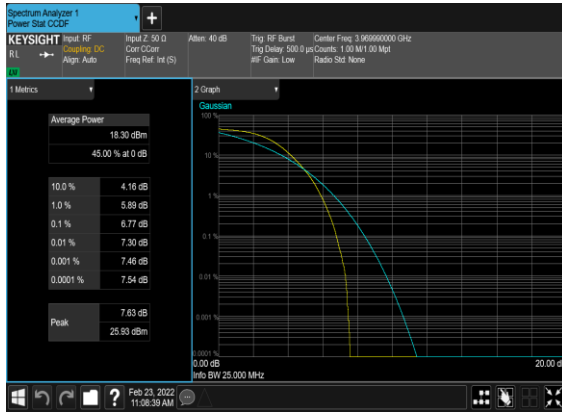

N77(20M)\_DFT-s-OFDM\_PI\_2-BPSK\_Edge\_1RB\_Left\_High\_CH

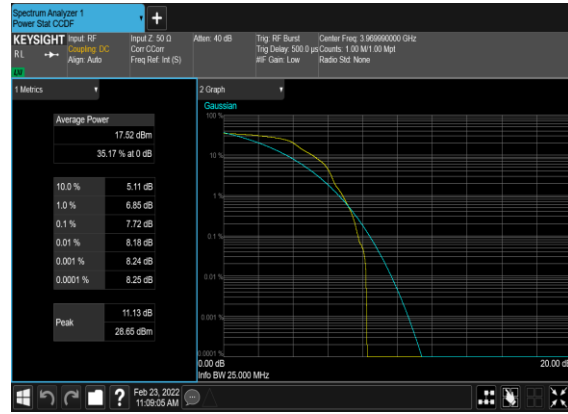

N77(20M)\_DFT-s-OFDM\_QPSK\_Outer\_Full\_High\_CH



N77(20M)\_DFT-s-OFDM\_QPSK\_Edge\_1RB\_Left\_High\_CH

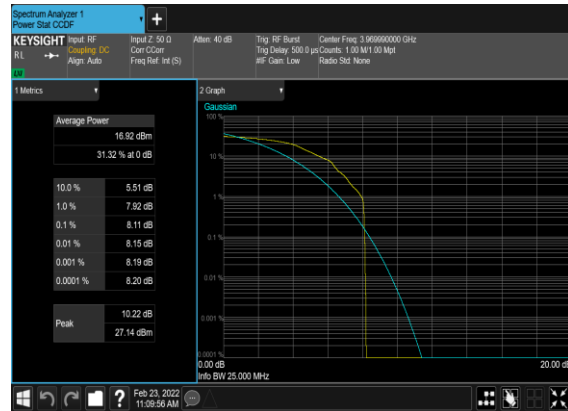

## Occupied Bandwidth

NR Band	SCS (kHz)	Bandwidth (MHz)	Arfcn	Freq (MHz)	Modulation	RB	OBW (MHz)	26dB OBW (MHz)
77	30	20	656000	3840.0	DFT-s-OFDM PI/2 BPSK	50@0	17.788	18.72
77	30	20	656000	3840.0	DFT-s-OFDM QPSK	50@0	17.801	18.77
77	30	20	656000	3840.0	CP-OFDM QPSK	51@0	18.202	19.26
77	30	20	656000	3840.0	CP-OFDM 16 QAM	51@0	18.231	19.23
77	30	20	656000	3840.0	CP-OFDM 64 QAM	51@0	18.222	19.31
77	30	20	656000	3840.0	CP-OFDM 256 QAM	51@0	18.174	19.38
77	30	30	656000	3840.0	DFT-s-OFDM PI/2 BPSK	75@0	26.696	28.04
77	30	30	656000	3840.0	DFT-s-OFDM QPSK	75@0	26.689	28.08
77	30	30	656000	3840.0	CP-OFDM QPSK	78@0	27.807	29.25
77	30	30	656000	3840.0	CP-OFDM 16 QAM	78@0	27.853	29.37
77	30	30	656000	3840.0	CP-OFDM 64 QAM	78@0	27.845	29.17
77	30	30	656000	3840.0	CP-OFDM 256 QAM	78@0	27.835	29.27
77	30	40	656000	3840.0	DFT-s-OFDM PI/2 BPSK	100@0	35.67	37.36
77	30	40	656000	3840.0	DFT-s-OFDM QPSK	100@0	35.752	37.44
77	30	40	656000	3840.0	CP-OFDM QPSK	106@0	37.841	39.62
77	30	40	656000	3840.0	CP-OFDM 16 QAM	106@0	37.784	39.2
77	30	40	656000	3840.0	CP-OFDM 64 QAM	106@0	37.779	39.46
77	30	40	656000	3840.0	CP-OFDM 256 QAM	106@0	37.798	39.29
77	30	60	656000	3840.0	DFT-s-OFDM PI/2 BPSK	162@0	57.906	60.01
77	30	60	656000	3840.0	DFT-s-OFDM QPSK	162@0	57.811	59.86
77	30	60	656000	3840.0	CP-OFDM QPSK	162@0	57.768	59.91
77	30	60	656000	3840.0	CP-OFDM 16 QAM	162@0	57.761	59.81
77	30	60	656000	3840.0	CP-OFDM 64 QAM	162@0	57.812	59.83
77	30	60	656000	3840.0	CP-OFDM 256 QAM	162@0	57.812	59.94

77	30	80	656000	3840.0	DFT-s-OFDM PI/2 BPSK	216@0	77.118	79.73
77	30	80	656000	3840.0	DFT-s-OFDM QPSK	216@0	76.957	79.59
77	30	80	656000	3840.0	CP-OFDM QPSK	217@0	77.405	79.93
77	30	80	656000	3840.0	CP-OFDM 16 QAM	217@0	77.539	79.96
77	30	80	656000	3840.0	CP-OFDM 64 QAM	217@0	77.465	80.07
77	30	80	656000	3840.0	CP-OFDM 256 QAM	217@0	77.383	79.96
77	30	100	656000	3840.0	DFT-s-OFDM PI/2 BPSK	270@0	96.41	99.55
77	30	100	656000	3840.0	DFT-s-OFDM QPSK	270@0	96.456	99.51
77	30	100	656000	3840.0	CP-OFDM QPSK	273@0	97.374	100.5
77	30	100	656000	3840.0	CP-OFDM 16 QAM	273@0	97.547	100.5
77	30	100	656000	3840.0	CP-OFDM 64 QAM	273@0	97.273	100.6
77	30	100	656000	3840.0	CP-OFDM 256 QAM	273@0	97.5	100.6

### N77(20M)\_DFT-s-OFDM\_PI\_2-BPSK\_Outer\_Full\_Mid\_CH

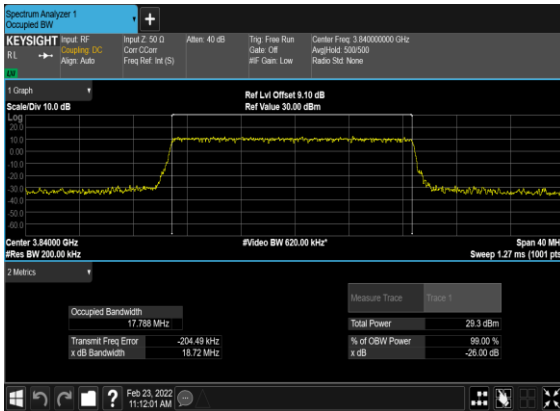

### N77(20M)\_DFT-s-OFDM\_QPSK\_Outer\_Full\_Mid\_CH

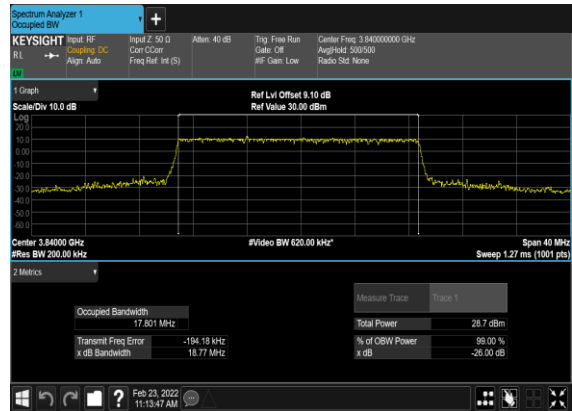

### N77(20M)\_CP-OFDM\_QPSK\_Outer\_Full\_Mid\_CH



### N77(20M)\_CP-OFDM\_16QAM\_Outer\_Full\_Mid\_CH

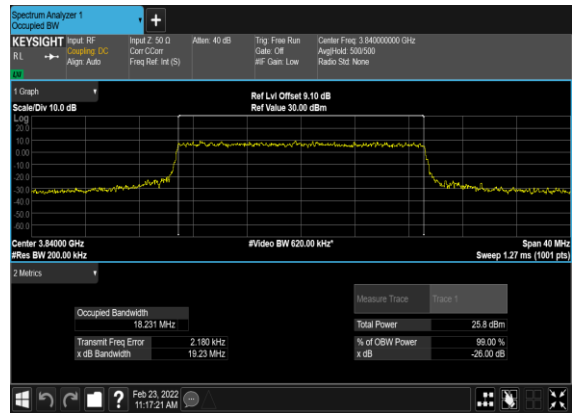

### N77(20M)\_CP-OFDM\_64QAM\_Outer\_Full\_Mid\_CH

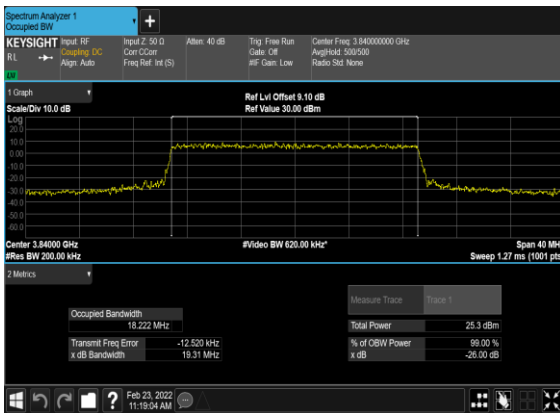

### N77(20M)\_CP-OFDM\_256QAM\_Outer\_Full\_Mid\_CH

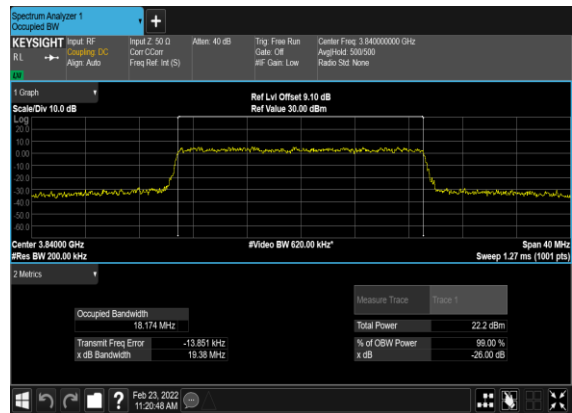



### N77(30M)\_DFT-s-OFDM\_PI\_2- BPSK\_Outer\_Full\_Mid\_CH

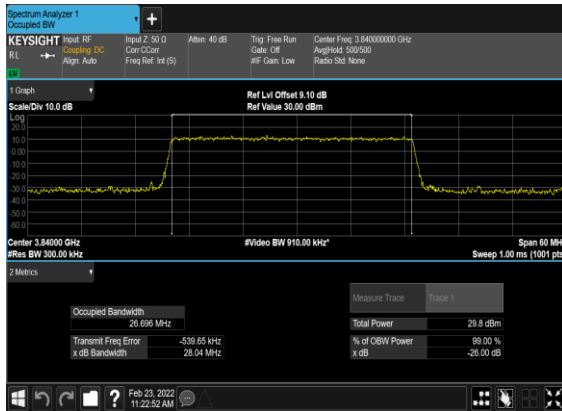

### N77(30M)\_DFT-s- OFDM\_QPSK\_Outer\_Full\_Mid\_CH

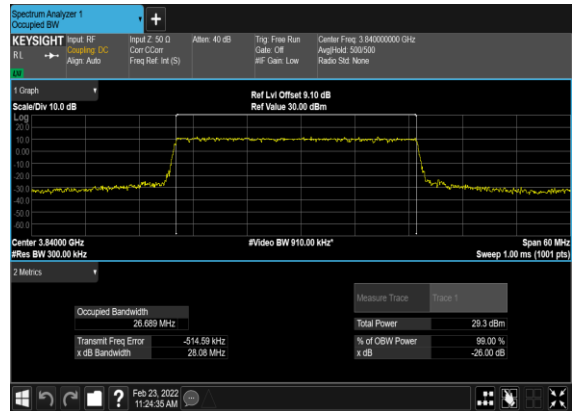

### N77(30M)\_CP- OFDM\_QPSK\_Outer\_Full\_Mid\_CH



### N77(30M)\_CP-OFDM\_16 QAM\_Outer\_Full\_Mid\_CH



### N77(30M)\_CP-OFDM\_64 QAM\_Outer\_Full\_Mid\_CH

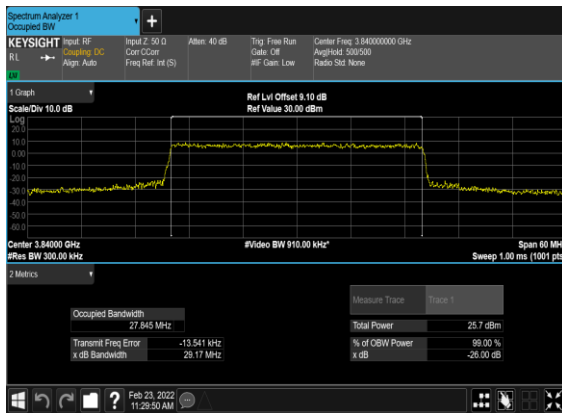

### N77(30M)\_CP-OFDM\_256 QAM\_Outer\_Full\_Mid\_CH

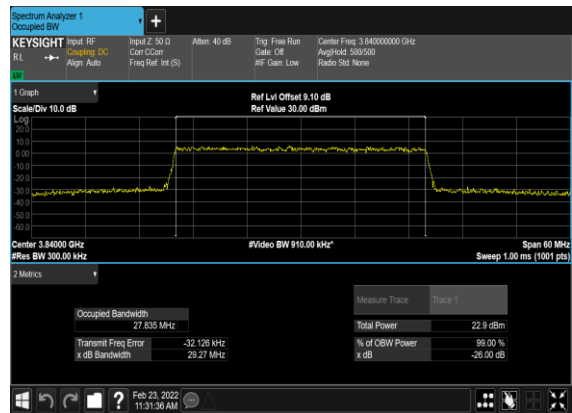

### N77(40M)\_DFT-s-OFDM\_PI\_2- BPSK\_Outer\_Full\_Mid\_CH

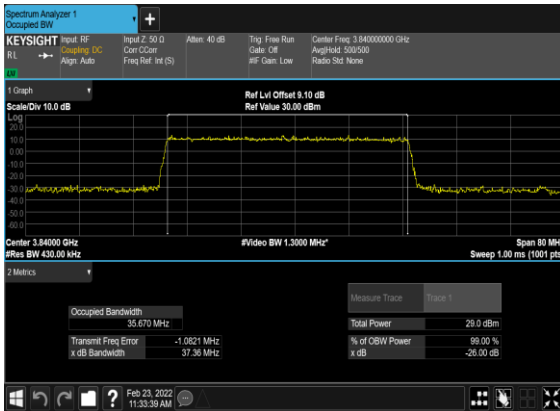

### N77(40M)\_DFT-s- OFDM\_QPSK\_Outer\_Full\_Mid\_CH

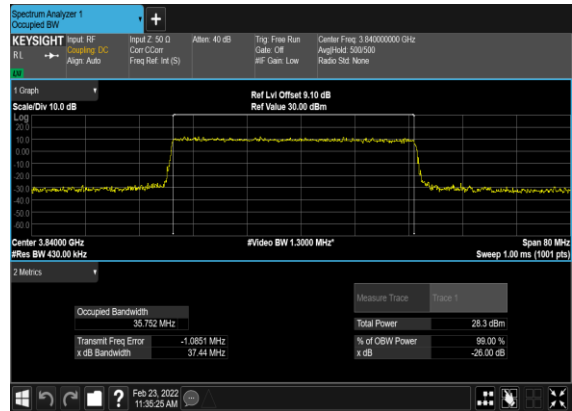

### N77(40M)\_CP- OFDM\_QPSK\_Outer\_Full\_Mid\_CH

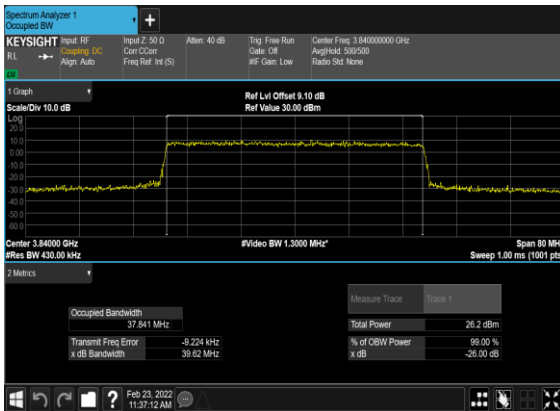

### N77(40M)\_CP-OFDM\_16 QAM\_Outer\_Full\_Mid\_CH

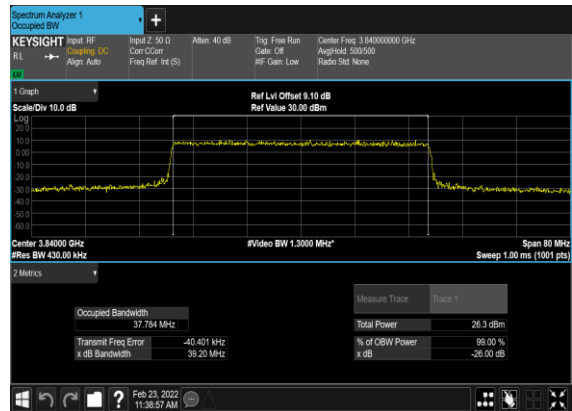

### N77(40M)\_CP-OFDM\_64 QAM\_Outer\_Full\_Mid\_CH

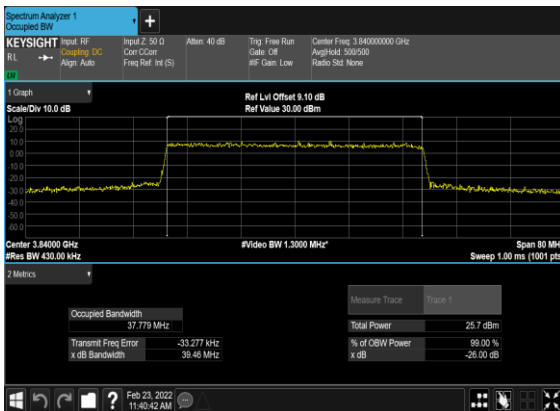

### N77(40M)\_CP-OFDM\_256 QAM\_Outer\_Full\_Mid\_CH

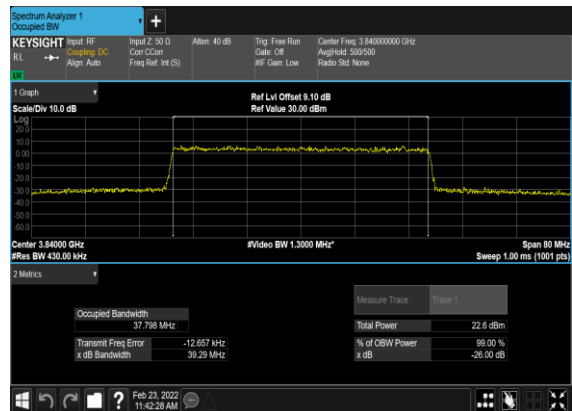

### N77(60M)\_DFT-s-OFDM\_PI\_2-BPSK\_Outer\_Full\_Mid\_CH

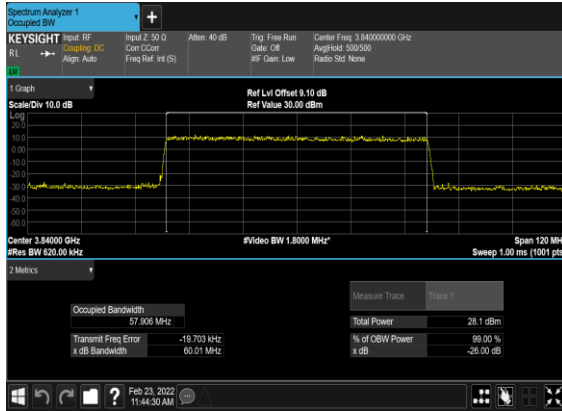

### N77(60M)\_DFT-s-OFDM\_QPSK\_Outer\_Full\_Mid\_CH

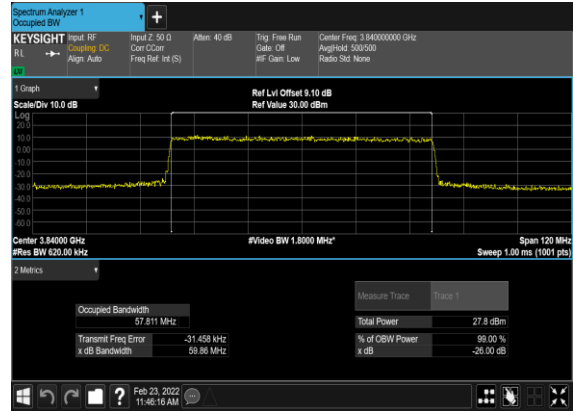

### N77(60M)\_CP-OFDM\_QPSK\_Outer\_Full\_Mid\_CH

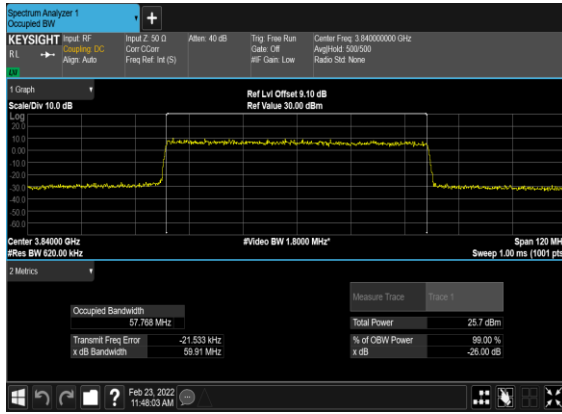

### N77(60M)\_CP-OFDM\_16QAM\_Outer\_Full\_Mid\_CH

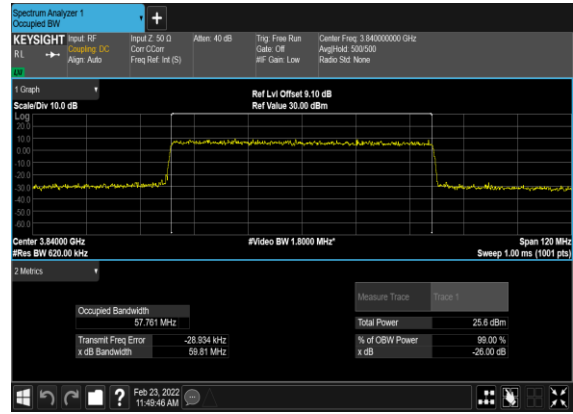

### N77(60M)\_CP-OFDM\_64QAM\_Outer\_Full\_Mid\_CH

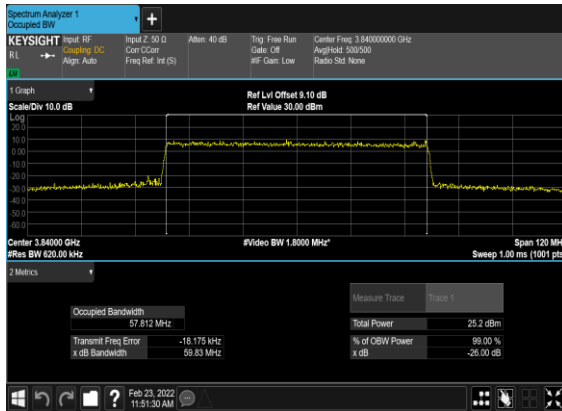

### N77(60M)\_CP-OFDM\_256QAM\_Outer\_Full\_Mid\_CH

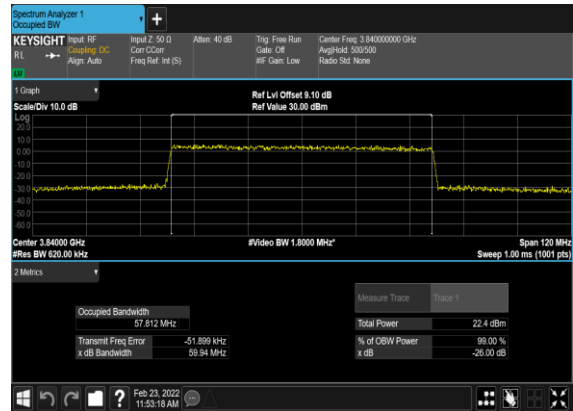

### N77(80M)\_DFT-s-OFDM\_PI\_2-BPSK\_Outer\_Full\_Mid\_CH

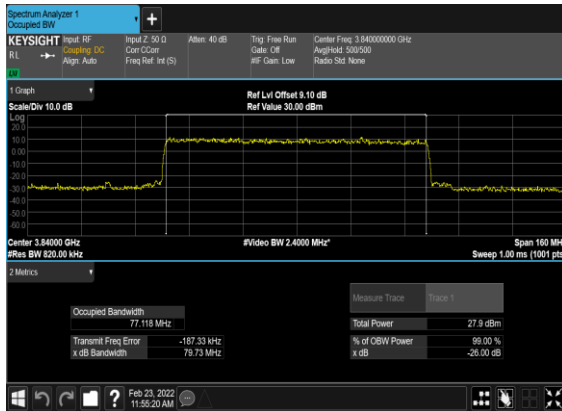

### N77(80M)\_DFT-s-OFDM\_QPSK\_Outer\_Full\_Mid\_CH

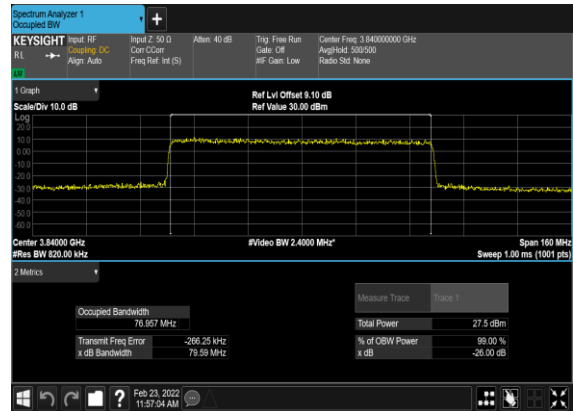

### N77(80M)\_CP-OFDM\_QPSK\_Outer\_Full\_Mid\_CH

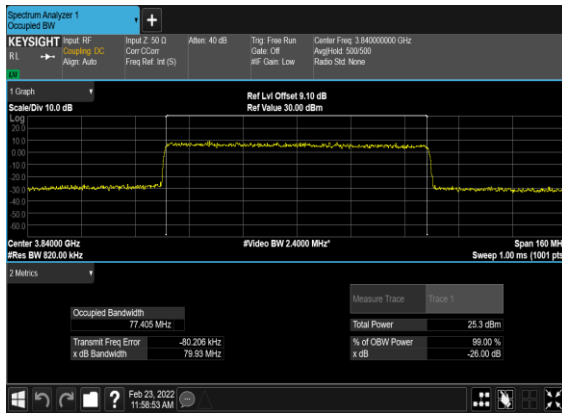

### N77(80M)\_CP-OFDM\_16QAM\_Outer\_Full\_Mid\_CH

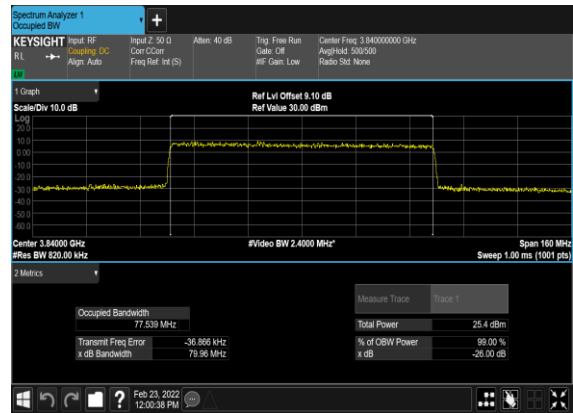

### N77(80M)\_CP-OFDM\_64QAM\_Outer\_Full\_Mid\_CH

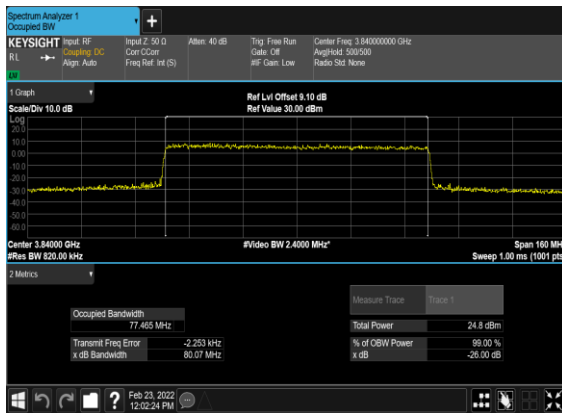

### N77(80M)\_CP-OFDM\_256QAM\_Outer\_Full\_Mid\_CH

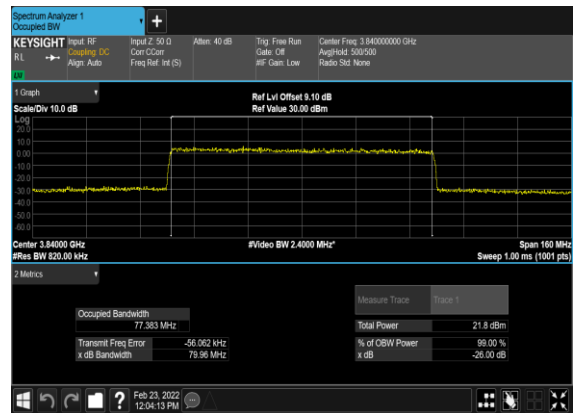

N77(100M)\_DFT-s-OFDM\_PI\_2-  
BPSK\_Outer\_Full\_Mid\_CH

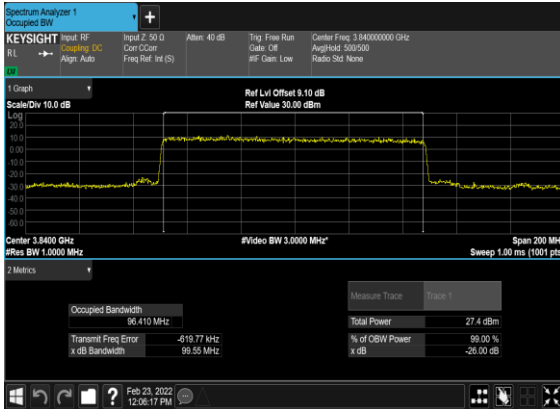

N77(100M)\_DFT-s-  
OFDM\_QPSK\_Outer\_Full\_Mid\_CH



N77(100M)\_CP-  
OFDM\_QPSK\_Outer\_Full\_Mid\_CH

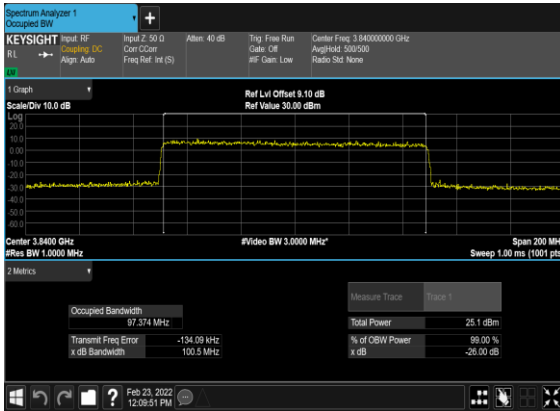

N77(100M)\_CP-OFDM\_16  
QAM\_Outer\_Full\_Mid\_CH

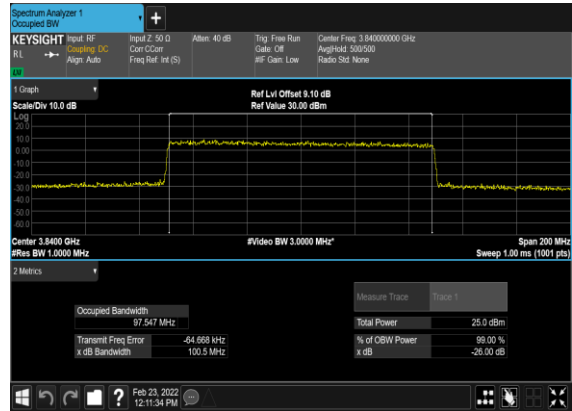

N77(100M)\_CP-OFDM\_64  
QAM\_Outer\_Full\_Mid\_CH

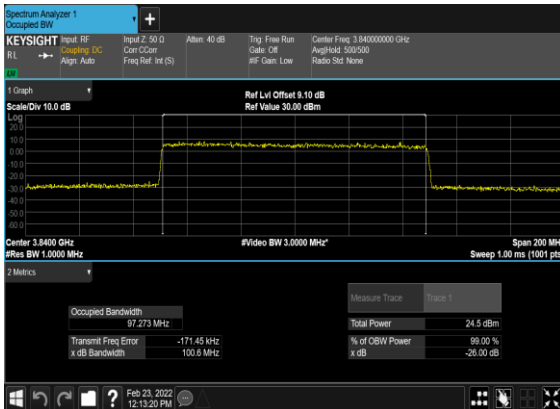

N77(100M)\_CP-OFDM\_256  
QAM\_Outer\_Full\_Mid\_CH

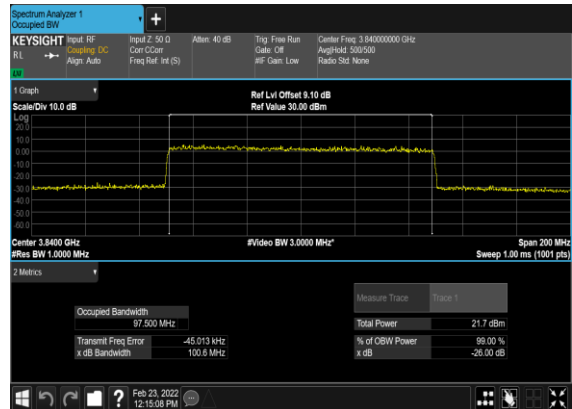

## Conducted Spurious Emissions

NR Band	SCS (kHz)	Bandwidth (MHz)	Arfcn	Freq (MHz)	Modulation	RB	Result	Verdict
77	30	20	647334	3710.01	DFT-s-OFDM BPSK	1@0	see graph	---
77	30	20	647334	3710.01	DFT-s-OFDM BPSK	1@0	see graph	PASS
77	30	20	647334	3710.01	DFT-s-OFDM BPSK	1@0	see graph	PASS
77	30	20	647334	3710.01	DFT-s-OFDM QPSK	1@0	see graph	---
77	30	20	647334	3710.01	DFT-s-OFDM QPSK	1@0	see graph	PASS
77	30	20	647334	3710.01	DFT-s-OFDM QPSK	1@0	see graph	PASS
77	30	20	656000	3840.0	DFT-s-OFDM BPSK	1@0	see graph	---
77	30	20	656000	3840.0	DFT-s-OFDM BPSK	1@0	see graph	PASS
77	30	20	656000	3840.0	DFT-s-OFDM BPSK	1@0	see graph	PASS
77	30	20	656000	3840.0	DFT-s-OFDM QPSK	1@0	see graph	---
77	30	20	656000	3840.0	DFT-s-OFDM QPSK	1@0	see graph	PASS
77	30	20	656000	3840.0	DFT-s-OFDM QPSK	1@0	see graph	PASS
77	30	20	664666	3969.99	DFT-s-OFDM BPSK	1@0	see graph	---
77	30	20	664666	3969.99	DFT-s-OFDM BPSK	1@0	see graph	PASS
77	30	20	664666	3969.99	DFT-s-OFDM BPSK	1@0	see graph	PASS
77	30	20	664666	3969.99	DFT-s-OFDM QPSK	1@0	see graph	---
77	30	20	664666	3969.99	DFT-s-OFDM QPSK	1@0	see graph	PASS
77	30	20	664666	3969.99	DFT-s-OFDM QPSK	1@0	see graph	PASS
77	30	60	648668	3730.02	DFT-s-OFDM BPSK	1@0	see graph	---
77	30	60	648668	3730.02	DFT-s-OFDM BPSK	1@0	see graph	PASS
77	30	60	648668	3730.02	DFT-s-OFDM BPSK	1@0	see graph	PASS
77	30	60	648668	3730.02	DFT-s-OFDM QPSK	1@0	see graph	---

77	30	60	648668	3730.02	DFT-s-OFDM QPSK	1@0	see graph	PASS
77	30	60	648668	3730.02	DFT-s-OFDM QPSK	1@0	see graph	PASS
77	30	60	656000	3840.0	DFT-s-OFDM BPSK	1@0	see graph	---
77	30	60	656000	3840.0	DFT-s-OFDM BPSK	1@0	see graph	PASS
77	30	60	656000	3840.0	DFT-s-OFDM BPSK	1@0	see graph	PASS
77	30	60	656000	3840.0	DFT-s-OFDM QPSK	1@0	see graph	---
77	30	60	656000	3840.0	DFT-s-OFDM QPSK	1@0	see graph	PASS
77	30	60	656000	3840.0	DFT-s-OFDM QPSK	1@0	see graph	PASS
77	30	60	663332	3949.98	DFT-s-OFDM BPSK	1@0	see graph	---
77	30	60	663332	3949.98	DFT-s-OFDM BPSK	1@0	see graph	PASS
77	30	60	663332	3949.98	DFT-s-OFDM BPSK	1@0	see graph	PASS
77	30	60	663332	3949.98	DFT-s-OFDM QPSK	1@0	see graph	---
77	30	60	663332	3949.98	DFT-s-OFDM QPSK	1@0	see graph	PASS
77	30	60	663332	3949.98	DFT-s-OFDM QPSK	1@0	see graph	PASS
77	30	100	650000	3750.0	DFT-s-OFDM BPSK	1@0	see graph	---
77	30	100	650000	3750.0	DFT-s-OFDM BPSK	1@0	see graph	PASS
77	30	100	650000	3750.0	DFT-s-OFDM BPSK	1@0	see graph	PASS
77	30	100	650000	3750.0	DFT-s-OFDM QPSK	1@0	see graph	---
77	30	100	650000	3750.0	DFT-s-OFDM QPSK	1@0	see graph	PASS
77	30	100	650000	3750.0	DFT-s-OFDM QPSK	1@0	see graph	PASS
77	30	100	656000	3840.0	DFT-s-OFDM BPSK	1@0	see graph	---
77	30	100	656000	3840.0	DFT-s-OFDM BPSK	1@0	see graph	PASS
77	30	100	656000	3840.0	DFT-s-OFDM BPSK	1@0	see graph	PASS
77	30	100	656000	3840.0	DFT-s-OFDM QPSK	1@0	see graph	---

<b>77</b>	30	100	656000	3840.0	DFT-s-OFDM QPSK	1@0	see graph	<b>PASS</b>
<b>77</b>	30	100	656000	3840.0	DFT-s-OFDM QPSK	1@0	see graph	<b>PASS</b>
<b>77</b>	30	100	662000	3930.0	DFT-s-OFDM BPSK	1@0	see graph	---
<b>77</b>	30	100	662000	3930.0	DFT-s-OFDM BPSK	1@0	see graph	<b>PASS</b>
<b>77</b>	30	100	662000	3930.0	DFT-s-OFDM BPSK	1@0	see graph	<b>PASS</b>
<b>77</b>	30	100	662000	3930.0	DFT-s-OFDM QPSK	1@0	see graph	---
<b>77</b>	30	100	662000	3930.0	DFT-s-OFDM QPSK	1@0	see graph	<b>PASS</b>
<b>77</b>	30	100	662000	3930.0	DFT-s-OFDM QPSK	1@0	see graph	<b>PASS</b>



N77(20M)\_DFT-s-OFDM\_BPSK\_Edge\_1RB\_Left\_Low\_CH



N77(20M)\_DFT-s-OFDM\_BPSK\_Edge\_1RB\_Left\_Low\_CH

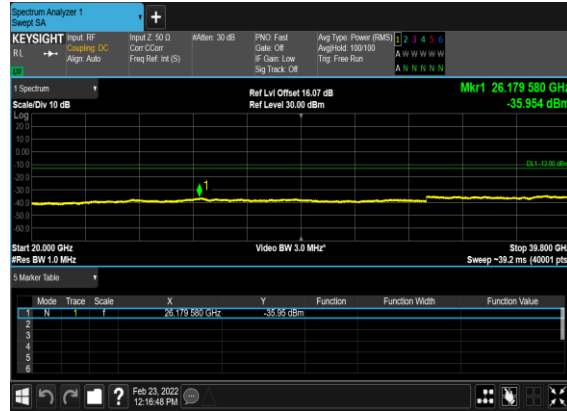

N77(20M)\_DFT-s-OFDM\_QPSK\_Edge\_1RB\_Left\_Low\_CH



N77(20M)\_DFT-s-OFDM\_QPSK\_Edge\_1RB\_Left\_Low\_CH

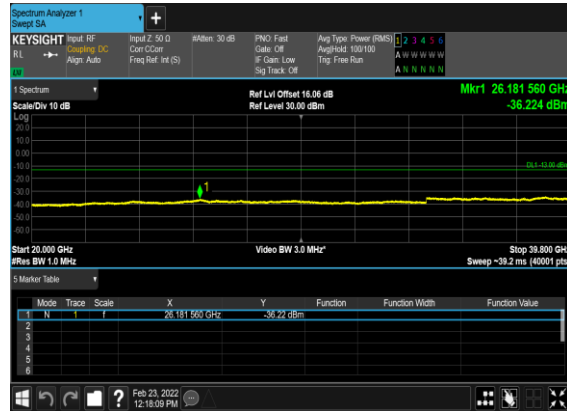

N77(20M)\_DFT-s-OFDM\_BPSK\_Edge\_1RB\_Left\_Mid\_CH

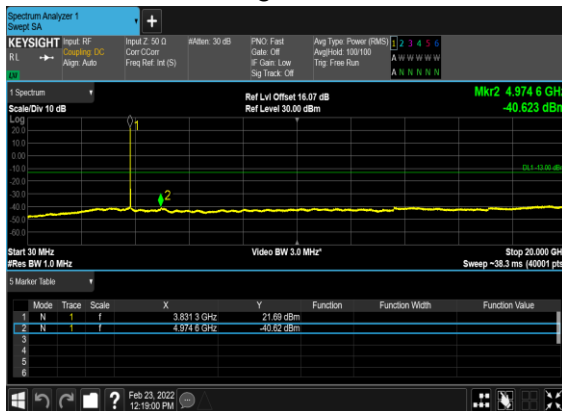

N77(20M)\_DFT-s-OFDM\_BPSK\_Edge\_1RB\_Left\_Mid\_CH

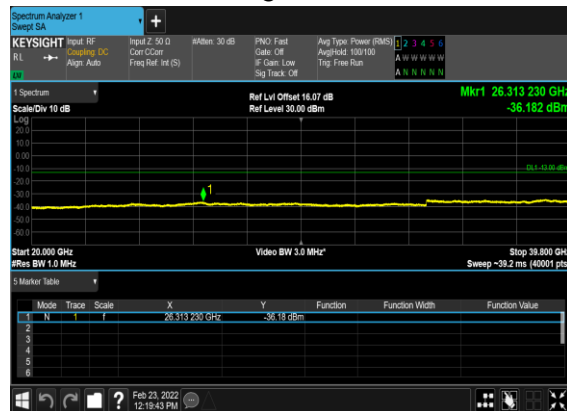

### N77(20M)\_DFT-s-OFDM\_QPSK\_Edge\_1RB\_Left\_Mid\_CH

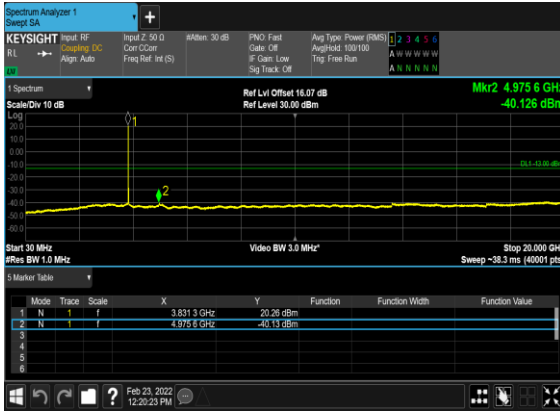

### N77(20M)\_DFT-s-OFDM\_QPSK\_Edge\_1RB\_Left\_Mid\_CH

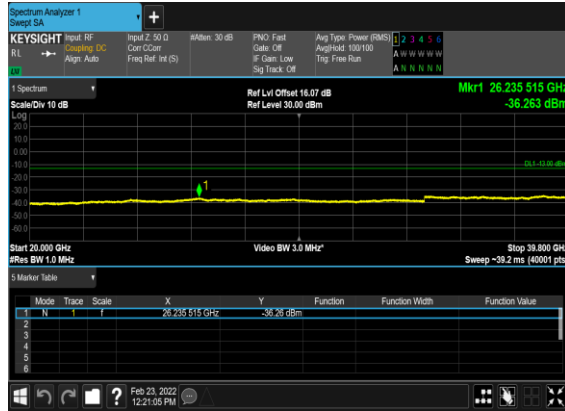

### N77(20M)\_DFT-s-OFDM\_BPSK\_Edge\_1RB\_Left\_High\_CH

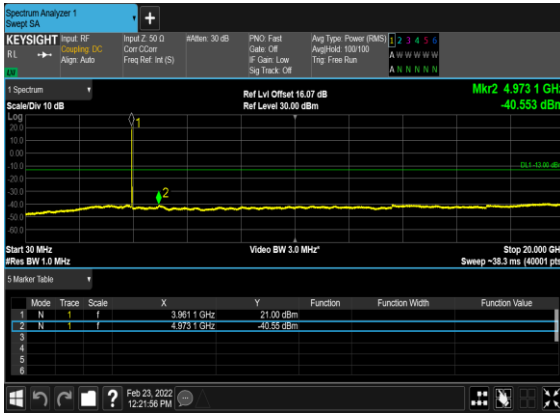

### N77(20M)\_DFT-s-OFDM\_BPSK\_Edge\_1RB\_Left\_High\_CH

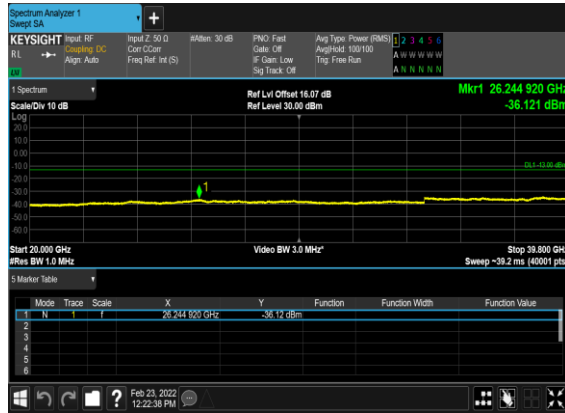

### N77(20M)\_DFT-s-OFDM\_QPSK\_Edge\_1RB\_Left\_High\_CH



### N77(20M)\_DFT-s-OFDM\_QPSK\_Edge\_1RB\_Left\_High\_CH

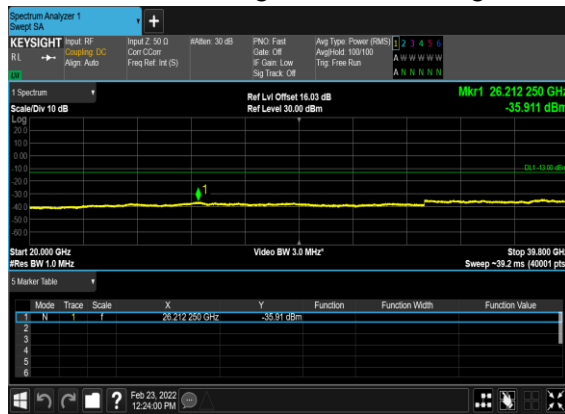

N77(60M)\_DFT-s-OFDM\_BPSK\_Edge\_1RB\_Left\_Low\_CH

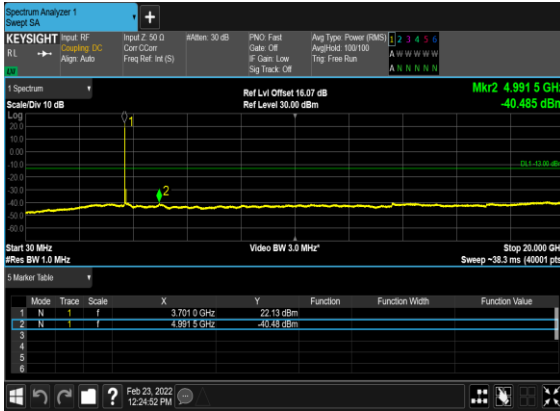

N77(60M)\_DFT-s-OFDM\_BPSK\_Edge\_1RB\_Left\_Low\_CH

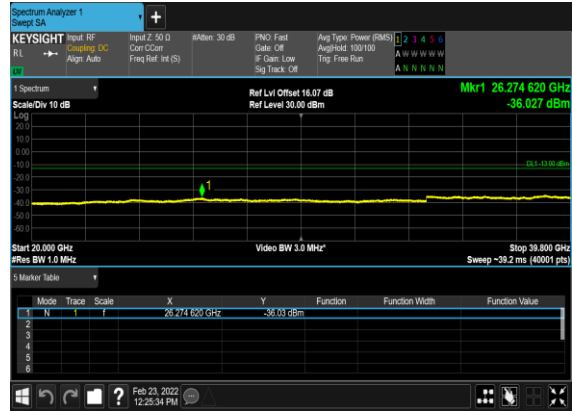

N77(60M)\_DFT-s-OFDM\_QPSK\_Edge\_1RB\_Left\_Low\_CH



N77(60M)\_DFT-s-OFDM\_QPSK\_Edge\_1RB\_Left\_Low\_CH

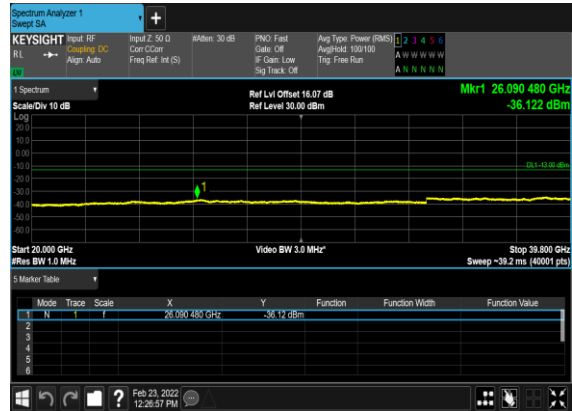

N77(60M)\_DFT-s-OFDM\_BPSK\_Edge\_1RB\_Left\_Mid\_CH

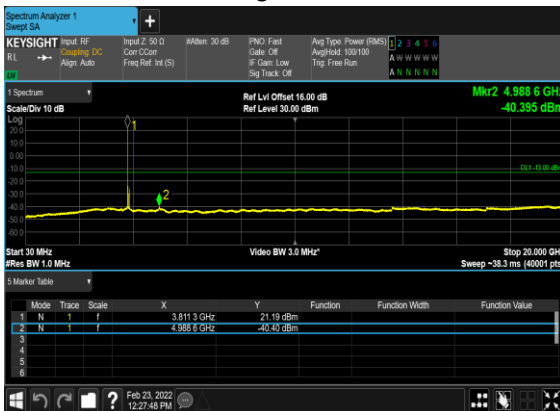

N77(60M)\_DFT-s-OFDM\_BPSK\_Edge\_1RB\_Left\_Mid\_CH

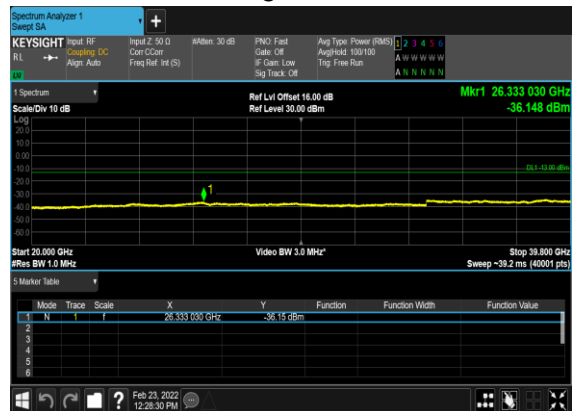

### N77(60M)\_DFT-s-OFDM\_QPSK\_Edge\_1RB\_Left\_Mid\_CH

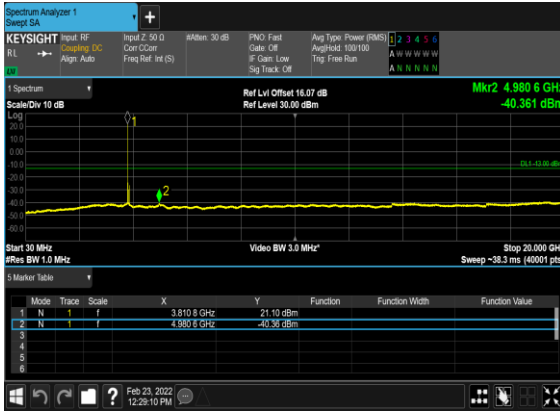

### N77(60M)\_DFT-s-OFDM\_QPSK\_Edge\_1RB\_Left\_Mid\_CH

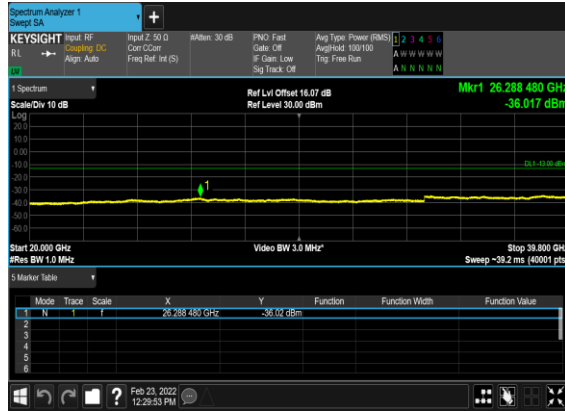

### N77(60M)\_DFT-s-OFDM\_BPSK\_Edge\_1RB\_Left\_High\_CH



### N77(60M)\_DFT-s-OFDM\_BPSK\_Edge\_1RB\_Left\_High\_CH

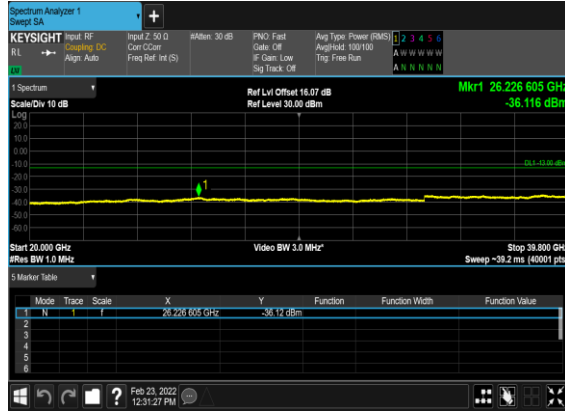

### N77(60M)\_DFT-s-OFDM\_QPSK\_Edge\_1RB\_Left\_High\_CH

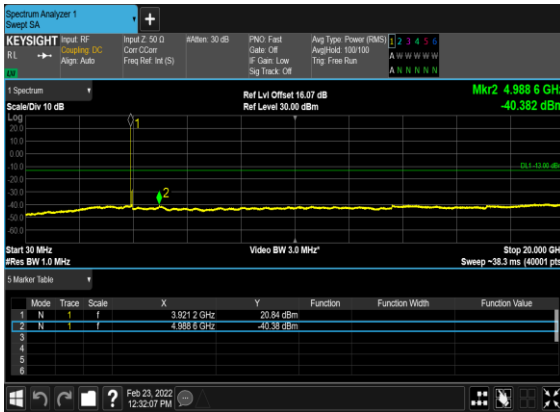

### N77(60M)\_DFT-s-OFDM\_QPSK\_Edge\_1RB\_Left\_High\_CH

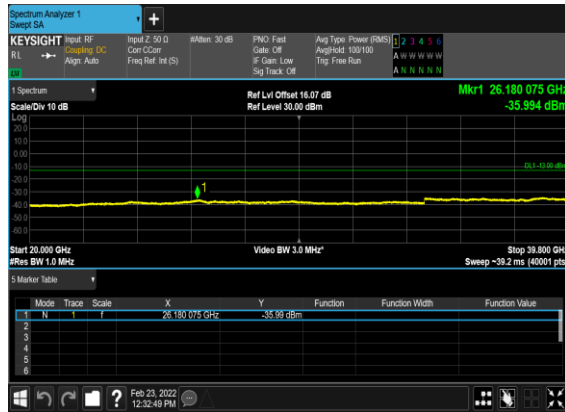

N77(100M)\_DFT-s-OFDM\_BPSK\_Edge\_1RB\_Left\_Low\_CH

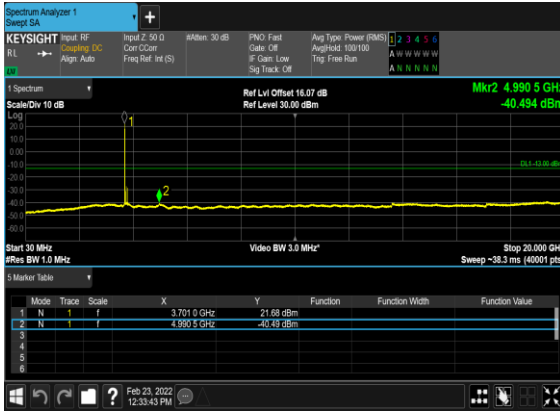

N77(100M)\_DFT-s-OFDM\_BPSK\_Edge\_1RB\_Left\_Low\_CH

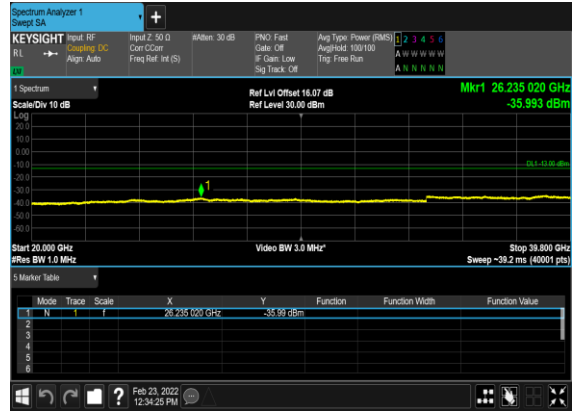

N77(100M)\_DFT-s-OFDM\_QPSK\_Edge\_1RB\_Left\_Low\_CH



N77(100M)\_DFT-s-OFDM\_QPSK\_Edge\_1RB\_Left\_Low\_CH

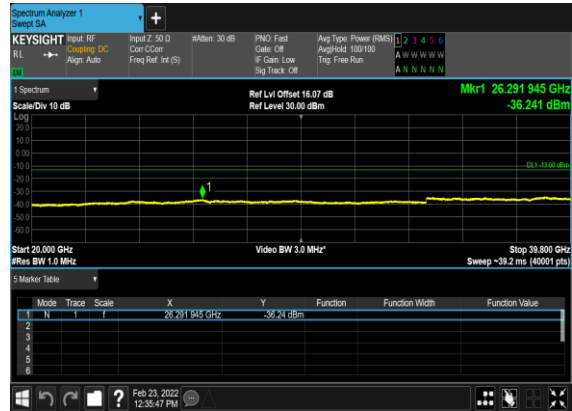

N77(100M)\_DFT-s-OFDM\_BPSK\_Edge\_1RB\_Left\_Mid\_CH

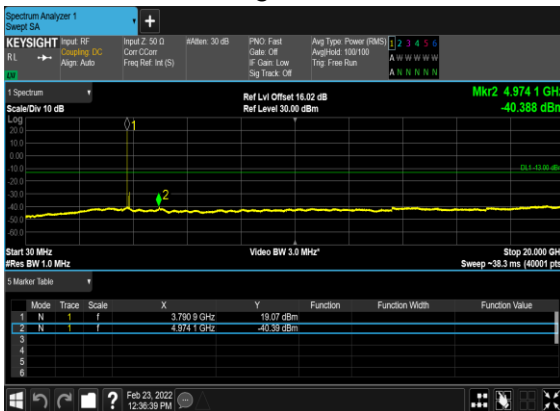

N77(100M)\_DFT-s-OFDM\_BPSK\_Edge\_1RB\_Left\_Mid\_CH

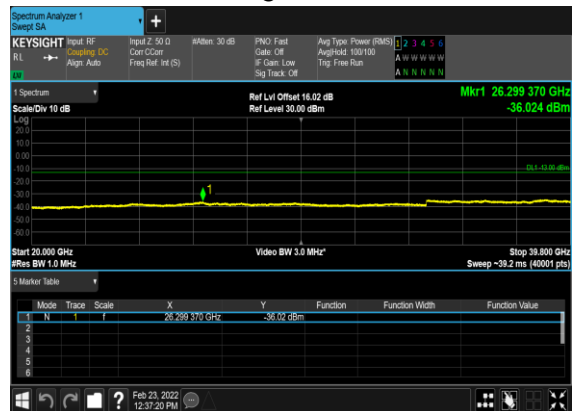

### N77(100M)\_DFT-s-OFDM\_QPSK\_Edge\_1RB\_Left\_Mid\_CH

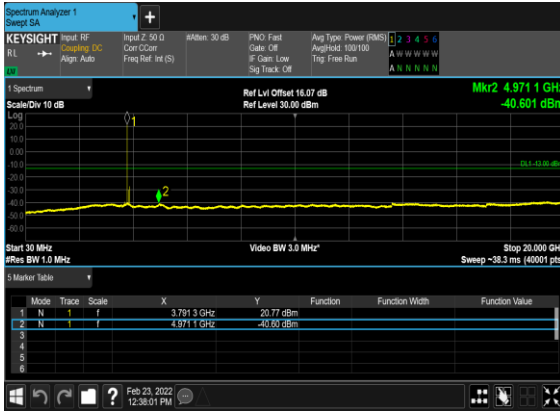

### N77(100M)\_DFT-s-OFDM\_QPSK\_Edge\_1RB\_Left\_Mid\_CH

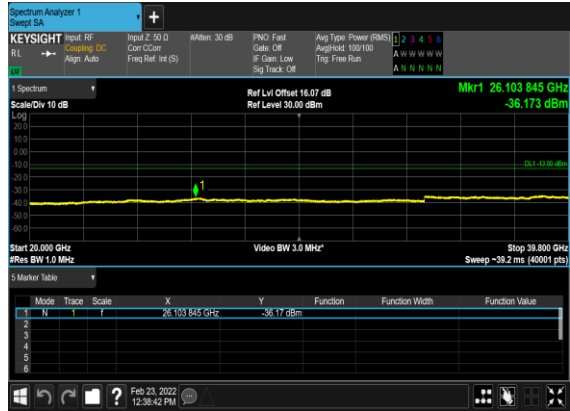

### N77(100M)\_DFT-s-OFDM\_BPSK\_Edge\_1RB\_Left\_High\_CH

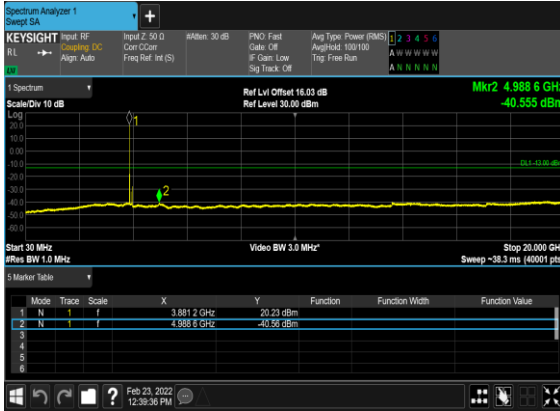

### N77(100M)\_DFT-s-OFDM\_BPSK\_Edge\_1RB\_Left\_High\_CH

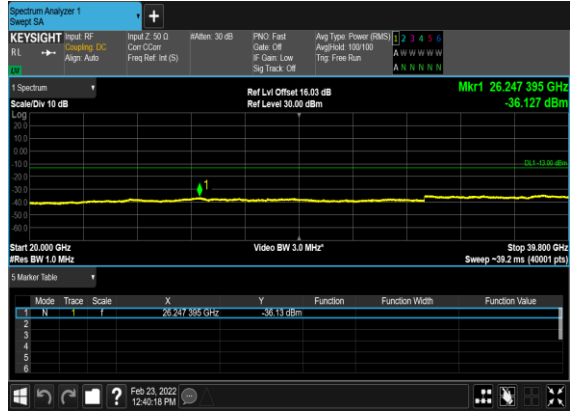

### N77(100M)\_DFT-s-OFDM\_QPSK\_Edge\_1RB\_Left\_High\_CH

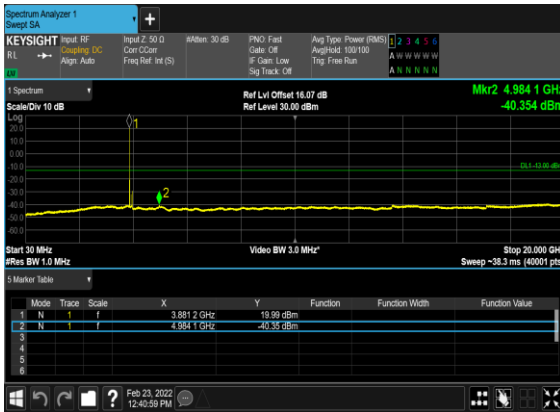

### N77(100M)\_DFT-s-OFDM\_QPSK\_Edge\_1RB\_Left\_High\_CH

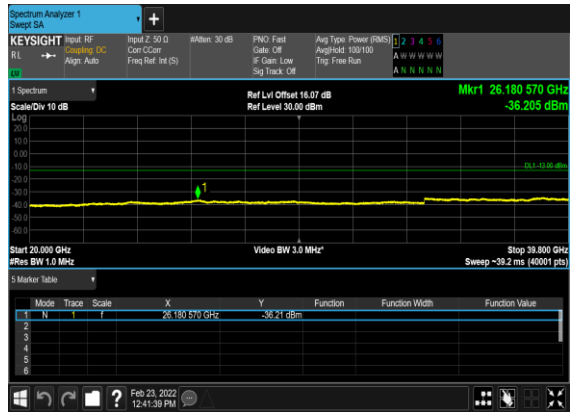

## Conducted Band Edge

NR Band	SCS (kHz)	Bandwidth (MHz)	Arfcn	Freq (MHz)	Modulation	RB	Result	Verdict
77	30	20	647334	3710.01	DFT-s-OFDM BPSK	1@0	see graph	PASS
77	30	20	647334	3710.01	DFT-s-OFDM QPSK	1@0	see graph	PASS
77	30	20	647334	3710.01	DFT-s-OFDM BPSK	50@0	see graph	PASS
77	30	20	647334	3710.01	DFT-s-OFDM QPSK	50@0	see graph	PASS
77	30	20	664666	3969.99	DFT-s-OFDM BPSK	1@50	see graph	PASS
77	30	20	664666	3969.99	DFT-s-OFDM QPSK	1@50	see graph	PASS
77	30	20	664666	3969.99	DFT-s-OFDM BPSK	50@0	see graph	PASS
77	30	20	664666	3969.99	DFT-s-OFDM QPSK	50@0	see graph	PASS
77	30	60	648668	3730.02	DFT-s-OFDM BPSK	1@0	see graph	PASS
77	30	60	648668	3730.02	DFT-s-OFDM QPSK	1@0	see graph	PASS
77	30	60	648668	3730.02	DFT-s-OFDM BPSK	162@0	see graph	PASS
77	30	60	648668	3730.02	DFT-s-OFDM QPSK	162@0	see graph	PASS
77	30	60	663332	3949.98	DFT-s-OFDM BPSK	1@161	see graph	PASS
77	30	60	663332	3949.98	DFT-s-OFDM QPSK	1@161	see graph	PASS
77	30	60	663332	3949.98	DFT-s-OFDM BPSK	162@0	see graph	PASS
77	30	60	663332	3949.98	DFT-s-OFDM QPSK	162@0	see graph	PASS
77	30	100	650000	3750.0	DFT-s-OFDM BPSK	1@0	see graph	PASS
77	30	100	650000	3750.0	DFT-s-OFDM QPSK	1@0	see graph	PASS
77	30	100	650000	3750.0	DFT-s-OFDM BPSK	270@0	see graph	PASS
77	30	100	650000	3750.0	DFT-s-OFDM QPSK	270@0	see graph	PASS
77	30	100	662000	3930.0	DFT-s-OFDM BPSK	1@272	see graph	PASS
77	30	100	662000	3930.0	DFT-s-OFDM QPSK	1@272	see graph	PASS

<b>77</b>	30	100	662000	3930.0	DFT-s-OFDM BPSK	270@0	see graph	<b>PASS</b>
<b>77</b>	30	100	662000	3930.0	DFT-s-OFDM QPSK	270@0	see graph	<b>PASS</b>



N77(20M)\_DFT-s-  
OFDM\_BPSK\_Edge\_1RB\_Left\_Low\_CH



N77(20M)\_DFT-s-  
OFDM\_QPSK\_Edge\_1RB\_Left\_Low\_CH

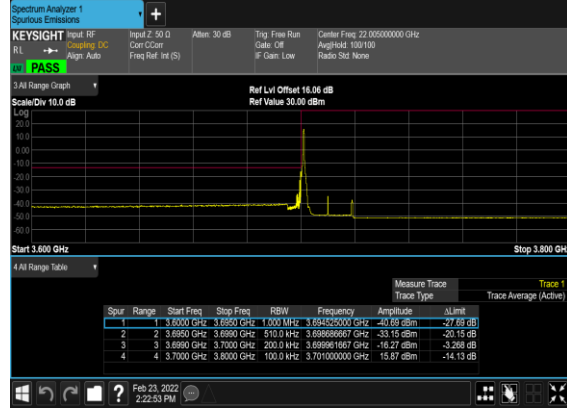

N77(20M)\_DFT-s-  
OFDM\_BPSK\_Outer\_Full\_Low\_CH

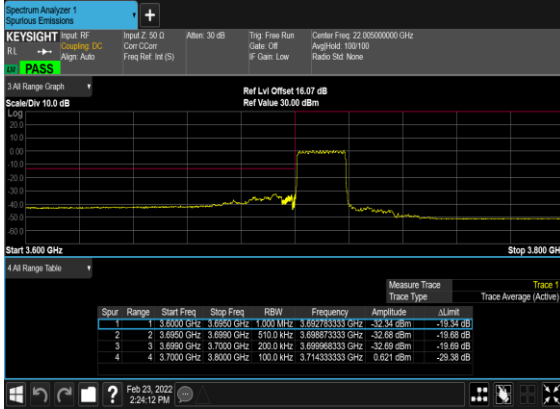

N77(20M)\_DFT-s-  
OFDM\_QPSK\_Outer\_Full\_Low\_CH

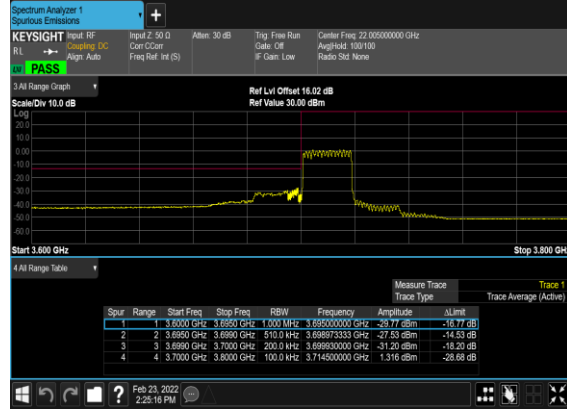

N77(20M)\_DFT-s-  
OFDM\_BPSK\_Edge\_1RB\_Right\_High\_CH



N77(20M)\_DFT-s-  
OFDM\_QPSK\_Edge\_1RB\_Right\_High\_CH

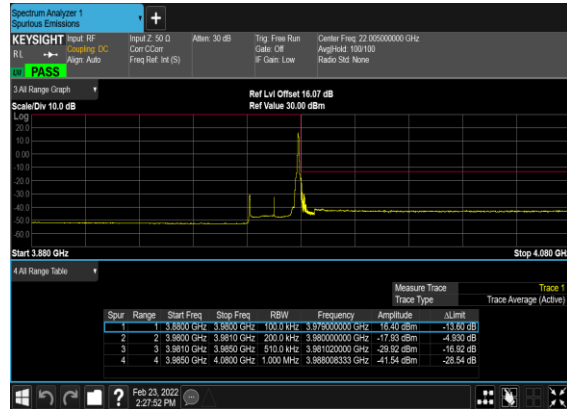

### N77(20M)\_DFT-s-OFDM\_BPSK\_Outer\_Full\_High\_CH

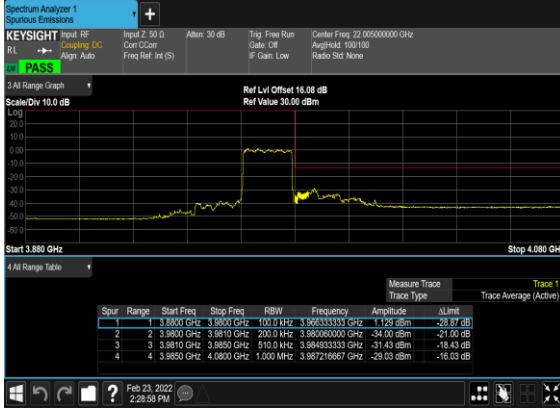

### N77(20M)\_DFT-s-OFDM\_QPSK\_Outer\_Full\_High\_CH



### N77(60M)\_DFT-s-OFDM\_BPSK\_Edge\_1RB\_Left\_Low\_CH

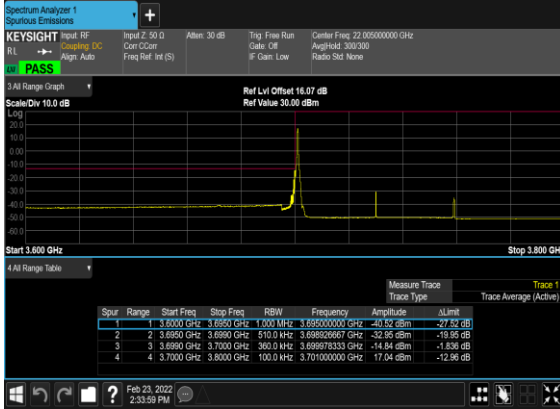

### N77(60M)\_DFT-s-OFDM\_QPSK\_Edge\_1RB\_Left\_Low\_CH

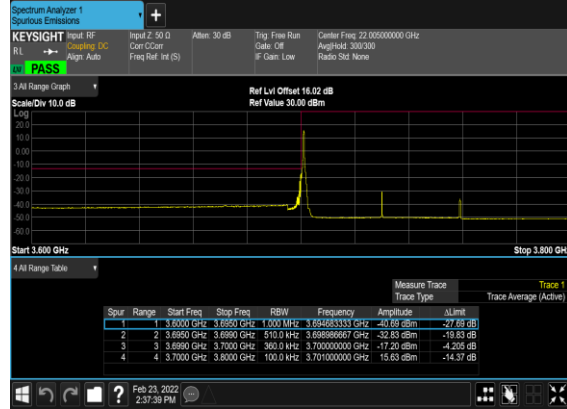

### N77(60M)\_DFT-s-OFDM\_BPSK\_Outer\_Full\_Low\_CH

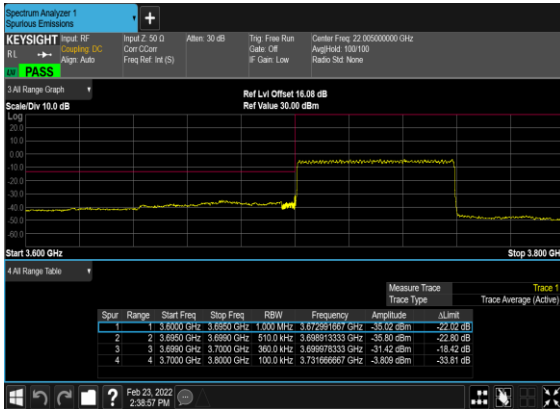

### N77(60M)\_DFT-s-OFDM\_QPSK\_Outer\_Full\_Low\_CH

