



FCC RADIO TEST REPORT

FCC ID : UZ7TC15BK
Equipment : Touch computer
Brand Name : Zebra
Model Name : TC15BK
Applicant : Zebra Technologies Corporation
1 Zebra Plaza, Holtsville, NY 11742
Manufacturer : Zebra Technologies Corporation
1 Zebra Plaza, Holtsville, NY 11742
Standard : FCC Part 15 Subpart C §15.225

The product was received on Dec. 20, 2021 and testing was performed from Mar. 12, 2022 to Mar. 22, 2022. We, Sporton International Inc. Wensan Laboratory, would like to declare that the tested sample has been evaluated in accordance with the test procedures and has been in compliance with the applicable technical standards.

The test results in this report apply exclusively to the tested model / sample. Without written approval from Sporton International Inc. Wensan Laboratory, the test report shall not be reproduced except in full.

Approved by: Louis Wu

Sporton International Inc. Wensan Laboratory

No.58, Aly. 75, Ln. 564, Wenhua 3rd, Rd., Guishan Dist., Taoyuan City 333010, Taiwan (R.O.C.)



Table of Contents

History of this test report	3
Summary of Test Result	4
1. General Description	5
1.1 Product Feature of Equipment Under Test	5
1.2 Product Specification of Equipment Under Test	5
1.3 Modification of EUT	6
1.4 Testing Location	6
1.5 Applicable Standards.....	7
2. Test Configuration of Equipment Under Test	8
2.1 Descriptions of Test Mode	8
2.2 Connection Diagram of Test System	9
2.3 Table for Supporting Units	10
2.4 EUT Operation Test Setup	10
3. Test Results	11
3.1 AC Power Line Conducted Emissions Measurement	11
3.2 20dB and 99% OBW Spectrum Bandwidth Measurement.....	13
3.3 Frequency Stability Measurement	14
3.4 Field Strength of Fundamental Emissions and Mask Measurement.....	15
3.5 Radiated Emissions Measurement	17
3.6 Antenna Requirements.....	20
4. List of Measuring Equipment	21
5. Uncertainty of Evaluation	22
Appendix A. Test Results of Conducted Emission Test	
Appendix B. Test Results of Near Field Test Items	
B1. Test Result of 20dB Spectrum Bandwidth	
B2. Test Result of Frequency Stability	
Appendix C. Test Results of Radiated Test Items	
C1. Test Result of Field Strength of Fundamental Emissions	
C2. Results of Radiated Emissions (9 kHz~30MHz)	
C3. Results of Radiated Emissions (30MHz~1GHz)	
Appendix D. Setup Photographs	



Summary of Test Result

Report Clause	Ref Std. Clause	Test Items	Result (PASS/FAIL)	Remark
3.1	15.207	AC Power Line Conducted Emissions	Pass	5.57 dB under the limit at 13.560MHz
3.2	15.215(c)	20dB Spectrum Bandwidth	Pass	-
	2.1049	99% OBW Spectrum Bandwidth	Reporting only	-
3.3	15.225(e)	Frequency Stability	Pass	-
3.4	15.225(a)(b)(c)	Field Strength of Fundamental Emissions	Pass	Max level 25.46 dB μ V/m at 13.560 MHz
3.5	15.225(d) 15.209	Radiated Spurious Emissions	Pass	3.45 dB under the limit at 40.670MHz
3.6	15.203	Antenna Requirements	Pass	-

Declaration of Conformity:

1. The test results (PASS/FAIL) with all measurement uncertainty excluded are presented in accordance with the regulation limits or requirements declared by manufacturers. It's means measurement values may risk exceeding the limit of regulation standards, if measurement uncertainty is include in test results.
2. The measurement uncertainty please refer to this report "Uncertainty of Evaluation".

Comments and Explanations:

The product specifications of the EUT presented in the report are declared by the manufacturer who shall take full responsibility for the authenticity.

Reviewed by: Keven Cheng

Report Producer: Clio Lo



1. General Description

1.1 Product Feature of Equipment Under Test

Product Feature	
Equipment	Touch computer
Brand Name	Zebra
Model Name	TC15BK
FCC ID	UZ7TC15BK
Sample 1	Scanner(SE4710)
Sample 2	Scanner(SE4100)
EUT supports Radios application	GSM/EGPRS/WCDMA/HSPA/LTE/5G NR/NFC/GNSS WLAN 11a/b/g/n HT20/HT40 WLAN 11ac VHT20/VHT40/VHT80 Bluetooth BR/EDR/LE
HW Version	EV2.4
SW Version	Groot-userdebug11 11-06-29.00-RG-U000-PRD-GRT FX3
MFD	26JAN22
EUT Stage	Identical Prototype

Remark: The EUT's information above is declared by manufacturer.

Specification of Accessories				
AC Adapter	Brand Name	Zebra	Part Number	PWR-WUA5V12W0US
Battery 1	Brand Name	Zebra	Model Number	BT-000454
			Part Number	BT-000454-20
Battery 2	Brand Name	Zebra	Model Number	BT-000454
			Part Number	BT-000454-70
Earphone	Brand Name	Zebra	Part Number	HDST-35MM-PTVP-01
USB Cable (Type C to Type A)	Brand Name	Zebra	Part Number	CBL-TC5X-USBC2A-01
Type C-Audio Cable (Type C to 3.5mm)	Brand Name	Zebra	Part Number	ADP-USBC-35MM1-01

1.2 Product Specification of Equipment Under Test

Product Specification is subject to this standard	
Tx/Rx Frequency Range	13.553 ~ 13.567MHz
Channel Number	1
20dBW	2.64 KHz
99%OBW	2.24 KHz
Antenna Type	Loop Antenna
Type of Modulation	ASK

Remark: The above EUT's information is declared by manufacturer. Please refer to Comments and Explanations in report summary.



1.3 Modification of EUT

No modifications made to the EUT during the testing.

1.4 Testing Location

Test Site	Sporton International Inc. EMC & Wireless Communications Laboratory	
Test Site Location	No.52, Huaya 1st Rd., Guishan Dist., Taoyuan City 333, Taiwan (R.O.C.) TEL: +886-3-327-3456 FAX: +886-3-328-4978	
Test Site No.	Sporton Site No.	
	TH03-HY (TAF Code: 1190)	
Test Engineer	Oscar Chi	
Temperature	22~24°C	
Relative Humidity	53~55%	
Remark	The Conducted test item subcontracted to Sporton International Inc. EMC & Wireless Communications Laboratory.	

Note: The test site complies with ANSI C63.4 2014 requirement.

Test Site	Sporton International Inc. Wensan Laboratory	
Test Site Location	No.58, Aly. 75, Ln. 564, Wenhua 3rd, Rd., Guishan Dist., Taoyuan City 333010, Taiwan (R.O.C.) TEL: +886-3-327-0868 FAX: +886-3-327-0855	
Test Site No.	Sporton Site No.	
	CO07-HY	03CH11-HY
Test Engineer	Louis Chung	Fu Chen and Troye Hsieh
Temperature	24.6~26.3°C	20.5~21.7°C
Relative Humidity	48.2~52.7%	57.6~66.6%

Note: The test site complies with ANSI C63.4 2014 requirement.

FCC designation No.: TW1190 and TW3786



1.5 Applicable Standards

According to the specifications declared by the manufacturer, the EUT must comply with the requirements of the following standards:

- ♦ FCC Part 15 Subpart C §15.225
- ♦ FCC KDB 414788 D01 Radiated Test Site v01r01
- ♦ ANSI C63.10-2013

Remark:

1. All the test items were validated and recorded in accordance with the standards without any modification during the testing.
2. The TAF code is not including all the FCC KDB listed without accreditation.
3. This EUT has also been tested and complied with the requirements of FCC Part 15, Subpart B, recorded in a separate test report.



2. Test Configuration of Equipment Under Test

2.1 Descriptions of Test Mode

Investigation has been done on all the possible configurations.

The following table is a list of the test modes shown in this test report.

Test Items	
AC Power Line Conducted Emissions	Field Strength of Fundamental Emissions
20dB Spectrum Bandwidth	Frequency Stability
Radiated Emissions 9kHz~30MHz	Radiated Emissions 30MHz~1GHz

The EUT pre-scanned in reader mode with NFC tag (four NFC type A, B, F, V) and without reading tag. Based on the highest field strength of fundamental and spurious emissions, the worst case type (type F) was recorded in this report.

The measured emission level of the EUT was maximized by rotating the EUT on a turntable, adjusting the orientation of the EUT and EUT antenna in three orthogonal axis (X: flat, Y: portrait, Z: landscape), and adjusting the measurement antenna orientation, following C63.10 exploratory test procedures and find Z plane as worst plane.

Test Cases	
AC Conducted Emission	Mode 1 : NFC Link + USB Cable (CBL-TC5X-USBC2A-01) (Charging from Adaptor (PWR-WUA5V12W0US)) + Battery 1 (LIFUN) (BT-000454) for Sample 1
Remark: For Radiated Test Cases, the tests were performed with Battery 1 and Sample1.	

2.2 Connection Diagram of Test System

<AC Conducted Emission Mode>

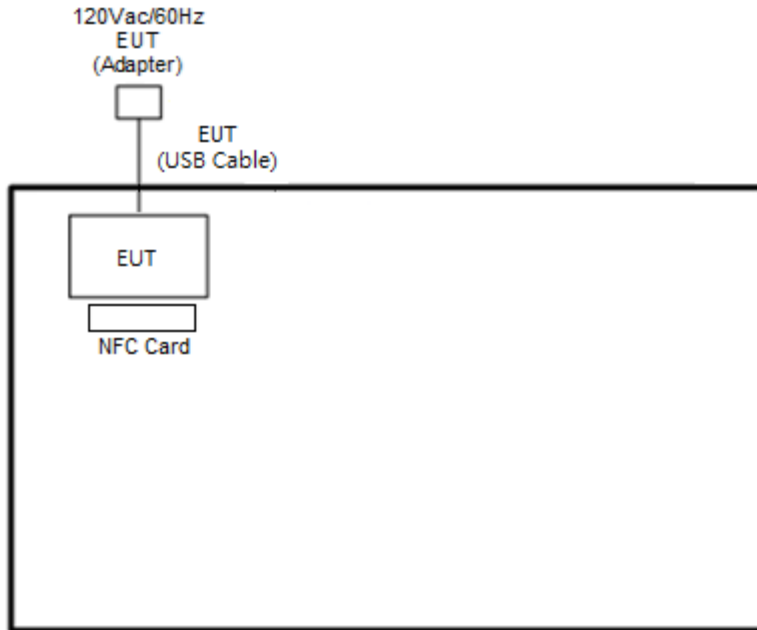

<NFC Tx Mode>

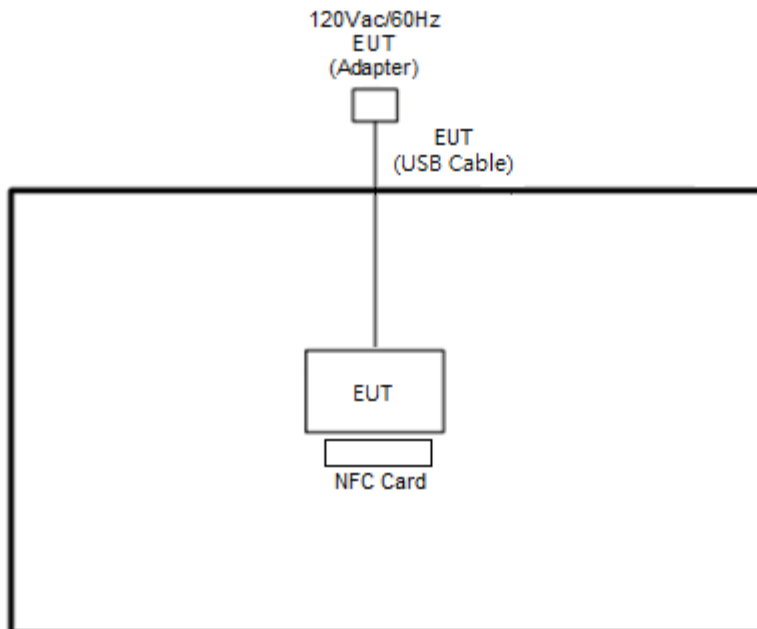



2.3 Table for Supporting Units

Item	Equipment	Brand Name	Model Name	FCC ID	Data Cable	Power Cord
1.	NFC Card	NFC Card F	NFCF-14	N/A	N/A	N/A

2.4 EUT Operation Test Setup

The EUT is programmed to be in continuously transmitting mode.

The ancillary equipment, NFC card, is used to make the EUT (NFC) continuously transmitting signal (Power Level: Default) at 13.56MHz and is placed around 3 cm gap to the EUT.



3. Test Results

3.1 AC Power Line Conducted Emissions Measurement

3.1.1 Limit of AC Conducted Emission

For equipment that is designed to be connected to the public utility (AC) power line, the radio frequency voltage that is conducted back onto the AC power line on any frequency or frequencies within the band 150 kHz to 30 MHz shall not exceed the limits in the following table.

Frequency of Emission (MHz)	Conducted Limit (dB μ V)	
	Quasi-Peak	Average
0.15-0.5	66 to 56*	56 to 46*
0.5-5	56	46
5-30	60	50

*Decreases with the logarithm of the frequency.

3.1.2 Measuring Instruments

Please refer to the measuring equipment list in this test report.

3.1.3 Test Procedures

1. The EUT is placed 0.4 meter away from the conducting wall of the shielding room, and is kept at least 80 centimeters from any other grounded conducting surface.
2. Connect EUT to the power mains through a line impedance stabilization network (LISN).
3. All the support units are connecting to the other LISN.
4. The LISN provides 50 ohm coupling impedance for the measuring instrument.
5. The FCC states that a 50 ohm, 50 microhenry LISN shall be used.
6. Both Line and Neutral shall be tested in order to find out the maximum conducted emission.
7. The frequency range from 150 kHz to 30 MHz is scanned.
8. Set the test-receiver system to Peak Detect Function and specified bandwidth (IF Bandwidth = 9 kHz) with Maximum Hold Mode. Then measurement is also conducted by Average Detector and Quasi-Peak Detector Function respectively.

3.1.4 Test setup

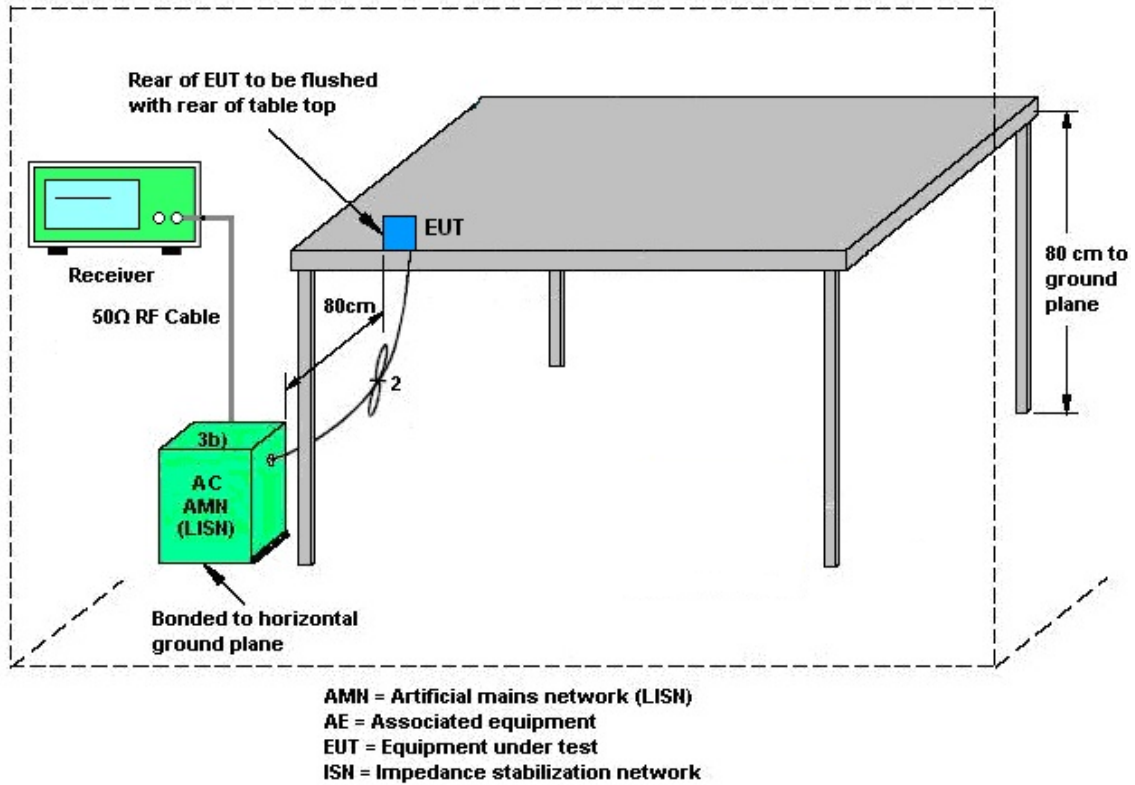

3.1.5 Test Result of AC Conducted Emission

Please refer to Appendix A.

3.2 20dB and 99% OBW Spectrum Bandwidth Measurement

3.2.1 Limit

Intentional radiators must be designed to ensure that the 20 dB and 99% emission bandwidth in the specific band 13.553~13.567 MHz.

3.2.2 Measuring Instruments

Please refer to the measuring equipment list in this test report.

3.2.3 Test Procedures

1. The spectrum analyzer connected via a receive antenna placed near the EUT in peak Max Hold Mode.
2. The resolution bandwidth of 1 kHz and the video bandwidth of 3 kHz were used.
3. Measured the spectrum width with power higher than 20 dB below carrier.
4. Measured the 99% OBW.

3.2.4 Test Setup

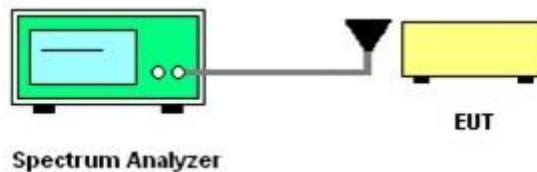

3.2.5 Test Result of Near Field Test Items

Please refer to Appendix B.

3.3 Frequency Stability Measurement

3.3.1 Limit

The frequency tolerance of the carrier signal shall be maintained within +/- 0.01% (100ppm) of the operating frequency over a temperature variation of -20 degrees to +50 degrees C at normal supply voltage, and for a variation in the primary supply voltage from 85% to 115% of the rated supply voltage at a temperature of 20 degrees C. For battery operated equipment, the equipment tests shall be performed by using a new battery.

3.3.2 Measuring Instruments

Please refer to the measuring equipment list in this test report.

3.3.3 Test Procedures

1. The spectrum analyzer connected via a receive antenna placed near the EUT.
2. EUT has transmitted signal and fixed channelize.
3. Set the spectrum analyzer span to view the entire emissions bandwidth.
4. Set RBW = 1 kHz, VBW = 3 kHz with peak detector and maxhold settings.
5. The f_c is declaring of channel frequency. Then the frequency error formula is $(f_c - f) / f_c \times 10^6$ ppm and the limit is less than ± 100 ppm.
6. Extreme temperature rule is -20°C~50°C.

3.3.4 Test Setup

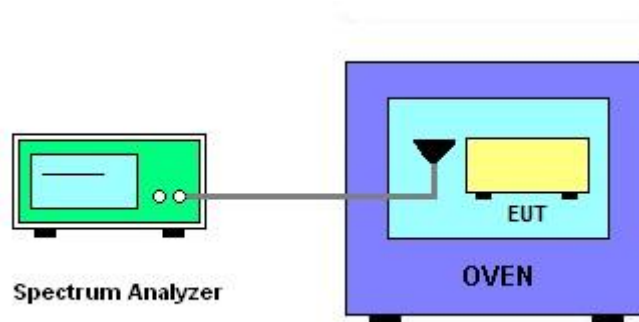

3.3.5 Test Result of Near Field Test Items

Please refer to Appendix B.



3.4 Field Strength of Fundamental Emissions and Mask Measurement

3.4.1 Limit

Rules and specifications	FCC CFR 47 Part 15 section 15.225			
Description	Compliance with the spectrum mask is tested with RBW set to 9kHz.			
Freq. of Emission (MHz)	Field Strength (μV/m) at 30m	Field Strength (dBμV/m) at 30m	Field Strength (dBμV/m) at 10m	Field Strength (dBμV/m) at 3m
1.705~13.110	30	29.5	48.58	69.5
13.110~13.410	106	40.5	59.58	80.5
13.410~13.553	334	50.5	69.58	90.5
13.553~13.567	15848	84.0	103.08	124.0
13.567~13.710	334	50.5	69.58	90.5
13.710~14.010	106	40.5	59.58	80.5
14.010~30.000	30	29.5	48.58	69.5

Remark:

1. The field strength test result is in 3m test distance, follow test rules the test data use distance extrapolation factor and reported in this report at 30m test result.
2. Distance extrapolation factor = 40 log (specific distance / test distance) (dB)

3.4.2 Measuring Instruments

Please refer to the measuring equipment list in this test report.

3.4.3 Test Procedures

1. Configure the EUT according to ANSI C63.10. The EUT is placed on the top of the turntable 0.8 meter above ground. The phase center of the loop receiving antenna mounted antenna tower is placed 3 meters far away from the turntable.
 2. Power on the EUT and all the supporting units. The turntable is rotated by 360 degrees to determine the position of the highest radiation.
 3. The height of the receiving antenna is fixed at one meter above ground to find the maximum emissions field strength.
 4. For Fundamental emissions, use the receiver to measure QP reading.
 5. When the radiated emissions limits are expressed in terms of the average value of the emissions, and pulsed operation is employed, the measurement field strength shall be determined by averaging over one complete pulse train, including blanking intervals, as long as the pulse train does not exceed 0.1 seconds. As an alternative (provided the transmitter operates for longer than 0.1 seconds) or in cases where the pulse train exceeds 0.1 seconds, the measured field strength shall be determined from the average absolute voltage during a 0.1 second interval during which the field strength is at its maximum value.
 6. Compliance with the spectrum mask is tested with RBW set to 9 kHz.
- Note: Emission level (dB μ V/m) = 20 log Emission level (μ V/m).

3.4.4 Test Setup

For radiated test below 30MHz

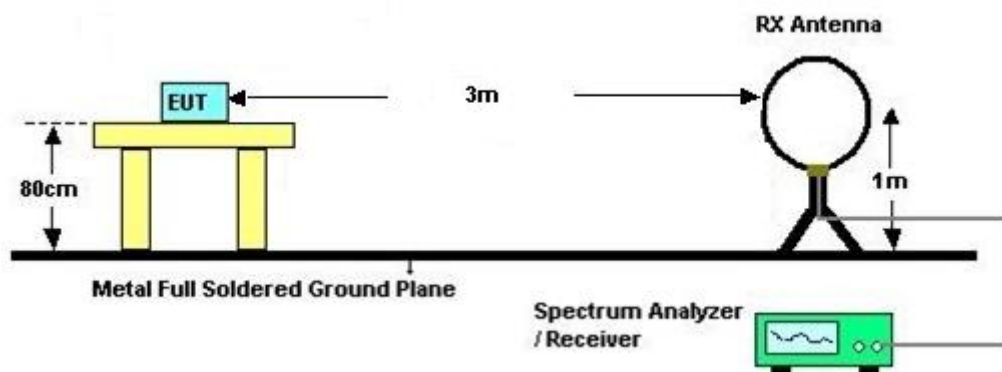

3.4.5 Test Result of Field Strength of Fundamental Emissions and Mask

Please refer to Appendix C.



3.5 Radiated Emissions Measurement

3.5.1 Limit

The field strength of any emissions which appear outside of 13.110 ~14.010MHz band shall not exceed the general radiated emissions limits.

Frequencies (MHz)	Field Strength (µV/m)	Measurement Distance (meters)
0.009~0.490	2400/F(kHz)	300
0.490~1.705	24000/F(kHz)	30
1.705~30.0	30	30
30~88	100	3
88~216	150	3
216~960	200	3
Above 960	500	3

3.5.2 Measuring Instruments

Please refer to the measuring equipment list in this test report.

3.5.3 Measuring Instrument Setting

The following table is the setting of receiver:

Receiver Parameter	Setting
Attenuation	Auto
Frequency Range: 9kHz~150kHz	RBW 200Hz for QP
Frequency Range: 150kHz~30MHz	RBW 9kHz for QP
Frequency Range: 30MHz~1000MHz	RBW 120kHz for Peak

Note: The emission limits shown in the above table are based on measurements employing a CISPR quasi-peak detector except for the frequency bands 9-90 kHz and 110-490 kHz. Radiated emission limits in these two bands are based on measurements employing an average detector.



3.5.4 Test Procedures

1. Configure the EUT according to ANSI C63.10. The EUT is placed on the top of the turntable 0.8 meter above ground. The phase center of the receiving antenna mounted on the top of a height-variable antenna tower is placed 3 meters far away from the turntable.
2. Power on the EUT and all the supporting units. The turntable is rotated by 360 degrees to determine the position of the highest radiation.
3. The height of the broadband receiving antenna is varied between one meter and four meters above ground to find the maximum emissions field strength of both horizontal and vertical polarization.
4. For each suspected emissions, the antenna tower is scanned (from 1 M to 4 M) and then the turntable is rotated (from 0 degree to 360 degrees) to find the maximum reading.
5. Set the test-receiver system to Peak or CISPR quasi-peak Detect Function with specified bandwidth under Maximum Hold Mode.
6. When the radiated emissions limits are expressed in terms of the average value of the emissions, and pulsed operation is employed, the measurement field strength shall be determined by averaging over one complete pulse train, including blanking intervals, as long as the pulse train does not exceed 0.1 seconds. As an alternative (provided the transmitter operates for longer than 0.1 seconds) or in cases where the pulse train exceeds 0.1 seconds, the measured field strength shall be determined from the average absolute voltage during a 0.1 second interval during which the field strength is at its maximum value.
7. In case the emission is lower than 30 MHz, loop antenna has to be used for measurement and the recorded data shall be QP measured by receiver.

3.5.5 Test Setup

For radiated test below 30MHz

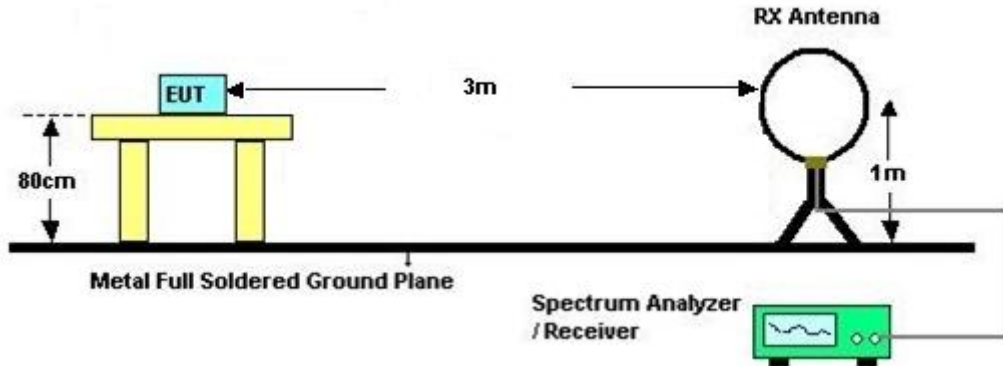

For radiated test above 30MHz

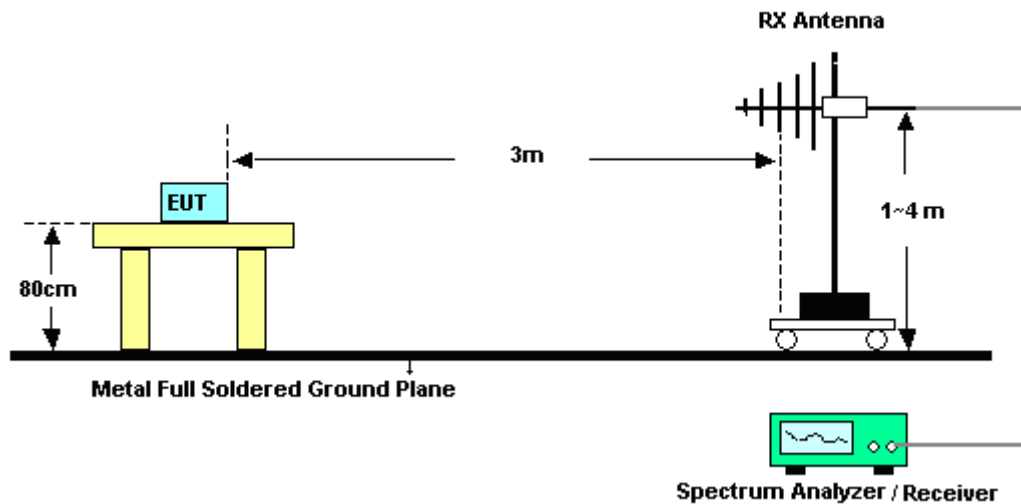

3.5.6 Test Result of Radiated Emissions Measurement

Please refer to Appendix C.

Remark: There is adequate comparison measurement of both open-field test site and alternative test site - semi-Anechoic chamber according to 414788 D01 Radiated Test Site v01r01, and the result came out very similar.



3.6 Antenna Requirements

3.6.1 Standard Applicable

Except for special regulations, the Low-power Radio-frequency Devices must not be equipped with any jacket for installing an antenna with extension cable. An intentional radiator shall be designed to ensure that no antenna other than that furnished by the responsible party shall be used with the device. The use of a permanently attached antenna or of an antenna that uses a unique coupling to the intentional radiator shall be considered sufficient to comply with the provisions of this Section. The manufacturer may design the unit so that the user can replace a broken antenna, but the use of a standard antenna jack or electrical connector is prohibited.

The use of a permanently attached antenna or of an antenna that uses a unique coupling to the intentional radiator shall be considered sufficient to comply with the rule.

3.6.2 Antenna Anti-Replacement Construction

An embedded-in antenna design is used.



4. List of Measuring Equipment

Instrument	Brand Name	Model No.	Serial No.	Characteristics	Calibration Date	Test Date	Due Date	Remark
Amplifier	SONOMA	310N	187312	9kHz~1GHz	Dec. 10, 2021	Mar. 21, 2022~ Mar. 22, 2022	Dec. 09, 2022	Radiation (03CH11-HY)
Bilog Antenna	TESEQ	CBL 6111D & N-6-06	35414 & AT-N0602	30MHz~1GHz	Oct. 09, 2021	Mar. 21, 2022~ Mar. 22, 2022	Oct. 08, 2022	Radiation (03CH11-HY)
Filter	Wainwright	WHK20/1000C 7/40SS	SN2	20M High Pass	Sep. 13, 2021	Mar. 21, 2022~ Mar. 22, 2022	Sep. 12, 2022	Radiation (03CH11-HY)
Loop Antenna	Rohde & Schwarz	HFH2-Z2	100315	9 kHz~30 MHz	Jan. 07, 2022	Mar. 21, 2022~ Mar. 22, 2022	Jan. 06, 2023	Radiation (03CH11-HY)
Software	Audix	E3 6.2009-8-24	RK-001053	N/A	N/A	Mar. 21, 2022~ Mar. 22, 2022	N/A	Radiation (03CH11-HY)
Controller	EMEC	EM 1000	N/A	Control Turn table & Ant Mast	N/A	Mar. 21, 2022~ Mar. 22, 2022	N/A	Radiation (03CH11-HY)
Turn Table	EMEC	TT 2000	N/A	0~360 Degree	N/A	Mar. 21, 2022~ Mar. 22, 2022	N/A	Radiation (03CH11-HY)
Antenna Mast	EMEC	AM-BS-4500-B	N/A	1~4m	N/A	Mar. 21, 2022~ Mar. 22, 2022	N/A	Radiation (03CH11-HY)
Spectrum Analyzer	Keysight	N9010A	MY54200486	10Hz~44GHz	Oct. 15, 2021	Mar. 21, 2022~ Mar. 22, 2022	Oct. 14, 2022	Radiation (03CH11-HY)
EMI Test Receiver	Keysight	N9038A(MXE)	MY55420170	20MHz~8.4GHz	Jul. 15, 2021	Mar. 21, 2022~ Mar. 22, 2022	Jul. 14, 2022	Radiation (03CH11-HY)
RF Cable	HUBER + SUHNER	SUCOFLEX 104	MY9837/4PE	9kHz-30MHz	Mar. 10, 2022	Mar. 21, 2022~ Mar. 22, 2022	Mar. 09, 2023	Radiation (03CH11-HY)
RF Cable	HUBER + SUHNER	SUCOFLEX 102	MY2859/2	30MHz-40GHz	Mar. 10, 2022	Mar. 21, 2022~ Mar. 22, 2022	Mar. 09, 2023	Radiation (03CH11-HY)
Hygrometer	TECPEL	DTM-303B	TP140325	N/A	Nov. 26, 2021	Mar. 21, 2022~ Mar. 22, 2022	Nov. 25, 2022	Radiation (03CH11-HY)
Hygrometer	TECPEL	DTM-303B	TP200880	QA-3-031	Sep. 30, 2021	Mar. 21, 2022~ Mar. 22, 2022	Sep. 29, 2022	Radiation (03CH11-HY)
AC Power Source	ACPOWER	AFC-11003G	F317040033	N/A	N/A	Mar. 14, 2022	N/A	Conduction (CO07-HY)
Software	Rohde & Schwarz	EMC32 V10.30	N/A	N/A	N/A	Mar. 14, 2022	N/A	Conduction (CO07-HY)
Pulse Limiter	SCHWARZBE CK	VTSD 9561-F N	9561-F N00373	9kHz-200MHz	Oct. 29, 2021	Mar. 14, 2022	Oct. 28, 2022	Conduction (CO07-HY)
RF Cable	HUBER + SUHNER	RG 214/U	1358175	9kHz~30MHz	N/A	Mar. 14, 2022	N/A	Conduction (CO07-HY)
Two-Line V-Network	TESEQ	NNB 51	45051	N/A	Feb. 16, 2022	Mar. 14, 2022	Feb. 15, 2023	Conduction (CO07-HY)
EMI Test Receiver	Rohde & Schwarz	ESR3	102317	9kHz~3.6GHz	Oct. 21, 2021	Mar. 14, 2022	Oct. 20, 2022	Conduction (CO07-HY)
5kVA AC Power Source	TESEQ	NSG 1007	1521A01677	N/A	Jun. 08, 2021	Mar. 12, 2022	Jun. 07, 2022	Near Field (TH03-HY)
Hygrometer	TECPEL	DTM-303B	TP210073	N/A	Nov. 16, 2021	Mar. 12, 2022	Nov. 15, 2022	Near Field (TH03-HY)
Spectrum Analyzer	Rohde & Schwarz	FSP30	101329	9kHz~30GHz	Sep. 30, 2021	Mar. 12, 2022	Sep. 29, 2022	Near Field (TH03-HY)
Temperature & Humidity Cabinet Chamber	ESPEC	LHU-113	1012005860	-20°C~85°C	Dec. 09, 2021	Mar. 12, 2022	Dec. 08, 2022	Near Field (TH03-HY)
Coupling loop antenna	EMCI	LF R 400	N/A	100KHz~50MH z	N/A	Mar. 12, 2022	N/A	Near Field (TH03-HY)



5. Uncertainty of Evaluation

Uncertainty of Conducted Emission Measurement (150 kHz ~ 30 MHz)

Measuring Uncertainty for a Level of Confidence of 95% ($U = 2Uc(y)$)	2.3 dB
---	--------

Uncertainty of Radiated Emission Measurement (9 kHz ~ 30 MHz)

Measuring Uncertainty for a Level of Confidence of 95% ($U = 2Uc(y)$)	3.7 dB
---	--------

Uncertainty of Radiated Emission Measurement (30 MHz ~ 1000 MHz)

Measuring Uncertainty for a Level of Confidence of 95% ($U = 2Uc(y)$)	5.8 dB
---	--------



Appendix A. Test Results of Conducted Emission Test

Test Engineer :	Louis Chung	Temperature :	24.6~26.3°C
		Relative Humidity :	48.2~52.7%

EUT Information

Report NO : 1N2513
 Test Mode : Mode 1
 Test Voltage : 120Vac/60Hz
 Phase : Line

Full Spectrum

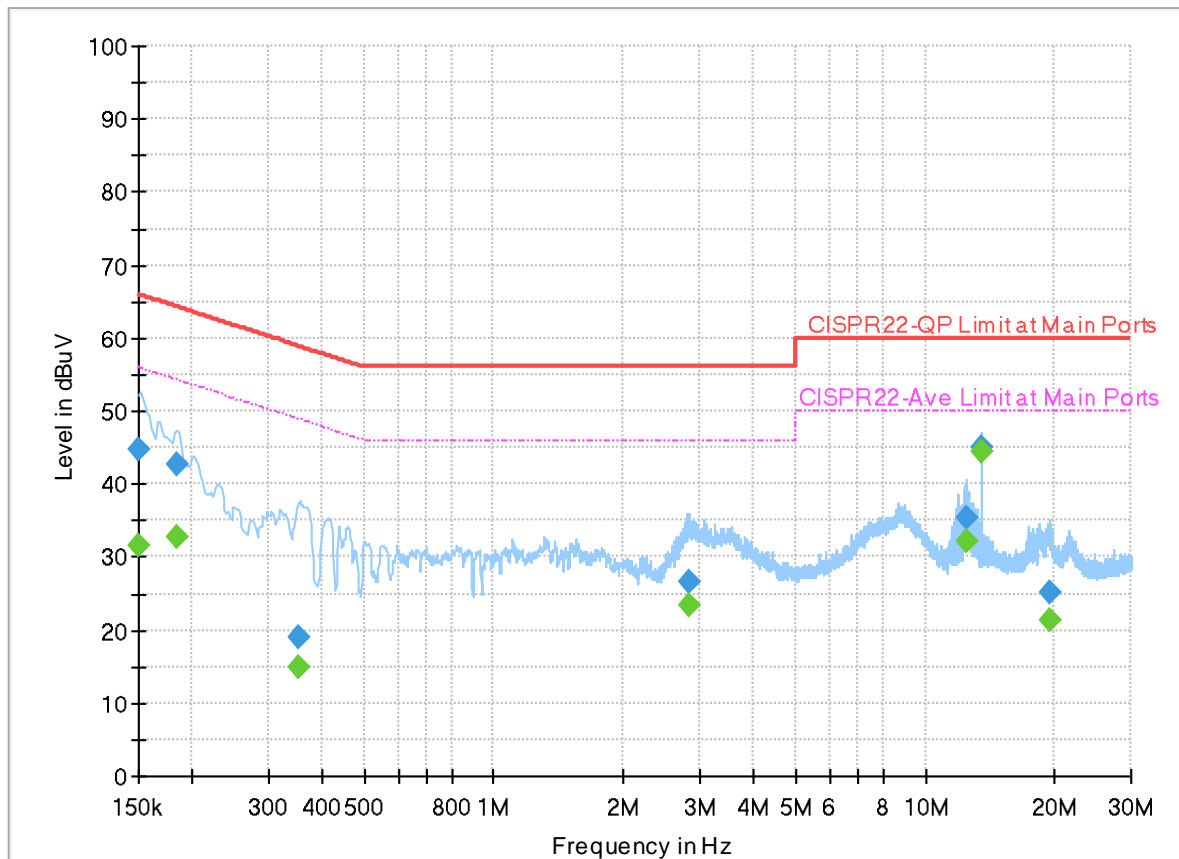

Final_Result

Frequency (MHz)	QuasiPeak (dBuV)	CAverage (dBuV)	Limit (dBuV)	Margin (dB)	Line	Filter	Corr. (dB)
0.150000	---	31.59	56.00	24.41	L1	OFF	20.0
0.150000	44.67	---	66.00	21.33	L1	OFF	20.0
0.184560	---	32.77	54.28	21.51	L1	OFF	20.0
0.184560	42.75	---	64.28	21.53	L1	OFF	20.0
0.350700	---	14.89	48.95	34.06	L1	OFF	20.0
0.350700	19.05	---	58.95	39.90	L1	OFF	20.0
2.821650	---	23.34	46.00	22.66	L1	OFF	20.0
2.821650	26.70	---	56.00	29.30	L1	OFF	20.0
12.510960	---	32.18	50.00	17.82	L1	OFF	20.2
12.510960	35.44	---	60.00	24.56	L1	OFF	20.2
13.559910	---	44.43	50.00	5.57	L1	OFF	20.2
13.559910	45.17	---	60.00	14.83	L1	OFF	20.2
19.434750	---	21.28	50.00	28.72	L1	OFF	20.2
19.434750	25.24	---	60.00	34.76	L1	OFF	20.2

EUT Information

Report NO : 1N2513
 Test Mode : Mode 1
 Test Voltage : 120Vac/60Hz
 Phase : Neutral

Full Spectrum

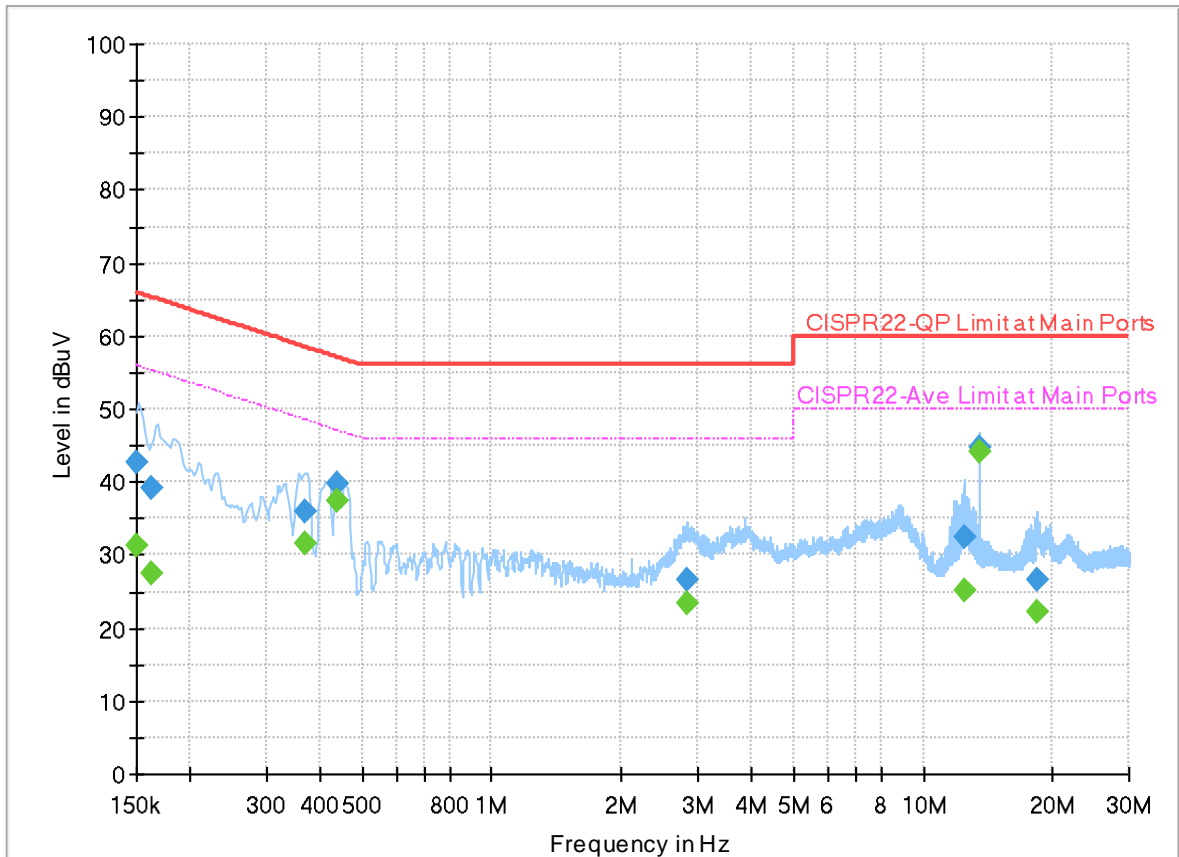

Final_Result

Frequency (MHz)	QuasiPeak (dBuV)	CAverage (dBuV)	Limit (dBuV)	Margin (dB)	Line	Filter	Corr. (dB)
0.150405	---	31.16	55.98	24.82	N	OFF	20.0
0.150405	42.72	---	65.98	23.26	N	OFF	20.0
0.162420	---	27.49	55.34	27.85	N	OFF	20.0
0.162420	39.19	---	65.34	26.15	N	OFF	20.0
0.367800	---	31.66	48.55	16.89	N	OFF	20.0
0.367800	36.09	---	58.55	22.46	N	OFF	20.0
0.438360	---	37.41	47.09	9.68	N	OFF	20.0
0.438360	39.66	---	57.09	17.43	N	OFF	20.0
2.829750	---	23.31	46.00	22.69	N	OFF	20.0
2.829750	26.49	---	56.00	29.51	N	OFF	20.0
12.427170	---	25.21	50.00	24.79	N	OFF	20.2
12.427170	32.31	---	60.00	27.69	N	OFF	20.2
13.559730	---	44.12	50.00	5.88	N	OFF	20.2
13.559730	44.86	---	60.00	15.14	N	OFF	20.2
18.305340	---	22.23	50.00	27.77	N	OFF	20.3
18.305340	26.56	---	60.00	33.44	N	OFF	20.3



Appendix B. Test Results of Near Field Test Items

B1. Test Result of 20dB Spectrum Bandwidth

Test mode	NFC Tx	Test Frequency (MHz)	13.56
Date: 12.MAR.2022 12:20:56		Date: 12.MAR.2022 12:20:29	
20dB Bandwidth (kHz)	2.640	99% OccupiedBW(kHz)	2.240
Frequency range (MHz)	$f_L > 13.553$	13.55836	Test Result
	$f_H < 13.567$	13.56100	Complies

Remark: Because the measured signal is CW adjusting the RBW per C63.10 would not be practical since measured bandwidth will always follow the RBW and the result will be approximately twice the RBW.



B2. Test Result of Frequency Stability

Voltage vs. Frequency Stability		Temperature vs. Frequency Stability		
Voltage (DC)	Measurement Frequency (MHz)	Temperature (°C)	Time	Measurement Frequency (MHz)
3.87	13.559680	-20	0	13.559800
			2	13.559800
			5	13.559800
			10	13.559800
3.65	13.559680	-10	0	13.559860
			2	13.559860
			5	13.559860
			10	13.559860
4.45	13.559680	0	0	13.559860
			2	13.559810
			5	13.559810
			10	13.559850
		10	0	13.559800
			2	13.559800
			5	13.559800
			10	13.559800
		20	0	13.559680
			2	13.559680
			5	13.559680
			10	13.559680
		30	0	13.559640
			2	13.559640
			5	13.559640
			10	13.559640
		40	0	13.559640
			2	13.559640
			5	13.559640
			10	13.559640



Voltage vs. Frequency Stability		Temperature vs. Frequency Stability		
Voltage (DC)	Measurement Frequency (MHz)	Temperature (°C)	Time	Measurement Frequency (MHz)
		50	0	13.559680
			2	13.559660
			5	13.559660
			10	13.559660
Max.Deviation (MHz)	-0.000320	Max.Deviation (MHz)		-0.000360
Max.Deviation (ppm)	-23.5988	Max.Deviation (ppm)		-26.5487
Limit	FS < ±100 ppm	Limit		FS < ±100 ppm
Test Result	PASS	Test Result		PASS



Appendix C. Test Results of Radiated Test Items

C1. Test Result of Field Strength of Fundamental Emissions

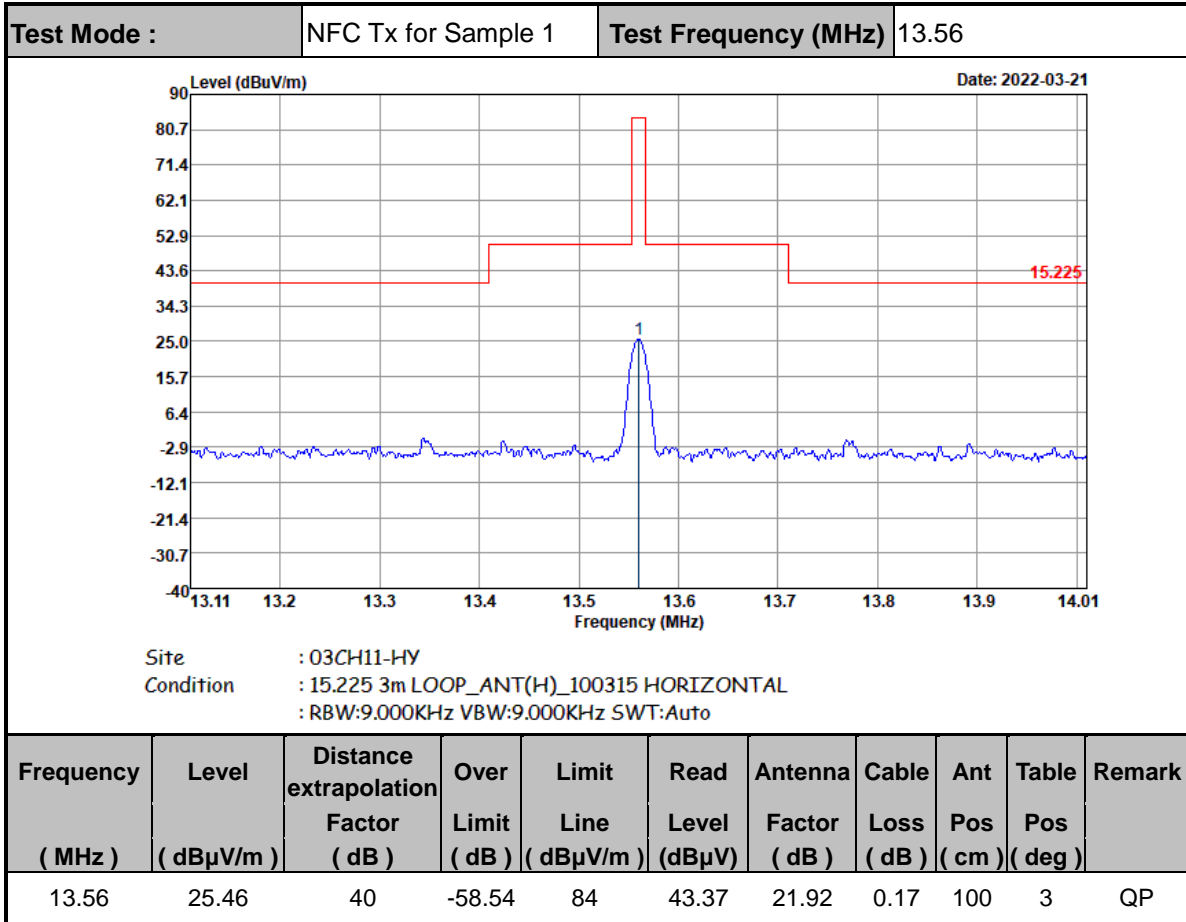



Test Mode :	NFC Tx for Sample 1	Test Frequency (MHz)	13.56
-------------	---------------------	----------------------	-------

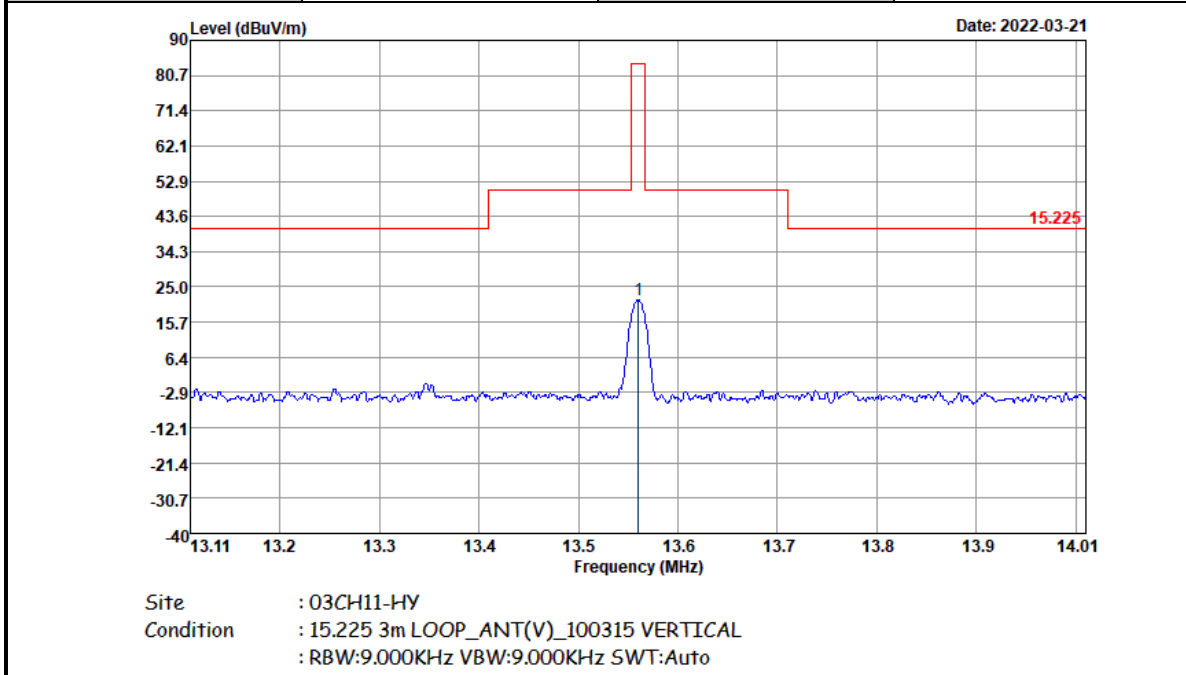

Frequency (MHz)	Level (dBμV/m)	Distance extrapolation Factor (dB)	Over Limit (dB)	Limit Line (dBμV/m)	Read Level (dBμV)	Antenna Factor (dB)	Cable Loss (dB)	Ant Pos (cm)	Table Pos (deg)	Remark
13.56	21.57	40	-62.43	84	39.48	21.92	0.17	100	82	QP

Note :

1. Distance extrapolation factor = 40 log (specific distance / test distance) (dB)
2. Level = Antenna Factor + Cable Loss + Read Level - Distance extrapolation factor.



Test Mode :	NFC Tx for Sample 2	Test Frequency (MHz)	13.56
-------------	---------------------	----------------------	-------

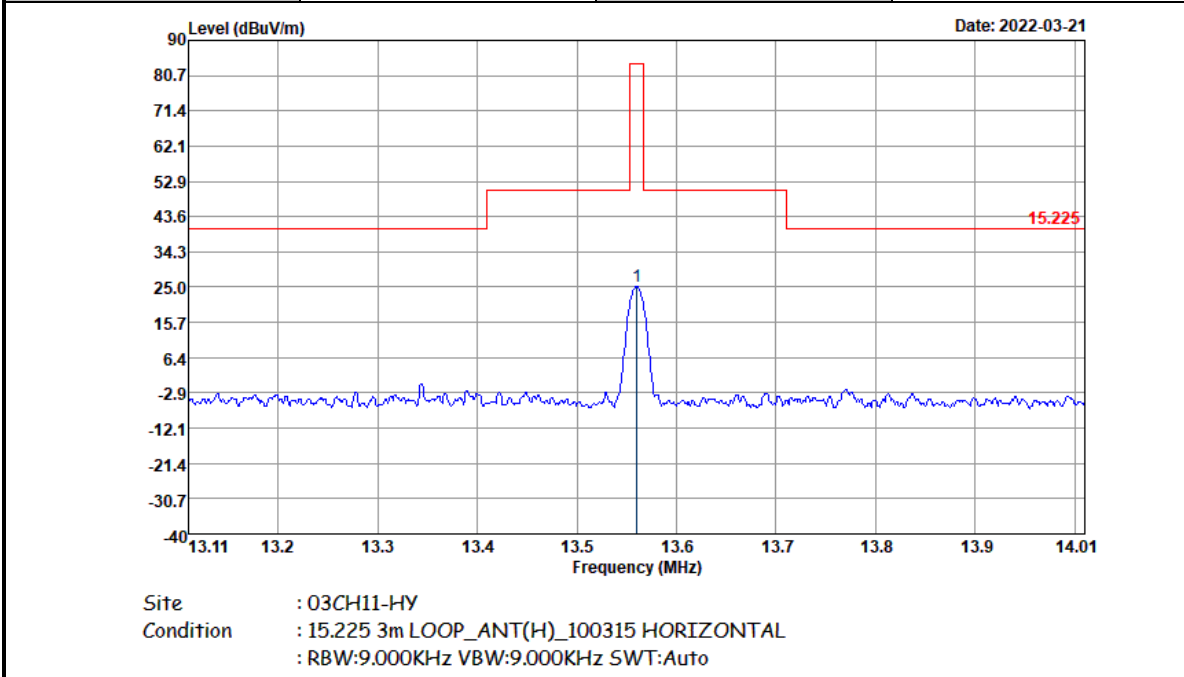

Frequency (MHz)	Level (dBμV/m)	Distance extrapolation Factor (dB)	Over Limit (dB)	Limit Line (dBμV/m)	Read Level (dBμV)	Antenna Factor (dB)	Cable Loss (dB)	Ant Pos (cm)	Table Pos (deg)	Remark
13.56	25.12	40	-58.88	84	43.03	21.92	0.17	100	4	QP



Test Mode :	NFC Tx for Sample 2	Test Frequency (MHz)	13.56
-------------	---------------------	----------------------	-------

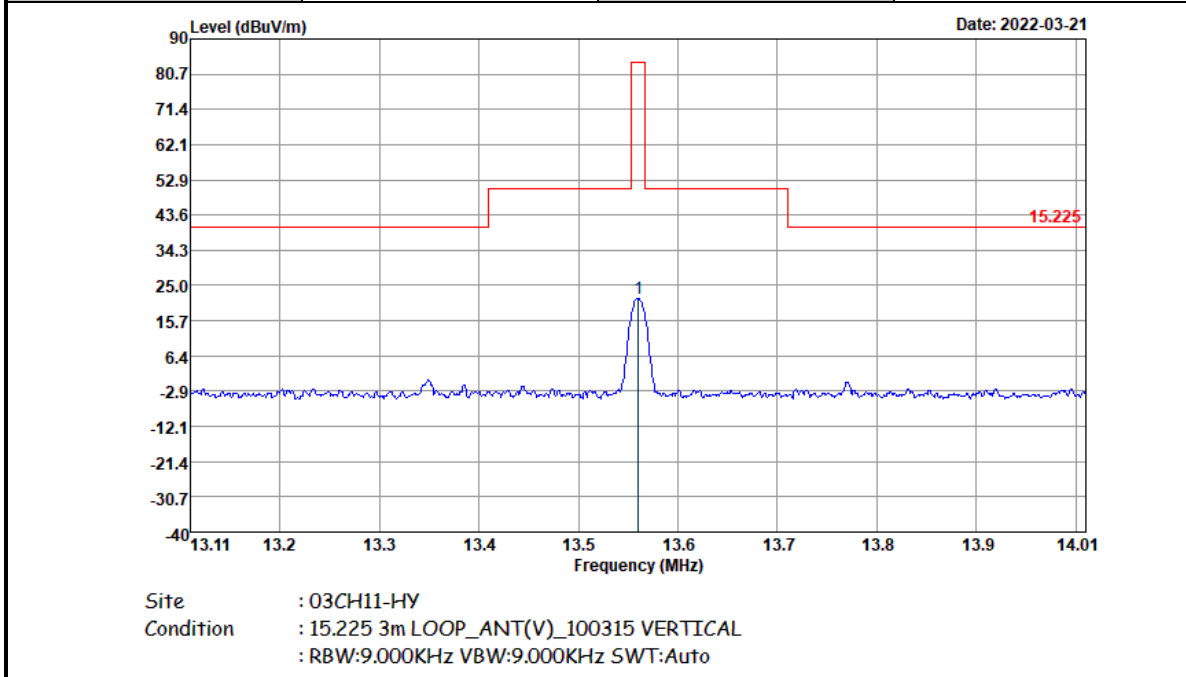

Frequency (MHz)	Level (dBμV/m)	Distance extrapolation Factor (dB)	Over Limit (dB)	Limit Line (dBμV/m)	Read Level (dBμV)	Antenna Factor (dB)	Cable Loss (dB)	Ant Pos (cm)	Table Pos (deg)	Remark
13.56	21.6	40	-62.4	84	39.51	21.92	0.17	100	94	QP

Note :

1. Distance extrapolation factor = 40 log (specific distance / test distance) (dB)
2. Level = Antenna Factor + Cable Loss + Read Level - Distance extrapolation factor.



C2. Results of Radiated Spurious Emissions (9 kHz~30MHz)

Test Mode :	NFC Tx for Sample 1	Polarization :	Horizontal
--------------------	---------------------	-----------------------	------------

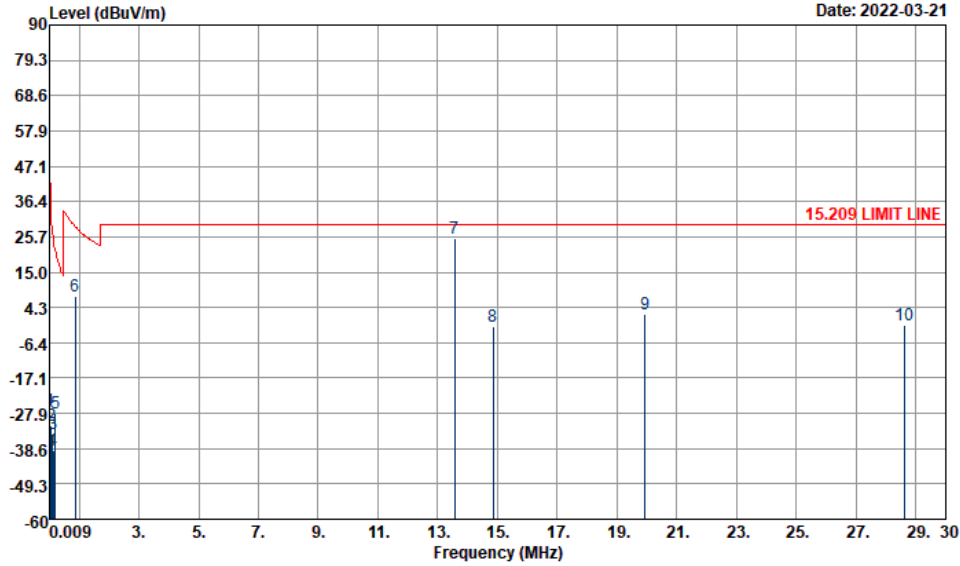

Frequency (MHz)	Level (dBμV/m)	Distance extrapolation Factor (dB)	Over Limit (dB)	Limit Line (dBμV/m)	Read Level (dBμV)	Antenna Factor (dB)	Cable Loss (dB)	Ant Pos (cm)	Table Pos (deg)	Remark
0.0192	-27.01	80	-68.95	41.94	33.7	19.14	0.15	-	-	Average
0.06138	-31.39	80	-63.23	31.84	29.02	19.45	0.14	-	-	Average
0.10636	-34.29	80	-61.36	27.07	26.95	18.62	0.14	-	-	QP
0.12472	-38.93	80	-64.62	25.69	22.24	18.69	0.14	-	-	Average
0.20848	-28	80	-49.22	21.22	32.87	18.98	0.15	-	-	Average
0.88052	7.63	40	-21.08	28.71	27.87	19.63	0.13	-	-	QP
13.56	25.17	40	-4.33	29.5	43.08	21.92	0.17	-	-	QP
14.856	-1.32	40	-30.82	29.5	16.46	22.04	0.18	-	-	QP
19.942	2.17	40	-27.33	29.5	19.48	22.49	0.2	-	-	QP
28.605	-1.03	40	-30.53	29.5	15.97	22.76	0.24	-	-	QP



Test Mode :	NFC Tx for Sample 1	Polarization :	Vertical
--------------------	---------------------	-----------------------	----------

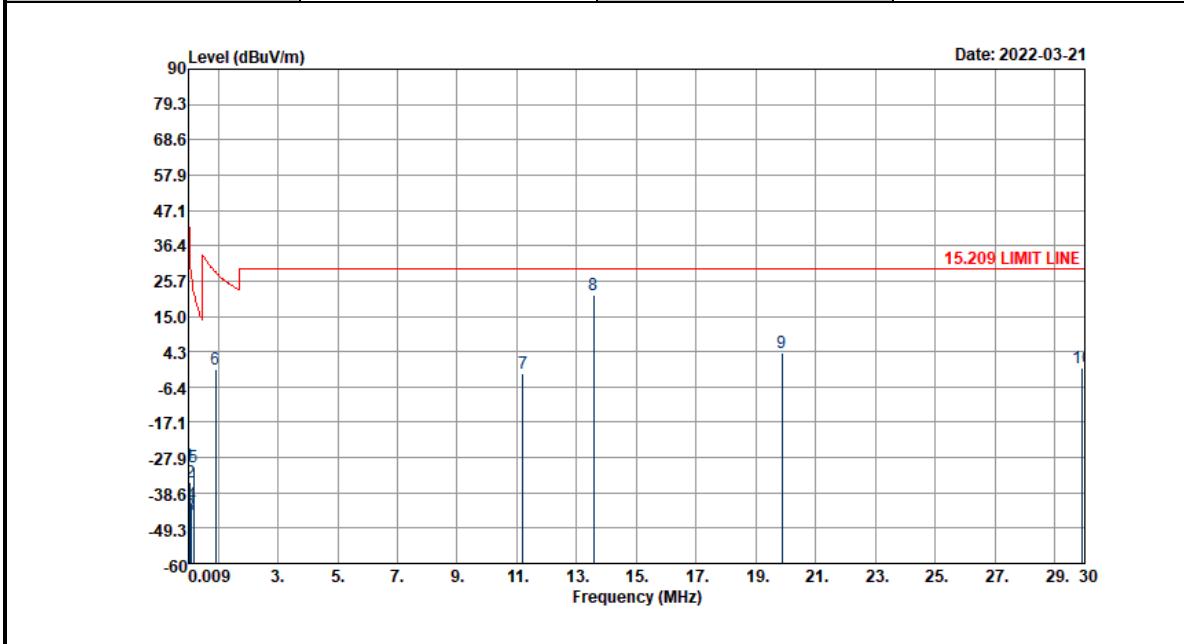

Frequency (MHz)	Level (dBμV/m)	Distance extrapolation Factor (dB)	Over Limit (dB)	Limit Line (dBμV/m)	Read Level (dBμV)	Antenna Factor (dB)	Cable Loss (dB)	Ant Pos (cm)	Table Pos (deg)	Remark
0.0192	-30.47	80	-72.41	41.94	30.24	19.14	0.15	-	-	Average
0.06246	-35.32	80	-67.01	31.69	25.11	19.43	0.14	-	-	Average
0.09366	-45.18	80	-73.35	28.17	15.94	18.74	0.14	-	-	QP
0.12028	-41.84	80	-67.84	26	19.35	18.67	0.14	-	-	Average
0.17516	-30.91	80	-53.65	22.74	30.08	18.86	0.15	-	-	Average
0.91056	-1.28	40	-29.7	28.42	18.94	19.65	0.13	-	-	QP
11.2	-2.36	40	-31.86	29.5	15.77	21.71	0.16	-	-	QP
13.56	21.27	40	-8.23	29.5	39.18	21.92	0.17	-	-	QP
19.879	3.74	40	-25.76	29.5	21.05	22.49	0.2	-	-	QP
29.93	-0.77	40	-30.27	29.5	16.18	22.8	0.25	-	-	QP

Note :

1. The amplitude of spurious emissions which are attenuated by more than 20dB below the permissible value has no need to be reported.
2. Distance extrapolation factor = 40 log (specific distance / test distance) (dB)
3. Level = Antenna Factor + Cable Loss + Read Level - Distance extrapolation factor.
4. 13.56 MHz is fundamental signal which can be ignored



Test Mode :	NFC Tx for Sample 2	Polarization :	Horizontal
--------------------	---------------------	-----------------------	------------

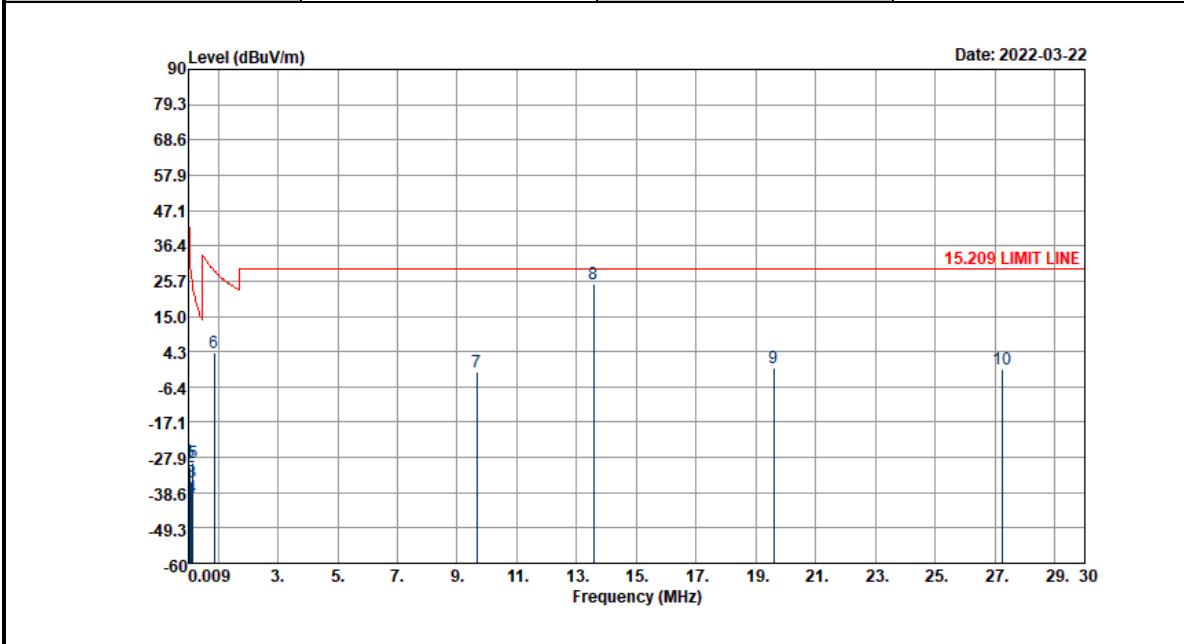

Frequency (MHz)	Level (dBμV/m)	Distance extrapolation Factor (dB)	Over Limit (dB)	Limit Line (dBμV/m)	Read Level (dBμV)	Antenna Factor (dB)	Cable Loss (dB)	Ant Pos (cm)	Table Pos (deg)	Remark
0.01925	-28.92	40	-70.84	41.92	-8.22	19.15	0.15	-	-	Average
0.06117	-30.8	40	-62.67	31.87	-10.39	19.45	0.14	-	-	Average
0.1065	-35.18	40	-62.24	27.06	-13.94	18.62	0.14	-	-	QP
0.1236	-39.92	40	-65.68	25.76	-18.74	18.68	0.14	-	-	Average
0.15068	-29.44	40	-53.48	24.04	-8.37	18.78	0.15	-	-	Average
0.87301	4.01	40	-24.77	28.78	24.26	19.62	0.13	-	-	QP
9.664	-2.07	40	-31.57	29.5	16.33	21.45	0.15	-	-	QP
13.56	24.99	40	-4.51	29.5	42.9	21.92	0.17	-	-	QP
19.6	-0.59	40	-30.09	29.5	16.75	22.46	0.2	-	-	QP
27.22	-1.08	40	-30.58	29.5	15.96	22.72	0.24	-	-	QP



Test Mode :	NFC Tx for Sample 2	Polarization :	Vertical
-------------	---------------------	----------------	----------

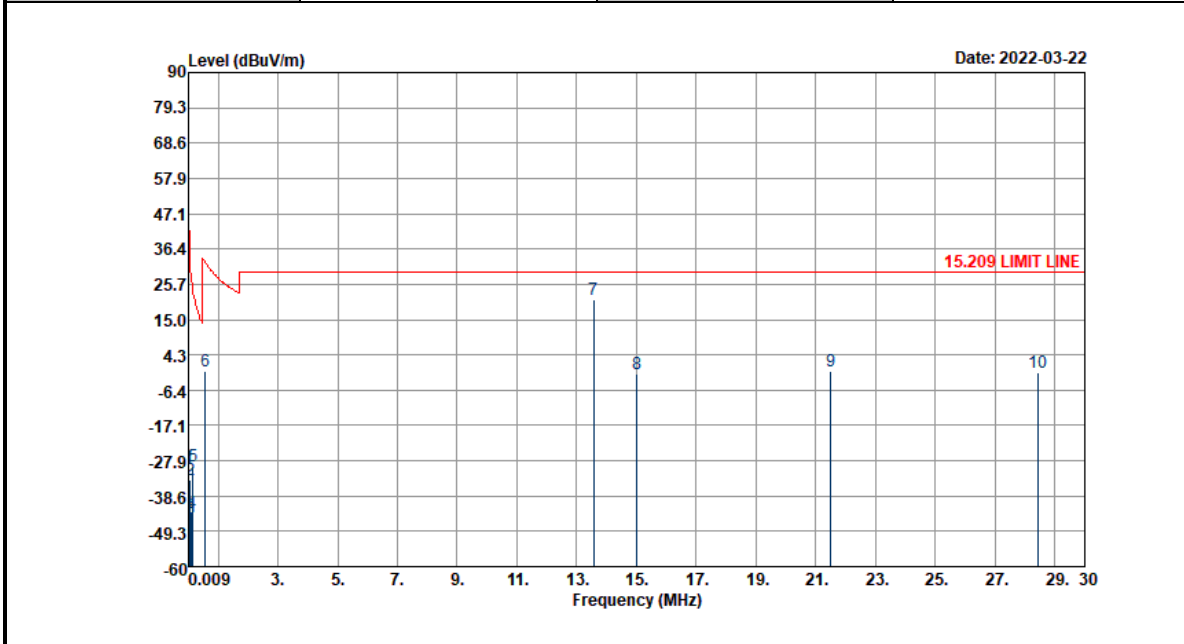

Frequency (MHz)	Level (dBμV/m)	Distance extrapolation Factor (dB)	Over Limit (dB)	Limit Line (dBμV/m)	Read Level (dBμV)	Antenna Factor (dB)	Cable Loss (dB)	Ant Pos (cm)	Table Pos (deg)	Remark
0.0192	-29.79	40	-71.73	41.94	-9.08	19.14	0.15	-	-	Average
0.06108	-33.77	40	-65.66	31.89	-13.37	19.46	0.14	-	-	Average
0.0932	-45.51	40	-73.73	28.22	-24.4	18.75	0.14	-	-	QP
0.11876	-43.73	40	-69.84	26.11	-22.54	18.67	0.14	-	-	Average
0.15306	-29.35	40	-53.26	23.91	-8.29	18.79	0.15	-	-	Average
0.57261	-0.48	40	-32.93	32.45	19.94	19.44	0.14	-	-	QP
13.56	21.24	40	-8.26	29.5	39.15	21.92	0.17	-	-	QP
15.008	-1.33	40	-30.83	29.5	16.44	22.05	0.18	-	-	QP
21.508	-0.81	40	-30.31	29.5	16.43	22.55	0.21	-	-	QP
28.425	-1.13	40	-30.63	29.5	15.88	22.75	0.24	-	-	QP

Note:

1. The amplitude of spurious emissions which are attenuated by more than 20dB below the permissible value has no need to be reported.
2. Emission level (dBμV/m) = 20 log Emission level (μV/m).
3. Corrected Reading: Antenna Factor + Cable Loss + Read Level - Preamp Factor= Level.
4. 13.56 MHz is fundamental signal which can be ignored



C3. Results of Radiated Spurious Emissions (30MHz~1GHz)

Test Mode :	NFC Tx for Sample 1	Polarization :	Horizontal
--------------------	---------------------	-----------------------	------------

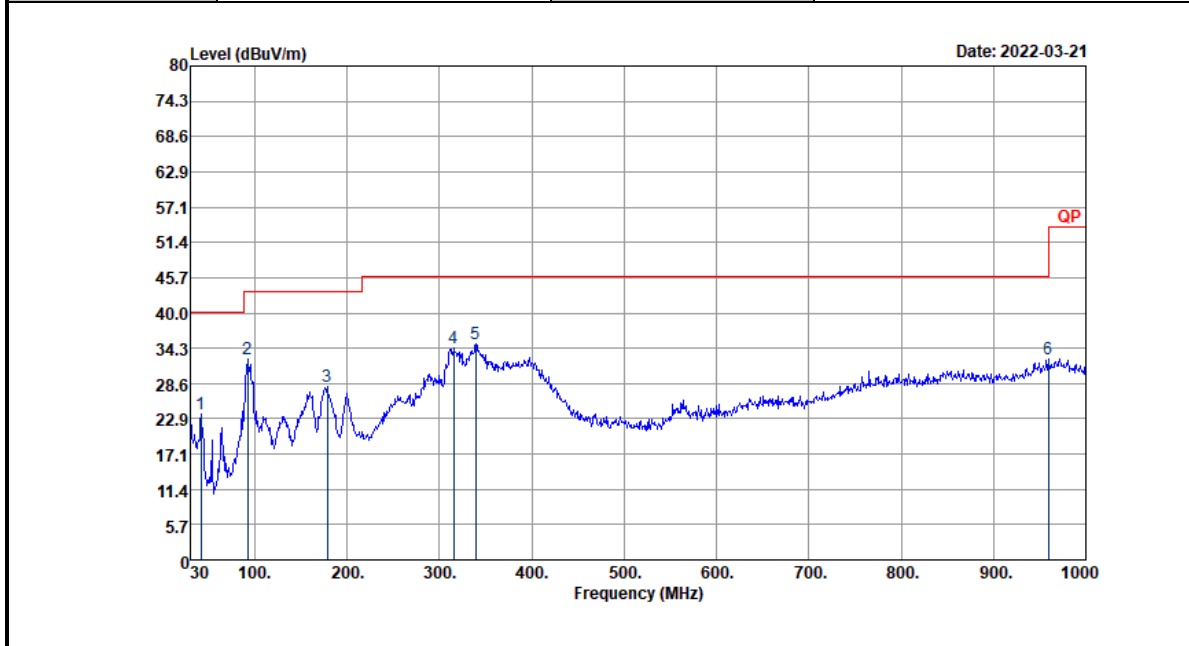

Frequency (MHz)	Level (dB μ V/m)	Over Limit (dB)	Limit Line (dB μ V/m)	Read Level (dB μ V)	Antenna Factor (dB)	Cable Loss (dB)	Preamp Factor (dB)	Ant Pos (cm)	Table Pos (deg)	Remark
41.64	23.68	-16.32	40	36.75	18.37	1	32.44	-	-	Peak
92.08	32.55	-10.95	43.5	48.63	14.74	1.58	32.4	-	-	Peak
178.41	28.1	-15.4	43.5	43.67	14.79	2.14	32.5	-	-	Peak
315.18	34.32	-11.68	46	44.23	19.31	2.8	32.02	-	-	Peak
339.43	34.88	-11.12	46	43.97	19.93	2.91	31.93	-	-	Peak
959.26	32.56	-13.44	46	26.67	30.87	5.85	30.83	-	-	Peak



Test Mode :	NFC Tx for Sample 1	Polarization :	Vertical
-------------	---------------------	----------------	----------

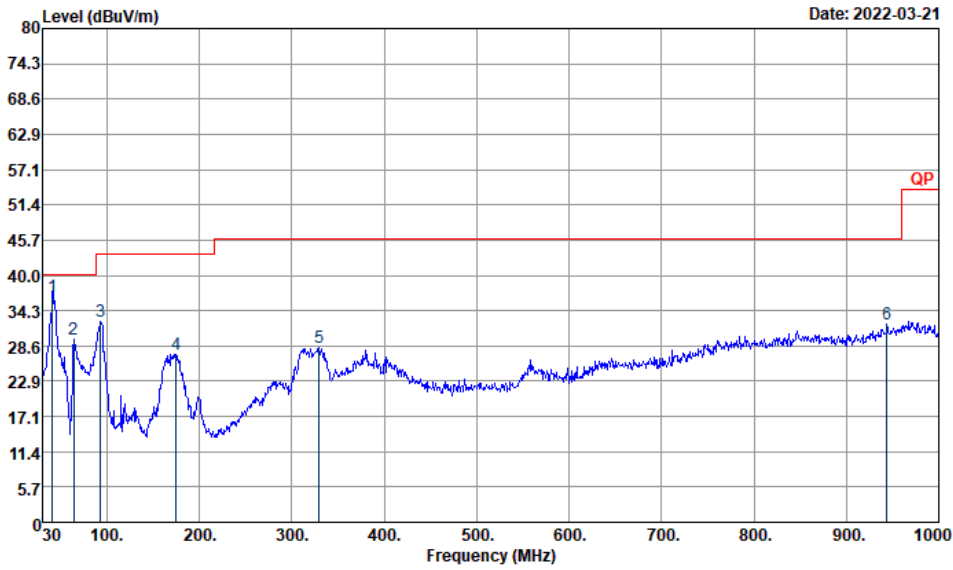

Frequency (MHz)	Level (dBμV/m)	Over Limit (dB)	Limit Line (dBμV/m)	Read Level (dBμV)	Antenna Factor (dB)	Cable Loss (dB)	Preamp Factor (dB)	Ant Pos (cm)	Table Pos (deg)	Remark
40.67	36.55	-3.45	40	49.11	18.89	0.98	32.43	100	73	QP
63.95	29.63	-10.37	40	48.96	11.81	1.32	32.46	-	-	Peak
93.05	32.64	-10.86	43.5	48.6	14.86	1.58	32.4	-	-	Peak
174.53	27.23	-16.27	43.5	42.53	15.08	2.11	32.49	-	-	Peak
329.73	28.21	-17.79	46	37.65	19.66	2.87	31.97	-	-	Peak
943.74	32.01	-13.99	46	27.17	30.08	5.7	30.94	-	-	Peak

Note:

1. The amplitude of spurious emissions which are attenuated by more than 20dB below the permissible value has no need to be reported.
2. Emission level (dBμV/m) = 20 log Emission level (μV/m).
3. Corrected Reading: Antenna Factor + Cable Loss + Read Level - Preamp Factor= Level.
4. The emission position marked as "-" means no suspected emission found with sufficient margin against limit line or noise floor only.



Test Mode :	NFC Tx for Sample 2	Polarization :	Horizontal
--------------------	---------------------	-----------------------	------------

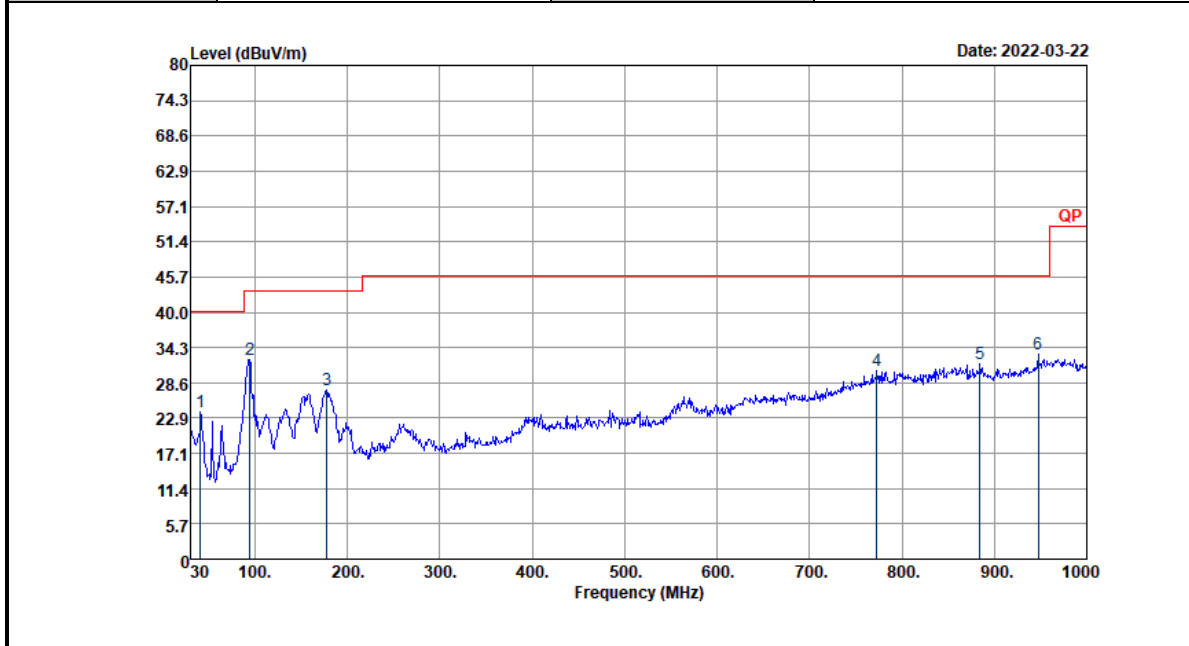

Frequency (MHz)	Level (dB μ V/m)	Over Limit (dB)	Limit Line (dB μ V/m)	Read Level (dB μ V)	Antenna Factor (dB)	Cable Loss (dB)	Preamp Factor (dB)	Ant Pos (cm)	Table Pos (deg)	Remark
40.67	23.93	-16.07	40	36.49	18.89	0.98	32.43	-	-	Peak
94.02	32.25	-11.25	43.5	48.13	14.93	1.58	32.39	-	-	Peak
177.44	27.35	-16.15	43.5	42.85	14.87	2.13	32.5	-	-	Peak
773.02	30.43	-15.57	46	29.21	27.98	5.15	31.91	-	-	Peak
884.57	31.59	-14.41	46	28.26	28.85	5.79	31.31	-	-	Peak
947.62	33.17	-12.83	46	28.11	30.28	5.69	30.91	-	-	Peak



Test Mode :	NFC Tx for Sample 2	Polarization :	Vertical
--------------------	---------------------	-----------------------	----------

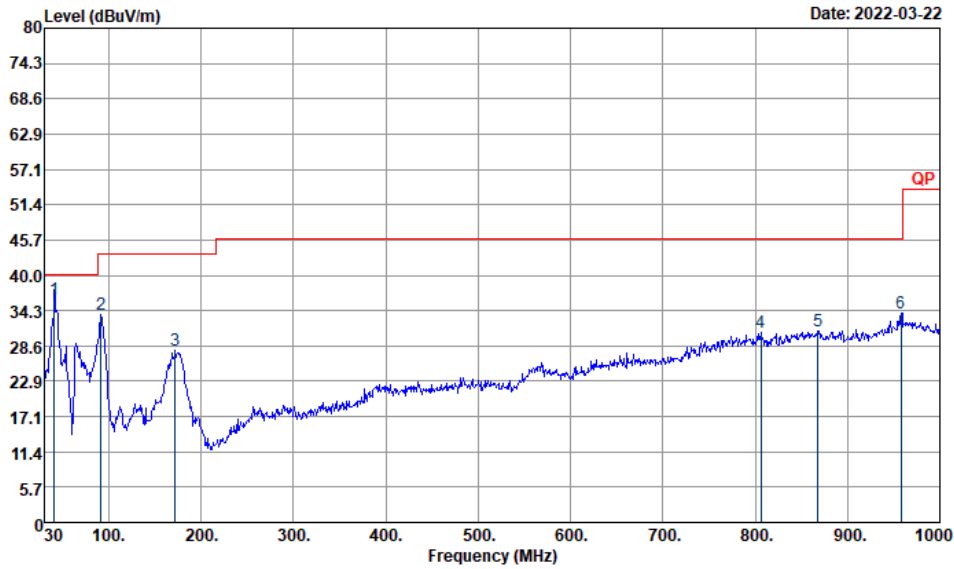

Frequency (MHz)	Level (dBμV/m)	Over Limit (dB)	Limit Line (dBμV/m)	Read Level (dBμV)	Antenna Factor (dB)	Cable Loss (dB)	Preamp Factor (dB)	Ant Pos (cm)	Table Pos (deg)	Remark
40.67	36.17	-3.83	40	48.73	18.89	0.98	32.43	101	100	QP
91.11	33.67	-9.83	43.5	49.88	14.61	1.58	32.4	-	-	Peak
171.62	27.82	-15.68	43.5	42.97	15.24	2.1	32.49	-	-	Peak
806	30.7	-15.3	46	28.73	27.99	5.7	31.72	-	-	Peak
868.08	30.96	-15.04	46	27.41	29.13	5.82	31.4	-	-	Peak
958.29	33.95	-12.05	46	28.14	30.82	5.83	30.84	-	-	Peak

Note:

1. The amplitude of spurious emissions which are attenuated by more than 20dB below the permissible value has no need to be reported.
2. Emission level (dBμV/m) = 20 log Emission level (μV/m).
3. Corrected Reading: Antenna Factor + Cable Loss + Read Level - Preamp Factor= Level.
4. The emission position marked as "-" means no suspected emission found with sufficient margin against limit line or noise floor only.