



SPORTON International Inc.

No. 52, Hwa Ya 1st Rd., Hwa Ya Technology Park, Kwei-Shan Hsiang, Tao Yuan Hsien, Taiwan, R.O.C.
Ph: 886-3-327-3456 / FAX: 886-3-327-0973 / www.sporton.com.tw

FCC RADIO TEST REPORT

Applicant's company	Zebra Technologies Corporation
Applicant Address	1 Zebra Plaza Holtsville, NY 11742 USA
FCC ID	UZ7SP5500
Manufacturer's company	Zebra Technologies Corporation
Manufacturer Address	1 Zebra Plaza Holtsville, NY 11742 USA

Product Name	Pole Mounted Reader
Brand Name	ZEBRA
Model Name	SP5500
Test Rule	47 CFR FCC Part 15 Subpart C § 15.247
Test Freq. Range	902 ~ 928 MHz
Received Date	Mar. 11, 2016
Final Test Date	Mar. 31, 2016
Submission Type	Original Equipment

Statement

The test result in this report refers exclusively to the presented test model / sample.

Without written approval of SPORTON International Inc., the test report shall not be reproduced except in full.

The measurements and test results shown in this test report were made in accordance with the procedures and found in compliance with the limit given in **ANSI C63.10-2013, DA-00705** and **47 CFR FCC Part 15 Subpart C**.

The test equipment used to perform the test is calibrated and traceable to NML/ROC.



Table of Contents

1. VERIFICATION OF COMPLIANCE	1
2. SUMMARY OF THE TEST RESULT	2
3. GENERAL INFORMATION	3
3.1. Product Details.....	3
3.2. Accessories.....	3
3.3. Table for Filed Antenna.....	4
3.4. Table for Carrier Frequencies	5
3.5. Table for Test Modes.....	6
3.6. Table for Testing Locations.....	6
3.7. Table for Supporting Units	7
3.8. Table for Parameters of Test Software Setting	7
3.9. EUT Operation during Test	7
3.10. Duty Cycle.....	8
3.11. Test Configurations	9
4. TEST RESULT	14
4.1. AC Power Line Conducted Emissions Measurement.....	14
4.2. Maximum Conducted Output Power Measurement.....	20
4.3. Hopping Channel Separation Measurement	22
4.4. Number of Hopping Frequency Measurement.....	30
4.5. Dwell Time Measurement.....	32
4.6. Radiated Emissions Measurement	38
4.7. Emissions Measurement	53
4.8. Antenna Requirements	63
5. LIST OF MEASURING EQUIPMENTS	64
6. MEASUREMENT UNCERTAINTY	65
APPENDIX A. TEST PHOTOS	A1 ~ A6



History of This Test Report

REPORT NO.	VERSION	DESCRIPTION	ISSUED DATE
FR631021	Rev. 01	Initial issue of report	Apr. 11, 2016

1. VERIFICATION OF COMPLIANCE

Product Name : Pole Mounted Reader
Brand Name : ZEBRA
Model No. : SP5500
Applicant : Zebra Technologies Corporation
Test Rule Part(s) : 47 CFR FCC Part 15 Subpart C § 15.247

Sporton International as requested by the applicant to evaluate the EMC performance of the product sample received on Mar. 11, 2016 would like to declare that the tested sample has been evaluated and found to be in compliance with the tested rule parts. The data recorded as well as the test configuration specified is true and accurate for showing the sample's EMC nature.

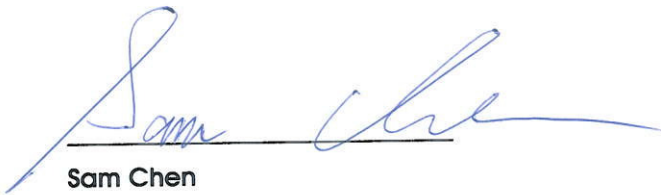

Sam Chen

SPORTON INTERNATIONAL INC.

2. SUMMARY OF THE TEST RESULT

Applied Standard: 47 CFR FCC Part 15 Subpart C				
Part	Rule Section	Description of Test	Result	Under Limit
4.1	15.207	AC Power Line Conducted Emissions	Complies	10.71 dB
4.2	15.247(b)(2)	Maximum Conducted Output Power	Complies	3.05 dB
4.3	15.247(a)(i)	Hopping Channel Separation	Complies	-
4.4	15.247(b)(2)	Number of Hopping Frequency	Complies	-
4.5	15.247(a)(i)	Dwell Time	Complies	-
4.6	15.247(d)	Radiated Emissions	Complies	4.05 dB
4.7	15.247(d)	Band Edge Emissions	Complies	-
4.8	15.203	Antenna Requirements	Complies	-

3. GENERAL INFORMATION

3.1. Product Details

Items	Description
Power Type	From power adapter or PoE
Modulation	DB-ASK, PR-ASK
Frequency Range	902 ~ 928 MHz
Operating Range	902.75 ~ 927.25 MHz
Channel Number	50
Channel Space	0.5 MHz
Channel Band Width (99%)	272.0694 kHz
Maximum Conducted Output Power	26.95 dBm
HW Version	EV
SW Version	1.2.11
MFD	17JAN15
Carrier Frequencies	Please refer to section 3.4
Antenna	Please refer to section 3.3

3.2. Accessories

Power	Brand	Model	Rating	Rmark
Adapter	Leader Electronics	NU80-4240325-11	Input: 100-240V~50/60Hz 1.4A Output: 24.0V, 3.25A	DC cable: Non-shielded, 2m
Power	Brand	P/N	Rating	
PoE	Microsemi	PD-9001GR/AC	Input: 100-240VAC~50/60Hz, 0.8A Output: 55Vdc, 0.6A	
Others				
Surge Protector*1				
Power line*1: Non-shielded, 1.9m				

3.3. Table for Filed Antenna

Ant.	Brand	Model Name	Antenna Type	Connector	Gain (dBi)
1	ZEBRA	AN710	Circular Polarized Patch Antenna (External)	Reverse Polarity TNC	3
2	MobileMark	PN6-915	Circular Polarized Patch Antenna (Internal)	Reverse Polarity TNC	3

Note: The EUT has two Antennas.

For function (1TX/1RX)

The EUT supports the antenna with TX/RX diversity function.

Both Ant. 1 and Ant. 2 support transmit and receive functions, but only one of them will be used at one time.

All test results were recorded in the report.

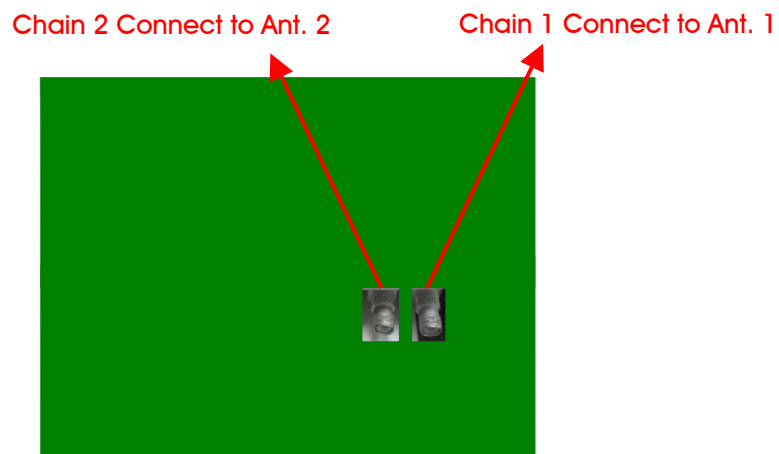

3.4. Table for Carrier Frequencies

Frequency Band	Channel No.	Frequency
902 ~ 928 MHz	1	902.75 MHz
	2	903.25 MHz
	:	:
	26	915.25 MHz
	27	915.75 MHz
	28	916.25 MHz
	:	:
	49	926.75 MHz
	50	927.25 MHz

3.5. Table for Test Modes

Preliminary tests were performed in different data rate to find the worst radiated emission. The data rate shown in the table below is the worst-case rate with respect to the specific test item. Investigation has been done on all the possible configurations for searching the worst cases. The following table is a list of the test modes shown in this test report.

Test Items	Mode	Channel	Antenna
AC Power Conducted Emissions	Normal Link	-	-
Maximum Conducted Output Power	CTX	1/27/50	1 & 2
Hopping Channel Separation	CTX	1~3 27~29 48~50	1 & 2
Number of Hopping Frequency	CTX	1~50	1 & 2
Dwell Time	CTX	1/27/50	1 & 2
Radiated Emissions Below 1GHz	Normal Link	-	-
Radiated Emissions Above 1GHz	CTX	1/27/50	1 & 2
Band Edge Emissions	CTX	1/50	1 & 2

Note: The EUT can only be used at Y axis position.

The following test modes were performed for all tests:

For Conducted Emission test:

Mode 1. Normal Link - EUT + Adapter

Mode 2. Normal Link - EUT + PoE

All test results were recorded in the report.

For Radiated Emission test below 1GHz:

Mode 1. Normal Link - EUT + Adapter

Mode 2. Normal Link - EUT + PoE

All test results were recorded in the report.

For Radiated Emission test above 1GHz:

Mode 1. CTX - EUT + Adapter

3.6. Table for Testing Locations

Test Site Location					
Address:	No.8, Lane 724, Bo-ai St., Jhubei City, Hsinchu County 302, Taiwan, R.O.C.				
TEL:	886-3-656-9065				
FAX:	886-3-656-9085				
Test Site No.	Site Category	Location	FCC Designation No.	IC File No.	VCCI Reg. No
03CH01-CB	SAC	Hsin Chu	TW0006	IC 4086D	-
CO01-CB	Conduction	Hsin Chu	TW0006	IC 4086D	-
TH01-CB	OVEN Room	Hsin Chu	-	-	-

Open Area Test Site (OATS); Semi Anechoic Chamber (SAC).

3.7. Table for Supporting Units

For Test Site No: 03CH01-CB

For Radiated Emission test below 1GHz:

Support Unit	Brand	Model	FCC ID
NB	DELL	E4300	DoC
RFID Tag	JCPenney	N/A	DoC

For Radiated Emission test above 1GHz:

Support Unit	Brand	Model	FCC ID
NB	DELL	E4300	DoC

For Test Site No: CO01-CB

Support Unit	Brand	Model	FCC ID
NB	DELL	E6430	DoC
RFID Tag	JCPenney	N/A	DoC

For Test Site No: TH01-CB

Support Unit	Brand	Model	FCC ID
NB	DELL	E4300	DoC

3.8. Table for Parameters of Test Software Setting

During testing, Channel and Power Controlling Software provided by the customer was used to control the operating channel as well as the output power level. The RF output power selection is for the setting of RF output power expected by the customer and is going to be fixed on the firmware of the final end product.

For Ant. 1:

Test Software Version	PUTTY		
Frequency	902.75 MHz	915.75 MHz	927.25 MHz
Power Parameters	267	267	267

For Ant. 2:

Test Software Version	PUTTY		
Frequency	902.75 MHz	915.75 MHz	927.25 MHz
Power Parameters	268	267	267

3.9. EUT Operation during Test

The EUT was programmed to be in continuously transmitting mode.

3.10. Duty Cycle

For Ant. 1:

On Time (ms)	On+Off Time (ms)	Duty Cycle (%)	Duty Factor (dB)	1/T Minimum VBW (kHz)
1.000	1.000	100.00%	0.00	0.01

For Ant. 2:

On Time (ms)	On+Off Time (ms)	Duty Cycle (%)	Duty Factor (dB)	1/T Minimum VBW (kHz)
1.000	1.000	100.00%	0.00	0.01

3.11. Test Configurations

3.11.1. AC Power Line Conduction Emissions Test Configuration

For Mode 1:

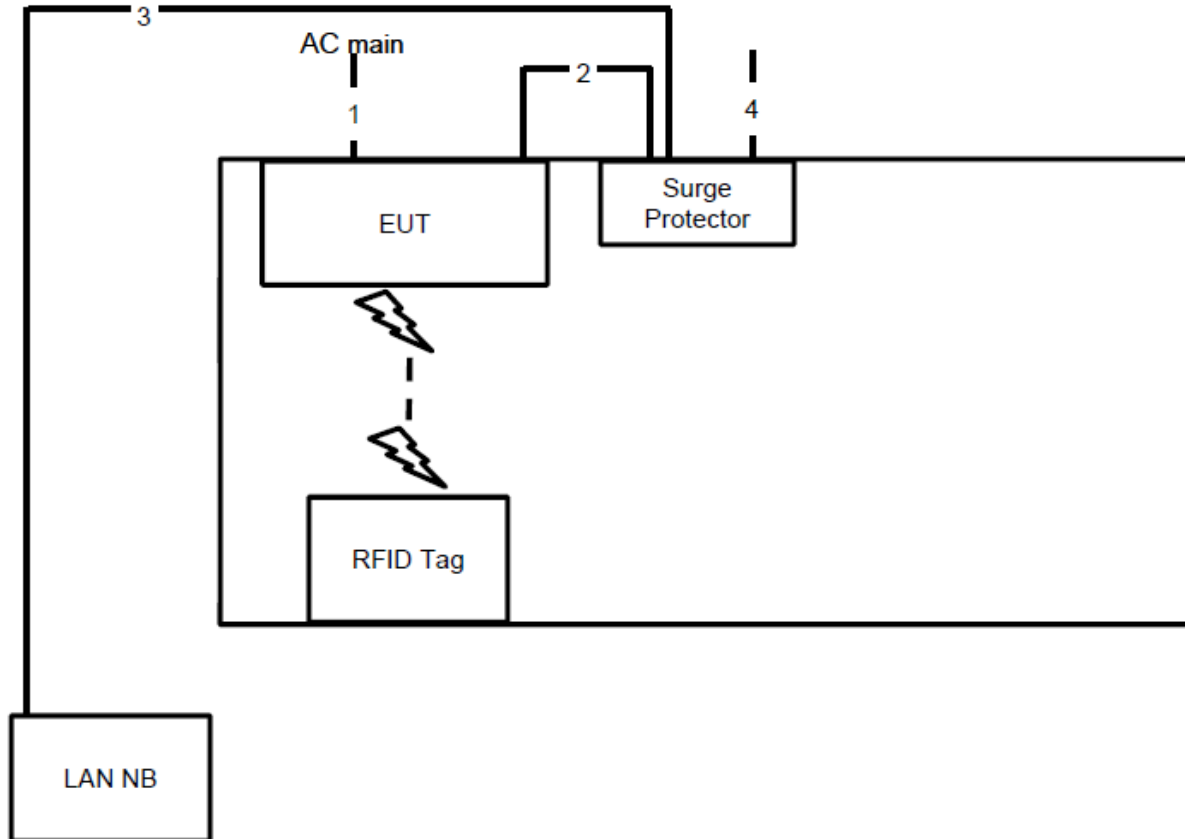

Item	Connection	Shielded	Length
1	Power cable	No	3.9m
2	RJ-45 cable	No	1m
3	RJ-45 cable	No	10m
4	Ground cable	Yes	1.5m

For Mode 2:

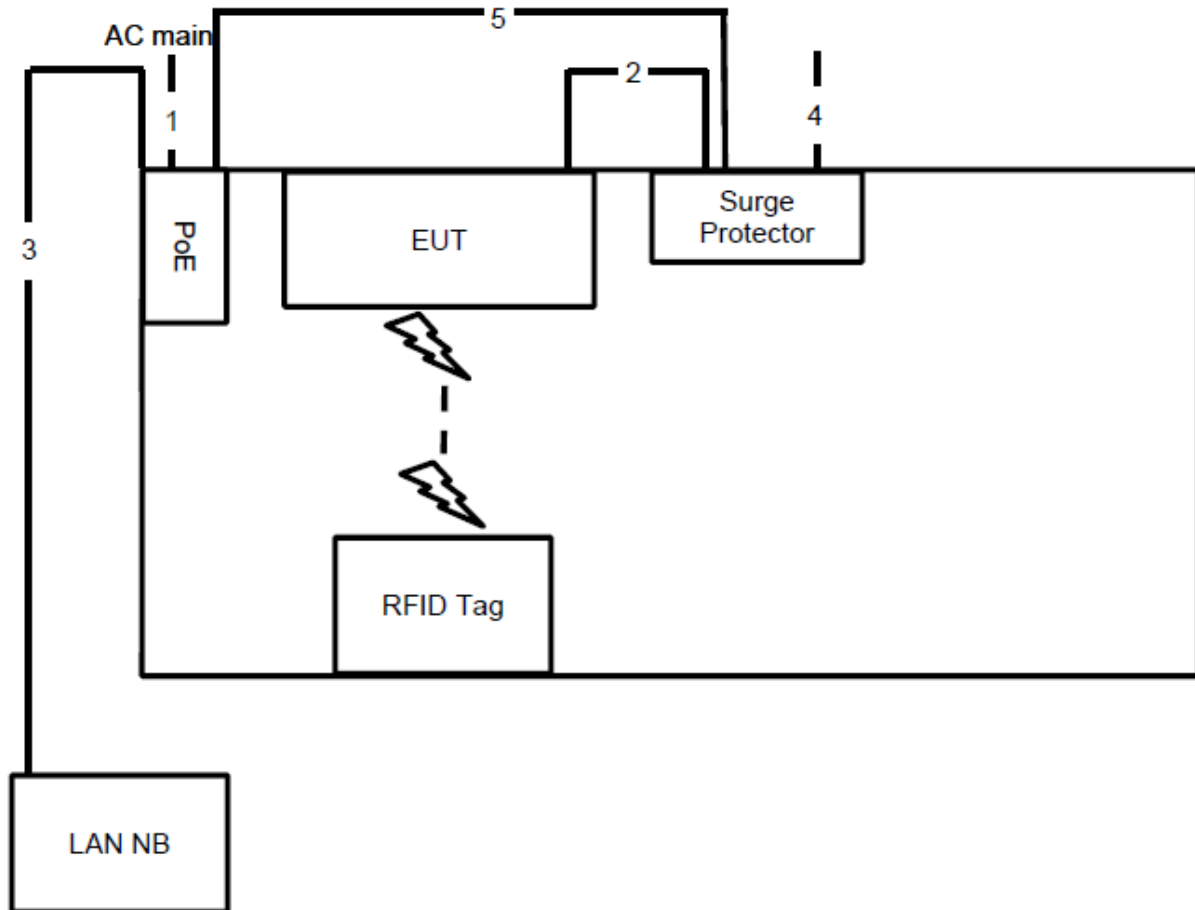

Item	Connection	Shielded	Length
1	Power cable	No	1.9m
2	RJ-45 cable	No	1m
3	RJ-45 cable	No	10m
4	Ground cable	Yes	1.5m
5	RJ-45 cable	No	1m

3.11.2. Radiation Emissions Test Configuration

Test Configuration: 30MHz~1GHz

For Mode 1:

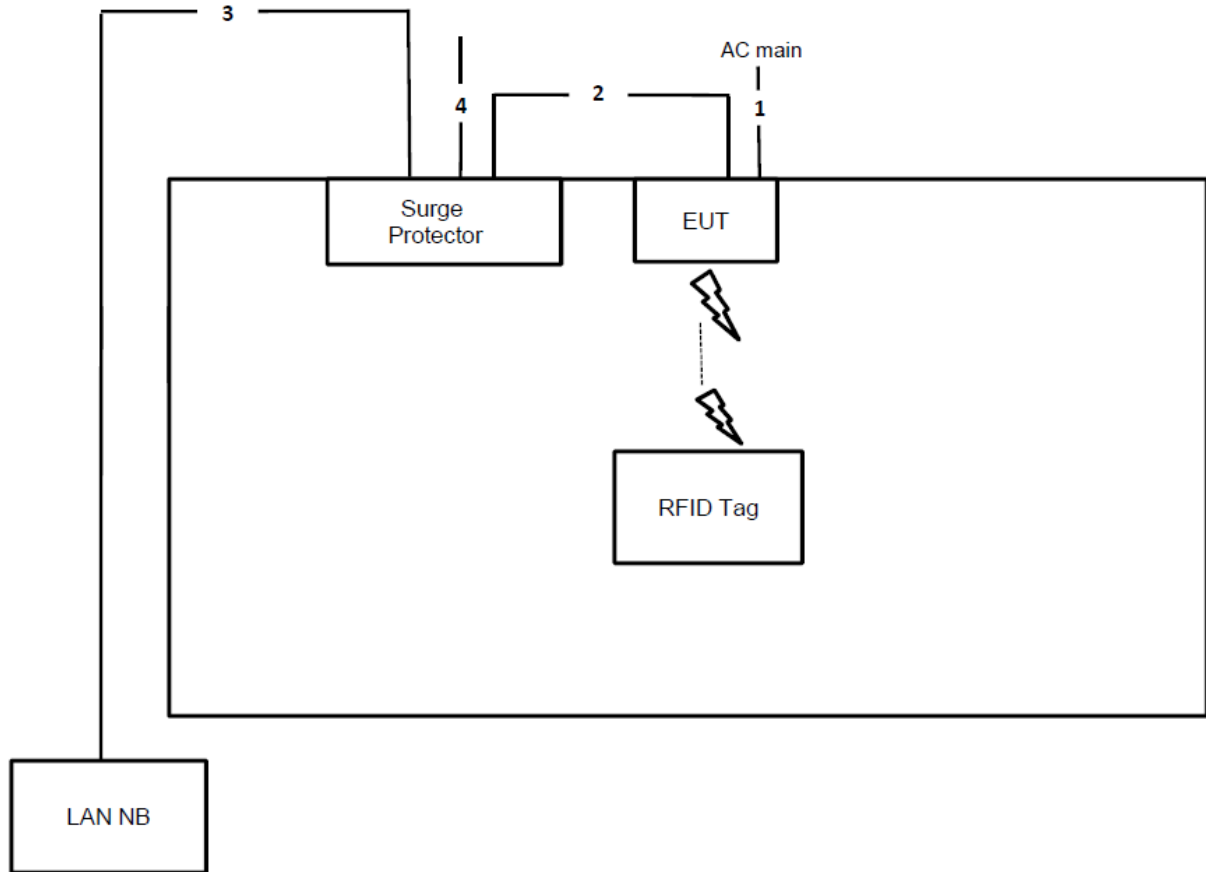

Item	Connection	Shielded	Length
1	Power cable	No	3.9m
2	RJ-45 cable	No	1.5m
3	RJ-45 cable	No	10m
4	Ground cable	Yes	1.5m

For Mode 2:

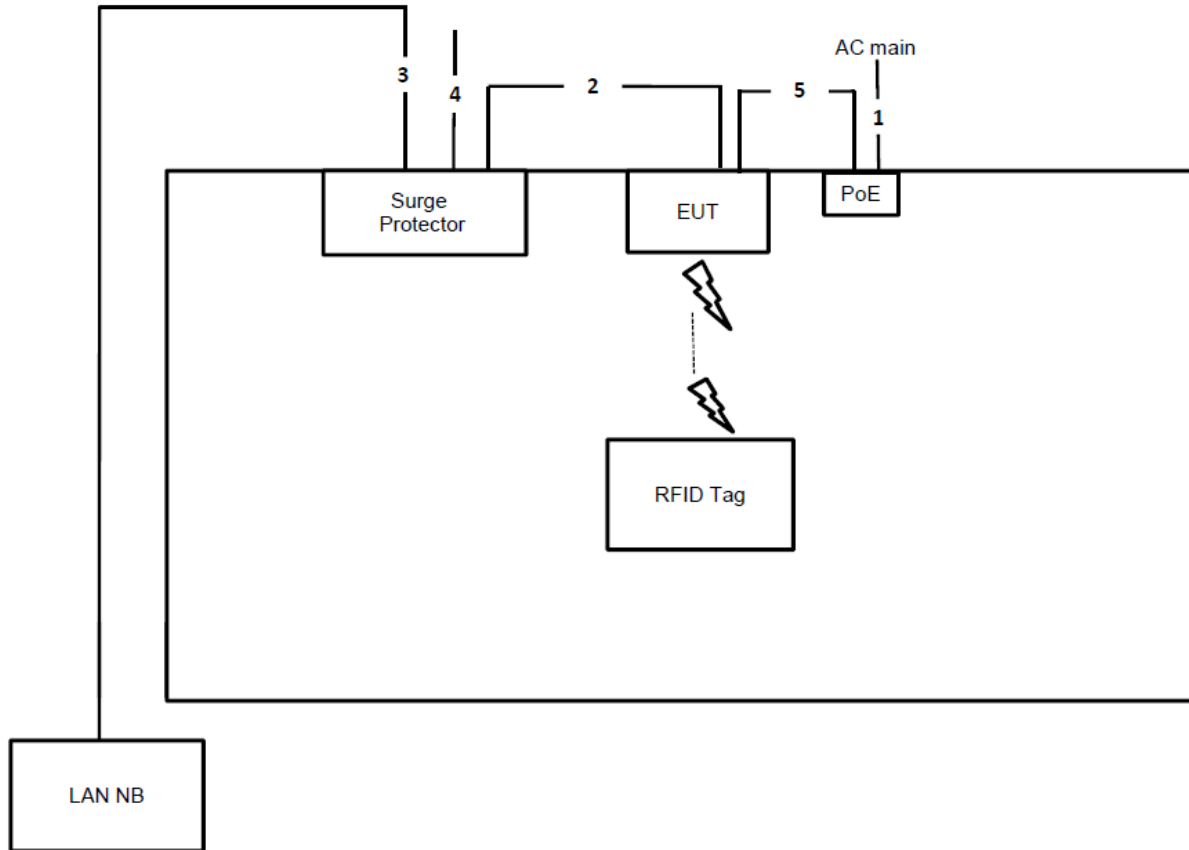

Item	Connection	Shielded	Length
1	Power cable	No	1.9m
2	RJ-45 cable	No	1.5m
3	RJ-45 cable	No	10m
4	Ground cable	Yes	1.5m
5	RJ-45 cable	No	1.5m

Test Configuration: above 1GHz

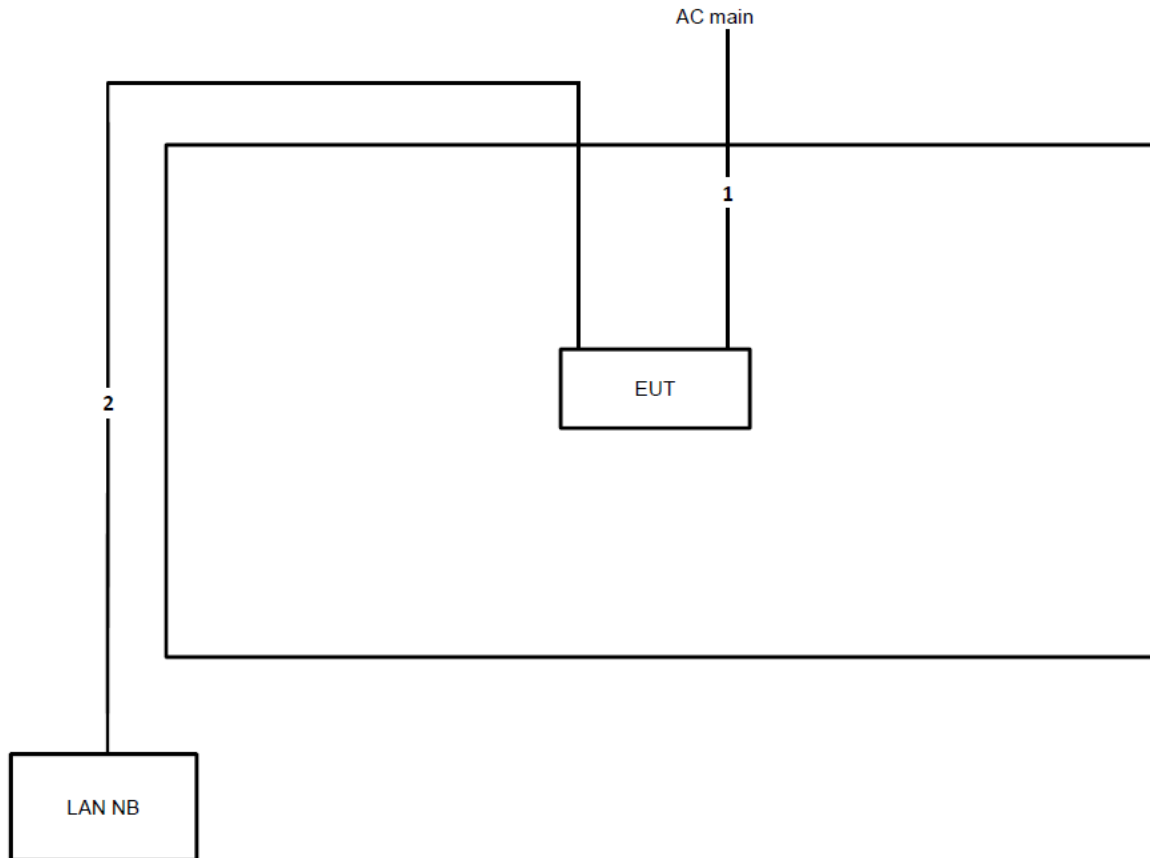

Item	Connection	Shielded	Length
1	Power cable	No	3.9m
2	RJ-45 cable	No	10m

4. TEST RESULT

4.1. AC Power Line Conducted Emissions Measurement

4.1.1. Limit

For a Low-power Radio-frequency Device which is designed to be connected to the AC power line, the radio frequency voltage that is conducted back onto the AC power line on any frequency or frequencies within the band 150 kHz to 30 MHz shall not exceed below limits table.

Frequency (MHz)	QP Limit (dBuV)	AV Limit (dBuV)
0.15~0.5	66~56	56~46
0.5~5	56	46
5~30	60	50

4.1.2. Measuring Instruments and Setting

Please refer to section 5 of equipments list in this report. The following table is the setting of the receiver.

Receiver Parameters	Setting
Attenuation	10 dB
Start Frequency	0.15 MHz
Stop Frequency	30 MHz
IF Bandwidth	9 kHz

4.1.3. Test Procedures

1. Configure the EUT according to ANSI C63.10. The EUT or host of EUT has to be placed 0.4 meter far from the conducting wall of the shielding room and at least 80 centimeters from any other grounded conducting surface.
2. Connect EUT or host of EUT to the power mains through a line impedance stabilization network (LISN).
3. All the support units are connected to the other LISNs. The LISN should provide 50uH/50ohms coupling impedance.
4. The frequency range from 150 kHz to 30 MHz was searched.
5. Set the test-receiver system to Peak Detect Function and Specified Bandwidth with Maximum Hold Mode.
6. The measurement has to be done between each power line and ground at the power terminal.

4.1.4. Test Setup Layout

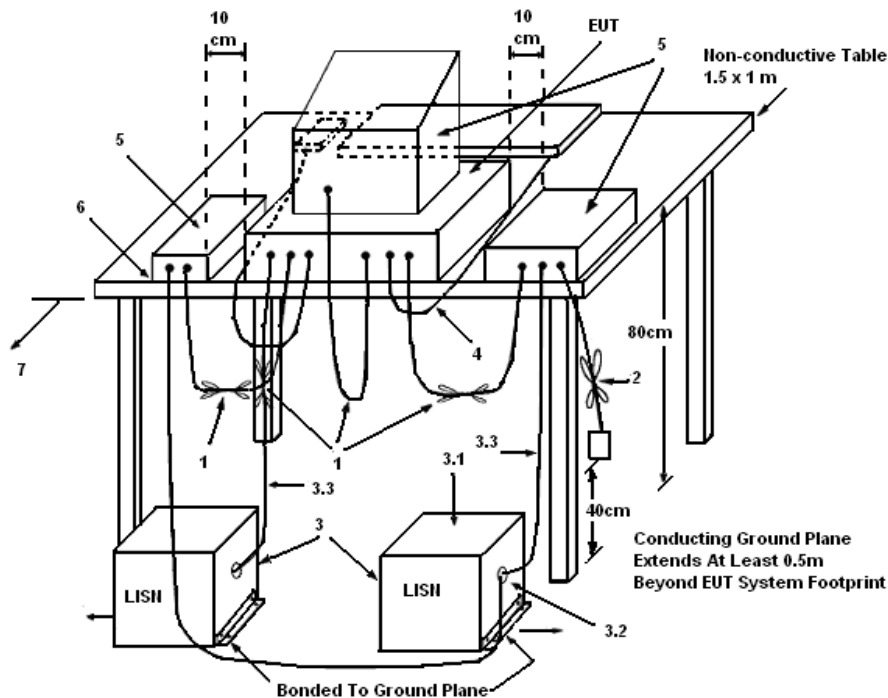

LEGEND:

- (1) Interconnecting cables that hang closer than 40 cm to the ground plane shall be folded back and forth in the center forming a bundle 30 to 40 cm long.
- (2) I/O cables that are not connected to a peripheral shall be bundled in the center. The end of the cable may be terminated, if required, using the correct terminating impedance. The overall length shall not exceed 1 m.
- (3) EUT connected to one LISN. Unused LISN measuring port connectors shall be terminated in 50Ω . LISN can be placed on top of, or immediately beneath, reference ground plane.
- (3.1) All other equipment powered from additional LISN(s).
- (3.2) Multiple outlet strip can be used for multiple power cords of non-EUT equipment.
- (3.3) LISN at least 80 cm from nearest part of EUT chassis.
- (4) Cables of hand-operated devices, such as keyboards, mice, etc., shall be placed as for normal use.
- (5) Non-EUT components of EUT system being tested.
- (6) Rear of EUT, including peripherals, shall all be aligned and flush with rear of tabletop.
- (7) Rear of tabletop shall be 40 cm removed from a vertical conducting plane that is bonded to the ground plane.

4.1.5. Test Deviation

There is no deviation with the original standard.

4.1.6. EUT Operation during Test

The EUT was placed on the test table and programmed in normal function.

4.1.7. Results of AC Power Line Conducted Emissions Measurement

Temperature	20°C	Humidity	60%
Test Engineer	Deven Huang	Phase	Line
Configuration	Normal Link	Test Mode	Mode 1

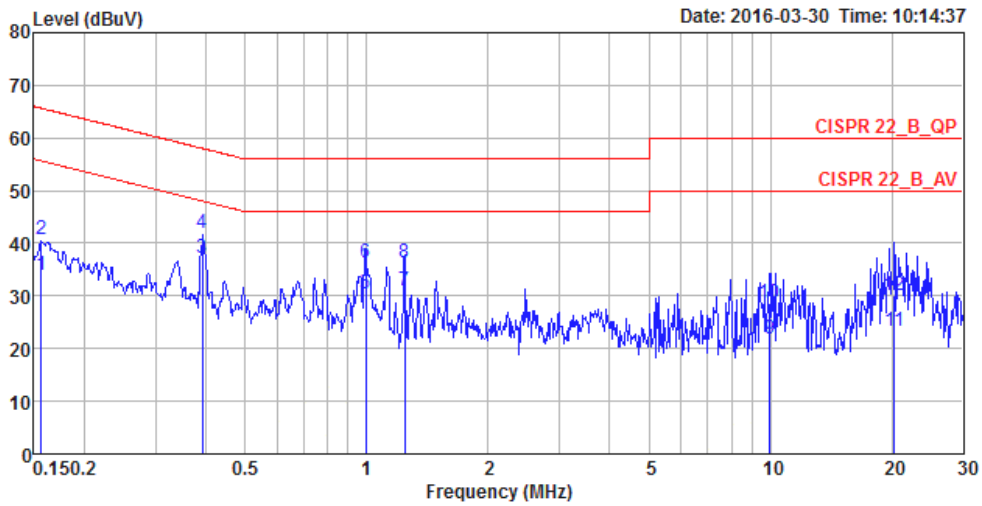

	Freq	Level	Over Limit	Limit Line	Read Level	LISN Factor	Cable Loss	Pol/Phase	Remark
	MHz	dBuV	dB	dBuV	dBuV	dB	dB		
1	0.1565	33.93	-21.72	55.65	23.89	10.02	0.02	LINE	Average
2	0.1565	40.81	-24.84	65.65	30.77	10.02	0.02	LINE	QP
3	0.3914	37.32	-10.71	48.03	27.36	9.92	0.04	LINE	Average
4	0.3914	41.87	-16.16	58.03	31.91	9.92	0.04	LINE	QP
5	0.9944	30.51	-15.49	46.00	20.52	9.94	0.05	LINE	Average
6	0.9944	36.33	-19.67	56.00	26.34	9.94	0.05	LINE	QP
7	1.2422	31.12	-14.88	46.00	21.13	9.94	0.05	LINE	Average
8	1.2422	36.17	-19.83	56.00	26.18	9.94	0.05	LINE	QP
9	9.9657	21.90	-28.10	50.00	11.50	10.15	0.25	LINE	Average
10	9.9657	28.72	-31.28	60.00	18.32	10.15	0.25	LINE	QP
11	20.2696	23.20	-26.80	50.00	12.62	10.32	0.26	LINE	Average
12	20.2696	30.16	-29.84	60.00	19.58	10.32	0.26	LINE	QP

Temperature	20°C	Humidity	60%
Test Engineer	Deven Huang	Phase	Neutral
Configuration	Normal Link	Test Mode	Mode 1

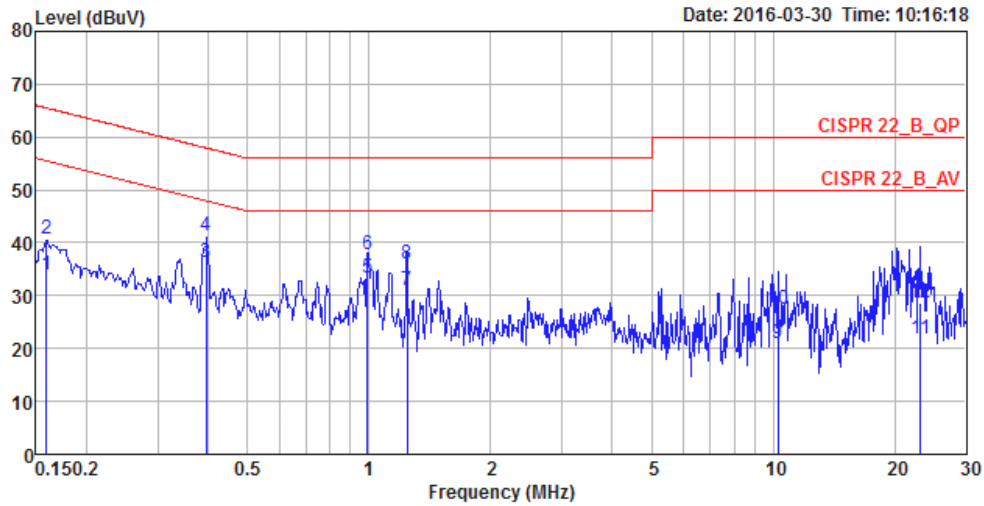

	Freq	Level	Over Limit	Limit Line	Read Level	LISN Factor	Cable Loss	Pol/Phase	Remark
	MHz	dBuV	dB	dBuV	dBuV	dB	dB		
1	0.1590	33.99	-21.53	55.52	23.95	10.02	0.02	NEUTRAL	Average
2	0.1590	40.76	-24.76	65.52	30.72	10.02	0.02	NEUTRAL	QP
3	0.3955	36.36	-11.59	47.95	26.40	9.92	0.04	NEUTRAL	Average
4	0.3955	41.26	-16.69	57.95	31.30	9.92	0.04	NEUTRAL	QP
5	0.9891	33.37	-12.63	46.00	23.38	9.94	0.05	NEUTRAL	Average
6	0.9891	37.90	-18.10	56.00	27.91	9.94	0.05	NEUTRAL	QP
7	1.2422	31.06	-14.94	46.00	21.07	9.94	0.05	NEUTRAL	Average
8	1.2422	36.14	-19.86	56.00	26.15	9.94	0.05	NEUTRAL	QP
9	10.2876	20.90	-29.10	50.00	10.50	10.15	0.25	NEUTRAL	Average
10	10.2876	27.49	-32.51	60.00	17.09	10.15	0.25	NEUTRAL	QP
11	23.1404	21.73	-28.27	50.00	11.07	10.39	0.27	NEUTRAL	Average
12	23.1404	28.52	-31.48	60.00	17.86	10.39	0.27	NEUTRAL	QP

Note: Level = Read Level + LISN Factor + Cable Loss.

Temperature	20°C	Humidity	60%
Test Engineer	Deven Huang	Phase	Line
Configuration	Normal Link	Test Mode	Mode 2

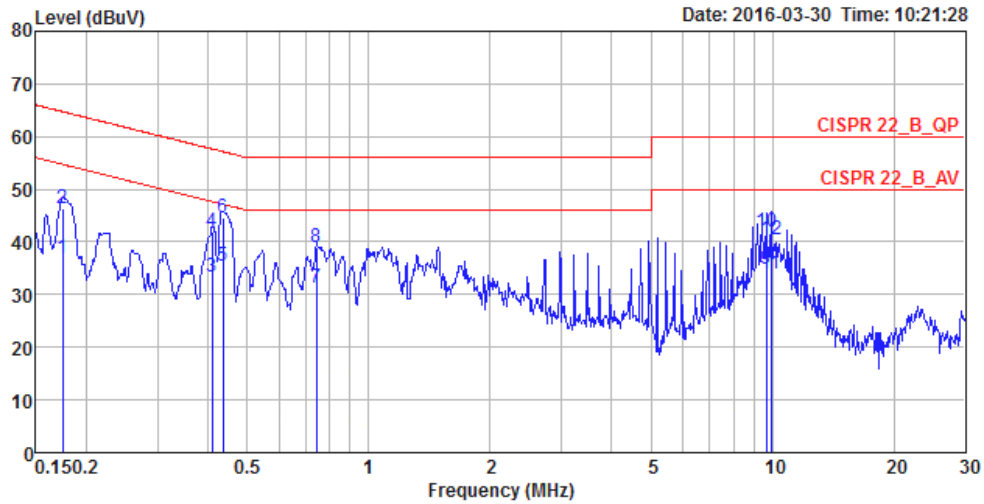

	Freq	Level	Over Limit	Limit Line	Read Level	LISN Factor	Cable Loss	Pol/Phase	Remark
	MHz	dBuV	dB	dBuV	dBuV	dB	dB		
1	0.1749	37.03	-17.69	54.72	27.09	9.92	0.02	LINE	Average
2	0.1749	46.28	-18.44	64.72	36.34	9.92	0.02	LINE	QP
3	0.4105	33.23	-14.41	47.64	23.27	9.92	0.04	LINE	Average
4	0.4105	41.90	-15.74	57.64	31.94	9.92	0.04	LINE	QP
5	0.4351	35.36	-11.79	47.15	25.40	9.92	0.04	LINE	Average
6	0.4351	44.59	-12.56	57.15	34.63	9.92	0.04	LINE	QP
7	0.7430	31.27	-14.73	46.00	21.30	9.93	0.04	LINE	Average
8	0.7430	38.90	-17.10	56.00	28.93	9.93	0.04	LINE	QP
9	9.6539	34.74	-15.26	50.00	24.36	10.14	0.24	LINE	Average
10	9.6539	41.81	-18.19	60.00	31.43	10.14	0.24	LINE	QP
11	9.9130	34.06	-15.94	50.00	23.66	10.15	0.25	LINE	Average
12	9.9130	40.36	-19.64	60.00	29.96	10.15	0.25	LINE	QP

Temperature	20°C	Humidity	60%
Test Engineer	Deven Huang	Phase	Neutral
Configuration	Normal Link	Test Mode	Mode 2

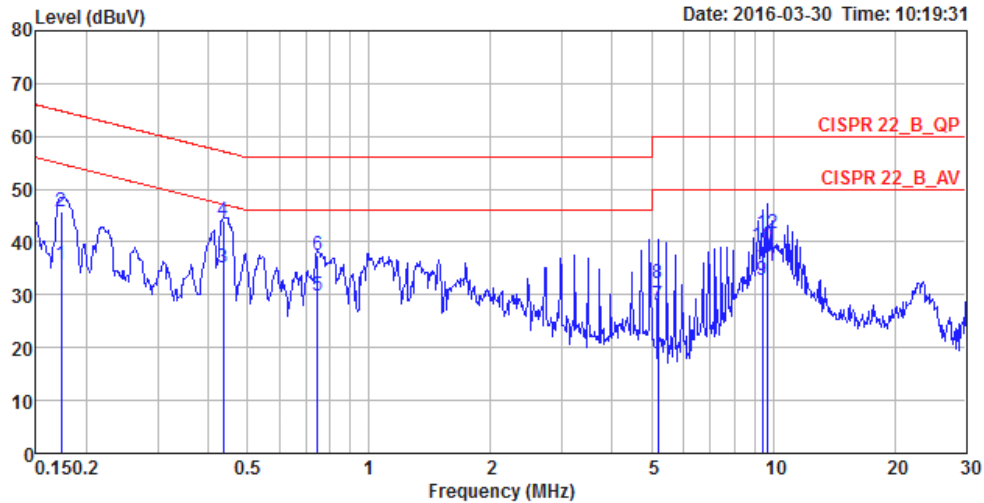

	Freq	Level	Over Limit	Limit Line	Read Level	LISN Factor	Cable Loss	Pol/Phase	Remark
	MHz	dBuV	dB	dBuV	dBuV	dB	dB		
1	0.1731	35.64	-19.17	54.81	25.60	10.02	0.02	NEUTRAL	Average
2	0.1731	45.76	-19.05	64.81	35.72	10.02	0.02	NEUTRAL	QP
3	0.4351	35.07	-12.08	47.15	25.11	9.92	0.04	NEUTRAL	Average
4	0.4351	44.00	-13.15	57.15	34.04	9.92	0.04	NEUTRAL	QP
5	0.7470	29.96	-16.04	46.00	20.00	9.93	0.03	NEUTRAL	Average
6	0.7470	37.57	-18.43	56.00	27.61	9.93	0.03	NEUTRAL	QP
7	5.1937	28.17	-21.83	50.00	18.05	10.02	0.10	NEUTRAL	Average
8	5.1937	32.13	-27.87	60.00	22.01	10.02	0.10	NEUTRAL	QP
9	9.4015	32.82	-17.18	50.00	22.46	10.13	0.23	NEUTRAL	Average
10	9.4015	39.24	-20.76	60.00	28.88	10.13	0.23	NEUTRAL	QP
11	9.6539	35.47	-14.53	50.00	25.09	10.14	0.24	NEUTRAL	Average
12	9.6539	41.77	-18.23	60.00	31.39	10.14	0.24	NEUTRAL	QP

Note: Level = Read Level + LISN Factor + Cable Loss.

4.2. Maximum Conducted Output Power Measurement

4.2.1. Limit

For frequency hopping systems operating in the 902-928 MHz band: 1 watt (30dBm) for systems employing at least 50 hopping channels; and, 0.25 watts for systems employing less than 50 hopping channels, but at least 25 hopping channels, as permitted under paragraph 15.247 (a)(1)(i).

4.2.2. Measuring Instruments and Setting

Please refer to section 5 of equipments list in this report. The following table is the setting of the power meter.

Power Meter Parameter	Setting
Bandwidth	50MHz bandwidth is greater than the EUT emission bandwidth
Detector	Peak

4.2.3. Test Procedures

This procedure provides an alternative for determining the RMS output power using a broadband RF average power meter with a thermocouple detector.

4.2.4. Test Setup Layout

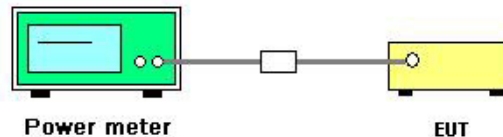

4.2.5. Test Deviation

There is no deviation with the original standard.

4.2.6. EUT Operation during Test

The EUT was programmed to be in continuously transmitting mode.

4.2.7. Test Result of Maximum Conducted Output Power

Temperature	22°C	Humidity	60%
Test Engineer	Peter Wu	Configurations	CTX
Test Date	Mar. 24, 2016 ~ Mar. 25, 2016		

For Ant. 1:

Channel	Frequency	Conducted Power (dBm)	Max. Limit (dBm)	Result
1	902.75 MHz	26.73	30.00	Complies
27	915.75 MHz	26.91	30.00	Complies
50	927.25 MHz	26.88	30.00	Complies

For Ant. 2:

Channel	Frequency	Conducted Power (dBm)	Max. Limit (dBm)	Result
1	902.75 MHz	26.95	30.00	Complies
27	915.75 MHz	26.89	30.00	Complies
50	927.25 MHz	26.87	30.00	Complies

4.3. Hopping Channel Separation Measurement

4.3.1. Limit

Frequency hopping systems operating in the 902-928 MHz band: if the 20 dB bandwidth of the hopping channel is less than 250 kHz, the system shall use at least 50 hopping frequencies and the average time of occupancy on any frequency shall not be greater than 0.4 seconds within a 20 second period; if the 20 dB bandwidth of the hopping channel is 250 kHz or greater, the system shall use at least 25 hopping frequencies and the average time of occupancy on any frequency shall not be greater than 0.4 seconds within a 10 second period. The maximum allowed 20 dB bandwidth of the hopping channel is 500 kHz.

4.3.2. Measuring Instruments and Setting

Please refer to section 5 of equipments list in this report. The following table is the setting of spectrum analyzer.

Spectrum Parameter	Setting
Attenuation	Auto
Span Frequency	> Measurement Bandwidth or Channel Separation
RBW	$\geq 1\%$ of the 20 dB bandwidth (20dB Bandwidth) / $\geq 1\%$ of the span (Channel Separation)
VBW	\geq RBW (20dB Bandwidth) / \geq RBW (Channel Separation)
Detector	Peak
Trace	Max Hold
Sweep Time	Auto

4.3.3. Test Procedures

1. The transmitter output (antenna port) was connected to the spectrum analyzer in peak hold mode.
2. The resolution bandwidth of 3 kHz and the video bandwidth of 30 kHz were utilized for 20 dB bandwidth measurement.
3. The resolution bandwidth of 100 kHz and the video bandwidth of 100 kHz were utilized for channel separation measurement.

4.3.4. Test Setup Layout

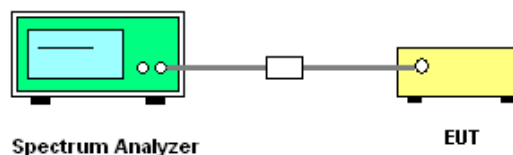

4.3.5. Test Deviation

There is no deviation with the original standard.

4.3.6. EUT Operation during Test

The EUT was programmed to be in continuously transmitting mode.

4.3.7. Test Result of Hopping Channel Separation

Temperature	22°C	Humidity	60%
Test Engineer	Peter Wu	Configurations	CTX

For Ant. 1:

Frequency	20dB Bandwidth (kHz)	99% Occupied Bandwidth (kHz)	Ch. Separation (kHz)	Limit of 20dB Bandwidth (kHz)	Result
902.75 MHz	263.7700	266.2807	500.00	500.000	Complies
915.75 MHz	247.8300	269.1751	500.00	500.000	Complies
927.25 MHz	256.5200	272.0694	500.00	500.000	Complies

For Ant. 2:

Frequency	20dB Bandwidth (kHz)	99% Occupied Bandwidth (kHz)	Ch. Separation (kHz)	Limit of 20dB Bandwidth (kHz)	Result
902.75 MHz	263.7700	270.6222	500.00	500.000	Complies
915.75 MHz	263.7700	267.7279	500.00	500.000	Complies
927.25 MHz	273.9100	270.6222	500.00	500.000	Complies

For Ant. 1:

20 dB Bandwidth Plot / Channel 1 / 902.75 MHz

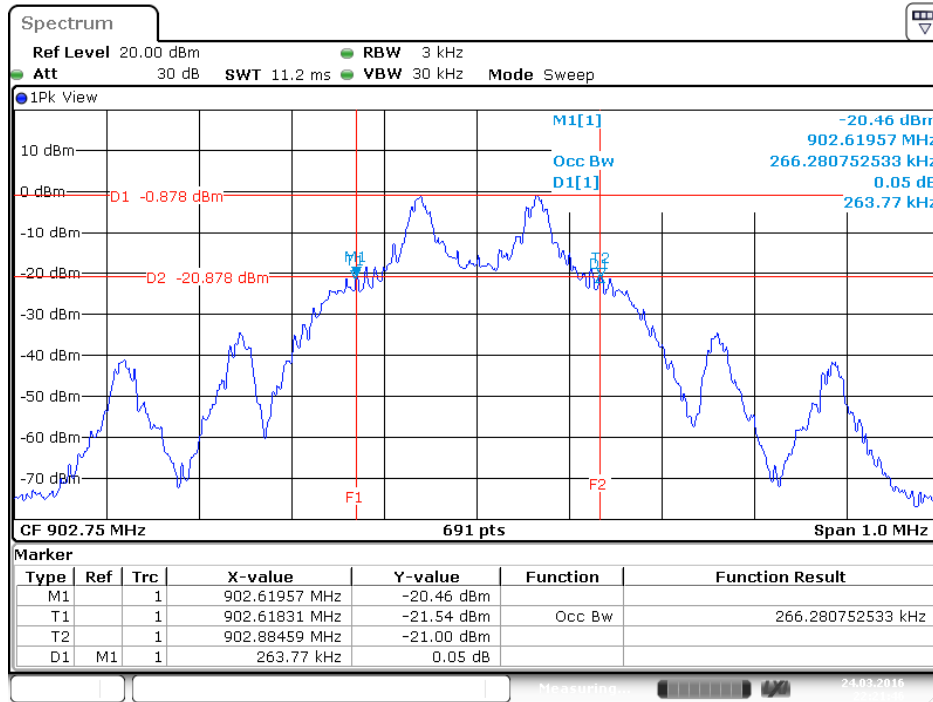

Date: 24 MAR 2016 22:21:46

20 dB Bandwidth Plot / Channel 27 / 915.75 MHz

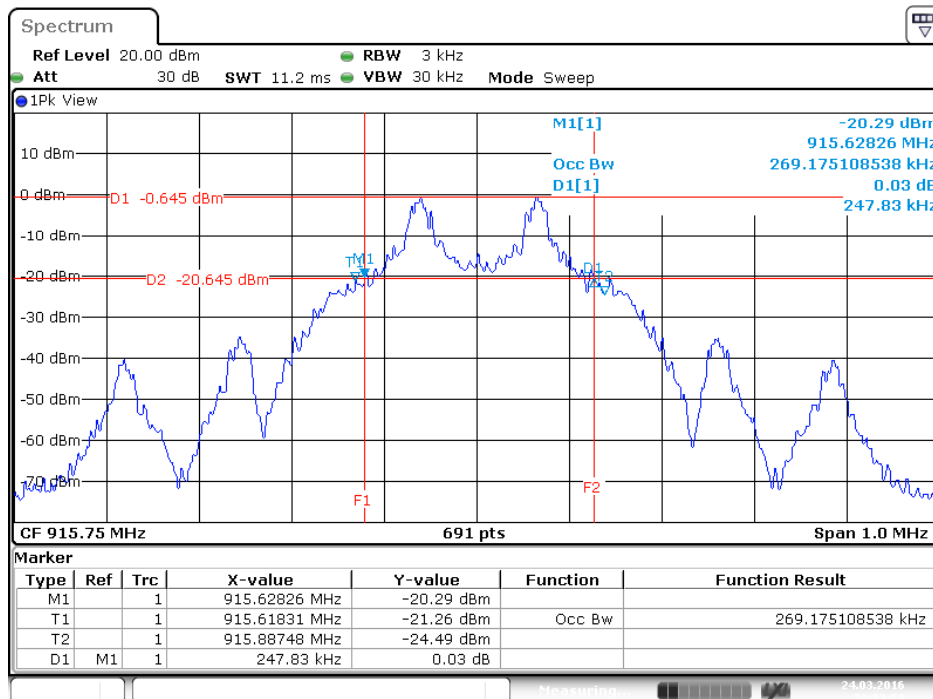

Date: 24 MAR 2016 22:22:52

20 dB Bandwidth Plot / Channel 50 / 927.25 MHz

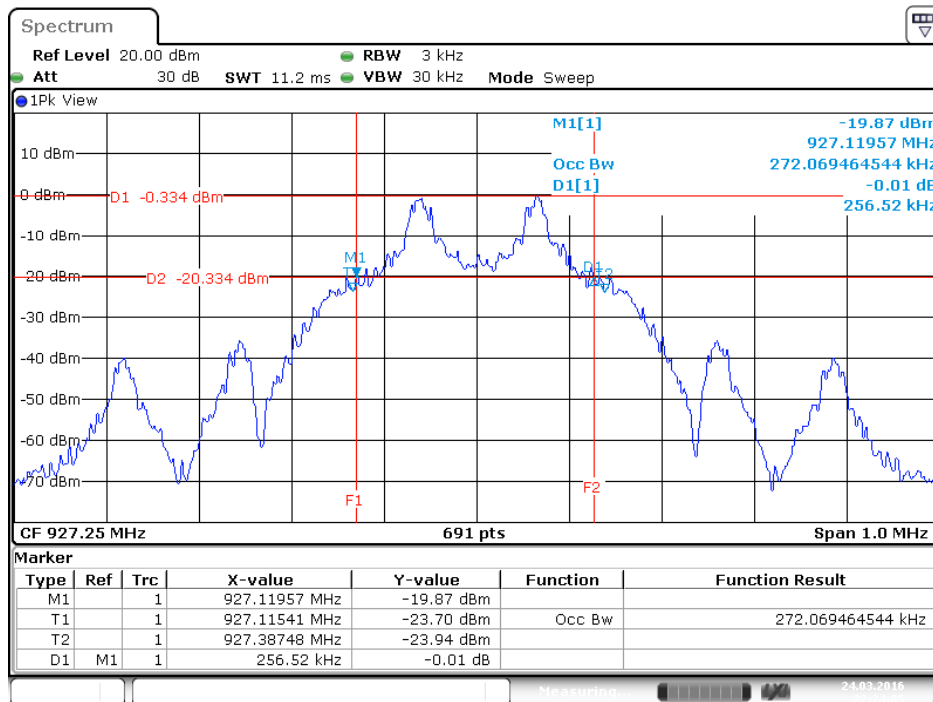

Date: 24 MAR 2016 22:24:05

Channel Separation Plot / Channel 1~3 / 902.75 MHz ~ 903.75 MHz

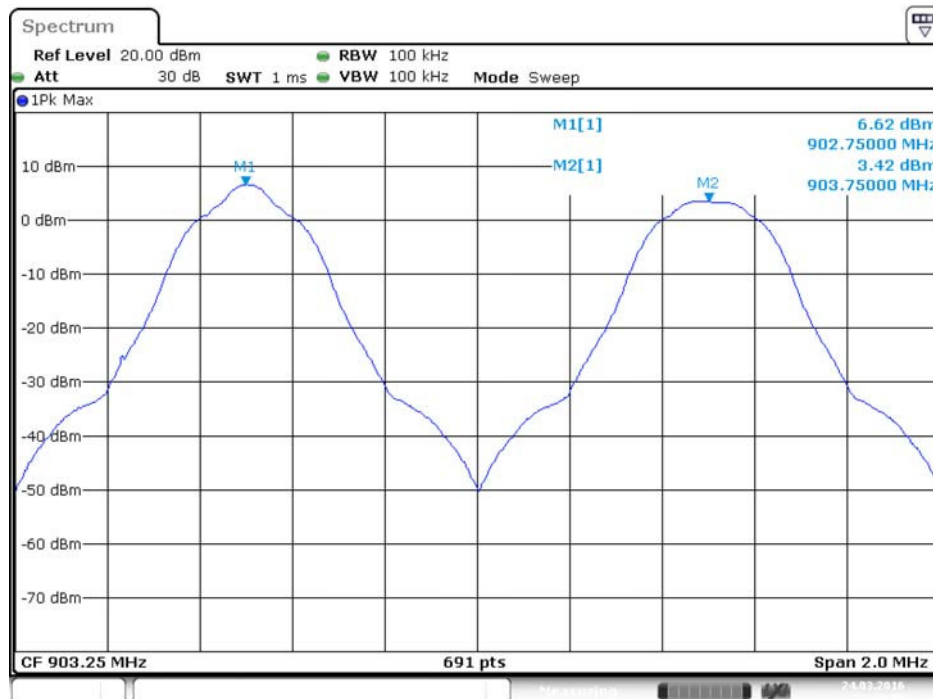

Date: 24.MAR.2016 22:45:58

Channel Separation Plot / Channel 27~29 / 915.75 MHz ~ 916.75 MHz

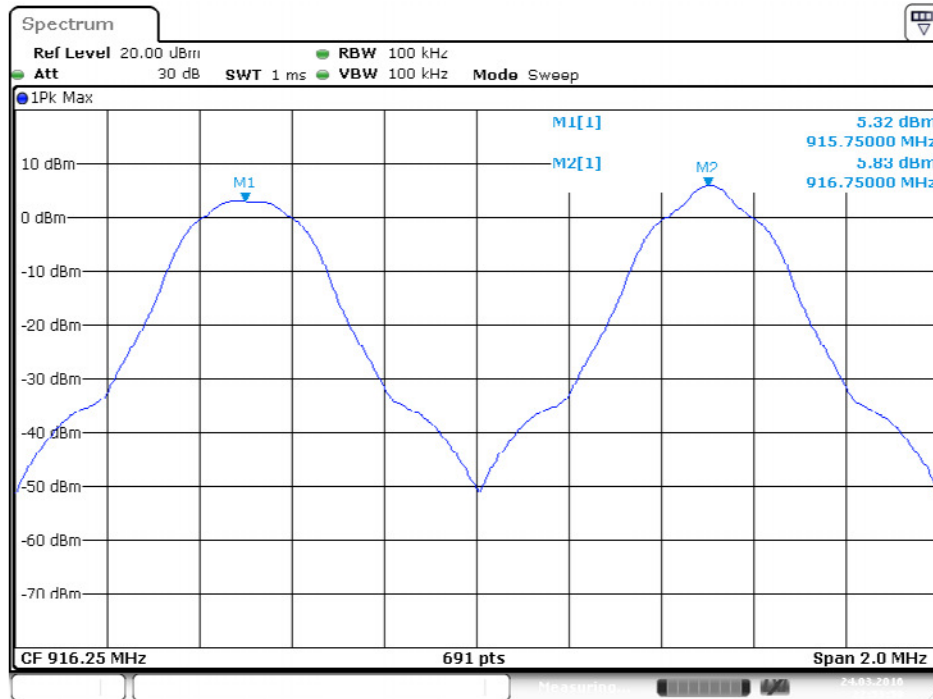

Date: 24.MAR.2016 22:53:49

Channel Separation Plot / Channel 48~50 / 926.25 MHz ~ 927.25 MHz

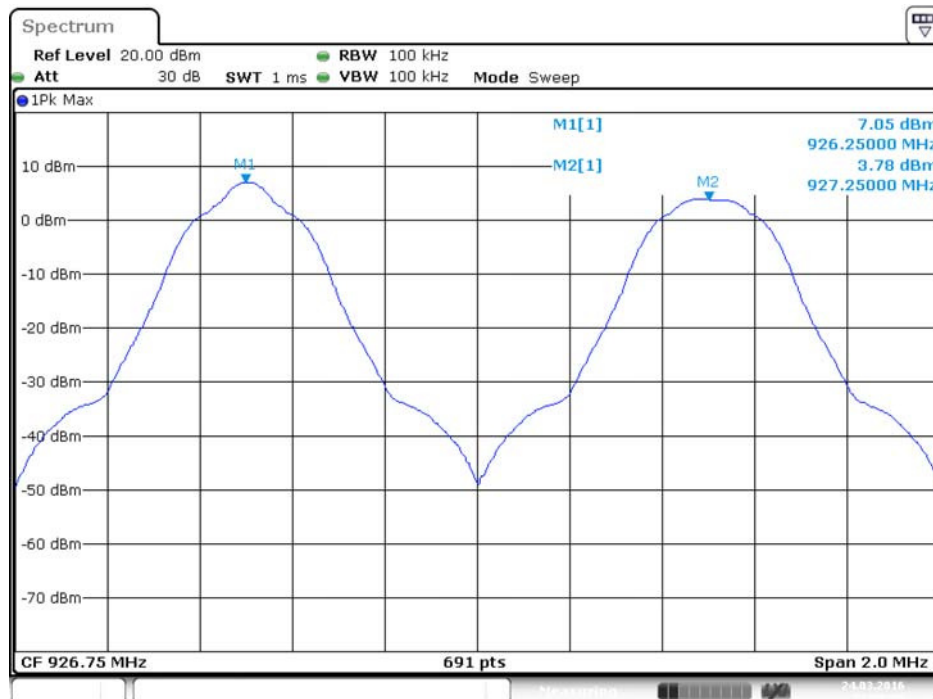

Date: 24.MAR.2016 22:58:36

For Ant. 2:

20 dB Bandwidth Plot / Channel 1 / 902.75 MHz

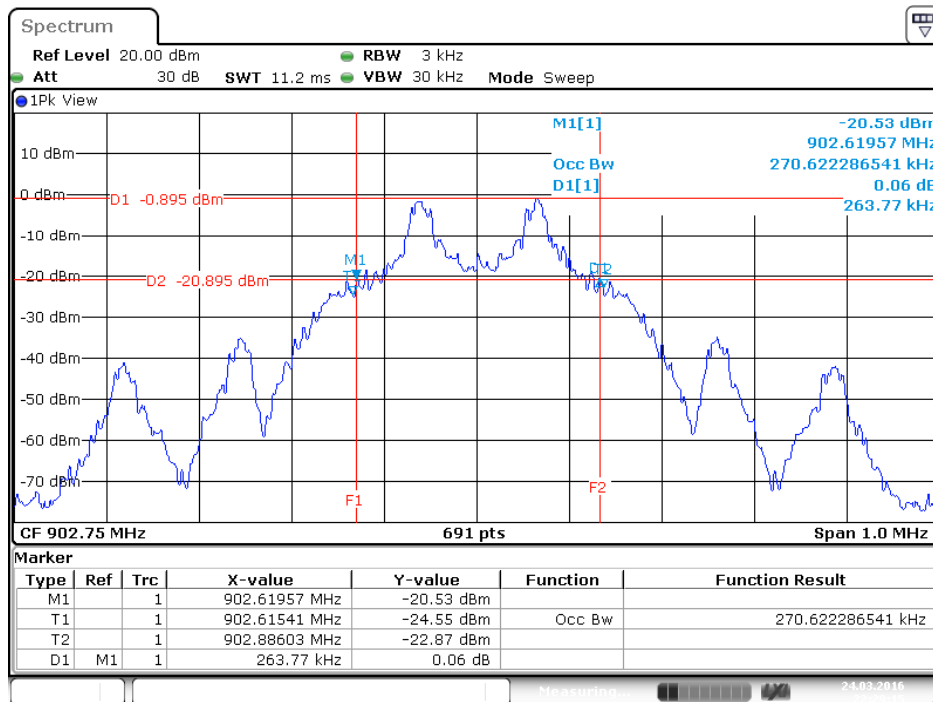

Date: 24 MAR 2016 22:29:16

20 dB Bandwidth Plot / Channel 27 / 915.75 MHz

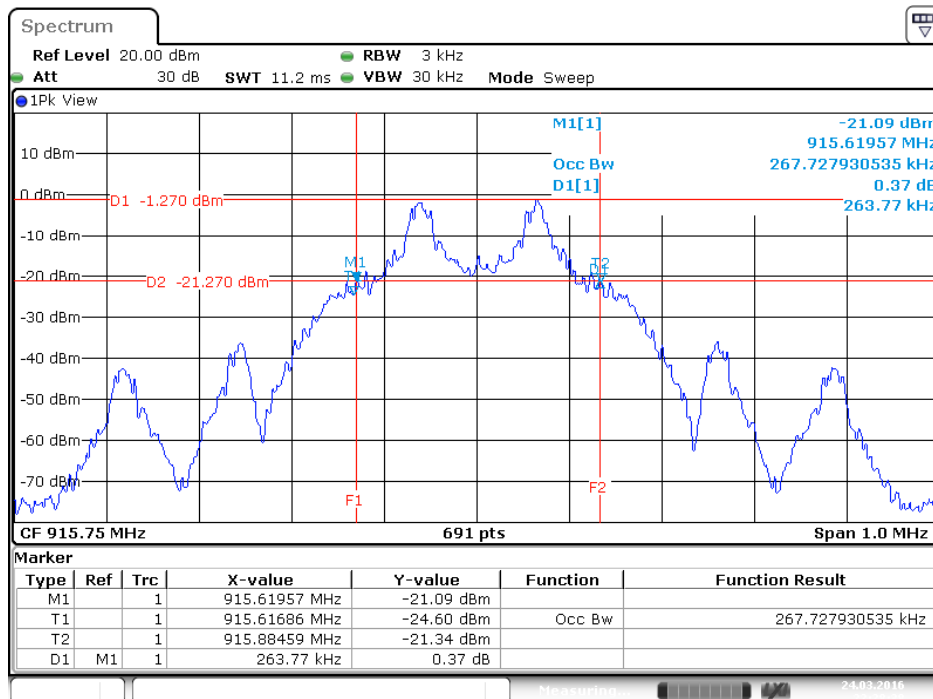

Date: 24 MAR 2016 22:28:38

20 dB Bandwidth Plot / Channel 50 / 927.25 MHz

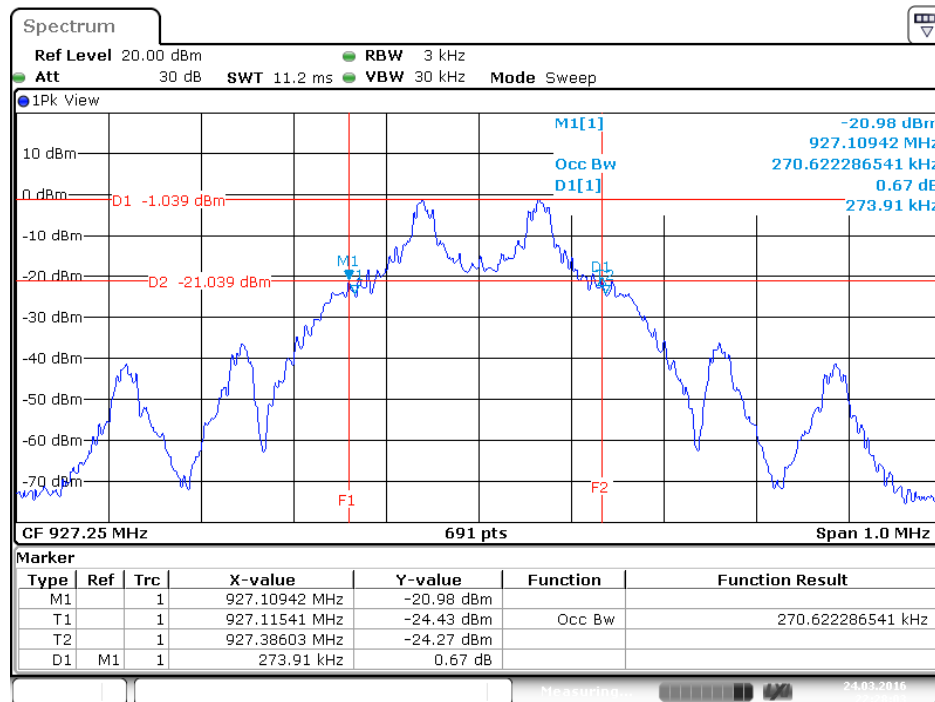

Date: 24 MAR 2016 22:28:03

Channel Separation Plot / Channel 1~3 / 902.75 MHz ~ 903.75 MHz

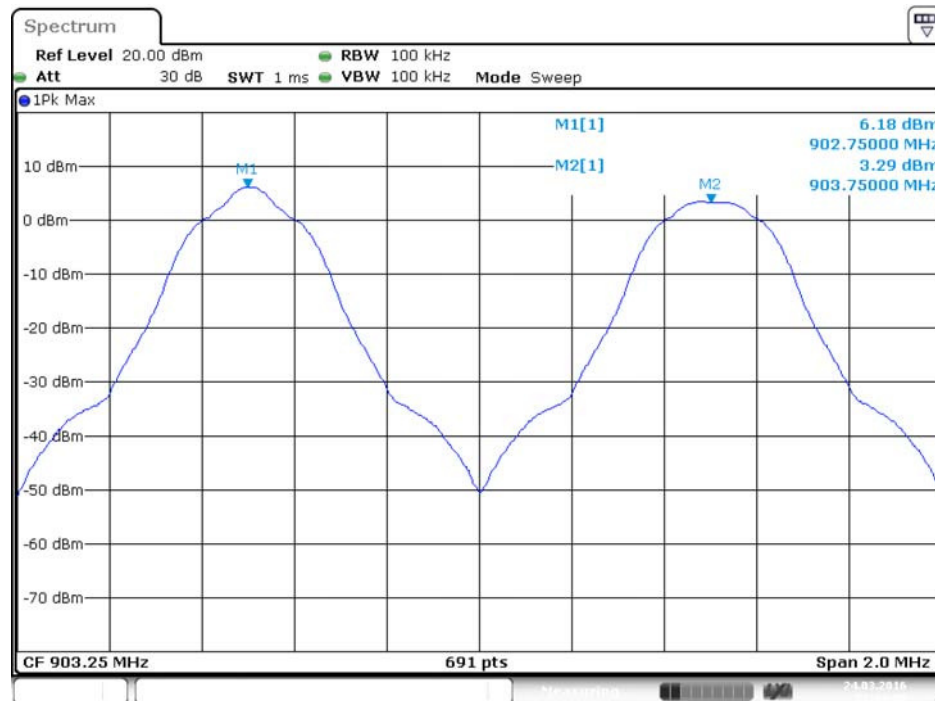

Date: 24.MAR.2016 22:44:30

Channel Separation Plot / Channel 27~29 / 915.75 MHz ~ 916.75 MHz

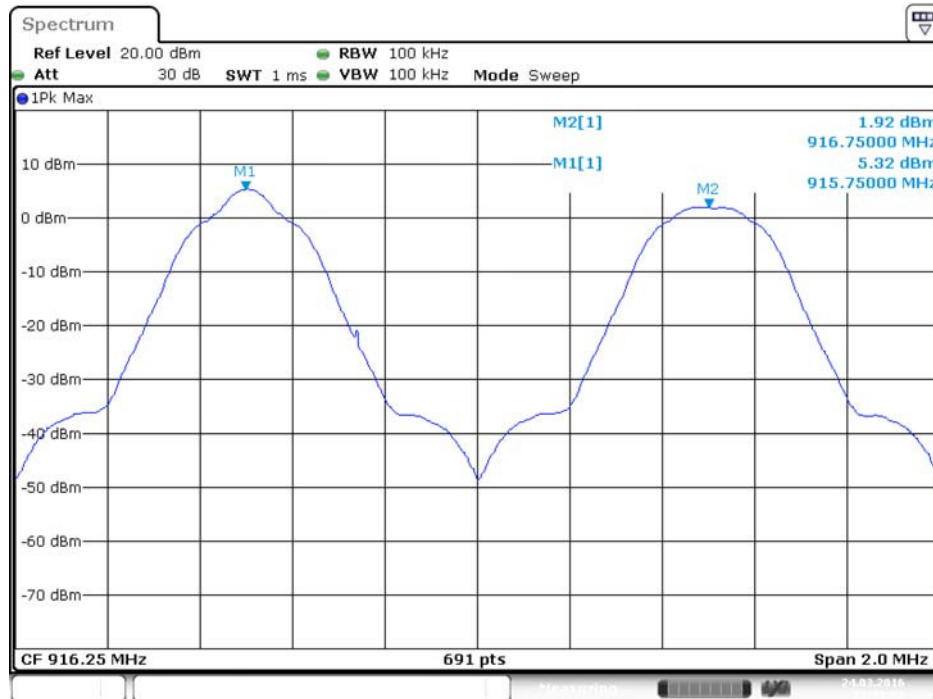

Date: 24.MAR.2016 22:52:52

Channel Separation Plot / Channel 48~50 / 926.25 MHz ~ 927.25 MHz

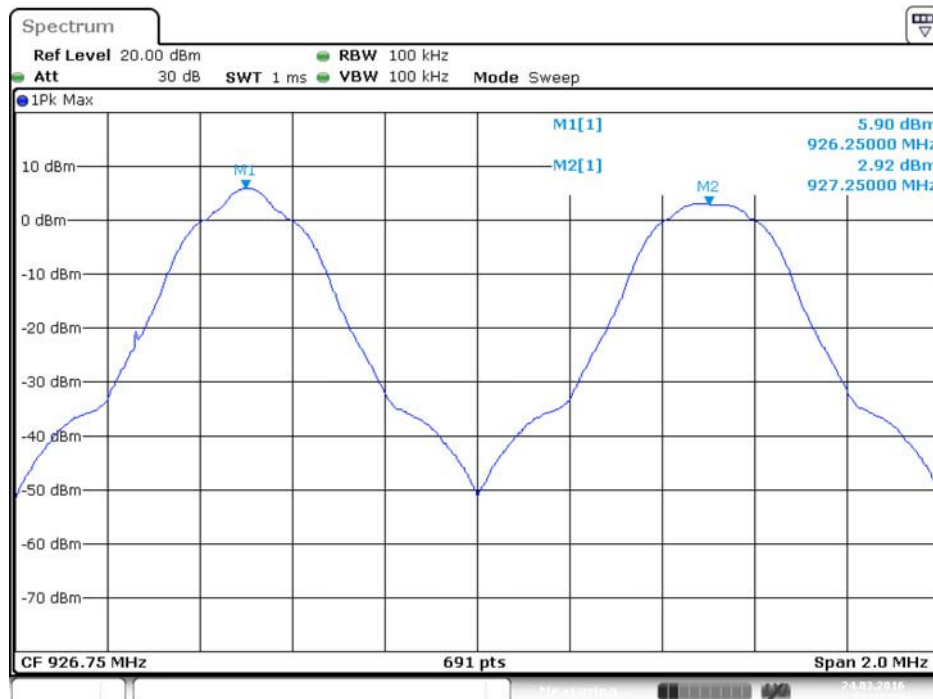

Date: 24.MAR.2016 22:57:23

4.4. Number of Hopping Frequency Measurement

4.4.1. Limit

At least 50 hopping channels.

4.4.2. Measuring Instruments and Setting

Please refer to section 5 of equipments list in this report. The following table is the setting of spectrum analyzer.

Spectrum Parameters	Setting
Attenuation	Auto
Span Frequency	> Operating Frequency Range
RBW	1% of the span
VBW	≥ RBW
Detector	Peak
Trace	Max Hold
Sweep Time	Auto

4.4.3. Test Procedures

1. The transmitter output (antenna port) was connected to the spectrum analyzer in peak hold mode.
2. The resolution bandwidth of 300 kHz and the video bandwidth of 1000 kHz were utilized.
3. Observe frequency hopping in 902MHz~928MHz, there are at least 50 channels.

4.4.4. Test Setup Layout

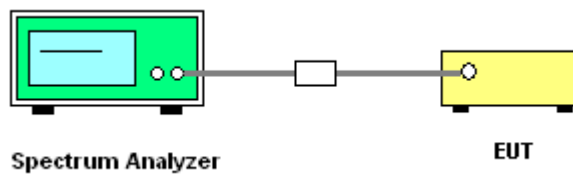

4.4.5. Test Deviation

There is no deviation with the original standard.

4.4.6. EUT Operation during Test

The EUT was programmed to be in continuously transmitting mode.

4.4.7. Test Result of Number of Hopping Frequency

Temperature	22°C	Humidity	60%
Test Engineer	Peter Wu	Configurations	CTX

Channel No.	Frequency (MHz)	Hopping Ch. (Channels)	Min. Limit (Channels)	Test Result
1 ~ 50	902 ~ 928 MHz	50	25	Complies

Number of Hopping Channel Plot / Channel 1~50 / 902.75 MHz ~ 927.25 MHz

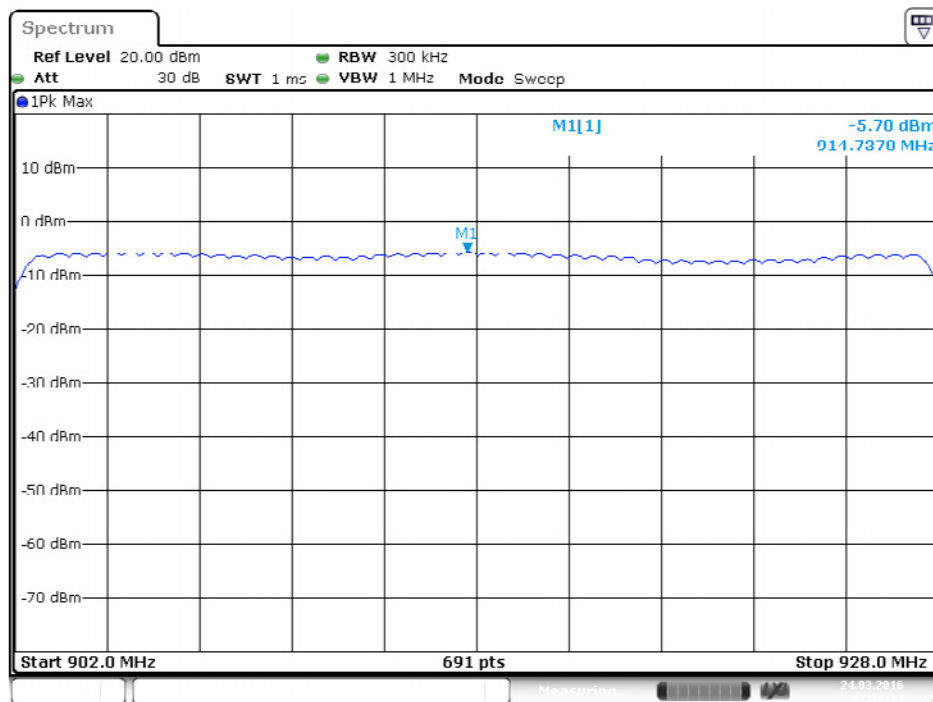

Date: 24.MAR.2016 22:10:54

4.5. Dwell Time Measurement

4.5.1. Limit

Frequency hopping systems operating in the 902-928 MHz band: if the 20 dB bandwidth of the hopping channel is less than 250 kHz, the system shall use at least 50 hopping frequencies and the average time of occupancy on any frequency shall not be greater than 0.4 seconds within a 20 second period; if the 20 dB bandwidth of the hopping channel is 250 kHz or greater, the system shall use at least 25 hopping frequencies and the average time of occupancy on any frequency shall not be greater than 0.4 seconds within a 10 second period.

4.5.2. Measuring Instruments and Setting

Please refer to section 5 of equipments list in this report. The following table is the setting of spectrum analyzer.

Spectrum Parameter	Setting
Attenuation	Auto
Span Frequency	0 MHz
RBW	1MHz
VBW	≥ RBW
Detector	Peak
Trace	Single Trigger

4.5.3. Test Procedures

1. The transmitter output (antenna port) was connected to the spectrum analyzer
2. Set RBW of spectrum analyzer to 1MHz and VBW to 1MHz.
3. Use a video trigger with the trigger level set to enable triggering only on full pulses.
4. Sweep Time is more than once pulse time.
5. Set the center frequency on any frequency would be measure and set the frequency span to zero span.
6. Measure the maximum time duration of one single pulse.

4.5.4. Test Setup Layout

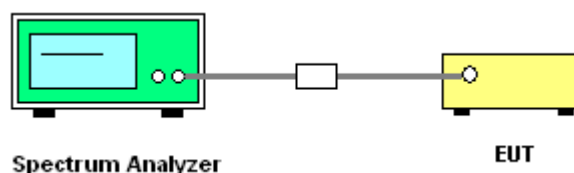

4.5.5. Test Deviation

There is no deviation with the original standard.

4.5.6. EUT Operation during Test

The EUT was programmed to be in continuously transmitting mode.

4.5.7. Test Result of Dwell Time

Temperature	22°C	Humidity	60%
Test Engineer	Peter Wu	Configurations	CTX

Frequency (MHz)	Pulse Duration (ms)	Pulse number within 10s	Dwell Time (s)	Limits (s)	Test Result
902.75 MHz	397.1000	1	0.397	0.4	Complies
902.75 MHz	397.1000	1	0.397	0.4	Complies
902.75 MHz	398.5500	1	0.399	0.4	Complies

Dwell Time Plot on Pulse Duration / Channel 1 / 902.75 MHz

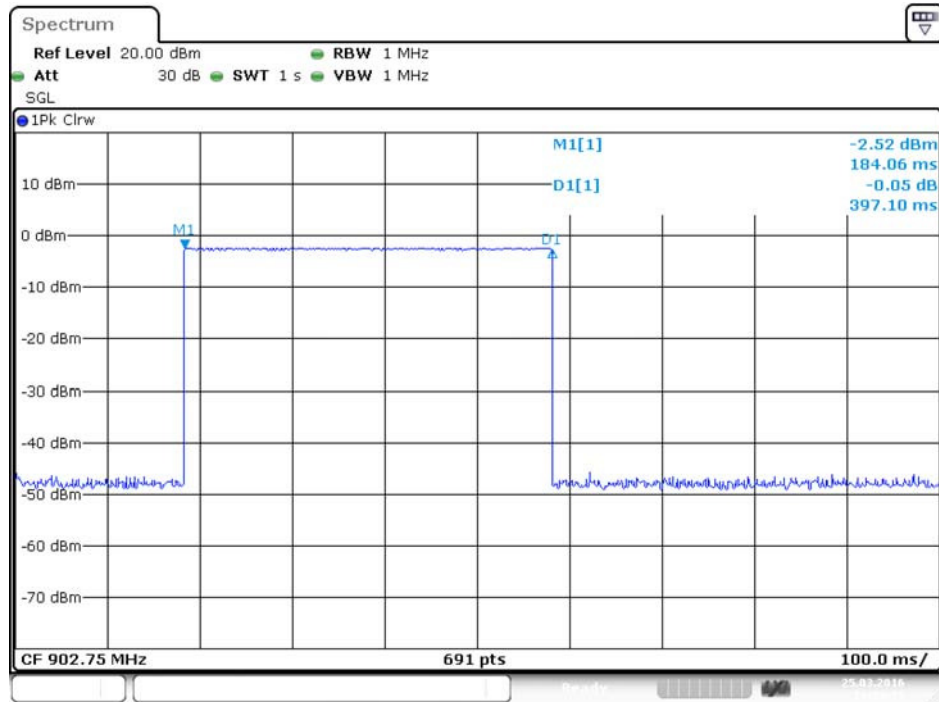

Date: 25.MAR.2016 19:24:31

Dwell Time Plot on Pulse Duration / Channel 27 / 915.75 MHz

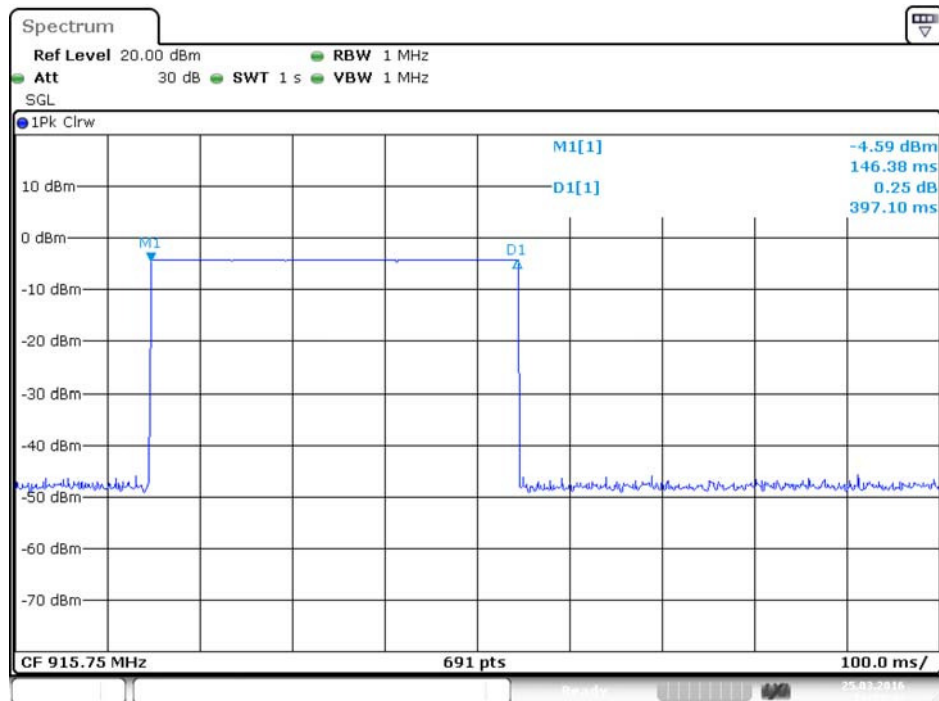

Date: 25.MAR.2016 19:35:42

Dwell Time Plot on Pulse Duration / Channel 50 / 927.25 MHz

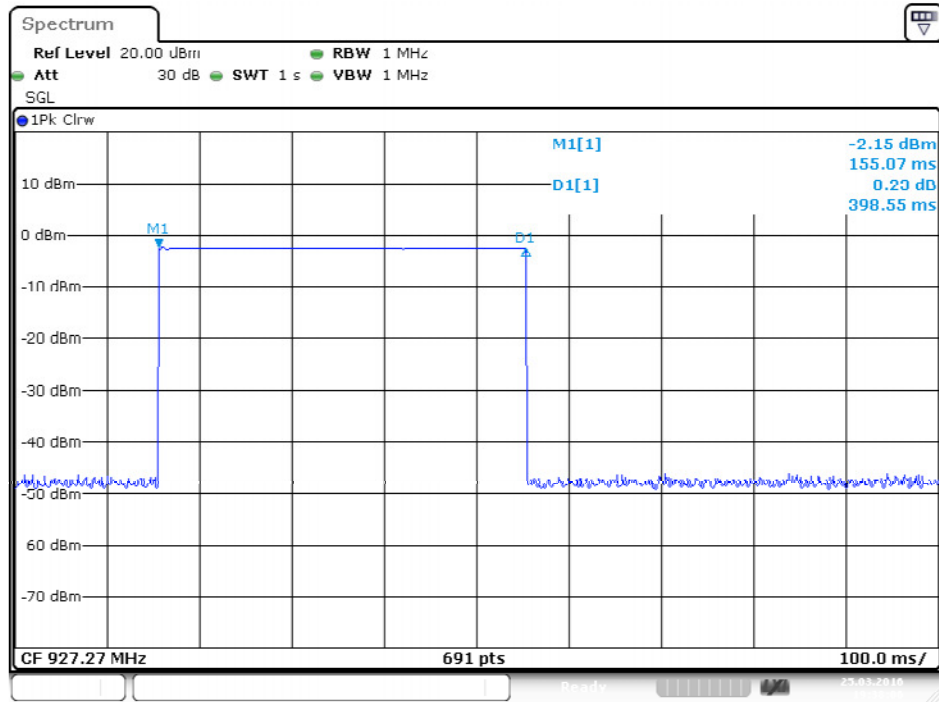

Dwell Time Plot on Pulse number within 10s / Channel 1 / 902.75 MHz

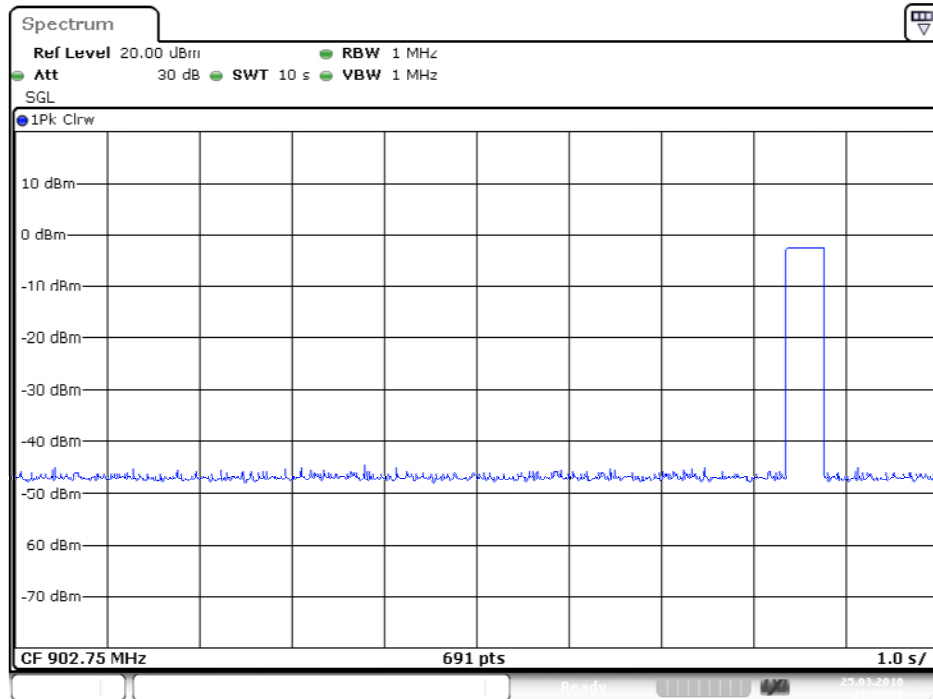

Dwell Time Plot on Pulse number within 10s / Channel 27 / 915.75 MHz

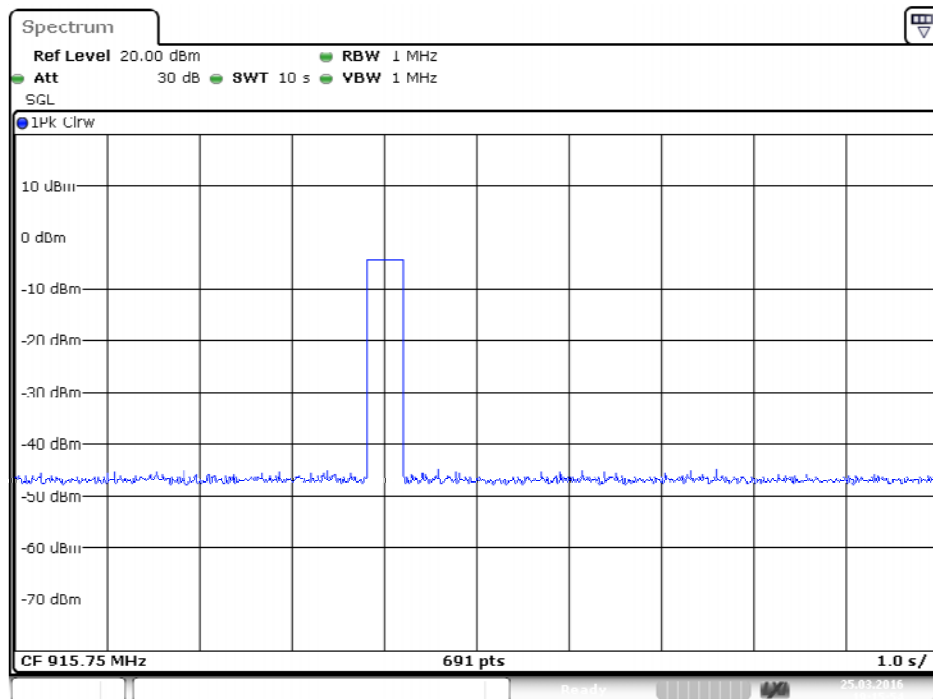

Dwell Time Plot on Pulse number within 10s / Channel 50 / 927.25 MHz

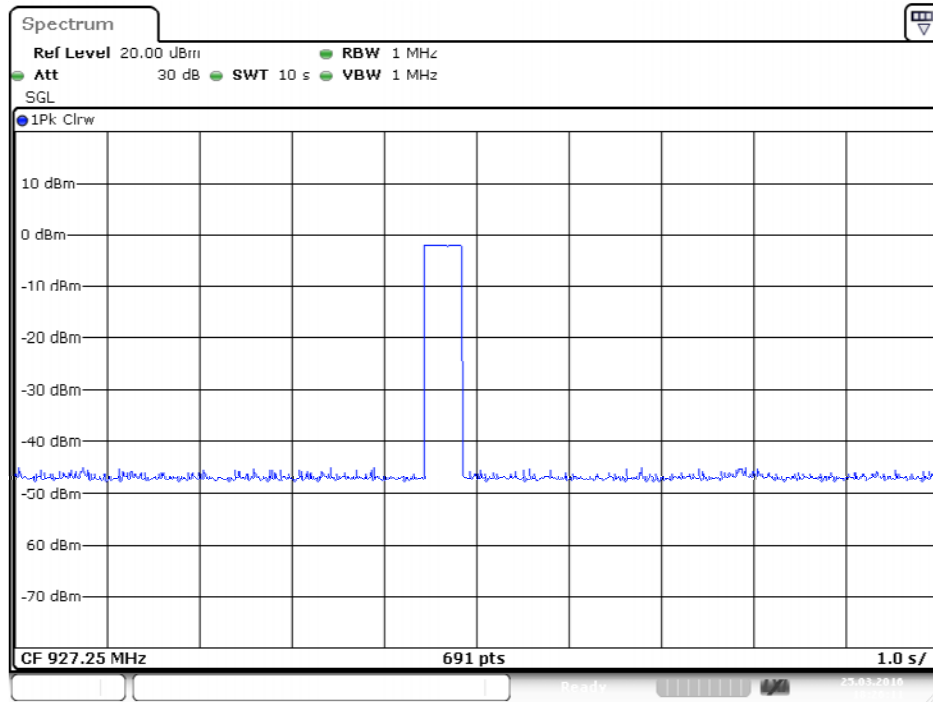

Date: 25.MAR.2016 18:26:11

4.6. Radiated Emissions Measurement

4.6.1. Limit

20dBc in any 100 kHz bandwidth outside the operating frequency band. In case the emission fall within the restricted band specified on 15.205(a), then the 15.209(a) limit in the table below has to be followed.

Frequencies (MHz)	Field Strength (micorvolts/meter)	Measurement Distance (meters)
0.009~0.490	2400/F(kHz)	300
0.490~1.705	24000/F(kHz)	30
1.705~30.0	30	30
30~88	100	3
88~216	150	3
216~960	200	3
Above 960	500	3

4.6.2. Measuring Instruments and Setting

Please refer to section 5 of equipments list in this report. The following table is the setting of spectrum analyzer and receiver.

Spectrum Parameter	Setting
Attenuation	Auto
Start Frequency	1000 MHz
Stop Frequency	10th carrier harmonic
RBW / VBW (Emission in restricted band)	1 MHz / 3MHz for Peak, 1 MHz / 1/T for Average
RBW / VBW (Emission in non-restricted band)	100kHz, 300kHz for peak

Receiver Parameter	Setting
Attenuation	Auto
Start ~ Stop Frequency	9kHz~150kHz, RBW 200Hz for QP
Start ~ Stop Frequency	150kHz~30MHz, RBW 9kHz for QP
Start ~ Stop Frequency	30MHz~1000MHz, RBW 120kHz for QP

4.6.3. Test Procedures

1. Configure the EUT according to ANSI C63.10. The EUT was placed on the top of the turntable 1.5 meter above ground. The phase center of the receiving antenna mounted on the top of a height-variable antenna tower was placed 1m & 3m far away from the turntable.
2. Power on the EUT and all the supporting units. The turntable was rotated by 360 degrees to determine the position of the highest radiation.
3. The height of the broadband receiving antenna was varied between one meter and four meters above ground to find the maximum emissions field strength of both horizontal and vertical polarization.
4. For each suspected emissions, the antenna tower was scan (from 1 M to 4 M) and then the turntable was rotated (from 0 degree to 360 degrees) to find the maximum reading.
5. Set the test-receiver system to Peak or CISPR quasi-peak Detect Function with specified bandwidth under Maximum Hold Mode.
6. For emissions above 1GHz, use 1MHz VBW and 3MHz RBW for peak reading. Then 1MHz RBW and 1/T VBW for average reading in spectrum analyzer.
7. When the radiated emissions limits are expressed in terms of the average value of the emissions, and pulsed operation is employed, the measurement field strength shall be determined by averaging over one complete pulse train, including blanking intervals, as long as the pulse train does not exceed 0.1 seconds. As an alternative (provided the transmitter operates for longer than 0.1 seconds) or in cases where the pulse train exceeds 0.1 seconds, the measured field strength shall be determined from the average absolute voltage during a 0.1 second interval during which the field strength is at its maximum value.
8. If the emissions level of the EUT in peak mode was 3 dB lower than the average limit specified, then testing will be stopped and peak values of EUT will be reported, otherwise, the emissions which do not have 3 dB margin will be repeated one by one using the quasi-peak method for below 1GHz.
9. For testing above 1GHz, the emissions level of the EUT in peak mode was lower than average limit (that means the emissions level in peak mode also complies with the limit in average mode), then testing will be stopped and peak values of EUT will be reported, otherwise, the emissions will be measured in average mode again and reported.
10. In case the emission is lower than 30MHz, loop antenna has to be used for measurement and the recorded data should be QP measured by receiver. High – Low scan is not required in this case.

4.6.4. Test Setup Layout

For Radiated Emissions: 9kHz ~30MHz

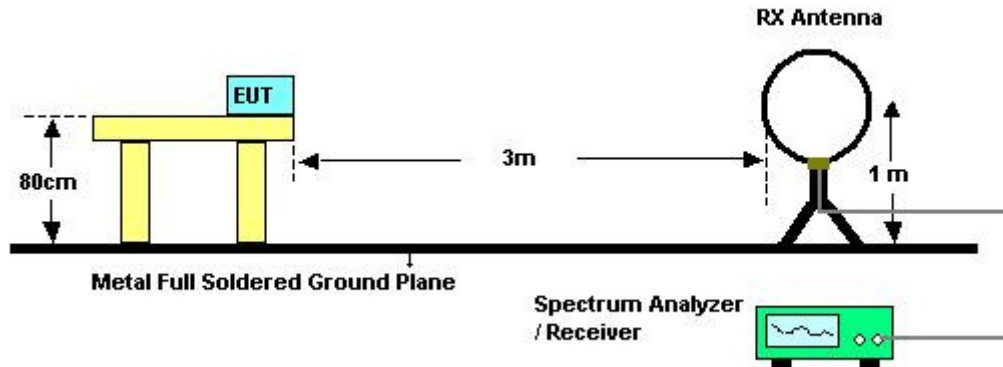

For Radiated Emissions: 30MHz~1GHz

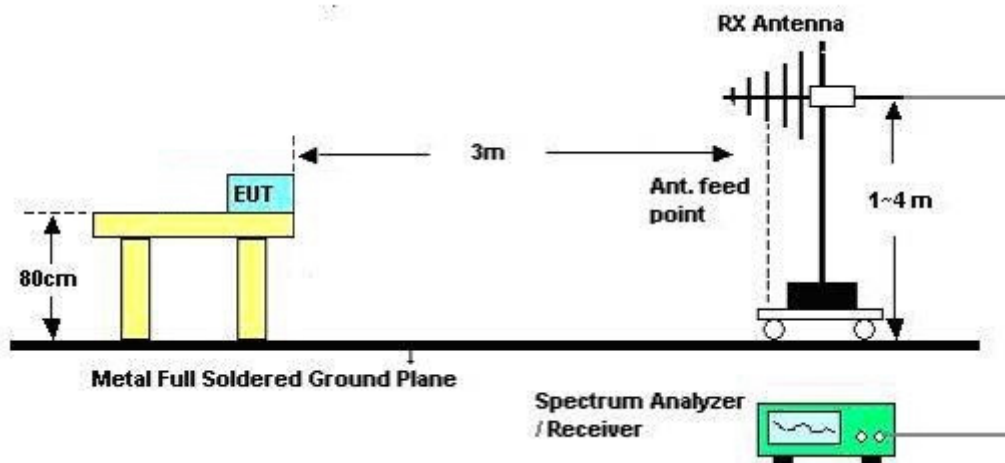

For Radiated Emissions: Above 1GHz

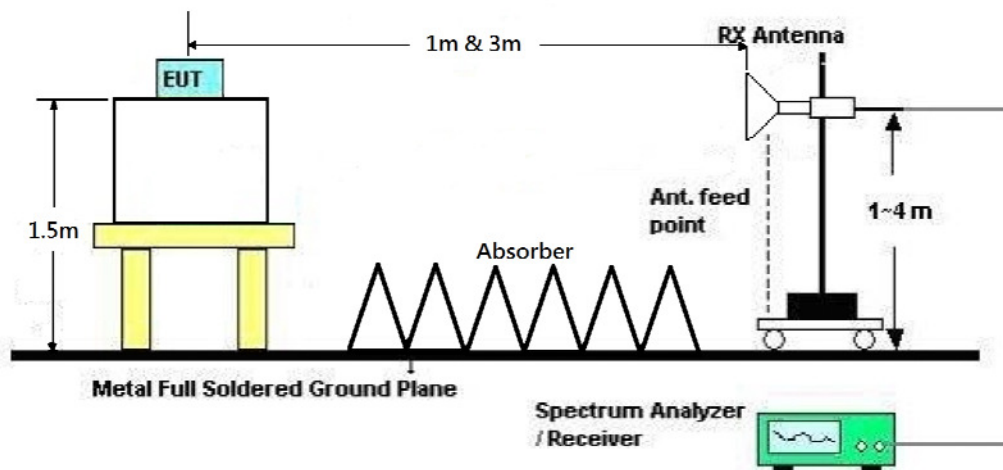

4.6.5. Test Deviation

There is no deviation with the original standard.

4.6.6. EUT Operation during Test

The EUT was programmed to be in continuously transmitting mode.

4.6.7. Results of Radiated Emissions (9kHz~30MHz)

Temperature	21.2°C	Humidity	61%
Test Engineer	Akina Chiu & Brian Sun	Test Date	Mar. 31, 2016
Configurations	Normal Link		

Freq. (MHz)	Level (dBuV)	Over Limit (dB)	Limit Line (dBuV)	Remark
-	-	-	-	See Note

Note:

The amplitude of spurious emissions which are attenuated by more than 20dB below the permissible value has no need to be reported.

Distance extrapolation factor = $40 \log(\text{specific distance} / \text{test distance})$ (dB);

Limit line = specific limits (dBuV) + distance extrapolation factor.

4.6.8. Results of Radiated Emissions (30MHz~1GHz)

Temperature	21.2°C	Humidity	61%
Test Engineer	Akina Chiu & Brian Sun	Configurations	Normal Link
Test Mode	Mode 1		

Horizontal

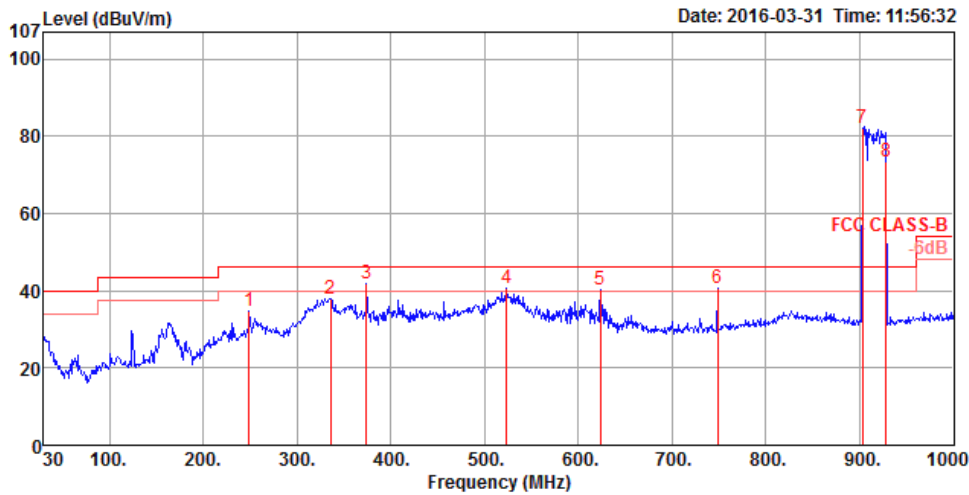

	Freq	Level	Limit	Over	Read	Cable	Antenna	Preamp	A/Pos	T/Pos	Remark	Pol/Phase
	MHz	dBuV/m	dBuV/m	dB	dBuV	dB	dB/m	dB	cm	deg		
1	249.22	34.64	46.00	-11.36	46.75	1.90	18.52	32.53	200	212	Peak	HORIZONTAL
2	335.55	38.07	46.00	-7.93	47.84	2.14	20.62	32.53	100	304	Peak	HORIZONTAL
3	374.35	41.95	46.00	-4.05	50.65	2.24	21.60	32.54	100	10	Peak	HORIZONTAL
4	523.73	40.74	46.00	-5.26	46.61	2.66	24.10	32.63	100	206	Peak	HORIZONTAL
5	623.64	40.09	46.00	-5.91	44.83	2.89	25.04	32.67	150	344	Peak	HORIZONTAL
6	748.77	40.63	46.00	-5.37	43.94	3.12	26.07	32.50	150	359	Peak	HORIZONTAL
7	903.00	82.21			83.14	3.37	27.52	31.82	125	320	Peak	HORIZONTAL
8	928.22	73.36			73.89	3.38	27.68	31.59	200	42	Peak	HORIZONTAL

Note: Item 7 and 8 are the fundamental frequency

Vertical

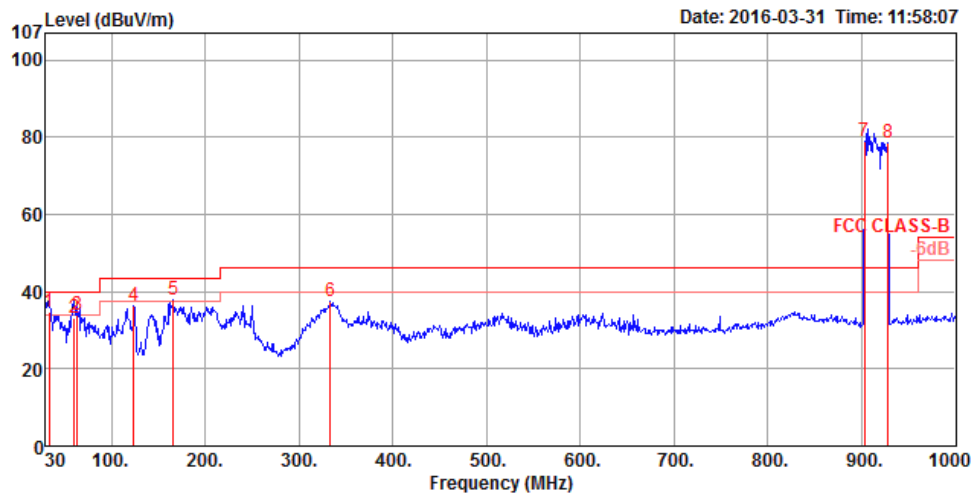

	Freq	Level	Limit	Over	Read	CableAntenna	Preamp	A/Pos	T/Pos	Remark	Pol/Phase
	MHz	dBuV/m	dBuV/m	dB	dBuV	dB	dB/m	dB	cm	deg	
1	33.88	34.87	40.00	-5.13	43.61	0.81	23.09	32.64	100	261 QP	VERTICAL
2	60.07	33.19	40.00	-6.81	52.40	1.10	12.30	32.61	100	360 QP	VERTICAL
3	63.95	33.89	40.00	-6.11	53.10	1.10	12.30	32.61	200	212 QP	VERTICAL
4	124.09	36.35	43.50	-7.15	49.35	1.40	18.16	32.56	100	180 Peak	VERTICAL
5	165.80	38.01	43.50	-5.49	52.97	1.57	16.03	32.56	100	124 Peak	VERTICAL
6	333.61	37.64	46.00	-8.36	47.48	2.14	20.55	32.53	150	54 Peak	VERTICAL
7	903.00	78.92			79.85	3.37	27.52	31.82	150	359 Peak	VERTICAL
8	928.22	78.40			78.93	3.38	27.68	31.59	150	334 Peak	VERTICAL

Note: Item 7 and 8 are the fundamental frequency

Note:

The amplitude of spurious emissions which are attenuated by more than 20 dB below the permissible value has no need to be reported.

Emission level (dBuV/m) = 20 log Emission level (uV/m).

Corrected Reading: Antenna Factor + Cable Loss + Read Level - Preamp Factor = Level.

Temperature	21.2°C	Humidity	61%
Test Engineer	Akina Chiu & Brian Sun	Configurations	Normal Link
Test Mode	Mode 2		

Horizontal

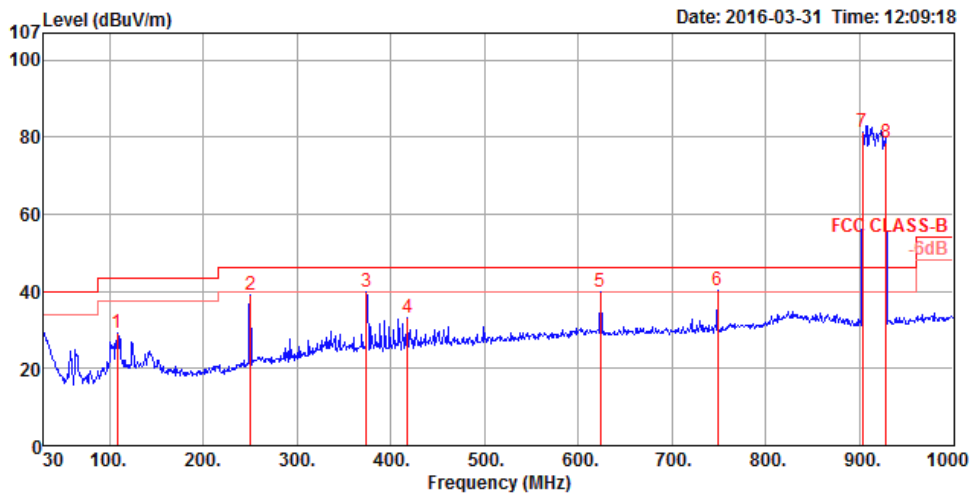

	Freq	Level	Limit	Over	Read	CableAntenna	Preamp	A/Pos	T/Pos	Remark	Pol/Phase	
	MHz	dBuV/m	dBuV/m	dB	dBuV	dB	dB/m	dB	cm	deg		
1	108.57	29.34	43.50	-14.16	42.96	1.31	17.64	32.57	200	358	Peak	HORIZONTAL
2	250.19	39.00	46.00	-7.00	51.03	1.90	18.60	32.53	125	202	Peak	HORIZONTAL
3	374.35	40.03	46.00	-5.97	48.73	2.24	21.60	32.54	100	355	Peak	HORIZONTAL
4	418.00	33.32	46.00	-12.68	41.04	2.34	22.49	32.55	100	356	Peak	HORIZONTAL
5	623.64	39.99	46.00	-6.01	44.73	2.89	25.04	32.67	150	338	Peak	HORIZONTAL
6	748.77	40.28	46.00	-5.72	43.59	3.12	26.07	32.50	150	0	Peak	HORIZONTAL
7	903.00	81.36			82.29	3.37	27.52	31.82	125	3	Peak	HORIZONTAL
8	928.22	78.38			78.91	3.38	27.68	31.59	125	34	Peak	HORIZONTAL

Note: Item 7 and 8 are the fundamental frequency

Vertical

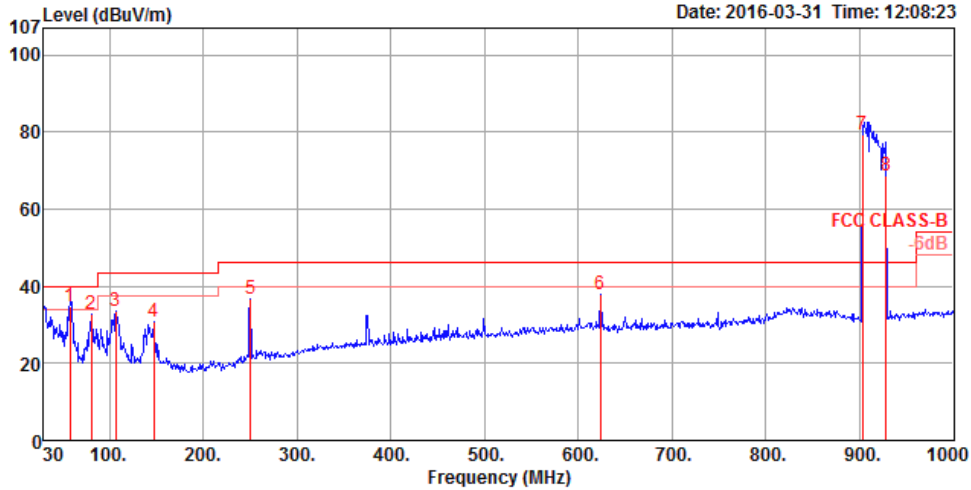

	Freq	Level	Limit Line	Over Limit	Read Level	CableAntenna Loss	Preamp Factor	A/Pos	T/Pos	Remark	Pol/Phase
	MHz	dBuV/m	dBuV/m	dB	dBuV	dB	dB/m	dB	cm	deg	
1	58.13	34.89	40.00	-5.11	53.80	1.05	12.66	32.62	100	168 QP	VERTICAL
2	80.44	32.65	40.00	-7.35	50.88	1.21	13.15	32.59	150	156 Peak	VERTICAL
3	106.63	33.74	43.50	-9.76	47.56	1.30	17.45	32.57	100	239 Peak	VERTICAL
4	147.37	30.73	43.50	-12.77	44.81	1.48	17.00	32.56	100	223 Peak	VERTICAL
5	250.19	36.65	46.00	-9.35	48.68	1.90	18.60	32.53	100	103 Peak	VERTICAL
6	623.64	37.83	46.00	-8.17	42.57	2.89	25.04	32.67	100	323 Peak	VERTICAL
7	903.00	79.46			80.39	3.37	27.52	31.82	150	12 Peak	VERTICAL
8	928.22	68.79			69.32	3.38	27.68	31.59	200	208 Peak	VERTICAL

Note: Item 7 and 8 are the fundamental frequency

Note:

The amplitude of spurious emissions which are attenuated by more than 20 dB below the permissible value has no need to be reported.

Emission level (dBuV/m) = 20 log Emission level (uV/m).

Corrected Reading: Antenna Factor + Cable Loss + Read Level - Preamp Factor = Level.

4.6.9. Results for Radiated Emissions (1GHz~10th Harmonic)

For Ant. 1:

Temperature	21.2°C	Humidity	60%
Test Engineer	Akina Chiu & Brian Sun	Configurations	Channel 1
Test Date	Mar. 22, 2016		

Horizontal

	Freq	Level	Limit Line	Over Limit	Read Level	CableAntenna Loss	Antenna Factor	Preamp Factor	A/Pos	T/Pos	Remark	Pol/Phase
	MHz	dBuV/m	dBuV/m	dB	dBuV	dB	dB/m	dB	cm	deg		
1	2708.01	27.87	54.00	-26.13	29.15	5.47	27.99	34.74	194	116	Average	HORIZONTAL
2	2708.35	40.95	74.00	-33.05	42.23	5.47	27.99	34.74	194	116	Peak	HORIZONTAL

Vertical

	Freq	Level	Limit Line	Over Limit	Read Level	CableAntenna Loss	Antenna Factor	Preamp Factor	A/Pos	T/Pos	Remark	Pol/Phase
	MHz	dBuV/m	dBuV/m	dB	dBuV	dB	dB/m	dB	cm	deg		
1	2707.73	40.96	74.00	-33.04	42.24	5.47	27.99	34.74	175	68	Peak	VERTICAL
2	2708.37	28.91	54.00	-25.09	30.19	5.47	27.99	34.74	175	68	Average	VERTICAL



Temperature	21.2°C	Humidity	60%
Test Engineer	Akina Chiu & Brian Sun	Configurations	Channel 27
Test Date	Mar. 22, 2016		

Horizontal

	Freq	Level	Limit Line	Over Limit	Read Level	CableAntenna Loss	Antenna Factor	Preamp Factor	A/Pos	T/Pos	Remark	Pol/Phase
	MHz	dBuV/m	dBuV/m	dB	dBuV	dB	dB/m	dB	cm	deg		
1	2746.80	29.15	54.00	-24.85	30.27	5.52	28.08	34.72	156	267	Average	HORIZONTAL
2	2748.56	42.65	74.00	-31.35	43.77	5.52	28.08	34.72	156	267	Peak	HORIZONTAL

Vertical

	Freq	Level	Limit Line	Over Limit	Read Level	CableAntenna Loss	Antenna Factor	Preamp Factor	A/Pos	T/Pos	Remark	Pol/Phase
	MHz	dBuV/m	dBuV/m	dB	dBuV	dB	dB/m	dB	cm	deg		
1	2747.02	42.51	74.00	-31.49	43.63	5.52	28.08	34.72	172	90	Peak	VERTICAL
2	2747.15	29.46	54.00	-24.54	30.58	5.52	28.08	34.72	172	90	Average	VERTICAL

Temperature	21.2°C	Humidity	60%
Test Engineer	Akina Chiu & Brian Sun	Configurations	Channel 50
Test Date	Mar. 22, 2016		

Horizontal

	Freq	Level	Limit Line	Over Limit	Read Level	CableAntenna Loss	Antenna Factor	Preamp Factor	A/Pos	T/Pos	Remark	Pol/Phase
	MHz	dBuV/m	dBuV/m	dB	dBuV	dB	dB/m	dB	cm	deg		
1	2781.82	43.99	74.00	-30.01	44.98	5.57	28.15	34.71	118	117	Peak	HORIZONTAL
2	2784.73	29.46	54.00	-24.54	30.44	5.57	28.15	34.70	118	117	Average	HORIZONTAL

Vertical

	Freq	Level	Limit Line	Over Limit	Read Level	CableAntenna Loss	Antenna Factor	Preamp Factor	A/Pos	T/Pos	Remark	Pol/Phase
	MHz	dBuV/m	dBuV/m	dB	dBuV	dB	dB/m	dB	cm	deg		
1	2782.61	30.43	54.00	-23.57	31.42	5.57	28.15	34.71	165	120	Average	VERTICAL
2	2782.70	42.25	74.00	-31.75	43.24	5.57	28.15	34.71	165	120	Peak	VERTICAL

Note:

The amplitude of spurious emissions which are attenuated by more than 20dB below the permissible value has no need to be reported.

Emission level (dBuV/m) = 20 log Emission level (uV/m).

Corrected Reading: Antenna Factor + Cable Loss + Read Level - Preamp Factor = Level.

For Ant. 2:

Temperature	21.2°C	Humidity	60%
Test Engineer	Akina Chiu & Brian Sun	Configurations	Channel 1
Test Date	Mar. 22, 2016		

Horizontal

	Freq	Level	Limit	Over	Read	CableAntenna	Preamp	A/Pos	T/Pos	Remark	Pol/Phase	
	MHz	dBuV/m	dBuV/m	dB	dBuV	dB	dB/m	dB	cm	deg		
1	2708.10	27.88	54.00	-26.12	29.16	5.47	27.99	34.74	145	108	Average	HORIZONTAL
2	2708.38	41.11	74.00	-32.89	42.39	5.47	27.99	34.74	145	108	Peak	HORIZONTAL

Vertical

	Freq	Level	Limit	Over	Read	CableAntenna	Preamp	A/Pos	T/Pos	Remark	Pol/Phase	
	MHz	dBuV/m	dBuV/m	dB	dBuV	dB	dB/m	dB	cm	deg		
1	2708.26	28.04	54.00	-25.96	29.32	5.47	27.99	34.74	133	88	Average	VERTICAL
2	2708.31	41.55	74.00	-32.45	42.83	5.47	27.99	34.74	133	88	Peak	VERTICAL



Temperature	21.2°C	Humidity	60%
Test Engineer	Akina Chiu & Brian Sun	Configurations	Channel 27
Test Date	Mar. 22, 2016		

Horizontal

	Freq	Level	Limit Line	Over Limit	Read Level	CableAntenna Loss	Antenna Factor	Preamp Factor	A/Pos	T/Pos	Remark	Pol/Phase
	MHz	dBuV/m	dBuV/m	dB	dBuV	dB	dB/m	dB	cm	deg		
1	2745.83	29.12	54.00	-24.88	30.27	5.51	28.06	34.72	128	151	Average	HORIZONTAL
2	2748.58	41.97	74.00	-32.03	43.09	5.52	28.08	34.72	128	151	Peak	HORIZONTAL

Vertical

	Freq	Level	Limit Line	Over Limit	Read Level	CableAntenna Loss	Antenna Factor	Preamp Factor	A/Pos	T/Pos	Remark	Pol/Phase
	MHz	dBuV/m	dBuV/m	dB	dBuV	dB	dB/m	dB	cm	deg		
1	2746.73	28.80	54.00	-25.20	29.92	5.52	28.08	34.72	145	108	Average	VERTICAL
2	2746.76	41.64	74.00	-32.36	42.76	5.52	28.08	34.72	145	108	Peak	VERTICAL



Temperature	21.2°C	Humidity	60%
Test Engineer	Akina Chiu & Brian Sun	Configurations	Channel 50
Test Date	Mar. 22, 2016		

Horizontal

	Freq	Level	Limit Line	Over Limit	Read Level	CableAntenna Loss	Antenna Factor	Preamp Factor	A/Pos	T/Pos	Remark	Pol/Phase
	MHz	dBuV/m	dBuV/m	dB	dBuV	dB	dB/m	dB	cm	deg		
1	2783.81	41.38	74.00	-32.62	42.37	5.57	28.15	34.71	167	158	Peak	HORIZONTAL
2	2784.20	28.28	54.00	-25.72	29.27	5.57	28.15	34.71	167	158	Average	HORIZONTAL

Vertical

	Freq	Level	Limit Line	Over Limit	Read Level	CableAntenna Loss	Antenna Factor	Preamp Factor	A/Pos	T/Pos	Remark	Pol/Phase
	MHz	dBuV/m	dBuV/m	dB	dBuV	dB	dB/m	dB	cm	deg		
1	2782.01	41.51	74.00	-32.49	42.50	5.57	28.15	34.71	135	130	Peak	VERTICAL
2	2784.16	28.18	54.00	-25.82	29.17	5.57	28.15	34.71	135	130	Average	VERTICAL

Note:

The amplitude of spurious emissions which are attenuated by more than 20dB below the permissible value has no need to be reported.

Emission level (dBuV/m) = 20 log Emission level (uV/m).

Corrected Reading: Antenna Factor + Cable Loss + Read Level - Preamp Factor = Level.

4.7. Emissions Measurement

4.7.1. Limit

20dBc in any 100 kHz bandwidth outside the operating frequency band. In case the emission fall within the restricted band specified on 15.205(a), then the 15.209(a) limit in the table below has to be followed.

Frequencies (MHz)	Field Strength (micovolts/meter)	Measurement Distance (meters)
0.009~0.490	2400/F(kHz)	300
0.490~1.705	24000/F(kHz)	30
1.705~30.0	30	30
30~88	100	3
88~216	150	3
216~960	200	3
Above 960	500	3

4.7.2. Measuring Instruments and Setting

Please refer to section 5 of equipments list in this report. The following table is the setting of the spectrum analyzer.

Spectrum Parameter	Setting
Attenuation	Auto
Span Frequency	100 MHz
RBW / VBW (Emission in restricted band)	1MHz / 3MHz for Peak, 1MHz / 1/T for Average
RBW / VBW (20dBc in any 100 kHz bandwidth emission)	100 kHz /100 kHz for Peak

4.7.3. Test Procedures

For Radiated band edges Measurement:

1. The test procedure is the same as section 4.6.3.

For Radiated Out of Band Emission Measurement:

1. The test procedure is follow 15.247(d).

4.7.4. Test Setup Layout

For Radiated band edges Measurement:

This test setup layout is the same as that shown in section 4.6.4.

For Radiated Out of Band Emission Measurement:

This test setup layout is the same as that shown in section 4.6.4.

4.7.5. Test Deviation

There is no deviation with the original standard.

4.7.6. EUT Operation during Test

The EUT was programmed to be in continuously transmitting mode.

4.7.7. Test Result of Band Edge and Fundamental Emissions

For Ant. 1:

Reference Level

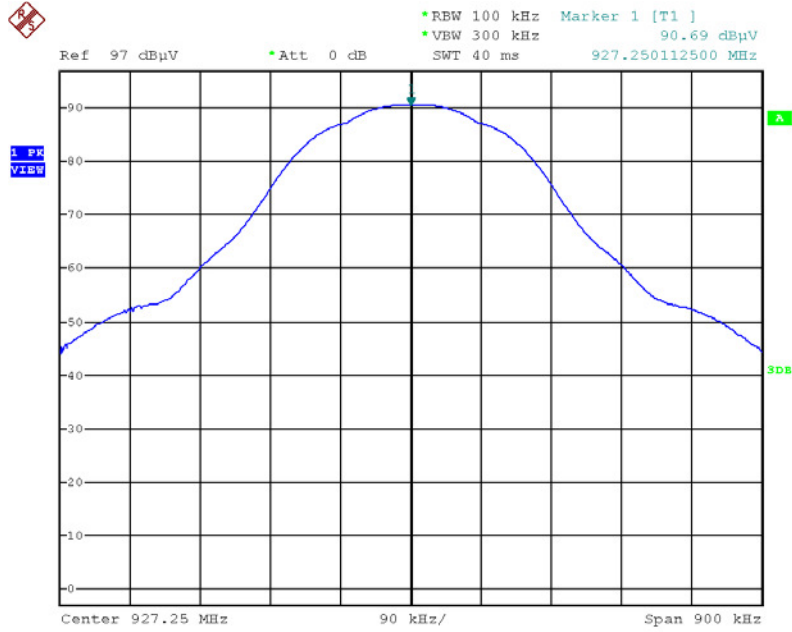

Date: 23.MAR.2016 20:20:48

Plot on Channel 1 / 30MHz~902MHz (down 20dBc)

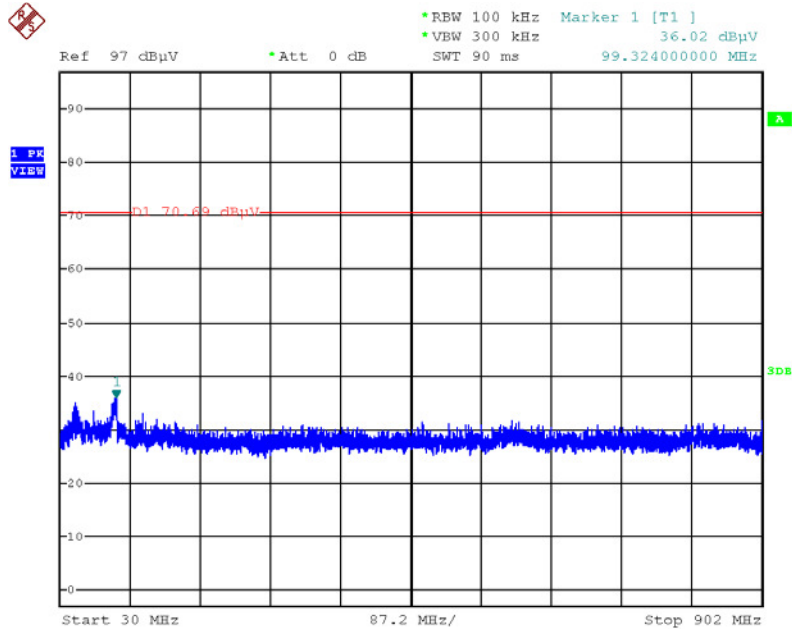

Date: 23.MAR.2016 20:23:14

Plot on Channel 1 / 928MHz~1000MHz (down 20dBc)

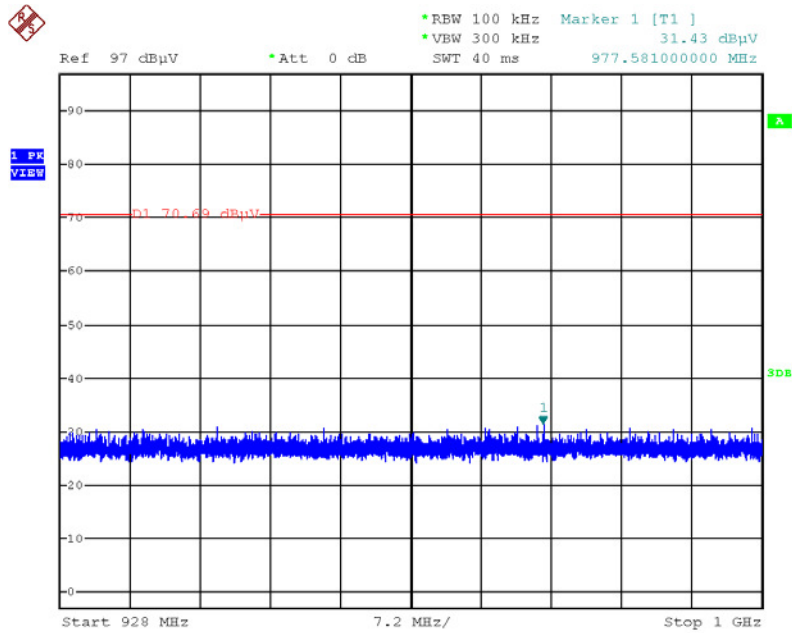

Date: 23.MAR.2016 20:25:10

Plot on Channel 1 / 1000MHz~10000MHz (down 20dBc)

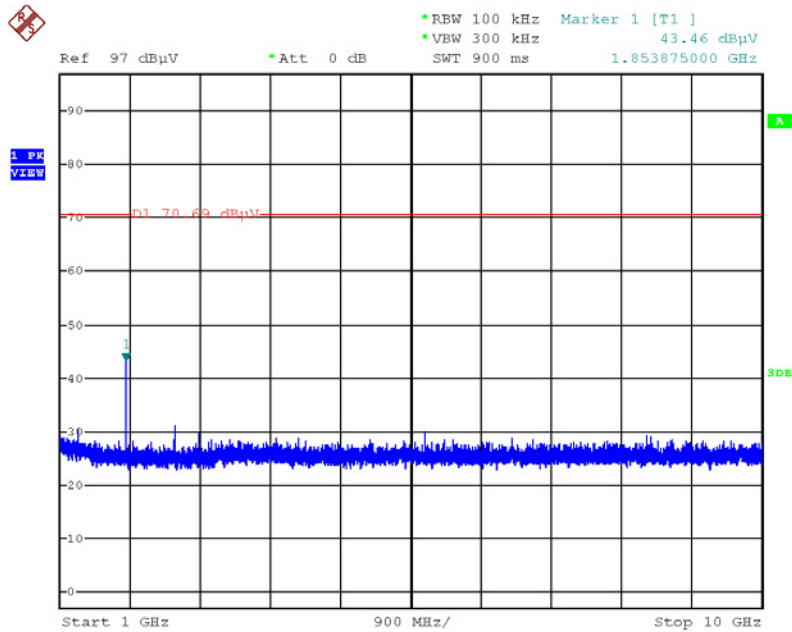

Date: 23.MAR.2016 20:31:09

Reference Level

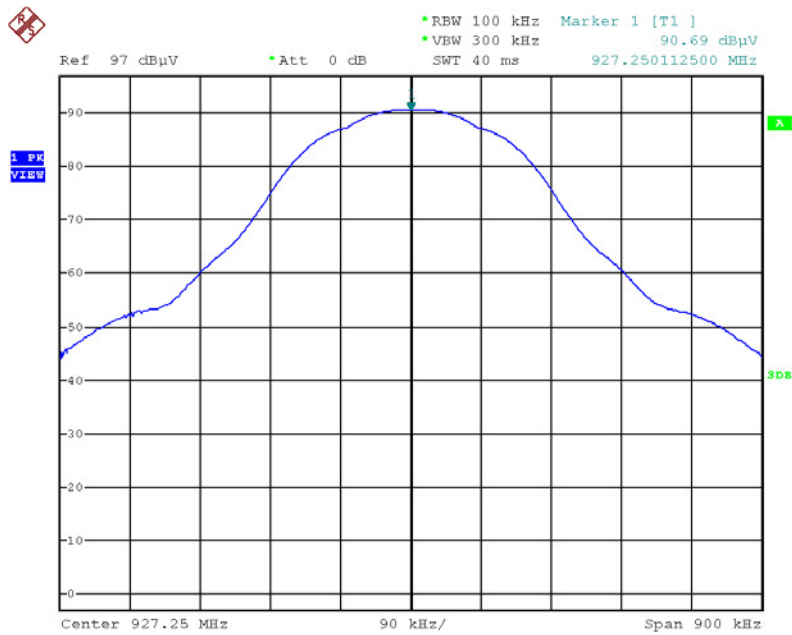

Date: 23.MAR.2016 20:20:48

Plot on Channel 50 / 30MHz~902MHz (down 20dBc)

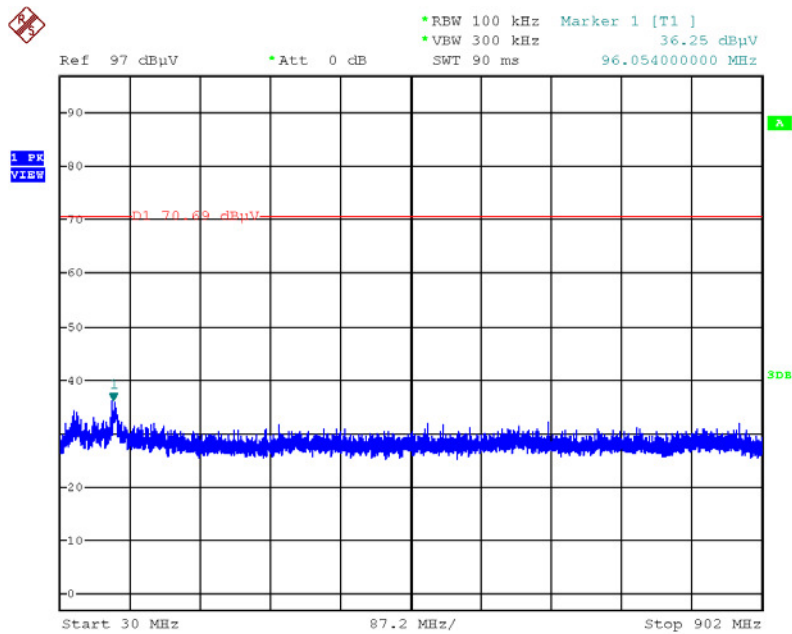

Date: 23.MAR.2016 20:26:24

Plot on Channel 50 / 928MHz~1000MHz (down 20dBc)

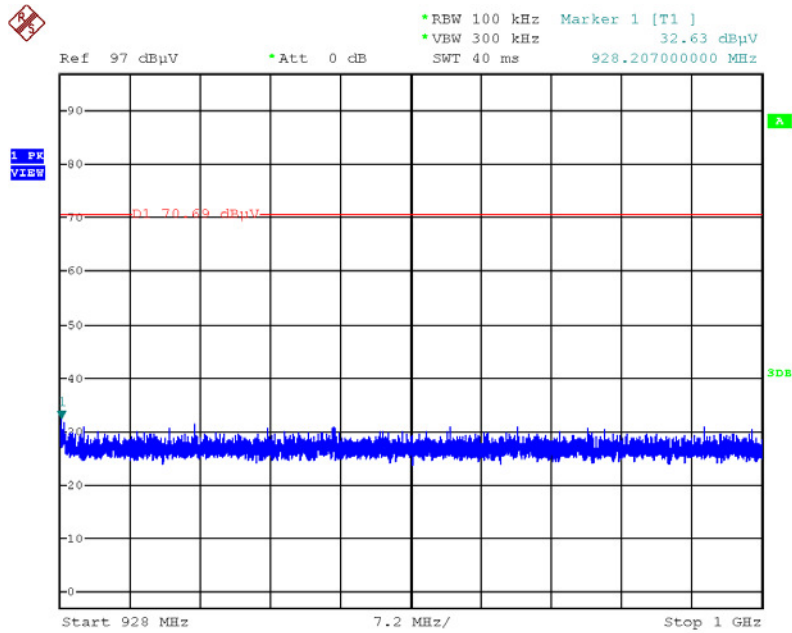

Date: 23.MAR.2016 20:27:18

Plot on Channel 50 / 1000MHz~10000MHz (down 20dBc)

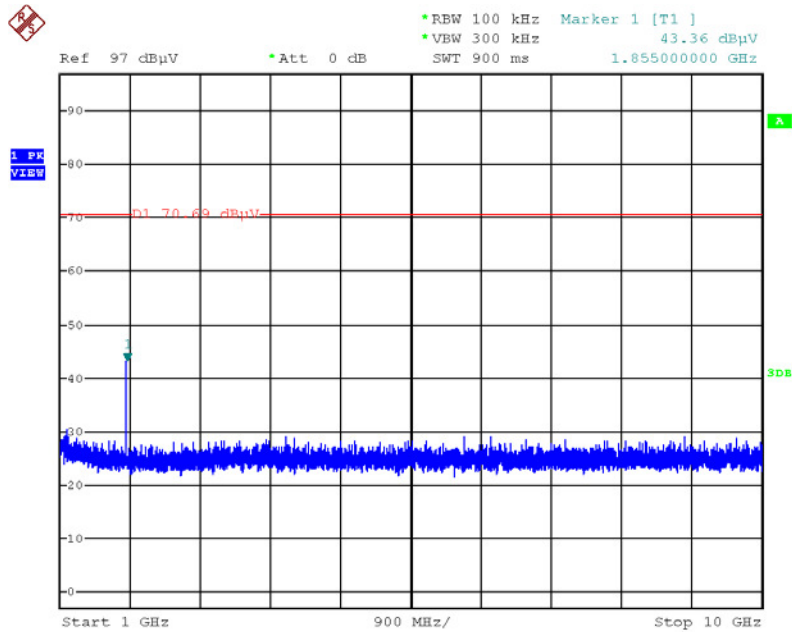

Date: 23.MAR.2016 20:33:37

For Ant. 2:

Reference Level

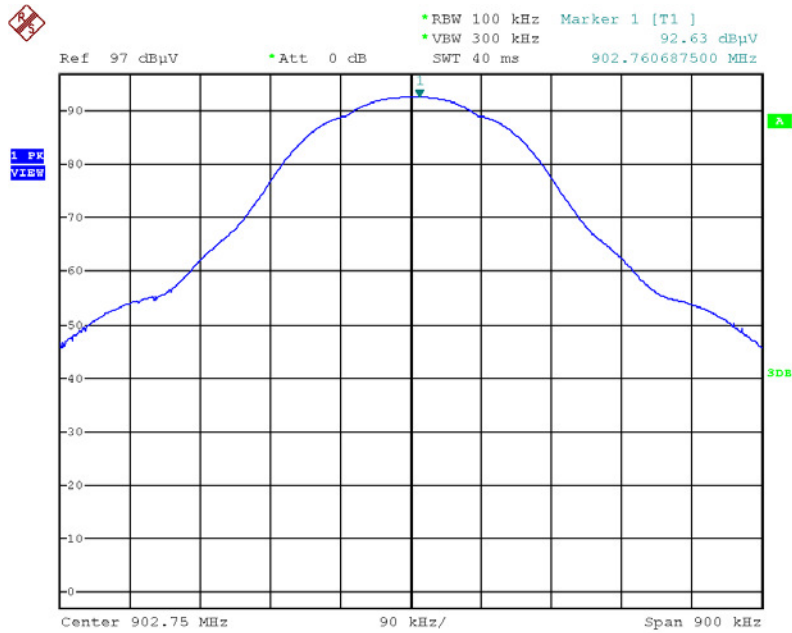

Date: 23.MAR.2016 19:55:14

Plot on Channel 1 / 30MHz~902MHz (down 20dBc)

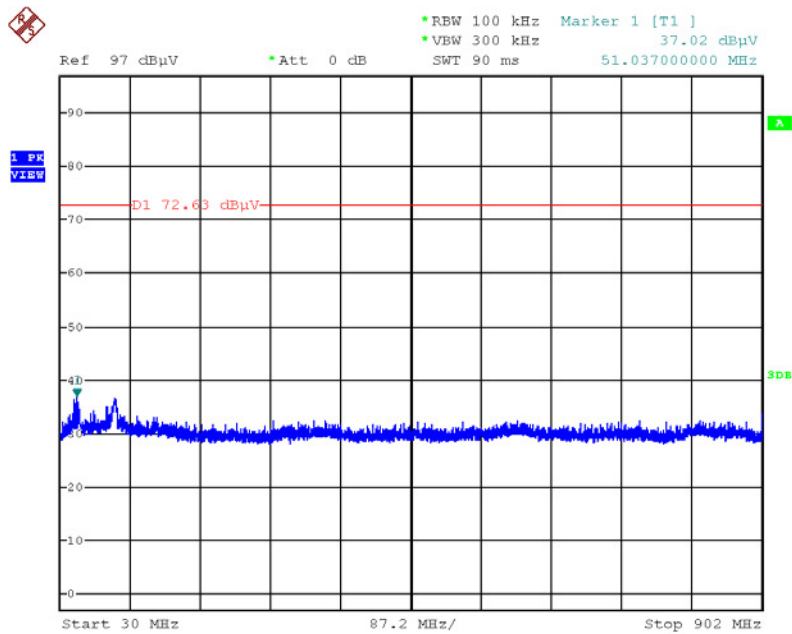

Date: 23.MAR.2016 20:07:02

Plot on Channel 1 / 928MHz~1000MHz (down 20dBc)

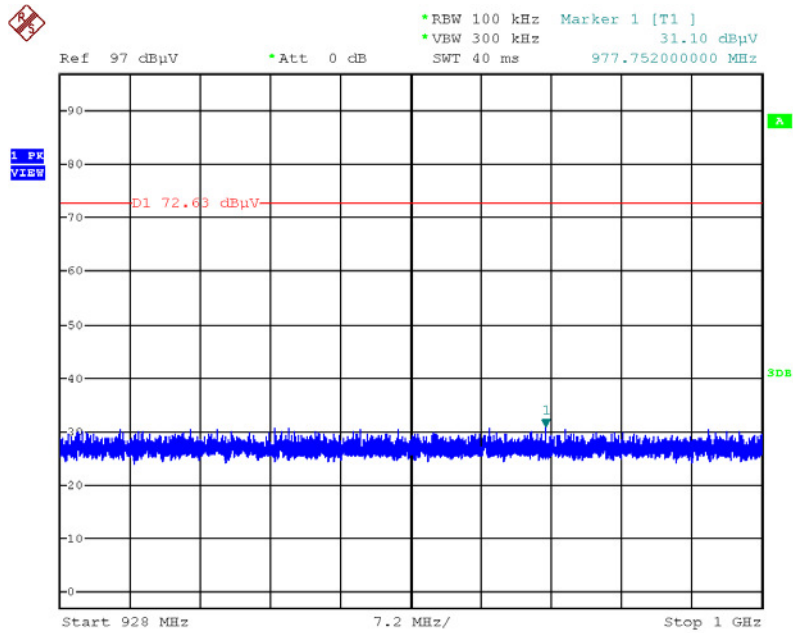

Date: 23.MAR.2016 20:10:45

Plot on Channel 1 / 1000MHz~10000MHz (down 20dBc)

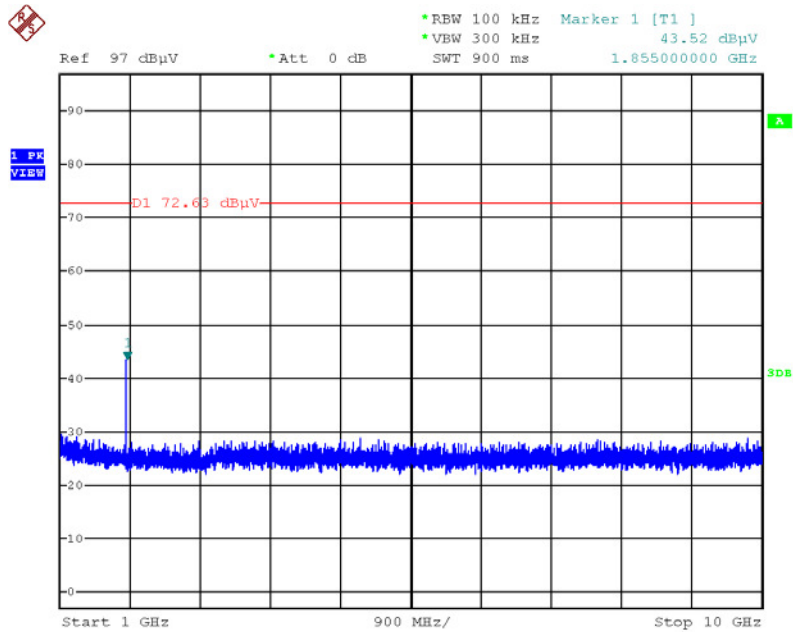

Date: 23.MAR.2016 20:31:46

Reference Level

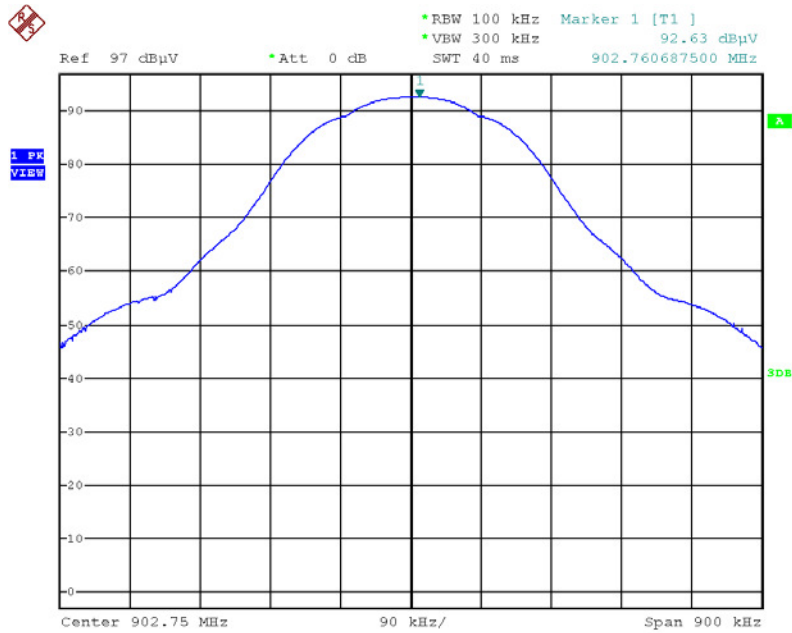

Date: 23.MAR.2016 19:55:14

Plot on Channel 50 / 30MHz~902MHz (down 20dBc)

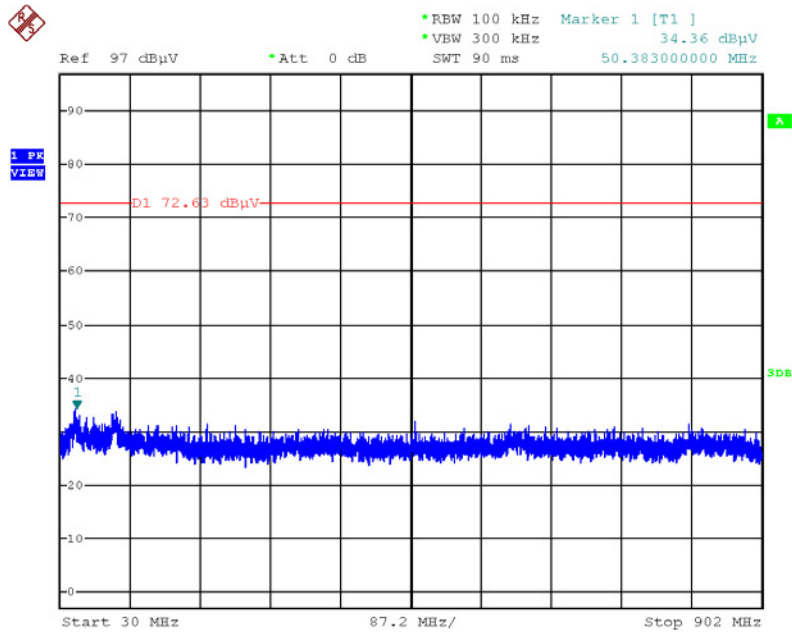

Date: 23.MAR.2016 20:11:57

Plot on Channel 50 / 928MHz~1000MHz (down 20dBc)

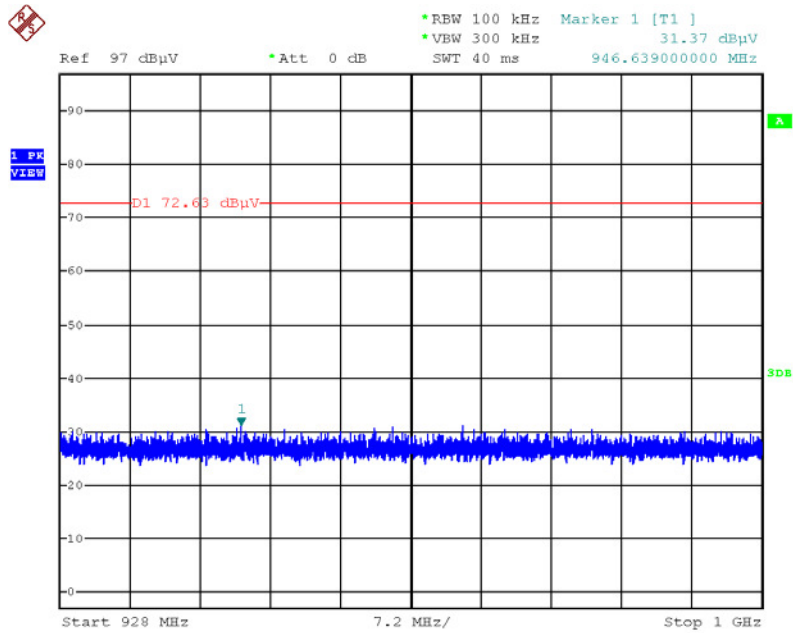

Date: 23.MAR.2016 20:12:31

Plot on Channel 50 / 1000MHz~10000MHz (down 20dBc)

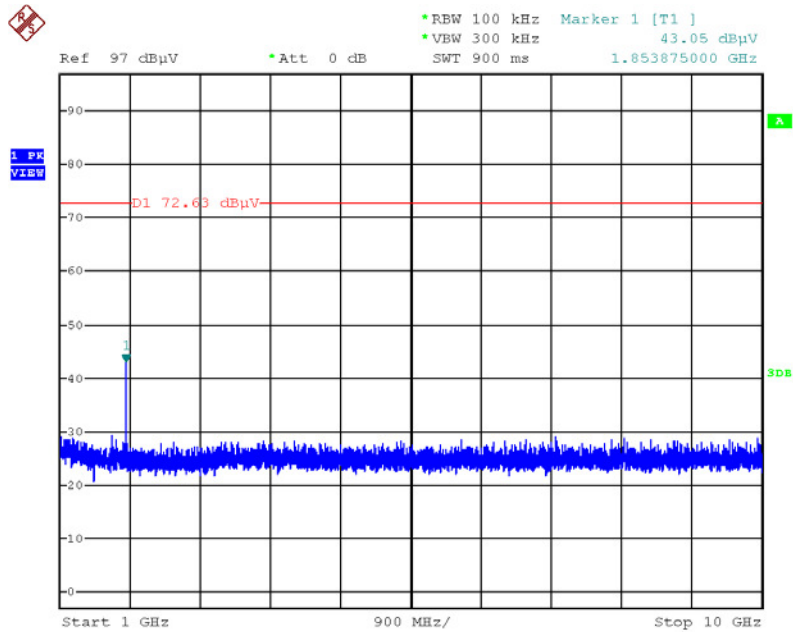

Date: 23.MAR.2016 20:32:53

4.8. Antenna Requirements

4.8.1. Limit

Except for special regulations, the Low-power Radio-frequency Devices must not be equipped with any jacket for installing an antenna with extension cable. An intentional radiator shall be designed to ensure that no antenna other than that furnished by the responsible party shall be used with the device. The use of a permanently attached antenna or of an antenna that uses a unique coupling to the intentional radiator shall be considered sufficient to comply with the provisions of this Section. The manufacturer may design the unit so that the user can replace a broken antenna, but the use of a standard antenna jack or electrical connector is prohibited.

4.8.2. Antenna Connector Construction

Please refer to section 3.3 in this test report, antenna connector complied with the requirements.

5. LIST OF MEASURING EQUIPMENTS

Instrument	Manufacturer	Model No.	Serial No.	Characteristics	Calibration Date	Remark
EMI Test Receiver	R&S	ESCS 30	100355	9kHz ~ 2.75GHz	Apr. 22, 2015	Conduction (CO01-CB)
LISN	F.C.C.	FCC-LISN-50-16-2	04083	150kHz ~ 100MHz	Dec. 08, 2015	Conduction (CO01-CB)
LISN	Schwarzbeck	NSLK 8127	8127647	9kHz ~ 30MHz	Dec. 23, 2015	Conduction (CO01-CB)
COND Cable	Woken	Cable	01	150kHz ~ 30MHz	May 25, 2015	Conduction (CO01-CB)
Software	Audix	E3	6.120210n	-	N.C.R.	Conduction (CO01-CB)
BILOG ANTENNA	Schaffner	CBL6112D	37880	20MHz ~ 2GHz	Sep. 03, 2015	Radiation (03CH01-CB)
Horn Antenna	EMCO	3115	00075790	750MHz ~ 18GHz	Oct. 22, 2015	Radiation (03CH01-CB)
Pre-Amplifier	Agilent	8447D	2944A10991	0.1MHz ~ 1.3GHz	Mar. 15, 2016	Radiation (03CH01-CB)
Pre-Amplifier	Agilent	8449B	3008A02310	1GHz ~ 26.5GHz	Jan. 18, 2016	Radiation (03CH01-CB)
Spectrum Analyzer	R&S	FSP40	100056	9kHz ~ 40GHz	Oct. 27, 2015	Radiation (03CH01-CB)
Loop Antenna	Teseq	HLA 6120	24155	9kHz - 30 MHz	Mar. 16, 2016*	Radiation (03CH01-CB)
EMI Receiver	Agilent	N9038A	MY52260123	9kHz ~ 8.4GHz	Jan. 27, 2016	Radiation (03CH01-CB)
RF Cable-low	Woken	Low Cable-1	N/A	30 MHz ~ 1 GHz	Nov. 02, 2015	Radiation (03CH01-CB)
RF Cable-high	Woken	High Cable-16	N/A	1 GHz ~ 18 GHz	Nov. 02, 2015	Radiation (03CH01-CB)
RF Cable-high	Woken	High Cable-17	N/A	1 GHz ~ 18 GHz	Nov. 02, 2015	Radiation (03CH01-CB)
Test Software	Audix	E3	6.2009-I0-7	N/A	N/A	Radiation (03CH01-CB)
Spectrum analyzer	R&S	FSV40	100979	9kHz~40GHz	Dec. 09, 2015	Conducted (TH01-CB)
RF Cable-high	Woken	RG402	High Cable-7	1 GHz – 26.5 GHz	Nov. 02, 2015	Conducted (TH01-CB)
RF Cable-high	Woken	RG402	High Cable-8	1 GHz – 26.5 GHz	Nov. 02, 2015	Conducted (TH01-CB)
RF Cable-high	Woken	RG402	High Cable-9	1 GHz – 26.5 GHz	Nov. 02, 2015	Conducted (TH01-CB)
RF Cable-high	Woken	RG402	High Cable-10	1 GHz – 26.5 GHz	Nov. 02, 2015	Conducted (TH01-CB)
RF Cable-high	Woken	RG402	High Cable-6	1 GHz – 26.5 GHz	Nov. 02, 2015	Conducted (TH01-CB)
Power Sensor	Agilent	U2021XA	MY53410001	50MHz~18GHz	Nov. 02, 2015	Conducted (TH01-CB)

Note: Calibration Interval of instruments listed above is one year.

* Calibration Interval of instruments listed above is two years.

N.C.R. means Non-Calibration required.

6. MEASUREMENT UNCERTAINTY

Test Items	Uncertainty	Remark
Conducted Emission (150kHz ~ 30MHz)	3.2 dB	Confidence levels of 95%
Radiated Emission (30MHz ~ 1,000MHz)	3.6 dB	Confidence levels of 95%
Radiated Emission (1GHz ~ 18GHz)	3.7 dB	Confidence levels of 95%
Radiated Emission (18GHz ~ 40GHz)	3.5 dB	Confidence levels of 95%
Conducted Emission	1.7 dB	Confidence levels of 95%