



FCC RADIO TEST REPORT

FCC ID : UZ7RTL10B1
Equipment : Tablet
Brand Name : Zebra
Model name : RTL10B1
Applicant : Zebra Technologies Corporation
1 Zebra Plaza, Holtsville, NY 11742
Manufacturer : Zebra Technologies Corporation
1 Zebra Plaza, Holtsville, NY 11742
Standard : FCC Part 15 Subpart E §15.407

The product was received on Feb. 22, 2019 and testing was started from Mar. 24, 2019 and completed on May 07, 2019. We, SPORTON INTERNATIONAL INC., EMC & Wireless Communications Laboratory, would like to declare that the tested sample has been evaluated in accordance with the test procedures and has been in compliance with the applicable technical standards.

The report must not be used by the client to claim product certification, approval, or endorsement by TAF or any agency of government.

The test results in this report apply exclusively to the tested model / sample. Without written approval of SPORTON INTERNATIONAL INC. EMC & Wireless Communications Laboratory, the test report shall not be reproduced except in full.

Approved by: Jones Tsai

SPORTON INTERNATIONAL INC. EMC & Wireless Communications Laboratory
No. 52, Huaya 1st Rd., Guishan Dist., Taoyuan City, Taiwan (R.O.C.)



Table of Contents

History of this test report.....	3
Summary of Test Result.....	4
1 General Description	5
1.1 Product Feature of Equipment Under Test.....	5
1.2 Product Specification of Equipment Under Test.....	7
1.3 Modification of EUT	8
1.4 Testing Location	8
1.5 Applicable Standards.....	9
2 Test Configuration of Equipment Under Test	10
2.1 Carrier Frequency and Channel	10
2.2 Test Mode.....	10
2.3 Connection Diagram of Test System.....	17
2.4 Support Unit used in test configuration and system	18
2.5 EUT Operation Test Setup	19
2.6 Measurement Results Explanation Example.....	19
3 Test Result	20
3.1 6dB and 26dB and 99% Occupied Bandwidth Measurement	20
3.2 Maximum Conducted Output Power Measurement	26
3.3 Power Spectral Density Measurement	30
3.4 Unwanted Emissions Measurement.....	36
3.5 AC Conducted Emission Measurement.....	42
3.6 Automatically Discontinue Transmission	44
3.7 Antenna Requirements.....	45
4 List of Measuring Equipment.....	47
5 Uncertainty of Evaluation.....	49
Appendix A. AC Conducted Emission Test Result	
Appendix B. Radiated Spurious Emission	
Appendix C. Radiated Spurious Emission Plots	
Appendix D. Duty Cycle Plots	
Appendix E. Setup Photographs	



Summary of Test Result

Report Clause	Ref Std. Clause	Test Items	Result (PASS/FAIL)	Remark
3.1	15.403 (i)	6dB & 26dB Bandwidth	Pass	-
3.1	2.1049	99% Occupied Bandwidth	Reporting only	-
3.2	15.407 (a)	Maximum Conducted Output Power	Pass	-
3.3	15.407 (a)	Power Spectral Density	Pass	-
3.4	15.407(b)	Unwanted Emissions	Pass	Under limit 6.37 dB at 75.590 MHz
3.5	15.207	AC Conducted Emission	Pass	Under limit 5.52 dB at 13.56 MHz
3.6	15.407 (c)	Automatically Discontinue Transmission	Pass	-
3.7	15.203 & 15.407 (a)	Antenna Requirement	Pass	-

Declaration of Conformity:

The test results with all measurement uncertainty excluded are presented in accordance with the regulation limits or requirements declared by manufacturers.

Comments and Explanations:

The declared of product specification for EUT presented in the report are provided by the manufacturer, and the manufacturer takes all the responsibilities for the accuracy of product specification.

Reviewed by: Wii Chang**Report Producer: Aileen Huang**



1 General Description

1.1 Product Feature of Equipment Under Test

Product Feature	
Equipment	Tablet
Brand Name	Zebra
Model Name	RTL10B1
FCC ID	UZ7RTL10B1
Sample 1	EUT with SKU 1 + Keyboard
Sample 2	EUT with SKU 1
Sample 3	EUT with SKU 2
Sample 4	EUT with SKU 3
Sample 5	EUT with SKU 4
EUT supports Radios application	WCDMA/HSPA/LTE/NFC/GNSS WLAN 11a/b/g/n HT20/HT40 WLAN 11ac VHT20/VHT40/VHT80 Bluetooth BR/EDR/LE
HW Version	DV0
SW Version	Android version 8.1.0
FW Version - Xpad	01-17-09.00-OG-U00-PLT
FW Version - Xslate	01-17-05.00-OG-U00-PRD
FW Version - Xbook	01-17-05.00-OG-U00-PRD
MFD - Xpad	19MAR01
MFD - Xslate	19MAR01
MFD - Xbook	19MAR01
EUT Stage	Identical Prototype

Remark: The above EUT's information was declared by manufacturer.

Specification of Accessories				
AC Adapter	Brand Name	Delta	Model Name	ADP-65JH HB
Spare Standard Battery 36Whr	Brand Name	XPLORE	Model Name	XLBM1
Keyboard dock	Brand Name	XPLORE	Model Name	LX-KB
Touch Pen	Brand Name	WACOM	Model Name	CP-903-05B-2
Touch Pen	Brand Name	EMPIA	Model Name	EPNB-8C1000-0000 40820A01
Touch Pen	Brand Name	HAO SHUAN	Model Name	440007



<Sample Information>

	Sample 1	Sample 2	Sample 3	Sample 4	Sample 5
DV0	SKU 1+ Keyboard	L10A - SKU1	L10A - SKU2	L10A - SKU3	L10A - SKU4
ID	Xbook	XSLATE	XPAD	XPAD	XPAD
OS	Refer Xsplate	Android O	Android O	Android O	Android O
CPU		Qualcomm SDM660	Qualcomm SDM660	Qualcomm SDM660	Qualcomm SDM660
Display with touch		Panasonic EP101R1912N50 OTG 10.1" LCD (500nits)	Panasonic EP101R1912N50 OTG 10.1" LCD (500nits)	Panasonic EP101R1912N50 OTG 10.1" LCD (1000nits)	Panasonic EP101R1912N50 OTG 10.1" LCD (1000nits) with digitizer
Memory		Samsung LPDDR4 4GB Hynix LPDD4 4 GB	Samsung LPDDR4 4GB Hynix LPDD4 4 GB	Samsung LPDDR4 4GB Micron LPDD4 4 GB	Samsung LPDDR4 4GB Micron LPDD4 4 GB
eMMC		TOSHIBA 64GB	TOSHIBA 64GB	TOSHIBA 64GB	TOSHIBA 64GB
GPS		Qualcomm	Qualcomm	Qualcomm	Qualcomm
WWAN		Qualcomm	Qualcomm	Qualcomm	Qualcomm
WLAN		Qualcomm WCN3990	Qualcomm WCN3990	Qualcomm WCN3990	Qualcomm WCN3990
Antenna		WLAN*2/NFC /GPS/WWAN*2	WLAN*2/NFC /GPS/WWAN*2	WLAN*2/NFC /GPS/WWAN*2	WLAN*2/NFC /GPS/WWAN*2
Barcode Reader		No	Yes	Yes	Yes
HDMI		No	No	Yes	No
Serial Port		No	Yes	No	No



1.2 Product Specification of Equipment Under Test

Standards-related Product Specification	
Tx/Rx Channel Frequency Range	5745 MHz ~ 5825 MHz
Maximum Output Power <CDD Modes>	<p><Ant. 1> 802.11a : 13.90 dBm / 0.0245 W 802.11n HT20 : 13.80 dBm / 0.0240 W 802.11n HT40 : 13.90 dBm / 0.0245 W 802.11ac VHT20: 13.90 dBm / 0.0245 W 802.11ac VHT40: 14.00 dBm / 0.0251 W 802.11ac VHT80: 13.80 dBm / 0.0240 W</p> <p><Ant. 2> 802.11a : 13.90 dBm / 0.0245 W 802.11n HT20 : 13.80 dBm / 0.0240 W 802.11n HT40 : 13.90 dBm / 0.0245 W 802.11ac VHT20: 13.90 dBm / 0.0245 W 802.11ac VHT40: 13.80 dBm / 0.0240 W 802.11ac VHT80: 13.90 dBm / 0.0245 W</p> <p>MIMO <Ant. 1 + 2> 802.11a : 16.81 dBm / 0.0480 W 802.11n HT20 : 16.62 dBm / 0.0459 W 802.11n HT40 : 16.67 dBm / 0.0465 W 802.11ac VHT20: 16.72 dBm / 0.0470 W 802.11ac VHT40: 16.77 dBm / 0.0475 W 802.11ac VHT80: 16.56 dBm / 0.0453 W</p>
Maximum Output Power <TXBF Modes>	<p>MIMO <Ant. 1 + 2> 802.11ac VHT20: 16.76 dBm / 0.0474 W 802.11ac VHT40: 16.61 dBm / 0.0458 W 802.11ac VHT80: 16.66 dBm / 0.0463 W</p>
99% Occupied Bandwidth <CDD Modes>	<p><Ant. 1> 802.11a : 16.90 MHz 802.11ac VHT20 : 18.10 MHz 802.11ac VHT40 : 36.90 MHz 802.11ac VHT80 : 77.28 MHz</p> <p><Ant. 2> 802.11a : 16.90 MHz 802.11ac VHT20 : 18.05 MHz 802.11ac VHT40 : 37.10 MHz 802.11ac VHT80 : 77.40 MHz</p> <p>MIMO <Ant. 1> 802.11a : 16.95 MHz 802.11ac VHT20 : 18.10 MHz 802.11ac VHT40 : 36.80 MHz 802.11ac VHT80 : 77.40 MHz</p> <p>MIMO <Ant. 2> 802.11a : 16.85 MHz 802.11ac VHT20 : 18.00 MHz 802.11ac VHT40 : 36.90 MHz 802.11ac VHT80 : 77.28 MHz</p>



Standards-related Product Specification													
99% Occupied Bandwidth <TXBF Modes>	MIMO <Ant. 1> 802.11ac VHT20 : 18.08 MHz 802.11ac VHT40 : 37.36 MHz 802.11ac VHT80 : 77.20 MHz MIMO <Ant. 2> 802.11ac VHT20 : 17.98 MHz 802.11ac VHT40 : 37.26 MHz 802.11ac VHT80 : 77.20 MHz												
Type of Modulation	802.11a/n : OFDM (BPSK / QPSK / 16QAM / 64QAM) 802.11ac : OFDM (BPSK / QPSK / 16QAM / 64QAM / 256QAM)												
Antenna Type / Gain	<Ant. 1> : PIFA Antenna with gain -0.22 dBi <Ant. 2> : PIFA Antenna with gain 0.16 dBi												
Antenna Function Description	<table border="1"> <thead> <tr> <th></th> <th>Ant. 1</th> <th>Ant. 2</th> </tr> </thead> <tbody> <tr> <td>802.11 a/n/ac</td> <td>V</td> <td>V</td> </tr> <tr> <td>802.11 n/ac MIMO</td> <td>V</td> <td>V</td> </tr> <tr> <td>802.11ac TXBF</td> <td>V</td> <td>V</td> </tr> </tbody> </table>		Ant. 1	Ant. 2	802.11 a/n/ac	V	V	802.11 n/ac MIMO	V	V	802.11ac TXBF	V	V
	Ant. 1	Ant. 2											
802.11 a/n/ac	V	V											
802.11 n/ac MIMO	V	V											
802.11ac TXBF	V	V											

Note: MIMO Ant. 1+2 is a calculated result from sum of the power MIMO Ant. 1 and MIMO Ant. 2.

1.3 Modification of EUT

No modifications are made to the EUT during all test items.

1.4 Testing Location

Test Site	SPORTON INTERNATIONAL INC.	
Test Site Location	No.52, Huaya 1st Rd., Guishan Dist., Taoyuan City, Taiwan (R.O.C.) TEL: +886-3-327-3456 FAX: +886-3-328-4978	
Test Site No.	Sporton Site No.	
	TH05-HY	CO05-HY

Note: The test site complies with ANSI C63.4 2014 requirement.

Test Site	SPORTON INTERNATIONAL INC.	
Test Site Location	No.58, Aly. 75, Ln. 564, Wenhua 3rd, Rd., Guishan Dist., Taoyuan City, Taiwan (R.O.C.) TEL: +886-3-327-0868 FAX: +886-3-327-0855	
Test Site No.	Sporton Site No.	
	03CH13-HY	

Note: The test site complies with ANSI C63.4 2014 requirement.

FCC designation No.: TW1190 and TW0007



1.5 Applicable Standards

According to the specifications of the manufacturer, the EUT must comply with the requirements of the following standards:

- ♦ FCC Part 15 Subpart E
- ♦ FCC KDB 789033 D02 General UNII Test Procedures New Rules v02r01.
- ♦ FCC KDB 414788 D01 Radiated Test Site v01r01.
- ♦ FCC KDB 662911 D01 Multiple Transmitter Output v02r01.
- ♦ ANSI C63.10-2013

Remark:

1. All test items were verified and recorded according to the standards and without any deviation during the test.
2. This EUT has also been tested and complied with the requirements of FCC Part 15, Subpart B, recorded in a separate test report.



2 Test Configuration of Equipment Under Test

- a. The EUT has been associated with peripherals and configuration operated in a manner tended to maximize its emission characteristics in a typical application. Frequency range investigated: conduction emission (150 kHz to 30 MHz), radiation emission (9 kHz to the 10th harmonic of the highest fundamental frequency or to 40 GHz, whichever is lower). For radiated measurement, pre-scanned in three orthogonal panels, X, Y, Z. The worst cases (X plane) were recorded in this report.
- b. AC power line Conducted Emission was tested under maximum output power.

2.1 Carrier Frequency and Channel

Frequency Band	Channel	Freq. (MHz)	Channel	Freq. (MHz)
5725-5850 MHz Band 4 (U-NII-3)	149	5745	157	5785
	151*	5755	159*	5795
	153	5765	161	5805
	155#	5775	165	5825

Note:

- 1. The above Frequency and Channel in "*" were 802.11n HT40 and 802.11ac VHT40.
- 2. The above Frequency and Channel in "#n" were 802.11ac VHT80.

2.2 Test Mode

Final test modes are considering the modulation and worse data rates as below table.

Single Mode

Modulation	Data Rate
802.11a	6 Mbps
802.11n HT20 (Covered by VHT20)	MCS0
802.11n HT40 (Covered by VHT40)	MCS0
802.11ac VHT20	MCS0
802.11ac VHT40	MCS0
802.11ac VHT80	MCS0



MIMO Mode

Modulation	Data Rate
802.11a	6 Mbps
802.11n HT20 (Covered by VHT20)	MCS0
802.11n HT40 (Covered by VHT40)	MCS0
802.11ac VHT20	MCS0
802.11ac VHT40	MCS0
802.11ac VHT80	MCS0

TXBF Mode

Modulation	Data Rate
802.11ac VHT20	MCS0
802.11ac VHT40	MCS0
802.11ac VHT80	MCS0

Test Cases	
AC Conducted Emission	Mode 1 : LTE Band 12 Idle + WLAN (5GHz) Link + Bluetooth Link + NFC Idle + Bar Code Scanner + AC Adapter + USB (Type C) with LCD Monitor + SD Card (Data Link) (eMMC to SD Card) + RJ45 Load with AP + Touch Pen (CP-903-05B-2) + HDMI in with Notebook for Sample 4
Remark:	
<ol style="list-style-type: none"> For Radiated Test Cases, the tests were performed with Sample 2. Data Link with Notebook means data application transferred mode between EUT and Notebook. HDMI Cable means media application transferred between EUT and external display. 	

<CDD Mode>

Ch. #		Band IV : 5725-5850 MHz			
		802.11a	802.11ac VHT20	802.11ac VHT40	802.11ac VHT80
L	Low	149	149	151	-
M	Middle	157	157	-	155
H	High	165	165	159	-

<TXBF Mode>

Ch. #		Band IV : 5725-5850 MHz		
		802.11ac VHT20	802.11ac VHT40	802.11ac VHT80
L	Low	149	151	-
M	Middle	157	-	155
H	High	165	159	-



<CDD Mode>

<Ant. 1>

802.11a RF Output Power (dBm)										
Power vs. Channel			Power vs Data Rate							
Channel	Frequency (MHz)	Data Rate (bps)	channel	Data Rate (bps)						
		6M		9M	12M	18M	24M	36M	48M	54M
Duty Cycle (%)		94.93		93.40	91.50	88.30	85.30	79.90	75.30	73.30
CH 149	5745	13.80	CH 157	13.80	13.80	13.80	13.50	13.50	13.50	13.50
CH 157	5785	13.90								
CH 165	5825	13.80								

802.11n HT20 RF Output Power (dBm)										
Power vs. Channel			Power vs Data Rate							
Channel	Frequency (MHz)	MCS Index	channel	MCS Index						
		MCS0		MCS1	MCS2	MCS3	MCS4	MCS5	MCS6	MCS7
Duty Cycle (%)		94.58		91.10	87.70	84.60	79.50	75.10	73.40	71.80
CH 149	5745	13.80	CH 149	13.70	13.70	13.70	13.40	13.40	13.40	13.40
CH 157	5785	13.70								
CH 165	5825	13.70								

802.11n HT40 RF Output Power (dBm)										
Power vs. Channel			Power vs Data Rate							
Channel	Frequency (MHz)	MCS Index	channel	MCS Index						
		MCS0		MCS1	MCS2	MCS3	MCS4	MCS5	MCS6	MCS7
Duty Cycle (%)		89.52		84.00	78.90	74.50	68.10	63.00	61.00	59.60
CH 151	5755	13.90	CH 151	13.80	13.80	13.80	13.50	13.50	13.50	13.50
CH 159	5795	13.70								

802.11ac VHT20 RF Output Power (dBm)											
Power vs. Channel			Power vs Data Rate								
Channel	Frequency (MHz)	MCS Index	channel	MCS Index							
		MCS0		MCS1	MCS2	MCS3	MCS4	MCS5	MCS6	MCS7	MCS8
Duty Cycle (%)		95.10		91.10	87.70	84.70	79.70	75.60	73.60	72.00	68.80
CH 149	5745	13.90	CH 149	13.80	13.80	13.80	13.50	13.50	13.50	13.50	13.50
CH 157	5785	13.80									
CH 165	5825	13.80									



802.11ac VHT40 RF Output Power (dBm)												
Power vs. Channel			Power vs Data Rate									
Channel	Frequency (MHz)	MCS Index	channel	MCS Index								
		MCS0		MCS1	MCS2	MCS3	MCS4	MCS5	MCS6	MCS7	MCS8	MCS9
Duty Cycle (%)		90.48		84.40	79.10	74.70	68.40	63.40	61.60	60.00	57.20	55.30
CH 151	5755	14.00	CH 151	13.70	13.70	13.70	13.40	13.40	13.40	13.40	13.40	13.40
CH 159	5795	13.80										

802.11ac VHT80 RF Output Power (dBm)												
Power vs. Channel			Power vs Data Rate									
Channel	Frequency (MHz)	MCS Index	channel	MCS Index								
		MCS0		MCS1	MCS2	MCS3	MCS4	MCS5	MCS6	MCS7	MCS8	MCS9
Duty Cycle (%)		89.02		73.50	13.70	13.70	13.40	13.40	13.40	13.40	13.40	13.40
CH155	5775	13.80	CH155	13.70	13.70	13.70	13.40	13.40	13.40	13.40	13.40	13.40

<Ant. 2>

802.11a RF Output Power (dBm)										
Power vs. Channel			Power vs Data Rate							
Channel	Frequency (MHz)	Data Rate (bps)	channel	Data Rate (bps)						
		6M		9M	12M	18M	24M	36M	48M	54M
Duty Cycle (%)		95.39		93.40	91.50	88.20	85.30	78.90	75.40	73.20
CH 149	5745	13.70	CH 157	13.80	13.80	13.80	13.50	13.50	13.50	13.50
CH 157	5785	13.90								
CH 165	5825	13.80								

802.11n HT20 RF Output Power (dBm)										
Power vs. Channel			Power vs Data Rate							
Channel	Frequency (MHz)	MCS Index	channel	MCS Index						
		MCS0		MCS1	MCS2	MCS3	MCS4	MCS5	MCS6	MCS7
Duty Cycle (%)		94.58		91.00	87.70	84.50	79.60	75.00	73.20	71.70
CH 149	5745	13.60	CH 157	13.70	13.70	13.70	13.40	13.40	13.40	13.40
CH 157	5785	13.80								
CH 165	5825	13.70								



802.11n HT40 RF Output Power (dBm)										
Power vs. Channel			Power vs Data Rate							
Channel	Frequency (MHz)	MCS Index	channel	MCS Index						
		MCS0		MCS1	MCS2	MCS3	MCS4	MCS5	MCS6	MCS7
Duty Cycle (%)		89.62		84.20	78.90	74.60	68.30	63.00	60.90	59.20
CH 151	5755	13.50	CH 159	84.20	78.90	74.60	68.30	63.00	60.90	59.20
CH 159	5795	13.90								

802.11ac VHT20 RF Output Power (dBm)											
Power vs. Channel			Power vs Data Rate								
Channel	Frequency (MHz)	MCS Index	channel	MCS Index							
		MCS0		MCS1	MCS2	MCS3	MCS4	MCS5	MCS6	MCS7	MCS8
Duty Cycle (%)		94.61		91.10	87.80	84.80	79.70	75.60	73.60	72.10	68.90
CH 149	5745	13.70	CH 157								
CH 157	5785	13.90		13.60	13.60	13.60	13.30	13.30	13.30	13.30	13.30
CH 165	5825	13.80									

802.11ac VHT40 RF Output Power (dBm)												
Power vs. Channel			Power vs Data Rate									
Channel	Frequency (MHz)	MCS Index	channel	MCS Index								
		MCS0		MCS1	MCS2	MCS3	MCS4	MCS5	MCS6	MCS7	MCS8	MCS9
Duty Cycle (%)		89.62		84.30	79.10	74.80	68.60	63.40	61.50	60.10	57.20	55.50
CH 151	5755	13.60	CH 159	84.30	79.10	74.80	68.60	63.40	61.50	60.10	57.20	55.50
CH 159	5795	13.80										

802.11ac VHT80 RF Output Power (dBm)												
Power vs. Channel			Power vs Data Rate									
Channel	Frequency (MHz)	MCS Index	channel	MCS Index								
		MCS0		MCS1	MCS2	MCS3	MCS4	MCS5	MCS6	MCS7	MCS8	MCS9
Duty Cycle (%)		89.16		73.50	67.10	62.20	56.30	51.50	50.30	49.10	46.70	45.40
CH155	5775	13.90	CH155	13.80	13.80	13.80	13.50	13.50	13.50	13.50	13.50	13.50



MIMO <Ant. 1 + 2>

802.11a RF Output Power (dBm)										
Power vs. Channel			Power vs Data Rate							
Channel	Frequency (MHz)	Data Rate (bps)	channel	Data Rate (bps)						
		6M		9M	12M	18M	24M	36M	48M	54M
CH 149	5745	16.77	CH 157	16.71	16.71	16.71	16.41	16.41	16.41	16.41
CH 157	5785	16.81								
CH 165	5825	16.47								

802.11n HT20 RF Output Power (dBm)										
Power vs. Channel			Power vs Data Rate							
Channel	Frequency (MHz)	MCS Index	channel	MCS Index						
		MCS0		MCS1	MCS2	MCS3	MCS4	MCS5	MCS6	MCS7
CH 149	5745	16.62	CH 149	16.52	16.52	16.52	16.22	16.22	16.22	16.22
CH 157	5785	16.61								
CH 165	5825	16.27								

802.11n HT40 RF Output Power (dBm)										
Power vs. Channel			Power vs Data Rate							
Channel	Frequency (MHz)	MCS Index	channel	MCS Index						
		MCS0		MCS1	MCS2	MCS3	MCS4	MCS5	MCS6	MCS7
CH 151	5755	16.67	CH 151	16.57	16.57	16.57	16.27	16.27	16.27	16.27
CH 159	5795	16.52								

802.11ac VHT20 RF Output Power (dBm)										
Power vs. Channel			Power vs Data Rate							
Channel	Frequency (MHz)	MCS Index	channel	MCS Index						
		MCS0		MCS1	MCS2	MCS3	MCS4	MCS5	MCS6	MCS7
CH 149	5745	16.72	CH 149	16.62	16.62	16.62	16.32	16.32	16.32	16.32
CH 157	5785	16.71								
CH 165	5825	16.37								



802.11ac VHT40 RF Output Power (dBm)												
Power vs. Channel			Power vs Data Rate									
Channel	Frequency (MHz)	MCS Index	channel	MCS Index								
		MCS0		MCS1	MCS2	MCS3	MCS4	MCS5	MCS6	MCS7	MCS8	MCS9
CH 151	5755	16.77	CH 151	16.67	16.67	16.67	16.37	16.37	16.37	16.37	16.37	16.37
CH 159	5795	16.62										

802.11ac VHT80 RF Output Power (dBm)												
Power vs. Channel			Power vs Data Rate									
Channel	Frequency (MHz)	MCS Index	channel	MCS Index								
		MCS0		MCS1	MCS2	MCS3	MCS4	MCS5	MCS6	MCS7	MCS8	MCS9
CH155	5775	16.56	CH155	16.46	16.46	16.46	16.16	16.16	16.16	16.16	16.16	16.16

<TXBF Mode>

MIMO <Ant. 1 + 2>

802.11ac VHT20 RF Output Power (dBm)											
Power vs. Channel			Power vs Data Rate								
Channel	Frequency (MHz)	MCS Index	channel	MCS Index							
		MCS0		MCS1	MCS2	MCS3	MCS4	MCS5	MCS6	MCS7	MCS8
CH 149	5745	16.76	CH 149	16.66	16.66	16.66	16.66	16.66	16.66	16.66	16.66
CH 157	5785	16.66									
CH 165	5825	16.61									

802.11ac VHT40 RF Output Power (dBm)												
Power vs. Channel			Power vs Data Rate									
Channel	Frequency (MHz)	MCS Index	channel	MCS Index								
		MCS0		MCS1	MCS2	MCS3	MCS4	MCS5	MCS6	MCS7	MCS8	MCS9
CH 151	5755	16.56	CH 159	16.51	16.51	16.51	16.51	16.51	16.51	16.51	16.51	16.51
CH 159	5795	16.61										

802.11ac VHT80 RF Output Power (dBm)												
Power vs. Channel			Power vs Data Rate									
Channel	Frequency (MHz)	MCS Index	channel	MCS Index								
		MCS0		MCS1	MCS2	MCS3	MCS4	MCS5	MCS6	MCS7	MCS8	MCS9
CH155	5775	16.66	CH155	16.56	16.56	16.56	16.56	16.56	16.56	16.56	16.56	16.56

2.3 Connection Diagram of Test System

<Radiated Emission Mode>

<CDD Mode>

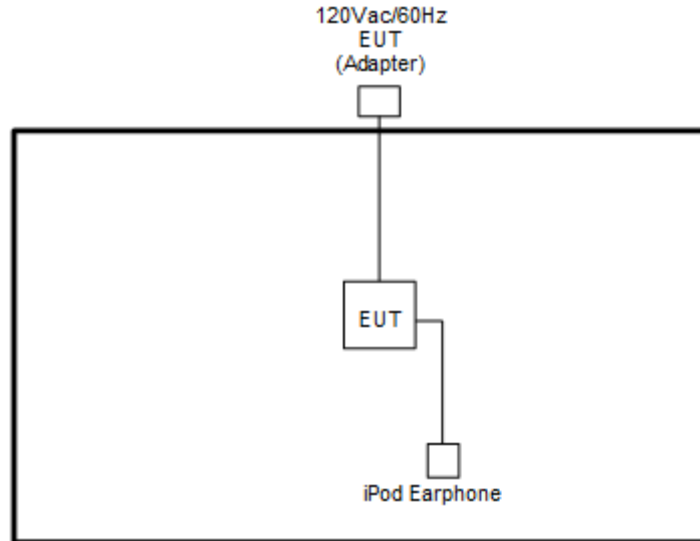

<TXBF Mode>

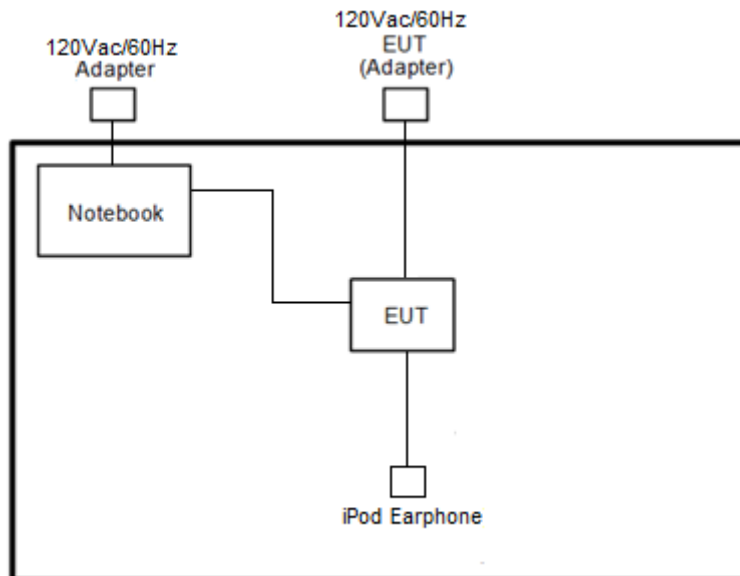

<AC Conducted Emission Mode>

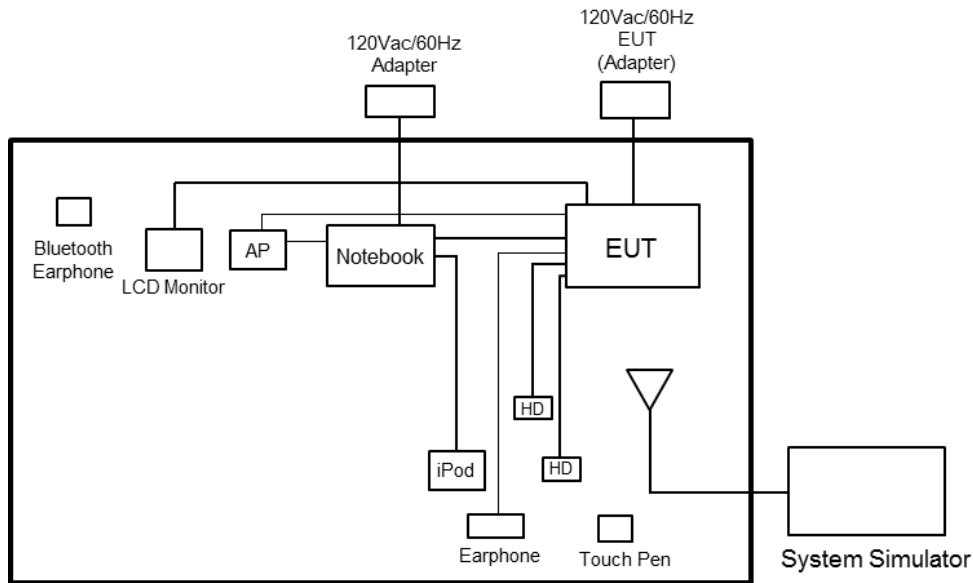

2.4 Support Unit used in test configuration and system

Item	Equipment	Trade Name	Model Name	FCC ID	Data Cable	Power Cord
1.	System Simulator	Anritsu	MT8820C	N/A	N/A	Unshielded, 1.8 m
2.	WLAN AP	TP-Link	ArcherC7	N/A	N/A	Unshielded, 1.8 m
3.	Bluetooth Earphone	Sony Ericsson	SBH20	PY7-RD0010	N/A	N/A
4.	Bluetooth Earphone	Sony Ericsson	MW600	PY7DDA-2029	N/A	N/A
5.	Notebook	DELL	Latitude E3340	FCC DoC/ Contains FCC ID: PD97260NGU	N/A	AC I/P: Unshielded, 1.2 m DC O/P: Shielded, 1.8 m
6.	iPod	Apple	A1285	FCC DoC	Shielded, 1.0 m	N/A
7.	iPod Earphone	Apple	N/A	Verification	Unshielded, 1.0 m	N/A
8.	LCD Monitor	DELL	P2715Qt	FCC DoC	Shielded, 1.6 m	Unshielded, 1.8 m
9.	USB HD	Lenovo	F310S	FCC DoC	Shielded, 0.5 m	N/A
10.	USB HD	Sony	HD-EG5	FCC DoC	Shielded, 0.5 m	N/A
11.	SD Card	SanDisk	MicroSD HC	FCC DoC	N/A	N/A



2.5 EUT Operation Test Setup

The RF test items, utility “QRCT” was installed in Notebook which was programmed in order to make the EUT get into the engineering modes to provide channel selection, power level, data rate and the application type and for continuous transmitting signals.

For TXBF mode, the modulation modes and data rates manipulated by the command lines in the engineering program made the EUT link to another EUT by power under the normal operation. The “adb” software tool was used to enable the EUT to transmit signals continuously.

2.6 Measurement Results Explanation Example

For all conducted test items:

The offset level is set in the spectrum analyzer to compensate the RF cable loss and attenuator factor between EUT conducted output port and spectrum analyzer. With the offset compensation, the spectrum analyzer reading level is exactly the EUT RF output level.

Example :

The spectrum analyzer offset is derived from RF cable loss and attenuator factor.

Offset = RF cable loss + attenuator factor.

Following shows an offset computation example with cable loss 4.2 dB and 10dB attenuator.

$$\begin{aligned} \text{Offset(dB)} &= \text{RF cable loss(dB)} + \text{attenuator factor(dB)}. \\ &= 4.2 + 10 = 14.2 \text{ (dB)} \end{aligned}$$

3 Test Result

3.1 6dB and 26dB and 99% Occupied Bandwidth Measurement

3.1.1 Description of 6dB and 26dB and 99% Occupied Bandwidth

The minimum 6 dB bandwidth shall be at least 500 kHz.

26dB and 99% Occupied bandwidth are reporting only.

3.1.2 Measuring Instruments

See list of measuring equipment of this test report.

3.1.3 Test Procedures

1. The testing follows FCC KDB 789033 D02 General UNII Test Procedures New Rules v02r01. Section C) Emission bandwidth for the band 5.725-5.85GHz
2. Set RBW = 100kHz.
3. Set the VBW $\geq 3 \times$ RBW.
4. Detector = Peak.
5. Trace mode = max hold
6. Measure the maximum width of the emission that is 6 dB down from the peak of the emission.
7. Measure and record the results in the test report.

3.1.4 Test Setup

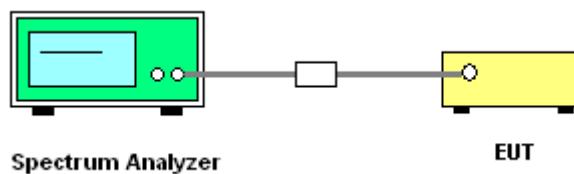



3.1.5 Test Result of 6dB and 26dB and 99% Occupied Bandwidth

Test Engineer :	Aking Chang and Kai Liao	Temperature :	21~25°C
		Relative Humidity :	51~54%

<CDD Mode>

Band IV												
Mod.	Data Rate	NTX	CH.	Freq. (MHz)	99% Bandwidth (MHz)		26dB Bandwidth (MHz)		6 dB Bandwidth (MHz)		6 dB Bandwidth Min. Limit (MHz)	Pass/Fail
					Ant 1	Ant 2	Ant 1	Ant 2	Ant 1	Ant 2		
11a	6Mbps	1	149	5745	16.80	16.90	25.35	25.40	16.30	16.30	0.5	Pass
11a	6Mbps	1	157	5785	16.85	16.80	25.80	26.65	16.25	16.30	0.5	Pass
11a	6Mbps	1	165	5825	16.90	16.80	24.75	25.80	16.30	16.30	0.5	Pass
VHT20	MCS0	1	149	5745	18.05	17.95	26.00	27.15	17.55	17.50	0.5	Pass
VHT20	MCS0	1	157	5785	18.05	18.05	25.50	27.00	17.50	17.60	0.5	Pass
VHT20	MCS0	1	165	5825	18.10	17.95	25.90	29.00	17.50	17.50	0.5	Pass
VHT40	MCS0	1	151	5755	36.90	36.90	43.38	43.38	36.00	36.18	0.5	Pass
VHT40	MCS0	1	159	5795	36.90	37.10	43.83	50.31	36.30	36.20	0.5	Pass
VHT80	MCS0	1	155	5775	77.28	77.40	85.12	85.44	75.20	75.52	0.5	Pass
11a	6Mbps	2	149	5745	16.80	16.85	24.60	24.50	16.35	16.35	0.5	Pass
11a	6Mbps	2	157	5785	16.95	16.75	26.05	24.70	16.30	16.30	0.5	Pass
11a	6Mbps	2	165	5825	16.95	16.80	25.05	24.05	16.30	16.30	0.5	Pass
VHT20	MCS0	2	149	5745	18.05	18.00	25.70	26.70	17.50	17.50	0.5	Pass
VHT20	MCS0	2	157	5785	18.00	17.95	26.05	26.40	17.60	17.50	0.5	Pass
VHT20	MCS0	2	165	5825	18.10	17.95	26.25	26.60	17.50	17.50	0.5	Pass
VHT40	MCS0	2	151	5755	36.80	36.90	43.11	43.20	36.00	36.09	0.5	Pass
VHT40	MCS0	2	159	5795	36.70	36.90	48.42	44.82	36.18	36.18	0.5	Pass
VHT80	MCS0	2	155	5775	77.40	77.28	84.80	84.80	75.84	75.68	0.5	Pass



<CDD Mode>

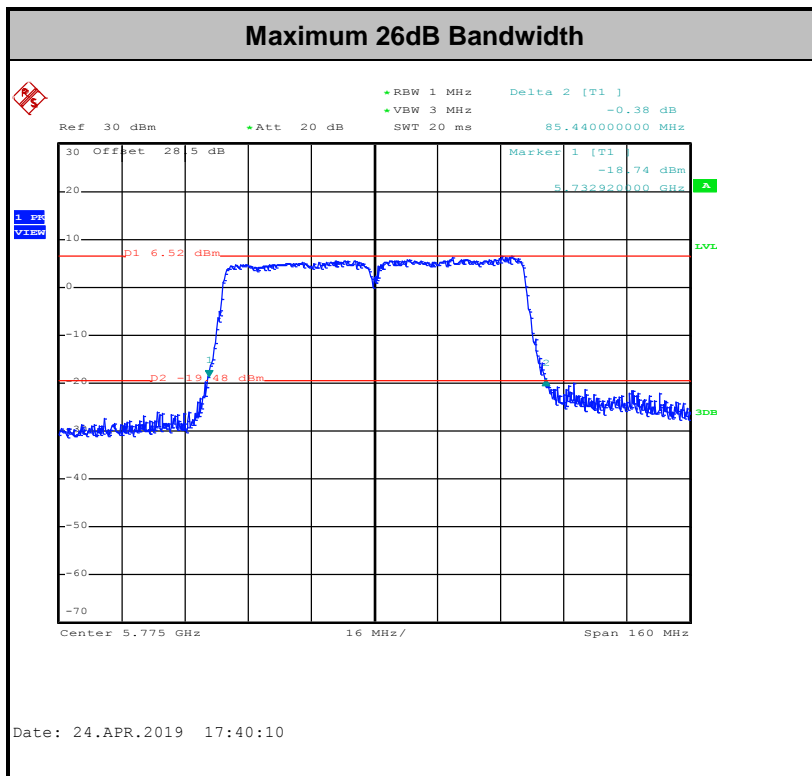
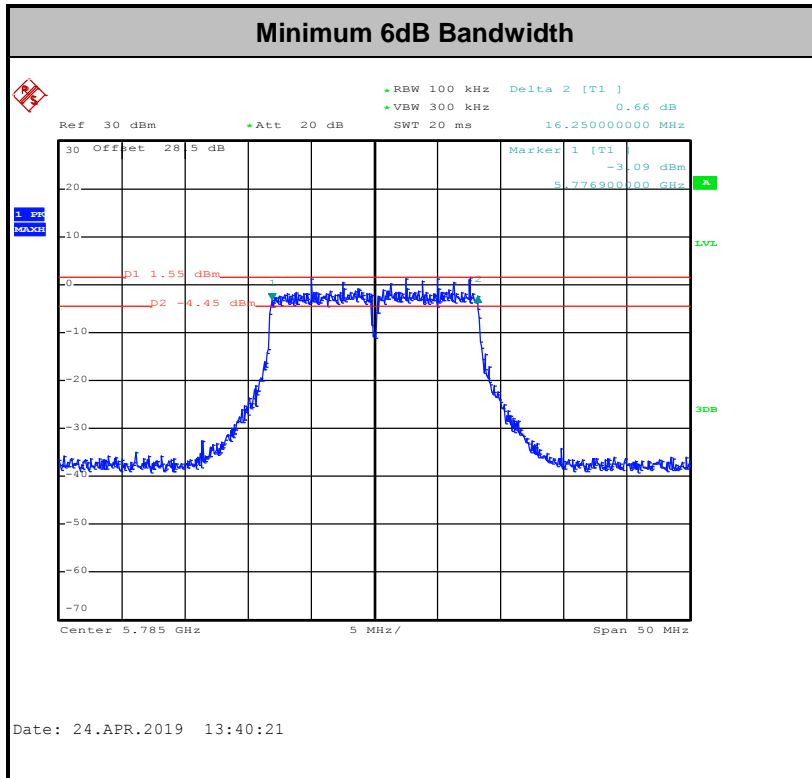

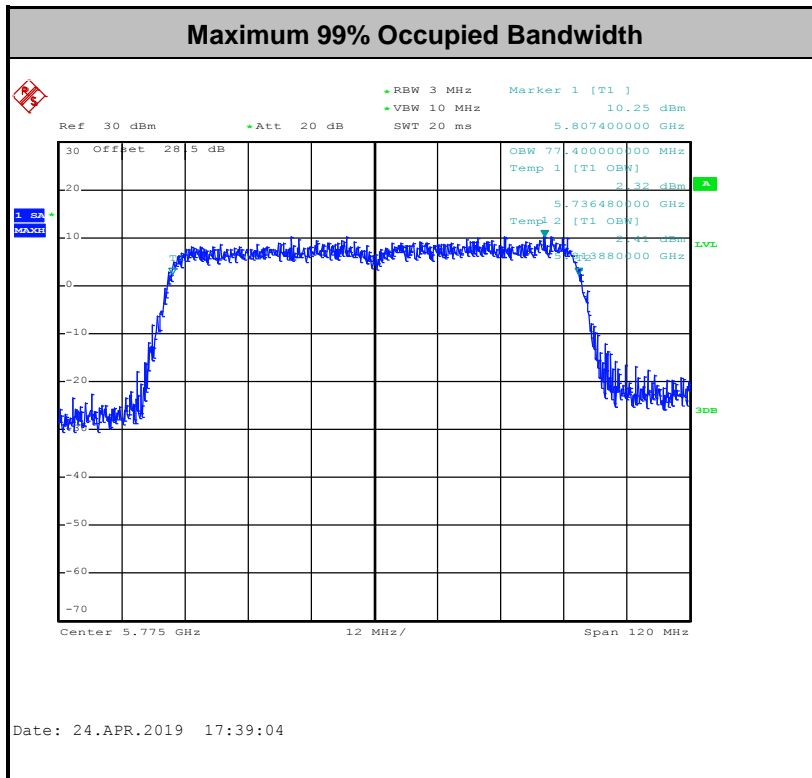

Note: The occupied channel bandwidth is maintained within the band of operation for all of the modulations.



<TXBF Modes>

Band IV												
Mod.	Data Rate	NTX	CH.	Freq. (MHz)	99% Bandwidth (MHz)		26dB Bandwidth (MHz)		6 dB Bandwidth (MHz)		6 dB Bandwidth Min. Limit (MHz)	Pass/Fail
					Ant 1	Ant 2	Ant 1	Ant 2	Ant 1	Ant 2		
VHT20	MCS0	2	149	5745	17.88	17.93	24.83	25.23	15.53	17.73	0.5	Pass
VHT20	MCS0	2	157	5785	17.98	17.98	25.18	25.28	17.68	17.68	0.5	Pass
VHT20	MCS0	2	165	5825	18.08	17.98	25.38	24.93	16.33	15.49	0.5	Pass
VHT40	MCS0	2	151	5755	37.36	37.26	45.76	45.76	36.68	36.68	0.5	Pass
VHT40	MCS0	2	159	5795	37.16	37.16	44.24	43.25	35.25	35.96	0.5	Pass
VHT80	MCS0	2	155	5775	77.20	77.20	86.15	96.22	71.29	76.08	0.5	Pass

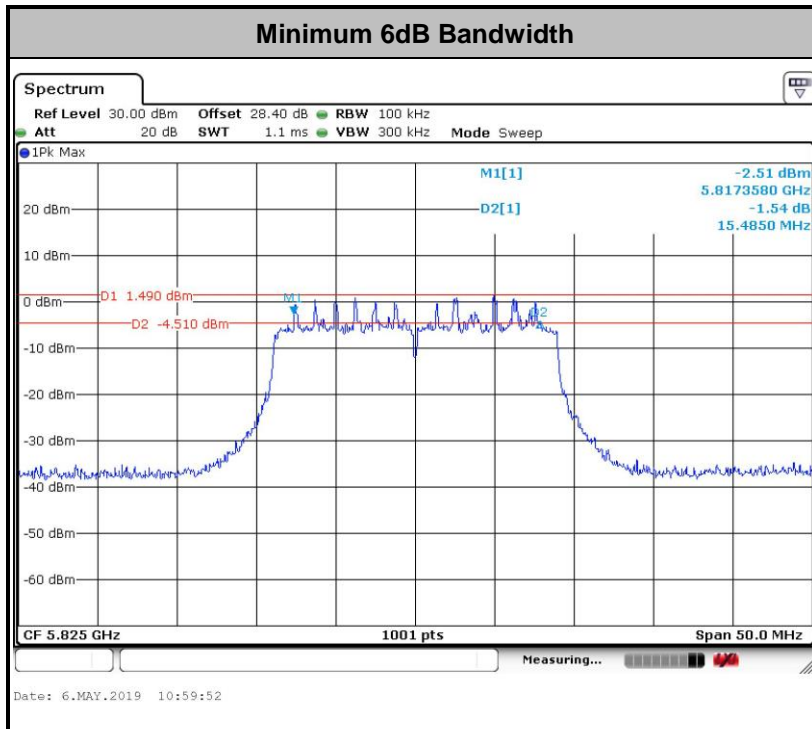

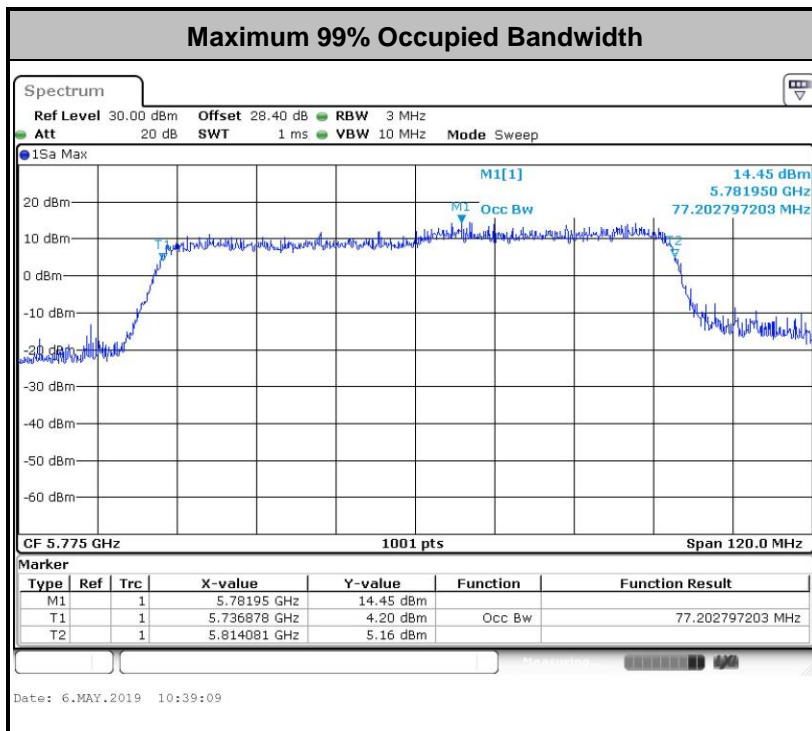
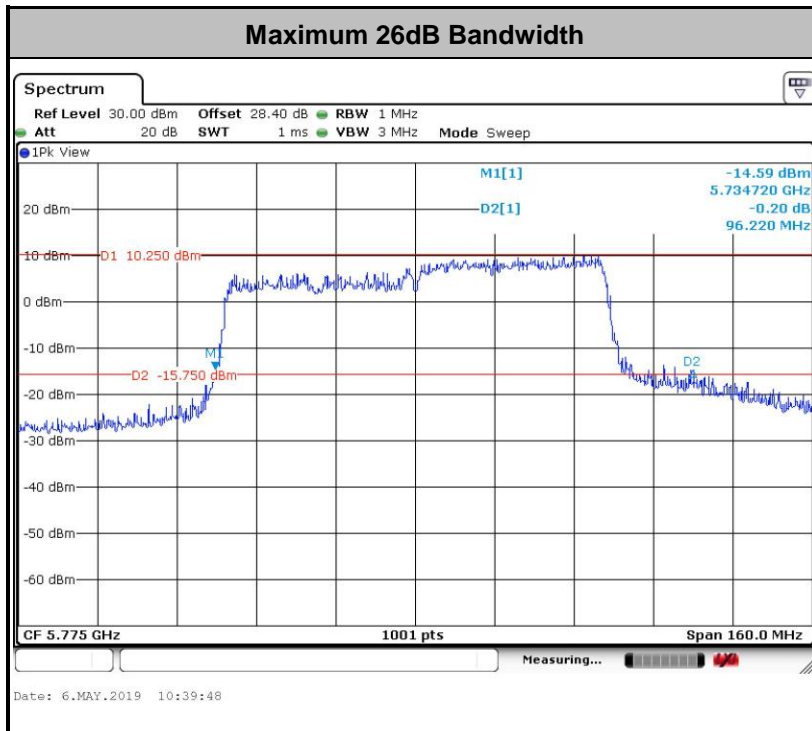

Note: The occupied channel bandwidth is maintained within the band of operation for all of the modulations.



3.2 Maximum Conducted Output Power Measurement

3.2.1 Limit of Maximum Conducted Output Power

For the band 5.725–5.85 GHz, the maximum conducted output power over the frequency band of operation shall not exceed 1 W.

If transmitting antennas of directional gain greater than 6 dBi are used, the peak output power shall be reduced by the amount in dB that the directional gain of the antenna exceeds 6 dBi.

3.2.2 Measuring Instruments

See list of measuring equipment of this test report.

3.2.3 Test Procedures

<CDD Modes>

The testing follows Method PM of FCC KDB 789033 D02 General UNII Test Procedures New Rules v02r01.

Method PM (Measurement using an RF average power meter):

1. Measurement is performed using a wideband RF power meter.
2. The EUT is configured to transmit continuously with a consistent duty cycle at its maximum power control level.
3. Measure the average power of the transmitter, and the average power is corrected with duty factor, $10 \log(1/x)$, where x is the duty cycle.

<TXBF Modes>

The testing follows Method PM-G of FCC KDB 789033 D02 General UNII Test Procedures New Rules v02r01 for TXBF modes.

Method PM-G (Measurement using a gated RF average power meter):

1. Measurement is performed using a wideband RF power meter.
2. The EUT is configured to transmit at its maximum power control level.
3. Measure the average power of the transmitter
4. Since the measurement is made only during the ON time of the transmitter, no duty cycle correction factor is required.

3.2.4 Test Setup

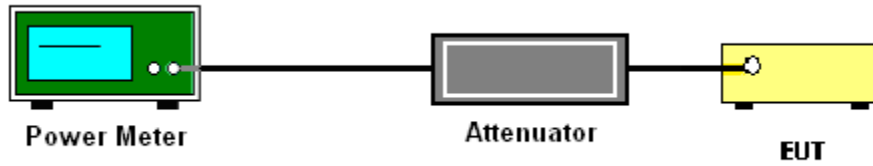

3.2.5 Test Result of Maximum Conducted Output Power

Test Engineer :	Aking Chang and Kai Liao	Temperature :	21~25°C
		Relative Humidity :	51~54%

<CDD Mode>

Band IV												
Mod.	Data Rate	NTX	CH.	Freq. (MHz)	Average Conducted Power (dBm)			FCC Conducted Power Limit (dBm)		DG (dBi)		Pass/Fail
					Ant 1	Ant 2	SUM	Ant 1	Ant 2	Ant 1	Ant 2	
11a	6Mbps	1	149	5745	13.80	13.70		30.00	30.00	-0.22	0.16	Pass
11a	6Mbps	1	157	5785	13.90	13.90		30.00	30.00	-0.22	0.16	Pass
11a	6Mbps	1	165	5825	13.80	13.80		30.00	30.00	-0.22	0.16	Pass
HT20	MCS0	1	149	5745	13.80	13.60		30.00	30.00	-0.22	0.16	Pass
HT20	MCS0	1	157	5785	13.70	13.80		30.00	30.00	-0.22	0.16	Pass
HT20	MCS0	1	165	5825	13.70	13.70		30.00	30.00	-0.22	0.16	Pass
HT40	MCS0	1	151	5755	13.90	13.50		30.00	30.00	-0.22	0.16	Pass
HT40	MCS0	1	159	5795	13.70	13.90		30.00	30.00	-0.22	0.16	Pass
VHT20	MCS0	1	149	5745	13.90	13.70		30.00	30.00	-0.22	0.16	Pass
VHT20	MCS0	1	157	5785	13.80	13.90		30.00	30.00	-0.22	0.16	Pass
VHT20	MCS0	1	165	5825	13.80	13.80		30.00	30.00	-0.22	0.16	Pass
VHT40	MCS0	1	151	5755	14.00	13.60		30.00	30.00	-0.22	0.16	Pass
VHT40	MCS0	1	159	5795	13.80	13.80		30.00	30.00	-0.22	0.16	Pass
VHT80	MCS0	1	155	5775	13.80	13.90		30.00	30.00	-0.22	0.16	Pass



Band IV												
Mod.	Data Rate	NTX	CH.	Freq. (MHz)	Average Conducted Power (dBm)			FCC Conducted Power Limit (dBm)		DG (dBi)		Pass/Fail
					Ant 1	Ant 2	SUM	Ant 1	Ant 2	Ant 1	Ant 2	
11a	6Mbps	2	149	5745	14.00	13.50	16.77	30.00		0.16		Pass
11a	6Mbps	2	157	5785	14.00	13.60	16.81	30.00		0.16		Pass
11a	6Mbps	2	165	5825	13.80	13.10	16.47	30.00		0.16		Pass
HT20	MCS0	2	149	5745	13.90	13.30	16.62	30.00		0.16		Pass
HT20	MCS0	2	157	5785	13.70	13.50	16.61	30.00		0.16		Pass
HT20	MCS0	2	165	5825	13.50	13.00	16.27	30.00		0.16		Pass
HT40	MCS0	2	151	5755	13.90	13.40	16.67	30.00		0.16		Pass
HT40	MCS0	2	159	5795	13.80	13.20	16.52	30.00		0.16		Pass
VHT20	MCS0	2	149	5745	14.00	13.40	16.72	30.00		0.16		Pass
VHT20	MCS0	2	157	5785	13.80	13.60	16.71	30.00		0.16		Pass
VHT20	MCS0	2	165	5825	13.60	13.10	16.37	30.00		0.16		Pass
VHT40	MCS0	2	151	5755	14.00	13.50	16.77	30.00		0.16		Pass
VHT40	MCS0	2	159	5795	13.90	13.30	16.62	30.00		0.16		Pass
VHT80	MCS0	2	155	5775	13.70	13.40	16.56	30.00		0.16		Pass



<TXBF Mode>

Band IV												
Mod.	Data Rate	NTX	CH.	Freq. (MHz)	Average Conducted Power (dBm)			FCC Conducted Power Limit (dBm)		DG (dBi)		Pass/Fail
					Ant 1	Ant 2	SUM	Ant 1	Ant 2	Ant 1	Ant 2	
VHT20	MCS0	2	149	5745	13.70	13.80	16.76	30.00		2.98		Pass
VHT20	MCS0	2	157	5785	13.50	13.80	16.66	30.00		2.98		Pass
VHT20	MCS0	2	165	5825	13.70	13.50	16.61	30.00		2.98		Pass
VHT40	MCS0	2	151	5755	13.60	13.50	16.56	30.00		2.98		Pass
VHT40	MCS0	2	159	5795	13.70	13.50	16.61	30.00		2.98		Pass
VHT80	MCS0	2	155	5775	13.80	13.50	16.66	30.00		2.98		Pass



3.3 Power Spectral Density Measurement

3.3.1 Limit of Power Spectral Density

For the band 5.725–5.85 GHz, the maximum power spectral density shall not exceed 30 dBm in any 500-kHz band.

If transmitting antennas of directional gain greater than 6 dBi are used, the peak output power shall be reduced by the amount in dB that the directional gain of the antenna exceeds 6 dBi.

3.3.2 Measuring Instruments

See list of measuring equipment of this test report.

3.3.3 Test Procedures

The testing follows FCC KDB 789033 D02 General UNII Test Procedures New Rules v02r01. Section F) Maximum power spectral density.

<CDD Modes>

Method SA-2

(trace averaging across on and off times of the EUT transmissions, followed by duty cycle correction).

- Measure the duty cycle.
- Set span to encompass the entire emission bandwidth (EBW) of the signal.
- Set RBW = 300 kHz.
- Set VBW \geq 1 MHz.
- Number of points in sweep \geq 2 Span / RBW.
- Sweep time = auto.
- Detector = RMS
- Trace average at least 100 traces in power averaging mode.
- Add $10 \log(500\text{kHz}/\text{RBW})$ to the test result.
- Add $10 \log(1/x)$, where x is the duty cycle, to the measured power in order to compute the average power during the actual transmission times. For example, add $10 \log(1/0.25) = 6$ dB if the duty cycle is 25 percent.

<TXBF Modes>**# Method SA-3 #**

(power averaging (rms) detection with max hold):

- Set span to encompass the entire emission bandwidth (EBW) of the signal.
 - Set RBW = 300 kHz.
 - Set VBW \geq 1 MHz.
 - Number of points in sweep \geq 2 Span / RBW.
 - Sweep time \leq (number of points in sweep) \times T, when duty cycle is less than 98 percent where T is the minimum transmission duration over which the transmitter is on and is transmitting at its maximum power control level for the tested mode of operation.
 - Detector = power averaging (rms).
 - Trace mode = max hold.
 - Allow max hold to run for at least 60 seconds, or longer as needed to allow the trace to stabilize.
1. The RF output of EUT was connected to the spectrum analyzer by a low loss cable.
 2. Each plot has already offset with cable loss, and attenuator loss. Measure the PPSD and record it.
 3. For MIMO mode, calculation method follows FCC KDB 662911 D01 Multiple Transmitter Output v02r01.

Method (c): Measure and add $10 \log(N_{ANT})$ dB.

With this technique, spectrum measurements are performed at each output of the device, but rather than summing the spectra or the spectral peaks across the outputs, the quantity $10 \log(N_{ANT})$ dB is added to each spectrum value before comparing to the emission limit. The addition of $10 \log(N_{ANT})$ dB serves to apportion the emission limit among the N_{ANT} outputs so that each output is permitted to contribute no more than $1/N_{ANT}^{th}$ of the PSD limit.

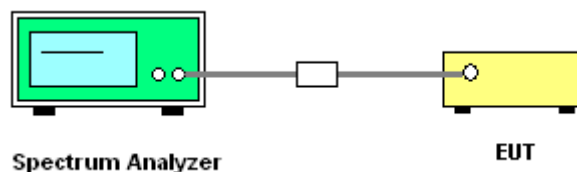
3.3.4 Test Setup



3.3.5 Test Result of Power Spectral Density

Test Engineer :	Aking Chang and Kai Liao	Temperature :	21~25°C
		Relative Humidity :	51~54%

<CDD Mode>

Band IV																
Mod.	Data Rate	NTX	CH.	Freq. (MHz)	Duty Factor (dB)		10log (500kHz /RBW) Factor (dB)		Average Power Density (dBm/500kHz)			Average PSD Limit (dBm/500kHz)		DG (dBi)		Pass /Fail
					Ant 1	Ant 2	Ant 1	Ant 2	Ant 1	Ant 2	SUM	Ant 1	Ant 2	Ant 1	Ant 2	
11a	6Mbps	1	149	5745	0.23	0.20	2.22	2.22	-0.24	0.48		30.00	30.00	-0.22	0.16	Pass
11a	6Mbps	1	157	5785	0.23	0.20	2.22	2.22	-0.70	0.62		30.00	30.00	-0.22	0.16	Pass
11a	6Mbps	1	165	5825	0.23	0.20	2.22	2.22	-0.53	0.66		30.00	30.00	-0.22	0.16	Pass
VHT20	MCS0	1	149	5745	0.22	0.24	2.22	2.22	-0.36	0.36		30.00	30.00	-0.22	0.16	Pass
VHT20	MCS0	1	157	5785	0.22	0.24	2.22	2.22	-0.80	0.42		30.00	30.00	-0.22	0.16	Pass
VHT20	MCS0	1	165	5825	0.22	0.24	2.22	2.22	-0.74	0.61		30.00	30.00	-0.22	0.16	Pass
VHT40	MCS0	1	151	5755	0.43	0.48	2.22	2.22	-3.46	-3.56		30.00	30.00	-0.22	0.16	Pass
VHT40	MCS0	1	159	5795	0.43	0.48	2.22	2.22	-3.67	-2.19		30.00	30.00	-0.22	0.16	Pass
VHT80	MCS0	1	155	5775	0.51	0.50	2.22	2.22	-6.41	-5.14		30.00	30.00	-0.22	0.16	Pass
11a	6Mbps	2	149	5745	0.20	0.20	2.22		0.13	0.61	3.62	30.00		2.98	Pass	
11a	6Mbps	2	157	5785	0.20	0.20	2.22		-0.31	0.46	3.47	30.00		2.98	Pass	
11a	6Mbps	2	165	5825	0.20	0.20	2.22		-0.24	0.45	5.43	30.00		2.98	Pass	
VHT20	MCS0	2	149	5745	0.22	0.22	2.22		-0.51	0.17	3.18	30.00		2.98	Pass	
VHT20	MCS0	2	157	5785	0.22	0.22	2.22		-0.82	0.01	3.02	30.00		2.98	Pass	
VHT20	MCS0	2	165	5825	0.22	0.22	2.22		-0.79	-0.03	2.98	30.00		2.98	Pass	
VHT40	MCS0	2	151	5755	0.39	0.43	2.22		-3.38	-2.30	0.71	30.00		2.98	Pass	
VHT40	MCS0	2	159	5795	0.39	0.43	2.22		-3.50	-2.45	0.56	30.00		2.98	Pass	
VHT80	MCS0	2	155	5775	0.51	0.51	2.22		-6.46	-5.85	-2.84	30.00		2.98	Pass	



Worst Case Power Density (dBm/MHz) for MIMO Ant. 1

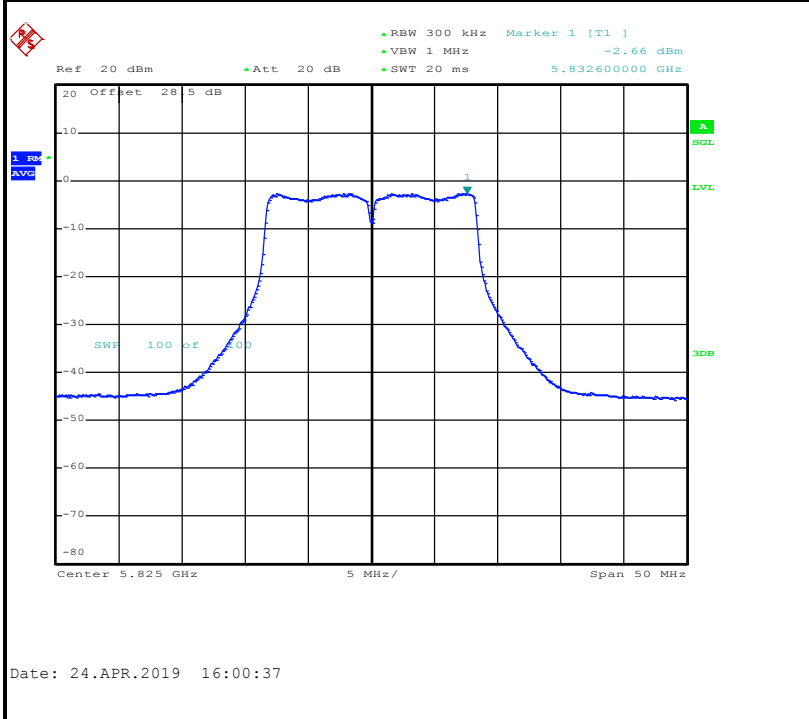

Worst Case Power Density (dBm/MHz) for MIMO Ant. 2

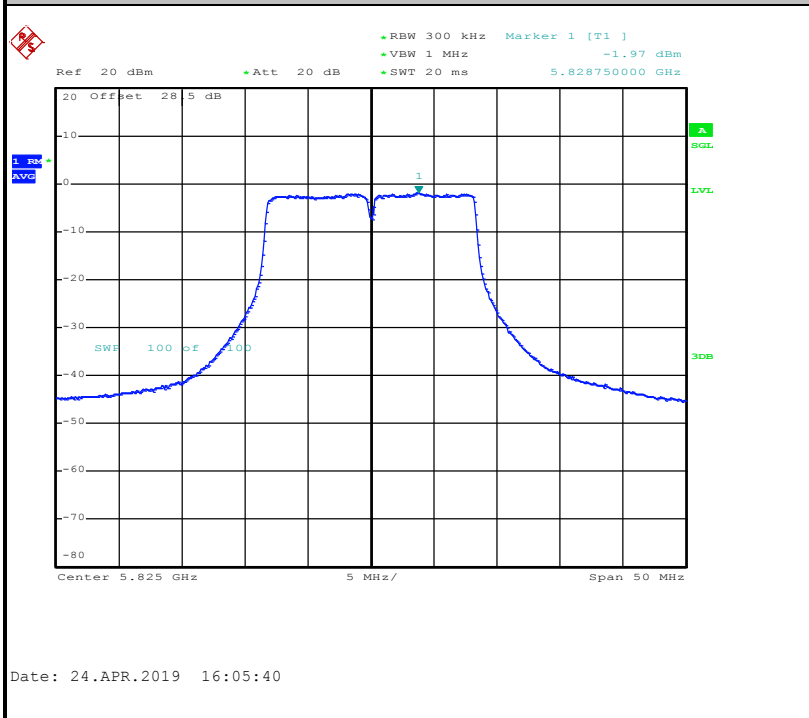



<TXBF Modes>

Band IV																
Mod.	Data Rate	NTX	CH.	Freq. (MHz)	Duty Factor (dB)		10log (500kHz /RBW) Factor (dB)		Average Power Density (dBm/500kHz)			Average PSD Limit (dBm/500kHz)		DG (dBi)		Pass /Fail
					Ant 1	Ant 2	Ant 1	Ant 2	Ant 1	Ant 2	SUM	Ant 1	Ant 2	Ant 1	Ant 2	
VHT20	MCS0	2	149	5745	0.00	0.00	2.22	2.47	1.82	5.48	30.00	2.98	Pass			
VHT20	MCS0	2	157	5785	0.00	0.00	2.22	2.20	0.93	5.21	30.00	2.98	Pass			
VHT20	MCS0	2	165	5825	0.00	0.00	2.22	1.67	-0.14	4.68	30.00	2.98	Pass			
VHT40	MCS0	2	151	5755	0.00	0.00	2.22	1.46	-0.28	4.47	30.00	2.98	Pass			
VHT40	MCS0	2	159	5795	0.00	0.00	2.22	1.26	-1.00	4.27	30.00	2.98	Pass			
VHT80	MCS0	2	155	5775	0.00	0.00	2.22	-0.54	-1.50	2.47	30.00	2.98	Pass			

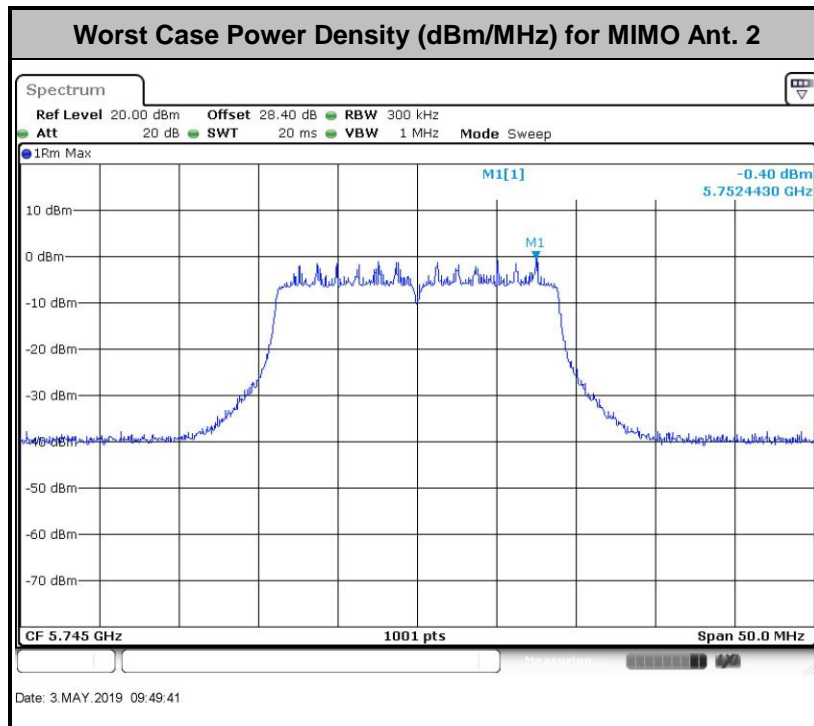
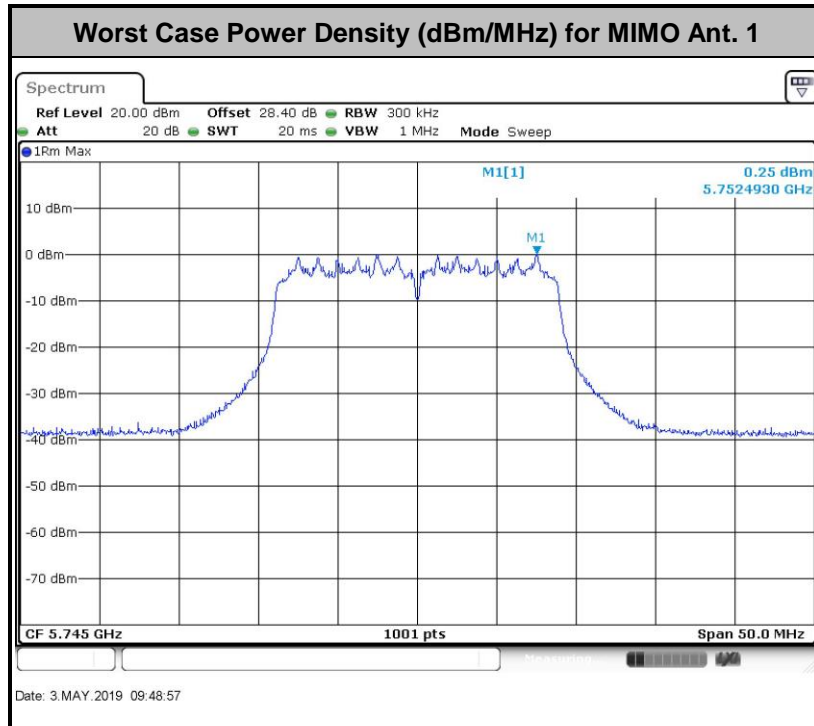



3.4 Unwanted Emissions Measurement

This section is to measure unwanted emissions through radiated measurement for band edge spurious emissions and out of band emissions measurement.

3.4.1 Limit of Unwanted Emissions

- (1) For transmitters operating in the 5.725-5.85 GHz band:
 15.407(b)(4)(i) All emissions shall be limited to a level of -27 dBm/MHz at 75 MHz or more above or below the band edge increasing linearly to 10 dBm/MHz at 25 MHz above or below the band edge, and from 25 MHz above or below the band edge increasing linearly to a level of 15.6 dBm/MHz at 5 MHz above or below the band edge, and from 5 MHz above or below the band edge increasing linearly to a level of 27 dBm/MHz at the band edge.
- (2) Unwanted spurious emissions fallen in restricted bands shall comply with the general field strength limits as below table,

Frequency (MHz)	Field Strength (microvolts/meter)	Measurement Distance (meters)
0.009 – 0.490	2400/F(kHz)	300
0.490 – 1.705	24000/F(kHz)	30
1.705 – 30.0	30	30
30 – 88	100	3
88 – 216	150	3
216 - 960	200	3
Above 960	500	3

Note: The following formula is used to convert the EIRP to field strength.

$$E = \frac{1000000\sqrt{30P}}{3} \mu\text{V/m, where P is the eirp (Watts)}$$



EIRP (dBm)	Field Strength at 3m (dBµV/m)
- 27	68.3

(3) KDB789033 D02 v02r01 G)2)c)

- (i) Section 15.407(b)(1) to (b)(3) specify the unwanted emission limits for the U-NII-1 and U-NII-2 bands. As specified, emissions above 1000 MHz that are outside of the restricted bands are subject to a peak emission limit of -27 dBm/MHz.³
- (ii) Section 15.407(b)(4) specifies the unwanted emission limit for the U-NII-3 band. A band emissions mask is specified in Section 15.407(b)(4)(i). The emission limits are in terms of a Peak detector. An alternative to the band emissions mask is specified in Section 15.407(b)(4)(ii). The alternative limits are based on the highest antenna gain specified in the filing. There are also marketing and importation restrictions for the devices using the alternative limit.⁴

Note 3: An out-of-band emission that complies with both the average and peak limits of Section 15.209 is not required to satisfy the -27 dBm/MHz peak emission limit.

Note 4: Only devices with antenna gains of 10 dBi or less may be approved using the emission limits specified in Section 15.247(d) till March 2, 2018; all other devices operating in this band must use the mask specified in Section 15.407(b)(4)(i).

3.4.2 Measuring Instruments

See list of measuring equipment of this test report.



3.4.3 Test Procedures

1. The testing follows FCC KDB 789033 D02 General UNII Test Procedures New Rules v02r01. Section G) Unwanted emissions measurement.
 - (1) Procedure for Unwanted Emissions Measurements Below 1000MHz
 - RBW = 120 kHz
 - VBW = 300 kHz
 - Detector = Peak
 - Trace mode = max hold
 - (2) Procedure for Peak Unwanted Emissions Measurements Above 1000 MHz
 - RBW = 1 MHz
 - VBW \geq 3 MHz
 - Detector = Peak
 - Sweep time = auto
 - Trace mode = max hold
 - (3) Procedures for Average Unwanted Emissions Measurements Above 1000MHz
 - RBW = 1 MHz
 - VBW = 10 Hz, when duty cycle is no less than 98 percent.
 - VBW \geq 1/T, when duty cycle is less than 98 percent where T is the minimum transmission duration over which the transmitter is on and is transmitting at its maximum power control level for the tested mode of operation.
2. The EUT was placed on a turntable with 0.8 meter for frequency below 1GHz and 1.5 meter for frequency above 1GHz respectively above ground.
3. The EUT was set 3 meters from the interference receiving antenna which was mounted on the top of a variable height antenna tower.
4. The antenna is a broadband antenna and its height is adjusted between one meter and four meters above ground to find the maximum value of the field strength for both horizontal polarization and vertical polarization of the antenna.
5. For each suspected emission, the EUT was arranged to its worst case and then adjust the antenna tower (from 1 m to 4 m) and turntable (from 0 degree to 360 degrees) to find the maximum reading.
6. For testing below 1GHz, if the emission level of the EUT in peak mode was 3 dB lower than the limit specified, then peak values of EUT will be reported, otherwise, the emissions will be repeated one by one using the CISPR quasi-peak method and reported.
7. For testing above 1GHz, the emission level of the EUT in peak mode was 20dB lower than average limit (that means the emission level in average mode also complies with the limit in average mode), then peak values of EUT will be reported, otherwise, the emissions will be measured in average mode again and reported.

3.4.4 Test Setup

For radiated emissions below 30MHz

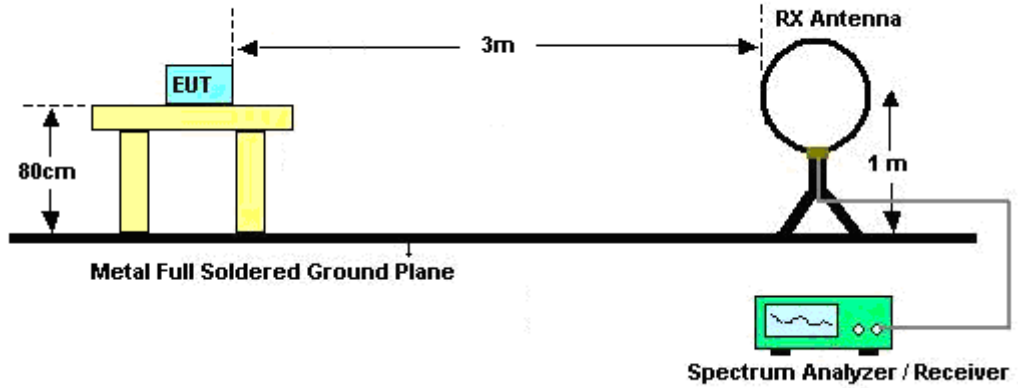

For radiated emissions from 30MHz to 1GHz

<CDD Mode>

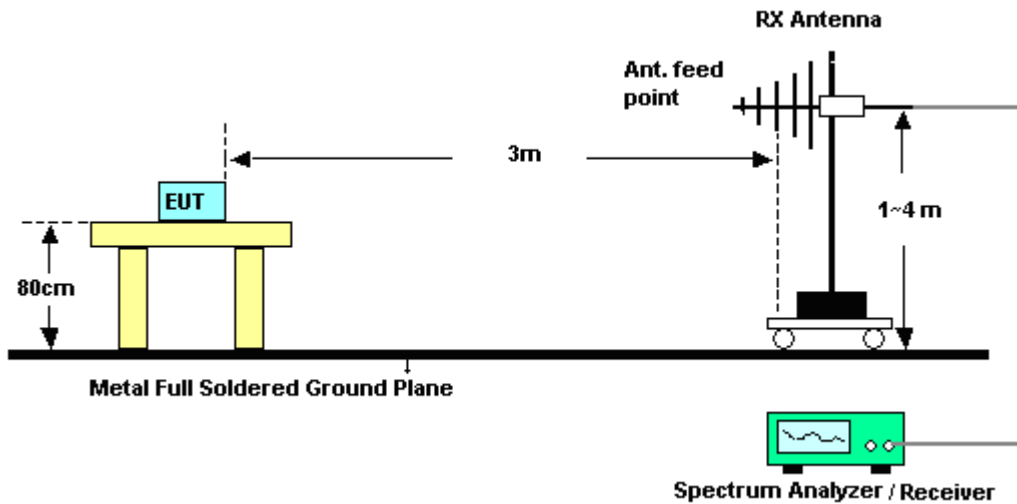

<TXBF Modes>

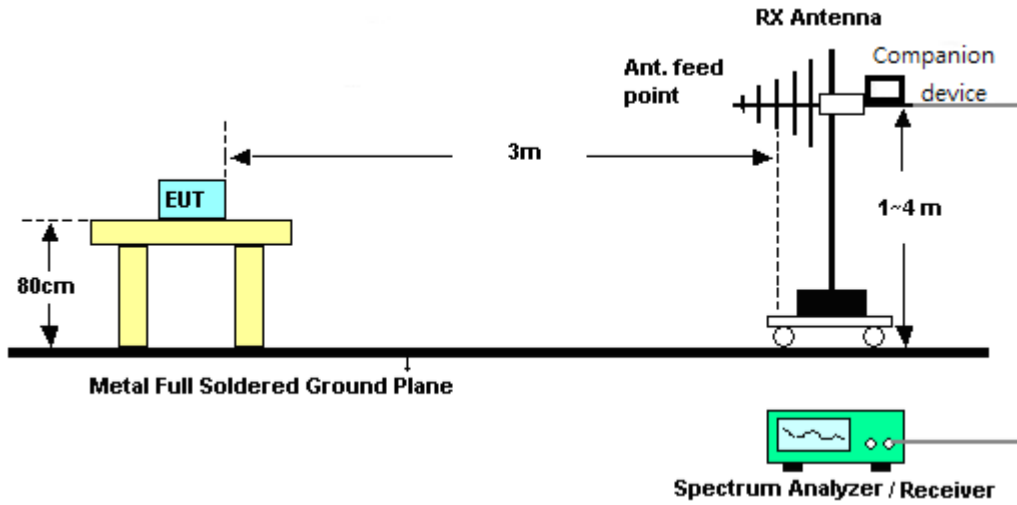

For radiated emissions above 1GHz

<CDD Mode>

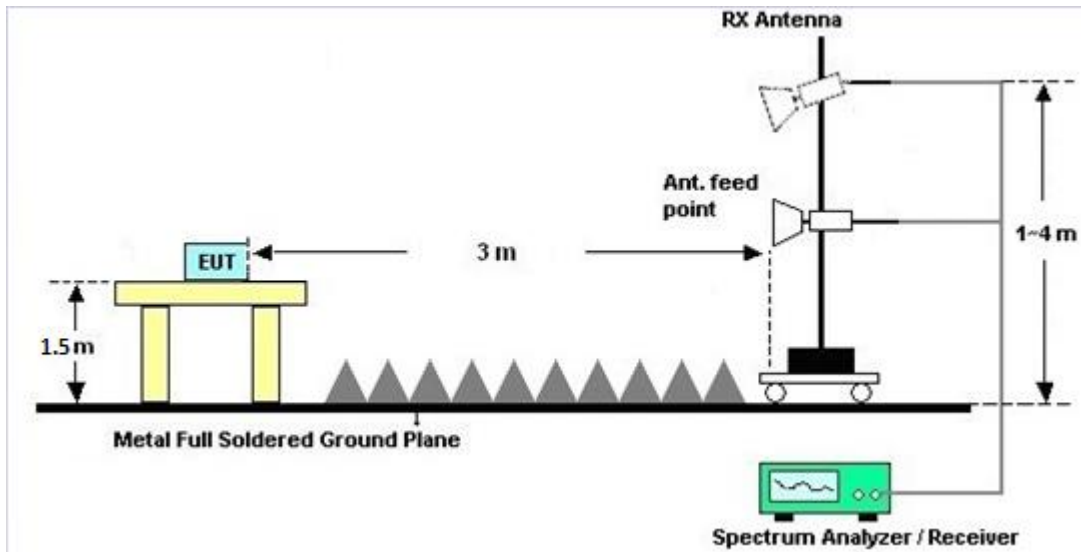

<TXBF Modes>

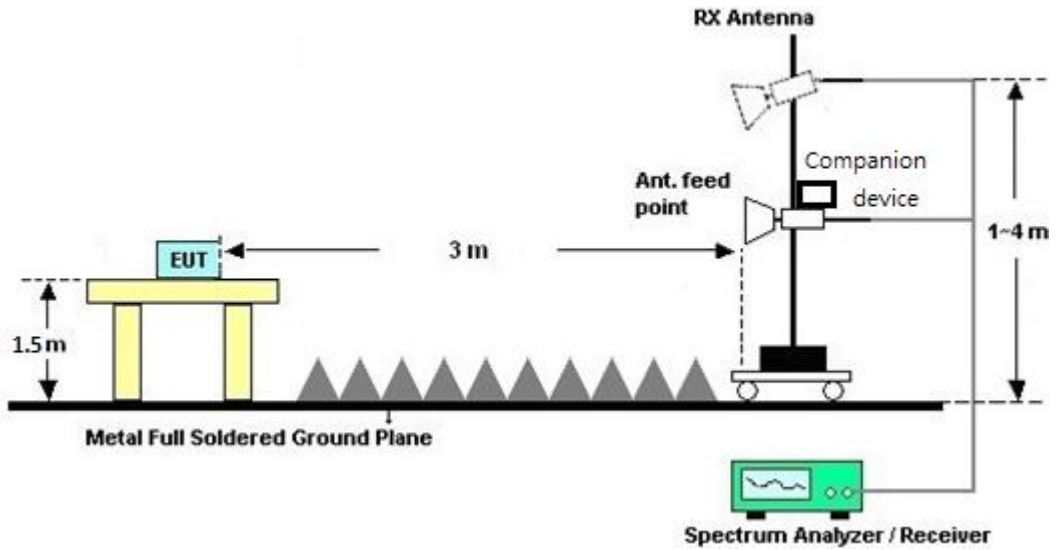

3.4.5 Test Results of Radiated Emissions (9 kHz ~ 30 MHz)

The low frequency, which started from 9 kHz to 30MHz, was pre-scanned and the result which was 20dB lower than the limit line was not reported.

There is a comparison data of both open-field test site and alternative test site - semi-Anechoic chamber according to 414788 D01 Radiated Test Site v01r01, and the result came out very similar.

3.4.6 Test Result of Radiated Band Edges

Please refer to Appendix B and C.

3.4.7 Duty Cycle

Please refer to Appendix D.

3.4.8 Test Result of Unwanted Radiated Emission (30MHz ~ 10th Harmonic)

Please refer to Appendix B and C.



3.5 AC Conducted Emission Measurement

3.5.1 Limit of AC Conducted Emission

For equipment that is designed to be connected to the public utility (AC) power line, the radio frequency voltage that is conducted back onto the AC power line on any frequency or frequencies within the band 150 kHz to 30 MHz shall not exceed the limits in the following table.

Frequency of emission (MHz)	Conducted limit (dB μ V)	
	Quasi-peak	Average
0.15-0.5	66 to 56*	56 to 46*
0.5-5	56	46
5-30	60	50

*Decreases with the logarithm of the frequency.

3.5.2 Measuring Instruments

See list of measuring equipment of this test report.

3.5.3 Test Procedures

1. The EUT was placed 0.4 meter from the conducting wall of the shielding room was kept at least 80 centimeters from any other grounded conducting surface.
2. Connect EUT to the power mains through a line impedance stabilization network (LISN).
3. All the support units are connecting to the other LISN.
4. The LISN provides 50 ohm coupling impedance for the measuring instrument.
5. The FCC states that a 50 ohm, 50 microhenry LISN should be used.
6. Both sides of AC line were checked for maximum conducted interference.
7. The frequency range from 150 kHz to 30 MHz was searched.
8. Set the test-receiver system to Peak Detect Function and specified bandwidth with Maximum Hold Mode.

3.5.4 Test Setup

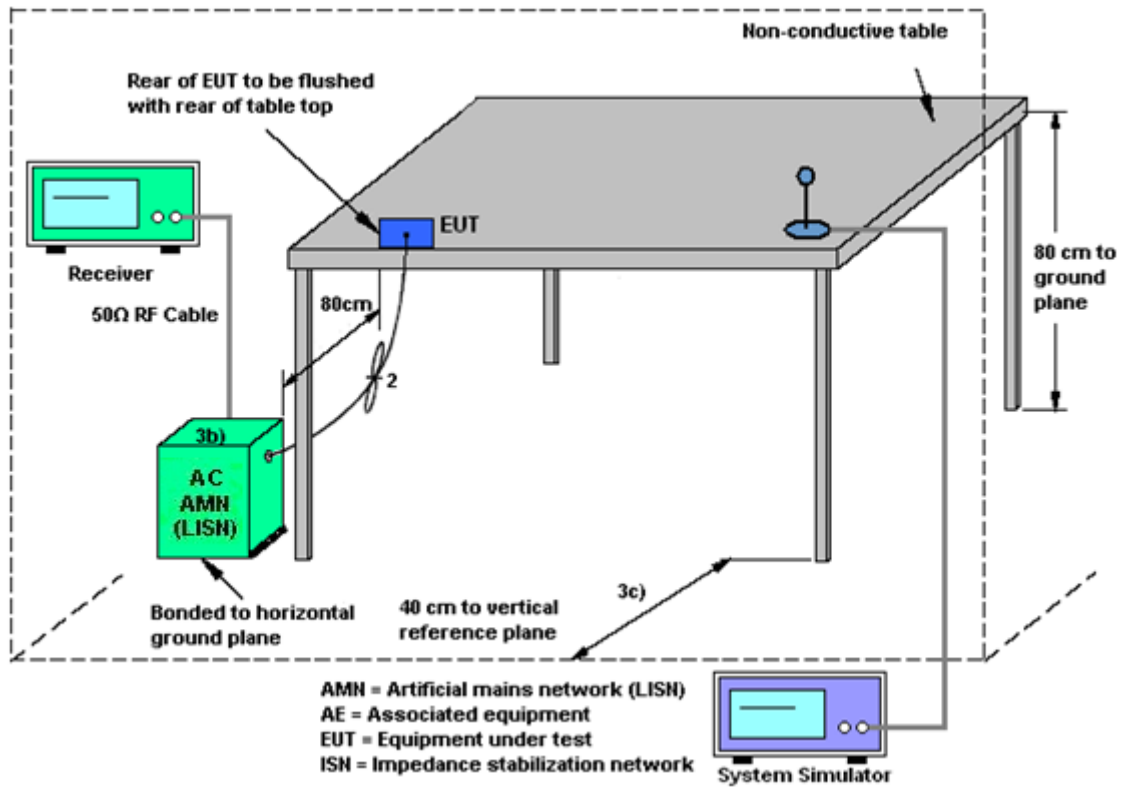

3.5.5 Test Result of AC Conducted Emission

Please refer to Appendix A.



3.6 Automatically Discontinue Transmission

3.6.1 Limit of Automatically Discontinue Transmission

The device shall automatically discontinue transmission in case of either absence of information to transmit or operational failure. These provisions are not intended to preclude the transmission of control or signaling information or the use of repetitive codes used by certain digital technologies to complete frame or burst intervals. Applicants shall include in their application for equipment authorization to describe how this requirement is met.

3.6.2 Measuring Instruments

See list of measuring equipment of this test report.

3.6.3 Test Result of Automatically Discontinue Transmission

While the EUT is not transmitting any information, the EUT can automatically discontinue transmission and become standby mode for power saving. The EUT can detect the controlling signal of ACK message transmitting from remote device and verify whether it shall resend or discontinue transmission.



3.7 Antenna Requirements

3.7.1 Standard Applicable

If transmitting antenna directional gain is greater than 6 dBi, both the peak transmit power and the peak power spectral density shall be reduced by the amount in dB that the directional gain of the antenna exceeds 6 dBi.

3.7.2 Antenna Anti-Replacement Construction

An embedded-in antenna design is used.

3.7.3 Antenna Gain

<CDD Modes >

FCC KDB 662911 D01 Multiple Transmitter Output v02r01

For CDD transmissions, directional gain is calculated as

Directional gain = GANT + Array Gain, where Array Gain is as follows.

For power spectral density (PSD) measurements on all devices,

Array Gain = 10 log(NANT/NSS=1) dB.

For power measurements on IEEE 802.11 devices,

Array Gain = 0 dB (i.e., no array gain) for NANT ≤ 4.

Directional gain may be calculated by using the formulas applicable to equal gain antennas with GANT set equal to the gain of the antenna having the highest gain;

The EUT supports CDD mode.

For power, the directional gain GANT is set equal to the antenna having the highest gain, i.e., F)2)f)i).

For PSD, the directional gain calculation is following F)2)f)ii) of KDB 662911 D01 v02r01.

The power and PSD limit should be modified if the directional gain of EUT is over 6 dBi,

The directional gain "DG" is calculated as following table.

<CDD Modes>						
			DG for Power (dBi)	DG for PSD (dBi)	Power Limit Reduction (dB)	PSD Limit Reduction (dB)
	Ant. 1 (dBi)	Ant. 2 (dBi)				
Band IV	-0.22	0.16	0.16	2.98	0.00	0.00

Power Limit Reduction = DG(Power) – 6dBi, (min = 0)

PSD Limit Reduction = DG(PSD) – 6dBi, (min = 0)

TXBF modes

FCC KDB 662911 D01 Multiple Transmitter Output v02r01

For CDD transmissions, directional gain is calculated as

$$DirectionalGain = 10 \cdot \log \left[\frac{\sum_{j=1}^{N_{SS}} \left\{ \sum_{k=1}^{N_{ANT}} g_{j,k} \right\}^2}{N_{ANT}} \right]$$

where

Each antenna is driven by no more than one spatial stream;

N_{SS} = the number of independent spatial streams of data;

N_{ANT} = the total number of antennas

$g_{j,k} = 10^{G_k / 20}$ if the k th antenna is being fed by spatial stream j , or zero if it is not;
 G_k is the gain in dBi of the k th antenna.

The EUT supports beamforming for 802.11ac modes.

The directional gain calculation is following F)2)e)ii) of KDB 662911 D01 v02r01.

The power and PSD limit should be modified if the directional gain of EUT is over 6 dBi,

The directional gain “DG” is calculated as following table.

			DG	DG	Power	PSD
			for	for	Limit	Limit
	Ant 1	Ant 2	Power	PSD	Reduction	Reduction
	(dBi)	(dBi)	(dBi)	(dBi)	(dB)	(dB)
Band IV	-0.22	0.16	2.98	2.98	0.00	0.00

$Power\ Limit\ Reduction = DG(Power) - 6dBi, (min = 0)$

$PSD\ Limit\ Reduction = DG(PSD) - 6dBi, (min = 0)$



4 List of Measuring Equipment

Instrument	Manufacturer	Model No.	Serial No.	Characteristics	Calibration Date	Test Date	Due Date	Remark
AC Power Source	ChainTek	APC-1000W	N/A	N/A	N/A	Mar. 24, 2019	N/A	Conduction (CO05-HY)
EMI Test Receiver	Rohde & Schwarz	ESR3	102388	9KHz~3.6GHz	Nov. 12, 2018	Mar. 24, 2019	Nov. 11, 2019	Conduction (CO05-HY)
LISN	Rohde & Schwarz	ENV216	100080	9kHz~30MHz	Nov. 14, 2018	Mar. 24, 2019	Nov. 13, 2019	Conduction (CO05-HY)
LISN	Rohde & Schwarz	ENV216	100081	9kHz~30MHz	Nov. 09, 2018	Mar. 24, 2019	Nov. 08, 2019	Conduction (CO05-HY)
Software	Rohde & Schwarz	EMC32 V10.30	N/A	N/A	N/A	Mar. 24, 2019	N/A	Conduction (CO05-HY)
RF Cable	HUBER + SUHNER	RG 214/U	1358175	9kHz~30MHz	Sep. 14, 2018	Mar. 24, 2019	Sep. 13, 2019	Conduction (CO05-HY)
Pulse Limiter	SCHWARZBECK	VTSD 9561-F N	9561-F N00373	9kHz-200MHz	Nov. 08, 2018	Mar. 24, 2019	Nov. 07, 2019	Conduction (CO05-HY)
Loop Antenna	Rohde & Schwarz	HFH2-Z2	100488	9 kHz~30 MHz	Jan. 07, 2019	Apr. 05, 2019 ~ May 07, 2019	Jan. 06, 2020	Radiation (03CH13-HY)
Horn Antenna	SCHWARZBECK	BBHA 9120 D	9120D-124 1	1GHz ~ 18GHz	Jun. 29, 2018	Apr. 05, 2019 ~ May 07, 2019	Jun. 28, 2019	Radiation (03CH13-HY)
Bilog Antenna	TESEQ	CBL 6111D&00800 N1D01N-06	37059&01	30MHz~1GHz	Oct. 13, 2018	Apr. 05, 2019 ~ May 07, 2019	Oct. 12, 2019	Radiation (03CH13-HY)
SHF-EHF Horn Antenna	SCHWARZBECK	BBHA 9170	BBHA9170 584	18GHz- 40GHz	Dec. 05, 2018	Apr. 05, 2019 ~ May 07, 2019	Dec. 04, 2019	Radiation (03CH13-HY)
Preamplifier	Keysight	83017A	MY532700 80	1GHz~26.5GHz	Nov. 14, 2018	Apr. 05, 2019 ~ May 07, 2019	Nov. 13, 2020	Radiation (03CH13-HY)
Preamplifier	MITEQ	AMF-7D-0010 1800-30-10P	1590074	1GHz~18GHz	May 21, 2018	Apr. 05, 2019 ~ May 07, 2019	May 20, 2019	Radiation (03CH13-HY)
Amplifier	Sonoma-Instrument	310 N	187282	9KHz~1GHz	Dec. 18, 2018	Apr. 05, 2019 ~ May 07, 2019	Dec. 17, 2019	Radiation (03CH13-HY)
Amplifier	MITEQ	TTA1840-35-HG	1871923	18GHz~40GHz, VSWR : 2.5:1 max	Jul. 16, 2018	Apr. 05, 2019 ~ May 07, 2019	Jul. 15, 2019	Radiation (03CH13-HY)
RF Cable	HUBER + SUHNER	SUCOFLEX 126E	0030/126E	30M-18G	Feb. 13, 2019	Apr. 05, 2019 ~ May 07, 2019	Feb. 12, 2020	Radiation (03CH13-HY)
RF Cable	HUBER + SUHNER	SUCOFLEX 104	804793/4	30M-18G	Feb. 13, 2019	Apr. 05, 2019 ~ May 07, 2019	Feb. 12, 2020	Radiation (03CH13-HY)
RF Cable	HUBER + SUHNER	SUCOFLEX 104	MY24961/ 4	30M-18G	Feb. 13, 2019	Apr. 05, 2019 ~ May 07, 2019	Feb. 12, 2020	Radiation (03CH13-HY)
RF Cable	HUBER + SUHNER	SUCOFLEX 102	MY2859/2	30M~40GHz	Mar. 13, 2019	Apr. 05, 2019 ~ May 07, 2019	Mar. 12, 2020	Radiation (03CH13-HY)
RF Cable	HUBER + SUHNER	SUCOFLEX 102	MY4274/2	30M~40GHz	Mar. 13, 2019	Apr. 05, 2019 ~ May 07, 2019	Mar. 12, 2020	Radiation (03CH13-HY)
Spectrum Analyzer	Agilent	N9010A	MY553705 26	10Hz~44GHz	Mar. 19, 2019	Apr. 05, 2019 ~ May 07, 2019	Mar. 18, 2020	Radiation (03CH13-HY)
Antenna Mast	EMEC	AM-BS-4500-B	N/A	1m~4m	N/A	Apr. 05, 2019 ~ May 07, 2019	N/A	Radiation (03CH13-HY)
Turn Table	EMEC	TT2000	N/A	0~360 Degree	N/A	Apr. 05, 2019 ~ May 07, 2019	N/A	Radiation (03CH13-HY)
Software	AUDIX	E3 6.2009-8-24c	RK-001124	N/A	N/A	Apr. 05, 2019 ~ May 07, 2019	N/A	Radiation (03CH13-HY)
EMI Test Receiver	Keysight	N9038A(MXE)	MY541300 85	20Hz ~ 8.4GHz	Nov. 01, 2018	Apr. 05, 2019 ~ May 07, 2019	Oct. 31, 2019	Radiation (03CH13-HY)
Filter	Woken	WHKX8-5272. 5-6750-18000 -40ST	SN5	6.75G Highpass	Mar. 13, 2019	Apr. 05, 2019 ~ May 07, 2019	Mar. 12, 2020	Radiation (03CH13-HY)
Filter	Wainwright	WHKX12-108 0-1200-15000 -60ST	SN3	1.2G Low Pass	Jul. 05, 2018	Apr. 05, 2019 ~ May 07, 2019	Jul. 04, 2019	Radiation (03CH13-HY)



Instrument	Manufacturer	Model No.	Serial No.	Characteristics	Calibration Date	Test Date	Due Date	Remark
<CDD Mode>								
Power Sensor	DARE	RPR3006W	15I00041S NO10	10MHz~6GHz	May 07, 2018	Apr. 04, 2019~ Apr. 24, 2019	May 06, 2019	Conducted (TH05-HY)
Spectrum Analyzer	Rohde & Schwarz	FSP40	100057	9kHz-40GHz	Nov. 21, 2018	Apr. 04, 2019~ Apr. 24, 2019	Nov. 20, 2019	Conducted (TH05-HY)
Switch Box & RF Cable	Burgeon	ETF-058	EC120838 2	N/A	Mar. 27, 2019	Apr. 04, 2019~ Apr. 24, 2019	Mar. 26, 2020	Conducted (TH05-HY)
<TXBF Mode>								
Power Sensor	DARE	RPR3006W	16I00054S NO10	10MHz~6GHz	Dec. 19, 2018	Apr. 19, 2019~ May 06, 2019	Dec. 18, 2019	Conducted (TH05-HY)
Signal Analyzer	Rohde & Schwarz	FSV40	101397	10Hz~40GHz	Nov. 13, 2018	Apr. 19, 2019~ May 06, 2019	Nov. 12, 2019	Conducted (TH05-HY)
Switch Box & RF Cable	Burgeon	ETF-058	EC120838 2	N/A	Mar. 27, 2019	Apr. 19, 2019~ May 06, 2019	Mar. 26, 2020	Conducted (TH05-HY)



5 Uncertainty of Evaluation

Uncertainty of Conducted Emission Measurement (150kHz ~ 30MHz)

Measuring Uncertainty for a Level of Confidence of 95% ($U = 2Uc(y)$)	2.2
---	-----

Uncertainty of Radiated Emission Measurement (30 MHz ~ 1000 MHz)

Measuring Uncertainty for a Level of Confidence of 95% ($U = 2Uc(y)$)	4.9
---	-----

Uncertainty of Radiated Emission Measurement (1000 MHz ~ 18000 MHz)

Measuring Uncertainty for a Level of Confidence of 95% ($U = 2Uc(y)$)	5.4
---	-----

Uncertainty of Radiated Emission Measurement (18000 MHz ~ 40000 MHz)

Measuring Uncertainty for a Level of Confidence of 95% ($U = 2Uc(y)$)	4.3
---	-----



Appendix A. AC Conducted Emission Test Results

Test Engineer :	Jimmy Chang	Temperature :	24~26°C
		Relative Humidity :	51~54%
Test Voltage :	120Vac / 60Hz	Phase :	Line

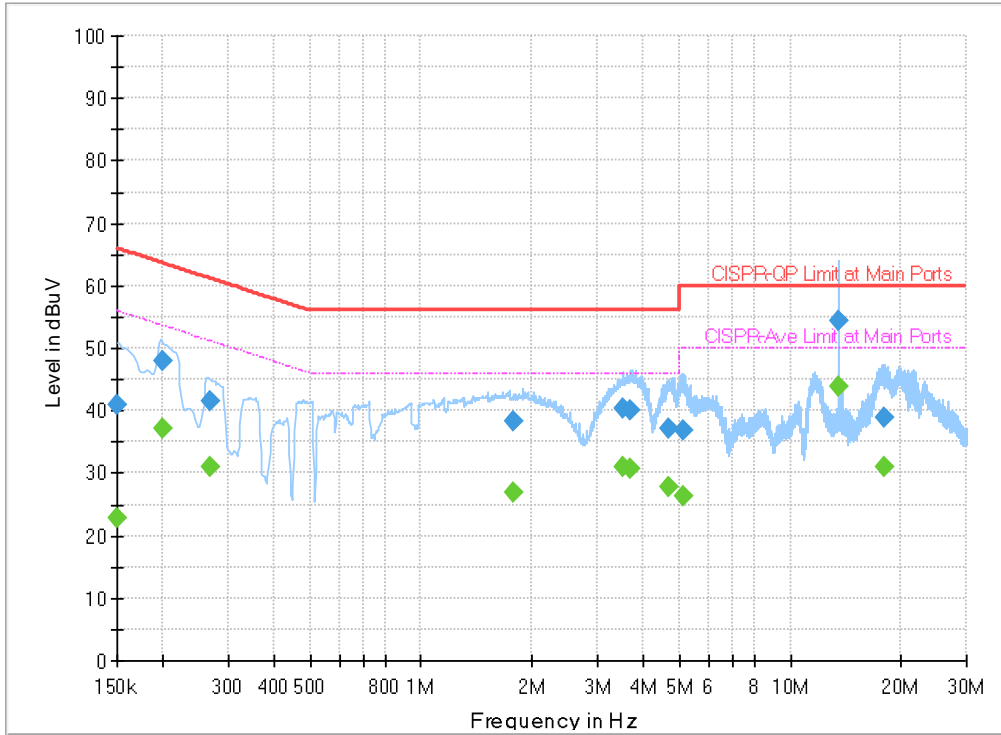

Final Result

Frequency (MHz)	QuasiPeak (dBuV)	CAverage (dBuV)	Limit (dBuV)	Margin (dB)	Line	Filter	Corr. (dB)
0.150000	---	22.72	56.00	33.28	L1	OFF	19.5
0.150000	40.97	---	66.00	25.03	L1	OFF	19.5
0.199500	---	37.27	53.63	16.36	L1	OFF	19.5
0.199500	48.04	---	63.63	15.59	L1	OFF	19.5
0.269250	---	30.95	51.14	20.19	L1	OFF	19.5
0.269250	41.39	---	61.14	19.75	L1	OFF	19.5
1.788000	---	27.05	46.00	18.95	L1	OFF	19.6
1.788000	38.25	---	56.00	17.75	L1	OFF	19.6
3.536250	---	31.00	46.00	15.00	L1	OFF	19.6
3.536250	40.43	---	56.00	15.57	L1	OFF	19.6
3.680250	---	30.69	46.00	15.31	L1	OFF	19.6
3.680250	40.02	---	56.00	15.98	L1	OFF	19.6
4.692750	---	27.85	46.00	18.15	L1	OFF	19.6
4.692750	37.14	---	56.00	18.86	L1	OFF	19.6
5.109000	---	26.45	50.00	23.55	L1	OFF	19.6
5.109000	36.81	---	60.00	23.19	L1	OFF	19.6
13.560000	---	43.96	50.00	6.04	L1	OFF	19.7
13.560000	54.48	---	60.00	5.52	L1	OFF	19.7
18.042000	---	31.02	50.00	18.98	L1	OFF	19.8
18.042000	38.81	---	60.00	21.19	L1	OFF	19.8



Test Engineer : Jimmy Chang	Temperature : 24~26°C
Test Voltage : 120Vac / 60Hz	Phase : Neutral

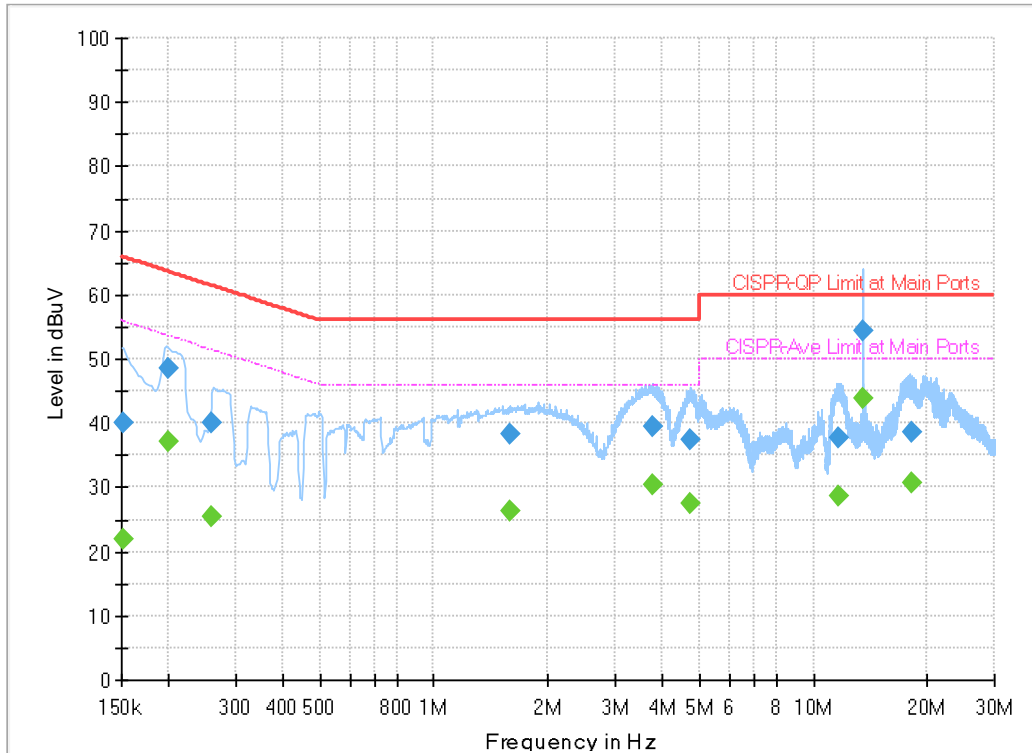

Final Result

Frequency (MHz)	QuasiPeak (dBuV)	CAverage (dBuV)	Limit (dBuV)	Margin (dB)	Line	Filter	Corr. (dB)
0.152250	---	21.91	55.88	33.97	N	OFF	19.5
0.152250	40.07	---	65.88	25.81	N	OFF	19.5
0.199500	---	37.26	53.63	16.37	N	OFF	19.5
0.199500	48.65	---	63.63	14.98	N	OFF	19.5
0.260250	---	25.47	51.42	25.95	N	OFF	19.5
0.260250	40.01	---	61.42	21.41	N	OFF	19.5
1.587750	---	26.36	46.00	19.64	N	OFF	19.6
1.587750	38.16	---	56.00	17.84	N	OFF	19.6
3.754500	---	30.44	46.00	15.56	N	OFF	19.6
3.754500	39.40	---	56.00	16.60	N	OFF	19.6
4.762500	---	27.40	46.00	18.60	N	OFF	19.6
4.762500	37.41	---	56.00	18.59	N	OFF	19.6
11.690250	---	28.63	50.00	21.37	N	OFF	19.7
11.690250	37.59	---	60.00	22.41	N	OFF	19.7
13.560000	---	43.91	50.00	6.09	N	OFF	19.8
13.560000	54.37	---	60.00	5.63	N	OFF	19.8
18.111750	---	30.76	50.00	19.24	N	OFF	19.9
18.111750	38.46	---	60.00	21.54	N	OFF	19.9



Appendix B. Radiated Spurious Emission

Test Engineer :	Alex Jheng, JC Liang, Wilson Wu	Temperature :	24.7~25.2°C
		Relative Humidity :	50~52%

<CDD Mode>

Band 4 - 5725~5850MHz
WIFI 802.11a (Band Edge @ 3m)

WIFI Ant.	Note	Frequency (MHz)	Level (dBμV/m)	Over Limit (dB)	Limit Line (dBμV/m)	Read Level (dBμV)	Antenna Factor (dB/m)	Path Loss (dB)	Preamp Factor (dB)	Ant Pos (cm)	Table Pos (deg)	Peak Avg. (P/A)	Pol. (H/V)	
802.11a CH 149 5745MHz		5638.2	49.99	-18.21	68.2	41.11	32.09	6.34	29.55	100	355	P	H	
		5691.8	50.86	-48.29	99.15	41.88	32.17	6.36	29.55	100	355	P	H	
		5718.6	55.33	-55.08	110.41	46.3	32.21	6.37	29.55	100	355	P	H	
		5721.6	58.73	-55.72	114.45	49.7	32.21	6.37	29.55	100	355	P	H	
	*	5745	106.62	-	-	97.55	32.24	6.38	29.55	100	355	P	H	
	*	5745	99.34	-	-	90.27	32.24	6.38	29.55	100	355	A	H	
														H
														H
			5634.8	49.48	-18.72	68.2	40.61	32.09	6.33	29.55	191	16	P	V
			5699.8	50.62	-54.43	105.05	41.64	32.17	6.36	29.55	191	16	P	V
			5719.6	59.39	-51.3	110.69	50.36	32.21	6.37	29.55	191	16	P	V
			5723	59.54	-58.1	117.64	50.51	32.21	6.37	29.55	191	16	P	V
	*	5745	105.93	-	-	96.86	32.24	6.38	29.55	191	16	P	V	
	*	5745	98.83	-	-	89.76	32.24	6.38	29.55	191	16	A	V	
														V
														V



WIFI Ant. 1	Note	Frequency (MHz)	Level (dBµV/m)	Over Limit (dB)	Limit Line (dBµV/m)	Read Level (dBµV)	Antenna Factor (dB/m)	Path Loss (dB)	Preamp Factor (dB)	Ant Pos (cm)	Table Pos (deg)	Peak Avg. (P/A)	Pol. (H/V)
		5605.8	49.59	-18.61	68.2	40.78	32.04	6.32	29.55	101	355	P	H
		5663	49.5	-28.35	77.85	40.58	32.12	6.35	29.55	101	355	P	H
		5719.2	49.89	-60.69	110.58	40.86	32.21	6.37	29.55	101	355	P	H
		5721.4	51.28	-62.71	113.99	42.25	32.21	6.37	29.55	101	355	P	H
	*	5785	106.81	-	-	97.69	32.29	6.39	29.56	101	355	P	H
	*	5785	99.35	-	-	90.23	32.29	6.39	29.56	101	355	A	H
		5851.4	50.9	-68.11	119.01	41.64	32.38	6.44	29.56	101	355	P	H
		5858.8	51.44	-58.29	109.73	42.14	32.41	6.45	29.56	101	355	P	H
		5913.2	51.65	-25.25	76.9	42.24	32.48	6.49	29.56	101	355	P	H
		5946.8	49.63	-18.57	68.2	40.14	32.53	6.52	29.56	101	355	P	H
													H
													H
802.11a													
CH 157													
5785MHz		5631.8	49.18	-19.02	68.2	40.33	32.07	6.33	29.55	207	13	P	V
		5693	49.04	-51	100.04	40.06	32.17	6.36	29.55	207	13	P	V
		5703.4	49.17	-56.98	106.15	40.17	32.19	6.36	29.55	207	13	P	V
		5720.4	50.52	-61.19	111.71	41.49	32.21	6.37	29.55	207	13	P	V
	*	5785	106.38	-	-	97.26	32.29	6.39	29.56	207	13	P	V
	*	5785	99.14	-	-	90.02	32.29	6.39	29.56	207	13	A	V
		5853	50.44	-64.92	115.36	41.18	32.38	6.44	29.56	207	13	P	V
		5856.6	51.39	-58.96	110.35	42.09	32.41	6.45	29.56	207	13	P	V
		5875	49.87	-55.33	105.2	40.54	32.43	6.46	29.56	207	13	P	V
		5927.8	50.16	-18.04	68.2	40.72	32.5	6.5	29.56	207	13	P	V
													V
													V



WIFI Ant. 1	Note	Frequency (MHz)	Level (dBμV/m)	Over Limit (dB)	Limit Line (dBμV/m)	Read Level (dBμV)	Antenna Factor (dB/m)	Path Loss (dB)	Preamp Factor (dB)	Ant Pos (cm)	Table Pos (deg)	Peak Avg. (P/A)	Pol. (H/V)	
802.11a CH 165 5825MHz	*	5825	106.61	-	-	97.39	32.36	6.42	29.56	100	355	P	H	
	*	5825	99.35	-	-	90.13	32.36	6.42	29.56	100	355	A	H	
		5852.8	52.82	-63	115.82	43.56	32.38	6.44	29.56	100	355	P	H	
		5857	56.88	-53.36	110.24	47.58	32.41	6.45	29.56	100	355	P	H	
		5883.2	52.05	-47.06	99.11	42.71	32.43	6.47	29.56	100	355	P	H	
		5947.4	49.95	-18.25	68.2	40.46	32.53	6.52	29.56	100	355	P	H	
														H
														H
	*	5825	105.8	-	-	96.58	32.36	6.42	29.56	213	13	P	V	
	*	5825	98.63	-	-	89.41	32.36	6.42	29.56	213	13	A	V	
		5852.6	60.58	-55.69	116.27	51.32	32.38	6.44	29.56	213	13	P	V	
		5858.4	59.33	-50.52	109.85	50.03	32.41	6.45	29.56	213	13	P	V	
		5886.4	51.05	-45.69	96.74	41.71	32.43	6.47	29.56	213	13	P	V	
		5946.2	48.82	-19.38	68.2	39.33	32.53	6.52	29.56	213	13	P	V	
														V
														V
														V
	Remark	1. No other spurious found. 2. All results are PASS against Peak and Average limit line.												



Band 4 5725~5850MHz
WIFI 802.11a (Harmonic @ 3m)

WIFI Ant. 1	Note	Frequency (MHz)	Level (dBμV/m)	Over Limit (dB)	Limit Line (dBμV/m)	Read Level (dBμV)	Antenna Factor (dB/m)	Path Loss (dB)	Preamp Factor (dB)	Ant Pos (cm)	Table Pos (deg)	Peak Avg. (P/A)	Pol. (H/V)	
802.11a CH 149 5745MHz		11490	47.27	-26.73	74	53.19	39.92	10.46	56.3	100	0	P	H	
		17235	49.21	-18.99	68.2	51.99	40.84	12.95	56.57	100	0	P	H	
													H	
													H	
			11490	47.46	-26.54	74	53.38	39.92	10.46	56.3	100	0	P	V
			17235	49.71	-18.49	68.2	52.49	40.84	12.95	56.57	100	0	P	V
														V
802.11a CH 157 5785MHz		11570	46.33	-27.67	74	52.37	39.76	10.5	56.3	100	0	P	H	
		17355	49.55	-18.65	68.2	52.02	41.26	13.08	56.81	100	0	P	H	
													H	
													H	
			11570	45.71	-28.29	74	51.75	39.76	10.5	56.3	100	0	P	V
			17355	49.16	-19.04	68.2	51.63	41.26	13.08	56.81	100	0	P	V
														V
802.11a CH 165 5825MHz		11650	46.54	-27.46	74	52.68	39.62	10.54	56.3	100	0	P	H	
		17475	50.15	-18.05	68.2	52.31	41.68	13.21	57.05	100	0	P	H	
													H	
													H	
			11650	47.01	-26.99	74	53.15	39.62	10.54	56.3	100	0	P	V
			17475	50.22	-17.98	68.2	52.38	41.68	13.21	57.05	100	0	P	V
														V
Remark	1. No other spurious found.													
	2. All results are PASS against Peak and Average limit line.													



Band 4 5725~5850MHz
WIFI 802.11ac VHT20 (Band Edge @ 3m)

WIFI Ant. 1	Note	Frequency (MHz)	Level (dBμV/m)	Over Limit (dB)	Limit Line (dBμV/m)	Read Level (dBμV)	Antenna Factor (dB/m)	Path Loss (dB)	Preamp Factor (dB)	Ant Pos (cm)	Table Pos (deg)	Peak Avg. (P/A)	Pol. (H/V)	
802.11ac VHT20 CH 149 5745MHz		5628.6	48.84	-19.36	68.2	39.99	32.07	6.33	29.55	101	355	P	H	
		5689	50.85	-46.24	97.09	41.87	32.17	6.36	29.55	101	355	P	H	
		5715.8	52.17	-57.46	109.63	43.16	32.19	6.37	29.55	101	355	P	H	
		5722.6	58.05	-58.68	116.73	49.02	32.21	6.37	29.55	101	355	P	H	
	*	5745	106.43	-	-	97.36	32.24	6.38	29.55	101	355	P	H	
	*	5745	99	-	-	89.93	32.24	6.38	29.55	101	355	A	H	
														H
														H
			5635.6	49.45	-18.75	68.2	40.58	32.09	6.33	29.55	206	14	P	V
			5687.4	50.15	-45.76	95.91	41.18	32.17	6.35	29.55	206	14	P	V
			5718.2	51.99	-58.31	110.3	42.96	32.21	6.37	29.55	206	14	P	V
			5724.6	59.27	-62.02	121.29	50.24	32.21	6.37	29.55	206	14	P	V
	*		5745	106.55	-	-	97.48	32.24	6.38	29.55	206	14	P	V
	*		5745	99.08	-	-	90.01	32.24	6.38	29.55	206	14	A	V
														V
													V	



WIFI Ant. 1	Note	Frequency (MHz)	Level (dBμV/m)	Over Limit (dB)	Limit Line (dBμV/m)	Read Level (dBμV)	Antenna Factor (dB/m)	Path Loss (dB)	Preamp Factor (dB)	Ant Pos (cm)	Table Pos (deg)	Peak Avg. (P/A)	Pol. (H/V)
		5624	49.43	-18.77	68.2	40.58	32.07	6.33	29.55	100	355	P	H
		5652.4	50.86	-19.12	69.98	41.95	32.12	6.34	29.55	100	355	P	H
		5713	50.49	-58.35	108.84	41.48	32.19	6.37	29.55	100	355	P	H
		5722.2	50.61	-65.21	115.82	41.58	32.21	6.37	29.55	100	355	P	H
	*	5785	106.47	-	-	97.35	32.29	6.39	29.56	100	355	P	H
	*	5785	99.14	-	-	90.02	32.29	6.39	29.56	100	355	A	H
		5854.4	50.13	-62.04	112.17	40.84	32.41	6.44	29.56	100	355	P	H
		5855.6	50.82	-59.81	110.63	41.53	32.41	6.44	29.56	100	355	P	H
		5875.6	50.4	-54.35	104.75	41.07	32.43	6.46	29.56	100	355	P	H
		5950	49.44	-18.76	68.2	39.95	32.53	6.52	29.56	100	355	P	H
802.11ac													H
VHT20													H
CH 157		5649.4	49.01	-19.19	68.2	40.13	32.09	6.34	29.55	206	14	P	V
5785MHz		5694	49.52	-51.26	100.78	40.54	32.17	6.36	29.55	206	14	P	V
		5705.4	50.04	-56.67	106.71	41.04	32.19	6.36	29.55	206	14	P	V
		5721.8	51.07	-63.83	114.9	42.04	32.21	6.37	29.55	206	14	P	V
	*	5785	105.98	-	-	96.86	32.29	6.39	29.56	206	14	P	V
	*	5785	98.77	-	-	89.65	32.29	6.39	29.56	206	14	A	V
		5854.2	50.02	-62.6	112.62	40.73	32.41	6.44	29.56	206	14	P	V
		5858	50.97	-58.99	109.96	41.67	32.41	6.45	29.56	206	14	P	V
		5913.8	49.68	-26.78	76.46	40.27	32.48	6.49	29.56	206	14	P	V
		5934.2	49.46	-18.74	68.2	40.01	32.5	6.51	29.56	206	14	P	V
													V
													V



WIFI Ant. 1	Note	Frequency (MHz)	Level (dBμV/m)	Over Limit (dB)	Limit Line (dBμV/m)	Read Level (dBμV)	Antenna Factor (dB/m)	Path Loss (dB)	Preamp Factor (dB)	Ant Pos (cm)	Table Pos (deg)	Peak Avg. (P/A)	Pol. (H/V)	
802.11ac VHT20 CH 165 5825MHz	*	5825	106.48	-	-	97.26	32.36	6.42	29.56	100	355	P	H	
	*	5825	99.43	-	-	90.21	32.36	6.42	29.56	100	355	A	H	
		5850.8	53.97	-66.41	120.38	44.71	32.38	6.44	29.56	100	355	P	H	
		5871.8	53.56	-52.53	106.09	44.23	32.43	6.46	29.56	100	355	P	H	
		5892.4	52.04	-40.25	92.29	42.67	32.46	6.47	29.56	100	355	P	H	
		5949.4	50.34	-17.86	68.2	40.85	32.53	6.52	29.56	100	355	P	H	
														H
														H
	*	5825	105.53	-	-	96.31	32.36	6.42	29.56	199	13	P	V	
	*	5825	98.28	-	-	89.06	32.36	6.42	29.56	199	13	A	V	
		5853.6	54.26	-59.73	113.99	44.97	32.41	6.44	29.56	199	13	P	V	
		5860.6	53.22	-56.01	109.23	43.92	32.41	6.45	29.56	199	13	P	V	
		5881.2	52.14	-48.45	100.59	42.81	32.43	6.46	29.56	199	13	P	V	
		5933.2	49.06	-19.14	68.2	39.61	32.5	6.51	29.56	199	13	P	V	
														V
													V	
Remark	1. No other spurious found. 2. All results are PASS against Peak and Average limit line.													



Band 4 5725~5850MHz
WIFI 802.11ac VHT20 (Harmonic @ 3m)

WIFI Ant. 1	Note	Frequency (MHz)	Level (dBμV/m)	Over Limit (dB)	Limit Line (dBμV/m)	Read Level (dBμV)	Antenna Factor (dB/m)	Path Loss (dB)	Preamp Factor (dB)	Ant Pos (cm)	Table Pos (deg)	Peak Avg. (P/A)	Pol. (H/V)	
802.11ac VHT20 CH 149 5745MHz		11490	47.43	-26.57	74	53.35	39.92	10.46	56.3	100	0	P	H	
		17235	49	-19.2	68.2	51.78	40.84	12.95	56.57	100	0	P	H	
													H	
													H	
			11490	47.24	-26.76	74	53.16	39.92	10.46	56.3	100	0	P	V
			17235	48.74	-19.46	68.2	51.52	40.84	12.95	56.57	100	0	P	V
														V
802.11ac VHT20 CH 157 5785MHz		11570	45.93	-28.07	74	51.97	39.76	10.5	56.3	100	0	P	H	
		17355	48.6	-19.6	68.2	51.07	41.26	13.08	56.81	100	0	P	H	
													H	
													H	
			11570	46.44	-27.56	74	52.48	39.76	10.5	56.3	100	0	P	V
			17355	48.73	-19.47	68.2	51.2	41.26	13.08	56.81	100	0	P	V
														V
802.11ac VHT20 CH 165 5825MHz		11650	46	-28	74	52.14	39.62	10.54	56.3	100	0	P	H	
		17475	49.9	-18.3	68.2	52.06	41.68	13.21	57.05	100	0	P	H	
													H	
													H	
			11650	46.53	-27.47	74	52.67	39.62	10.54	56.3	100	0	P	V
			17475	49.47	-18.73	68.2	51.63	41.68	13.21	57.05	100	0	P	V
														V
Remark	1. No other spurious found.													
	2. All results are PASS against Peak and Average limit line.													



Band 4 5725~5850MHz
WIFI 802.11ac VHT40 (Band Edge @ 3m)

WIFI Ant. 1	Note	Frequency (MHz)	Level (dBμV/m)	Over Limit (dB)	Limit Line (dBμV/m)	Read Level (dBμV)	Antenna Factor (dB/m)	Path Loss (dB)	Preamp Factor (dB)	Ant Pos (cm)	Table Pos (deg)	Peak Avg. (P/A)	Pol. (H/V)
		5633	49.88	-18.32	68.2	41.01	32.09	6.33	29.55	109	354	P	H
		5698.8	53.92	-50.4	104.32	44.94	32.17	6.36	29.55	109	354	P	H
		5719.4	60.61	-50.02	110.63	51.58	32.21	6.37	29.55	109	354	P	H
		5721.8	63.23	-51.67	114.9	54.2	32.21	6.37	29.55	109	354	P	H
	*	5755	104.01	-	-	94.93	32.26	6.38	29.56	109	354	P	H
	*	5755	97.18	-	-	88.1	32.26	6.38	29.56	109	354	A	H
		5850.4	52.06	-69.23	121.29	42.8	32.38	6.44	29.56	109	354	P	H
		5870.4	51.03	-55.46	106.49	41.72	32.41	6.46	29.56	109	354	P	H
		5875.4	50.49	-54.41	104.9	41.16	32.43	6.46	29.56	109	354	P	H
		5940.6	49.54	-18.66	68.2	40.06	32.53	6.51	29.56	109	354	P	H
													H
													H
802.11ac													
VHT40													
CH 151		5645	49.39	-18.81	68.2	40.51	32.09	6.34	29.55	271	18	P	V
5755MHz		5697.6	54.29	-49.14	103.43	45.31	32.17	6.36	29.55	271	18	P	V
		5719	59.29	-51.23	110.52	50.26	32.21	6.37	29.55	271	18	P	V
		5725	61.15	-61.05	122.2	52.12	32.21	6.37	29.55	271	18	P	V
	*	5755	102.93	-	-	93.85	32.26	6.38	29.56	271	18	P	V
	*	5755	96.09	-	-	87.01	32.26	6.38	29.56	271	18	A	V
		5850.6	52.53	-68.3	120.83	43.27	32.38	6.44	29.56	271	18	P	V
		5860	50.8	-58.6	109.4	41.5	32.41	6.45	29.56	271	18	P	V
		5907	51.24	-30.24	81.48	41.83	32.48	6.49	29.56	271	18	P	V
		5931.8	49.87	-18.33	68.2	40.42	32.5	6.51	29.56	271	18	P	V
													V
													V



WIFI Ant. 1	Note	Frequency (MHz)	Level (dBμV/m)	Over Limit (dB)	Limit Line (dBμV/m)	Read Level (dBμV)	Antenna Factor (dB/m)	Path Loss (dB)	Preamp Factor (dB)	Ant Pos (cm)	Table Pos (deg)	Peak Avg. (P/A)	Pol. (H/V)
		5611.8	48.55	-19.65	68.2	39.74	32.04	6.32	29.55	112	355	P	H
		5683.2	48.81	-43.99	92.8	39.87	32.14	6.35	29.55	112	355	P	H
		5716.8	49.8	-60.11	109.91	40.79	32.19	6.37	29.55	112	355	P	H
		5722.8	50.88	-66.3	117.18	41.85	32.21	6.37	29.55	112	355	P	H
	*	5795	103.47	-	-	94.32	32.31	6.4	29.56	112	355	P	H
	*	5795	96.95	-	-	87.8	32.31	6.4	29.56	112	355	A	H
		5853.2	55.69	-59.21	114.9	46.43	32.38	6.44	29.56	112	355	P	H
		5864.8	53.21	-54.84	108.05	43.91	32.41	6.45	29.56	112	355	P	H
		5881.6	51.56	-48.74	100.3	42.22	32.43	6.47	29.56	112	355	P	H
		5934.6	49.58	-18.62	68.2	40.13	32.5	6.51	29.56	112	355	P	H
802.11ac													H
VHT40													H
CH 159		5642.4	49.86	-18.34	68.2	40.98	32.09	6.34	29.55	284	17	P	V
5795MHz		5669.4	49.52	-33.07	82.59	40.58	32.14	6.35	29.55	284	17	P	V
		5712	49.46	-59.1	108.56	40.46	32.19	6.36	29.55	284	17	P	V
		5722.4	50.33	-65.94	116.27	41.3	32.21	6.37	29.55	284	17	P	V
	*	5795	102.37	-	-	93.22	32.31	6.4	29.56	284	17	P	V
	*	5795	95.63	-	-	86.48	32.31	6.4	29.56	284	17	A	V
		5850.8	51.26	-69.12	120.38	42	32.38	6.44	29.56	284	17	P	V
		5865.6	52.77	-55.06	107.83	43.47	32.41	6.45	29.56	284	17	P	V
		5883.6	51.59	-47.22	98.81	42.25	32.43	6.47	29.56	284	17	P	V
		5925.4	50.39	-17.81	68.2	40.95	32.5	6.5	29.56	284	17	P	V
													V
													V
Remark	1. No other spurious found. 2. All results are PASS against Peak and Average limit line.												



**Band 4 5725~5850MHz
WIFI 802.11ac VHT40 (Harmonic @ 3m)**

WIFI Ant. 1	Note	Frequency (MHz)	Level (dBμV/m)	Over Limit (dB)	Limit Line (dBμV/m)	Read Level (dBμV)	Antenna Factor (dB/m)	Path Loss (dB)	Preamp Factor (dB)	Ant Pos (cm)	Table Pos (deg)	Peak Avg. (P/A)	Pol. (H/V)	
802.11ac VHT40 CH 151 5755MHz		11510	47.09	-26.91	74	53.02	39.9	10.47	56.3	100	0	P	H	
		17265	48.69	-19.51	68.2	51.38	40.96	12.98	56.63	100	0	P	H	
													H	
													H	
			11510	46.58	-27.42	74	52.51	39.9	10.47	56.3	100	0	P	V
			17265	48.42	-19.78	68.2	51.11	40.96	12.98	56.63	100	0	P	V
														V
802.11ac VHT40 CH 159 5795MHz		11590	47.57	-26.43	74	53.63	39.73	10.51	56.3	100	0	P	H	
		17385	50.14	-18.06	68.2	52.52	41.38	13.11	56.87	100	0	P	H	
													H	
													H	
			11590	47.05	-26.95	74	53.11	39.73	10.51	56.3	100	0	P	V
			17385	50.23	-17.97	68.2	52.61	41.38	13.11	56.87	100	0	P	V
														V
Remark	1. No other spurious found.													
	2. All results are PASS against Peak and Average limit line.													



Band 4 5725~5850MHz
WIFI 802.11ac VHT80 (Band Edge @ 3m)

WIFI Ant. 1	Note	Frequency (MHz)	Level (dBμV/m)	Over Limit (dB)	Limit Line (dBμV/m)	Read Level (dBμV)	Antenna Factor (dB/m)	Path Loss (dB)	Preamp Factor (dB)	Ant Pos (cm)	Table Pos (deg)	Peak Avg. (P/A)	Pol. (H/V)
		5634.2	50.14	-18.06	68.2	41.27	32.09	6.33	29.55	108	355	P	H
		5692.6	54.31	-45.43	99.74	45.33	32.17	6.36	29.55	108	355	P	H
		5717	59.36	-50.6	109.96	50.35	32.19	6.37	29.55	108	355	P	H
		5724.6	59.19	-62.1	121.29	50.16	32.21	6.37	29.55	108	355	P	H
	*	5775	101.18	-	-	92.06	32.29	6.39	29.56	108	355	P	H
	*	5775	95.07	-	-	85.95	32.29	6.39	29.56	108	355	A	H
		5851	61.25	-58.67	119.92	51.99	32.38	6.44	29.56	108	355	P	H
		5866.2	60.26	-47.4	107.66	50.96	32.41	6.45	29.56	108	355	P	H
		5877.2	53.71	-49.86	103.57	44.38	32.43	6.46	29.56	108	355	P	H
		5928.4	50.17	-18.03	68.2	40.73	32.5	6.5	29.56	108	355	P	H
802.11ac													H
VHT80													H
CH 155		5620	49.37	-18.83	68.2	40.52	32.07	6.33	29.55	285	19	P	V
5775MHz		5699.6	53.38	-51.53	104.91	44.4	32.17	6.36	29.55	285	19	P	V
		5715	59.54	-49.86	109.4	50.53	32.19	6.37	29.55	285	19	P	V
		5721.6	57.72	-56.73	114.45	48.69	32.21	6.37	29.55	285	19	P	V
	*	5775	99.81	-	-	90.69	32.29	6.39	29.56	285	19	P	V
	*	5775	93.71	-	-	84.59	32.29	6.39	29.56	285	19	A	V
		5854	57.97	-55.11	113.08	48.68	32.41	6.44	29.56	285	19	P	V
		5871.2	57.35	-48.91	106.26	48.02	32.43	6.46	29.56	285	19	P	V
		5875	53.99	-51.21	105.2	44.66	32.43	6.46	29.56	285	19	P	V
		5941.2	48.75	-19.45	68.2	39.27	32.53	6.51	29.56	285	19	P	V
													V
													V
Remark	1. No other spurious found. 2. All results are PASS against Peak and Average limit line.												



Band 4 5725~5850MHz

WIFI 802.11ac VHT80 (Harmonic @ 3m)

WIFI Ant. 1	Note	Frequency (MHz)	Level (dBμV/m)	Over Limit (dB)	Limit Line (dBμV/m)	Read Level (dBμV)	Antenna Factor (dB/m)	Path Loss (dB)	Preamp Factor (dB)	Ant Pos (cm)	Table Pos (deg)	Peak Avg. (P/A)	Pol. (H/V)	
802.11ac VHT80 CH 155 5775MHz		11550	46.98	-27.02	74	52.99	39.8	10.49	56.3	100	0	P	H	
		17325	49.61	-18.59	68.2	52.18	41.14	13.04	56.75	100	0	P	H	
													H	
													H	
			11550	46.58	-27.42	74	52.59	39.8	10.49	56.3	100	0	P	V
			17325	49.11	-19.09	68.2	51.68	41.14	13.04	56.75	100	0	P	V
														V
Remark	1. No other spurious found. 2. All results are PASS against Peak and Average limit line.													



Band 4 - 5725~5850MHz
WIFI 802.11a (Band Edge @ 3m)

WIFI	Note	Frequency	Level	Over	Limit	Read	Antenna	Path	Preamp	Ant	Table	Peak	Pol.	
Ant.				Limit	Line	Level	Factor	Loss	Factor	Pos	Pos	Avg.		
2		(MHz)	(dBμV/m)	(dB)	(dBμV/m)	(dBμV)	(dB/m)	(dB)	(dB)	(cm)	(deg)	(P/A)	(H/V)	
802.11a CH 149 5745MHz		5609.2	49.84	-18.36	68.2	41.03	32.04	6.32	29.55	108	21	P	H	
		5696.6	50.85	-51.84	102.69	41.87	32.17	6.36	29.55	108	21	P	H	
		5717.4	57.76	-52.31	110.07	48.75	32.19	6.37	29.55	108	21	P	H	
		5722.4	58.92	-57.35	116.27	49.89	32.21	6.37	29.55	108	21	P	H	
	*	5745	107.14	-	-	98.07	32.24	6.38	29.55	108	21	P	H	
	*	5745	99.98	-	-	90.91	32.24	6.38	29.55	108	21	A	H	
														H
														H
			5620.2	48.82	-19.38	68.2	39.97	32.07	6.33	29.55	348	180	P	V
			5694.8	49.09	-52.28	101.37	40.11	32.17	6.36	29.55	348	180	P	V
			5719.8	57.02	-53.72	110.74	47.99	32.21	6.37	29.55	348	180	P	V
			5722.8	55.84	-61.34	117.18	46.81	32.21	6.37	29.55	348	180	P	V
	*		5745	102.4	-	-	93.33	32.24	6.38	29.55	348	180	P	V
	*		5745	95.14	-	-	86.07	32.24	6.38	29.55	348	180	A	V
														V
													V	



WIFI Ant. 2	Note	Frequency (MHz)	Level (dBµV/m)	Over Limit (dB)	Limit Line (dBµV/m)	Read Level (dBµV)	Antenna Factor (dB/m)	Path Loss (dB)	Preamp Factor (dB)	Ant Pos (cm)	Table Pos (deg)	Peak Avg. (P/A)	Pol. (H/V)
		5631	48.7	-19.5	68.2	39.85	32.07	6.33	29.55	118	22	P	H
		5677	48.87	-39.35	88.22	39.93	32.14	6.35	29.55	118	22	P	H
		5718	49.7	-60.54	110.24	40.67	32.21	6.37	29.55	118	22	P	H
		5723.4	50	-68.55	118.55	40.97	32.21	6.37	29.55	118	22	P	H
	*	5785	106.93	-	-	97.81	32.29	6.39	29.56	118	22	P	H
	*	5785	99.8	-	-	90.68	32.29	6.39	29.56	118	22	A	H
		5854.4	51.81	-60.36	112.17	42.52	32.41	6.44	29.56	118	22	P	H
		5856	51.43	-59.09	110.52	42.14	32.41	6.44	29.56	118	22	P	H
		5902.4	51.07	-33.82	84.89	41.69	32.46	6.48	29.56	118	22	P	H
		5928.6	48.87	-19.33	68.2	39.43	32.5	6.5	29.56	118	22	P	H
													H
													H
802.11a													
CH 157													
5785MHz		5621	48.94	-19.26	68.2	40.09	32.07	6.33	29.55	259	209	P	V
		5692	49.55	-49.75	99.3	40.57	32.17	6.36	29.55	259	209	P	V
		5717.4	49.38	-60.69	110.07	40.37	32.19	6.37	29.55	259	209	P	V
		5721	49.7	-63.38	113.08	40.67	32.21	6.37	29.55	259	209	P	V
	*	5785	104.04	-	-	94.92	32.29	6.39	29.56	259	209	P	V
	*	5785	96.6	-	-	87.48	32.29	6.39	29.56	259	209	A	V
		5850.6	49.08	-71.75	120.83	39.82	32.38	6.44	29.56	259	209	P	V
		5859	49.29	-60.39	109.68	39.99	32.41	6.45	29.56	259	209	P	V
		5924.8	49.02	-19.33	68.35	39.58	32.5	6.5	29.56	259	209	P	V
		5927.2	48.98	-19.22	68.2	39.54	32.5	6.5	29.56	259	209	P	V
													V
													V



WiFi Ant. 2	Note	Frequency (MHz)	Level (dBµV/m)	Over Limit (dB)	Limit Line (dBµV/m)	Read Level (dBµV)	Antenna Factor (dB/m)	Path Loss (dB)	Preamp Factor (dB)	Ant Pos (cm)	Table Pos (deg)	Peak Avg. (P/A)	Pol. (H/V)	
802.11a CH 165 5825MHz	*	5825	106.97	-	-	97.75	32.36	6.42	29.56	101	22	P	H	
	*	5825	99.88	-	-	90.66	32.36	6.42	29.56	101	22	A	H	
		5850.6	59.74	-61.09	120.83	50.48	32.38	6.44	29.56	101	22	P	H	
		5870	52.8	-53.8	106.6	43.49	32.41	6.46	29.56	101	22	P	H	
		5880	52.17	-49.32	101.49	42.84	32.43	6.46	29.56	101	22	P	H	
		5939.2	49.64	-18.56	68.2	40.16	32.53	6.51	29.56	101	22	P	H	
														H
														H
	*	5825	102.71	-	-	93.49	32.36	6.42	29.56	255	199	P	V	
	*	5825	95.61	-	-	86.39	32.36	6.42	29.56	255	199	A	V	
		5850	57.8	-64.4	122.2	48.54	32.38	6.44	29.56	255	199	P	V	
		5857	51.46	-58.78	110.24	42.16	32.41	6.45	29.56	255	199	P	V	
		5889	51.32	-43.49	94.81	41.95	32.46	6.47	29.56	255	199	P	V	
		5943.6	49.91	-18.29	68.2	40.43	32.53	6.51	29.56	255	199	P	V	
														V
														V
													V	
Remark	3. No other spurious found. 4. All results are PASS against Peak and Average limit line.													



Band 4 5725~5850MHz
WIFI 802.11a (Harmonic @ 3m)

WIFI Ant. 2	Note	Frequency (MHz)	Level (dBμV/m)	Over Limit (dB)	Limit Line (dBμV/m)	Read Level (dBμV)	Antenna Factor (dB/m)	Path Loss (dB)	Preamp Factor (dB)	Ant Pos (cm)	Table Pos (deg)	Peak Avg. (P/A)	Pol. (H/V)	
802.11a CH 149 5745MHz		11490	45.9	-28.1	74	51.82	39.92	10.46	56.3	100	0	P	H	
		17235	47.9	-20.3	68.2	50.68	40.84	12.95	56.57	100	0	P	H	
													H	
													H	
			11490	46.66	-27.34	74	52.58	39.92	10.46	56.3	100	0	P	V
			17235	47.88	-20.32	68.2	50.66	40.84	12.95	56.57	100	0	P	V
														V
														V
802.11a CH 157 5785MHz		11570	46.58	-27.42	74	52.62	39.76	10.5	56.3	100	0	P	H	
		17355	48.49	-19.71	68.2	50.96	41.26	13.08	56.81	100	0	P	H	
													H	
													H	
			11570	46.25	-27.75	74	52.29	39.76	10.5	56.3	100	0	P	V
			17355	49.52	-18.68	68.2	51.99	41.26	13.08	56.81	100	0	P	V
														V
														V
802.11a CH 165 5825MHz		11650	48.33	-25.67	74	54.47	39.62	10.54	56.3	100	0	P	H	
		17475	50.51	-17.69	68.2	52.67	41.68	13.21	57.05	100	0	P	H	
													H	
													H	
			11650	46.1	-27.9	74	52.24	39.62	10.54	56.3	100	0	P	V
			17475	49.26	-18.94	68.2	51.42	41.68	13.21	57.05	100	0	P	V
														V
														V
Remark	3. No other spurious found. 4. All results are PASS against Peak and Average limit line.													



Band 4 5725~5850MHz
WIFI 802.11ac VHT20 (Band Edge @ 3m)

WIFI Ant. 2	Note	Frequency (MHz)	Level (dBμV/m)	Over Limit (dB)	Limit Line (dBμV/m)	Read Level (dBμV)	Antenna Factor (dB/m)	Path Loss (dB)	Preamp Factor (dB)	Ant Pos (cm)	Table Pos (deg)	Peak Avg. (P/A)	Pol. (H/V)	
802.11ac VHT20 CH 149 5745MHz		5611.8	50.05	-18.15	68.2	41.24	32.04	6.32	29.55	109	23	P	H	
		5698.6	51.4	-52.77	104.17	42.42	32.17	6.36	29.55	109	23	P	H	
		5710	54.38	-53.62	108	45.38	32.19	6.36	29.55	109	23	P	H	
		5723.8	57.96	-61.5	119.46	48.93	32.21	6.37	29.55	109	23	P	H	
	*	5745	107.05	-	-	97.98	32.24	6.38	29.55	109	23	P	H	
	*	5745	99.7	-	-	90.63	32.24	6.38	29.55	109	23	A	H	
														H
														H
			5628	48.33	-19.87	68.2	39.48	32.07	6.33	29.55	367	175	P	V
			5673.4	48.82	-36.74	85.56	39.88	32.14	6.35	29.55	367	175	P	V
			5716	51.48	-58.2	109.68	42.47	32.19	6.37	29.55	367	175	P	V
			5724.8	54.15	-67.59	121.74	45.12	32.21	6.37	29.55	367	175	P	V
	*		5745	101.7	-	-	92.63	32.24	6.38	29.55	367	175	P	V
	*		5745	94.41	-	-	85.34	32.24	6.38	29.55	367	175	A	V
														V
													V	



WIFI Ant. 2	Note	Frequency (MHz)	Level (dBµV/m)	Over Limit (dB)	Limit Line (dBµV/m)	Read Level (dBµV)	Antenna Factor (dB/m)	Path Loss (dB)	Preamp Factor (dB)	Ant Pos (cm)	Table Pos (deg)	Peak Avg. (P/A)	Pol. (H/V)
		5632.6	48.92	-19.28	68.2	40.05	32.09	6.33	29.55	100	22	P	H
		5652.4	50.8	-19.18	69.98	41.89	32.12	6.34	29.55	100	22	P	H
		5715	51	-58.4	109.4	41.99	32.19	6.37	29.55	100	22	P	H
		5721	50.91	-62.17	113.08	41.88	32.21	6.37	29.55	100	22	P	H
	*	5785	106.86	-	-	97.74	32.29	6.39	29.56	100	22	P	H
	*	5785	99.61	-	-	90.49	32.29	6.39	29.56	100	22	A	H
		5851.6	52.42	-66.13	118.55	43.16	32.38	6.44	29.56	100	22	P	H
		5873.4	51.65	-54	105.65	42.32	32.43	6.46	29.56	100	22	P	H
		5883.6	51.09	-47.72	98.81	41.75	32.43	6.47	29.56	100	22	P	H
		5944	49.86	-18.34	68.2	40.37	32.53	6.52	29.56	100	22	P	H
802.11ac													H
VHT20													H
CH 157		5614.6	48.52	-19.68	68.2	39.7	32.04	6.33	29.55	272	200	P	V
5785MHz		5658.2	49.08	-25.21	74.29	40.17	32.12	6.34	29.55	272	200	P	V
		5704.6	47.8	-58.69	106.49	38.8	32.19	6.36	29.55	272	200	P	V
		5724.6	48.54	-72.75	121.29	39.51	32.21	6.37	29.55	272	200	P	V
	*	5785	103.04	-	-	93.92	32.29	6.39	29.56	272	200	P	V
	*	5785	95.75	-	-	86.63	32.29	6.39	29.56	272	200	A	V
		5852	48.91	-68.73	117.64	39.65	32.38	6.44	29.56	272	200	P	V
		5856	50	-60.52	110.52	40.71	32.41	6.44	29.56	272	200	P	V
		5885.6	49.4	-47.93	97.33	40.06	32.43	6.47	29.56	272	200	P	V
		5926.6	48.61	-19.59	68.2	39.17	32.5	6.5	29.56	272	200	P	V
													V
													V



WIFI Ant. 2	Note	Frequency (MHz)	Level (dBμV/m)	Over Limit (dB)	Limit Line (dBμV/m)	Read Level (dBμV)	Antenna Factor (dB/m)	Path Loss (dB)	Preamp Factor (dB)	Ant Pos (cm)	Table Pos (deg)	Peak Avg. (P/A)	Pol. (H/V)	
802.11ac VHT20 CH 165 5825MHz	*	5825	107.1	-	-	97.88	32.36	6.42	29.56	101	22	P	H	
	*	5825	99.86	-	-	90.64	32.36	6.42	29.56	101	22	A	H	
		5850	56.2	-66	122.2	46.94	32.38	6.44	29.56	101	22	P	H	
		5860.8	54.35	-54.82	109.17	45.05	32.41	6.45	29.56	101	22	P	H	
		5891.2	52.67	-40.51	93.18	43.3	32.46	6.47	29.56	101	22	P	H	
		5939.2	50.29	-17.91	68.2	40.81	32.53	6.51	29.56	101	22	P	H	
														H
														H
	*	5825	102.64	-	-	93.42	32.36	6.42	29.56	254	201	P	V	
	*	5825	95.1	-	-	85.88	32.36	6.42	29.56	254	201	A	V	
		5853.6	51.47	-62.52	113.99	42.18	32.41	6.44	29.56	254	201	P	V	
		5867.8	49.35	-57.86	107.21	40.05	32.41	6.45	29.56	254	201	P	V	
		5881.8	50.56	-49.59	100.15	41.22	32.43	6.47	29.56	254	201	P	V	
		5937.4	49.7	-18.5	68.2	40.25	32.5	6.51	29.56	254	201	P	V	
														V
													V	
Remark	3. No other spurious found. 4. All results are PASS against Peak and Average limit line.													



Band 4 5725~5850MHz
WIFI 802.11ac VHT20 (Harmonic @ 3m)

WIFI Ant. 2	Note	Frequency (MHz)	Level (dBμV/m)	Over Limit (dB)	Limit Line (dBμV/m)	Read Level (dBμV)	Antenna Factor (dB/m)	Path Loss (dB)	Preamp Factor (dB)	Ant Pos (cm)	Table Pos (deg)	Peak Avg. (P/A)	Pol. (H/V)	
802.11ac VHT20 CH 149 5745MHz		11490	46.38	-27.62	74	52.3	39.92	10.46	56.3	100	0	P	H	
		17235	48.71	-19.49	68.2	51.49	40.84	12.95	56.57	100	0	P	H	
													H	
													H	
			11490	46.48	-27.52	74	52.4	39.92	10.46	56.3	100	0	P	V
			17235	48.75	-19.45	68.2	51.53	40.84	12.95	56.57	100	0	P	V
														V
802.11ac VHT20 CH 157 5785MHz		11570	46.13	-27.87	74	52.17	39.76	10.5	56.3	100	0	P	H	
		17355	49.86	-18.34	68.2	52.33	41.26	13.08	56.81	100	0	P	H	
													H	
													H	
			11570	45.7	-28.3	74	51.74	39.76	10.5	56.3	100	0	P	V
			17355	49.16	-19.04	68.2	51.63	41.26	13.08	56.81	100	0	P	V
														V
802.11ac VHT20 CH 165 5825MHz		11650	47.27	-26.73	74	53.41	39.62	10.54	56.3	100	0	P	H	
		17475	49.67	-18.53	68.2	51.83	41.68	13.21	57.05	100	0	P	H	
													H	
													H	
			11650	46.37	-27.63	74	52.51	39.62	10.54	56.3	100	0	P	V
			17475	48.96	-19.24	68.2	51.12	41.68	13.21	57.05	100	0	P	V
														V
Remark	3. No other spurious found.													
	4. All results are PASS against Peak and Average limit line.													



Band 4 5725~5850MHz
WIFI 802.11ac VHT40 (Band Edge @ 3m)

WIFI Ant. 2	Note	Frequency (MHz)	Level (dBμV/m)	Over Limit (dB)	Limit Line (dBμV/m)	Read Level (dBμV)	Antenna Factor (dB/m)	Path Loss (dB)	Preamp Factor (dB)	Ant Pos (cm)	Table Pos (deg)	Peak Avg. (P/A)	Pol. (H/V)
		5648	48.99	-19.21	68.2	40.11	32.09	6.34	29.55	107	23	P	H
		5693.6	50.23	-50.25	100.48	41.25	32.17	6.36	29.55	107	23	P	H
		5716	59.21	-50.47	109.68	50.2	32.19	6.37	29.55	107	23	P	H
		5724	59.81	-60.11	119.92	50.78	32.21	6.37	29.55	107	23	P	H
	*	5755	103.14	-	-	94.06	32.26	6.38	29.56	107	23	P	H
	*	5755	96.27	-	-	87.19	32.26	6.38	29.56	107	23	A	H
		5853.4	50.25	-64.2	114.45	40.99	32.38	6.44	29.56	107	23	P	H
		5865	50.21	-57.79	108	40.91	32.41	6.45	29.56	107	23	P	H
		5902.2	50.46	-34.57	85.03	41.08	32.46	6.48	29.56	107	23	P	H
		5928	49.29	-18.91	68.2	39.85	32.5	6.5	29.56	107	23	P	H
													H
													H
802.11ac													
VHT40													
CH 151		5635	49.13	-19.07	68.2	40.26	32.09	6.33	29.55	272	191	P	V
5755MHz		5693.2	49.97	-50.22	100.19	40.99	32.17	6.36	29.55	272	191	P	V
		5710.4	50.9	-57.21	108.11	41.9	32.19	6.36	29.55	272	191	P	V
		5723	52.12	-65.52	117.64	43.09	32.21	6.37	29.55	272	191	P	V
	*	5755	98.19	-	-	89.11	32.26	6.38	29.56	272	191	P	V
	*	5755	91.42	-	-	82.34	32.26	6.38	29.56	272	191	A	V
		5850.4	47.77	-73.52	121.29	38.51	32.38	6.44	29.56	272	191	P	V
		5856	49.35	-61.17	110.52	40.06	32.41	6.44	29.56	272	191	P	V
		5911.6	48.99	-29.1	78.09	39.58	32.48	6.49	29.56	272	191	P	V
		5948.8	48.25	-19.95	68.2	38.76	32.53	6.52	29.56	272	191	P	V
													V
													V



WIFI Ant. 2	Note	Frequency (MHz)	Level (dBμV/m)	Over Limit (dB)	Limit Line (dBμV/m)	Read Level (dBμV)	Antenna Factor (dB/m)	Path Loss (dB)	Preamp Factor (dB)	Ant Pos (cm)	Table Pos (deg)	Peak Avg. (P/A)	Pol. (H/V)
		5602	50.23	-17.97	68.2	41.42	32.04	6.32	29.55	104	23	P	H
		5678.2	50.19	-38.92	89.11	41.25	32.14	6.35	29.55	104	23	P	H
		5709	50.43	-57.29	107.72	41.43	32.19	6.36	29.55	104	23	P	H
		5722.6	50.38	-66.35	116.73	41.35	32.21	6.37	29.55	104	23	P	H
	*	5795	103.04	-	-	93.89	32.31	6.4	29.56	104	23	P	H
	*	5795	96.38	-	-	87.23	32.31	6.4	29.56	104	23	A	H
		5853	53.52	-61.84	115.36	44.26	32.38	6.44	29.56	104	23	P	H
		5871.4	52.65	-53.56	106.21	43.32	32.43	6.46	29.56	104	23	P	H
		5880.2	52.69	-48.65	101.34	43.36	32.43	6.46	29.56	104	23	P	H
		5933.8	49.85	-18.35	68.2	40.4	32.5	6.51	29.56	104	23	P	H
802.11ac													H
VHT40													H
CH 159		5602.8	49.12	-19.08	68.2	40.31	32.04	6.32	29.55	243	198	P	V
5795MHz		5692.4	48.94	-50.66	99.6	39.96	32.17	6.36	29.55	243	198	P	V
		5708.2	49.03	-58.47	107.5	40.03	32.19	6.36	29.55	243	198	P	V
		5723.2	47.56	-70.54	118.1	38.53	32.21	6.37	29.55	243	198	P	V
	*	5795	98.62	-	-	89.47	32.31	6.4	29.56	243	198	P	V
	*	5795	91.86	-	-	82.71	32.31	6.4	29.56	243	198	A	V
		5850	48.61	-73.59	122.2	39.35	32.38	6.44	29.56	243	198	P	V
		5871.6	50.86	-55.29	106.15	41.53	32.43	6.46	29.56	243	198	P	V
		5890	49.8	-44.27	94.07	40.43	32.46	6.47	29.56	243	198	P	V
		5930.2	49.03	-19.17	68.2	39.59	32.5	6.5	29.56	243	198	P	V
													V
													V
Remark	3. No other spurious found. 4. All results are PASS against Peak and Average limit line.												



Band 4 5725~5850MHz
WIFI 802.11ac VHT40 (Harmonic @ 3m)

WIFI Ant. 2	Note	Frequency (MHz)	Level (dBµV/m)	Over Limit (dB)	Limit Line (dBµV/m)	Read Level (dBµV)	Antenna Factor (dB/m)	Path Loss (dB)	Preamp Factor (dB)	Ant Pos (cm)	Table Pos (deg)	Peak Avg. (P/A)	Pol. (H/V)	
802.11ac VHT40 CH 151 5755MHz		11510	46.26	-27.74	74	52.19	39.9	10.47	56.3	100	0	P	H	
		17265	48.65	-19.55	68.2	51.34	40.96	12.98	56.63	100	0	P	H	
													H	
													H	
			11510	47.21	-26.79	74	53.14	39.9	10.47	56.3	100	0	P	V
			17265	48.35	-19.85	68.2	51.04	40.96	12.98	56.63	100	0	P	V
														V
802.11ac VHT40 CH 159 5795MHz		11590	47.01	-26.99	74	53.07	39.73	10.51	56.3	100	0	P	H	
		17385	50.13	-18.07	68.2	52.51	41.38	13.11	56.87	100	0	P	H	
													H	
													H	
			11590	45.85	-28.15	74	51.91	39.73	10.51	56.3	100	0	P	V
			17385	49.21	-18.99	68.2	51.59	41.38	13.11	56.87	100	0	P	V
														V
Remark	3. No other spurious found.													
	4. All results are PASS against Peak and Average limit line.													



Band 4 5725~5850MHz
WIFI 802.11ac VHT80 (Band Edge @ 3m)

WIFI Ant. 2	Note	Frequency (MHz)	Level (dBμV/m)	Over Limit (dB)	Limit Line (dBμV/m)	Read Level (dBμV)	Antenna Factor (dB/m)	Path Loss (dB)	Preamp Factor (dB)	Ant Pos (cm)	Table Pos (deg)	Peak Avg. (P/A)	Pol. (H/V)	
		5644.4	51.34	-16.86	68.2	42.46	32.09	6.34	29.55	101	22	P	H	
		5694.8	55.99	-45.38	101.37	47.01	32.17	6.36	29.55	101	22	P	H	
		5717.2	60.35	-49.67	110.02	51.34	32.19	6.37	29.55	101	22	P	H	
		5722.8	60.35	-56.83	117.18	51.32	32.21	6.37	29.55	101	22	P	H	
	*	5775	101.15	-	-	92.03	32.29	6.39	29.56	101	22	P	H	
	*	5775	94.93	-	-	85.81	32.29	6.39	29.56	101	22	A	H	
		5854	64.4	-48.68	113.08	55.11	32.41	6.44	29.56	101	22	P	H	
		5866	63.84	-43.88	107.72	54.54	32.41	6.45	29.56	101	22	P	H	
		5876.8	57.56	-46.3	103.86	48.23	32.43	6.46	29.56	101	22	P	H	
		5936.4	51.18	-17.02	68.2	41.73	32.5	6.51	29.56	101	22	P	H	
802.11ac VHT80 CH 155 5775MHz													H	
													H	
			5635.2	48.67	-19.53	68.2	39.8	32.09	6.33	29.55	268	200	P	V
			5697	53.33	-49.66	102.99	44.35	32.17	6.36	29.55	268	200	P	V
			5717.2	54.96	-55.06	110.02	45.95	32.19	6.37	29.55	268	200	P	V
			5724.4	54.47	-66.36	120.83	45.44	32.21	6.37	29.55	268	200	P	V
		*	5775	97.03	-	-	87.91	32.29	6.39	29.56	268	200	P	V
		*	5775	90.82	-	-	81.7	32.29	6.39	29.56	268	200	A	V
			5855	55.59	-55.21	110.8	46.3	32.41	6.44	29.56	268	200	P	V
			5860.8	56.08	-53.09	109.17	46.78	32.41	6.45	29.56	268	200	P	V
			5876	51.35	-53.11	104.46	42.02	32.43	6.46	29.56	268	200	P	V
			5940	49.6	-18.6	68.2	40.12	32.53	6.51	29.56	268	200	P	V
														V
														V
	Remark	3. No other spurious found. 4. All results are PASS against Peak and Average limit line.												



Band 4 5725~5850MHz

WIFI 802.11ac VHT80 (Harmonic @ 3m)

WIFI Ant. 2	Note	Frequency (MHz)	Level (dBμV/m)	Over Limit (dB)	Limit Line (dBμV/m)	Read Level (dBμV)	Antenna Factor (dB/m)	Path Loss (dB)	Preamp Factor (dB)	Ant Pos (cm)	Table Pos (deg)	Peak Avg. (P/A)	Pol. (H/V)	
802.11ac VHT80 CH 155 5775MHz		11550	46.72	-27.28	74	52.73	39.8	10.49	56.3	100	0	P	H	
		17325	48.29	-19.91	68.2	50.86	41.14	13.04	56.75	100	0	P	H	
													H	
													H	
			11550	46.49	-27.51	74	52.5	39.8	10.49	56.3	100	0	P	V
			17325	49.39	-18.81	68.2	51.96	41.14	13.04	56.75	100	0	P	V
														V
Remark	3. No other spurious found. 4. All results are PASS against Peak and Average limit line.													



Emission below 1GHz

5GHz WIFI 802.11ac VHT80 (LF @ 3m)

WIFI	Note	Frequency	Level	Over	Limit	Read	Antenna	Path	Preamp	Ant	Table	Peak	Pol.	
Ant.				Limit	Line	Level	Factor	Loss	Factor	Pos	Pos	Avg.		
2		(MHz)	(dBμV/m)	(dB)	(dBμV/m)	(dBμV)	(dB/m)	(dB)	(dB)	(cm)	(deg)	(P/A)	(H/V)	
5GHz 802.11ac VHT80 LF		30.97	23.08	-16.92	40	31.17	23.74	0.46	32.29	-	-	P	H	
		136.7	29.05	-14.45	43.5	42.86	17.36	1.01	32.18	-	-	P	H	
		159.98	27.72	-15.78	43.5	42.1	16.71	1.08	32.17	-	-	P	H	
		264.74	30.75	-15.25	46	42.08	19.44	1.38	32.15	-	-	P	H	
		327.79	28.5	-17.5	46	39.49	19.67	1.49	32.15	-	-	P	H	
		950.53	33.17	-12.83	46	30.94	30.55	2.66	30.98	100	0	P	H	
													H	
													H	
													H	
													H	
													H	
													H	
													H	
													H	
													H	
													H	
													H	
			69.77	33.07	-6.93	40	52.51	12.16	0.66	32.26	100	0	P	V
			91.11	25.71	-17.79	43.5	42.21	14.96	0.76	32.22	-	-	P	V
		137.67	25.03	-18.47	43.5	38.85	17.35	1.01	32.18	-	-	P	V	
		160.95	25.84	-17.66	43.5	40.34	16.59	1.08	32.17	-	-	P	V	
		266.68	23.35	-22.65	46	34.77	19.35	1.38	32.15	-	-	P	V	
		957.32	33.43	-12.57	46	30.89	30.78	2.68	30.92	-	-	P	V	
													V	
													V	
													V	
													V	
													V	
													V	
													V	
Remark	3. No other spurious found. 4. All results are PASS against limit line.													



Band 4 - 5725~5850MHz
WIFI 802.11a (Band Edge @ 3m)

WIFI Ant.	Note	Frequency	Level	Over Limit	Limit Line	Read Level	Antenna Factor	Path Loss	Preamp Factor	Ant Pos	Table Pos	Peak Avg.	Pol.	
1+2		(MHz)	(dBμV/m)	(dB)	(dBμV/m)	(dBμV)	(dB/m)	(dB)	(dB)	(cm)	(deg)	(P/A)	(H/V)	
802.11a CH 149 5745MHz		5629.4	49.97	-18.23	68.2	41.12	32.07	6.33	29.55	277	31	P	H	
		5688.4	52.48	-44.16	96.64	43.5	32.17	6.36	29.55	277	31	P	H	
		5715.2	59.35	-50.11	109.46	50.34	32.19	6.37	29.55	277	31	P	H	
		5725	67.55	-54.65	122.2	58.52	32.21	6.37	29.55	277	31	P	H	
	*	5745	112.23	-	-	103.16	32.24	6.38	29.55	277	31	P	H	
	*	5745	104.83	-	-	95.76	32.24	6.38	29.55	277	31	A	H	
														H
														H
			5629.8	50.2	-18	68.2	41.35	32.07	6.33	29.55	377	19	P	V
			5675	50.48	-36.26	86.74	41.54	32.14	6.35	29.55	377	19	P	V
			5715.6	52.85	-56.72	109.57	43.84	32.19	6.37	29.55	377	19	P	V
			5724.8	60.76	-60.98	121.74	51.73	32.21	6.37	29.55	377	19	P	V
	*		5745	108.37	-	-	99.3	32.24	6.38	29.55	377	19	P	V
	*		5745	101.07	-	-	92	32.24	6.38	29.55	377	19	A	V
														V
														V



WIFI Ant. 1+2	Note	Frequency (MHz)	Level (dBµV/m)	Over Limit (dB)	Limit Line (dBµV/m)	Read Level (dBµV)	Antenna Factor (dB/m)	Path Loss (dB)	Preamp Factor (dB)	Ant Pos (cm)	Table Pos (deg)	Peak Avg. (P/A)	Pol. (H/V)	
802.11a CH 157 5785MHz		5612.2	49.18	-19.02	68.2	40.37	32.04	6.32	29.55	284	31	P	H	
		5693.8	50.84	-49.79	100.63	41.86	32.17	6.36	29.55	284	31	P	H	
		5702.6	51.39	-54.54	105.93	42.39	32.19	6.36	29.55	284	31	P	H	
		5723	51.6	-66.04	117.64	42.57	32.21	6.37	29.55	284	31	P	H	
	*	5785	111.74	-	-	102.62	32.29	6.39	29.56	284	31	P	H	
	*	5785	104.24	-	-	95.12	32.29	6.39	29.56	284	31	A	H	
		5850	53.23	-68.97	122.2	43.97	32.38	6.44	29.56	284	31	P	H	
		5859.4	53.1	-56.47	109.57	43.8	32.41	6.45	29.56	284	31	P	H	
		5888.8	51.52	-43.44	94.96	42.15	32.46	6.47	29.56	284	31	P	H	
		5941	50.63	-17.57	68.2	41.15	32.53	6.51	29.56	284	31	P	H	
														H
														H
			5623.8	49.81	-18.39	68.2	40.96	32.07	6.33	29.55	398	329	P	V
			5673.4	49.79	-35.77	85.56	40.85	32.14	6.35	29.55	398	329	P	V
			5704	48.75	-57.57	106.32	39.75	32.19	6.36	29.55	398	329	P	V
			5721.8	48.64	-66.26	114.9	39.61	32.21	6.37	29.55	398	329	P	V
	*		5785	107.37	-	-	98.25	32.29	6.39	29.56	398	329	P	V
	*		5785	100.5	-	-	91.38	32.29	6.39	29.56	398	329	A	V
			5854.4	49.75	-62.42	112.17	40.46	32.41	6.44	29.56	398	329	P	V
			5857.8	50.44	-59.57	110.01	41.14	32.41	6.45	29.56	398	329	P	V
		5922.6	51.22	-18.75	69.97	41.78	32.5	6.5	29.56	398	329	P	V	
		5930.6	49.86	-18.34	68.2	40.42	32.5	6.5	29.56	398	329	P	V	
													V	
													V	



WiFi Ant. 1+2	Note	Frequency (MHz)	Level (dBµV/m)	Over Limit (dB)	Limit Line (dBµV/m)	Read Level (dBµV)	Antenna Factor (dB/m)	Path Loss (dB)	Preamp Factor (dB)	Ant Pos (cm)	Table Pos (deg)	Peak Avg. (P/A)	Pol. (H/V)	
802.11a CH 165 5825MHz	*	5825	111.16	-	-	101.94	32.36	6.42	29.56	264	26	P	H	
	*	5825	104.12	-	-	94.9	32.36	6.42	29.56	264	26	A	H	
		5851.8	65.16	-52.94	118.1	55.9	32.38	6.44	29.56	264	26	P	H	
		5866.6	56.77	-50.78	107.55	47.47	32.41	6.45	29.56	264	26	P	H	
		5878.6	54.88	-47.65	102.53	45.55	32.43	6.46	29.56	264	26	P	H	
		5938.2	52.52	-15.68	68.2	43.07	32.5	6.51	29.56	264	26	P	H	
														H
														H
	*	5825	106.37	-	-	97.15	32.36	6.42	29.56	385	19	P	V	
	*	5825	99.07	-	-	89.85	32.36	6.42	29.56	385	19	A	V	
		5850.8	56.34	-64.04	120.38	47.08	32.38	6.44	29.56	385	19	P	V	
		5860.6	55.07	-54.16	109.23	45.77	32.41	6.45	29.56	385	19	P	V	
		5881.8	52.79	-47.36	100.15	43.45	32.43	6.47	29.56	385	19	P	V	
		5925.2	49.79	-18.41	68.2	40.35	32.5	6.5	29.56	385	19	P	V	
														V
														V
														V
Remark	5. No other spurious found. 6. All results are PASS against Peak and Average limit line.													



Band 4 5725~5850MHz
WIFI 802.11a (Harmonic @ 3m)

WIFI Ant. 1+2	Note	Frequency (MHz)	Level (dBμV/m)	Over Limit (dB)	Limit Line (dBμV/m)	Read Level (dBμV)	Antenna Factor (dB/m)	Path Loss (dB)	Preamp Factor (dB)	Ant Pos (cm)	Table Pos (deg)	Peak Avg. (P/A)	Pol. (H/V)
802.11a CH 149 5745MHz		11490	46.72	-27.28	74	52.64	39.92	10.46	56.3	100	0	P	H
		17235	49.52	-18.68	68.2	52.3	40.84	12.95	56.57	100	0	P	H
													H
													H
		11490	47.94	-26.06	74	53.86	39.92	10.46	56.3	100	0	P	V
		17235	48.87	-19.33	68.2	51.65	40.84	12.95	56.57	100	0	P	V
													V
													V
802.11a CH 157 5785MHz		11570	46.65	-27.35	74	52.69	39.76	10.5	56.3	100	0	P	H
		17355	49.61	-18.59	68.2	52.08	41.26	13.08	56.81	100	0	P	H
													H
													H
		11570	46.19	-27.81	74	52.23	39.76	10.5	56.3	100	0	P	V
		17355	49.79	-18.41	68.2	52.26	41.26	13.08	56.81	100	0	P	V
													V
													V
802.11a CH 165 5825MHz		11650	46.9	-27.1	74	53.04	39.62	10.54	56.3	100	0	P	H
		17475	49.55	-18.65	68.2	51.71	41.68	13.21	57.05	100	0	P	H
													H
													H
		11650	46.63	-27.37	74	52.77	39.62	10.54	56.3	100	0	P	V
		17475	49.46	-18.74	68.2	51.62	41.68	13.21	57.05	100	0	P	V
													V
													V
Remark	5. No other spurious found. 6. All results are PASS against Peak and Average limit line.												



Band 4 5725~5850MHz
WIFI 802.11ac VHT20 (Band Edge @ 3m)

WIFI Ant. 1+2	Note	Frequency (MHz)	Level (dBμV/m)	Over Limit (dB)	Limit Line (dBμV/m)	Read Level (dBμV)	Antenna Factor (dB/m)	Path Loss (dB)	Preamp Factor (dB)	Ant Pos (cm)	Table Pos (deg)	Peak Avg. (P/A)	Pol. (H/V)	
802.11ac VHT20 CH 149 5745MHz		5643.4	49.8	-18.4	68.2	40.92	32.09	6.34	29.55	289	32	P	H	
		5682.6	53.14	-39.22	92.36	44.2	32.14	6.35	29.55	289	32	P	H	
		5719.6	55.74	-54.95	110.69	46.71	32.21	6.37	29.55	289	32	P	H	
		5724.4	65.89	-54.94	120.83	56.86	32.21	6.37	29.55	289	32	P	H	
	*	5745	111.86	-	-	102.79	32.24	6.38	29.55	289	32	P	H	
	*	5745	104.13	-	-	95.06	32.24	6.38	29.55	289	32	A	H	
														H
														H
			5644.6	49.64	-18.56	68.2	40.76	32.09	6.34	29.55	377	21	P	V
			5697.8	51.95	-51.63	103.58	42.97	32.17	6.36	29.55	377	21	P	V
			5720	55.04	-55.76	110.8	46.01	32.21	6.37	29.55	377	21	P	V
			5720.4	56.95	-54.76	111.71	47.92	32.21	6.37	29.55	377	21	P	V
	*		5745	108.55	-	-	99.48	32.24	6.38	29.55	377	21	P	V
	*		5745	101.17	-	-	92.1	32.24	6.38	29.55	377	21	A	V
														V
													V	



WIFI Ant. 1+2	Note	Frequency (MHz)	Level (dBμV/m)	Over Limit (dB)	Limit Line (dBμV/m)	Read Level (dBμV)	Antenna Factor (dB/m)	Path Loss (dB)	Preamp Factor (dB)	Ant Pos (cm)	Table Pos (deg)	Peak Avg. (P/A)	Pol. (H/V)
		5619.8	49.23	-18.97	68.2	40.38	32.07	6.33	29.55	284	31	P	H
		5691.8	49.76	-49.39	99.15	40.78	32.17	6.36	29.55	284	31	P	H
		5720	52.01	-58.79	110.8	42.98	32.21	6.37	29.55	284	31	P	H
		5723	51.87	-65.77	117.64	42.84	32.21	6.37	29.55	284	31	P	H
	*	5785	112.02	-	-	102.9	32.29	6.39	29.56	284	31	P	H
	*	5785	104.55	-	-	95.43	32.29	6.39	29.56	284	31	A	H
		5850.2	53.71	-68.03	121.74	44.45	32.38	6.44	29.56	284	31	P	H
		5869.2	52.87	-53.95	106.82	43.56	32.41	6.46	29.56	284	31	P	H
		5877.2	51.81	-51.76	103.57	42.48	32.43	6.46	29.56	284	31	P	H
		5925	51.73	-16.47	68.2	42.29	32.5	6.5	29.56	284	31	P	H
802.11ac													H
VHT20													H
CH 157		5601.4	49.07	-19.13	68.2	40.26	32.04	6.32	29.55	378	330	P	V
5785MHz		5653.8	49.28	-21.74	71.02	40.37	32.12	6.34	29.55	378	330	P	V
		5713	48.86	-59.98	108.84	39.85	32.19	6.37	29.55	378	330	P	V
		5721.4	48.82	-65.17	113.99	39.79	32.21	6.37	29.55	378	330	P	V
	*	5788	108.04	-	-	98.89	32.31	6.4	29.56	378	330	P	V
	*	5788	100.37	-	-	91.22	32.31	6.4	29.56	378	330	A	V
		5854.2	49.77	-62.85	112.62	40.48	32.41	6.44	29.56	378	330	P	V
		5857	50.98	-59.26	110.24	41.68	32.41	6.45	29.56	378	330	P	V
		5898.4	50.5	-37.35	87.85	41.12	32.46	6.48	29.56	378	330	P	V
		5940	50.23	-17.97	68.2	40.75	32.53	6.51	29.56	378	330	P	V
													V
													V



WiFi Ant. 1+2	Note	Frequency (MHz)	Level (dBμV/m)	Over Limit (dB)	Limit Line (dBμV/m)	Read Level (dBμV)	Antenna Factor (dB/m)	Path Loss (dB)	Preamp Factor (dB)	Ant Pos (cm)	Table Pos (deg)	Peak Avg. (P/A)	Pol. (H/V)	
802.11ac VHT20 CH 165 5825MHz	*	5825	111.61	-	-	102.39	32.36	6.42	29.56	269	25	P	H	
	*	5825	104.12	-	-	94.9	32.36	6.42	29.56	269	25	A	H	
		5850	61.91	-60.29	122.2	52.65	32.38	6.44	29.56	269	25	P	H	
		5855.6	57.31	-53.32	110.63	48.02	32.41	6.44	29.56	269	25	P	H	
		5875.2	56.33	-48.72	105.05	47	32.43	6.46	29.56	269	25	P	H	
		5936.6	51.33	-16.87	68.2	41.88	32.5	6.51	29.56	269	25	P	H	
														H
														H
	*	5825	106.75	-	-	97.53	32.36	6.42	29.56	400	20	P	V	
	*	5825	99.14	-	-	89.92	32.36	6.42	29.56	400	20	A	V	
		5850	56.61	-65.59	122.2	47.35	32.38	6.44	29.56	400	20	P	V	
		5869	53.25	-53.63	106.88	43.94	32.41	6.46	29.56	400	20	P	V	
		5900.6	51.17	-35.05	86.22	41.79	32.46	6.48	29.56	400	20	P	V	
		5930.6	50.4	-17.8	68.2	40.96	32.5	6.5	29.56	400	20	P	V	
														V
														V
Remark	5. No other spurious found. 6. All results are PASS against Peak and Average limit line.													



Band 4 5725~5850MHz
WIFI 802.11ac VHT20 (Harmonic @ 3m)

WIFI Ant. 1+2	Note	Frequency (MHz)	Level (dBμV/m)	Over Limit (dB)	Limit Line (dBμV/m)	Read Level (dBμV)	Antenna Factor (dB/m)	Path Loss (dB)	Preamp Factor (dB)	Ant Pos (cm)	Table Pos (deg)	Peak Avg. (P/A)	Pol. (H/V)	
802.11ac VHT20 CH 149 5745MHz		11490	47.25	-26.75	74	53.17	39.92	10.46	56.3	100	0	P	H	
		17235	48.88	-19.32	68.2	51.66	40.84	12.95	56.57	100	0	P	H	
													H	
													H	
			11490	47.89	-26.11	74	53.81	39.92	10.46	56.3	100	0	P	V
			17235	49.27	-18.93	68.2	52.05	40.84	12.95	56.57	100	0	P	V
														V
802.11ac VHT20 CH 157 5785MHz		11570	45.59	-28.41	74	51.63	39.76	10.5	56.3	100	0	P	H	
		17355	49.2	-19	68.2	51.67	41.26	13.08	56.81	100	0	P	H	
													H	
													H	
			11570	45.81	-28.19	74	51.85	39.76	10.5	56.3	100	0	P	V
			17355	49.72	-18.48	68.2	52.19	41.26	13.08	56.81	100	0	P	V
														V
802.11ac VHT20 CH 165 5825MHz		11650	46.52	-27.48	74	52.66	39.62	10.54	56.3	100	0	P	H	
		17475	49.95	-18.25	68.2	52.11	41.68	13.21	57.05	100	0	P	H	
													H	
													H	
			11650	46.88	-27.12	74	53.02	39.62	10.54	56.3	100	0	P	V
			17475	50.05	-18.15	68.2	52.21	41.68	13.21	57.05	100	0	P	V
														V
Remark	5. No other spurious found.													
	6. All results are PASS against Peak and Average limit line.													



Band 4 5725~5850MHz
WIFI 802.11ac VHT40 (Band Edge @ 3m)

WIFI Ant. 1+2	Note	Frequency (MHz)	Level (dBμV/m)	Over Limit (dB)	Limit Line (dBμV/m)	Read Level (dBμV)	Antenna Factor (dB/m)	Path Loss (dB)	Preamp Factor (dB)	Ant Pos (cm)	Table Pos (deg)	Peak Avg. (P/A)	Pol. (H/V)
		5636.8	50.42	-17.78	68.2	41.55	32.09	6.33	29.55	106	26	P	H
		5699.4	59.72	-45.04	104.76	50.74	32.17	6.36	29.55	106	26	P	H
		5718.4	71.83	-38.52	110.35	62.8	32.21	6.37	29.55	106	26	P	H
		5724.4	69.86	-50.97	120.83	60.83	32.21	6.37	29.55	106	26	P	H
	*	5755	109.56	-	-	100.48	32.26	6.38	29.56	106	26	P	H
	*	5755	101.72	-	-	92.64	32.26	6.38	29.56	106	26	A	H
		5851.6	50.96	-67.59	118.55	41.7	32.38	6.44	29.56	106	26	P	H
		5870.2	51.41	-55.13	106.54	42.1	32.41	6.46	29.56	106	26	P	H
		5879	51.67	-50.56	102.23	42.34	32.43	6.46	29.56	106	26	P	H
		5927.4	50.18	-18.02	68.2	40.74	32.5	6.5	29.56	106	26	P	H
													H
													H
802.11ac													
VHT40													
CH 151		5601	50.28	-17.92	68.2	41.47	32.04	6.32	29.55	299	164	P	V
5755MHz		5700	54.72	-50.48	105.2	45.74	32.17	6.36	29.55	299	164	P	V
		5718.6	66.5	-43.91	110.41	57.47	32.21	6.37	29.55	299	164	P	V
		5724	66.82	-53.1	119.92	57.79	32.21	6.37	29.55	299	164	P	V
	*	5755	105.04	-	-	95.96	32.26	6.38	29.56	299	164	P	V
	*	5755	97.02	-	-	87.94	32.26	6.38	29.56	299	164	A	V
		5851.8	49.73	-68.37	118.1	40.47	32.38	6.44	29.56	299	164	P	V
		5868.4	50.17	-56.88	107.05	40.87	32.41	6.45	29.56	299	164	P	V
		5875.4	49.77	-55.13	104.9	40.44	32.43	6.46	29.56	299	164	P	V
		5948	49.03	-19.17	68.2	39.54	32.53	6.52	29.56	299	164	P	V
													V
													V



WIFI Ant. 1+2	Note	Frequency (MHz)	Level (dBμV/m)	Over Limit (dB)	Limit Line (dBμV/m)	Read Level (dBμV)	Antenna Factor (dB/m)	Path Loss (dB)	Preamp Factor (dB)	Ant Pos (cm)	Table Pos (deg)	Peak Avg. (P/A)	Pol. (H/V)
		5608.8	49.09	-19.11	68.2	40.28	32.04	6.32	29.55	101	27	P	H
		5698.8	50.08	-54.24	104.32	41.1	32.17	6.36	29.55	101	27	P	H
		5714.4	51.75	-57.48	109.23	42.74	32.19	6.37	29.55	101	27	P	H
		5723	51.61	-66.03	117.64	42.58	32.21	6.37	29.55	101	27	P	H
	*	5795	109.3	-	-	100.15	32.31	6.4	29.56	101	27	P	H
	*	5795	101.29	-	-	92.14	32.31	6.4	29.56	101	27	A	H
		5852.8	56.98	-58.84	115.82	47.72	32.38	6.44	29.56	101	27	P	H
		5855.6	57.58	-53.05	110.63	48.29	32.41	6.44	29.56	101	27	P	H
		5904.8	52.15	-30.96	83.11	42.75	32.48	6.48	29.56	101	27	P	H
		5926	50.53	-17.67	68.2	41.09	32.5	6.5	29.56	101	27	P	H
802.11ac													H
VHT40													H
CH 159		5644.2	48.78	-19.42	68.2	39.9	32.09	6.34	29.55	298	348	P	V
5795MHz		5662.2	49.08	-28.18	77.26	40.17	32.12	6.34	29.55	298	348	P	V
		5717.2	48.91	-61.11	110.02	39.9	32.19	6.37	29.55	298	348	P	V
		5722.2	48.08	-67.74	115.82	39.05	32.21	6.37	29.55	298	348	P	V
	*	5795	103.88	-	-	94.73	32.31	6.4	29.56	298	348	P	V
	*	5795	96.14	-	-	86.99	32.31	6.4	29.56	298	348	A	V
		5850.4	51.49	-69.8	121.29	42.23	32.38	6.44	29.56	298	348	P	V
		5857.6	52.86	-57.21	110.07	43.56	32.41	6.45	29.56	298	348	P	V
		5886.6	50.6	-45.99	96.59	41.26	32.43	6.47	29.56	298	348	P	V
		5926.4	49.55	-18.65	68.2	40.11	32.5	6.5	29.56	298	348	P	V
													V
													V
Remark	5. No other spurious found. 6. All results are PASS against Peak and Average limit line.												



**Band 4 5725~5850MHz
WIFI 802.11ac VHT40 (Harmonic @ 3m)**

WIFI Ant. 1+2	Note	Frequency (MHz)	Level (dBµV/m)	Over Limit (dB)	Limit Line (dBµV/m)	Read Level (dBµV)	Antenna Factor (dB/m)	Path Loss (dB)	Preamp Factor (dB)	Ant Pos (cm)	Table Pos (deg)	Peak Avg. (P/A)	Pol. (H/V)	
802.11ac VHT40 CH 151 5755MHz		11510	46.85	-27.15	74	52.78	39.9	10.47	56.3	100	0	P	H	
		17265	48.65	-19.55	68.2	51.34	40.96	12.98	56.63	100	0	P	H	
													H	
													H	
			11510	46.89	-27.11	74	52.82	39.9	10.47	56.3	100	0	P	V
			17265	48.13	-20.07	68.2	50.82	40.96	12.98	56.63	100	0	P	V
														V
802.11ac VHT40 CH 159 5795MHz		11590	46.31	-27.69	74	52.37	39.73	10.51	56.3	100	0	P	H	
		17385	50.01	-18.19	68.2	52.39	41.38	13.11	56.87	100	0	P	H	
													H	
													H	
			11590	46.25	-27.75	74	52.31	39.73	10.51	56.3	100	0	P	V
			17385	49.32	-18.88	68.2	51.7	41.38	13.11	56.87	100	0	P	V
														V
Remark	5. No other spurious found.													
	6. All results are PASS against Peak and Average limit line.													



Band 4 5725~5850MHz
WIFI 802.11ac VHT80 (Band Edge @ 3m)

WIFI Ant. 1+2	Note	Frequency (MHz)	Level (dBμV/m)	Over Limit (dB)	Limit Line (dBμV/m)	Read Level (dBμV)	Antenna Factor (dB/m)	Path Loss (dB)	Preamp Factor (dB)	Ant Pos (cm)	Table Pos (deg)	Peak Avg. (P/A)	Pol. (H/V)	
		5638.2	53.01	-15.19	68.2	44.13	32.09	6.34	29.55	101	25	P	H	
		5698.6	69	-35.17	104.17	60.02	32.17	6.36	29.55	101	25	P	H	
		5717.8	71.9	-38.28	110.18	62.87	32.21	6.37	29.55	101	25	P	H	
		5722	72.67	-42.69	115.36	63.64	32.21	6.37	29.55	101	25	P	H	
	*	5775	106.67	-	-	97.55	32.29	6.39	29.56	101	25	P	H	
	*	5775	98.63	-	-	89.51	32.29	6.39	29.56	101	25	A	H	
		5855	69.88	-40.92	110.8	60.59	32.41	6.44	29.56	101	25	P	H	
		5861.4	72.76	-36.25	109.01	63.46	32.41	6.45	29.56	101	25	P	H	
		5875	63.48	-41.72	105.2	54.15	32.43	6.46	29.56	101	25	P	H	
		5941.8	51.68	-16.52	68.2	42.2	32.53	6.51	29.56	101	25	P	H	
802.11ac VHT80 CH 155 5775MHz													H	
													H	
			5637.6	50.06	-18.14	68.2	41.18	32.09	6.34	29.55	266	177	P	V
			5700	64.78	-40.42	105.2	55.8	32.17	6.36	29.55	266	177	P	V
			5716.8	67.53	-42.38	109.91	58.52	32.19	6.37	29.55	266	177	P	V
			5723	68.32	-49.32	117.64	59.29	32.21	6.37	29.55	266	177	P	V
		*	5775	102.07	-	-	92.95	32.29	6.39	29.56	266	177	P	V
		*	5775	94.32	-	-	85.2	32.29	6.39	29.56	266	177	A	V
			5851.8	65.34	-52.76	118.1	56.08	32.38	6.44	29.56	266	177	P	V
			5860	66.77	-42.63	109.4	57.47	32.41	6.45	29.56	266	177	P	V
			5875.6	59.37	-45.38	104.75	50.04	32.43	6.46	29.56	266	177	P	V
			5939.6	49.63	-18.57	68.2	40.15	32.53	6.51	29.56	266	177	P	V
														V
														V
	Remark	5. No other spurious found. 6. All results are PASS against Peak and Average limit line.												



Band 4 5725~5850MHz

WIFI 802.11ac VHT80 (Harmonic @ 3m)

WIFI Ant. 1+2	Note	Frequency (MHz)	Level (dBμV/m)	Over Limit (dB)	Limit Line (dBμV/m)	Read Level (dBμV)	Antenna Factor (dB/m)	Path Loss (dB)	Preamp Factor (dB)	Ant Pos (cm)	Table Pos (deg)	Peak Avg. (P/A)	Pol. (H/V)	
802.11ac VHT80 CH 155 5775MHz		11550	45.82	-28.18	74	51.83	39.8	10.49	56.3	100	0	P	H	
		17325	48.83	-19.37	68.2	51.4	41.14	13.04	56.75	100	0	P	H	
													H	
													H	
			11550	46.74	-27.26	74	52.75	39.8	10.49	56.3	100	0	P	V
			17325	48.31	-19.89	68.2	50.88	41.14	13.04	56.75	100	0	P	V
														V
Remark	5. No other spurious found. 6. All results are PASS against Peak and Average limit line.													



<TXBF Mode>

Band 4 - 5725~5850MHz

WIFI 802.11ac VHT20 (Band Edge @ 3m)

WIFI Ant.	Note	Frequency	Level	Over Limit	Limit Line	Read Level	Antenna Factor	Path Loss	Preamp Factor	Ant Pos	Table Pos	Peak Avg.	Pol.	
1+2		(MHz)	(dBμV/m)	(dB)	(dBμV/m)	(dBμV)	(dB/m)	(dB)	(dB)	(cm)	(deg)	(P/A)	(H/V)	
802.11ac VHT20 CH 149 5745MHz		5649	49.39	-18.81	68.2	40.51	32.09	6.34	29.55	100	20	P	H	
		5699.6	57.35	-47.56	104.91	48.37	32.17	6.36	29.55	100	20	P	H	
		5720	73.62	-37.18	110.8	64.59	32.21	6.37	29.55	100	20	P	H	
		5724.4	81.37	-39.46	120.83	72.34	32.21	6.37	29.55	100	20	P	H	
	*	5745	114.56	-	-	105.49	32.24	6.38	29.55	100	20	P	H	
	*	5745	105.94	-	-	96.87	32.24	6.38	29.55	100	20	A	H	
														H
														H
			5630.4	48.93	-19.27	68.2	40.08	32.07	6.33	29.55	247	211	P	V
			5696.8	52.11	-50.73	102.84	43.13	32.17	6.36	29.55	247	211	P	V
			5720	70.43	-40.37	110.8	61.4	32.21	6.37	29.55	247	211	P	V
			5725	77.78	-44.42	122.2	68.75	32.21	6.37	29.55	247	211	P	V
	*		5745	110.23	-	-	101.16	32.24	6.38	29.55	247	211	P	V
	*		5745	101.19	-	-	92.12	32.24	6.38	29.55	247	211	A	V
													V	
													V	



WIFI Ant. 1+2	Note	Frequency (MHz)	Level (dBµV/m)	Over Limit (dB)	Limit Line (dBµV/m)	Read Level (dBµV)	Antenna Factor (dB/m)	Path Loss (dB)	Preamp Factor (dB)	Ant Pos (cm)	Table Pos (deg)	Peak Avg. (P/A)	Pol. (H/V)
		5623.2	49.85	-18.35	68.2	41	32.07	6.33	29.55	231	20	P	H
		5684.4	50.16	-43.53	93.69	41.19	32.17	6.35	29.55	231	20	P	H
		5718.8	52.05	-58.41	110.46	43.02	32.21	6.37	29.55	231	20	P	H
		5723.6	52.03	-66.98	119.01	43	32.21	6.37	29.55	231	20	P	H
	*	5785	114.76	-	-	105.64	32.29	6.39	29.56	231	20	P	H
	*	5785	106.07	-	-	96.95	32.29	6.39	29.56	231	20	A	H
		5850.2	52.81	-68.93	121.74	43.55	32.38	6.44	29.56	231	20	P	H
		5865.6	51.73	-56.1	107.83	42.43	32.41	6.45	29.56	231	20	P	H
		5885.4	51.18	-46.3	97.48	41.84	32.43	6.47	29.56	231	20	P	H
		5929.4	50.71	-17.49	68.2	41.27	32.5	6.5	29.56	231	20	P	H
802.11ac													H
VHT20													H
CH 157		5638.4	49.38	-18.82	68.2	40.5	32.09	6.34	29.55	227	211	P	V
5785MHz		5660.6	48.81	-27.26	76.07	39.9	32.12	6.34	29.55	227	211	P	V
		5704	49.22	-57.1	106.32	40.22	32.19	6.36	29.55	227	211	P	V
		5721.6	49.89	-64.56	114.45	40.86	32.21	6.37	29.55	227	211	P	V
	*	5785	110.25	-	-	101.13	32.29	6.39	29.56	227	211	P	V
	*	5785	102.04	-	-	92.92	32.29	6.39	29.56	227	211	A	V
		5850.8	52.32	-68.06	120.38	43.06	32.38	6.44	29.56	227	211	P	V
		5856.6	49.94	-60.41	110.35	40.64	32.41	6.45	29.56	227	211	P	V
		5877	49.55	-54.16	103.71	40.22	32.43	6.46	29.56	227	211	P	V
		5934.8	49.49	-18.71	68.2	40.04	32.5	6.51	29.56	227	211	P	V
													V
													V



WIFI Ant. 1+2	Note	Frequency (MHz)	Level (dBμV/m)	Over Limit (dB)	Limit Line (dBμV/m)	Read Level (dBμV)	Antenna Factor (dB/m)	Path Loss (dB)	Preamp Factor (dB)	Ant Pos (cm)	Table Pos (deg)	Peak Avg. (P/A)	Pol. (H/V)	
802.11ac VHT20 CH 165 5825MHz	*	5825	109.66	-	-	100.44	32.36	6.42	29.56	107	358	P	H	
	*	5825	100.46	-	-	91.24	32.36	6.42	29.56	107	358	A	H	
		5850.4	59.8	-61.49	121.29	50.54	32.38	6.44	29.56	107	358	P	H	
		5857.2	57.82	-52.36	110.18	48.52	32.41	6.45	29.56	107	358	P	H	
		5885.8	53.97	-43.21	97.18	44.63	32.43	6.47	29.56	107	358	P	H	
		5933.8	51.17	-17.03	68.2	41.72	32.5	6.51	29.56	107	358	P	H	
														H
														H
	*	5825	105.35	-	-	96.13	32.36	6.42	29.56	112	23	P	V	
	*	5825	96.54	-	-	87.32	32.36	6.42	29.56	112	23	A	V	
		5853.4	50.82	-63.63	114.45	41.56	32.38	6.44	29.56	112	23	P	V	
		5864.4	53.14	-55.03	108.17	43.84	32.41	6.45	29.56	112	23	P	V	
		5877	52.26	-51.45	103.71	42.93	32.43	6.46	29.56	112	23	P	V	
		5935.4	49.61	-18.59	68.2	40.16	32.5	6.51	29.56	112	23	P	V	
														V
													V	
Remark	7. No other spurious found. 8. All results are PASS against Peak and Average limit line.													



**Band 4 5725~5850MHz
WIFI 802.11ac VHT20 (Harmonic @ 3m)**

WIFI Ant. 1+2	Note	Frequency (MHz)	Level (dBμV/m)	Over Limit (dB)	Limit Line (dBμV/m)	Read Level (dBμV)	Antenna Factor (dB/m)	Path Loss (dB)	Preamp Factor (dB)	Ant Pos (cm)	Table Pos (deg)	Peak Avg. (P/A)	Pol. (H/V)	
802.11ac VHT20 CH 149 5745MHz		11490	46.74	-27.26	74	52.66	39.92	10.46	56.3	100	0	P	H	
		17235	48.54	-19.66	68.2	51.32	40.84	12.95	56.57	100	0	P	H	
													H	
													H	
			11490	46.97	-27.03	74	52.89	39.92	10.46	56.3	100	0	P	V
			17235	48.41	-19.79	68.2	51.19	40.84	12.95	56.57	100	0	P	V
														V
802.11ac VHT20 CH 157 5785MHz		11570	47.03	-26.97	74	53.07	39.76	10.5	56.3	100	0	P	H	
		17355	48.8	-19.4	68.2	51.27	41.26	13.08	56.81	100	0	P	H	
													H	
													H	
			11570	46.34	-27.66	74	52.38	39.76	10.5	56.3	100	0	P	V
			17355	50.11	-18.09	68.2	52.58	41.26	13.08	56.81	100	0	P	V
														V
802.11ac VHT20 CH 165 5825MHz		11650	45.98	-28.02	74	52.12	39.62	10.54	56.3	100	0	P	H	
		17475	49.55	-18.65	68.2	51.71	41.68	13.21	57.05	100	0	P	H	
													H	
													H	
			11650	45.82	-28.18	74	51.96	39.62	10.54	56.3	100	0	P	V
			17475	49.8	-18.4	68.2	51.96	41.68	13.21	57.05	100	0	P	V
														V
Remark	7. No other spurious found.													
	8. All results are PASS against Peak and Average limit line.													



Band 4 5725~5850MHz
WIFI 802.11ac VHT40 (Band Edge @ 3m)

WIFI Ant. 1+2	Note	Frequency (MHz)	Level (dBμV/m)	Over Limit (dB)	Limit Line (dBμV/m)	Read Level (dBμV)	Antenna Factor (dB/m)	Path Loss (dB)	Preamp Factor (dB)	Ant Pos (cm)	Table Pos (deg)	Peak Avg. (P/A)	Pol. (H/V)
		5647.4	50.53	-17.67	68.2	41.65	32.09	6.34	29.55	284	29	P	H
		5690	58.54	-39.29	97.83	49.56	32.17	6.36	29.55	284	29	P	H
		5708.4	65.45	-42.1	107.55	56.45	32.19	6.36	29.55	284	29	P	H
		5720.2	63.17	-48.09	111.26	54.14	32.21	6.37	29.55	284	29	P	H
	*	5755	108.09	-	-	99.01	32.26	6.38	29.56	284	29	P	H
	*	5755	98.67	-	-	89.59	32.26	6.38	29.56	284	29	A	H
		5852.6	52.29	-63.98	116.27	43.03	32.38	6.44	29.56	284	29	P	H
		5856.2	52.3	-58.16	110.46	43.01	32.41	6.44	29.56	284	29	P	H
		5880.2	52.51	-48.83	101.34	43.18	32.43	6.46	29.56	284	29	P	H
		5945	50.68	-17.52	68.2	41.19	32.53	6.52	29.56	284	29	P	H
													H
													H
802.11ac													
VHT40													
CH 151		5609.4	49.71	-18.49	68.2	40.9	32.04	6.32	29.55	228	207	P	V
5755MHz		5691.6	53.44	-45.57	99.01	44.46	32.17	6.36	29.55	228	207	P	V
		5713.2	62.85	-46.05	108.9	53.84	32.19	6.37	29.55	228	207	P	V
		5722.6	59.28	-57.45	116.73	50.25	32.21	6.37	29.55	228	207	P	V
	*	5755	103.77	-	-	94.69	32.26	6.38	29.56	228	207	P	V
	*	5755	94.7	-	-	85.62	32.26	6.38	29.56	228	207	A	V
		5851.6	51.11	-67.44	118.55	41.85	32.38	6.44	29.56	228	207	P	V
		5860.2	49.68	-59.66	109.34	40.38	32.41	6.45	29.56	228	207	P	V
		5897.2	49.51	-39.22	88.73	40.13	32.46	6.48	29.56	228	207	P	V
		5950	49.17	-19.03	68.2	39.68	32.53	6.52	29.56	228	207	P	V
													V
													V



WIFI Ant. 1+2	Note	Frequency (MHz)	Level (dBμV/m)	Over Limit (dB)	Limit Line (dBμV/m)	Read Level (dBμV)	Antenna Factor (dB/m)	Path Loss (dB)	Preamp Factor (dB)	Ant Pos (cm)	Table Pos (deg)	Peak Avg. (P/A)	Pol. (H/V)
		5621.4	49.26	-18.94	68.2	40.41	32.07	6.33	29.55	261	24	P	H
		5690.2	50.63	-47.34	97.97	41.65	32.17	6.36	29.55	261	24	P	H
		5718.2	55.84	-54.46	110.3	46.81	32.21	6.37	29.55	261	24	P	H
		5725	56.93	-65.27	122.2	47.9	32.21	6.37	29.55	261	24	P	H
	*	5795	107.73	-	-	98.58	32.31	6.4	29.56	261	24	P	H
	*	5795	98.53	-	-	89.38	32.31	6.4	29.56	261	24	A	H
		5850	61.22	-60.98	122.2	51.96	32.38	6.44	29.56	261	24	P	H
		5855.4	62.03	-48.66	110.69	52.74	32.41	6.44	29.56	261	24	P	H
		5875	60.14	-45.06	105.2	50.81	32.43	6.46	29.56	261	24	P	H
		5928.8	51.81	-16.39	68.2	42.37	32.5	6.5	29.56	261	24	P	H
802.11ac													H
VHT40													H
CH 159		5639.4	48.53	-19.67	68.2	39.65	32.09	6.34	29.55	229	208	P	V
5795MHz		5684.6	50.04	-43.8	93.84	41.07	32.17	6.35	29.55	229	208	P	V
		5718.2	50.33	-59.97	110.3	41.3	32.21	6.37	29.55	229	208	P	V
		5723.6	50.12	-68.89	119.01	41.09	32.21	6.37	29.55	229	208	P	V
	*	5795	102.77	-	-	93.62	32.31	6.4	29.56	229	208	P	V
	*	5795	93.79	-	-	84.64	32.31	6.4	29.56	229	208	A	V
		5851	54.48	-65.44	119.92	45.22	32.38	6.44	29.56	229	208	P	V
		5855.6	54.97	-55.66	110.63	45.68	32.41	6.44	29.56	229	208	P	V
		5890.2	50.65	-43.27	93.92	41.28	32.46	6.47	29.56	229	208	P	V
		5946.2	49.29	-18.91	68.2	39.8	32.53	6.52	29.56	229	208	P	V
													V
													V
Remark	7. No other spurious found. 8. All results are PASS against Peak and Average limit line.												



**Band 4 5725~5850MHz
WIFI 802.11ac VHT40 (Harmonic @ 3m)**

WIFI Ant. 1+2	Note	Frequency (MHz)	Level (dBμV/m)	Over Limit (dB)	Limit Line (dBμV/m)	Read Level (dBμV)	Antenna Factor (dB/m)	Path Loss (dB)	Preamp Factor (dB)	Ant Pos (cm)	Table Pos (deg)	Peak Avg. (P/A)	Pol. (H/V)	
802.11ac VHT40 CH 151 5755MHz		11510	46.17	-27.83	74	52.1	39.9	10.47	56.3	100	0	P	H	
		17265	48.46	-19.74	68.2	51.15	40.96	12.98	56.63	100	0	P	H	
													H	
													H	
			11510	46.78	-27.22	74	52.71	39.9	10.47	56.3	100	0	P	V
			17265	48.61	-19.59	68.2	51.3	40.96	12.98	56.63	100	0	P	V
														V
802.11ac VHT40 CH 159 5795MHz		11590	47.76	-26.24	74	53.82	39.73	10.51	56.3	100	0	P	H	
		17385	48.84	-19.36	68.2	51.22	41.38	13.11	56.87	100	0	P	H	
													H	
													H	
			11590	45.83	-28.17	74	51.89	39.73	10.51	56.3	100	0	P	V
			17385	49.61	-18.59	68.2	51.99	41.38	13.11	56.87	100	0	P	V
														V
Remark	7. No other spurious found.													
	8. All results are PASS against Peak and Average limit line.													



Band 4 5725~5850MHz
WIFI 802.11ac VHT80 (Band Edge @ 3m)

WIFI Ant. 1+2	Note	Frequency (MHz)	Level (dBμV/m)	Over Limit (dB)	Limit Line (dBμV/m)	Read Level (dBμV)	Antenna Factor (dB/m)	Path Loss (dB)	Preamp Factor (dB)	Ant Pos (cm)	Table Pos (deg)	Peak Avg. (P/A)	Pol. (H/V)	
		5631	50.12	-18.08	68.2	41.27	32.07	6.33	29.55	257	22	P	H	
		5687.6	61.52	-34.53	96.05	52.54	32.17	6.36	29.55	257	22	P	H	
		5710	66.49	-41.51	108	57.49	32.19	6.36	29.55	257	22	P	H	
		5724.6	69.61	-51.68	121.29	60.58	32.21	6.37	29.55	257	22	P	H	
	*	5775	108.65	-	-	99.53	32.29	6.39	29.56	257	22	P	H	
	*	5775	94.61	-	-	85.49	32.29	6.39	29.56	257	22	A	H	
		5850.6	64.09	-56.74	120.83	54.83	32.38	6.44	29.56	257	22	P	H	
		5869.4	66.8	-39.97	106.77	57.49	32.41	6.46	29.56	257	22	P	H	
		5878.4	63.22	-39.45	102.67	53.89	32.43	6.46	29.56	257	22	P	H	
		5942.8	50.58	-17.62	68.2	41.1	32.53	6.51	29.56	257	22	P	H	
802.11ac VHT80 CH 155 5775MHz													H	
													H	
			5641	49.27	-18.93	68.2	40.39	32.09	6.34	29.55	237	207	P	V
			5696.4	56.49	-46.06	102.55	47.51	32.17	6.36	29.55	237	207	P	V
			5716.2	60.25	-49.49	109.74	51.24	32.19	6.37	29.55	237	207	P	V
			5723.4	56.9	-61.65	118.55	47.87	32.21	6.37	29.55	237	207	P	V
		*	5775	101.23	-	-	92.11	32.29	6.39	29.56	237	207	P	V
		*	5775	90.63	-	-	81.51	32.29	6.39	29.56	237	207	A	V
			5851	60.55	-59.37	119.92	51.29	32.38	6.44	29.56	237	207	P	V
			5871.4	59.72	-46.49	106.21	50.39	32.43	6.46	29.56	237	207	P	V
			5876	54.3	-50.16	104.46	44.97	32.43	6.46	29.56	237	207	P	V
			5944.6	49.38	-18.82	68.2	39.89	32.53	6.52	29.56	237	207	P	V
														V
														V
	Remark	7. No other spurious found.												
		8. All results are PASS against Peak and Average limit line.												



Band 4 5725~5850MHz

WIFI 802.11ac VHT80 (Harmonic @ 3m)

WIFI Ant. 1+2	Note	Frequency (MHz)	Level (dBμV/m)	Over Limit (dB)	Limit Line (dBμV/m)	Read Level (dBμV)	Antenna Factor (dB/m)	Path Loss (dB)	Preamp Factor (dB)	Ant Pos (cm)	Table Pos (deg)	Peak Avg. (P/A)	Pol. (H/V)	
802.11ac VHT80 CH 155 5775MHz		11550	46.18	-27.82	74	52.19	39.8	10.49	56.3	100	0	P	H	
		17325	48.83	-19.37	68.2	51.4	41.14	13.04	56.75	100	0	P	H	
													H	
													H	
			11550	46.35	-27.65	74	52.36	39.8	10.49	56.3	100	0	P	V
			17325	48.93	-19.27	68.2	51.5	41.14	13.04	56.75	100	0	P	V
														V
Remark	7. No other spurious found. 8. All results are PASS against Peak and Average limit line.													



Emission below 1GHz

5GHz WIFI 802.11ac VHT40 (LF @ 3m)

WIFI	Note	Frequency	Level	Over	Limit	Read	Antenna	Path	Preamp	Ant	Table	Peak	Pol.	
Ant.				Limit	Line	Level	Factor	Loss	Factor	Pos	Pos	Avg.		
1+2		(MHz)	(dBμV/m)	(dB)	(dBμV/m)	(dBμV)	(dB/m)	(dB)	(dB)	(cm)	(deg)	(P/A)	(H/V)	
5GHz 802.11ac VHT40 LF		196.84	25.67	-17.83	43.5	41.6	14.98	1.23	32.14	-	-	P	H	
		292.87	27.08	-18.92	46	38.81	18.98	1.44	32.15	-	-	P	H	
		322.94	33.4	-12.6	46	44.53	19.52	1.5	32.15	100	0	P	H	
		342.34	29.07	-16.93	46	39.57	20.13	1.52	32.15	-	-	P	H	
		576.11	30.45	-15.55	46	35.24	25.36	2.07	32.22	-	-	P	H	
		943.74	33.05	-12.95	46	31.12	30.32	2.65	31.04	-	-	P	H	
														H
														H
														H
														H
														H
														H
														H
														H
														H
			31.94	27.33	-12.67	40	35.84	23.32	0.46	32.29	-	-	P	V
			67.83	29.63	-10.37	40	49.24	12	0.65	32.26	100	0	P	V
			157.07	26.16	-17.34	43.5	40.41	16.85	1.07	32.17	-	-	P	V
			310.33	26.76	-19.24	46	38.15	19.28	1.48	32.15	-	-	P	V
			850.62	32.58	-13.42	46	32.51	29.1	2.62	31.65	-	-	P	V
		954.41	33.76	-12.24	46	31.36	30.68	2.67	30.95	-	-	P	V	
													V	
													V	
													V	
													V	
													V	
													V	
Remark	7. No other spurious found. 8. All results are PASS against limit line.													



Note symbol

*	Fundamental Frequency which can be ignored. However, the level of any unwanted emissions shall not exceed the level of the fundamental frequency.
!	Test result is over limit line.
P/A	Peak or Average
H/V	Horizontal or Vertical



A calculation example for radiated spurious emission is shown as below:

WIFI	Note	Frequency	Level	Over	Limit	Read	Antenna	Path	Preamp	Ant	Table	Peak	Pol.
Ant.				Limit	Line	Level	Factor	Loss	Factor	Pos	Pos	Avg.	
1		(MHz)	(dBμV/m)	(dB)	(dBμV/m)	(dBμV)	(dB/m)	(dB)	(dB)	(cm)	(deg)	(P/A)	(H/V)
802.11b		2390	55.45	-18.55	74	54.51	32.22	4.58	35.86	103	308	P	H
CH 01													
2412MHz		2390	43.54	-10.46	54	42.6	32.22	4.58	35.86	103	308	A	H

1. Path Loss(dB) = Cable loss(dB) + Filter loss(dB) + Attenuator loss(dB)
2. Level(dBμV/m) = Antenna Factor(dB/m) + Path Loss(dB) + Read Level(dBμV) - Preamp Factor(dB)
3. Over Limit(dB) = Level(dBμV/m) – Limit Line(dBμV/m)

For Peak Limit @ 2390MHz:

1. Level(dBμV/m)
= Antenna Factor(dB/m) + Path Loss(dB) + Read Level(dBμV) - Preamp Factor(dB)
= 32.22(dB/m) + 4.58(dB) + 54.51(dBμV) – 35.86 (dB)
= 55.45 (dBμV/m)
2. Over Limit(dB)
= Level(dBμV/m) – Limit Line(dBμV/m)
= 55.45(dBμV/m) – 74(dBμV/m)
= -18.55(dB)

For Average Limit @ 2390MHz:

1. Level(dBμV/m)
= Antenna Factor(dB/m) + Path Loss(dB) + Read Level(dBμV) - Preamp Factor(dB)
= 32.22(dB/m) + 4.58(dB) + 42.6(dBμV) – 35.86 (dB)
= 43.54 (dBμV/m)
2. Over Limit(dB) = Level(dBμV/m) – Limit Line(dBμV/m)
= 43.54(dBμV/m) – 54(dBμV/m)
= -10.46(dB)

Both peak and average measured complies with the limit line, so test result is “PASS”.



Appendix C. Radiated Spurious Emission Plots

Test Engineer :	Alex Jheng, JC Liang, Wilson Wu	Temperature :	24.7~25.2°C
		Relative Humidity :	50~52%

Note symbol

-L	Low channel location
-R	High channel location

<CDD Mode>

Band 4 - 5725~5850MHz WIFI 802.11a (Band Edge @ 3m)

WIFI	Band 4 5725~5850MHz Band Edge @ 3m	
ANT	802.11a CH149 5745MHz	
1	Horizontal	Fundamental
Peak	<p>Site : 09CH13-HY Condition : PEAK_8E(94)_16-24 3m HORN_91200_1241 HORIZONTAL RBW:1000.000KHz VBW:3000.000KHz SWT:Auto Detector : Peak Project : 922214 Mode : 34 Power : 14</p>	<p>Site : 09CH13-HY Condition : PEAK(LINE) 3m HORN_91200_1241 HORIZONTAL RBW:1000.000KHz VBW:3000.000KHz SWT:Auto Detector : Peak Project : 922214 Mode : 34 Power : 14</p>

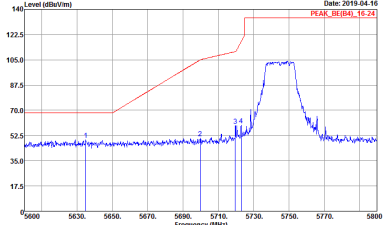
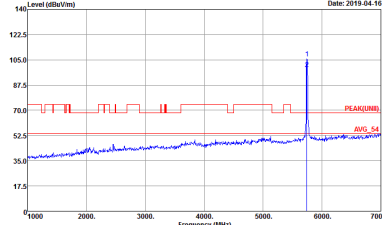

WIFI	Band 4 5725~5850MHz Band Edge @ 3m	
ANT	802.11a CH149 5745MHz	
1	Vertical	Fundamental
<p>Peak</p>	 <p>Date: 2019-04-16 PEAK: 85.045, 75.20</p> <p>Site : 03CH12-HY Condition : PEAK_BE(84)_16-24 3m HORN_91200_1241 VERTICAL Detector : Peak Project : 922214 Mode : 34 Power : 14</p>	 <p>Date: 2019-04-16 PEAK: 85.045, 75.20</p> <p>Site : 03CH12-HY Condition : PEAK(UNII) 3m HORN_91200_1241 VERTICAL Detector : Peak Project : 922214 Mode : 34 Power : 14</p>



WIFI	Band 4 5725~5850MHz Band Edge @ 3m	
ANT	802.11a CH157 5785MHz	
1	Horizontal	Fundamental
Peak	<p>Site : 03CH13-HY Condition : PEAK_BE(B4)_16-24 3m HORN_91200_1241 HORIZONTAL Detector : Peak Project : 922214 Mode : 35 Power : 14</p>	<p>Site : 03CH13-HY Condition : PEAK(UNII) 3m HORN_91200_1241 HORIZONTAL Detector : Peak Project : 922214 Mode : 35 Power : 14</p>
Peak	<p>Site : 03CH13-HY Condition : PEAK_BE(B4)_16-24 3m HORN_91200_1241 HORIZONTAL Detector : Peak Project : 922214 Mode : 35 Power : 14</p>	Left blank



WIFI	Band 4 5725~5850MHz Band Edge @ 3m	
ANT	802.11a CH157 5785MHz	
1	Vertical	Fundamental
Peak	<p>Site : 03CH13-HY Condition : PEAK_BE(B4)_16-24 3m HORN_91200_1241 VERTICAL Detector : Peak Project : 922214 Mode : 35 Power : 14</p>	<p>Site : 03CH13-HY Condition : PEAK(UNII) 3m HORN_91200_1241 VERTICAL Detector : Peak Project : 922214 Mode : 35 Power : 14</p>
Peak	<p>Site : 03CH13-HY Condition : PEAK_BE(B4)_16-24 3m HORN_91200_1241 VERTICAL Detector : Peak Project : 922214 Mode : 35 Power : 14</p>	Left blank

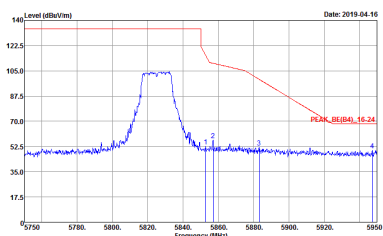
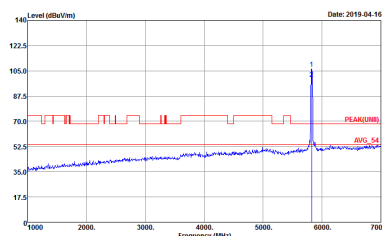

WIFI	Band 4 5725~5850MHz Band Edge @ 3m	
ANT	802.11a CH165 5825MHz	
1	Horizontal	Fundamental
<p>Peak</p>	 <p>Site : 03CH12-HY Condition : PEAK_BE(B4)_16-24 3m HORN_91200_1241 HORIZONTAL Detector : Peak Project : 922214 Mode : 36 Power : 14</p>	 <p>Site : 03CH12-HY Condition : PEAK(UNII) 3m HORN_91200_1241 HORIZONTAL Detector : Peak Project : 922214 Mode : 36 Power : 14</p>



WIFI	Band 4 5725~5850MHz Band Edge @ 3m	
ANT	802.11a CH165 5825MHz	
1	Vertical	Fundamental
Peak	<p> Site : 03CH12-HY Condition : PEAK_BE(B4)_16-24 3m HORN_91200_1241 VERTICAL Detector : Peak Project : 922214 Mode : 36 Power : 14 </p>	<p> Site : 03CH12-HY Condition : PEAK(UNII) 3m HORN_91200_1241 VERTICAL Detector : Peak Project : 922214 Mode : 36 Power : 14 </p>



Band 4 5725~5850MHz
WIFI 802.11ac VHT20 (Band Edge @ 3m)

Table with 2 columns: WIFI (Band 4 5725~5850MHz Band Edge @ 3m), ANT (802.11ac VHT20 CH149 5745MHz). Row 1: Peak, Horizontal (graph and metadata), Fundamental (graph and metadata).

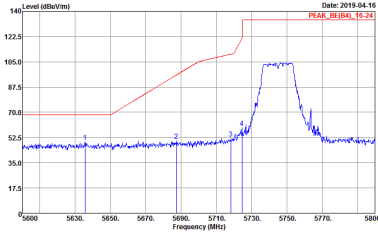
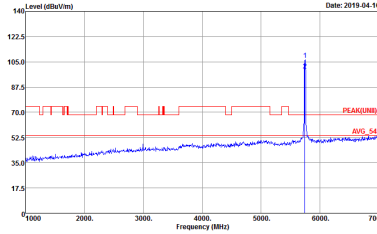

WIFI	Band 4 5725~5850MHz Band Edge @ 3m	
ANT	802.11ac VHT20 CH149 5745MHz	
1	Vertical	Fundamental
<p>Peak</p> <p>Avg.</p>	 <p>Site : 03CH13-HY Condition : PEAK_8E(84)_16-24 3m HORN_91200_1241 VERTICAL Detector : Peak Project : 922214 Mode : 37 Power : 14</p>	 <p>Site : 03CH13-HY Condition : PEAK(UNB) 3m HORN_91200_1241 VERTICAL Detector : Peak Project : 922214 Mode : 37 Power : 14</p>



WIFI	Band 4 5725~5850MHz Band Edge @ 3m	
ANT	802.11ac VHT20 CH157 5785MHz	
1	Horizontal	Fundamental
Peak	<p>Site : 03CH13-HY Condition : PEAK_BE(B4)_16-24 3m HORN_91200_1241 HORIZONTAL Detector : Peak Project : 922214 Mode : 38 Power : 14</p>	<p>Site : 03CH13-HY Condition : PEAK(UNII) 3m HORN_91200_1241 HORIZONTAL Detector : Peak Project : 922214 Mode : 38 Power : 14</p>
Peak	<p>Site : 03CH13-HY Condition : PEAK_BE(B4)_16-24 3m HORN_91200_1241 HORIZONTAL Detector : Peak Project : 922214 Mode : 38 Power : 14</p>	Left blank



WIFI	Band 4 5725~5850MHz Band Edge @ 3m	
ANT	802.11ac VHT20 CH157 5785MHz	
1	Vertical	Fundamental
Peak	<p>Site : 03CH13-HY Condition : PEAK_BE(B4)_16-24 3m HORN_91200_1241 VERTICAL Detector : Peak Project : 922214 Mode : 38 Power : 14</p>	<p>Site : 03CH13-HY Condition : PEAK(UNII) 3m HORN_91200_1241 VERTICAL Detector : Peak Project : 922214 Mode : 38 Power : 14</p>
Peak	<p>Site : 03CH13-HY Condition : PEAK_BE(B4)_16-24 3m HORN_91200_1241 VERTICAL Detector : Peak Project : 922214 Mode : 38 Power : 14</p>	Left blank



WIFI	Band 4 5725~5850MHz Band Edge @ 3m	
ANT	802.11ac VHT20 CH165 5825MHz	
1	Horizontal	Fundamental
Peak	<p>Site : 03CH13-HY Condition : PEAK_BE(B4)_16-24 3m HORN_91200_1241 HORIZONTAL Detector : Peak Project : 922214 Mode : 39 Power : 14</p>	<p>Site : 03CH13-HY Condition : PEAK(FB) 3m HORN_91200_1241 HORIZONTAL Detector : Peak Project : 922214 Mode : 39 Power : 14</p>

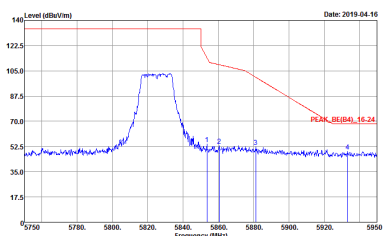
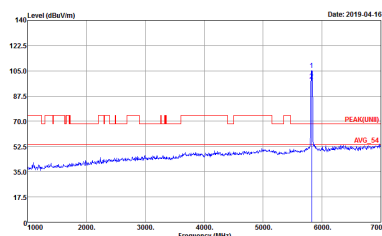

WIFI	Band 4 5725~5850MHz Band Edge @ 3m	
ANT	802.11ac VHT20 CH165 5825MHz	
1	Vertical	Fundamental
<p>Peak</p> <p>Avg.</p>	 <p>Site : 03CH12-HY Condition : PEAK_BE(B4)_16-24 3m HORN_91200_1241 VERTICAL Detector : Peak Project : 922214 Mode : 39 Power : 14</p>	 <p>Site : 03CH12-HY Condition : PEAK(UNII) 3m HORN_91200_1241 VERTICAL Detector : Peak Project : 922214 Mode : 39 Power : 14</p>

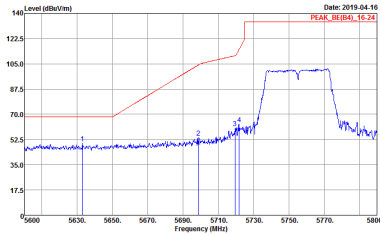
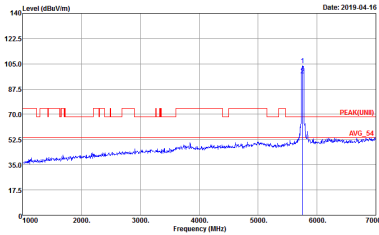
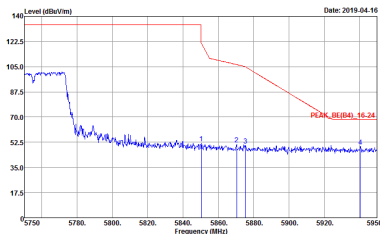

**Band 4 5725~5850MHz
WIFI 802.11ac VHT40 (Band Edge @ 3m)**

WIFI	Band 4 5725~5850MHz Band Edge @ 3m	
ANT	802.11ac VHT40 CH151 5755MHz	
1	Horizontal	Fundamental
Peak	 <p>Site : 03CH13-HY Condition : PEAK_BE(B4)_16-24 3m HORN_91200_1241 HORIZONTAL Detector : Peak Project : 922214 Mode : 40 Power : 13</p>	 <p>Site : 03CH13-HY Condition : PEAK(UNI) 3m HORN_91200_1241 HORIZONTAL Detector : Peak Project : 922214 Mode : 40 Power : 13</p>
Peak	 <p>Site : 03CH13-HY Condition : PEAK_BE(B4)_16-24 3m HORN_91200_1241 HORIZONTAL Detector : Peak Project : 922214 Mode : 40 Power : 13</p>	Left blank



WIFI	Band 4 5725~5850MHz Band Edge @ 3m	
ANT	802.11ac VHT40 CH151 5755MHz	
1	Vertical	Fundamental
Peak	<p>Site : 03CH13-HY Condition : PEAK_BE(B4)_16-24 3m HORN_91200_1241 VERTICAL Detector : Peak Project : 922214 Mode : 40 Power : 13</p>	<p>Site : 03CH13-HY Condition : PEAK(UNII) 3m HORN_91200_1241 VERTICAL Detector : Peak Project : 922214 Mode : 40 Power : 13</p>
Peak	<p>Site : 03CH13-HY Condition : PEAK_BE(B4)_16-24 3m HORN_91200_1241 VERTICAL Detector : Peak Project : 922214 Mode : 40 Power : 13</p>	Left blank



WIFI	Band 4 5725~5850MHz Band Edge @ 3m	
ANT	802.11ac VHT40 CH159 5795MHz	
1	Horizontal	Fundamental
<p>Peak</p>	<p>Date: 2019-04-16 PEAK_BE(84)_16-24</p> <p>Site : 03CH13-HY Condition : PEAK_BE(84)_16-24 3m HORN_91200_1241 HORIZONTAL Detector : Peak Project : 922214 Mode : 41 Power : 14</p>	<p>Date: 2019-04-16 PEAK(84)_16-24</p> <p>Site : 03CH13-HY Condition : PEAK(UNII) 3m HORN_91200_1241 HORIZONTAL Detector : Peak Project : 922214 Mode : 41 Power : 14</p>
<p>Peak</p>	<p>Date: 2019-04-16 PEAK_BE(84)_16-24</p> <p>Site : 03CH13-HY Condition : PEAK_BE(84)_16-24 3m HORN_91200_1241 HORIZONTAL Detector : Peak Project : 922214 Mode : 41 Power : 14</p>	<p>Left blank</p>



WIFI	Band 4 5725~5850MHz Band Edge @ 3m	
ANT	802.11ac VHT40 CH159 5795MHz	
1	Vertical	Fundamental
Peak	<p>Site : 03CH13-HY Condition : PEAK_BE(B4)_16-24 3m HORN_91200_1241 VERTICAL Detector : Peak Project : 922214 Mode : 41 Power : 14</p>	<p>Site : 03CH13-HY Condition : PEAK(UNII) 3m HORN_91200_1241 VERTICAL Detector : Peak Project : 922214 Mode : 41 Power : 14</p>
Peak	<p>Site : 03CH13-HY Condition : PEAK_BE(B4)_16-24 3m HORN_91200_1241 VERTICAL Detector : Peak Project : 922214 Mode : 41 Power : 14</p>	Left blank



Band 4 5725~5850MHz
WIFI 802.11ac VHT80 (Band Edge @ 3m)

WIFI	Band 4 5725~5850MHz Band Edge @ 3m	
ANT	802.11ac VHT80 CH155 5775MHz	
1	Horizontal	Fundamental
Peak	<p>Site : 03CH13-HY Condition : PEAK_BE(B4)_16-24 3m HORN_91200_1241 HORIZONTAL RBW:1000.000KHz VBW:3000.000KHz SWT:Auto Detector : Peak Project : 922214 Mode : 42 Power : 14</p>	<p>Site : 03CH13-HY Condition : PEAK(UNIT) 3m HORN_91200_1241 HORIZONTAL RBW:1000.000KHz VBW:3000.000KHz SWT:Auto Detector : Peak Project : 922214 Mode : 42 Power : 14</p>
Peak	<p>Site : 03CH13-HY Condition : PEAK_BE(B4)_16-24 3m HORN_91200_1241 HORIZONTAL RBW:1000.000KHz VBW:3000.000KHz SWT:Auto Detector : Peak Project : 922214 Mode : 42 Power : 14</p>	Left blank



WIFI	Band 4 5725~5850MHz Band Edge @ 3m	
ANT	802.11ac VHT80 CH155 5775MHz	
1	Vertical	Fundamental
Peak	<p>Site : 03CH13-HY Condition : PEAK_BE(B4)_16-24 3m HORN_91200_1241 VERTICAL Detector : Peak Project : 922214 Mode : 42 Power : 14</p>	<p>Site : 03CH13-HY Condition : PEAK(UNII) 3m HORN_91200_1241 VERTICAL Detector : Peak Project : 922214 Mode : 42 Power : 14</p>
Peak	<p>Site : 03CH13-HY Condition : PEAK_BE(B4)_16-24 3m HORN_91200_1241 VERTICAL Detector : Peak Project : 922214 Mode : 42 Power : 14</p>	Left blank



Band 4 - 5725~5850MHz
WIFI 802.11a (Harmonic @ 3m)

WIFI	Band 4 5725~5850MHz Harmonic @ 3m	
ANT	802.11a CH149 5745MHz	
1	Horizontal	Vertical
Peak Avg.		

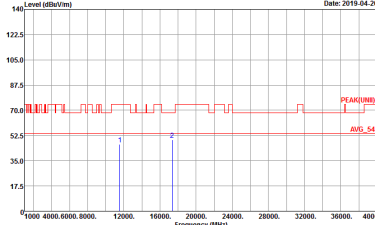
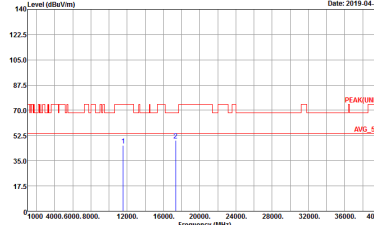

WIFI	Band 4 5725~5850MHz Harmonic @ 3m	
ANT	802.11a CH157 5785MHz	
1	Horizontal	Vertical
<p>Peak</p> <p>Avg.</p>	 <p>Site : 03CH12-HY Condition : PEAK(UNII) 3m HORN_91200_1241 HORIZONTAL Detector : Peak Project : 922214 Mode : 35 Power : 14</p>	 <p>Site : 03CH12-HY Condition : PEAK(UNII) 3m HORN_91200_1241 VERTICAL Detector : Peak Project : 922214 Mode : 35 Power : 14</p>

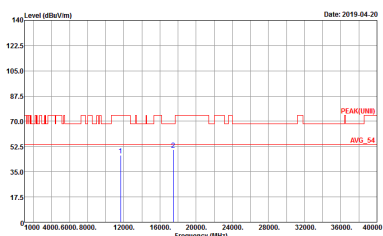
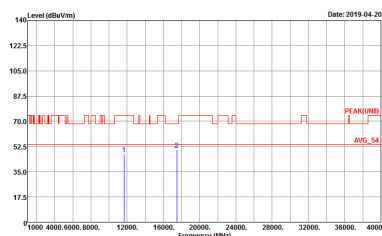

WIFI	Band 4 5725~5850MHz Harmonic @ 3m	
ANT	802.11a CH165 5825MHz	
1	Horizontal	Vertical
Peak Avg.	 <p>Site : 03CH12-HY Condition : PEAK(UNII) 3m HORN_91200_1241 HORIZONTAL Detector : Peak Project : 922214 Mode : 36 Power : 14</p>	 <p>Site : 03CH12-HY Condition : PEAK(UNII) 3m HORN_91200_1241 VERTICAL Detector : Peak Project : 922214 Mode : 36 Power : 14</p>



**Band 4 5725~5850MHz
WIFI 802.11ac VHT20 (Harmonic @ 3m)**

WIFI	Band 4 5725~5850MHz Harmonic @ 3m	
ANT	802.11ac VHT20 CH149 5745MHz	
1	Horizontal	Vertical
Peak Avg.	<p>Site : 03CH13-HY Condition : PEAK(UNII) 3m HORN_91200_1241 HORIZONTAL Detector : Peak Project : 922214 Mode : 37 Power : 14</p>	<p>Site : 03CH13-HY Condition : PEAK(UNII) 3m HORN_91200_1241 VERTICAL Detector : Peak Project : 922214 Mode : 37 Power : 14</p>

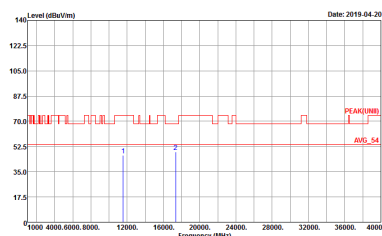

WIFI	Band 4 5725~5850MHz Harmonic @ 3m	
ANT	802.11ac VHT20 CH157 5785MHz	
1	Horizontal	Vertical
Peak Avg.	 <p>Site : 03CH12-HY Condition : PEAK(UNII) 3m HORN_91200_1241 HORIZONTAL Detector : Peak Project : 922214 Mode : 38 Power : 14</p>	 <p>Site : 03CH12-HY Condition : PEAK(UNII) 3m HORN_91200_1241 VERTICAL Detector : Peak Project : 922214 Mode : 38 Power : 14</p>



WIFI	Band 4 5725~5850MHz Harmonic @ 3m	
ANT	802.11ac VHT20 CH165 5825MHz	
1	Horizontal	Vertical
Peak Avg.	<p>Site : 03CH12-HY Condition : PEAK(UNII) 3m HORN_91200_1241 HORIZONTAL Detector : Peak Project : 922214 Mode : 39 Power : 14</p>	<p>Site : 03CH12-HY Condition : PEAK(UNII) 3m HORN_91200_1241 VERTICAL Detector : Peak Project : 922214 Mode : 39 Power : 14</p>



Band 4 5725~5850MHz
WIFI 802.11ac VHT40 (Harmonic @ 3m)

WIFI	Band 4 5725~5850MHz Harmonic @ 3m	
ANT	802.11ac VHT40 CH151 5755MHz	
1	Horizontal	Vertical
Peak Avg.	<p>Site : 03CH13-HY Condition : PEAK(UNII) 3m HORN_91200_1241 HORIZONTAL Detector : Peak Project : 922214 Mode : 40 Power : 13</p>	<p>Site : 03CH13-HY Condition : PEAK(UNII) 3m HORN_91200_1241 VERTICAL Detector : Peak Project : 922214 Mode : 40 Power : 13</p>



WIFI	Band 4 5725~5850MHz Harmonic @ 3m	
ANT	802.11ac VHT40 CH159 5795MHz	
1	Horizontal	Vertical
Peak Avg.	<p>Site : 03CH13-HV Condition : PEAK(UNII) 3m HORN_91200_1241 HORIZONTAL Detector : Peak Project : 922214 Mode : 41 Power : 14</p>	<p>Site : 03CH13-HV Condition : PEAK(UNII) 3m HORN_91200_1241 VERTICAL Detector : Peak Project : 922214 Mode : 41 Power : 14</p>



Band 4 5725~5850MHz
WIFI 802.11ac VHT80 (Harmonic @ 3m)

WIFI	Band 4 5725~5850MHz Harmonic @ 3m	
ANT	802.11ac VHT80 CH155 5775MHz	
1	Horizontal	Vertical
Peak Avg.	<p>Site : 03CH13-HY Condition : PEAK(UNII) 3m HORN_91200_1241 HORIZONTAL Detector : Peak Project : 922214 Mode : 42 Power : 14</p>	<p>Site : 03CH13-HY Condition : PEAK(UNII) 3m HORN_91200_1241 VERTICAL Detector : Peak Project : 922214 Mode : 42 Power : 14</p>



Emission below 1GHz
5GHz WIFI 802.11ac VHT40 (LF)

WIFI	5GHz 5725~5850MHz	
ANT	802.11ac VHT40 LF	
1	Horizontal	Vertical
QP / Peak	<p>Site : 03CH13-HY Condition : QP 3m B1LOG_37059401 HORIZONTAL Detector : Peak Project : 922214 Mode : 158</p>	<p>Site : 03CH13-HY Condition : QP 3m B1LOG_37059401 VERTICAL Detector : Peak Project : 922214 Mode : 158</p>



Band 4 - 5725~5850MHz
WIFI 802.11a (Band Edge @ 3m)

WIFI	Band 4 5725~5850MHz Band Edge @ 3m	
ANT	802.11a CH149 5745MHz	
2	Horizontal	Fundamental
Peak	<p> Date: 2019-04-18 PEAK_BE(04)_TC(3) </p> <p> Site : 03CH13-HY Condition : PEAK_BE(04)_16-24 3m HORN_91200_1241 HORIZONTAL Detector : Peak Project : 922214 Mode : 76 Power : 14 </p>	<p> Date: 2019-04-18 PEAK(FUN)_AVG_C1 </p> <p> Site : 03CH13-HY Condition : PEAK(FUN)II 3m HORN_91200_1241 HORIZONTAL Detector : Peak Project : 922214 Mode : 76 Power : 14 </p>



WIFI	Band 4 5725~5850MHz Band Edge @ 3m	
ANT	802.11a CH149 5745MHz	
2	Vertical	Fundamental
Peak	<p>Site : 03CH13-HY Condition : PEAK_BE(04)_16-24 3m HORN_91200_1241 VERTICAL Detector : Peak Project : 922214 Mode : 76 Power : 14</p>	<p>Site : 03CH13-HY Condition : PEAK(04)_16-24 3m HORN_91200_1241 VERTICAL Detector : Peak Project : 922214 Mode : 76 Power : 14</p>



WIFI	Band 4 5725~5850MHz Band Edge @ 3m	
ANT	802.11a CH157 5785MHz	
2	Horizontal	Fundamental
Peak	<p>Site : 03CH13-HY Condition : PEAK_BE(B4)_16-24 3m HORN_91200_1241 HORIZONTAL Detector : Peak Project : 922214 Mode : 77 Power : 14</p>	<p>Site : 03CH13-HY Condition : PEAK(UNII) 3m HORN_91200_1241 HORIZONTAL Detector : Peak Project : 922214 Mode : 77 Power : 14</p>
Peak	<p>Site : 03CH13-HY Condition : PEAK_BE(B4)_16-24 3m HORN_91200_1241 HORIZONTAL Detector : Peak Project : 922214 Mode : 77 Power : 14</p>	Left blank



WIFI	Band 4 5725~5850MHz Band Edge @ 3m	
ANT	802.11a CH157 5785MHz	
2	Vertical	Fundamental
Peak	<p>Site : 03CH13-HY Condition : PEAK_BE(B4)_16-24 3m HORN_91200_1241 VERTICAL Detector : Peak Project : 922214 Mode : 77 Power : 14</p>	<p>Site : 03CH13-HY Condition : PEAK(UNII) 3m HORN_91200_1241 VERTICAL Detector : Peak Project : 922214 Mode : 77 Power : 14</p>
Peak	<p>Site : 03CH13-HY Condition : PEAK_BE(B4)_16-24 3m HORN_91200_1241 VERTICAL Detector : Peak Project : 922214 Mode : 77 Power : 14</p>	Left blank

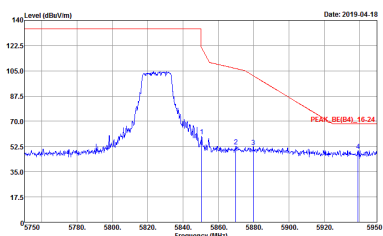
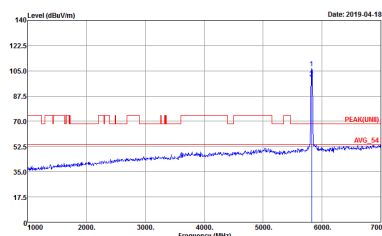

WIFI	Band 4 5725~5850MHz Band Edge @ 3m	
ANT	802.11a CH165 5825MHz	
2	Horizontal	Fundamental
Peak	 <p>Site : 03CH12-HY Condition : PEAK_BE(B4)_16-24 3m HORN_91200_1241 HORIZONTAL Detector : Peak Project : 922214 Mode : 78 Power : 14</p>	 <p>Site : 03CH12-HY Condition : PEAK(UNII) 3m HORN_91200_1241 HORIZONTAL Detector : Peak Project : 922214 Mode : 78 Power : 14</p>

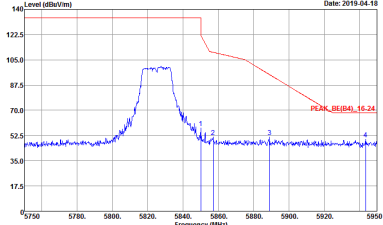
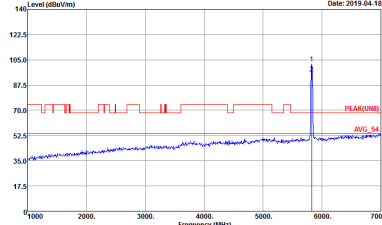

WIFI	Band 4 5725~5850MHz Band Edge @ 3m	
ANT	802.11a CH165 5825MHz	
2	Vertical	Fundamental
<p>Peak</p>	 <p>Site : 03CH12-HY Condition : PEAK_BE(B4)_16-24 3m HORN_91200_1241 VERTICAL RBW:1000.000KHz VBW:3000.000KHz SWT:Auto Detector : Peak Project : 922214 Mode : 78 Power : 14</p>	 <p>Site : 03CH12-HY Condition : PEAK(UNII) 3m HORN_91200_1241 VERTICAL RBW:1000.000KHz VBW:3000.000KHz SWT:Auto Detector : Peak Project : 922214 Mode : 78 Power : 14</p>



Band 4 5725~5850MHz
WIFI 802.11ac VHT20 (Band Edge @ 3m)

WIFI	Band 4 5725~5850MHz Band Edge @ 3m	
ANT	802.11ac VHT20 CH149 5745MHz	
2	Horizontal	Fundamental
Peak	<p>Site : 03CH13-HY Condition : PEAK_BE(B4)_16-24 3m HORN_91200_1241 HORIZONTAL Detector : Peak Project : 922214 Mode : 79 Power : 14</p>	<p>Site : 03CH13-HY Condition : PEAK(UNI) 3m HORN_91200_1241 HORIZONTAL Detector : Peak Project : 922214 Mode : 79 Power : 14</p>

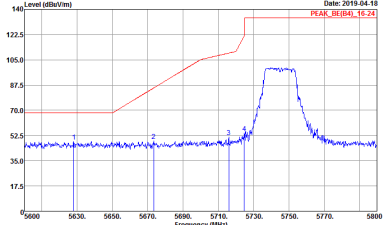
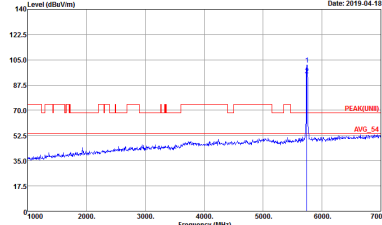

WIFI	Band 4 5725~5850MHz Band Edge @ 3m	
ANT	802.11ac VHT20 CH149 5745MHz	
2	Vertical	Fundamental
<p>Peak</p> <p>Avg.</p>	 <p>Site : 03CH13-HY Condition : PEAK_8E(84)_16-24 3m HORN_91200_1241 VERTICAL Detector : Peak Project : 922214 Mode : 79 Power : 14</p>	 <p>Site : 03CH13-HY Condition : PEAK(UNB) 3m HORN_91200_1241 VERTICAL Detector : Peak Project : 922214 Mode : 79 Power : 14</p>



WIFI	Band 4 5725~5850MHz Band Edge @ 3m	
ANT	802.11ac VHT20 CH157 5785MHz	
2	Horizontal	Fundamental
Peak	<p>Date: 2019-04-18 PEAK_BE(B4)_16-24</p> <p>Site : 03CH13-HY Condition : PEAK_BE(B4)_16-24 3m HORN_91200_1241 HORIZONTAL RBW:1000.000KHz VBW:3000.000KHz SWT:Auto Detector : Peak Project : 922214 Mode : 80 Power : 14</p>	<p>Date: 2019-04-18 PEAK(B4)_16-24</p> <p>Site : 03CH13-HY Condition : PEAK(UNII) 3m HORN_91200_1241 HORIZONTAL RBW:1000.000KHz VBW:3000.000KHz SWT:Auto Detector : Peak Project : 922214 Mode : 80 Power : 14</p>
Peak	<p>Date: 2019-04-18 PEAK_BE(B4)_16-24</p> <p>Site : 03CH13-HY Condition : PEAK_BE(B4)_16-24 3m HORN_91200_1241 HORIZONTAL RBW:1000.000KHz VBW:3000.000KHz SWT:Auto Detector : Peak Project : 922214 Mode : 80 Power : 14</p>	Left blank



WIFI	Band 4 5725~5850MHz Band Edge @ 3m	
ANT	802.11ac VHT20 CH157 5785MHz	
2	Vertical	Fundamental
Peak	<p>Site : 03CH13-HY Condition : PEAK_BE(B4)_16-24 3m HORN_91200_1241 VERTICAL Detector : Peak Project : 922214 Mode : 80 Power : 14</p>	<p>Site : 03CH13-HY Condition : PEAK(UNII) 3m HORN_91200_1241 VERTICAL Detector : Peak Project : 922214 Mode : 80 Power : 14</p>
Peak	<p>Site : 03CH13-HY Condition : PEAK_BE(B4)_16-24 3m HORN_91200_1241 VERTICAL Detector : Peak Project : 922214 Mode : 80 Power : 14</p>	Left blank

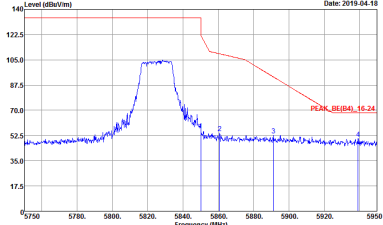
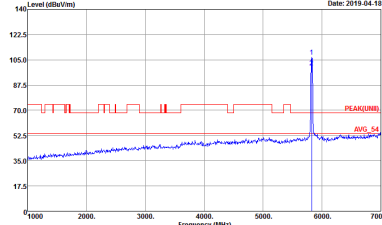

WIFI	Band 4 5725~5850MHz Band Edge @ 3m	
ANT	802.11ac VHT20 CH165 5825MHz	
2	Horizontal	Fundamental
Peak	 <p>Site : 03CH12-HY Condition : PEAK_BE(B4)_16-24 3m HORN_91200_1241 HORIZONTAL Detector : Peak Project : 922214 Mode : 81 Power : 14</p>	 <p>Site : 03CH12-HY Condition : PEAK(UNII) 3m HORN_91200_1241 HORIZONTAL Detector : Peak Project : 922214 Mode : 81 Power : 14</p>

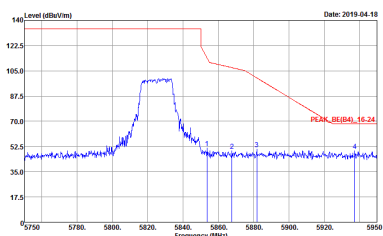
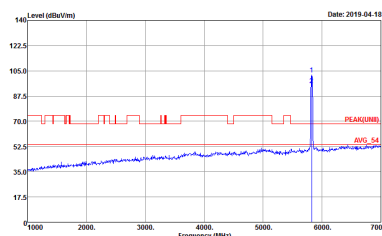

WIFI	Band 4 5725~5850MHz Band Edge @ 3m	
ANT	802.11ac VHT20 CH165 5825MHz	
2	Vertical	Fundamental
<p>Peak</p> <p>Avg.</p>	 <p>Site : 03CH12-HY Condition : PEAK_BE(B4)_16-24 3m HORN_91200_1241 VERTICAL Detector : Peak Project : 922214 Mode : 81 Power : 14</p>	 <p>Site : 03CH12-HY Condition : PEAK(UNII) 3m HORN_91200_1241 VERTICAL Detector : Peak Project : 922214 Mode : 81 Power : 14</p>

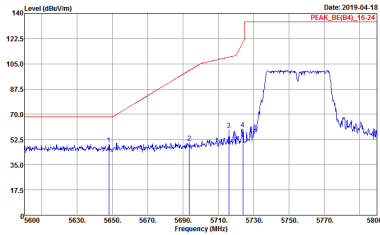
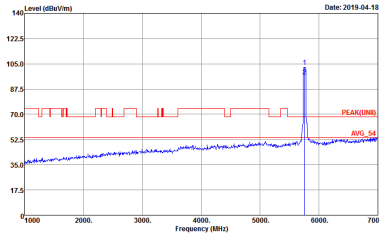
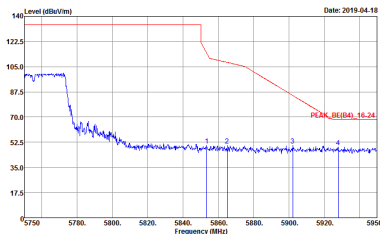

Band 4 5725~5850MHz
WIFI 802.11ac VHT40 (Band Edge @ 3m)

WIFI	Band 4 5725~5850MHz Band Edge @ 3m	
ANT	802.11ac VHT40 CH151 5755MHz	
2	Horizontal	Fundamental
Peak	 <p>Site : 03CH13-HY Condition : PEAK_BE(84)_16-24 3m HORN_91200_1241 HORIZONTAL Detector : Peak Project : 922214 Mode : 82 Power : 13</p>	 <p>Site : 03CH13-HY Condition : PEAK(UNIT) 3m HORN_91200_1241 HORIZONTAL Detector : Peak Project : 922214 Mode : 82 Power : 13</p>
Peak	 <p>Site : 03CH13-HY Condition : PEAK_BE(84)_16-24 3m HORN_91200_1241 HORIZONTAL Detector : Peak Project : 922214 Mode : 82 Power : 13</p>	Left blank



WIFI	Band 4 5725~5850MHz Band Edge @ 3m	
ANT	802.11ac VHT40 CH151 5755MHz	
2	Vertical	Fundamental
Peak	<p>Date: 2019-04-18 PEAK_BE(04)_16-24</p> <p>Site : 03CH13-HY Condition : PEAK_BE(04)_16-24 3m HORN_91200_1241 VERTICAL RBW:1000.000KHz VBW:3000.000KHz SWT:Auto Detector : Peak Project : 922214 Mode : 82 Power : 13</p>	<p>Date: 2019-04-18 PEAK(04)_16-24</p> <p>Site : 03CH13-HY Condition : PEAK(UNII) 3m HORN_91200_1241 VERTICAL RBW:1000.000KHz VBW:3000.000KHz SWT:Auto Detector : Peak Project : 922214 Mode : 82 Power : 13</p>
Peak	<p>Date: 2019-04-18 PEAK_BE(04)_16-24</p> <p>Site : 03CH13-HY Condition : PEAK_BE(04)_16-24 3m HORN_91200_1241 VERTICAL RBW:1000.000KHz VBW:3000.000KHz SWT:Auto Detector : Peak Project : 922214 Mode : 82 Power : 13</p>	Left blank



WIFI	Band 4 5725~5850MHz Band Edge @ 3m	
ANT	802.11ac VHT40 CH159 5795MHz	
2	Horizontal	Fundamental
Peak	<p>Site : 03CH13-HY Condition : PEAK_BE(B4)_16-24 3m HORN_91200_1241 HORIZONTAL Detector : Peak Project : 922214 Mode : 83 Power : 14</p>	<p>Site : 03CH13-HY Condition : PEAK(UNII) 3m HORN_91200_1241 HORIZONTAL Detector : Peak Project : 922214 Mode : 83 Power : 14</p>
Peak	<p>Site : 03CH13-HY Condition : PEAK_BE(B4)_16-24 3m HORN_91200_1241 HORIZONTAL Detector : Peak Project : 922214 Mode : 83 Power : 14</p>	Left blank



WIFI	Band 4 5725~5850MHz Band Edge @ 3m	
ANT	802.11ac VHT40 CH159 5795MHz	
2	Vertical	Fundamental
Peak	<p>Site : 03CH13-HY Condition : PEAK_BE(B4)_16-24 3m HORN_91200_1241 VERTICAL Detector : Peak Project : 922214 Mode : 83 Power : 14</p>	<p>Site : 03CH13-HY Condition : PEAK(UNII) 3m HORN_91200_1241 VERTICAL Detector : Peak Project : 922214 Mode : 83 Power : 14</p>
Peak	<p>Site : 03CH13-HY Condition : PEAK_BE(B4)_16-24 3m HORN_91200_1241 VERTICAL Detector : Peak Project : 922214 Mode : 83 Power : 14</p>	Left blank



Band 4 5725~5850MHz
WIFI 802.11ac VHT80 (Band Edge @ 3m)

WIFI	Band 4 5725~5850MHz Band Edge @ 3m	
ANT	802.11ac VHT80 CH155 5775MHz	
2	Horizontal	Fundamental
Peak	<p>Site : 03CH13-HY Condition : PEAK_BE(B4)_16-24 3m HORN_91200_1241 HORIZONTAL Detector : Peak Project : 922214 Mode : 84 Power : 14</p>	<p>Site : 03CH13-HY Condition : PEAK(UNIT) 3m HORN_91200_1241 HORIZONTAL Detector : Peak Project : 922214 Mode : 84 Power : 14</p>
Peak	<p>Site : 03CH13-HY Condition : PEAK_BE(B4)_16-24 3m HORN_91200_1241 HORIZONTAL Detector : Peak Project : 922214 Mode : 84 Power : 14</p>	Left blank



WIFI	Band 4 5725~5850MHz Band Edge @ 3m	
ANT	802.11ac VHT80 CH155 5775MHz	
2	Vertical	Fundamental
Peak	<p>Site : 03CH13-HY Condition : PEAK_BE(B4)_16-24 3m HORN_91200_1241 VERTICAL Detector : Peak Project : 922214 Mode : 84 Power : 14</p>	<p>Site : 03CH13-HY Condition : PEAK(UNII) 3m HORN_91200_1241 VERTICAL Detector : Peak Project : 922214 Mode : 84 Power : 14</p>
Peak	<p>Site : 03CH13-HY Condition : PEAK_BE(B4)_16-24 3m HORN_91200_1241 VERTICAL Detector : Peak Project : 922214 Mode : 84 Power : 14</p>	Left blank



Band 4 - 5725~5850MHz
WIFI 802.11a (Harmonic @ 3m)

WIFI	Band 4 5725~5850MHz Harmonic @ 3m	
ANT	802.11a CH149 5745MHz	
2	Horizontal	Vertical
Peak Avg.	<p>Site : 03CH13-1F Condition : PEAK(UNII) 3m HORN_91200_1241 HORIZONTAL Detector : Peak Project : 922214 Mode : 76 Power : 14</p>	<p>Site : 03CH13-1F Condition : PEAK(UNII) 3m HORN_91200_1241 VERTICAL Detector : Peak Project : 922214 Mode : 76 Power : 14</p>

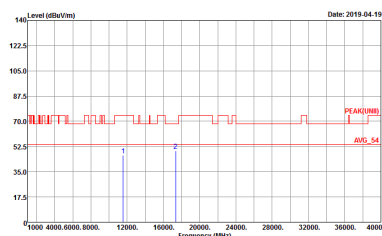

WIFI	Band 4 5725~5850MHz Harmonic @ 3m	
ANT	802.11a CH157 5785MHz	
2	Horizontal	Vertical
<p>Peak</p> <p>Avg.</p>	 <p>Site : 03CH12-HY Condition : PEAK(UNII) 3m HORN_91200_1241 HORIZONTAL Detector : Peak Project : 922214 Mode : 77 Power : 14</p>	 <p>Site : 03CH12-HY Condition : PEAK(UNII) 3m HORN_91200_1241 VERTICAL Detector : Peak Project : 922214 Mode : 77 Power : 14</p>



WIFI	Band 4 5725~5850MHz Harmonic @ 3m	
ANT	802.11a CH165 5825MHz	
2	Horizontal	Vertical
<p>Peak</p> <p>Avg.</p>	<p>Site : 03CH12-HY Condition : PEAK(UNII) 3m HORN_91200_1241 HORIZONTAL Detector : Peak Project : 922214 Mode : 79 Power : 14</p>	<p>Site : 03CH12-HY Condition : PEAK(UNII) 3m HORN_91200_1241 VERTICAL Detector : Peak Project : 922214 Mode : 79 Power : 14</p>



**Band 4 5725~5850MHz
WIFI 802.11ac VHT20 (Harmonic @ 3m)**

WIFI	Band 4 5725~5850MHz Harmonic @ 3m	
ANT	802.11ac VHT20 CH149 5745MHz	
2	Horizontal	Vertical
Peak Avg.	<p>Site : 03CH13-HY Condition : PEAK(UNII) 3m HORN_91200_1241 HORIZONTAL Detector : Peak Project : 922214 Mode : 79 Power : 14</p>	<p>Site : 03CH13-HY Condition : PEAK(UNII) 3m HORN_91200_1241 VERTICAL Detector : Peak Project : 922214 Mode : 79 Power : 14</p>



WIFI	Band 4 5725~5850MHz Harmonic @ 3m	
ANT	802.11ac VHT20 CH157 5785MHz	
2	Horizontal	Vertical
Peak Avg.	<p>Site : 03CH12-HY Condition : PEAK(UNII) 3m HORN_91200_1241 HORIZONTAL Detector : Peak Project : 922214 Mode : 80 Power : 14</p>	<p>Site : 03CH12-HY Condition : PEAK(UNII) 3m HORN_91200_1241 VERTICAL Detector : Peak Project : 922214 Mode : 80 Power : 14</p>

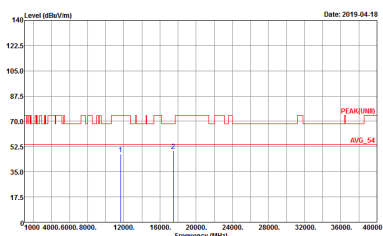
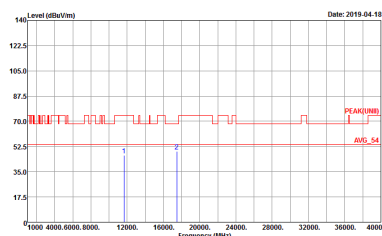

WIFI	Band 4 5725~5850MHz Harmonic @ 3m	
ANT	802.11ac VHT20 CH165 5825MHz	
2	Horizontal	Vertical
Peak Avg.	 <p>Site : 03CH12-HY Condition : PEAK(UNII) 3m HORN_91200_1241 HORIZONTAL Detector : Peak Project : 922214 Mode : 81 Power : 14</p>	 <p>Site : 03CH12-HY Condition : PEAK(UNII) 3m HORN_91200_1241 VERTICAL Detector : Peak Project : 922214 Mode : 81 Power : 14</p>



**Band 4 5725~5850MHz
WIFI 802.11ac VHT40 (Harmonic @ 3m)**

WIFI	Band 4 5725~5850MHz Harmonic @ 3m	
ANT	802.11ac VHT40 CH151 5755MHz	
2	Horizontal	Vertical
Peak Avg.	<p>Site : 03CH13-HY Condition : PEAK(UNII) 3m HORN_91200_1241 HORIZONTAL Detector : Peak Project : 922214 Mode : 82 Power : 13</p>	<p>Site : 03CH13-HY Condition : PEAK(UNII) 3m HORN_91200_1241 VERTICAL Detector : Peak Project : 922214 Mode : 82 Power : 13</p>



WIFI	Band 4 5725~5850MHz Harmonic @ 3m	
ANT	802.11ac VHT40 CH159 5795MHz	
2	Horizontal	Vertical
<p>Peak</p> <p>Avg.</p>	<p>Site : 03CH12-HY Condition : PEAK(UNII) 3m HORN_91200_1241 HORIZONTAL Detector : Peak Project : 922214 Mode : 83 Power : 14</p>	<p>Site : 03CH12-HY Condition : PEAK(UNII) 3m HORN_91200_1241 VERTICAL Detector : Peak Project : 922214 Mode : 83 Power : 14</p>



Band 4 5725~5850MHz
WIFI 802.11ac VHT80 (Harmonic @ 3m)

WIFI	Band 4 5725~5850MHz Harmonic @ 3m	
ANT	802.11ac VHT80 CH155 5775MHz	
2	Horizontal	Vertical
Peak Avg.	<p>Site : 03CH13-HY Condition : PEAK(UNII) 3m HORN_91200_1241 HORIZONTAL Detector : Peak Project : 922214 Mode : 84 Power : 14</p>	<p>Site : 03CH13-HY Condition : PEAK(UNII) 3m HORN_91200_1241 VERTICAL Detector : Peak Project : 922214 Mode : 84 Power : 14</p>



**Emission below 1GHz
5GHz WIFI 802.11ac VHT80 (LF)**

WIFI	5GHz 5725-5850MHz	
ANT	802.11ac VHT80 LF	
2	Horizontal	Vertical
QP / Peak	<p>Site : 03CH13-HY Condition : QP 3m B1LOG_37059A01 HORIZONTAL Detector : Peak Project : 922214 Mode : 160</p>	<p>Site : 03CH13-HY Condition : QP 3m B1LOG_37059A01 VERTICAL Detector : Peak Project : 922214 Mode : 160</p>



Band 4 - 5725~5850MHz
WIFI 802.11a (Band Edge @ 3m)

WIFI	Band 4 5725~5850MHz Band Edge @ 3m	
ANT	802.11a CH149 5745MHz	
1+2	Horizontal	Fundamental
Peak	<p> Site : 03CH13-HY Condition : PEAK_BE(B4)_16-24 3m HORN_91200_1241 HORIZONTAL Detector : Peak Project : 922214 Mode : 147 Power : 14 </p>	<p> Site : 03CH13-HY Condition : PEAK(UNII) 3m HORN_91200_1241 HORIZONTAL Detector : Peak Project : 922214 Mode : 147 Power : 14 </p>



WIFI	Band 4 5725~5850MHz Band Edge @ 3m	
ANT	802.11a CH149 5745MHz	
1+2	Vertical	Fundamental
Peak	<p>Date: 2019-04-06 PEAK: 125.21</p> <p>Site : 03CH13-HY Condition : PEAK_BE(84)_16-24 3m HORN_91200_1241 VERTICAL RBW:1000.000KHz VBW:3000.000KHz SWT:Auto Detector : Peak Project : 922214 Mode : 147 Power : 14</p>	<p>Date: 2019-04-06 PEAK: 125.21</p> <p>Site : 03CH13-HY Condition : PEAK(UNII) 3m HORN_91200_1241 VERTICAL RBW:1000.000KHz VBW:3000.000KHz SWT:Auto Detector : Peak Project : 922214 Mode : 147 Power : 14</p>



WIFI	Band 4 5725~5850MHz Band Edge @ 3m	
ANT	802.11a CH157 5785MHz	
1+2	Horizontal	Fundamental
<p>Peak</p>	<p>Date: 2019-04-06 PEAK_BE(84)_16-24</p> <p>Site : 03CH13-HY Condition : PEAK_BE(84)_16-24 3m HORN_91200_1241 HORIZONTAL RBW:1000.000KHz VBW:3000.000KHz SWT:Auto Detector : Peak Project : 922214 Mode : 148 Power : 14</p>	<p>Date: 2019-04-06 PEAK_BE(84)_16-24</p> <p>Site : 03CH13-HY Condition : PEAK(UNII) 3m HORN_91200_1241 HORIZONTAL RBW:1000.000KHz VBW:3000.000KHz SWT:Auto Detector : Peak Project : 922214 Mode : 148 Power : 14</p>
<p>Peak</p>	<p>Date: 2019-04-06 PEAK_BE(84)_16-24</p> <p>Site : 03CH13-HY Condition : PEAK_BE(84)_16-24 3m HORN_91200_1241 HORIZONTAL RBW:1000.000KHz VBW:3000.000KHz SWT:Auto Detector : Peak Project : 922214 Mode : 148 Power : 14</p>	<p>Left blank</p>



WIFI	Band 4 5725~5850MHz Band Edge @ 3m	
ANT	802.11a CH157 5785MHz	
1+2	Vertical	Fundamental
Peak	<p>Site : 03CH13-HY Condition : PEAK_BE(B4)_16-24 3m HORN_91200_1241 VERTICAL RBW:1000.000KHz VBW:3000.000KHz SWT:Auto Detector : Peak Project : 922214 Mode : 148 Power : 14</p>	<p>Site : 03CH13-HY Condition : PEAK(UNII) 3m HORN_91200_1241 VERTICAL RBW:1000.000KHz VBW:3000.000KHz SWT:Auto Detector : Peak Project : 922214 Mode : 148 Power : 14</p>
Peak	<p>Site : 03CH13-HY Condition : PEAK_BE(B4)_16-24 3m HORN_91200_1241 VERTICAL RBW:1000.000KHz VBW:3000.000KHz SWT:Auto Detector : Peak Project : 922214 Mode : 148 Power : 14</p>	Left blank

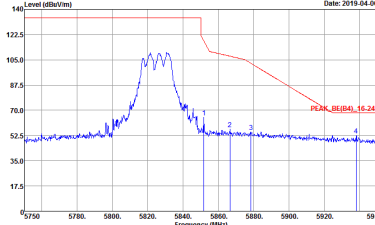
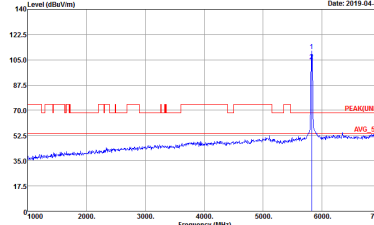

WIFI	Band 4 5725~5850MHz Band Edge @ 3m	
ANT	802.11a CH165 5825MHz	
1+2	Horizontal	Fundamental
Peak	 <p>Site : 03CH12-HY Condition : PEAK_BE(B4)_16-24 3m HORN_91200_1241 HORIZONTAL Detector : Peak Project : 922214 Mode : 149 Power : 14</p>	 <p>Site : 03CH12-HY Condition : PEAK(UNII) 3m HORN_91200_1241 HORIZONTAL Detector : Peak Project : 922214 Mode : 149 Power : 14</p>

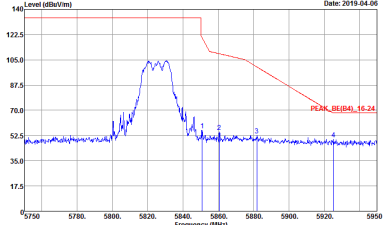
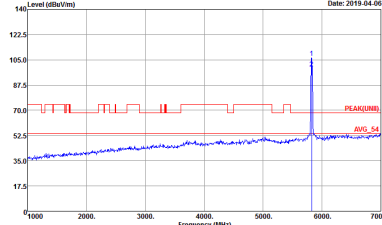

WIFI	Band 4 5725~5850MHz Band Edge @ 3m	
ANT	802.11a CH165 5825MHz	
1+2	Vertical	Fundamental
<p>Peak</p>	 <p>Site : 03CH12-HY Condition : PEAK_BE(B4)_16-24 3m HORN_91200_1241 VERTICAL Detector : Peak Project : 922214 Mode : 149 Power : 14</p>	 <p>Site : 03CH12-HY Condition : PEAK(UNII) 3m HORN_91200_1241 VERTICAL Detector : Peak Project : 922214 Mode : 149 Power : 14</p>



Band 4 5725~5850MHz
WIFI 802.11ac VHT20 (Band Edge @ 3m)

WIFI	Band 4 5725~5850MHz Band Edge @ 3m	
ANT	802.11ac VHT20 CH149 5745MHz	
1+2	Horizontal	Fundamental
Peak	<p>Site : 03CH13-HY Condition : PEAK_B8(B4)_16-24 3m HORN_91200_1241 HORIZONTAL RBW:3000.000KHz VBW:3000.000KHz SWT:Auto Detector : Peak Project : 922214 Mode : 150 Power : 14</p>	<p>Site : 03CH13-HY Condition : PEAK(UWB) 3m HORN_91200_1241 HORIZONTAL RBW:3000.000KHz VBW:3000.000KHz SWT:Auto Detector : Peak Project : 922214 Mode : 150 Power : 14</p>

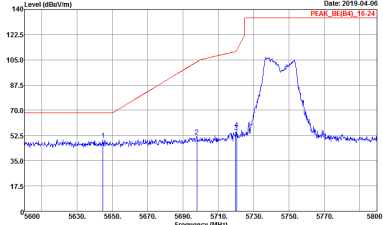
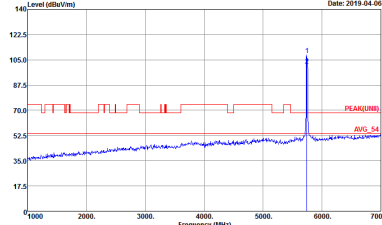

WIFI	Band 4 5725~5850MHz Band Edge @ 3m	
ANT	802.11ac VHT20 CH149 5745MHz	
1+2	Vertical	Fundamental
Peak Avg.	<div style="display: flex; justify-content: space-around;"> <div style="width: 45%;">  <p>Site : 03CH13-HY Condition : PEAK_BE(B4)_16-24 3m HORN_91200_1241 VERTICAL Detector : Peak Project : 922214 Mode : 150 Power : 14</p> </div> <div style="width: 45%;">  <p>Site : 03CH13-HY Condition : PEAK(UNII) 3m HORN_91200_1241 VERTICAL Detector : Peak Project : 922214 Mode : 150 Power : 14</p> </div> </div>	



WIFI	Band 4 5725~5850MHz Band Edge @ 3m	
ANT	802.11ac VHT20 CH157 5785MHz	
1+2	Horizontal	Fundamental
<p>Peak</p>	<p>Site : 03CH13-HY Condition : PEAK_BE(B4)_16-24 3m HORN_91200_1241 HORIZONTAL Detector : Peak Project : 922214 Mode : 151 Power : 14</p>	<p>Site : 03CH13-HY Condition : PEAK(UNII) 3m HORN_91200_1241 HORIZONTAL Detector : Peak Project : 922214 Mode : 151 Power : 14</p>
<p>Peak</p>	<p>Site : 03CH13-HY Condition : PEAK_BE(B4)_16-24 3m HORN_91200_1241 HORIZONTAL Detector : Peak Project : 922214 Mode : 151 Power : 14</p>	<p>Left blank</p>



WIFI	Band 4 5725~5850MHz Band Edge @ 3m	
ANT	802.11ac VHT20 CH157 5785MHz	
1+2	Vertical	Fundamental
Peak	<p>Date: 2019-04-06 PEAK_BE(04)_16-24</p> <p>Site : 03CH13-HY Condition : PEAK_BE(04)_16-24 3m HORN_91200_1241 VERTICAL RBW:1000.000KHz VBW:3000.000KHz SWT:Auto Detector : Peak Project : 922214 Mode : 151 Power : 14</p>	<p>Date: 2019-04-06 PEAK(04)_16-24</p> <p>Site : 03CH13-HY Condition : PEAK(UNII) 3m HORN_91200_1241 VERTICAL RBW:1000.000KHz VBW:3000.000KHz SWT:Auto Detector : Peak Project : 922214 Mode : 151 Power : 14</p>
Peak	<p>Date: 2019-04-06 PEAK_BE(04)_16-24</p> <p>Site : 03CH13-HY Condition : PEAK_BE(04)_16-24 3m HORN_91200_1241 VERTICAL RBW:1000.000KHz VBW:3000.000KHz SWT:Auto Detector : Peak Project : 922214 Mode : 151 Power : 14</p>	Left blank



WIFI	Band 4 5725~5850MHz Band Edge @ 3m	
ANT	802.11ac VHT20 CH165 5825MHz	
1+2	Horizontal	Fundamental
Peak	<p>Site : 03CH13-HY Condition : PEAK_BE(B4)_16-24 3m HORN_91200_1241 HORIZONTAL Detector : Peak Project : 922214 Mode : 152 Power : 14</p>	<p>Site : 03CH13-HY Condition : PEAK(UNII) 3m HORN_91200_1241 HORIZONTAL Detector : Peak Project : 922214 Mode : 152 Power : 14</p>

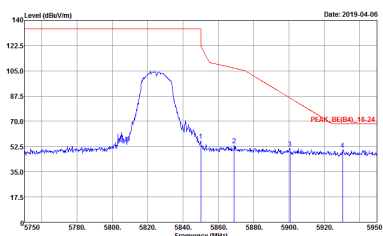
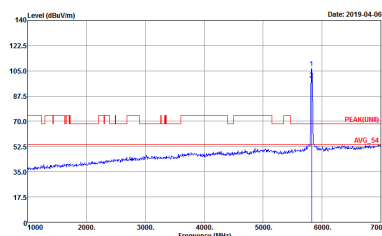

WIFI	Band 4 5725~5850MHz Band Edge @ 3m	
ANT	802.11ac VHT20 CH165 5825MHz	
1+2	Vertical	Fundamental
<p>Peak</p> <p>Avg.</p>	 <p>Site : 03CH12-HY Condition : PEAK_BE(B4)_16-24 3m HORN_91200_1241 VERTICAL Detector : Peak Project : 922214 Mode : 152 Power : 14</p>	 <p>Site : 03CH12-HY Condition : PEAK(UNII) 3m HORN_91200_1241 VERTICAL Detector : Peak Project : 922214 Mode : 152 Power : 14</p>



Band 4 5725~5850MHz
WIFI 802.11ac VHT40 (Band Edge @ 3m)

WIFI	Band 4 5725~5850MHz Band Edge @ 3m	
ANT	802.11ac VHT40 CH151 5755MHz	
1+2	Horizontal	Fundamental
Peak	<p>Site : 03CH13-HY Condition : PEAK_BE(84)_16-24 3m HORN_91200_1241 HORIZONTAL Detector : Peak Project : 922214 Mode : 153 Power : 14</p>	<p>Site : 03CH13-HY Condition : PEAK(UNIT) 3m HORN_91200_1241 HORIZONTAL Detector : Peak Project : 922214 Mode : 153 Power : 14</p>
Peak	<p>Site : 03CH13-HY Condition : PEAK_BE(84)_16-24 3m HORN_91200_1241 HORIZONTAL Detector : Peak Project : 922214 Mode : 153 Power : 14</p>	Left blank



WIFI	Band 4 5725~5850MHz Band Edge @ 3m	
ANT	802.11ac VHT40 CH151 5755MHz	
1+2	Vertical	Fundamental
<p>Peak</p>	<p>Site : 03CH13-HY Condition : PEAK_BE(B4)_16-24 3m HORN_91200_1241 VERTICAL Detector : Peak Project : 922214 Mode : 153 Power : 14</p>	<p>Site : 03CH13-HY Condition : PEAK(UNII) 3m HORN_91200_1241 VERTICAL Detector : Peak Project : 922214 Mode : 153 Power : 14</p>
<p>Peak</p>	<p>Site : 03CH13-HY Condition : PEAK_BE(B4)_16-24 3m HORN_91200_1241 VERTICAL Detector : Peak Project : 922214 Mode : 153 Power : 14</p>	<p>Left blank</p>



WIFI	Band 4 5725~5850MHz Band Edge @ 3m	
ANT	802.11ac VHT40 CH159 5795MHz	
1+2	Horizontal	Fundamental
<p>Peak</p>	<p>Date: 2019-04-06 PEAK_BE(84)_16-24</p> <p>Site : 03CH13-HY Condition : PEAK_BE(84)_16-24 3m HORN_91200_1241 HORIZONTAL Detector : Peak Project : 922214 Mode : 154 Power : 14</p>	<p>Date: 2019-04-06 PEAK(84)_16-24</p> <p>Site : 03CH13-HY Condition : PEAK(UNII) 3m HORN_91200_1241 HORIZONTAL Detector : Peak Project : 922214 Mode : 154 Power : 14</p>
<p>Peak</p>	<p>Date: 2019-04-06 PEAK_BE(84)_16-24</p> <p>Site : 03CH13-HY Condition : PEAK_BE(84)_16-24 3m HORN_91200_1241 HORIZONTAL Detector : Peak Project : 922214 Mode : 154 Power : 14</p>	<p>Left blank</p>



WIFI	Band 4 5725~5850MHz Band Edge @ 3m	
ANT	802.11ac VHT40 CH159 5795MHz	
1+2	Vertical	Fundamental
<p>Peak</p>	<p>Site : 03CH13-HY Condition : PEAK_BE(B4)_16-24 3m HORN_91200_1241 VERTICAL Detector : Peak Project : 922214 Mode : 154 Power : 14</p>	<p>Site : 03CH13-HY Condition : PEAK(UNII) 3m HORN_91200_1241 VERTICAL Detector : Peak Project : 922214 Mode : 154 Power : 14</p>
<p>Peak</p>	<p>Site : 03CH13-HY Condition : PEAK_BE(B4)_16-24 3m HORN_91200_1241 VERTICAL Detector : Peak Project : 922214 Mode : 154 Power : 14</p>	<p>Left blank</p>

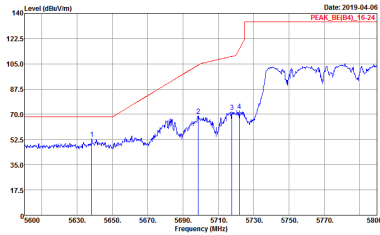
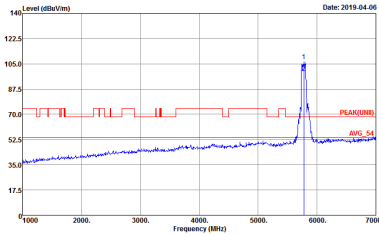
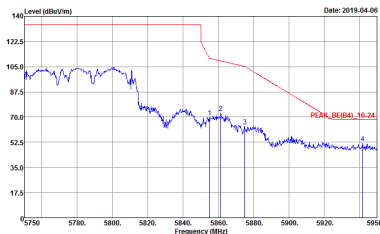

Band 4 5725~5850MHz
WIFI 802.11ac VHT80 (Band Edge @ 3m)

WIFI	Band 4 5725~5850MHz Band Edge @ 3m	
ANT	802.11ac VHT80 CH155 5775MHz	
1+2	Horizontal	Fundamental
Peak	 <p>Site : 03CH13-HY Condition : PEAK_BE(B4)_16-24 3m HORN_91200_1241 HORIZONTAL RBW:1000.000KHz VBW:3000.000KHz SWT:Auto Detector : Peak Project : 922214 Mode : 155 Power : 14</p>	 <p>Site : 03CH13-HY Condition : PEAK(UNIT) 3m HORN_91200_1241 HORIZONTAL RBW:1000.000KHz VBW:3000.000KHz SWT:Auto Detector : Peak Project : 922214 Mode : 155 Power : 14</p>
Peak	 <p>Site : 03CH13-HY Condition : PEAK_BE(B4)_16-24 3m HORN_91200_1241 HORIZONTAL RBW:1000.000KHz VBW:3000.000KHz SWT:Auto Detector : Peak Project : 922214 Mode : 155 Power : 14</p>	Left blank



WIFI	Band 4 5725~5850MHz Band Edge @ 3m	
ANT	802.11ac VHT80 CH155 5775MHz	
1+2	Vertical	Fundamental
Peak	<p>Date: 2019-04-06 PEAK_BE(04)_15-21</p> <p>Site : 03CH13-HY Condition : PEAK_BE(04)_16-24 3m HORN_91200_1241 VERTICAL RBW:1000.000KHz VBW:3000.000KHz SWT:Auto Detector : Peak Project : 922214 Mode : 155 Power : 14</p>	<p>Date: 2019-04-06 PEAK(04)_15-21</p> <p>Site : 03CH13-HY Condition : PEAK(UNII) 3m HORN_91200_1241 VERTICAL RBW:1000.000KHz VBW:3000.000KHz SWT:Auto Detector : Peak Project : 922214 Mode : 155 Power : 14</p>
Peak	<p>Date: 2019-04-06 PEAK_BE(04)_16-24</p> <p>Site : 03CH13-HY Condition : PEAK_BE(04)_16-24 3m HORN_91200_1241 VERTICAL RBW:1000.000KHz VBW:3000.000KHz SWT:Auto Detector : Peak Project : 922214 Mode : 155 Power : 14</p>	Left blank



Band 4 - 5725~5850MHz
WIFI 802.11a (Harmonic @ 3m)

WIFI	Band 4 5725~5850MHz Harmonic @ 3m	
ANT	802.11a CH149 5745MHz	
1+2	Horizontal	Vertical
Peak Avg.	<p>Site : 03CH13-1F Condition : PEAK(UNII) 3m HORN_91200_1241 HORIZONTAL Detector : Peak Project : 922214 Mode : 147 Power : 14</p>	<p>Site : 03CH13-1F Condition : PEAK(UNII) 3m HORN_91200_1241 VERTICAL Detector : Peak Project : 922214 Mode : 147 Power : 14</p>

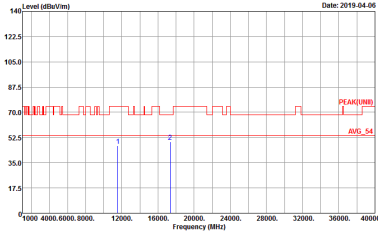
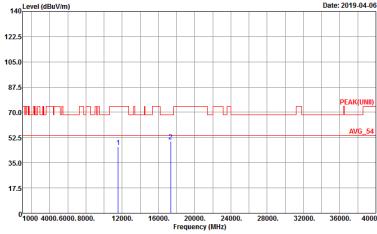

WIFI	Band 4 5725~5850MHz Harmonic @ 3m	
ANT	802.11a CH157 5785MHz	
1+2	Horizontal	Vertical
Peak Avg.	 <p>Site : 03CH12-HY Condition : PEAK(UNII) 3m HORN_91200_1241 HORIZONTAL Detector : Peak Project : 922214 Mode : 146 Power : 14</p>	 <p>Site : 03CH12-HY Condition : PEAK(UNII) 3m HORN_91200_1241 VERTICAL Detector : Peak Project : 922214 Mode : 146 Power : 14</p>



WIFI	Band 4 5725~5850MHz Harmonic @ 3m	
ANT	802.11a CH165 5825MHz	
1+2	Horizontal	Vertical
Peak Avg.	<p>Site : 03CH12-HV Condition : PEAK(UNII) 3m HORN_91200_1241 HORIZONTAL Detector : Peak Project : 922214 Mode : 149 Power : 14</p>	<p>Site : 03CH12-HV Condition : PEAK(UNII) 3m HORN_91200_1241 VERTICAL Detector : Peak Project : 922214 Mode : 149 Power : 14</p>