



FCC RADIO TEST REPORT

FCC ID : UZ7RTL10B1
Equipment : Tablet
Brand Name : Zebra
Model Name : RTL10B1
Applicant : Zebra Technologies Corporation
1 Zebra Plaza, Holtsville, NY 11742
Manufacturer : Zebra Technologies Corporation
1 Zebra Plaza, Holtsville, NY 11742
Standard : FCC Part 15 Subpart C §15.247

The product was received on Feb. 22, 2019 and testing was started from Mar. 19, 2019 and completed on May 06, 2019. We, SPORTON INTERNATIONAL INC., EMC & Wireless Communications Laboratory, would like to declare that the tested sample has been evaluated in accordance with the test procedures and has been in compliance with the applicable technical standards.

The report must not be used by the client to claim product certification, approval, or endorsement by TAF or any agency of government.

The test results in this report apply exclusively to the tested model / sample. Without written approval of SPORTON INTERNATIONAL INC. EMC & Wireless Communications Laboratory, the test report shall not be reproduced except in full.

Approved by: Jones Tsai

SPORTON INTERNATIONAL INC. EMC & Wireless Communications Laboratory
No. 52, Huaya 1st Rd., Guishan Dist., Taoyuan City, Taiwan (R.O.C.)



Table of Contents

History of this test report..... 3

Summary of Test Result..... 4

1 General Description 5

 1.1 Product Feature of Equipment Under Test..... 5

 1.2 Product Specification of Equipment Under Test..... 7

 1.3 Modification of EUT 8

 1.4 Testing Location 8

 1.5 Applicable Standards..... 9

2 Test Configuration of Equipment Under Test 10

 2.1 Carrier Frequency and Channel 10

 2.2 Test Mode..... 11

 2.3 Connection Diagram of Test System..... 16

 2.4 Support Unit used in test configuration and system 17

 2.5 EUT Operation Test Setup 18

 2.6 Measurement Results Explanation Example..... 18

3 Test Result 19

 3.1 6dB and 99% Bandwidth Measurement 19

 3.2 Output Power Measurement..... 23

 3.3 Power Spectral Density Measurement 26

 3.4 Conducted Band Edges and Spurious Emission Measurement 32

 3.5 Radiated Band Edges and Spurious Emission Measurement 93

 3.6 AC Conducted Emission Measurement..... 98

 3.7 Antenna Requirements 100

4 List of Measuring Equipment..... 102

5 Uncertainty of Evaluation 105

Appendix A. AC Conducted Emission Test Result

Appendix B. Radiated Spurious Emission

Appendix C. Radiated Spurious Emission Plots

Appendix D. Duty Cycle Plots

Appendix E. Setup Photographs



Summary of Test Result

Report Clause	Ref Std. Clause	Test Items	Result (PASS/FAIL)	Remark
3.1	15.247(a)(2)	6dB Bandwidth	Pass	-
3.1	2.1049	99% Occupied Bandwidth	Reporting only	-
3.2	15.247(b)	Power Output Measurement	Pass	-
3.3	15.247(e)	Power Spectral Density	Pass	-
3.4	15.247(d)	Conducted Band Edges	Pass	-
		Conducted Spurious Emission	Pass	-
3.5	15.247(d)	Radiated Band Edges and Radiated Spurious Emission	Pass	Under limit 1.03 dB at 2483.690 MHz
3.6	15.207	AC Conducted Emission	Pass	Under limit 5.67 dB at 13.560 MHz
3.7	15.203 & 15.247(b)	Antenna Requirement	Pass	-

Declaration of Conformity:

The test results with all measurement uncertainty excluded are presented in accordance with the regulation limits or requirements declared by manufacturers.

Comments and Explanations:

The declared of product specification for EUT presented in the report are provided by the manufacturer, and the manufacturer takes all the responsibilities for the accuracy of product specification.

Reviewed by: Wii Chang

Report Producer: Elise Chang



1 General Description

1.1 Product Feature of Equipment Under Test

Product Feature	
Equipment	Tablet
Brand Name	Zebra
Model Name	RTL10B1
FCC ID	UZ7RTL10B1
Sample 1	EUT with SKU 1 + Keyboard
Sample 2	EUT with SKU 1
Sample 3	EUT with SKU 2
Sample 4	EUT with SKU 3
Sample 5	EUT with SKU 4
EUT supports Radios application	WCDMA/HSPA/LTE/NFC/GNSS WLAN 11a/b/g/n HT20/HT40 WLAN 11ac VHT20/VHT40/VHT80 Bluetooth BR/EDR/LE
HW Version	DV0
SW Version	Android version 8.1.0
FW Version - Xpad	01-17-09.00-OG-U00-PLT
FW Version - Xslate	01-17-05.00-OG-U00-PRD
FW Version - Xbook	01-17-05.00-OG-U00-PRD
MFD - Xpad	19MAR01
MFD - Xslate	19MAR01
MFD - Xbook	19MAR01
EUT Stage	Identical Prototype

Remark: The above EUT's information was declared by manufacturer.

Specification of Accessories				
AC Adapter	Brand Name	Delta	Model Name	ADP-65JH HB
Spare Standard Battery 36Whr	Brand Name	XPLORE	Model Name	XLBM1
Keyboard dock	Brand Name	XPLORE	Model Name	LX-KB
Touch Pen	Brand Name	WACOM	Model Name	CP-903-05B-2
Touch Pen	Brand Name	EMPIA	Model Name	EPNB-8C1000-0000 40820A01
Touch Pen	Brand Name	HAO SHUAN	Model Name	440007



<Sample Information>

	Sample 1	Sample 2	Sample 3	Sample 4	Sample 5
DV0	SKU 1+ Keyboard	L10A - SKU1	L10A - SKU2	L10A - SKU3	L10A - SKU4
ID	Xbook	XSLATE	XPAD	XPAD	XPAD
OS	Refer Xslate	Android O	Android O	Android O	Android O
CPU		Qualcomm SDM660	Qualcomm SDM660	Qualcomm SDM660	Qualcomm SDM660
Display with touch		Panasonic EP101R1912N50 OTG 10.1" LCD (500nits)	Panasonic EP101R1912N50 OTG 10.1" LCD (500nits)	Panasonic EP101R1912N50 OTG 10.1" LCD (1000nits)	Panasonic EP101R1912N50 OTG 10.1" LCD (1000nits) with digitizer
Memory		Samsung LPDDR4 4GB Hynix LPDD4 4 GB	Samsung LPDDR4 4GB Hynix LPDD4 4 GB	Samsung LPDDR4 4GB Micron LPDD4 4 GB	Samsung LPDDR4 4GB Micron LPDD4 4 GB
eMMC		TOSHIBA 64GB	TOSHIBA 64GB	TOSHIBA 64GB	TOSHIBA 64GB
GPS		Qualcomm	Qualcomm	Qualcomm	Qualcomm
WWAN		Qualcomm	Qualcomm	Qualcomm	Qualcomm
WLAN		Qualcomm WCN3990	Qualcomm WCN3990	Qualcomm WCN3990	Qualcomm WCN3990
Antenna		WLAN*2/NFC /GPS/WWAN*2	WLAN*2/NFC /GPS/WWAN*2	WLAN*2/NFC /GPS/WWAN*2	WLAN*2/NFC /GPS/WWAN*2
Barcode Reader		No	Yes	Yes	Yes
HDMI		No	No	Yes	No
Serial Port		No	Yes	No	No

1.2 Product Specification of Equipment Under Test

Standards-related Product Specification	
Tx/Rx Channel Frequency Range	2412 MHz ~ 2462 MHz
Maximum (Average) Output Power to antenna <CDD Mode>	<p><Ant. 1> 802.11b : 20.20 dBm (0.1047 W) 802.11g : 20.40 dBm (0.1096 W) 802.11n HT20 : 19.30 dBm (0.0851 W) 802.11n HT40 : 15.70 dBm (0.0372 W) 802.11ac VHT20 : 20.40 dBm (0.1096 W) 802.11ac VHT40 : 15.90 dBm (0.0389 W)</p> <p><Ant. 2> 802.11b : 20.30 dBm (0.1072 W) 802.11g : 20.10 dBm (0.1023 W) 802.11n HT20 : 19.40 dBm (0.0871 W) 802.11n HT40 : 15.50 dBm (0.0355 W) 802.11ac VHT20 : 20.10 dBm (0.1023 W) 802.11ac VHT40 : 15.70 dBm (0.0372 W)</p> <p><MIMO Ant. 1 + 2> 802.11b : 23.31 dBm (0.2143 W) 802.11g : 22.75 dBm (0.1884 W) 802.11n HT20 : 22.64 dBm (0.1837 W) 802.11n HT40 : 18.37 dBm (0.0687 W) 802.11ac VHT20 : 22.74 dBm (0.1879 W) 802.11ac VHT40 : 18.47 dBm (0.0703 W)</p>
Maximum (Average) Output Power to antenna <TXBF Mode>	<p><MIMO Ant. 1 + 2> 802.11ac VHT20 : 21.46 dBm (0.1400 W) 802.11ac VHT40 : 15.26 dBm (0.0336 W)</p>
99% Occupied Bandwidth <CDD Mode>	<p><Ant. 1> 802.11b : 13.20MHz 802.11g : 17.50MHz 802.11n HT20 : 18.50MHz 802.11n HT40 : 37.20MHz</p> <p><Ant. 2> 802.11b : 13.00MHz 802.11g : 17.60MHz 802.11n HT20 : 18.70MHz 802.11n HT40 : 37.20MHz</p> <p><MIMO Ant. 1> 802.11b : 13.75MHz 802.11g : 17.65MHz 802.11n HT20 : 18.70MHz 802.11n HT40 : 37.00MHz</p> <p><MIMO Ant. 2> 802.11b : 13.10MHz 802.11g : 17.20MHz 802.11n HT20 : 18.35MHz 802.11n HT40 : 37.10MHz</p>
99% Occupied Bandwidth <TXBF Mode>	<p><MIMO Ant. 1> 802.11n VHT20 : 18.15MHz 802.11n VHT40 : 37.10MHz</p> <p><MIMO Ant. 2> 802.11n VHT20 : 18.15MHz 802.11n VHT40 : 37.20MHz</p>



Standards-related Product Specification			
Antenna Type / Gain	<Ant. 1> PIFA Antenna with gain -0.21 dBi <Ant. 2> PIFA Antenna with gain -2.29 dBi		
Type of Modulation	802.11b : DSSS (DBPSK / DQPSK / CCK) 802.11g/n : OFDM (BPSK / QPSK / 16QAM / 64QAM) 802.11ac: OFDM (BPSK / QPSK / 16QAM / 64QAM / 256QAM)		
Antenna Function Description		Ant. 1	Ant. 2
	802.11 b/g/n/ac	V	V
	802.11 b/g/n/ac MIMO	V	V
	802.11 ac TXBF	V	V

Note: MIMO Ant. 1+2 is a calculated result from sum of the power MIMO Ant. 1 and MIMO Ant. 2.

1.3 Modification of EUT

No modifications are made to the EUT during all test items.

1.4 Testing Location

Test Site	SPORTON INTERNATIONAL INC.	
Test Site Location	No.52, Huaya 1st Rd., Guishan Dist., Taoyuan City, Taiwan (R.O.C.) TEL: +886-3-327-3456 FAX: +886-3-328-4978	
Test Site No.	Sporton Site No.	
	TH05-HY	CO05-HY

Note: The test site complies with ANSI C63.4 2014 requirement.

Test Site	SPORTON INTERNATIONAL INC.	
Test Site Location	No.58, Aly. 75, Ln. 564, Wenhua 3rd, Rd., Guishan Dist., Taoyuan City, Taiwan (R.O.C.) TEL: +886-3-327-0868 FAX: +886-3-327-0855	
Test Site No.	Sporton Site No.	
	03CH15-HY	

Note: The test site complies with ANSI C63.4 2014 requirement.

FCC designation No.: TW1190 and TW0007



1.5 Applicable Standards

According to the specifications of the manufacturer, the EUT must comply with the requirements of the following standards:

- ♦ FCC Part 15 Subpart C §15.247
- ♦ FCC KDB Publication No. 558074 D01 DTS Meas. Guidance v05r02
- ♦ FCC KDB 414788 D01 Radiated Test Site v01r01.
- ♦ FCC KDB 662911 D01 Multiple Transmitter Output v02r01.
- ♦ ANSI C63.10-2013

Remark:

1. All test items were verified and recorded according to the standards and without any deviation during the test.
2. This EUT has also been tested and complied with the requirements of FCC Part 15, Subpart B, recorded in a separate test report.



2 Test Configuration of Equipment Under Test

- a. The EUT has been associated with peripherals and configuration operated in a manner tended to maximize its emission characteristics in a typical application. Frequency range investigated: conduction emission (150 kHz to 30 MHz), radiation emission (9 kHz to the 10th harmonic of the highest fundamental frequency or to 40 GHz, whichever is lower). For radiated measurement, pre-scanned in three orthogonal panels, X, Y, Z. The worst cases (CDD Mode: Y plane for XPAD and X plane with Ant. 2, Y plane with Ant. 1 & MIMO Ant. 1+2 for XSLATE and TXBF Mode: X plane) were recorded in this report.

- b. AC power line Conducted Emission was tested under maximum output power.

2.1 Carrier Frequency and Channel

Frequency Band	Channel	Freq. (MHz)	Channel	Freq. (MHz)
2400-2483.5 MHz	1	2412	7	2442
	2	2417	8	2447
	3	2422	9	2452
	4	2427	10	2457
	5	2432	11	2462
	6	2437		



2.2 Test Mode

Final test modes are considering the modulation and worse data rates as below table.

Single Mode

Modulation	Data Rate
802.11b	1 Mbps
802.11g	6 Mbps
802.11n HT20 (Covered by VHT20)	MCS0
802.11n HT40 (Covered by VHT40)	MCS0
802.11ac VHT20	MCS0
802.11ac VHT40	MCS0

MIMO Mode

Modulation	Data Rate
802.11b	1 Mbps
802.11g	6 Mbps
802.11n HT20 (Covered by VHT20)	MCS0
802.11n HT40 (Covered by VHT40)	MCS0
802.11ac VHT20	MCS0
802.11ac VHT40	MCS0

TXBF Mode

Modulation	Data Rate
802.11ac VHT20	MCS0
802.11ac VHT40	MCS0

Test Cases	
AC Conducted Emission	Mode 1 :LTE Band 12 Idle + WLAN (2.4GHz) Link + Bluetooth Link + NFC Idle + Bar Code Scanner + AC Adapter + USB (Type C) with LCD Monitor + SD Card (Data Link) (eMMC to SD Card) + RJ45 Load with AP + Touch Pen (CP-903-05B-2) + HDMI in with Notebook for Sample 4
Remark:	
<ol style="list-style-type: none"> For Radiated Test Cases, the tests were performed with Sample2 and Sample5. Data Link with Notebook means data application transferred mode between EUT and Notebook. HDMI Cable means media application transferred between EUT and external display. 	



<CDD Mode>

<Ant. 1>

802.11b RF Avg Output Power (dBm)						
Power vs. Channel			Power vs Data Rate			
Channel	Frequency (MHz)	Data Rate (bps)	Channel	Data Rate (bps)		
		1M		2M	5.5M	11M
CH 01	2412	20.00	CH 06	20.10	20.10	19.80
CH 06	2437	20.20				
CH 11	2462	20.10				

802.11g RF Avg Output Power (dBm)										
Power vs. Channel			Power vs Data Rate							
Channel	Frequency (MHz)	Data Rate (bps)	Channel	Data Rate (bps)						
		6M		9Mbps	12Mbps	18Mbps	24Mbps	36Mbps	48Mbps	54Mbps
CH 01	2412	14.80	CH 06	20.30	20.30	20.30	20.00	20.00	20.00	20.00
CH 06	2437	20.40								
CH 11	2462	14.80								

802.11n HT20 RF Avg Output Power (dBm)										
Power vs. Channel			Power vs Data Rate							
Channel	Frequency (MHz)	MCS Index	Channel	MCS Index						
		MCS 0		MCS 1	MCS 2	MCS 3	MCS 4	MCS 5	MCS 6	MCS 7
CH 01	2412	13.40	CH 06	19.20	19.20	19.20	18.90	18.90	18.90	18.90
CH 06	2437	19.30								
CH 11	2462	14.50								

802.11n HT40 RF Avg Output Power (dBm)										
Power vs. Channel			Power vs Data Rate							
Channel	Frequency (MHz)	MCS Index	Channel	MCS Index						
		MCS 0		MCS 1	MCS 2	MCS 3	MCS 4	MCS 5	MCS 6	MCS 7
CH 03	2422	12.80	CH 06	15.60	15.60	15.60	15.30	15.30	15.30	15.30
CH 06	2437	15.70								
CH 09	2452	11.10								

802.11ac VHT20 RF Avg Output Power (dBm)										
Power vs. Channel			Power vs Data Rate							
Channel	Frequency (MHz)	MCS Index	Channel	MCS Index						
		MCS 0		MCS 1	MCS 2	MCS 3	MCS 4	MCS 5	MCS 6	MCS 7
CH 01	2412	13.50	CH 06	20.30	20.30	20.30	20.00	20.00	20.00	20.00
CH 06	2437	20.40								
CH 11	2462	14.60								

802.11ac VHT40 RF Avg Output Power (dBm)											
Power vs. Channel			Power vs Data Rate								
Channel	Frequency (MHz)	MCS Index	Channel	MCS Index							
		MCS 0		MCS 1	MCS 2	MCS 3	MCS 4	MCS 5	MCS 6	MCS 7	MCS 8
CH 03	2422	12.90	CH 06	15.80	15.80	15.80	15.80	15.50	15.50	15.50	15.50
CH 06	2437	15.90									
CH 09	2452	11.20									



<Ant. 2>

802.11b RF Avg Output Power (dBm)						
Power vs. Channel			Power vs Data Rate			
Channel	Frequency (MHz)	Data Rate (bps)	Channel	Data Rate (bps)		
		1M		2M	5.5M	11M
CH 01	2412	20.10	CH 06	20.20	20.20	19.90
CH 06	2437	20.30				
CH 11	2462	20.10				

802.11g RF Avg Output Power (dBm)										
Power vs. Channel			Power vs Data Rate							
Channel	Frequency (MHz)	Data Rate (bps)	Channel	Data Rate (bps)						
		6M		9Mbps	12Mbps	18Mbps	24Mbps	36Mbps	48Mbps	54Mbps
CH 01	2412	14.70	CH 06	20.00	20.00	20.00	19.70	19.70	19.70	19.70
CH 06	2437	20.10								
CH 11	2462	14.80								

802.11n HT20 RF Avg Output Power (dBm)										
Power vs. Channel			Power vs Data Rate							
Channel	Frequency (MHz)	MCS Index	Channel	MCS Index						
		MCS 0		MCS 1	MCS 2	MCS 3	MCS 4	MCS 5	MCS 6	MCS 7
CH 01	2412	13.50	CH 06	19.30	19.30	19.30	19.00	19.00	19.00	19.00
CH 06	2437	19.40								
CH 11	2462	14.60								

802.11n HT40 RF Avg Output Power (dBm)										
Power vs. Channel			Power vs Data Rate							
Channel	Frequency (MHz)	MCS Index	Channel	MCS Index						
		MCS 0		MCS 1	MCS 2	MCS 3	MCS 4	MCS 5	MCS 6	MCS 7
CH 03	2422	12.60	CH 06	15.40	15.40	15.40	15.10	15.10	15.10	15.10
CH 06	2437	15.50								
CH 09	2452	11.30								

802.11ac VHT20 RF Avg Output Power (dBm)										
Power vs. Channel			Power vs Data Rate							
Channel	Frequency (MHz)	MCS Index	Channel	MCS Index						
		MCS 0		MCS 1	MCS 2	MCS 3	MCS 4	MCS 5	MCS 6	MCS 7
CH 01	2412	13.60	CH 06	20.00	20.00	20.00	19.70	19.70	19.70	19.70
CH 06	2437	20.10								
CH 11	2462	14.70								

802.11ac VHT40 RF Avg Output Power (dBm)										
Power vs. Channel			Power vs Data Rate							
Channel	Frequency (MHz)	MCS Index	Channel	MCS Index						
		MCS 0		MCS 1	MCS 2	MCS 3	MCS 4	MCS 5	MCS 6	MCS 7
CH 03	2422	12.70	CH 06	15.60	15.60	15.60	15.60	15.30	15.30	15.30
CH 06	2437	15.70								
CH 09	2452	11.40								



<Ant. 1+2>

802.11b RF Avg Output Power (dBm)						
Power vs. Channel			Power vs Data Rate			
Channel	Frequency (MHz)	Data Rate (bps)	Channel	Data Rate (bps)		
		1M		2M	5.5M	11M
CH 01	2412	23.31	CH 01	23.21	23.21	22.91
CH 06	2437	22.84				
CH 11	2462	22.98				

802.11g RF Avg Output Power (dBm)										
Power vs. Channel			Power vs Data Rate							
Channel	Frequency (MHz)	Data Rate (bps)	Channel	Data Rate (bps)						
		6M		9Mbps	12Mbps	18Mbps	24Mbps	36Mbps	48Mbps	54Mbps
CH 01	2412	17.97	CH 06	22.65	22.65	22.65	22.35	22.35	22.35	22.35
CH 06	2437	22.75								
CH 11	2462	18.08								

802.11n HT20 RF Avg Output Power (dBm)										
Power vs. Channel			Power vs Data Rate							
Channel	Frequency (MHz)	MCS Index	Channel	MCS Index						
		MCS0		MCS1	MCS2	MCS3	MCS4	MCS5	MCS6	MCS7
CH 01	2412	15.87	CH 06	22.54	22.54	22.54	22.24	22.24	22.24	22.24
CH 06	2437	22.64								
CH 11	2462	17.52								

802.11n HT40 RF Output Power (dBm)										
Power vs. Channel			Power vs Data Rate							
Channel	Frequency (MHz)	MCS Index	Channel	MCS Index						
		MCS0		MCS1	MCS2	MCS3	MCS4	MCS5	MCS6	MCS7
CH 03	2422	14.44	CH 06	18.27	18.27	18.27	17.97	17.97	17.97	17.97
CH 06	2437	18.37								
CH 09	2452	15.08								

802.11ac VHT20 RF Avg Output Power (dBm)										
Power vs. Channel			Power vs Data Rate							
Channel	Frequency (MHz)	MCS Index	Channel	MCS Index						
		MCS0		MCS 1	MCS 2	MCS 3	MCS 4	MCS 5	MCS 6	MCS 7
CH 01	2412	15.97	CH 06	22.64	22.64	22.64	22.34	22.34	22.34	22.34
CH 06	2437	22.74								
CH 11	2462	17.62								

802.11ac VHT40 RF Avg Output Power (dBm)											
Power vs. Channel			Power vs Data Rate								
Channel	Frequency (MHz)	MCS Index	Channel	MCS Index							
		MCS0		MCS 1	MCS 2	MCS 3	MCS 4	MCS 5	MCS 6	MCS 7	MCS 8
CH 03	2422	14.58	CH 06	18.37	18.37	18.37	18.37	18.07	18.07	18.07	18.07
CH 06	2437	18.47									
CH 09	2452	15.23									



<TXBF Mode>

<Ant. 1+2>

802.11ac VHT20 RF Avg Output Power (dBm)											
Power vs. Channel			Power vs Data Rate								
Channel	Frequency (MHz)	MCS Index	Channel	MCS Index							
		MCS 0		MCS 1	MCS 2	MCS 3	MCS 4	MCS 5	MCS 6	MCS 7	MCS 8
CH 01	2412	16.31	CH 06	21.36	21.36	21.36	21.36	21.36	21.36	21.36	21.36
CH 06	2437	21.46									
CH 11	2462	16.57									

802.11ac VHT40 RF Avg Output Power (dBm)											
Power vs. Channel			Power vs Data Rate								
Channel	Frequency (MHz)	MCS Index	Channel	MCS Index							
		MCS 0		MCS 1	MCS 2	MCS 3	MCS 4	MCS 5	MCS 6	MCS 7	MCS 8
CH 03	2422	13.26	CH 06	15.16	15.16	15.16	15.16	15.16	15.16	15.16	15.16
CH 06	2437	15.26									
CH 09	2452	12.21									

2.3 Connection Diagram of Test System

<WLAN CDD Tx Mode>

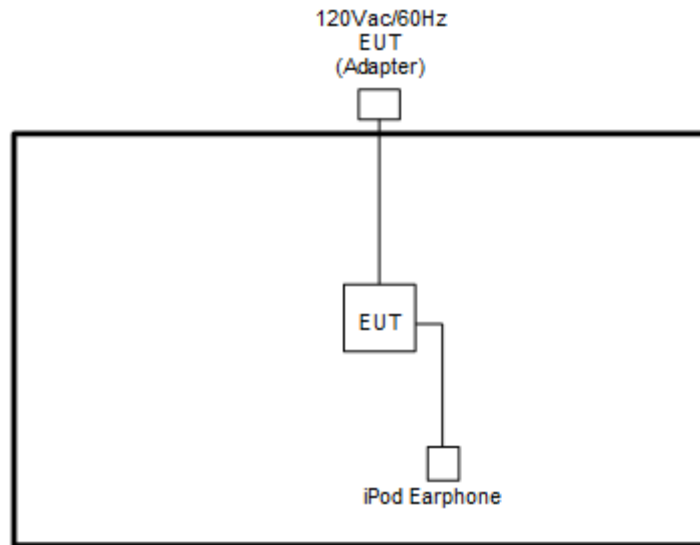

<WLAN TXBF Mode>

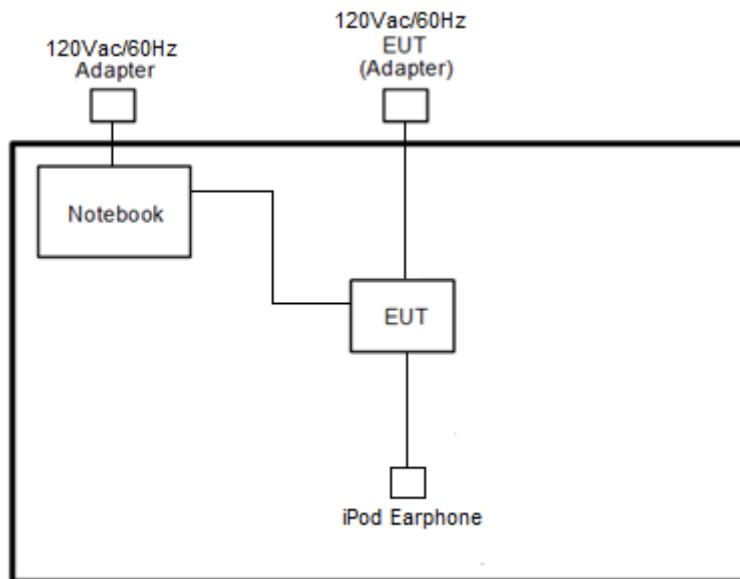

<AC Conducted Emission Mode>

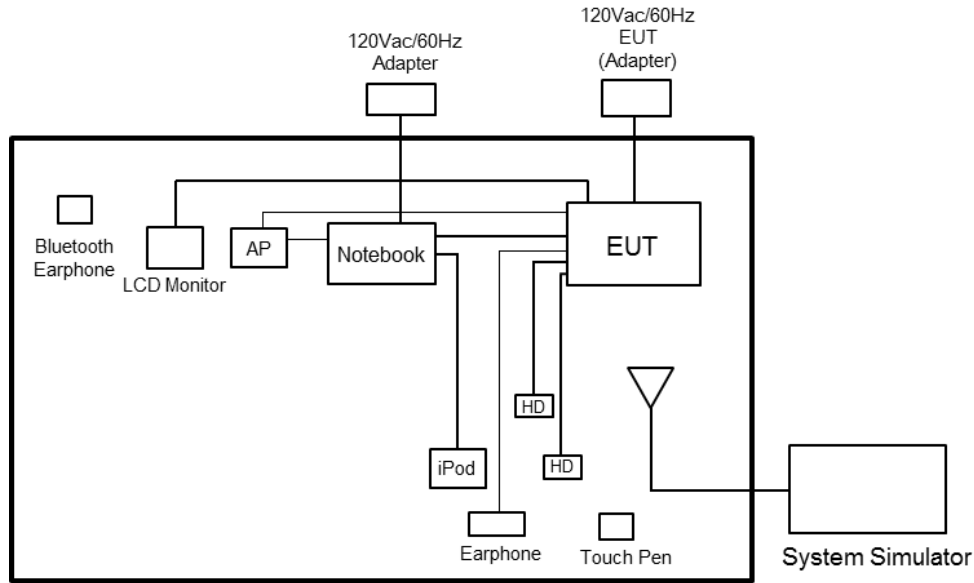

2.4 Support Unit used in test configuration and system

Item	Equipment	Trade Name	Model Name	FCC ID	Data Cable	Power Cord
1.	System Simulator	Anritsu	MT8820C	N/A	N/A	Unshielded, 1.8 m
2.	WLAN AP	TP-Link	Archer7	N/A	N/A	Unshielded, 1.8 m
3.	Notebook	DELL	Latitude E3340	FCC DoC/ Contains FCC ID: PD97260NGU	N/A	AC I/P: Unshielded, 1.2 m DC O/P: Shielded, 1.8 m
4.	Notebook	Lenovo	L570	FCC DoC	N/A	AC I/P: Unshielded, 1.2 m DC O/P: Shielded, 1.8 m
5.	LCD Monitor	DELL	U2715Qt	FCC DoC	Shielded, 1.6 m	Unshielded, 1.8 m
6.	Bluetooth Earphone	Sony Ericsson	SBH20	PY7-RD0010	N/A	N/A
7.	Bluetooth Earphone	Sony Ericsson	MW600	PY7DDA-2029	N/A	N/A
8.	iPod	Apple	A1285	FCC DoC	Shielded, 1.0 m	N/A
9.	iPod Earphone	Apple	N/A	Verification	Unshielded, 1.0 m	N/A
10.	USB HD	Lenovo	F310S	FCC DoC	Shielded, 0.5 m	N/A
11.	USB HD	SONY	HD-EG5	FCC DoC	Shielded, 0.5 m	N/A
12.	SD Card	SanDisk	MicroSD HC	FCC DoC	N/A	N/A



2.5 EUT Operation Test Setup

The RF test items, utility “QRCT” was installed in Notebook which was programmed in order to make the EUT get into the engineering modes to provide channel selection, power level, data rate and the application type and for continuous transmitting signals.

For TXBF mode, the modulation modes and data rates manipulated by the command lines in the engineering program made the EUT link to another EUT by power under the normal operation. The “adb” software tool was used to enable the EUT to transmit signals continuously.

2.6 Measurement Results Explanation Example

For all conducted test items:

The offset level is set in the spectrum analyzer to compensate the RF cable loss and attenuator factor between EUT conducted output port and spectrum analyzer. With the offset compensation, the spectrum analyzer reading level is exactly the EUT RF output level.

Example:

The spectrum analyzer offset is derived from RF cable loss and attenuator factor.

Offset = RF cable loss + attenuator factor.

Following shows an offset computation example with cable loss 4.2 dB and 10dB attenuator.

Offset(dB) = RF cable loss(dB) + attenuator factor(dB).

= 4.2 + 10 = 14.2 (dB)

3 Test Result

3.1 6dB and 99% Bandwidth Measurement

3.1.1 Limit of 6dB and 99% Bandwidth

The minimum 6 dB bandwidth shall be at least 500 kHz.

3.1.2 Measuring Instruments

See list of measuring equipment of this test report.

3.1.3 Test Procedures

1. The testing follows the ANSI C63.10 Section 6.9.3 (OBW) and 11.8.1 (6dB BW).
2. The RF output of EUT was connected to the spectrum analyzer by RF cable and attenuator. The path loss was compensated to the results for each measurement.
3. Set to the maximum power setting and enable the EUT transmit continuously.
4. Make the measurement with the spectrum analyzer's resolution bandwidth (RBW) = 100 kHz. Set the Video bandwidth (VBW) = 300 kHz. In order to make an accurate measurement. The 6 dB bandwidth must be greater than 500 kHz.
5. For 99% Bandwidth Measurement, the spectrum analyzer's resolution bandwidth (RBW) is set 1-5% of the emission bandwidth and set the Video bandwidth (VBW) $\geq 3 * RBW$.
6. Measure and record the results in the test report.

3.1.4 Test Setup





3.1.5 Test Result of 6dB and 99% Occupied Bandwidth

Test Engineer :	Aking Chang, Kai Liao, Howard Lin	Temperature :	21~25°C
		Relative Humidity :	51~54%

<CDD Mode>

2.4GHz Band										
Mod.	Data Rate	NTX	CH.	Freq. (MHz)	99% Occupied BW (MHz)		6dB BW (MHz)		6dB BW Limit (MHz)	Pass/Fail
					Ant 1	Ant 2	Ant 1	Ant 2		
11b	1Mbps	1	1	2412	13.20	12.95	7.52	7.56	0.50	Pass
11b	1Mbps	1	6	2437	13.05	12.95	7.04	7.04	0.50	Pass
11b	1Mbps	1	11	2462	13.05	13.00	7.08	7.56	0.50	Pass
11g	6Mbps	1	1	2412	17.00	16.95	16.36	16.34	0.50	Pass
11g	6Mbps	1	6	2437	17.50	17.60	16.30	16.32	0.50	Pass
11g	6Mbps	1	11	2462	16.85	16.85	16.32	16.32	0.50	Pass
VHT20	MCS0	1	1	2412	18.15	18.10	17.56	17.60	0.50	Pass
VHT20	MCS0	1	6	2437	18.50	18.70	17.56	17.58	0.50	Pass
VHT20	MCS0	1	11	2462	18.05	18.00	17.56	17.58	0.50	Pass
VHT40	MCS0	1	3	2422	36.90	36.70	36.32	36.32	0.50	Pass
VHT40	MCS0	1	6	2437	37.00	36.90	36.08	36.32	0.50	Pass
VHT40	MCS0	1	9	2452	37.20	37.20	36.36	36.36	0.50	Pass
11b	1Mbps	2	1	2412	13.75	13.00	8.04	7.52	0.50	Pass
11b	1Mbps	2	6	2437	13.45	13.10	7.52	7.08	0.50	Pass
11b	1Mbps	2	11	2462	13.20	12.90	8.04	7.52	0.50	Pass
11g	6Mbps	2	1	2412	17.05	16.80	16.32	16.32	0.50	Pass
11g	6Mbps	2	6	2437	17.65	17.20	16.30	16.32	0.50	Pass
11g	6Mbps	2	11	2462	16.90	16.75	16.34	16.32	0.50	Pass
VHT20	MCS0	2	1	2412	18.15	18.10	17.60	17.56	0.50	Pass
VHT20	MCS0	2	6	2437	18.70	18.35	17.60	17.60	0.50	Pass
VHT20	MCS0	2	11	2462	18.05	17.95	17.60	17.56	0.50	Pass
VHT40	MCS0	2	3	2422	36.80	36.80	35.44	36.24	0.50	Pass
VHT40	MCS0	2	6	2437	36.80	36.90	35.92	36.04	0.50	Pass
VHT40	MCS0	2	9	2452	37.00	37.10	36.36	36.28	0.50	Pass

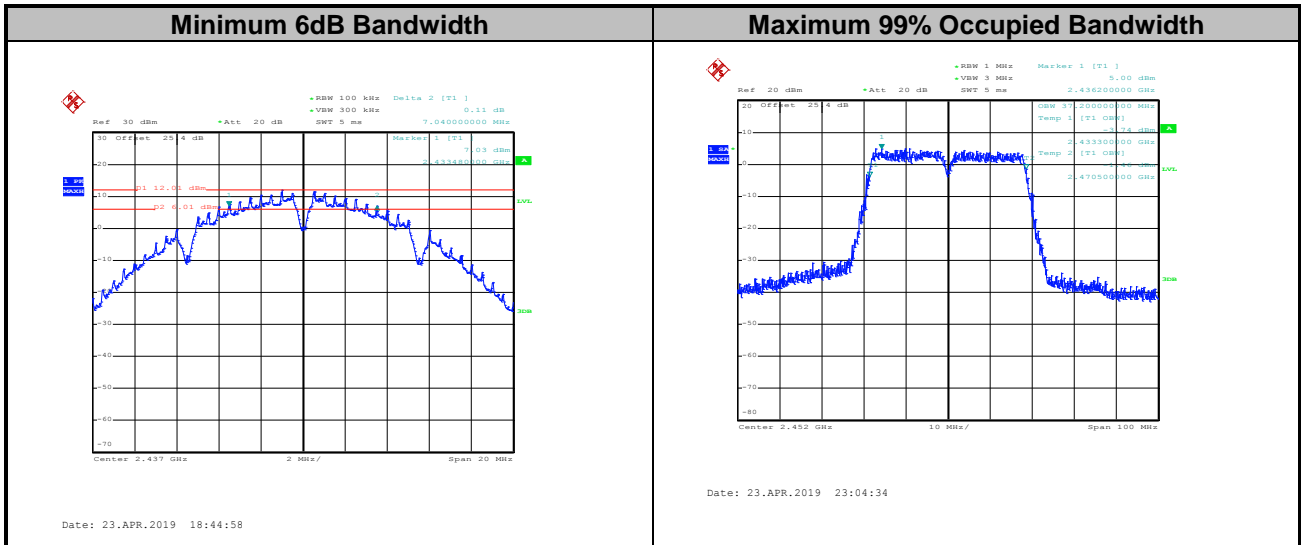

Note: The occupied channel bandwidth is maintained within the band of operation for all of the modulations.



<TXBF Modes>

2.4GHz Band										
Mod.	Data Rate	NTX	CH.	Freq. (MHz)	99% Occupied BW (MHz)		6dB BW (MHz)		6dB BW Limit (MHz)	Pass/Fail
					Ant 1	Ant 2	Ant 1	Ant 2		
VHT20	MCS0	2	1	2412	17.90	18.00	17.56	16.31	0.50	Pass
VHT20	MCS0	2	6	2437	18.15	18.15	17.56	17.57	0.50	Pass
VHT20	MCS0	2	11	2462	18.00	17.95	17.52	17.60	0.50	Pass
VHT40	MCS0	2	3	2422	36.80	36.70	32.56	33.84	0.50	Pass
VHT40	MCS0	2	6	2437	36.90	37.20	36.72	35.00	0.50	Pass
VHT40	MCS0	2	9	2452	37.10	36.90	35.36	35.56	0.50	Pass

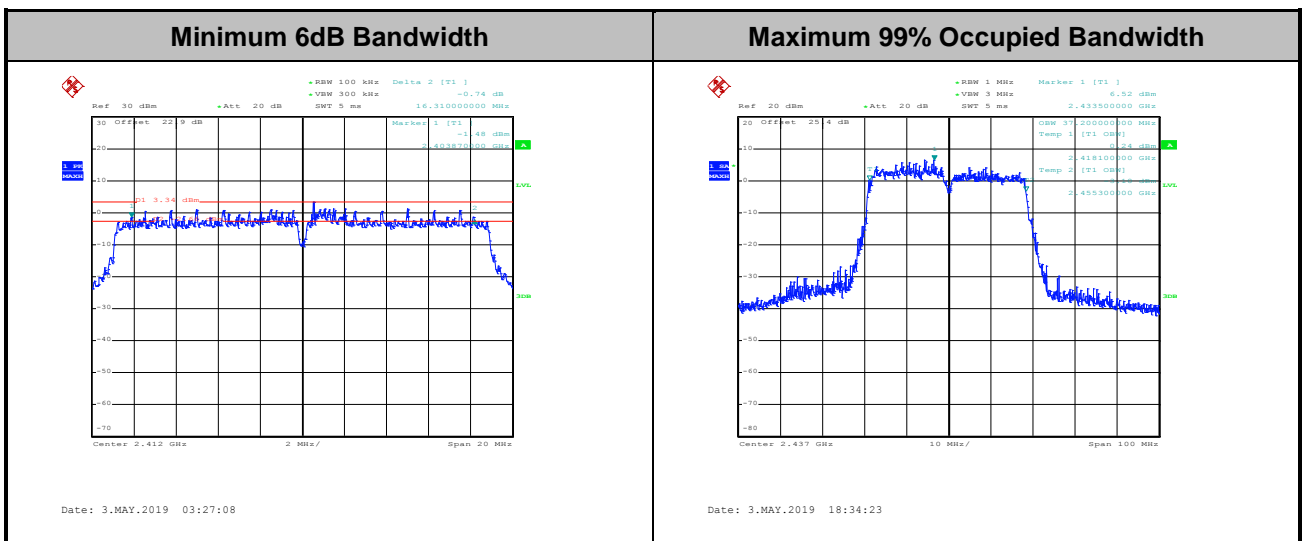

Note: The occupied channel bandwidth is maintained within the band of operation for all of the modulations.

3.2 Output Power Measurement

3.2.1 Limit of Output Power

For systems using digital modulation in the 2400-2483.5MHz, the limit for output power is 30dBm. If transmitting antenna with directional gain greater than 6dBi is used, the output power from the intentional radiator shall be reduced below the above stated value by the amount in dB that the directional gain of the antenna exceeds 6 dBi. In case of point-to-point operation, the limit has to be reduced by 1dB for every 3dB that the directional gain of the antenna exceeds 6dBi.

3.2.2 Measuring Instruments

See list of measuring equipment of this test report.

3.2.3 Test Procedures

<CDD Modes>

1. For Average Power, the testing follows ANSI C63.10 Section 11.9.2.3.2 Method AVGPM-G
2. The RF output of EUT was connected to the power meter by RF cable and attenuator. The path loss was compensated to the results for each measurement.
3. Set to the maximum power setting and enable the EUT transmit continuously.
4. Measure the conducted output power and record the results in the test report.
5. For MIMO mode, calculation method follows FCC KDB 662911 D01 Multiple Transmitter Output v02r01.

<TXBF Modes>

1. For Average Power, the testing follows ANSI C63.10 Section 11.9.2.3.2 Method AVGPM-G
2. The RF output of EUT was connected to the power meter by RF cable and attenuator. The path loss was compensated to the results for each measurement.
3. Set to the maximum power setting and enable the EUT transmit continuously.
4. Measure the conducted output power and record the results in the test report.
5. For MIMO mode, calculation method follows FCC KDB 662911 D01 Multiple Transmitter Output v02r01.

3.2.4 Test Setup

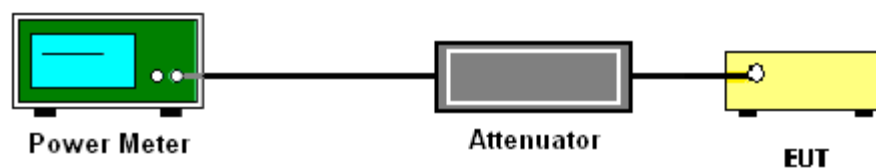



3.2.5 Test Result of Average Output Power

Test Engineer :	Aking Chang, Kai Liao, Howard Lin	Temperature :	21~25°C
		Relative Humidity :	51~54%

<CDD Mode>

2.4GHz Band																
Mod.	Data Rate	NTX	CH.	Freq. (MHz)	Average Conducted Power (dBm)			Conducted Power Limit (dBm)		DG (dBi)		EIRP Power (dBm)		EIRP Power Limit (dBm)		Pass /Fail
					Ant 1	Ant 2	SUM	Ant 1	Ant 2	Ant 1	Ant 2	Ant 1	Ant 2	Ant 1	Ant 2	
11b	1Mbps	1	1	2412	20.00	20.10		30.00	30.00	-0.21	-2.29	19.79	17.81	36.00	36.00	Pass
11b	1Mbps	1	6	2437	20.20	20.30		30.00	30.00	-0.21	-2.29	19.99	18.01	36.00	36.00	Pass
11b	1Mbps	1	11	2462	20.10	20.10		30.00	30.00	-0.21	-2.29	19.89	17.81	36.00	36.00	Pass
11g	6Mbps	1	1	2412	14.80	14.70		30.00	30.00	-0.21	-2.29	14.59	12.41	36.00	36.00	Pass
11g	6Mbps	1	6	2437	20.40	20.10		30.00	30.00	-0.21	-2.29	20.19	17.81	36.00	36.00	Pass
11g	6Mbps	1	11	2462	14.80	14.80		30.00	30.00	-0.21	-2.29	14.59	12.51	36.00	36.00	Pass
HT20	MCS0	1	1	2412	13.40	13.50		30.00	30.00	-0.21	-2.29	13.19	11.21	36.00	36.00	Pass
HT20	MCS0	1	6	2437	19.30	19.40		30.00	30.00	-0.21	-2.29	19.09	17.11	36.00	36.00	Pass
HT20	MCS0	1	11	2462	14.50	14.60		30.00	30.00	-0.21	-2.29	14.29	12.31	36.00	36.00	Pass
HT40	MCS0	1	3	2422	12.80	12.60		30.00	30.00	-0.21	-2.29	12.59	10.31	36.00	36.00	Pass
HT40	MCS0	1	6	2437	15.70	15.50		30.00	30.00	-0.21	-2.29	15.49	13.21	36.00	36.00	Pass
HT40	MCS0	1	9	2452	11.10	11.30		30.00	30.00	-0.21	-2.29	10.89	9.01	36.00	36.00	Pass
VHT20	MCS0	1	1	2412	13.50	13.60		30.00	30.00	-0.21	-2.29	13.29	11.31	36.00	36.00	Pass
VHT20	MCS0	1	6	2437	20.40	20.10		30.00	30.00	-0.21	-2.29	20.19	17.81	36.00	36.00	Pass
VHT20	MCS0	1	11	2462	14.60	14.70		30.00	30.00	-0.21	-2.29	14.39	12.41	36.00	36.00	Pass
VHT40	MCS0	1	3	2422	12.90	12.70		30.00	30.00	-0.21	-2.29	12.69	10.41	36.00	36.00	Pass
VHT40	MCS0	1	6	2437	15.90	15.70		30.00	30.00	-0.21	-2.29	15.69	13.41	36.00	36.00	Pass
VHT40	MCS0	1	9	2452	11.20	11.40		30.00	30.00	-0.21	-2.29	10.99	9.11	36.00	36.00	Pass



2.4GHz Band																
Mod.	Data Rate	NTX	CH.	Freq. (MHz)	Average Conducted Power (dBm)			Conducted Power Limit (dBm)		DG (dBi)		EIRP Power (dBm)		EIRP Power Limit (dBm)		Pass /Fail
					Ant 1	Ant 2	SUM	Ant 1	Ant 2	Ant 1	Ant 2	Ant 1	Ant 2	Ant 1	Ant 2	
11b	1Mbps	2	1	2412	20.50	20.10	23.31	30.00		-0.21		23.10		36.00		Pass
11b	1Mbps	2	6	2437	20.30	19.30	22.84	30.00		-0.21		22.63		36.00		Pass
11b	1Mbps	2	11	2462	20.40	19.50	22.98	30.00		-0.21		22.77		36.00		Pass
11g	6Mbps	2	1	2412	15.30	14.60	17.97	30.00		-0.21		17.76		36.00		Pass
11g	6Mbps	2	6	2437	20.30	19.10	22.75	30.00		-0.21		22.54		36.00		Pass
11g	6Mbps	2	11	2462	15.50	14.60	18.08	30.00		-0.21		17.87		36.00		Pass
HT20	MCS0	2	1	2412	13.20	12.50	15.87	30.00		-0.21		15.66		36.00		Pass
HT20	MCS0	2	6	2437	20.10	19.10	22.64	30.00		-0.21		22.43		36.00		Pass
HT20	MCS0	2	11	2462	14.80	14.20	17.52	30.00		-0.21		17.31		36.00		Pass
HT40	MCS0	2	3	2422	11.90	10.90	14.44	30.00		-0.21		14.23		36.00		Pass
HT40	MCS0	2	6	2437	16.00	14.60	18.37	30.00		-0.21		18.16		36.00		Pass
HT40	MCS0	2	9	2452	12.50	11.60	15.08	30.00		-0.21		14.87		36.00		Pass
VHT20	MCS0	2	1	2412	13.30	12.60	15.97	30.00		-0.21		15.76		36.00		Pass
VHT20	MCS0	2	6	2437	20.20	19.20	22.74	30.00		-0.21		22.53		36.00		Pass
VHT20	MCS0	2	11	2462	14.90	14.30	17.62	30.00		-0.21		17.41		36.00		Pass
VHT40	MCS0	2	3	2422	12.00	11.10	14.58	30.00		-0.21		14.37		36.00		Pass
VHT40	MCS0	2	6	2437	16.10	14.70	18.47	30.00		-0.21		18.26		36.00		Pass
VHT40	MCS0	2	9	2452	12.60	11.80	15.23	30.00		-0.21		15.02		36.00		Pass

<TXBF Mode>

2.4GHz Band																
Mod.	Data Rate	NTX	CH.	Freq. (MHz)	Average Conducted Power (dBm)			Conducted Power Limit (dBm)		DG (dBi)		EIRP Power (dBm)		EIRP Power Limit (dBm)		Pass /Fail
					Ant 1	Ant 2	SUM	Ant 1	Ant 2	Ant 1	Ant 2	Ant 1	Ant 2	Ant 1	Ant 2	
VHT20	MCS0	2	1	2412	13.50	13.10	16.31	30.00		1.82		18.14		36.00		Pass
VHT20	MCS0	2	6	2437	18.30	18.60	21.46	30.00		1.82		23.29		36.00		Pass
VHT20	MCS0	2	11	2462	13.80	13.30	16.57	30.00		1.82		18.39		36.00		Pass
VHT40	MCS0	2	3	2422	10.20	10.30	13.26	30.00		1.82		15.08		36.00		Pass
VHT40	MCS0	2	6	2437	12.20	12.30	15.26	30.00		1.82		17.08		36.00		Pass
VHT40	MCS0	2	9	2452	9.10	9.30	12.21	30.00		1.82		14.03		36.00		Pass



3.3 Power Spectral Density Measurement

3.3.1 Limit of Power Spectral Density

The peak power spectral density shall not be greater than 8dBm in any 3kHz band at any time interval of continuous transmission.

3.3.2 Measuring Instruments

See list of measuring equipment of this test report.

3.3.3 Test Procedures

<CDD Modes>

Method AVGPSD-2

1. The testing follows the ANSI C63.10 Section 11.10.5 Method AVGPSD-2.
2. The RF output of EUT was connected to the spectrum analyzer by RF cable and attenuator. The path loss was compensated to the results for each measurement.
3. Set to the maximum power setting and enable the EUT transmit continuously.
4. Make the measurement with the spectrum analyzer's resolution bandwidth (RBW) = 10 kHz. Video bandwidth VBW = 30 kHz In order to make an accurate measurement, set the span to 1.5 times DTS Channel Bandwidth. (6dB BW).
5. Number of points in sweep ≥ 2 Span / RBW. (This ensures that bin-to-bin spacing is \leq RBW/2, so that narrowband signals are not lost between frequency bins).
6. Detector = RMS, Sweep time = auto couple.
7. Trace average at least 100 traces in power averaging mode.
8. Add $10 \log(1/x)$, where x is the duty cycle, to the measured power in order to compute the average power during the actual transmission times. For example, add $10 \log(1/0.25) = 6$ dB if the duty cycle is 25 percent.
9. Measure and record the results in the test report.
10. For MIMO mode, calculation method follows FCC KDB 662911 D01 Multiple Transmitter Output v02r01.

Method (c): Measure and add $10 \log(N_{ANT})$ dB.

With this technique, spectrum measurements are performed at each output of the device, but rather than summing the spectra or the spectral peaks across the outputs, the quantity $10 \log(N_{ANT})$ dB is added to each spectrum value before comparing to the emission limit. The addition of $10 \log(N_{ANT})$ dB serves to apportion the emission limit among the N_{ANT} outputs so that each output is permitted to contribute no more than $1/N_{ANT}^{th}$ of the PSD limit .

<TXBF Modes>

Method AVGPSD-3

1. The testing follows the ANSI C63.10 Section 11.10.7 Method AVGPSD-3.
2. The RF output of EUT was connected to the spectrum analyzer by RF cable and attenuator. The path loss was compensated to the results for each measurement.
3. Set to the maximum power setting and enable the EUT transmit continuously.
4. Make the measurement with the spectrum analyzer's resolution bandwidth (RBW) = 10 kHz. Video bandwidth VBW = 30 kHz In order to make an accurate measurement, set the span to 1.5 times DTS Channel Bandwidth. (6dB BW).
5. Number of points in sweep ≥ 2 Span / RBW. (This ensures that bin-to-bin spacing is \leq RBW/2, so that narrowband signals are not lost between frequency bins).
6. Detector = RMS, Sweep time = auto couple.
7. Trace mode = max hold.
8. Allow max hold to run for at least 60 seconds, or longer as needed to allow the trace to stabilize.
9. Measure and record the results in the test report.
10. For MIMO mode, calculation method follows FCC KDB 662911 D01 Multiple Transmitter Output v02r01.

Method (c): Measure and add $10 \log(N_{ANT})$ dB.

With this technique, spectrum measurements are performed at each output of the device, but rather than summing the spectra or the spectral peaks across the outputs, the quantity $10 \log(N_{ANT})$ dB is added to each spectrum value before comparing to the emission limit. The addition of $10 \log(N_{ANT})$ dB serves to apportion the emission limit among the N_{ANT} outputs so that each output is permitted to contribute no more than $1/N_{ANT}^{\text{th}}$ of the PSD limit .

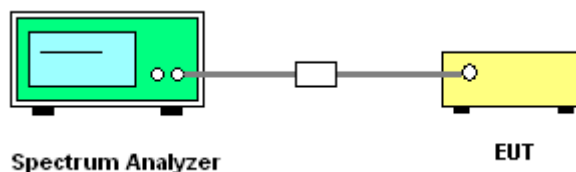
3.3.4 Test Setup



3.3.5 Test Result of Power Spectral Density

Test Engineer :	Aking Chang, Kai Liao, Howard Lin	Temperature :	21~25°C
		Relative Humidity :	51~54%

<CDD Modes>

2.4GHz Band												
Mod.	Data Rate	NTX	CH.	Freq. (MHz)	Peak PSD (dBm/3kHz)			DG (dBi)		Peak PSD Limit (dBm/3kHz)		Pass/Fail
					Ant 1	Ant 2	Worse + 3.01	Ant 1	Ant 2	Ant 1	Ant 2	
11b	1Mbps	1	1	2412	-1.43	-1.67	-	-0.21	-2.29	8.00	8.00	Pass
11b	1Mbps	1	6	2437	-2.22	-1.48	-	-0.21	-2.29	8.00	8.00	Pass
11b	1Mbps	1	11	2462	-2.31	-1.46	-	-0.21	-2.29	8.00	8.00	Pass
11g	6Mbps	1	1	2412	-11.15	-11.36	-	-0.21	-2.29	8.00	8.00	Pass
11g	6Mbps	1	6	2437	-4.82	-5.72	-	-0.21	-2.29	8.00	8.00	Pass
11g	6Mbps	1	11	2462	-10.76	-10.39	-	-0.21	-2.29	8.00	8.00	Pass
VHT20	MCS0	1	1	2412	-12.39	-12.53	-	-0.21	-2.29	8.00	8.00	Pass
VHT20	MCS0	1	6	2437	-4.62	-5.95	-	-0.21	-2.29	8.00	8.00	Pass
VHT20	MCS0	1	11	2462	-11.19	-10.96	-	-0.21	-2.29	8.00	8.00	Pass
VHT40	MCS0	1	3	2422	-14.76	-14.10	-	-0.21	-2.29	8.00	8.00	Pass
VHT40	MCS0	1	6	2437	-12.76	-12.67	-	-0.21	-2.29	8.00	8.00	Pass
VHT40	MCS0	1	9	2452	-18.18	-16.57	-	-0.21	-2.29	8.00	8.00	Pass
11b	1Mbps	2	1	2412	-0.96	-3.56	2.05	1.82		8.00		Pass
11b	1Mbps	2	6	2437	-0.57	-2.36	2.44	1.82		8.00		Pass
11b	1Mbps	2	11	2462	-1.72	-1.91	1.29	1.82		8.00		Pass
11g	6Mbps	2	1	2412	-10.00	-10.80	-6.99	1.82		8.00		Pass
11g	6Mbps	2	6	2437	-5.46	-5.62	-2.45	1.82		8.00		Pass
11g	6Mbps	2	11	2462	-9.05	-11.29	-6.04	1.82		8.00		Pass
VHT20	MCS0	2	1	2412	-12.19	-12.73	-9.18	1.82		8.00		Pass
VHT20	MCS0	2	6	2437	-5.46	-7.53	-2.45	1.82		8.00		Pass
VHT20	MCS0	2	11	2462	-11.38	-11.39	-8.37	1.82		8.00		Pass
VHT40	MCS0	2	3	2422	-14.33	-17.59	-11.32	1.82		8.00		Pass
VHT40	MCS0	2	6	2437	-13.33	-14.28	-10.32	1.82		8.00		Pass
VHT40	MCS0	2	9	2452	-17.10	-16.83	-13.82	1.82		8.00		Pass

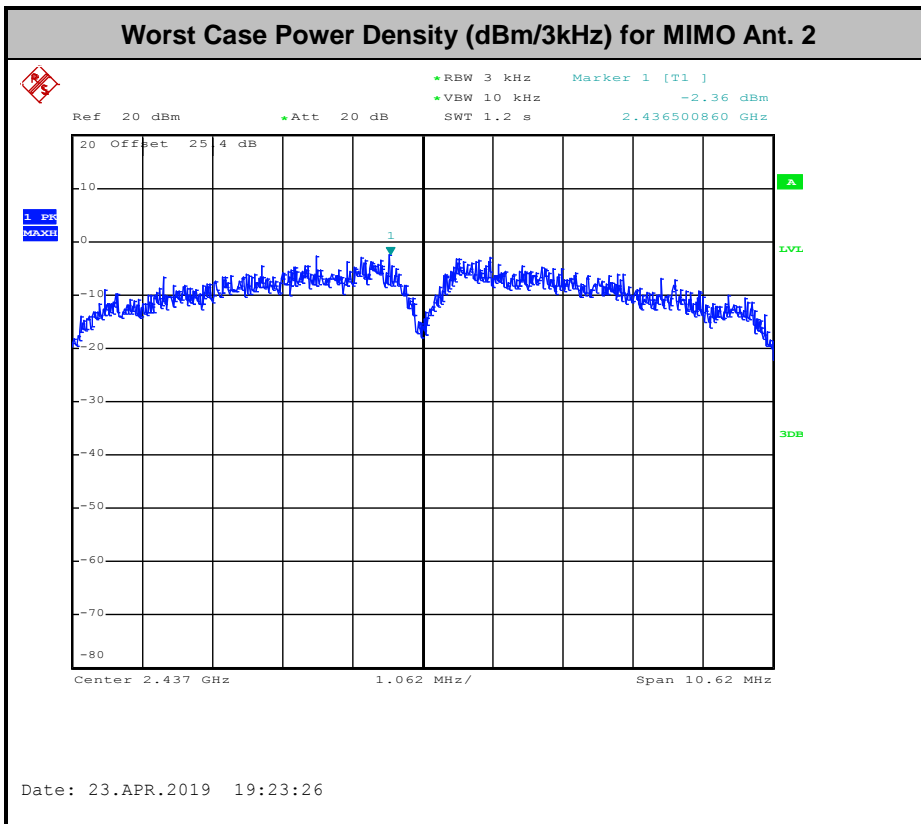
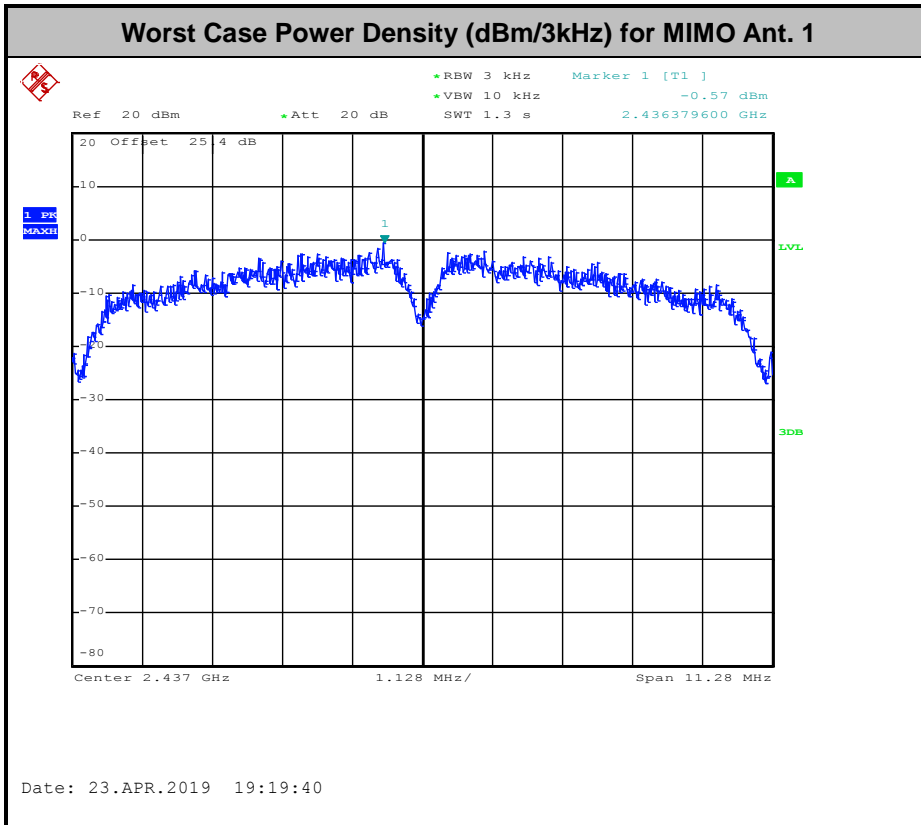



<TXBF Modes>

2.4GHz Band												
Mod.	Data Rate	NTX	CH.	Freq. (MHz)	Peak PSD (dBm/3kHz)			DG (dBi)		Peak PSD Limit (dBm/3kHz)		Pass/Fail
					Ant 1	Ant 2	Worse + 3.01	Ant 1	Ant 2	Ant 1	Ant 2	
VHT20	MCS0	2	1	2412	-13.03	-13.66	-10.02	1.82		8.00		Pass
VHT20	MCS0	2	6	2437	-7.82	-7.53	-4.52	1.82		8.00		Pass
VHT20	MCS0	2	11	2462	-12.83	-12.46	-9.45	1.82		8.00		Pass
VHT40	MCS0	2	3	2422	-20.16	-20.12	-17.11	1.82		8.00		Pass
VHT40	MCS0	2	6	2437	-21.47	-17.77	-14.76	1.82		8.00		Pass
VHT40	MCS0	2	9	2452	-23.53	-21.77	-18.76	1.82		8.00		Pass

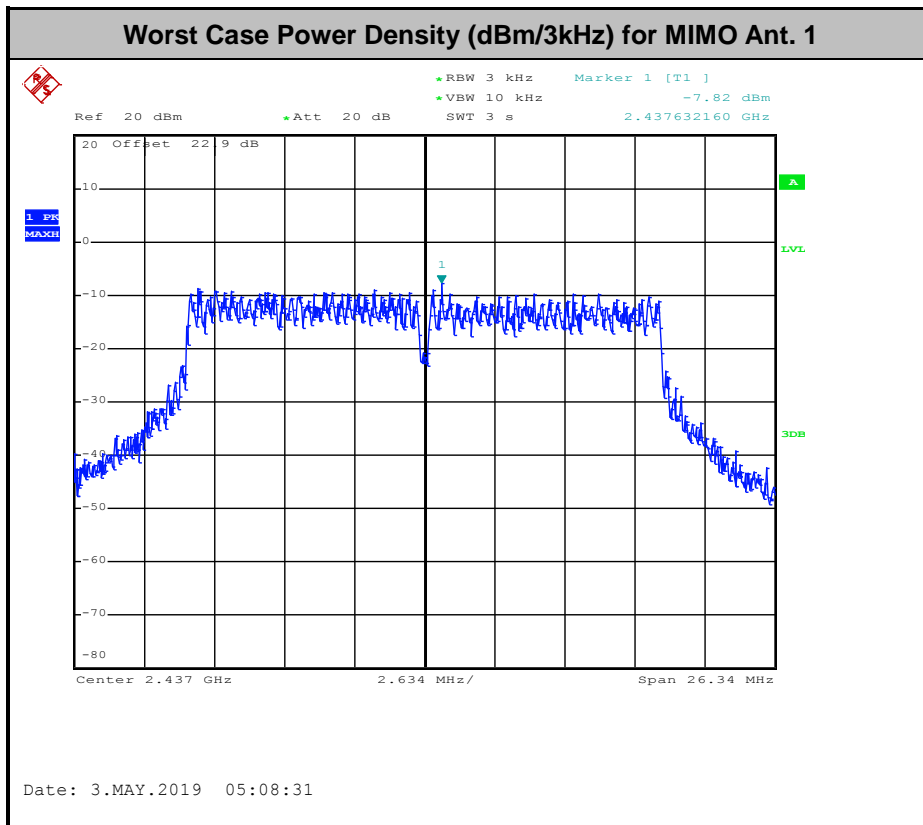

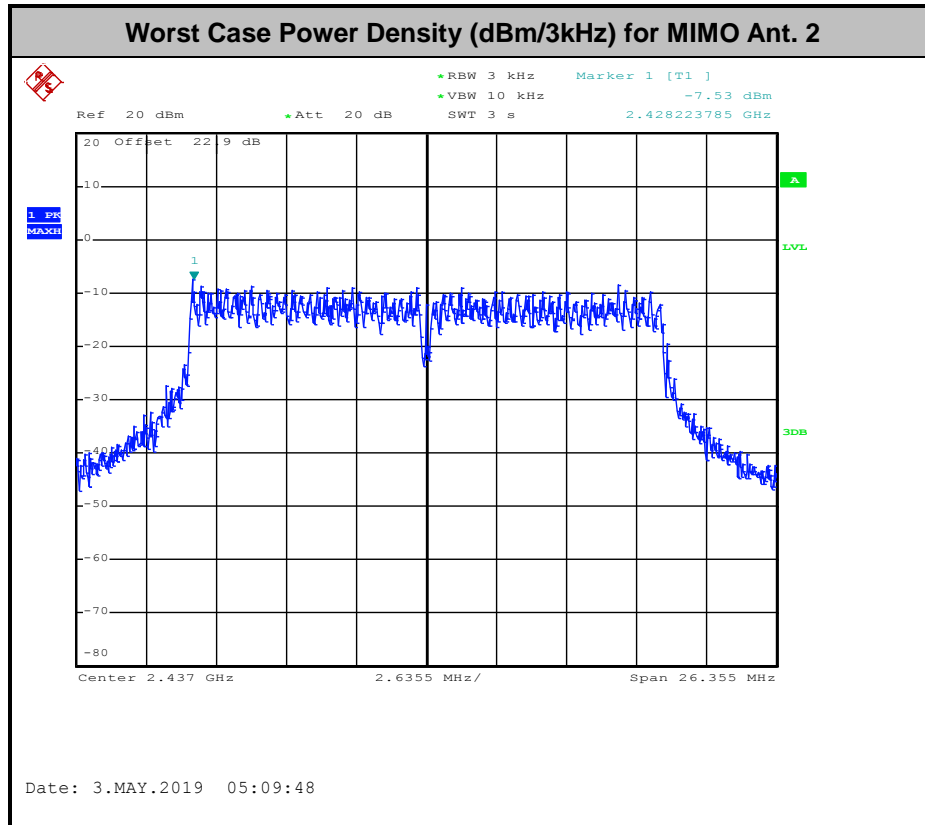

3.4 Conducted Band Edges and Spurious Emission Measurement

3.4.1 Limit of Conducted Band Edges and Spurious Emission Measurement

In any 100 kHz bandwidth outside of the authorized frequency band, the emissions which fall in the non-restricted bands shall be attenuated at least 20 dB / 30dB relative to the maximum PSD level in 100 kHz by RF conducted measurement.

3.4.2 Measuring Instruments

See list of measuring equipment of this test report.

3.4.3 Test Procedures

1. The testing follows the ANSI C63.10 Section 11.11.3 Emission level measurement
2. The RF output of EUT was connected to the spectrum analyzer by RF cable and attenuator. The path loss was compensated to the results for each measurement.
3. Set to the maximum power setting and enable the EUT transmit continuously.
4. Set RBW = 100 kHz, VBW=300 kHz, Peak Detector. Unwanted Emissions measured in any 100 kHz bandwidth outside of the authorized frequency band shall be attenuated by at least 20 dB relative to the maximum in-band peak PSD level in 100 kHz when maximum peak conducted output power procedure is used. If the transmitter complies with the conducted power limits based on the use of RMS averaging over a time interval, the attenuation required under this paragraph shall be 30 dB instead of 20 dB per 15.247(d).
5. Measure and record the results in the test report.
6. The RF fundamental frequency should be excluded against the limit line in the operating frequency band.

3.4.4 Test Setup

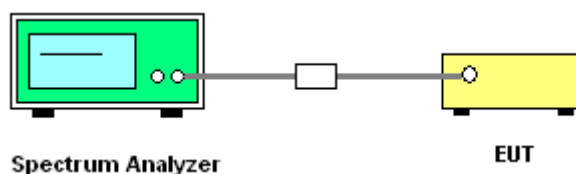



3.4.5 Test Result of Conducted Band Edges and Spurious Emission

Test Engineer : Aking Chang, Kai Liao, Howard Lin	Temperature :	21~25°C
	Relative Humidity :	51~54%

<CDD Mode>

Number of TX = 1, Ant. 1 (Measured)

Test Mode :	802.11b	Test Channel :	01
-------------	---------	----------------	----

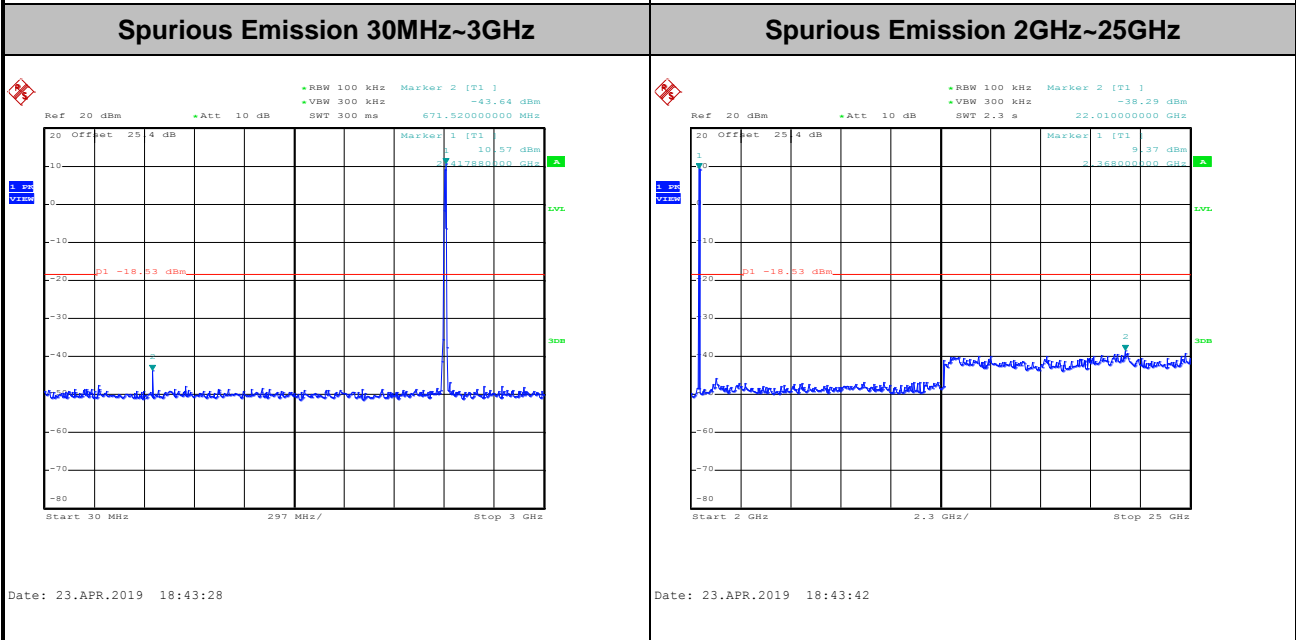
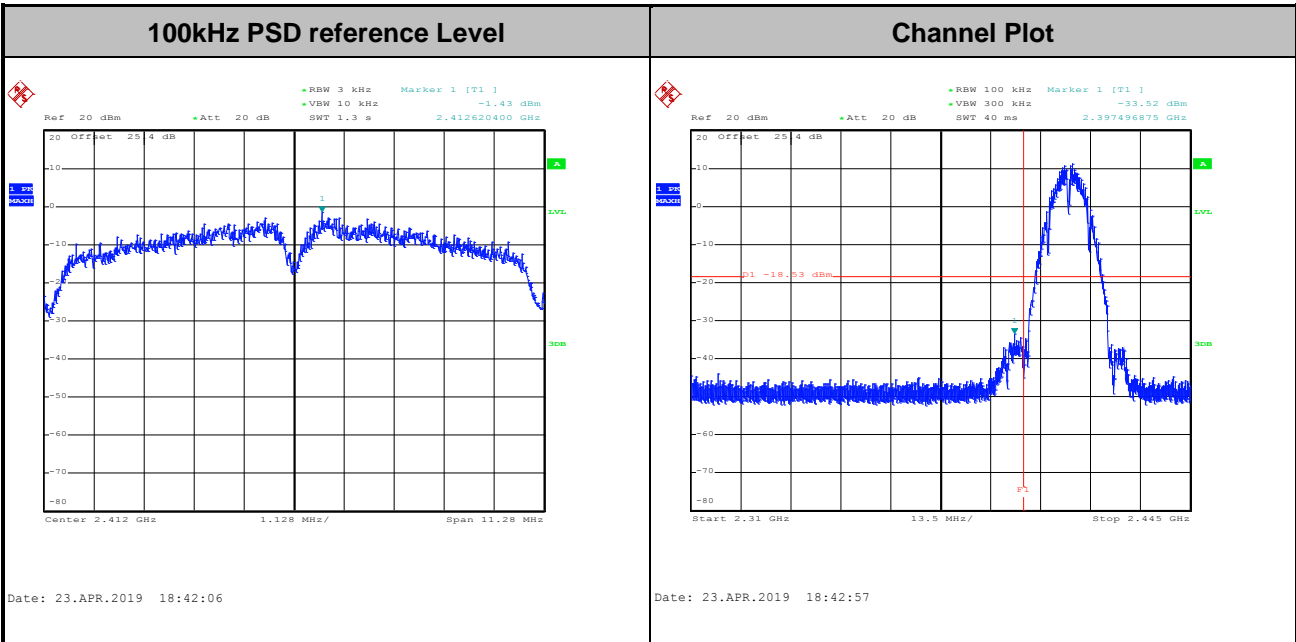



Test Mode :	802.11b	Test Channel :	06
-------------	---------	----------------	----

100kHz PSD reference Level

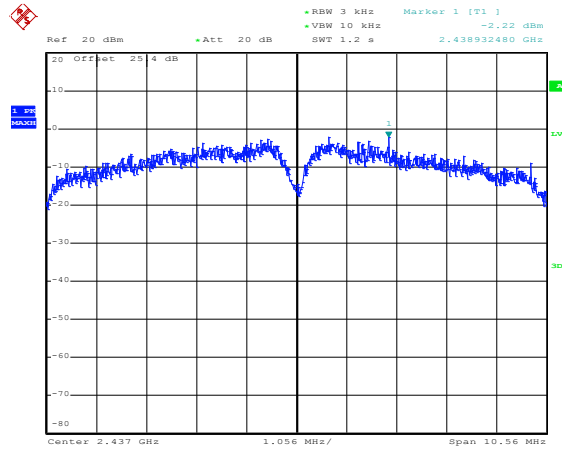

Date: 23.APR.2019 18:45:13

Spurious Emission 30MHz~3GHz

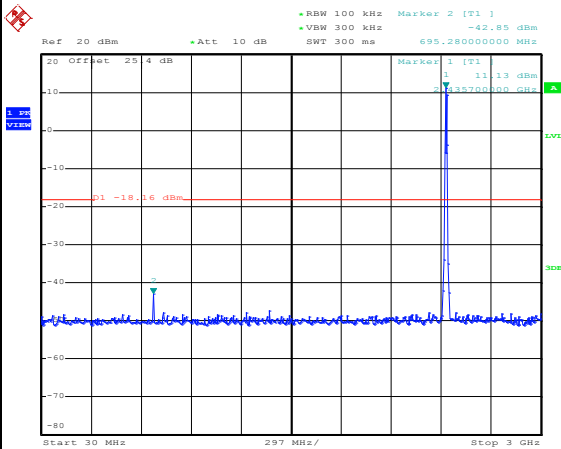

Date: 23.APR.2019 18:45:57

Spurious Emission 2GHz~25GHz

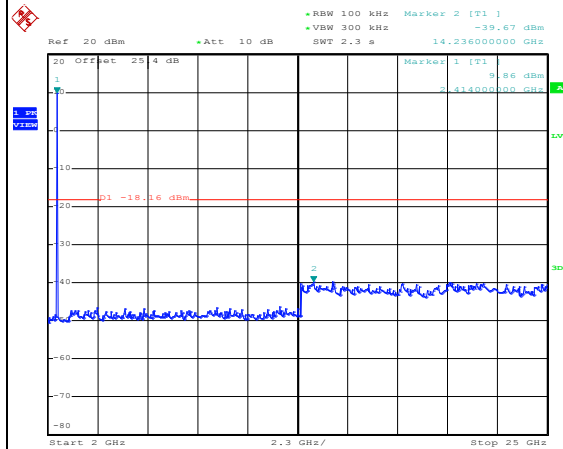

Date: 23.APR.2019 18:46:11



Test Mode :	802.11b	Test Channel :	11
-------------	---------	----------------	----

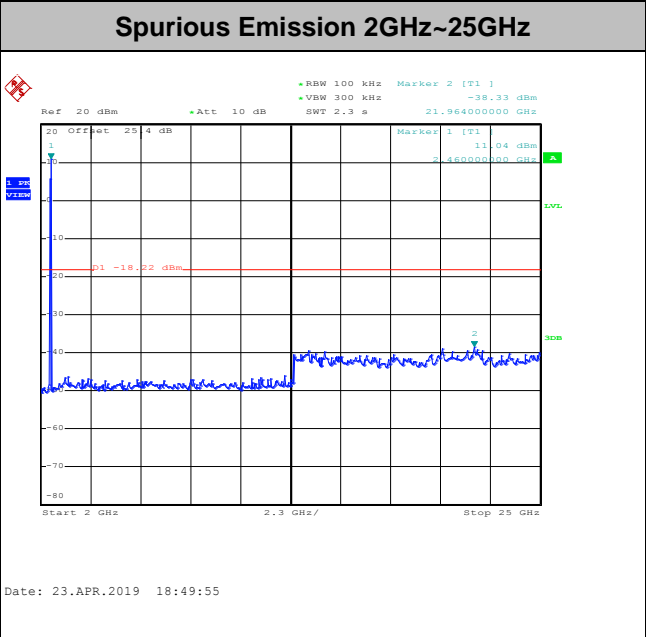
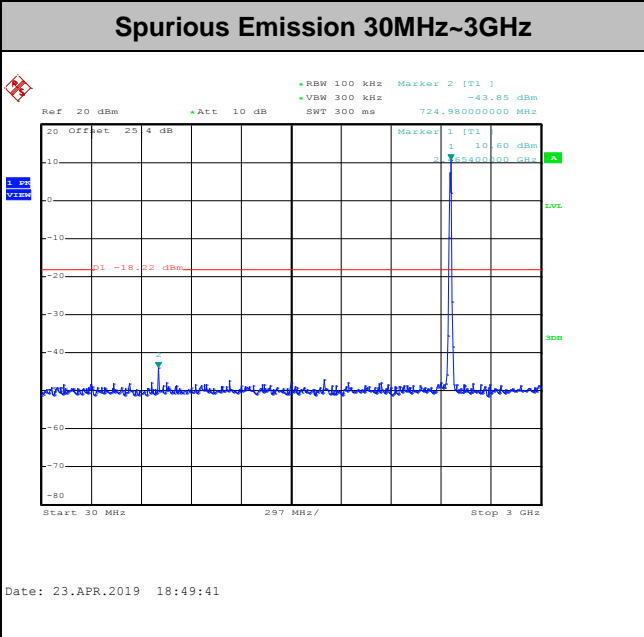
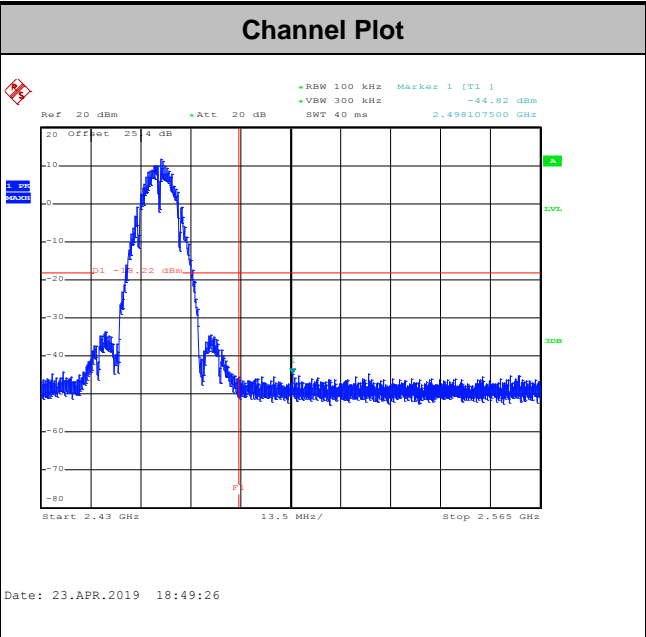
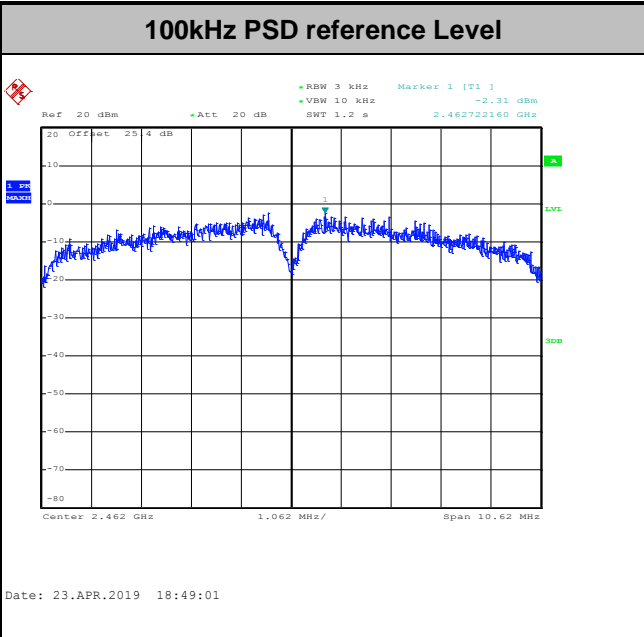



Test Mode : 802.11g Test Channel : 01

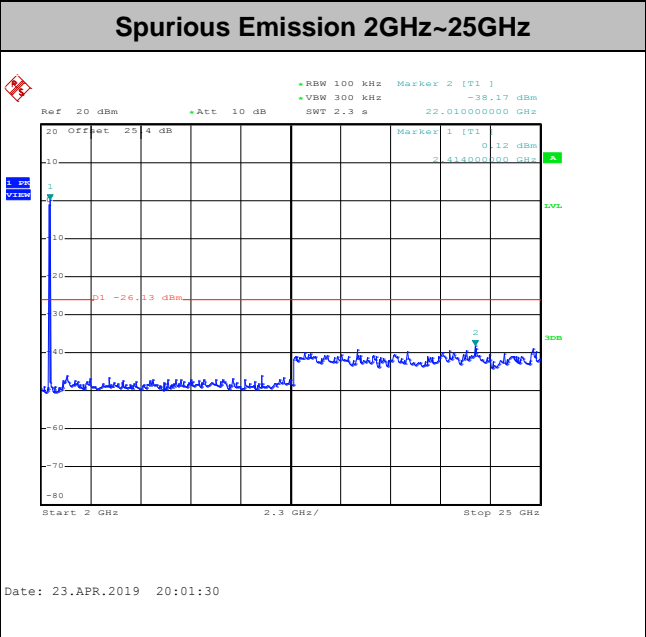
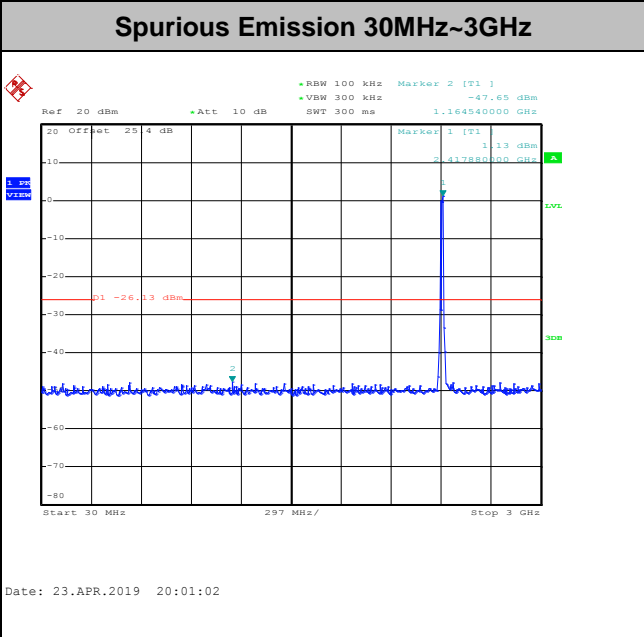
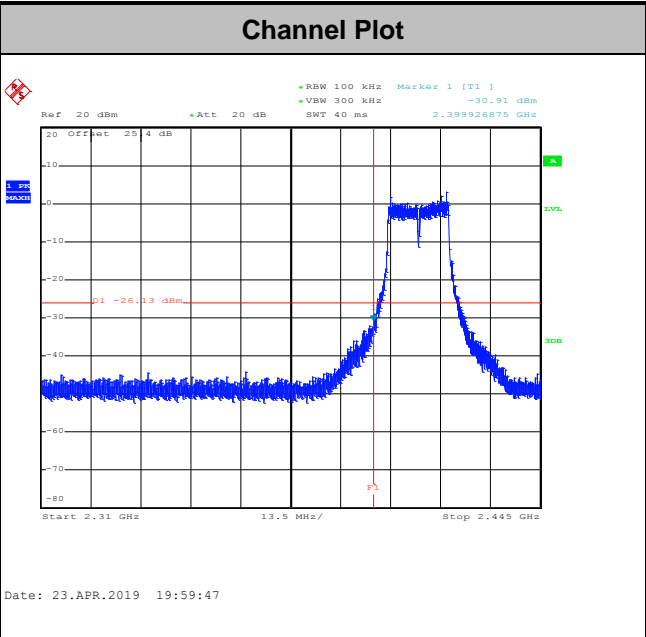
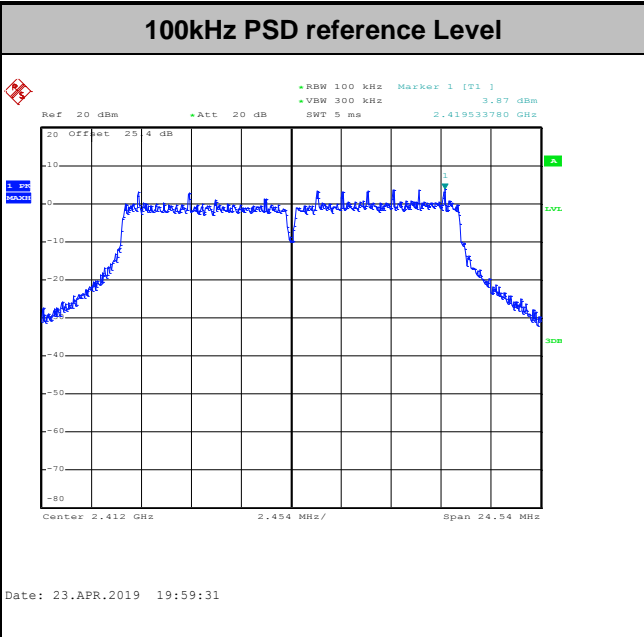



Test Mode :	802.11g	Test Channel :	06
-------------	---------	----------------	----

100kHz PSD reference Level

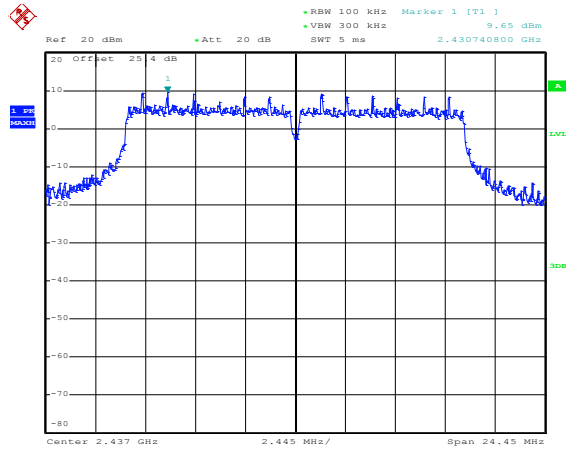

Date: 23.APR.2019 20:46:19

Spurious Emission 30MHz~3GHz

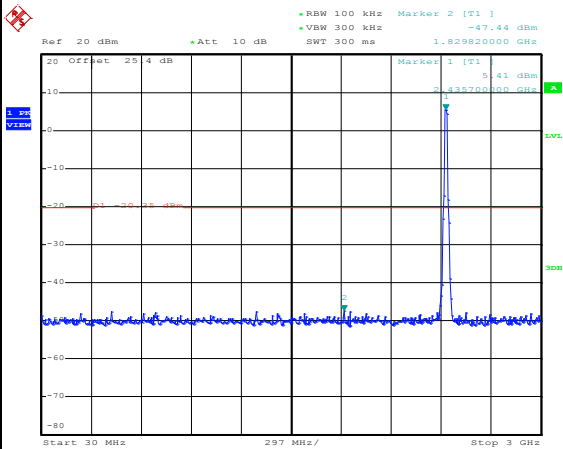

Date: 23.APR.2019 20:47:15

Spurious Emission 2GHz~25GHz

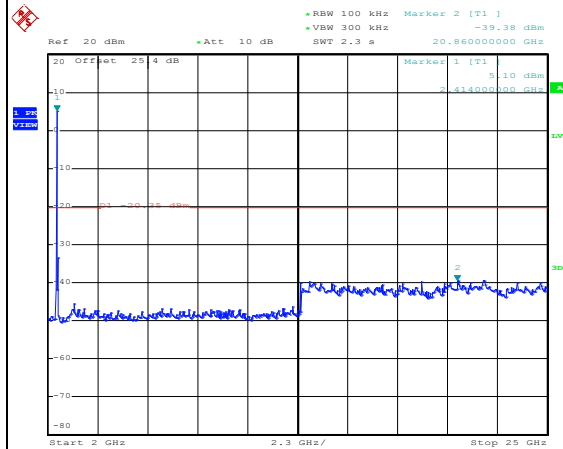

Date: 23.APR.2019 20:47:31



Test Mode :	802.11g	Test Channel :	11
-------------	---------	----------------	----

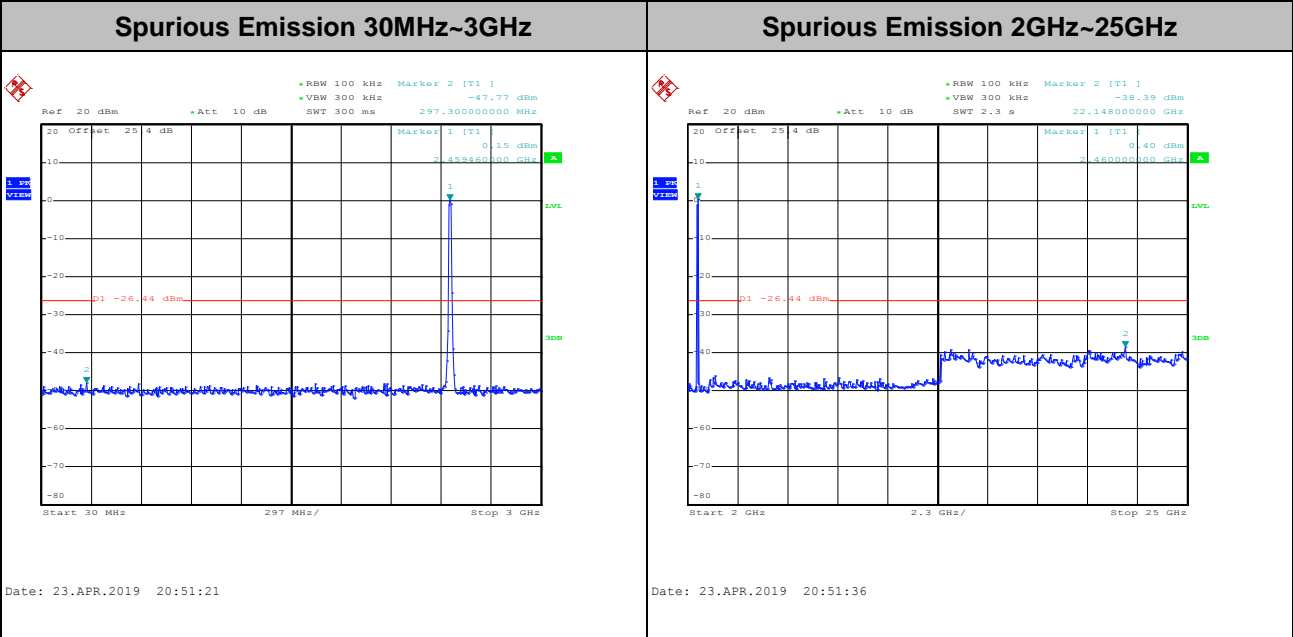
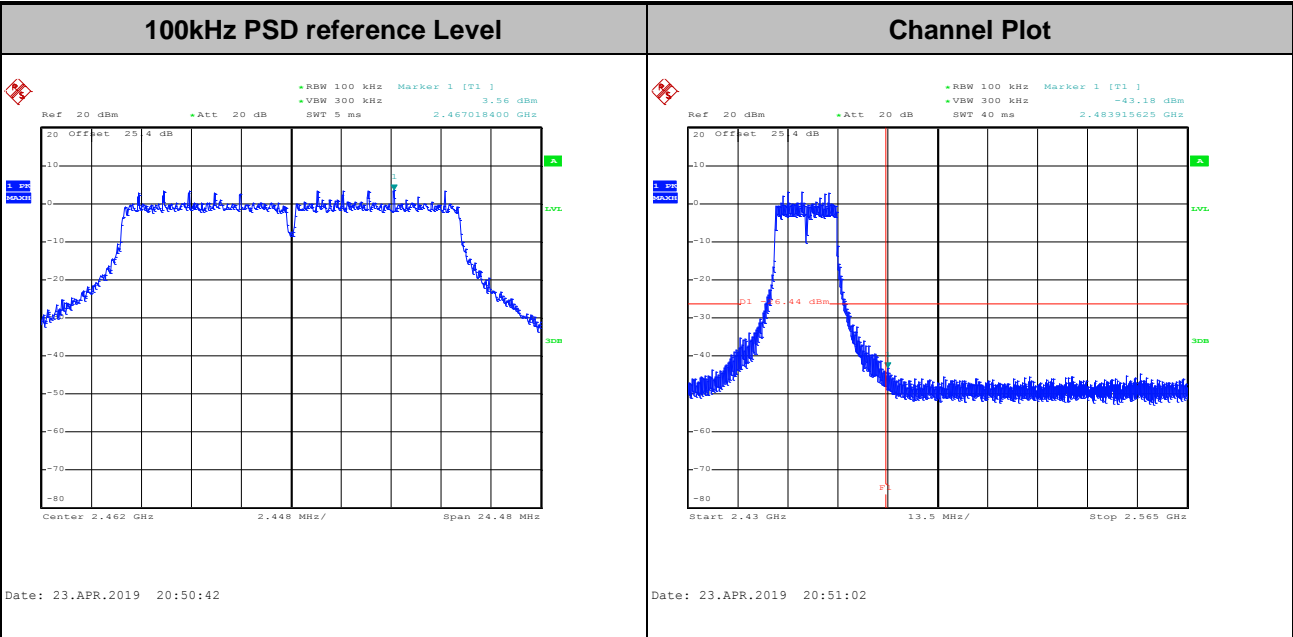



Test Mode :	802.11ac VHT20	Test Channel :	01
-------------	----------------	----------------	----

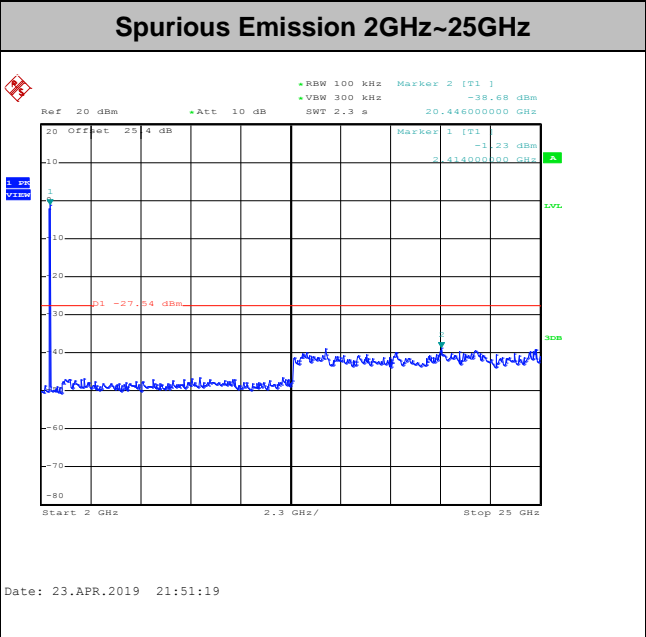
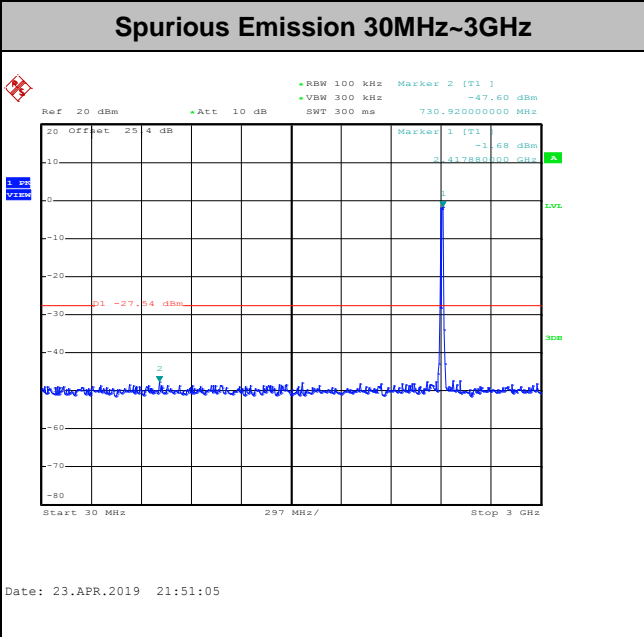
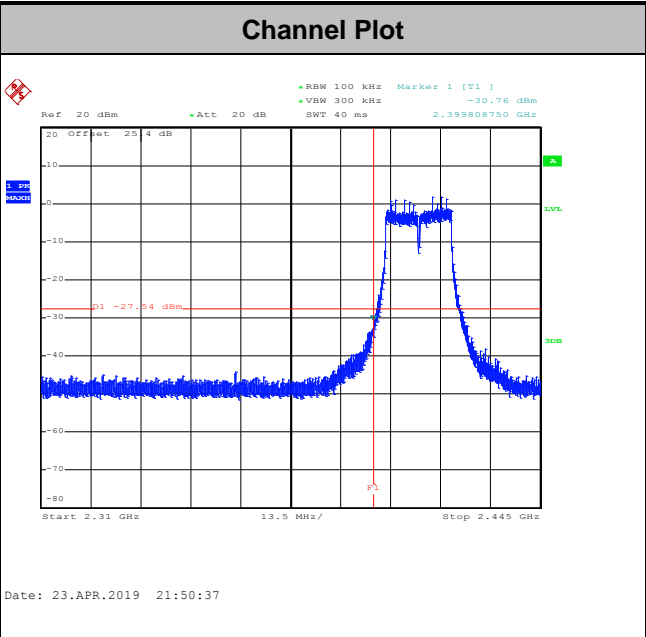
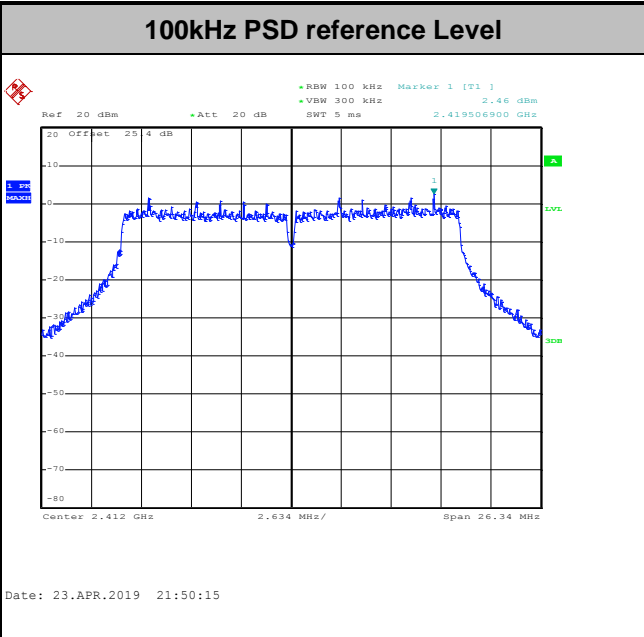



Test Mode :	802.11ac VHT20	Test Channel :	06
-------------	----------------	----------------	----

100kHz PSD reference Level

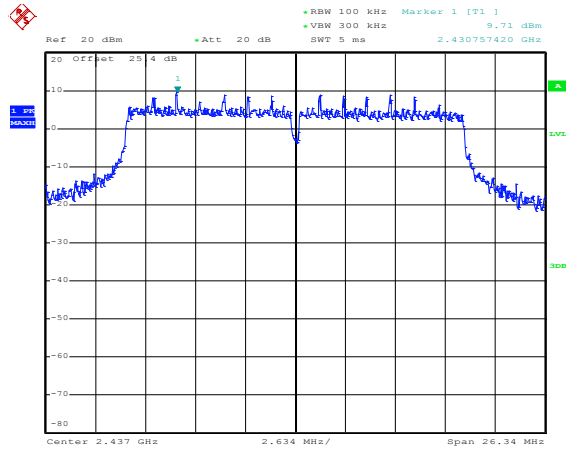

Date: 23.APR.2019 21:52:51

Spurious Emission 30MHz~3GHz

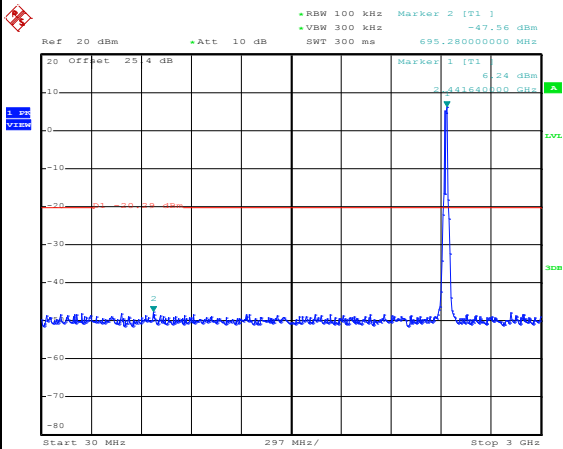

Date: 23.APR.2019 21:53:21

Spurious Emission 2GHz~25GHz

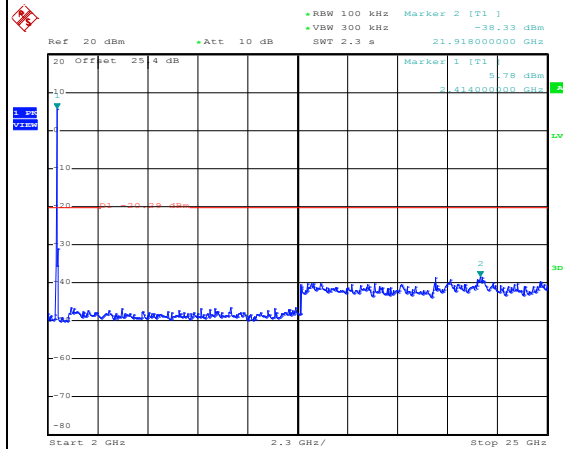

Date: 23.APR.2019 21:53:34



Test Mode :	802.11ac VHT20	Test Channel :	11
-------------	----------------	----------------	----

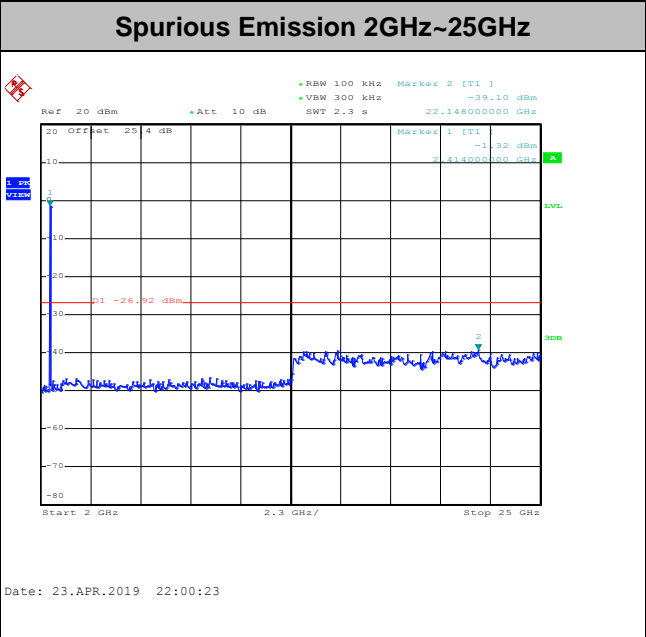
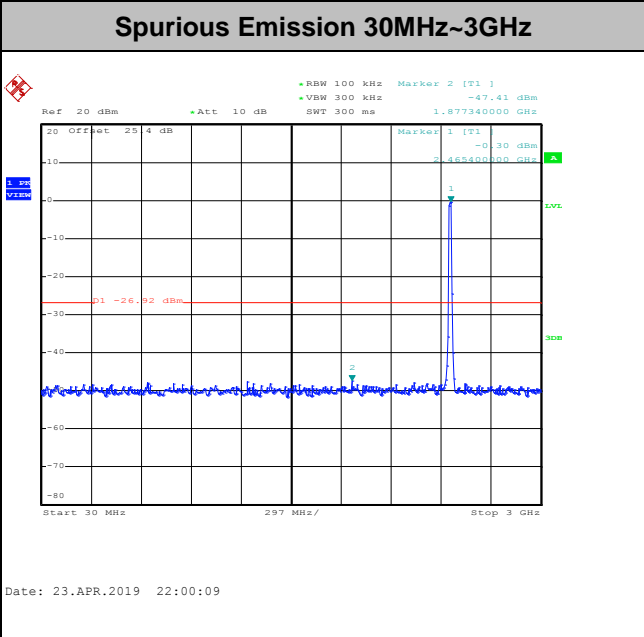
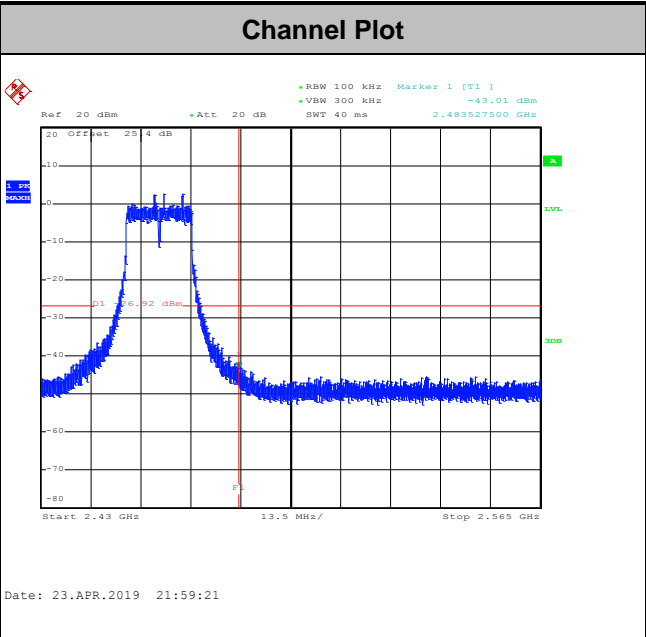
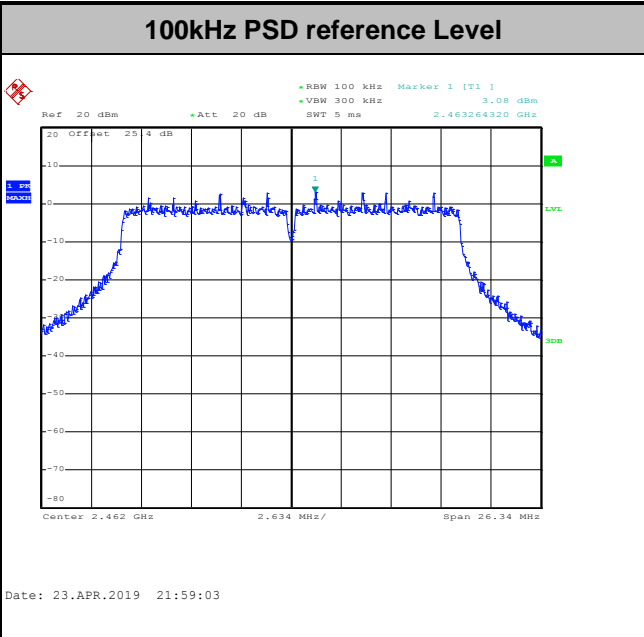



Test Mode :	802.11ac VHT40	Test Channel :	03
-------------	----------------	----------------	----

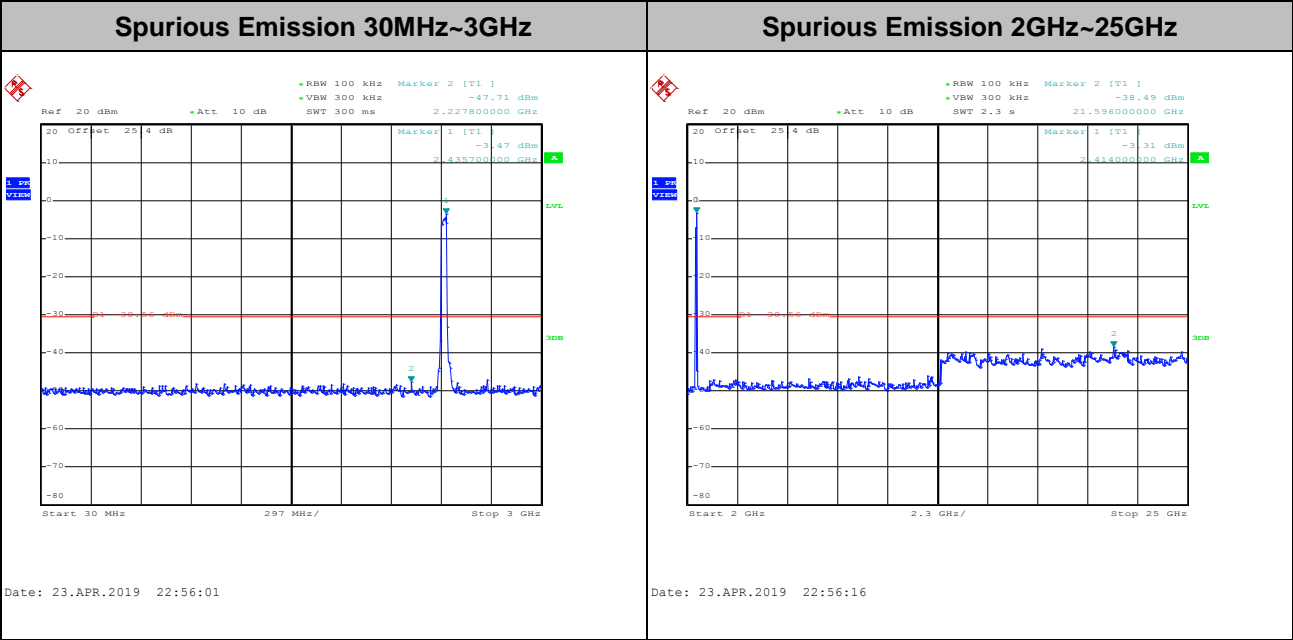
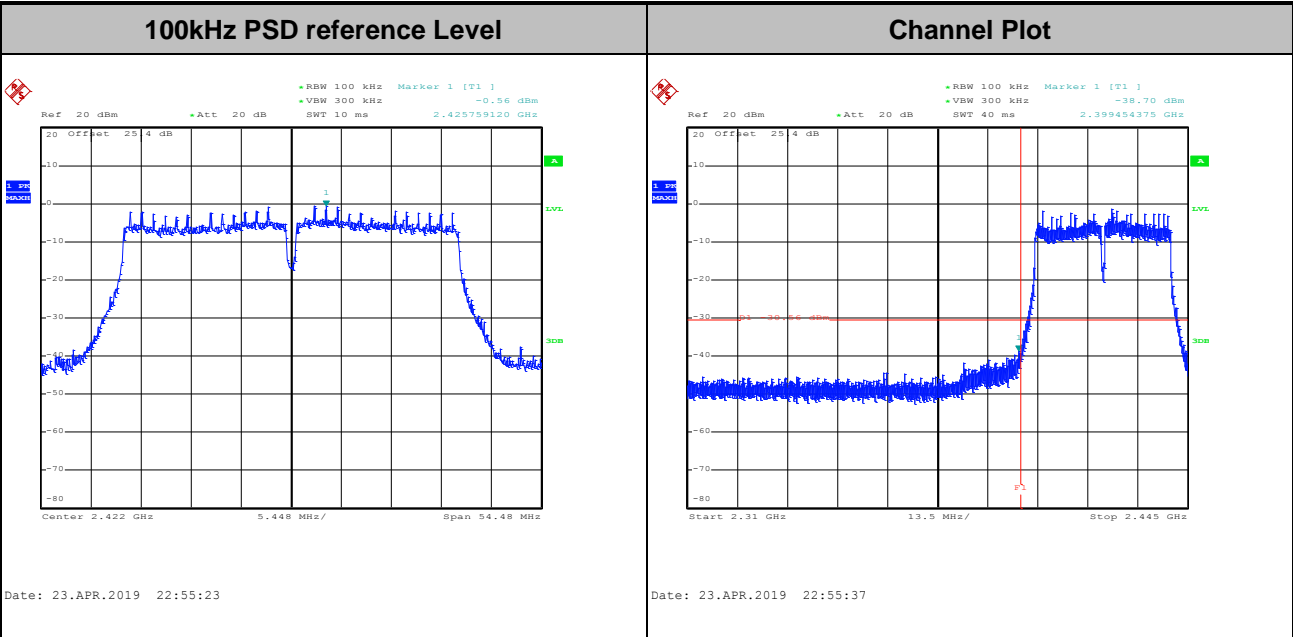



Test Mode :	802.11ac VHT40	Test Channel :	06
-------------	----------------	----------------	----

100kHz PSD reference Level

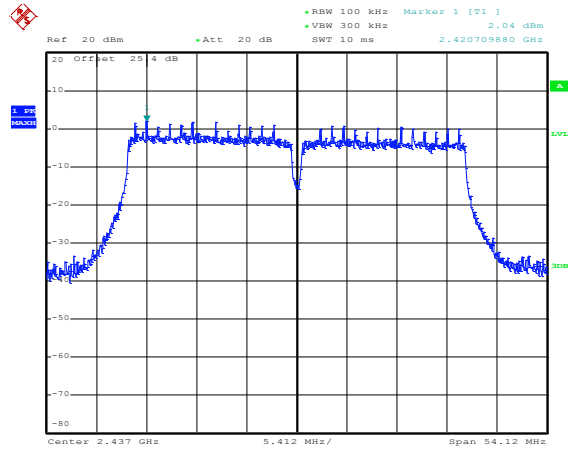

Date: 23.APR.2019 22:59:20

Spurious Emission 30MHz~3GHz

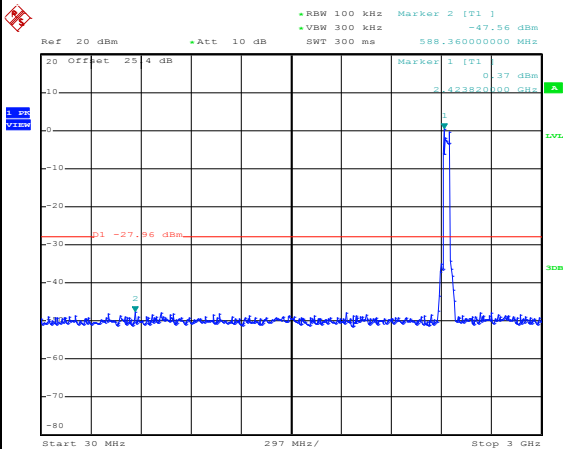

Date: 23.APR.2019 23:00:02

Spurious Emission 2GHz~25GHz

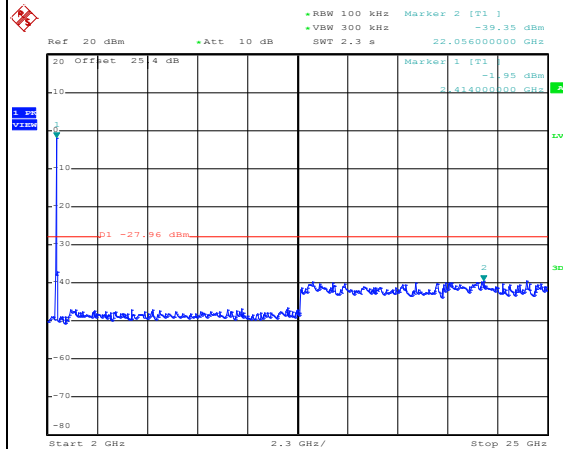

Date: 23.APR.2019 23:00:16



Test Mode :	802.11ac VHT40	Test Channel :	09
-------------	----------------	----------------	----

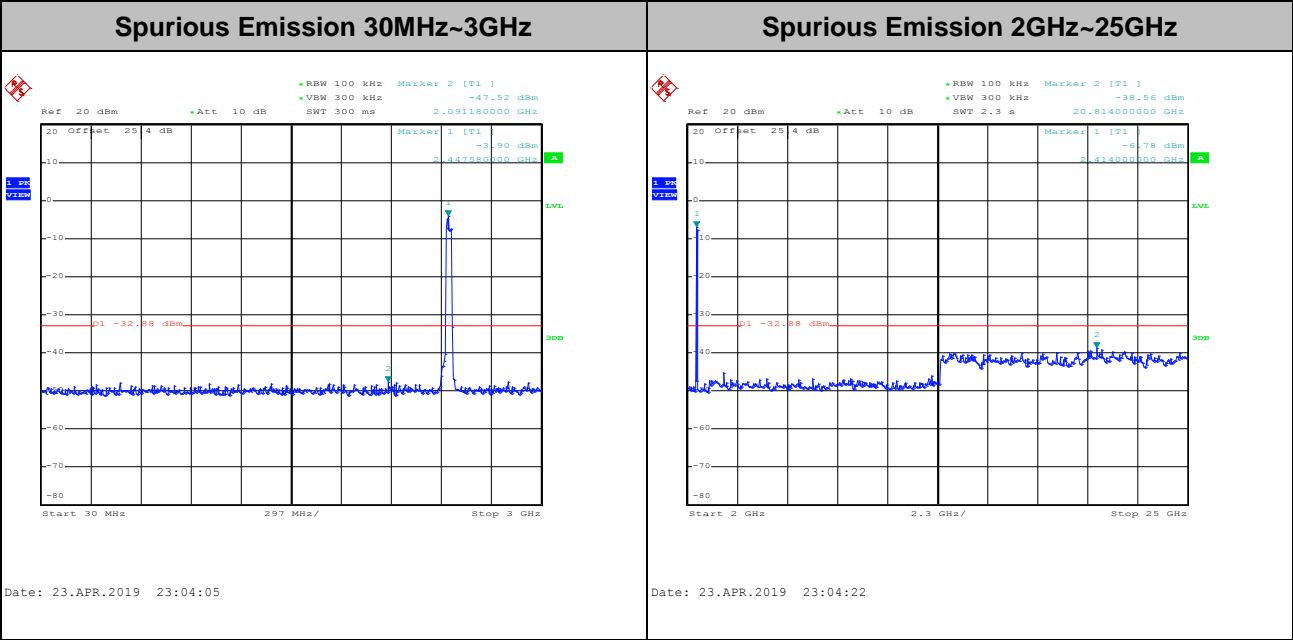
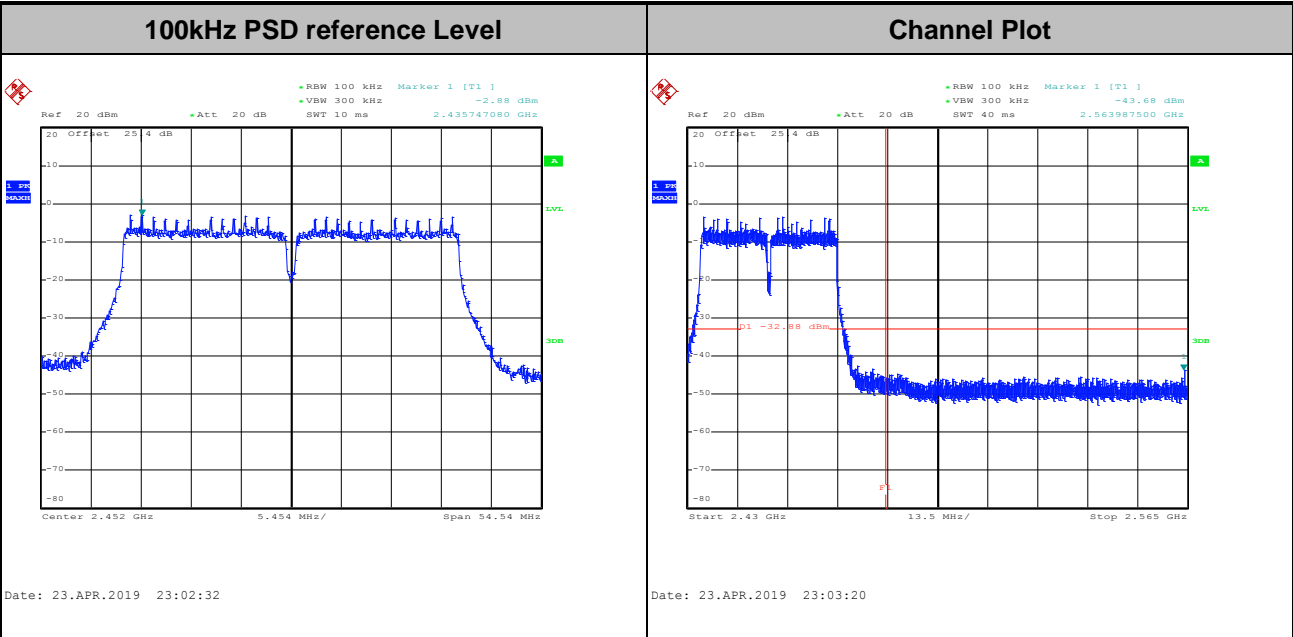



Number of TX = 1, Ant. 2 (Measured)

Test Mode :	802.11b	Test Channel :	01
-------------	---------	----------------	----

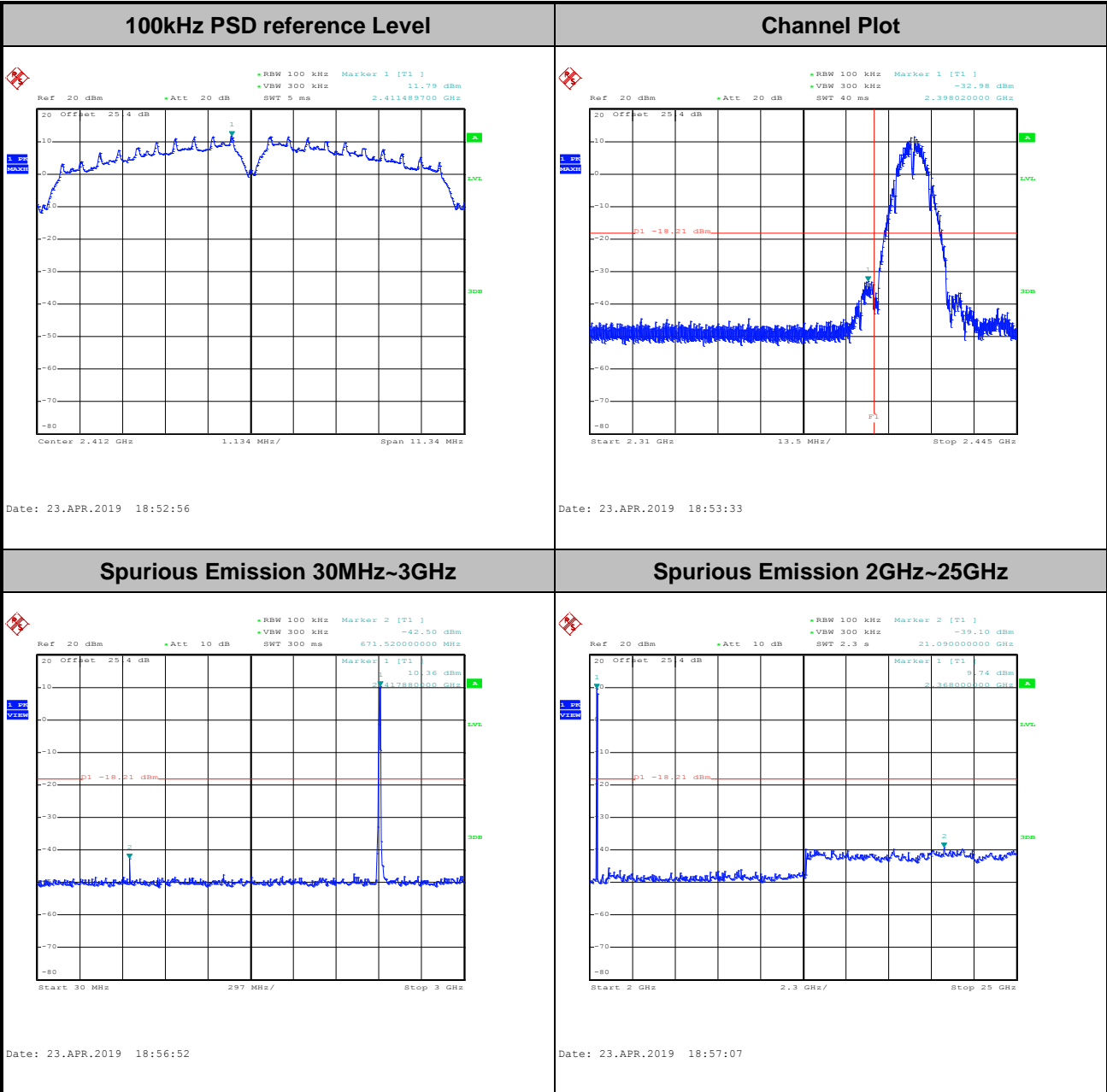



Test Mode :	802.11b	Test Channel :	06
-------------	---------	----------------	----

100kHz PSD reference Level

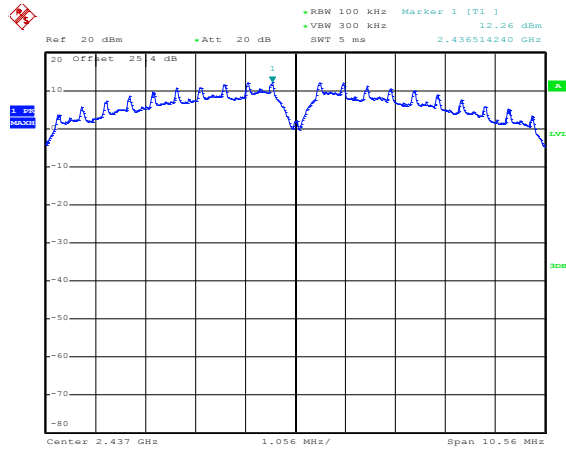

Date: 23.APR.2019 18:58:49

Spurious Emission 30MHz~3GHz

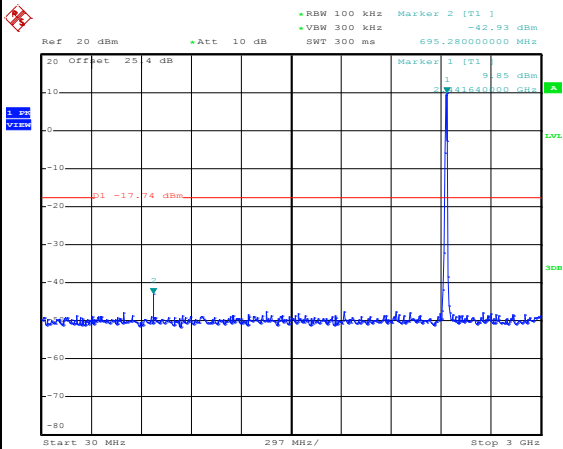

Date: 23.APR.2019 18:59:13

Spurious Emission 2GHz~25GHz

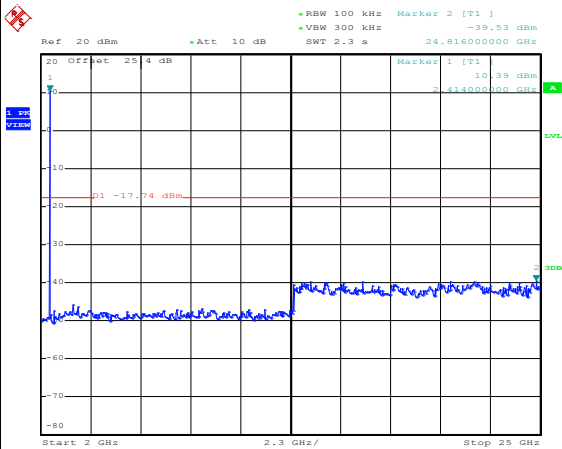

Date: 23.APR.2019 18:59:26



Test Mode :	802.11b	Test Channel :	11
-------------	---------	----------------	----

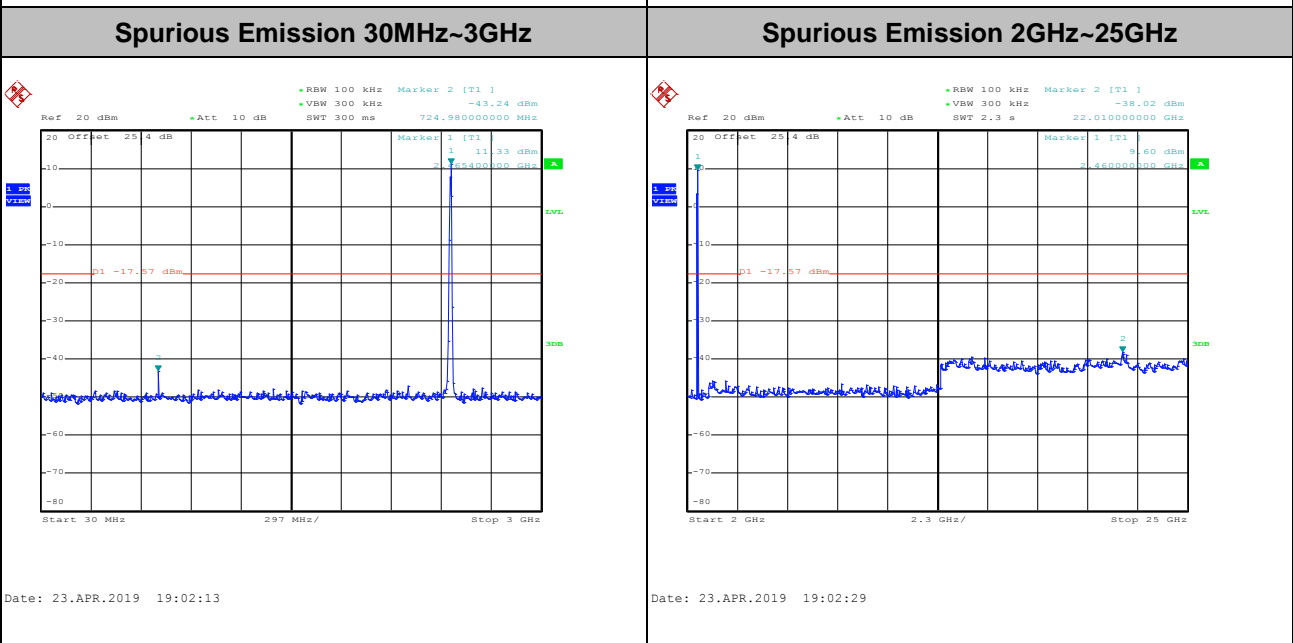
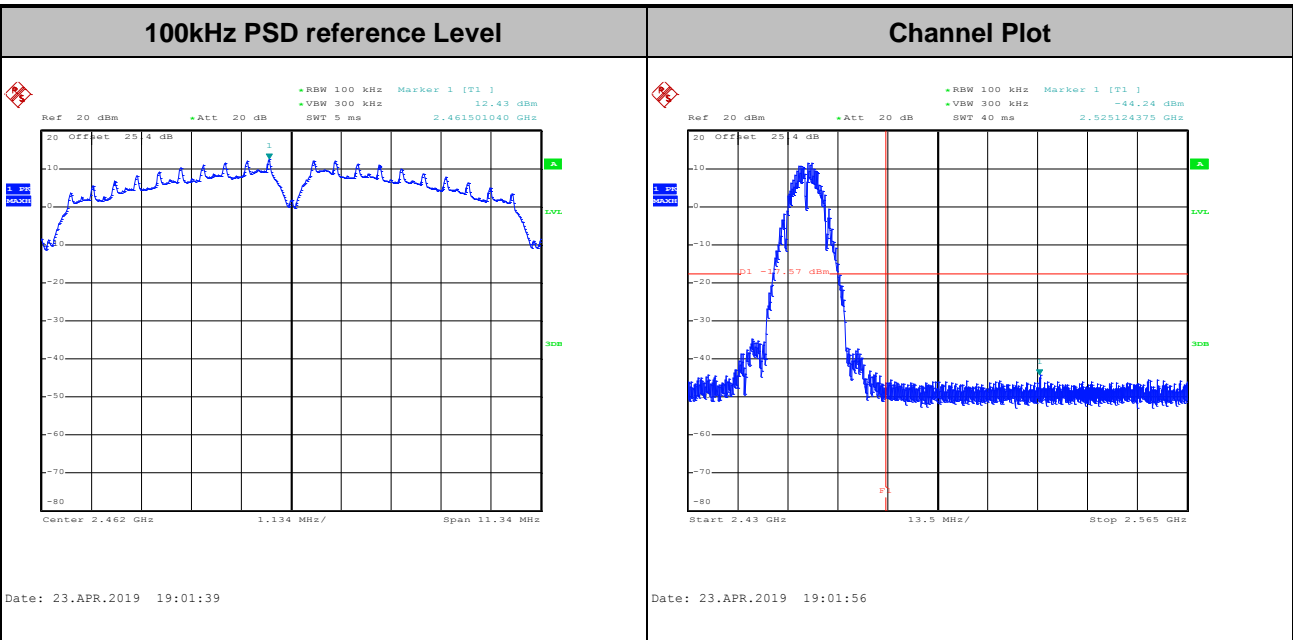



Test Mode : 802.11g Test Channel : 01

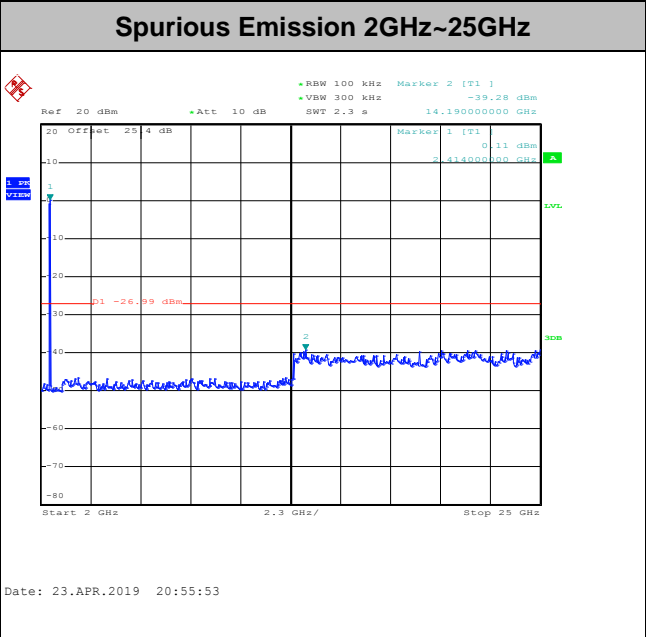
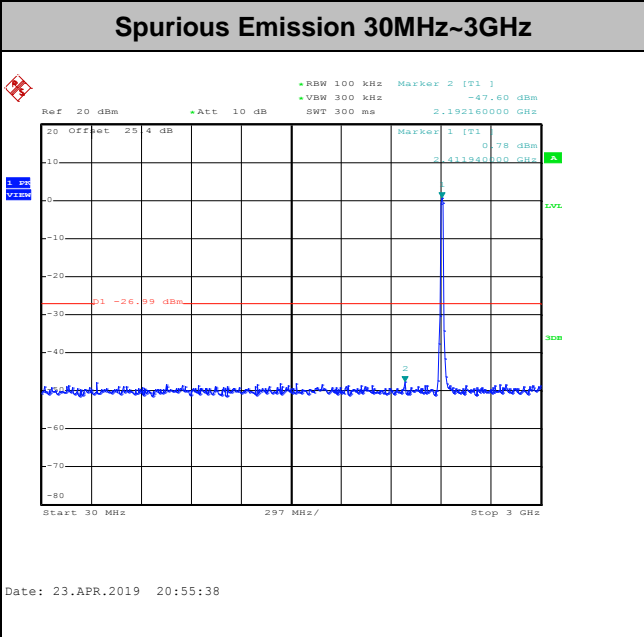
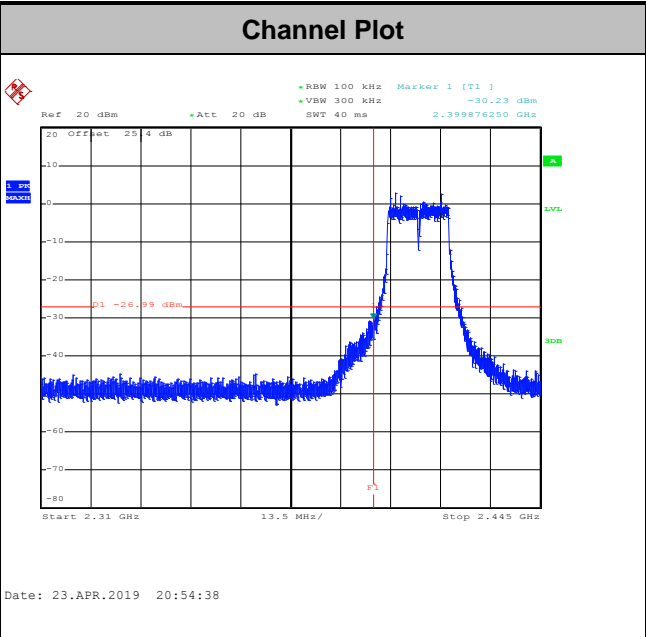
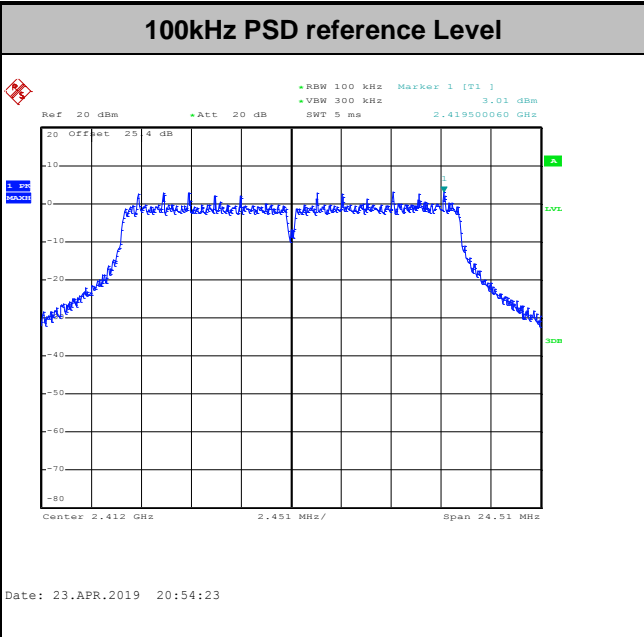



Test Mode :	802.11g	Test Channel :	06
-------------	---------	----------------	----

100kHz PSD reference Level

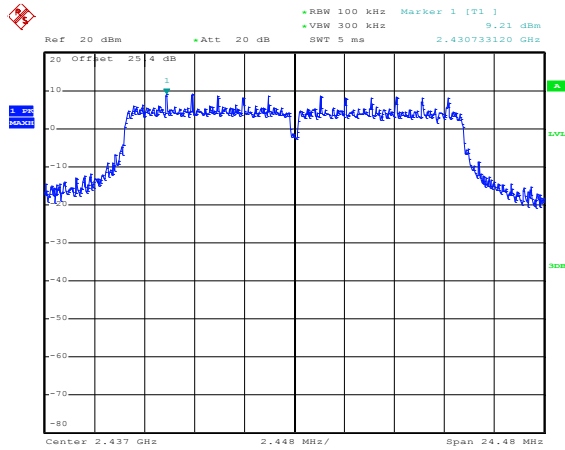

Date: 23.APR.2019 20:57:27

Spurious Emission 30MHz~3GHz

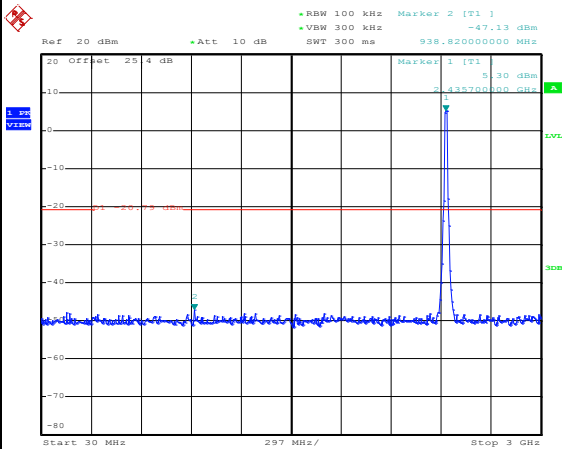

Date: 23.APR.2019 20:58:26

Spurious Emission 2GHz~25GHz

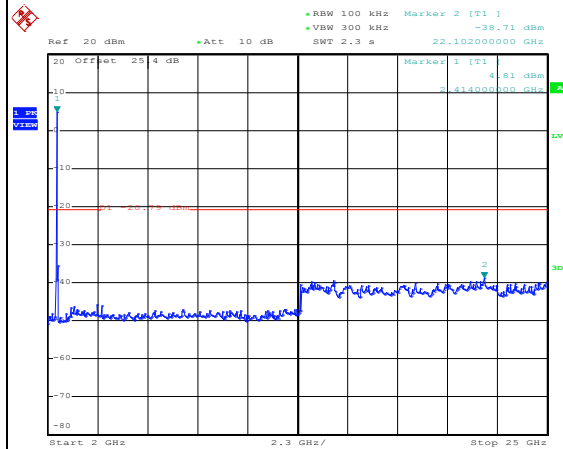

Date: 23.APR.2019 20:58:41



Test Mode :	802.11g	Test Channel :	11
-------------	---------	----------------	----

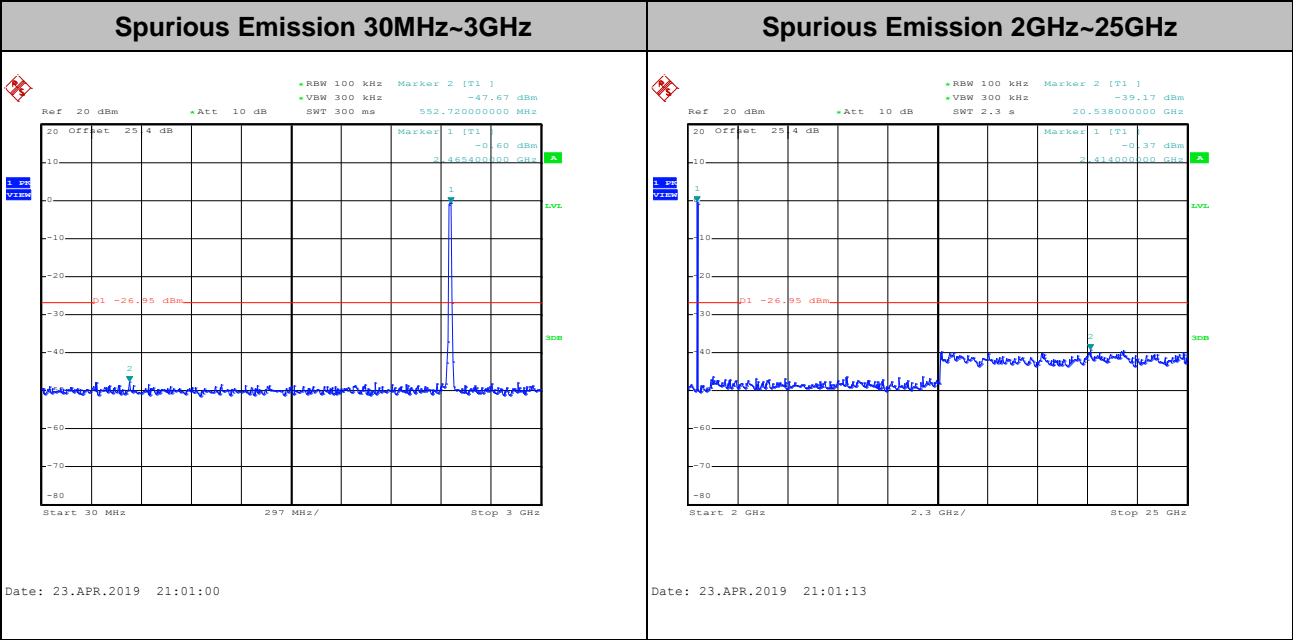
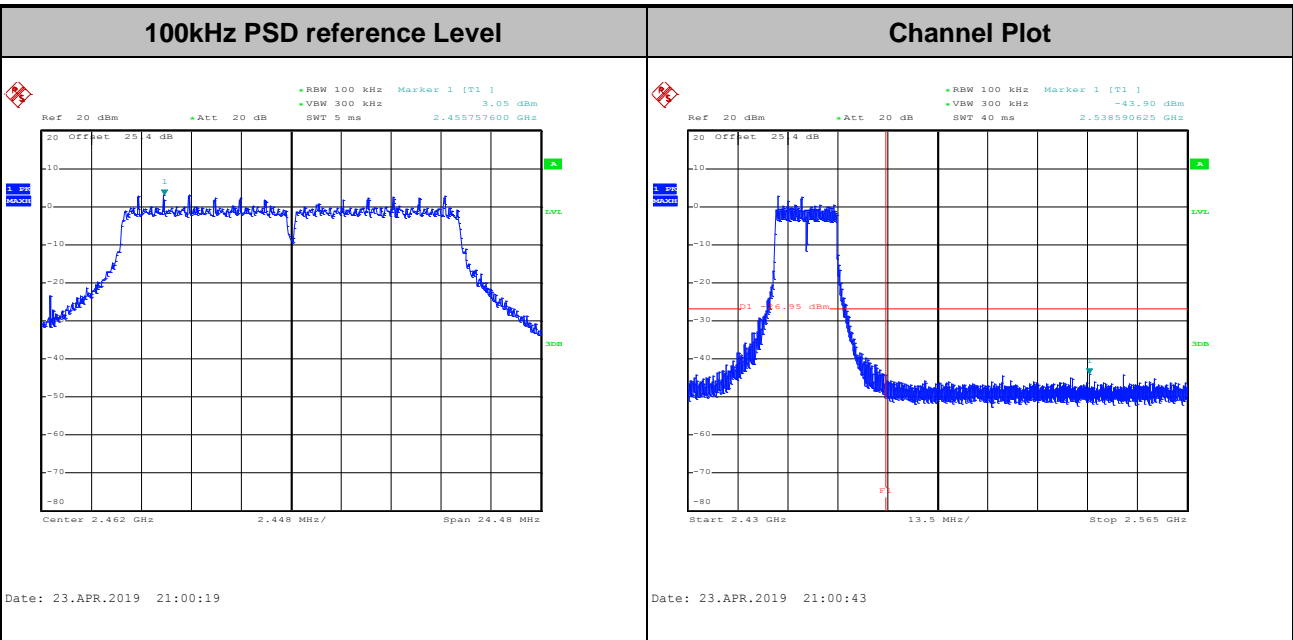



Test Mode :	802.11ac VHT20	Test Channel :	01
-------------	----------------	----------------	----

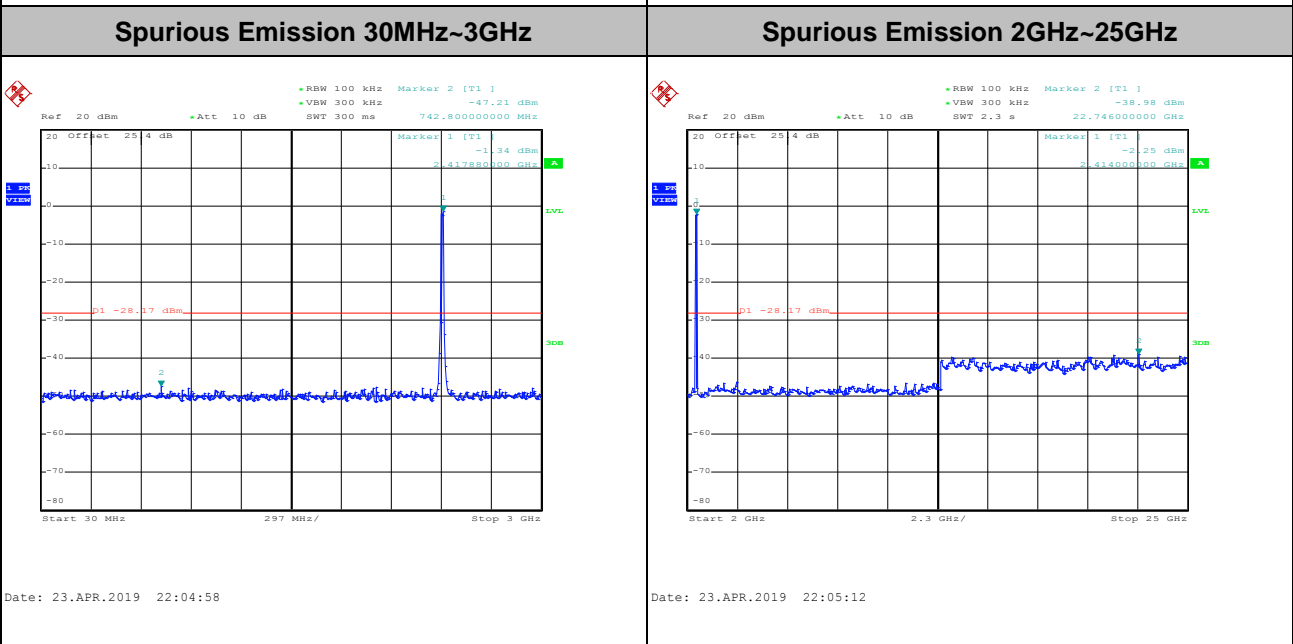
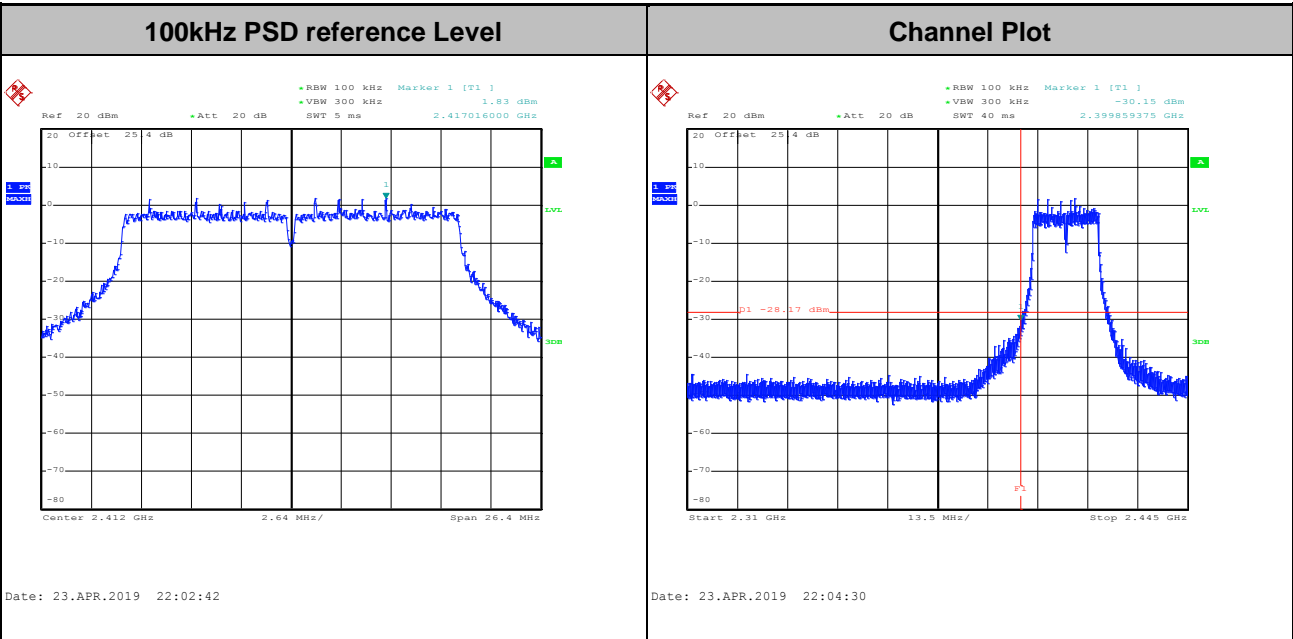



Test Mode :	802.11ac VHT20	Test Channel :	06
-------------	----------------	----------------	----

100kHz PSD reference Level

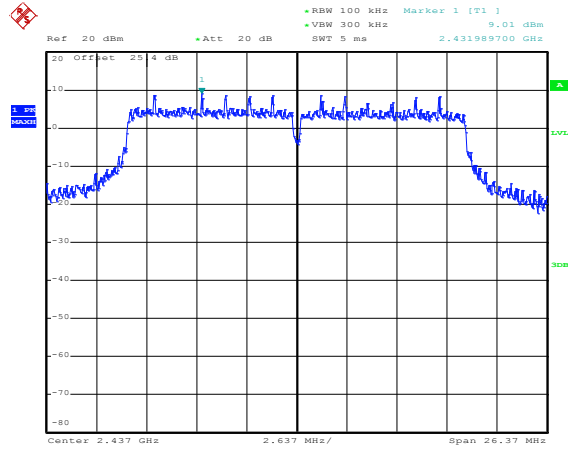

Date: 23.APR.2019 22:06:49

Spurious Emission 30MHz~3GHz

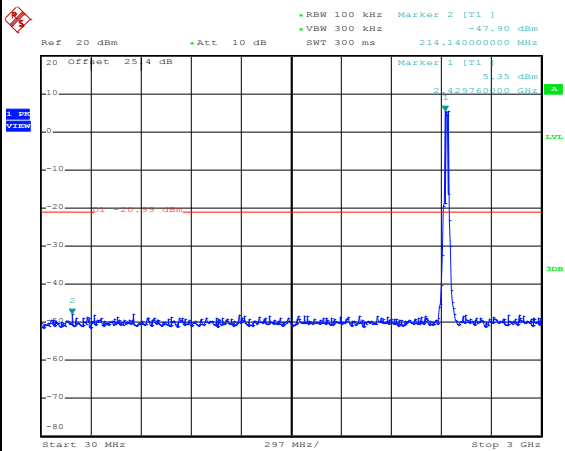

Date: 23.APR.2019 22:07:36

Spurious Emission 2GHz~25GHz

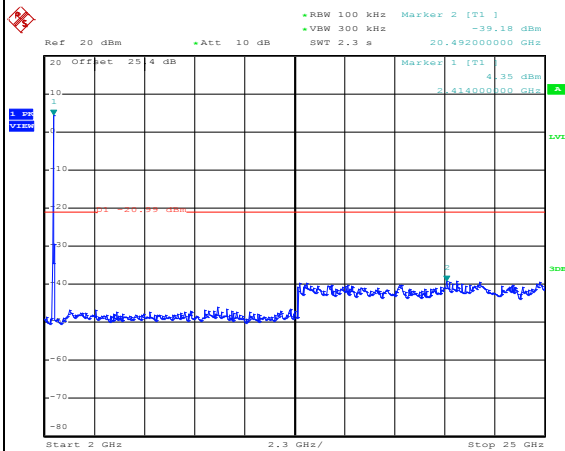

Date: 23.APR.2019 22:07:50



Test Mode :	802.11ac VHT20	Test Channel :	11
-------------	----------------	----------------	----

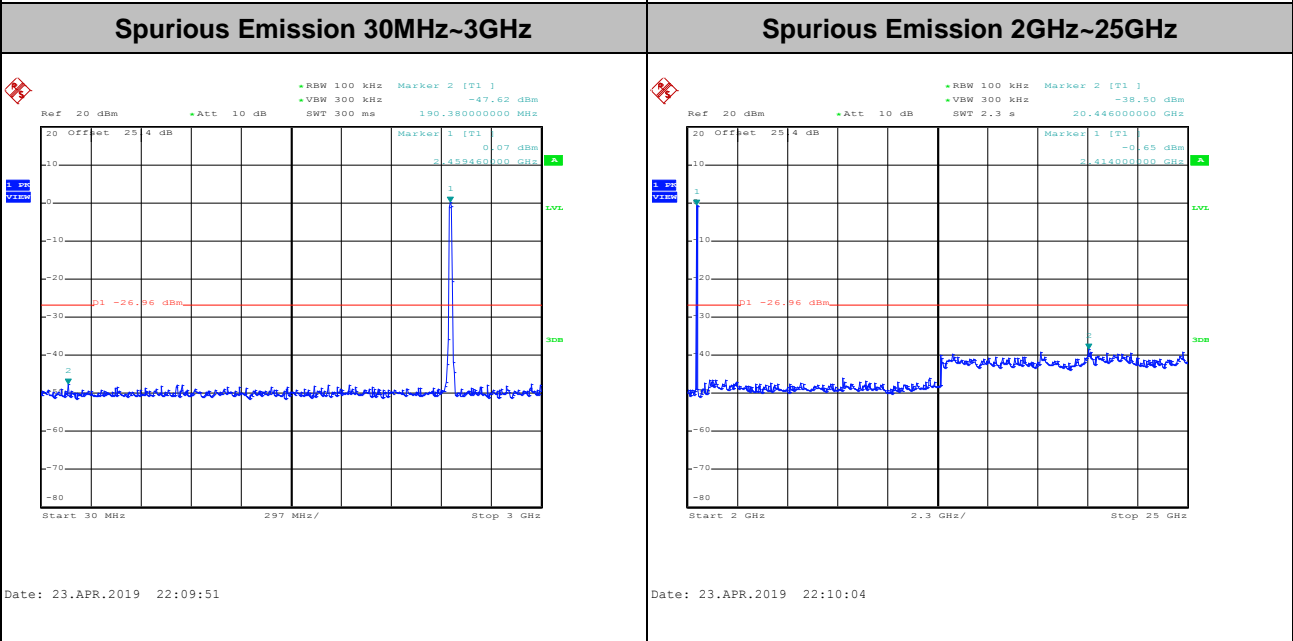
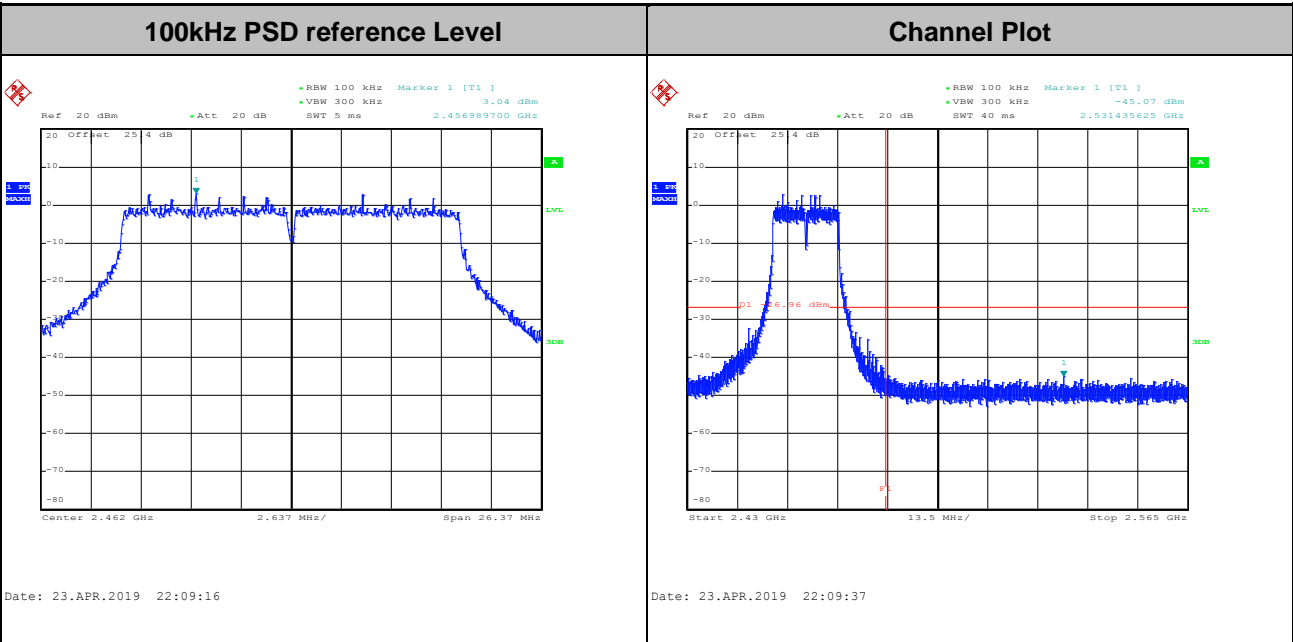



Test Mode :	802.11ac VHT40	Test Channel :	03
-------------	----------------	----------------	----

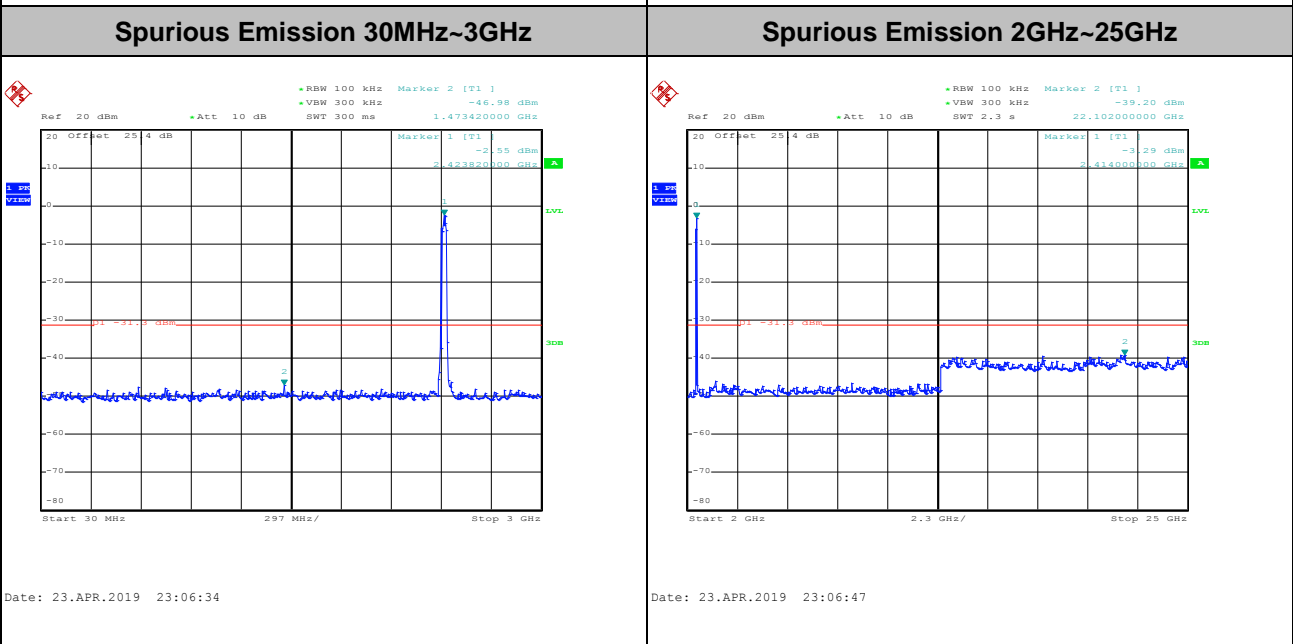
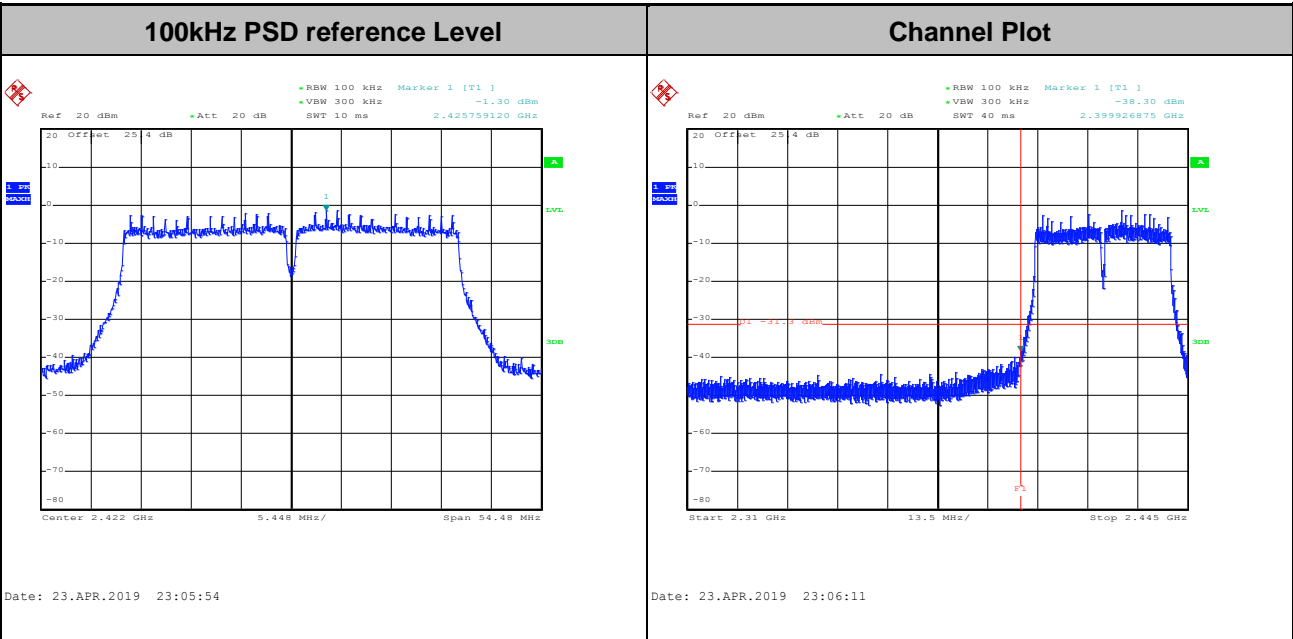



Test Mode :	802.11ac VHT40	Test Channel :	06
-------------	----------------	----------------	----

100kHz PSD reference Level

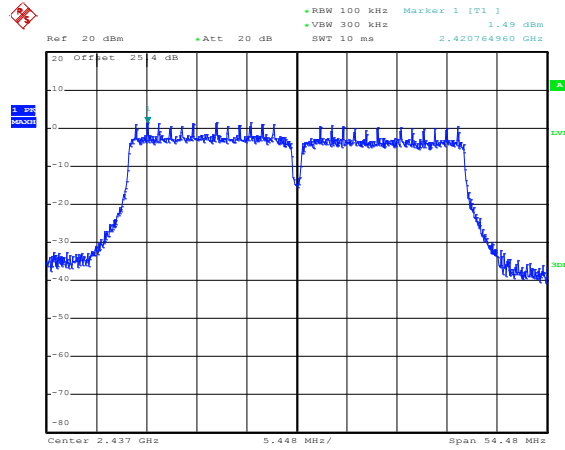

Date: 23.APR.2019 23:08:27

Spurious Emission 30MHz~3GHz

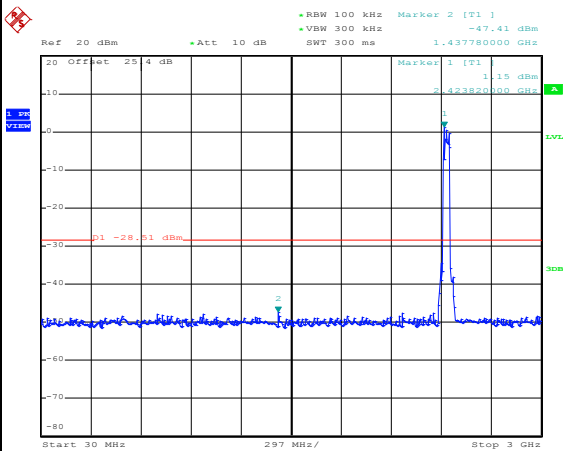

Date: 23.APR.2019 23:08:50

Spurious Emission 2GHz~25GHz

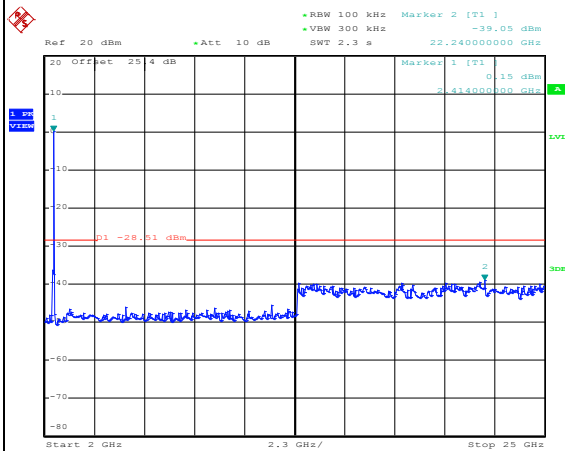

Date: 23.APR.2019 23:09:04



Test Mode :	802.11ac VHT40	Test Channel :	09
-------------	----------------	----------------	----

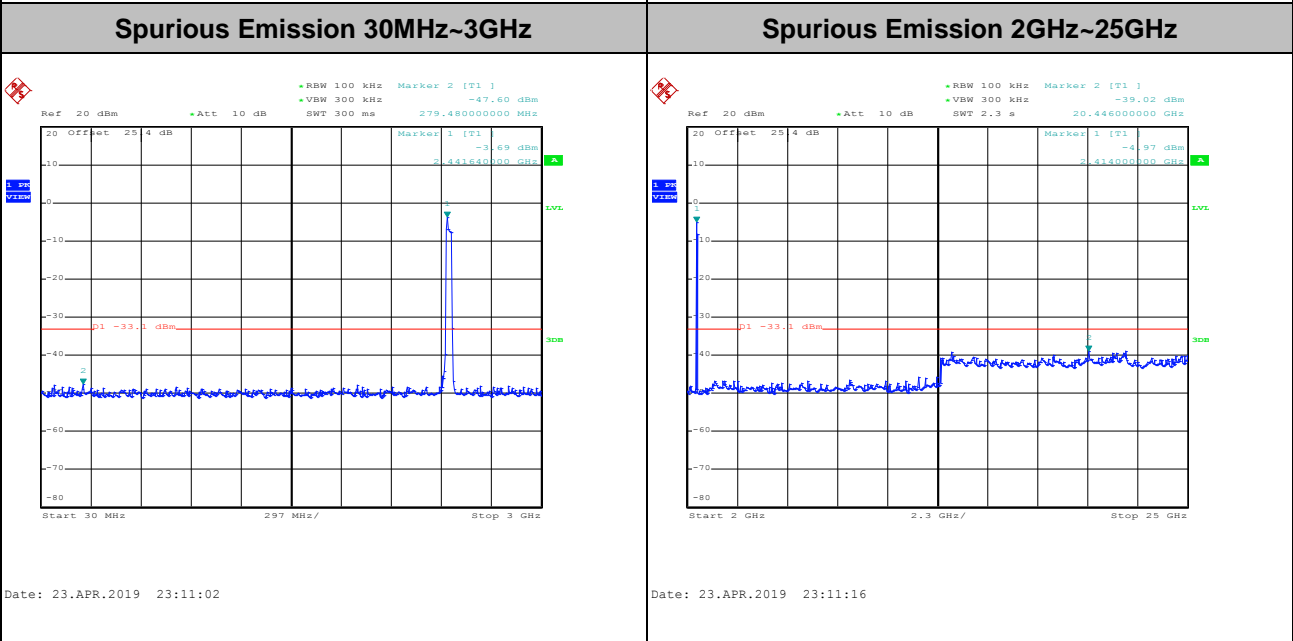
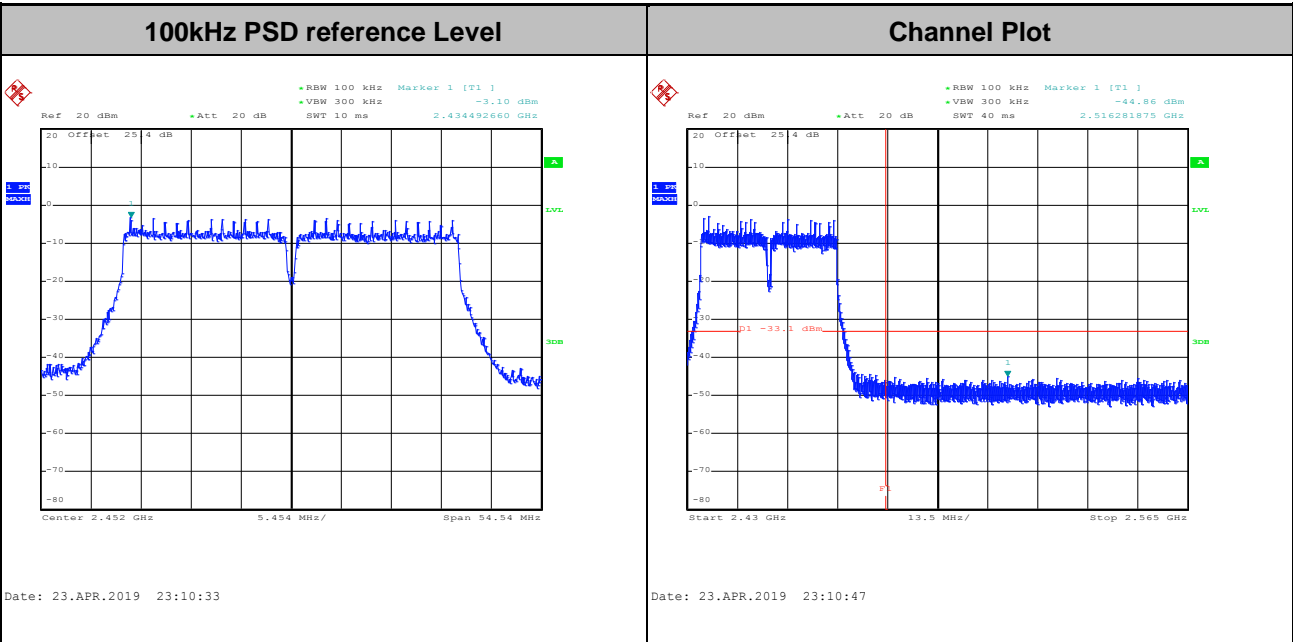



Test Mode :	802.11b	Test Channel :	06
-------------	---------	----------------	----

100kHz PSD reference Level

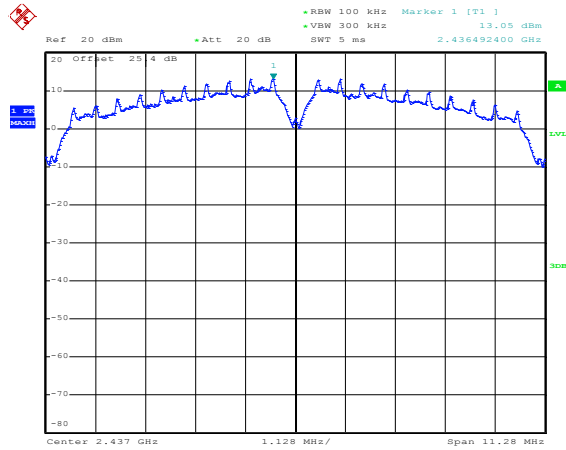

Date: 23.APR.2019 19:19:58

Spurious Emission 30MHz~3GHz

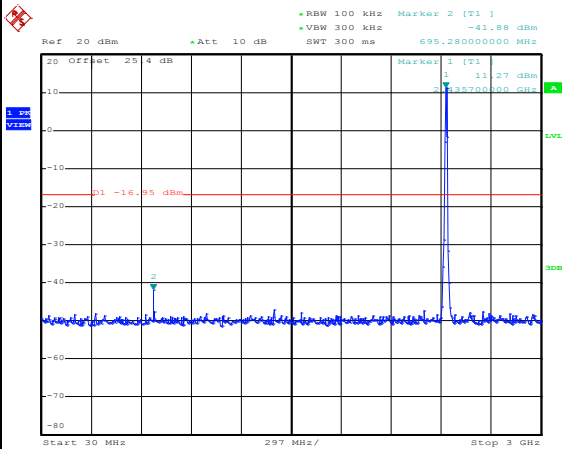

Date: 23.APR.2019 19:20:37

Spurious Emission 2GHz~25GHz

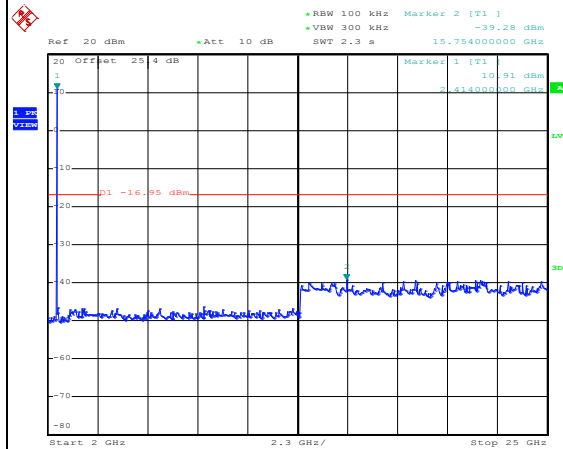

Date: 23.APR.2019 19:20:51



Test Mode :	802.11b	Test Channel :	11
-------------	---------	----------------	----

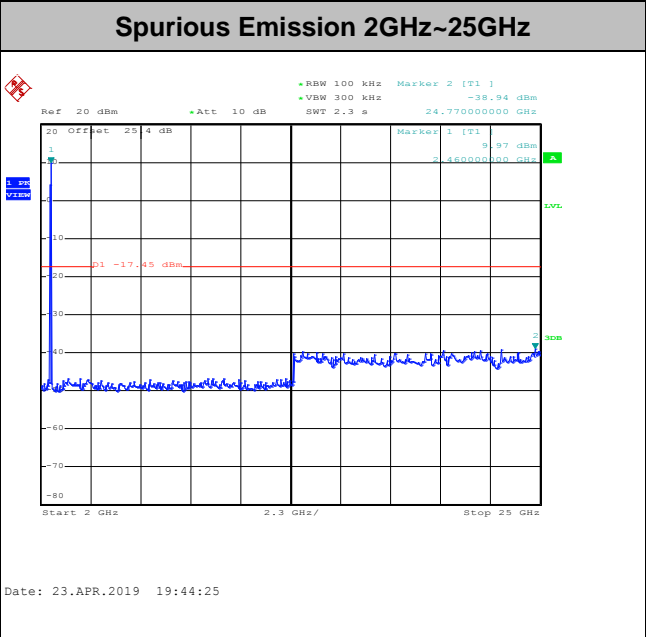
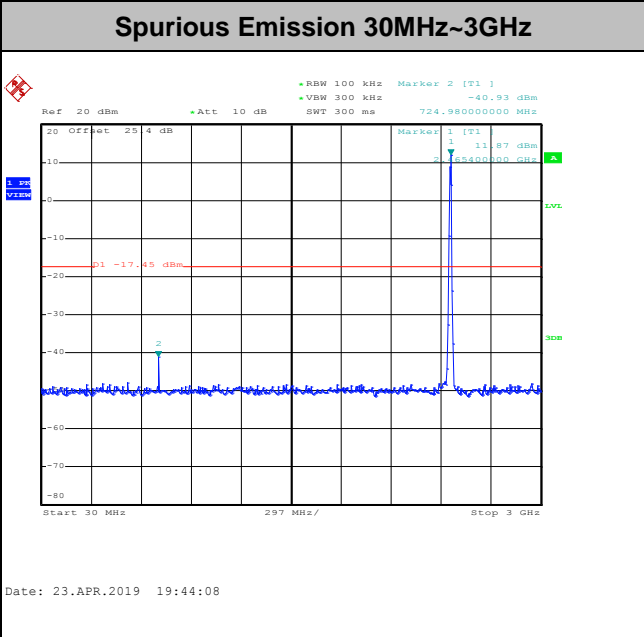
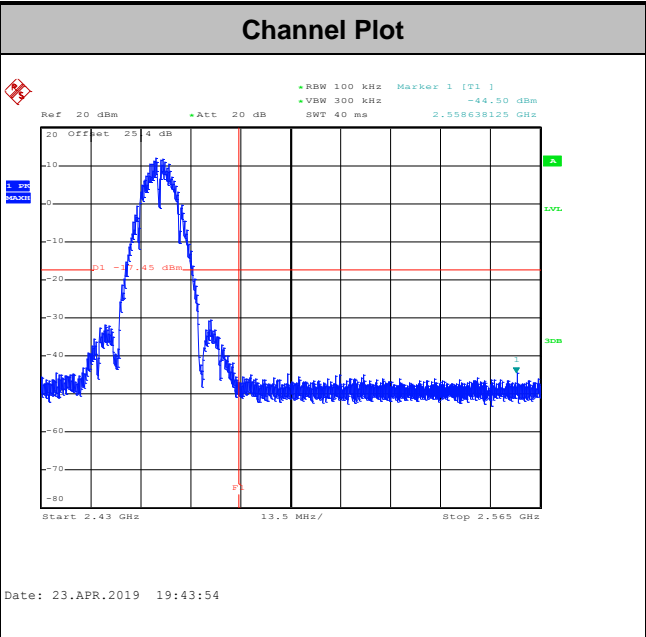
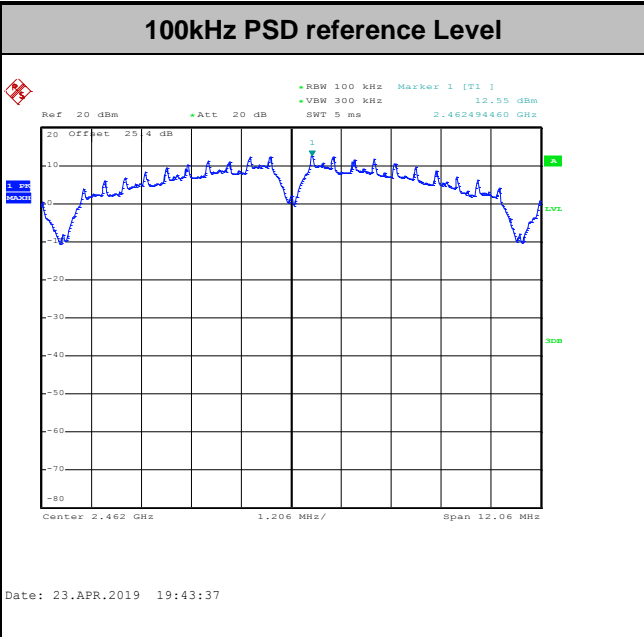



Test Mode : 802.11g Test Channel : 01

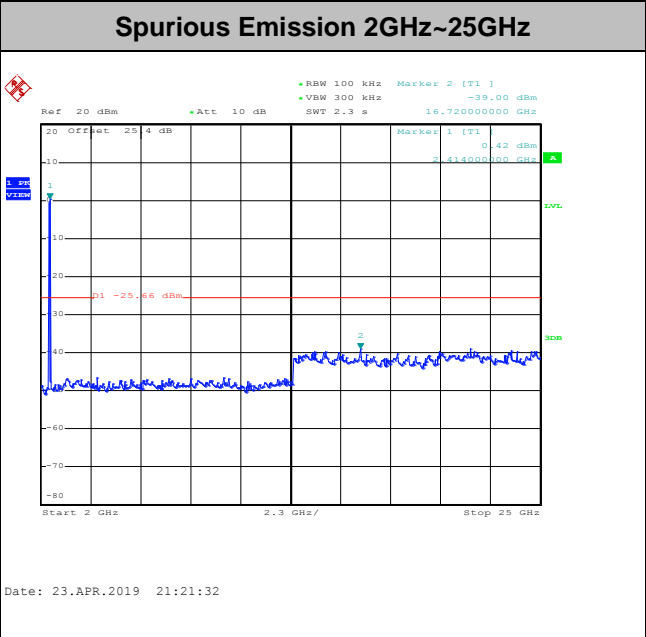
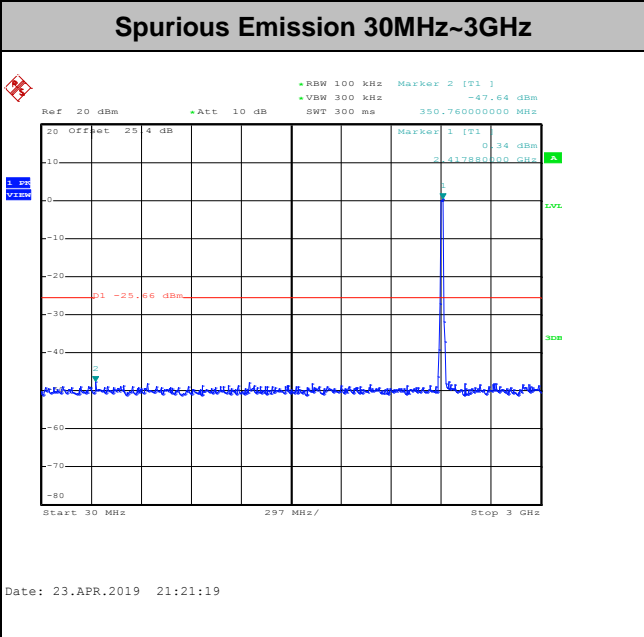
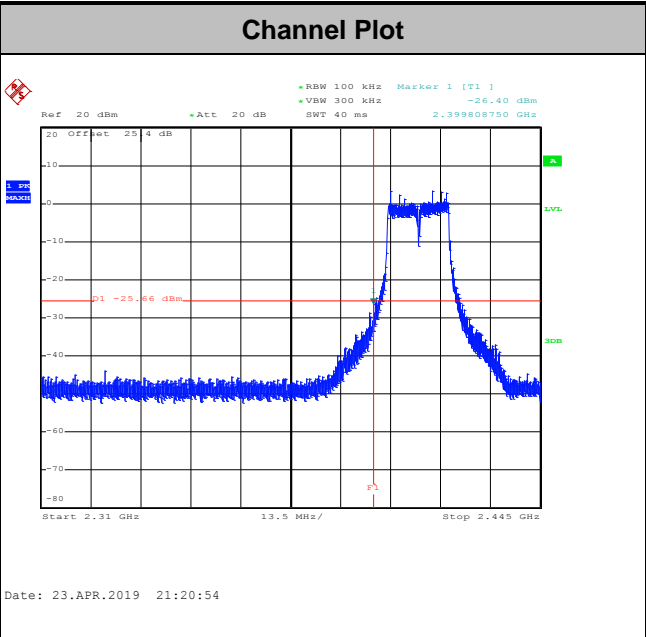
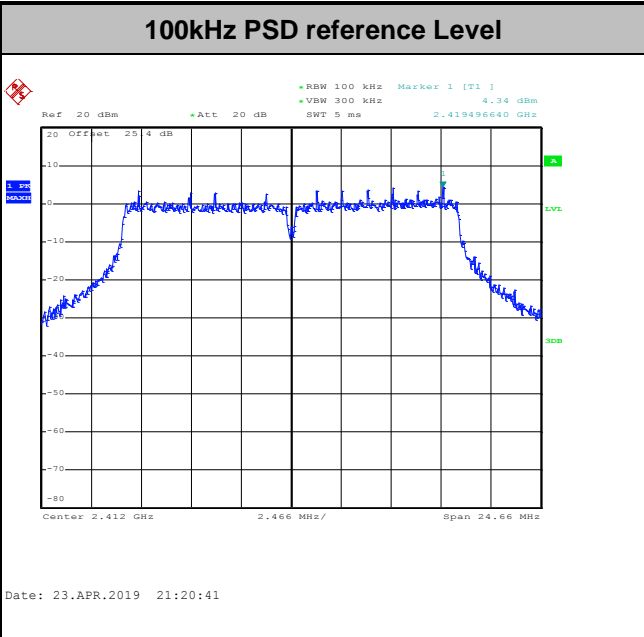



Test Mode :	802.11g	Test Channel :	06
-------------	---------	----------------	----

100kHz PSD reference Level

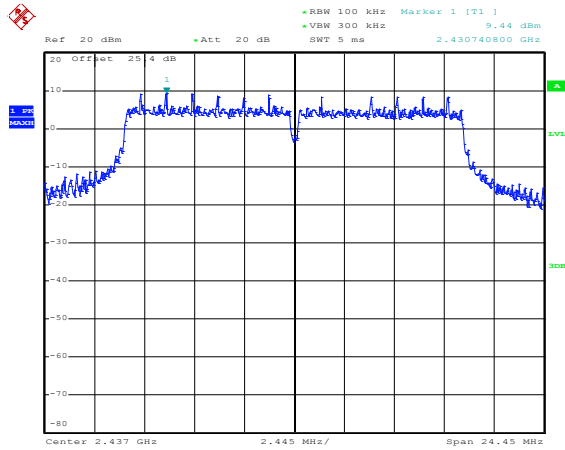

Date: 23.APR.2019 21:25:10

Spurious Emission 30MHz~3GHz

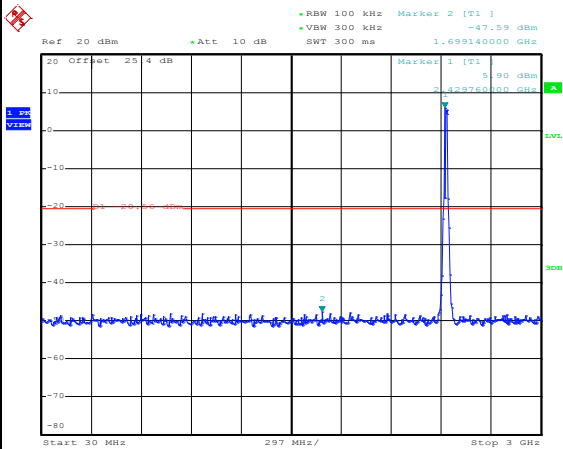

Date: 23.APR.2019 21:25:42

Spurious Emission 2GHz~25GHz

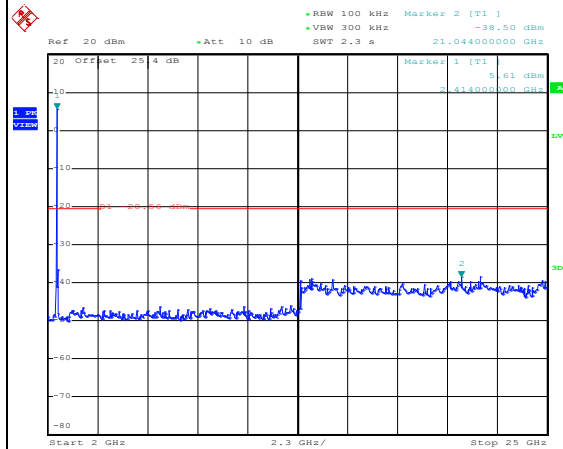

Date: 23.APR.2019 21:25:58



Test Mode :	802.11g	Test Channel :	11
-------------	---------	----------------	----

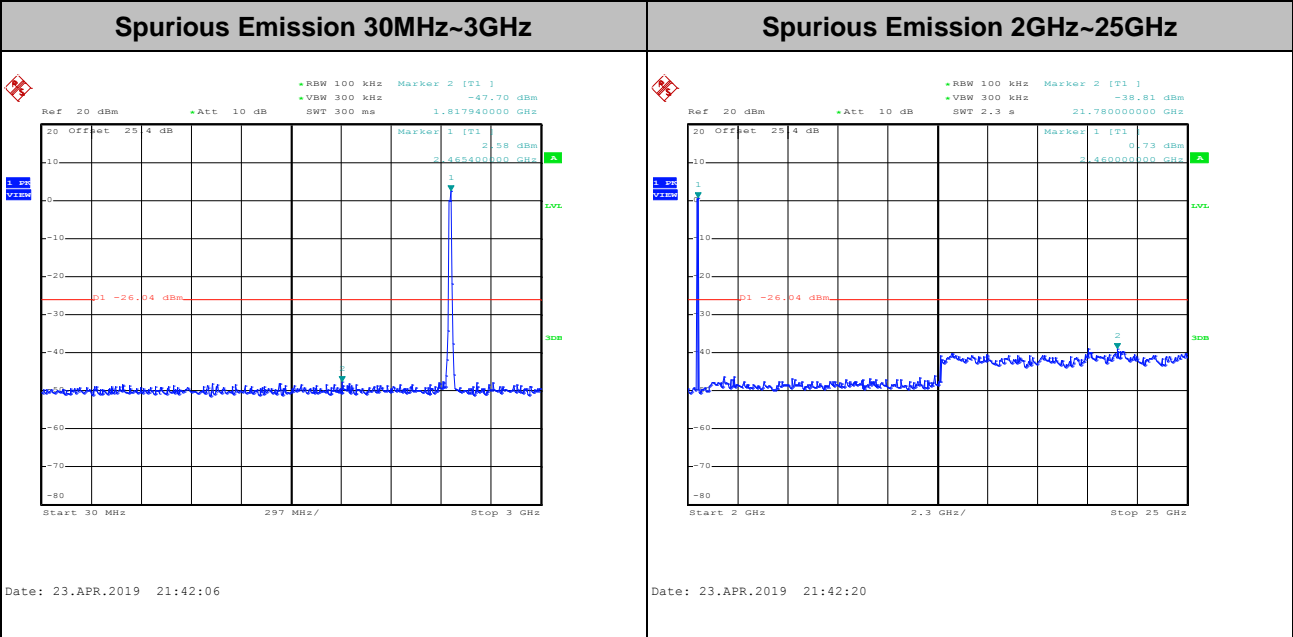
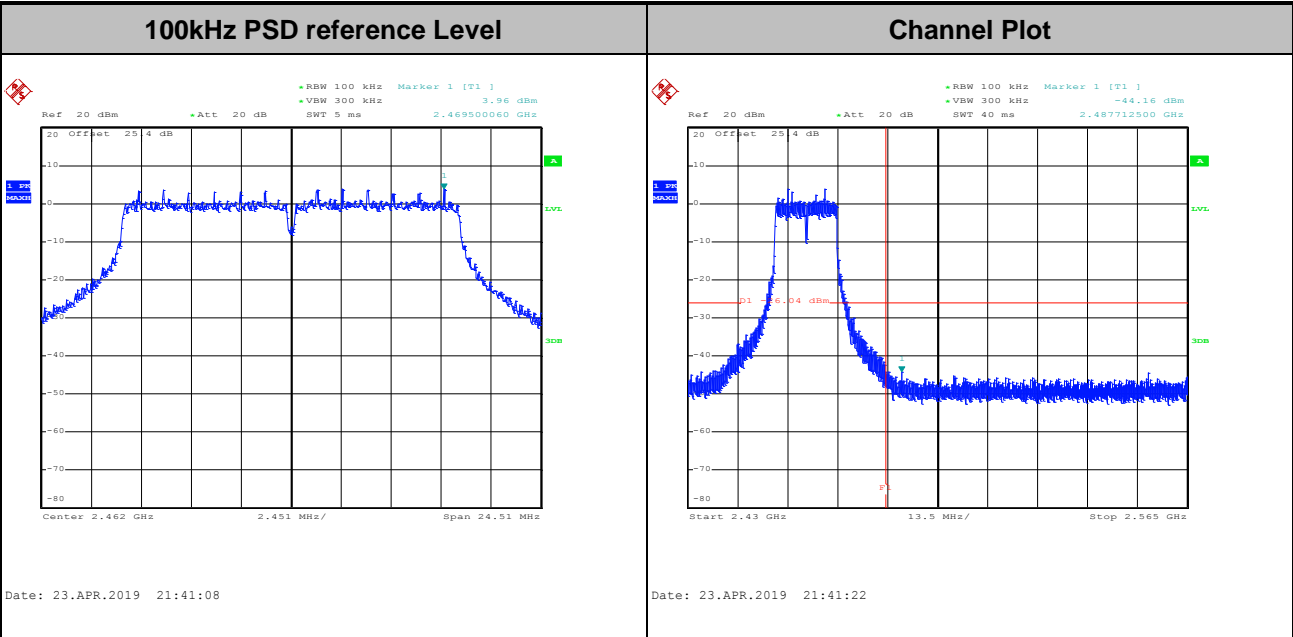



Test Mode :	802.11ac VHT20	Test Channel :	01
-------------	----------------	----------------	----

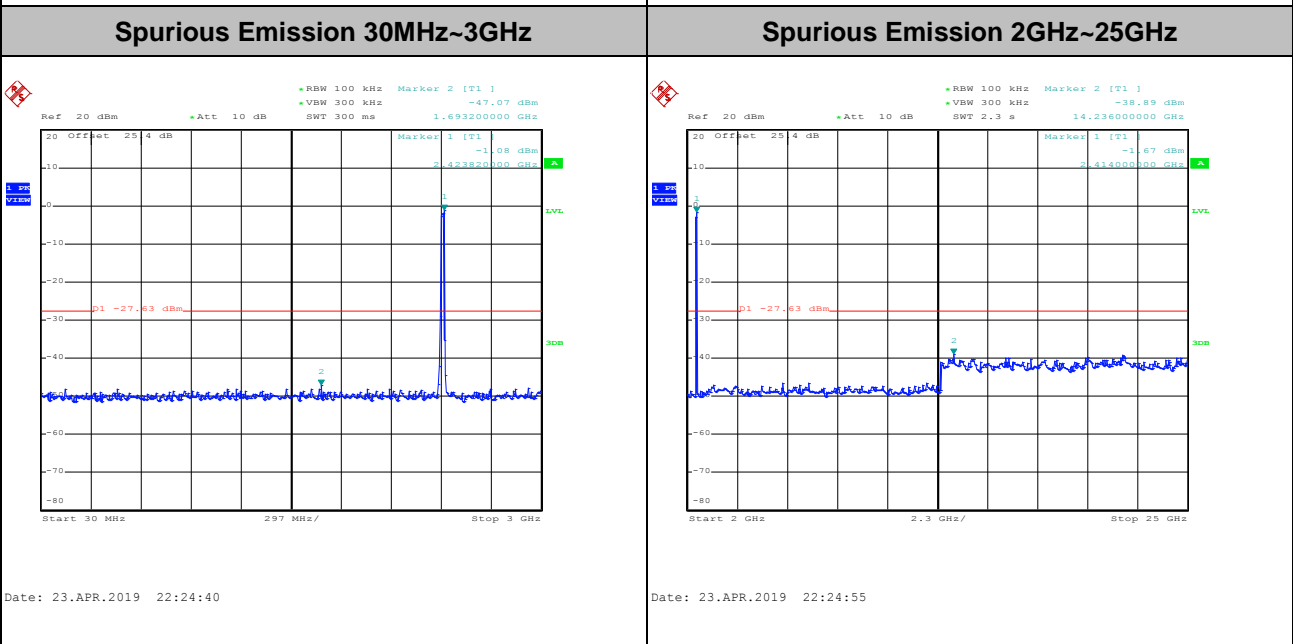
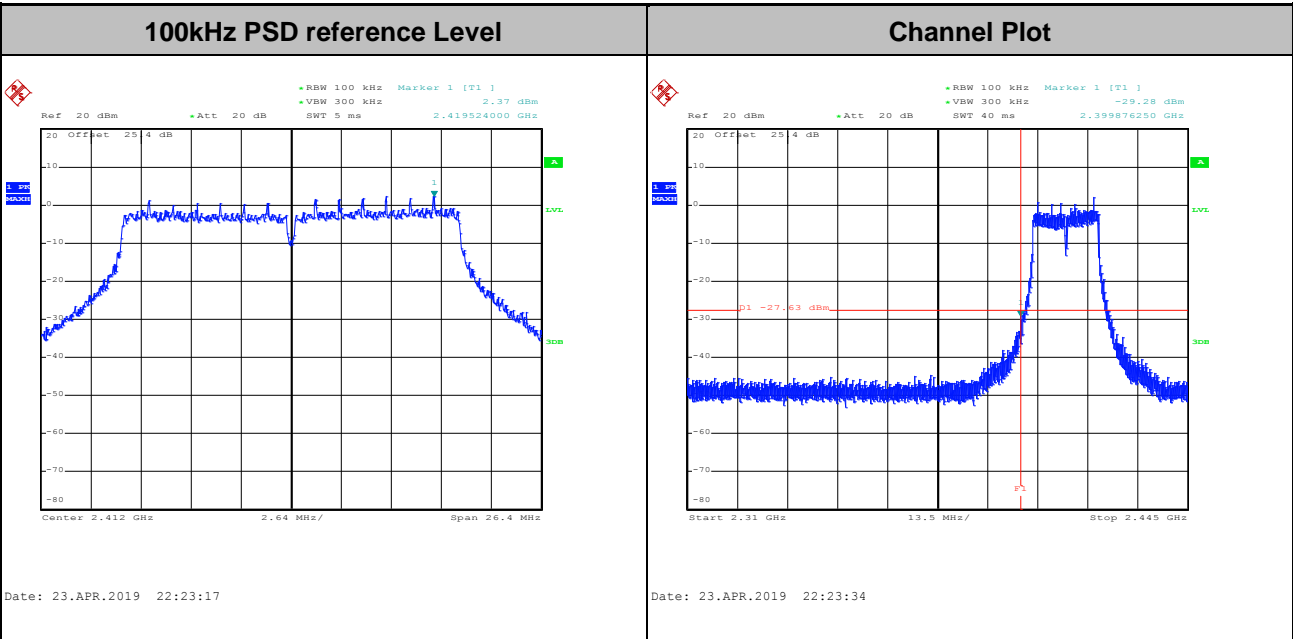



Test Mode :	802.11ac VHT20	Test Channel :	06
-------------	----------------	----------------	----

100kHz PSD reference Level

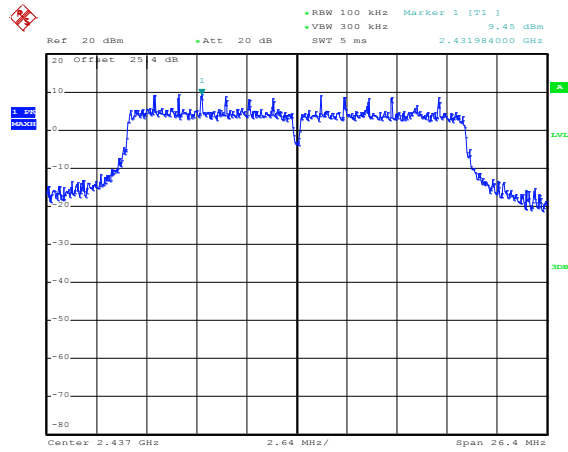

Date: 23.APR.2019 22:31:00

Spurious Emission 30MHz~3GHz

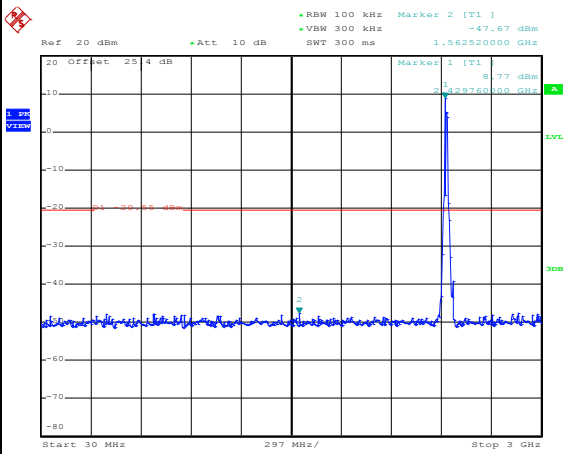

Date: 23.APR.2019 22:31:58

Spurious Emission 2GHz~25GHz

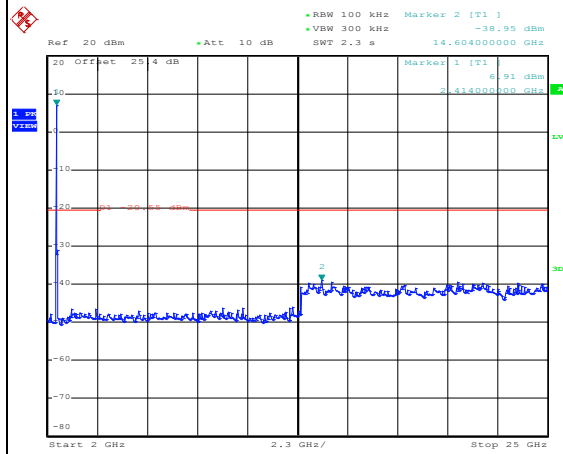

Date: 23.APR.2019 22:32:15



Test Mode :	802.11ac VHT20	Test Channel :	11
-------------	----------------	----------------	----

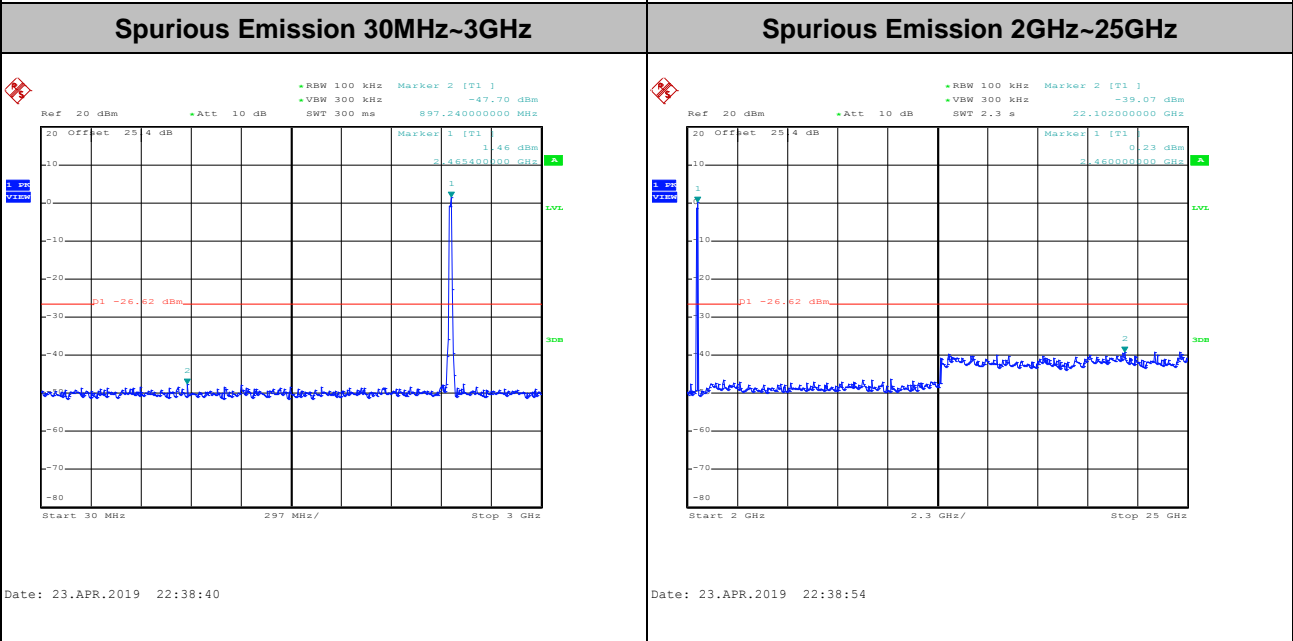
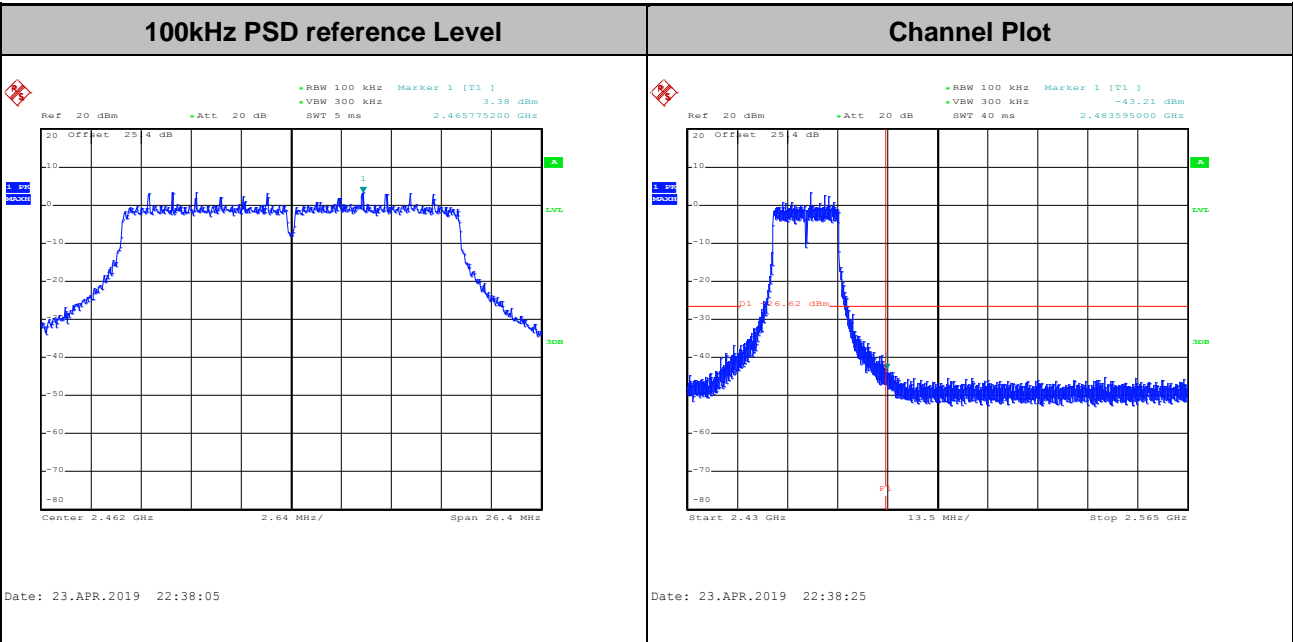



Test Mode :	802.11ac VHT40	Test Channel :	03
-------------	----------------	----------------	----

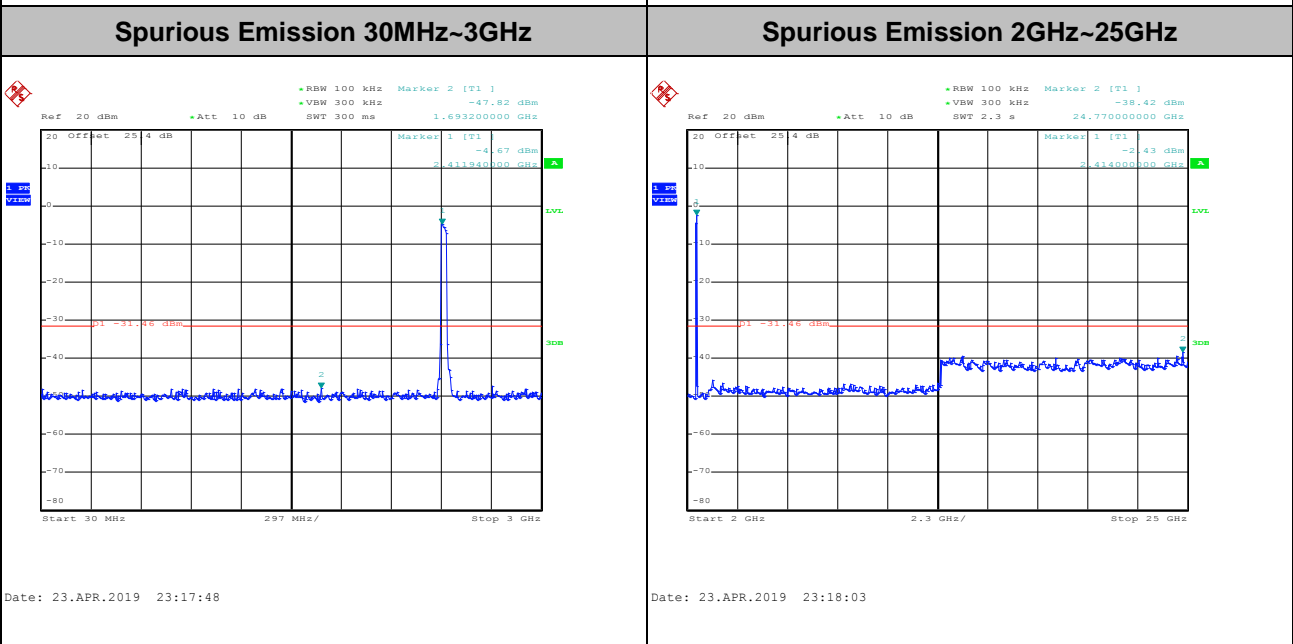
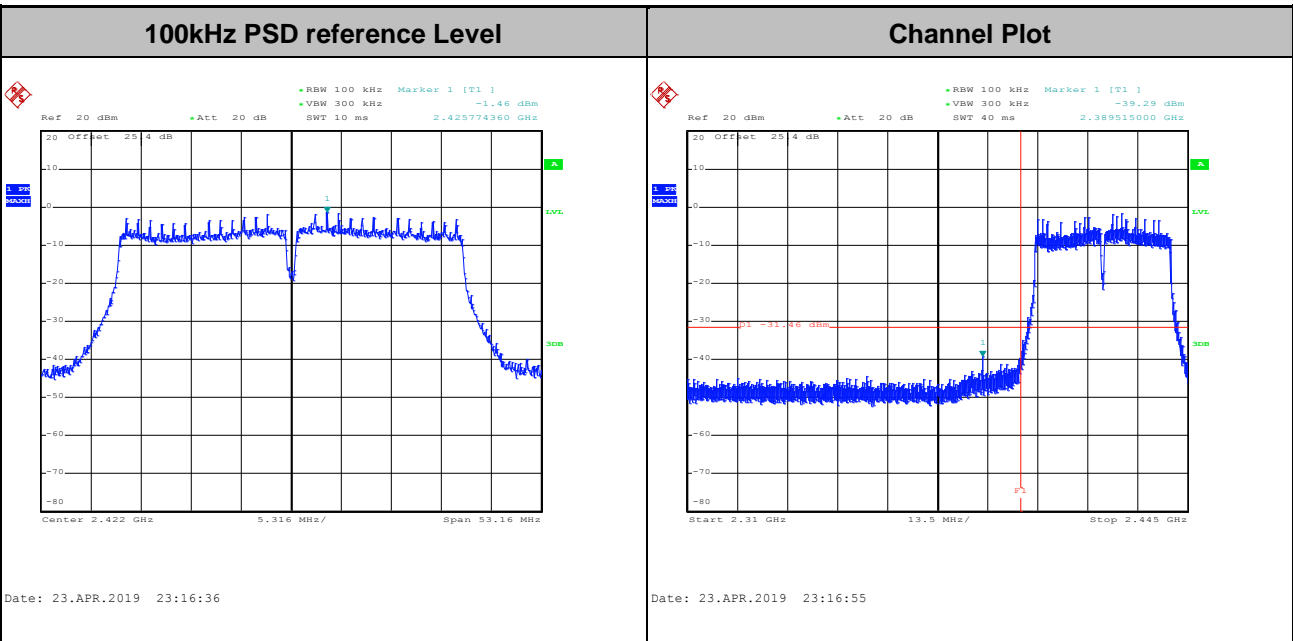



Test Mode :	802.11ac VHT40	Test Channel :	06
-------------	----------------	----------------	----

100kHz PSD reference Level

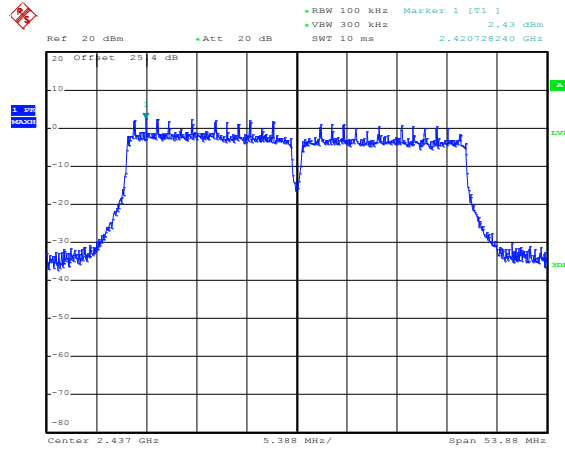

Date: 23.APR.2019 23:28:37

Spurious Emission 30MHz~3GHz

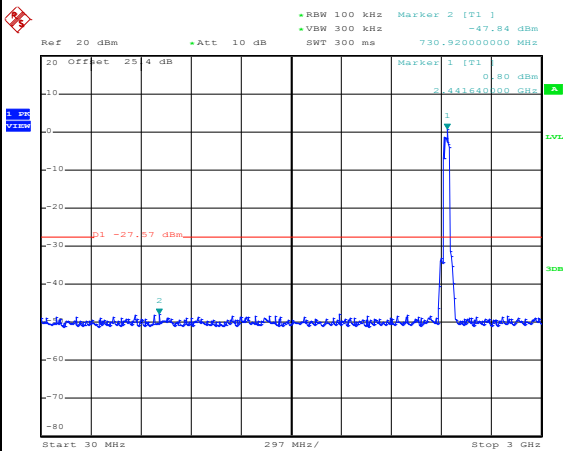

Date: 23.APR.2019 23:29:21

Spurious Emission 2GHz~25GHz

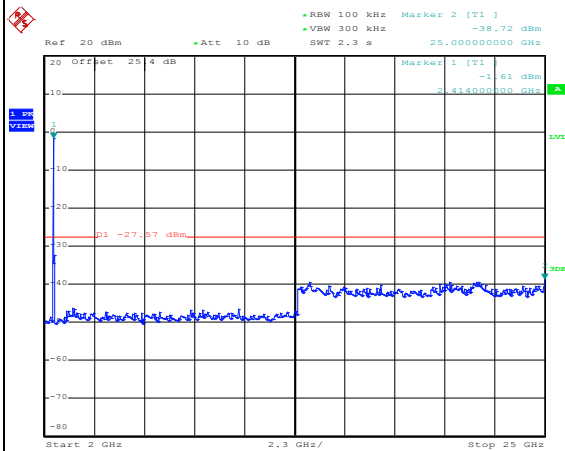

Date: 23.APR.2019 23:29:37



Test Mode :	802.11ac VHT40	Test Channel :	09
--------------------	----------------	-----------------------	----

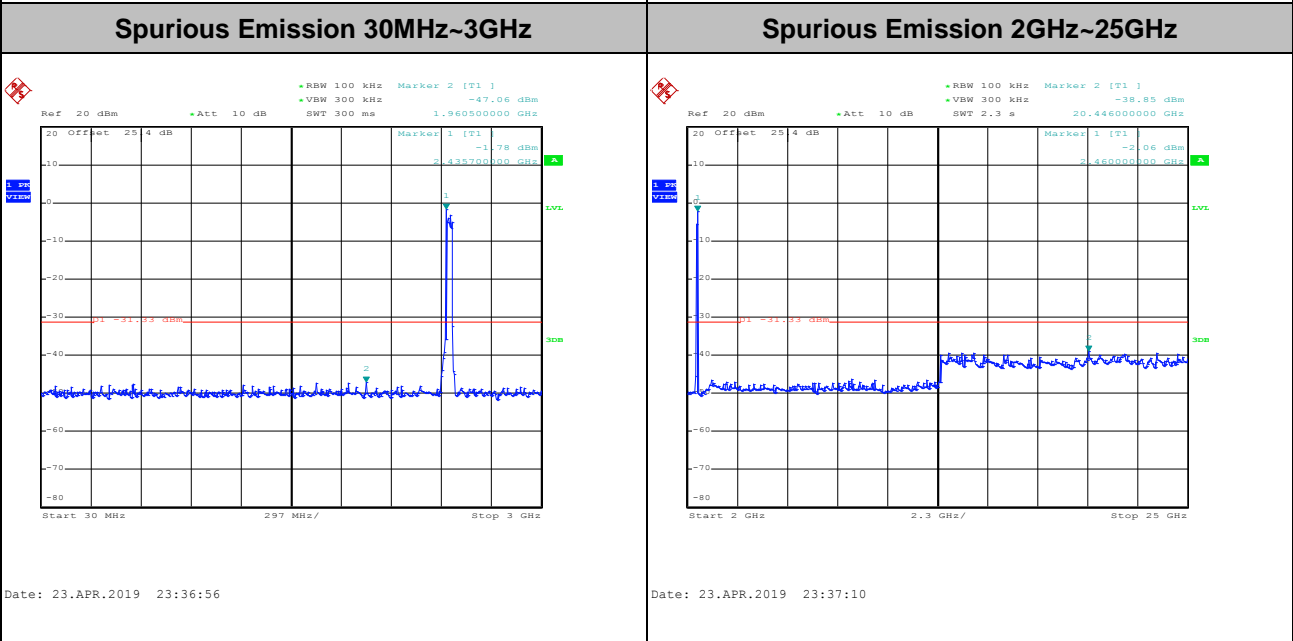
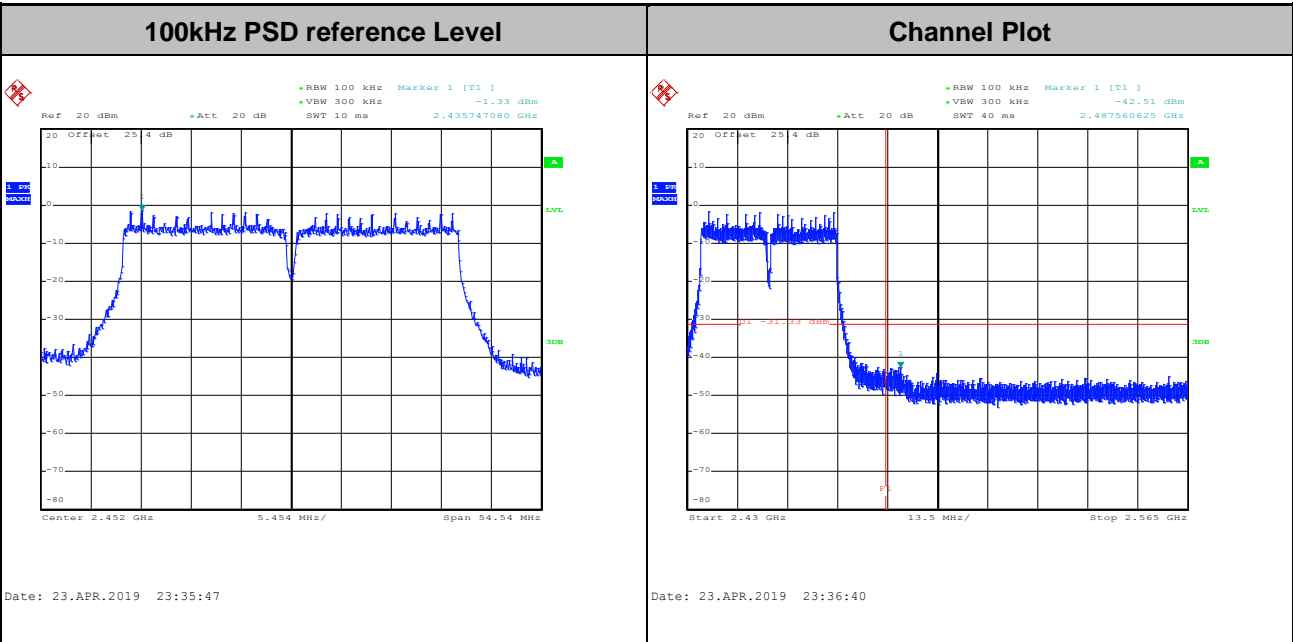



Test Mode :	802.11b	Test Channel :	06
-------------	---------	----------------	----

100kHz PSD reference Level

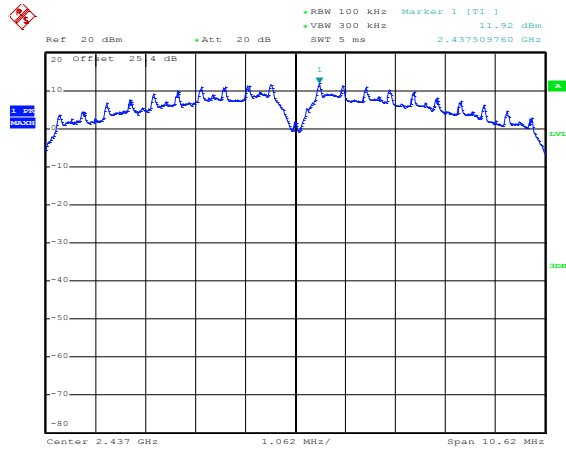

Date: 23.APR.2019 19:23:37

Spurious Emission 30MHz~3GHz

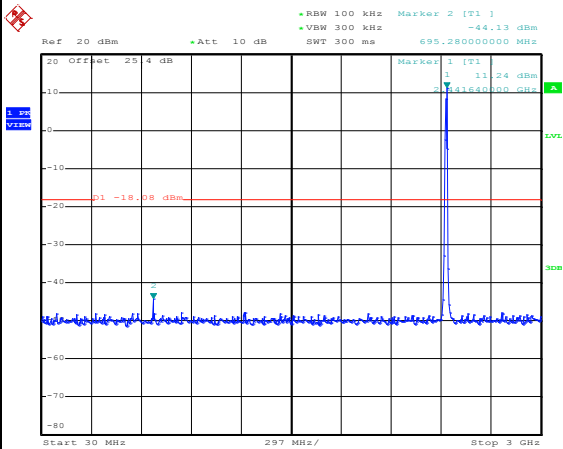

Date: 23.APR.2019 19:24:46

Spurious Emission 2GHz~25GHz

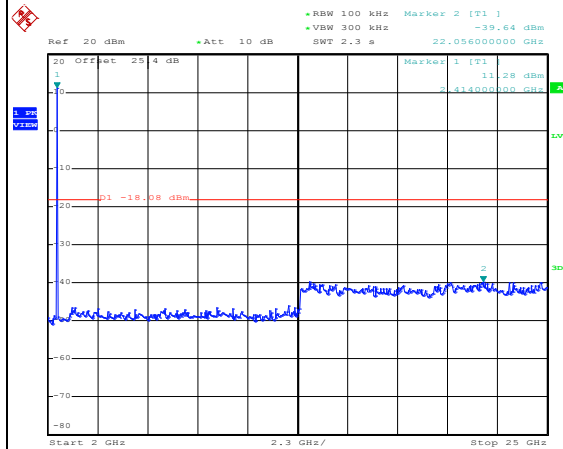

Date: 23.APR.2019 19:25:00



Test Mode :	802.11b	Test Channel :	11
-------------	---------	----------------	----

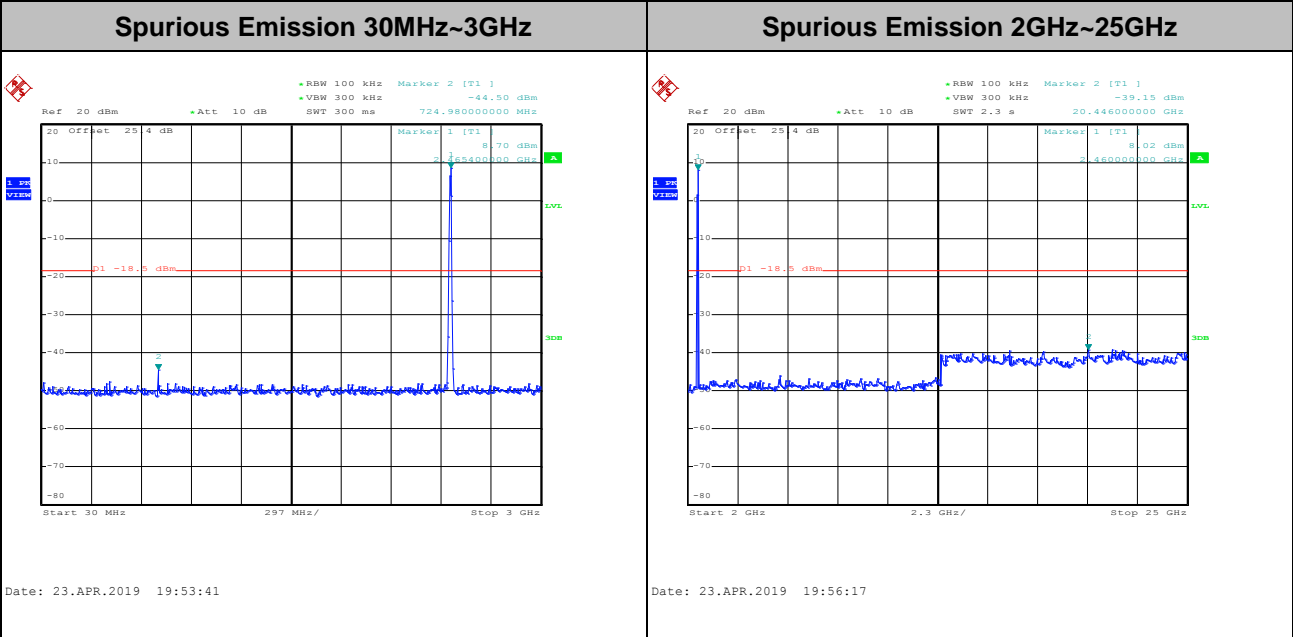
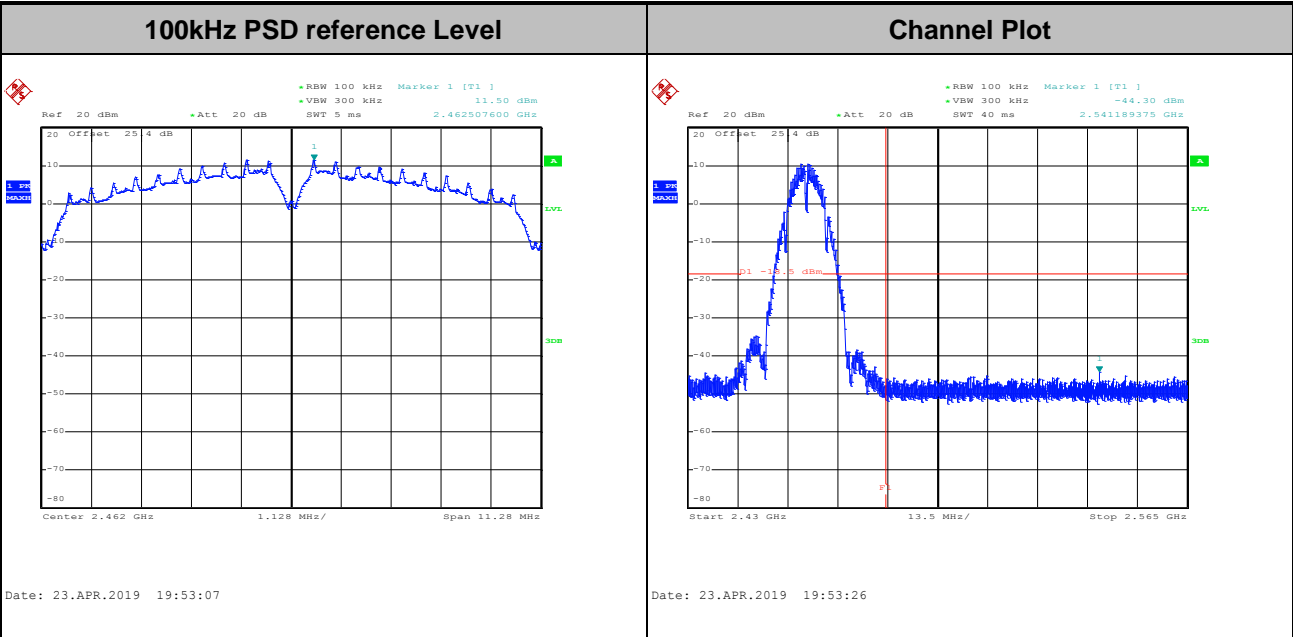



Test Mode :	802.11g	Test Channel :	01
-------------	---------	----------------	----

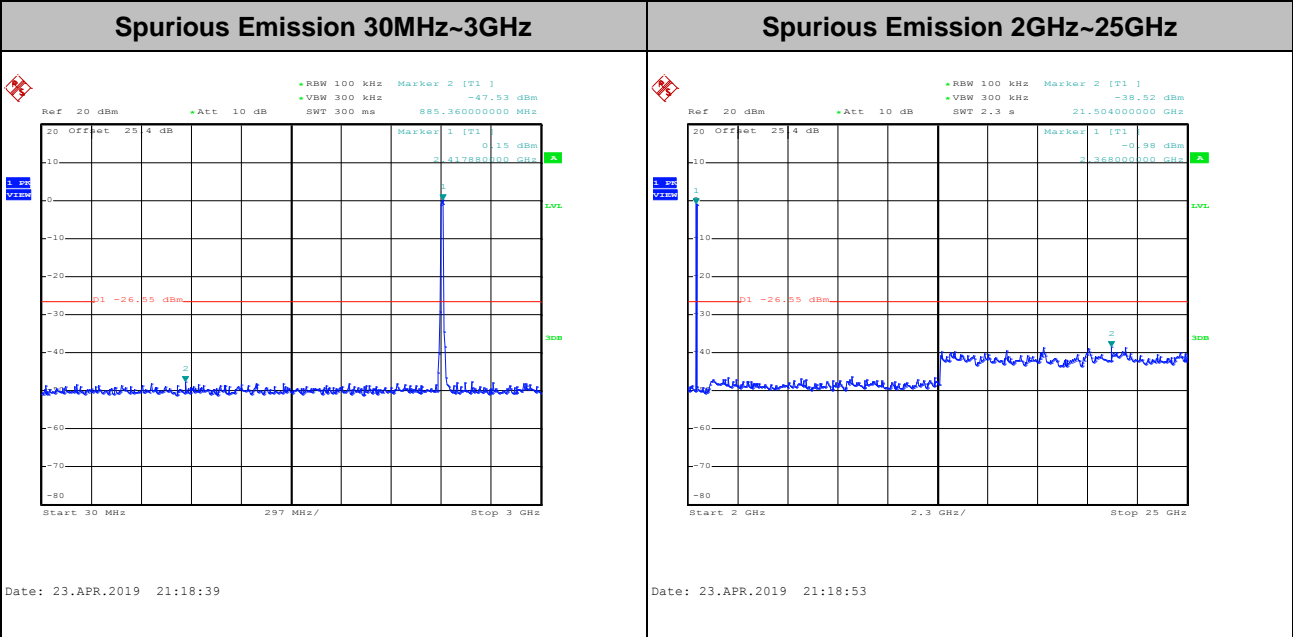
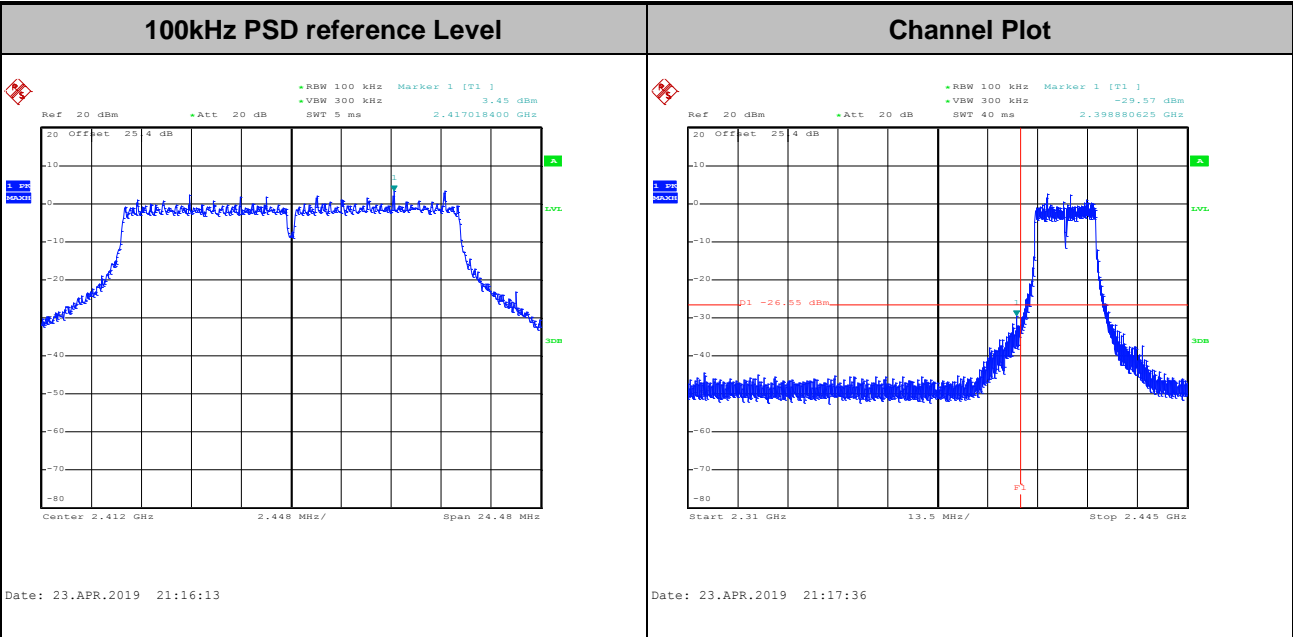



Test Mode :	802.11g	Test Channel :	06
-------------	---------	----------------	----

100kHz PSD reference Level

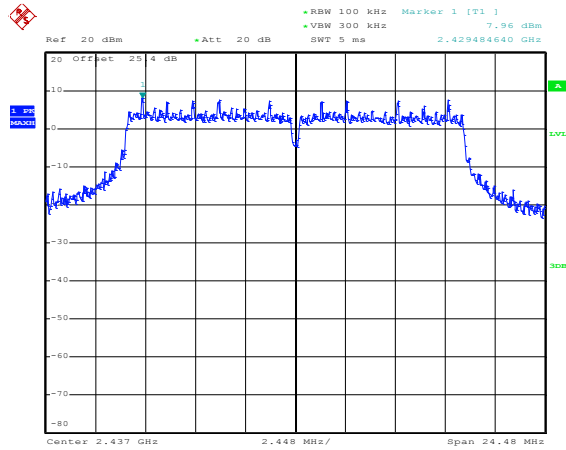

Date: 23.APR.2019 21:37:04

Spurious Emission 30MHz~3GHz

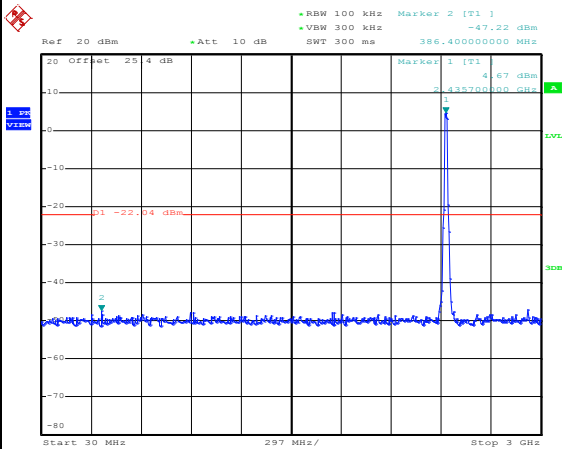

Date: 23.APR.2019 21:38:25

Spurious Emission 2GHz~25GHz

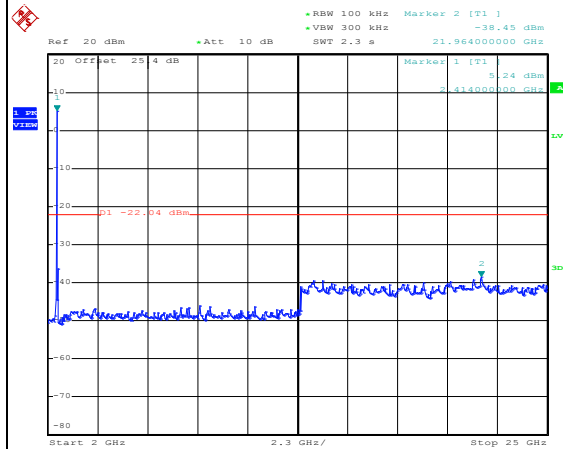

Date: 23.APR.2019 21:38:40



Test Mode :	802.11g	Test Channel :	11
-------------	---------	----------------	----

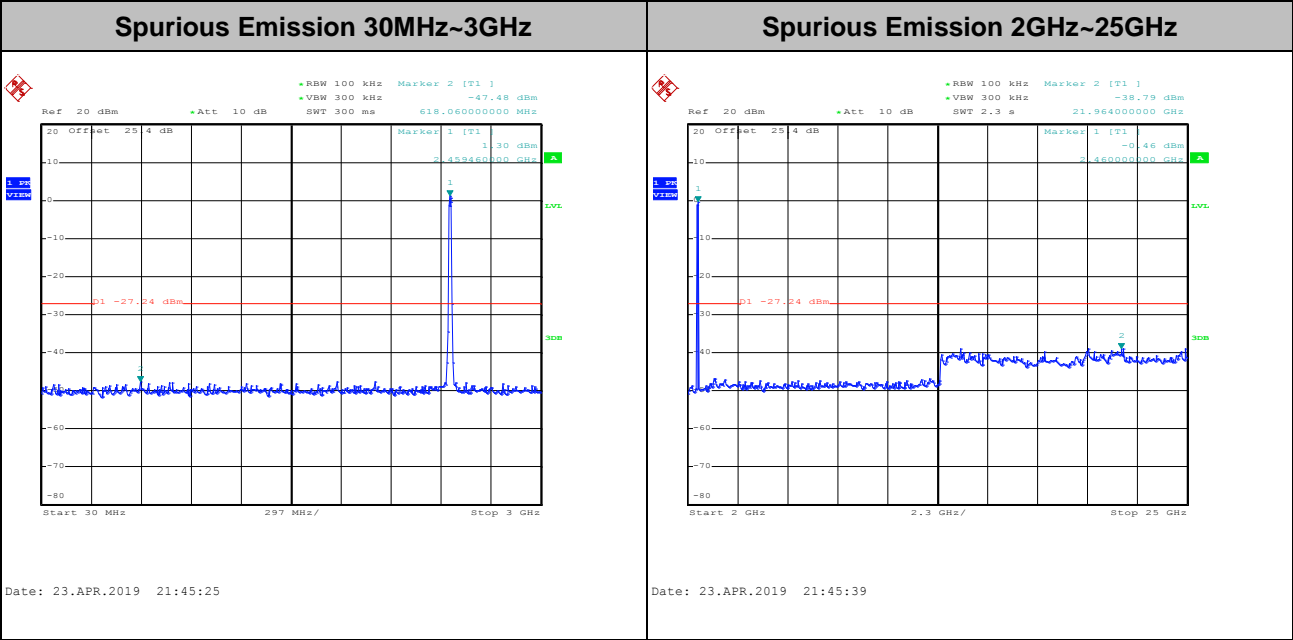
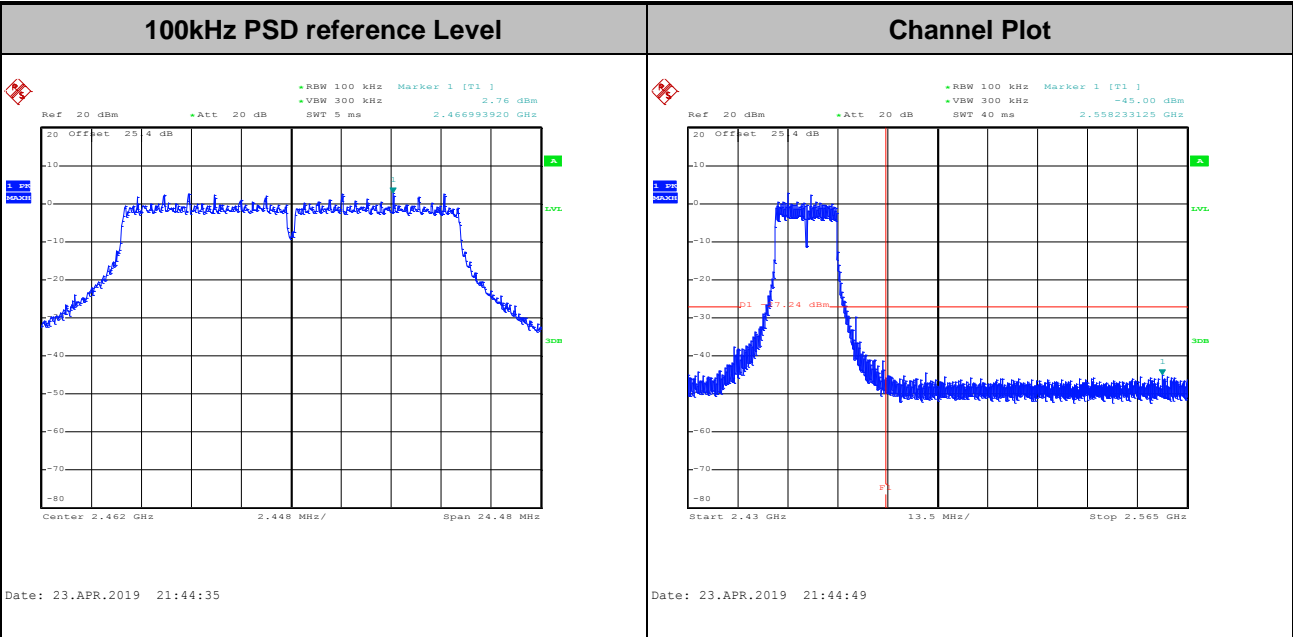



Test Mode :	802.11ac VHT20	Test Channel :	01
-------------	----------------	----------------	----

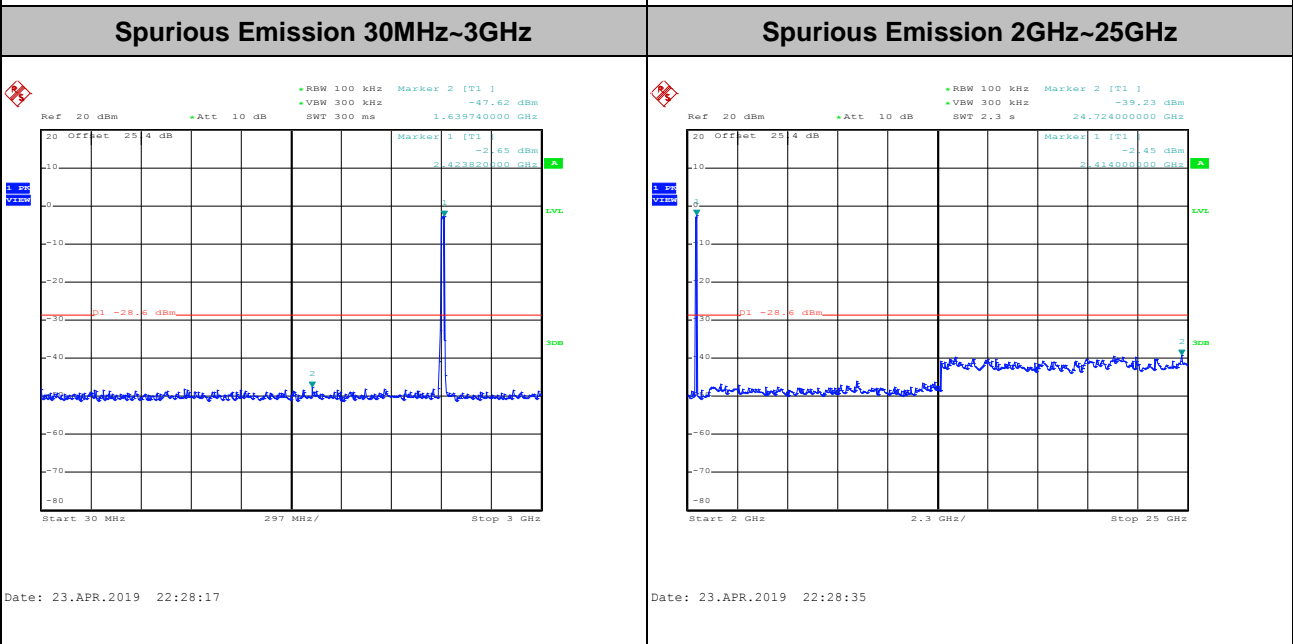
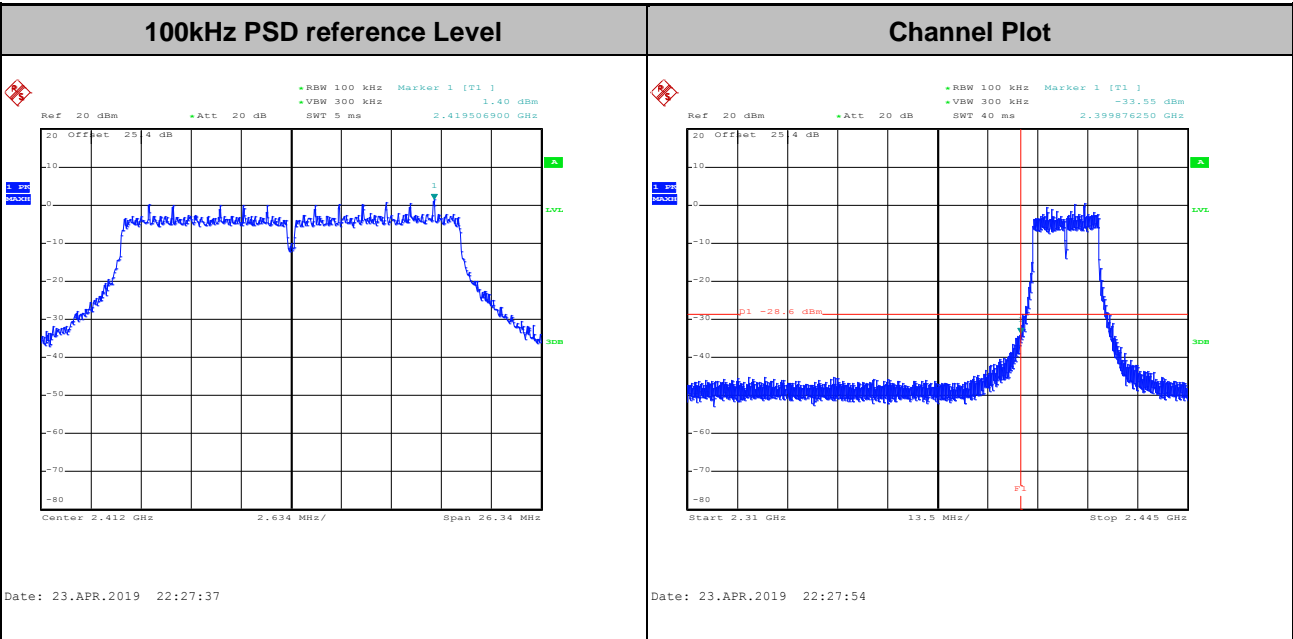



Test Mode :	802.11ac VHT20	Test Channel :	06
-------------	----------------	----------------	----

100kHz PSD reference Level

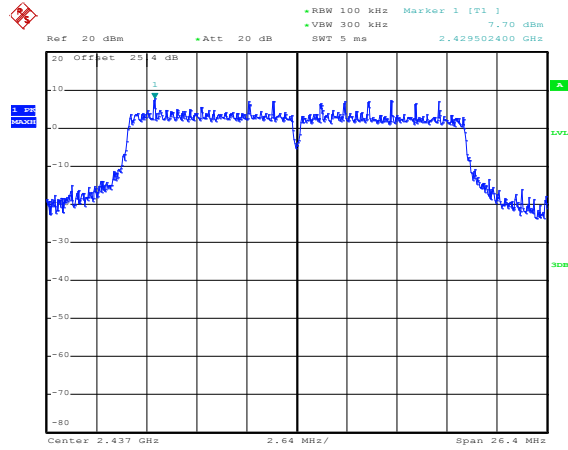

Date: 23.APR.2019 22:34:22

Spurious Emission 30MHz~3GHz

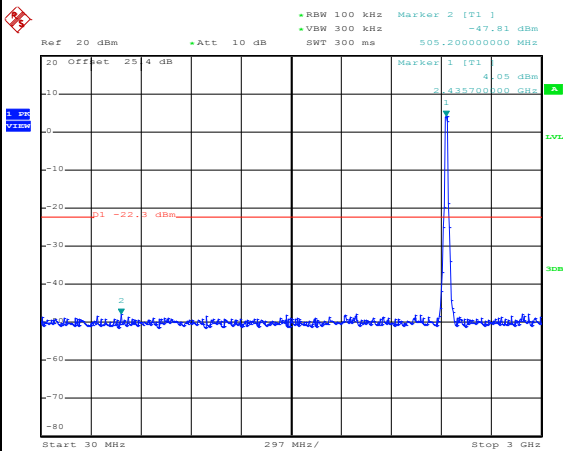

Date: 23.APR.2019 22:35:31

Spurious Emission 2GHz~25GHz

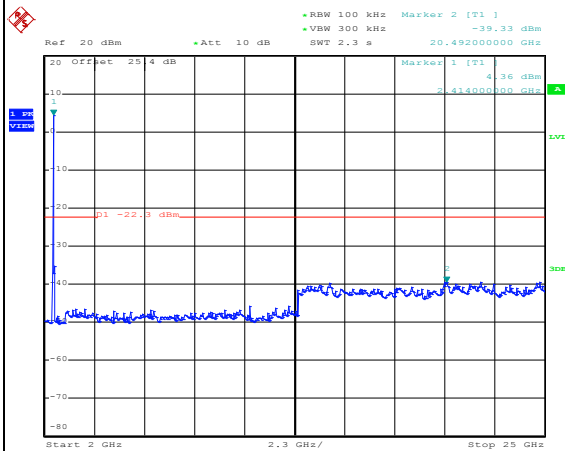

Date: 23.APR.2019 22:35:49



Test Mode :	802.11ac VHT20	Test Channel :	11
-------------	----------------	----------------	----

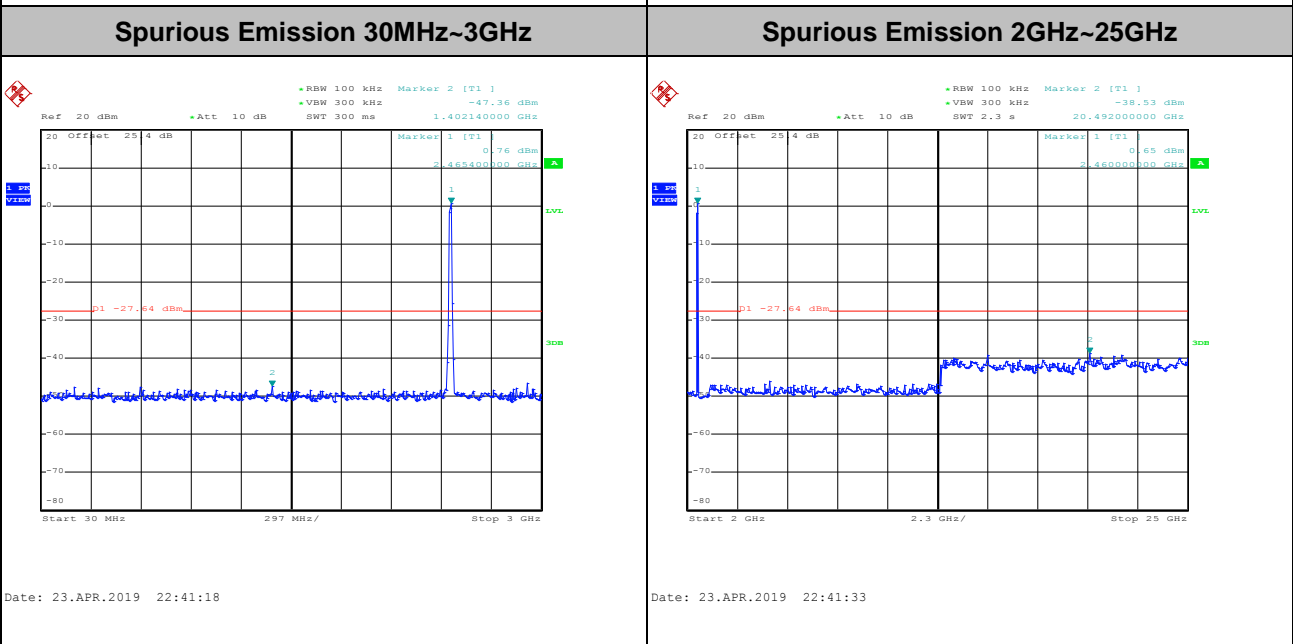
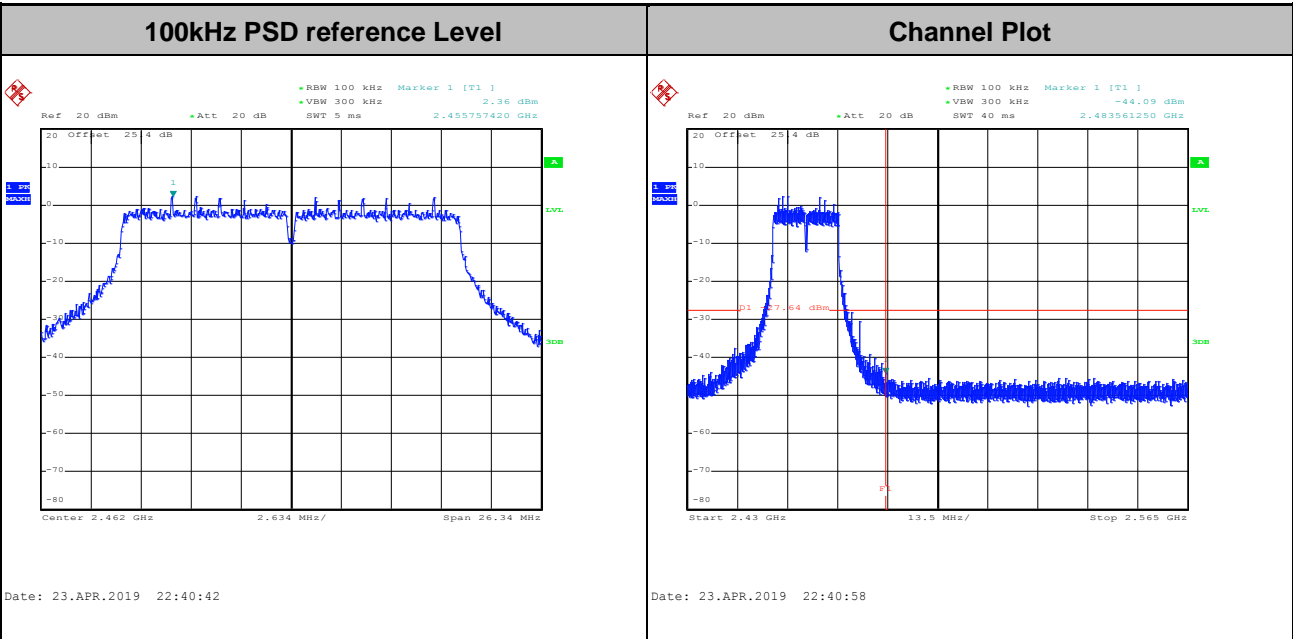



Test Mode :	802.11ac VHT40	Test Channel :	03
-------------	----------------	----------------	----

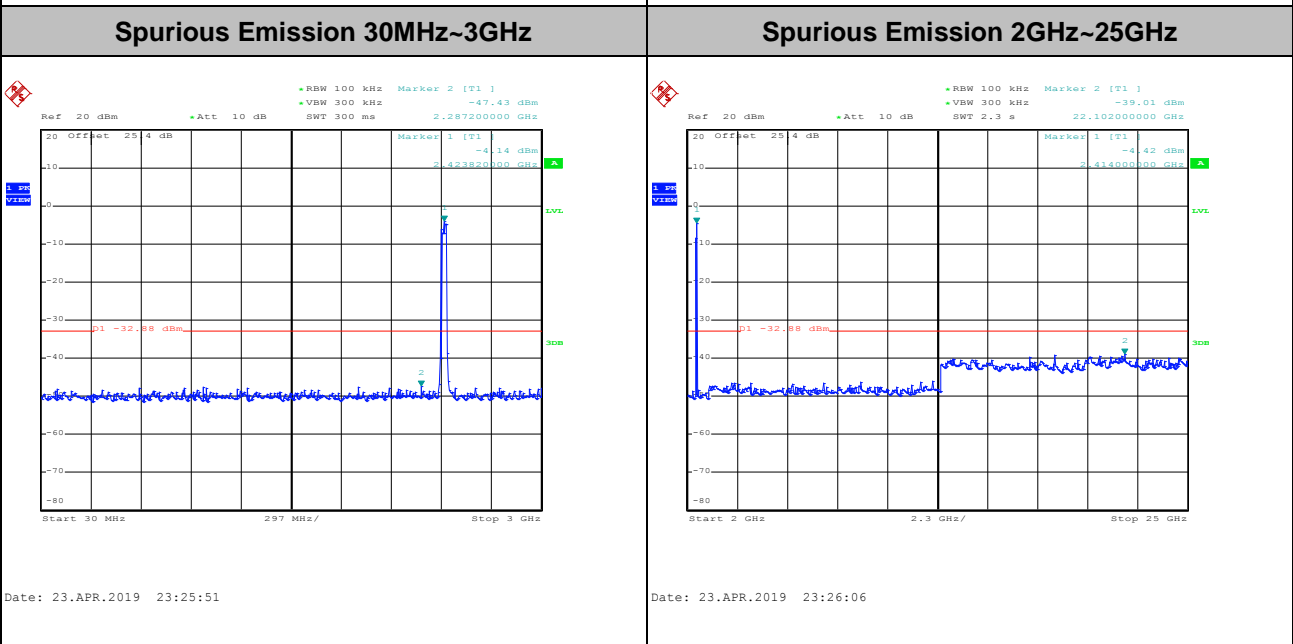
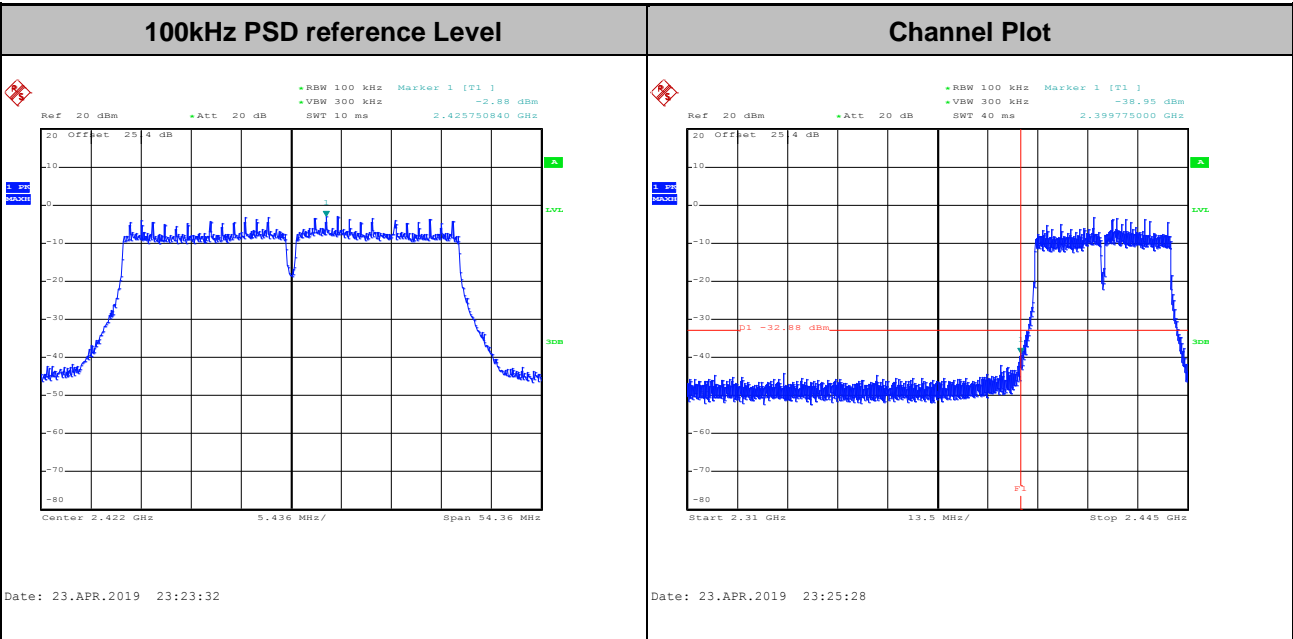



Test Mode :	802.11ac VHT40	Test Channel :	06
-------------	----------------	----------------	----

100kHz PSD reference Level

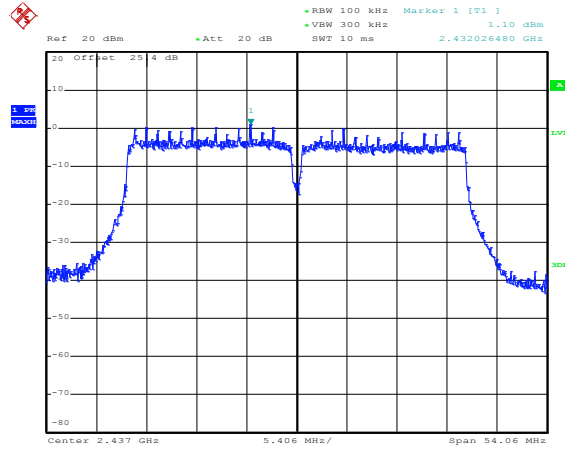

Date: 23.APR.2019 23:31:10

Spurious Emission 30MHz~3GHz

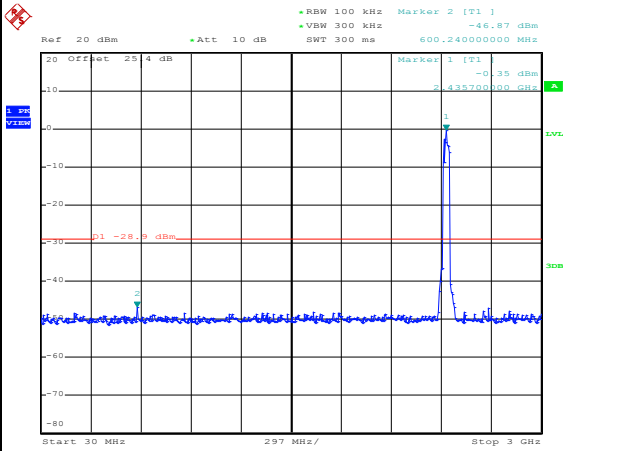

Date: 23.APR.2019 23:31:43

Spurious Emission 2GHz~25GHz

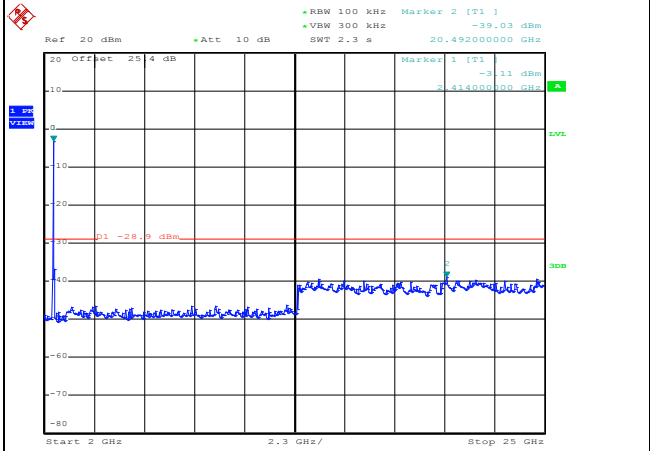

Date: 23.APR.2019 23:31:59



Test Mode :	802.11ac VHT40	Test Channel :	09
-------------	----------------	----------------	----

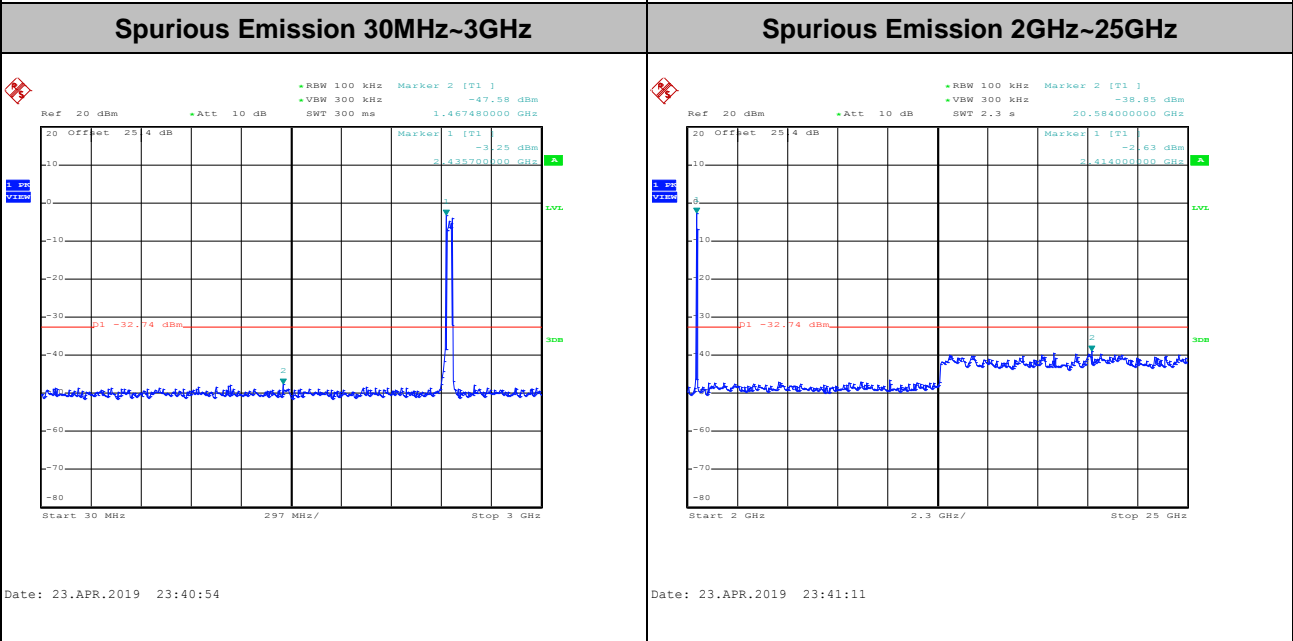
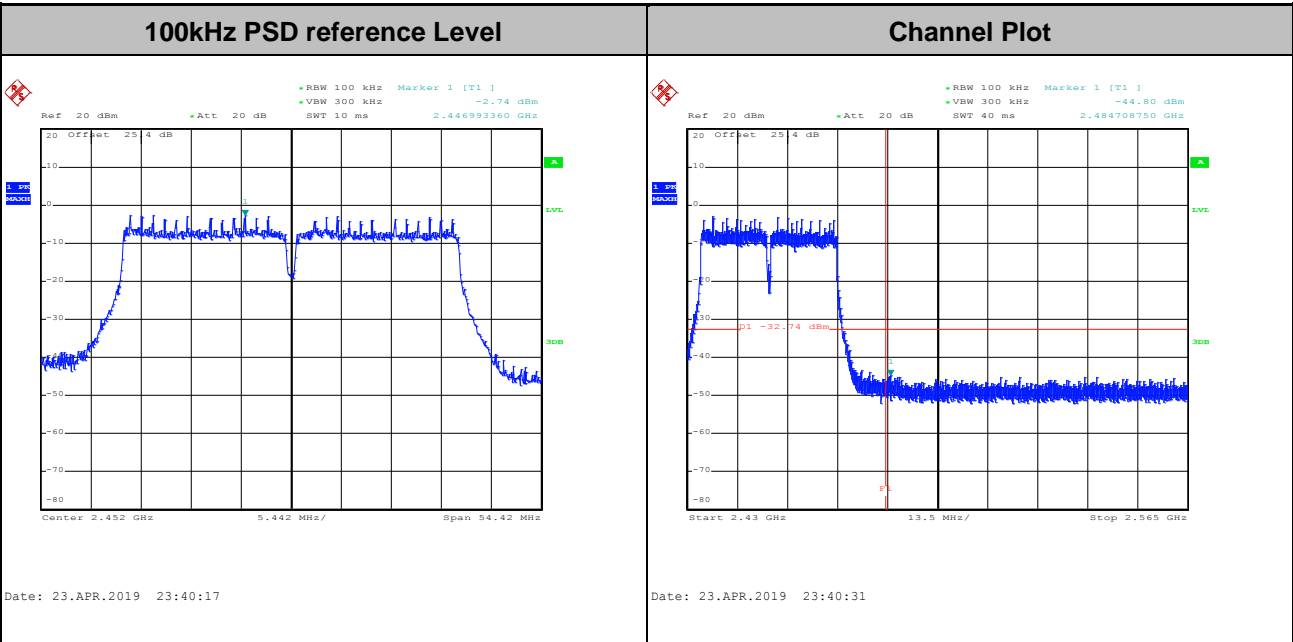



<TXBF Modes>

Number of TX = 2, Ant. 1 (Measured)

Test Mode :	802.11ac VHT20	Test Channel :	01
-------------	----------------	----------------	----

100kHz PSD reference Level	Channel Plot
-----------------------------------	---------------------

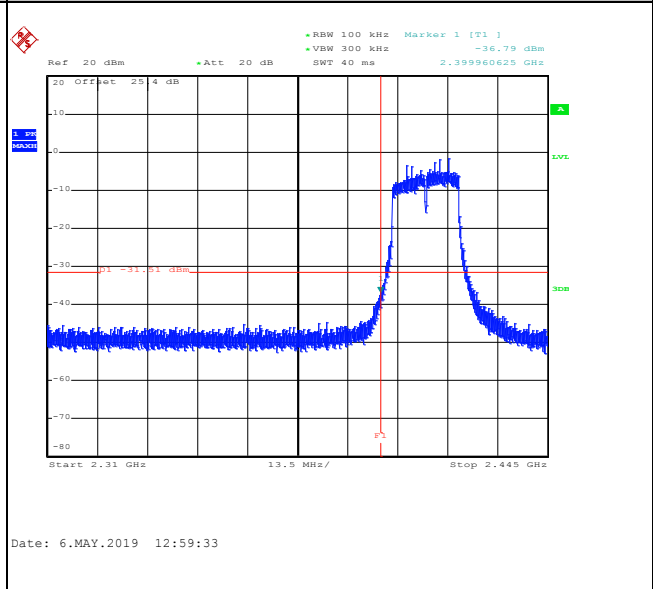
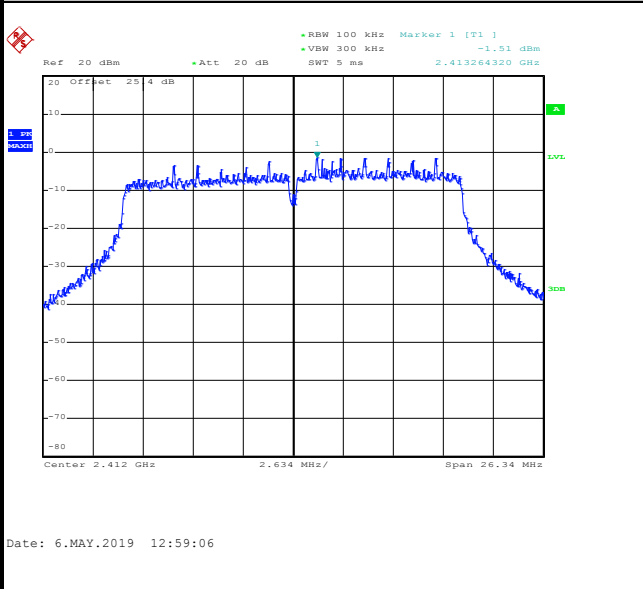

Spurious Emission 30MHz~3GHz	Spurious Emission 2GHz~25GHz
-------------------------------------	-------------------------------------

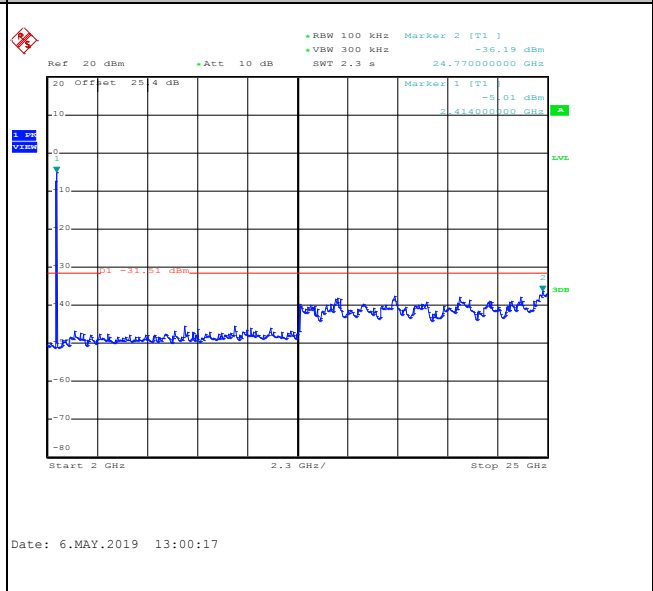
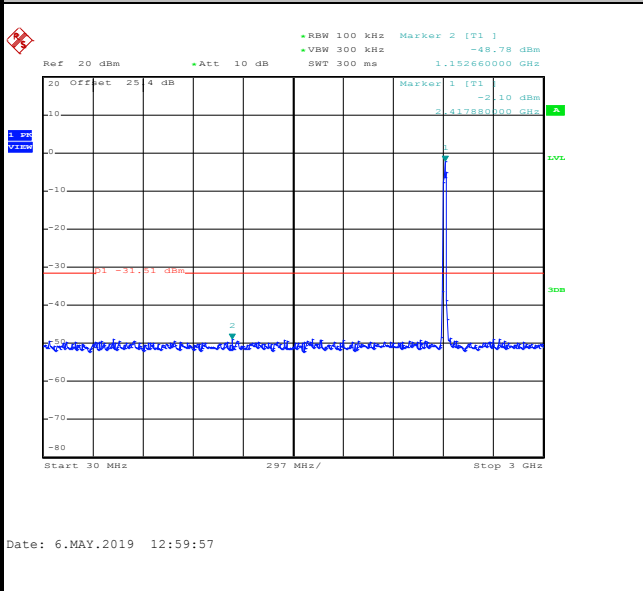



Test Mode :	802.11ac VHT20	Test Channel :	06
-------------	----------------	----------------	----

100kHz PSD reference Level

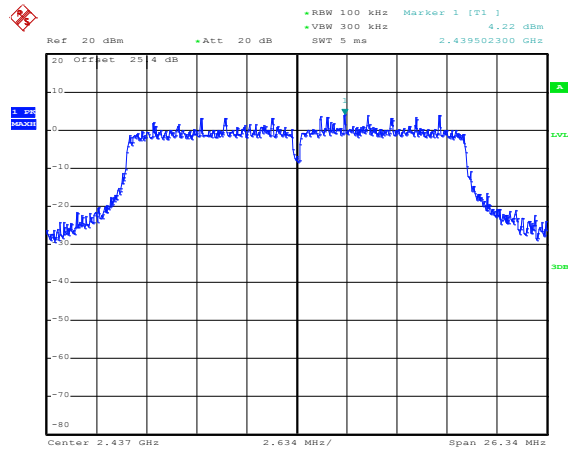

Date: 6.MAY.2019 14:53:06

Spurious Emission 30MHz~3GHz

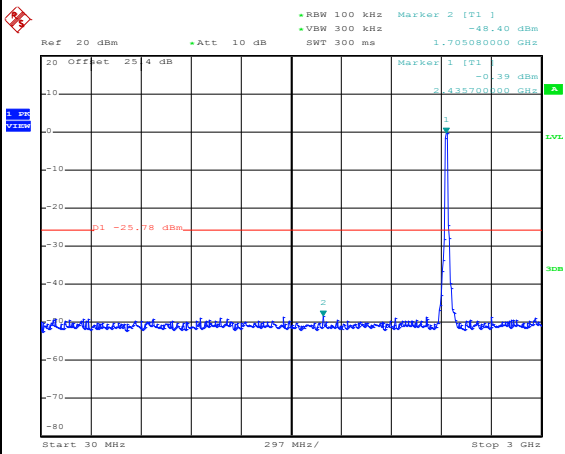

Date: 6.MAY.2019 14:54:04

Spurious Emission 2GHz~25GHz

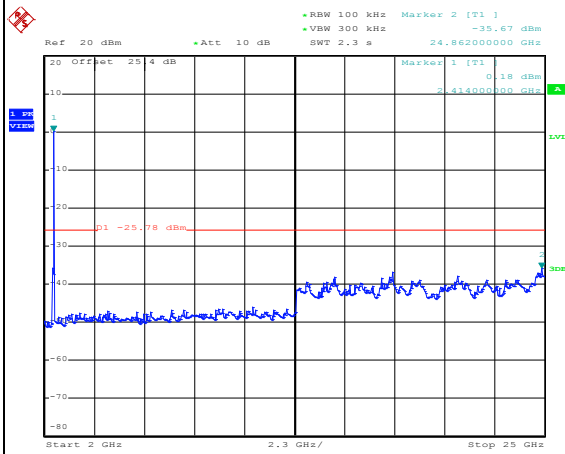

Date: 6.MAY.2019 14:54:18



Test Mode :	802.11ac VHT20	Test Channel :	11
-------------	----------------	----------------	----

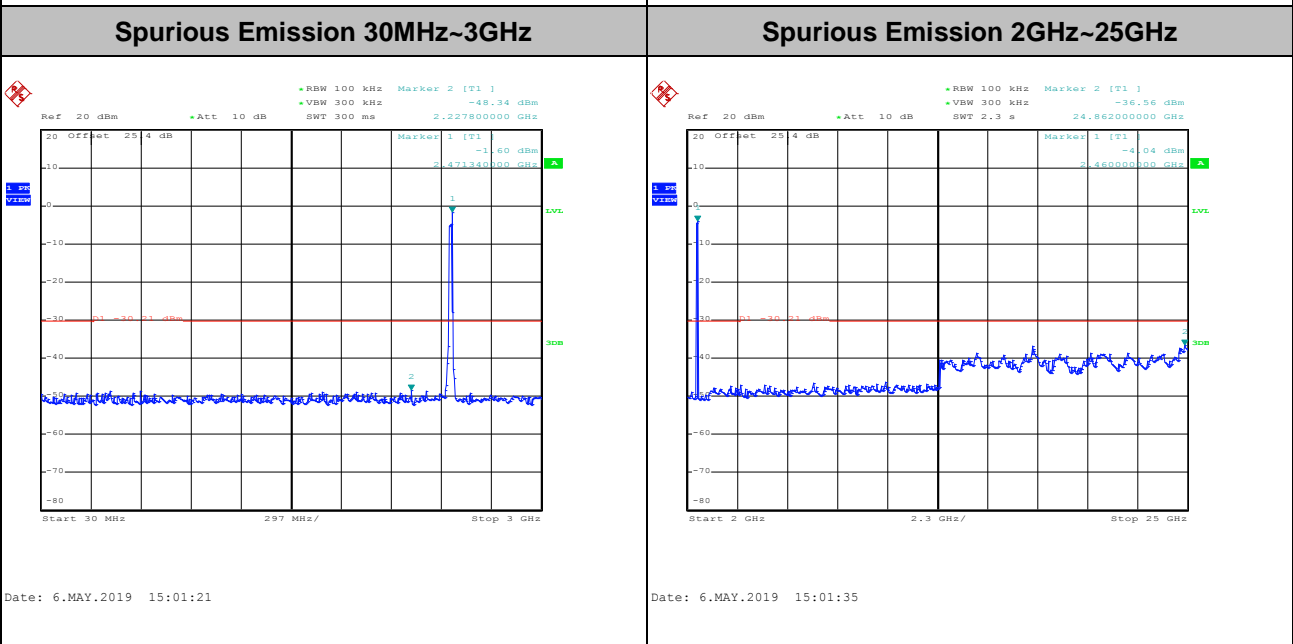
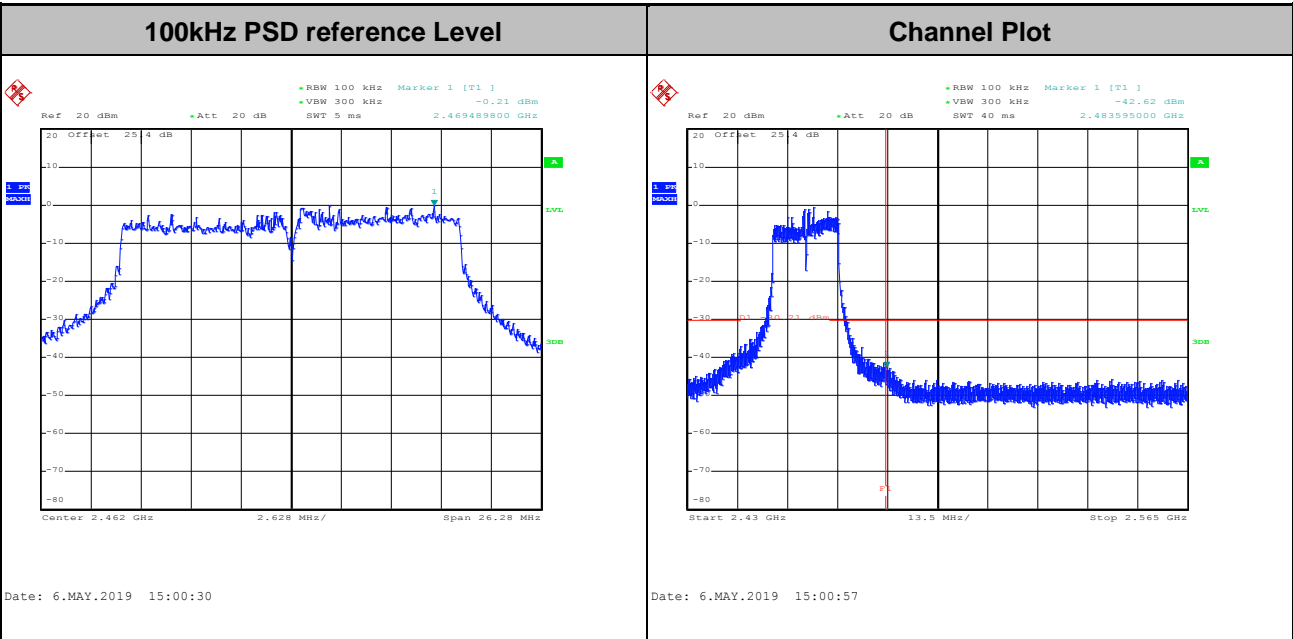



Test Mode :	802.11ac VHT40	Test Channel :	03
-------------	----------------	----------------	----

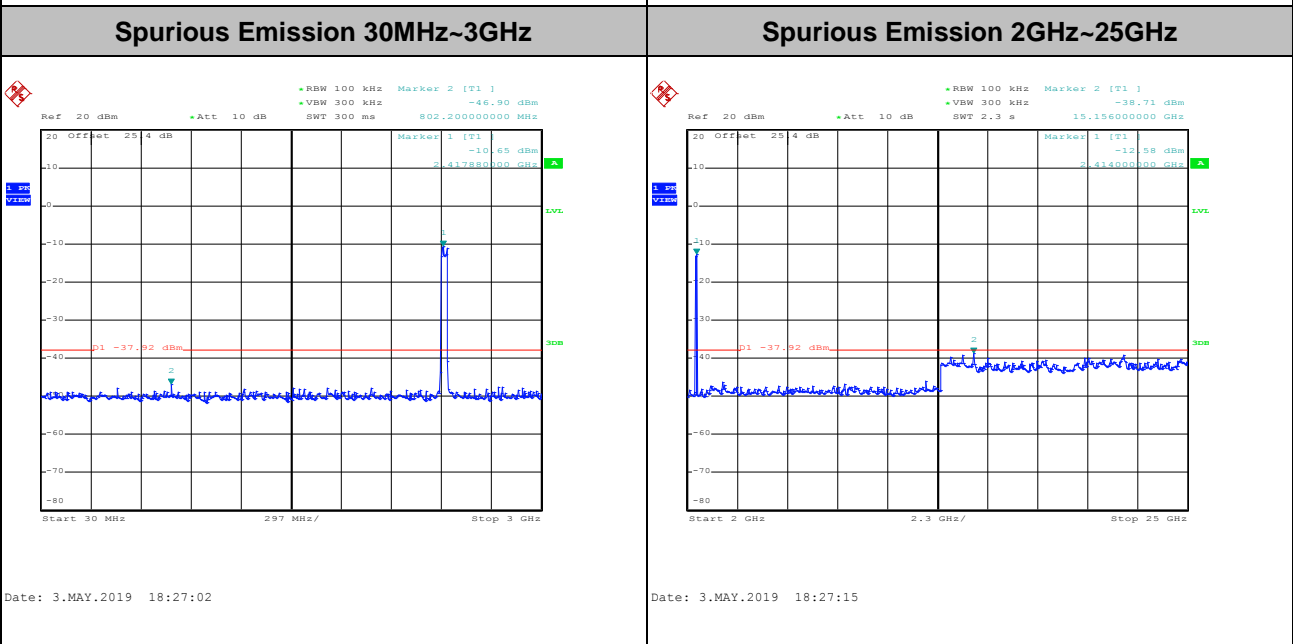
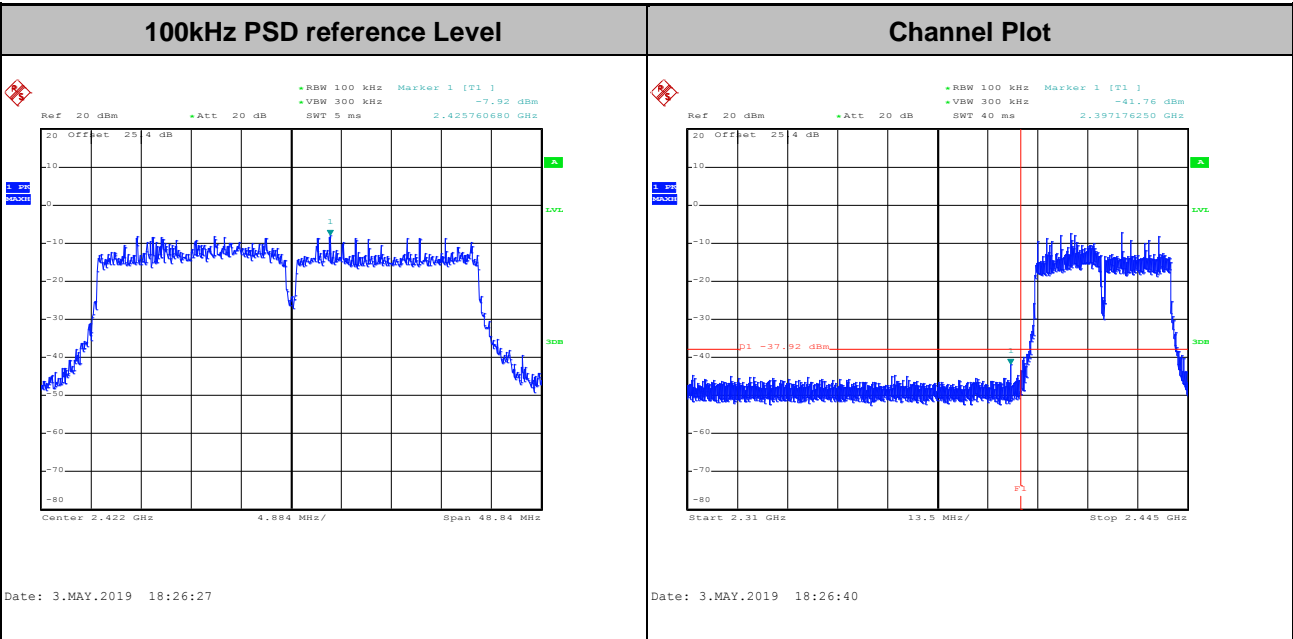



Test Mode :	802.11ac VHT40	Test Channel :	06
-------------	----------------	----------------	----

100kHz PSD reference Level

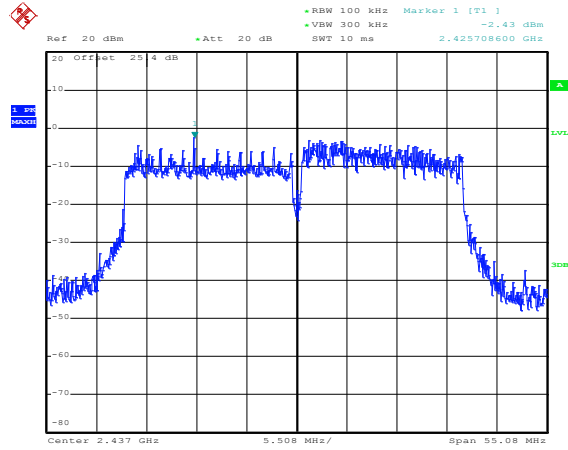

Date: 3.MAY.2019 18:06:22

Spurious Emission 30MHz~3GHz

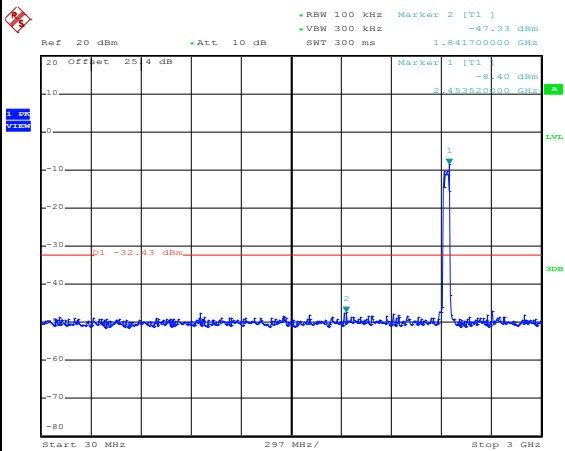

Date: 3.MAY.2019 18:06:44

Spurious Emission 2GHz~25GHz

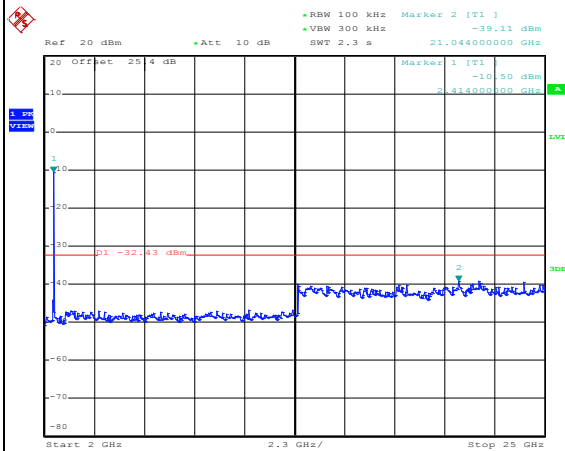

Date: 3.MAY.2019 18:06:59



Test Mode :	802.11ac VHT40	Test Channel :	09
-------------	----------------	----------------	----

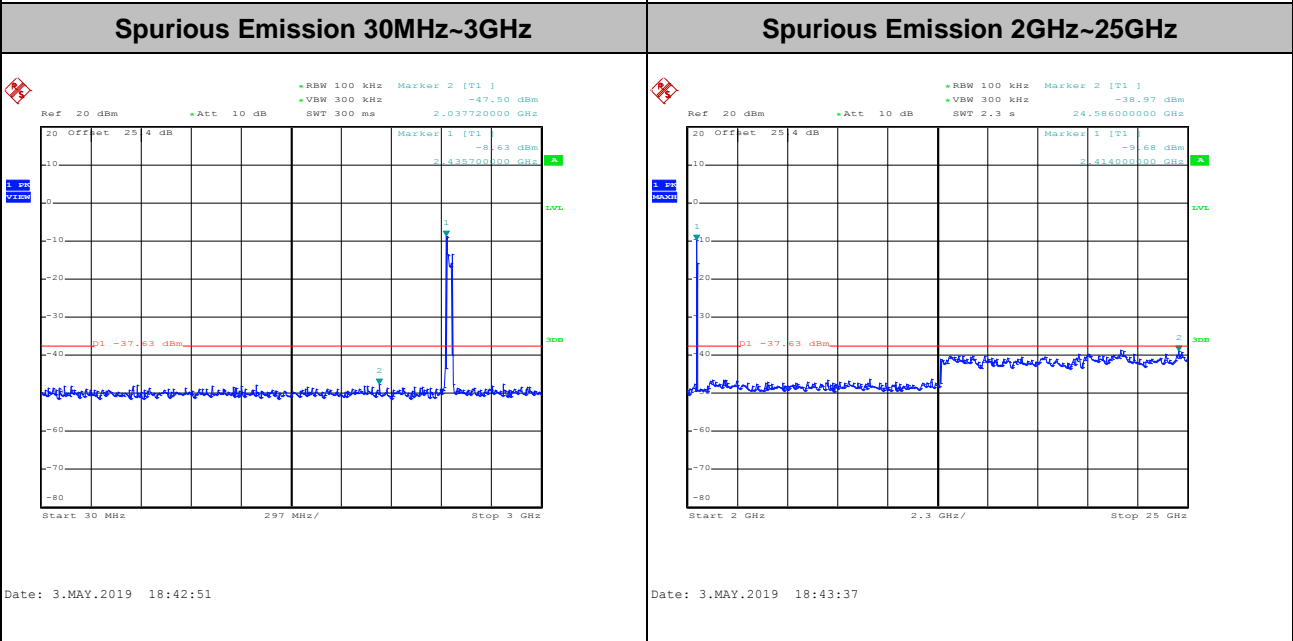
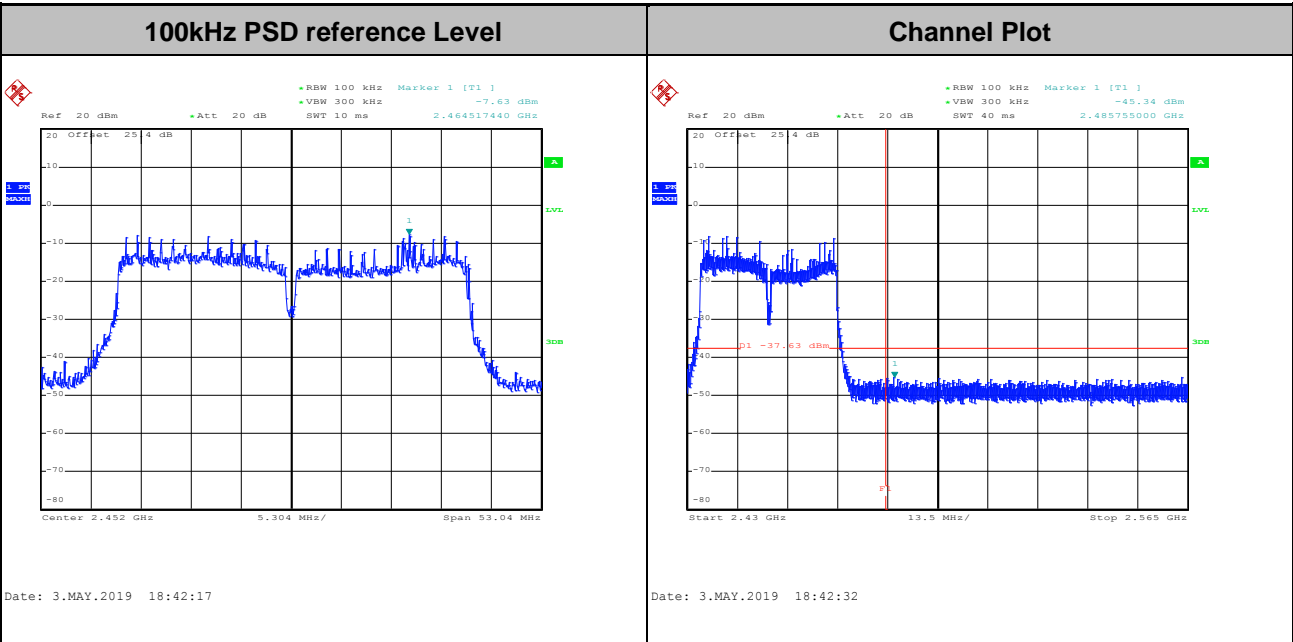



Number of TX = 2, Ant. 2 (Measured)

Test Mode :	802.11ac VHT20	Test Channel :	01
-------------	----------------	----------------	----

100kHz PSD reference Level	Channel Plot
-----------------------------------	---------------------

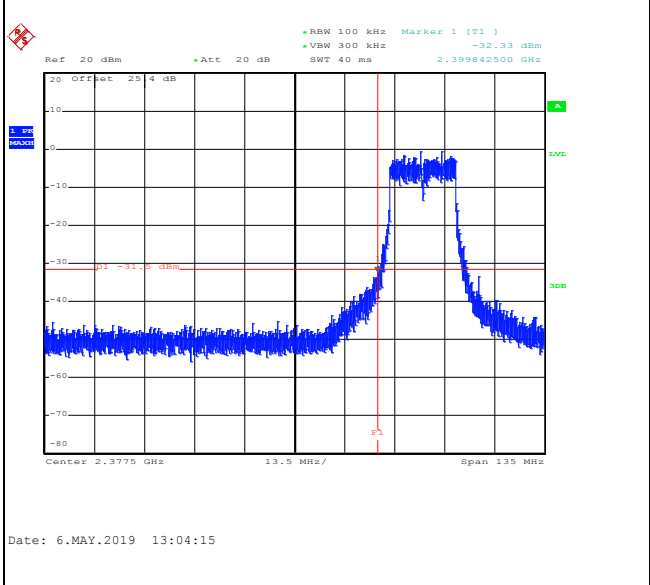
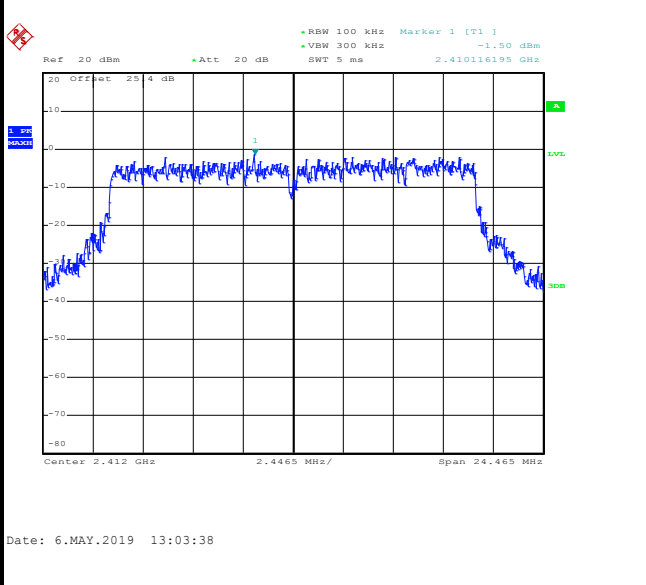

Spurious Emission 30MHz~3GHz

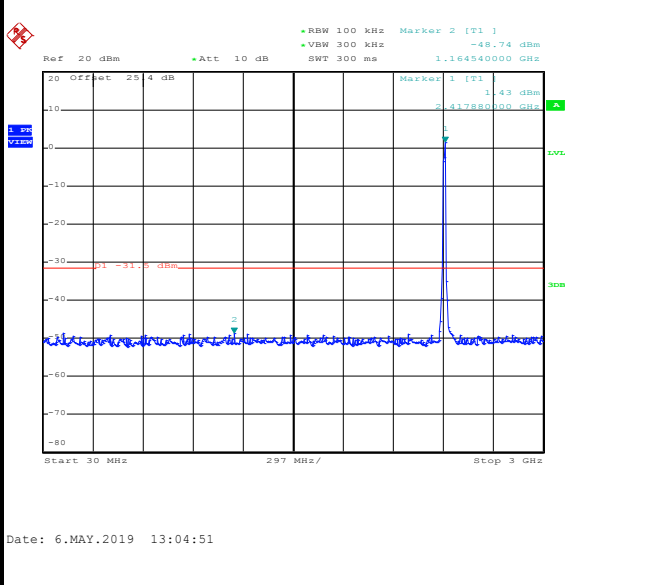

Spurious Emission 2GHz~25GHz

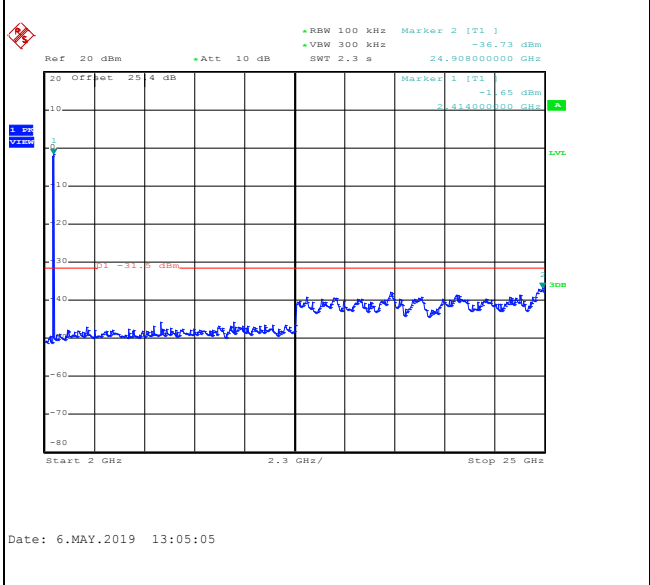



Test Mode :	802.11ac VHT20	Test Channel :	06
-------------	----------------	----------------	----

100kHz PSD reference Level

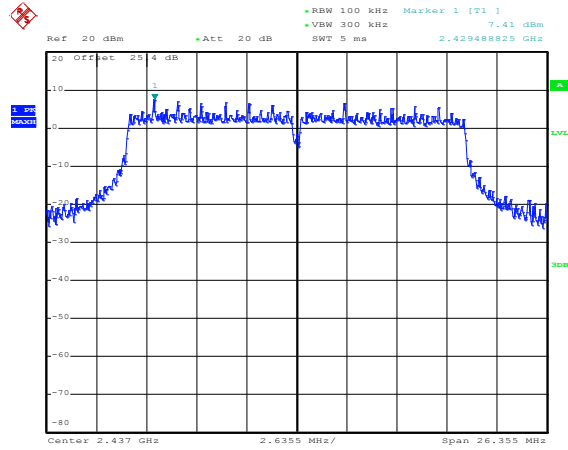

Date: 6.MAY.2019 14:50:56

Spurious Emission 30MHz~3GHz

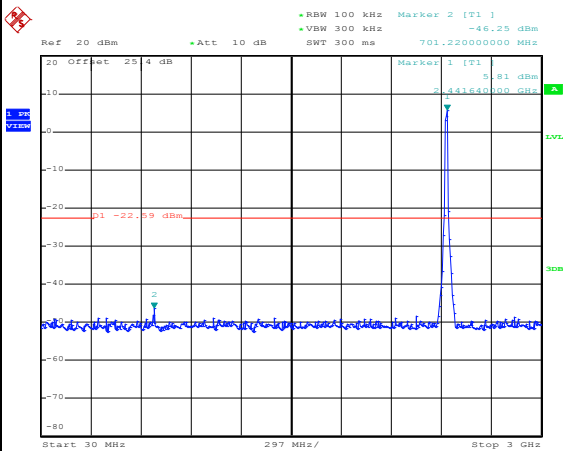

Date: 6.MAY.2019 14:51:22

Spurious Emission 2GHz~25GHz

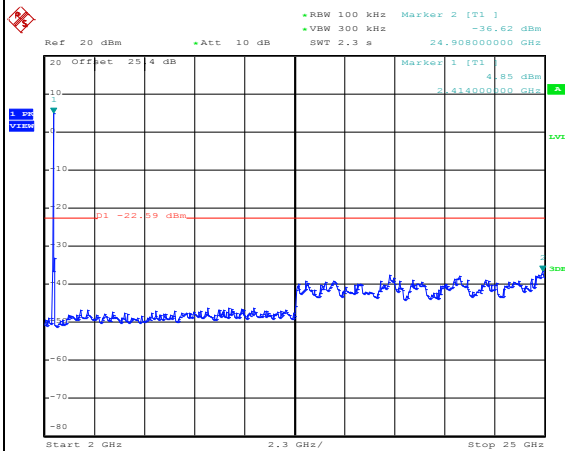

Date: 6.MAY.2019 14:51:39



Test Mode :	802.11ac VHT20	Test Channel :	11
-------------	----------------	----------------	----

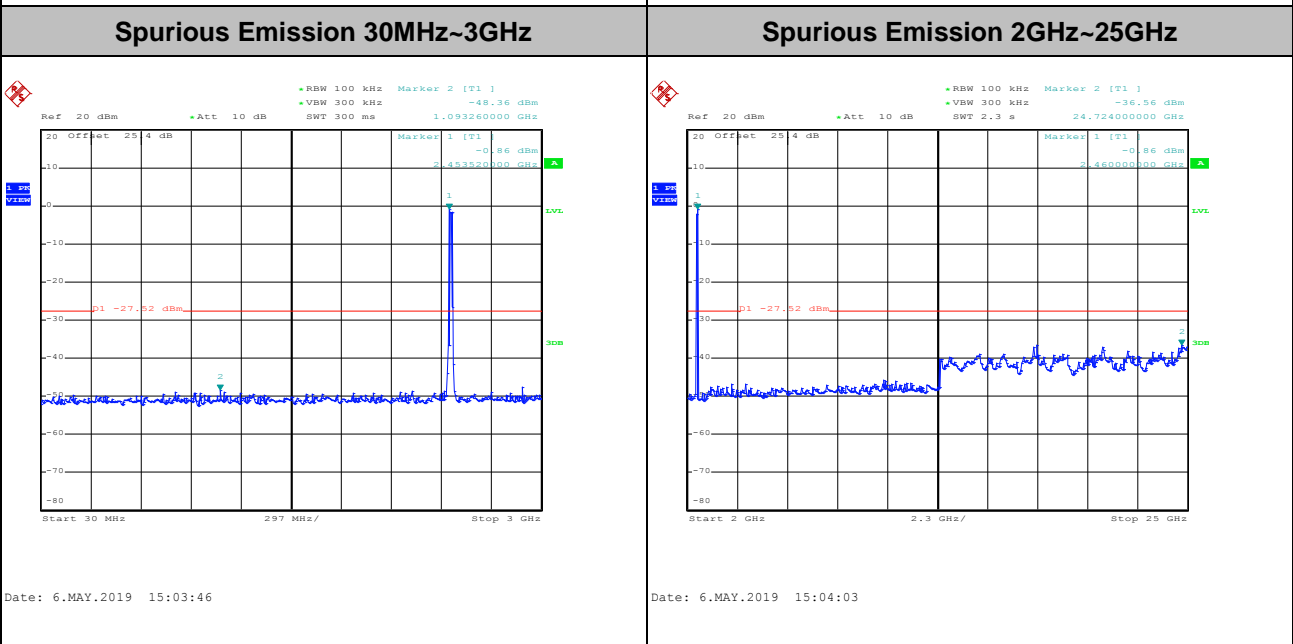
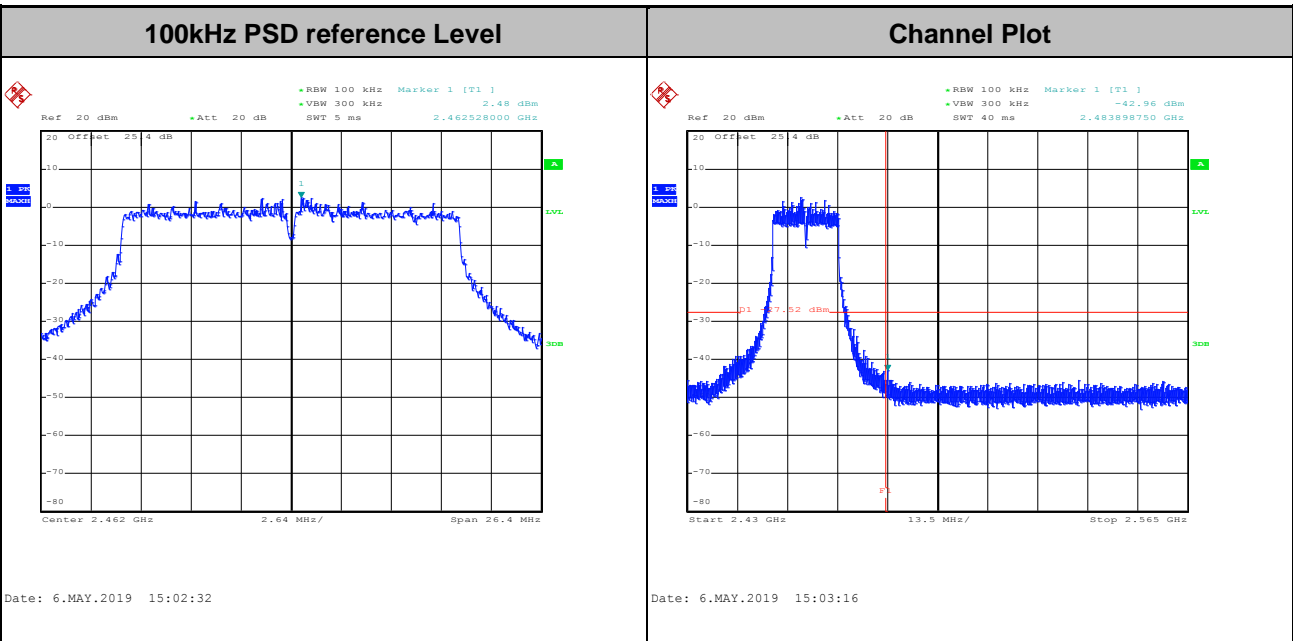



Test Mode :	802.11ac VHT40	Test Channel :	03
-------------	----------------	----------------	----

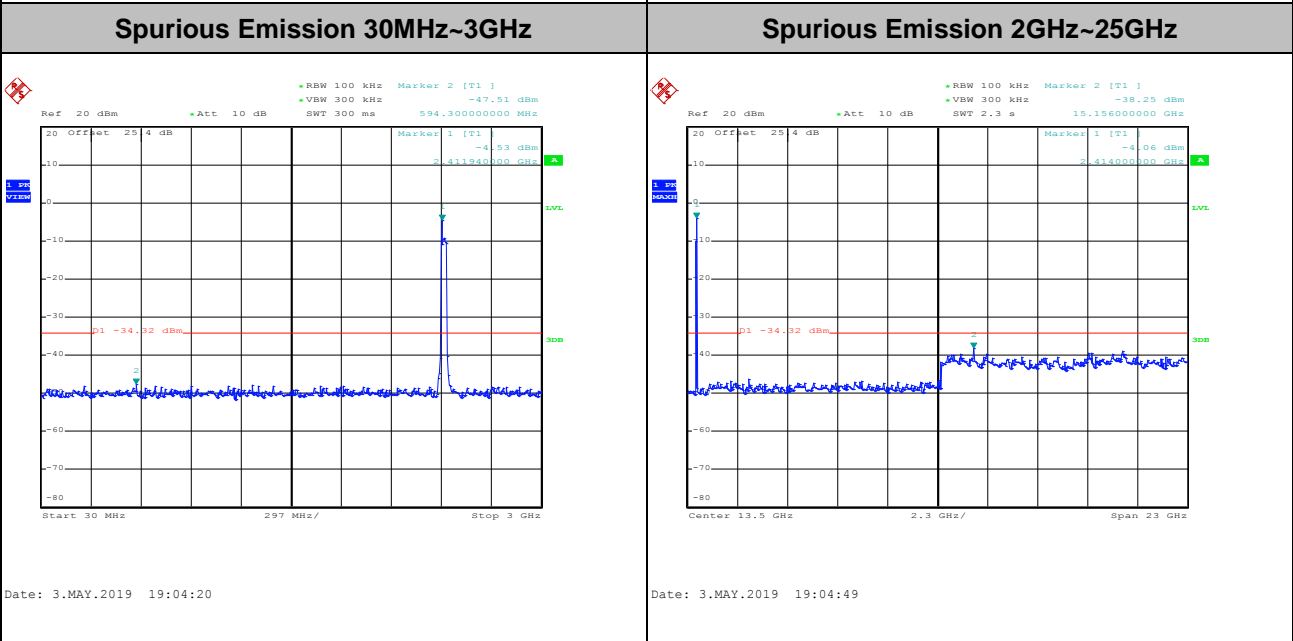
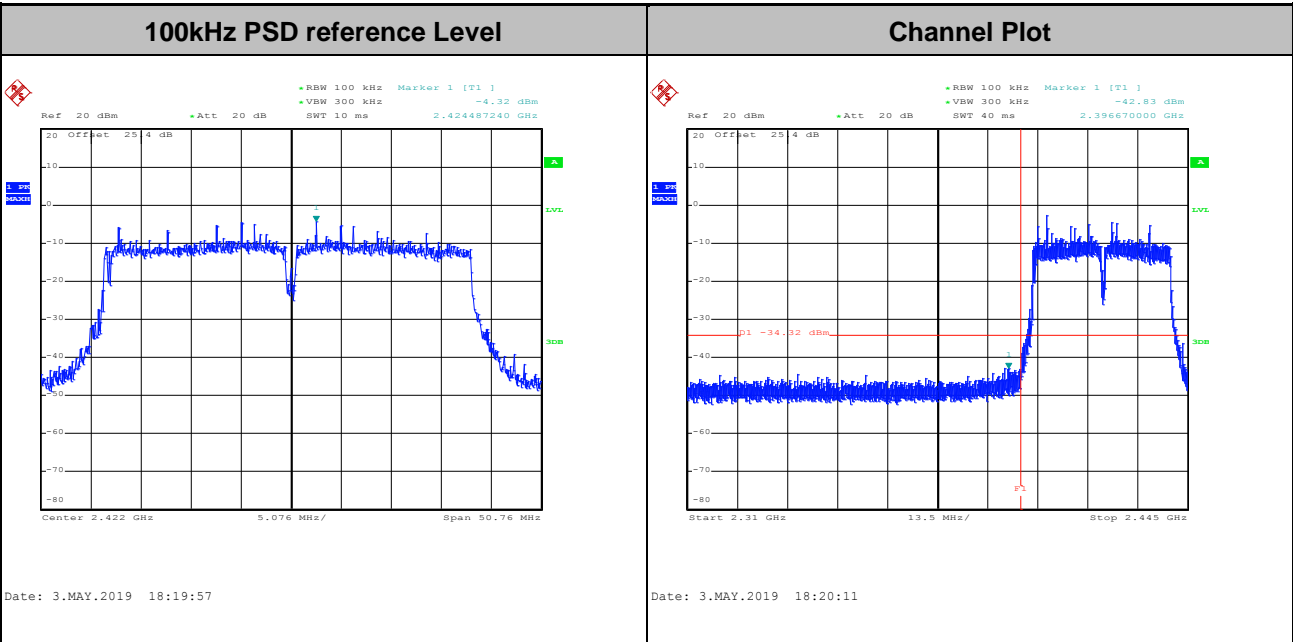



Test Mode :	802.11ac VHT40	Test Channel :	06
-------------	----------------	----------------	----

100kHz PSD reference Level

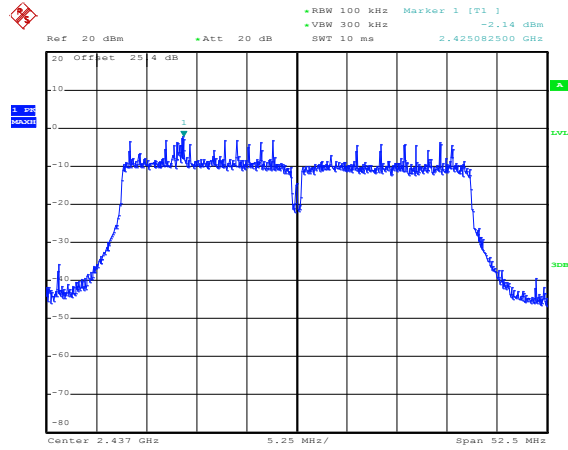

Date: 3.MAY.2019 18:09:29

Spurious Emission 30MHz~3GHz

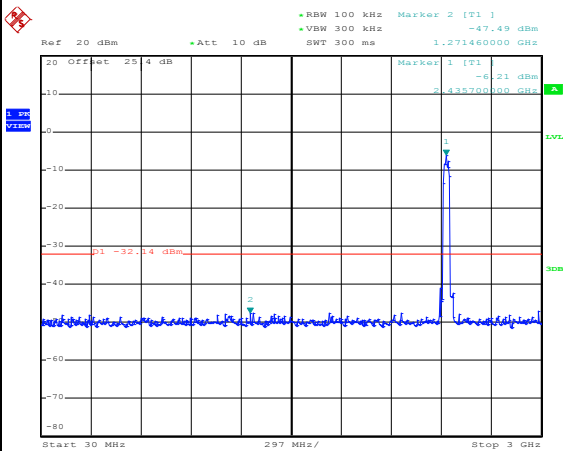

Date: 3.MAY.2019 18:09:53

Spurious Emission 2GHz~25GHz

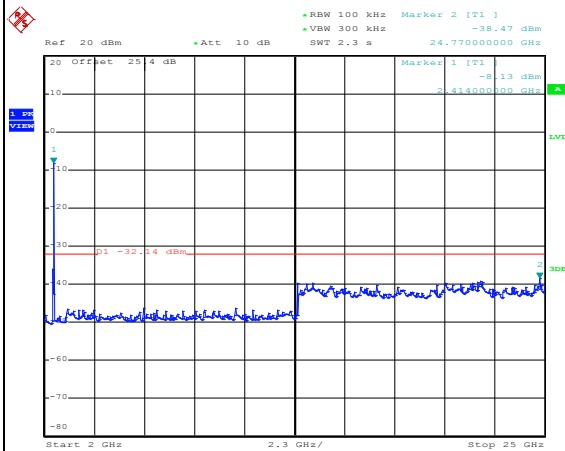

Date: 3.MAY.2019 18:10:09



Test Mode :	802.11ac VHT40	Test Channel :	09
-------------	----------------	----------------	----

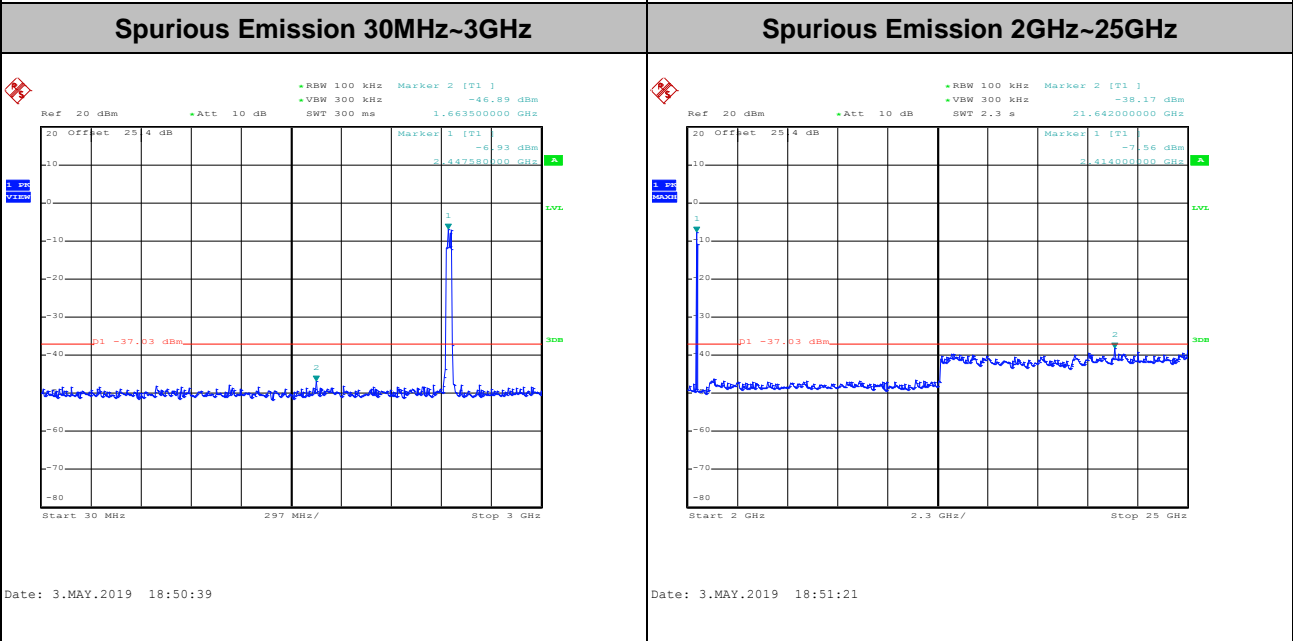
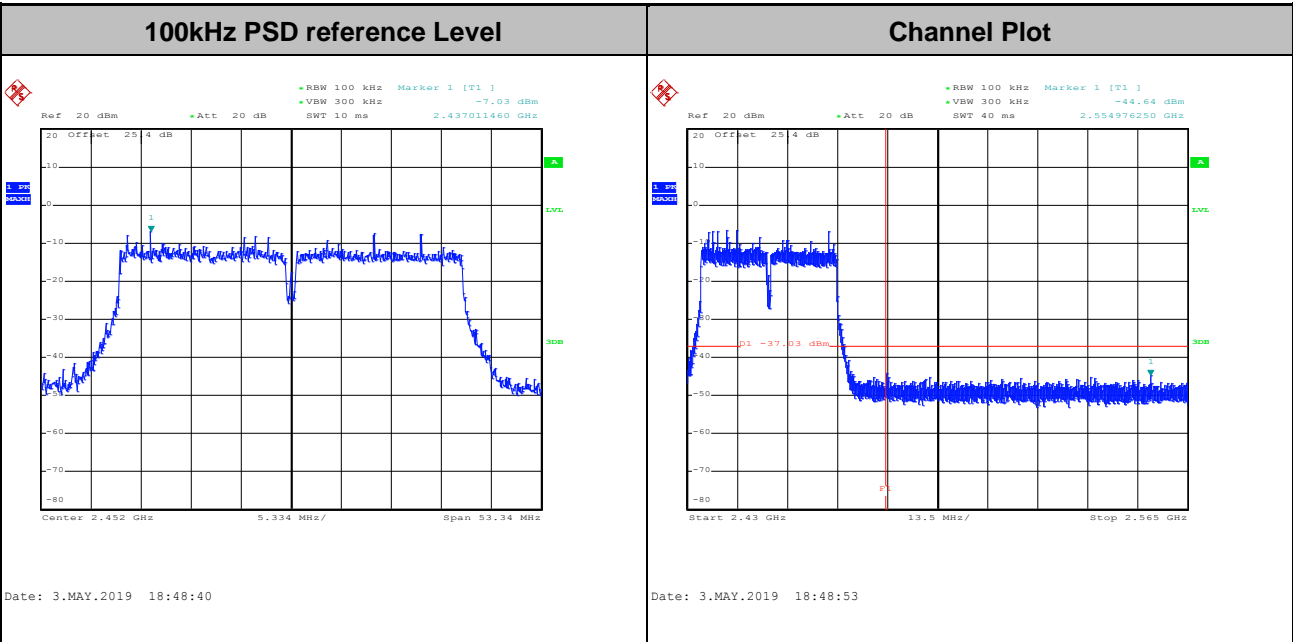



3.5 Radiated Band Edges and Spurious Emission Measurement

3.5.1 Limit of Radiated band edge and Spurious Emission Measurement

In any 100 kHz bandwidth outside the intentional radiator frequency band, all harmonics/spurious must be at least 20 dB below the highest emission level within the authorized band. If the output power of this device was measured by spectrum analyzer, the attenuation under this paragraph shall be 30 dB instead of 20 dB. In addition, radiated emissions which fall in the restricted bands must also comply with the limits as below.

Frequency (MHz)	Field Strength (microvolts/meter)	Measurement Distance (meters)
0.009 – 0.490	2400/F(kHz)	300
0.490 – 1.705	24000/F(kHz)	30
1.705 – 30.0	30	30
30 – 88	100	3
88 – 216	150	3
216 - 960	200	3
Above 960	500	3

3.5.2 Measuring Instruments

See list of measuring equipment of this test report.



3.5.3 Test Procedures

1. The testing follows the ANSI C63.10 Section 11.12.1 Radiated emission measurements
2. The EUT was arranged to its worst case and then tune the antenna tower (from 1 m to 4 m) and turntable (from 0 degree to 360 degrees) to find the maximum reading. A pre-amp and a high pass filter are used for the test in order to get better signal level.
3. The EUT was placed on a turntable with 0.8 meter for frequency below 1GHz and 1.5 meter for frequency above 1GHz respectively above ground.
4. The EUT was set 3 meters from the interference receiving antenna, which was mounted on the top of a variable height antenna tower.
5. Corrected Reading: Antenna Factor + Cable Loss + Read Level - Preamp Factor = Level
6. For testing below 1GHz, if the emission level of the EUT in peak mode was 3 dB lower than the limit specified, then peak values of EUT will be reported, otherwise, the emissions will be repeated one by one using the CISPR quasi-peak method and reported.
7. For testing above 1GHz, the emission level of the EUT in peak mode was 20dB lower than average limit (that means the emission level in average mode also complies with the limit in average mode), then peak values of EUT will be reported, otherwise, the emissions will be measured in average mode again and reported.
8. Use the following spectrum analyzer settings:
 - (1) Span shall wide enough to fully capture the emission being measured;
 - (2) Set RBW=100 kHz for $f < 1$ GHz; $VBW \geq RBW$; Sweep = auto; Detector function = peak; Trace = max hold;
 - (3) Set RBW = 1 MHz, VBW= 3MHz for $f \geq 1$ GHz for peak measurement.
For average measurement:
 - $VBW = 10$ Hz, when duty cycle is no less than 98 percent.
 - $VBW \geq 1/T$, when duty cycle is less than 98 percent where T is the minimum transmission duration over which the transmitter is on and is transmitting at its maximum power control level for the tested mode of operation.

3.5.4 Test Setup

For radiated emissions below 30MHz

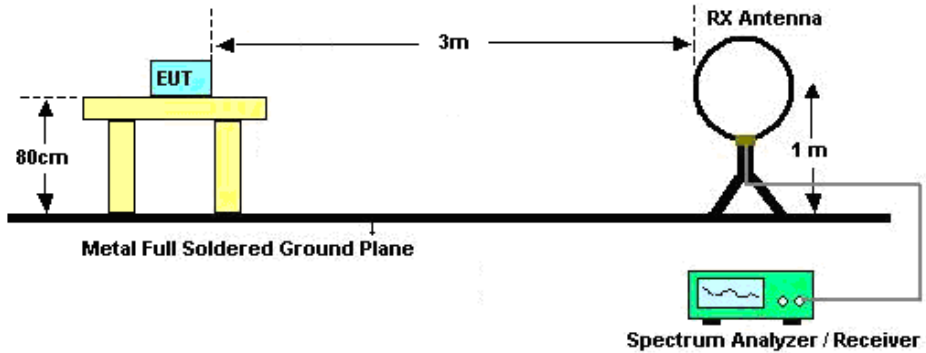

For radiated emissions from 30MHz to 1GHz

<CDD Mode>

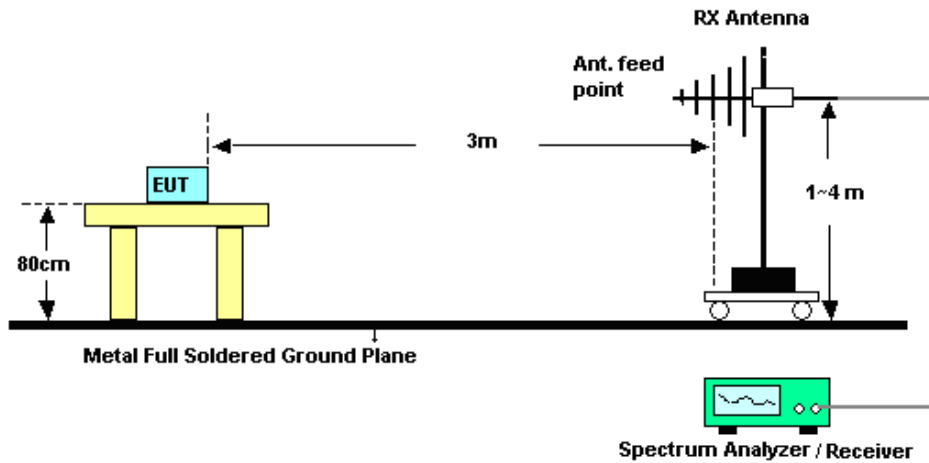

<TXBF Modes>

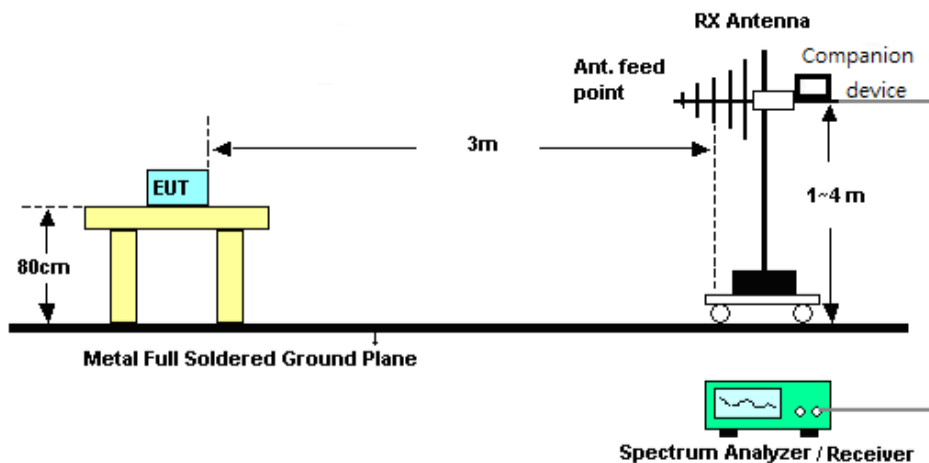

For radiated emissions above 1GHz

<CDD Mode>

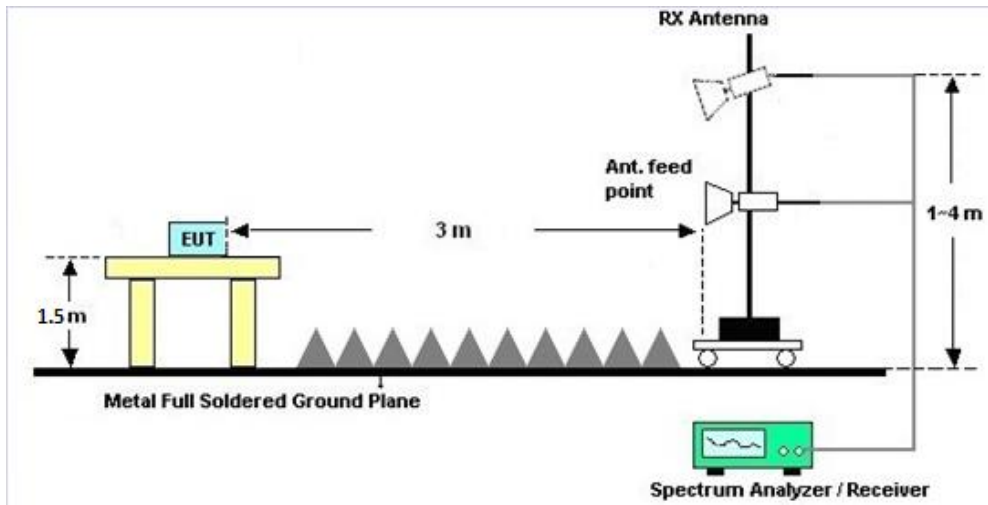

<TXBF Modes>

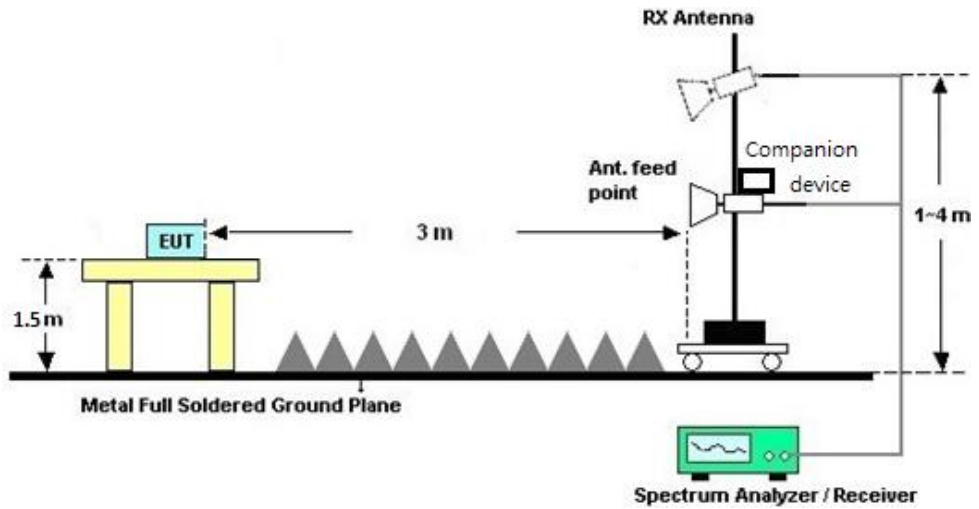



3.5.5 Test Results of Radiated Spurious Emissions (9kHz ~ 30MHz)

The low frequency, which started from 9 kHz to 30MHz, was pre-scanned and the result which was 20dB lower than the limit line was not reported.

There is a comparison data of both open-field test site and alternative test site - semi-Anechoic chamber according to 414788 D01 Radiated Test Site v01r01, and the result came out very similar.

3.5.6 Test Result of Radiated Spurious at Band Edges

Please refer to Appendix Band C.

3.5.7 Duty Cycle

Please refer to Appendix D.

3.5.8 Test Result of Radiated Spurious Emission (30MHz ~ 10th Harmonic)

Please refer to Appendix B and C



3.6 AC Conducted Emission Measurement

3.6.1 Limit of AC Conducted Emission

For equipment that is designed to be connected to the public utility (AC) power line, the radio frequency voltage that is conducted back onto the AC power line on any frequency or frequencies within the band 150 kHz to 30 MHz shall not exceed the limits in the following table.

Frequency of Emission (MHz)	Conducted Limit (dB μ V)	
	Quasi-Peak	Average
0.15-0.5	66 to 56*	56 to 46*
0.5-5	56	46
5-30	60	50

*Decreases with the logarithm of the frequency.

3.6.2 Measuring Instruments

See list of measuring equipment of this test report.

3.6.3 Test Procedures

1. The EUT was placed 0.4 meter from the conducting wall of the shielding room, and it was kept at least 80 centimeters from any other grounded conducting surface.
2. Connect EUT to the power mains through a line impedance stabilization network (LISN).
3. All the support units are connecting to the other LISN.
4. The LISN provides 50 ohm coupling impedance for the measuring instrument.
5. The FCC states that a 50 ohm, 50 microhenry LISN should be used.
6. Both sides of AC line were checked for maximum conducted interference.
7. The frequency range from 150 kHz to 30 MHz was searched.
8. Set the test-receiver system to Peak Detect Function and specified bandwidth (IF bandwidth = 9kHz) with Maximum Hold Mode.

3.6.4 Test Setup

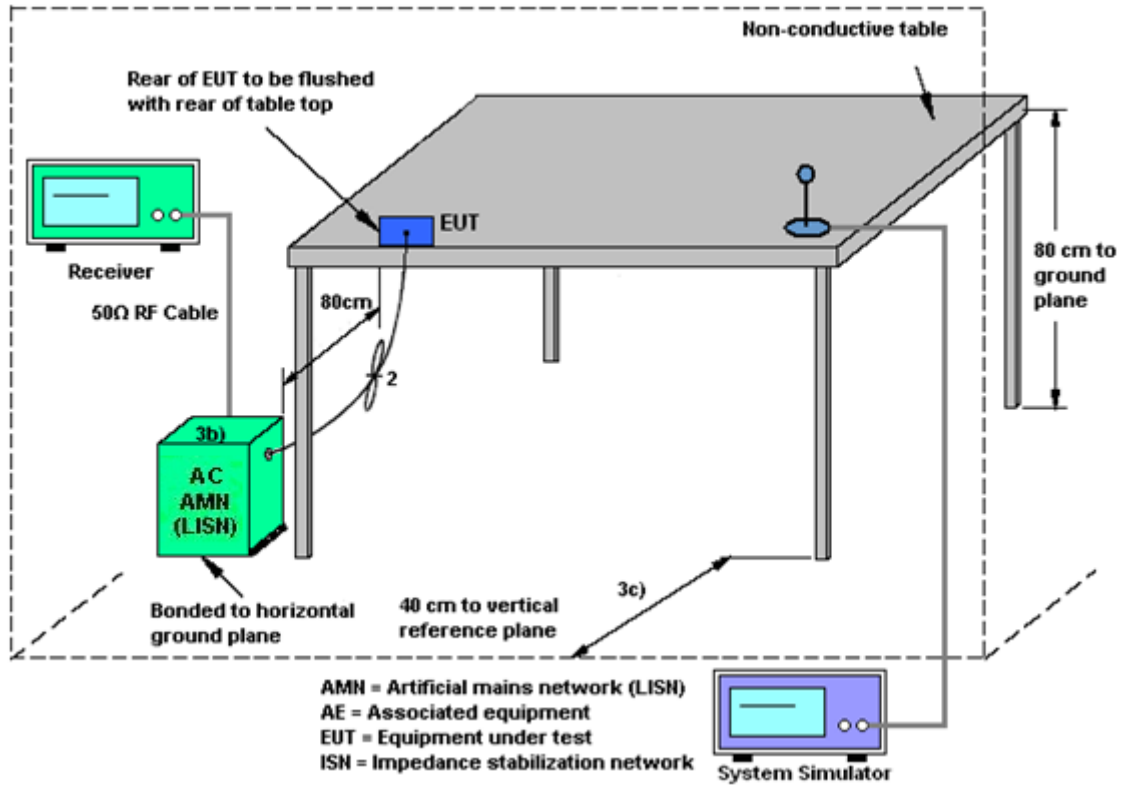

3.6.5 Test Result of AC Conducted Emission

Please refer to Appendix A.



3.7 Antenna Requirements

3.7.1 Standard Applicable

If directional gain of transmitting Antennas is greater than 6dBi, the power shall be reduced by the same level in dB comparing to gain minus 6dBi. The use of a permanently attached Antenna or of an Antenna that uses a unique coupling to the intentional radiator shall be considered sufficient to comply with the rule.

3.7.2 Antenna Anti-Replacement Construction

An embedded-in antenna design is used.

3.7.3 Antenna Gain

<CDD Modes >

FCC KDB 662911 D01 Multiple Transmitter Output v02r01

For CDD transmissions, directional gain is calculated as

Directional gain = G_{ANT} + Array Gain, where Array Gain is as follows.

For power spectral density (PSD) measurements on all devices,

Array Gain = $10 \log(N_{ANT}/N_{SS}=1)$ dB.

For power measurements on IEEE 802.11 devices,

Array Gain = 0 dB (i.e., no array gain) for $N_{ANT} \leq 4$.

Directional gain may be calculated by using the formulas applicable to equal gain antennas with G_{ANT} set equal to the gain of the antenna having the highest gain;

The EUT supports CDD mode.

For power, the directional gain G_{ANT} is set equal to the antenna having the highest gain, i.e., F)2)f)i).

For PSD, the directional gain calculation is following F)2)f)ii) of KDB 662911 D01 v02r01.

The power and PSD limit should be modified if the directional gain of EUT is over 6 dBi,

The directional gain "DG" is calculated as following table.

<CDD Modes>						
			DG	DG	Power	PSD
			for	for	Limit	Limit
	Ant. 1	Ant. 2	Power	PSD	Reduction	Reduction
	(dBi)	(dBi)	(dBi)	(dBi)	(dB)	(dB)
2.4 GHz	-0.21	-2.29	-0.21	1.82	0.00	0.00

$Power\ Limit\ Reduction = DG(Power) - 6dBi, (min = 0)$

$PSD\ Limit\ Reduction = DG(PSD) - 6dBi, (min = 0)$

TXBF modes

FCC KDB 662911 D01 Multiple Transmitter Output v02r01

For CDD transmissions, directional gain is calculated as

$$DirectionalGain = 10 \cdot \log \left[\frac{\sum_{j=1}^{N_{SS}} \left\{ \sum_{k=1}^{N_{ANT}} g_{j,k} \right\}^2}{N_{ANT}} \right]$$

where

Each antenna is driven by no more than one spatial stream;

N_{SS} = the number of independent spatial streams of data;

N_{ANT} = the total number of antennas

$g_{j,k} = 10^{G_k / 20}$ if the k th antenna is being fed by spatial stream j , or zero if it is not;
 G_k is the gain in dBi of the k th antenna.

The EUT supports beamforming for 802.11ac modes.

The directional gain calculation is following F)2)e)ii) of KDB 662911 D01 v02r01.

The power and PSD limit should be modified if the directional gain of EUT is over 6 dBi,

The directional gain “DG” is calculated as following table.

			DG	DG	Power	PSD
			for	for	Limit	Limit
	Ant. 1	Ant. 2	Power	PSD	Reduction	Reduction
	(dBi)	(dBi)	(dBi)	(dBi)	(dB)	(dB)
2.4 GHz	-0.21	-2.29	1.82	1.82	0.00	0.00

Power Limit Reduction = DG(Power) – 6dBi, (min = 0)

PSD Limit Reduction = DG(PSD) – 6dBi, (min = 0)



4 List of Measuring Equipment

Instrument	Manufacturer	Model No.	Serial No.	Characteristics	Calibration Date	Test Date	Due Date	Remark
<CDD Mode>								
Power Sensor	DARE	RPR3006W	15100041S NO10	10MHz~6GHz	May 07, 2018	Mar. 19, 2019~ Apr. 23, 2019	May 06, 2019	Conducted (TH05-HY)
Spectrum Analyzer	Rohde & Schwarz	FSP40	100057	9kHz-40GHz	Nov. 21, 2018	Mar. 19, 2019~ Apr. 23, 2019	Nov. 20, 2019	Conducted (TH05-HY)
Switch Box & RF Cable	EM	EMSW18	SW107090 3	N/A	Dec. 27, 2018	Mar. 19, 2019~ Apr. 23, 2019	Dec. 26, 2019	Conducted (TH05-HY)
Loop Antenna	Rohde & Schwarz	HFH2-Z2	100488	9 kHz~30 MHz	Jan. 07, 2019	Apr. 04, 2019 ~ Apr. 12, 2019	Jan. 06, 2020	Radiation (03CH15-HY)
Preamplifier	EMEC	EM18G40G	060715	18GHz ~ 40GHz	Dec. 06, 2018	Apr. 04, 2019 ~ Apr. 12, 2019	Dec. 05, 2019	Radiation (03CH15-HY)
Bilog Antenna	TESEQ	CBL6111D&0 0802N1D01N- 06	47020&06	30MHz to 1GHz	Oct. 13, 2018	Apr. 12, 2019	Oct. 12, 2019	Radiation (03CH15-HY)
Horn Antenna	SCHWARZBE CK	BBHA 9120D	9120D-162 0	1G~18GHz	Oct. 17, 2018	Apr. 04, 2019 ~ Apr. 12, 2019	Oct. 16, 2019	Radiation (03CH15-HY)
SHF-EHF Horn Antenna	SCHWARZBE CK	BBHA 9170	BBHA9170 576	18GHz ~ 40GHz	May 08, 2018	Apr. 04, 2019 ~ Apr. 12, 2019	May 07, 2019	Radiation (03CH15-HY)
Amplifier	SONOMA	310N	363440	9kHz~1GHz	Dec. 28, 2018	Apr. 12, 2019	Dec. 27, 2019	Radiation (03CH15-HY)
Preamplifier	Jet-Power	JPA0118-55-3 03	171000180 00550006	1GHz~18GHz	Jul. 10, 2018	Apr. 04, 2019 ~ Apr. 12, 2019	Jul. 09, 2019	Radiation (03CH15-HY)
Preamplifier	Keysight	83017A	MY532701 95	1GHz~26.5GHz	Aug. 23, 2018	Apr. 04, 2019 ~ Apr. 12, 2019	Aug. 22, 2019	Radiation (03CH15-HY)
EMI Test Receiver	Keysight	N9038A (MXE)	MY541300 85	20Hz ~ 8.4GHz	Nov. 01, 2018	Apr. 04, 2019 ~ Apr. 12, 2019	Oct. 31, 2019	Radiation (03CH15-HY)
Spectrum Analyzer	Agilent	E4446A	MY501801 36	3Hz~44GHz	Apr. 25, 2018	Apr. 04, 2019 ~ Apr. 12, 2019	Apr. 24, 2019	Radiation (03CH15-HY)
Antenna Mast	ChainTek	MBS-520-1	N/A	1m~4m	N/A	Apr. 04, 2019 ~ Apr. 12, 2019	N/A	Radiation (03CH15-HY)
Turn Table	ChainTek	T-200-S-1	N/A	0~360 Degree	N/A	Apr. 04, 2019 ~ Apr. 12, 2019	N/A	Radiation (03CH15-HY)
Software	Audix	E3 6.2009-8-24(k 5)	RK-00045 1	N/A	N/A	Apr. 04, 2019 ~ Apr. 12, 2019	N/A	Radiation (03CH15-HY)
RF Cable	HUBER + SUHNER	SUCOFLEX 104	MY36980/ 4	30M-18G	Apr. 16, 2018	Apr. 04, 2019 ~ Apr. 12, 2019	Apr. 15, 2019	Radiation (03CH15-HY)
RF Cable	HUBER + SUHNER	SUCOFLEX 104	MY9838/4	30M-18G	Apr. 16, 2018	Apr. 04, 2019 ~ Apr. 12, 2019	Apr. 15, 2019	Radiation (03CH15-HY)
RF Cable	HUBER + SUHNER	MTJ	000000-M T18A-100 D3210	30M-18G	Apr. 16, 2018	Apr. 04, 2019 ~ Apr. 12, 2019	Apr. 15, 2019	Radiation (03CH15-HY)
RF Cable	HUBER + SUHNER	SUCOFLEX 102	MY2859/2	30MHz-40GHz	Mar. 13, 2019	Apr. 04, 2019 ~ Apr. 12, 2019	Mar. 12, 2020	Radiation (03CH15-HY)
RF Cable	HUBER + SUHNER	SUCOFLEX 102	MY4274/2	30MHz-40GHz	Mar. 13, 2019	Apr. 04, 2019 ~ Apr. 12, 2019	Mar. 12, 2020	Radiation (03CH15-HY)
Filter	Wainwright	WLK4-1000-1 530-8000-40S S	SN11	1G Low Pass	Sep. 16, 2018	Apr. 04, 2019 ~ Apr. 12, 2019	Sep. 15, 2019	Radiation (03CH15-HY)
Filter	Wainwright	WHKX12-270 0-3000-18000 -60ST	SN1	3 GHz Highpass	Sep. 16, 2018	Apr. 04, 2019 ~ Apr. 12, 2019	Sep. 15, 2019	Radiation (03CH15-HY)



Instrument	Manufacturer	Model No.	Serial No.	Characteristics	Calibration Date	Test Date	Due Date	Remark
<TXBF Mode>								
Power Sensor	DARE	RPR3006W	16I00054S NO10	10MHz~6GHz	Dec. 19, 2018	Mar. 20, 2019~ May 06, 2019	Dec. 18, 2019	Conducted (TH05-HY)
Signal Analyzer	Rohde & Schwarz	FSV40	101397	10Hz~40GHz	Nov. 13, 2018	Mar. 20, 2019~ May 06, 2019	Nov. 12, 2019	Conducted (TH05-HY)
Switch Box & RF Cable	EM	EMSW18	SW107090 3	N/A	Dec. 27, 2018	Mar. 20, 2019~ May 06, 2019	Dec. 26, 2019	Conducted (TH05-HY)
Loop Antenna	Rohde & Schwarz	HFH2-Z2	100488	9 kHz~30 MHz	Jan. 07, 2019	Apr. 25, 2019 ~ Apr. 30, 2019	Jan. 06, 2020	Radiation (03CH15-HY)
Preamplifier	EMEC	EM18G40G	060715	18GHz ~ 40GHz	Dec. 06, 2018	Apr. 25, 2019 ~ Apr. 30, 2019	Dec. 05, 2019	Radiation (03CH15-HY)
Bilog Antenna	TESEQ	CBL6111D&0 0802N1D01N- 06	47020&06	30MHz to 1GHz	Oct. 13, 2018	Apr. 25, 2019 ~ Apr. 30, 2019	Oct. 12, 2019	Radiation (03CH15-HY)
Horn Antenna	SCHWARZBE CK	BBHA 9120D	9120D-162 0	1G~18GHz	Oct. 17, 2018	Apr. 25, 2019 ~ Apr. 30, 2019	Oct. 16, 2019	Radiation (03CH15-HY)
SHF-EHF Horn Antenna	SCHWARZBE CK	BBHA 9170	BBHA9170 576	18GHz ~ 40GHz	May 08, 2018	Apr. 25, 2019 ~ Apr. 30, 2019	May 07, 2019	Radiation (03CH15-HY)
Amplifier	SONOMA	310N	363440	9kHz~1GHz	Dec. 28, 2018	Apr. 25, 2019 ~ Apr. 30, 2019	Dec. 27, 2019	Radiation (03CH15-HY)
Preamplifier	Jet-Power	JAP00101800 -30-10P	160118550 004	1GHz~18GHz	Apr. 25, 2019	Apr. 25, 2019 ~ Apr. 30, 2019	Apr. 24, 2020	Radiation (03CH15-HY)
Preamplifier	Keysight	83017A	MY532701 95	1GHz~26.5GHz	Aug. 23, 2018	Apr. 25, 2019 ~ Apr. 30, 2019	Aug. 22, 2019	Radiation (03CH15-HY)
EMI Test Receiver	Keysight	N9038A (MXE)	MY541300 85	20Hz ~ 8.4GHz	Nov. 01, 2018	Apr. 25, 2019 ~ Apr. 30, 2019	Oct. 31, 2019	Radiation (03CH15-HY)
Spectrum Analyzer	Agilent	N9010A	MY534701 18	10Hz~44GHz	Apr. 18, 2019	Apr. 25, 2019 ~ Apr. 30, 2019	Apr. 17, 2020	Radiation (03CH15-HY)
Controller	ChainTek	3000-1	N/A	Control Turn table & Ant Mast	N/A	Apr. 25, 2019 ~ Apr. 30, 2019	N/A	Radiation (03CH15-HY)
Antenna Mast	ChainTek	MBS-520-1	N/A	1m~4m	N/A	Apr. 25, 2019 ~ Apr. 30, 2019	N/A	Radiation (03CH15-HY)
Turn Table	ChainTek	T-200-S-1	N/A	0~360 Degree	N/A	Apr. 25, 2019 ~ Apr. 30, 2019	N/A	Radiation (03CH15-HY)
Software	Audix	E3 6.2009-8-24 (k5)	RK-00045 1	N/A	N/A	Apr. 25, 2019 ~ Apr. 30, 2019	N/A	Radiation (03CH15-HY)
RF Cable	HUBER + SUHNER	SUCOFLEX 104	MY36980/ 4	30M-18G	Apr. 15, 2019	Apr. 25, 2019 ~ Apr. 30, 2019	Apr. 14, 2020	Radiation (03CH15-HY)
RF Cable	HUBER + SUHNER	SUCOFLEX 104	MY9838/4	30M-18G	Apr. 15, 2019	Apr. 25, 2019 ~ Apr. 30, 2019	Apr. 14, 2020	Radiation (03CH15-HY)
RF Cable	HUBER + SUHNER	MTJ	000000-M T18A-100 D3210	30M-18G	Apr. 15, 2019	Apr. 25, 2019 ~ Apr. 30, 2019	Apr. 14, 2020	Radiation (03CH15-HY)
RF Cable	HUBER + SUHNER	SUCOFLEX 102	MY2859/2	30MHz-40GHz	Mar. 13, 2019	Apr. 25, 2019 ~ Apr. 30, 2019	Mar. 12, 2020	Radiation (03CH15-HY)
RF Cable	HUBER + SUHNER	SUCOFLEX 102	MY4274/2	30MHz-40GHz	Mar. 13, 2019	Apr. 25, 2019 ~ Apr. 30, 2019	Mar. 12, 2020	Radiation (03CH15-HY)
Filter	Wainwright	WLK4-1000-1 530-8000-40S S	SN11	1G Low Pass	Sep. 16, 2018	Apr. 25, 2019 ~ Apr. 30, 2019	Sep. 15, 2019	Radiation (03CH15-HY)
Filter	Wainwright	WHKX12-270 0-3000-18000 -60ST	SN1	3 GHz Highpass	Sep. 16, 2018	Apr. 25, 2019 ~ Apr. 30, 2019	Sep. 15, 2019	Radiation (03CH15-HY)
Filter	Wainwright	WHKX8-5872. 5-6750-18000 -40ST	SN3	6.75 GHz Highpass	Sep. 16, 2018	Apr. 25, 2019 ~ Apr. 30, 2019	Sep. 15, 2019	Radiation (03CH15-HY)



Instrument	Manufacturer	Model No.	Serial No.	Characteristics	Calibration Date	Test Date	Due Date	Remark
AC Power Source	ChainTek	APC-1000W	N/A	N/A	N/A	Mar. 24, 2019	N/A	Conduction (CO05-HY)
EMI Test Receiver	Rohde & Schwarz	ESR3	102388	9KHz~3.6GHz	Nov. 12, 2018	Mar. 24, 2019	Nov. 11, 2019	Conduction (CO05-HY)
LISN	Rohde & Schwarz	ENV216	100080	9kHz~30MHz	Nov. 14, 2018	Mar. 24, 2019	Nov. 13, 2019	Conduction (CO05-HY)
LISN	Rohde & Schwarz	ENV216	100081	9kHz~30MHz	Nov. 09, 2018	Mar. 24, 2019	Nov. 08, 2019	Conduction (CO05-HY)
Software	Rohde & Schwarz	EMC32 V10.30	N/A	N/A	N/A	Mar. 24, 2019	N/A	Conduction (CO05-HY)
RF Cable	HUBER + SUHNER	RG 214/U	1358175	9kHz~30MHz	Sep. 14, 2018	Mar. 24, 2019	Sep. 13, 2019	Conduction (CO05-HY)
Pulse Limiter	SCHWARZBECK	VTSD 9561-F N	9561-F N00373	9kHz-200MHz	Nov. 08, 2018	Mar. 24, 2019	Nov. 07, 2019	Conduction (CO05-HY)



5 Uncertainty of Evaluation

Uncertainty of Conducted Emission Measurement (150kHz ~ 30MHz)

Measuring Uncertainty for a Level of Confidence of 95% ($U = 2Uc(y)$)	2.2
---	-----

Uncertainty of Radiated Emission Measurement (30 MHz ~ 1000 MHz)

Measuring Uncertainty for a Level of Confidence of 95% ($U = 2Uc(y)$)	5.2
---	-----

Uncertainty of Radiated Emission Measurement (1000 MHz ~ 18000 MHz)

Measuring Uncertainty for a Level of Confidence of 95% ($U = 2Uc(y)$)	5.5
---	-----

Uncertainty of Radiated Emission Measurement (18000 MHz ~ 40000 MHz)

Measuring Uncertainty for a Level of Confidence of 95% ($U = 2Uc(y)$)	5.2
---	-----



Appendix A. AC Conducted Emission Test Results

Test Engineer :	Jimmy Chang	Temperature :	24~26°C
		Relative Humidity :	51~54%
Test Voltage :	120Vac / 60Hz	Phase :	Line

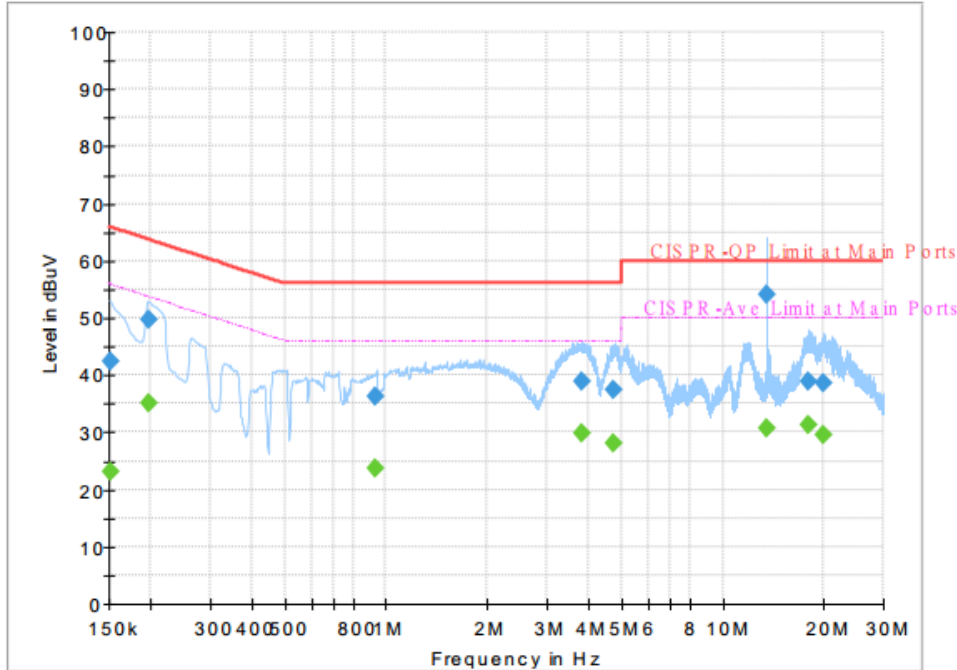

Final Result

Frequency (MHz)	QuasiPeak (dBuV)	CAverage (dBuV)	Limit (dBuV)	Margin (dB)	Line	Filter	Corr. (dB)
0.152250	---	22.96	55.88	32.92	L1	OFF	19.5
0.152250	42.38	---	65.88	23.50	L1	OFF	19.5
0.197250	---	35.05	53.73	18.68	L1	OFF	19.5
0.197250	49.65	---	63.73	14.08	L1	OFF	19.5
0.930750	---	23.81	46.00	22.19	L1	OFF	19.5
0.930750	36.30	---	56.00	19.70	L1	OFF	19.5
3.831000	---	29.78	46.00	16.22	L1	OFF	19.6
3.831000	38.95	---	56.00	17.05	L1	OFF	19.6
4.719750	---	27.94	46.00	18.06	L1	OFF	19.6
4.719750	37.31	---	56.00	18.69	L1	OFF	19.6
13.560000	---	30.66	50.00	19.34	L1	OFF	19.7
13.560000	54.21	---	60.00	5.79	L1	OFF	19.7
17.988000	---	31.18	50.00	18.82	L1	OFF	19.8
17.988000	38.76	---	60.00	21.24	L1	OFF	19.8
19.866750	---	29.64	50.00	20.36	L1	OFF	19.8
19.866750	38.47	---	60.00	21.53	L1	OFF	19.8



Test Engineer :	Jimmy Chang	Temperature :	24~26°C
		Relative Humidity :	51~54%
Test Voltage :	120Vac / 60Hz	Phase :	Neutral

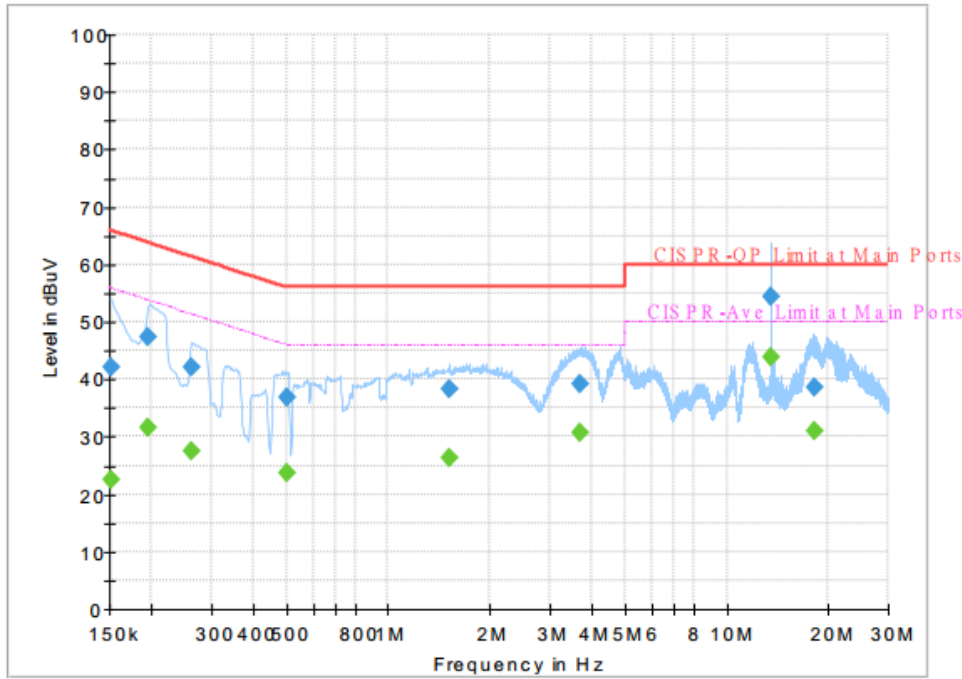

Final Result

Frequency (MHz)	QuasiPeak (dBuV)	CAverage (dBuV)	Limit (dBuV)	Margin (dB)	Line	Filter	Corr. (dB)
0.152250	---	22.50	55.88	33.38	N	OFF	19.5
0.152250	42.22	---	65.88	23.66	N	OFF	19.5
0.195000	---	31.52	53.82	22.30	N	OFF	19.5
0.195000	47.51	---	63.82	16.31	N	OFF	19.5
0.262500	---	27.51	51.35	23.84	N	OFF	19.5
0.262500	42.02	---	61.35	19.33	N	OFF	19.5
0.503250	---	23.57	46.00	22.43	N	OFF	19.5
0.503250	36.79	---	56.00	19.21	N	OFF	19.5
1.515750	---	26.35	46.00	19.65	N	OFF	19.5
1.515750	38.33	---	56.00	17.67	N	OFF	19.5
3.684750	---	30.61	46.00	15.39	N	OFF	19.6
3.684750	39.27	---	56.00	16.73	N	OFF	19.6
13.560000	---	43.86	50.00	6.14	N	OFF	19.8
13.560000	54.33	---	60.00	5.67	N	OFF	19.8
18.125250	---	31.04	50.00	18.96	N	OFF	19.9
18.125250	38.63	---	60.00	21.37	N	OFF	19.9



Appendix B. Radiated Spurious Emission

Test Engineer :	Watt Tseng, Karl Hou, Big-Show Wang	Temperature :	23~26°C
		Relative Humidity :	50~57%

<CDD Mode for XSLATE>

2.4GHz 2400~2483.5MHz

WIFI 802.11b (Band Edge @ 3m)

WIFI Ant.	Note	Frequency	Level	Over Limit	Limit Line	Read Level	Antenna Factor	Path Loss	Preamp Factor	Ant Pos	Table Pos	Peak Avg.	Pol.	
1		(MHz)	(dBμV/m)	(dB)	(dBμV/m)	(dBμV)	(dB/m)	(dB)	(dB)	(cm)	(deg)	(P/A)	(H/V)	
802.11b CH 01 2412MHz		2389.8	54.62	-19.38	74	42.1	27.6	15.77	30.85	136	39	P	H	
		2387.385	45.35	-8.65	54	32.84	27.6	15.77	30.86	136	39	A	H	
	*	2412	113.49	-	-	100.93	27.6	15.81	30.85	136	39	P	H	
	*	2412	110.51	-	-	97.95	27.6	15.81	30.85	136	39	A	H	
													H	
													H	
			2387.28	54.15	-19.85	74	41.64	27.6	15.77	30.86	230	108	P	V
			2387.385	44.36	-9.64	54	31.85	27.6	15.77	30.86	230	108	A	V
	*		2412	110.55	-	-	97.99	27.6	15.81	30.85	230	108	P	V
	*		2412	107.47	-	-	94.91	27.6	15.81	30.85	230	108	A	V
													V	
													V	
802.11b CH 06 2437MHz		2383.64	53.77	-20.23	74	41.23	27.63	15.77	30.86	213	331	P	H	
		2389.94	43.46	-10.54	54	30.94	27.6	15.77	30.85	213	331	A	H	
	*	2437	113.25	-	-	100.65	27.6	15.84	30.84	213	331	P	H	
	*	2437	110	-	-	97.4	27.6	15.84	30.84	213	331	A	H	
			2485.51	53.17	-20.83	74	40.61	27.47	15.91	30.82	213	331	P	H
			2484.67	42.76	-11.24	54	30.2	27.47	15.91	30.82	213	331	A	H
			2332.54	53.69	-20.31	74	41.12	27.77	15.69	30.89	353	92	P	V
			2389.94	43.22	-10.78	54	30.7	27.6	15.77	30.85	353	92	A	V
	*		2437	111.86	-	-	99.26	27.6	15.84	30.84	353	92	P	V
	*		2437	108.69	-	-	96.09	27.6	15.84	30.84	353	92	A	V
			2485.51	53.34	-20.66	74	40.78	27.47	15.91	30.82	353	92	P	V
			2483.5	42.75	-11.25	54	30.19	27.47	15.91	30.82	353	92	A	V



802.11b CH 11 2462MHz	*	2462	112.67	-	-	100.09	27.53	15.88	30.83	202	134	P	H
	*	2462	109.66	-	-	97.08	27.53	15.88	30.83	202	134	A	H
		2485.52	53.87	-20.13	74	41.31	27.47	15.91	30.82	202	134	P	H
		2483.52	45.14	-8.86	54	32.58	27.47	15.91	30.82	202	134	A	H
													H
													H
	*	2462	110.89	-	-	98.31	27.53	15.88	30.83	199	91	P	V
	*	2462	107.84	-	-	95.26	27.53	15.88	30.83	199	91	A	V
		2486.72	53.64	-20.36	74	41.08	27.47	15.91	30.82	199	91	P	V
		2485.64	44.44	-9.56	54	31.88	27.47	15.91	30.82	199	91	A	V
													V
													V
Remark	1. No other spurious found. 2. All results are PASS against Peak and Average limit line.												



2.4GHz 2400~2483.5MHz

WIFI 802.11b (Harmonic @ 3m)

WIFI Ant. 1	Note	Frequency (MHz)	Level (dBμV/m)	Over Limit (dB)	Limit Line (dBμV/m)	Read Level (dBμV)	Antenna Factor (dB/m)	Path Loss (dB)	Preamp Factor (dB)	Ant Pos (cm)	Table Pos (deg)	Peak Avg. (P/A)	Pol. (H/V)
802.11b CH 01 2412MHz		4824	41.09	-32.91	74	59.35	31.3	8.5	58.06	100	0	P	H
													H
													H
													H
		4824	38.49	-35.51	74	56.75	31.3	8.5	58.06	100	0	P	V
													V
													V
802.11b CH 06 2437MHz		4874	40.1	-33.9	74	58.25	31.3	8.65	58.1	100	0	P	H
		7311	44.3	-29.7	74	55.17	36.2	11.27	58.34	100	0	P	H
													H
													H
		4874	38.67	-35.33	74	56.82	31.3	8.65	58.1	100	0	P	V
		7311	43.57	-30.43	74	54.44	36.2	11.27	58.34	100	0	P	V
													V
802.11b CH 11 2462MHz		4924	39.65	-34.35	74	57.62	31.37	8.8	58.14	100	0	P	H
		7386	44.77	-29.23	74	55.31	36.5	11.28	58.32	100	0	P	H
													H
													H
		4924	38.42	-35.58	74	56.39	31.37	8.8	58.14	100	0	P	V
		7386	44.31	-29.69	74	54.85	36.5	11.28	58.32	100	0	P	V
													V
Remark	1. No other spurious found.												
	2. All results are PASS against Peak and Average limit line.												



**2.4GHz 2400~2483.5MHz
WIFI 802.11g (Band Edge @ 3m)**

WIFI Ant. 1	Note	Frequency (MHz)	Level (dBμV/m)	Over Limit (dB)	Limit Line (dBμV/m)	Read Level (dBμV)	Antenna Factor (dB/m)	Path Loss (dB)	Preamp Factor (dB)	Ant Pos (cm)	Table Pos (deg)	Peak Avg. (P/A)	Pol. (H/V)	
802.11g CH 01 2412MHz		2389.59	64.74	-9.26	74	52.23	27.6	15.77	30.86	204	44	P	H	
		2389.905	52.54	-1.46	54	40.02	27.6	15.77	30.85	204	44	A	H	
	*	2412	110.95	-	-	98.39	27.6	15.81	30.85	204	44	P	H	
	*	2412	103.44	-	-	90.88	27.6	15.81	30.85	204	44	A	H	
													H	
													H	
			2389.38	63.5	-10.5	74	50.99	27.6	15.77	30.86	319	87	P	V
			2390	50.19	-3.81	54	37.66	27.6	15.78	30.85	319	87	A	V
	*		2412	107.3	-	-	94.74	27.6	15.81	30.85	319	87	P	V
	*		2412	99.89	-	-	87.33	27.6	15.81	30.85	319	87	A	V
													V	
													V	
802.11g CH 06 2437MHz		2389.94	56.9	-17.1	74	44.38	27.6	15.77	30.85	214	334	P	H	
		2389.52	47.42	-6.58	54	34.91	27.6	15.77	30.86	214	334	A	H	
	*	2437	114.72	-	-	102.12	27.6	15.84	30.84	214	334	P	H	
	*	2437	106.91	-	-	94.31	27.6	15.84	30.84	214	334	A	H	
			2484.46	54.15	-19.85	74	41.59	27.47	15.91	30.82	214	334	P	H
			2484.6	45.24	-8.76	54	32.68	27.47	15.91	30.82	214	334	A	H
			2389.24	55.36	-18.64	74	42.85	27.6	15.77	30.86	356	91	P	V
			2389.52	46.1	-7.9	54	33.59	27.6	15.77	30.86	356	91	A	V
	*		2437	112.19	-	-	99.59	27.6	15.84	30.84	356	91	P	V
	*		2437	104.56	-	-	91.96	27.6	15.84	30.84	356	91	A	V
			2484.39	55.09	-18.91	74	42.53	27.47	15.91	30.82	356	91	P	V
			2485.37	45.74	-8.26	54	33.18	27.47	15.91	30.82	356	91	A	V



802.11g CH 11 2462MHz	*	2462	110.02	-	-	97.44	27.53	15.88	30.83	204	46	P	H
	*	2462	102.32	-	-	89.74	27.53	15.88	30.83	204	46	A	H
		2483.92	63.41	-10.59	74	50.85	27.47	15.91	30.82	204	46	P	H
		2483.56	52.81	-1.19	54	40.25	27.47	15.91	30.82	204	46	A	H
													H
													H
	*	2462	107.99	-	-	95.41	27.53	15.88	30.83	199	83	P	V
	*	2462	100.29	-	-	87.71	27.53	15.88	30.83	199	83	A	V
		2483.68	63.37	-10.63	74	50.81	27.47	15.91	30.82	199	83	P	V
		2483.52	52.17	-1.83	54	39.61	27.47	15.91	30.82	199	83	A	V
													V
													V
Remark	1. No other spurious found. 2. All results are PASS against Peak and Average limit line.												



2.4GHz 2400~2483.5MHz

WIFI 802.11g (Harmonic @ 3m)

WIFI Ant. 1	Note	Frequency (MHz)	Level (dBμV/m)	Over Limit (dB)	Limit Line (dBμV/m)	Read Level (dBμV)	Antenna Factor (dB/m)	Path Loss (dB)	Preamp Factor (dB)	Ant Pos (cm)	Table Pos (deg)	Peak Avg. (P/A)	Pol. (H/V)	
802.11g CH 01 2412MHz		4824	38.28	-35.72	74	56.54	31.3	8.5	58.06	100	0	P	H	
													H	
													H	
													H	
			4824	37.91	-36.09	74	56.17	31.3	8.5	58.06	100	0	P	V
														V
														V
802.11g CH 06 2437MHz		4874	38	-36	74	56.15	31.3	8.65	58.1	100	0	P	H	
		7311	43.84	-30.16	74	54.71	36.2	11.27	58.34	100	0	P	H	
													H	
													H	
			4874	38.74	-35.26	74	56.89	31.3	8.65	58.1	100	0	P	V
			7311	44.1	-29.9	74	54.97	36.2	11.27	58.34	100	0	P	V
														V
802.11g CH 11 2462MHz		4924	38.9	-35.1	74	56.87	31.37	8.8	58.14	100	0	P	H	
		7386	44.21	-29.79	74	54.75	36.5	11.28	58.32	100	0	P	H	
													H	
													H	
			4924	38.44	-35.56	74	56.41	31.37	8.8	58.14	100	0	P	V
			7386	44.73	-29.27	74	55.27	36.5	11.28	58.32	100	0	P	V
														V
Remark	1. No other spurious found.													
	2. All results are PASS against Peak and Average limit line.													