



FCC RADIO TEST REPORT

FCC ID : UZ7RTL10B1
Equipment : Tablet
Brand Name : Zebra
Model Name : RTL10B1
Applicant : Zebra Technologies Corporation
1 Zebra Plaza, Holtsville, NY 11742
Manufacturer : Zebra Technologies Corporation
1 Zebra Plaza, Holtsville, NY 11742
Standard : FCC Part 15 Subpart C §15.247

The product was received on Feb. 22, 2019 and testing was started from Mar. 24, 2019 and completed on Apr. 12, 2019. We, SPORTON INTERNATIONAL INC., EMC & Wireless Communications Laboratory, would like to declare that the tested sample has been evaluated in accordance with the test procedures and has been in compliance with the applicable technical standards.

The report must not be used by the client to claim product certification, approval, or endorsement by TAF or any agency of government.

The test results in this report apply exclusively to the tested model / sample. Without written approval of SPORTON INTERNATIONAL INC. EMC & Wireless Communications Laboratory, the test report shall not be reproduced except in full.

Approved by: Jones Tsai

SPORTON INTERNATIONAL INC. EMC & Wireless Communications Laboratory
No. 52, Huaya 1st Rd., Guishan Dist., Taoyuan City, Taiwan (R.O.C.)



Table of Contents

History of this test report.....	3
Summary of Test Result.....	4
1 General Description.....	5
1.1 Product Feature of Equipment Under Test.....	5
1.2 Product Specification of Equipment Under Test.....	6
1.3 Modification of EUT	6
1.4 Testing Location	7
1.5 Applicable Standards.....	7
2 Test Configuration of Equipment Under Test.....	8
2.1 Carrier Frequency Channel	8
2.2 Test Mode.....	9
2.3 Connection Diagram of Test System.....	11
2.4 Support Unit used in test configuration and system	12
2.5 EUT Operation Test Setup	12
2.6 Measurement Results Explanation Example.....	13
3 Test Result.....	14
3.1 6dB and 99% Bandwidth Measurement	14
3.2 Output Power Measurement.....	23
3.3 Power Spectral Density Measurement	25
3.4 Conducted Band Edges and Spurious Emission Measurement	33
3.5 Radiated Band Edges and Spurious Emission Measurement	42
3.6 AC Conducted Emission Measurement.....	46
3.7 Antenna Requirements.....	48
4 List of Measuring Equipment	49
5 Uncertainty of Evaluation.....	51
Appendix A. AC Conducted Emission Test Result	
Appendix B. Radiated Spurious Emission	
Appendix C. Radiated Spurious Emission Plots	
Appendix D. Duty Cycle Plots	
Appendix E. Setup Photographs	



Summary of Test Result

Report Clause	Ref Std. Clause	Test Items	Result (PASS/FAIL)	Remark
3.1	15.247(a)(2)	6dB Bandwidth	Pass	-
3.1	2.1049	99% Occupied Bandwidth	Reporting only	-
3.2	15.247(b)(3)	Output Power	Pass	-
3.3	15.247(e)	Power Spectral Density	Pass	-
3.4	15.247(d)	Conducted Band Edges and Spurious Emission	Pass	-
3.5	15.247(d)	Radiated Band Edges and Spurious Emission	Pass	Under limit 7.41 dB at 2347.275 MHz
3.6	15.207	AC Conducted Emission	Pass	Under limit 5.67 dB at 13.560 MHz
3.7	15.203 & 15.247(b)	Antenna Requirement	Pass	-

Declaration of Conformity:

The test results with all measurement uncertainty excluded are presented in accordance with the regulation limits or requirements declared by manufacturers.

Comments and Explanations:

The declared of product specification for EUT presented in the report are provided by the manufacturer, and the manufacturer takes all the responsibilities for the accuracy of product specification.

Reviewed by: Wii Chang

Report Producer: Aileen Huang



1 General Description

1.1 Product Feature of Equipment Under Test

Product Feature	
Equipment	Tablet
Brand Name	Zebra
Model Name	RTL10B1
FCC ID	UZ7RTL10B1
Sample 1	EUT with SKU 1 + Keyboard
Sample 2	EUT with SKU 1
Sample 3	EUT with SKU 2
Sample 4	EUT with SKU 3
Sample 5	EUT with SKU 4
EUT supports Radios application	WCDMA/HSPA/LTE/NFC/GNSS WLAN 11a/b/g/n HT20/HT40 WLAN 11ac VHT20/VHT40/VHT80 Bluetooth BR/EDR/LE
HW Version	DV0
SW Version	Android version 8.1.0
FW Version - Xpad	01-17-09.00-OG-U00-PLT
FW Version - Xslate	01-17-05.00-OG-U00-PRD
FW Version - Xbook	01-17-05.00-OG-U00-PRD
MFD - Xpad	19MAR01
MFD - Xslate	19MAR01
MFD - Xbook	19MAR01
EUT Stage	Identical Prototype

Remark: The above EUT's information was declared by manufacturer.

Specification of Accessories				
AC Adapter	Brand Name	Delta	Model Name	ADP-65JH HB
Spare Standard Battery 36Whr	Brand Name	XPLORE	Model Name	XLBM1
Keyboard dock	Brand Name	XPLORE	Model Name	LX-KB
Touch Pen	Brand Name	WACOM	Model Name	CP-903-05B-2
Touch Pen	Brand Name	EMPIA	Model Name	EPNB-8C1000-0000 40820A01
Touch Pen	Brand Name	HAO SHUAN	Model Name	440007

<Sample Information>

	Sample 1	Sample 2	Sample 3	Sample 4	Sample 5
DV0	SKU 1+ Keyboard	L10A - SKU1	L10A - SKU2	L10A - SKU3	L10A - SKU4
ID	Xbook	XSLATE	XPAD	XPAD	XPAD
OS	Refer Xslate	Android O	Android O	Android O	Android O
CPU		Qualcomm SDM660	Qualcomm SDM660	Qualcomm SDM660	Qualcomm SDM660
Display with touch		Panasonic EP101R1912N500 TG 10.1" LCD (500nits)	Panasonic EP101R1912N500 TG 10.1" LCD (500nits)	Panasonic EP101R1912N500 TG 10.1" LCD (1000nits)	Panasonic EP101R1912N500 TG 10.1" LCD (1000nits) with digitizer
Memory		Samsung LPDDR4 4GB Hynix LPDD4 4 GB	Samsung LPDDR4 4GB Hynix LPDD4 4 GB	Samsung LPDDR4 4GB Micron LPDD4 4 GB	Samsung LPDDR4 4GB Micron LPDD4 4 GB
eMMC		TOSHIBA 64GB	TOSHIBA 64GB	TOSHIBA 64GB	TOSHIBA 64GB
GPS		Qualcomm	Qualcomm	Qualcomm	Qualcomm
WWAN		Qualcomm	Qualcomm	Qualcomm	Qualcomm
WLAN		Qualcomm WCN3990	Qualcomm WCN3990	Qualcomm WCN3990	Qualcomm WCN3990
Antenna		WLAN*2/NFC /GPS/WWAN*2	WLAN*2/NFC /GPS/WWAN*2	WLAN*2/NFC /GPS/WWAN*2	WLAN*2/NFC /GPS/WWAN*2
Barcode Reader		No	Yes	Yes	Yes
HDMI		No	No	Yes	No
Serial Port		No	Yes	No	No

1.2 Product Specification of Equipment Under Test

Standards-related Product Specification	
Tx/Rx Frequency Range	2402 MHz ~ 2480 MHz
Number of Channels	40
Carrier Frequency of Each Channel	40 Channel(37 hopping + 3 advertising channel)
Maximum Output Power to Antenna	2.20 dBm (0.0017 W) for 1Mbps 2.20 dBm (0.0017 W) for 2Mbps
99% Occupied Bandwidth	1.270 MHz for 1Mbps 2.038 MHz for 2Mbps
Antenna Type / Gain	PIFA Antenna type with gain -0.21 dBi
Type of Modulation	Bluetooth LE : GFSK

1.3 Modification of EUT

No modifications are made to the EUT during all test items.



1.4 Testing Location

Test Site	SPORTON INTERNATIONAL INC.	
Test Site Location	No.52, Huaya 1st Rd., Guishan Dist., Taoyuan City, Taiwan (R.O.C.) TEL: +886-3-327-3456 FAX: +886-3-328-4978	
Test Site No.	Sporton Site No.	
	TH02-HY	CO05-HY

Note: The test site complies with ANSI C63.4 2014 requirement.

Test Site	SPORTON INTERNATIONAL INC.	
Test Site Location	No.58, Aly. 75, Ln. 564, Wenhua 3rd, Rd., Guishan Dist., Taoyuan City, Taiwan (R.O.C.) TEL: +886-3-327-0868 FAX: +886-3-327-0855	
Test Site No.	Sporton Site No.	
	03CH15-HY	

Note: The test site complies with ANSI C63.4 2014 requirement.

FCC designation No.: TW1190 and TW0007

1.5 Applicable Standards

According to the specifications of the manufacturer, the EUT must comply with the requirements of the following standards:

- ♦ FCC Part 15 Subpart C §15.247
- ♦ FCC KDB Publication No. 558074 D01 DTS Meas. Guidance v05r02
- ♦ FCC KDB 414788 D01 Radiated Test Site v01r01
- ♦ ANSI C63.10-2013

Remark:

1. All test items were verified and recorded according to the standards and without any deviation during the test.
2. This EUT has also been tested and complied with the requirements of FCC Part 15, Subpart B, recorded in a separate test report.



2 Test Configuration of Equipment Under Test

2.1 Carrier Frequency Channel

Frequency Band	Channel	Freq. (MHz)	Channel	Freq. (MHz)
2400-2483.5 MHz	0	2402	21	2444
	1	2404	22	2446
	2	2406	23	2448
	3	2408	24	2450
	4	2410	25	2452
	5	2412	26	2454
	6	2414	27	2456
	7	2416	28	2458
	8	2418	29	2460
	9	2420	30	2462
	10	2422	31	2464
	11	2424	32	2466
	12	2426	33	2468
	13	2428	34	2470
	14	2430	35	2472
	15	2432	36	2474
	16	2434	37	2476
	17	2436	38	2478
	18	2438	39	2480
	19	2440	-	-
20	2442	-	-	



2.2 Test Mode

Channel	Frequency	Bluetooth – LE 1Mbps RF Average Output Power	
		Data Rate / Modulation	
		GFSK	
		1Mbps	
Ch00	2402MHz	2.20 dBm	
Ch19	2440MHz	1.80 dBm	
Ch39	2480MHz	1.50 dBm	

Channel	Frequency	Bluetooth – LE 2Mbps RF Average Output Power	
		Data Rate / Modulation	
		GFSK	
		2Mbps	
Ch00	2402MHz	2.20 dBm	
Ch19	2440MHz	1.80 dBm	
Ch39	2480MHz	1.50 dBm	

- a. The EUT has been associated with peripherals and configuration operated in a manner tended to maximize its emission characteristics in a typical application. Frequency range investigated: conduction emission (150 kHz to 30 MHz), radiation emission (9 kHz to the 10th harmonic of the highest fundamental frequency or to 40 GHz, whichever is lower). For radiated measurement, pre-scanned in three orthogonal panels, X, Y, Z. The worst cases (X plane) were recorded in this report.

- b. AC power line Conducted Emission was tested under maximum output power.



The following summary table is showing all test modes to demonstrate in compliance with the standard.

Summary table of Test Cases	
Test Item	Data Rate / Modulation
	Bluetooth – LE / GFSK
Conducted Test Cases	Mode 1: Bluetooth Tx CH00_2402 MHz_1Mbps Mode 2: Bluetooth Tx CH19_2440 MHz_1Mbps Mode 3: Bluetooth Tx CH39_2480 MHz_1Mbps Mode 4: Bluetooth Tx CH00_2402 MHz_2Mbps Mode 5: Bluetooth Tx CH19_2440 MHz_2Mbps Mode 6: Bluetooth Tx CH39_2480 MHz_2Mbps
Radiated Test Cases	Mode 1: Bluetooth Tx CH00_2402 MHz_1Mbps Mode 2: Bluetooth Tx CH19_2440 MHz_1Mbps Mode 3: Bluetooth Tx CH39_2480 MHz_1Mbps Mode 4: Bluetooth Tx CH00_2402 MHz_2Mbps Mode 5: Bluetooth Tx CH19_2440 MHz_2Mbps Mode 6: Bluetooth Tx CH39_2480 MHz_2Mbps
AC Conducted Emission	Mode 1: LTE Band 12 Idle + WLAN (2.4GHz) Link + Bluetooth Link + NFC Idle + Bar Code Scanner + AC Adapter + USB (Type C) with LCD Monitor + SD Card (Data Link) (eMMC to SD Card) + RJ45 Load with AP + Touch Pen (CP-903-05B-2) + HDMI in with Notebook for Sample 4
Remark: 1. For Radiated Test Cases, the tests were performed with Sample 2. 2. Data Link with Notebook means data application transferred mode between EUT and Notebook. 3. HDMI Cable means media application transferred between EUT and external display.	

2.3 Connection Diagram of Test System

<Bluetooth – LE Tx Mode>

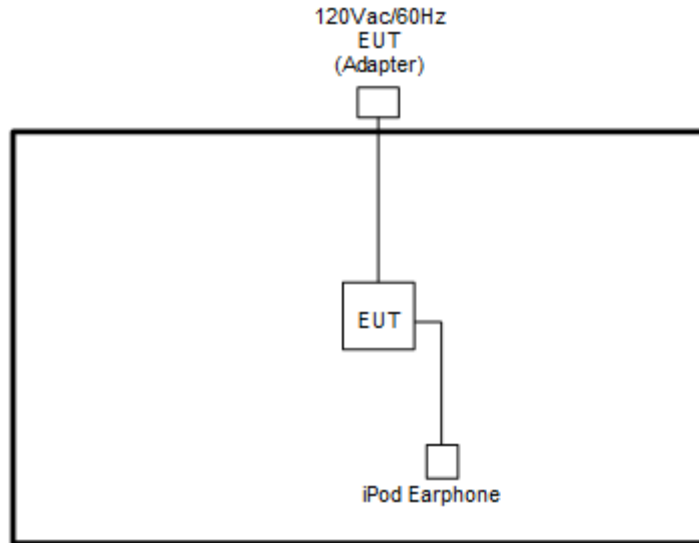

<AC Conducted Emission Mode>

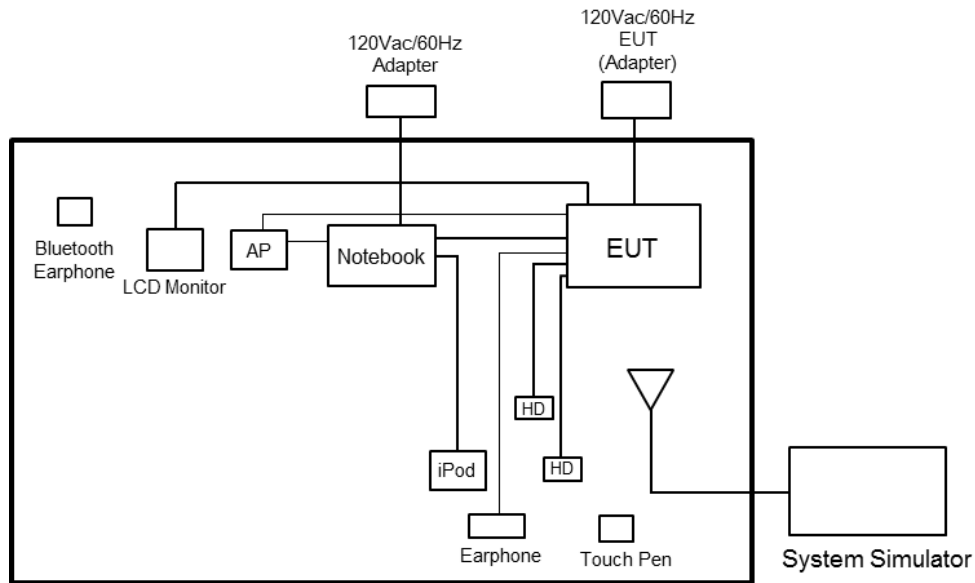

2.4 Support Unit used in test configuration and system

Item	Equipment	Trade Name	Model Name	FCC ID	Data Cable	Power Cord
1.	System Simulator	Anritsu	MT8820C	N/A	N/A	Unshielded, 1.8 m
2.	WLAN AP	TP-Link	Archer7	N/A	N/A	Unshielded, 1.8 m
3.	Notebook	DELL	Latitude E3340	FCC DoC/ Contains FCC ID: PD97260NGU	N/A	AC I/P: Unshielded, 1.2 m DC O/P: Shielded, 1.8 m
4.	LCD Monitor	DELL	U2715Qt	FCC DoC	Shielded, 1.6 m	Unshielded, 1.8 m
5.	Bluetooth Earphone	Sony Ericsson	SBH20	PY7-RD0010	N/A	N/A
6.	Bluetooth Earphone	Sony Ericsson	MW600	PY7DDA-2029	N/A	N/A
7.	iPod	Apple	A1285	FCC DoC	Shielded, 1.0 m	N/A
8.	iPod Earphone	Apple	N/A	Verification	Unshielded, 1.0 m	N/A
9.	USB HD	Lenovo	F310S	FCC DoC	Shielded, 0.5 m	N/A
10.	USB HD	SONY	HD-EG5	FCC DoC	Shielded, 0.5 m	N/A
11.	SD Card	SanDisk	MicroSD HC	FCC DoC	N/A	N/A

2.5 EUT Operation Test Setup

The RF test items, utility “QRCT” was installed in Notebook which was programmed in order to make the EUT get into the engineering modes to provide channel selection, power level, data rate and the application type and for continuous transmitting signals.



2.6 Measurement Results Explanation Example

For all conducted test items:

The offset level is set in the spectrum analyzer to compensate the RF cable loss and attenuator factor between EUT conducted output port and spectrum analyzer. With the offset compensation, the spectrum analyzer reading level is exactly the EUT RF output level.

Example :

The spectrum analyzer offset is derived from RF cable loss and attenuator factor.

Offset = RF cable loss + attenuator factor.

Following shows an offset computation example with cable loss 4.2 dB and 10dB attenuator.

$$\begin{aligned} \text{Offset(dB)} &= \text{RF cable loss(dB)} + \text{attenuator factor(dB)}. \\ &= 4.2 + 10 = 14.2 \text{ (dB)} \end{aligned}$$

3 Test Result

3.1 6dB and 99% Bandwidth Measurement

3.1.1 Limit of 6dB and 99% Bandwidth

The minimum 6 dB bandwidth shall be at least 500 kHz.

3.1.2 Measuring Instruments

See list of measuring equipment of this test report.

3.1.3 Test Procedures

1. The testing follows the ANSI C63.10 Section 6.9.3 (OBW) and 11.8.1 (6dB BW).
2. The RF output of EUT was connected to the spectrum analyzer by RF cable and attenuator. The path loss was compensated to the results for each measurement.
3. Set to the maximum power setting and enable the EUT transmit continuously.
4. Make the measurement with the spectrum analyzer's resolution bandwidth (RBW) = 100 kHz. Set the Video bandwidth (VBW) = 300 kHz. In order to make an accurate measurement. The 6 dB bandwidth must be greater than 500 kHz.
5. For 99% Bandwidth Measurement, the spectrum analyzer's resolution bandwidth (RBW) is set 1-5% of the emission bandwidth and set the Video bandwidth (VBW) $\geq 3 * RBW$.
6. Measure and record the results in the test report.

3.1.4 Test Setup

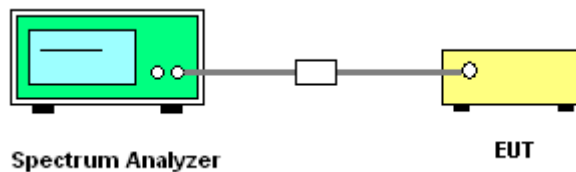



3.1.5 Test Result of 6dB Bandwidth

Test Engineer :	Aking Chang	Temperature :	21~25°C
		Relative Humidity :	51~54%

Mod.	Data Rate	NTX	CH.	Freq. (MHz)	6dB BW (MHz)	6dB BW Limit (MHz)	Pass/Fail
BLE	1Mbps	1	0	2402	0.663	0.50	Pass
BLE	1Mbps	1	19	2440	0.665	0.50	Pass
BLE	1Mbps	1	39	2480	0.665	0.50	Pass
BLE	2Mbps	1	0	2402	1.143	0.50	Pass
BLE	2Mbps	1	19	2440	1.151	0.50	Pass
BLE	2Mbps	1	39	2480	1.151	0.50	Pass

<1 Mbps>

6 dB Bandwidth Plot on Channel 00

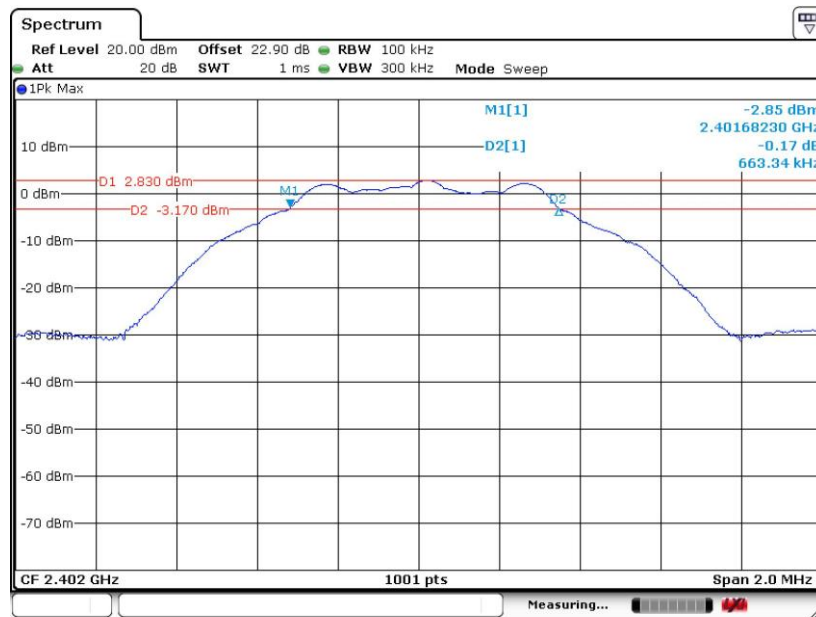

Date: 10.APR.2019 01:18:27



6 dB Bandwidth Plot on Channel 19

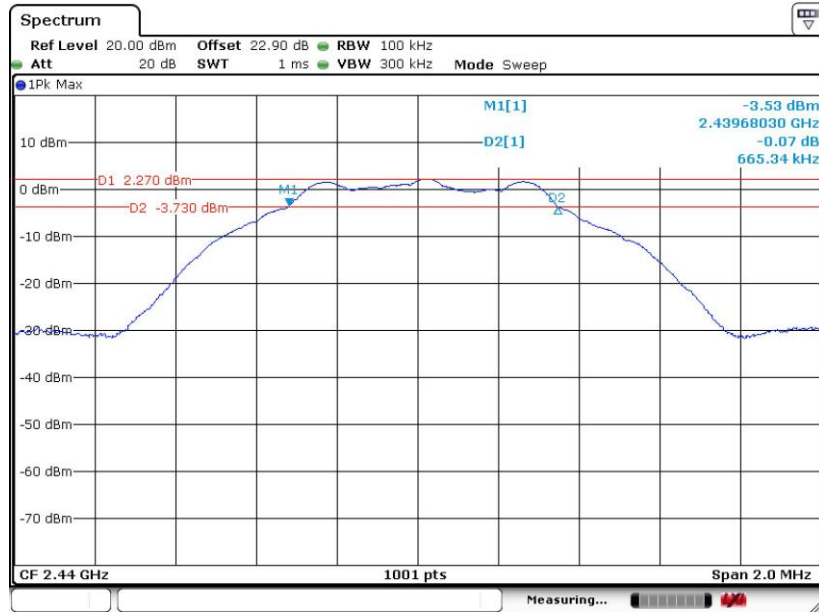

Date: 10.APR.2019 01:21:25

6 dB Bandwidth Plot on Channel 39

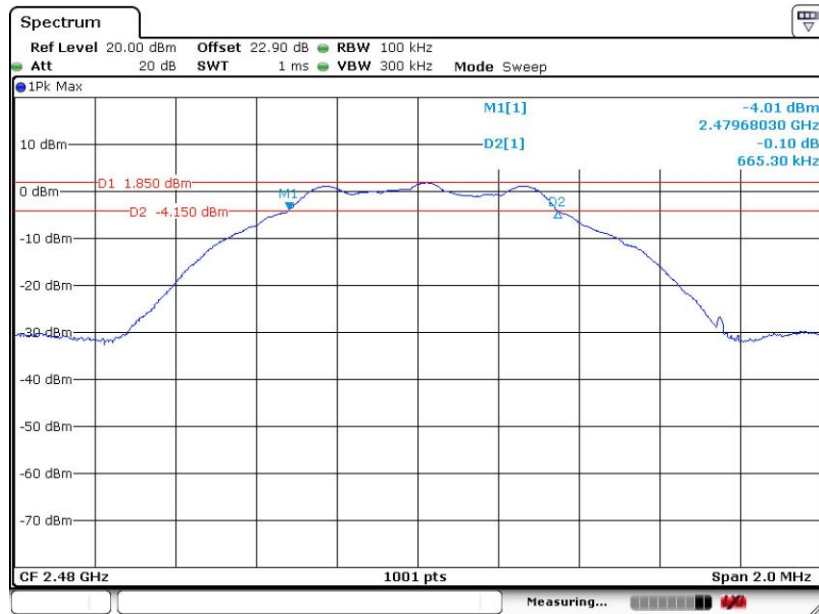

Date: 10.APR.2019 01:24:40



<2 Mbps>

6 dB Bandwidth Plot on Channel 00

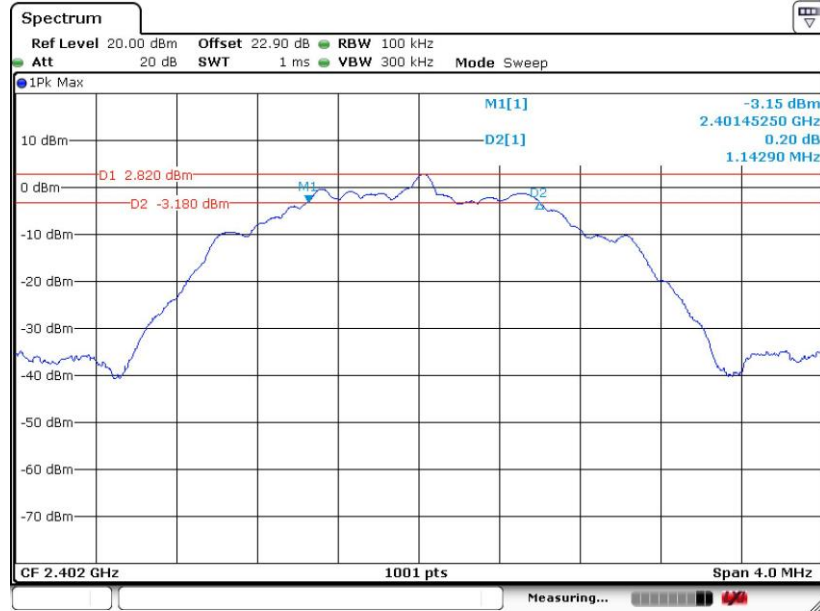

Date: 10.APR.2019 01:26:56

6 dB Bandwidth Plot on Channel 19

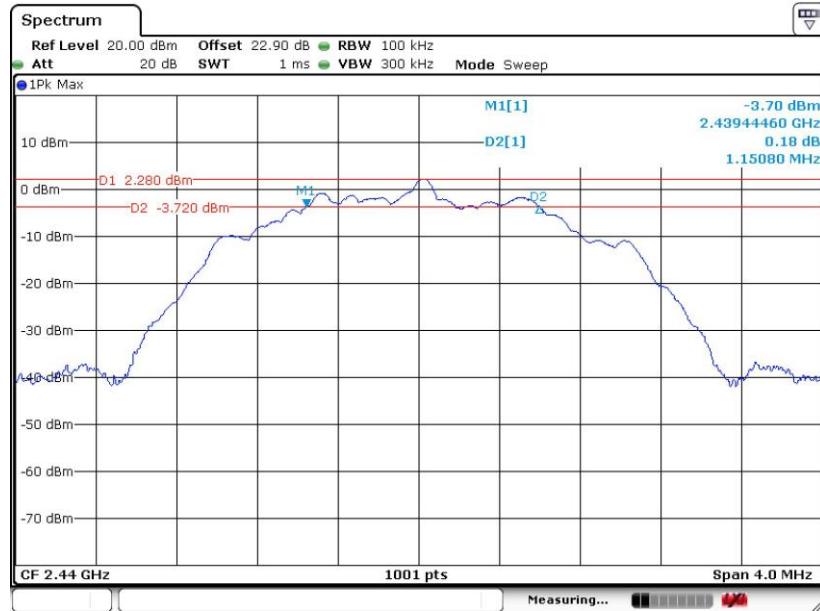

Date: 10.APR.2019 01:29:11



6 dB Bandwidth Plot on Channel 39

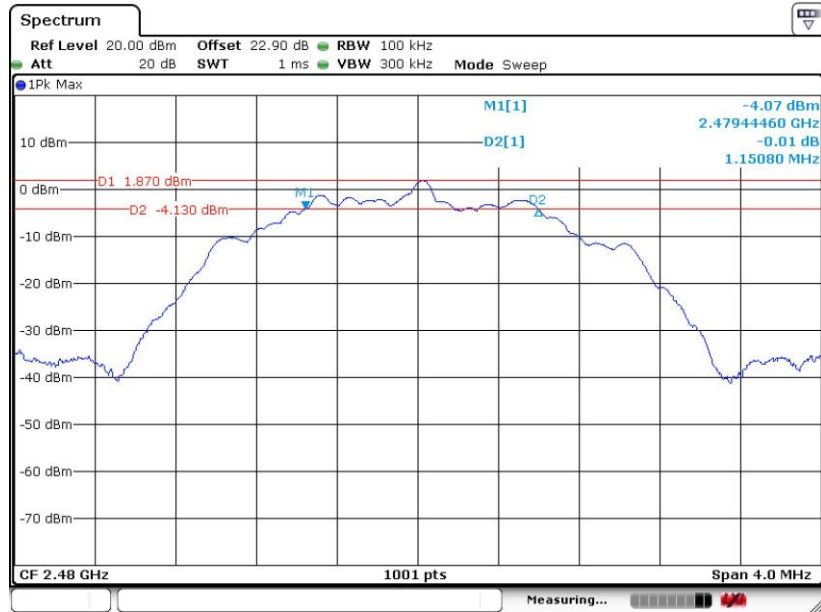

Date: 10.APR.2019 01:30:59



3.1.6 Test Result of 99% Occupied Bandwidth

Test Engineer :	Aking Chang	Temperature :	21~25°C
		Relative Humidity :	51~54%

Mod.	Data Rate	NTX	CH.	Freq. (MHz)	99% Occupied BW (MHz)	Pass/Fail
BLE	1Mbps	1	0	2402	1.025	Pass
BLE	1Mbps	1	19	2440	1.027	Pass
BLE	1Mbps	1	39	2480	1.270	Pass
BLE	2Mbps	1	0	2402	2.034	Pass
BLE	2Mbps	1	19	2440	2.034	Pass
BLE	2Mbps	1	39	2480	2.038	Pass

<1 Mbps>

99% Bandwidth Plot on Channel 00

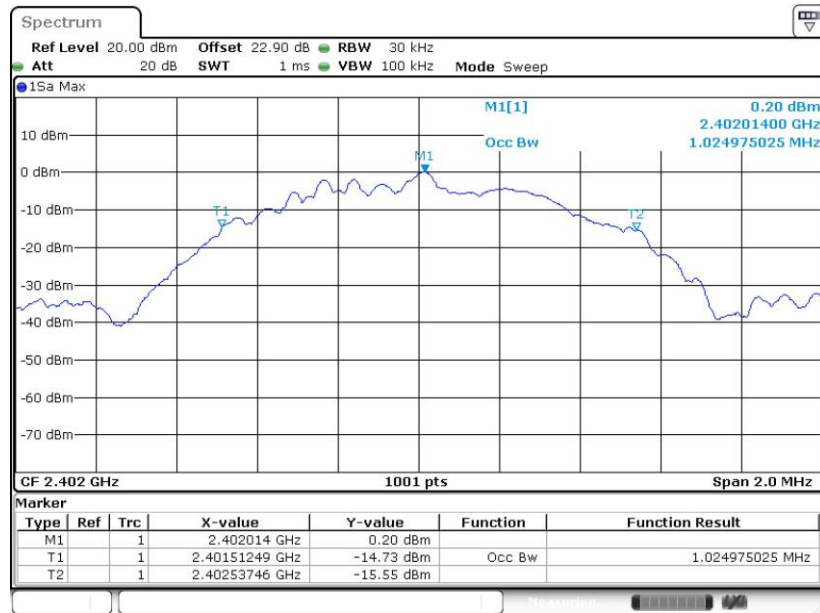

Date: 10.APR.2019 01:20:19



99% Occupied Bandwidth Plot on Channel 19

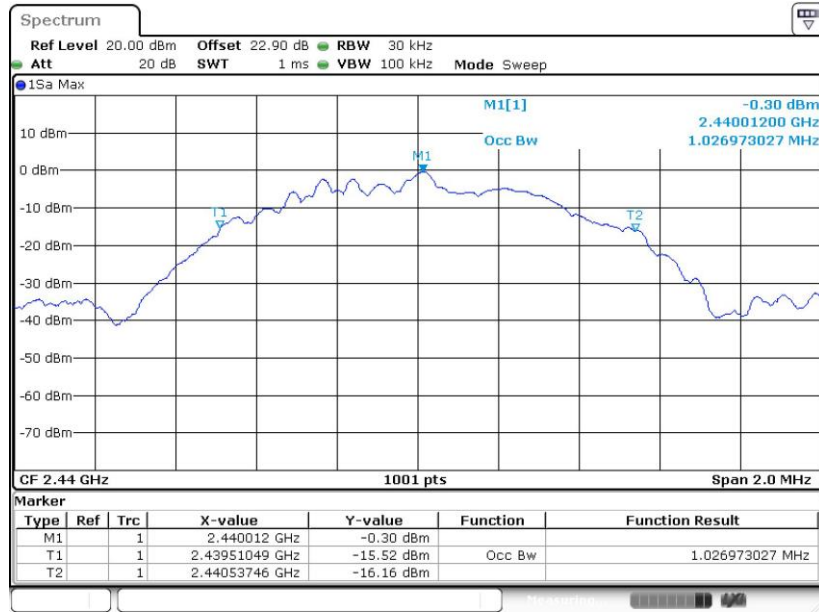

Date: 10.APR.2019 01:22:35

99% Occupied Bandwidth Plot on Channel 39

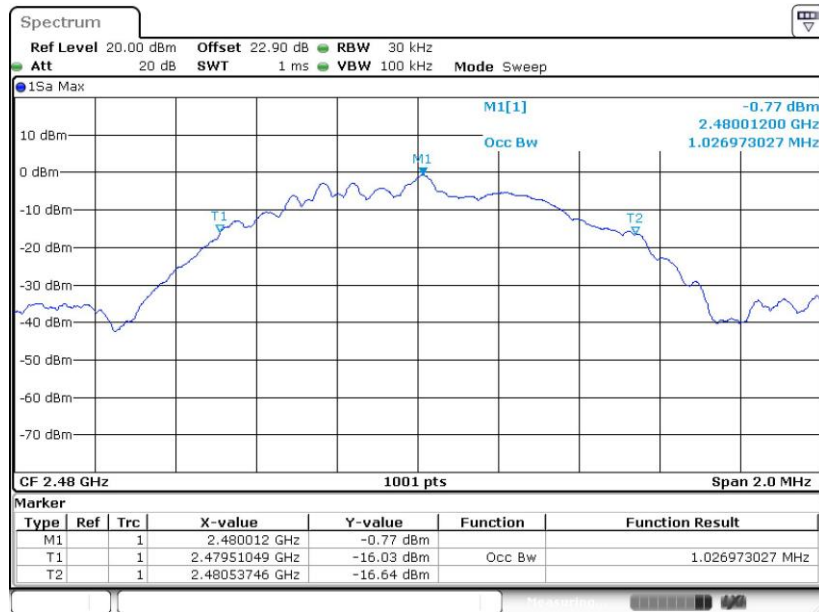

Date: 10.APR.2019 01:25:50



<2 Mbps>

99% Bandwidth Plot on Channel 00

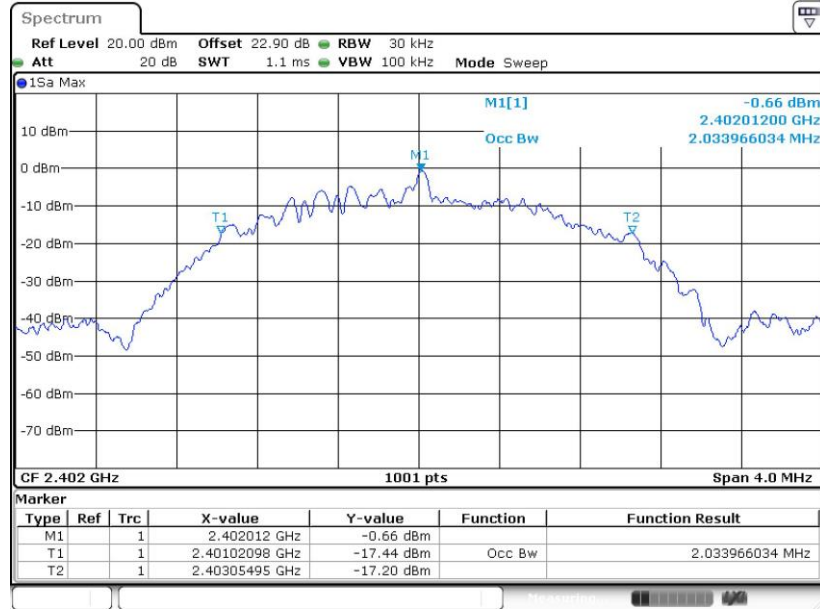

Date: 10.APR.2019 01:28:24

99% Occupied Bandwidth Plot on Channel 19

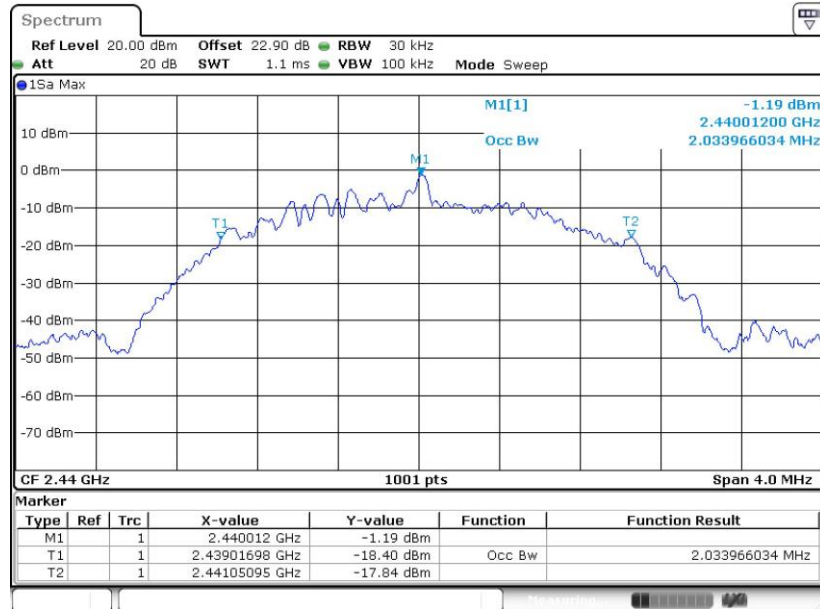

Date: 10.APR.2019 01:30:11



99% Occupied Bandwidth Plot on Channel 39

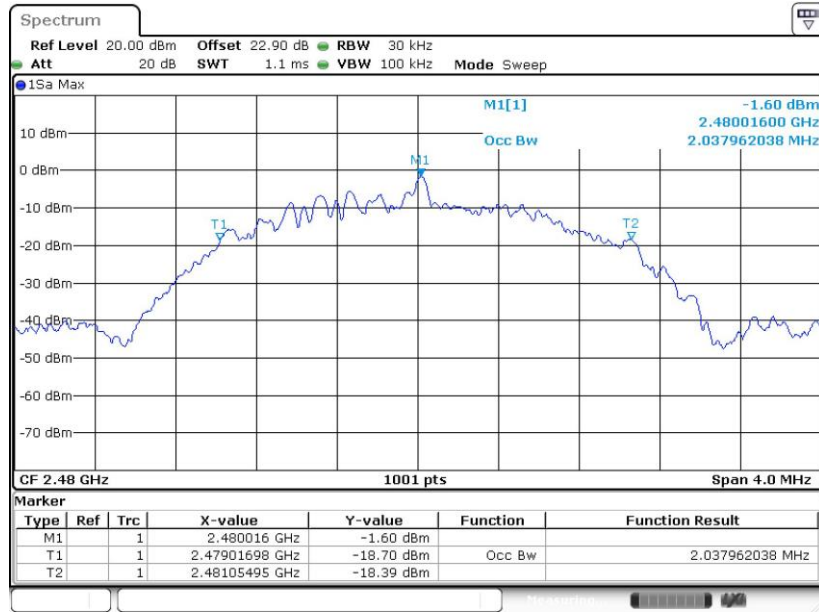

Date: 10.APR.2019 01:32:26

Note: The occupied channel bandwidth is maintained within the band of operation for all of the modulations.

3.2 Output Power Measurement

3.2.1 Limit of Output Power

For systems using digital modulation in the 2400-2483.5MHz, the limit for peak output power is 30dBm. If transmitting antenna of directional gain greater than 6dBi is used, the peak output power from the intentional radiator shall be reduced below the above stated value by the amount in dB that the directional gain of the antenna exceeds 6 dBi. In case of point-to-point operation, the limit has to be reduced by 1dB for every 3dB that the directional gain of the antenna exceeds 6dBi.

3.2.2 Measuring Instruments

See list of measuring equipment of this test report.

3.2.3 Test Procedures

1. For Average Power, the testing follows ANSI C63.10 Section 11.9.2.3.2 Method AVGPM-G
2. The RF output of EUT was connected to the power meter by RF cable and attenuator. The path loss was compensated to the results for each measurement.
3. Set to the maximum power setting and enable the EUT transmit continuously.
4. Measure the conducted output power and record the results in the test report.

3.2.4 Test Setup

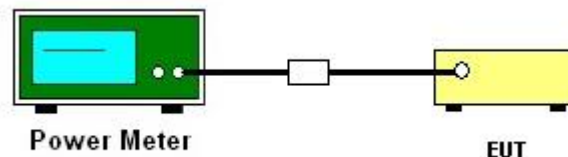



3.2.5 Test Result of Average Output Power

Test Engineer :	Aking Chang	Temperature :	21~25°C
		Relative Humidity :	51~54%

Mod.	Data Rate	NTX	CH.	Freq. (MHz)	Average Conducted Power (dBm)	Conducted Power Limit (dBm)	DG (dBi)	EIRP Power (dBm)	EIRP Power Limit (dBm)	Pass /Fail
BLE	1Mbps	1	0	2402	2.20	30.00	-0.21	1.99	36.00	Pass
BLE	1Mbps	1	19	2440	1.80	30.00	-0.21	1.59	36.00	Pass
BLE	1Mbps	1	39	2480	1.50	30.00	-0.21	1.29	36.00	Pass
BLE	2Mbps	1	0	2402	2.20	30.00	-0.21	1.99	36.00	Pass
BLE	2Mbps	1	19	2440	1.80	30.00	-0.21	1.59	36.00	Pass
BLE	2Mbps	1	39	2480	1.50	30.00	-0.21	1.29	36.00	Pass

3.3 Power Spectral Density Measurement

3.3.1 Limit of Power Spectral Density

The peak power spectral density shall not be greater than 8dBm in any 3kHz band at any time interval of continuous transmission.

3.3.2 Measuring Instruments

See list of measuring equipment of this test report.

3.3.3 Test Procedures

1. The testing follows the ANSI C63.10 Section 11.10.2 Method PKPSD.
2. The RF output of EUT was connected to the spectrum analyzer by RF cable and attenuator. The path loss was compensated to the results for each measurement.
3. Set to the maximum power setting and enable the EUT transmit continuously.
4. Make the measurement with the spectrum analyzer's resolution bandwidth (RBW) = 3 kHz. Video bandwidth VBW = 10 kHz In order to make an accurate measurement, set the span to 1.5 times DTS Channel Bandwidth. (6dB BW)
5. Detector = peak, Sweep time = auto couple, Trace mode = max hold, Allow trace to fully stabilize. Use the peak marker function to determine the maximum power level.
6. Measure and record the results in the test report.
7. The Measured power density (dBm)/ 100kHz is a reference level and used as 20dBc down limit line for Conducted Band Edges and Conducted Spurious Emission.

3.3.4 Test Setup

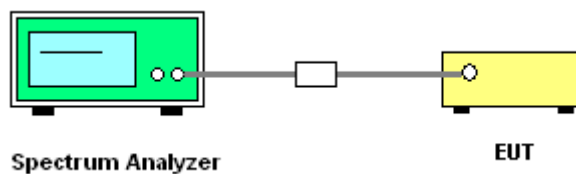



3.3.5 Test Result of Power Spectral Density

Test Engineer :	Aking Chang	Temperature :	21~25°C
		Relative Humidity :	51~54%

Mod.	Data Rate	NTX	CH.	Freq. (MHz)	Peak PSD (dBm /100kHz)	Peak PSD (dBm /3kHz)	DG (dBi)	Peak PSD Limit (dBm /3kHz)	Pass/Fail
BLE	1Mbps	1	0	2402	2.82	-11.7	-0.21	8.00	Pass
BLE	1Mbps	1	19	2440	2.29	-12.14	-0.21	8.00	Pass
BLE	1Mbps	1	39	2480	1.86	-12.67	-0.21	8.00	Pass
BLE	2Mbps	1	0	2402	2.79	-15.36	-0.21	8.00	Pass
BLE	2Mbps	1	19	2440	2.25	-15.87	-0.21	8.00	Pass
BLE	2Mbps	1	39	2480	1.84	-16.34	-0.21	8.00	Pass

3.3.6 Test Result of Power Spectral Density Plots (100kHz)

Test Engineer :	Aking Chang	Temperature :	21~25°C
		Relative Humidity :	51~54%

<1 Mbps>

PSD 100kHz Plot on Channel 00

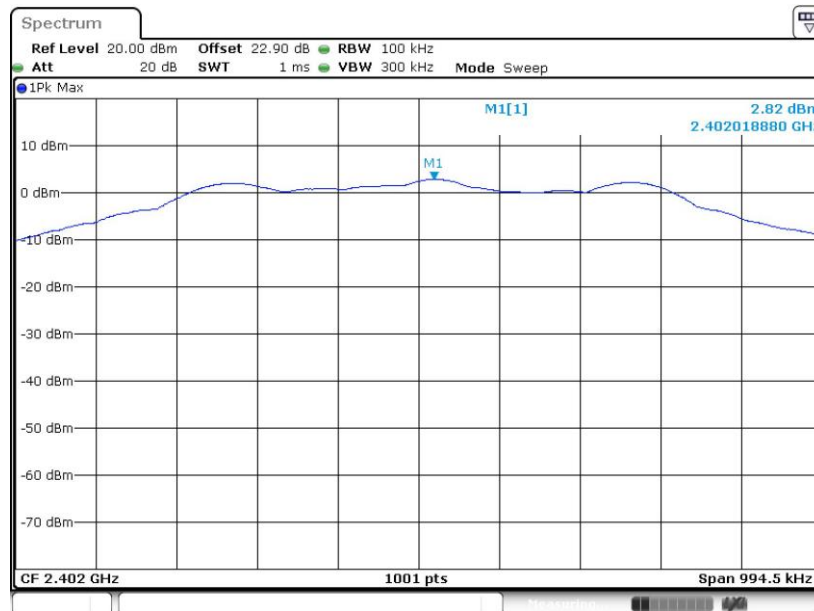

Date: 10.APR.2019 01:18:56



PSD 100kHz Plot on Channel 19

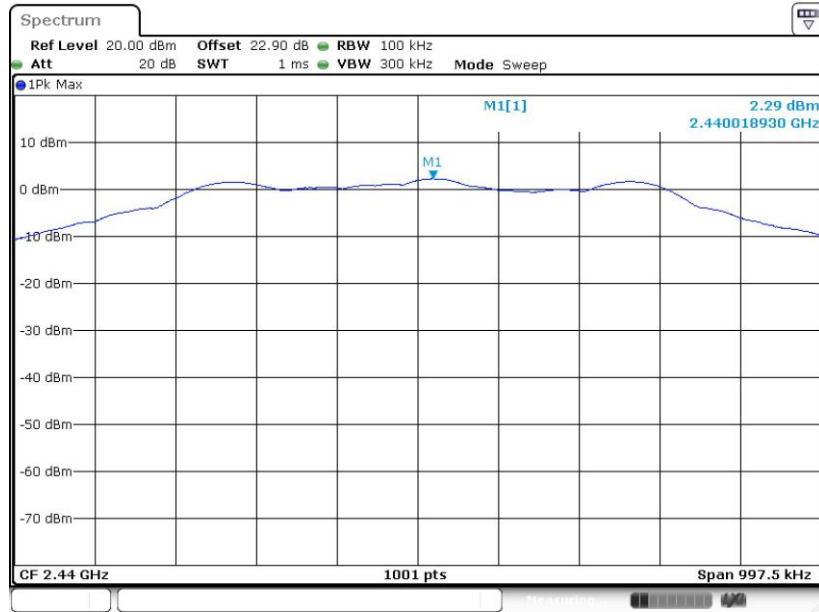

Date: 10.APR.2019 01:21:52

PSD 100kHz Plot on Channel 39

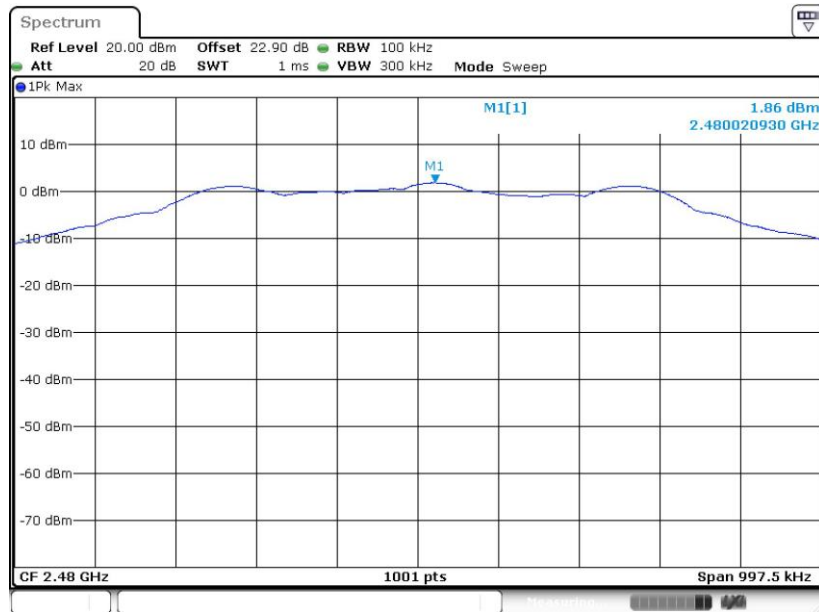

Date: 10.APR.2019 01:25:04



<2 Mbps>

PSD 100kHz Plot on Channel 00

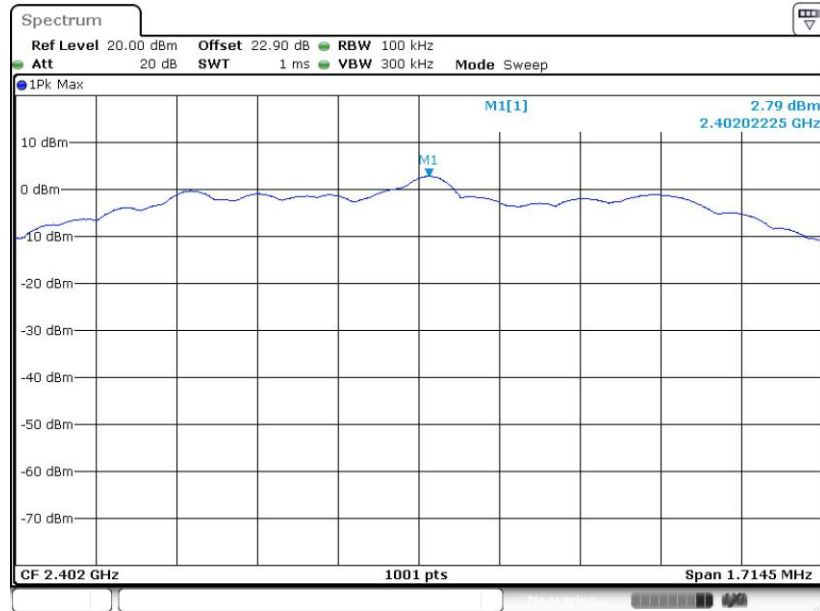

Date: 10.APR.2019 01:27:18

PSD 100kHz Plot on Channel 19

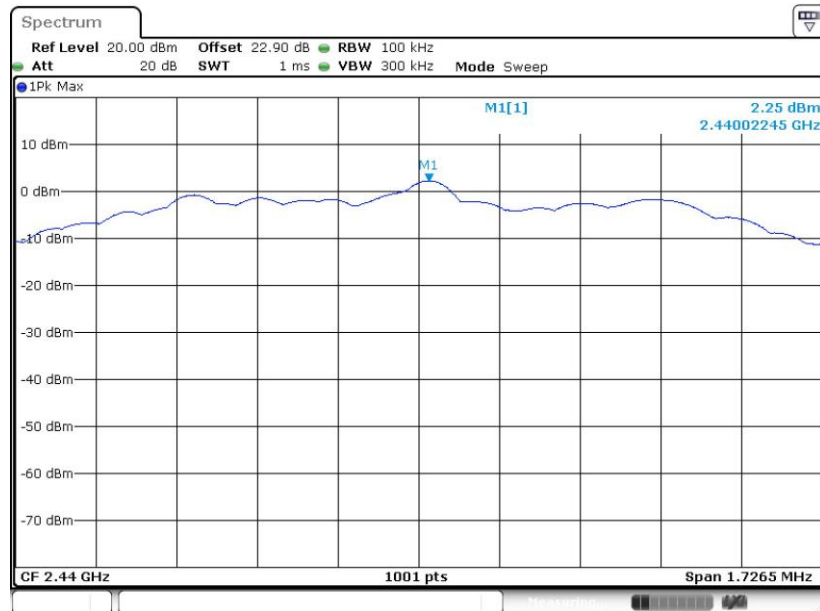

Date: 10.APR.2019 01:29:33



PSD 100kHz Plot on Channel 39

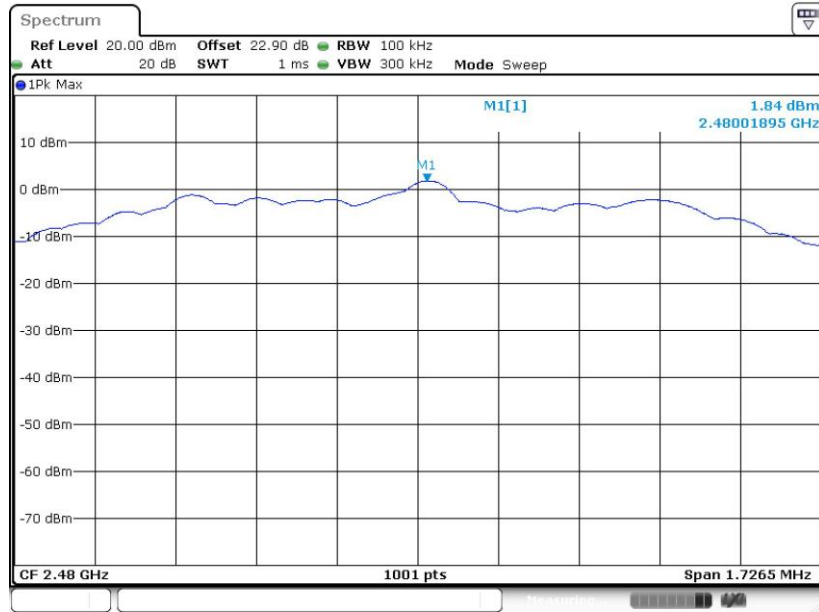

Date: 10.APR.2019 01:31:27



3.3.7 Test Result of Power Spectral Density Plots (3kHz)

Test Engineer :	Aking Chang	Temperature :	21~25°C
		Relative Humidity :	51~54%

<1 Mbps>

PSD 3kHz Plot on Channel 00

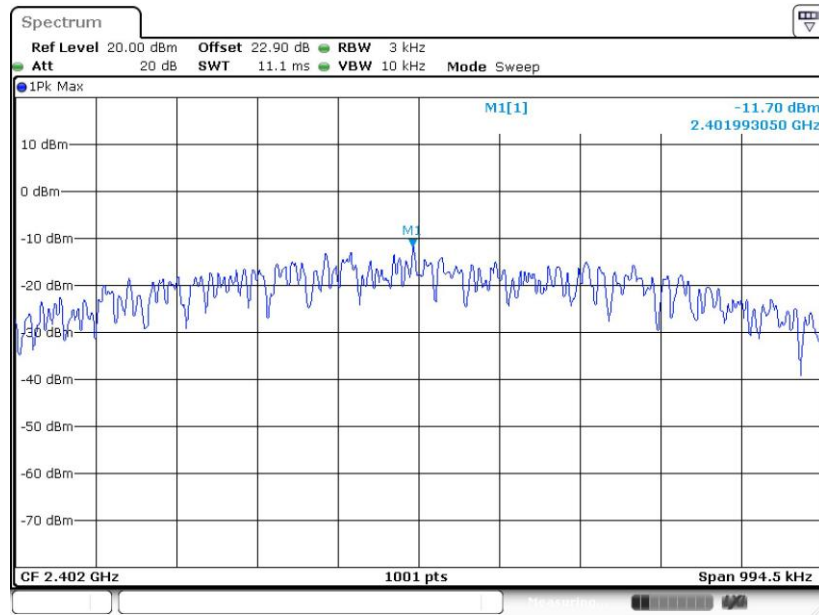

Date: 10.APR.2019 01:18:40

PSD 3kHz Plot on Channel 19

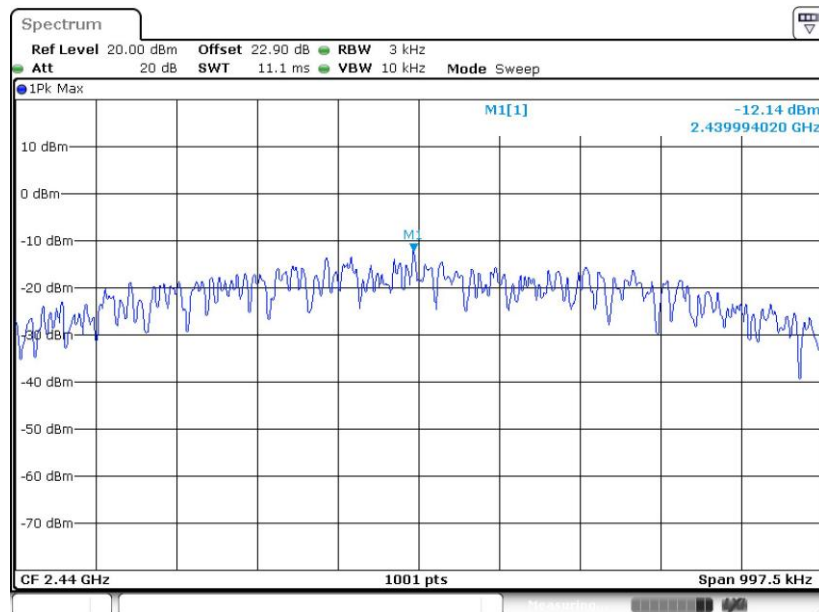

Date: 10.APR.2019 01:21:40



PSD 3kHz Plot on Channel 39

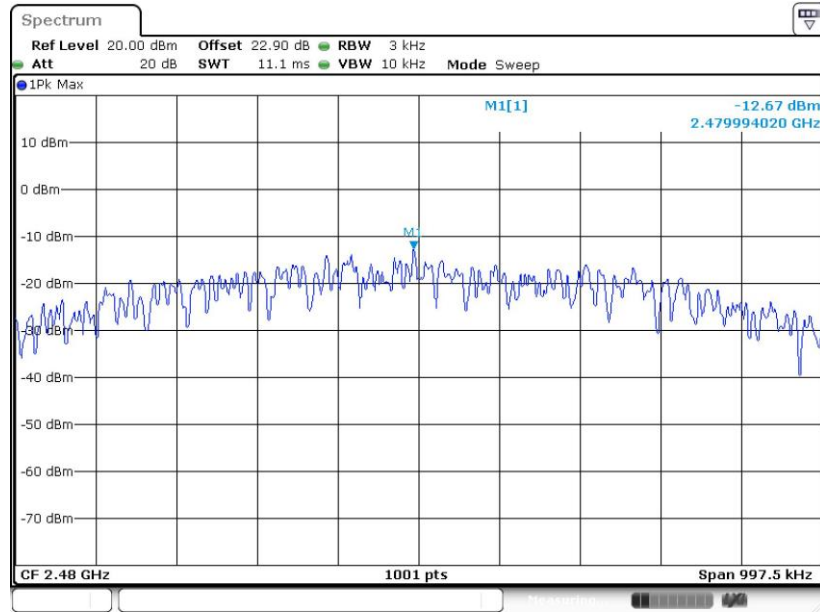

Date: 10.APR.2019 01:24:52

<2 Mbps>

PSD 3kHz Plot on Channel 00

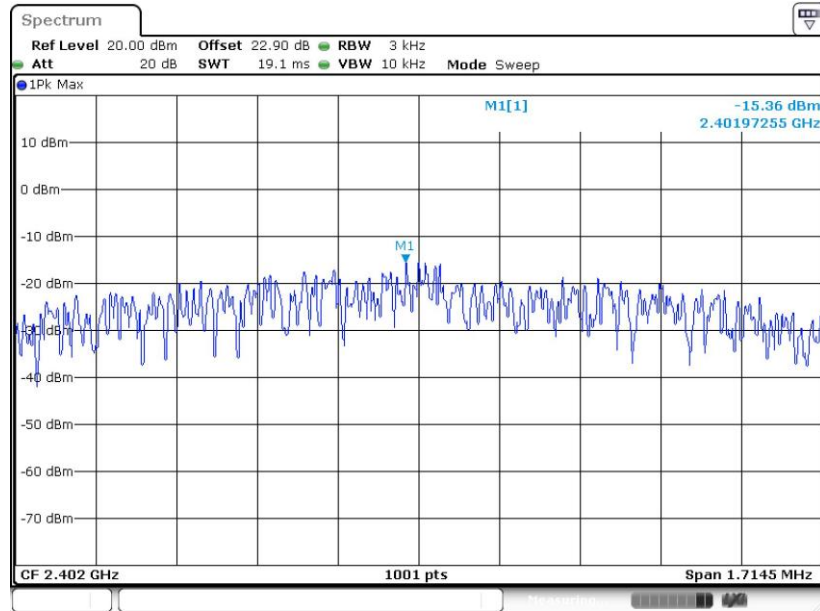

Date: 10.APR.2019 01:27:07



PSD 3kHz Plot on Channel 19

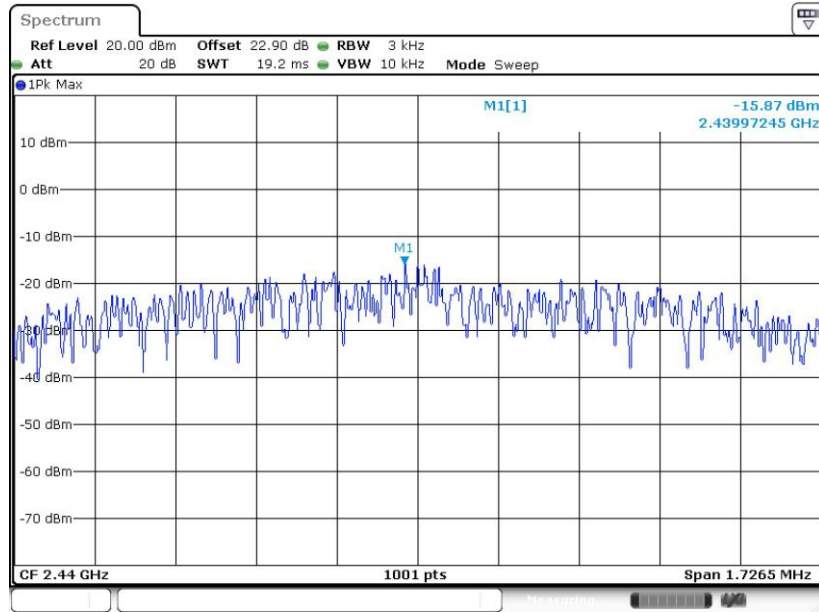

Date: 10.APR.2019 01:29:23

PSD 3kHz Plot on Channel 39

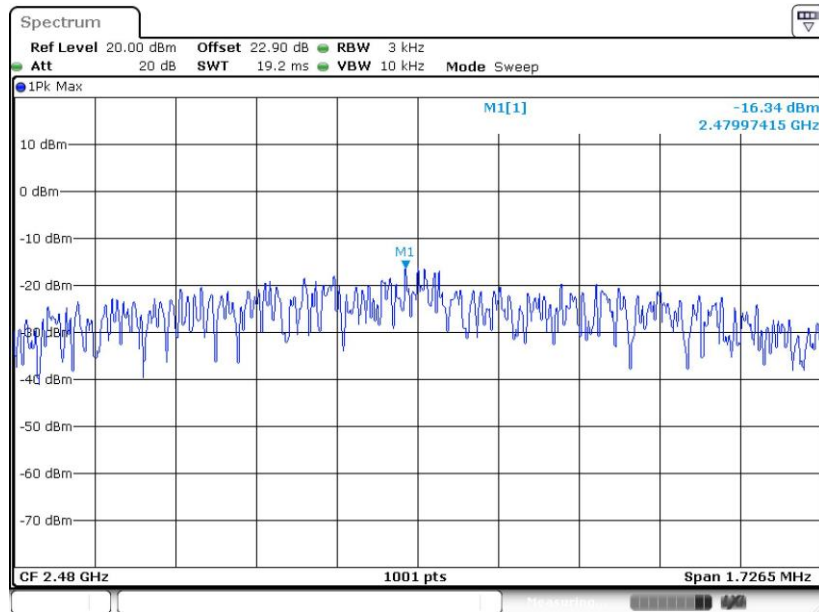

Date: 10.APR.2019 01:31:13

3.4 Conducted Band Edges and Spurious Emission Measurement

3.4.1 Limit of Conducted Band Edges and Spurious Emission

All harmonics/spurious must be at least 20 dB down from the highest emission level within the authorized band.

3.4.2 Measuring Instruments

See list of measuring equipment of this test report.

3.4.3 Test Procedure

1. The testing follows the ANSI C63.10 Section 11.11.3 Emission level measurement.
2. The RF output of EUT was connected to the spectrum analyzer by RF cable and attenuator. The path loss was compensated to the results for each measurement.
3. Set to the maximum power setting and enable the EUT transmit continuously.
4. Set RBW = 100 kHz, VBW=300 kHz, Peak Detector. Unwanted Emissions measured in any 100 kHz bandwidth outside of the authorized frequency band shall be attenuated by at least 20 dB relative to the maximum in-band peak PSD level in 100 kHz when maximum peak conducted output power procedure is used. If the transmitter complies with the conducted power limits based on the use of RMS averaging over a time interval, the attenuation required under this paragraph shall be 30 dB instead of 20 dB.
5. Measure and record the results in the test report.
6. The RF fundamental frequency should be excluded against the limit line in the operating frequency band.

3.4.4 Test Setup

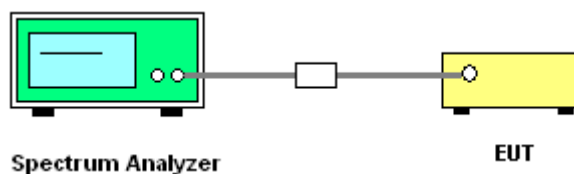



3.4.5 Test Result of Conducted Band Edges Plots

Test Engineer :	Aking Chang	Temperature :	21~25°C
		Relative Humidity :	51~54%

<1 Mbps>

Low Band Edge Plot on Channel 00

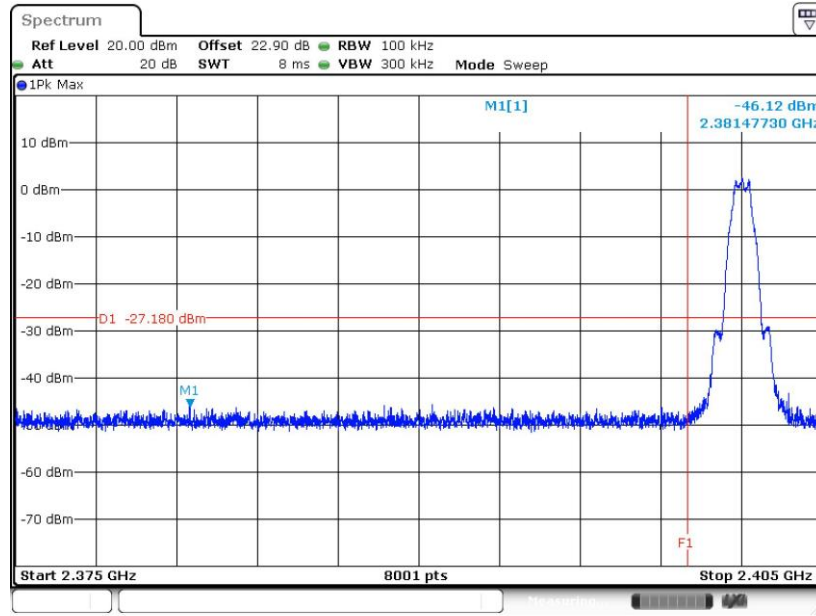

Date: 10.APR.2019 01:19:16

High Band Edge Plot on Channel 39

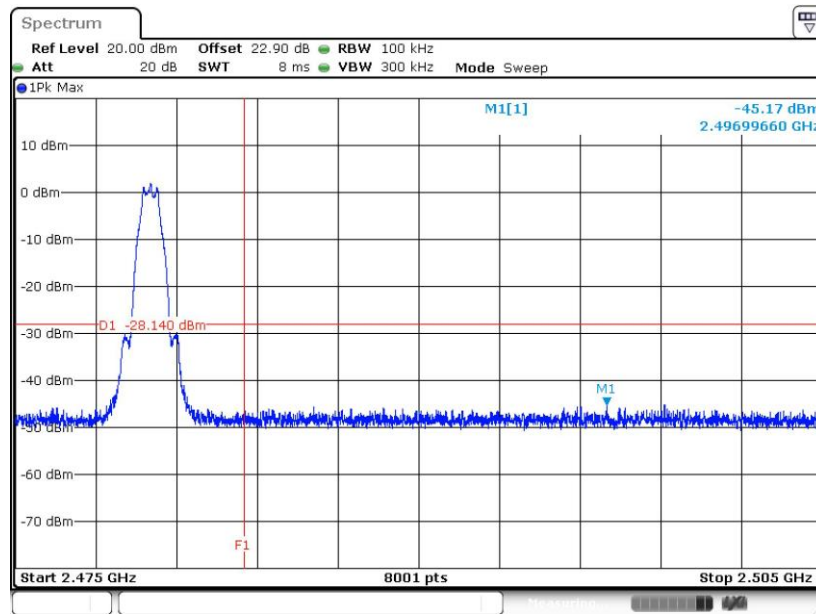

Date: 10.APR.2019 01:25:15



<2 Mbps>

Low Band Edge Plot on Channel 00

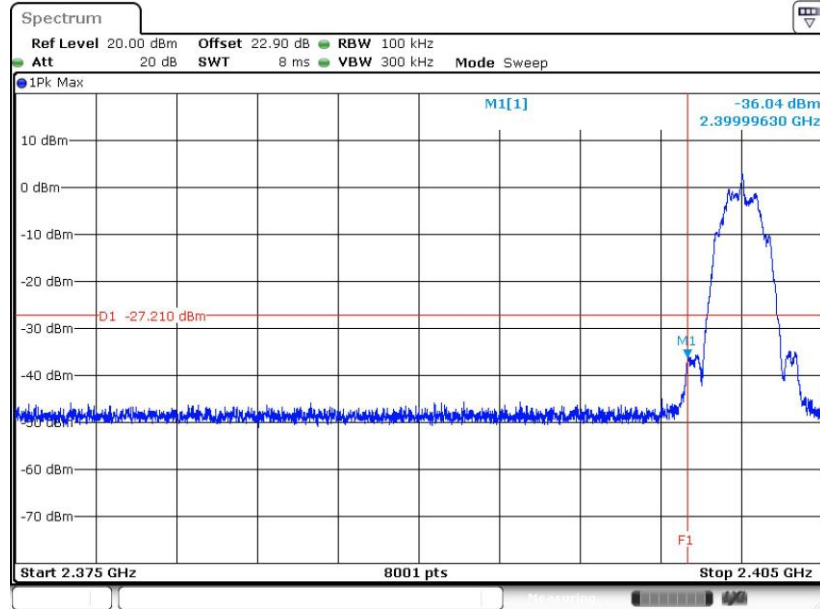

Date: 10.APR.2019 01:27:36

High Band Edge Plot on Channel 39

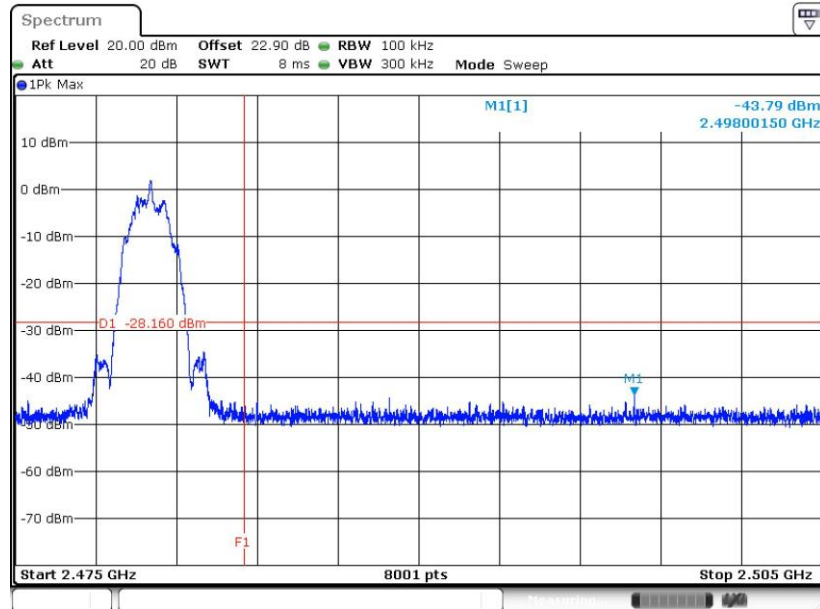

Date: 10.APR.2019 01:31:40



3.4.6 Test Result of Conducted Spurious Emission Plots

Test Engineer :	Aking Chang	Temperature :	21~25°C
		Relative Humidity :	51~54%

Conducted Spurious Emission Plot on Bluetooth LE 1Mbps GFSK Channel 00

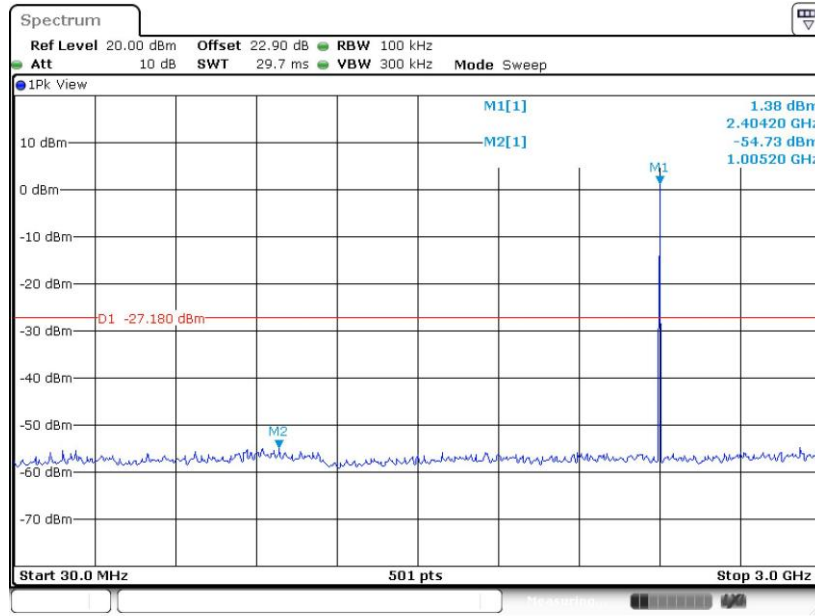

Date: 10.APR.2019 01:19:40

Conducted Spurious Emission Plot on Bluetooth LE 1Mbps GFSK Channel 00

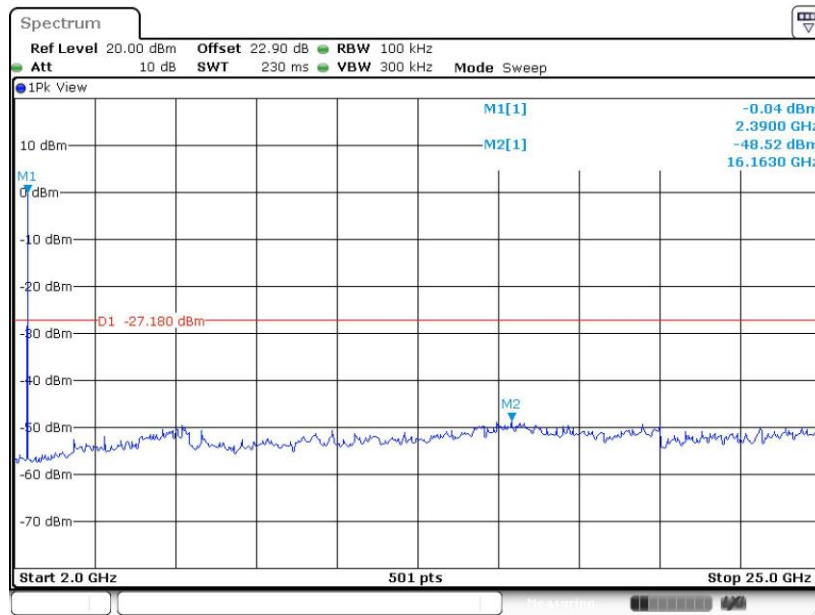

Date: 10.APR.2019 01:19:50



Conducted Spurious Emission Plot on Bluetooth LE 1Mbps GFSK Channel 19

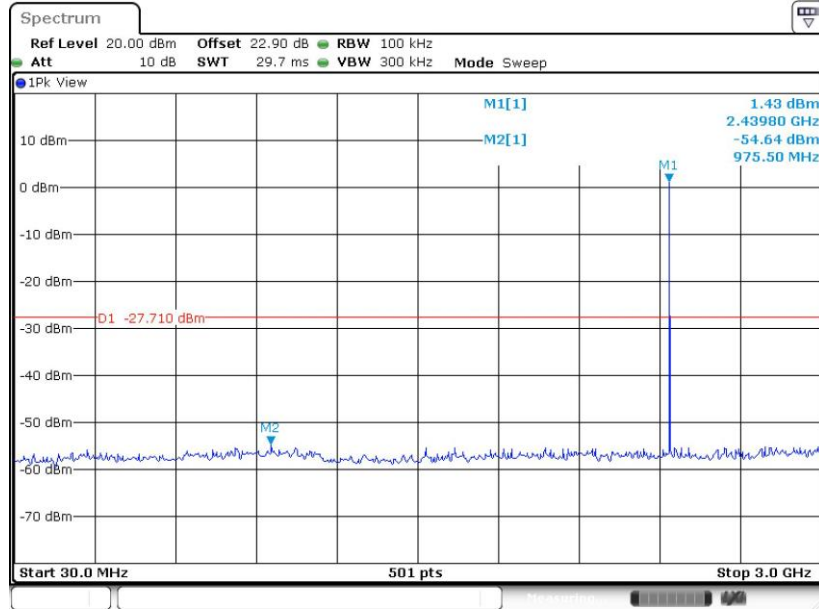

Date: 10.APR.2019 01:22:05

Conducted Spurious Emission Plot on Bluetooth LE 1Mbps GFSK Channel 19

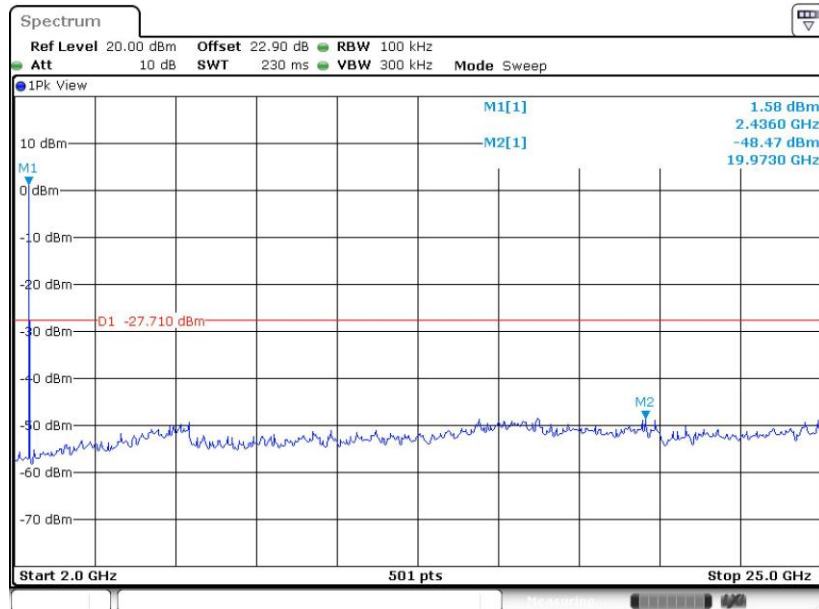

Date: 10.APR.2019 01:22:17



Conducted Spurious Emission Plot on Bluetooth LE 1Mbps GFSK Channel 39

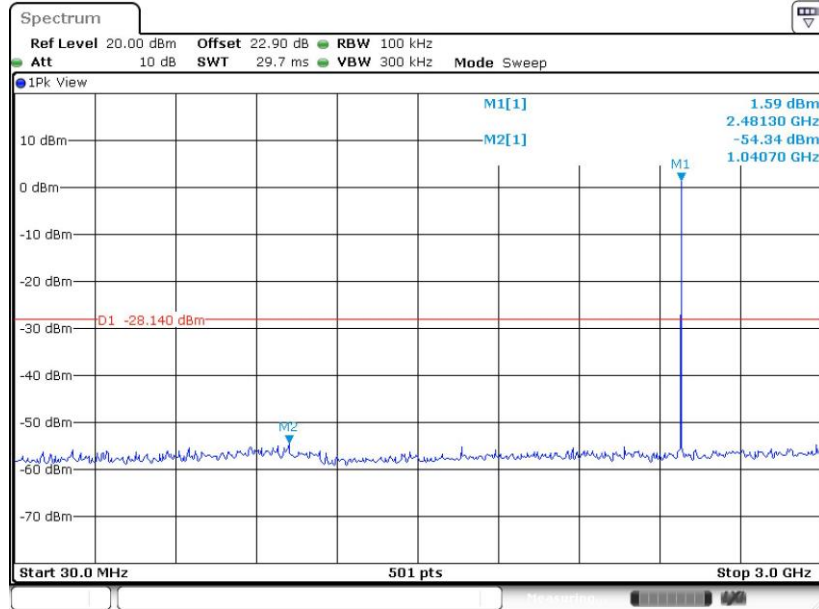

Date: 10.APR.2019 01:25:28

Conducted Spurious Emission Plot on Bluetooth LE 1Mbps GFSK Channel 39

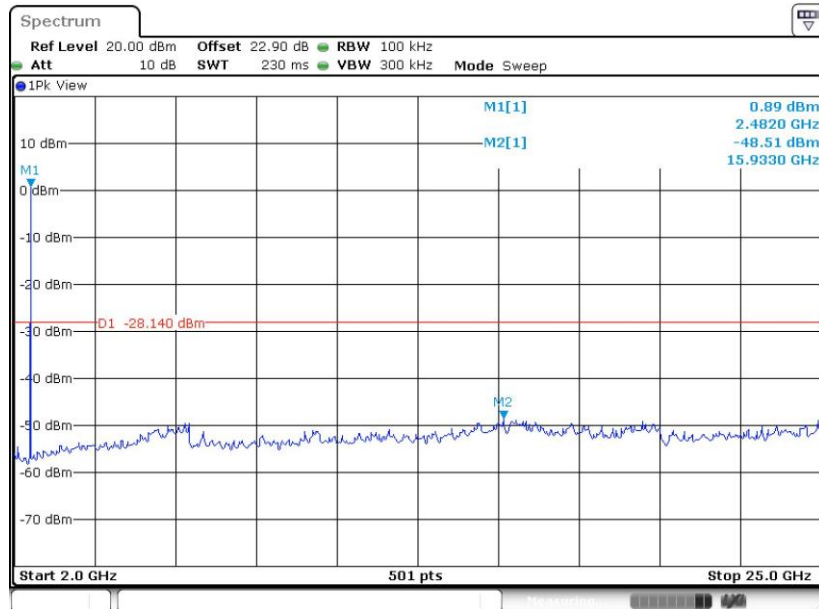

Date: 10.APR.2019 01:25:39



Conducted Spurious Emission Plot on Bluetooth LE 2Mbps GFSK Channel 00

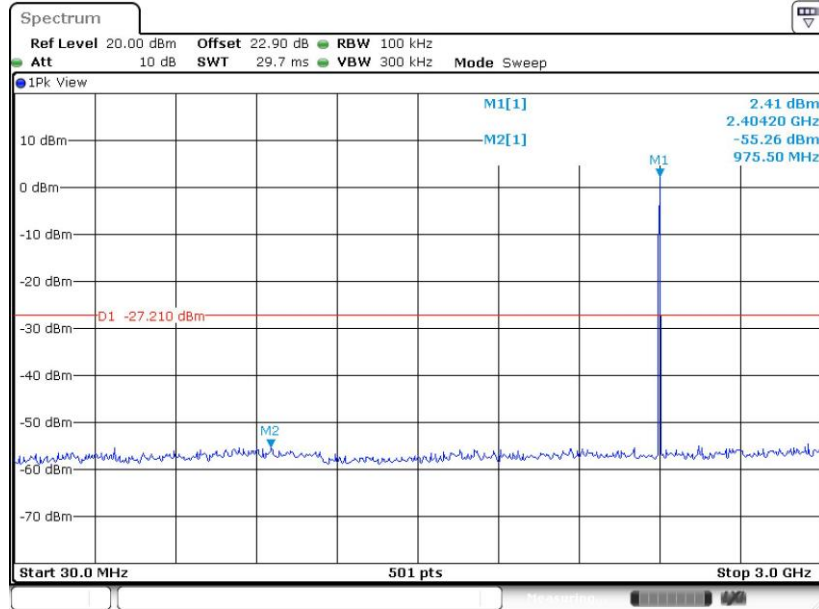

Date: 10.APR.2019 01:27:59

Conducted Spurious Emission Plot on Bluetooth LE 2Mbps GFSK Channel 00

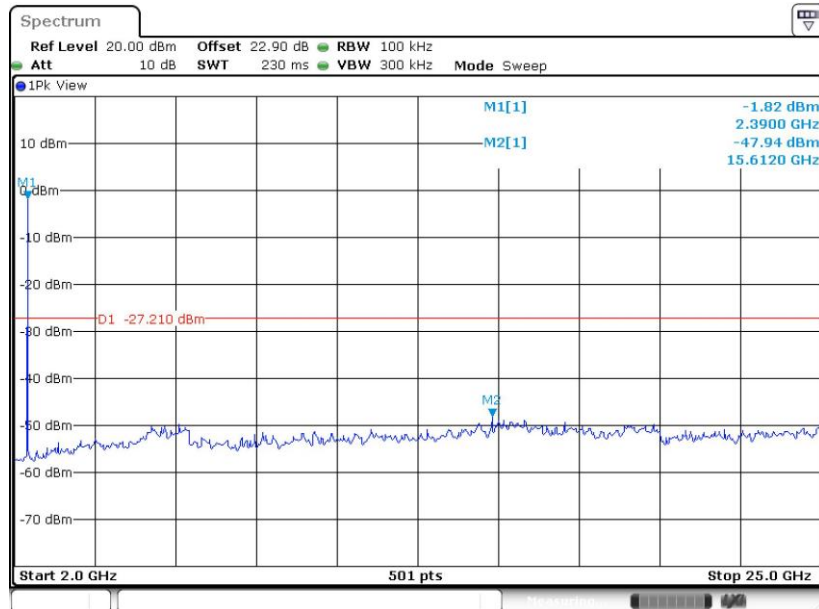

Date: 10.APR.2019 01:28:11



Conducted Spurious Emission Plot on Bluetooth LE 2Mbps GFSK Channel 19

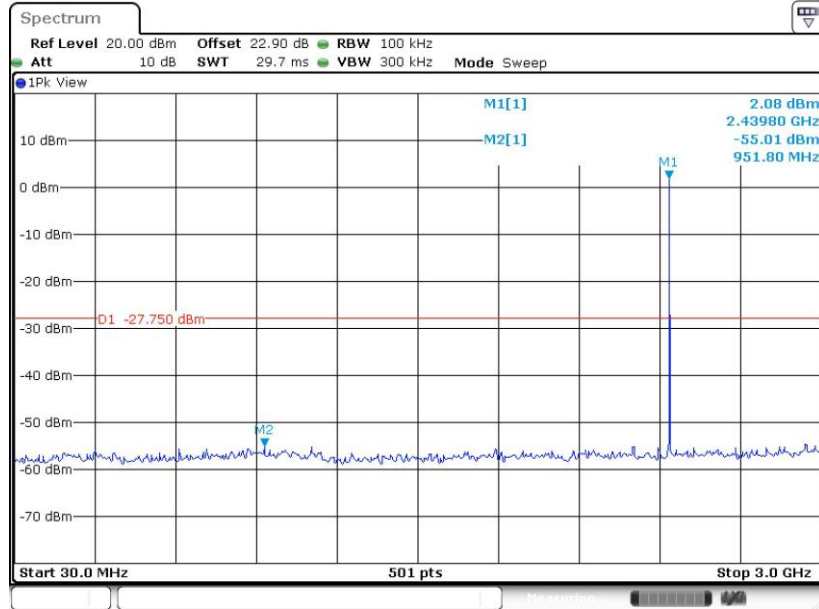

Date: 10.APR.2019 01:29:46

Conducted Spurious Emission Plot on Bluetooth LE 2Mbps GFSK Channel 19

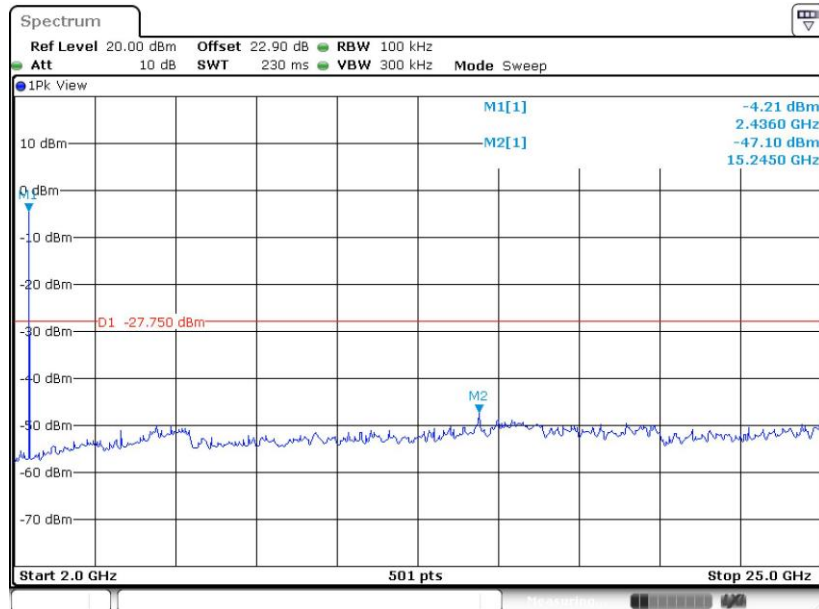

Date: 10.APR.2019 01:29:57



Conducted Spurious Emission Plot on Bluetooth LE 2Mbps GFSK Channel 39

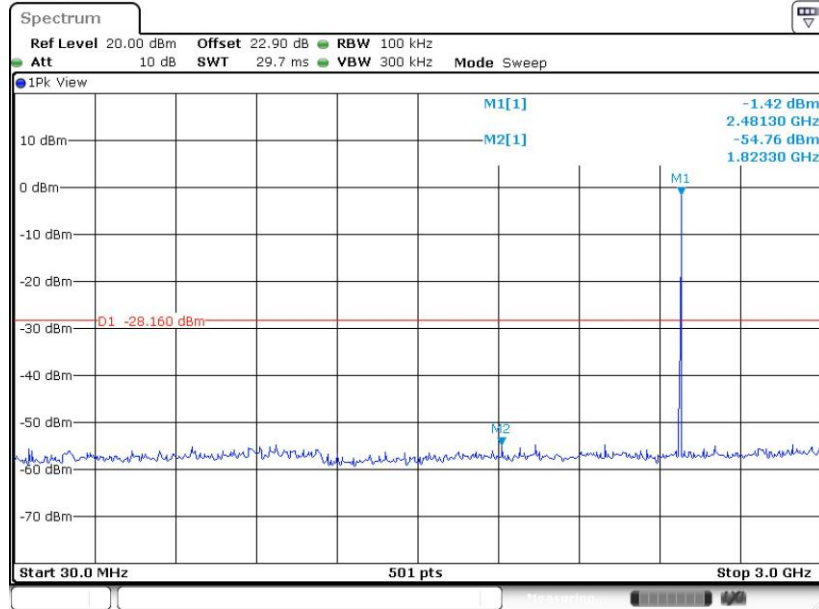

Date: 10.APR.2019 01:31:54

Conducted Spurious Emission Plot on Bluetooth LE 2Mbps GFSK Channel 39

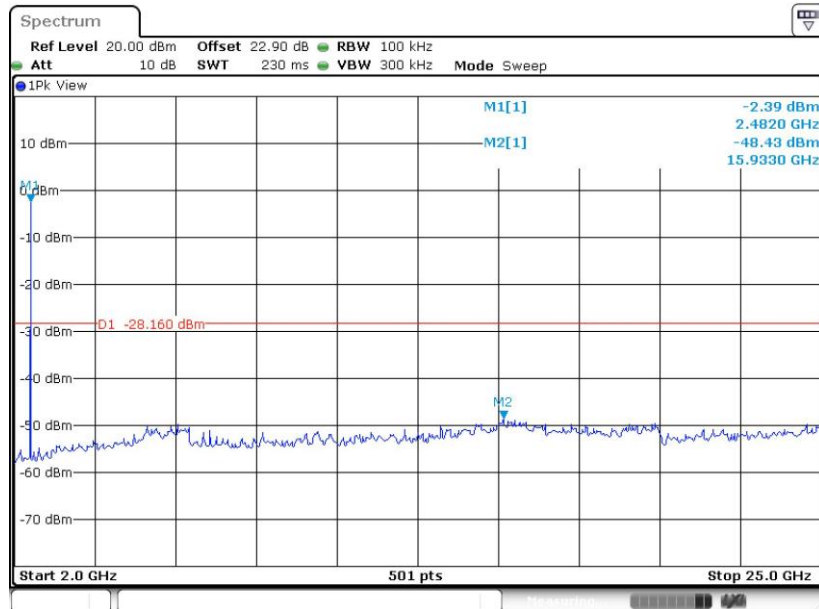

Date: 10.APR.2019 01:32:05



3.5 Radiated Band Edges and Spurious Emission Measurement

3.5.1 Limit of Radiated Band Edges and Spurious Emission

In any 100 kHz bandwidth outside the intentional radiator frequency band, all harmonics/spurious must be at least 20 dB below the highest emission level within the authorized band. If the output power of this device was measured by spectrum analyzer, the attenuation under this paragraph shall be 30 dB instead of 20 dB. In addition, radiated emissions which fall in the restricted bands must also comply with the limits as below.

Frequency (MHz)	Field Strength (microvolts/meter)	Measurement Distance (meters)
0.009 – 0.490	2400/F(kHz)	300
0.490 – 1.705	24000/F(kHz)	30
1.705 – 30.0	30	30
30 – 88	100	3
88 – 216	150	3
216 - 960	200	3
Above 960	500	3

3.5.2 Measuring Instruments

See list of measuring equipment of this test report.



3.5.3 Test Procedures

1. The testing follows the ANSI C63.10 Section 11.12.1 Radiated emission measurements.
2. The EUT was arranged to its worst case and then tune the antenna tower (from 1 m to 4 m) and turntable (from 0 degree to 360 degrees) to find the maximum reading. A pre-amp and a high pass filter are used for the test in order to get better signal level.
3. The EUT was placed on a turntable with 0.8 meter for frequency below 1GHz and 1.5 meter for frequency above 1GHz respectively above ground.
4. The EUT was set 3 meters from the interference receiving antenna, which was mounted on the top of a variable height antenna tower.
5. Corrected Reading: Antenna Factor + Cable Loss + Read Level - Preamp Factor = Level
6. For testing below 1GHz, if the emission level of the EUT in peak mode was 3 dB lower than the limit specified, then peak values of EUT will be reported, otherwise, the emissions will be repeated one by one using the CISPR quasi-peak method and reported.
7. For testing above 1GHz, the emission level of the EUT in peak mode was 20dB lower than average limit (that means the emission level in average mode also complies with the limit in average mode), then peak values of EUT will be reported, otherwise, the emissions will be measured in average mode again and reported.
8. Use the following spectrum analyzer settings:
 - (1) Span shall wide enough to fully capture the emission being measured;
 - (2) Set RBW=100 kHz for $f < 1$ GHz; $VBW \geq RBW$; Sweep = auto; Detector function = peak; Trace = max hold;
 - (3) Set RBW = 1 MHz, VBW= 3MHz for $f \geq 1$ GHz for peak measurement.
For average measurement:
 - $VBW = 10$ Hz, when duty cycle is no less than 98 percent.
 - $VBW \geq 1/T$, when duty cycle is less than 98 percent where T is the minimum transmission duration over which the transmitter is on and is transmitting at its maximum power control level for the tested mode of operation.

3.5.4 Test Setup

For radiated emissions below 30MHz

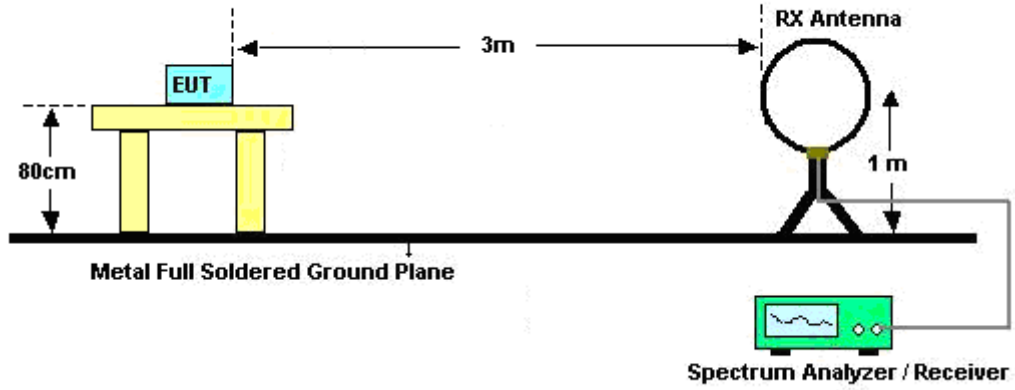

For radiated emissions from 30MHz to 1GHz

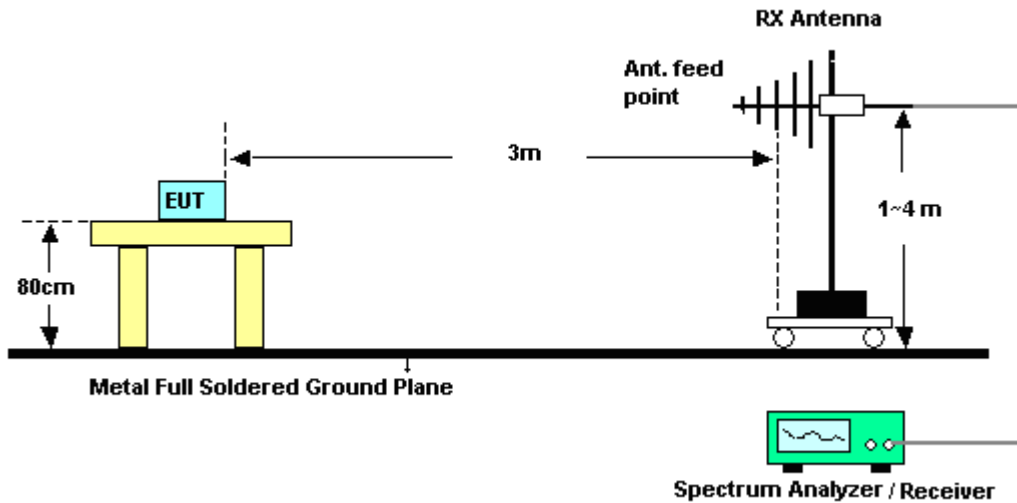

For radiated emissions above 1GHz

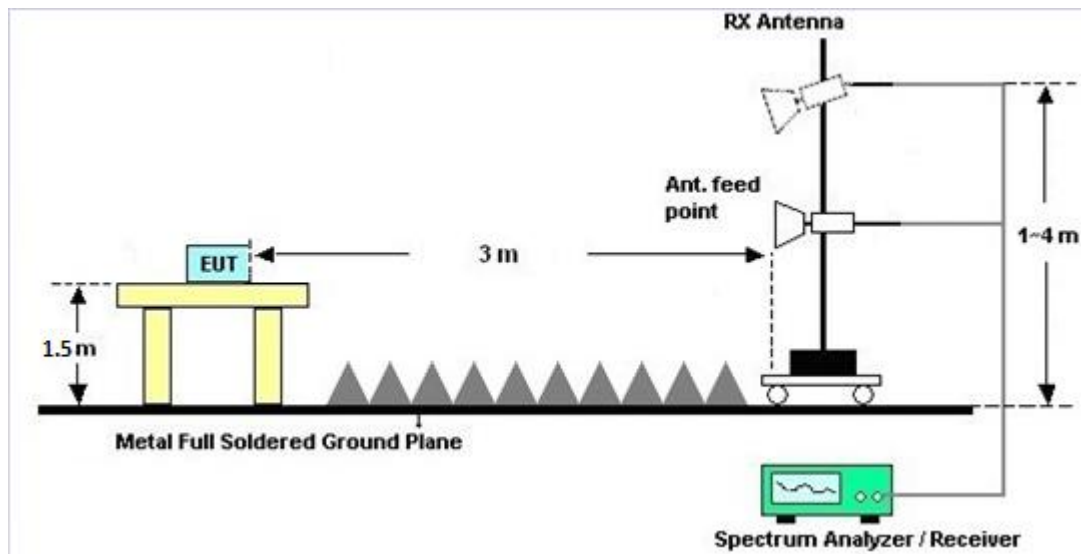

3.5.5 Test Results of Radiated Spurious Emissions (9 kHz ~ 30 MHz)

The low frequency, which started from 9 kHz to 30MHz, was pre-scanned and the result which was 20dB lower than the limit line was not reported.

There is a comparison data of both open-field test site and alternative test site - semi-Anechoic chamber according to 414788 D01 Radiated Test Site v01r01, and the result came out very similar.

3.5.6 Test Result of Radiated Spurious at Band Edges

Please refer to Appendix B and C.

3.5.7 Duty Cycle

Please refer to Appendix D.

3.5.8 Test Result of Radiated Spurious Emission (30MHz ~ 10th Harmonic)

Please refer to Appendix B and C.



3.6 AC Conducted Emission Measurement

3.6.1 Limit of AC Conducted Emission

For equipment that is designed to be connected to the public utility (AC) power line, the radio frequency voltage that is conducted back onto the AC power line on any frequency or frequencies within the band 150 kHz to 30 MHz shall not exceed the limits in the following table.

Frequency of emission (MHz)	Conducted limit (dB μ V)	
	Quasi-peak	Average
0.15-0.5	66 to 56*	56 to 46*
0.5-5	56	46
5-30	60	50

*Decreases with the logarithm of the frequency.

3.6.2 Measuring Instruments

See list of measuring equipment of this test report.

3.6.3 Test Procedures

1. The EUT was placed 0.4 meter from the conducting wall of the shielding room was kept at least 80 centimeters from any other grounded conducting surface.
2. Connect EUT to the power mains through a line impedance stabilization network (LISN).
3. All the support units are connecting to the other LISN.
4. The LISN provides 50 ohm coupling impedance for the measuring instrument.
5. The FCC states that a 50 ohm, 50 microhenry LISN should be used.
6. Both sides of AC line were checked for maximum conducted interference.
7. The frequency range from 150 kHz to 30 MHz was searched.
8. Set the test-receiver system to Peak Detect Function and specified bandwidth (IF Bandwidth = 9kHz) with Maximum Hold Mode. Then measurement is also conducted by Average Detector and Quasi-Peak Detector Function respectively.

3.6.4 Test Setup

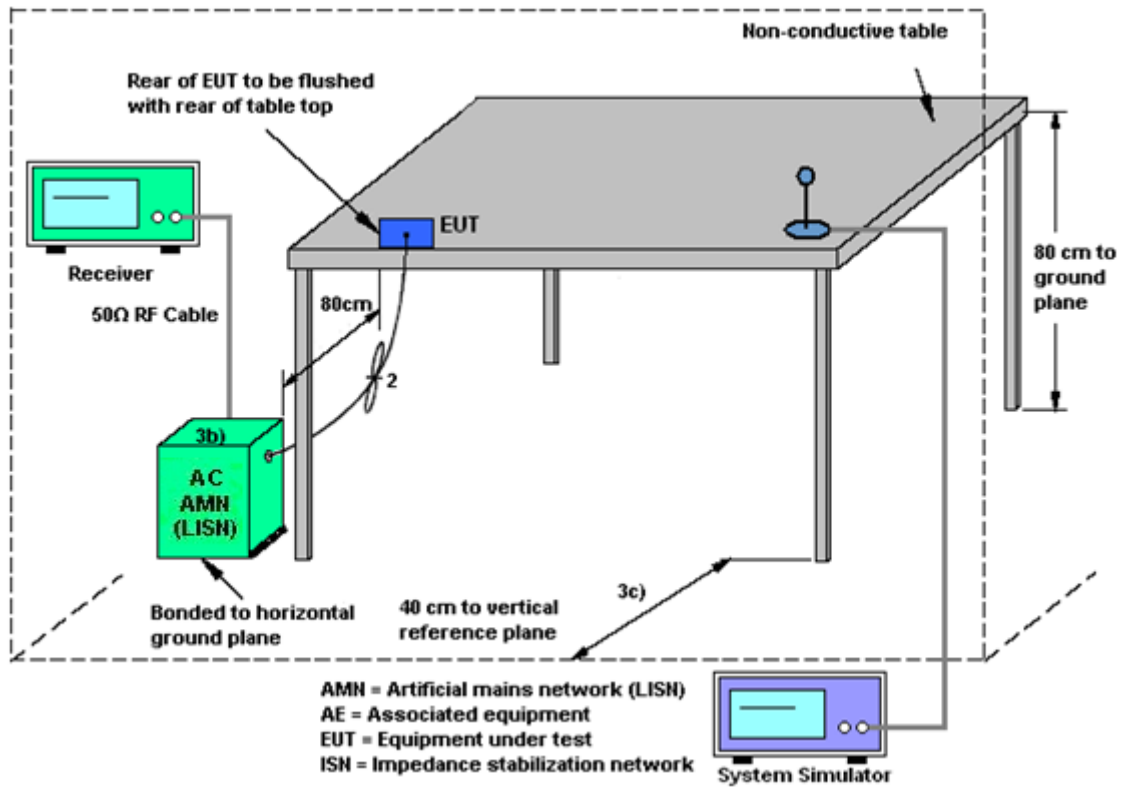

3.6.5 Test Result of AC Conducted Emission

Please refer to Appendix A.



3.7 Antenna Requirements

3.7.1 Standard Applicable

If directional gain of transmitting antennas is greater than 6dBi, the power shall be reduced by the same level in dB comparing to gain minus 6dBi. The use of a permanently attached antenna or of an antenna that uses a unique coupling to the intentional radiator shall be considered sufficient to comply with the rule.

3.7.2 Antenna Anti-Replacement Construction

An embedded-in antenna design is used.

3.7.3 Antenna Gain

The antenna peak gain of EUT is less than 6 dBi. Therefore, it is not necessary to reduce maximum peak output power limit.



4 List of Measuring Equipment

Instrument	Manufacturer	Model No.	Serial No.	Characteristics	Calibration Date	Test Date	Due Date	Remark
Loop Antenna	Rohde & Schwarz	HFH2-Z2	100488	9 kHz~30 MHz	Jan. 07, 2019	Apr. 04, 2019 ~ Apr. 12, 2019	Jan. 06, 2020	Radiation (03CH15-HY)
Preamplifier	EMEC	EM18G40G	060715	18GHz ~ 40GHz	Dec. 06, 2018	Apr. 04, 2019 ~ Apr. 12, 2019	Dec. 05, 2019	Radiation (03CH15-HY)
Bilog Antenna	TESEQ	CBL6111D&0802N1D01N-06	47020&06	30MHz to 1GHz	Oct. 13, 2018	Apr. 12, 2019	Oct. 12, 2019	Radiation (03CH15-HY)
Horn Antenna	SCHWARZBECK	BBHA 9120D	9120D-1620	1G~18GHz	Oct. 17, 2018	Apr. 04, 2019 ~ Apr. 12, 2019	Oct. 16, 2019	Radiation (03CH15-HY)
SHF-EHF Horn Antenna	SCHWARZBECK	BBHA 9170	BBHA9170576	18GHz ~ 40GHz	May 08, 2018	Apr. 04, 2019 ~ Apr. 12, 2019	May 07, 2019	Radiation (03CH15-HY)
Amplifier	SONOMA	310N	363440	9kHz~1GHz	Dec. 28, 2018	Apr. 12, 2019	Dec. 27, 2019	Radiation (03CH15-HY)
Preamplifier	Jet-Power	JPA0118-55-303	17100018000550006	1GHz~18GHz	Jul. 10, 2018	Apr. 04, 2019 ~ Apr. 12, 2019	Jul. 09, 2019	Radiation (03CH15-HY)
Preamplifier	Keysight	83017A	MY53270195	1GHz~26.5GHz	Aug. 23, 2018	Apr. 04, 2019 ~ Apr. 12, 2019	Aug. 22, 2019	Radiation (03CH15-HY)
EMI Test Receiver	Keysight	N9038A (MXE)	MY54130085	20Hz ~ 8.4GHz	Nov. 01, 2018	Apr. 04, 2019 ~ Apr. 12, 2019	Oct. 31, 2019	Radiation (03CH15-HY)
Spectrum Analyzer	Agilent	E4446A	MY50180136	3Hz~44GHz	Apr. 25, 2018	Apr. 04, 2019 ~ Apr. 12, 2019	Apr. 24, 2019	Radiation (03CH15-HY)
Controller	ChainTek	3000-1	N/A	Control Turn table & Ant Mast	N/A	Apr. 04, 2019 ~ Apr. 12, 2019	N/A	Radiation (03CH15-HY)
Antenna Mast	ChainTek	MBS-520-1	N/A	1m~4m	N/A	Apr. 04, 2019 ~ Apr. 12, 2019	N/A	Radiation (03CH15-HY)
Turn Table	ChainTek	T-200-S-1	N/A	0~360 Degree	N/A	Apr. 04, 2019 ~ Apr. 12, 2019	N/A	Radiation (03CH15-HY)
Software	Audix	E3 6.2009-8-24(k5)	RK-000451	N/A	N/A	Apr. 04, 2019 ~ Apr. 12, 2019	N/A	Radiation (03CH15-HY)
RF Cable	HUBER + SUHNER	SUCOFLEX 104	MY36980/4	30M-18G	Apr. 16, 2018	Apr. 04, 2019 ~ Apr. 12, 2019	Apr. 15, 2019	Radiation (03CH15-HY)
RF Cable	HUBER + SUHNER	SUCOFLEX 104	MY9838/4	30M-18G	Apr. 16, 2018	Apr. 04, 2019 ~ Apr. 12, 2019	Apr. 15, 2019	Radiation (03CH15-HY)
RF Cable	HUBER + SUHNER	MTJ	000000-MT18A-100D3210	30M-18G	Apr. 16, 2018	Apr. 04, 2019 ~ Apr. 12, 2019	Apr. 15, 2019	Radiation (03CH15-HY)
RF Cable	HUBER + SUHNER	SUCOFLEX 102	MY2859/2	30MHz-40GHz	Mar. 13, 2019	Apr. 04, 2019 ~ Apr. 12, 2019	Mar. 12, 2020	Radiation (03CH15-HY)
RF Cable	HUBER + SUHNER	SUCOFLEX 102	MY4274/2	30MHz-40GHz	Mar. 13, 2019	Apr. 04, 2019 ~ Apr. 12, 2019	Mar. 12, 2020	Radiation (03CH15-HY)
Filter	Wainwright	WLK4-1000-1530-8000-40S	SN11	1G Low Pass	Sep. 16, 2018	Apr. 04, 2019 ~ Apr. 12, 2019	Sep. 15, 2019	Radiation (03CH15-HY)
Filter	Wainwright	WHKX12-2700-3000-18000-60ST	SN1	3 GHz Highpass	Sep. 16, 2018	Apr. 04, 2019 ~ Apr. 12, 2019	Sep. 15, 2019	Radiation (03CH15-HY)



Instrument	Manufacturer	Model No.	Serial No.	Characteristics	Calibration Date	Test Date	Due Date	Remark
AC Power Source	ChainTek	APC-1000W	N/A	N/A	N/A	Mar. 24, 2019	N/A	Conduction (CO05-HY)
EMI Test Receiver	Rohde & Schwarz	ESR3	102388	9KHz~3.6GHz	Nov. 12, 2018	Mar. 24, 2019	Nov. 11, 2019	Conduction (CO05-HY)
LISN	Rohde & Schwarz	ENV216	100080	9kHz~30MHz	Nov. 14, 2018	Mar. 24, 2019	Nov. 13, 2019	Conduction (CO05-HY)
LISN	Rohde & Schwarz	ENV216	100081	9kHz~30MHz	Nov. 09, 2018	Mar. 24, 2019	Nov. 08, 2019	Conduction (CO05-HY)
Software	Rohde & Schwarz	EMC32 V10.30	N/A	N/A	N/A	Mar. 24, 2019	N/A	Conduction (CO05-HY)
RF Cable	HUBER + SUHNER	RG 214/U	1358175	9kHz~30MHz	Sep. 14, 2018	Mar. 24, 2019	Sep. 13, 2019	Conduction (CO05-HY)
Pulse Limiter	SCHWARZBECK	VTSD 9561-F N	9561-F N00373	9kHz~200MHz	Nov. 08, 2018	Mar. 24, 2019	Nov. 07, 2019	Conduction (CO05-HY)
Power Sensor	DARE	RadiPower	15I00041S NO09	10MHz~6GHz	May 07, 2018	Apr. 10, 2019	May 06, 2019	Conducted (TH05-HY)
Spectrum Analyzer	Rohde & Schwarz	FSV 30	100895	9kHz~30GHz	Apr. 20, 2018	Apr. 10, 2019	Apr. 19, 2019	Conducted (TH05-HY)
Switch Box & RF Cable	EM	EMSW18	SW1070903	N/A	Dec. 19, 2018	Apr. 10, 2019	Dec. 18, 2019	Conducted (TH05-HY)



5 Uncertainty of Evaluation

Uncertainty of Conducted Emission Measurement (150 kHz ~ 30 MHz)

Measuring Uncertainty for a Level of Confidence of 95% ($U = 2Uc(y)$)	2.2
---	-----

Uncertainty of Radiated Emission Measurement (30 MHz ~ 1000 MHz)

Measuring Uncertainty for a Level of Confidence of 95% ($U = 2Uc(y)$)	5.2
---	-----

Uncertainty of Radiated Emission Measurement (1000 MHz ~ 18000 MHz)

Measuring Uncertainty for a Level of Confidence of 95% ($U = 2Uc(y)$)	5.5
---	-----

Uncertainty of Radiated Emission Measurement (18000 MHz ~ 40000 MHz)

Measuring Uncertainty for a Level of Confidence of 95% ($U = 2Uc(y)$)	5.2
---	-----



Appendix A. AC Conducted Emission Test Results

Test Engineer :	Jimmy Chang	Temperature :	24~26°C
		Relative Humidity :	51~54%
Test Voltage :	120Vac / 60Hz	Phase :	Line

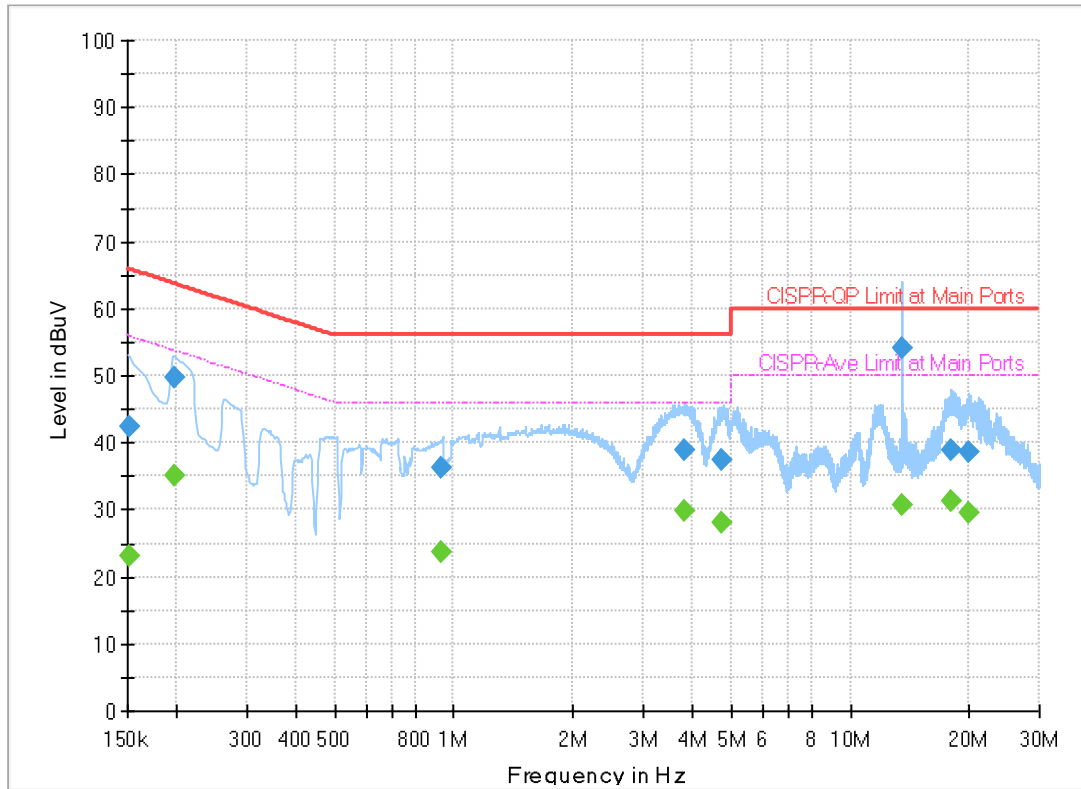

Final Result

Frequency (MHz)	QuasiPeak (dBuV)	CAverage (dBuV)	Limit (dBuV)	Margin (dB)	Line	Filter	Corr. (dB)
0.152250	---	22.96	55.88	32.92	L1	OFF	19.5
0.152250	42.38	---	65.88	23.50	L1	OFF	19.5
0.197250	---	35.05	53.73	18.68	L1	OFF	19.5
0.197250	49.65	---	63.73	14.08	L1	OFF	19.5
0.930750	---	23.81	46.00	22.19	L1	OFF	19.5
0.930750	36.30	---	56.00	19.70	L1	OFF	19.5
3.831000	---	29.78	46.00	16.22	L1	OFF	19.6
3.831000	38.95	---	56.00	17.05	L1	OFF	19.6
4.719750	---	27.94	46.00	18.06	L1	OFF	19.6
4.719750	37.31	---	56.00	18.69	L1	OFF	19.6
13.560000	---	30.66	50.00	19.34	L1	OFF	19.7
13.560000	54.21	---	60.00	5.79	L1	OFF	19.7
17.988000	---	31.18	50.00	18.82	L1	OFF	19.8
17.988000	38.76	---	60.00	21.24	L1	OFF	19.8
19.866750	---	29.64	50.00	20.36	L1	OFF	19.8
19.866750	38.47	---	60.00	21.53	L1	OFF	19.8



Test Engineer :	Jimmy Chang	Temperature :	24~26°C
		Relative Humidity :	51~54%
Test Voltage :	120Vac / 60Hz	Phase :	Neutral

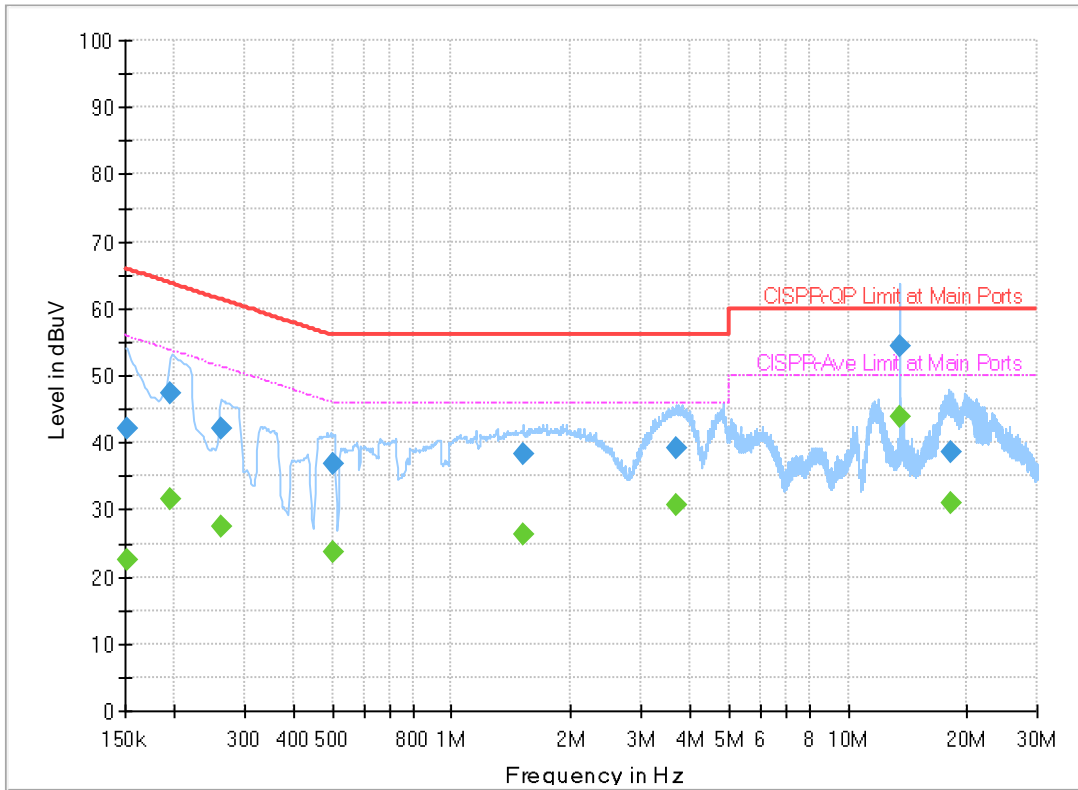

Final Result

Frequency (MHz)	QuasiPeak (dBuV)	CAverage (dBuV)	Limit (dBuV)	Margin (dB)	Line	Filter	Corr. (dB)
0.152250	---	22.50	55.88	33.38	N	OFF	19.5
0.152250	42.22	---	65.88	23.66	N	OFF	19.5
0.195000	---	31.52	53.82	22.30	N	OFF	19.5
0.195000	47.51	---	63.82	16.31	N	OFF	19.5
0.262500	---	27.51	51.35	23.84	N	OFF	19.5
0.262500	42.02	---	61.35	19.33	N	OFF	19.5
0.503250	---	23.57	46.00	22.43	N	OFF	19.5
0.503250	36.79	---	56.00	19.21	N	OFF	19.5
1.515750	---	26.35	46.00	19.65	N	OFF	19.5
1.515750	38.33	---	56.00	17.67	N	OFF	19.5
3.684750	---	30.61	46.00	15.39	N	OFF	19.6
3.684750	39.27	---	56.00	16.73	N	OFF	19.6
13.560000	---	43.86	50.00	6.14	N	OFF	19.8
13.560000	54.33	---	60.00	5.67	N	OFF	19.8
18.125250	---	31.04	50.00	18.96	N	OFF	19.9
18.125250	38.63	---	60.00	21.37	N	OFF	19.9



Appendix B. Radiated Spurious Emission

Test Engineer :	Watt Tseng, Karl Hou and BigShow Wang	Temperature :	23~26°C
		Relative Humidity :	50~57%

2.4GHz 2400~2483.5MHz

BLE_1Mbps (Band Edge @ 3m)

BLE	Note	Frequency	Level	Over	Limit	Read	Antenna	Path	Preamp	Ant	Table	Peak	Pol.	
		(MHz)	(dBμV/m)	(dB)	Limit	Line	Level	Factor	Loss	Factor	Pos	Pos	Avg.	
					(dBμV/m)	(dBμV)	(dB/m)	(dB)	(dB)	(cm)	(deg)	(P/A)	(H/V)	
BLE CH 00 2402MHz		2311.68	54.13	-19.87	74	41.54	27.83	15.66	30.9	141	360	P	H	
		2385.18	45.14	-8.86	54	32.6	27.63	15.77	30.86	141	360	A	H	
	*	2402	99.52	-	-	86.98	27.6	15.79	30.85	141	360	P	H	
	*	2402	98.98	-	-	86.44	27.6	15.79	30.85	141	360	A	H	
													H	
														H
			2385.6	54.21	-19.79	74	41.7	27.6	15.77	30.86	400	74	P	V
			2365.23	45.01	-8.99	54	32.46	27.67	15.74	30.86	400	74	A	V
	*		2402	97.54	-	-	85	27.6	15.79	30.85	400	74	P	V
	*		2402	96.81	-	-	84.27	27.6	15.79	30.85	400	74	A	V
														V
													V	
BLE CH 19 2440MHz		2355.36	53.91	-20.09	74	41.4	27.67	15.72	30.88	110	0	P	H	
		2355.78	44.96	-9.04	54	32.45	27.67	15.72	30.88	110	0	A	H	
	*	2440	98.45	-	-	85.84	27.6	15.85	30.84	110	0	P	H	
	*	2440	97.92	-	-	85.31	27.6	15.85	30.84	110	0	A	H	
			2489.29	53.55	-20.45	74	41.05	27.4	15.92	30.82	110	0	P	H
			2495.03	44.38	-9.62	54	31.87	27.4	15.92	30.81	110	0	A	H
			2334.22	54.37	-19.63	74	41.8	27.77	15.69	30.89	358	153	P	V
			2325.12	44.8	-9.2	54	32.24	27.77	15.68	30.89	358	153	A	V
	*		2440	98.16	-	-	85.55	27.6	15.85	30.84	358	153	P	V
	*		2440	97.77	-	-	85.16	27.6	15.85	30.84	358	153	P	V
			2489.29	53.68	-20.32	74	41.18	27.4	15.92	30.82	358	153	P	V
		2497.62	44.66	-9.34	54	32.14	27.4	15.93	30.81	358	153	A	V	



BLE CH 39 2480MHz	*	2480	98.84	-	-	86.29	27.47	15.9	30.82	384	7	P	H
	*	2480	98.27	-	-	85.72	27.47	15.9	30.82	384	7	A	H
		2488.48	54.06	-19.94	74	41.57	27.4	15.91	30.82	384	7	P	H
		2497.88	44.74	-9.26	54	32.22	27.4	15.93	30.81	384	7	A	H
													H
													H
	*	2480	97.56	-	-	85.01	27.47	15.9	30.82	346	152	P	V
	*	2480	97.04	-	-	84.49	27.47	15.9	30.82	346	152	A	V
		2485.04	53.6	-20.4	74	41.04	27.47	15.91	30.82	346	152	P	V
		2488	44.51	-9.49	54	32.02	27.4	15.91	30.82	346	152	A	V
													V
													V
Remark	1. No other spurious found. 2. All results are PASS against Peak and Average limit line.												



2.4GHz 2400~2483.5MHz
BLE_1Mbps (Harmonic @ 3m)

BLE	Note	Frequency (MHz)	Level (dBµV/m)	Over Limit (dB)	Limit Line (dBµV/m)	Read Level (dBµV)	Antenna Factor (dB/m)	Path Loss (dB)	Preamp Factor (dB)	Ant Pos (cm)	Table Pos (deg)	Peak Avg. (P/A)	Pol. (H/V)
BLE CH 00 2402MHz		4804	38.71	-35.29	74	57.01	31.3	8.44	58.04	100	0	P	H
													H
													H
													H
		4804	37.96	-36.04	74	56.26	31.3	8.44	58.04	100	0	P	V
													V
													V
BLE CH 19 2440MHz		4880	39.13	-34.87	74	57.26	31.3	8.67	58.1	100	0	P	H
		7320	43.82	-30.18	74	54.66	36.23	11.27	58.34	100	0	P	H
													H
													H
		4880	38.31	-35.69	74	56.44	31.3	8.67	58.1	100	0	P	V
		7320	43.7	-30.3	74	54.54	36.23	11.27	58.34	100	0	P	V
													V
BLE CH 39 2480MHz		4960	38.93	-35.07	74	56.73	31.47	8.9	58.17	100	0	P	H
		7440	44.45	-29.55	74	54.83	36.6	11.33	58.31	100	0	P	H
													H
													H
		4960	38.86	-35.14	74	56.66	31.47	8.9	58.17	100	0	P	V
		7440	44.5	-29.5	74	54.88	36.6	11.33	58.31	100	0	P	V
													V
Remark	1. No other spurious found. 2. All results are PASS against Peak and Average limit line.												



Emission below 1GHz
2.4GHz BLE_1Mbps (LF)

BLE	Note	Frequency	Level	Over	Limit	Read	Antenna	Path	Preamp	Ant	Table	Peak	Pol.	
		(MHz)	(dBμV/m)	(dB)	(dBμV/m)	(dBμV)	(dB/m)	(dB)	(dB)	(cm)	(deg)	(P/A)	(H/V)	
2.4GHz BLE LF		84.32	23.12	-16.88	40	40.42	14.03	1.21	32.54	-	-	P	H	
		113.42	23.29	-20.21	43.5	37.21	17.24	1.35	32.51	-	-	P	H	
		290.93	31.25	-14.75	46	42.45	19.12	2.22	32.54	-	-	P	H	
		323.91	34.73	-11.27	46	45.47	19.58	2.22	32.54	100	0	P	H	
		387.93	29	-17	46	37.68	21.42	2.45	32.55	-	-	P	H	
		724.52	29.51	-16.49	46	31.2	27.38	3.28	32.35	-	-	P	H	
														H
														H
														H
														H
														H
														H
			121.18	22.33	-21.17	43.5	35.94	17.52	1.38	32.51	-	-	P	V
			270.56	25.04	-20.96	46	36.43	18.98	2.16	32.53	-	-	P	V
			323.91	27.21	-18.79	46	37.95	19.58	2.22	32.54	-	-	P	V
			557.68	27.76	-18.24	46	31.28	26.11	2.96	32.59	-	-	P	V
			768.17	30.86	-15.14	46	31.3	28.44	3.38	32.26	-	-	P	V
			943.74	32.71	-13.29	46	29.6	30.52	3.86	31.27	100	0	P	V
														V
														V
													V	
													V	
													V	
													V	
Remark	1. No other spurious found. 2. All results are PASS against limit line.													



2.4GHz 2400~2483.5MHz

BLE_2Mbps (Band Edge @ 3m)

BLE	Note	Frequency	Level	Over	Limit	Read	Antenna	Path	Preamp	Ant	Table	Peak	Pol.	
		(MHz)	(dBμV/m)	(dB)	(dBμV/m)	(dBμV)	(dB/m)	(dB)	(dB)	(cm)	(deg)	(P/A)	(H/V)	
BLE CH 00 2402MHz		2373.315	54.31	-19.69	74	41.79	27.63	15.75	30.86	165	359	P	H	
		2347.275	46.59	-7.41	54	34.06	27.7	15.71	30.88	165	359	A	H	
	*	2402	98.64	-	-	86.1	27.6	15.79	30.85	165	359	P	H	
	*	2402	97.21	-	-	84.67	27.6	15.79	30.85	165	359	A	H	
													H	
														H
			2389.8	54.68	-19.32	74	42.16	27.6	15.77	30.85	397	72	P	V
			2389.275	46.34	-7.66	54	33.83	27.6	15.77	30.86	397	72	A	V
	*		2402	97.29	-	-	84.75	27.6	15.79	30.85	397	72	P	V
	*		2402	96.03	-	-	83.49	27.6	15.79	30.85	397	72	A	V
														V
														V
BLE CH 19 2440MHz		2325.12	53.51	-20.49	74	40.95	27.77	15.68	30.89	353	348	P	H	
		2383.64	46.24	-7.76	54	33.7	27.63	15.77	30.86	353	348	A	H	
	*	2440	98.35	-	-	85.74	27.6	15.85	30.84	353	348	P	H	
	*	2440	97.1	-	-	84.49	27.6	15.85	30.84	353	348	A	H	
			2483.83	53.95	-20.05	74	41.39	27.47	15.91	30.82	353	348	P	H
			2492.51	46.04	-7.96	54	33.53	27.4	15.92	30.81	353	348	A	H
			2340.38	54.63	-19.37	74	42.11	27.7	15.7	30.88	399	163	P	V
			2383.22	46.33	-7.67	54	33.8	27.63	15.76	30.86	399	163	A	V
	*		2440	97.58	-	-	84.97	27.6	15.85	30.84	399	163	P	V
	*		2440	96.35	-	-	83.74	27.6	15.85	30.84	399	163	A	V
			2492.51	53.21	-20.79	74	40.7	27.4	15.92	30.81	399	163	P	V
			2493.42	45.96	-8.04	54	33.45	27.4	15.92	30.81	399	163	A	V



BLE CH 39 2480MHz	*	2480	98.39	-	-	85.84	27.47	15.9	30.82	340	10	P	H
	*	2480	97.13	-	-	84.58	27.47	15.9	30.82	340	10	A	H
		2490.64	54.58	-19.42	74	42.08	27.4	15.92	30.82	340	10	P	H
		2496.28	46.2	-7.8	54	33.69	27.4	15.92	30.81	340	10	A	H
													H
													H
	*	2480	97.15	-	-	84.6	27.47	15.9	30.82	396	151	P	V
	*	2480	95.65	-	-	83.1	27.47	15.9	30.82	396	151	A	V
		2483.92	52.93	-21.07	74	40.37	27.47	15.91	30.82	396	151	P	V
		2483.96	46.13	-7.87	54	33.57	27.47	15.91	30.82	396	151	A	V
													V
													V
Remark	1. No other spurious found. 2. All results are PASS against Peak and Average limit line.												



**2.4GHz 2400~2483.5MHz
BLE_2Mbps (Harmonic @ 3m)**

BLE	Note	Frequency (MHz)	Level (dBµV/m)	Over Limit (dB)	Limit Line (dBµV/m)	Read Level (dBµV)	Antenna Factor (dB/m)	Path Loss (dB)	Preamp Factor (dB)	Ant Pos (cm)	Table Pos (deg)	Peak Avg. (P/A)	Pol. (H/V)
BLE CH 00 2402MHz		4804	39.23	-34.77	74	57.53	31.3	8.44	58.04	100	0	P	H
													H
													H
													H
		4804	38.69	-35.31	74	56.99	31.3	8.44	58.04	100	0	P	V
													V
													V
BLE CH 19 2440MHz		4880	38.23	-35.77	74	56.36	31.3	8.67	58.1	100	0	P	H
		7320	44.56	-29.44	74	55.4	36.23	11.27	58.34	100	0	P	H
													H
													H
		4880	39.09	-34.91	74	57.22	31.3	8.67	58.1	100	0	P	V
		7320	44.03	-29.97	74	54.87	36.23	11.27	58.34	100	0	P	V
													V
BLE CH 39 2480MHz		4960	38.78	-35.22	74	56.58	31.47	8.9	58.17	100	0	P	H
		7440	43.96	-30.04	74	54.34	36.6	11.33	58.31	100	0	P	H
													H
													H
		4960	38.51	-35.49	74	56.31	31.47	8.9	58.17	100	0	P	V
		7440	44.79	-29.21	74	55.17	36.6	11.33	58.31	100	0	P	V
													V
Remark	1. No other spurious found.												
	2. All results are PASS against Peak and Average limit line.												



Emission below 1GHz
2.4GHz BLE_2Mbps (LF)

BLE	Note	Frequency	Level	Over	Limit	Read	Antenna	Path	Preamp	Ant	Table	Peak	Pol.	
		(MHz)	(dBμV/m)	(dB)	(dBμV/m)	(dBμV)	(dB/m)	(dB)	(dB)	(cm)	(deg)	(P/A)	(H/V)	
2.4GHz BLE LF		113.42	23.16	-20.34	43.5	37.08	17.24	1.35	32.51	-	-	P	H	
		258.92	29.94	-16.06	46	40.54	19.83	2.09	32.52	-	-	P	H	
		323.91	36.86	-9.14	46	47.6	19.58	2.22	32.54	100	0	P	H	
		387.93	29.1	-16.9	46	37.78	21.42	2.45	32.55	-	-	P	H	
		420.91	30.8	-15.2	46	38.2	22.62	2.53	32.55	-	-	P	H	
		565.44	32.29	-13.71	46	35.51	26.39	2.98	32.59	-	-	P	H	
														H
														H
														H
														H
														H
														H
			84.32	20.89	-19.11	40	38.19	14.03	1.21	32.54	-	-	P	V
			122.15	21.41	-22.09	43.5	34.94	17.6	1.38	32.51	-	-	P	V
			258.92	25.75	-20.25	46	36.35	19.83	2.09	32.52	-	-	P	V
			323.91	28	-18	46	38.74	19.58	2.22	32.54	-	-	P	V
			477.17	35.65	-10.35	46	42	23.54	2.68	32.57	100	0	P	V
			957.32	33.35	-12.65	46	29.51	31.09	3.91	31.16	-	-	P	V
														V
														V
													V	
													V	
													V	
													V	
Remark	1. No other spurious found. 2. All results are PASS against limit line.													



Note symbol

*	Fundamental Frequency which can be ignored. However, the level of any unwanted emissions shall not exceed the level of the fundamental frequency.
!	Test result is over limit line.
P/A	Peak or Average
H/V	Horizontal or Vertical



A calculation example for radiated spurious emission is shown as below:

BLE	Note	Frequency	Level	Over	Limit	Read	Antenna	Path	Preamp	Ant	Table	Peak	Pol.
		(MHz)	(dBμV/m)	(dB)	(dBμV/m)	(dBμV)	(dB/m)	(dB)	(dB)	(cm)	(deg)	(P/A)	(H/V)
BLE CH 00 2402MHz		2390	55.45	-18.55	74	54.51	32.22	4.58	35.86	103	308	P	H
		2390	43.54	-10.46	54	42.6	32.22	4.58	35.86	103	308	A	H

1. Path Loss(dB) = Cable loss(dB) + Filter loss(dB) + Attenuator loss(dB)
2. Level(dBμV/m) =
Antenna Factor(dB/m) + Path Loss(dB) + Read Level(dBμV) - Preamp Factor(dB)
3. Over Limit(dB) = Level(dBμV/m) – Limit Line(dBμV/m)

For Peak Limit @ 2390MHz:

1. Level(dBμV/m)
= Antenna Factor(dB/m) + Path Loss(dB) + Read Level(dBμV) - Preamp Factor(dB)
= 32.22(dB/m) + 4.58(dB) + 54.51(dBμV) – 35.86 (dB)
= 55.45 (dBμV/m)
2. Over Limit(dB)
= Level(dBμV/m) – Limit Line(dBμV/m)
= 55.45(dBμV/m) – 74(dBμV/m)
= -18.55(dB)

For Average Limit @ 2390MHz:

1. Level(dBμV/m)
= Antenna Factor(dB/m) + Path Loss(dB) + Read Level(dBμV) - Preamp Factor(dB)
= 32.22(dB/m) + 4.58(dB) + 42.6(dBμV) – 35.86 (dB)
= 43.54 (dBμV/m)
2. Over Limit(dB)
= Level(dBμV/m) – Limit Line(dBμV/m)
= 43.54(dBμV/m) – 54(dBμV/m)
= -10.46(dB)

Both peak and average measured complies with the limit line, so test result is “PASS”.



Appendix C. Radiated Spurious Emission Plots

Test Engineer :	Watt Tseng, Karl Hou and BigShow Wang	Temperature :	23~26°C
		Relative Humidity :	50~57%

Note symbol

-L	Low channel location
-R	High channel location



2.4GHz 2400~2483.5MHz
BLE_1Mbps (Band Edge @ 3m)

BLE	2.4GHz 2400~2483.5MHz Band Edge @ 3m	
ANT	BLE_1Mbps CH00 2402MHz	
1	Horizontal	Fundamental
Peak	<p>Site : 03CH15-IHY Condition : PEAK_BE_74 3m 91200_15_1620 HORIZONTAL Detector : Peak Project : 922214 Mode : 4</p>	<p>Site : 03CH15-IHY Condition : PEAK_74 3m 91200_15_1620 HORIZONTAL Detector : Peak Project : 922214 Mode : 4</p>
Avg.	<p>Site : 03CH15-IHY Condition : AVG_BE_54 3m 91200_15_1620 HORIZONTAL Detector : Peak Project : 922214 Mode : 4</p>	<p>Site : 03CH15-IHY Condition : AVG_54 3m 91200_15_1620 HORIZONTAL Detector : Peak Project : 922214 Mode : 4</p>



BLE	2.4GHz 2400~2483.5MHz Band Edge @ 3m	
ANT	BLE_1Mbps CH00 2402MHz	
1	Vertical	Fundamental
<p>Peak</p>	<p>Site : 03CH15-HY Condition : PEAK_BE_74 3m 91200_15_1620 VERTICAL : RBW:1000.000KHz VBW:3000.000KHz SWT:Auto Detector : Peak Project : 922214 Mode : 4</p>	<p>Site : 03CH15-HY Condition : PEAK_74 3m 91200_15_1620 VERTICAL : RBW:1000.000KHz VBW:3000.000KHz SWT:Auto Detector : Peak Project : 922214 Mode : 4</p>
<p>Avg</p>	<p>Site : 03CH15-HY Condition : AVG_BE_54 3m 91200_15_1620 VERTICAL : RBW:1000.000KHz VBW:3.000KHz SWT:Auto Detector : Peak Project : 922214 Mode : 4</p>	<p>Site : 03CH15-HY Condition : AVG_54 3m 91200_15_1620 VERTICAL : RBW:1000.000KHz VBW:3.000KHz SWT:Auto Detector : Peak Project : 922214 Mode : 4</p>

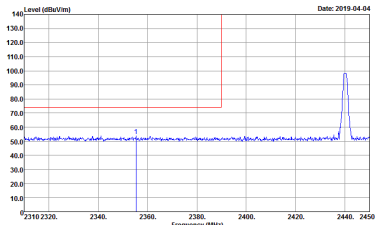
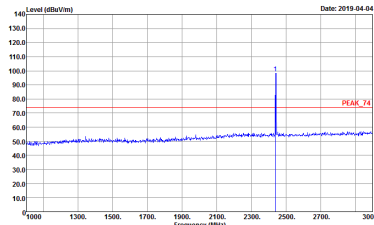
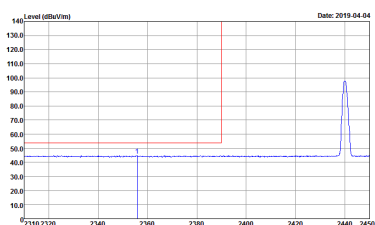
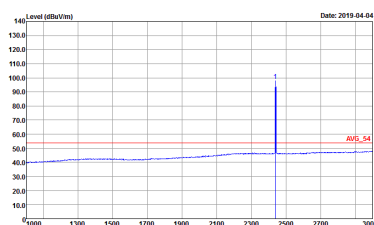

BLE	2.4GHz 2400~2483.5MHz Band Edge @ 3m	
ANT	BLE_1Mbps CH19 2440MHz - L	
1	Horizontal	Fundamental
<p>Peak</p>	 <p>Level (dBm/1m) vs Frequency (MHz) plot showing a peak at 2440 MHz. The y-axis ranges from 10.0 to 140.0 dBm/1m, and the x-axis ranges from 2310 to 2450 MHz. A red line indicates the peak level at approximately 100 dBm/1m.</p> <p>Site : 03CH15-HV Condition : PEAK_BE_74 3m 91200_15_1620 HORIZONTAL Detector : RBW:1000.000KHz VBW:3000.000KHz SWT:Auto Detector : Peak Project : 922214 Mode : 5</p>	 <p>Level (dBm/1m) vs Frequency (MHz) plot showing a peak at 2440 MHz. The y-axis ranges from 10.0 to 140.0 dBm/1m, and the x-axis ranges from 1000 to 3000 MHz. A red line indicates the peak level at approximately 75 dBm/1m, labeled 'PEAK_74'.</p> <p>Site : 03CH15-HV Condition : PEAK_74 3m 91200_15_1620 HORIZONTAL Detector : RBW:1000.000KHz VBW:3000.000KHz SWT:Auto Detector : Peak Project : 922214 Mode : 5</p>
<p>Avg.</p>	 <p>Level (dBm/1m) vs Frequency (MHz) plot showing an average level at 2440 MHz. The y-axis ranges from 10.0 to 140.0 dBm/1m, and the x-axis ranges from 2310 to 2450 MHz. A red line indicates the average level at approximately 50 dBm/1m.</p> <p>Site : 03CH15-HV Condition : AVG_BE_54 3m 91200_15_1620 HORIZONTAL Detector : RBW:1000.000KHz VBW:3.000KHz SWT:Auto Detector : Peak Project : 922214 Mode : 5</p>	 <p>Level (dBm/1m) vs Frequency (MHz) plot showing an average level at 2440 MHz. The y-axis ranges from 10.0 to 140.0 dBm/1m, and the x-axis ranges from 1000 to 3000 MHz. A red line indicates the average level at approximately 50 dBm/1m, labeled 'AVG_54'.</p> <p>Site : 03CH15-HV Condition : AVG_54 3m 91200_15_1620 HORIZONTAL Detector : RBW:1000.000KHz VBW:3.000KHz SWT:Auto Detector : Peak Project : 922214 Mode : 5</p>

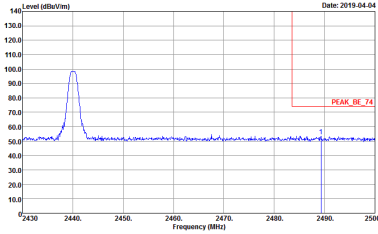
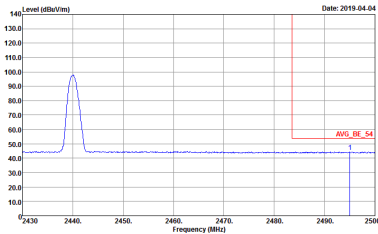

BLE	2.4GHz 2400~2483.5MHz Band Edge @ 3m	
ANT	BLE_1Mbps CH19 2440MHz - R	
1	Horizontal	Fundamental
<p>Peak</p>	 <p>Site : 03CH15-HY Condition : PEAK_BE_74 3m 91200_15_1620 HORIZONTAL RBW:1000.000KHz VBW:3000.000KHz SWF:Auto Detector : Peak Project : 922214 Mode : 5</p>	<p>Left blank</p>
<p>Avg.</p>	 <p>Site : 03CH15-HY Condition : AVG_BE_54 3m 91200_15_1620 HORIZONTAL RBW:1000.000KHz VBW:3.000KHz SWF:Auto Detector : Peak Project : 922214 Mode : 5</p>	<p>Left blank</p>

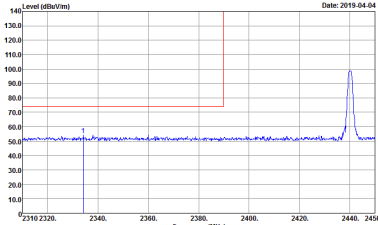
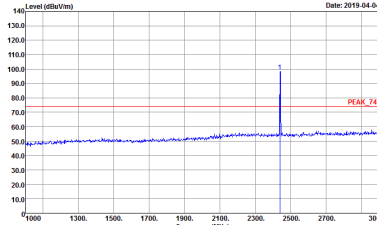
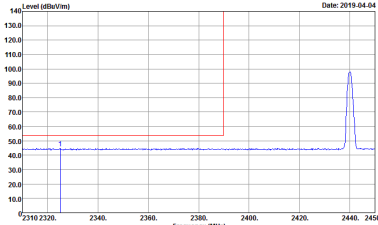
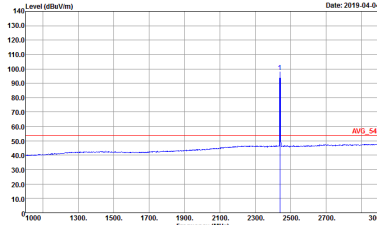

BLE	2.4GHz 2400~2483.5MHz Band Edge @ 3m	
ANT	BLE_1Mbps CH19 2440MHz - L	
1	Vertical	Fundamental
Peak	 <p>Date: 2019-04-04</p> <p>Site : 03CH15-HY Condition : PEAK_BE_74 3m 91200_15_1620 VERTICAL RBW:1000.000KHz VBW:3000.000KHz SWT:Auto Detector : Peak Project : 922214 Mode : 5</p>	 <p>Date: 2019-04-04</p> <p>Site : 03CH15-HY Condition : PEAK_74 3m 91200_15_1620 VERTICAL RBW:1000.000KHz VBW:3000.000KHz SWT:Auto Detector : Peak Project : 922214 Mode : 5</p>
Avg.	 <p>Date: 2019-04-04</p> <p>Site : 03CH15-HY Condition : AVG_BE_54 3m 91200_15_1620 VERTICAL RBW:1000.000KHz VBW:3.000KHz SWT:Auto Detector : Peak Project : 922214 Mode : 5</p>	 <p>Date: 2019-04-04</p> <p>Site : 03CH15-HY Condition : AVG_54 3m 91200_15_1620 VERTICAL RBW:1000.000KHz VBW:3.000KHz SWT:Auto Detector : Peak Project : 922214 Mode : 5</p>

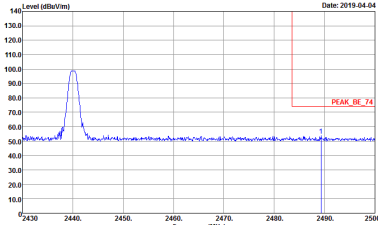
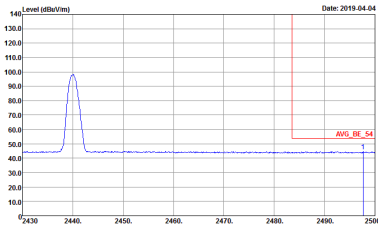

BLE	2.4GHz 2400~2483.5MHz Band Edge @ 3m	
ANT	BLE_1Mbps CH19 2440MHz - R	
1	Vertical	Fundamental
<p>Peak</p>	 <p>Site : 03CH15-HY Condition : PEAK_BE_74 3m 91200_15_1620 VERTICAL RBW:1000.000kHz VBW:3000.000kHz SWF:Auto Detector : Peak Project : 922214 Mode : 5</p>	<p>Left blank</p>
<p>Avg.</p>	 <p>Site : 03CH15-HY Condition : AVG_BE_54 3m 91200_15_1620 VERTICAL RBW:1000.000kHz VBW:3.000kHz SWF:Auto Detector : Peak Project : 922214 Mode : 5</p>	<p>Left blank</p>

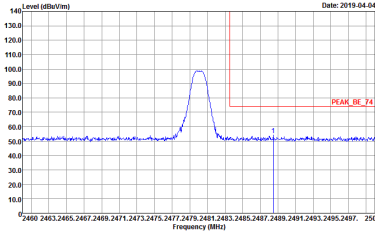
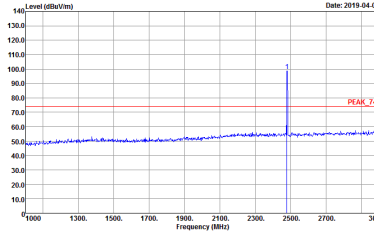
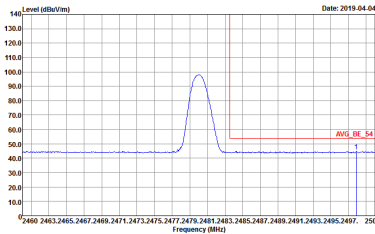
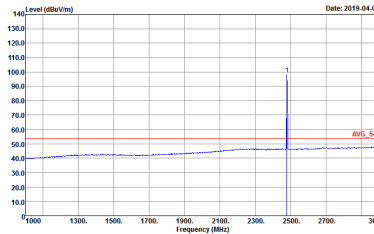

BLE	2.4GHz 2400~2483.5MHz Band Edge @ 3m	
ANT	BLE_1Mbps CH39 2480MHz	
1	Horizontal	Fundamental
<p>Peak</p>	 <p>Site : 03CH15-HY Condition : PEAK_BE_74 3m 91200_15_1620 HORIZONTAL RBW:1000.000KHz VBW:3000.000KHz SWT:Auto Detector : Peak Project : 922214 Mode : 6</p>	 <p>Site : 03CH15-HY Condition : PEAK_74 3m 91200_15_1620 HORIZONTAL RBW:1000.000KHz VBW:3000.000KHz SWT:Auto Detector : Peak Project : 922214 Mode : 6</p>
<p>Avg.</p>	 <p>Site : 03CH15-HY Condition : AVG_BE_54 3m 91200_15_1620 HORIZONTAL RBW:1000.000KHz VBW:3.000KHz SWT:Auto Detector : Peak Project : 922214 Mode : 6</p>	 <p>Site : 03CH15-HY Condition : AVG_54 3m 91200_15_1620 HORIZONTAL RBW:1000.000KHz VBW:3.000KHz SWT:Auto Detector : Peak Project : 922214 Mode : 6</p>

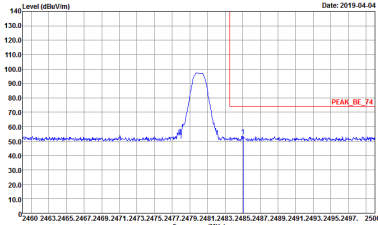
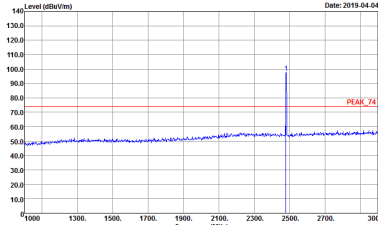
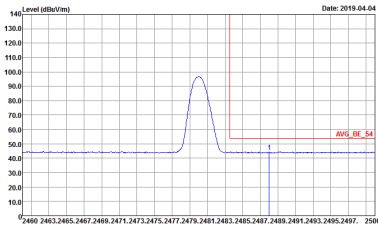
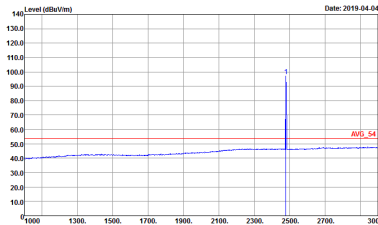

BLE	2.4GHz 2400~2483.5MHz Band Edge @ 3m	
ANT	BLE_1Mbps CH39 2480MHz	
1	Vertical	Fundamental
Peak	 <p>Site : 03CH15-HY Condition : PEAK_BE_74 3m 91200_15_1620 VERTICAL RBW:1000.000KHz VBW:3000.000KHz SWT:Auto Detector : Peak Project : 922214 Mode : 6</p>	 <p>Site : 03CH15-HY Condition : PEAK_74 3m 91200_15_1620 VERTICAL RBW:1000.000KHz VBW:3000.000KHz SWT:Auto Detector : Peak Project : 922214 Mode : 6</p>
Avg.	 <p>Site : 03CH15-HY Condition : AVG_BE_54 3m 91200_15_1620 VERTICAL RBW:1000.000KHz VBW:3.000KHz SWT:Auto Detector : Peak Project : 922214 Mode : 6</p>	 <p>Site : 03CH15-HY Condition : AVG_54 3m 91200_15_1620 VERTICAL RBW:1000.000KHz VBW:3.000KHz SWT:Auto Detector : Peak Project : 922214 Mode : 6</p>



2.4GHz 2400~2483.5MHz

BLE_1Mbps (Harmonic @ 3m)

BLE	2.4GHz 2400~2483.5MHz Harmonic @ 3m	
ANT	BLE_1Mbps CH00 2402MHz	
1	Horizontal	Vertical
Peak Avg.	<p>Site : 03CH15-1FY Condition : PEAK_74 3m 91200_15_1620 HORIZONTAL Detector : Peak Project : 922214 Mode : 4</p>	<p>Site : 03CH15-1FY Condition : PEAK_74 3m 91200_15_1620 VERTICAL Detector : Peak Project : 922214 Mode : 4</p>



BLE	2.4GHz 2400~2483.5MHz Harmonic @ 3m	
ANT	BLE_1Mbps CH19 2440MHz	
1	Horizontal	Vertical
Peak Avg.	<p>Site : 03CH15-HY Condition : PEAK_74 3m 91200_15_1620 HORIZONTAL Detector : Peak Project : 922214 Mode : 15</p>	<p>Site : 03CH15-HY Condition : PEAK_74 3m 91200_15_1620 VERTICAL Detector : Peak Project : 922214 Mode : 15</p>



BLE	2.4GHz 2400~2483.5MHz Harmonic @ 3m	
ANT	BLE_1Mbps CH39 2480MHz	
1	Horizontal	Vertical
Peak	<p>Site : 03CH15-HY Condition : PEAK_74 3m 91200_15_1620 HORIZONTAL Detector : Peak Project : 922214 Mode : C</p>	<p>Site : 03CH15-HY Condition : PEAK_74 3m 91200_15_1620 VERTICAL Detector : Peak Project : 922214 Mode : C</p>



Emission below 1GHz
2.4GHz BLE_1Mbps (LF)

Table with 2 columns: Horizontal and Vertical. Each column contains a spectral plot showing Level (dBuV/m) vs Frequency (MHz) with a 'QP / Peak' label on the left.

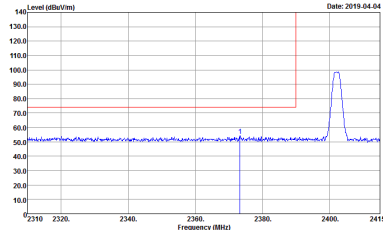
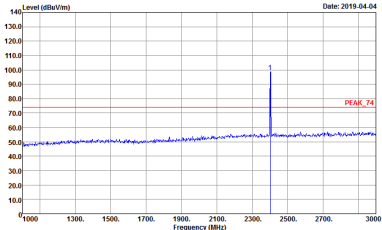
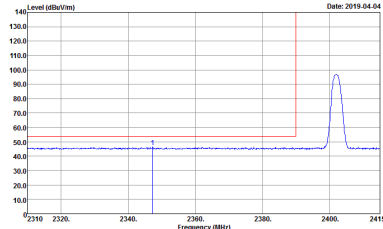
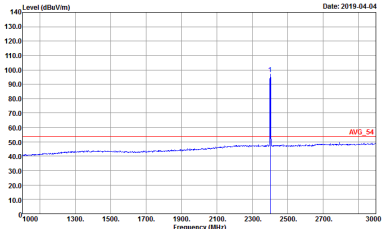

2.4GHz 2400~2483.5MHz
BLE_2Mbps (Band Edge @ 3m)

BLE	2.4GHz 2400~2483.5MHz Band Edge @ 3m	
ANT	BLE_2Mbps CH00 2402MHz	
1	Horizontal	Fundamental
Peak	 <p>Site : 03CH15-HY Condition : PEAK_BE_74 3m 91200_15_1620 HORIZONTAL Detector : Peak Project : 922214 Mode : 7</p>	 <p>Site : 03CH15-HY Condition : PEAK_74 3m 91200_15_1620 HORIZONTAL Detector : Peak Project : 922214 Mode : 7</p>
Avg.	 <p>Site : 03CH15-HY Condition : AVG_BE_54 3m 91200_15_1620 HORIZONTAL Detector : Peak Project : 922214 Mode : 7</p>	 <p>Site : 03CH15-HY Condition : AVG_54 3m 91200_15_1620 HORIZONTAL Detector : Peak Project : 922214 Mode : 7</p>

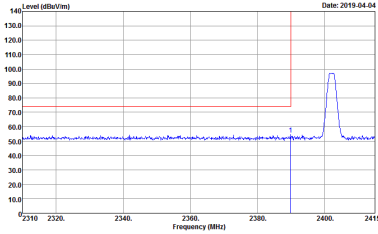
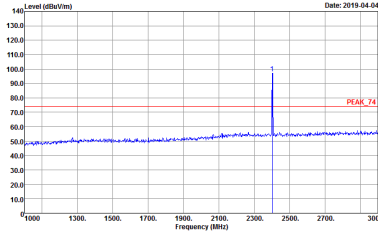
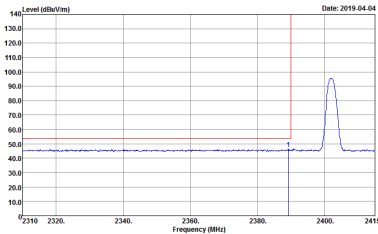
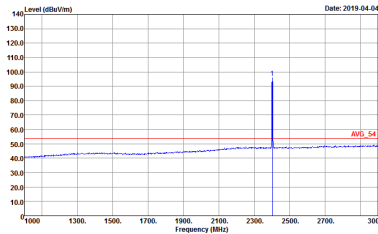

BLE	2.4GHz 2400~2483.5MHz Band Edge @ 3m	
ANT	BLE_2Mbps CH00 2402MHz	
1	Vertical	Fundamental
Peak	 <p>Date: 2019-04-04</p> <p>Site : 03CH15-HY Condition : PEAK_BE_74 3m 91200_15_1620 VERTICAL RBW:1000.000KHz VBW:3000.000KHz SWT:Auto Detector : Peak Project : 922214 Mode : 7</p>	 <p>Date: 2019-04-04</p> <p>Site : 03CH15-HY Condition : PEAK_74 3m 91200_15_1620 VERTICAL RBW:1000.000KHz VBW:3000.000KHz SWT:Auto Detector : Peak Project : 922214 Mode : 7</p>
Avg	 <p>Date: 2019-04-04</p> <p>Site : 03CH15-HY Condition : AVG_BE_54 3m 91200_15_1620 VERTICAL RBW:1000.000KHz VBW:10.000KHz SWT:Auto Detector : Peak Project : 922214 Mode : 7</p>	 <p>Date: 2019-04-04</p> <p>Site : 03CH15-HY Condition : AVG_54 3m 91200_15_1620 VERTICAL RBW:1000.000KHz VBW:10.000KHz SWT:Auto Detector : Peak Project : 922214 Mode : 7</p>

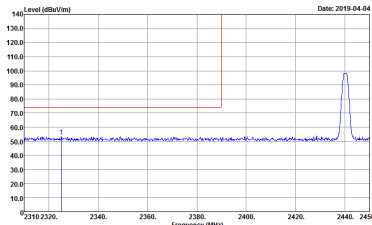
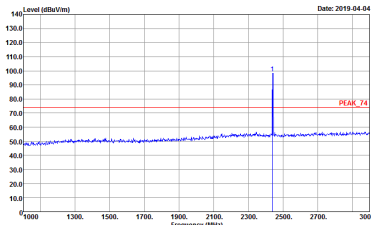
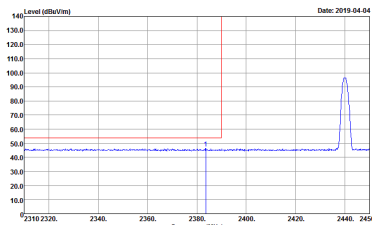
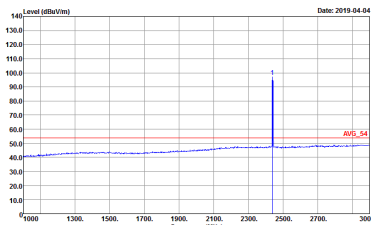

BLE	2.4GHz 2400~2483.5MHz Band Edge @ 3m	
ANT	BLE_2Mbps CH19 2440MHz - L	
1	Horizontal	Fundamental
<p>Peak</p>	 <p>Level (dBm/1m) vs Frequency (MHz) plot showing a peak at 2440 MHz. The y-axis ranges from 10.0 to 140.0 dBm/1m, and the x-axis ranges from 2310 to 2450 MHz. A red line indicates the peak level at approximately 100 dBm/1m.</p> <p>Site : 03CH15-HV Condition : PEAK_BE_74 3m 91200_15_1620 HORIZONTAL Detector : RBW:1000.000KHz VBW:3000.000KHz SWT:Auto Detector : Peak Project : 922214 Mode : 8</p>	 <p>Level (dBm/1m) vs Frequency (MHz) plot showing a peak at 2440 MHz. The y-axis ranges from 10.0 to 140.0 dBm/1m, and the x-axis ranges from 1000 to 3000 MHz. A red line indicates the peak level at approximately 75 dBm/1m, labeled as PEAK_74.</p> <p>Site : 03CH15-HV Condition : PEAK_74 3m 91200_15_1620 HORIZONTAL Detector : RBW:1000.000KHz VBW:3000.000KHz SWT:Auto Detector : Peak Project : 922214 Mode : 8</p>
<p>Avg.</p>	 <p>Level (dBm/1m) vs Frequency (MHz) plot showing an average level at 2440 MHz. The y-axis ranges from 10.0 to 140.0 dBm/1m, and the x-axis ranges from 2310 to 2450 MHz. A red line indicates the average level at approximately 50 dBm/1m.</p> <p>Site : 03CH15-HV Condition : AVG_BE_54 3m 91200_15_1620 HORIZONTAL Detector : RBW:1000.000KHz VBW:10.000KHz SWT:Auto Detector : Peak Project : 922214 Mode : 8</p>	 <p>Level (dBm/1m) vs Frequency (MHz) plot showing an average level at 2440 MHz. The y-axis ranges from 10.0 to 140.0 dBm/1m, and the x-axis ranges from 1000 to 3000 MHz. A red line indicates the average level at approximately 55 dBm/1m, labeled as AVG_54.</p> <p>Site : 03CH15-HV Condition : AVG_54 3m 91200_15_1620 HORIZONTAL Detector : RBW:1000.000KHz VBW:10.000KHz SWT:Auto Detector : Peak Project : 922214 Mode : 8</p>

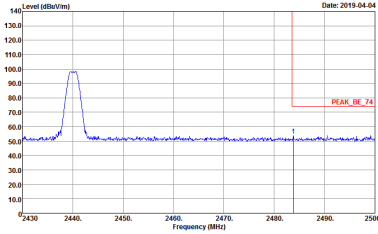
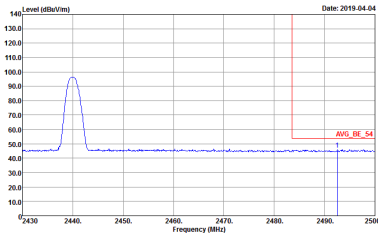

BLE	2.4GHz 2400~2483.5MHz Band Edge @ 3m	
ANT	BLE_2Mbps CH19 2440MHz - R	
1	Horizontal	Fundamental
<p>Peak</p>	 <p> Site : 03CH15-HY Condition : PEAK_BE_74 3m 91200_15_1620 HORIZONTAL RBW:1000.000kHz VBW:3000.000kHz SWT:Auto Detector : Peak Project : 922214 Mode : 8 </p>	<p>Left blank</p>
<p>Avg.</p>	 <p> Site : 03CH15-HY Condition : AVG_BE_54 3m 91200_15_1620 HORIZONTAL RBW:1000.000kHz VBW:30.000kHz SWT:Auto Detector : Peak Project : 922214 Mode : 8 </p>	<p>Left blank</p>

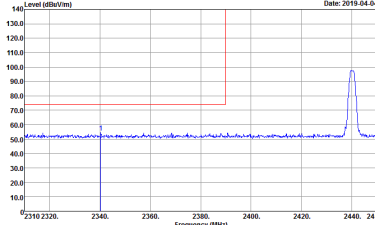
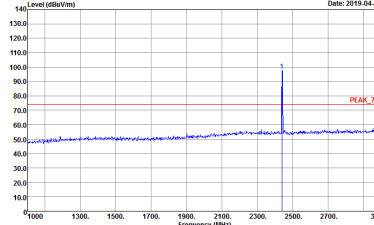
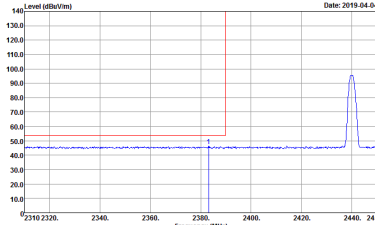
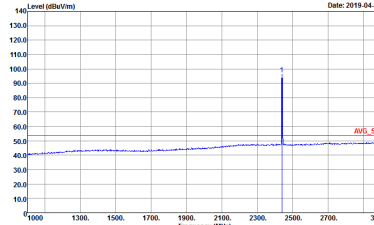

BLE	2.4GHz 2400~2483.5MHz Band Edge @ 3m	
ANT	BLE_2Mbps CH19 2440MHz - L	
1	Vertical	Fundamental
Peak	 <p>Date: 2019-04-04</p> <p>Site : 03CH15-HY Condition : PEAK_BE_74 3m 91200_15_1620 VERTICAL RBW:1000.000KHz VBW:3000.000KHz SWT:Auto Detector : Peak Project : 922214 Mode : 8</p>	 <p>Date: 2019-04-04</p> <p>Site : 03CH15-HY Condition : PEAK_74 3m 91200_15_1620 VERTICAL RBW:1000.000KHz VBW:3000.000KHz SWT:Auto Detector : Peak Project : 922214 Mode : 8</p>
Avg.	 <p>Date: 2019-04-04</p> <p>Site : 03CH15-HY Condition : AVG_BE_54 3m 91200_15_1620 VERTICAL RBW:1000.000KHz VBW:10.000KHz SWT:Auto Detector : Peak Project : 922214 Mode : 8</p>	 <p>Date: 2019-04-04</p> <p>Site : 03CH15-HY Condition : AVG_54 3m 91200_15_1620 VERTICAL RBW:1000.000KHz VBW:10.000KHz SWT:Auto Detector : Peak Project : 922214 Mode : 8</p>

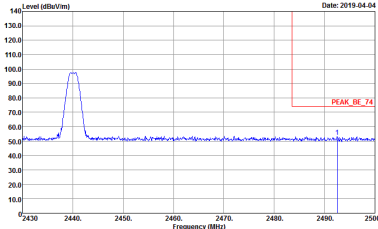
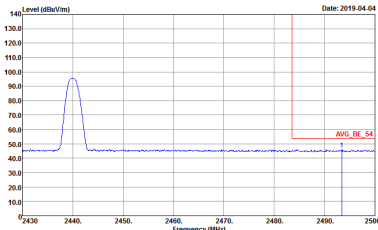

BLE	2.4GHz 2400~2483.5MHz Band Edge @ 3m	
ANT	BLE_2Mbps CH19 2440MHz - R	
1	Vertical	Fundamental
<p>Peak</p>	 <p>Site : 03CH15-HY Condition : PEAK_BE_74 3m 91200_15_1620 VERTICAL RBW:1000.000KHz VBW:3000.000KHz SWT:Auto Detector : Peak Project : 922214 Mode : 8</p>	<p>Left blank</p>
<p>Avg.</p>	 <p>Site : 03CH15-HY Condition : AVG_BE_54 3m 91200_15_1620 VERTICAL RBW:1000.000KHz VBW:30.000KHz SWT:Auto Detector : Peak Project : 922214 Mode : 8</p>	<p>Left blank</p>

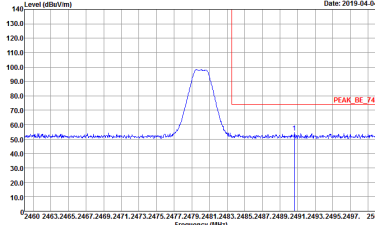
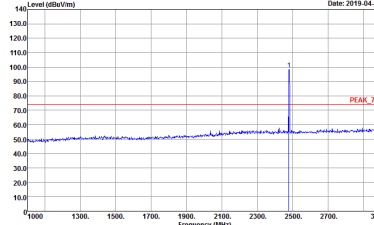
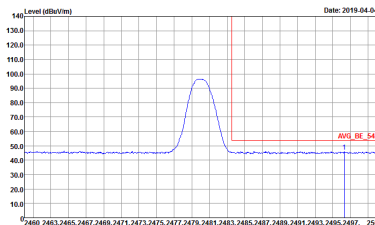
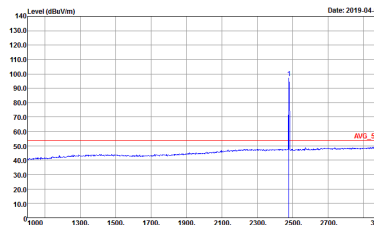

BLE	2.4GHz 2400~2483.5MHz Band Edge @ 3m	
ANT	BLE_2Mbps CH39 2480MHz	
1	Horizontal	Fundamental
Peak	 <p>Site : 03CH15-HY Condition : PEAK_BE_74 3m 91200_15_1620 HORIZONTAL Detector : Peak Project : 922214 Mode : 9</p>	 <p>Site : 03CH15-HY Condition : PEAK_74 3m 91200_15_1620 HORIZONTAL Detector : Peak Project : 922214 Mode : 9</p>
Avg.	 <p>Site : 03CH15-HY Condition : AVG_BE_54 3m 91200_15_1620 HORIZONTAL Detector : Peak Project : 922214 Mode : 9</p>	 <p>Site : 03CH15-HY Condition : AVG_54 3m 91200_15_1620 HORIZONTAL Detector : Peak Project : 922214 Mode : 9</p>

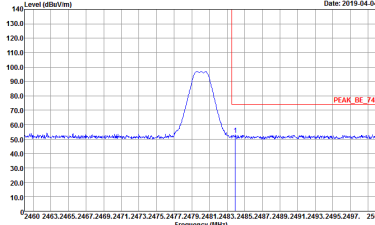
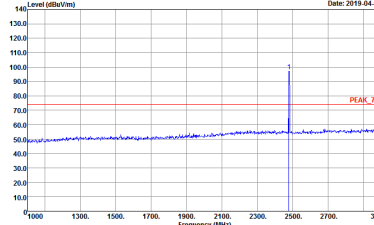
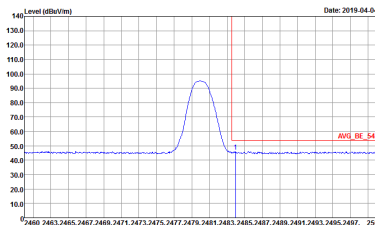
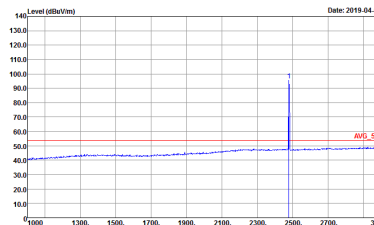

BLE	2.4GHz 2400~2483.5MHz Band Edge @ 3m	
ANT	BLE_2Mbps CH39 2480MHz	
1	Vertical	Fundamental
Peak	 <p>Date: 2019-04-04</p> <p>Level (dBm/100kHz)</p> <p>Frequency (MHz)</p> <p>PEAK_BE_74</p> <p>Site : 03CH15-HY Condition : PEAK_BE_74 3m 91200_15_1620 VERTICAL RBW:1000.000KHz VBW:3000.000KHz SWT:Auto Detector : Peak Project : 922214 Mode : 9</p>	 <p>Date: 2019-04-04</p> <p>Level (dBm/100kHz)</p> <p>Frequency (MHz)</p> <p>PEAK_74</p> <p>Site : 03CH15-HY Condition : PEAK_74 3m 91200_15_1620 VERTICAL RBW:1000.000KHz VBW:3000.000KHz SWT:Auto Detector : Peak Project : 922214 Mode : 9</p>
Avg.	 <p>Date: 2019-04-04</p> <p>Level (dBm/100kHz)</p> <p>Frequency (MHz)</p> <p>AVG_BE_54</p> <p>Site : 03CH15-HY Condition : AVG_BE_54 3m 91200_15_1620 VERTICAL RBW:1000.000KHz VBW:10.000KHz SWT:Auto Detector : Peak Project : 922214 Mode : 9</p>	 <p>Date: 2019-04-04</p> <p>Level (dBm/100kHz)</p> <p>Frequency (MHz)</p> <p>AVG_54</p> <p>Site : 03CH15-HY Condition : AVG_54 3m 91200_15_1620 VERTICAL RBW:1000.000KHz VBW:10.000KHz SWT:Auto Detector : Peak Project : 922214 Mode : 9</p>



2.4GHz 2400~2483.5MHz

BLE_2Mbps (Harmonic @ 3m)

BLE	2.4GHz 2400~2483.5MHz Harmonic @ 3m	
ANT	BLE_2Mbps CH00 2402MHz	
1	Horizontal	Vertical
Peak Avg.	<p>Site : 03CH15-1F Condition : PEAK_74 3m 91200_15_1620 HORIZONTAL Detector : Peak Project : 922214 Mode : 7</p>	<p>Site : 03CH15-1F Condition : PEAK_74 3m 91200_15_1620 VERTICAL Detector : Peak Project : 922214 Mode : 7</p>

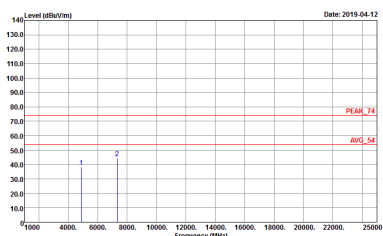
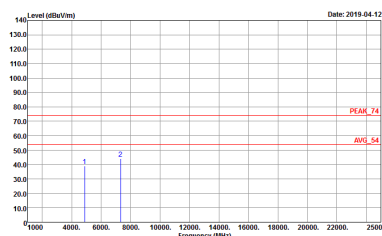

BLE	2.4GHz 2400~2483.5MHz Harmonic @ 3m	
ANT	BLE_2Mbps CH19 2440MHz	
1	Horizontal	Vertical
<p>Peak</p> <p>Avg.</p>	 <p>Site : 03CH15-HY Condition : PEAK_74 3m 91200_15_1620 HORIZONTAL Detector : Peak Project : 922214 Mode : S</p>	 <p>Site : 03CH15-HY Condition : PEAK_74 3m 91200_15_1620 VERTICAL Detector : Peak Project : 922214 Mode : S</p>



BLE	2.4GHz 2400~2483.5MHz Harmonic @ 3m	
ANT	BLE_2Mbps CH39 2480MHz	
1	Horizontal	Vertical
Peak	<p>Site : 03CH15-HY Condition : PEAK_74 3m 91200_15_1620 HORIZONTAL Detector : Peak Project : 922214 Mode : 9</p>	<p>Site : 03CH15-HY Condition : PEAK_74 3m 91200_15_1620 VERTICAL Detector : Peak Project : 922214 Mode : 9</p>



Emission below 1GHz
2.4GHz BLE_2Mbps (LF)

BLE	2.4GHz 2400~2483.5MHz	
ANT	BLE_2Mbps LF	
1	Horizontal	Vertical
QP / Peak	<p>Site : 03CH15-HY Condition : QP 3m BTL0G_15_41912 HORIZONTAL Detector : Peak Project : 922214 Mode : 56</p>	<p>Site : 03CH15-HY Condition : QP 3m BTL0G_15_41912 VERTICAL Detector : Peak Project : 922214 Mode : 56</p>



Appendix D. Duty Cycle Plots

Band	Duty Cycle(%)	T(us)	1/T(kHz)	VBW Setting	Duty Factor(dB)
Bluetooth –LE for 1Mbps	62.62	392	2.55	3kHz	2.03
Bluetooth –LE for 2Mbps	32.91	206	4.85	10kHz	4.83

<1 Mbps>

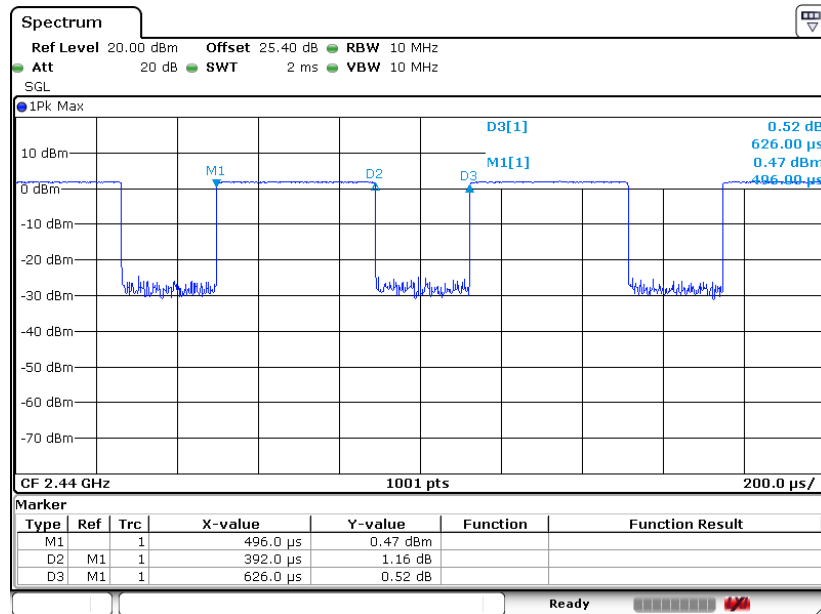

Date: 19.MAR.2019 03:47:01



<2 Mbps>

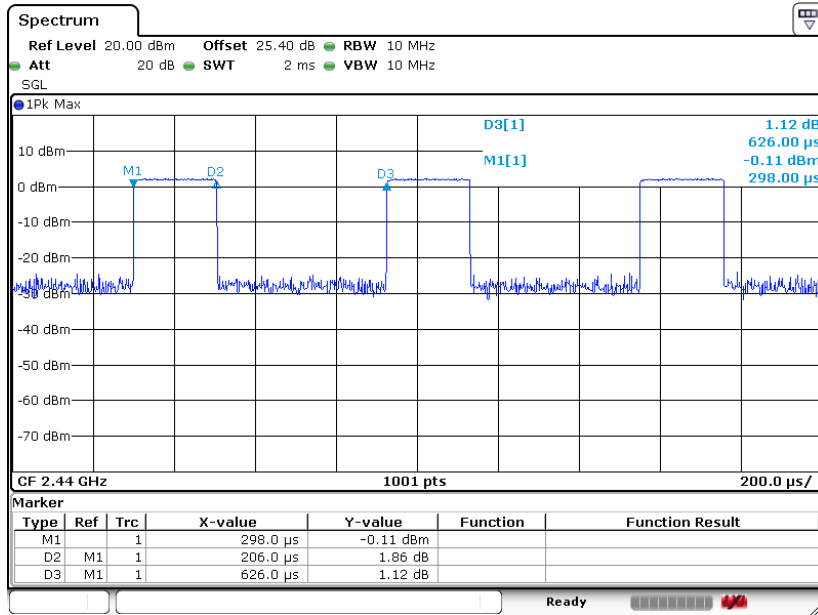

Date: 19.MAR.2019 03:57:50