



FCC RADIO TEST REPORT

FCC ID : UZ7RFD8500
Equipment : RFD8500 UHF RFID READER
Brand Name : ZEBRA
Model Name : RFD8500
Applicant : Zebra Technologies Corporation
1 Zebra Plaza, Holtsville, NY 11742
Manufacturer : Zebra Technologies Corporation
1 Zebra Plaza, Holtsville, NY 11742
Standard : FCC Part 15 Subpart C §15.247

The product was received on Jul. 07, 2022 and testing was started from Jul. 12, 2022 to Jul. 25, 2022. We, Sporton International Inc. EMC & Wireless Communications Laboratory, would like to declare that the tested sample has been evaluated in accordance with the test procedures and has been in compliance with the applicable technical standards.

The test results in this report apply exclusively to the tested model / sample. Without written approval of Sporton International Inc. EMC & Wireless Communications Laboratory, the test report shall not be reproduced except in full.

Approved by: Louis Wu

Sporton International Inc. EMC & Wireless Communications Laboratory
No. 52, Huaya 1st Rd., Guishan Dist., Taoyuan City 333, Taiwan (R.O.C.)



Table of Contents

History of this test report.....	3
Summary of Test Result.....	4
1 General Description.....	5
1.1 Product Feature of Equipment Under Test.....	5
1.2 Product Specification of Equipment Under Test.....	5
1.3 Modification of EUT	5
1.4 Testing Location	6
1.5 Applicable Standards.....	6
2 Test Configuration of Equipment Under Test.....	7
2.1 Carrier Frequency Channel	7
2.2 Test Mode.....	8
2.3 Connection Diagram of Test System.....	9
2.4 Support Unit used in test configuration and system	10
2.5 EUT Operation Test Setup	10
2.6 Measurement Results Explanation Example.....	10
3 Test Result.....	11
3.1 Number of Channel Measurement	11
3.2 Hopping Channel Separation Measurement	13
3.3 Dwell Time Measurement.....	15
3.4 20dB and 99% Bandwidth Measurement	17
3.5 Output Power Measurement.....	20
3.6 Conducted Band Edges Measurement.....	22
3.7 Conducted Spurious Emission Measurement	24
3.8 Radiated Band Edges and Spurious Emission Measurement	26
3.9 AC Power Line Conducted Emissions Measurement.....	30
3.10 Antenna Requirements.....	32
4 List of Measuring Equipment	33
5 Uncertainty of Evaluation.....	34
Appendix A. AC Conducted Emission Test Result	
Appendix B. Radiated Spurious Emission	
Appendix C. Radiated Spurious Emission Plots	
Appendix D. Duty Cycle Plots	
Appendix E. Setup Photographs	



History of this test report

Report No.	Version	Description	Issued Date
FR252407C	01	Initial issue of report	Aug. 19, 2022
FR252407C	02	1. Revise Applicable Standards 2. Revise Test Result of Output Power in section 3.5.5	Sep. 01, 2022



Summary of Test Result

Report Clause	Ref Std. Clause	Test Items	Result (PASS/FAIL)	Remark
3.1	15.247(a)(1)	Number of Channels	Pass	-
3.2	15.247(a)(1)	Hopping Channel Separation	Pass	-
3.3	15.247(a)(1)	Dwell Time of Each Channel	Pass	-
3.4	15.247(a)(1)	20dB Bandwidth	Pass	-
3.4	2.1049	99% Occupied Bandwidth	Reporting Only	-
3.5	15.247(b)(1)	Output Power	Pass	-
3.6	15.247(d)	Conducted Band Edges	Pass	-
3.7	15.247(d)	Conducted Spurious Emission	Pass	-
3.8	15.247(d)	Radiated Band Edges and Radiated Spurious Emission	Pass	6.77 dB under the limit at 211.440 MHz
3.9	15.207	AC Conducted Emission	Pass	12.53 dB under the limit at 0.456 MHz
3.10	15.203 & 15.247(b)	Antenna Requirement	Pass	-

Declaration of Conformity:

1. The test results (PASS/FAIL) with all measurement uncertainty excluded are presented in accordance with the regulation limits or requirements declared by manufacturers. It's means measurement values may risk exceeding the limit of regulation standards, if measurement uncertainty is include in test results.
2. The measurement uncertainty please refer to this report "Uncertainty of Evaluation".

Comments and Explanations:

The product specifications of the EUT presented in the report are declared by the manufacturer who shall take full responsibility for the authenticity.

Reviewed by: Wei Chen

Report Producer: Cindy Liu



1 General Description

1.1 Product Feature of Equipment Under Test

Product Feature	
Equipment	RFD8500 UHF RFID READER
Brand Name	ZEBRA
Model Name	RFD8500
FCC ID	UZ7RFD8500
EUT supports Radios application	UHF RFID Bluetooth BR/EDR/LE
HW Version	EV1
SW Version	PAACPS00-008-N02D0
MFD	28JUN22
EUT Stage	Identical Prototype

Remark: The above EUT's information was declared by manufacturer.

Specification of Accessories				
Battery	Brand Name	symbol	Part Number	82-172087-01
Micro USB Cable	Brand Name	ZEBRA	Part Number	25-MCXUSB-01R

Supported Unit used in test configuration and system				
AC Adapter	Brand Name	ZEBRA	Part Number	PWR-WUA5V6W0WHT
Termial	Brand Name	Zebra	Model Name	TC26BK

1.2 Product Specification of Equipment Under Test

Product Specification is subject to this standard	
Tx/Rx Frequency Range	902.75 MHz ~ 927.25 MHz
Number of Channels	50
Maximum Output Power to Antenna	29.85 dBm (0.9661 W)
20dB Bandwidth	0.097 MHz
99% Occupied Bandwidth	0.092 MHz
Antenna Type / Gain	Patch Antenna with gain 4.63 dBi
Type of Modulation	ASK

Remark: The above EUT's information was declared by manufacturer. Please refer to Comments and Explanations in report summary.

1.3 Modification of EUT

No modifications are made to the EUT during all test items.



1.4 Testing Location

Test Site	Sporton International Inc. EMC & Wireless Communications Laboratory
Test Site Location	No.52, Huaya 1st Rd., Guishan Dist., Taoyuan City 333, Taiwan (R.O.C.) TEL: +886-3-327-3456 FAX: +886-3-328-4978
Test Site No.	Sporton Site No. CO05-HY, 03CH07-HY

Note: The test site complies with ANSI C63.4 2014 requirement.

Test Site	Sporton International Inc. Wensan Laboratory
Test Site Location	No.58, Aly. 75, Ln. 564, Wenhua 3rd, Rd., Guishan Dist., Taoyuan City 333010, Taiwan (R.O.C.) TEL: +886-3-327-0868 FAX: +886-3-327-0855
Test Site No.	Sporton Site No. TH05-HY (TAF Code: 3786)
Remark	The Conducted test item subcontracted to Sporton International Inc. Wensan Laboratory.

FCC designation No.: TW1190 and TW3786

1.5 Applicable Standards

According to the specifications of the manufacturer, the EUT must comply with the requirements of the following standards:

- ♦ FCC Part 15 Subpart C §15.247
- ♦ FCC KDB Publication No. 558074 D01 15.247 Meas Guidance v05r02
- ♦ FCC KDB 414788 D01 Radiated Test Site v01r01
- ♦ ANSI C63.10-2013

Remark:

1. All test items were verified and recorded according to the standards and without any deviation during the test.
2. The TAF code is not including all the FCC KDB listed without accreditation.
3. This EUT has also been tested and complied with the requirements of FCC Part 15, Subpart B, recorded in a separate test report.



2 Test Configuration of Equipment Under Test

2.1 Carrier Frequency Channel

Frequency Band	Channel	Freq. (MHz)	Channel	Freq. (MHz)
902.75-927.25 MHz	1	915.45	28	922.20
	2	915.70	29	922.45
	3	915.95	30	922.70
	4	916.20	31	922.95
	5	916.45	32	923.20
	6	916.70	33	923.45
	7	916.95	34	923.70
	8	917.20	35	923.95
	9	917.45	36	924.20
	10	917.70	37	924.45
	11	917.95	38	924.70
	12	918.20	39	924.95
	13	918.45	40	925.20
	14	918.70	41	925.45
	15	918.95	42	925.70
	16	919.20	43	925.95
	17	919.45	44	926.20
	18	919.70	45	926.45
	19	919.95	46	926.70
	20	920.20	47	926.95
	21	920.45	48	927.20
	22	920.70	49	927.45
	23	920.95	50	927.70
	24	921.20		
	25	921.45		
	26	921.70		
	27	921.95		



2.2 Test Mode

- a. The EUT has been associated with peripherals and configuration operated in a manner tended to maximize its emission characteristics in a typical application. Frequency range investigated: conduction emission (150 kHz to 30 MHz), radiation emission (9 kHz to the 10th harmonic of the highest fundamental frequency or to 40 GHz, whichever is lower). For radiated measurement, the measured emission level of the EUT was maximized by rotating the EUT on a turntable, adjusting the orientation of the EUT and EUT antenna in three orthogonal axis (X: flat, Y: portrait, Z: landscape), and adjusting the measurement antenna orientation, following C63.10 exploratory test procedures and find Y plane as worst plane.

- b. AC power line Conducted Emission was tested under maximum output power.

The following summary table is showing all test modes to demonstrate in compliance with the standard.

Summary table of Test Cases	
Test Item	UHF RFID
Conducted Test Cases	Mode 1: UHF RFID Tx 902.75 MHz Mode 2: UHF RFID Tx 914.75 MHz Mode 3: UHF RFID Tx 927.25 MHz
Radiated Test Cases	Mode 1: UHF RFID Tx 902.75 MHz Mode 2: UHF RFID Tx 914.75 MHz Mode 3: UHF RFID Tx 927.25 MHz
AC Conducted Emission	Mode 1: Bluetooth Idle + Terminal PDA + Micro USB Cable (Charging with AC Adapter)

2.3 Connection Diagram of Test System

<AC Conducted Emission Mode>

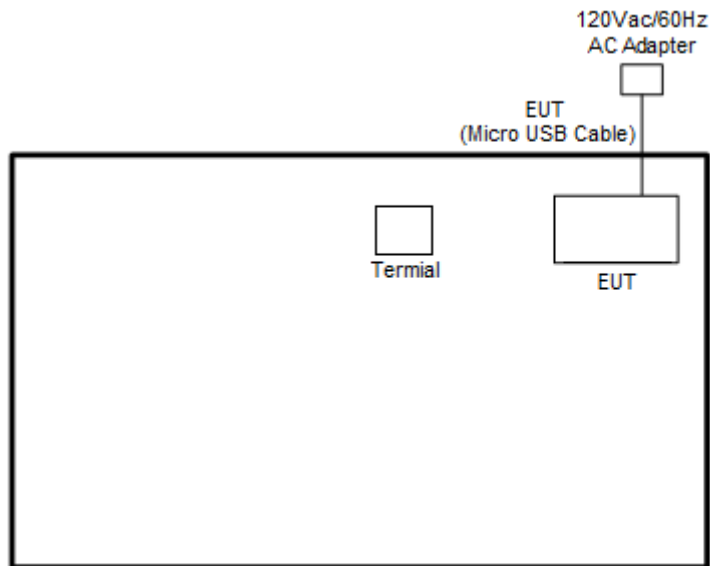

<Radiated Spurious Emission Mode>

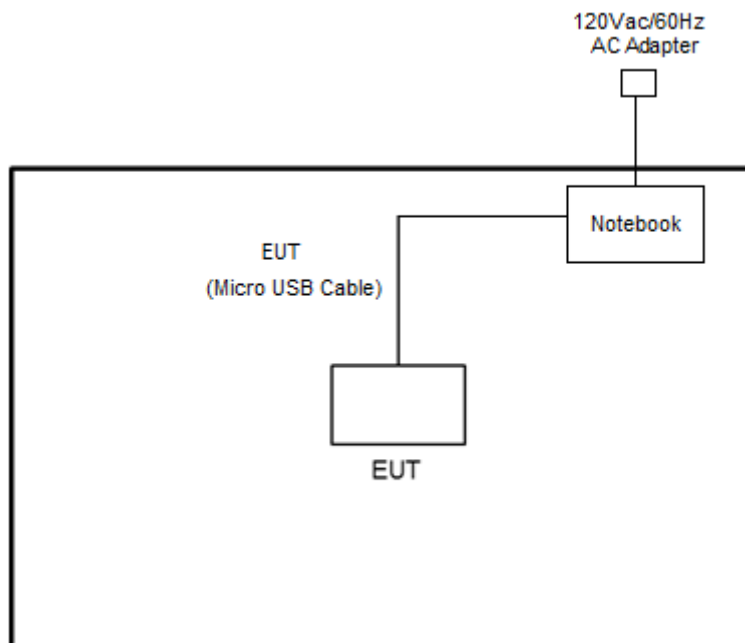



2.4 Support Unit used in test configuration and system

Item	Equipment	Brand Name	Model Name	FCC ID	Data Cable	Power Cord
1.	Notebook	Dell	E3340	FCC DoC	N/A	AC I/P: Unshielded, 1.2 m DC O/P: Shielded, 1.8 m

2.5 EUT Operation Test Setup

The RF test items, utility “Tera Term Version 4.95” was installed in EUT which was programmed in order to make the EUT get into the engineering modes to provide channel selection, power level, data rate and the application type and for continuous transmitting signals.

2.6 Measurement Results Explanation Example

For all conducted test items:

The offset level is set in the spectrum analyzer to compensate the RF cable loss and attenuator factor between EUT conducted output port and spectrum analyzer. With the offset compensation, the spectrum analyzer reading level is exactly the EUT RF output level.

Example:

The spectrum analyzer offset is derived from RF cable loss and attenuator factor.

Offset = RF cable loss + attenuator factor.

Following shows an offset computation example with cable loss 4.2 dB and 10 dB attenuator.

$$\begin{aligned} \text{Offset(dB)} &= \text{RF cable loss(dB)} + \text{attenuator factor(dB)}. \\ &= 4.2 + 10 = 14.2 \text{ (dB)} \end{aligned}$$

3 Test Result

3.1 Number of Channel Measurement

3.1.1 Limits of Number of Hopping Frequency

Frequency hopping systems in the 902.75-927.25 MHz band shall use at least 25 channels.

3.1.2 Measuring Instruments

Please refer to the measuring equipment list in this test report.

3.1.3 Test Procedure

1. The testing follows ANSI C63.10-2013 clause 7.8.3.
2. The RF output of EUT was connected to the spectrum analyzer by RF cable and attenuator. The path loss was compensated to the results for each measurement.
3. Set the maximum power setting and enable the EUT to transmit continuously.
4. Enable the EUT hopping function.
5. Use the following spectrum analyzer settings: Span = the frequency band of operation; RBW = 300 kHz; VBW \geq RBW; Sweep = auto; Detector function = peak; Trace = max hold.
6. The number of hopping frequency used is defined as the number of total channel.
7. Record the measurement data derived from spectrum analyzer.

3.1.4 Test Setup

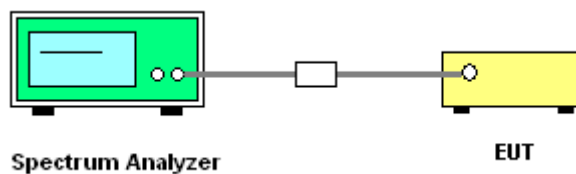



3.1.5 Test Result of Number of Hopping Frequency

Test Mode :	UHF RFID	Temperature :	20~25°C
Test Engineer :	Shiming Liu	Relative Humidity :	50~56%

Number of Hopping (Channel)	Limits (Channel)	Pass/Fail
50	> 25	Pass

Number of Hopping Channel Plot on Channel 00 - 49

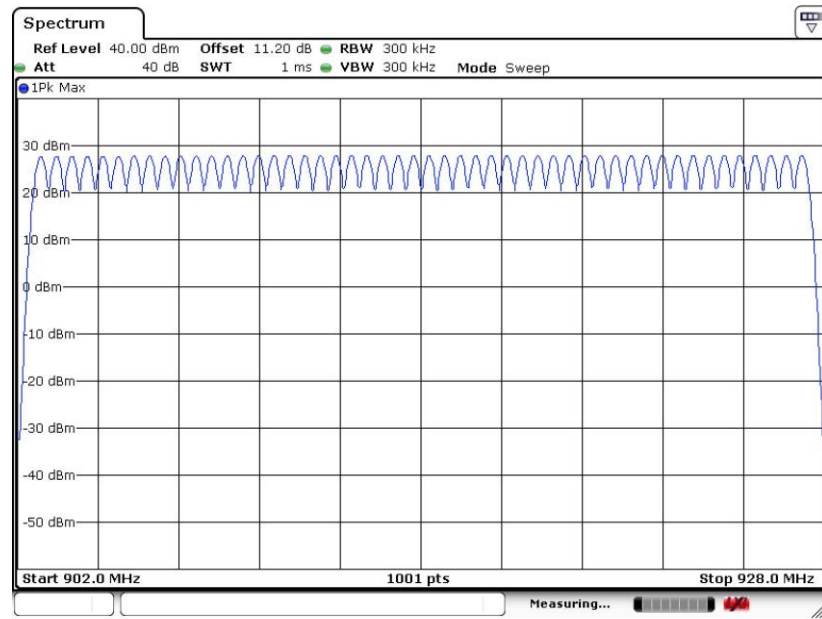

3.2 Hopping Channel Separation Measurement

3.2.1 Limit of Hopping Channel Separation

Frequency hopping systems operating in the 902.75-927.25 MHz band may have hopping channel carrier frequencies that are 20 dB bandwidth of the hopping channel, whichever is greater.

3.2.2 Measuring Instruments

Please refer to the measuring equipment list in this test report.

3.2.3 Test Procedures

1. The testing follows ANSI C63.10-2013 clause 7.8.2.
2. The RF output of EUT was connected to the spectrum analyzer by RF cable and attenuator. The path loss was compensated to the results for each measurement.
3. Set the maximum power setting and enable the EUT to transmit continuously.
4. Enable the EUT hopping function.
5. Use the following spectrum analyzer settings:
Span = wide enough to capture the peaks of two adjacent channels;
RBW = 300 kHz; VBW \geq RBW; Sweep = auto; Detector function = peak; Trace = max hold.
6. Measure and record the results in the test report.

3.2.4 Test Setup





3.2.5 Test Result of Hopping Channel Separation

Test Mode :	UHF RFID	Temperature :	20~25°C
Test Engineer :	Shiming Liu	Relative Humidity :	50~56%

Mod.	NTX	Freq. (MHz)	Hopping Channel Separation Measurement (MHz)	Hopping Channel Separation Measurement Limit (MHz)	Pass/Fail
UHF RFID	1	902.75	0.501	0.0949	Pass
UHF RFID	1	914.75	0.501	0.0969	Pass
UHF RFID	1	927.25	0.492	0.0969	Pass

Channel Separation Plot on 902.75 MHz

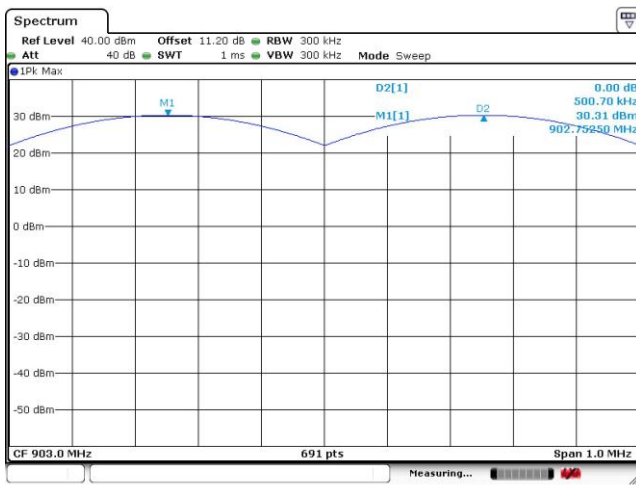

Date: 25.JUL.2022 21:14:00

Channel Separation Plot on 914.75 MHz

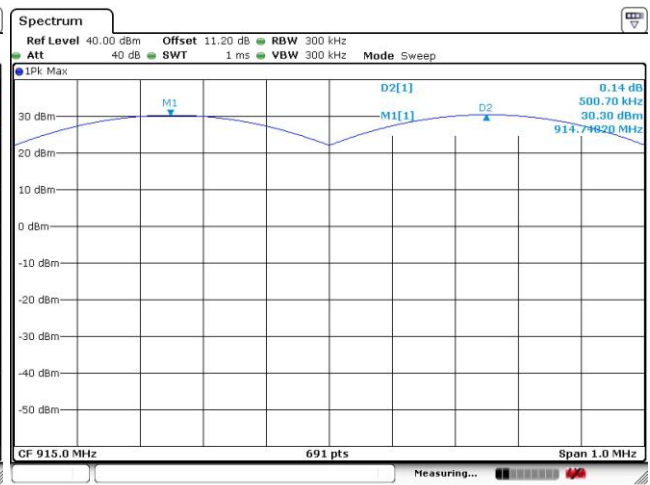

Date: 25.JUL.2022 21:19:45

Channel Separation Plot on 927.25 MHz

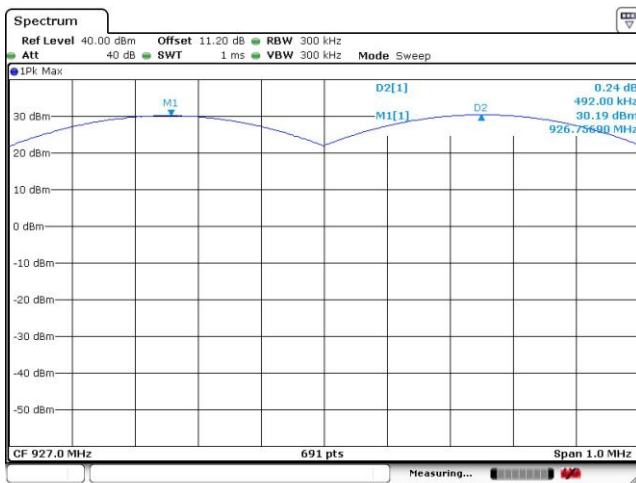

Date: 25.JUL.2022 21:32:32

3.3 Dwell Time Measurement

3.3.1 Limit of Dwell Time

The average time of occupancy on any channel shall not be greater than 0.4 seconds within a period of 20 seconds multiplied by the number of hopping channels employed.

3.3.2 Measuring Instruments

Please refer to the measuring equipment list in this test report.

3.3.3 Test Procedures

1. The testing follows ANSI C63.10-2013 clause 7.8.4.
2. The RF output of EUT was connected to the spectrum analyzer by RF cable and attenuator. The path loss was compensated to the results for each measurement.
3. Set the maximum power setting and enable the EUT to transmit continuously.
4. Enable the EUT hopping function.
5. Use the following spectrum analyzer settings: Span = zero span, centered on a hopping channel; RBW = 1 MHz; VBW \geq RBW; Sweep = as necessary to capture the entire dwell time per hopping channel; Detector function = peak; Trace = max hold.
6. Measure and record the results in the test report.

3.3.4 Test Setup

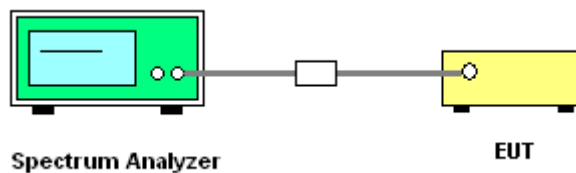



3.3.5 Test Result of Dwell Time

Test Mode :	UHF RFID	Temperature :	20~25°C
Test Engineer :	Shiming Liu	Relative Humidity :	50~56%

Mod.	Channel Number Rate	Package Transfer Time (msec)	Hops Over Occupancy Time (hops)	Dwell Time (sec)	Limits (sec)	Pass/Fail
Nomal	50	13.04	1.00	0.013	0.4	Pass

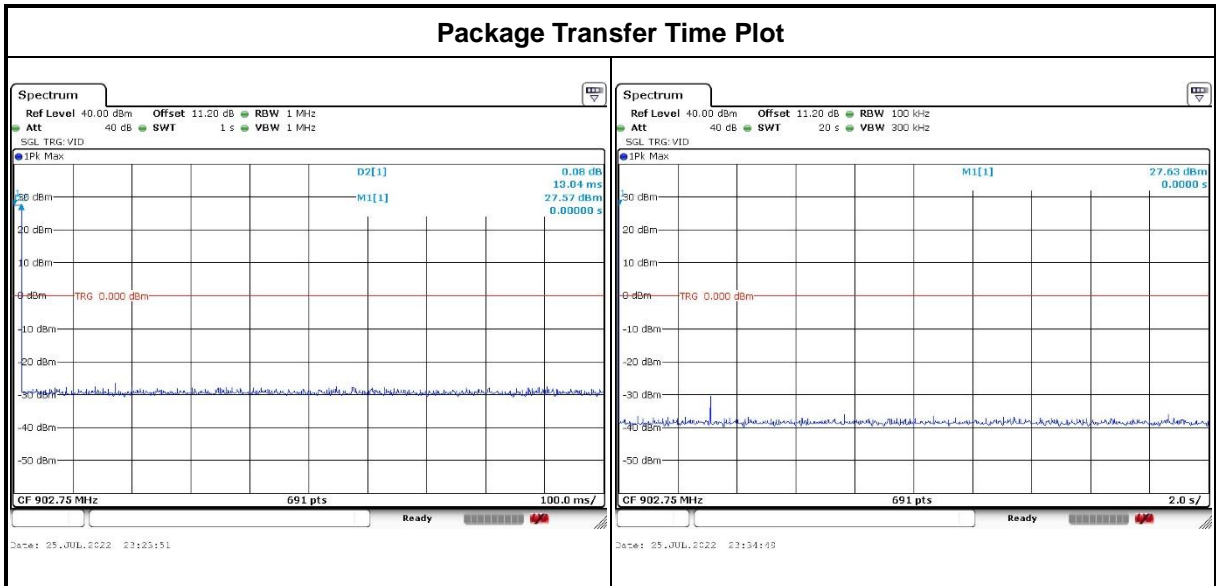

Remark: Dwell Time(s) = Hops Over Occupancy Time (hops) x Package Transfer Time

3.4 20dB and 99% Bandwidth Measurement

3.4.1 Limit of 20dB and 99% Bandwidth

Reporting only

3.4.2 Measuring Instruments

Please refer to the measuring equipment list in this test report.

3.4.3 Test Procedures

1. The testing follows ANSI C63.10-2013 clause 6.9.2 and 6.9.3.
2. The RF output of EUT was connected to the spectrum analyzer by RF cable and attenuator. The path loss was compensated to the results for each measurement.
3. Set the maximum power setting and enable the EUT to transmit continuously.
4. Use the following spectrum analyzer settings for 20 dB Bandwidth measurement.
Span = approximately 2 to 5 times the 20 dB bandwidth, centered on a hopping channel;
RBW \geq 1% of the 20 dB bandwidth; VBW \geq RBW; Sweep = auto; Detector function = peak;
Trace = max hold.
5. Use the following spectrum analyzer settings for 99 % Bandwidth measurement.
Span = approximately 1.5 to 5 times the 99% bandwidth, centered on a hopping channel;
RBW \geq 1-5% of the 99% bandwidth; VBW \geq 3 * RBW; Sweep = auto; Detector function = peak;
Trace = max hold.
6. Measure and record the results in the test report.

3.4.4 Test Setup

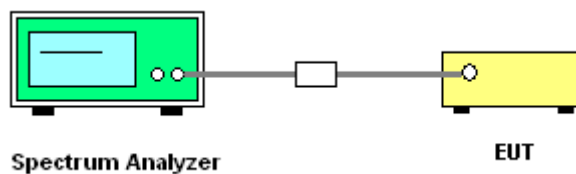



3.4.5 Test Result of 20dB Bandwidth

Test Mode :	UHF RFID	Temperature :	20~25°C
Test Engineer :	Shiming Liu	Relative Humidity :	50~56%

Mod.	NTX	Freq.(MHz)	20db BW (MHz)	Pass/Fail
UHF RFID	1	902.75	0.095	Pass
UHF RFID	1	914.75	0.097	Pass
UHF RFID	1	927.25	0.097	Pass

20 dB Bandwidth Plot on 902.75 MHz

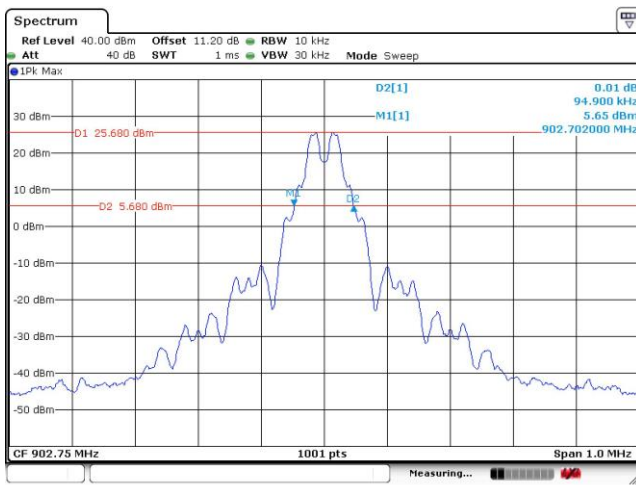

Date: 22.JUL.2022 21:26:37

20 dB Bandwidth Plot on 914.75 MHz

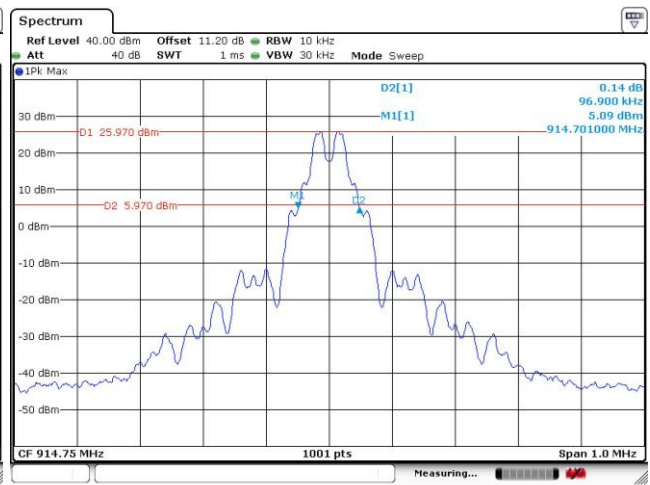

Date: 22.JUL.2022 21:32:43

20 dB Bandwidth Plot on 927.25 MHz



Date: 22.JUL.2022 22:15:35



3.4.6 Test Result of 99% Occupied Bandwidth

Test Mode :	UHF RFID	Temperature :	20~25°C
Test Engineer :	Shiming Liu	Relative Humidity :	50~56%

Mod.	NTX	Freq. (MHz)	99% Bandwidth (MHz)	Pass/Fail
UHF RFID	1	902.75	0.088	Pass
UHF RFID	1	914.75	0.090	Pass
UHF RFID	1	927.25	0.092	Pass

99% Occupied Bandwidth Plot on 902.75 MHz

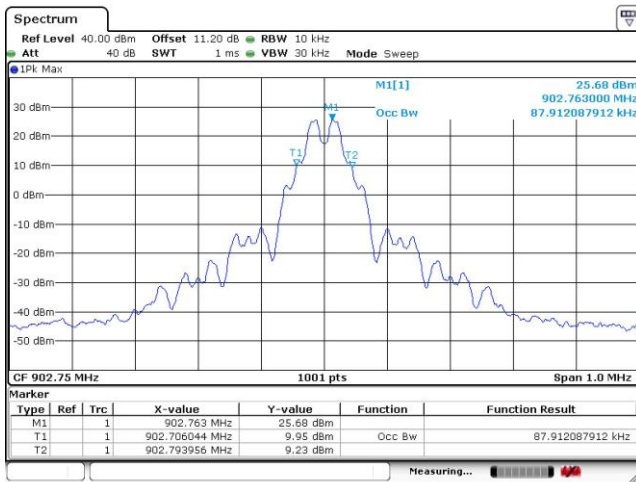

Date: 25.JUL.2022 22:53:34

99% Occupied Bandwidth Plot on 914.75 MHz

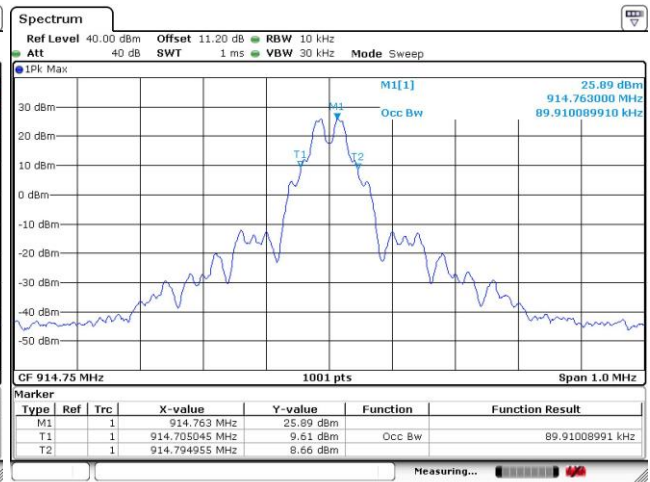

Date: 25.JUL.2022 22:54:46

99% Occupied Bandwidth Plot on 927.25 MHz



Date: 25.JUL.2022 22:55:50

Note: The occupied channel bandwidth is maintained within the band of operation for all of the modulations.

3.5 Output Power Measurement

3.5.1 Limit of Output Power

Section 15.247 (a) Operation under the provisions of this Section is limited to frequency hopping and digitally modulated intentional radiators that comply with the following provisions: (1)(i) For frequency hopping systems operating in the 902-928 MHz band: if the 20 dB bandwidth of the hopping channel is less than 250 kHz, the system shall use at least 50 hopping frequencies and the average time of occupancy on any frequency shall not be greater than 0.4 seconds within a 20 second period; if the 20 dB bandwidth of the hopping channel is 250 kHz or greater, the system shall use at least 25 hopping frequencies and the average time of occupancy on any frequency shall not be greater than 0.4 seconds within a 10 second period. The maximum allowed 20 dB bandwidth of the hopping channel is 500 kHz.

Section 15.247 (b) The maximum peak conducted output power of the intentional radiator shall not exceed the following: (2) For frequency hopping systems operating in the 902-928 MHz band: 1 watt for systems employing at least 50 hopping channels; and, 0.25 watts for systems employing less than 50 hopping channels, but at least 25 hopping channels, as permitted under paragraph (a)(1)(i) of this section.

3.5.2 Measuring Instruments

Please refer to the measuring equipment list in this test report.

3.5.3 Test Procedures

1. The testing follows ANSI C63.10-2013 clause 7.8.5.
2. The RF output of EUT was connected to the power meter by RF cable and attenuator. The path loss was compensated to the results for each measurement.
3. Set the maximum power setting and enable the EUT to transmit continuously.
4. Measure the conducted output power with cable loss and record the results in the test report.
5. Measure and record the results in the test report.

3.5.4 Test Setup

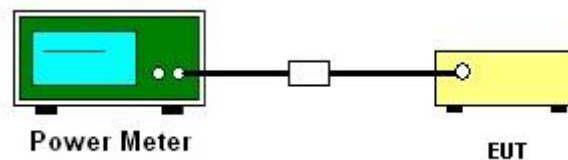

**3.5.5 Test Result of Output Power**

Test Mode :	UHF RFID	Temperature :	20~25°C
Test Engineer :	Shiming Liu	Relative Humidity :	50~56%

Frequency (MHz)	RF Power (dBm)		
	UHF	Max. Limits (dBm)	Pass/Fail
902.75	29.85	30.00	Pass
914.75	29.77	30.00	Pass
927.25	29.85	30.00	Pass

3.5.6 Test Result of Average Power (Reporting Only)

Test Mode :	UHF RFID	Temperature :	20~25°C
Test Engineer :	Shiming Liu	Relative Humidity :	50~56%

Frequency (MHz)	RF Power (dBm)
	UHF
902.75	28.32
914.75	28.40
927.25	28.45

3.6 Conducted Band Edges Measurement

3.6.1 Limit of Band Edges

In any 100 kHz bandwidth outside the intentional radiation frequency band, the radio frequency power shall be at least 20 dB below the highest level of the radiated power. In addition, radiated emissions which fall in the restricted bands must also comply with the radiated emission limits.

3.6.2 Measuring Instruments

Please refer to the measuring equipment list in this test report.

3.6.3 Test Procedures

1. The testing follows ANSI C63.10-2013 clause 7.8.6.
2. Set the maximum power setting and enable the EUT to transmit continuously.
3. Set RBW = 100 kHz, VBW = 300 kHz. Band edge emissions must be at least 20 dB down from the highest emission level within the authorized band as measured with a 100 kHz RBW. The attenuation shall be 30 dB instead of 20 dB when RMS conducted output power procedure is used.
4. Enable hopping function of the EUT and then repeat step 2 and 3.
5. Measure and record the results in the test report.

3.6.4 Test Setup

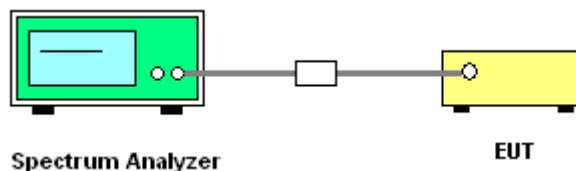



3.6.5 Test Result of Conducted Band Edges

Test Mode :	UHF RFID	Temperature :	20~25°C
Test Engineer :	Shiming Liu	Relative Humidity :	50~56%

Low Band Edge Plot on 902.75 MHz

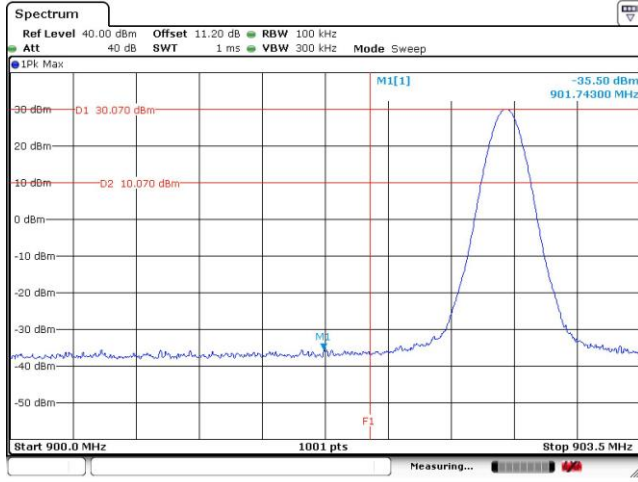

High Band Edge Plot on 927.25 MHz

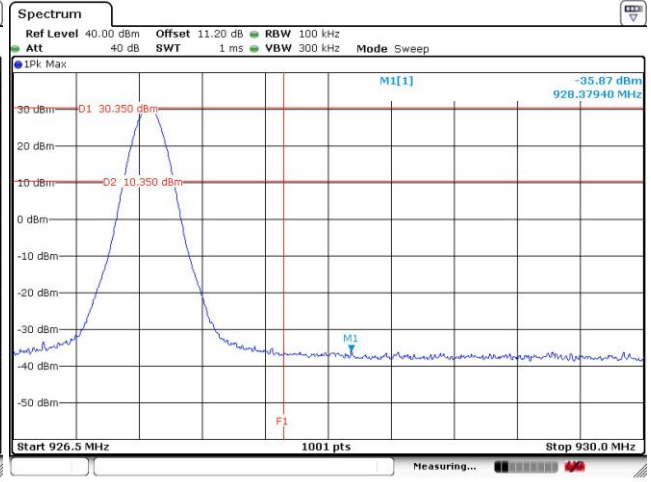

3.6.6 Test Result of Conducted Hopping Mode Band Edges

Test Mode :	UHF RFID	Temperature :	20~25°C
Test Engineer :	Shiming Liu	Relative Humidity :	50~56%

Hopping Mode Low Band Edge Plot on 902.75 MHz

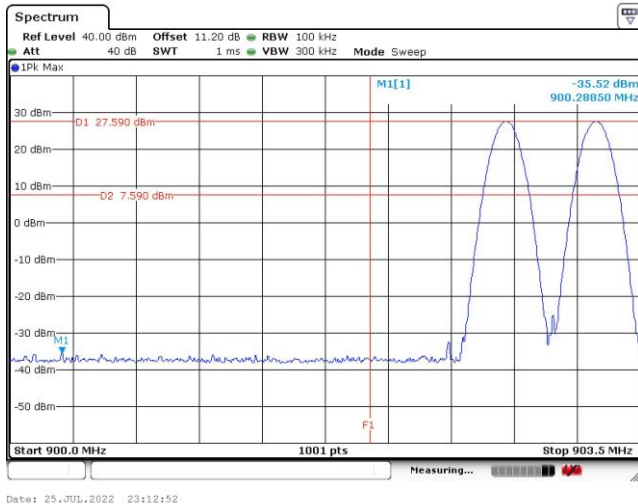

Hopping Mode Low Band Edge Plot on 927.25 MHz

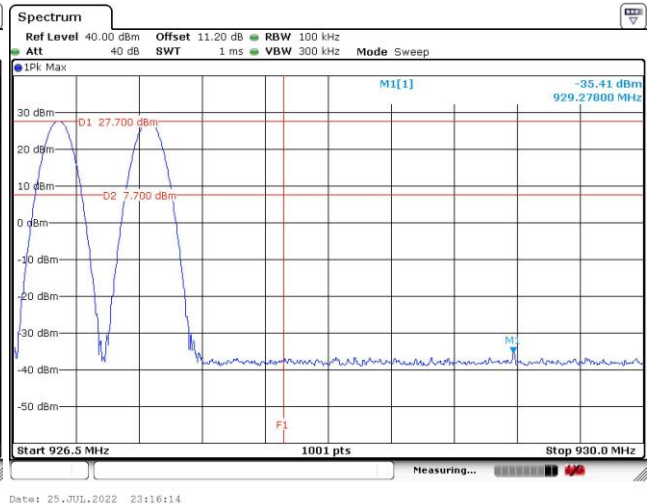

3.7 Conducted Spurious Emission Measurement

3.7.1 Limit of Spurious Emission Measurement

In any 100 kHz bandwidth outside the intentional radiation frequency band, the radio frequency power shall be at least 20 dB below the highest level of the radiated power. In addition, radiated emissions which fall in the restricted bands must also comply with the radiated emission limits.

3.7.2 Measuring Instruments

Please refer to the measuring equipment list in this test report.

3.7.3 Test Procedure

1. The testing follows ANSI C63.10-2013 clause 7.8.8.
2. The RF output of EUT was connected to the spectrum analyzer by RF cable and attenuator. The path loss was compensated to the results for each measurement.
3. Set the maximum power setting and enable the EUT to transmit continuously.
4. Set RBW = 100 kHz, VBW = 300 kHz, scan up through 10th harmonic. All harmonics / spurs must be at least 20 dB down from the highest emission level within the authorized band as measured with a 100 kHz RBW.
5. Measure and record the results in the test report.
6. The RF fundamental frequency should be excluded against the limit line in the operating frequency band.

3.7.4 Test Setup

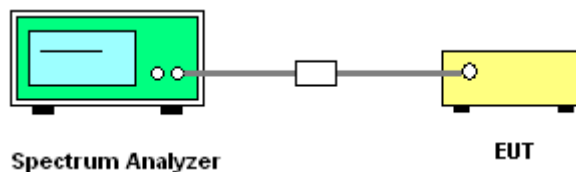



3.7.5 Test Result of Conducted Spurious Emission

Test Mode :	UHF RFID	Temperature :	20~25°C
Test Engineer :	Shiming Liu	Relative Humidity :	50~56%

CSE Plot on 902.75 MHz between 30MHz ~ 10 GHz CSE Plot on 914.75 MHz between 30MHz ~ 10 GHz

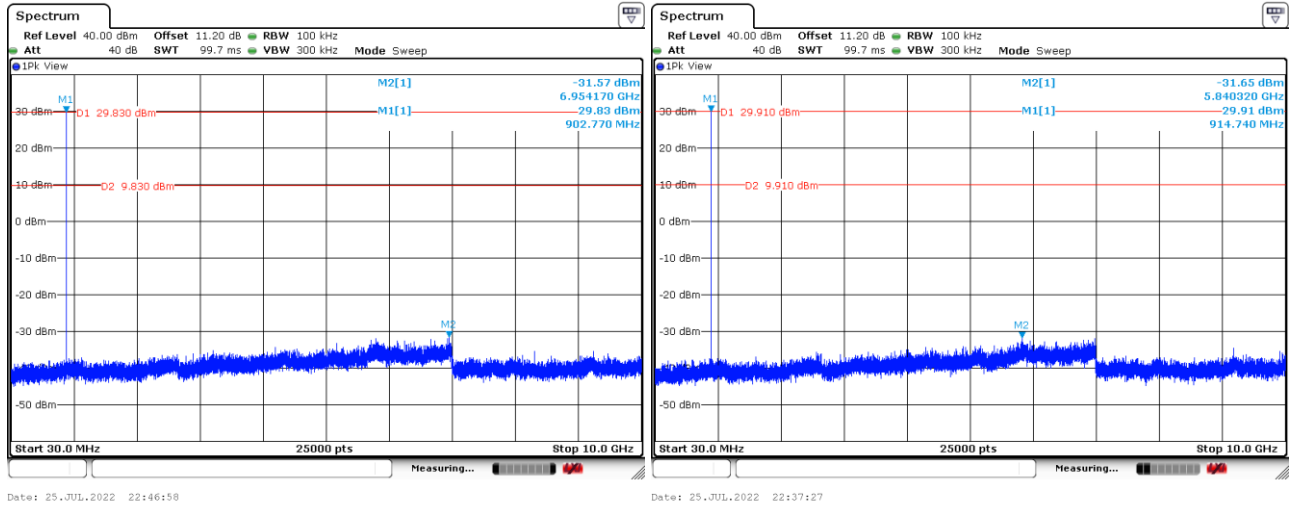

CSE Plot on 927.25 MHz between 30MHz ~ 10 GHz

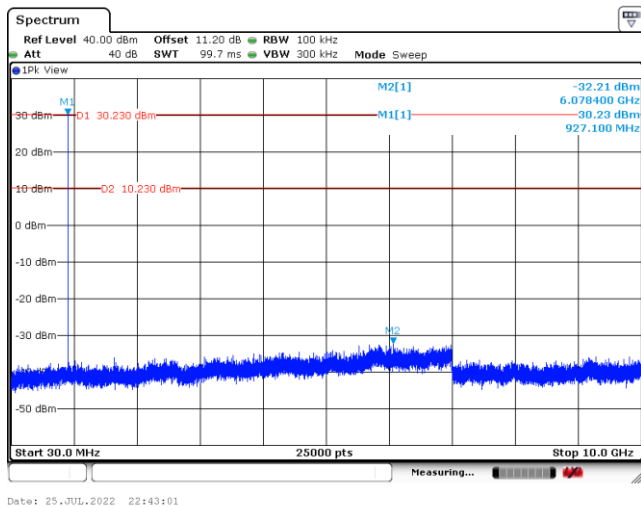



3.8 Radiated Band Edges and Spurious Emission Measurement

3.8.1 Limit of Radiated Band Edges and Spurious Emission

In any 100 kHz bandwidth outside the intentional radiator frequency band, all harmonics/spurious must be at least 20 dB below the highest emission level within the authorized band. In addition, radiated emissions which fall in the restricted bands must also comply with the limits as below.

Frequency (MHz)	Field Strength (microvolts/meter)	Measurement Distance (meters)
0.009 – 0.490	2400/F(kHz)	300
0.490 – 1.705	24000/F(kHz)	30
1.705 – 30.0	30	30
30 – 88	100	3
88 – 216	150	3
216 - 960	200	3
Above 960	500	3

3.8.2 Measuring Instruments

Please refer to the measuring equipment list in this test report.

**3.8.3 Test Procedures**

1. The EUT is placed on a turntable with 0.8 meter for frequency below 1 GHz and 1.5 meter for frequency above 1 GHz respectively above ground.
2. The EUT is set 3 meters away from the receiving antenna, which is mounted on the top of a variable height antenna tower.
3. For each suspected emission, the EUT is arranged to its worst case and then tune the Antenna tower (from 1 m to 4 m) and turntable (from 0 degree to 360 degrees) to find the maximum reading. A pre-amp and a high pass filter are used for the test in order to get better signal level to comply with the guidelines.
4. Set the maximum power setting and enable the EUT to transmit continuously.
5. Use the following spectrum analyzer settings:
 - (1) Span shall wide enough to fully capture the emission being measured;
 - (2) Set RBW = 100 kHz for $f < 1$ GHz, RBW = 1 MHz for $f > 1$ GHz ; VBW \geq RBW; Sweep = auto; Detector function = peak; Trace = max hold for peak
 - (3) For average measurement: use duty cycle correction factor method per 15.35(c).
Duty cycle = On time/100 milliseconds
On time = $N_1 * L_1 + N_2 * L_2 + \dots + N_{n-1} * L_{n-1} + N_n * L_n$
Where N_1 is number of type 1 pulses, L_1 is length of type 1 pulses, etc.
Average Emission Level = Peak Emission Level + $20 * \log$ (Duty cycle)
6. Corrected Reading: Antenna Factor + Cable Loss + Read Level - Preamp Factor = Level
7. Radiated testing below 1 GHz is performed by adjusting the antenna tower from 1 m to 4 m and by rotating the turn table from 0 degree to 360 degrees to find the peak maximum hold reading. When there is no suspected emission found and the emission level is with at least 6 dB margin against QP limit line, the position is marked as “-“.
8. Radiated testing above 1 GHz is performed by adjusting the antenna tower from 1 m to 4 m and by rotating the turn table from 0 degree to 360 degrees to find the peak maximum hold reading for scanning all frequencies. When there is no suspected emission found and the harmonic emission level is with at least 6 dB margin against average limit line, the position is marked as “-“.

3.8.4 Test Setup

For radiated emissions below 30MHz

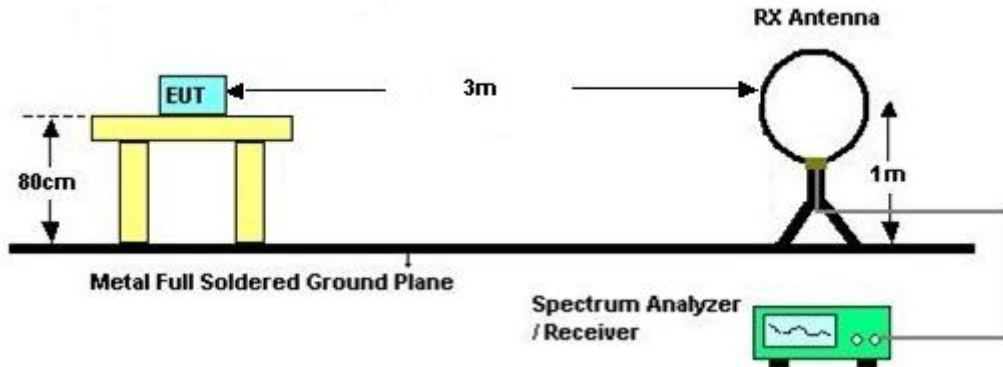

For radiated emissions from 30MHz to 1GHz

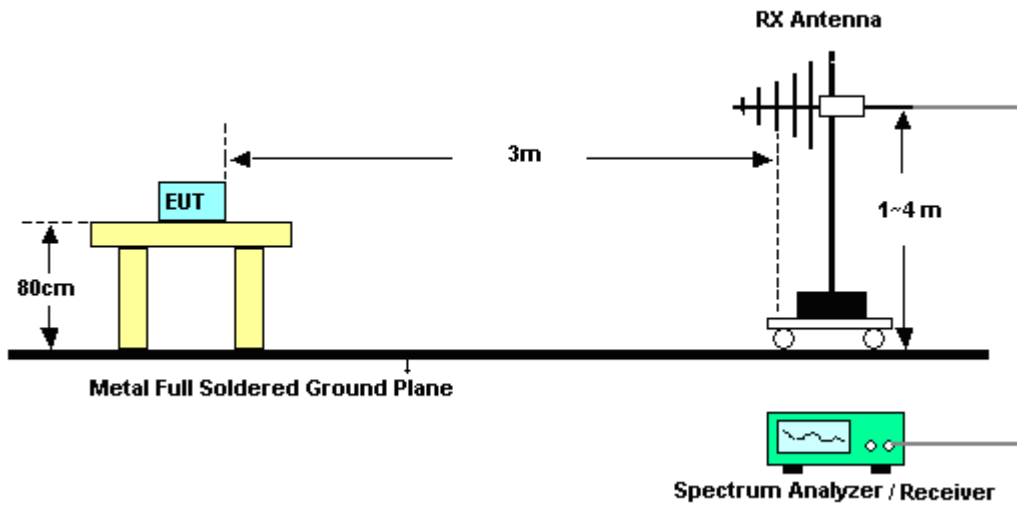

For radiated emissions above 1GHz

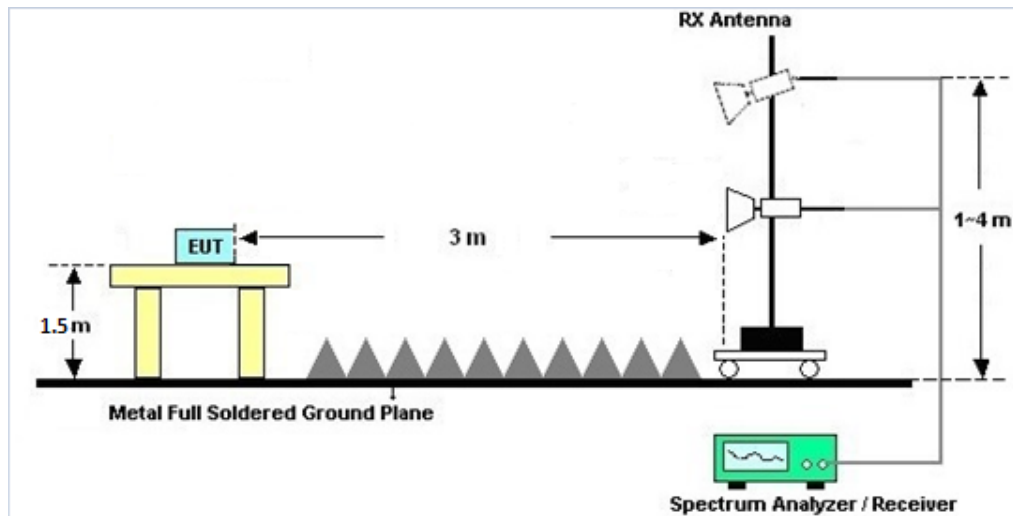

3.8.5 Test Results of Radiated Spurious Emissions (9 kHz ~ 30 MHz)

The low frequency, which started from 9 kHz to 30MHz, was pre-scanned and the result which was 20dB lower than the limit line was not reported.

There is adequate comparison measurement of both open-field test site and alternative test site - semi-Anechoic chamber according to 414788 D01 Radiated Test Site v01r01, and the result came out very similar.

3.8.6 Test Result of Radiated Spurious at Band Edges

Please refer to Appendix B and C.

3.8.7 Duty Cycle

Please refer to Appendix D.

3.8.8 Test Result of Radiated Spurious Emission

Please refer to Appendix B and C.



3.9 AC Power Line Conducted Emissions Measurement

3.9.1 Limit of AC Conducted Emission

For equipment that is designed to be connected to the public utility (AC) power line, the radio frequency voltage that is conducted back onto the AC power line on any frequency or frequencies within the band 150 kHz to 30 MHz shall not exceed the limits in the following table.

Frequency of Emission (MHz)	Conducted Limit (dBµV)	
	Quasi-Peak	Average
0.15-0.5	66 to 56*	56 to 46*
0.5-5	56	46
5-30	60	50

*Decreases with the logarithm of the frequency.

3.9.2 Measuring Instruments

Please refer to the measuring equipment list in this test report.

3.9.3 Test Procedures

1. The EUT was placed 0.4 meter from the conducting wall of the shielding room, and it was kept at least 80 centimeters from any other grounded conducting surface.
2. Connect EUT to the power mains through a line impedance stabilization network (LISN).
3. All the support units are connecting to the other LISN.
4. The LISN provides 50 ohm coupling impedance for the measuring instrument.
5. The FCC states that a 50 ohm, 50 microhenry LISN shall be used.
6. Both sides of AC line were checked for maximum conducted interference.
7. The frequency range from 150 kHz to 30 MHz was searched.
8. Set the test-receiver system to Peak Detect Function and specified bandwidth (IF Bandwidth = 9kHz) with Maximum Hold Mode. Then measurement is also conducted by Average Detector and Quasi-Peak Detector Function respectively.

3.9.4 Test setup

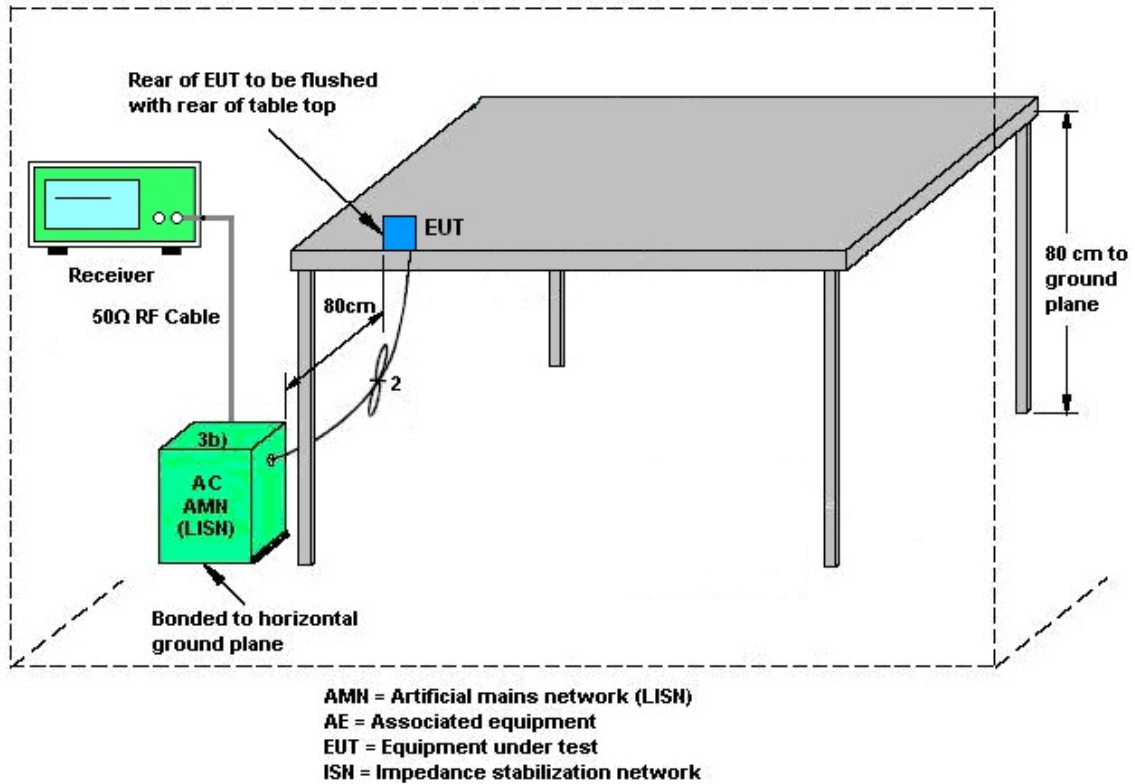

3.9.5 Test Result of AC Conducted Emission

Please refer to Appendix A.



3.10 Antenna Requirements

3.10.1 Standard Applicable

If directional gain of transmitting Antennas is greater than 6 dBi, the power shall be reduced by the same level in dB comparing to gain minus 6 dBi. The use of a permanently attached antenna or of an antenna that uses a unique coupling to the intentional radiator shall be considered sufficient to comply with the rule.

3.10.2 Antenna Anti-Replacement Construction

An embedded-in antenna design is used.

3.10.3 Antenna Gain

The antenna peak gain of EUT is 6 dBi. Therefore, it is not necessary to reduce maximum peak output power limit.



4 List of Measuring Equipment

Instrument	Brand Name	Model No.	Serial No.	Characteristics	Calibration Date	Test Date	Due Date	Remark
Bilog Antenna	TESEQ	CBL 6111D & 00800N1D01N-06	35419 & 03	30MHz~1GHz	Apr. 24, 2022	Jul. 15, 2022~Jul. 16, 2022	Apr. 23, 2023	Radiation (03CH07-HY)
Double Ridge Horn Antenna	ESCO	3117	00075962	1GHz ~ 18GHz	Dec. 03, 2021	Jul. 15, 2022~Jul. 16, 2022	Dec. 02, 2022	Radiation (03CH07-HY)
Loop Antenna	Rohde & Schwarz	HFH2-Z2	100315	9 kHz~30 MHz	Jan. 07, 2022	Jul. 15, 2022~Jul. 16, 2022	Jan. 06, 2023	Radiation (03CH07-HY)
Preamplifier	MITEQ	AMF-7D-0010 1800-30-10P	1590075	1GHz~18GHz	Apr. 21, 2022	Jul. 15, 2022~Jul. 16, 2022	Apr. 20, 2023	Radiation (03CH07-HY)
Preamplifier	COM-POWER	PA-103A	161241	10MHz~1GHz	Oct. 04, 2021	Jul. 15, 2022~Jul. 16, 2022	Oct. 03, 2022	Radiation (03CH07-HY)
Spectrum Analyzer	Agilent	N9030A	MY52350276	3Hz~44GHz	Jul. 22, 2021	Jul. 15, 2022~Jul. 16, 2022	Jul. 21, 2022	Radiation (03CH07-HY)
RF Cable	HUBER + SUHNER	SUCOFLEX 104	MY15682/4	30MHz to 18GHz	Feb. 23, 2022	Jul. 15, 2022~Jul. 16, 2022	Feb. 22, 2023	Radiation (03CH07-HY)
RF Cable	HUBER + SUHNER	SUCOFLEX 104	MY24971/4	9kHz to 18GHz	Feb. 23, 2022	Jul. 15, 2022~Jul. 16, 2022	Feb. 22, 2023	Radiation (03CH07-HY)
RF Cable	HUBER + SUHNER	SUCOFLEX 104	MY28655/4	9kHz to 18GHz	Feb. 23, 2022	Jul. 15, 2022~Jul. 16, 2022	Feb. 22, 2023	Radiation (03CH07-HY)
RF Cable	HUBER + SUHNER	SUCOFLEX 126	532078/126E	30MHz~18GHz	Sep. 17, 2021	Jul. 15, 2022~Jul. 16, 2022	Sep. 16, 2022	Radiation (03CH07-HY)
Controller	EMEC	EM1000	N/A	Control Ant Mast	N/A	Jul. 15, 2022~Jul. 16, 2022	N/A	Radiation (03CH07-HY)
Controller	MF	MF-7802	N/A	Control Turn table	N/A	Jul. 15, 2022~Jul. 16, 2022	N/A	Radiation (03CH07-HY)
Antenna Mast	EMEC	AM-BS-4500E	N/A	Boresight mast 1M~4M	N/A	Jul. 15, 2022~Jul. 16, 2022	N/A	Radiation (03CH07-HY)
Turn Table	ChainTek	Chaintek 3000	N/A	0~360 Degree	N/A	Jul. 15, 2022~Jul. 16, 2022	N/A	Radiation (03CH07-HY)
Software	Audix	E3 6.2009-8-24	N/A	N/A	N/A	Jul. 15, 2022~Jul. 16, 2022	N/A	Radiation (03CH07-HY)
USB Data Logger	TECPEL	TR-32	HE17XB2495	N/A	Mar. 07, 2022	Jul. 15, 2022~Jul. 16, 2022	Mar. 06, 2023	Radiation (03CH07-HY)
EMI Test Receiver	Agilent	N9038A(MXE)	MY53290053	20Hz~26.5GHz	May 27, 2022	Jul. 15, 2022~Jul. 16, 2022	May 26, 2023	Radiation (03CH07-HY)
AC Power Source	ChainTek	APC-1000W	N/A	N/A	N/A	Jul. 12, 2022	N/A	Conduction (CO05-HY)
EMI Test Receiver	Rohde & Schwarz	ESR3	102388	9kHz~3.6GHz	Dec. 01, 2021	Jul. 12, 2022	Nov. 30, 2022	Conduction (CO05-HY)
Hygrometer	Testo	608-H1	34913912	N/A	Nov. 17, 2021	Jul. 12, 2022	Nov. 16, 2022	Conduction (CO05-HY)
LISN	Rohde & Schwarz	ENV216	100080	9kHz~30MHz	Dec. 03, 2021	Jul. 12, 2022	Dec. 02, 2022	Conduction (CO05-HY)
Software	Rohde & Schwarz	EMC32	N/A	N/A	N/A	Jul. 12, 2022	N/A	Conduction (CO05-HY)
Pulse Limiter	SCHWARZBECK	VTSD 9561-FN	00691	N/A	Jul. 28, 2021	Jul. 12, 2022	Jul. 27, 2022	Conduction (CO05-HY)
LISN Cable	MVE	RG-400	260260	N/A	Dec. 30, 2021	Jul. 12, 2022	Dec. 29, 2022	Conduction (CO05-HY)
Hygrometer	TECPEL	DTM-303A	TP201996	N/A	Nov. 16, 2021	Jul. 14, 2022~Jul. 25, 2022	Nov. 15, 2022	Conducted (TH05-HY)
Power Meter	Anritsu	ML2495A	932001	N/A	Sep. 30, 2021	Jul. 14, 2022~Jul. 25, 2022	Sep. 29, 2022	Conducted (TH05-HY)
Power Sensor	Anritsu	MA2411B	846202	300MHz~40GHz	Sep. 30, 2021	Jul. 14, 2022~Jul. 25, 2022	Sep. 29, 2022	Conducted (TH05-HY)
Signal Analyzer	Rohde & Schwarz	FSV40	101566	10Hz~40GHz	Aug. 30, 2021	Jul. 14, 2022~Jul. 25, 2022	Aug. 29, 2022	Conducted (TH05-HY)



5 Uncertainty of Evaluation

Uncertainty of Conducted Emission Measurement (150kHz ~ 30MHz)

Measuring Uncertainty for a Level of Confidence of 95% ($U = 2Uc(y)$)	3.1 dB
---	--------

Uncertainty of Radiated Emission Measurement (30 MHz ~ 1000 MHz)

Measuring Uncertainty for a Level of Confidence of 95% ($U = 2Uc(y)$)	5.1 dB
---	--------

Uncertainty of Radiated Emission Measurement (1000 MHz ~ 18000 MHz)

Measuring Uncertainty for a Level of Confidence of 95% ($U = 2Uc(y)$)	5.8 dB
---	--------

Uncertainty of Radiated Emission Measurement (18000 MHz ~ 40000 MHz)

Measuring Uncertainty for a Level of Confidence of 95% ($U = 2Uc(y)$)	4.0 dB
---	--------



Appendix A. AC Conducted Emission Test Results

Test Engineer :	Calvin Wang	Temperature :	23~26°C
		Relative Humidity :	45~55%

EUT Information

Report NO : 252407
 Test Mode : Mode 1
 Test Voltage : 120Vac/60Hz
 Phase : Line

Full Spectrum

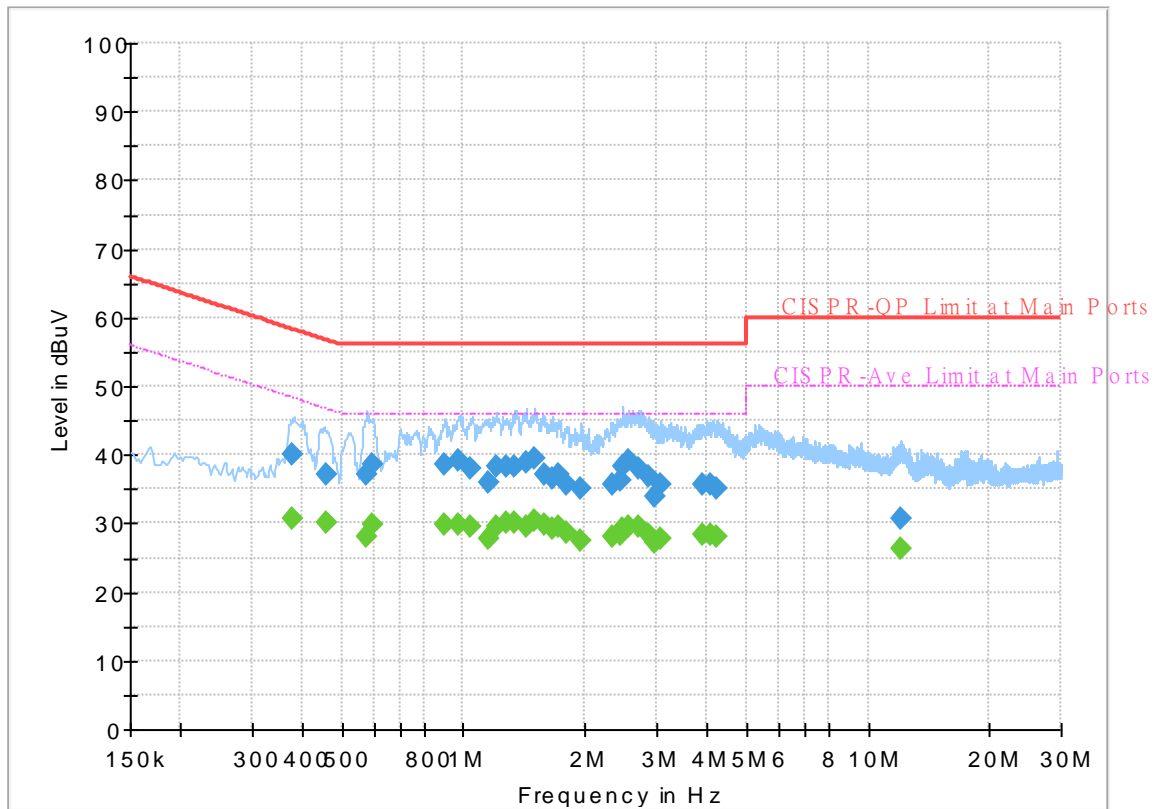

Final_Result

Frequency (MHz)	QuasiPeak (dBuV)	CAverage (dBuV)	Limit (dBuV)	Margin (dB)	Line	Filter	Corr. (dB)
0.379500	---	30.66	48.29	17.63	L1	OFF	19.6
0.379500	40.13	---	58.29	18.16	L1	OFF	19.6
0.460500	---	30.10	46.68	16.58	L1	OFF	19.6
0.460500	37.01	---	56.68	19.67	L1	OFF	19.6
0.577500	---	28.02	46.00	17.98	L1	OFF	19.6
0.577500	37.06	---	56.00	18.94	L1	OFF	19.6
0.595500	---	29.73	46.00	16.27	L1	OFF	19.6
0.595500	38.68	---	56.00	17.32	L1	OFF	19.6
0.899250	---	29.70	46.00	16.30	L1	OFF	19.6
0.899250	38.58	---	56.00	17.42	L1	OFF	19.6
0.973500	---	29.76	46.00	16.24	L1	OFF	19.6
0.973500	39.24	---	56.00	16.76	L1	OFF	19.6
1.041000	---	29.66	46.00	16.34	L1	OFF	19.7
1.041000	37.94	---	56.00	18.06	L1	OFF	19.7
1.146750	---	27.89	46.00	18.11	L1	OFF	19.7
1.146750	35.93	---	56.00	20.07	L1	OFF	19.7
1.200750	---	29.55	46.00	16.45	L1	OFF	19.7
1.200750	38.22	---	56.00	17.78	L1	OFF	19.7
1.272750	---	30.06	46.00	15.94	L1	OFF	19.7
1.272750	38.24	---	56.00	17.76	L1	OFF	19.7
1.340250	---	30.15	46.00	15.85	L1	OFF	19.7

1.340250	38.30	---	56.00	17.70	L1	OFF	19.7
1.430250	---	29.66	46.00	16.34	L1	OFF	19.7
1.430250	38.91	---	56.00	17.09	L1	OFF	19.7
1.502250	---	30.38	46.00	15.62	L1	OFF	19.7
1.502250	39.56	---	56.00	16.44	L1	OFF	19.7
1.578750	---	29.74	46.00	16.26	L1	OFF	19.7
1.578750	37.03	---	56.00	18.97	L1	OFF	19.7
1.655250	---	29.13	46.00	16.87	L1	OFF	19.7
1.655250	36.46	---	56.00	19.54	L1	OFF	19.7
1.727250	---	29.59	46.00	16.41	L1	OFF	19.7
1.727250	37.09	---	56.00	18.91	L1	OFF	19.7
1.806000	---	28.68	46.00	17.32	L1	OFF	19.7
1.806000	35.78	---	56.00	20.22	L1	OFF	19.7
1.956750	---	27.40	46.00	18.60	L1	OFF	19.7
1.956750	35.06	---	56.00	20.94	L1	OFF	19.7
2.328000	---	27.99	46.00	18.01	L1	OFF	19.7
2.328000	35.61	---	56.00	20.39	L1	OFF	19.7
2.436000	---	28.31	46.00	17.69	L1	OFF	19.7
2.436000	36.33	---	56.00	19.67	L1	OFF	19.7
2.481000	---	29.16	46.00	16.84	L1	OFF	19.7
2.481000	38.31	---	56.00	17.69	L1	OFF	19.7
2.553000	---	29.66	46.00	16.34	L1	OFF	19.7
2.553000	39.15	---	56.00	16.85	L1	OFF	19.7
2.706000	---	29.47	46.00	16.53	L1	OFF	19.7
2.706000	37.95	---	56.00	18.05	L1	OFF	19.7
2.854500	---	28.35	46.00	17.65	L1	OFF	19.7
2.854500	36.80	---	56.00	19.20	L1	OFF	19.7
2.976000	---	27.16	46.00	18.84	L1	OFF	19.7
2.976000	34.03	---	56.00	21.97	L1	OFF	19.7
3.081750	---	27.74	46.00	18.26	L1	OFF	19.7
3.081750	35.65	---	56.00	20.35	L1	OFF	19.7
3.916500	---	28.22	46.00	17.78	L1	OFF	19.8
3.916500	35.82	---	56.00	20.18	L1	OFF	19.8
4.080750	---	28.38	46.00	17.62	L1	OFF	19.8
4.080750	35.65	---	56.00	20.35	L1	OFF	19.8
4.247250	---	28.11	46.00	17.89	L1	OFF	19.8
4.247250	35.09	---	56.00	20.91	L1	OFF	19.8
12.039000	---	26.40	50.00	23.60	L1	OFF	20.2
12.039000	30.76	---	60.00	29.24	L1	OFF	20.2

EUT Information

Report NO : 252407
 Test Mode : Mode 1
 Test Voltage : 120Vac/60Hz
 Phase : Neutral

Full Spectrum

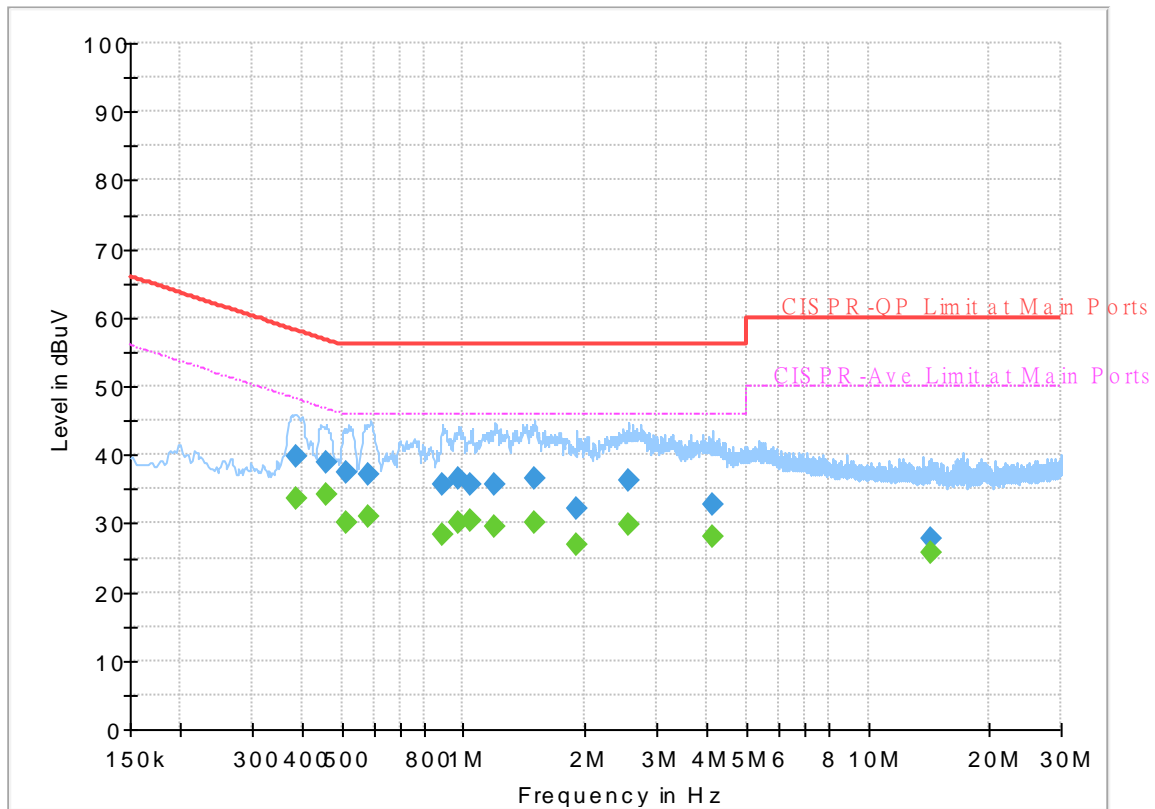

Final_Result

Frequency (MHz)	QuasiPeak (dBuV)	CAverage (dBuV)	Limit (dBuV)	Margin (dB)	Line	Filter	Corr. (dB)
0.386250	---	33.72	48.14	14.42	N	OFF	19.6
0.386250	39.86	---	58.14	18.28	N	OFF	19.6
0.456000	---	34.24	46.77	12.53	N	OFF	19.6
0.456000	38.95	---	56.77	17.82	N	OFF	19.6
0.512250	---	30.05	46.00	15.95	N	OFF	19.6
0.512250	37.34	---	56.00	18.66	N	OFF	19.6
0.579750	---	30.86	46.00	15.14	N	OFF	19.6
0.579750	37.28	---	56.00	18.72	N	OFF	19.6
0.888000	---	28.42	46.00	17.58	N	OFF	19.6
0.888000	35.53	---	56.00	20.47	N	OFF	19.6
0.971250	---	30.19	46.00	15.81	N	OFF	19.6
0.971250	36.52	---	56.00	19.48	N	OFF	19.6
1.043250	---	30.50	46.00	15.50	N	OFF	19.6
1.043250	35.79	---	56.00	20.21	N	OFF	19.6
1.198500	---	29.50	46.00	16.50	N	OFF	19.6
1.198500	35.79	---	56.00	20.21	N	OFF	19.6
1.495500	---	30.08	46.00	15.92	N	OFF	19.7
1.495500	36.69	---	56.00	19.31	N	OFF	19.7
1.909500	---	26.98	46.00	19.02	N	OFF	19.7
1.909500	32.30	---	56.00	23.70	N	OFF	19.7
2.553000	---	29.78	46.00	16.22	N	OFF	19.7

2.553000	36.31	---	56.00	19.69	N	OFF	19.7
4.132500	---	28.18	46.00	17.82	N	OFF	19.8
4.132500	32.66	---	56.00	23.34	N	OFF	19.8
14.363250	---	25.72	50.00	24.28	N	OFF	20.2
14.363250	27.88	---	60.00	32.12	N	OFF	20.2



Appendix B. Radiated Spurious Emission

Test Engineer :	Stan Hsieh and KeuWu	Temperature :	24.5~25.9°C
		Relative Humidity :	55.6~61%

UHF RFID

UHF RFID (Band Edge @ 3m)

UHF RFID	Note	Frequency (MHz)	Level (dBμV/m)	Margin (dB)	Limit Line (dBμV/m)	Read Level (dBμV)	Antenna Factor (dB/m)	Path Loss (dB)	Preamp Factor (dB)	Ant Pos (cm)	Table Pos (deg)	Peak Avg. (P/A)	Pol. (H/V)	
RFID 902.75MHz		30	30.27	-9.73	40	34.84	24.57	0.97	30.11	-	-	P	H	
		91.29	33.59	-9.91	43.5	47.3	14.79	1.52	30.02	-	-	P	H	
		211.44	36.73	-6.77	43.5	49.27	14.91	2.36	29.81	-	-	P	H	
		500.2	30.94	-15.06	46	33.15	23.82	3.75	29.78	-	-	P	H	
		688.5	33.88	-12.12	46	32.96	26.14	4.36	29.58	-	-	P	H	
	*	902.75	119.15	-	-	114.26	28.62	5.07	28.8	220	260	P	H	
		979.7	39.09	-14.91	54	31.76	30.6	5.29	28.56	-	-	P	H	
														H
														H
			30.81	30.74	-9.26	40	35.92	23.97	0.96	30.11	-	-	P	V
			83.46	29.68	-10.32	40	44.5	13.77	1.45	30.04	-	-	P	V
			125.04	29.81	-13.69	43.5	40.41	17.52	1.81	29.93	-	-	P	V
			458.9	28.06	-17.94	46	31.01	23.3	3.54	29.79	-	-	P	V
			740.3	31.63	-14.37	46	29.1	27.44	4.54	29.45	-	-	P	V
	*		902.75	119.53	-	-	114.64	28.62	5.07	28.8	125	340	P	V
			965	39.25	-14.75	54	31.74	30.88	5.23	28.6	-	-	P	V
													V	
													V	

Remark

- No other spurious found.
- All results are PASS against limit line.
- Non restricted band limit is radio frequency level down 20db
- The emission position marked as "-" means no suspected emission found and emission level has at least 6dB margin against limit or emission is noise floor only.



UHF RFID	Note	Frequency (MHz)	Level (dBµV/m)	Margin (dB)	Limit Line (dBµV/m)	Read Level (dBµV)	Antenna Factor (dB/m)	Path Loss (dB)	Preamp Factor (dB)	Ant Pos (cm)	Table Pos (deg)	Peak Avg. (P/A)	Pol. (H/V)	
RFID 914.75MHz		30	30.38	-9.62	40	34.95	24.57	0.97	30.11	-	-	P	H	
		91.29	31.6	-11.9	43.5	45.31	14.79	1.52	30.02	-	-	P	H	
		125.04	34.36	-9.14	43.5	44.96	17.52	1.81	29.93	-	-	P	H	
		311.9	28.74	-17.26	46	36.27	19.32	2.91	29.76	-	-	P	H	
		679.4	33.58	-12.42	46	32.66	26.19	4.33	29.6	-	-	P	H	
	*	914.75	119.54	-	-	114.34	28.86	5.1	28.76	228	252	P	H	
		991.6	37.27	-16.73	54	30.3	30.17	5.33	28.53	-	-	P	H	
														H
														H
														H
														H
														H
														H
			31.35	32.56	-7.44	40	38.06	23.65	0.95	30.1	-	-	P	V
			83.73	29.6	-10.4	40	44.41	13.78	1.45	30.04	-	-	P	V
			91.29	32.15	-11.35	43.5	45.86	14.79	1.52	30.02	-	-	P	V
			443.5	26.95	-19.05	46	30.28	22.99	3.46	29.78	-	-	P	V
			741.7	32.36	-13.64	46	29.81	27.46	4.54	29.45	-	-	P	V
	*		914.75	119.83	-	-	114.63	28.86	5.1	28.76	200	327	P	V
			991.6	37.68	-16.32	54	30.71	30.17	5.33	28.53	-	-	P	V
													V	
													V	
													V	
													V	
													V	
Remark	<ol style="list-style-type: none"> No other spurious found. All results are PASS against limit line. Non restricted band limit is radio frequency level down 20db The emission position marked as "-" means no suspected emission found and emission level has at least 6dB margin against limit or emission is noise floor only. 													



UHF RFID	Note	Frequency (MHz)	Level (dBµV/m)	Margin (dB)	Limit Line (dBµV/m)	Read Level (dBµV)	Antenna Factor (dB/m)	Path Loss (dB)	Preamp Factor (dB)	Ant Pos (cm)	Table Pos (deg)	Peak Avg. (P/A)	Pol. (H/V)	
RFID 927.25MHz		91.29	30.46	-13.04	43.5	44.17	14.79	1.52	30.02	-	-	P	H	
		197.13	35.03	-8.47	43.5	47.64	14.94	2.28	29.83	-	-	P	H	
		242.76	38.65	-7.35	46	48.52	17.36	2.53	29.76	-	-	P	H	
		308.4	28.66	-17.34	46	36.23	19.29	2.9	29.76	-	-	P	H	
		730.5	33.66	-12.34	46	31.67	26.97	4.5	29.48	-	-	P	H	
		888.7	33.76	-12.24	46	28.93	28.68	5.02	28.87	-	-	P	H	
		*	927.25	118.97	-	-	113.45	29.11	5.13	28.72	200	215	P	H
														H
														H
														H
														H
			30	31.89	-8.11	40	36.46	24.57	0.97	30.11	-	-	P	V
			91.02	31.72	-11.78	43.5	45.5	14.73	1.52	30.03	-	-	P	V
			125.04	33.92	-9.58	43.5	44.52	17.52	1.81	29.93	-	-	P	V
			432.3	25.79	-20.21	46	29.32	22.84	3.4	29.77	-	-	P	V
			624.1	27.7	-18.3	46	27.72	25.57	4.1	29.69	-	-	P	V
			802.6	34.09	-11.91	46	30.84	27.72	4.77	29.24	-	-	P	V
	*	927.25	119.03	-	-	113.51	29.11	5.13	28.72	200	337	P	V	
													V	
													V	
													V	
													V	
													V	

Remark	1. No other spurious found.
	2. All results are PASS against limit line.
	3. Non restricted band limit is radio frequency level down 20db
	4. The emission position marked as "-" means no suspected emission found and emission level has at least 6dB margin against limit or emission is noise floor only.



UHF RFID (Harmonic @ 3m)

UHF RFID	Note	Frequency (MHz)	Level (dBµV/m)	Margin (dB)	Limit Line (dBµV/m)	Read Level (dBµV)	Antenna Factor (dB/m)	Path Loss (dB)	Preamp Factor (dB)	Ant Pos (cm)	Table Pos (deg)	Peak Avg. (P/A)	Pol. (H/V)	
RFID 902.75MHz		2708.25	40.19	-33.81	74	56.7	32.65	9.7	58.86	-	-	P	H	
		3611	40.44	-33.56	74	55.34	33.12	11.3	59.32	-	-	P	H	
		4513.75	42.61	-31.39	74	56.22	34.01	11.9	59.52	-	-	P	H	
		5416.5	40.07	-33.93	74	49.81	34.7	12.89	57.33	-	-	P	H	
		8124.75	42.58	-31.42	74	48.58	35.8	15.66	57.46	-	-	P	H	
		9027.5	43.62	-30.38	74	49.4	36.3	16.48	58.56	-	-	P	H	
													P	H
		2708.25	43.48	-30.52	74	59.99	32.65	9.7	58.86	-	-	P	V	
		3611	41.15	-32.85	74	56.05	33.12	11.3	59.32	-	-	P	V	
		4513.75	41.71	-32.29	74	55.32	34.01	11.9	59.52	-	-	P	V	
		5416.5	41.98	-32.02	74	51.72	34.7	12.89	57.33	-	-	P	V	
		8124.75	41.08	-32.92	74	47.08	35.8	15.66	57.46	-	-	P	V	
		9027.5	41.45	-32.55	74	47.23	36.3	16.48	58.56	-	-	P	V	
													P	V
RFID 914.75MHz		2744.25	42.03	-31.97	74	58.62	32.43	9.84	58.86	-	-	P	H	
		3659	41.34	-32.66	74	56.14	33.2	11.38	59.38	-	-	P	H	
		4573.75	41.09	-32.91	74	54.25	34.35	11.91	59.42	-	-	P	H	
		7318	44.26	-29.74	74	51.03	35.67	15.06	57.5	-	-	P	H	
		8232.75	41.17	-32.83	74	47.16	35.8	15.69	57.48	-	-	P	H	
		9147.5	42.58	-31.42	74	48.88	36.1	16.4	58.8	-	-	P	H	
													P	H
		2744.25	43.52	-30.48	74	60.11	32.43	9.84	58.86	-	-	P	V	
		3659	41.17	-32.83	74	55.97	33.2	11.38	59.38	-	-	P	V	
		4573.75	41.05	-32.95	74	54.21	34.35	11.91	59.42	-	-	P	V	
		7318	45.09	-28.91	74	51.86	35.67	15.06	57.5	-	-	P	V	
		8232.75	41.07	-32.93	74	47.06	35.8	15.69	57.48	-	-	P	V	
		9147.5	42.34	-31.66	74	48.64	36.1	16.4	58.8	-	-	P	V	
													P	V
												P	V	



RFID 927.25MHz		2781.75	40.97	-33.03	74	57.43	32.4	10	58.86	-	-	P	H	
		3709	40.45	-33.55	74	55.24	33.2	11.45	59.44	-	-	P	H	
		4636.25	40.07	-33.93	74	53.02	34.4	11.95	59.3	-	-	P	H	
		7418	47.92	-26.08	74	54.48	35.86	15.16	57.58	-	-	P	H	
		8345.25	41.69	-32.31	74	47.86	35.8	15.53	57.5	-	-	P	H	
		2781.75	43.94	-30.06	74	60.4	32.4	10	58.86	-	-	P	V	
		3709	40.65	-33.35	74	55.44	33.2	11.45	59.44	-	-	P	V	
		4636.25	41.09	-32.91	74	54.04	34.4	11.95	59.3	-	-	P	V	
		7418	45.75	-28.25	74	52.31	35.86	15.16	57.58	-	-	P	V	
		8345.25	41.63	-32.37	74	47.8	35.8	15.53	57.5	-	-	P	V	
														V
Remark	<ol style="list-style-type: none"> 1. No other spurious found. 2. All results are PASS against Peak and Average limit line. 3. Non restricted band limit is radio frequency level down 20db 4. The emission position marked as "-" means no suspected emission found with sufficient margin against limit line or noise floor only. 													



Note symbol

*	Fundamental Frequency which can be ignored. However, the level of any unwanted emissions shall not exceed the level of the fundamental frequency.
!	Test result is over limit line.
P/A	Peak or Average
H/V	Horizontal or Vertical



A calculation example for radiated spurious emission is shown as below:

UHF RFID	Note	Frequency	Level	Margin	Limit	Read	Antenna	Path	Preamp	Ant	Table	Peak	Pol.
		(MHz)	(dBμV/m)	(dB)	(dBμV/m)	(dBμV)	(dB/m)	(dB)	(dB)	(cm)	(deg)	(P/A)	(H/V)
UHF RFID 913.25MHz		2739.75	38.54	-35.46	74	55.12	32.46	9.82	58.86	103	308	P	H

1. Path Loss(dB) = Cable loss(dB) + Filter loss(dB) + Attenuator loss(dB)
2. Level(dBμV/m) =
Antenna Factor(dB/m) + Path Loss(dB) + Read Level(dBμV) - Preamp Factor(dB)
3. Margin(dB) = Level(dBμV/m) – Limit Line(dBμV/m)

For Peak Limit @ 2739.75MHz:

1. Level(dBμV/m)
= Antenna Factor(dB/m) + Path Loss(dB) + Read Level(dBμV) - Preamp Factor(dB)
= 32.46(dB/m) + 9.82(dB) + 55.12(dBμV) – 58.86 (dB)
= 38.54 (dBμV/m)
2. Margin(dB)
= Level(dBμV/m) – Limit Line(dBμV/m)
= 38.54(dBμV/m) – 74(dBμV/m)
= -35.46(dB)

Peak measured complies with the limit line, so test result is “PASS”.



Appendix C. Radiated Spurious Emission Plots

Test Engineer :	Stan Hsieh and KeuWu	Temperature :	24.5~25.9°C
		Relative Humidity :	55.6~61%

RFID (Band Edge @ 3m)

UHF RFID	UHF RFID	
	UHF RFID 920.75MHz	
	Horizontal	Vertical
QP / Peak	<p>Site : 03CH07-HY Condition : QP 3m LF-ANT-35419(6) HORIZONTAL Detector : Peak Project : 253407 Mode : 1</p>	<p>Site : 03CH07-HY Condition : QP 3m LF-ANT-35419(6) VERTICAL Detector : Peak Project : 253407 Mode : 1</p>



UHF RFID	UHF RFID	
	UHF RFID 914.75MHz	
	Horizontal	Vertical
QP / Peak	<p>Site : 03CM07-011 Condition : QP 3m LF-ANT-35419(6) HORIZONTAL Detector : Peak Project : 252407 Mode : 2</p>	<p>Site : 03CM07-011 Condition : QP 3m LF-ANT-35419(6) VERTICAL Detector : Peak Project : 252407 Mode : 2</p>



UHF RFID	UHF RFID	
	UHF RFID 927.25MHz	
	Horizontal	Vertical
Peak Avg.	<p>Site : 03CM07-01 Condition : QP 3m LF-ANT-35419(6) HORIZONTAL Detector : Peak Project : 252407 Mode : 3</p>	<p>Site : 03CM07-01 Condition : QP 3m LF-ANT-35419(6) VERTICAL Detector : Peak Project : 252407 Mode : 3</p>



RFID (Harmonic @ 3m)

UHF RFID	UHF RFID	
	UHF RFID 902.75MHz	
	Horizontal	Vertical
<p>Peak</p> <p>Avg.</p>	<p>Level (dBm/1m)</p> <p>Date: 2022-07-16</p> <p>Frequency (MHz)</p> <p>PEAK_74</p> <p>AVG_54</p> <p>Site : 03CH07-HY Condition : PEAK_74 3m HF_ANT_00075962 HORIZONTAL Detector : Peak Project : 252407 Mode : 1</p>	<p>Level (dBm/1m)</p> <p>Date: 2022-07-16</p> <p>Frequency (MHz)</p> <p>PEAK_74</p> <p>AVG_54</p> <p>Site : 03CH07-HY Condition : PEAK_74 3m HF_ANT_00075962 VERTICAL Detector : Peak Project : 252407 Mode : 1</p>



UHF RFID	UHF RFID	
	UHF RFID 914.75MHz	
	Horizontal	Vertical
Peak Avg.	<p>Site : 03CM07-011 Condition : PEAK_24.3m_HF_ANT_00075962 HORIZONTAL Detector : Peak Project : 1224007 Mode : 2</p>	<p>Site : 03CM07-011 Condition : PEAK_24.3m_HF_ANT_00075962 VERTICAL Detector : Peak Project : 1224007 Mode : 2</p>



UHF RFID	UHF RFID	
	UHF RFID 927.25MHz	
	Horizontal	Vertical
Peak Avg.	<p>Site : 03CM07-011 Condition : PEAK_24.3m_HF_ANT_00075962 HORIZONTAL Detector : Peak Project : 252407 Mode : 3</p>	<p>Site : 03CM07-011 Condition : PEAK_24.3m_HF_ANT_00075962 VERTICAL Detector : Peak Project : 252407 Mode : 3</p>



Appendix D. Duty Cycle Plots

Band	Duty Cycle(%)	T(us)	1/T(kHz)	VBW Setting
UHF RFID	100.00	-	-	10Hz

