



## FCC Test Report (BT-LE)

**Report No.:** RF150423E12-1

**FCC ID:** UZ7RFD8500

**Test Model:** RFD8500

**Received Date:** Apr. 26, 2015

**Test Date:** June 02 to 17, 2015

**Issued Date:** July 20, 2015

**Applicant:** Zebra Technologies Corporation

**Address:** 1 Zebra Plaza, Holtsville, NY 11742

**Manufacturer:** Zebra Technologies Corporation

**Address:** 1 Zebra Plaza, Holtsville, NY 11742

**Issued By:** Bureau Veritas Consumer Products Services (H.K.) Ltd., Taoyuan Branch  
Hsin Chu Laboratory

**Lab Address:** No. 81-1, Lu Liao Keng, 9th Ling, Wu Lung Tsuen, Chiung Lin Hsiang, Hsin  
Chu Hsien 307, Taiwan R.O.C.

**Test Location (1):** No. 81-1, Lu Liao Keng, 9th Ling, Wu Lung Tsuen, Chiung Lin Hsiang, Hsin  
Chu Hsien 307, Taiwan R.O.C.

**Test Location (2):** No. 49, Ln. 206, Wende Rd., Shangshan Tsuen, Chiung Lin Hsiang, Hsin  
Chu Hsien 307, Taiwan R.O.C.

This report is for your exclusive use. Any copying or replication of this report to or for any other person or entity, or use of our name or trademark, is permitted only with our prior written permission. This report sets forth our findings solely with respect to the test samples identified herein. The results set forth in this report are not indicative or representative of the quality or characteristics of the lot from which a test sample was taken or any similar or identical product specifically and expressly noted. Our report includes all of the tests requested by you and the results thereof based upon the information that you provided to us. You have 60 days from date of issuance of this report to notify us of any material error or omission caused by our negligence, provided, however, that such notice shall be in writing and shall specifically address the issue you wish to raise. A failure to raise such issue within the prescribed time shall constitute your unqualified acceptance of the completeness of this report, the tests conducted and the correctness of the report contents. Unless specific mention, the uncertainty of measurement has been explicitly taken into account to declare the compliance or non-compliance to the specification. The report must not be used by the client to claim product certification, approval, or endorsement by any government agencies.

**Table of Contents**

<b>Release Control Record</b> .....	<b>4</b>
<b>1 Certificate of Conformity</b> .....	<b>5</b>
<b>2 Summary of Test Results</b> .....	<b>6</b>
2.1 Measurement Uncertainty.....	6
2.2 Modification Record.....	6
<b>3 General Information</b> .....	<b>7</b>
3.1 General Description of EUT (BT-LE).....	7
3.2 Description of Test Modes.....	9
3.2.1 Test Mode Applicability and Tested Channel Detail.....	10
3.3 Description of Support Units.....	12
3.3.1 Configuration of System under Test.....	12
3.4 Duty Cycle of Test Signal.....	13
3.5 General Description of Applied Standards.....	14
<b>4 Test Types and Results</b> .....	<b>15</b>
4.1 Radiated Emission and Bandedge Measurement.....	15
4.1.1 Limits of Radiated Emission and Bandedge Measurement.....	15
4.1.2 Test Instruments.....	16
4.1.3 Test Procedures.....	18
4.1.4 Deviation from Test Standard.....	18
4.1.5 Test Setup.....	19
4.1.6 EUT Operating Conditions.....	19
4.1.7 Test Results.....	20
4.2 Conducted Emission Measurement.....	26
4.2.1 Limits of Conducted Emission Measurement.....	26
4.2.2 Test Instruments.....	26
4.2.3 Test Procedures.....	27
4.2.4 Deviation from Test Standard.....	27
4.2.5 Test Setup.....	27
4.2.6 EUT Operating Conditions.....	27
4.2.7 Test Results.....	28
4.3 6dB Bandwidth Measurement.....	30
4.3.1 Limits of 6dB Bandwidth Measurement.....	30
4.3.2 Test Setup.....	30
4.3.3 Test Instruments.....	30
4.3.4 Test Procedure.....	30
4.3.5 Deviation from Test Standard.....	30
4.3.6 EUT Operating Conditions.....	30
4.3.7 Test Result.....	31
4.4 Conducted Output Power Measurement.....	32
4.4.1 Limits of Conducted Output Power Measurement.....	32
4.4.2 Test Setup.....	32
4.4.3 Test Instruments.....	32
4.4.4 Test Procedures.....	32
4.4.5 Deviation from Test Standard.....	32
4.4.6 EUT Operating Conditions.....	32
4.4.7 Test Results.....	33
4.5 Power Spectral Density Measurement.....	34
4.5.1 Limits of Power Spectral Density Measurement.....	34
4.5.2 Test Setup.....	34
4.5.3 Test Instruments.....	34
4.5.4 Test Procedure.....	34
4.5.5 Deviation from Test Standard.....	34
4.5.6 EUT Operating Condition.....	34



4.5.7 Test Results .....	35
4.6 Conducted Out of Band Emission Measurement.....	36
4.6.1 Limits of Conducted Out of Band Emission Measurement .....	36
4.6.2 Test Setup.....	36
4.6.3 Test Instruments .....	36
4.6.4 Test Procedure .....	36
4.6.5 Deviation from Test Standard .....	36
4.6.6 EUT Operating Condition .....	37
4.6.7 Test Results .....	38
<b>5 Pictures of Test Arrangements.....</b>	<b>39</b>
<b>Appendix – Information on the Testing Laboratories .....</b>	<b>40</b>



### Release Control Record

Issue No.	Description	Date Issued
RF150423E12-1	Original release.	July 20, 2015

**1 Certificate of Conformity**

**Product:** RFD8500 UHF RFID READER  
**Brand:** ZEBRA  
**Test Model:** RFD8500  
**Sample Status:** ENGINEERING SAMPLE  
**Applicant:** Zebra Technologies Corporation  
**Test Date:** June 02 to 17, 2015  
**Standards:** 47 CFR FCC Part 15, Subpart C (Section 15.247)  
ANSI C63.10: 2009

The above equipment has been tested by **Bureau Veritas Consumer Products Services (H.K.) Ltd., Taoyuan Branch**, and found compliance with the requirement of the above standards. The test record, data evaluation & Equipment Under Test (EUT) configurations represented herein are true and accurate accounts of the measurements of the sample's EMC characteristics under the conditions specified in this report.

**Prepared by :** \_\_\_\_\_, **Date:** \_\_\_\_\_  
  *C. Kuan*  
  Claire Kuan / Specialist

**Approved by :** \_\_\_\_\_, **Date:** \_\_\_\_\_  
  *May Chen*  
  May Chen / Manager

## 2 Summary of Test Results

47 CFR FCC Part 15, Subpart C (SECTION 15.247)			
FCC Clause	Test Item	Result	Remarks
15.207	AC Power Conducted Emission	PASS	Meet the requirement of limit. Minimum passing margin is -17.59dB at 0.32578MHz.
15.205 / 15.209 / 15.247(d)	Radiated Emissions & Band Edge Measurement	PASS	Meet the requirement of limit. Minimum passing margin is -5.8dB at 7440.00MHz.
15.247(d)	Antenna Port Emission	PASS	Meet the requirement of limit.
15.247(a)(2)	6dB bandwidth	PASS	Meet the requirement of limit.
15.247(b)	Conducted power	PASS	Meet the requirement of limit.
15.247(e)	Power Spectral Density	PASS	Meet the requirement of limit.
15.203	Antenna Requirement	PASS	No antenna connector is used.

### 2.1 Measurement Uncertainty

Where relevant, the following measurement uncertainty levels have been estimated for tests performed on the EUT as specified in CISPR 16-4-2:

Measurement	Frequency	Expanded Uncertainty (k=2) (±)
Conducted Emissions at mains ports	150kHz ~ 30MHz	2.86 dB
Radiated Emissions up to 1 GHz	30MHz ~ 1000MHz	5.43 dB
Radiated Emissions above 1 GHz	1GHz ~ 6GHz	3.65 dB
	6GHz ~ 18GHz	3.88 dB
	18GHz ~ 40GHz	4.11 dB

### 2.2 Modification Record

There were no modifications required for compliance.

### 3 General Information

#### 3.1 General Description of EUT (BT-LE)

Product	RFD8500 UHF RFID READER
Brand	ZEBRA
Test Model	RFD8500
Status of EUT	ENGINEERING SAMPLE
Operating Software	GENX_DEVICE 1.2.28 NGE 1.4.32.0
Power Supply Rating	DC 4.2V/3.7V from battery DC 5V or DC 12V from Cradle
Modulation Type	GFSK
Modulation Technology	DTS
Transfer Rate	Up to 1Mbps
Operating Frequency	2402MHz ~ 2480MHz
Number of Channel	40
Output Power	2.188mW
Antenna Type	Refer to note as below
Antenna Connector	Refer to note as below
Accessory Device	Battery x1
Data Cable Supplied	NA

Note:

1. There are BT and RFID technology used for the EUT.
2. Conducted emission and Radiated emission of the simultaneous operation (Bluetooth & RFID) has been evaluated and no non-compliance was found.
3. The EUT could be supplied with a Cradle and battery as below table:

<b>Cradle 1</b> (TC55 Rugged Charging Cable, not for sale together)	
Brand:	MOTOROLA / Symbol
Model No.:	CBL-TC55-CHG1-01
Input power :	+5V ----- 1.2A
<b>Cradle 2</b> (USB power supply cable, not for sale together)	
Brand:	MOTOROLA / no Brand
Model No.:	25-MCXUSB-01R
<b>Cradle 3</b> (5-slot, not for sale together)	
Brand:	MOTOROLA / Symbol
Model No.:	CRDUNIV
Input power :	+12V ----- 4.16A
Associated Devices:	Adapter x 2 (Adapter 1: Part No.: PWRS-124306-01R) (Adapter 2: Part No.: PWRS-14000-148C)
Adapter 1 (for Cradle 1 & 2, and not for sale together)	
Brand:	MOTOROLA / Symbol
Model No.:	IU08-2050120-WP
Part No.:	PWRS-124306-01R
Input power :	100-240V, 50-60Hz, 0.2A
Output power :	+5V ----- 1.2A

Adapter 2 (for Cradle 3 only, and not for sale together)

Brand: HIPRO  
 Model No.: HP-A0502R3D  
 Part No.: PWRS-14000-148C  
 Input power : 100-240V, 50-60Hz, 2.4A  
 Output power : +12V ----- 4.16A  
 Remark: Core \*1pcs

**Battery**

Brand:	MOTOROLA / Symbol
Part No.:	82-172087-01
Rating:	4.2V/ 3.7V, 4410mAh, 16.32Wh

4. The EUT antennas information:

Bluetooth							
No.	Brand	Antenna Type	Gain (dBi) < excluded cable loss>	Connecter Type	Frequency range (MHz)	Cable Loss (dB)	
1	Auden	PIFA and PCB chip	2.6	NA	2400~2483.5	1	
RFID Antenna Spec.							
No.	Brand	Antenna Type	Gain (dBi) < included cable loss>	Connecter Type	Frequency range (MHz)	Cable Loss (dB)	Cable Length (mm)
1	Auden	Patch	4.63	U.fl	902~928	0.4	130

5. The EUT was pre-tested under following test modes:

Pre-test Mode	Description
Mode A	Cradle 1 + Battery
Mode B	Cradle 2 + Battery
Mode C	Cradle 3 + Battery

The worst radiated emission was found in **Mode C**. Therefore only the test data of the modes were recorded in this report.

6. The above EUT information is declared by manufacturer and for more detailed features description, please refer to the manufacturer's specifications or User's Manual.



### 3.2 Description of Test Modes

40 channels are provided to this EUT:

CHANNEL	FREQ. (MHz)	CHANNEL	FREQ. (MHz)	CHANNEL	FREQ. (MHz)	CHANNEL	FREQ. (MHz)
0	2402	10	2422	20	2442	30	2462
1	2404	11	2424	21	2444	31	2464
2	2406	12	2426	22	2446	32	2466
3	2408	13	2428	23	2448	33	2468
4	2410	14	2430	24	2450	34	2470
5	2412	15	2432	25	2452	35	2472
6	2414	16	2434	26	2454	36	2474
7	2416	17	2436	27	2456	37	2476
8	2418	18	2438	28	2458	38	2478
9	2420	19	2440	29	2460	39	2480

### 3.2.1 Test Mode Applicability and Tested Channel Detail

EUT CONFIGURE MODE	APPLICABLE TO				DESCRIPTION
	RE $\geq$ 1G	RE $<$ 1G	PLC	APCM	
-	√	√	√	√	-

Where **RE $\geq$ 1G**: Radiated Emission above 1GHz      **RE $<$ 1G**: Radiated Emission below 1GHz  
**PLC**: Power Line Conducted Emission      **APCM**: Antenna Port Conducted Measurement

**NOTE:** The EUT had been pre-tested on the positioned of each 3 axis. The worst case was found when positioned on **X-plane**.

#### **Radiated Emission Test (Above 1GHz):**

- Pre-Scan has been conducted to determine the worst-case mode from all possible combinations between available modulations, data rates and antenna ports (if EUT with antenna diversity architecture).
- Following channel(s) was (were) selected for the final test as listed below.

AVAILABLE CHANNEL	TESTED CHANNEL	MODULATION TYPE	DATA RATE (Mbps)
0 to 39	0, 19, 39	GFSK	1

#### **Radiated Emission Test (Below 1GHz):**

- Pre-Scan has been conducted to determine the worst-case mode from all possible combinations between available modulations, data rates and antenna ports (if EUT with antenna diversity architecture).
- Following channel(s) was (were) selected for the final test as listed below.

AVAILABLE CHANNEL	TESTED CHANNEL	MODULATION TYPE	DATA RATE (Mbps)
0 to 39	0, 19, 39	GFSK	1

#### **Power Line Conducted Emission Test:**

- Pre-Scan has been conducted to determine the worst-case mode from all possible combinations between available modulations, data rates and antenna ports (if EUT with antenna diversity architecture).
- Following channel(s) was (were) selected for the final test as listed below.

AVAILABLE CHANNEL	TESTED CHANNEL	MODULATION TYPE	DATA RATE (Mbps)
0 to 39	19	GFSK	1

**Antenna Port Conducted Measurement:**

- This item includes all test value of each mode, but only includes spectrum plot of worst value of each mode.
- Pre-Scan has been conducted to determine the worst-case mode from all possible combinations between available modulations, data rates and antenna ports (if EUT with antenna diversity architecture).
- Following channel(s) was (were) selected for the final test as listed below.

AVAILABLE CHANNEL	TESTED CHANNEL	MODULATION TYPE	DATA RATE (Mbps)
0 to 39	0, 19, 39	GFSK	1

**Test Condition:**

APPLICABLE TO	ENVIRONMENTAL CONDITIONS	INPUT POWER	TESTED BY
RE≥1G	23deg. C, 66%RH	3.7Vdc	Tim Ho
RE<1G	27deg. C, 76%RH	3.7Vdc	Tim Ho
PLC	24deg. C, 54%RH	120Vac, 60Hz (System)	JyunChun.Lin
APCM	25deg. C, 60%RH	3.7Vdc	Robert Cheng

### 3.3 Description of Support Units

The EUT has been tested as an independent unit together with other necessary accessories or support units. The following support units or accessories were used to form a representative test configuration during the tests.

No.	Product	Brand	Model No.	Serial No.	FCC ID	Remark
A	USB ADAPTER	Nicelink	US-T12B(W)	NA	NA	Supplied by client

**NOTE:**

1. All power cords of the above support units are non-shielded (1.8 m).

No.	Cable	Qty.	Length (m)	Shielded (Yes/ No)	Cores (Number)	Remark
1	USB	1	1	Yes	0	Supplied by client

#### 3.3.1 Configuration of System under Test

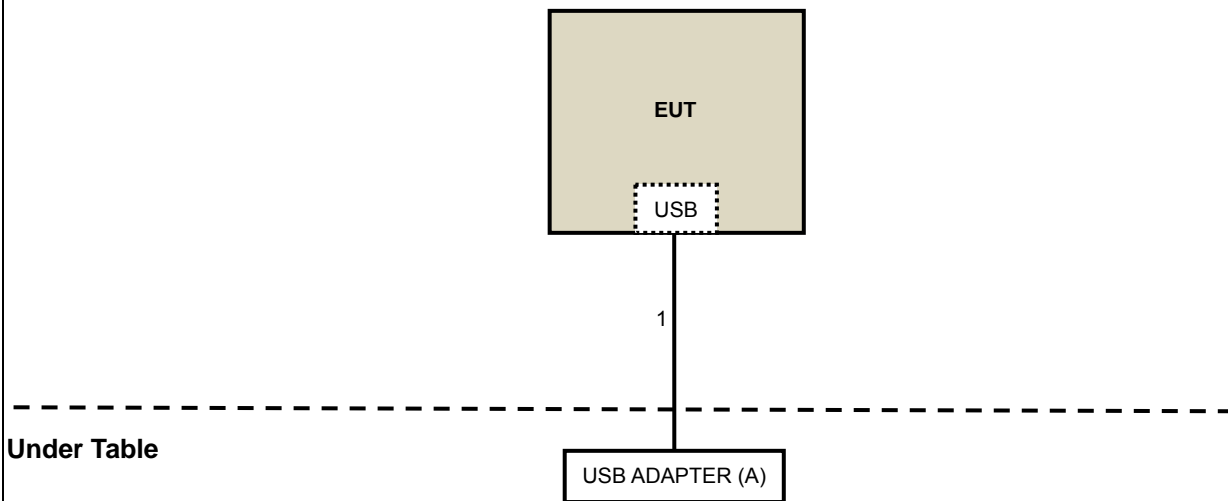

### 3.4 Duty Cycle of Test Signal

If duty cycle of test signal is < 98%, duty factor shall be considered.

Duty cycle =  $0.399/0.624 = 0.639$ , Duty factor =  $10 * \log(1/0.639) = 1.9$

#### BT-LE

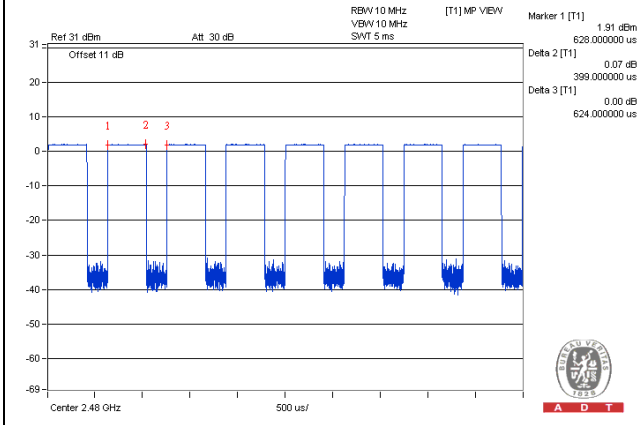

### 3.5 General Description of Applied Standards

The EUT is a RF Product. According to the specifications of the manufacturer, it must comply with the requirements of the following standards:

**FCC Part 15, Subpart C (15.247)**  
**558074 D01 DTS Meas Guidance v03r02**  
ANSI C63.10-2009

All test items have been performed and recorded as per the above standards.

## 4 Test Types and Results

### 4.1 Radiated Emission and Bandedge Measurement

#### 4.1.1 Limits of Radiated Emission and Bandedge Measurement

Radiated emissions which fall in the restricted bands must comply with the radiated emission limits specified as below table. Other emissions shall be at least 20dB below the highest level of the desired power:

Frequencies (MHz)	Field Strength (microvolts/meter)	Measurement Distance (meters)
0.009 ~ 0.490	2400/F(kHz)	300
0.490 ~ 1.705	24000/F(kHz)	30
1.705 ~ 30.0	30	30
30 ~ 88	100	3
88 ~ 216	150	3
216 ~ 960	200	3
Above 960	500	3

**NOTE:**

1. The lower limit shall apply at the transition frequencies.
2. Emission level (dBuV/m) = 20 log Emission level (uV/m).
3. For frequencies above 1000MHz, the field strength limits are based on average detector, however, the peak field strength of any emission shall not exceed the maximum permitted average limits, specified above by more than 20dB under any condition of modulation.

#### 4.1.2 Test Instruments

##### For Above 1GHz test:

DESCRIPTION & MANUFACTURER	MODEL NO.	SERIAL NO.	CALIBRATED DATE	CALIBRATED UNTIL
Test Receiver Agilent	N9038A	MY51210105	July 21, 2014	July 20, 2015
Horn_Antenna AISI	AIH.8018	000032009111 0	Feb. 09, 2015	Feb. 08, 2016
Pre-Amplifier Agilent	8449B	3008A02578	June 24, 2014	June 23, 2015
RF Cable	NA	131205 131216 131217 SNMY23684/ 4	Jan. 16, 2015	Jan. 15, 2016
Spectrum Analyzer R&S	FSV40	100964	July 05, 2014	July 04, 2015
Pre-Amplifier SPACEK LABS	SLKKa-48-6	9K16	Dec. 12, 2014	Dec. 11, 2015
Horn_Antenna SCHWARZBECK	BBHA 9170	9170-424	Feb. 05, 2015	Feb. 04, 2016
RF Cable	NA	329751/4 RF104-204	Dec. 11, 2014	Dec. 10, 2015
Software	ADT_Radiated _V8.7.07	NA	NA	NA
Antenna Tower & Turn Table CT	NA	NA	NA	NA

##### Note:

1. The calibration interval of the above test instruments is 12 months and the calibrations are traceable to NML/ROC and NIST/USA.
2. The test was performed in 966 Chamber No. G.
3. The FCC Site Registration No. is 966073.
4. The VCCI Site Registration No. is G-137.
5. The CANADA Site Registration No. is IC 7450H-2.
6. Tested Date: June 17, 2015



**For Below 1GHz test:**

DESCRIPTION & MANUFACTURER	MODEL NO.	SERIAL NO.	CALIBRATED DATE	CALIBRATED UNTIL
Test Receiver Agilent	N9038A	MY50010156	Aug. 11, 2014	Aug. 10, 2015
Pre-Amplifier Mini-Circuits	ZFL-1000VH2 B	AMP-ZFL-04	Nov. 12, 2014	Nov. 11, 2015
Trilog Broadband Antenna SCHWARZBECK	VULB 9168	9168-361	Feb. 09, 2015	Feb. 08, 2016
RF Cable	8D-FB	CHHCAB-001-1	Oct. 05, 2014	Oct. 04, 2015
		CHHCAB-001-2		
	RF-141	CHHCAB-004	Oct. 05, 2014	Oct. 04, 2015
Software	ADT_Radiated _V8.7.07	NA	NA	NA
Antenna Tower & Turn Table CT	NA	NA	NA	NA

**Note:**

1. The calibration interval of the above test instruments is 12 months and the calibrations are traceable to NML/ROC and NIST/USA.
2. The test was performed in 966 Chamber No. H.
3. The FCC Site Registration No. is 797305.
4. The CANADA Site Registration No. is IC 7450H-3.
5. Tested Date: June 16, 2015

#### 4.1.3 Test Procedures

- a. The EUT was placed on the top of a rotating table 0.8 meters (for below 1GHz) / 1.5 meters (for above 1GHz) above the ground at 3 meter chamber room for test. The table was rotated 360 degrees to determine the position of the highest radiation.
- b. The EUT was set 3 meters away from the interference-receiving antenna, which was mounted on the top of a variable-height antenna tower.
- c. The height of antenna is varied from one meter to four meters above the ground to determine the maximum value of the field strength. Both horizontal and vertical polarizations of the antenna are set to make the measurement.
- d. For each suspected emission, the EUT was arranged to its worst case and then the antenna was tuned to heights from 1 meter to 4 meters and the rotatable table was turned from 0 degrees to 360 degrees to find the maximum reading.
- e. The test-receiver system was set to quasi-peak detect function and specified bandwidth with maximum hold mode when the test frequency is below 1 GHz.
- f. The test-receiver system was set to peak and average detect function and specified bandwidth with maximum hold mode when the test frequency is above 1 GHz. If the peak reading value also meets average limit, measurement with the average detector is unnecessary.

**Note:**

1. The resolution bandwidth and video bandwidth of test receiver/spectrum analyzer is 120kHz for Quasi-peak detection (QP) at frequency below 1GHz.
2. The resolution bandwidth of test receiver/spectrum analyzer is 1 MHz and the video bandwidth is 3 MHz for Peak detection (PK) at frequency above 1GHz.
3. The resolution bandwidth of test receiver/spectrum analyzer is 1MHz and the video bandwidth is 3MHz for RMS Average (Duty cycle < 98%) for Average detection (AV) at frequency above 1GHz, then the measurement results was added to a correction factor ( $10 \log(1/\text{duty cycle})$ ).
4. The resolution bandwidth of test receiver/spectrum analyzer is 1MHz and the video bandwidth is 10Hz (Duty cycle  $\geq 98\%$ ) for Average detection (AV) at frequency above 1GHz.
5. All modes of operation were investigated and the worst-case emissions are reported.

#### 4.1.4 Deviation from Test Standard

No deviation.

4.1.5 Test Setup

<Frequency Range below 1GHz>

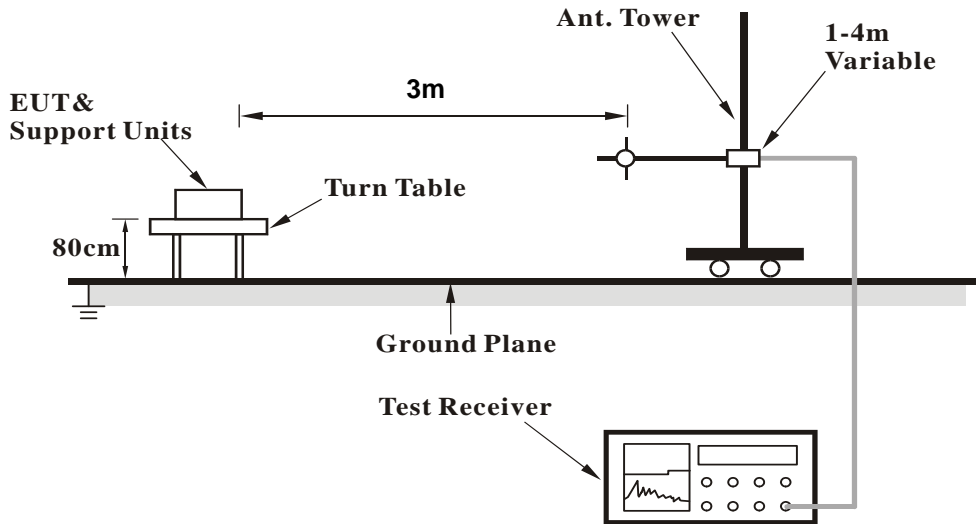

<Frequency Range above 1GHz>

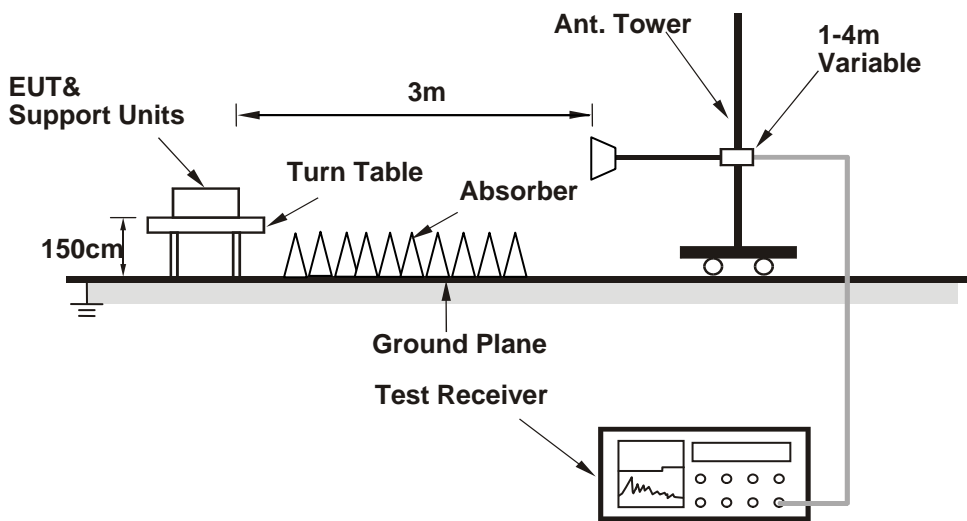

For the actual test configuration, please refer to the attached file (Test Setup Photo).

4.1.6 EUT Operating Conditions

Set the EUT under transmission condition continuously at specific channel frequency.

#### 4.1.7 Test Results

##### Above 1GHz Data

<b>CHANNEL</b>	TX Channel 0	<b>DETECTOR FUNCTION</b>	Peak (PK)
<b>FREQUENCY RANGE</b>	1GHz ~ 25GHz		Average (AV)

ANTENNA POLARITY & TEST DISTANCE: HORIZONTAL AT 3 M								
NO.	FREQ. (MHz)	EMISSION LEVEL (dBuV/m)	LIMIT (dBuV/m)	MARGIN (dB)	ANTENNA HEIGHT (m)	TABLE ANGLE (Degree)	RAW VALUE (dBuV)	CORRECTION FACTOR (dB/m)
1	2390.00	55.2 PK	74.0	-18.8	1.73 H	193	58.39	-3.19
2	2390.00	39.1 AV	54.0	-14.9	1.73 H	193	42.29	-3.19
3	*2402.00	101.3 PK			1.73 H	193	104.46	-3.16
4	*2402.00	99.2 AV			1.73 H	193	102.36	-3.16
5	4804.00	50.6 PK	74.0	-23.4	1.77 H	158	44.66	5.94
6	4804.00	40.2 AV	54.0	-13.8	1.77 H	158	34.26	5.94
ANTENNA POLARITY & TEST DISTANCE: VERTICAL AT 3 M								
NO.	FREQ. (MHz)	EMISSION LEVEL (dBuV/m)	LIMIT (dBuV/m)	MARGIN (dB)	ANTENNA HEIGHT (m)	TABLE ANGLE (Degree)	RAW VALUE (dBuV)	CORRECTION FACTOR (dB/m)
1	2390.00	53.7 PK	74.0	-20.3	1.77 V	129	56.89	-3.19
2	2390.00	39.0 AV	54.0	-15.0	1.77 V	129	42.19	-3.19
3	*2402.00	94.2 PK			1.77 V	129	97.36	-3.16
4	*2402.00	91.2 AV			1.77 V	129	94.36	-3.16
5	4804.00	50.1 PK	74.0	-23.9	1.77 V	158	44.16	5.94
6	4804.00	40.3 AV	54.0	-13.7	1.77 V	158	34.36	5.94

#### REMARKS:

1. Emission Level(dBuV/m) = Raw Value(dBuV) + Correction Factor(dB/m)
2. Correction Factor(dB/m) = Antenna Factor(dB/m) + Cable Factor(dB) – Pre-Amplifier Factor(dB)
3. The other emission levels were very low against the limit.
4. Margin value = Emission Level – Limit value
5. " \* " : Fundamental frequency.

<b>CHANNEL</b>	TX Channel 19	<b>DETECTOR FUNCTION</b>	Peak (PK)
<b>FREQUENCY RANGE</b>	1GHz ~ 25GHz		Average (AV)

**ANTENNA POLARITY & TEST DISTANCE: HORIZONTAL AT 3 M**

NO.	FREQ. (MHz)	EMISSION LEVEL (dBuV/m)	LIMIT (dBuV/m)	MARGIN (dB)	ANTENNA HEIGHT (m)	TABLE ANGLE (Degree)	RAW VALUE (dBuV)	CORRECTION FACTOR (dB/m)
1	*2440.00	101.0 PK			1.89 H	193	104.03	-3.03
2	*2440.00	98.7 AV			1.89 H	193	101.73	-3.03
3	4880.00	50.1 PK	74.0	-23.9	1.77 H	155	44.05	6.05
4	4880.00	39.9 AV	54.0	-14.1	1.77 H	155	33.85	6.05
5	7320.00	57.2 PK	74.0	-16.8	1.31 H	173	46.20	11.00
6	7320.00	47.7 AV	54.0	-6.3	1.31 H	173	36.70	11.00

**ANTENNA POLARITY & TEST DISTANCE: VERTICAL AT 3 M**

NO.	FREQ. (MHz)	EMISSION LEVEL (dBuV/m)	LIMIT (dBuV/m)	MARGIN (dB)	ANTENNA HEIGHT (m)	TABLE ANGLE (Degree)	RAW VALUE (dBuV)	CORRECTION FACTOR (dB/m)
1	*2440.00	93.5 PK			1.55 V	180	96.53	-3.03
2	*2440.00	90.3 AV			1.55 V	180	93.33	-3.03
3	4880.00	49.8 PK	74.0	-24.2	1.35 V	222	43.75	6.05
4	4880.00	41.0 AV	54.0	-13.0	1.35 V	222	34.95	6.05
5	7320.00	58.2 PK	74.0	-15.8	1.25 V	158	47.20	11.00
6	7320.00	47.8 AV	54.0	-6.2	1.25 V	158	36.80	11.00

**REMARKS:**

1. Emission Level(dBuV/m) = Raw Value(dBuV) + Correction Factor(dB/m)
2. Correction Factor(dB/m) = Antenna Factor(dB/m) + Cable Factor(dB) – Pre-Amplifier Factor(dB)
3. The other emission levels were very low against the limit.
4. Margin value = Emission Level – Limit value
5. " \* ": Fundamental frequency.

<b>CHANNEL</b>	TX Channel 39	<b>DETECTOR FUNCTION</b>	Peak (PK)
<b>FREQUENCY RANGE</b>	1GHz ~ 25GHz		Average (AV)

**ANTENNA POLARITY & TEST DISTANCE: HORIZONTAL AT 3 M**

NO.	FREQ. (MHz)	EMISSION LEVEL (dBuV/m)	LIMIT (dBuV/m)	MARGIN (dB)	ANTENNA HEIGHT (m)	TABLE ANGLE (Degree)	RAW VALUE (dBuV)	CORRECTION FACTOR (dB/m)
1	*2480.00	100.8 PK			1.57 H	190	103.68	-2.88
2	*2480.00	98.5 AV			1.57 H	190	101.38	-2.88
3	2483.50	49.1 PK	74.0	-24.9	1.57 H	190	51.97	-2.87
4	2483.50	39.3 AV	54.0	-14.7	1.57 H	190	42.17	-2.87
5	4960.00	50.0 PK	74.0	-24.0	1.83 H	140	43.96	6.04
6	4960.00	39.8 AV	54.0	-14.2	1.83 H	140	33.76	6.04
7	7440.00	57.5 PK	74.0	-16.5	1.26 H	184	45.77	11.73
<b>8</b>	<b>7440.00</b>	<b>48.2 AV</b>	<b>54.0</b>	<b>-5.8</b>	<b>1.26 H</b>	<b>184</b>	<b>36.47</b>	<b>11.73</b>

**ANTENNA POLARITY & TEST DISTANCE: VERTICAL AT 3 M**

NO.	FREQ. (MHz)	EMISSION LEVEL (dBuV/m)	LIMIT (dBuV/m)	MARGIN (dB)	ANTENNA HEIGHT (m)	TABLE ANGLE (Degree)	RAW VALUE (dBuV)	CORRECTION FACTOR (dB/m)
1	*2480.00	93.1 PK			1.72 V	126	95.98	-2.88
2	*2480.00	89.9 AV			1.72 V	126	92.78	-2.88
3	2483.50	49.1 PK	74.0	-24.9	1.72 V	126	51.97	-2.87
4	2483.50	38.8 AV	54.0	-15.2	1.72 V	126	41.67	-2.87
5	4960.00	49.6 PK	74.0	-24.4	1.30 V	210	43.56	6.04
6	4960.00	40.1 AV	54.0	-13.9	1.30 V	210	34.06	6.04
7	7440.00	58.1 PK	74.0	-15.9	1.25 V	152	46.37	11.73
8	7440.00	47.5 AV	54.0	-6.5	1.25 V	152	35.77	11.73

**REMARKS:**

1. Emission Level(dBuV/m) = Raw Value(dBuV) + Correction Factor(dB/m)
2. Correction Factor(dB/m) = Antenna Factor(dB/m) + Cable Factor(dB) – Pre-Amplifier Factor(dB)
3. The other emission levels were very low against the limit.
4. Margin value = Emission Level – Limit value
5. " \* ": Fundamental frequency.

**Below 1GHz Data**

<b>CHANNEL</b>	TX Channel 0	<b>DETECTOR FUNCTION</b>	Quasi-Peak (QP)
<b>FREQUENCY RANGE</b>	Below 1GHz		

**ANTENNA POLARITY & TEST DISTANCE: HORIZONTAL AT 3 M**

NO.	FREQ. (MHz)	EMISSION LEVEL (dBuV/m)	LIMIT (dBuV/m)	MARGIN (dB)	ANTENNA HEIGHT (m)	TABLE ANGLE (Degree)	RAW VALUE (dBuV)	CORRECTION FACTOR (dB/m)
1	139.77	22.4 QP	43.5	-21.1	1.10 H	109	35.74	-13.38
2	259.15	26.2 QP	46.0	-19.8	1.10 H	296	39.84	-13.65
3	432.14	24.1 QP	46.0	-21.9	1.10 H	326	32.47	-8.40
4	504.10	24.2 QP	46.0	-21.8	1.20 H	111	31.27	-7.06
5	611.37	25.2 QP	46.0	-20.8	1.10 H	24	29.60	-4.42
6	777.59	29.0 QP	46.0	-17.0	1.90 H	194	30.58	-1.56

**ANTENNA POLARITY & TEST DISTANCE: VERTICAL AT 3 M**

NO.	FREQ. (MHz)	EMISSION LEVEL (dBuV/m)	LIMIT (dBuV/m)	MARGIN (dB)	ANTENNA HEIGHT (m)	TABLE ANGLE (Degree)	RAW VALUE (dBuV)	CORRECTION FACTOR (dB/m)
1	32.15	28.2 QP	40.0	-11.8	1.00 V	152	43.09	-14.85
2	108.75	24.3 QP	43.5	-19.2	1.20 V	104	40.42	-16.15
3	141.10	34.3 QP	43.5	-9.3	1.10 V	161	47.54	-13.29
4	182.70	26.2 QP	43.5	-17.3	1.10 V	94	41.03	-14.81
5	247.67	30.1 QP	46.0	-15.9	1.00 V	181	44.04	-13.90
6	956.71	31.3 QP	46.0	-14.8	1.20 V	151	30.09	1.16

**REMARKS:**

1. Emission Level(dBuV/m) = Raw Value(dBuV) + Correction Factor(dB/m)
2. Correction Factor(dB/m) = Antenna Factor(dB/m) + Cable Factor(dB) – Pre-Amplifier Factor(dB)
3. The other emission levels were very low against the limit.
4. Margin value = Emission Level – Limit value

<b>CHANNEL</b>	TX Channel 19	<b>DETECTOR FUNCTION</b>	Quasi-Peak (QP)
<b>FREQUENCY RANGE</b>	Below 1GHz		

**ANTENNA POLARITY & TEST DISTANCE: HORIZONTAL AT 3 M**

NO.	FREQ. (MHz)	EMISSION LEVEL (dBuV/m)	LIMIT (dBuV/m)	MARGIN (dB)	ANTENNA HEIGHT (m)	TABLE ANGLE (Degree)	RAW VALUE (dBuV)	CORRECTION FACTOR (dB/m)
1	139.70	22.4 QP	43.5	-21.1	1.00 H	110	35.79	-13.39
2	259.10	26.2 QP	46.0	-19.8	1.00 H	290	39.87	-13.65
3	432.10	24.1 QP	46.0	-21.9	1.00 H	320	32.52	-8.40
4	504.12	24.2 QP	46.0	-21.8	1.20 H	101	31.29	-7.06
5	611.30	25.2 QP	46.0	-20.8	1.00 H	124	29.65	-4.42
6	777.50	29.0 QP	46.0	-17.0	1.20 H	187	30.57	-1.57

**ANTENNA POLARITY & TEST DISTANCE: VERTICAL AT 3 M**

NO.	FREQ. (MHz)	EMISSION LEVEL (dBuV/m)	LIMIT (dBuV/m)	MARGIN (dB)	ANTENNA HEIGHT (m)	TABLE ANGLE (Degree)	RAW VALUE (dBuV)	CORRECTION FACTOR (dB/m)
1	32.10	28.3 QP	40.0	-11.7	1.00 V	142	43.19	-14.86
2	108.71	24.2 QP	43.5	-19.3	1.10 V	100	40.36	-16.15
3	141.13	34.2 QP	43.5	-9.3	1.00 V	121	47.48	-13.28
4	182.68	26.2 QP	43.5	-17.3	1.00 V	104	41.01	-14.81
5	247.60	30.1 QP	46.0	-15.9	1.10 V	168	44.02	-13.90
6	956.68	31.2 QP	46.0	-14.8	1.11 V	111	30.06	1.16

**REMARKS:**

1. Emission Level(dBuV/m) = Raw Value(dBuV) + Correction Factor(dB/m)
2. Correction Factor(dB/m) = Antenna Factor(dB/m) + Cable Factor(dB) – Pre-Amplifier Factor(dB)
3. The other emission levels were very low against the limit.
4. Margin value = Emission Level – Limit value



<b>CHANNEL</b>	TX Channel 39	<b>DETECTOR FUNCTION</b>	Quasi-Peak (QP)
<b>FREQUENCY RANGE</b>	Below 1GHz		

**ANTENNA POLARITY & TEST DISTANCE: HORIZONTAL AT 3 M**

NO.	FREQ. (MHz)	EMISSION LEVEL (dBuV/m)	LIMIT (dBuV/m)	MARGIN (dB)	ANTENNA HEIGHT (m)	TABLE ANGLE (Degree)	RAW VALUE (dBuV)	CORRECTION FACTOR (dB/m)
1	139.72	22.4 QP	43.5	-21.1	1.10 H	100	35.77	-13.39
2	259.22	26.2 QP	46.0	-19.8	1.10 H	223	39.85	-13.65
3	432.22	24.2 QP	46.0	-21.8	1.10 H	300	32.60	-8.40
4	504.10	24.2 QP	46.0	-21.8	1.12 H	111	31.26	-7.06
5	611.32	25.2 QP	46.0	-20.8	1.10 H	114	29.62	-4.42
6	777.52	29.2 QP	46.0	-16.8	1.10 H	167	30.76	-1.57

**ANTENNA POLARITY & TEST DISTANCE: VERTICAL AT 3 M**

NO.	FREQ. (MHz)	EMISSION LEVEL (dBuV/m)	LIMIT (dBuV/m)	MARGIN (dB)	ANTENNA HEIGHT (m)	TABLE ANGLE (Degree)	RAW VALUE (dBuV)	CORRECTION FACTOR (dB/m)
1	32.22	28.3 QP	40.0	-11.7	1.20 V	122	43.13	-14.83
2	108.68	24.3 QP	43.5	-19.2	1.00 V	120	40.42	-16.15
3	141.10	34.1 QP	43.5	-9.4	1.20 V	111	47.39	-13.29
4	182.72	26.2 QP	43.5	-17.3	1.10 V	114	41.03	-14.81
5	247.46	30.1 QP	46.0	-15.9	1.10 V	128	44.01	-13.90
6	956.60	31.3 QP	46.0	-14.7	1.01 V	101	30.16	1.16

**REMARKS:**

1. Emission Level(dBuV/m) = Raw Value(dBuV) + Correction Factor(dB/m)
2. Correction Factor(dB/m) = Antenna Factor(dB/m) + Cable Factor(dB) – Pre-Amplifier Factor(dB)
3. The other emission levels were very low against the limit.
4. Margin value = Emission Level – Limit value

## 4.2 Conducted Emission Measurement

### 4.2.1 Limits of Conducted Emission Measurement

Frequency (MHz)	Conducted Limit (dBuV)	
	Quasi-peak	Average
0.15 - 0.5	66 - 56	56 - 46
0.50 - 5.0	56	46
5.0 - 30.0	60	50

Note: 1. The lower limit shall apply at the transition frequencies.

2. The limit decreases in line with the logarithm of the frequency in the range of 0.15 to 0.50MHz.

### 4.2.2 Test Instruments

DESCRIPTION & MANUFACTURER	MODEL NO.	SERIAL NO.	CALIBRATED DATE	CALIBRATED UNTIL
Test Receiver R&S	ESCS 30	100375	May 06, 2015	May 05, 2016
Line-Impedance Stabilization Network (for EUT) SCHWARZBECK	NSLK-8127	8127-522	Sep. 15, 2014	Sep. 14, 2015
Line-Impedance Stabilization Network (for Peripheral) R&S	ENV216	100071	Nov. 10, 2014	Nov. 09, 2015
RF Cable	5D-FB	COCCAB-001	Mar. 09, 2015	Mar. 08, 2016
50 ohms Terminator	N/A	EMC-03	Sep. 22, 2014	Sep. 21, 2015
50 ohms Terminator	N/A	EMC-02	Sep. 30, 2014	Sep. 29, 2015
Software BVADT	BVADT_Cond_ V7.3.7.3	NA	NA	NA

**Note:**

1. The calibration interval of the above test instruments are 12 months and the calibrations are traceable to NML/ROC and NIST/USA.
2. The test was performed in Shielded Room No. C.
3. The VCCI Con C Registration No. is C-3611.
4. Tested Date: June 02, 2015

4.2.3 Test Procedures

- a. The EUT was placed 0.4 meters from the conducting wall of the shielded room with EUT being connected to the power mains through a line impedance stabilization network (LISN). Other support units were connected to the power mains through another LISN. The two LISNs provide 50 ohm/ 50uH of coupling impedance for the measuring instrument.
- b. Both lines of the power mains connected to the EUT were checked for maximum conducted interference.
- c. The frequency range from 150kHz to 30MHz was searched. Emission levels under (Limit - 20dB) was not recorded.

**NOTE:** The resolution bandwidth and video bandwidth of test receiver is 9kHz for quasi-peak detection (QP) and average detection (AV) at frequency 0.15MHz-30MHz.

4.2.4 Deviation from Test Standard

No deviation.

4.2.5 Test Setup

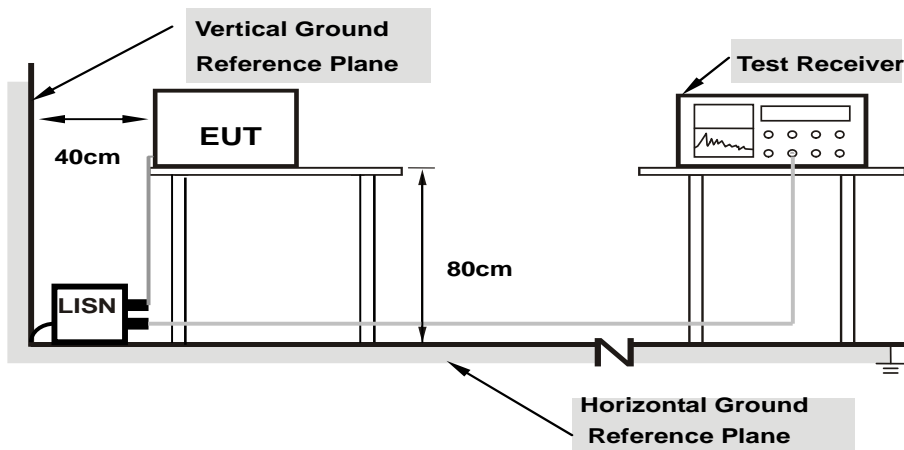

- Note:**
- 1.Support units were connected to second LISN.
  - 2.Both of LISNs (AMN) are 80 cm from EUT and at least 80 from other units and other metal planes

For the actual test configuration, please refer to the attached file (Test Setup Photo).

4.2.6 EUT Operating Conditions

Same as 4.1.6.

#### 4.2.7 Test Results

Phase	Line (L)	Detector Function	Quasi-Peak (QP) / Average (AV)
-------	----------	-------------------	--------------------------------

Phase Of Power : Line (L)										
No	Frequency (MHz)	Correction Factor (dB)	Reading Value (dBuV)		Emission Level (dBuV)		Limit (dBuV)		Margin (dB)	
			Q.P.	AV.	Q.P.	AV.	Q.P.	AV.	Q.P.	AV.
1	0.16953	0.14	24.08	11.83	24.22	11.97	64.98	54.98	-40.76	-43.01
2	0.32578	0.16	35.92	26.37	36.08	26.53	59.56	49.56	-23.48	-23.03
3	0.65781	0.18	20.30	12.52	20.48	12.70	56.00	46.00	-35.52	-33.30
4	1.72266	0.24	15.32	6.19	15.56	6.43	56.00	46.00	-40.44	-39.57
5	18.67578	1.06	28.96	18.50	30.02	19.56	60.00	50.00	-29.98	-30.44
6	24.50000	1.28	32.39	19.32	33.67	20.60	60.00	50.00	-26.33	-29.40

**Remarks:**

1. Q.P. and AV. are abbreviations of quasi-peak and average individually.
2. The emission levels of other frequencies were very low against the limit.
3. Margin value = Emission level – Limit value
4. Correction factor = Insertion loss + Cable loss
5. Emission Level = Correction Factor + Reading Value

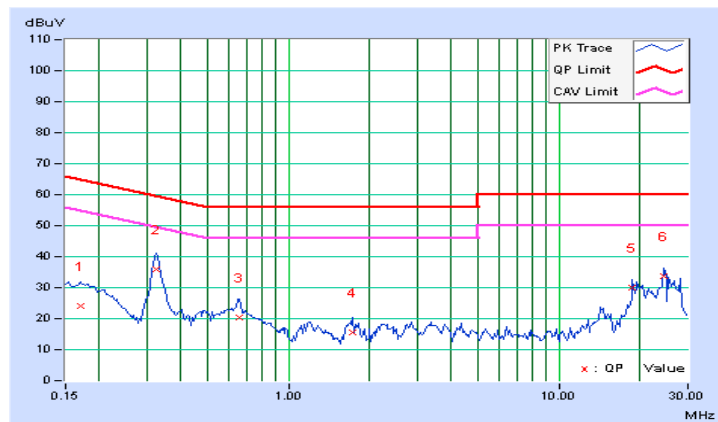

Phase	Neutral (N)	Detector Function	Quasi-Peak (QP) / Average (AV)
-------	-------------	-------------------	--------------------------------

Phase Of Power : Neutral (N)										
No	Frequency (MHz)	Correction Factor (dB)	Reading Value (dBuV)		Emission Level (dBuV)		Limit (dBuV)		Margin (dB)	
			Q.P.	AV.	Q.P.	AV.	Q.P.	AV.	Q.P.	AV.
1	0.32578	0.18	38.38	31.79	38.56	31.97	59.56	49.56	-21.00	-17.59
2	0.65781	0.21	19.99	11.63	20.20	11.84	56.00	46.00	-35.80	-34.16
3	1.16406	0.25	17.29	9.50	17.54	9.75	56.00	46.00	-38.46	-36.25
4	1.66797	0.28	19.35	11.19	19.63	11.47	56.00	46.00	-36.37	-34.53
5	20.12109	1.23	24.17	10.71	25.40	11.94	60.00	50.00	-34.60	-38.06
6	25.44531	1.39	30.26	11.67	31.65	13.06	60.00	50.00	-28.35	-36.94

**Remarks:**

1. Q.P. and AV. are abbreviations of quasi-peak and average individually.
2. The emission levels of other frequencies were very low against the limit.
3. Margin value = Emission level – Limit value
4. Correction factor = Insertion loss + Cable loss
5. Emission Level = Correction Factor + Reading Value

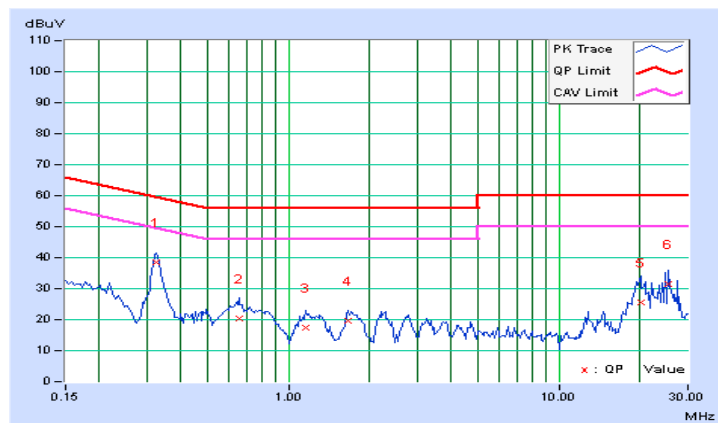

**4.3 6dB Bandwidth Measurement**

4.3.1 Limits of 6dB Bandwidth Measurement

The minimum of 6dB Bandwidth Measurement is 0.5 MHz.

4.3.2 Test Setup

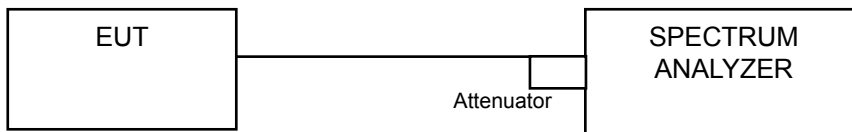

4.3.3 Test Instruments

DESCRIPTION & MANUFACTURER	MODEL NO.	SERIAL NO.	CALIBRATED DATE	CALIBRATED UNTIL
SPECTRUM ANALYZER R&S	FSV 40	100964	July 05, 2014	July 04, 2015

- NOTE:**
1. The test was performed in Oven room B.
  2. The calibration interval of the above test instruments is 12 months and the calibrations are traceable to NML/ROC and NIST/USA.
  3. Tested Date: June 17, 2015

4.3.4 Test Procedure

- a. Set resolution bandwidth (RBW) = 100kHz
- b. Set the video bandwidth (VBW) ≥ 3 x RBW, Detector = Peak.
- c. Trace mode = max hold.
- d. Sweep = auto couple.
- e. Measure the maximum width of the emission that is constrained by the frequencies associated with the two amplitude points (upper and lower) that are attenuated by 6 dB relative to the maximum level measured in the fundamental emission

4.3.5 Deviation from Test Standard

No deviation.

4.3.6 EUT Operating Conditions

The software provided by client to enable the EUT under transmission condition continuously at lowest, middle and highest channel frequencies individually.

#### 4.3.7 Test Result

Channel	Frequency (MHz)	6dB Bandwidth (MHz)	Minimum Limit (MHz)	Pass / Fail
0	2402	0.67	0.5	PASS
19	2440	0.67	0.5	PASS
39	2480	0.67	0.5	PASS

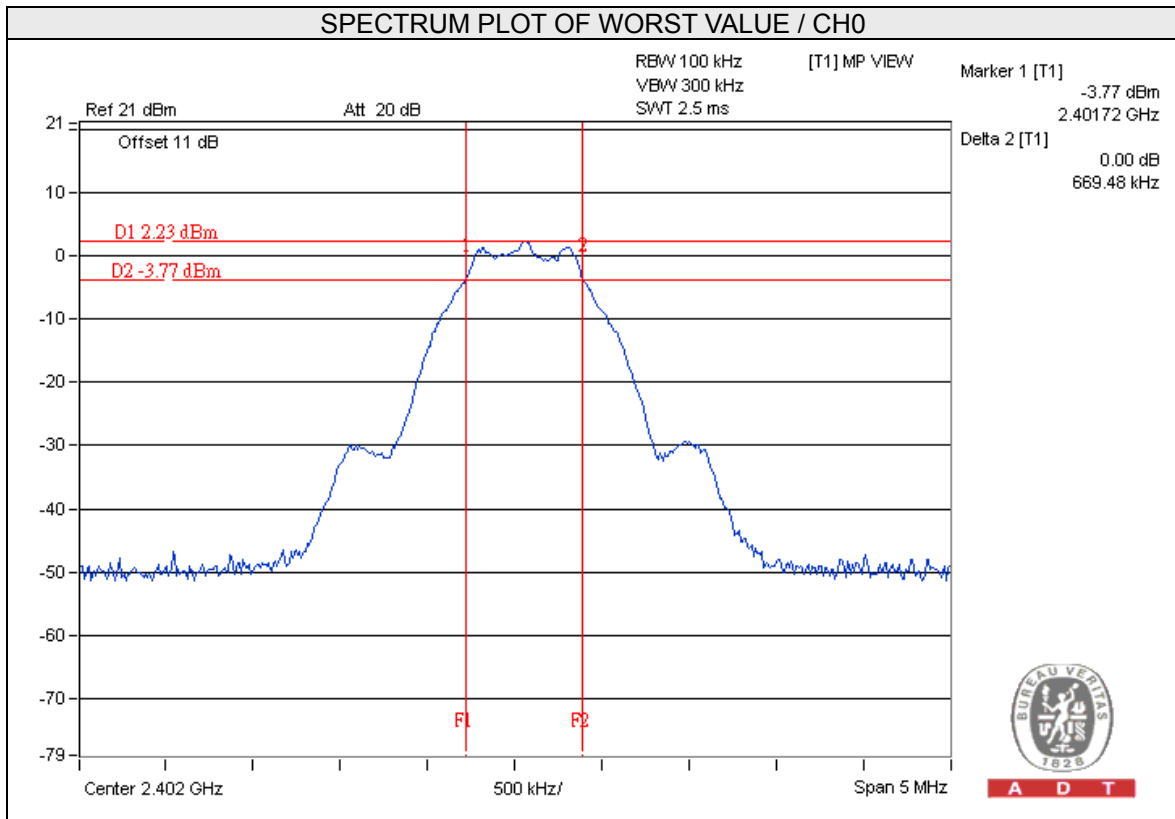

#### 4.4 Conducted Output Power Measurement

##### 4.4.1 Limits of Conducted Output Power Measurement

For systems using digital modulation in the 2400–2483.5 MHz bands: 1 Watt (30dBm)

##### 4.4.2 Test Setup

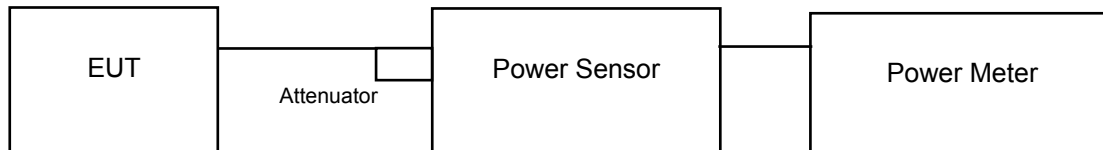

##### 4.4.3 Test Instruments

DESCRIPTION & MANUFACTURER	MODEL NO.	SERIAL NO.	CALIBRATED DATE	CALIBRATED UNTIL
Power Meter Anritsu	ML2495A	1014008	Apr. 28, 2015	Apr. 27, 2016
Power Sensor Anritsu	MA2411B	0917122	Apr. 28, 2015	Apr. 27, 2016

- NOTE:**
1. The test was performed in Oven room B.
  2. The calibration interval of the above test instruments is 12 months and the calibrations are traceable to NML/ROC and NIST/USA.
  3. Tested Date: June 17, 2015

##### 4.4.4 Test Procedures

A peak / average power sensor was used on the output port of the EUT. A power meter was used to read the response of the peak / average power sensor. Record the power level.

##### 4.4.5 Deviation from Test Standard

No deviation.

##### 4.4.6 EUT Operating Conditions

Same as Item 4.3.6.



#### 4.4.7 Test Results

##### For Peak Power

Channel	Frequency (MHz)	Peak Power (mW)	Peak Power (dBm)	Limit (dBm)	Pass/Fail
0	2402	1.923	2.84	30	Pass
19	2440	2.188	3.40	30	Pass
39	2480	1.91	2.81	30	Pass

##### For Average Power

Channel	Frequency (MHz)	Average Power (mW)	Average Power (dBm)
0	2402	1.879	2.74
19	2440	2.143	3.31
39	2480	1.858	2.69

**4.5 Power Spectral Density Measurement**

4.5.1 Limits of Power Spectral Density Measurement

The Maximum of Power Spectral Density Measurement is 8dBm.

4.5.2 Test Setup

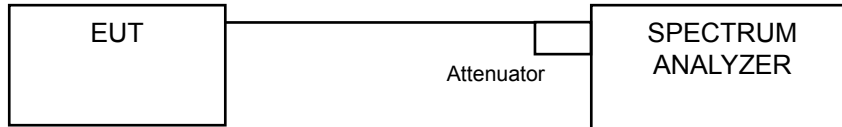

4.5.3 Test Instruments

DESCRIPTION & MANUFACTURER	MODEL NO.	SERIAL NO.	CALIBRATED DATE	CALIBRATED UNTIL
SPECTRUM ANALYZER R&S	FSV 40	100964	July 05, 2014	July 04, 2015

- NOTE:**
1. The test was performed in Oven room B.
  2. The calibration interval of the above test instruments is 12 months and the calibrations are traceable to NML/ROC and NIST/USA.
  3. Tested Date: June 17, 2015

4.5.4 Test Procedure

- a. Set analyzer center frequency to DTS channel center frequency.
- b. Set the span to 1.5 times the DTS bandwidth.
- c. Set the RBW to:  $3 \text{ kHz} \leq \text{RBW} \leq 100 \text{ kHz}$ .
- d. Set the VBW  $\geq 3 \times \text{RBW}$ .
- e. Detector = peak.
- f. Sweep time = auto couple.
- g. Trace mode = max hold.
- h. Allow trace to fully stabilize.
- i. Use the peak marker function to determine the maximum amplitude level within the RBW.

4.5.5 Deviation from Test Standard

No deviation.

4.5.6 EUT Operating Condition

Same as Item 4.3.6

4.5.7 Test Results

Channel	Freq. (MHz)	PSD (dBm)	Limit (dBm)	Pass /Fail
0	2402	-12.69	8	Pass
19	2440	-12.63	8	Pass
39	2480	-12.80	8	Pass

SPECTRUM PLOT OF WORST VALUE / CH19

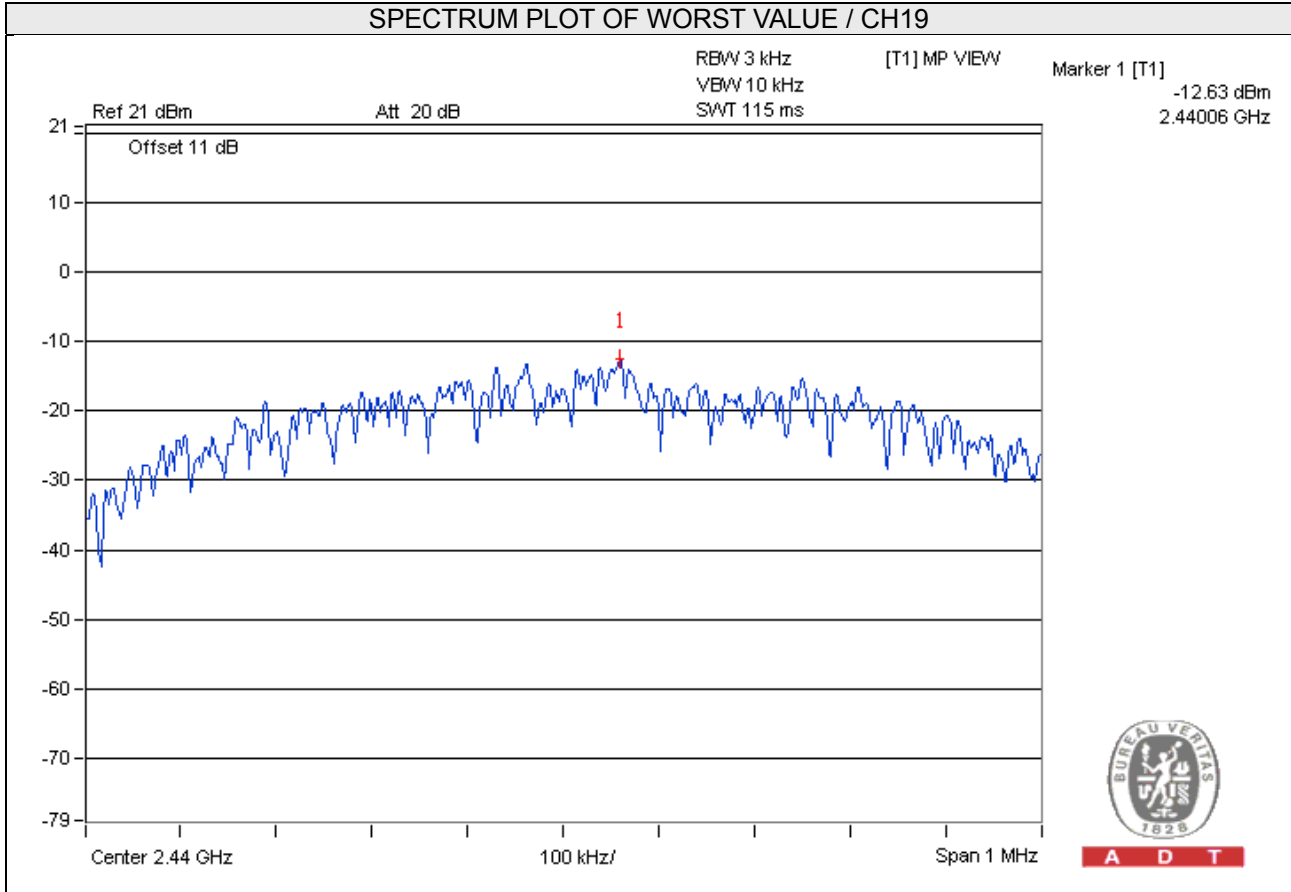

**4.6 Conducted Out of Band Emission Measurement**

4.6.1 Limits of Conducted Out of Band Emission Measurement

Below -20dB of the highest emission level of operating band (in 100kHz Resolution Bandwidth).

4.6.2 Test Setup

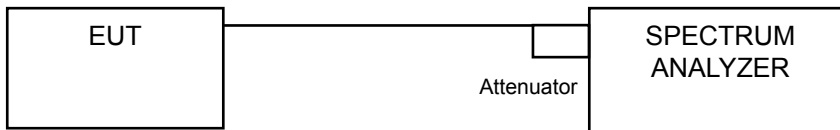

4.6.3 Test Instruments

DESCRIPTION & MANUFACTURER	MODEL NO.	SERIAL NO.	CALIBRATED DATE	CALIBRATED UNTIL
SPECTRUM ANALYZER R&S	FSV 40	100964	July 05, 2014	July 04, 2015

- NOTE:**
1. The test was performed in Oven room B.
  2. The calibration interval of the above test instruments is 12 months and the calibrations are traceable to NML/ROC and NIST/USA.
  3. Tested Date: June 17, 2015

4.6.4 Test Procedure

**MEASUREMENT PROCEDURE REF**

1. Set the RBW = 100 kHz.
2. Set the VBW ≥ 300 kHz.
3. Detector = peak.
4. Sweep time = auto couple.
5. Trace mode = max hold.
6. Allow trace to fully stabilize.
7. Use the peak marker function to determine the maximum power level in any 100 kHz band segment within the fundamental EBW.

**MEASUREMENT PROCEDURE OOB**

1. Set RBW = 100 kHz.
2. Set VBW ≥ 300 kHz.
3. Detector = peak.
4. Sweep = auto couple.
5. Trace Mode = max hold.
6. Allow trace to fully stabilize.
7. Use the peak marker function to determine the maximum amplitude level.

4.6.5 Deviation from Test Standard

No deviation.



4.6.6 EUT Operating Condition

Same as Item 4.3.6

### 4.6.7 Test Results

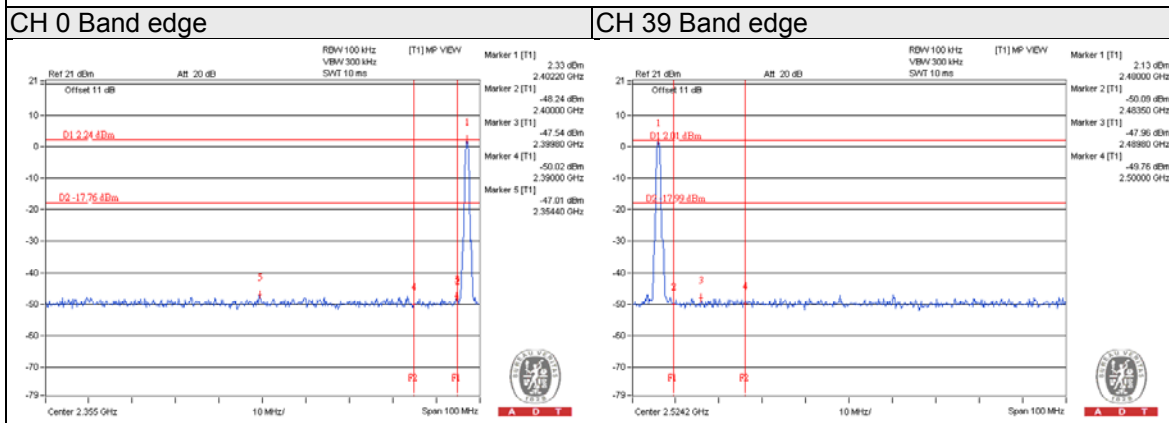
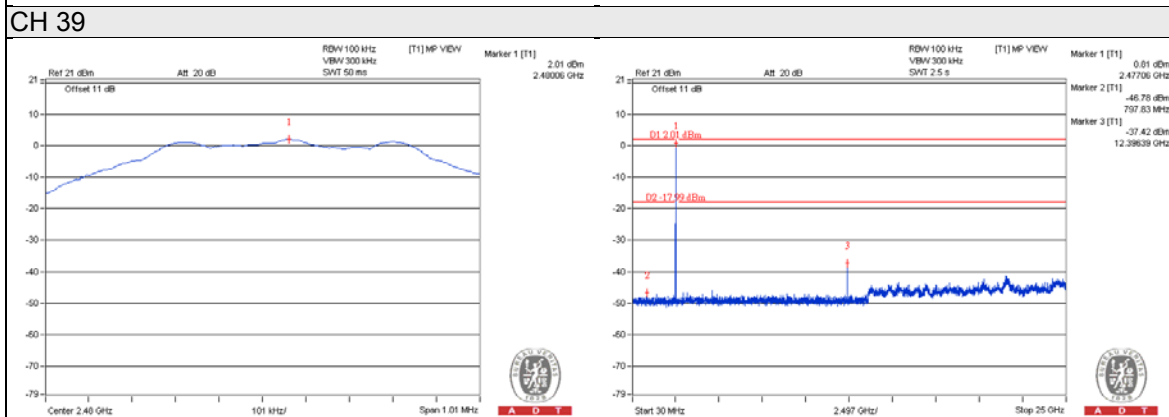
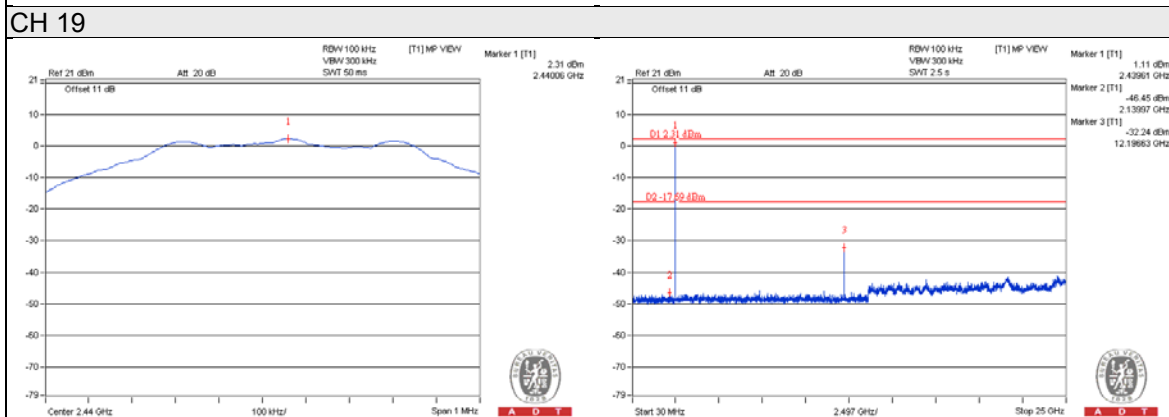
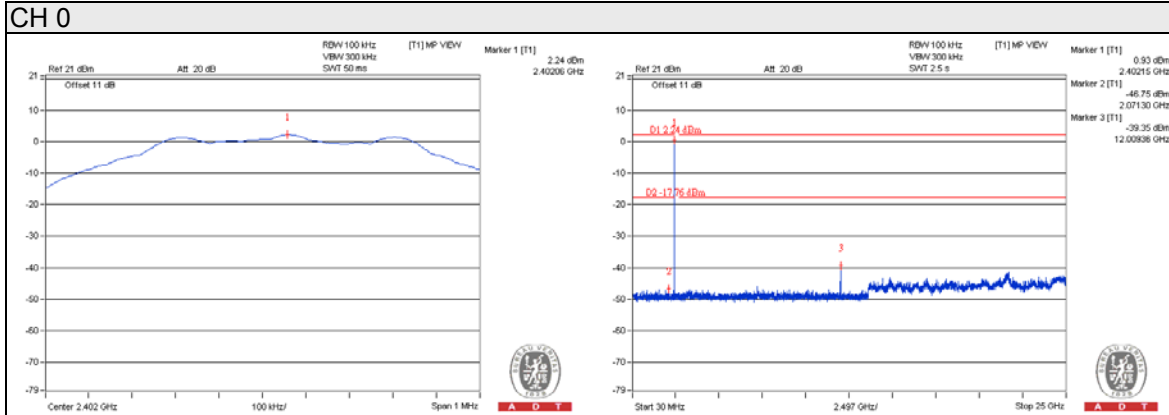

## 5 Pictures of Test Arrangements

Please refer to the attached file (Test Setup Photo).



## Appendix – Information on the Testing Laboratories

We, Bureau Veritas Consumer Products Services (H.K.) Ltd., Taoyuan Branch, were founded in 1988 to provide our best service in EMC, Radio, Telecom and Safety consultation. Our laboratories are accredited and approved according to ISO/IEC 17025.

If you have any comments, please feel free to contact us at the following:

**Linko EMC/RF Lab**

Tel: 886-2-26052180

Fax: 886-2-26051924

**Hsin Chu EMC/RF Lab/Telecom Lab**

Tel: 886-3-5935343

Fax: 886-3-5935342

**Hwa Ya EMC/RF/Safety**

Tel: 886-3-3183232

Fax: 886-3-3270892

**Email:** [service.adt@tw.bureauveritas.com](mailto:service.adt@tw.bureauveritas.com)**Web Site:** [www.bureauveritas-adt.com](http://www.bureauveritas-adt.com)

The address and road map of all our labs can be found in our web site also.

--- END ---