



FCC RADIO TEST REPORT

FCC ID : UZ7PS20J
Equipment : PS20 Personal Shopper
Brand Name : ZEBRA
Model Name : PS20J
Applicant : Zebra Technologies Corporation
1 Zebra Plaza Holtsville, NY 11742
Manufacturer : Zebra Technologies Corporation
1 Zebra Plaza Holtsville, NY 11742
Standard : FCC Part 15 Subpart C §15.247

The product was received on Jun. 02, 2018 and testing was started from Jun. 06, 2018 and completed on Sep. 08, 2018. We, SPORTON INTERNATIONAL INC., would like to declare that the tested sample has been evaluated in accordance with the test procedures and has been in compliance with the applicable technical standards.

The report must not be used by the client to claim product certification, approval, or endorsement by TAF or any agency of government.

The test results in this report apply exclusively to the tested model / sample. Without written approval of SPORTON INTERNATIONAL INC. EMC & Wireless Communications Laboratory, the test report shall not be reproduced except in full.

Approved by: Joseph Lin

SPORTON INTERNATIONAL INC. EMC & Wireless Communications Laboratory
No. 52, Huaya 1st Rd., Guishan Dist., Taoyuan City, Taiwan (R.O.C.)



Table of Contents

History of this test report.....	3
Summary of Test Result.....	4
1 General Description	5
1.1 Product Feature of Equipment Under Test.....	5
1.2 Product Specification of Equipment Under Test.....	6
1.3 Modification of EUT	7
1.4 Testing Location	8
1.5 Applicable Standards.....	8
2 Test Configuration of Equipment Under Test	9
2.1 Carrier Frequency and Channel	9
2.2 Test Mode.....	10
2.3 Connection Diagram of Test System.....	18
2.4 Support Unit used in test configuration and system	19
2.5 EUT Operation Test Setup	20
2.6 Measurement Results Explanation Example.....	20
3 Test Result	21
3.1 6dB and 99% Bandwidth Measurement	21
3.2 Output Power Measurement.....	25
3.3 Power Spectral Density Measurement	32
3.4 Conducted Band Edges and Spurious Emission Measurement	38
3.5 Radiated Band Edges and Spurious Emission Measurement	99
3.6 AC Conducted Emission Measurement.....	104
3.7 Antenna Requirements.....	106
4 List of Measuring Equipment.....	108
5 Uncertainty of Evaluation	109
Appendix A. AC Conducted Emission Test Result	
Appendix B. Radiated Spurious Emission	
Appendix C. Radiated Spurious Emission Plots	
Appendix D. Duty Cycle Plots	
Appendix E. Setup Photographs	



History of this test report

Report No.	Version	Description	Issued Date
FR860204C	01	Initial issue of report	Sep. 13, 2018



Summary of Test Result

Report Clause	Ref Std. Clause	Test Items	Result (PASS/FAIL)	Remark
3.1	15.247(a)(2)	6dB Bandwidth	Pass	-
3.1	2.1049	99% Occupied Bandwidth	Reporting only	-
3.2	15.247(b)	Power Output Measurement	Pass	-
3.3	15.247(e)	Power Spectral Density	Pass	-
3.4	15.247(d)	Conducted Band Edges	Pass	-
		Conducted Spurious Emission	Pass	-
3.5	15.247(d)	Radiated Band Edges and Radiated Spurious Emission	Pass	Under limit 1.04 dB at 2390.000 MHz
3.6	15.207	AC Conducted Emission	Pass	Under limit 4.20 dB at 0.544 MHz
3.7	15.203 & 15.247(b)	Antenna Requirement	Pass	-

Reviewed by: Wii Chang

Report Producer: Maggie Chiang



1 General Description

1.1 Product Feature of Equipment Under Test

Product Feature	
Equipment	PS20 Personal Shopper
Sample 1	Plus SKU
Sample 2	Base SKU
Brand Name	ZEBRA
Model Name	PS20J
FCC ID	UZ7PS20J
EUT supports Radios application	WLAN 11a/b/g/n HT20/HT40 WLAN 11ac VHT20/VHT40/VHT80 Bluetooth BR/EDR/LE
HW Version	EV3
SW Version	91-09-06.00-ON-U00-STD
FW Version	91-09-06.00-ON-U00-STD
MFD	06JUL18
EUT Stage	Engineering Sample

Remark: The above EUT's information was declared by manufacturer.

Specification of Accessories				
Battery	Brand Name	Zebra	Part Number	BT-000351

Supported Unit Used in Test Configuration and System				
1-slot cradle	Brand Name	Symbol	Part Number	CRD-MC18-1SL
Adapter	Brand Name	Zebra	Part Number	PWR-BGA12V108W0WW
Programming USB cable	Brand Name	Zebra	Part Number	CBL-PS20-USBCHG-01



1.2 Product Specification of Equipment Under Test

Standards-related Product Specification	
Tx/Rx Channel Frequency Range	2412 MHz ~ 2462 MHz
Maximum Output Power to antenna <CDD Mode>	<p><Ant. 1> 802.11b : 20.94 dBm (0.1242 W) 802.11g : 18.94 dBm (0.0783 W) 802.11n HT20 : 18.82 dBm (0.0762 W) 802.11n HT40 : 20.24 dBm (0.1057 W) 802.11ac VHT20 : 18.81 dBm (0.0760 W) 802.11ac VHT40 : 20.19 dBm (0.1045 W)</p> <p><Ant. 2> 802.11b : 20.97 dBm (0.1250 W) 802.11g : 18.77 dBm (0.0753 W) 802.11n HT20 : 18.70 dBm (0.0741 W) 802.11n HT40 : 20.08 dBm (0.1019 W) 802.11ac VHT20 : 18.66 dBm (0.0735 W) 802.11ac VHT40 : 20.04 dBm (0.1009 W)</p> <p>MIMO <Ant. 1 + 2> 802.11b : 23.84 dBm (0.2421 W) 802.11g : 21.50 dBm (0.1413 W) 802.11n HT20 : 21.78 dBm (0.1507 W) 802.11n HT40 : 19.91 dBm (0.0979 W) 802.11ac VHT20 : 21.77 dBm (0.1503 W) 802.11ac VHT40 : 19.90 dBm (0.0977 W)</p>
Maximum Output Power to antenna <TXBF Mode>	<p>MIMO <Ant. 1 + 2> 802.11ac VHT20 : 21.75 dBm (0.1496 W) 802.11ac VHT40 : 18.86 dBm (0.0769 W)</p>
99% Occupied Bandwidth <CDD Mode>	<p><Ant. 1> 802.11b : 13.29MHz 802.11g : 16.83MHz 802.11n HT20 : 17.93MHz 802.11n HT40 : 36.46MHz</p> <p><Ant. 2> 802.11b : 14.19MHz 802.11g : 16.78MHz 802.11n HT20 : 17.93MHz 802.11n HT40 : 36.46MHz</p> <p>MIMO <Ant. 1> 802.11b : 13.29MHz 802.11g : 16.83MHz 802.11n HT20 : 18.03MHz 802.11n HT40 : 36.46MHz</p> <p>MIMO <Ant. 2> 802.11b : 14.19MHz 802.11g : 16.78MHz 802.11n HT20 : 17.93MHz 802.11n HT40 : 36.66MHz</p>



Standards-related Product Specification			
99% Occupied Bandwidth <TXBF Mode>	MIMO <Ant. 1> 802.11n VHT20 : 17.78MHz 802.11n VHT40 : 37.26MHz		
	MIMO <Ant. 2> 802.11n VHT20 : 18.23MHz 802.11n VHT40 : 36.46MHz		
Antenna Type / Gain	<Ant. 1> PIFA Antenna with gain 2.02 dBi <Ant. 2> PIFA Antenna with gain 2.23 dBi		
Type of Modulation	802.11b : DSSS (DBPSK/DQPSK/CCK) 802.11g/n : OFDM (BPSK/QPSK/16QAM/64QAM) 802.11ac : OFDM (BPSK/QPSK/16QAM/64QAM/256QAM)		
Antenna Function Description		Ant. 1	Ant. 2
	802.11 b/g/n/ac	V	V
	802.11 b/g/n/ac MIMO	V	V
	802.11 ac TXBF	V	V

Note: MIMO Ant. 1+2 is a calculated result from sum of the power MIMO Ant. 1 and MIMO Ant. 2.

1.3 Modification of EUT

No modifications are made to the EUT during all test items.



1.4 Testing Location

Sporton Lab is accredited to ISO 17025 by Taiwan Accreditation Foundation (TAF code : 1190) and the FCC designation No. TW1190 and TW0007 under the FCC 2.948(e) by Mutual Recognition Agreement (MRA) in FCC Test.

Test Site	SPORTON INTERNATIONAL INC.	
Test Site Location	No.52, Huaya 1st Rd., Guishan Dist., Taoyuan City, Taiwan (R.O.C.) TEL: +886-3-327-3456 FAX: +886-3-328-4978	
Test Site No.	Sporton Site No.	
	TH05-HY	CO05-HY

Note: The test site complies with ANSI C63.4 2014 requirement.

Test Site	SPORTON INTERNATIONAL INC.	
Test Site Location	No.58, Aly. 75, Ln. 564, Wenhua 3rd, Rd., Guishan Dist., Taoyuan City, Taiwan (R.O.C.) TEL: +886-3-327-0868 FAX: +886-3-327-0855	
Test Site No.	Sporton Site No.	
	03CH11-HY	

Note: The test site complies with ANSI C63.4 2014 requirement.

1.5 Applicable Standards

According to the specifications of the manufacturer, the EUT must comply with the requirements of the following standards:

- ♦ FCC Part 15 Subpart C §15.247
- ♦ FCC KDB Publication No. 558074 D01 DTS Meas. Guidance v05
- ♦ FCC KDB 414788 D01 Radiated Test Site v01r01.
- ♦ FCC KDB 662911 D01 Multiple Transmitter Output v02r01.
- ♦ ANSI C63.10-2013

Remark:

1. All test items were verified and recorded according to the standards and without any deviation during the test.
2. This EUT has also been tested and complied with the requirements of FCC Part 15, Subpart B, recorded in a separate test report.



2 Test Configuration of Equipment Under Test

- a. The EUT has been associated with peripherals and configuration operated in a manner tended to maximize its emission characteristics in a typical application. Frequency range investigated: conduction emission (150 kHz to 30 MHz), radiation emission (9 kHz to the 10th harmonic of the highest fundamental frequency or to 40 GHz, whichever is lower). For radiated measurement, pre-scanned in three orthogonal panels, X, Y, Z. The worst cases (Z plane for Sample 1 CDD Mode Ant. 1, Ant. 1+2, TXBF Mode Ant. 1+2, and Sample 2 CDD Mode Ant. 1+2 ; Y Plane for Sample 1 CDD Mode Ant. 2) for were recorded in this report.

- b. AC power line Conducted Emission was tested under maximum output power.

2.1 Carrier Frequency and Channel

Frequency Band	Channel	Freq. (MHz)	Channel	Freq. (MHz)
2400-2483.5 MHz	1	2412	7	2442
	2	2417	8	2447
	3	2422	9	2452
	4	2427	10	2457
	5	2432	11	2462
	6	2437		



2.2 Test Mode

Final test modes are considering the modulation and worse data rates as below table.

Single Mode

Modulation	Data Rate
802.11b	1 Mbps
802.11g	6 Mbps
802.11n HT20	MCS0
802.11n HT40	MCS0
802.11ac VHT20 (Covered by HT20)	MCS0
802.11ac VHT40 (Covered by HT40)	MCS0

MIMO Mode

Modulation	Data Rate
802.11b	1 Mbps
802.11g	6 Mbps
802.11n HT20	MCS0
802.11n HT40	MCS0
802.11ac VHT20 (Covered by HT20)	MCS0
802.11ac VHT40 (Covered by HT40)	MCS0

TXBF Mode

Modulation	Data Rate
802.11ac VHT20	MCS0
802.11ac VHT40	MCS0

Test Cases	
AC Conducted Emission	Mode 1: WLAN (2.4GHz) Link + Bluetooth Link + MPEG4 + 1 Slot Locking Cradle + AC Adapter (Sanhua) for Sample 1



<CDD Mode>

<Ant. 1>

802.11b RF Avg Output Power (dBm)						
Power vs. Channel			Power vs Data Rate			
Channel	Frequency (MHz)	Data Rate (bps)	Channel	Data Rate (bps)		
		1M		2M	5.5M	11M
Duty Cycle (%)		99.03		98.10	95.56	93.48
CH 01	2412	20.67	CH 06	20.89	20.93	20.93
CH 02	2417	20.72				
CH 06	2437	20.94				
CH 10	2457	20.65				
CH 11	2462	20.80				

802.11g RF Avg Output Power (dBm)										
Power vs. Channel			Power vs Data Rate							
Channel	Frequency (MHz)	Data Rate (bps)	Channel	Data Rate (bps)						
		6M		9Mbps	12Mbps	18Mbps	24Mbps	36Mbps	48Mbps	54Mbps
Duty Cycle (%)		94.39		93.15	90.27	88.69	85.62	78.07	76.40	74.39
CH 01	2412	18.61	CH 02	18.71	18.75	18.92	18.89	18.72	18.55	18.54
CH 02	2417	18.94								
CH 06	2437	18.78								
CH 10	2457	18.91								
CH 11	2462	17.47								

802.11n HT20 RF Avg Output Power (dBm)										
Power vs. Channel			Power vs Data Rate							
Channel	Frequency (MHz)	MCS Index	Channel	MCS Index						
		MCS 0		MCS 1	MCS 2	MCS 3	MCS 4	MCS 5	MCS 6	MCS 7
Duty Cycle (%)		94.00		91.90	88.68	85.37	79.82	75.49	74.39	71.96
CH 01	2412	18.82	CH 01	18.50	18.80	18.79	18.52	18.52	18.46	18.53
CH 02	2417	18.75								
CH 06	2437	18.66								
CH 10	2457	18.71								
CH 11	2462	17.09								



802.11n HT40 RF Avg Output Power (dBm)										
Power vs. Channel			Power vs Data Rate							
Channel	Frequency (MHz)	MCS Index	Channel	MCS Index						
		MCS 0		MCS 1	MCS 2	MCS 3	MCS 4	MCS 5	MCS 6	MCS 7
Duty Cycle (%)		91.18		85.51	79.62	76.02	69.12	63.79	61.26	60.28
CH 03	2422	17.08	CH 06	19.97	20.02	20.03	19.96	19.85	19.91	19.92
CH 04	2427	18.23								
CH 06	2437	20.24								
CH 08	2447	17.72								
CH 09	2452	15.72								

802.11ac VHT20 RF Avg Output Power (dBm)											
Power vs. Channel			Power vs Data Rate								
Channel	Frequency (MHz)	MCS Index	Channel	MCS Index							
		MCS 0		MCS 1	MCS 2	MCS 3	MCS 4	MCS 5	MCS 6	MCS 7	MCS 8
Duty Cycle (%)		94.00		91.08	88.00	83.83	79.91	76.24	74.92	73.08	69.75
CH 01	2412	18.81	CH 01	18.60	18.80	18.79	18.55	18.53	18.47	18.53	18.51
CH 02	2417	18.71									
CH 06	2437	18.62									
CH 10	2457	18.67									
CH 11	2462	17.05									

802.11ac VHT40 RF Avg Output Power (dBm)												
Power vs. Channel			Power vs Data Rate									
Channel	Frequency (MHz)	MCS Index	Channel	MCS Index								
		MCS 0		MCS 1	MCS 2	MCS 3	MCS 4	MCS 5	MCS 6	MCS 7	MCS 8	MCS 9
Duty Cycle (%)		90.29		84.72	76.92	73.33	69.82	64.14	61.67	57.64	55.29	51.92
CH 03	2422	17.06	CH 06	20.03	20.16	20.13	19.90	19.91	19.90	20.09	20.11	20.18
CH 04	2427	18.20										
CH 06	2437	20.19										
CH 08	2447	17.64										
CH 09	2452	15.69										



<Ant. 2>

802.11b RF Avg Output Power (dBm)						
Power vs. Channel			Power vs Data Rate			
Channel	Frequency (MHz)	Data Rate (bps)	Channel	Data Rate (bps)		
		1M		2M	5.5M	11M
Duty Cycle (%)		99.03		98.41	95.56	92.81
CH 01	2412	20.96	CH 06	20.78	20.80	20.58
CH 02	2417	20.93				
CH 06	2437	20.97				
CH 10	2457	20.94				
CH 11	2462	20.90				

802.11g RF Avg Output Power (dBm)										
Power vs. Channel			Power vs Data Rate							
Channel	Frequency (MHz)	Data Rate (bps)	Channel	Data Rate (bps)						
		6M		9Mbps	12Mbps	18Mbps	24Mbps	36Mbps	48Mbps	54Mbps
Duty Cycle (%)		95.33		93.15	91.07	88.66	84.97	80.18	75.28	73.86
CH 01	2412	18.19	CH 06	18.36	18.34	18.48	18.52	18.03	18.09	18.02
CH 02	2417	18.73								
CH 06	2437	18.77								
CH 10	2457	18.26								
CH 11	2462	17.01								

802.11n HT20 RF Avg Output Power (dBm)										
Power vs. Channel			Power vs Data Rate							
Channel	Frequency (MHz)	MCS Index	Channel	MCS Index						
		MCS 0		MCS 1	MCS 2	MCS 3	MCS 4	MCS 5	MCS 6	MCS 7
Duty Cycle (%)		94.00		92.34	88.53	85.96	80.18	76.14	72.84	72.03
CH 01	2412	17.98	CH 06	18.61	18.31	18.32	18.01	17.94	18.07	17.99
CH 02	2417	18.64								
CH 06	2437	18.70								
CH 10	2457	17.58								
CH 11	2462	16.87								



802.11n HT40 RF Avg Output Power (dBm)										
Power vs. Channel			Power vs Data Rate							
Channel	Frequency (MHz)	MCS Index	Channel	MCS Index						
		MCS 0		MCS 1	MCS 2	MCS 3	MCS 4	MCS 5	MCS 6	MCS 7
Duty Cycle (%)		91.18		85.26	80.00	73.24	69.37	64.07	61.82	60.66
CH 03	2422	18.22	CH 06	19.96	20.03	19.71	19.41	19.35	19.41	19.38
CH 04	2427	19.03								
CH 06	2437	20.08								
CH 08	2447	16.64								
CH 09	2452	15.25								

802.11ac VHT20 RF Avg Output Power (dBm)											
Power vs. Channel			Power vs Data Rate								
Channel	Frequency (MHz)	MCS Index	Channel	MCS Index							
		MCS 0		MCS 1	MCS 2	MCS 3	MCS 4	MCS 5	MCS 6	MCS 7	MCS 8
Duty Cycle (%)		94.00		90.65	86.84	85.52	80.73	76.24	74.25	70.81	69.01
CH 01	2412	17.97	CH 06	18.65	18.39	18.35	17.96	18.02	18.05	18.18	18.00
CH 02	2417	18.62									
CH 06	2437	18.66									
CH 10	2457	17.47									
CH 11	2462	16.81									

802.11ac VHT40 RF Avg Output Power (dBm)												
Power vs. Channel			Power vs Data Rate									
Channel	Frequency (MHz)	MCS Index	Channel	MCS Index								
		MCS 0		MCS 1	MCS 2	MCS 3	MCS 4	MCS 5	MCS 6	MCS 7	MCS 8	MCS 9
Duty Cycle (%)		90.29		82.99	79.81	76.30	68.82	63.07	61.95	61.11	57.43	56.25
CH 03	2422	18.21	CH 06	19.61	19.58	19.46	19.47	19.48	19.46	19.40	19.37	19.38
CH 04	2427	19.02										
CH 06	2437	20.04										
CH 08	2447	16.63										
CH 09	2452	15.14										



MIMO <Ant. 1+2>

802.11b RF Avg Output Power (dBm)						
Power vs. Channel			Power vs Data Rate			
Channel	Frequency (MHz)	Data Rate (bps)	Channel	Data Rate (bps)		
		1M		2M	5.5M	11M
CH 01	2412	23.72	CH 10	23.39	23.62	23.44
CH 02	2417	23.65				
CH 06	2437	23.19				
CH 10	2457	23.84				
CH 11	2462	23.50				

802.11g RF Avg Output Power (dBm)										
Power vs. Channel			Power vs Data Rate							
Channel	Frequency (MHz)	Data Rate (bps)	Channel	Data Rate (bps)						
		6M		9Mbps	12Mbps	18Mbps	24Mbps	36Mbps	48Mbps	54Mbps
CH 01	2412	21.05	CH 02	21.49	21.09	21.27	21.12	20.96	20.87	20.84
CH 02	2417	21.50								
CH 06	2437	21.44								
CH 10	2457	19.69								
CH 11	2462	18.33								

802.11n HT20 RF Avg Output Power (dBm)										
Power vs. Channel			Power vs Data Rate							
Channel	Frequency (MHz)	MCS Index	Channel	MCS Index						
		MCS0		MCS1	MCS2	MCS3	MCS4	MCS5	MCS6	MCS7
CH 01	2412	21.45	CH 06	21.41	21.63	21.69	21.40	21.32	21.29	21.33
CH 02	2417	21.12								
CH 06	2437	21.78								
CH 10	2457	20.13								
CH 11	2462	18.15								



Power vs. Channel			Power vs Data Rate							
Channel	Frequency (MHz)	MCS Index	Channel	MCS Index						
		MCS0		MCS1	MCS2	MCS3	MCS4	MCS5	MCS6	MCS7
CH 03	2422	17.97	CH 04	19.96	20.03	19.71	19.41	19.35	19.41	19.38
CH 04	2427	19.91								
CH 06	2437	18.79								
CH 08	2447	17.07								
CH 09	2452	15.55								

802.11ac VHT20 RF Avg Output Power (dBm)											
Power vs. Channel			Power vs Data Rate								
Channel	Frequency (MHz)	MCS Index	Channel	MCS Index							
		MCS 0		MCS 1	MCS 2	MCS 3	MCS 4	MCS 5	MCS 6	MCS 7	MCS 8
CH 01	2412	21.41	CH 06	21.44	21.60	21.71	21.38	21.38	21.23	21.34	21.30
CH 02	2417	21.09									
CH 06	2437	21.77									
CH 10	2457	20.11									
CH 11	2462	18.14									

802.11ac VHT40 RF Avg Output Power (dBm)												
Power vs. Channel			Power vs Data Rate									
Channel	Frequency (MHz)	MCS Index	Channel	MCS Index								
		MCS 0		MCS 1	MCS 2	MCS 3	MCS 4	MCS 5	MCS 6	MCS 7	MCS 8	MCS 9
CH 03	2422	17.94	CH 04	19.58	19.66	19.69	19.66	19.49	19.64	19.65	19.57	19.48
CH 04	2427	19.90										
CH 06	2437	18.71										
CH 08	2447	17.06										
CH 09	2452	15.54										



<TXBF Mode>

MIMO <Ant. 1+2>

802.11ac VHT20 RF Avg Output Power (dBm)											
Power vs. Channel			Power vs Data Rate								
Channel	Frequency (MHz)	MCS Index	Channel	MCS Index							
		MCS 0		MCS 1	MCS 2	MCS 3	MCS 4	MCS 5	MCS 6	MCS 7	MCS 8
CH 01	2412	20.97	CH 06	21.72	21.46	21.50	21.65	21.54	21.67	21.67	21.72
CH 02	2417	20.94									
CH 06	2437	21.75									
CH 10	2457	19.66									
CH 11	2462	18.28									

802.11ac VHT40 RF Avg Output Power (dBm)												
Power vs. Channel			Power vs Data Rate									
Channel	Frequency (MHz)	MCS Index	Channel	MCS Index								
		MCS 0		MCS 1	MCS 2	MCS 3	MCS 4	MCS 5	MCS 6	MCS 7	MCS 8	MCS 9
CH 03	2422	18.37	CH 04	18.76	18.76	18.22	18.72	18.56	18.69	18.65	18.71	18.71
CH 04	2427	18.86										
CH 06	2437	18.80										
CH 08	2447	16.21										
CH 09	2452	14.62										

2.3 Connection Diagram of Test System

<WLAN Tx Mode>

<CDD Mode>

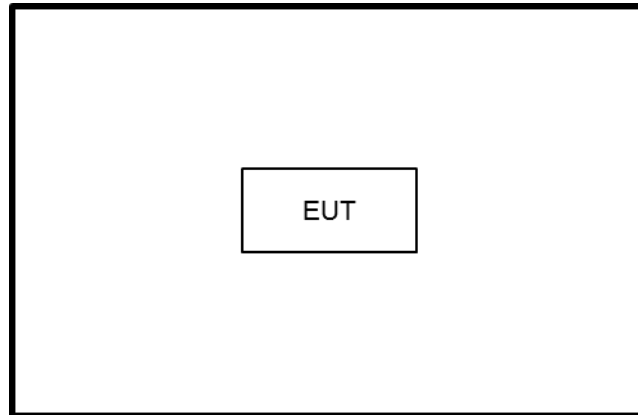

<TXBF Mode>

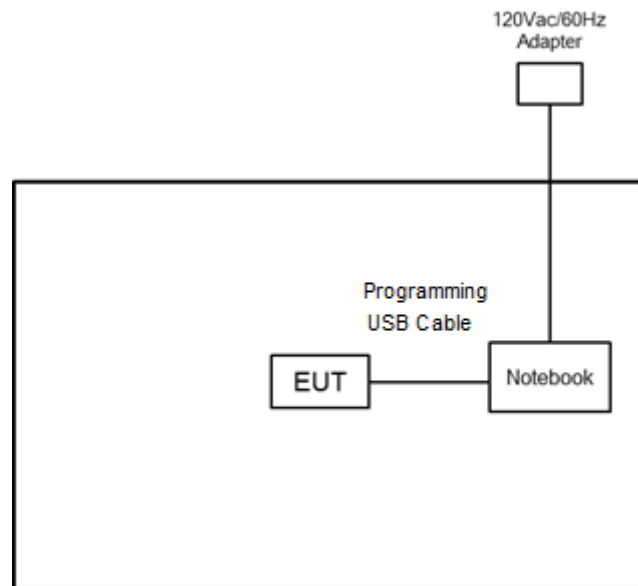

<AC Conducted Emission Mode>

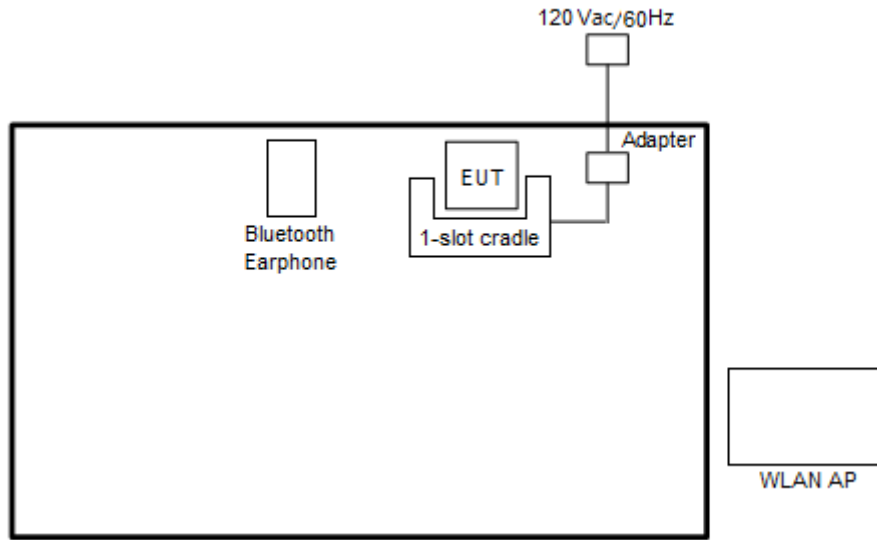

2.4 Support Unit used in test configuration and system

Item	Equipment	Trade Name	Model Name	FCC ID	Data Cable	Power Cord
1.	Bluetooth Earphone	Sony Ericsson	MW600	PY7DDA-2029	N/A	N/A
2.	WLAN AP	ASUS	RT-AC66U	MSQ-RTAC66U	N/A	Unshielded, 1.8m
3.	Notebook	DELL	Latitude E6320	FCC DoC/ Contains FCC ID: QDS-BRCM1054	N/A	AC I/P: Unshielded, 1.2m DC O/P: Shielded, 1.8m
4.	Notebook	Lenovo	G480	PPD-AR5895	N/A	AC Non-Shielded, 1.8m



2.5 EUT Operation Test Setup

The RF test items, utility “QRCT” was installed in Notebook which was programmed in order to make the EUT get into the engineering modes to provide channel selection, power level, data rate and the application type and for continuous transmitting signals.

For TXBF mode, the modulation modes and data rates manipulated by the command lines in the engineering program made the EUT link to another EUT by power under the normal operation. The “QRCT” software tool was used to enable the EUT to transmit signals continuously.

2.6 Measurement Results Explanation Example

For all conducted test items:

The offset level is set in the spectrum analyzer to compensate the RF cable loss and attenuator factor between EUT conducted output port and spectrum analyzer. With the offset compensation, the spectrum analyzer reading level is exactly the EUT RF output level.

Example:

The spectrum analyzer offset is derived from RF cable loss and attenuator factor.

Offset = RF cable loss + attenuator factor.

Following shows an offset computation example with cable loss 4.2 dB and 10dB attenuator.

$$\begin{aligned} \text{Offset}(dB) &= \text{RF cable loss}(dB) + \text{attenuator factor}(dB). \\ &= 4.2 + 10 = 14.2 \text{ (dB)} \end{aligned}$$

3 Test Result

3.1 6dB and 99% Bandwidth Measurement

3.1.1 Limit of 6dB and 99% Bandwidth

The minimum 6 dB bandwidth shall be at least 500 kHz.

3.1.2 Measuring Instruments

See list of measuring equipment of this test report.

3.1.3 Test Procedures

1. The testing follows FCC KDB Publication No. 558074 DTS D01 Meas. Guidance v05.
2. The RF output of EUT was connected to the spectrum analyzer by RF cable and attenuator. The path loss was compensated to the results for each measurement.
3. Set to the maximum power setting and enable the EUT transmit continuously.
4. Make the measurement with the spectrum analyzer's resolution bandwidth (RBW) = 100 kHz. Set the Video bandwidth (VBW) = 300 kHz. In order to make an accurate measurement. The 6 dB bandwidth must be greater than 500 kHz.
5. For 99% Bandwidth Measurement, the spectrum analyzer's resolution bandwidth (RBW) is set 1-5% of the emission bandwidth and set the Video bandwidth (VBW) $\geq 3 * RBW$.
6. Measure and record the results in the test report.

3.1.4 Test Setup





3.1.5 Test Result of 6dB and 99% Occupied Bandwidth

<CDD Modes>

2.4GHz Band										
Mod.	Data Rate	NTX	CH.	Freq. (MHz)	99% Occupied BW (MHz)		6dB BW (MHz)		6dB BW Limit (MHz)	Pass/Fail
					Ant 1	Ant 2	Ant 1	Ant 2		
11b	1Mbps	1	1	2412	13.09	13.79	8.01	8.01	0.50	Pass
11b	1Mbps	1	6	2437	13.09	13.64	8.03	8.03	0.50	Pass
11b	1Mbps	1	11	2462	13.29	14.19	7.57	8.03	0.50	Pass
11g	6Mbps	1	1	2412	16.73	16.78	15.46	15.52	0.50	Pass
11g	6Mbps	1	6	2437	16.78	16.73	15.88	15.42	0.50	Pass
11g	6Mbps	1	11	2462	16.83	16.73	15.46	15.72	0.50	Pass
HT20	MCS0	1	1	2412	17.83	17.88	16.12	15.44	0.50	Pass
HT20	MCS0	1	6	2437	17.88	17.93	16.52	15.66	0.50	Pass
HT20	MCS0	1	11	2462	17.93	17.93	16.12	16.62	0.50	Pass
HT40	MCS0	1	3	2422	36.46	36.46	35.12	35.12	0.50	Pass
HT40	MCS0	1	6	2437	36.46	36.46	35.60	35.12	0.50	Pass
HT40	MCS0	1	9	2452	36.46	36.46	35.12	35.68	0.50	Pass
11b	1Mbps	2	1	2412	13.24	14.14	8.01	8.03	0.50	Pass
11b	1Mbps	2	6	2437	13.09	13.39	8.01	8.03	0.50	Pass
11b	1Mbps	2	11	2462	13.29	14.19	7.55	8.05	0.50	Pass
11g	6Mbps	2	1	2412	16.73	16.68	15.44	15.68	0.50	Pass
11g	6Mbps	2	6	2437	16.78	16.73	15.34	16.26	0.50	Pass
11g	6Mbps	2	11	2462	16.83	16.78	15.88	16.28	0.50	Pass
HT20	MCS0	2	1	2412	17.93	17.93	15.94	15.70	0.50	Pass
HT20	MCS0	2	6	2437	17.93	17.88	15.90	16.02	0.50	Pass
HT20	MCS0	2	11	2462	18.03	17.93	15.94	16.76	0.50	Pass
HT40	MCS0	2	3	2422	36.36	36.46	35.68	35.12	0.50	Pass
HT40	MCS0	2	6	2437	36.46	36.36	35.12	35.08	0.50	Pass
HT40	MCS0	2	9	2452	36.46	36.66	35.16	35.28	0.50	Pass

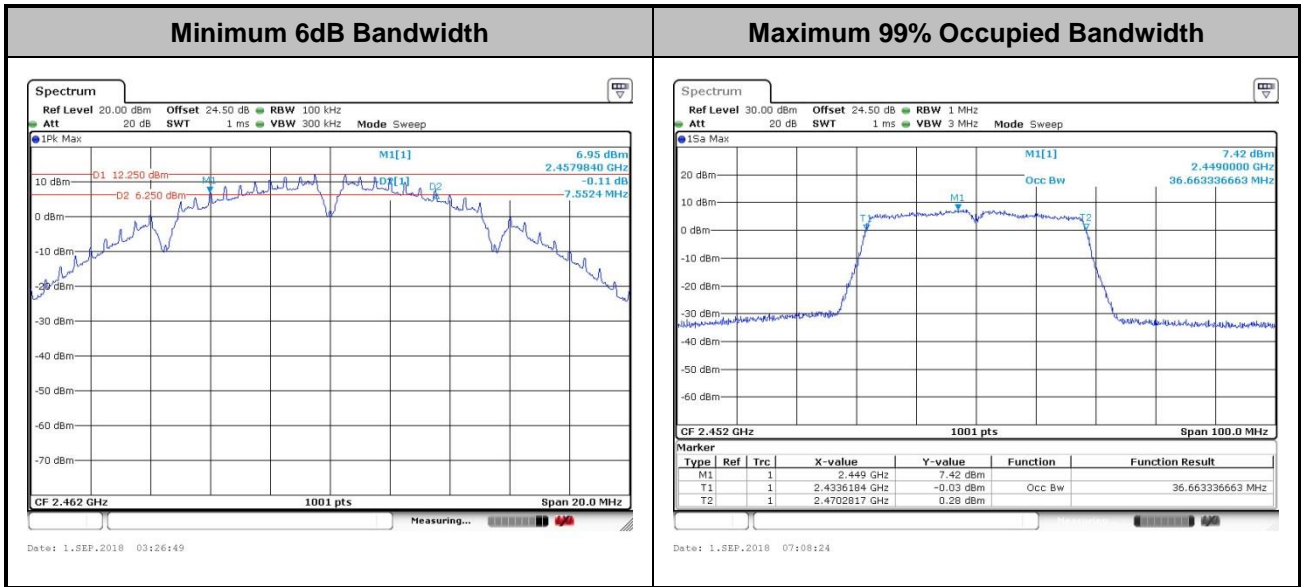

Note: The occupied channel bandwidth is maintained within the band of operation for all of the modulations.



<TXBF Modes>

2.4GHz Band										
Mod.	Data Rate	NTX	CH.	Freq. (MHz)	99% Occupied BW (MHz)		6dB BW (MHz)		6dB BW Limit (MHz)	Pass/Fail
					Ant 1	Ant 2	Ant 1	Ant 2		
VHT20	MCS0	2	1	2412	17.78	17.73	15.11	17.17	0.50	Pass
VHT20	MCS0	2	6	2437	17.78	17.83	15.12	17.54	0.50	Pass
VHT20	MCS0	2	11	2462	17.68	18.23	15.70	16.66	0.50	Pass
VHT40	MCS0	2	3	2422	36.26	36.46	33.89	35.96	0.50	Pass
VHT40	MCS0	2	6	2437	36.56	36.36	35.72	35.05	0.50	Pass
VHT40	MCS0	2	9	2452	37.26	36.36	35.40	36.44	0.50	Pass

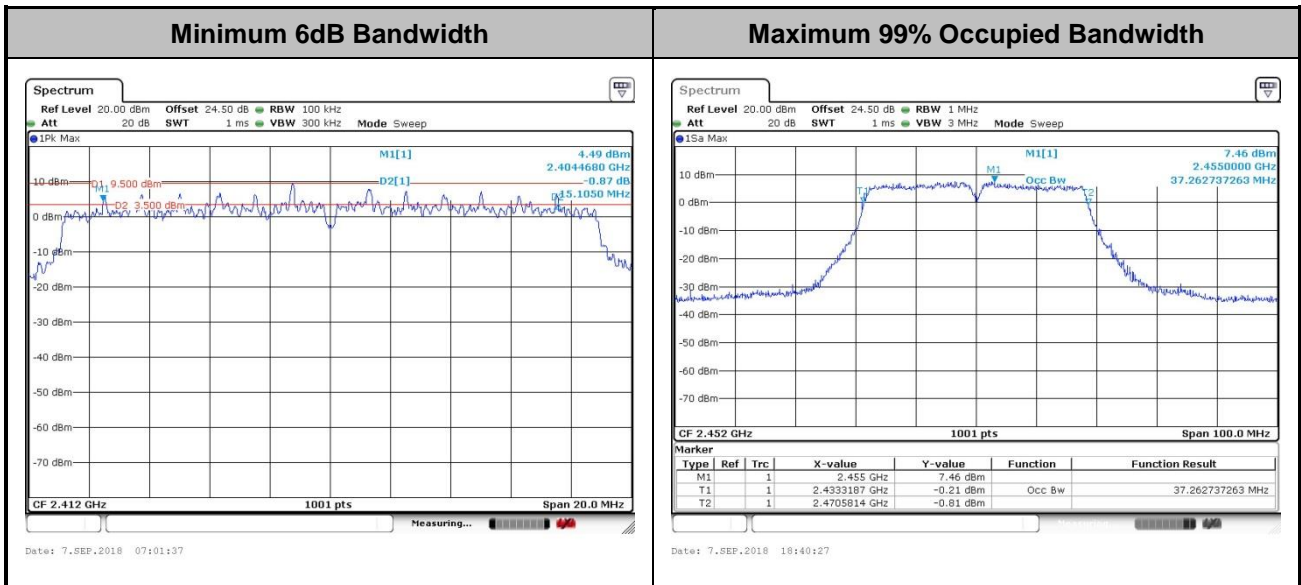

Note: The occupied channel bandwidth is maintained within the band of operation 1 MHz for all of the modulations.



3.2 Output Power Measurement

3.2.1 Limit of Output Power

For systems using digital modulation in the 2400-2483.5MHz, the limit for output power is 30dBm. If transmitting antenna with directional gain greater than 6dBi is used, the output power from the intentional radiator shall be reduced below the above stated value by the amount in dB that the directional gain of the antenna exceeds 6 dBi. In case of point-to-point operation, the limit has to be reduced by 1dB for every 3dB that the directional gain of the antenna exceeds 6dBi.

3.2.2 Measuring Instruments

See list of measuring equipment of this test report.

3.2.3 Test Procedures

<CDD Modes>

1. For Peak Power, the testing follows the Measurement Procedure of FCC KDB No. 558074 DTS D01 Meas. Guidance v05 section 9.1.3 PKPM1 Peak power meter method.
2. For Average Power, the testing follows the Measurement Procedure of FCC KDB No. 558074 DTS D01 Meas. Guidance v05 section 9.2.3.1 Method AVGPM.
3. The RF output of EUT was connected to the power meter by RF cable and attenuator. The path loss was compensated to the results for each measurement.
4. Set to the maximum power setting and enable the EUT transmit continuously.
5. Measure the conducted output power and record the results in the test report.
6. For MIMO mode, calculation method follows FCC KDB 662911 D01 Multiple Transmitter Output v02r01.

<TXBF Modes>

1. The testing follows the Measurement Procedure of FCC KDB No. 558074 DTS D01 Meas. Guidance v05 section 9.2.3.2 Method AVGPM-G.
2. The RF output of EUT was connected to the power meter by RF cable and attenuator. The path loss was compensated to the results for each measurement.
3. Set to the maximum power setting and enable the EUT transmit continuously.
4. Measure the conducted output power and record the results in the test report.
5. For MIMO mode, calculation method follows FCC KDB 662911 D01 Multiple Transmitter Output v02r01.

3.2.4 Test Setup

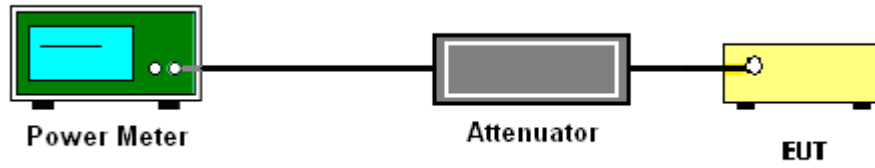



3.2.5 Test Result of Peak Output Power (Reporting Only)

<CDD Modes>

2.4GHz Band											
Mod.	Data Rate	NTX	CH.	Freq. (MHz)	Peak Conducted Power (dBm)			DG (dBi)		EIRP Power (dBm)	
					Ant 1	Ant 2	SUM	Ant 1	Ant 2	Ant 1	Ant 2
11b	1Mbps	1	1	2412	23.20	23.42		2.02	2.23	25.22	25.65
11b	1Mbps	1	2	2417	23.25	23.40		2.02	2.23	25.27	25.63
11b	1Mbps	1	6	2437	23.59	23.44		2.02	2.23	25.61	25.67
11b	1Mbps	1	10	2457	23.11	23.42		2.02	2.23	25.13	25.65
11b	1Mbps	1	11	2462	23.20	23.10		2.02	2.23	25.22	25.33
11g	6Mbps	1	1	2412	23.59	22.89		2.02	2.23	25.61	25.12
11g	6Mbps	1	2	2417	23.75	23.35		2.02	2.23	25.77	25.58
11g	6Mbps	1	6	2437	23.62	23.41		2.02	2.23	25.64	25.64
11g	6Mbps	1	10	2457	23.67	22.95		2.02	2.23	25.69	25.18
11g	6Mbps	1	11	2462	21.90	21.91		2.02	2.23	23.92	24.14
HT20	MCS0	1	1	2412	23.70	22.25		2.02	2.23	25.72	24.48
HT20	MCS0	1	2	2417	23.77	23.45		2.02	2.23	25.79	25.68
HT20	MCS0	1	6	2437	23.40	23.54		2.02	2.23	25.42	25.77
HT20	MCS0	1	10	2457	23.73	22.33		2.02	2.23	25.75	24.56
HT20	MCS0	1	11	2462	21.53	21.70		2.02	2.23	23.55	23.93
HT40	MCS0	1	3	2422	22.98	23.78		2.02	2.23	25.00	26.01
HT40	MCS0	1	4	2427	23.70	24.70		2.02	2.23	25.72	26.93
HT40	MCS0	1	6	2437	25.70	25.06		2.02	2.23	27.72	27.29
HT40	MCS0	1	8	2447	23.35	22.92		2.02	2.23	25.37	25.15
HT40	MCS0	1	9	2452	21.75	21.30		2.02	2.23	23.77	23.53
VHT20	MCS0	1	1	2412	23.66	22.23		2.02	2.23	25.68	24.46
VHT20	MCS0	1	2	2417	23.70	23.41		2.02	2.23	25.72	25.64
VHT20	MCS0	1	6	2437	23.35	23.50		2.02	2.23	25.37	25.73
VHT20	MCS0	1	10	2457	23.63	22.30		2.02	2.23	25.65	24.53
VHT20	MCS0	1	11	2462	20.36	21.69		2.02	2.23	22.38	23.92
VHT40	MCS0	1	3	2422	22.91	23.72		2.02	2.23	24.93	25.95
VHT40	MCS0	1	4	2427	23.65	24.62		2.02	2.23	25.67	26.85
VHT40	MCS0	1	6	2437	25.64	25.00		2.02	2.23	27.66	27.23
VHT40	MCS0	1	8	2447	23.30	22.81		2.02	2.23	25.32	25.04
VHT40	MCS0	1	9	2452	21.62	21.44		2.02	2.23	23.64	23.67



2.4GHz Band											
Mod.	Data Rate	NTX	CH.	Freq. (MHz)	Peak Conducted Power (dBm)			DG (dBi)		EIRP Power (dBm)	
					Ant 1	Ant 2	SUM	Ant 1	Ant 2	Ant 1	Ant 2
11b	1Mbps	2	1	2412	23.24	21.03	25.28	2.23		27.51	
11b	1Mbps	2	2	2417	23.13	23.10	26.13	2.23		28.36	
11b	1Mbps	2	6	2437	22.77	22.77	25.78	2.23		28.01	
11b	1Mbps	2	10	2457	23.13	23.12	26.14	2.23		28.37	
11b	1Mbps	2	11	2462	22.92	22.69	25.82	2.23		28.05	
11g	6Mbps	2	1	2412	22.80	22.82	25.82	2.23		28.05	
11g	6Mbps	2	2	2417	22.93	23.40	26.18	2.23		28.41	
11g	6Mbps	2	6	2437	22.72	23.52	26.15	2.23		28.38	
11g	6Mbps	2	10	2457	21.24	21.54	24.40	2.23		26.63	
11g	6Mbps	2	11	2462	19.98	20.32	23.16	2.23		25.39	
HT20	MCS0	2	1	2412	23.15	23.25	26.21	2.23		28.44	
HT20	MCS0	2	2	2417	22.70	23.00	25.86	2.23		28.09	
HT20	MCS0	2	6	2437	23.46	23.85	26.67	2.23		28.90	
HT20	MCS0	2	10	2457	21.80	21.70	24.76	2.23		26.99	
HT20	MCS0	2	11	2462	19.90	20.28	23.10	2.23		25.33	
HT40	MCS0	2	3	2422	20.98	21.66	24.34	2.23		26.57	
HT40	MCS0	2	4	2427	22.63	23.11	25.89	2.23		28.12	
HT40	MCS0	2	6	2437	21.71	22.41	25.08	2.23		27.31	
HT40	MCS0	2	8	2447	20.22	20.60	23.42	2.23		25.65	
HT40	MCS0	2	9	2452	18.64	19.04	21.85	2.23		24.08	
VHT20	MCS0	2	1	2412	23.23	23.12	26.19	2.23		28.42	
VHT20	MCS0	2	2	2417	23.22	22.21	25.75	2.23		27.98	
VHT20	MCS0	2	6	2437	23.40	23.82	26.63	2.23		28.86	
VHT20	MCS0	2	10	2457	21.74	21.74	24.75	2.23		26.98	
VHT20	MCS0	2	11	2462	19.76	20.30	23.05	2.23		25.28	
VHT40	MCS0	2	3	2422	20.99	21.32	24.17	2.23		26.40	
VHT40	MCS0	2	4	2427	22.62	23.10	25.88	2.23		28.11	
VHT40	MCS0	2	6	2437	21.54	22.00	24.79	2.23		27.02	
VHT40	MCS0	2	8	2447	20.07	20.64	23.37	2.23		25.60	
VHT40	MCS0	2	9	2452	18.52	18.99	21.77	2.23		24.00	



3.2.6 Test Result of Average output Power

<CDD Modes>

2.4GHz Band																		
Mod.	Data Rate	NTX	CH.	Freq. (MHz)	Duty Factor (dB)		Average Conducted Power (dBm)			Conducted Power Limit (dBm)		DG (dBi)		EIRP Power (dBm)		EIRP Power Limit (dBm)		Pass /Fail
					Ant 1	Ant 2	Ant 1	Ant 2	SUM	Ant 1	Ant 2	Ant 1	Ant 2	Ant 1	Ant 2	Ant 1	Ant 2	
11b	1Mbps	1	1	2412	0.04	0.04	20.67	20.96		30.00	30.00	2.02	2.23	22.69	23.19	36.00	36.00	Pass
11b	1Mbps	1	2	2417	0.04	0.04	20.72	20.93		30.00	30.00	2.02	2.23	22.74	23.16	36.00	36.00	Pass
11b	1Mbps	1	6	2437	0.04	0.04	20.94	20.97		30.00	30.00	2.02	2.23	22.96	23.20	36.00	36.00	Pass
11b	1Mbps	1	10	2457	0.04	0.04	20.65	20.94		30.00	30.00	2.02	2.23	22.67	23.17	36.00	36.00	Pass
11b	1Mbps	1	11	2462	0.04	0.04	20.80	20.90		30.00	30.00	2.02	2.23	22.82	23.13	36.00	36.00	Pass
11g	6Mbps	1	1	2412	0.25	0.21	18.61	18.19		30.00	30.00	2.02	2.23	20.63	20.42	36.00	36.00	Pass
11g	6Mbps	1	2	2417	0.25	0.21	18.94	18.73		30.00	30.00	2.02	2.23	20.96	20.96	36.00	36.00	Pass
11g	6Mbps	1	6	2437	0.25	0.21	18.78	18.77		30.00	30.00	2.02	2.23	20.80	21.00	36.00	36.00	Pass
11g	6Mbps	1	10	2457	0.25	0.21	18.91	18.26		30.00	30.00	2.02	2.23	20.93	20.49	36.00	36.00	Pass
11g	6Mbps	1	11	2462	0.25	0.21	17.47	17.01		30.00	30.00	2.02	2.23	19.49	19.24	36.00	36.00	Pass
HT20	MCS0	1	1	2412	0.27	0.27	18.82	17.98		30.00	30.00	2.02	2.23	20.84	20.21	36.00	36.00	Pass
HT20	MCS0	1	2	2417	0.27	0.27	18.75	18.64		30.00	30.00	2.02	2.23	20.77	20.87	36.00	36.00	Pass
HT20	MCS0	1	6	2437	0.27	0.27	18.66	18.70		30.00	30.00	2.02	2.23	20.68	20.93	36.00	36.00	Pass
HT20	MCS0	1	10	2457	0.27	0.27	18.71	17.58		30.00	30.00	2.02	2.23	20.73	19.81	36.00	36.00	Pass
HT20	MCS0	1	11	2462	0.27	0.27	17.09	16.87		30.00	30.00	2.02	2.23	19.11	19.10	36.00	36.00	Pass
HT40	MCS0	1	3	2422	0.40	0.40	17.08	18.22		30.00	30.00	2.02	2.23	19.10	20.45	36.00	36.00	Pass
HT40	MCS0	1	4	2427	0.40	0.40	18.23	19.03		30.00	30.00	2.02	2.23	20.25	21.26	36.00	36.00	Pass
HT40	MCS0	1	6	2437	0.40	0.40	20.24	20.08		30.00	30.00	2.02	2.23	22.26	22.31	36.00	36.00	Pass
HT40	MCS0	1	8	2447	0.40	0.40	17.72	16.64		30.00	30.00	2.02	2.23	19.74	18.87	36.00	36.00	Pass
HT40	MCS0	1	9	2452	0.40	0.40	15.72	15.25		30.00	30.00	2.02	2.23	17.74	17.48	36.00	36.00	Pass
VHT20	MCS0	1	1	2412	0.27	0.27	18.81	17.97		30.00	30.00	2.02	2.23	20.83	20.20	36.00	36.00	Pass
VHT20	MCS0	1	2	2417	0.27	0.27	18.71	18.62		30.00	30.00	2.02	2.23	20.73	20.85	36.00	36.00	Pass
VHT20	MCS0	1	6	2437	0.27	0.27	18.62	18.66		30.00	30.00	2.02	2.23	20.64	20.89	36.00	36.00	Pass
VHT20	MCS0	1	10	2457	0.27	0.27	18.67	17.47		30.00	30.00	2.02	2.23	20.69	19.70	36.00	36.00	Pass
VHT20	MCS0	1	11	2462	0.27	0.27	17.05	16.81		30.00	30.00	2.02	2.23	19.07	19.04	36.00	36.00	Pass
VHT40	MCS0	1	3	2422	0.44	0.44	17.06	18.21		30.00	30.00	2.02	2.23	19.08	20.44	36.00	36.00	Pass
VHT40	MCS0	1	4	2427	0.44	0.44	18.20	19.02		30.00	30.00	2.02	2.23	20.22	21.25	36.00	36.00	Pass
VHT40	MCS0	1	6	2437	0.44	0.44	20.19	20.04		30.00	30.00	2.02	2.23	22.21	22.27	36.00	36.00	Pass
VHT40	MCS0	1	8	2447	0.44	0.44	17.64	16.63		30.00	30.00	2.02	2.23	19.66	18.86	36.00	36.00	Pass
VHT40	MCS0	1	9	2452	0.44	0.44	15.69	15.14		30.00	30.00	2.02	2.23	17.71	17.37	36.00	36.00	Pass



2.4GHz Band																		
Mod.	Data Rate	NTX	CH.	Freq. (MHz)	Duty Factor (dB)		Average Conducted Power (dBm)			Conducted Power Limit (dBm)		DG (dBi)		EIRP Power (dBm)		EIRP Power Limit (dBm)		Pass /Fail
					Ant 1	Ant 2	Ant 1	Ant 2	SUM	Ant 1	Ant 2	Ant 1	Ant 2	Ant 1	Ant 2	Ant 1	Ant 2	
11b	1Mbps	2	1	2412	0.04	0.04	20.40	20.99	23.72	30.00	2.23	25.95	36.00	Pass				
11b	1Mbps	2	2	2417	0.04	0.04	20.57	20.70	23.65	30.00	2.23	25.88	36.00	Pass				
11b	1Mbps	2	6	2437	0.04	0.04	20.00	20.35	23.19	30.00	2.23	25.42	36.00	Pass				
11b	1Mbps	2	10	2457	0.04	0.04	20.69	20.97	23.84	30.00	2.23	26.07	36.00	Pass				
11b	1Mbps	2	11	2462	0.04	0.04	20.44	20.53	23.50	30.00	2.23	25.73	36.00	Pass				
11g	6Mbps	2	1	2412	0.25	0.25	18.06	18.01	21.05	30.00	2.23	23.28	36.00	Pass				
11g	6Mbps	2	2	2417	0.25	0.25	18.23	18.73	21.50	30.00	2.23	23.73	36.00	Pass				
11g	6Mbps	2	6	2437	0.25	0.25	18.15	18.70	21.44	30.00	2.23	23.67	36.00	Pass				
11g	6Mbps	2	10	2457	0.25	0.25	16.61	16.75	19.69	30.00	2.23	21.92	36.00	Pass				
11g	6Mbps	2	11	2462	0.25	0.25	15.26	15.37	18.33	30.00	2.23	20.56	36.00	Pass				
HT20	MCS0	2	1	2412	0.27	0.22	18.41	18.47	21.45	30.00	2.23	23.68	36.00	Pass				
HT20	MCS0	2	2	2417	0.27	0.22	18.19	18.03	21.12	30.00	2.23	23.35	36.00	Pass				
HT20	MCS0	2	6	2437	0.27	0.22	18.56	18.97	21.78	30.00	2.23	24.01	36.00	Pass				
HT20	MCS0	2	10	2457	0.27	0.22	17.17	17.07	20.13	30.00	2.23	22.36	36.00	Pass				
HT20	MCS0	2	11	2462	0.27	0.22	15.17	15.11	18.15	30.00	2.23	20.38	36.00	Pass				
HT40	MCS0	2	3	2422	0.40	0.40	14.71	15.20	17.97	30.00	2.23	20.20	36.00	Pass				
HT40	MCS0	2	4	2427	0.40	0.40	16.68	17.10	19.91	30.00	2.23	22.14	36.00	Pass				
HT40	MCS0	2	6	2437	0.40	0.40	15.50	16.05	18.79	30.00	2.23	21.02	36.00	Pass				
HT40	MCS0	2	8	2447	0.40	0.40	13.96	14.16	17.07	30.00	2.23	19.30	36.00	Pass				
HT40	MCS0	2	9	2452	0.40	0.40	12.43	12.64	15.55	30.00	2.23	17.78	36.00	Pass				
VHT20	MCS0	2	1	2412	0.22	0.27	18.29	18.51	21.41	30.00	2.23	23.64	36.00	Pass				
VHT20	MCS0	2	2	2417	0.22	0.27	17.99	18.17	21.09	30.00	2.23	23.32	36.00	Pass				
VHT20	MCS0	2	6	2437	0.22	0.27	18.47	19.03	21.77	30.00	2.23	24.00	36.00	Pass				
VHT20	MCS0	2	10	2457	0.22	0.27	17.02	17.17	20.11	30.00	2.23	22.34	36.00	Pass				
VHT20	MCS0	2	11	2462	0.22	0.27	15.04	15.21	18.14	30.00	2.23	20.37	36.00	Pass				
VHT40	MCS0	2	3	2422	0.40	0.40	14.70	15.14	17.94	30.00	2.23	20.17	36.00	Pass				
VHT40	MCS0	2	4	2427	0.40	0.40	16.66	17.10	19.90	30.00	2.23	22.13	36.00	Pass				
VHT40	MCS0	2	6	2437	0.40	0.40	15.50	15.90	18.71	30.00	2.23	20.94	36.00	Pass				
VHT40	MCS0	2	8	2447	0.40	0.40	13.90	14.20	17.06	30.00	2.23	19.29	36.00	Pass				
VHT40	MCS0	2	9	2452	0.40	0.40	12.50	12.55	15.54	30.00	2.23	17.77	36.00	Pass				



<TXBF Modes>

2.4GHz Band																		
Mod.	Data Rate	NTX	CH.	Freq. (MHz)	Duty Factor (dB)		Average Conducted Power (dBm)			Conducted Power Limit (dBm)		DG (dBi)		EIRP Power (dBm)		EIRP Power Limit (dBm)		Pass /Fail
					Ant 1	Ant 2	Ant 1	Ant 2	SUM	Ant 1	Ant 2	Ant 1	Ant 2	Ant 1	Ant 2	Ant 1	Ant 2	
VHT20	MCS0	2	1	2412	0.00	0.00	17.70	18.20	20.97	30.00	30.00	5.14	5.14	26.10	26.10	36.00	36.00	Pass
VHT20	MCS0	2	2	2417	0.00	0.00	17.00	18.70	20.94	30.00	30.00	5.14	5.14	26.08	26.08	36.00	36.00	Pass
VHT20	MCS0	2	6	2437	0.00	0.00	17.50	19.70	21.75	30.00	30.00	5.14	5.14	26.88	26.88	36.00	36.00	Pass
VHT20	MCS0	2	10	2457	0.00	0.00	16.60	16.70	19.66	30.00	30.00	5.14	5.14	24.80	24.80	36.00	36.00	Pass
VHT20	MCS0	2	11	2462	0.00	0.00	14.40	16.00	18.28	30.00	30.00	5.14	5.14	23.42	23.42	36.00	36.00	Pass
VHT40	MCS0	2	3	2422	0.00	0.00	14.60	16.00	18.37	30.00	30.00	5.14	5.14	23.50	23.50	36.00	36.00	Pass
VHT40	MCS0	2	4	2427	0.00	0.00	15.90	15.80	18.86	30.00	30.00	5.14	5.14	24.00	24.00	36.00	36.00	Pass
VHT40	MCS0	2	6	2437	0.00	0.00	15.20	16.30	18.80	30.00	30.00	5.14	5.14	23.93	23.93	36.00	36.00	Pass
VHT40	MCS0	2	8	2447	0.00	0.00	13.40	13.00	16.21	30.00	30.00	5.14	5.14	21.35	21.35	36.00	36.00	Pass
VHT40	MCS0	2	9	2452	0.00	0.00	11.90	11.30	14.62	30.00	30.00	5.14	5.14	19.76	19.76	36.00	36.00	Pass



3.3 Power Spectral Density Measurement

3.3.1 Limit of Power Spectral Density

The peak power spectral density shall not be greater than 8dBm in any 3kHz band at any time interval of continuous transmission.

3.3.2 Measuring Instruments

See list of measuring equipment of this test report.

3.3.3 Test Procedures

<CDD Modes>

Method AVGPSD-2

1. The testing follows Measurement Procedure 10.5 Method AVGPSD-2 of FCC KDB Publication No. 558074 D01 DTS Meas. Guidance v05.
2. The RF output of EUT was connected to the spectrum analyzer by RF cable and attenuator. The path loss was compensated to the results for each measurement.
3. Set to the maximum power setting and enable the EUT transmit continuously.
4. Make the measurement with the spectrum analyzer's resolution bandwidth (RBW) = 10 kHz. Video bandwidth VBW = 30 kHz In order to make an accurate measurement, set the span to 1.5 times DTS Channel Bandwidth. (6dB BW).
5. Number of points in sweep ≥ 2 Span / RBW. (This ensures that bin-to-bin spacing is \leq RBW/2, so that narrowband signals are not lost between frequency bins).
6. Detector = RMS, Sweep time = auto couple.
7. Trace average at least 100 traces in power averaging mode.
8. Add $10 \log(1/x)$, where x is the duty cycle, to the measured power in order to compute the average power during the actual transmission times. For example, add $10 \log(1/0.25) = 6$ dB if the duty cycle is 25 percent.
9. Measure and record the results in the test report.
10. For MIMO mode, calculation method follows FCC KDB 662911 D01 Multiple Transmitter Output v02r01.

Method (c): Measure and add $10 \log(N_{ANT})$ dB.

With this technique, spectrum measurements are performed at each output of the device, but rather than summing the spectra or the spectral peaks across the outputs, the quantity $10 \log(N_{ANT})$ dB is added to each spectrum value before comparing to the emission limit. The addition of $10 \log(N_{ANT})$ dB serves to apportion the emission limit among the N_{ANT} outputs so that each output is permitted to contribute no more than $1/N_{ANT}^{th}$ of the PSD limit .

<TXBF Modes>**Method AVGPSD-3**

1. The testing follows Measurement Procedure 10.7 Method AVGPSD-3 of FCC KDB Publication No. 558074 D01 DTS Meas. Guidance v05.
2. The RF output of EUT was connected to the spectrum analyzer by RF cable and attenuator. The path loss was compensated to the results for each measurement.
3. Set to the maximum power setting and enable the EUT transmit continuously.
4. Make the measurement with the spectrum analyzer's resolution bandwidth (RBW) = 10 kHz. Video bandwidth VBW = 30 kHz In order to make an accurate measurement, set the span to 1.5 times DTS Channel Bandwidth. (6dB BW).
5. Number of points in sweep ≥ 2 Span / RBW. (This ensures that bin-to-bin spacing is \leq RBW/2, so that narrowband signals are not lost between frequency bins).
6. Detector = RMS, Sweep time = auto couple.
7. Trace mode = max hold.
8. Allow max hold to run for at least 60 seconds, or longer as needed to allow the trace to stabilize.
9. Measure and record the results in the test report.
10. For MIMO mode, calculation method follows FCC KDB 662911 D01 Multiple Transmitter Output v02r01.

Method (c): Measure and add $10 \log(N_{\text{ANT}})$ dB.

With this technique, spectrum measurements are performed at each output of the device, but rather than summing the spectra or the spectral peaks across the outputs, the quantity $10 \log(N_{\text{ANT}})$ dB is added to each spectrum value before comparing to the emission limit. The addition of $10 \log(N_{\text{ANT}})$ dB serves to apportion the emission limit among the N_{ANT} outputs so that each output is permitted to contribute no more than $1/N_{\text{ANT}}^{\text{th}}$ of the PSD limit .

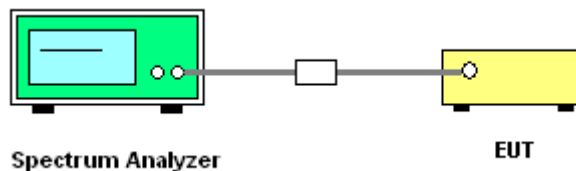
3.3.4 Test Setup



3.3.5 Test Result of Power Spectral Density

<CDD Modes>

2.4GHz Band														
Mod.	Data Rate	NTX	CH.	Freq. (MHz)	Duty Factor (dB)		Average PSD (dBm/3kHz)			DG (dBi)		Average PSD Limit (dBm/3kHz)		Pass/Fail
					Ant 1	Ant 2	Ant 1	Ant 2	Worse + 3.01	Ant 1	Ant 2	Ant 1	Ant 2	
11b	1Mbps	1	1	2412	0.04	0.04	4.15	4.72		2.02	2.23	8.00	8.00	Pass
11b	1Mbps	1	6	2437	0.04	0.04	4.10	3.53		2.02	2.23	8.00	8.00	Pass
11b	1Mbps	1	11	2462	0.04	0.04	3.85	3.29		2.02	2.23	8.00	8.00	Pass
11g	6Mbps	1	1	2412	0.25	0.21	-0.22	-0.72		2.02	2.23	8.00	8.00	Pass
11g	6Mbps	1	6	2437	0.25	0.21	-0.08	-0.22		2.02	2.23	8.00	8.00	Pass
11g	6Mbps	1	11	2462	0.25	0.21	-1.58	-2.65		2.02	2.23	8.00	8.00	Pass
HT20	MCS0	1	1	2412	0.27	0.27	0.54	-1.89		2.02	2.23	8.00	8.00	Pass
HT20	MCS0	1	6	2437	0.27	0.27	-0.27	0.87		2.02	2.23	8.00	8.00	Pass
HT20	MCS0	1	11	2462	0.27	0.27	-1.72	-2.38		2.02	2.23	8.00	8.00	Pass
HT40	MCS0	1	3	2422	0.40	0.40	-5.28	-3.34		2.02	2.23	8.00	8.00	Pass
HT40	MCS0	1	6	2437	0.40	0.40	-1.93	-2.06		2.02	2.23	8.00	8.00	Pass
HT40	MCS0	1	9	2452	0.40	0.40	-6.58	-6.08		2.02	2.23	8.00	8.00	Pass
11b	1Mbps	2	1	2412	0.04	0.04	4.29	3.55	7.30	5.14		8.00		Pass
11b	1Mbps	2	6	2437	0.04	0.04	2.12	3.18	6.19	5.14		8.00		Pass
11b	1Mbps	2	11	2462	0.04	0.04	3.55	3.65	6.66	5.14		8.00		Pass
11g	6Mbps	2	1	2412	0.25	0.25	-1.43	-1.94	1.58	5.14		8.00		Pass
11g	6Mbps	2	6	2437	0.25	0.25	-1.08	0.15	3.16	5.14		8.00		Pass
11g	6Mbps	2	11	2462	0.25	0.25	-4.47	-3.97	-0.96	5.14		8.00		Pass
HT20	MCS0	2	1	2412	0.27	0.22	-1.20	-1.36	1.81	5.14		8.00		Pass
HT20	MCS0	2	6	2437	0.27	0.22	-0.54	-0.50	2.51	5.14		8.00		Pass
HT20	MCS0	2	11	2462	0.27	0.22	-4.47	-4.61	-1.46	5.14		8.00		Pass
HT40	MCS0	2	3	2422	0.40	0.40	-7.63	-7.70	-4.62	5.14		8.00		Pass
HT40	MCS0	2	6	2437	0.40	0.40	-6.69	-6.46	-3.45	5.14		8.00		Pass
HT40	MCS0	2	9	2452	0.40	0.40	-9.76	-10.36	-6.75	5.14		8.00		Pass



Worst Case Power Density (dBm/3kHz) for MIMO Ant. 1

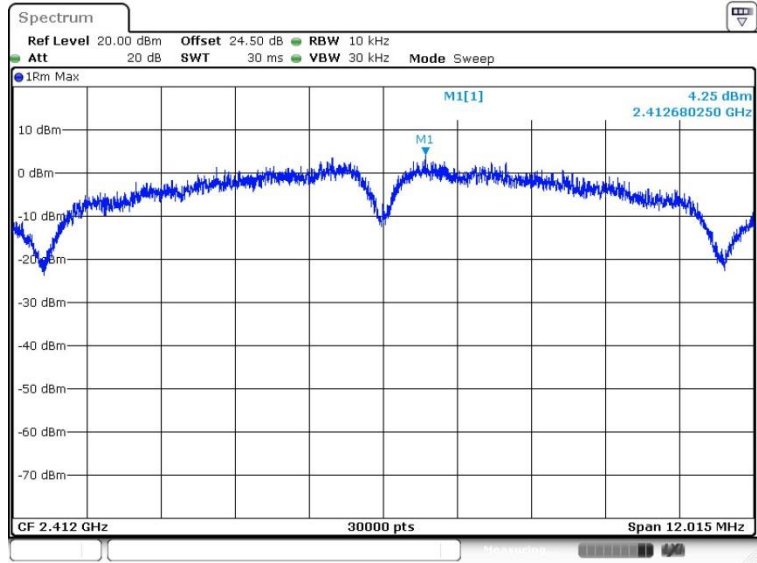

Worst Case Power Density (dBm/3kHz) for MIMO Ant. 2

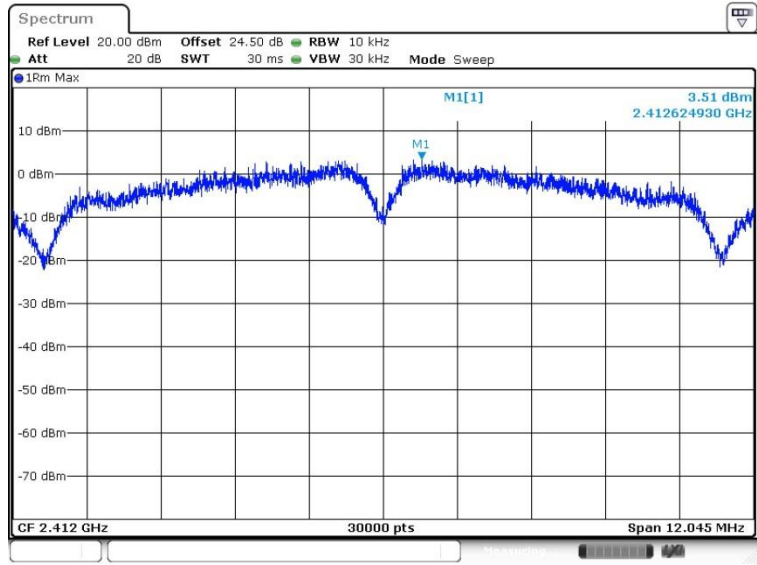



<TXBF Modes>

2.4GHz Band														
Mod.	Data Rate	NTX	CH.	Freq. (MHz)	Duty Factor (dB)		Average PSD (dBm/10kHz)			DG (dBi)		Average PSD Limit (dBm/3kHz)		Pass/Fail
					Ant 1	Ant 2	Ant 1	Ant 2	Worse + 3.01	Ant 1	Ant 2	Ant 1	Ant 2	
VHT20	MCS0	2	1	2412	0.00	0.00	-1.51	0.68	3.69	5.14	5.14	8.00	8.00	Pass
VHT20	MCS0	2	6	2437	0.00	0.00	-3.85	-1.26	1.75	5.14	5.14	8.00	8.00	Pass
VHT20	MCS0	2	11	2462	0.00	0.00	-5.23	-7.55	-2.22	5.14	5.14	8.00	8.00	Pass
VHT40	MCS0	2	3	2422	0.00	0.00	-4.92	-2.86	0.15	5.14	5.14	8.00	8.00	Pass
VHT40	MCS0	2	6	2437	0.00	0.00	-4.49	-8.11	-1.48	5.14	5.14	8.00	8.00	Pass
VHT40	MCS0	2	9	2452	0.00	0.00	-9.94	-10.62	-6.93	5.14	5.14	8.00	8.00	Pass



Worst Case Power Density (dBm/3kHz) for MIMO Ant. 1

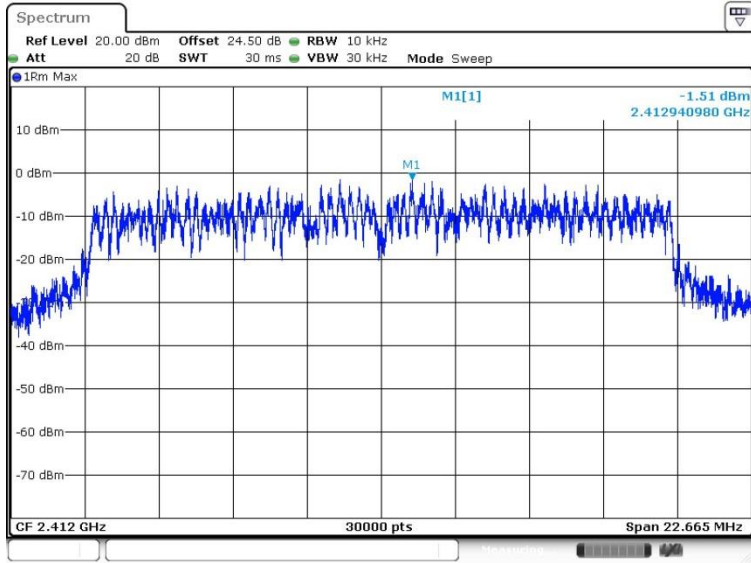

Date: 7.SEP.2018 07:03:30

Worst Case Power Density (dBm/3kHz) for MIMO Ant. 2

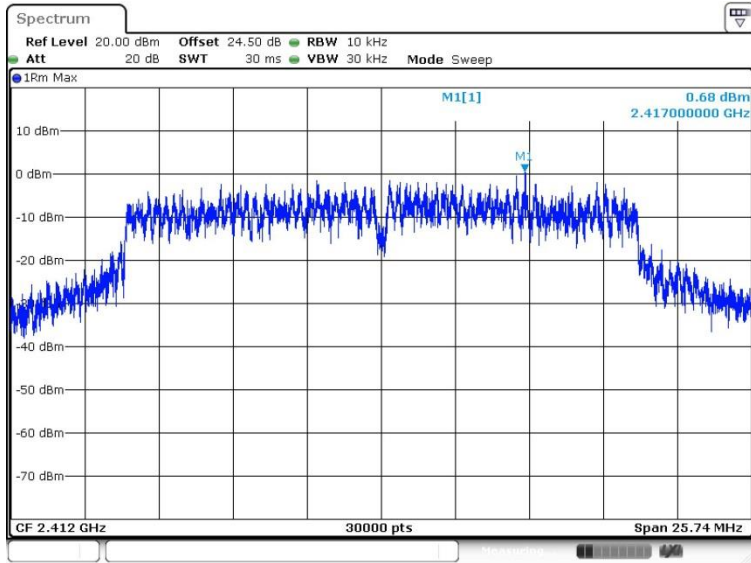

Date: 7.SEP.2018 07:22:14

3.4 Conducted Band Edges and Spurious Emission Measurement

3.4.1 Limit of Conducted Band Edges and Spurious Emission Measurement

In any 100 kHz bandwidth outside of the authorized frequency band, the emissions which fall in the non-restricted bands shall be attenuated at least 20 dB / 30dB relative to the maximum PSD level in 100 kHz by RF conducted measurement.

3.4.2 Measuring Instruments

See list of measuring equipment of this test report.

3.4.3 Test Procedures

1. The testing follows FCC KDB Publication No. 558074 D01 DTS Meas. Guidance v05.
2. The RF output of EUT was connected to the spectrum analyzer by RF cable and attenuator. The path loss was compensated to the results for each measurement.
3. Set to the maximum power setting and enable the EUT transmit continuously.
4. Set RBW = 100 kHz, VBW=300 kHz, Peak Detector. Unwanted Emissions measured in any 100 kHz bandwidth outside of the authorized frequency band shall be attenuated by at least 20 dB relative to the maximum in-band peak PSD level in 100 kHz when maximum peak conducted output power procedure is used. If the transmitter complies with the conducted power limits based on the use of RMS averaging over a time interval, the attenuation required under this paragraph shall be 30 dB instead of 20 dB per 15.247(d).
5. Measure and record the results in the test report.
6. The RF fundamental frequency should be excluded against the limit line in the operating frequency band.

3.4.4 Test Setup

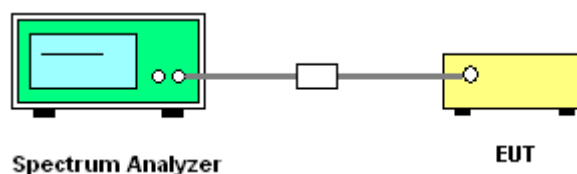



3.4.5 Test Result of Conducted Band Edges and Spurious Emission

Test Engineer :	Derek Hsu and Shiming Liu	Temperature :	21~25°C
		Relative Humidity :	51~54%

Number of TX = 1, Ant. 1 (Measured)

Test Mode :	802.11b	Test Channel :	01
-------------	---------	----------------	----

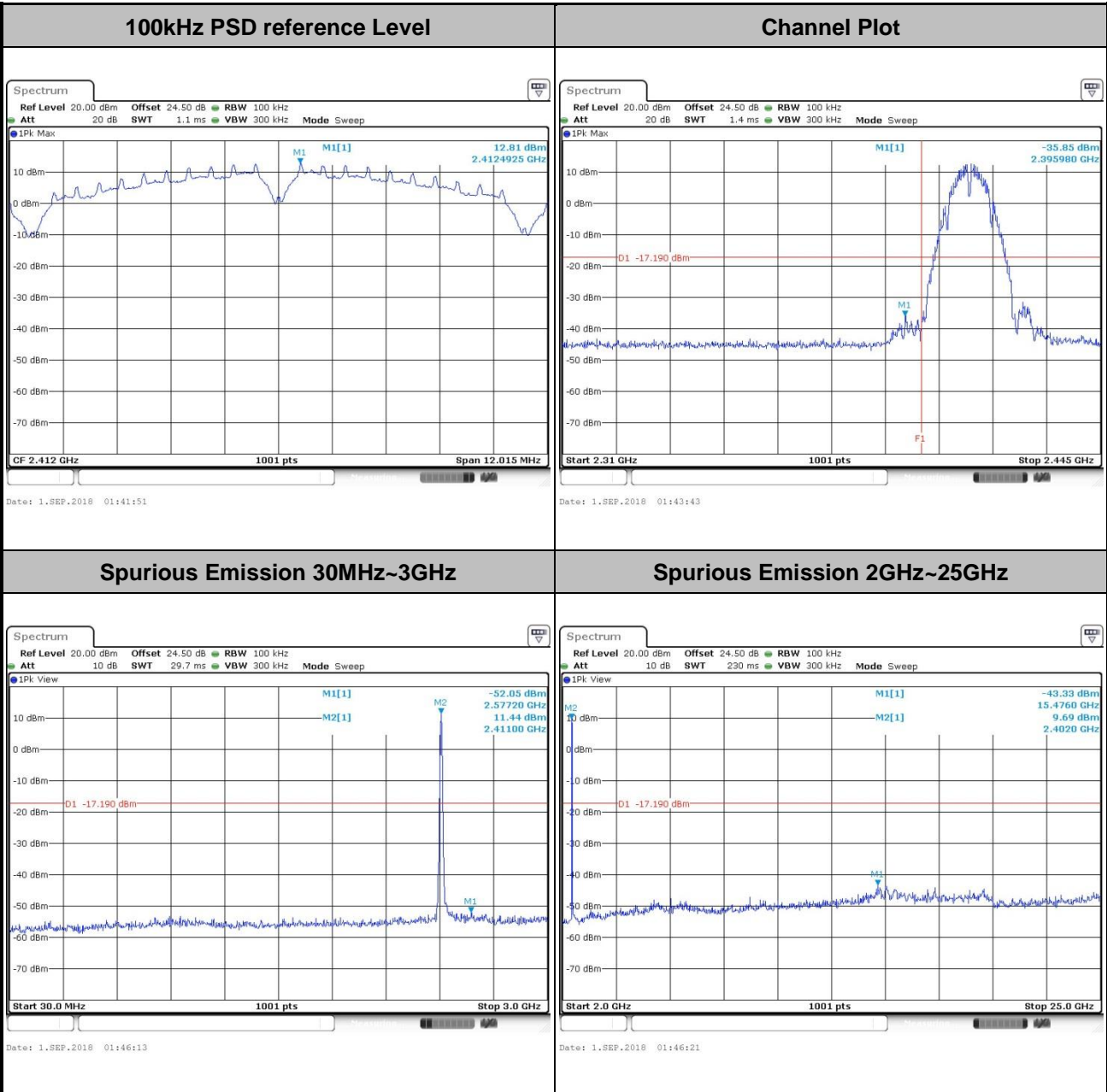



Test Mode :	802.11b	Test Channel :	06
-------------	---------	----------------	----

100kHz PSD reference Level

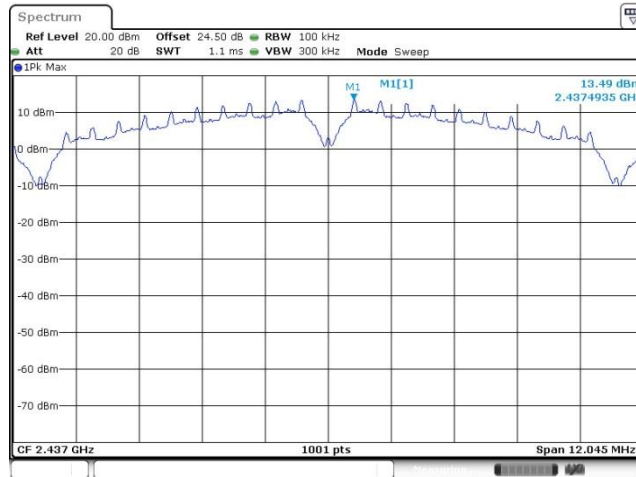

Date: 1.SEP.2018 01:55:37

Spurious Emission 30MHz~3GHz

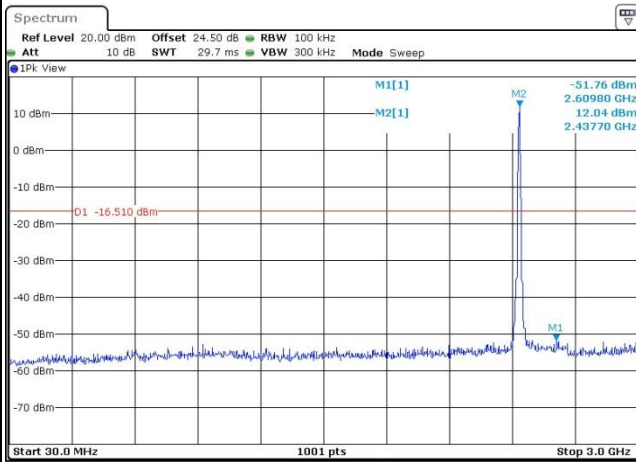

Date: 1.SEP.2018 02:00:43

Spurious Emission 2GHz~25GHz

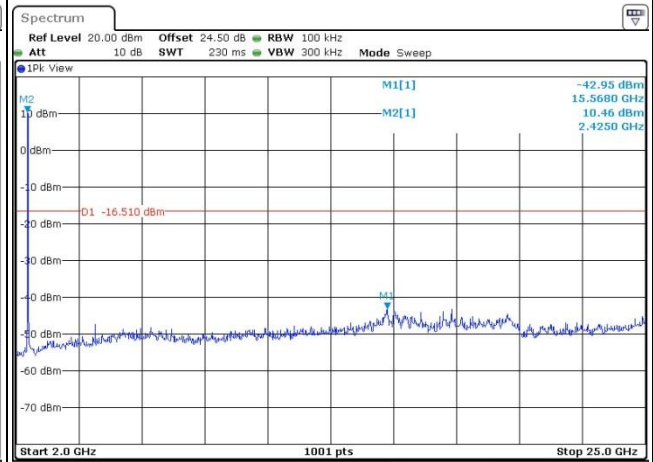

Date: 1.SEP.2018 02:00:51



Test Mode :	802.11b	Test Channel :	11
-------------	---------	----------------	----

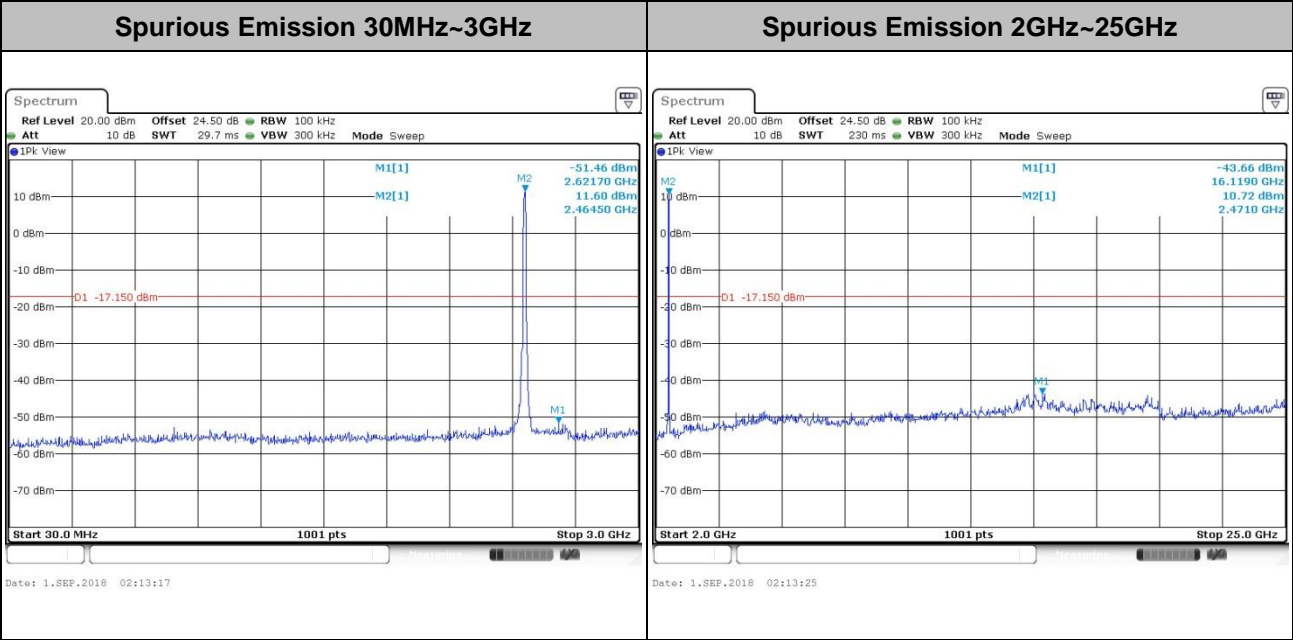
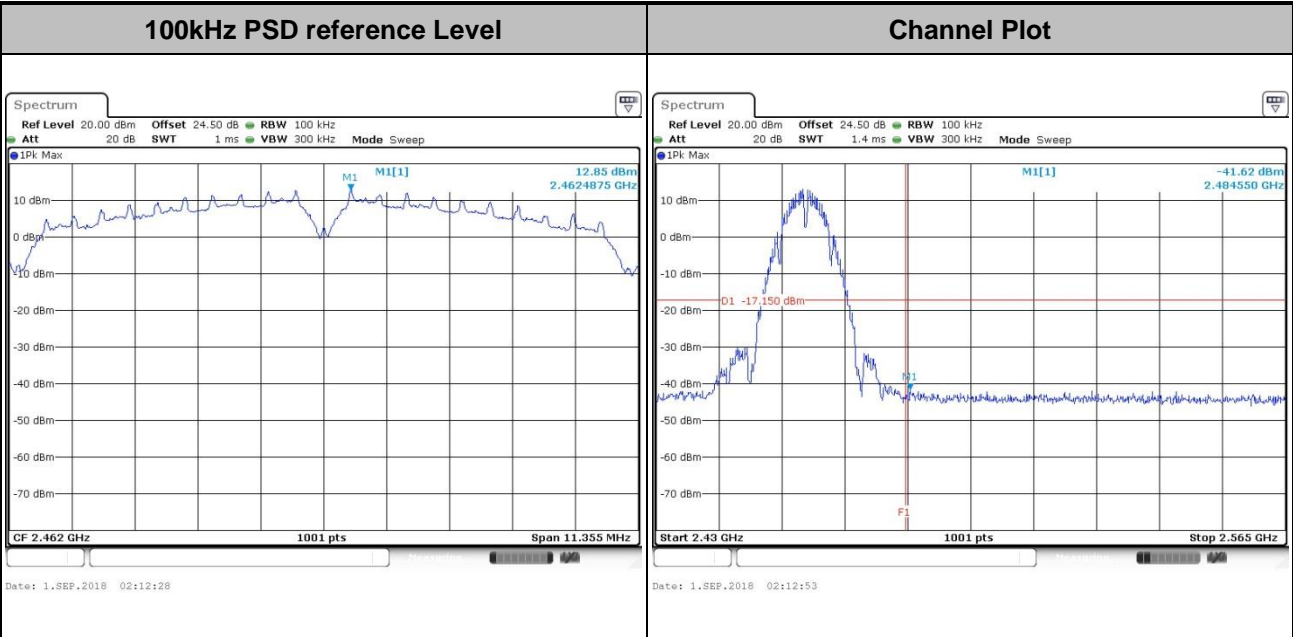



Test Mode : 802.11g Test Channel : 01

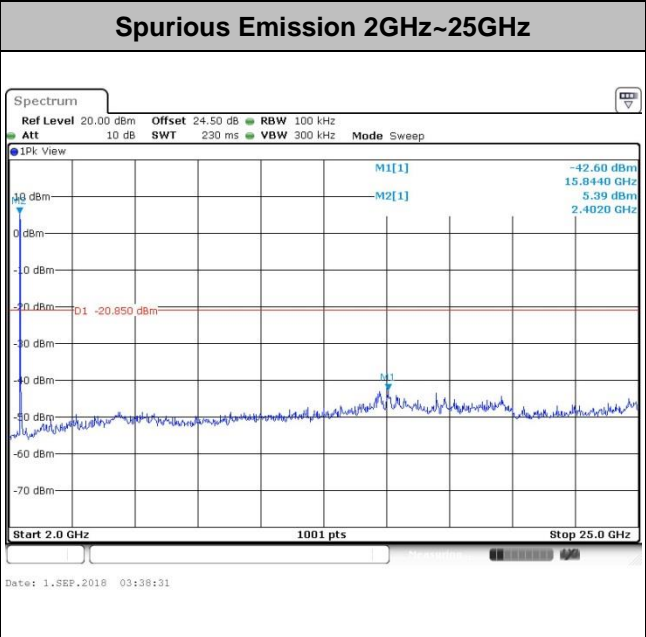
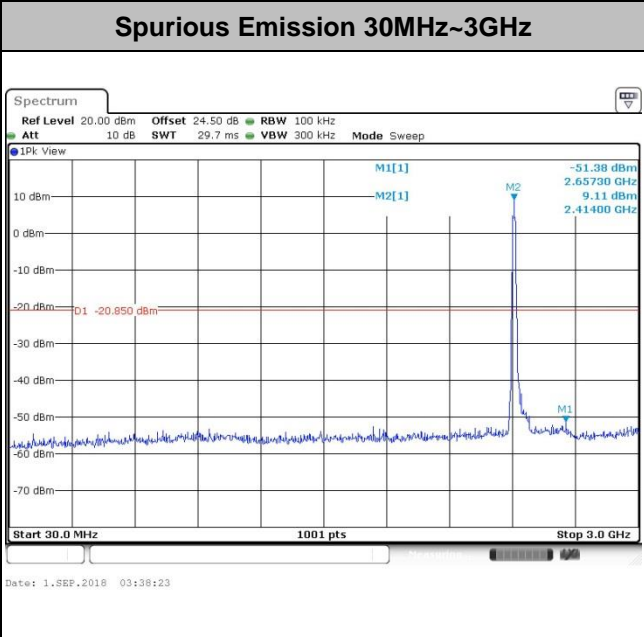
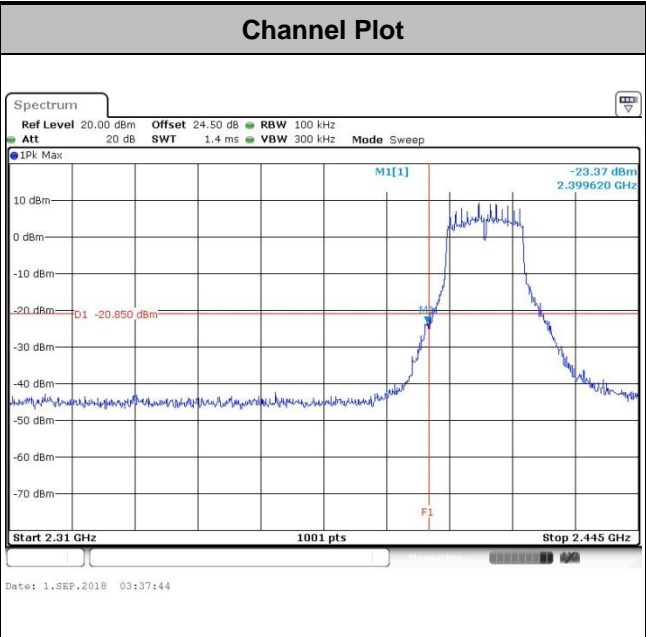
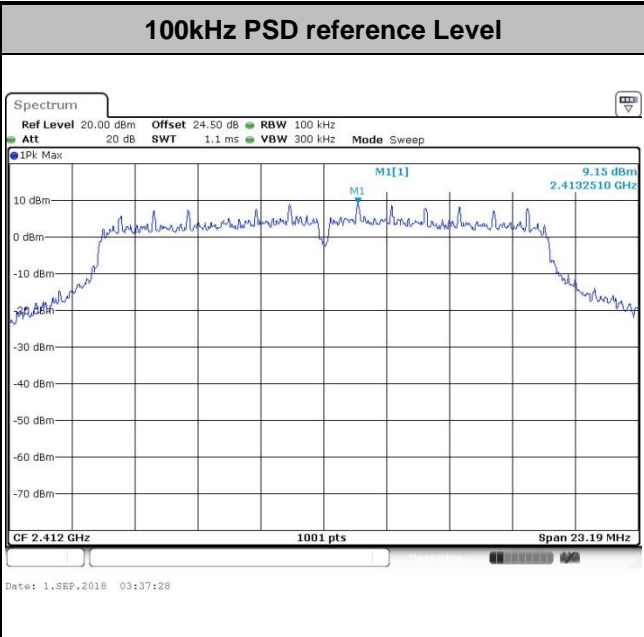



Test Mode :	802.11g	Test Channel :	06
-------------	---------	----------------	----

100kHz PSD reference Level

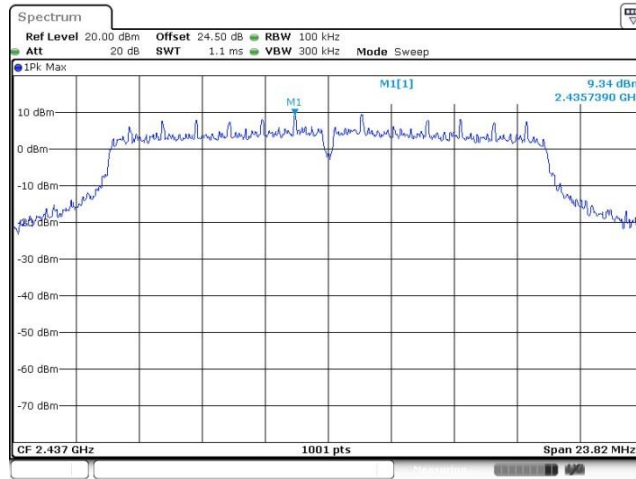

Date: 1.SEP.2018 03:42:20

Spurious Emission 30MHz~3GHz

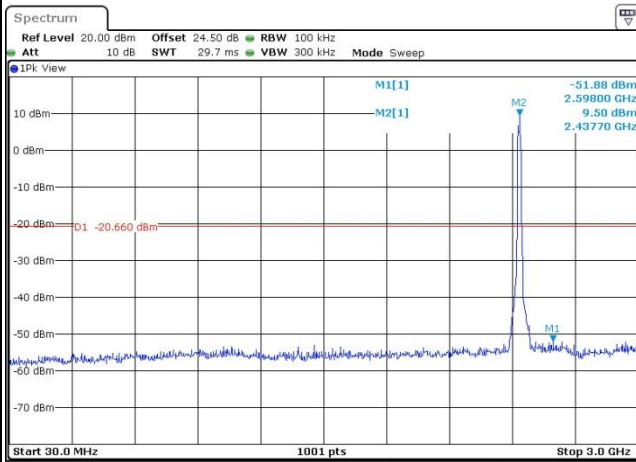

Date: 1.SEP.2018 03:43:28

Spurious Emission 2GHz~25GHz

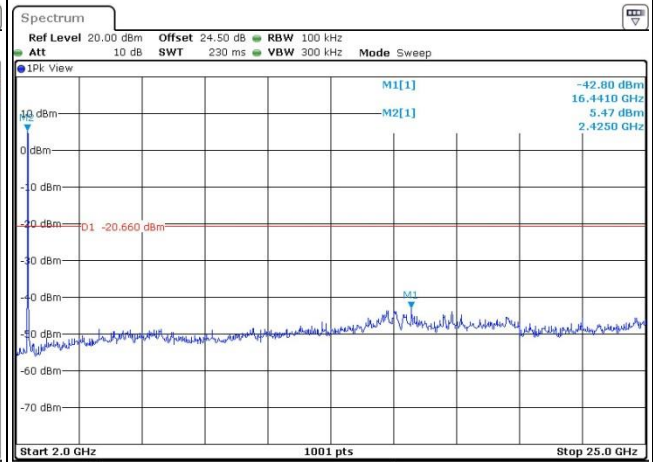

Date: 1.SEP.2018 03:43:27



Test Mode :	802.11g	Test Channel :	11
-------------	---------	----------------	----

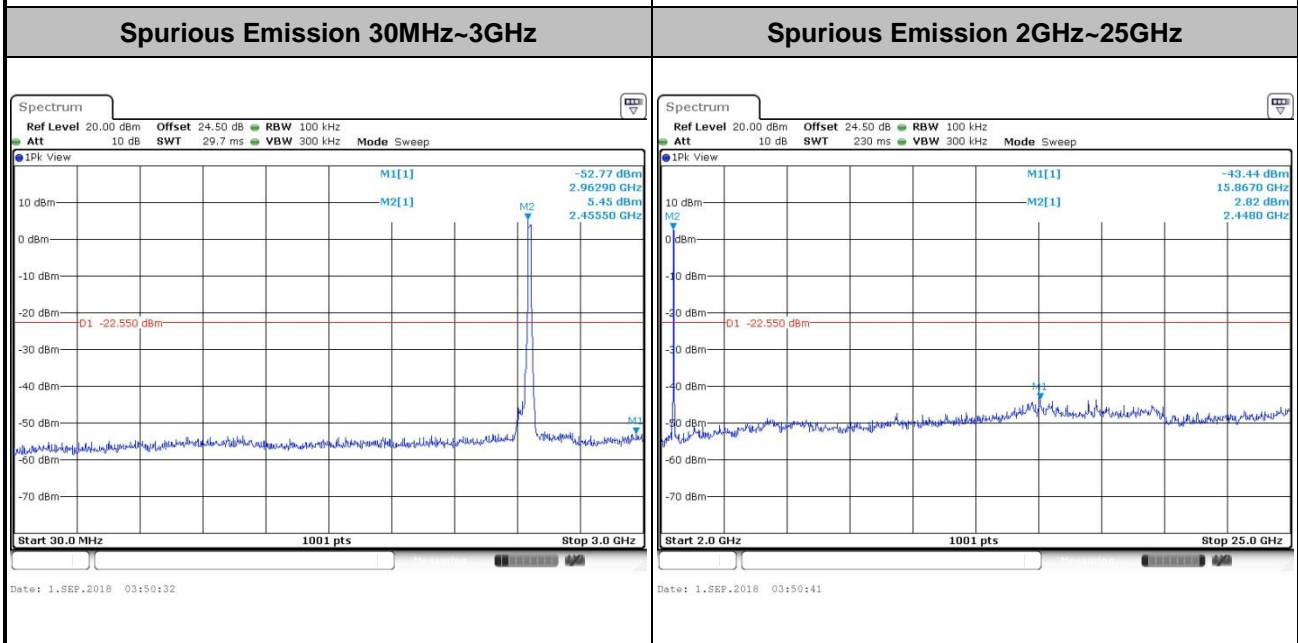
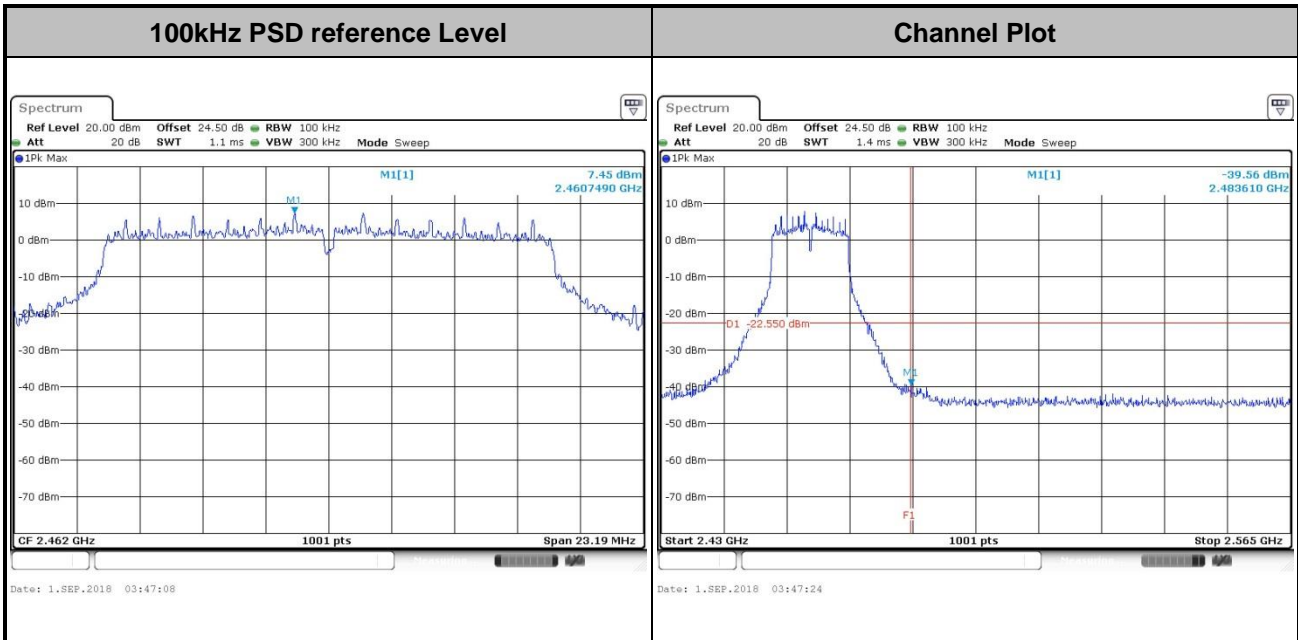



Test Mode : 802.11n HT20 Test Channel : 01

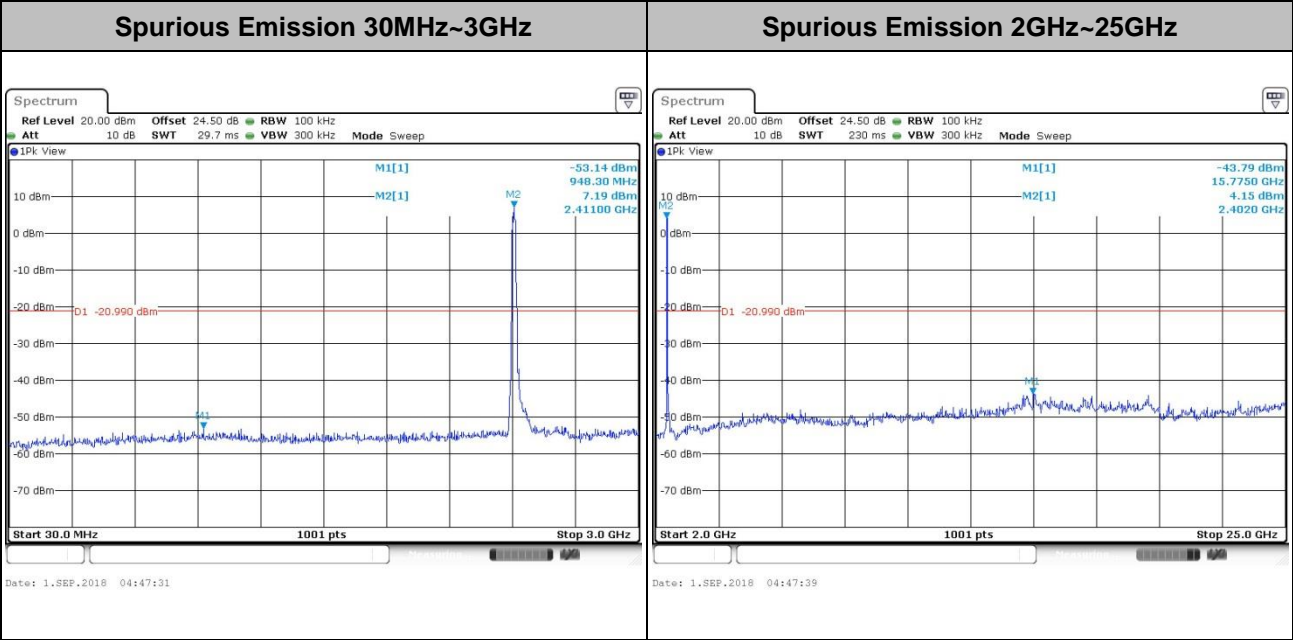
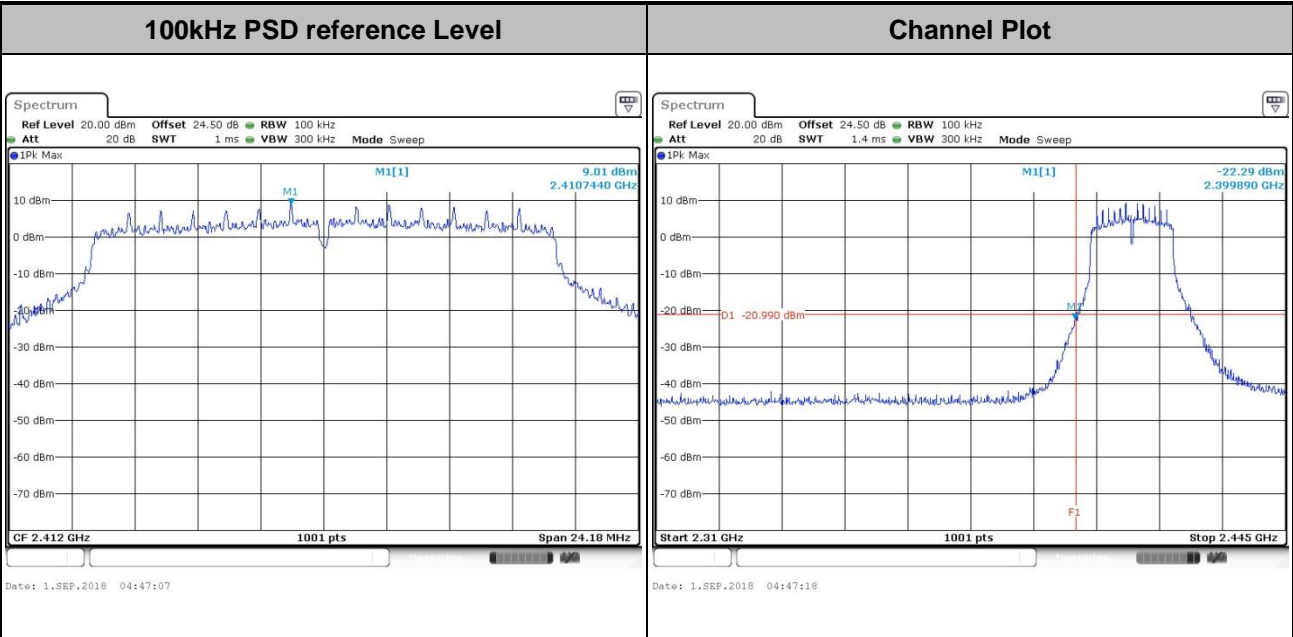



Test Mode :	802.11n HT20	Test Channel :	06
-------------	--------------	----------------	----

100kHz PSD reference Level

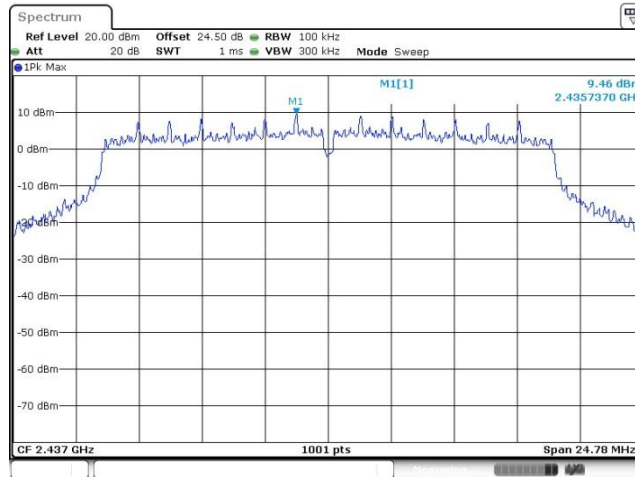

Spurious Emission 30MHz~3GHz

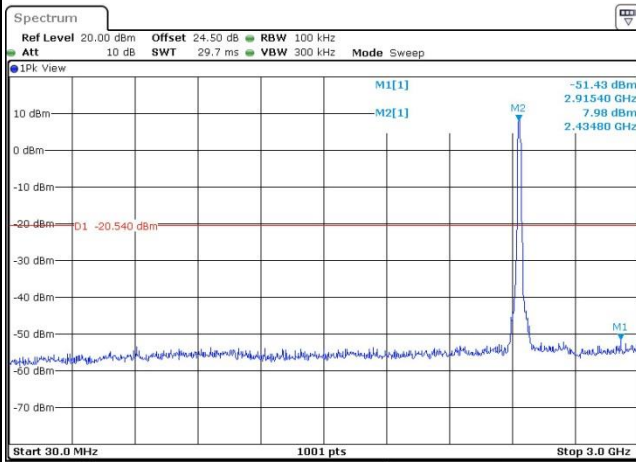

Spurious Emission 2GHz~25GHz

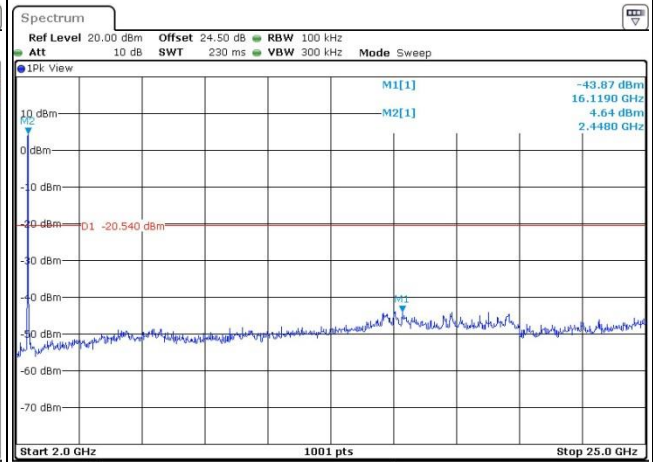



Test Mode :	802.11n HT20	Test Channel :	11
-------------	--------------	----------------	----

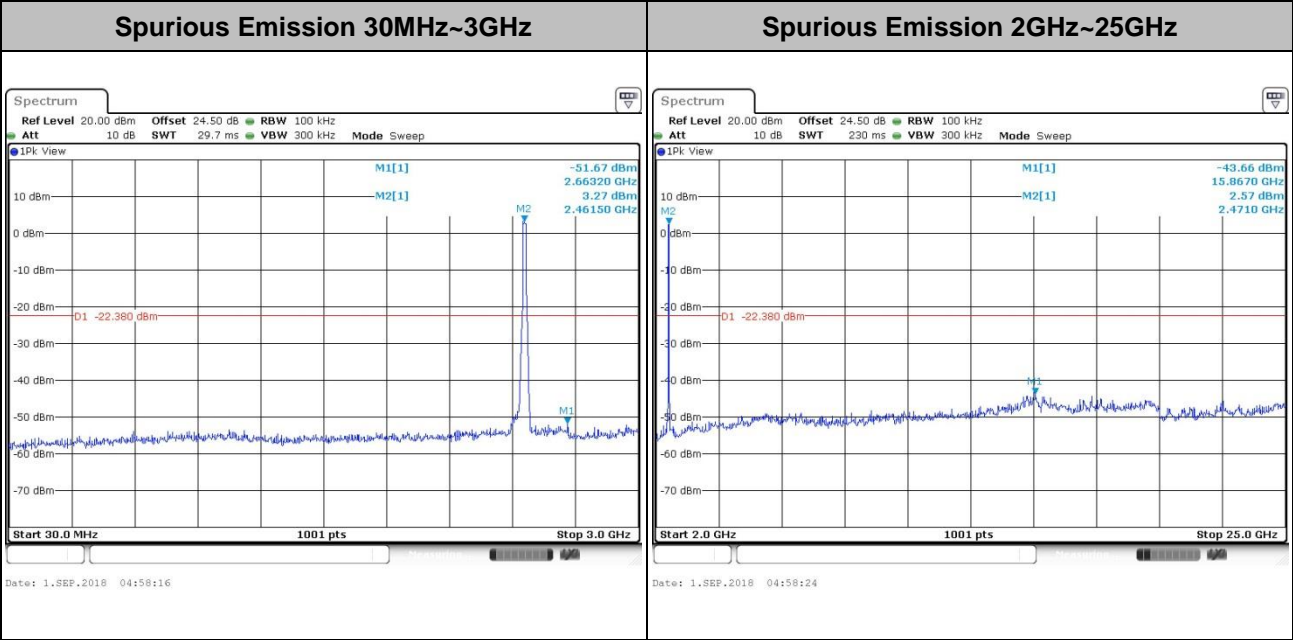
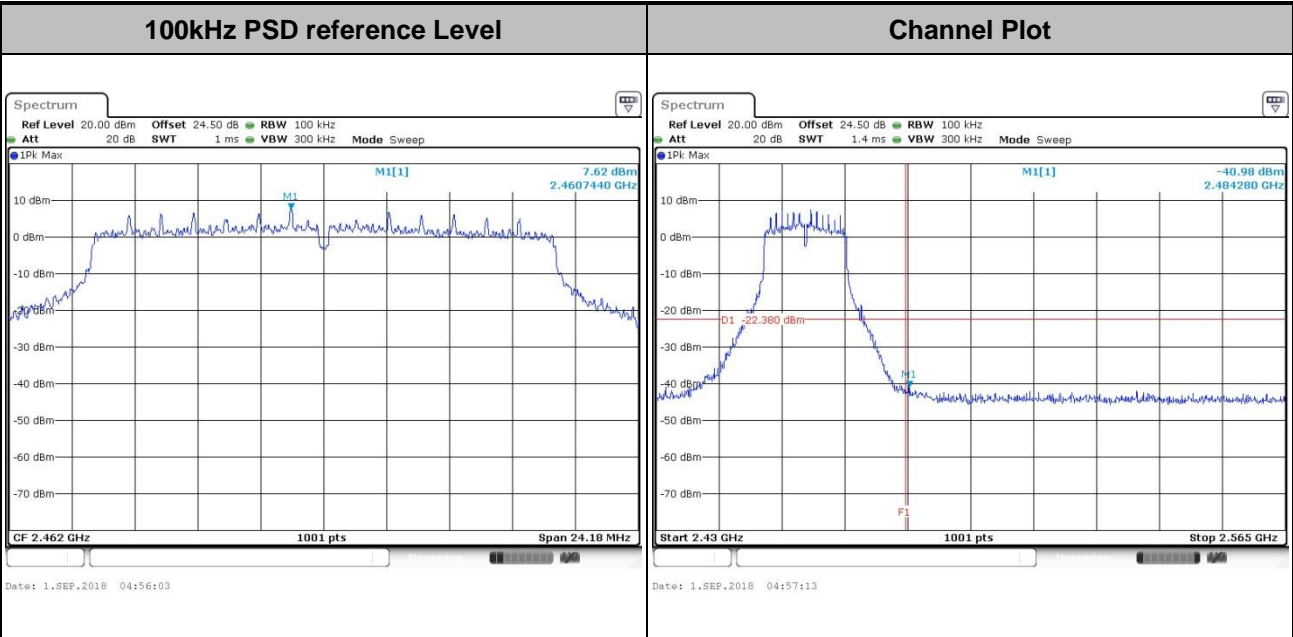



Test Mode :	802.11n HT40	Test Channel :	03
-------------	--------------	----------------	----

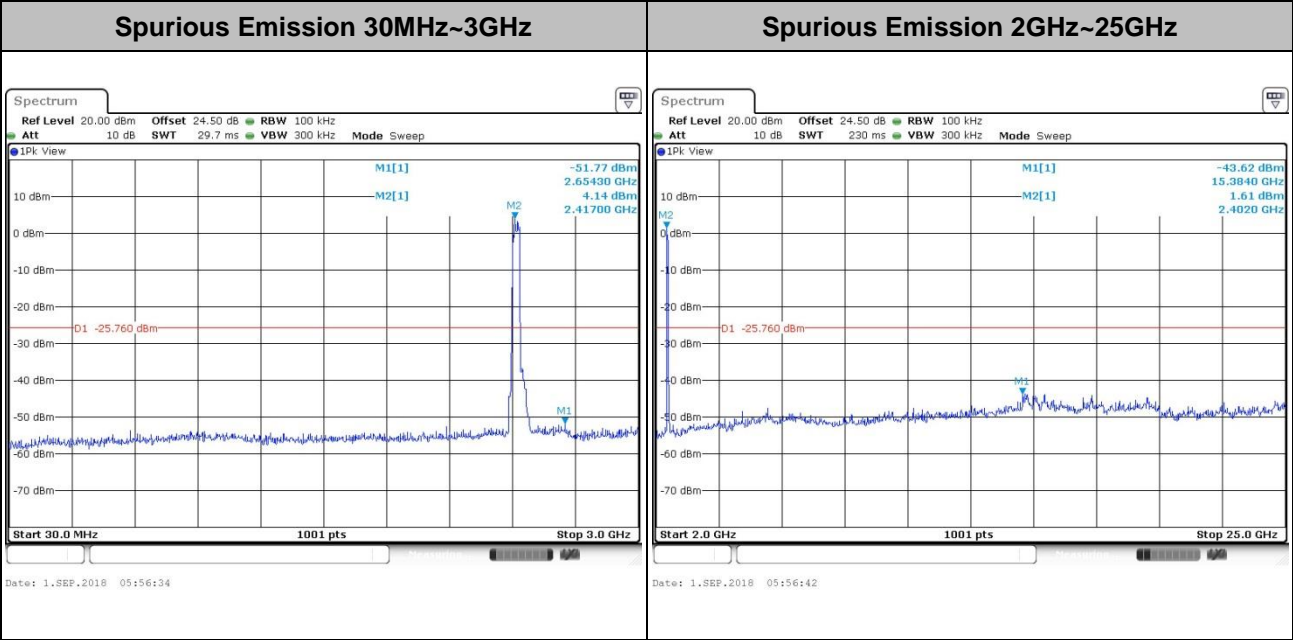
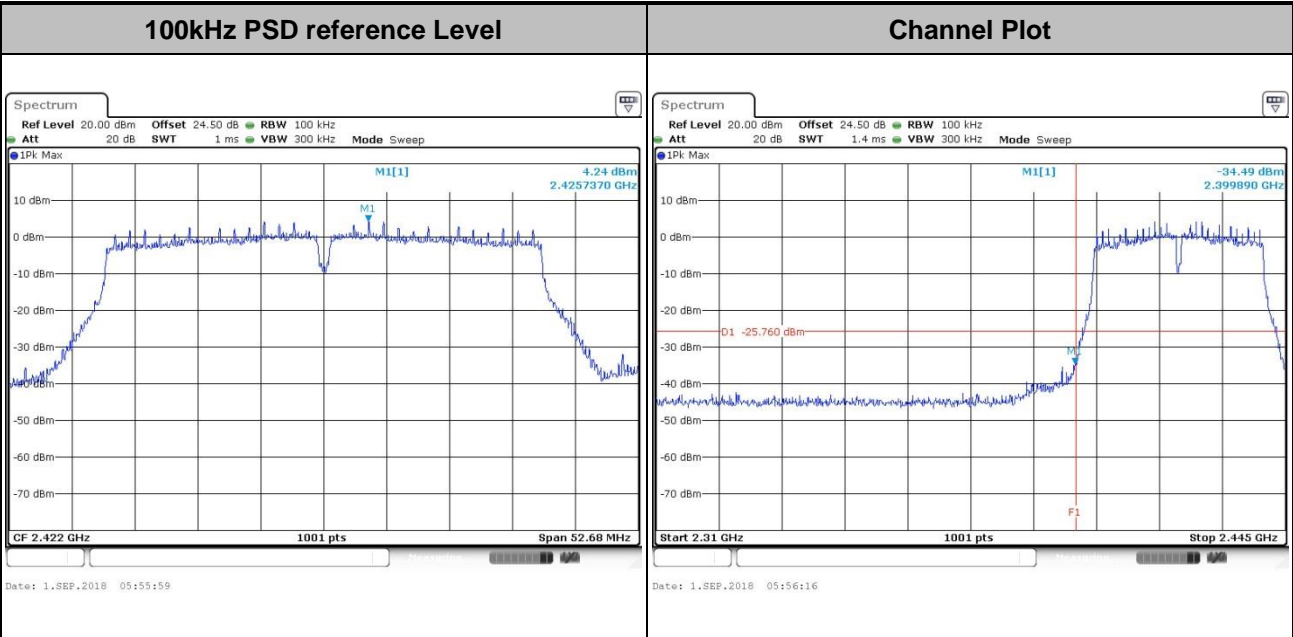



Test Mode :	802.11n HT40	Test Channel :	06
-------------	--------------	----------------	----

100kHz PSD reference Level



Spurious Emission 30MHz~3GHz

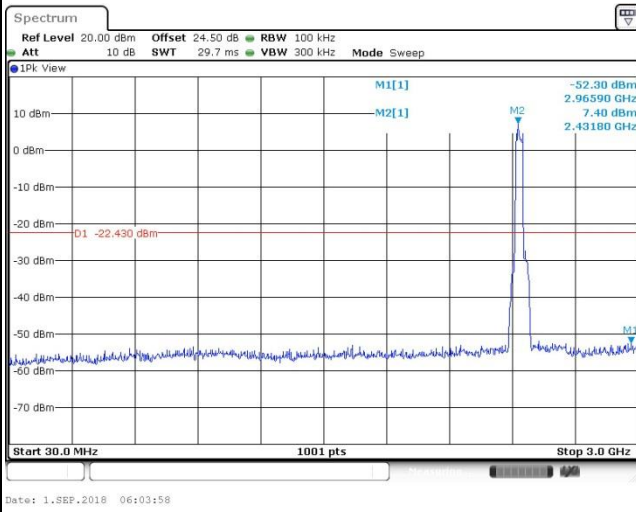

Spurious Emission 2GHz~25GHz

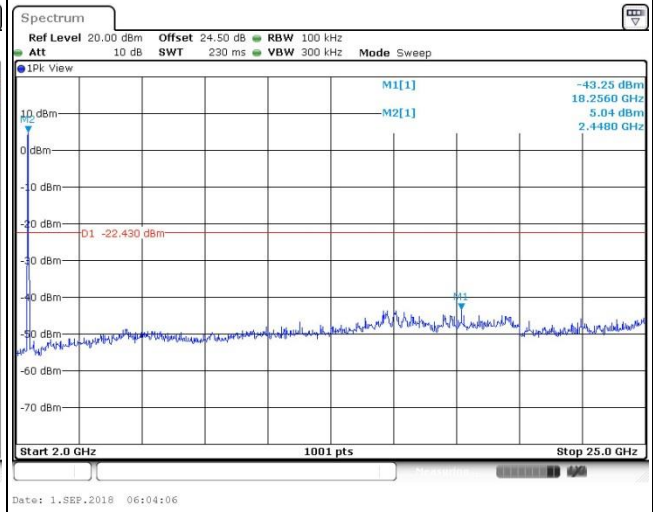



Test Mode : 802.11n HT40 Test Channel : 09

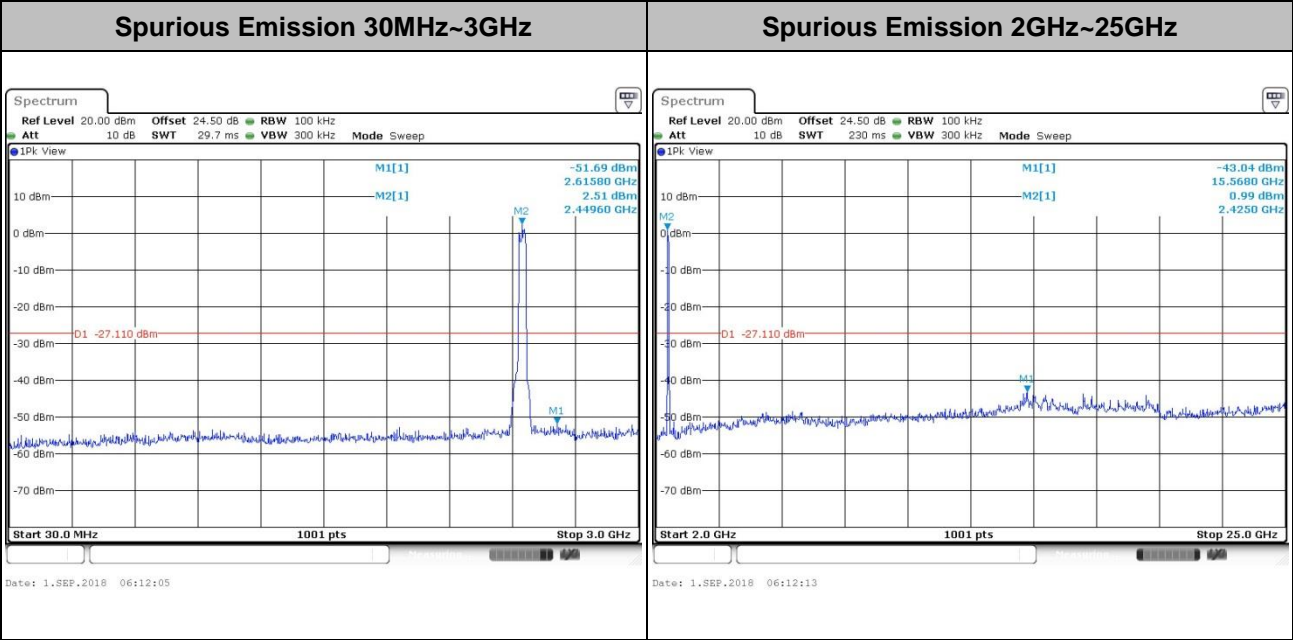
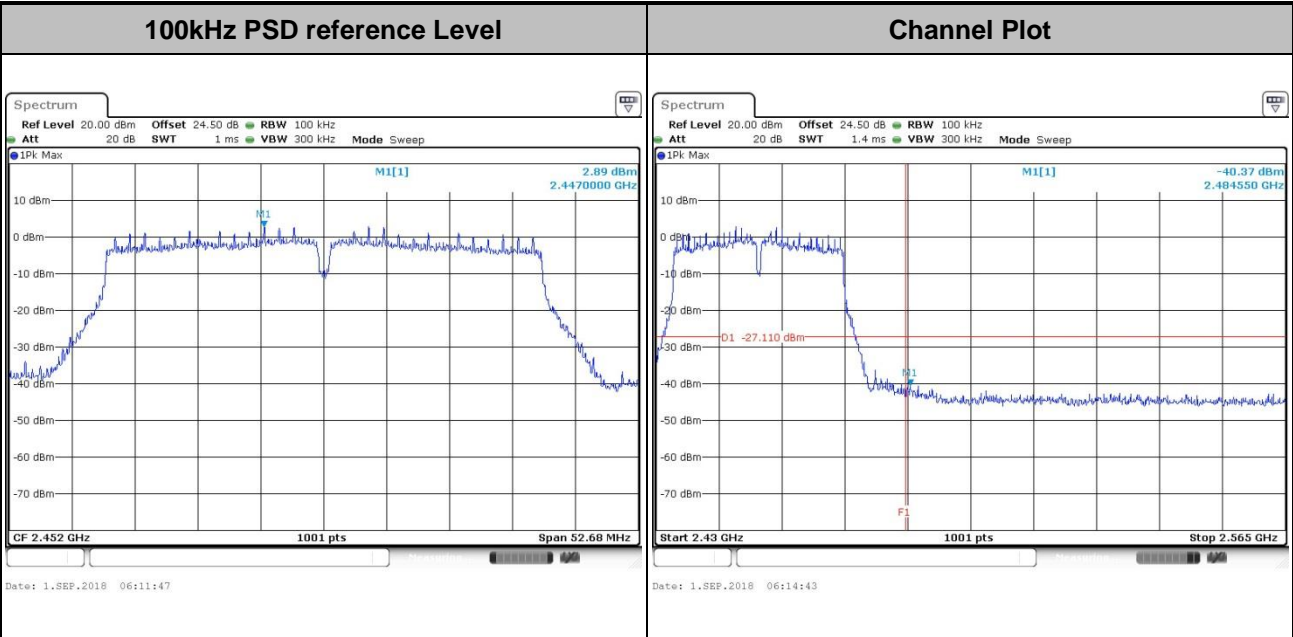



Number of TX = 1, Ant. 2 (Measured)

Test Mode :	802.11b	Test Channel :	01
-------------	---------	----------------	----

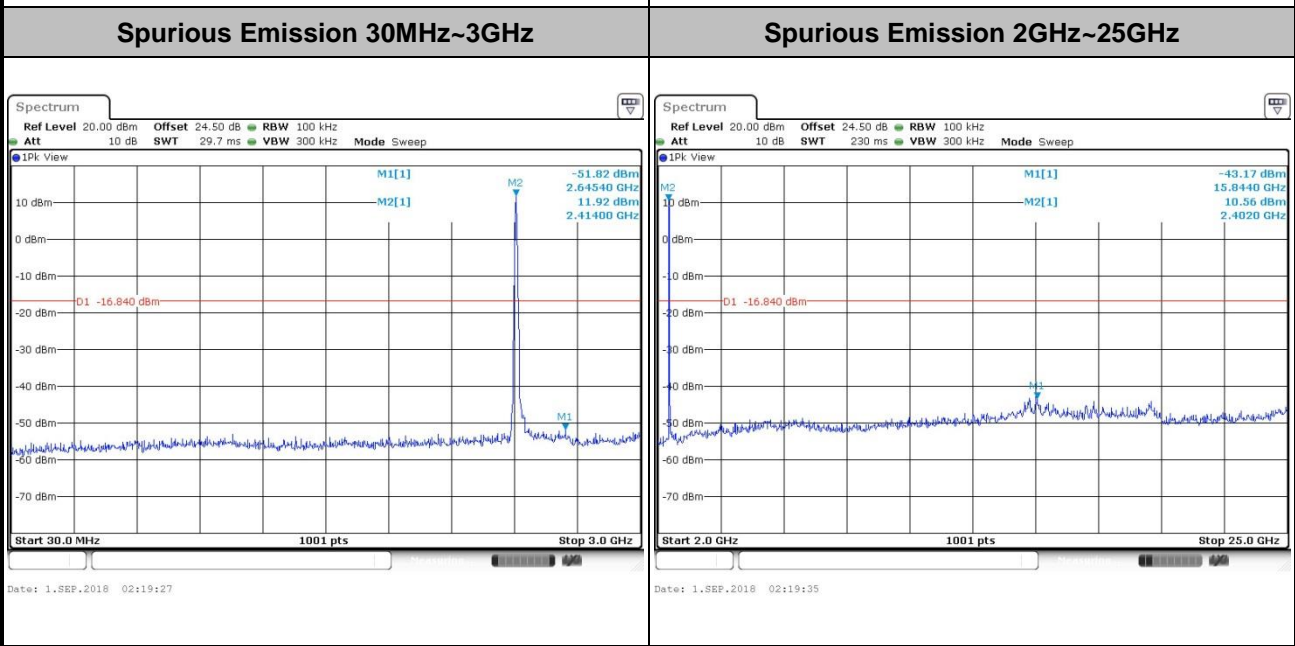
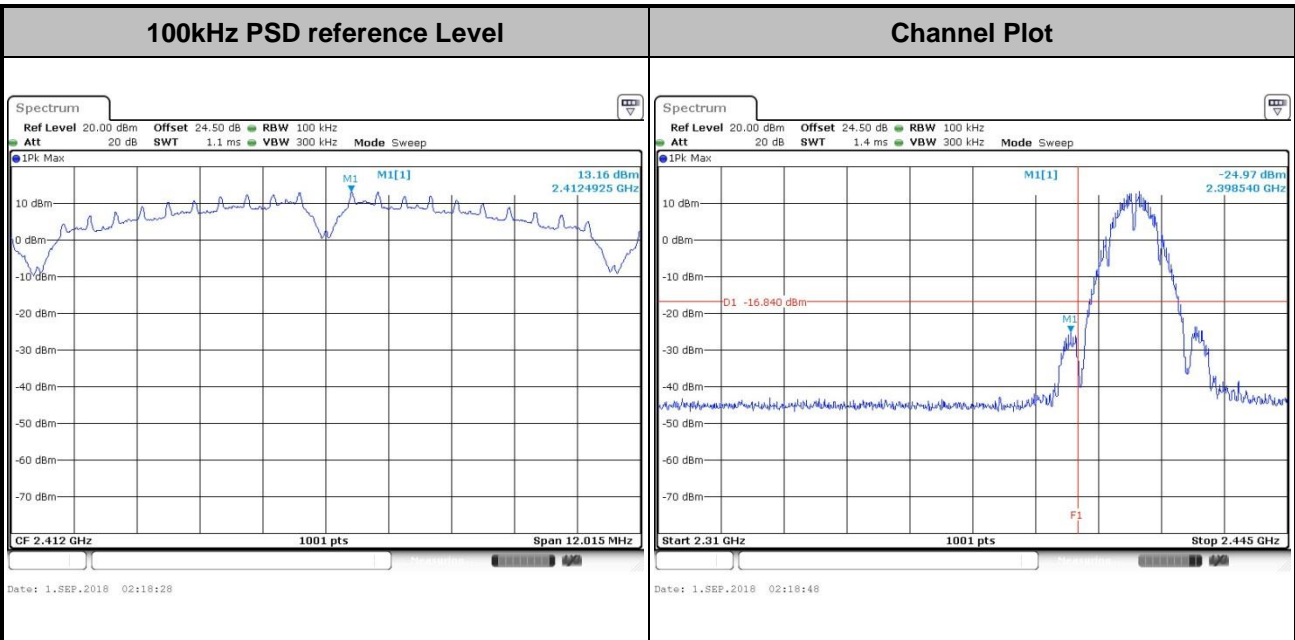



Test Mode :	802.11b	Test Channel :	06
-------------	---------	----------------	----

100kHz PSD reference Level

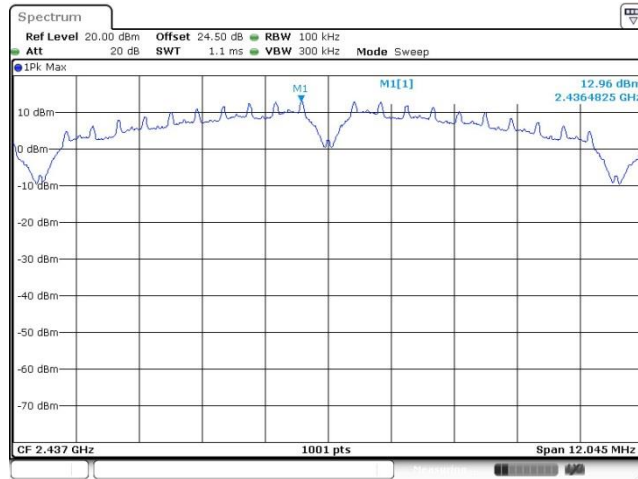

Date: 1.SEP.2018 02:23:17

Spurious Emission 30MHz~3GHz

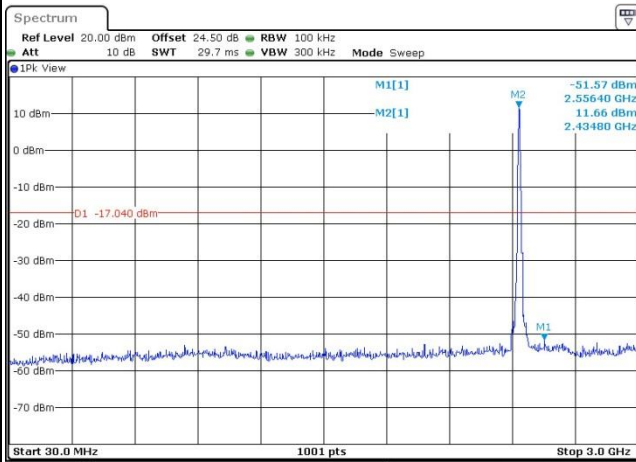

Date: 1.SEP.2018 02:23:40

Spurious Emission 2GHz~25GHz

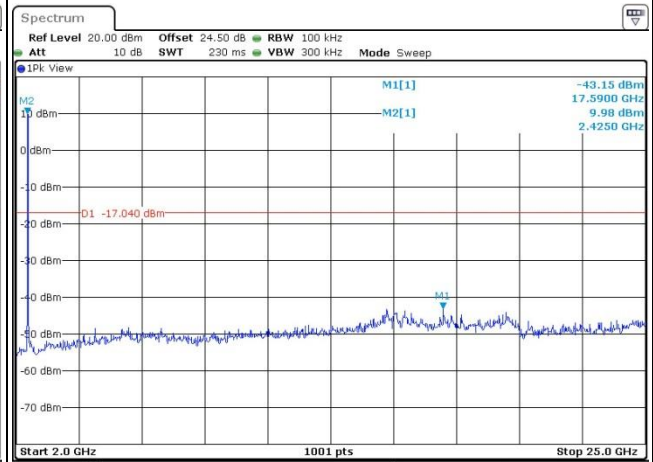

Date: 1.SEP.2018 02:23:48



Test Mode :	802.11b	Test Channel :	11
-------------	---------	----------------	----

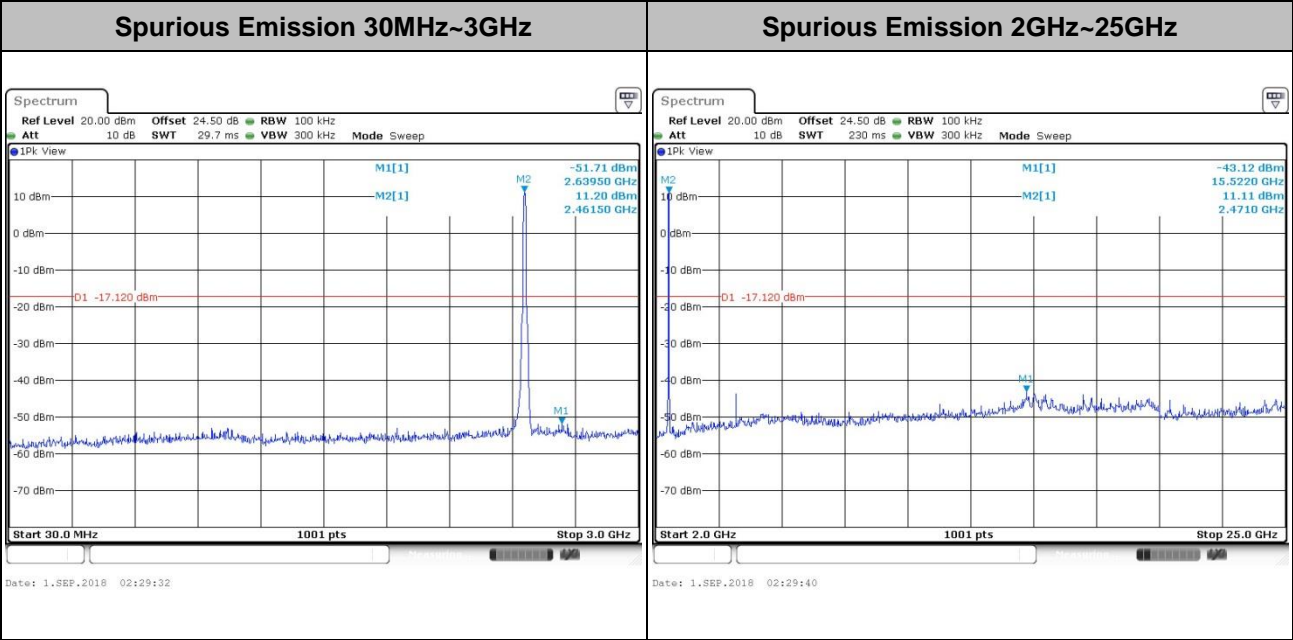
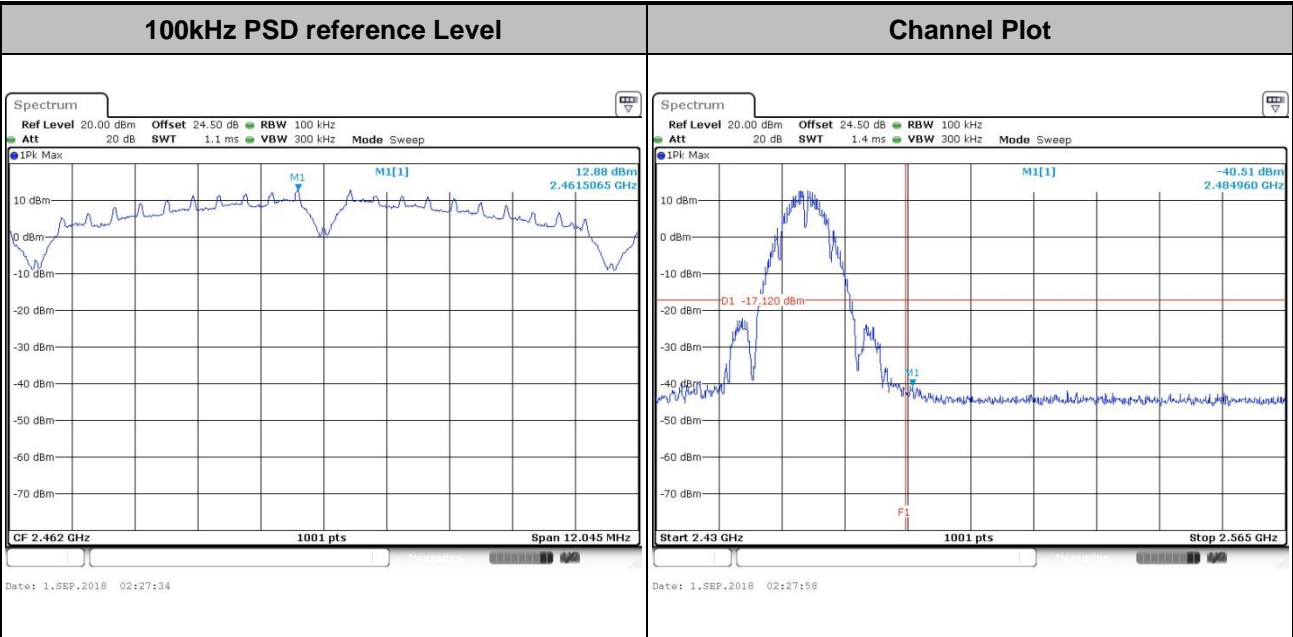



Test Mode : 802.11g Test Channel : 01

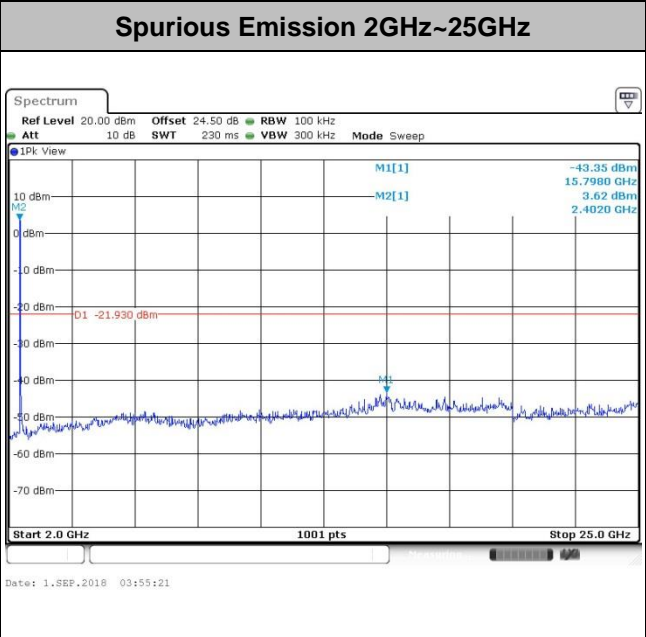
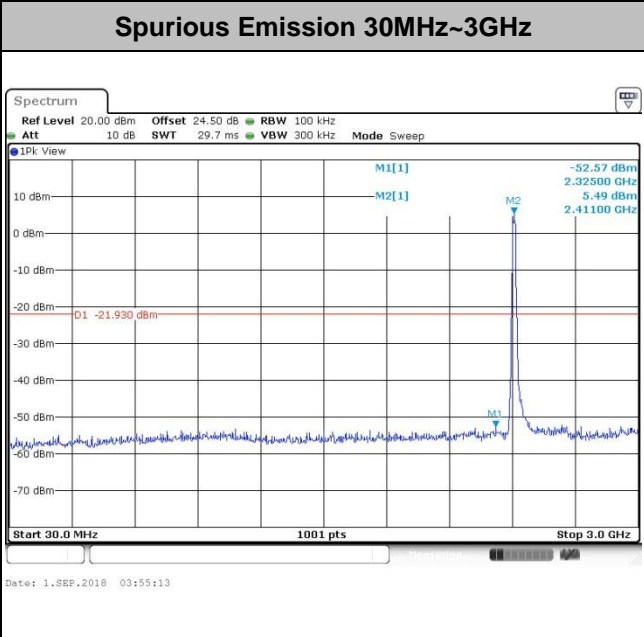
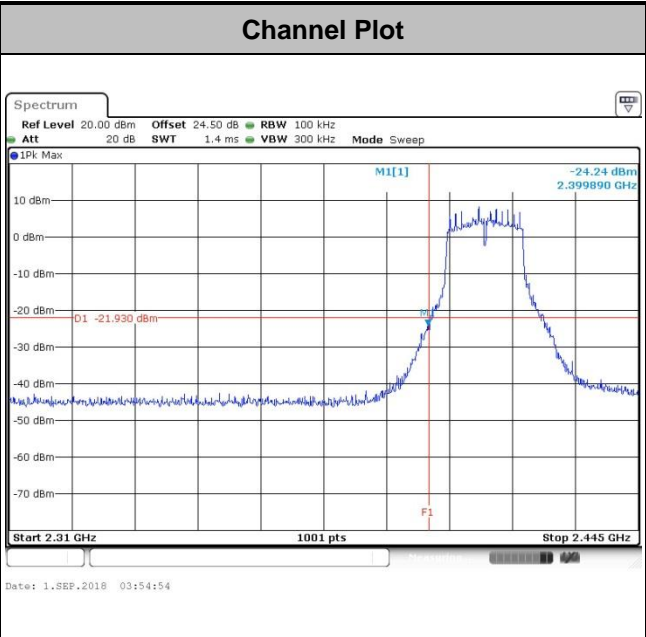
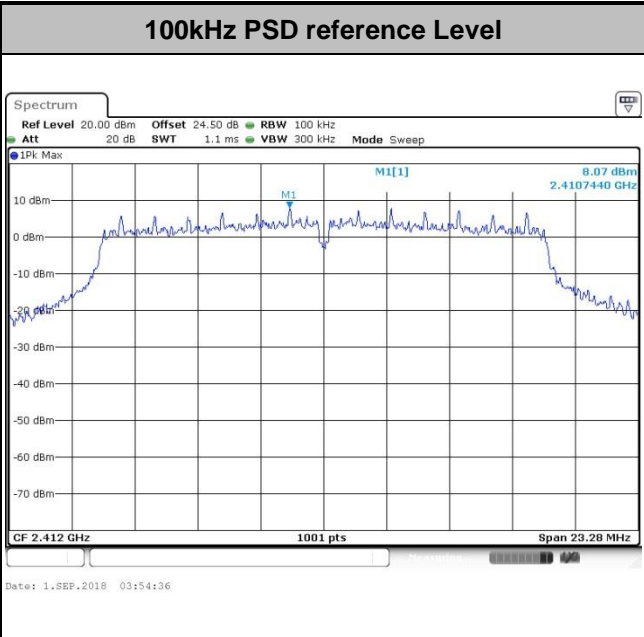



Test Mode :	802.11g	Test Channel :	06
-------------	---------	----------------	----

100kHz PSD reference Level

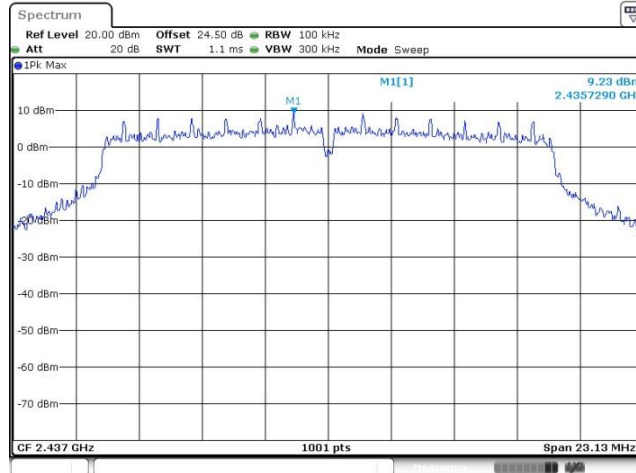

Date: 1.SEP.2018 03:59:18

Spurious Emission 30MHz~3GHz

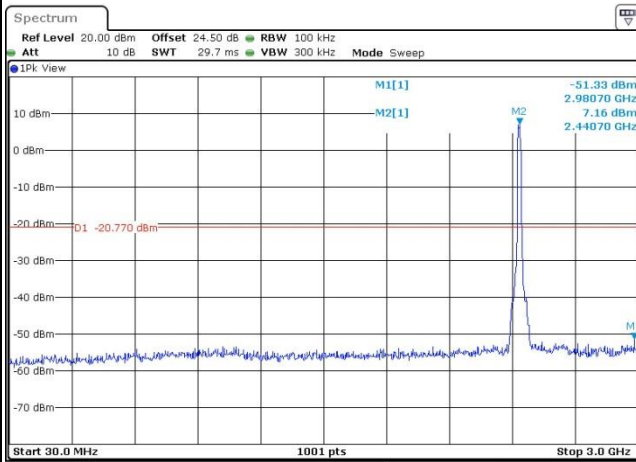

Date: 1.SEP.2018 03:59:43

Spurious Emission 2GHz~25GHz

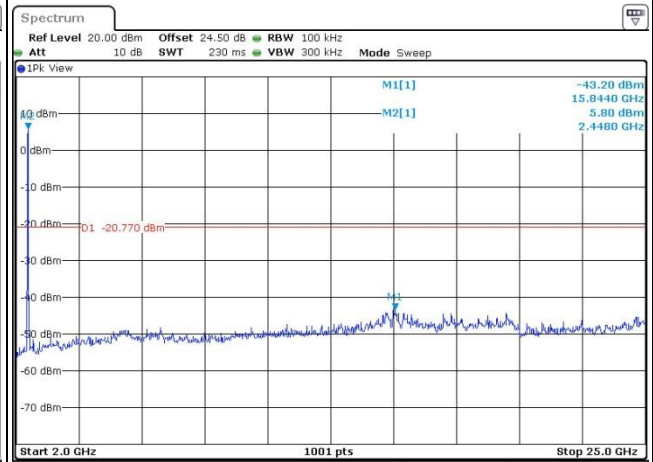

Date: 1.SEP.2018 03:59:51



Test Mode :	802.11g	Test Channel :	11
-------------	---------	----------------	----

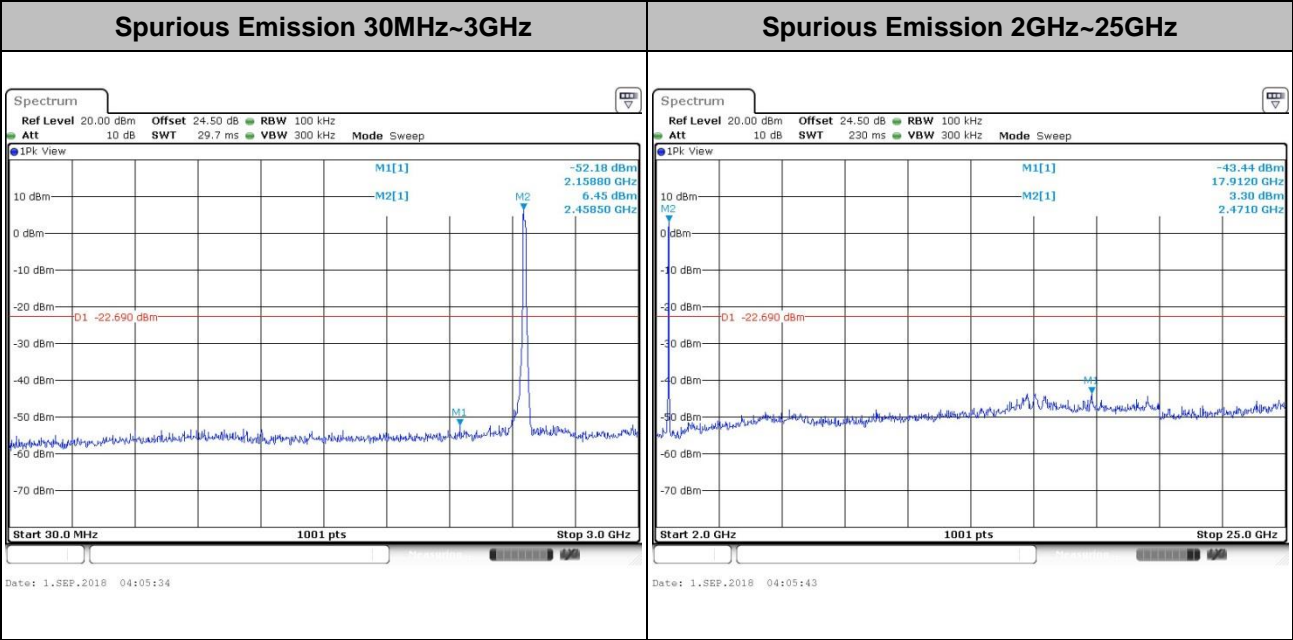
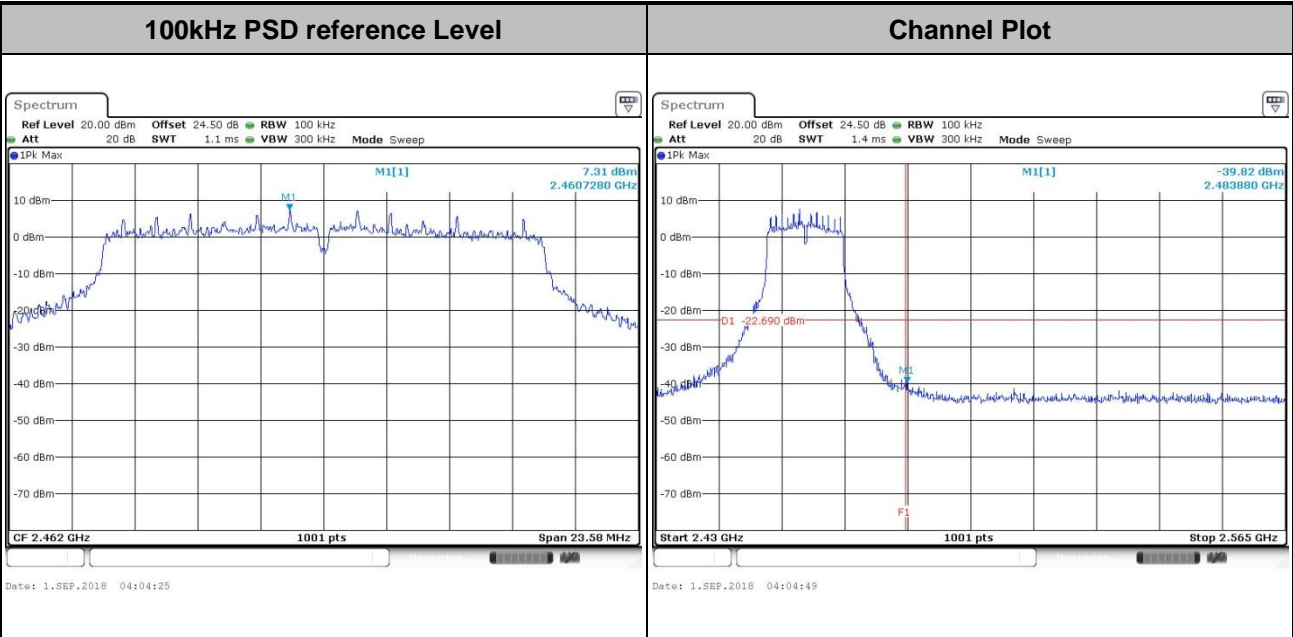



Test Mode : 802.11n HT20 Test Channel : 01

