



FCC RADIO TEST REPORT

FCC ID : UZ7PS20J
Equipment : PS20 Personal Shopper
Brand Name : ZEBRA
Model name : PS20J
Applicant : Zebra Technologies Corporation
1 Zebra Plaza Holtsville, NY 11742
Manufacturer : Zebra Technologies Corporation
1 Zebra Plaza Holtsville, NY 11742
Standard : FCC Part 15 Subpart E §15.407

The product was received on Jun. 02, 2018 and testing was started from Jun. 07, 2018 and completed on Sep. 11, 2018. We, SPORTON INTERNATIONAL INC., would like to declare that the tested sample has been evaluated in accordance with the test procedures and has been in compliance with the applicable technical standards.

The report must not be used by the client to claim product certification, approval, or endorsement by TAF or any agency of government.

The test results in this report apply exclusively to the tested model / sample. Without written approval of SPORTON INTERNATIONAL INC. EMC & Wireless Communications Laboratory, the test report shall not be reproduced except in full.

Approved by: Joseph Lin

SPORTON INTERNATIONAL INC. EMC & Wireless Communications Laboratory

No. 52, Huaya 1st Rd., Guishan Dist., Taoyuan City, Taiwan (R.O.C.)



Table of Contents

History of this test report.....	3
Summary of Test Result.....	4
1 General Description	5
1.1 Product Feature of Equipment Under Test.....	5
1.2 Product Specification of Equipment Under Test.....	6
1.3 Modification of EUT	7
1.4 Testing Location	8
1.5 Applicable Standards.....	8
2 Test Configuration of Equipment Under Test	9
2.1 Carrier Frequency and Channel	9
2.2 Test Mode.....	10
2.3 Connection Diagram of Test System.....	19
2.4 Support Unit used in test configuration and system	20
2.5 EUT Operation Test Setup	21
2.6 Measurement Results Explanation Example.....	21
3 Test Result	22
3.1 6dB and 26dB and 99% Occupied Bandwidth Measurement	22
3.2 Maximum Conducted Output Power Measurement	28
3.3 Power Spectral Density Measurement	32
3.4 Unwanted Emissions Measurement.....	38
3.5 AC Conducted Emission Measurement.....	45
3.6 Automatically Discontinue Transmission	47
3.7 Antenna Requirements	48
4 List of Measuring Equipment.....	50
5 Uncertainty of Evaluation.....	52
Appendix A. AC Conducted Emission Test Result	
Appendix B. Radiated Spurious Emission	
Appendix C. Radiated Spurious Emission Plots	
Appendix D. Duty Cycle Plots	
Appendix E. Setup Photographs	



History of this test report

Report No.	Version	Description	Issued Date
FR860204E	01	Initial issue of report	Sep. 13, 2018



Summary of Test Result

Report Clause	Ref Std. Clause	Test Items	Result (PASS/FAIL)	Remark
3.1	15.403 (i)	6dB & 26dB Bandwidth	Pass	-
3.1	2.1049	99% Occupied Bandwidth	Reporting only	-
3.2	15.407 (a)	Maximum Conducted Output Power	Pass	-
3.3	15.407 (a)	Power Spectral Density	Pass	-
3.4	15.407(b)	Unwanted Emissions	Pass	Under limit 3.04 dB at 237.360 MHz
3.5	15.207	AC Conducted Emission	Pass	Under limit 4.57 dB at 0.542 MHz
3.6	15.407 (c)	Automatically Discontinue Transmission	Pass	-
3.7	15.203 & 15.407 (a)	Antenna Requirement	Pass	-

Reviewed by: Wii Chang

Report Producer: Nancy Yang



1 General Description

1.1 Product Feature of Equipment Under Test

Product Feature	
Equipment	PS20 Personal Shopper
Brand Name	ZEBRA
Model Name	PS20J
FCC ID	UZ7PS20J
Sample 1	Plus SKU
Sample 2	Base SKU
EUT supports Radios application	WLAN 11a/b/g/n HT20/HT40 WLAN 11ac VHT20/VHT40/VHT80 Bluetooth BR/EDR/LE
HW Version	EV3
SW Version	91-09-06.00-ON-U00-STD
FW Version	91-09-06.00-ON-U00-STD
MFD	06JUL18
EUT Stage	Engineering Sample

Remark:

1. The above EUT's information was declared by manufacturer.
2. All the test results were performed with Sample 1.

Specification of Accessories				
Battery	Brand Name	Zebra	Part Number	BT-000351

Supported Unit Used in Test Configuration and System				
1-slot cradle	Brand Name	Symbol	Part Number	CRD-MC18-1SL
Adapter	Brand Name	Zebra	Part Number	PWR-BGA12V108W0WW
Programming USB cable	Brand Name	Zebra	Part Number	CBL-PS20-USBCHG-01



1.2 Product Specification of Equipment Under Test

Standards-related Product Specification	
Tx/Rx Channel Frequency Range	5745 MHz ~ 5825 MHz
Maximum Output Power <CDD Mode>	<p><5745 MHz ~ 5825 MHz></p> <p><Ant. 1> 802.11a : 20.30 dBm / 0.1072 W 802.11n HT20 : 20.49 dBm / 0.1119 W 802.11n HT40 : 20.49 dBm / 0.1119 W 802.11ac VHT20: 20.48 dBm / 0.1117 W 802.11ac VHT40: 20.48 dBm / 0.1117 W 802.11ac VHT80: 20.45 dBm / 0.1109 W</p> <p><Ant. 2> 802.11a : 20.10 dBm / 0.1023 W 802.11n HT20 : 20.40 dBm / 0.1096 W 802.11n HT40 : 20.43 dBm / 0.1104 W 802.11ac VHT20: 20.39 dBm / 0.1094 W 802.11ac VHT40: 20.37 dBm / 0.1089 W 802.11ac VHT80: 20.25 dBm / 0.1059 W</p> <p>MIMO <Ant. 1 + 2> 802.11a : 20.31 dBm / 0.1074 W 802.11n HT20 : 20.35 dBm / 0.1084 W 802.11n HT40 : 20.40 dBm / 0.1096 W 802.11ac VHT20: 20.28 dBm / 0.1067 W 802.11ac VHT40: 20.31 dBm / 0.1074 W 802.11ac VHT80: 20.16 dBm / 0.1038 W</p>
Maximum Output Power <TXBF Mode>	<p><5745 MHz ~ 5825 MHz></p> <p>MIMO <Ant. 1 + 2> 802.11ac VHT20: 19.67 dBm / 0.0927 W 802.11ac VHT40: 20.16 dBm / 0.1038 W 802.11ac VHT80: 19.96 dBm / 0.0991 W</p>

Standards-related Product Specification													
99% Occupied Bandwidth <CDD Mode>	<p><Ant. 1> 802.11a : 16.95 MHz 802.11n HT20 : 18.05 MHz 802.11n HT40 : 36.70 MHz 802.11ac VHT80 : 77.28 MHz</p> <p><Ant. 2> 802.11a : 16.90 MHz 802.11n HT20 : 18.05 MHz 802.11n HT40 : 36.70 MHz 802.11ac VHT80 : 77.04 MHz</p> <p>MIMO <Ant. 1> 802.11a : 16.85 MHz 802.11n HT20 : 18.00 MHz 802.11n HT40 : 36.70 MHz 802.11ac VHT80 : 77.16 MHz</p> <p>MIMO <Ant. 2> 802.11a : 16.75 MHz 802.11n HT20 : 17.90 MHz 802.11n HT40 : 36.60 MHz 802.11ac VHT80 : 77.04 MHz</p>												
99% Occupied Bandwidth <TXBF Mode>	<p>MIMO <Ant. 1> 802.11ac VHT20 : 17.80 MHz 802.11ac VHT40 : 36.60 MHz 802.11ac VHT80 : 77.04 MHz</p> <p>MIMO <Ant. 2> 802.11ac VHT20 : 18.65 MHz 802.11ac VHT40 : 36.60 MHz 802.11ac VHT80 : 77.04 MHz</p>												
Type of Modulation	802.11a/n : OFDM (BPSK / QPSK / 16QAM / 64QAM) 802.11ac : OFDM (BPSK / QPSK / 16QAM / 64QAM / 256QAM)												
Antenna Gain / Gain	<Ant. 1> : PIFA Antenna with gain 3.89 dBi <Ant. 2> : PIFA Antenna with gain 3.07 dBi												
Antenna Function Description	<table border="1"> <thead> <tr> <th></th> <th>Ant. 1</th> <th>Ant. 2</th> </tr> </thead> <tbody> <tr> <td>802.11 a/n/ac</td> <td>V</td> <td>V</td> </tr> <tr> <td>802.11 a/n/ac MIMO</td> <td>V</td> <td>V</td> </tr> <tr> <td>802.11 ac TXBF</td> <td>V</td> <td>V</td> </tr> </tbody> </table>		Ant. 1	Ant. 2	802.11 a/n/ac	V	V	802.11 a/n/ac MIMO	V	V	802.11 ac TXBF	V	V
	Ant. 1	Ant. 2											
802.11 a/n/ac	V	V											
802.11 a/n/ac MIMO	V	V											
802.11 ac TXBF	V	V											

Note: MIMO Ant. 1+2 is a calculated result from sum of the power MIMO Ant. 1 and MIMO Ant. 2.

1.3 Modification of EUT

No modifications are made to the EUT during all test items.



1.4 Testing Location

Sporton Lab is accredited to ISO 17025 by Taiwan Accreditation Foundation (TAF code : 1190) and the FCC designation No. TW1190 and TW0007 under the FCC 2.948(e) by Mutual Recognition Agreement (MRA) in FCC Test.

Test Site	SPORTON INTERNATIONAL INC.	
Test Site Location	No.52, Huaya 1st Rd., Guishan Dist., Taoyuan City, Taiwan (R.O.C.) TEL: +886-3-327-3456 FAX: +886-3-328-4978	
Test Site No.	Sporton Site No.	
	TH05-HY	CO05-HY

Note: The test site complies with ANSI C63.4 2014 requirement.

Test Site	SPORTON INTERNATIONAL INC.	
Test Site Location	No.58, Aly. 75, Ln. 564, Wenhua 3rd, Rd., Guishan Dist., Taoyuan City, Taiwan (R.O.C.) TEL: +886-3-327-0868 FAX: +886-3-327-0855	
Test Site No.	Sporton Site No.	
	03CH13-HY	

Note: The test site complies with ANSI C63.4 2014 requirement.

1.5 Applicable Standards

According to the specifications of the manufacturer, the EUT must comply with the requirements of the following standards:

- ♦ FCC Part 15 Subpart E
- ♦ FCC KDB 789033 D02 General UNII Test Procedures New Rules v02r01.
- ♦ FCC KDB 414788 D01 Radiated Test Site v01r01.
- ♦ FCC KDB 662911 D01 Multiple Transmitter Output v02r01.
- ♦ ANSI C63.10-2013

Remark:

1. All test items were verified and recorded according to the standards and without any deviation during the test.
2. This EUT has also been tested and complied with the requirements of FCC Part 15, Subpart B, recorded in a separate test report.



2 Test Configuration of Equipment Under Test

- a. The EUT has been associated with peripherals and configuration operated in a manner tended to maximize its emission characteristics in a typical application. Frequency range investigated: conduction emission (150 kHz to 30 MHz), radiation emission (9 kHz to the 10th harmonic of the highest fundamental frequency or to 40 GHz, whichever is lower). For radiated measurement, pre-scanned in three orthogonal panels, X, Y, Z. The worst cases (X plane for Ant. 1 and Ant. 2, Z plane for Ant. 1+2) were recorded in this report.

- b. AC power line Conducted Emission was tested under maximum output power.

2.1 Carrier Frequency and Channel

Frequency Band	Channel	Freq. (MHz)	Channel	Freq. (MHz)
5725-5850 MHz Band 4 (U-NII-3)	149	5745	157	5785
	151*	5755	159*	5795
	153	5765	161	5805
	155 [#]	5775	165	5825

Note:

- 1. The above Frequency and Channel in "*" were 802.11n HT40 and 802.11ac VHT40.
- 2. The above Frequency and Channel in "[#]" were 802.11ac VHT80.



2.2 Test Mode

Final test modes are considering the modulation and worse data rates as below table.

Single Mode

Modulation	Data Rate
802.11a	6 Mbps
802.11n HT20	MCS0
802.11n HT40	MCS0
802.11ac VHT20 (Covered by HT20)	MCS0
802.11ac VHT40 (Covered by HT40)	MCS0
802.11ac VHT80	MCS0

MIMO Mode

Modulation	Data Rate
802.11a	6 Mbps
802.11n HT20	MCS0
802.11n HT40	MCS0
802.11ac VHT20 (Covered by HT20)	MCS0
802.11ac VHT40 (Covered by HT40)	MCS0
802.11ac VHT80	MCS0

TXBF Mode

Modulation	Data Rate
802.11ac VHT20	MCS0
802.11ac VHT40	MCS0
802.11ac VHT80	MCS0



Test Cases	
AC Conducted Emission	Mode 1 : WLAN (5GHz) Link + Bluetooth Link + MPEG4 + 1 slot locking cradle + AC Adapter

<CDD Mode>

Ch. #		Band IV : 5725-5850 MHz			
		802.11a	802.11n HT20	802.11n HT40	802.11ac VHT80
L	Low	149	149	151	-
M	Middle	157	157	-	155
H	High	165	165	159	-

<TXBF Mode>

Ch. #		Band IV : 5725-5850 MHz		
		802.11ac VHT20	802.11ac VHT40	802.11ac VHT80
L	Low	149	151	-
M	Middle	157	-	155
H	High	165	159	-



<CDD Mode>

<Ant. 1>

802.11a RF Output Power (dBm)										
Power vs. Channel			Power vs Data Rate							
Channel	Frequency (MHz)	Data Rate (bps)	channel	Data Rate (bps)						
		6M		9M	12M	18M	24M	36M	48M	54M
Duty Cycle (%)		95.31		93.84	92.75	89.15	86.67	81.11	77.27	74.39
CH 149	5745	20.21	CH 165	19.93	19.93	20.23	19.92	19.99	20.00	20.11
CH 157	5785	20.11								
CH 165	5825	20.30								

802.11n HT20 RF Output Power (dBm)										
Power vs. Channel			Power vs Data Rate							
Channel	Frequency (MHz)	MCS Index	channel	MCS Index						
		MCS0		MCS1	MCS2	MCS3	MCS4	MCS5	MCS6	MCS7
Duty Cycle (%)		94.97		90.91	88.62	84.35	80.19	73.74	73.17	72.55
CH 149	5745	20.48	CH 165	20.35	20.34	20.44	20.46	20.41	20.38	20.44
CH 157	5785	20.42								
CH 165	5825	20.49								

802.11n HT40 RF Output Power (dBm)										
Power vs. Channel			Power vs Data Rate							
Channel	Frequency (MHz)	MCS Index	channel	MCS Index						
		MCS0		MCS1	MCS2	MCS3	MCS4	MCS5	MCS6	MCS7
Duty Cycle (%)		91.18		85.82	80.77	75.29	68.66	62.07	61.11	60.00
CH 151	5755	20.17	CH 159	20.26	20.24	20.41	20.29	20.30	20.22	20.21
CH 159	5795	20.49								



802.11ac VHT20 RF Output Power (dBm)											
Power vs. Channel			Power vs Data Rate								
Channel	Frequency (MHz)	MCS Index	channel	MCS Index							
		MCS0		MCS1	MCS2	MCS3	MCS4	MCS5	MCS6	MCS7	MCS8
Duty Cycle (%)		95.50		90.98	88.71	85.71	80.65	76.67	74.70	70.44	69.57
CH 149	5745	20.47	CH 165								
CH 157	5785	20.41		20.34	20.32	20.37	20.43	20.24	20.29	20.32	20.33
CH 165	5825	20.48									

802.11ac VHT40 RF Output Power (dBm)												
Power vs. Channel			Power vs Data Rate									
Channel	Frequency (MHz)	MCS Index	channel	MCS Index								
		MCS0		MCS1	MCS2	MCS3	MCS4	MCS5	MCS6	MCS7	MCS8	MCS9
Duty Cycle (%)		90.29		85.31	80.00	73.03	69.12	60.66	62.96	60.38	58.33	55.32
CH 151	5755	20.14	CH 159									
CH 159	5795	20.48		20.24	20.22	20.36	20.26	20.27	20.09	20.18	20.24	20.37

802.11ac VHT80 RF Output Power (dBm)												
Power vs. Channel			Power vs Data Rate									
Channel	Frequency (MHz)	MCS Index	channel	MCS Index								
		MCS0		MCS1	MCS2	MCS3	MCS4	MCS5	MCS6	MCS7	MCS8	MCS9
Duty Cycle (%)		89.09		82.91	75.28	72.60	63.33	59.62	58.00	57.45	54.95	51.16
CH155	5775	20.45	CH155	20.25	20.43	20.36	20.34	20.30	20.31	20.27	20.22	20.38



<Ant. 2>

802.11a RF Output Power (dBm)										
Power vs. Channel			Power vs Data Rate							
Channel	Frequency (MHz)	Data Rate (bps)	channel	Data Rate (bps)						
		6M		9M	12M	18M	24M	36M	48M	54M
Duty Cycle (%)		95.31		93.79	91.43	87.79	85.86	80.91	77.27	72.62
CH 149	5745	20.04	CH 165							
CH 157	5785	20.01		20.02	20.06	20.07	19.99	20.02	20.03	20.09
CH 165	5825	20.10								

802.11n HT20 RF Output Power (dBm)										
Power vs. Channel			Power vs Data Rate							
Channel	Frequency (MHz)	MCS Index	channel	MCS Index						
		MCS0		MCS1	MCS2	MCS3	MCS4	MCS5	MCS6	MCS7
Duty Cycle (%)		95.00		92.31	87.20	83.89	81.22	77.01	74.07	72.85
CH 149	5745	20.36	CH 165							
CH 157	5785	20.30		20.29	20.39	20.38	20.35	20.33	20.38	20.35
CH 165	5825	20.40								

802.11n HT40 RF Output Power (dBm)										
Power vs. Channel			Power vs Data Rate							
Channel	Frequency (MHz)	MCS Index	channel	MCS Index						
		MCS0		MCS1	MCS2	MCS3	MCS4	MCS5	MCS6	MCS7
Duty Cycle (%)		91.09		84.51	79.81	76.19	68.38	60.00	61.11	59.62
CH 151	5755	20.43	CH 151							
CH 159	5795	20.14		20.23	20.13	20.13	20.13	20.37	20.14	20.17



802.11ac VHT20 RF Output Power (dBm)											
Power vs. Channel			Power vs Data Rate								
Channel	Frequency (MHz)	MCS Index	channel	MCS Index							
		MCS0		MCS1	MCS2	MCS3	MCS4	MCS5	MCS6	MCS7	MCS8
Duty Cycle (%)		95.00		90.64	87.90	84.16	79.64	75.56	74.40	72.73	71.01
CH 149	5745	20.35	CH 165								
CH 157	5785	20.27		20.26	20.36	20.37	20.29	20.28	20.36	20.33	20.35
CH 165	5825	20.39									

802.11ac VHT40 RF Output Power (dBm)												
Power vs. Channel			Power vs Data Rate									
Channel	Frequency (MHz)	MCS Index	channel	MCS Index								
		MCS0		MCS1	MCS2	MCS3	MCS4	MCS5	MCS6	MCS7	MCS8	MCS9
Duty Cycle (%)		90.29		85.92	80.95	77.19	66.67	65.52	58.33	61.90	54.90	57.45
CH 151	5755	20.37	CH 151									
CH 159	5795	20.11		20.16	20.07	20.12	20.08	19.99	20.12	20.00	20.32	20.11

802.11ac VHT80 RF Output Power (dBm)												
Power vs. Channel			Power vs Data Rate									
Channel	Frequency (MHz)	MCS Index	channel	MCS Index								
		MCS0		MCS1	MCS2	MCS3	MCS4	MCS5	MCS6	MCS7	MCS8	MCS9
Duty Cycle (%)		90.24		81.36	77.01	72.97	66.10	56.36	58.00	58.33	55.56	52.38
CH155	5775	20.25	CH155	20.05	20.01	19.96	20.20	20.18	19.97	19.80	19.85	19.97



MIMO<Ant. 1 + 2>

802.11a RF Output Power (dBm)										
Power vs. Channel			Power vs Data Rate							
Channel	Frequency (MHz)	Data Rate (bps)	channel	Data Rate (bps)						
		6M		9M	12M	18M	24M	36M	48M	54M
CH 149	5745	20.31	CH 149							
CH 157	5785	20.15		20.29	20.28	20.02	20.08	20.12	20.20	20.28
CH 165	5825	20.12								

802.11n HT20 RF Output Power (dBm)										
Power vs. Channel			Power vs Data Rate							
Channel	Frequency (MHz)	MCS Index	channel	MCS Index						
		MCS0		MCS1	MCS2	MCS3	MCS4	MCS5	MCS6	MCS7
CH 149	5745	20.13	CH 165							
CH 157	5785	20.31		19.92	20.17	20.17	19.93	20.06	19.96	19.94
CH 165	5825	20.35								

802.11n HT40 RF Output Power (dBm)										
Power vs. Channel			Power vs Data Rate							
Channel	Frequency (MHz)	MCS Index	channel	MCS Index						
		MCS0		MCS1	MCS2	MCS3	MCS4	MCS5	MCS6	MCS7
CH 151	5755	20.40	CH 151							
CH 159	5795	20.24		20.37	20.36	20.38	20.39	20.07	20.03	19.96



802.11ac VHT20 RF Output Power (dBm)											
Power vs. Channel			Power vs Data Rate								
Channel	Frequency (MHz)	MCS Index	channel	MCS Index							
		MCS0		MCS1	MCS2	MCS3	MCS4	MCS5	MCS6	MCS7	MCS8
CH 149	5745	20.07	CH 165	19.91	20.07	20.14	19.90	19.91	19.88	19.92	19.90
CH 157	5785	20.26									
CH 165	5825	20.28									

802.11ac VHT40 RF Output Power (dBm)												
Power vs. Channel			Power vs Data Rate									
Channel	Frequency (MHz)	MCS Index	channel	MCS Index								
		MCS0		MCS1	MCS2	MCS3	MCS4	MCS5	MCS6	MCS7	MCS8	MCS9
CH 151	5755	20.31	CH 151	20.21	20.26	20.31	20.22	19.93	19.98	19.90	19.98	20.28
CH 159	5795	20.18										

802.11ac VHT80 RF Output Power (dBm)												
Power vs. Channel			Power vs Data Rate									
Channel	Frequency (MHz)	MCS Index	channel	MCS Index								
		MCS0		MCS1	MCS2	MCS3	MCS4	MCS5	MCS6	MCS7	MCS8	MCS9
CH155	5775	20.16	CH155	20.05	20.15	20.13	20.15	20.12	20.14	20.15	20.14	20.10



<TXBF Mode>

MIMO<Ant. 1 + 2>

802.11ac VHT20 RF Output Power (dBm)											
Power vs. Channel			Power vs Data Rate								
Channel	Frequency (MHz)	MCS Index	channel	MCS Index							
		MCS0		MCS1	MCS2	MCS3	MCS4	MCS5	MCS6	MCS7	MCS8
CH 149	5745	19.67	CH 149	19.50	19.47	19.54	19.59	19.62	19.62	19.52	19.40
CH 157	5785	19.52									
CH 165	5825	19.47									

802.11ac VHT40 RF Output Power (dBm)												
Power vs. Channel			Power vs Data Rate									
Channel	Frequency (MHz)	MCS Index	channel	MCS Index								
		MCS0		MCS1	MCS2	MCS3	MCS4	MCS5	MCS6	MCS7	MCS8	MCS9
CH 151	5755	20.16	CH 151	20.11	20.00	19.93	20.07	19.77	19.75	19.66	19.81	19.81
CH 159	5795	20.07										

802.11ac VHT80 RF Output Power (dBm)												
Power vs. Channel			Power vs Data Rate									
Channel	Frequency (MHz)	MCS Index	channel	MCS Index								
		MCS0		MCS1	MCS2	MCS3	MCS4	MCS5	MCS6	MCS7	MCS8	MCS9
CH155	5775	19.96	CH155	19.66	19.94	19.82	19.87	19.82	19.83	19.82	19.83	19.77

2.3 Connection Diagram of Test System

<Radiated Emission Mode>

<CDD Mode>



<TXBF Mode>

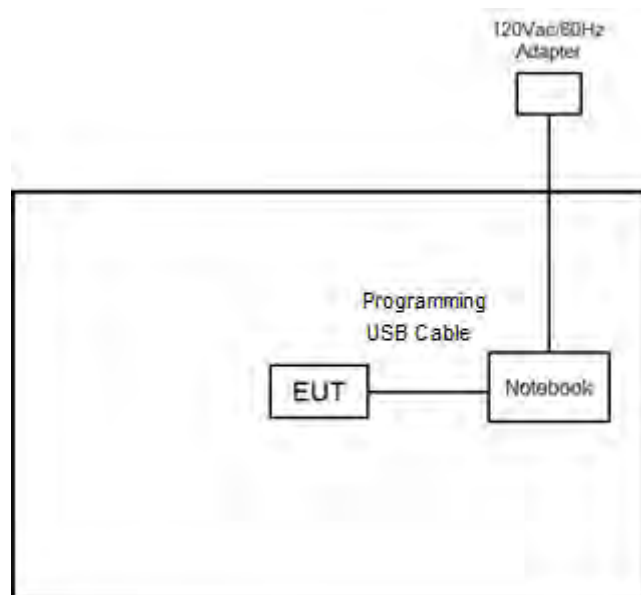

<AC Conducted Emission Mode>

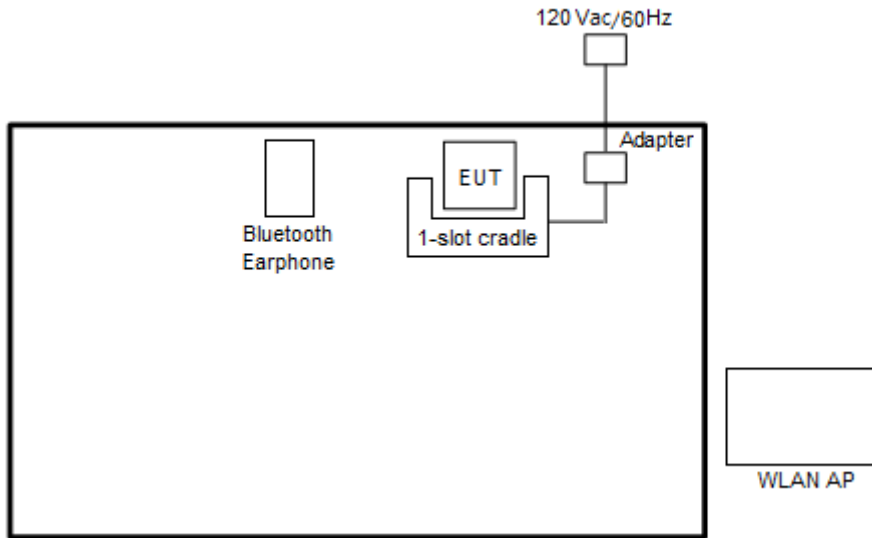

2.4 Support Unit used in test configuration and system

Item	Equipment	Trade Name	Model Name	FCC ID	Data Cable	Power Cord
1.	Bluetooth Earphone	Sony Ericsson	MW600	PY7DDA-2029	N/A	N/A
2.	WLAN AP	ASUS	RT-AC66U	MSQ-RTAC66U	N/A	Unshielded, 1.8 m
3.	Notebook	DELL	Latitude E6320	FCC DoC/ Contains FCC ID: QDS-BRCM1054	N/A	AC I/P: Unshielded, 1.2 m DC O/P: Shielded, 1.8 m
4.	Notebook	DELL	Latitude E3340	FCC DoC/ Contains FCC ID: PD97260NGU	N/A	AC I/P: Unshielded, 1.2 m DC O/P: Shielded, 1.8 m



2.5 EUT Operation Test Setup

The RF test items, utility “QRCT” was installed in Notebook which was programmed in order to make the EUT get into the engineering modes to provide channel selection, power level, data rate and the application type and for continuous transmitting signals.

For TXBF mode, the modulation modes and data rates manipulated by the command lines in the engineering program made the EUT link to another EUT by power under the normal operation. The “QRCT” software tool was used to enable the EUT to transmit signals continuously.

2.6 Measurement Results Explanation Example

For all conducted test items:

The offset level is set in the spectrum analyzer to compensate the RF cable loss and attenuator factor between EUT conducted output port and spectrum analyzer. With the offset compensation, the spectrum analyzer reading level is exactly the EUT RF output level.

Example :

The spectrum analyzer offset is derived from RF cable loss and attenuator factor.

Offset = RF cable loss + attenuator factor.

Following shows an offset computation example with cable loss 4.2 dB and 10dB attenuator.

$$\begin{aligned} \text{Offset(dB)} &= \text{RF cable loss(dB)} + \text{attenuator factor(dB)}. \\ &= 4.2 + 10 = 14.2 \text{ (dB)} \end{aligned}$$

3 Test Result

3.1 6dB and 26dB and 99% Occupied Bandwidth Measurement

3.1.1 Description of 6dB and 26dB and 99% Occupied Bandwidth

The minimum 6 dB bandwidth shall be at least 500 kHz.

26dB and 99% Occupied bandwidth are reporting only.

3.1.2 Measuring Instruments

See list of measuring equipment of this test report.

3.1.3 Test Procedures

1. The testing follows FCC KDB 789033 D02 General UNII Test Procedures New Rules v02r01. Section C) Emission bandwidth for the band 5.725-5.85GHz
2. Set RBW = 100kHz.
3. Set the VBW $\geq 3 \times$ RBW.
4. Detector = Peak.
5. Trace mode = max hold
6. Measure the maximum width of the emission that is 6 dB down from the peak of the emission.
7. Measure and record the results in the test report.

3.1.4 Test Setup

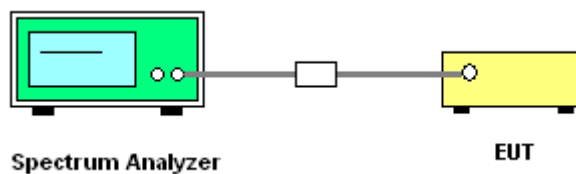



3.1.5 Test Result of 6dB Bandwidth

Test Engineer :	Derek Hsu, Shiming Liu, and An An Wu	Temperature :	21~25°C
		Relative Humidity :	51~54%

<CDD Mode>

Band IV													
Mod.	Data Rate	NTX	CH.	Freq. (MHz)	99% Bandwidth (MHz)		26dB Bandwidth (MHz)		6 dB Bandwidth (MHz)		6 dB Bandwidth Min. Limit (MHz)		Pass/Fail
					Ant 1	Ant 2	Ant 1	Ant 2	Ant 1	Ant 2	Ant 1	Ant 2	
11a	6Mbps	1	149	5745	16.95	16.85	26.55	26.20	15.70	16.25	0.5	0.5	Pass
11a	6Mbps	1	157	5785	16.90	16.90	26.25	26.35	15.40	16.00	0.5	0.5	Pass
11a	6Mbps	1	165	5825	16.90	16.90	26.40	26.60	15.50	16.00	0.5	0.5	Pass
HT20	MCS0	1	149	5745	18.05	18.05	27.30	27.80	15.00	15.65	0.5	0.5	Pass
HT20	MCS0	1	157	5785	18.00	18.00	26.80	28.80	15.10	15.90	0.5	0.5	Pass
HT20	MCS0	1	165	5825	18.00	18.05	28.05	27.35	15.65	15.40	0.5	0.5	Pass
HT40	MCS0	1	151	5755	36.60	36.70	42.48	42.60	35.64	35.10	0.5	0.5	Pass
HT40	MCS0	1	159	5795	36.70	36.50	42.48	42.48	35.58	35.64	0.5	0.5	Pass
VHT80	MCS0	1	155	5775	77.28	77.04	88.00	85.68	75.84	75.20	0.5	0.5	Pass
11a	6Mbps	2	149	5745	16.65	16.75	24.40	25.10	15.10	16.30	0.5	0.5	Pass
11a	6Mbps	2	157	5785	16.85	16.70	24.50	24.15	15.35	16.25	0.5	0.5	Pass
11a	6Mbps	2	165	5825	16.75	16.70	24.60	24.70	16.05	16.30	0.5	0.5	Pass
HT20	MCS0	2	149	5745	17.90	17.90	26.40	25.80	15.35	16.25	0.5	0.5	Pass
HT20	MCS0	2	157	5785	17.90	17.85	26.60	25.55	15.85	16.40	0.5	0.5	Pass
HT20	MCS0	2	165	5825	18.00	17.90	26.40	25.55	16.70	15.65	0.5	0.5	Pass
HT40	MCS0	2	151	5755	36.70	36.50	42.30	42.01	35.82	36.30	0.5	0.5	Pass
HT40	MCS0	2	159	5795	36.60	36.60	42.06	42.30	35.10	35.64	0.5	0.5	Pass
VHT80	MCS0	2	155	5775	77.16	77.04	83.84	83.60	75.20	75.76	0.5	0.5	Pass

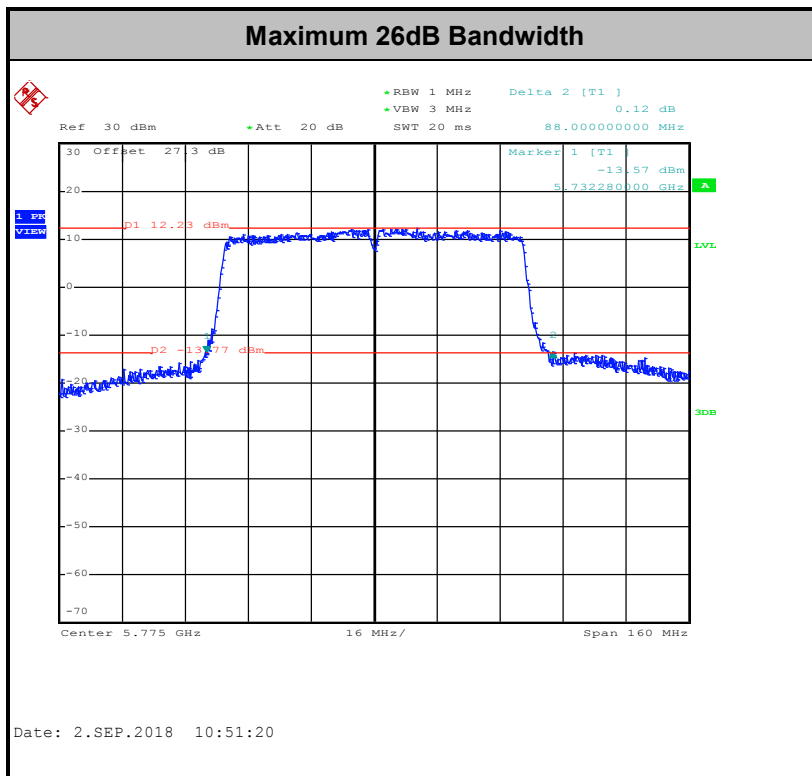
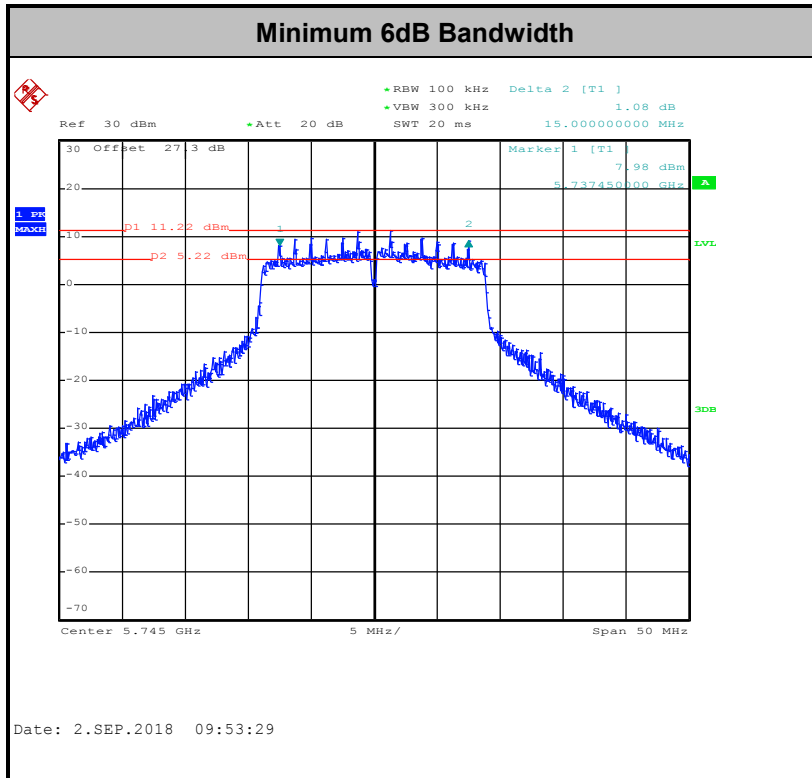

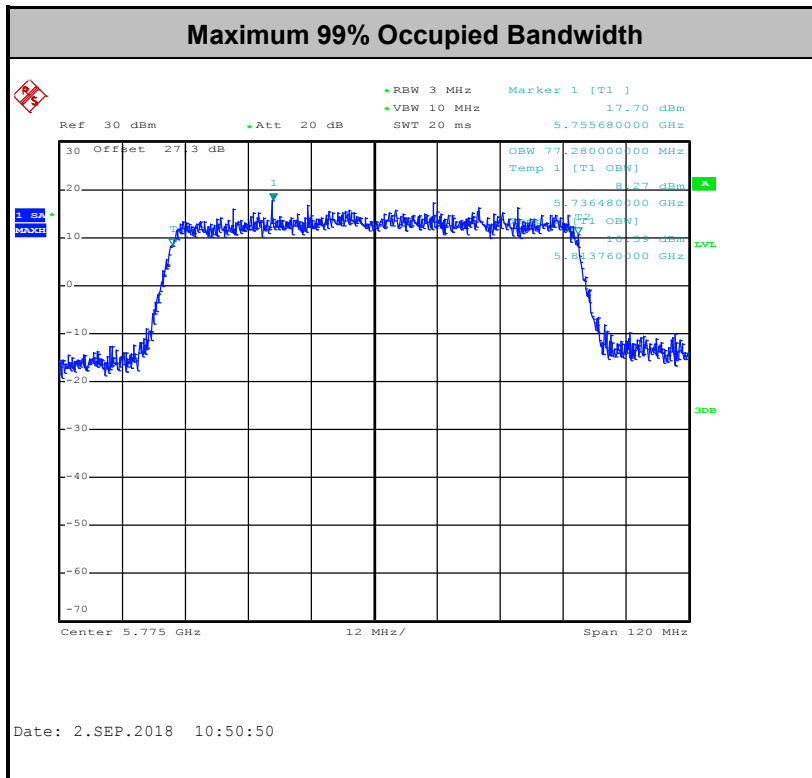

Note: The occupied channel bandwidth is maintained within the band of operation for all of the modulations.



<TXBF Modes>

Band IV												
Mod.	Data Rate	NTX	CH.	Freq. (MHz)	99% Bandwidth (MHz)		26dB Bandwidth (MHz)		6 dB Bandwidth (MHz)		6 dB Bandwidth Min. Limit (MHz)	Pass/Fail
					Ant 1	Ant 2	Ant 1	Ant 2	Ant 1	Ant 2		
VHT20	MCS0	2	149	5745	17.70	18.35	23.22	27.19	15.14	17.52	0.5	Pass
VHT20	MCS0	2	157	5785	17.65	18.40	23.46	27.90	15.00	17.52	0.5	Pass
VHT20	MCS0	2	165	5825	17.80	18.65	23.88	27.30	15.08	17.58	0.5	Pass
VHT40	MCS0	2	151	5755	36.40	36.60	41.22	41.58	33.80	35.92	0.5	Pass
VHT40	MCS0	2	159	5795	36.60	36.60	42.12	42.48	35.68	36.00	0.5	Pass
VHT80	MCS0	2	155	5775	77.04	77.04	81.28	84.16	71.28	74.80	0.5	Pass

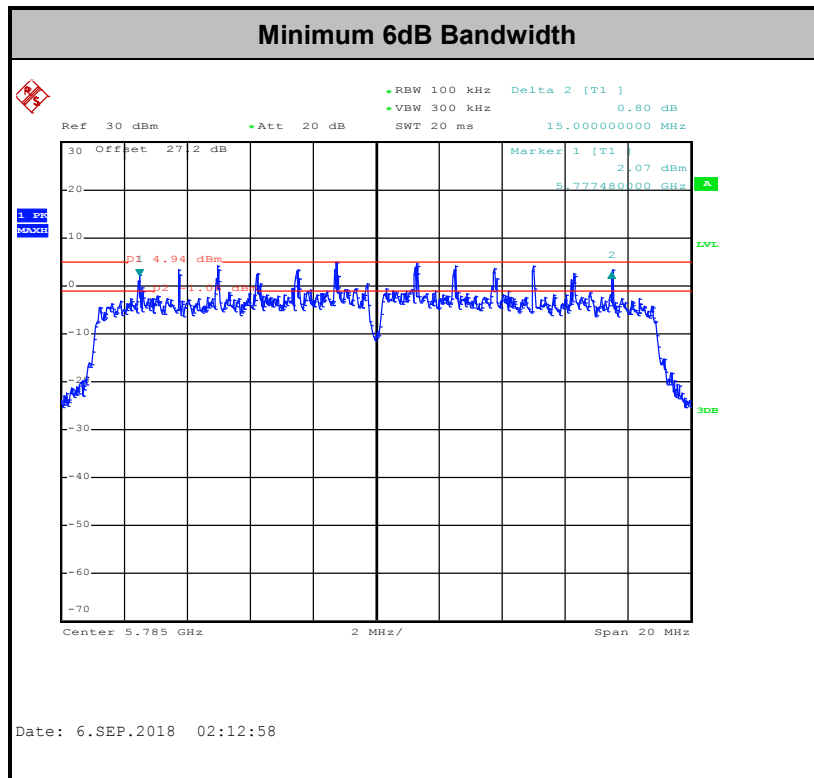

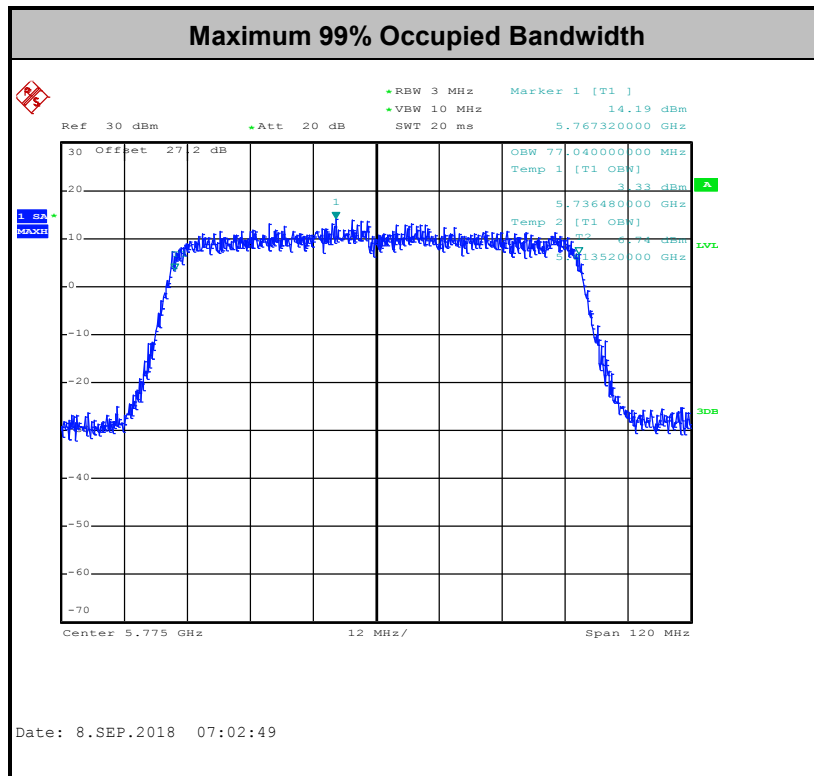
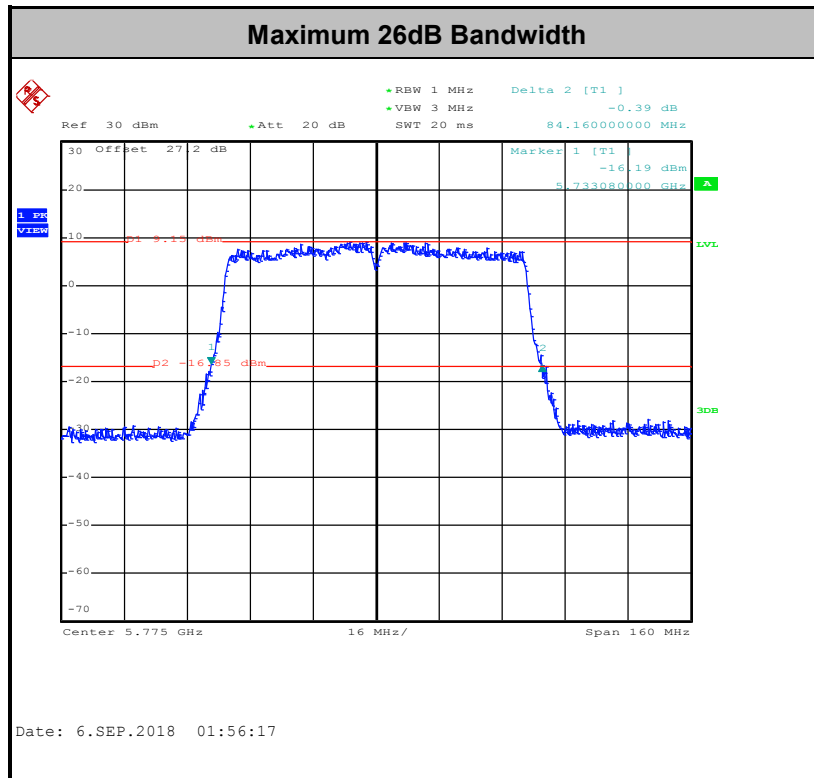

Note: The occupied channel bandwidth is maintained within the band of operation for all of the modulations.



3.2 Maximum Conducted Output Power Measurement

3.2.1 Limit of Maximum Conducted Output Power

For the band 5.725–5.85 GHz, the maximum conducted output power over the frequency band of operation shall not exceed 1 W.

If transmitting antennas of directional gain greater than 6 dBi are used, the peak output power shall be reduced by the amount in dB that the directional gain of the antenna exceeds 6 dBi.

3.2.2 Measuring Instruments

See list of measuring equipment of this test report.

3.2.3 Test Procedures

<CDD Mode>

The testing follows Method PM of FCC KDB 789033 D02 General UNII Test Procedures New Rules v02r01.

Method PM (Measurement using an RF average power meter):

1. Measurement is performed using a wideband RF power meter.
2. The EUT is configured to transmit continuously with a consistent duty cycle at its maximum power control level.
3. Measure the average power of the transmitter, and the average power is corrected with duty factor, $10 \log(1/x)$, where x is the duty cycle.

<TXBF Mode>

The testing follows Method PM-G of FCC KDB 789033 D02 General UNII Test Procedures New Rules v02r01 for TXBF modes.

Method PM-G (Measurement using a gated RF average power meter):

1. Measurement is performed using a wideband RF power meter.
2. The EUT is configured to transmit at its maximum power control level.
3. Measure the average power of the transmitter
4. Since the measurement is made only during the ON time of the transmitter, no duty cycle correction factor is required.

3.2.4 Test Setup

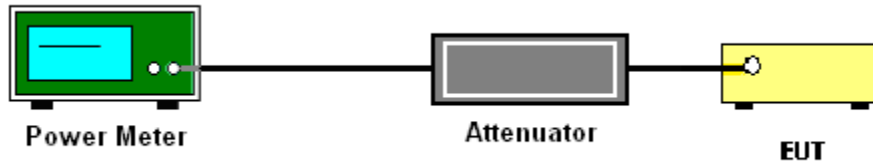

3.2.5 Test Result of Maximum Conducted Output Power

Test Engineer :	Derek Hsu, Shiming Liu, and An An Wu	Temperature :	21~25°C
		Relative Humidity :	51~54%



<CDD Mode>

Band IV														
Mod.	Data Rate	NTX	CH.	Freq. (MHz)	Duty Factor (dB)		Average Conducted Power (dBm)			FCC Conducted Power Limit (dBm)		DG (dBi)		Pass/Fail
					Ant 1	Ant 2	Ant 1	Ant 2	SUM	Ant 1	Ant 2	Ant 1	Ant 2	
11a	6Mbps	1	149	5745	0.21	0.21	20.21	20.04		30.00	30.00	3.89	3.07	Pass
11a	6Mbps	1	157	5785	0.21	0.21	20.11	20.01		30.00	30.00	3.89	3.07	Pass
11a	6Mbps	1	165	5825	0.21	0.21	20.30	20.10		30.00	30.00	3.89	3.07	Pass
HT20	MCS0	1	149	5745	0.22	0.00	20.48	20.36		30.00	30.00	3.89	3.07	Pass
HT20	MCS0	1	157	5785	0.22	0.00	20.42	20.30		30.00	30.00	3.89	3.07	Pass
HT20	MCS0	1	165	5825	0.22	0.00	20.49	20.40		30.00	30.00	3.89	3.07	Pass
HT40	MCS0	1	151	5755	0.40	0.41	20.17	20.43		30.00	30.00	3.89	3.07	Pass
HT40	MCS0	1	159	5795	0.40	0.41	20.49	20.14		30.00	30.00	3.89	3.07	Pass
VHT20	MCS0	1	149	5745	0.20	0.22	20.47	20.35		30.00	30.00	3.89	3.07	Pass
VHT20	MCS0	1	157	5785	0.20	0.22	20.41	20.27		30.00	30.00	3.89	3.07	Pass
VHT20	MCS0	1	165	5825	0.20	0.22	20.48	20.39		30.00	30.00	3.89	3.07	Pass
VHT40	MCS0	1	151	5755	0.44	0.44	20.14	20.37		30.00	30.00	3.89	3.07	Pass
VHT40	MCS0	1	159	5795	0.44	0.44	20.48	20.11		30.00	30.00	3.89	3.07	Pass
VHT80	MCS0	1	155	5775	0.50	0.45	20.45	20.25		30.00	30.00	3.89	3.07	Pass
11a	6Mbps	2	149	5745	0.21	0.19	17.43	17.17	20.31	30.00		3.89		Pass
11a	6Mbps	2	157	5785	0.21	0.19	17.26	17.02	20.15	30.00		3.89		Pass
11a	6Mbps	2	165	5825	0.21	0.19	17.21	17.01	20.12	30.00		3.89		Pass
HT20	MCS0	2	149	5745	0.22	0.22	17.14	17.10	20.13	30.00		3.89		Pass
HT20	MCS0	2	157	5785	0.22	0.22	17.33	17.26	20.31	30.00		3.89		Pass
HT20	MCS0	2	165	5825	0.22	0.22	17.41	17.27	20.35	30.00		3.89		Pass
HT40	MCS0	2	151	5755	0.44	0.40	17.48	17.30	20.40	30.00		3.89		Pass
HT40	MCS0	2	159	5795	0.44	0.40	17.37	17.07	20.24	30.00		3.89		Pass
VHT20	MCS0	2	149	5745	0.20	0.22	17.10	17.02	20.07	30.00		3.89		Pass
VHT20	MCS0	2	157	5785	0.20	0.22	17.28	17.21	20.26	30.00		3.89		Pass
VHT20	MCS0	2	165	5825	0.20	0.22	17.37	17.16	20.28	30.00		3.89		Pass
VHT40	MCS0	2	151	5755	0.40	0.44	17.36	17.24	20.31	30.00		3.89		Pass
VHT40	MCS0	2	159	5795	0.40	0.44	17.29	17.04	20.18	30.00		3.89		Pass
VHT80	MCS0	2	155	5775	0.56	0.56	17.28	17.02	20.16	30.00		3.89		Pass



<TXBF Mode>

Band IV														
Mod.	Data Rate	NTX	CH.	Freq. (MHz)	Duty Factor (dB)		Average Conducted Power (dBm)			FCC Conducted Power Limit (dBm)		DG (dBi)		Pass/Fail
					Ant 1	Ant 2	Ant 1	Ant 2	SUM	Ant 1	Ant 2	Ant 1	Ant 2	
VHT20	MCS0	2	149	5745	0.00	0.00	15.90	17.30	19.67	29.50	29.50	6.50	6.50	Pass
VHT20	MCS0	2	157	5785	0.00	0.00	15.70	17.20	19.52	29.50	29.50	6.50	6.50	Pass
VHT20	MCS0	2	165	5825	0.00	0.00	15.70	17.10	19.47	29.50	29.50	6.50	6.50	Pass
VHT40	MCS0	2	151	5755	0.00	0.00	17.30	17.00	20.16	29.50	29.50	6.50	6.50	Pass
VHT40	MCS0	2	159	5795	0.00	0.00	16.80	17.30	20.07	29.50	29.50	6.50	6.50	Pass
VHT80	MCS0	2	155	5775	0.00	0.00	16.90	17.00	19.96	29.50	29.50	6.50	6.50	Pass



3.3 Power Spectral Density Measurement

3.3.1 Limit of Power Spectral Density

For the band 5.725–5.85 GHz, the maximum power spectral density shall not exceed 30 dBm in any 500-kHz band.

If transmitting antennas of directional gain greater than 6 dBi are used, the peak output power shall be reduced by the amount in dB that the directional gain of the antenna exceeds 6 dBi.

3.3.2 Measuring Instruments

See list of measuring equipment of this test report.

3.3.3 Test Procedures

The testing follows FCC KDB 789033 D02 General UNII Test Procedures New Rules v02r01. Section F) Maximum power spectral density.

<CDD Mode>

Method SA-2

(trace averaging across on and off times of the EUT transmissions, followed by duty cycle correction).

- Measure the duty cycle.
- Set span to encompass the entire emission bandwidth (EBW) of the signal.
- Set RBW = 300 kHz.
- Set VBW \geq 1 MHz.
- Number of points in sweep \geq 2 Span / RBW.
- Sweep time = auto.
- Detector = RMS
- Trace average at least 100 traces in power averaging mode.
- Add $10 \log(500\text{kHz}/\text{RBW})$ to the test result.
- Add $10 \log(1/x)$, where x is the duty cycle, to the measured power in order to compute the average power during the actual transmission times. For example, add $10 \log(1/0.25) = 6$ dB if the duty cycle is 25 percent.

<TXBF Mode>**# Method SA-3 #**

(power averaging (rms) detection with max hold):

- Set span to encompass the entire emission bandwidth (EBW) of the signal.
 - Set RBW = 300 kHz.
 - Set VBW \geq 1 MHz.
 - Number of points in sweep \geq 2 Span / RBW.
 - Sweep time \leq (number of points in sweep) \times T, when duty cycle is less than 98 percent where T is the minimum transmission duration over which the transmitter is on and is transmitting at its maximum power control level for the tested mode of operation.
 - Detector = power averaging (rms).
 - Trace mode = max hold.
 - Allow max hold to run for at least 60 seconds, or longer as needed to allow the trace to stabilize.
1. The RF output of EUT was connected to the spectrum analyzer by a low loss cable.
 2. Each plot has already offset with cable loss, and attenuator loss. Measure the PPSD and record it.
 3. For MIMO mode, calculation method follows FCC KDB 662911 D01 Multiple Transmitter Output v02r01.

Method (c): Measure and add $10 \log(N_{ANT})$ dB.

With this technique, spectrum measurements are performed at each output of the device, but rather than summing the spectra or the spectral peaks across the outputs, the quantity $10 \log(N_{ANT})$ dB is added to each spectrum value before comparing to the emission limit. The addition of $10 \log(N_{ANT})$ dB serves to apportion the emission limit among the N_{ANT} outputs so that each output is permitted to contribute no more than $1/N_{ANT}^{th}$ of the PSD limit.

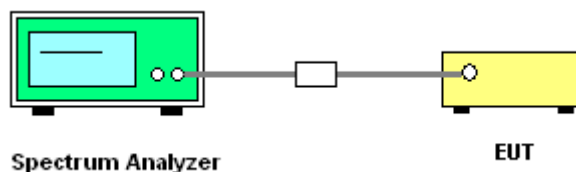
3.3.4 Test Setup



3.3.5 Test Result of Power Spectral Density

Test Engineer :	Derek Hsu, Shiming Liu, and An An Wu	Temperature :	21~25°C
		Relative Humidity :	51~54%

<CDD Mode>

Band IV																
Mod.	Data Rate	NTX	CH.	Freq. (MHz)	Duty Factor (dB)		10log (500kHz /RBW) Factor (dB)		Average Power Density (dBm/500kHz)			Average PSD Limit (dBm/500kHz)		DG (dBi)		Pass /Fail
					Ant 1	Ant 2	Ant 1	Ant 2	Ant 1	Ant 2	SUM	Ant 1	Ant 2	Ant 1	Ant 2	
11a	6Mbps	1	149	5745	0.21	0.21	2.22	2.22	4.87	4.55		30.00	30.00	3.89	3.07	Pass
11a	6Mbps	1	157	5785	0.21	0.21	2.22	2.22	4.52	4.25		30.00	30.00	3.89	3.07	Pass
11a	6Mbps	1	165	5825	0.21	0.21	2.22	2.22	4.42	3.99		30.00	30.00	3.89	3.07	Pass
HT20	MCS0	1	149	5745	0.22	0.00	2.22	2.22	4.97	4.40		30.00	30.00	3.89	3.07	Pass
HT20	MCS0	1	157	5785	0.22	0.00	2.22	2.22	4.37	3.94		30.00	30.00	3.89	3.07	Pass
HT20	MCS0	1	165	5825	0.22	0.00	2.22	2.22	4.55	3.84		30.00	30.00	3.89	3.07	Pass
HT40	MCS0	1	151	5755	0.40	0.41	2.22	2.22	1.68	1.10		30.00	30.00	3.89	3.07	Pass
HT40	MCS0	1	159	5795	0.40	0.41	2.22	2.22	1.54	0.89		30.00	30.00	3.89	3.07	Pass
VHT80	MCS0	1	155	5775	0.50	0.45	2.22	2.22	-1.55	-1.63		30.00	30.00	3.89	3.07	Pass
11a	6Mbps	2	149	5745	0.21	0.19	2.22		2.21	1.44	7.44	29.50		6.50		Pass
11a	6Mbps	2	157	5785	0.21	0.19	2.22		1.53	1.00	6.76	29.50		6.50		Pass
11a	6Mbps	2	165	5825	0.21	0.19	2.22		1.21	0.94	6.44	29.50		6.50		Pass
HT20	MCS0	2	149	5745	0.22	0.22	2.22		1.15	1.33	6.56	29.50		6.50		Pass
HT20	MCS0	2	157	5785	0.22	0.22	2.22		1.16	1.31	6.54	29.50		6.50		Pass
HT20	MCS0	2	165	5825	0.22	0.22	2.22		1.03	1.03	6.26	29.50		6.50		Pass
HT40	MCS0	2	151	5755	0.44	0.40	2.22		-1.83	-1.90	3.40	29.50		6.50		Pass
HT40	MCS0	2	159	5795	0.44	0.40	2.22		-2.10	-1.95	3.28	29.50		6.50		Pass
VHT80	MCS0	2	155	5775	0.56	0.56	2.22		-4.88	-5.42	0.35	29.50		6.50		Pass



<CDD Mode>

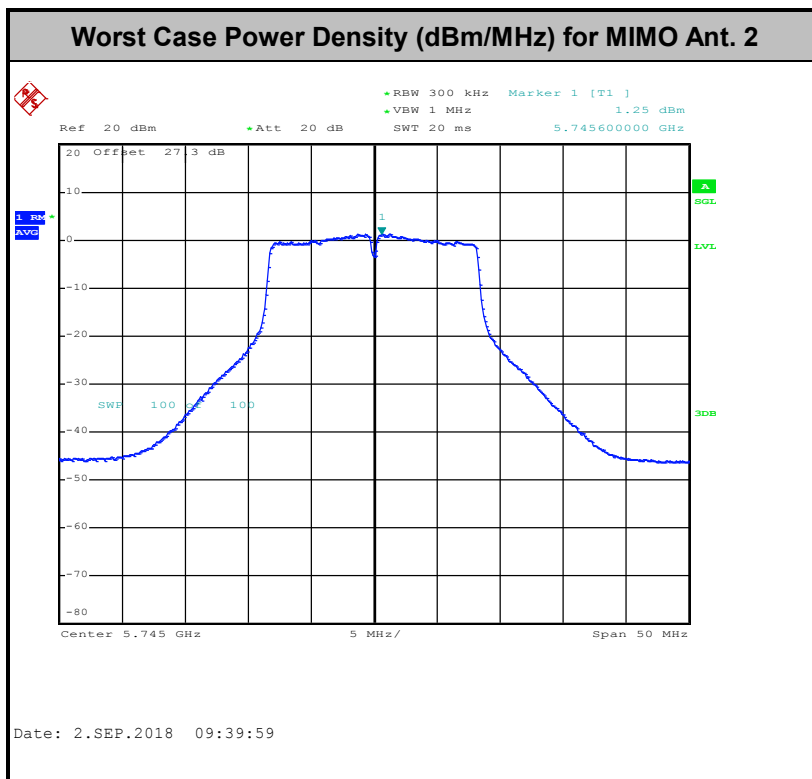
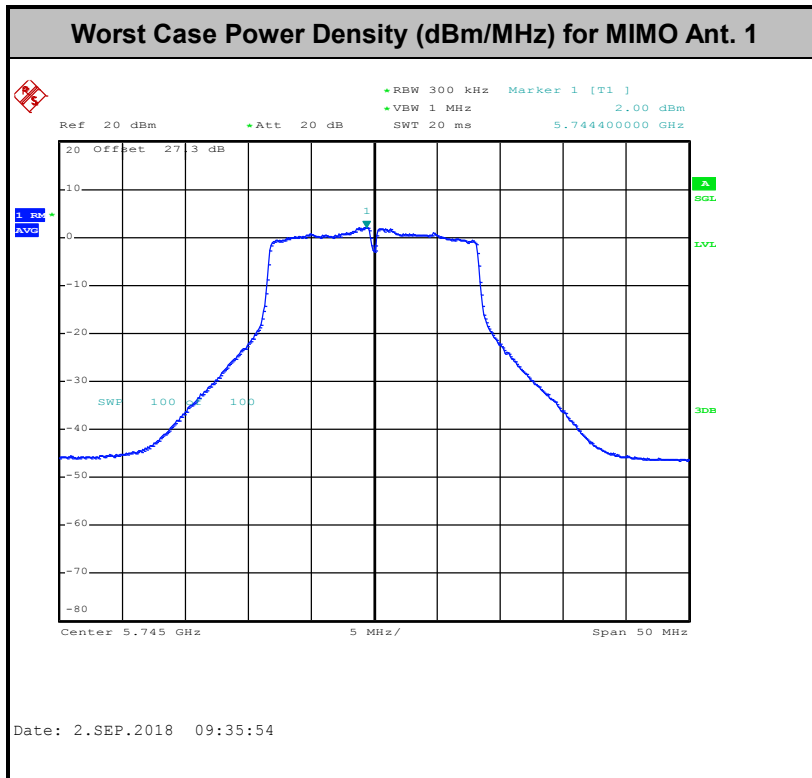



<TXBF Mode>

Band IV																
Mod.	Data Rate	NTX	CH.	Freq. (MHz)	Duty Factor (dB)		10log (500kHz /RBW) Factor (dB)		Average Power Density (dBm/500kHz)			Average PSD Limit (dBm/500kHz)		DG (dBi)		Pass /Fail
					Ant 1	Ant 2	Ant 1	Ant 2	Ant 1	Ant 2	SUM	Ant 1	Ant 2	Ant 1	Ant 2	
VHT20	MCS0	2	149	5745	0.00	0.00	2.22	3.48	3.90	9.13	29.50	6.50	Pass			
VHT20	MCS0	2	157	5785	0.00	0.00	2.22	2.73	4.31	9.54	29.50	6.50	Pass			
VHT20	MCS0	2	165	5825	0.00	0.00	2.22	2.93	3.35	8.58	29.50	6.50	Pass			
VHT40	MCS0	2	151	5755	0.00	0.00	2.22	2.34	1.32	7.57	29.50	6.50	Pass			
VHT40	MCS0	2	159	5795	0.00	0.00	2.22	2.60	1.39	7.83	29.50	6.50	Pass			
VHT80	MCS0	2	155	5775	0.00	0.00	2.22	4.43	-2.35	9.66	29.50	6.50	Pass			



<TXBF Mode>

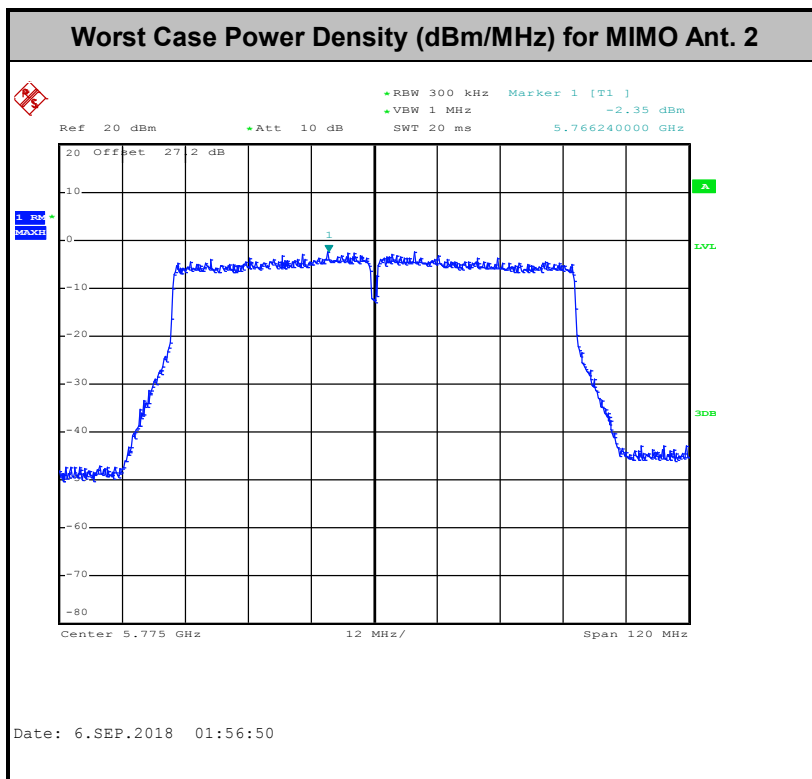
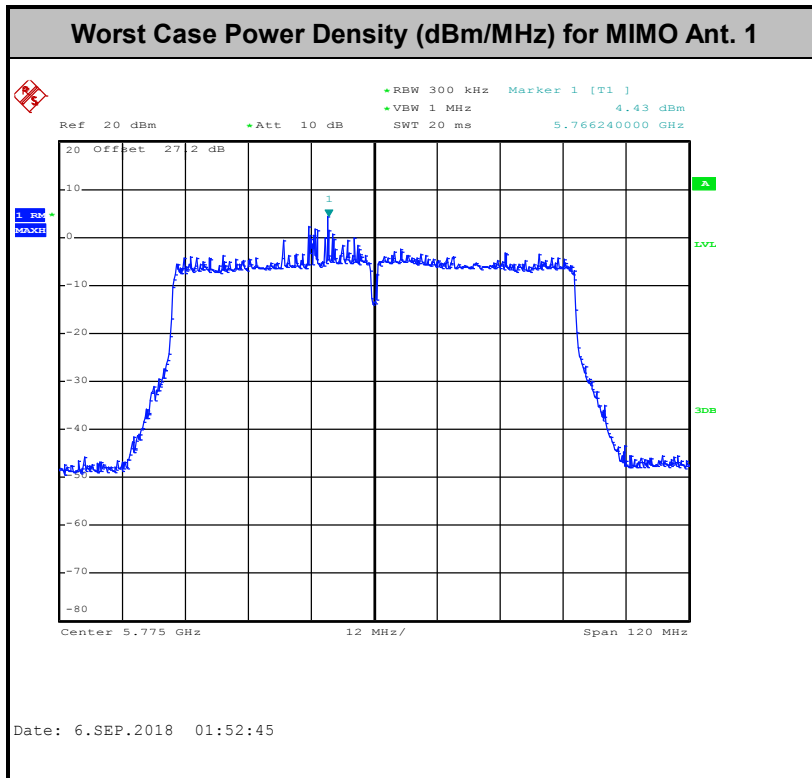



3.4 Unwanted Emissions Measurement

This section is to measure unwanted emissions through radiated measurement for band edge spurious emissions and out of band emissions measurement.

3.4.1 Limit of Unwanted Emissions

(1) For transmitters operating in the 5.725-5.85 GHz band:

15.407(b)(4)(i) All emissions shall be limited to a level of -27 dBm/MHz at 75 MHz or more above or below the band edge increasing linearly to 10 dBm/MHz at 25 MHz above or below the band edge, and from 25 MHz above or below the band edge increasing linearly to a level of 15.6 dBm/MHz at 5 MHz above or below the band edge, and from 5 MHz above or below the band edge increasing linearly to a level of 27 dBm/MHz at the band edge.

(2) Unwanted spurious emissions fallen in restricted bands shall comply with the general field strength limits as below table,

Frequency (MHz)	Field Strength (microvolts/meter)	Measurement Distance (meters)
0.009 – 0.490	2400/F(kHz)	300
0.490 – 1.705	24000/F(kHz)	30
1.705 – 30.0	30	30
30 – 88	100	3
88 – 216	150	3
216 - 960	200	3
Above 960	500	3

Note: The following formula is used to convert the EIRP to field strength.

$$E = \frac{1000000\sqrt{30P}}{3} \text{ } \mu\text{V/m, where P is the eirp (Watts)}$$



EIRP (dBm)	Field Strength at 3m (dBμV/m)
- 27	68.3

(3) KDB789033 D02 v02r01 G)2)c)

- (i) Section 15.407(b)(1) to (b)(3) specify the unwanted emission limits for the U-NII-1 and U-NII-2 bands. As specified, emissions above 1000 MHz that are outside of the restricted bands are subject to a peak emission limit of -27 dBm/MHz.³
- (ii) Section 15.407(b)(4) specifies the unwanted emission limit for the U-NII-3 band. A band emissions mask is specified in Section 15.407(b)(4)(i). The emission limits are in terms of a Peak detector. An alternative to the band emissions mask is specified in Section 15.407(b)(4)(ii). The alternative limits are based on the highest antenna gain specified in the filing. There are also marketing and importation restrictions for the devices using the alternative limit.⁴

Note 3: An out-of-band emission that complies with both the average and peak limits of Section 15.209 is not required to satisfy the -27 dBm/MHz peak emission limit.

Note 4: Only devices with antenna gains of 10 dBi or less may be approved using the emission limits specified in Section 15.247(d) till March 2, 2018; all other devices operating in this band must use the mask specified in Section 15.407(b)(4)(i).

3.4.2 Measuring Instruments

See list of measuring equipment of this test report.



3.4.3 Test Procedures

1. The testing follows FCC KDB 789033 D02 General UNII Test Procedures New Rules v02r01. Section G) Unwanted emissions measurement.

(1) Procedure for Unwanted Emissions Measurements Below 1000MHz

- RBW = 120 kHz
- VBW = 300 kHz
- Detector = Peak
- Trace mode = max hold

(2) Procedure for Peak Unwanted Emissions Measurements Above 1000 MHz

- RBW = 1 MHz
- VBW \geq 3 MHz
- Detector = Peak
- Sweep time = auto
- Trace mode = max hold

(3) Procedures for Average Unwanted Emissions Measurements Above 1000MHz

- RBW = 1 MHz
- VBW = 10 Hz, when duty cycle is no less than 98 percent.
- VBW \geq 1/T, when duty cycle is less than 98 percent where T is the minimum transmission duration over which the transmitter is on and is transmitting at its maximum power control level for the tested mode of operation.



2. The EUT was placed on a turntable with 0.8 meter for frequency below 1GHz and 1.5 meter for frequency above 1GHz respectively above ground.
3. The EUT was set 3 meters from the interference receiving antenna which was mounted on the top of a variable height antenna tower.
4. The antenna is a broadband antenna and its height is adjusted between one meter and four meters above ground to find the maximum value of the field strength for both horizontal polarization and vertical polarization of the antenna.
5. For each suspected emission, the EUT was arranged to its worst case and then adjust the antenna tower (from 1 m to 4 m) and turntable (from 0 degree to 360 degrees) to find the maximum reading.
6. For testing below 1GHz, if the emission level of the EUT in peak mode was 3 dB lower than the limit specified, then peak values of EUT will be reported, otherwise, the emissions will be repeated one by one using the CISPR quasi-peak method and reported.
7. For testing above 1GHz, the emission level of the EUT in peak mode was 20dB lower than average limit (that means the emission level in average mode also complies with the limit in average mode), then peak values of EUT will be reported, otherwise, the emissions will be measured in average mode again and reported.

3.4.4 Test Setup

For radiated emissions below 30MHz

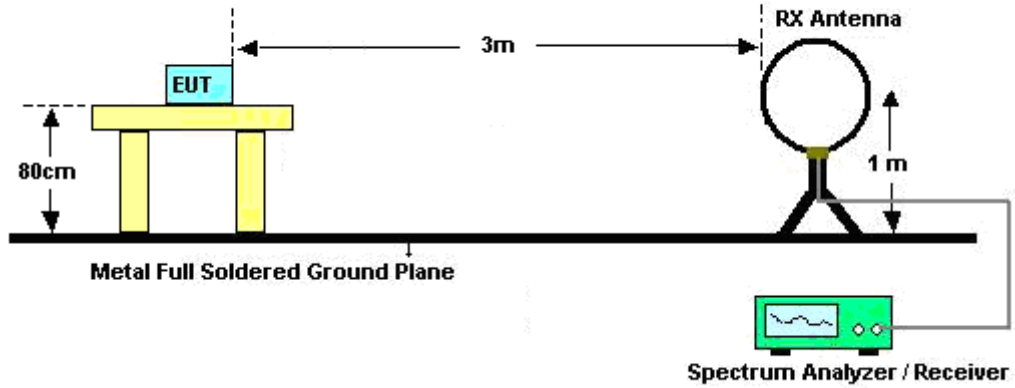

For radiated emissions from 30MHz to 1GHz

<CDD Mode>

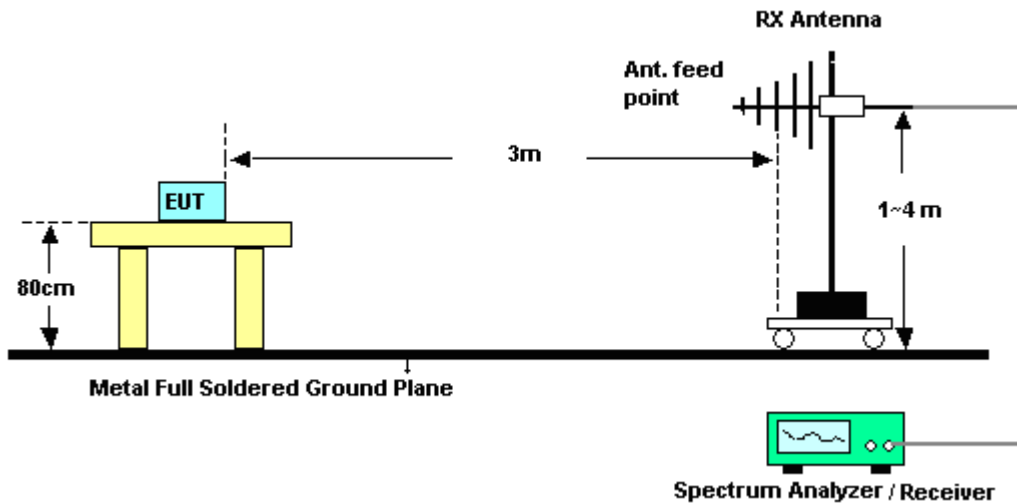

<TXBF Mode>

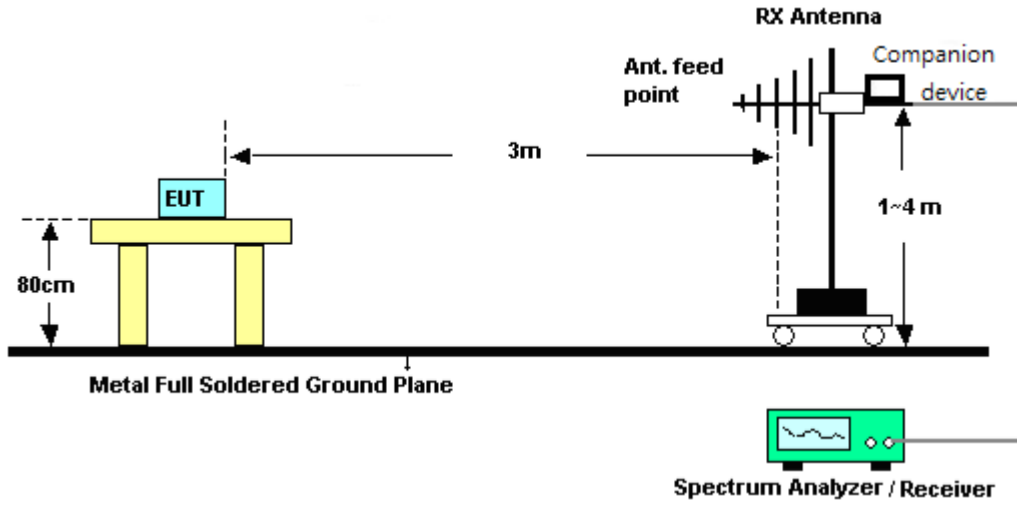

For radiated emissions above 1GHz

<CDD Mode>

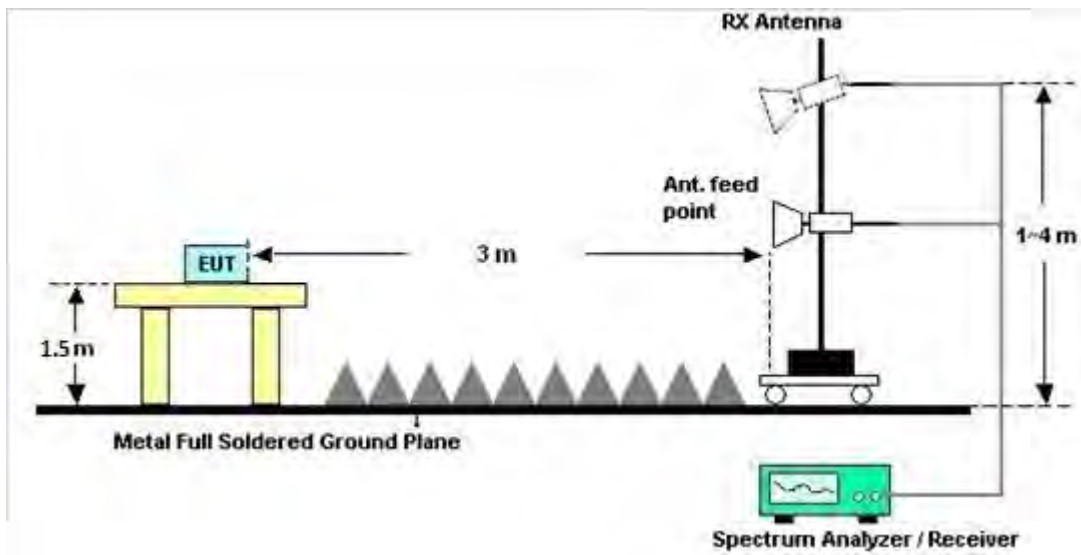

<TXBF Mode>

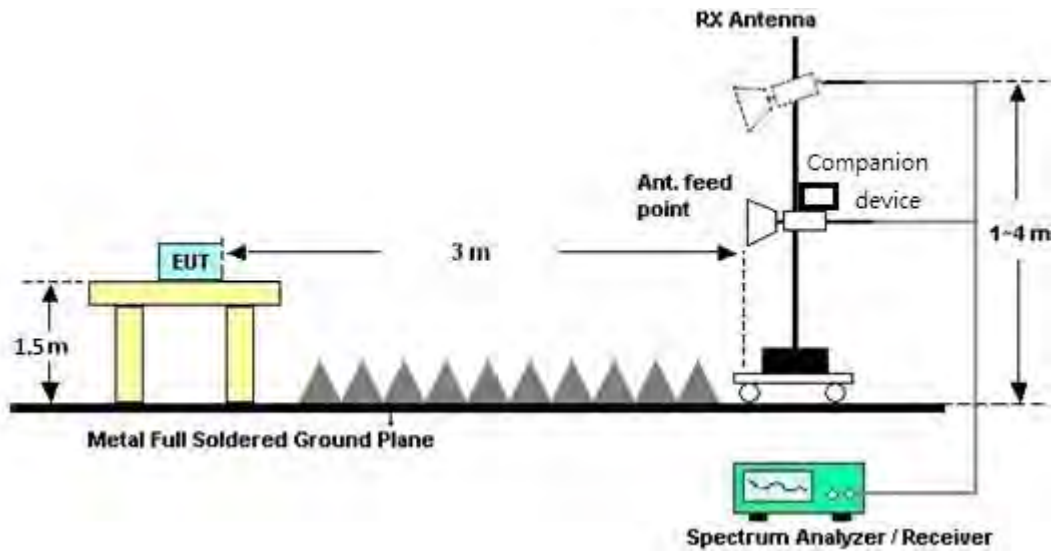

3.4.5 Test Results of Radiated Emissions (9 kHz ~ 30 MHz)

The low frequency, which started from 9 kHz to 30MHz, was pre-scanned and the result which was 20dB lower than the limit line was not reported.

There is a comparison data of both open-field test site and alternative test site - semi-Anechoic chamber according to 414788 D01 Radiated Test Site v01r01, and the result came out very similar.

3.4.6 Test Result of Radiated Band Edges

Please refer to Appendix B and C.

3.4.7 Duty Cycle

Please refer to Appendix D.

3.4.8 Test Result of Unwanted Radiated Emission (30MHz ~ 10th Harmonic)

Please refer to Appendix B and C.



3.5 AC Conducted Emission Measurement

3.5.1 Limit of AC Conducted Emission

For equipment that is designed to be connected to the public utility (AC) power line, the radio frequency voltage that is conducted back onto the AC power line on any frequency or frequencies within the band 150 kHz to 30 MHz shall not exceed the limits in the following table.

Frequency of emission (MHz)	Conducted limit (dB μ V)	
	Quasi-peak	Average
0.15-0.5	66 to 56*	56 to 46*
0.5-5	56	46
5-30	60	50

*Decreases with the logarithm of the frequency.

3.5.2 Measuring Instruments

See list of measuring equipment of this test report.

3.5.3 Test Procedures

1. The EUT was placed 0.4 meter from the conducting wall of the shielding room was kept at least 80 centimeters from any other grounded conducting surface.
2. Connect EUT to the power mains through a line impedance stabilization network (LISN).
3. All the support units are connecting to the other LISN.
4. The LISN provides 50 ohm coupling impedance for the measuring instrument.
5. The FCC states that a 50 ohm, 50 microhenry LISN should be used.
6. Both sides of AC line were checked for maximum conducted interference.
7. The frequency range from 150 kHz to 30 MHz was searched.
8. Set the test-receiver system to Peak Detect Function and specified bandwidth with Maximum Hold Mode.

3.5.4 Test Setup

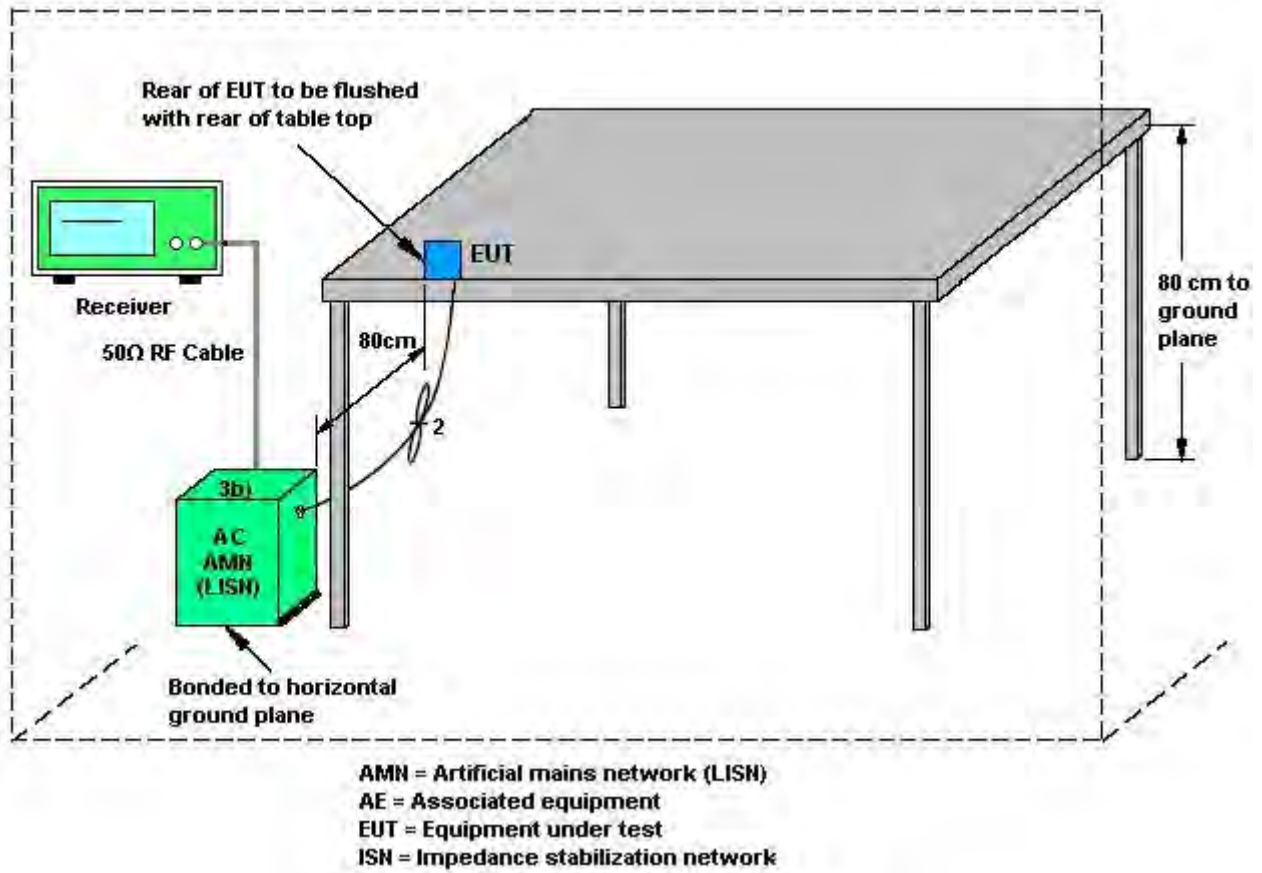

3.5.5 Test Result of AC Conducted Emission

Please refer to Appendix A.



3.6 Automatically Discontinue Transmission

3.6.1 Limit of Automatically Discontinue Transmission

The device shall automatically discontinue transmission in case of either absence of information to transmit or operational failure. These provisions are not intended to preclude the transmission of control or signaling information or the use of repetitive codes used by certain digital technologies to complete frame or burst intervals. Applicants shall include in their application for equipment authorization to describe how this requirement is met.

3.6.2 Measuring Instruments

See list of measuring equipment of this test report.

3.6.3 Test Result of Automatically Discontinue Transmission

While the EUT is not transmitting any information, the EUT can automatically discontinue transmission and become standby mode for power saving. The EUT can detect the controlling signal of ACK message transmitting from remote device and verify whether it shall resend or discontinue transmission.



3.7 Antenna Requirements

3.7.1 Standard Applicable

If transmitting antenna directional gain is greater than 6 dBi, both the peak transmit power and the peak power spectral density shall be reduced by the amount in dB that the directional gain of the antenna exceeds 6 dBi.

3.7.2 Antenna Anti-Replacement Construction

An embedded-in antenna design is used.

3.7.3 Antenna Gain

<CDD Modes >

FCC KDB 662911 D01 Multiple Transmitter Output v02r01

For CDD transmissions, directional gain is calculated as

Directional gain = GANT + Array Gain, where Array Gain is as follows.

For power spectral density (PSD) measurements on all devices,

Array Gain = 10 log(NANT/NSS=1) dB.

For power measurements on IEEE 802.11 devices,

Array Gain = 0 dB (i.e., no array gain) for NANT ≤ 4.

Directional gain may be calculated by using the formulas applicable to equal gain antennas with GANT set equal to the gain of the antenna having the highest gain;

The EUT supports CDD mode.

For power, the directional gain GANT is set equal to the antenna having the highest gain, i.e., F)2)f)i).

For PSD, the directional gain calculation is following F)2)f)ii) of KDB 662911 D01 v02r01.

The power and PSD limit should be modified if the directional gain of EUT is over 6 dBi,

The directional gain "DG" is calculated as following table.

<CDD Modes>						
			DG for Power (dBi)	DG for PSD (dBi)	Power Limit Reduction (dB)	PSD Limit Reduction (dB)
	Ant. 1 (dBi)	Ant. 2 (dBi)				
Band IV	3.89	3.07	3.89	6.50	0.00	0.50

Power Limit Reduction = DG(Power) – 6dBi, (min = 0)

PSD Limit Reduction = DG(PSD) – 6dBi, (min = 0)

TXBF modes

FCC KDB 662911 D01 Multiple Transmitter Output v02r01

For CDD transmissions, directional gain is calculated as

$$DirectionalGain = 10 \cdot \log \left[\frac{\sum_{j=1}^{N_{SS}} \left\{ \sum_{k=1}^{N_{ANT}} g_{j,k} \right\}^2}{N_{ANT}} \right]$$

where

Each antenna is driven by no more than one spatial stream;

N_{SS} = the number of independent spatial streams of data;

N_{ANT} = the total number of antennas

$g_{j,k} = 10^{G_k / 20}$ if the k th antenna is being fed by spatial stream j , or zero if it is not;
 G_k is the gain in dBi of the k th antenna.

The EUT supports beamforming for 802.11ac modes.

The directional gain calculation is following F)2)e)ii) of KDB 662911 D01 v02r01.

The power and PSD limit should be modified if the directional gain of EUT is over 6 dBi,

The directional gain “DG” is calculated as following table.

			DG	DG	Power	PSD
			for	for	Limit	Limit
	Ant 1	Ant 2	Power	PSD	Reduction	Reduction
	(dBi)	(dBi)	(dBi)	(dBi)	(dB)	(dB)
Band IV	3.89	3.07	6.50	6.50	0.50	0.50

Power Limit Reduction = DG(Power) – 6dBi, (min = 0)

PSD Limit Reduction = DG(PSD) – 6dBi, (min = 0)



4 List of Measuring Equipment

Instrument	Manufacturer	Model No.	Serial No.	Characteristics	Calibration Date	Test Date	Due Date	Remark
Power Meter	Anritsu	ML2495A	0932001	N/A	Sep. 26, 2017	Jun. 07, 2018 ~ Sep. 11, 2018	Sep. 25, 2018	Conducted (TH05-HY)
Power Sensor	Anritsu	MA2411B	0846202	300MHz~40GHz z	Sep. 26, 2017	Jun. 07, 2018 ~ Sep. 11, 2018	Sep. 25, 2018	Conducted (TH05-HY)
Spectrum Analyzer	Rohde & Schwarz	FSP30	101067	9kHz ~ 30GHz	Nov. 13, 2017	Jun. 07, 2018 ~ Sep. 11, 2018	Nov. 12, 2018	Conducted (TH05-HY)
Programmable Power Supply	GW Instek	PSS-2005	EL890001	1V~20V 0.5A~4A	Oct. 06, 2017	Jun. 07, 2018 ~ Sep. 11, 2018	Oct. 05, 2018	Conducted (TH05-HY)
Switch Box & RF Cable	Burgeon	ETF-058	EC130048 4	N/A	Mar. 01, 2018	Jun. 07, 2018 ~ Sep. 11, 2018	Feb. 28, 2019	Conducted (TH05-HY)
AC Power Source	ChainTek	APC-1000W	N/A	N/A	N/A	Aug. 04, 2018	N/A	Conduction (CO05-HY)
EMI Test Receiver	Rohde & Schwarz	ESR3	102388	9KHz~3.6GHz	Dec. 08, 2017	Aug. 04, 2018	Dec. 07, 2018	Conduction (CO05-HY)
LISN	Rohde & Schwarz	ENV216	100080	9kHz~30MHz	Nov. 30, 2017	Aug. 04, 2018	Nov. 29, 2018	Conduction (CO05-HY)
Software	Rohde & Schwarz	EMC32 V10.30	N/A	N/A	N/A	Aug. 04, 2018	N/A	Conduction (CO05-HY)
LF Cable	HUBER + SUHNER	RG-214/U	LF01	N/A	Jan. 03, 2018	Aug. 04, 2018	Jan. 02, 2019	Conduction (CO05-HY)
Pulse Limiter	Rohde & Schwarz	ESH3-Z2	100851	N/A	Jan. 03, 2018	Aug. 04, 2018	Jan. 02, 2019	Conduction (CO05-HY)



Instrument	Manufacturer	Model No.	Serial No.	Characteristics	Calibration Date	Test Date	Due Date	Remark
Horn Antenna	SCHWARZBECK	BBHA 9120 D	9120D-1241	1GHz ~ 18GHz	Jun. 29, 2018	Aug. 18, 2018 ~ Sep. 05, 2018	Jun. 28, 2019	Radiation (03CH13-HY)
Loop Antenna	Rohde & Schwarz	HFH2-Z2	100315	9 kHz~30 MHz	Nov. 10, 2017	Aug. 18, 2018 ~ Sep. 05, 2018	Nov. 09, 2018	Radiation (03CH13-HY)
Amplifier	MITEQ	TTA1840-35-HG	1871923	18GHz~40GHz, VSWR : 2.5:1 max	Jul. 16, 2018	Aug. 18, 2018 ~ Sep. 05, 2018	Jul. 15, 2019	Radiation (03CH13-HY)
Filter	Wainwright	WLK4-1000-1530-8000-40SS	SN1	1G Lowpass Filter	Sep. 18, 2017	Aug. 18, 2018 ~ Sep. 05, 2018	Sep. 17, 2018	Radiation (03CH13-HY)
Filter	Woken	WHKX8-587 2.5-6750-18000-40ST	SN3	6.75G Highpass	Sep. 18, 2017	Aug. 18, 2018 ~ Sep. 05, 2018	Sep. 17, 2018	Radiation (03CH13-HY)
Filter	Wainwright	WHKX12-2700-3000-18000-60SS	SN2	3G High Pass	Sep. 18, 2017	Aug. 18, 2018 ~ Sep. 05, 2018	Sep. 17, 2018	Radiation (03CH13-HY)
Amplifier	Sonoma-Instrument	310 N	187282	9KHz~1GHz	Jan. 19, 2018	Aug. 18, 2018 ~ Sep. 05, 2018	Jan. 18, 2020	Radiation (03CH13-HY)
Bilog Antenna	TESEQ	CBL 6111D&00800N1D01N-06	40103&07	30MHz to 1GHz	Jan. 10, 2018	Aug. 18, 2018 ~ Sep. 05, 2018	Jan. 09, 2019	Radiation (03CH13-HY)
Preamplifier	Jet-Power	JPA0118-55-303K	1710001800054002	1GHz~18GHz	Apr. 16, 2018	Aug. 18, 2018 ~ Sep. 05, 2018	Apr. 15, 2019	Radiation (03CH13-HY)
Preamplifier	Keysight	83017A	MY53270147	1GHz~26.5GHz	Feb. 02, 2018	Aug. 18, 2018 ~ Sep. 05, 2018	Feb. 01, 2019	Radiation (03CH13-HY)
Spectrum Analyzer	Keysight	N9010A	MY55370526	10Hz~44GHz	Mar. 15, 2018	Aug. 18, 2018 ~ Sep. 05, 2018	Mar. 14, 2019	Radiation (03CH13-HY)
Antenna Mast	EMEC	AM-BS-4500-B	N/A	1m~4m	N/A	Aug. 18, 2018 ~ Sep. 05, 2018	N/A	Radiation (03CH13-HY)
Turn Table	EMEC	TT2000	N/A	0~360 Degree	N/A	Aug. 18, 2018 ~ Sep. 05, 2018	N/A	Radiation (03CH13-HY)
SHF-EHF Horn Antenna	SCHWARZBECK	BBHA 9170	BBHA9170584	18GHz- 40GHz	Nov. 27, 2017	Aug. 18, 2018 ~ Sep. 05, 2018	Nov. 26, 2018	Radiation (03CH13-HY)
EMI Test Receiver	Agilent	N9038A(MXE)	MY53290053	20Hz to 26.5GHz	Jan. 16, 2018	Aug. 18, 2018 ~ Sep. 05, 2018	Jan. 15, 2019	Radiation (03CH13-HY)
RF Cable	HUBER + SUHNER	SUCOFLEX 126E	0030/126E	30M-18G	Jan. 22, 2018	Aug. 18, 2018 ~ Sep. 05, 2018	Jan. 21, 2019	Radiation (03CH13-HY)
RF Cable	HUBER + SUHNER	SUCOFLEX 104	335041/4	30M-18G	Jan. 22, 2018	Aug. 18, 2018 ~ Sep. 05, 2018	Jan. 21, 2019	Radiation (03CH13-HY)
RF Cable	HUBER + SUHNER	SUCOFLEX 104	MY24961/4	30M~18GHz	Jan. 22, 2018	Aug. 18, 2018 ~ Sep. 05, 2018	Jan. 21, 2019	Radiation (03CH13-HY)
RF Cable	HUBER + SUHNER	SUCOFLEX 102	505134/2	30M~40GHz	Oct. 17, 2017	Aug. 18, 2018 ~ Sep. 05, 2018	Oct. 16, 2018	Radiation (03CH13-HY)
RF Cable	HUBER + SUHNER	SUCOFLEX 102	800740/2	30M~40GHz	Oct. 17, 2017	Aug. 18, 2018 ~ Sep. 05, 2018	Oct. 16, 2018	Radiation (03CH13-HY)
Software	AUDIX	E3 6.2009-8-24c	RK-001124	N/A	N/A	Aug. 18, 2018 ~ Sep. 05, 2018	N/A	Radiation (03CH13-HY)



5 Uncertainty of Evaluation

Uncertainty of Conducted Emission Measurement (150kHz ~ 30MHz)

Measuring Uncertainty for a Level of Confidence of 95% ($U = 2Uc(y)$)	2.7
---	-----

Uncertainty of Radiated Emission Measurement (30 MHz ~ 1000 MHz)

Measuring Uncertainty for a Level of Confidence of 95% ($U = 2Uc(y)$)	4.9
---	-----

Uncertainty of Radiated Emission Measurement (1000 MHz ~ 18000 MHz)

Measuring Uncertainty for a Level of Confidence of 95% ($U = 2Uc(y)$)	5.4
---	-----

Uncertainty of Radiated Emission Measurement (18000 MHz ~ 40000 MHz)

Measuring Uncertainty for a Level of Confidence of 95% ($U = 2Uc(y)$)	4.3
---	-----



Appendix A. AC Conducted Emission Test Results

Test Engineer :	Arthur Hsieh	Temperature :	25~27°C
		Relative Humidity :	50~52%
Test Voltage :	120Vac / 60Hz	Phase :	Line

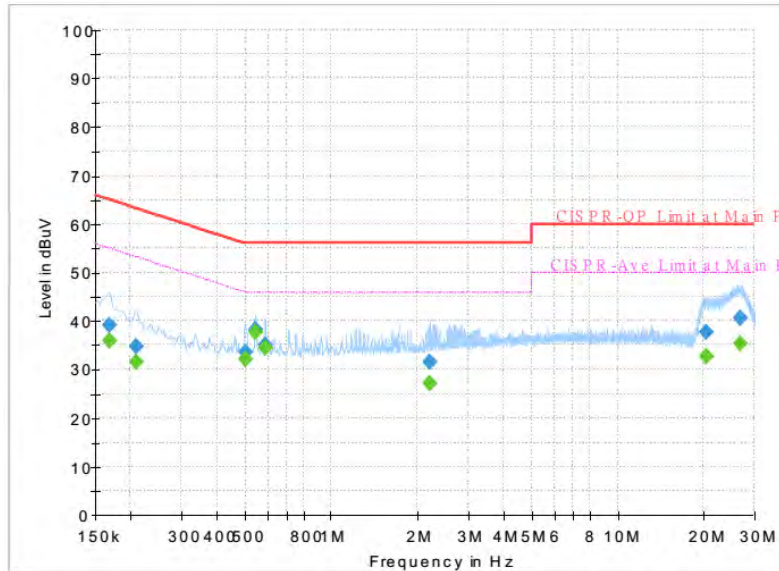

Final Result

Frequency (MHz)	QuasiPeak (dBuV)	CAverage (dBuV)	Limit (dBuV)	Margin (dB)	Line	Filter	Corr. (dB)
0.168000	---	35.93	55.06	19.13	L1	OFF	19.5
0.168000	39.16	---	65.06	25.90	L1	OFF	19.5
0.208500	---	31.58	53.27	21.69	L1	OFF	19.5
0.208500	34.76	---	63.27	28.51	L1	OFF	19.5
0.501000	---	32.04	46.00	13.96	L1	OFF	19.5
0.501000	33.56	---	56.00	22.44	L1	OFF	19.5
0.543750	---	37.81	46.00	8.19	L1	OFF	19.5
0.543750	38.28	---	56.00	17.72	L1	OFF	19.5
0.586500	---	34.49	46.00	11.51	L1	OFF	19.5
0.586500	35.11	---	56.00	20.89	L1	OFF	19.5
2.217750	---	27.12	46.00	18.88	L1	OFF	19.5
2.217750	31.57	---	56.00	24.43	L1	OFF	19.5
20.251500	---	32.85	50.00	17.15	L1	OFF	20.3
20.251500	37.76	---	60.00	22.24	L1	OFF	20.3
26.731500	---	35.51	50.00	14.49	L1	OFF	20.4
26.731500	40.52	---	60.00	19.48	L1	OFF	20.4



Test Engineer :	Arthur Hsieh	Temperature :	25~27°C
		Relative Humidity :	50~52%
Test Voltage :	120Vac / 60Hz	Phase :	Neutral

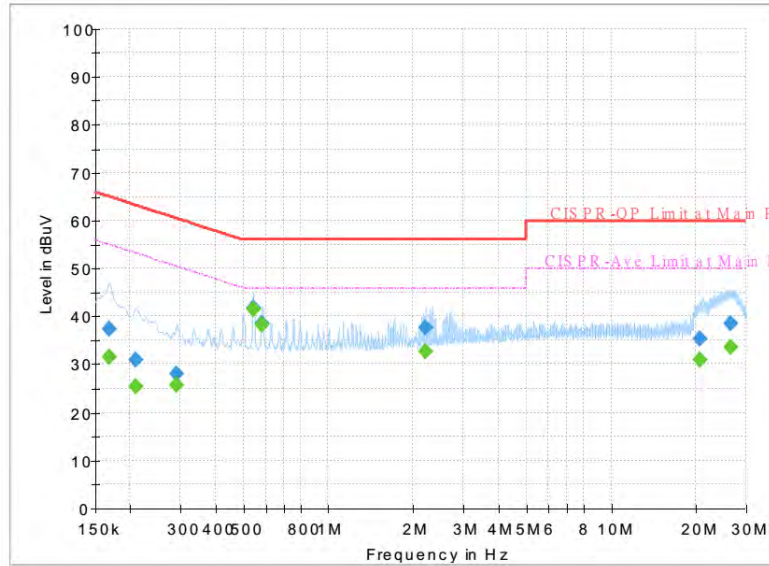

Final Result

Frequency (MHz)	QuasiPeak (dBuV)	CAverage (dBuV)	Limit (dBuV)	Margin (dB)	Line	Filter	Corr. (dB)
0.168000	---	31.47	55.06	23.59	N	OFF	19.5
0.168000	37.43	---	65.06	27.63	N	OFF	19.5
0.208500	---	25.39	53.27	27.88	N	OFF	19.5
0.208500	30.89	---	63.27	32.38	N	OFF	19.5
0.291750	---	25.69	50.47	24.78	N	OFF	19.5
0.291750	27.93	---	60.47	32.54	N	OFF	19.5
0.541500	---	41.43	46.00	4.57	N	OFF	19.5
0.541500	41.95	---	56.00	14.05	N	OFF	19.5
0.584250	---	38.17	46.00	7.83	N	OFF	19.5
0.584250	38.61	---	56.00	17.39	N	OFF	19.5
2.211000	---	32.72	46.00	13.28	N	OFF	19.5
2.211000	37.61	---	56.00	18.39	N	OFF	19.5
20.634000	---	30.99	50.00	19.01	N	OFF	20.3
20.634000	35.47	---	60.00	24.53	N	OFF	20.3
26.493000	---	33.73	50.00	16.27	N	OFF	20.6
26.493000	38.49	---	60.00	21.51	N	OFF	20.6



Appendix B. Radiated Spurious Emission

Test Engineer :	Fu Chen, Alex Jheng, and Wilson Wu	Temperature :	24~25°C
		Relative Humidity :	48~52%

<For Sample 1>

<CDD Mode>

Band 4 - 5725~5850MHz

WIFI 802.11a (Band Edge @ 3m)

WIFI Ant. 1	Note	Frequency (MHz)	Level (dBμV/m)	Over Limit (dB)	Limit Line (dBμV/m)	Read Level (dBμV)	Antenna Factor (dB/m)	Path Loss (dB)	Preamp Factor (dB)	Ant Pos (cm)	Table Pos (deg)	Peak Avg. (P/A)	Pol. (H/V)	
802.11a CH 149 5745MHz		5643.6	52.75	-15.45	68.2	41.47	32.09	8.84	29.65	100	182	P	H	
		5687.2	54.55	-41.21	95.76	43.22	32.17	8.83	29.67	100	182	P	H	
		5719.2	59.7	-50.88	110.58	48.35	32.21	8.82	29.68	100	182	P	H	
		5721	58.18	-54.9	113.08	46.83	32.21	8.82	29.68	100	182	P	H	
	*	5745	110.04	-	-	98.68	32.24	8.81	29.69	100	182	P	H	
	*	5745	102.67	-	-	91.31	32.24	8.81	29.69	100	182	A	H	
														H
														H
			5609.8	51.32	-16.88	68.2	40.07	32.04	8.85	29.64	336	212	P	V
			5699.6	53.14	-51.77	104.91	41.82	32.17	8.82	29.67	336	212	P	V
			5717.6	51.9	-58.23	110.13	40.55	32.21	8.82	29.68	336	212	P	V
			5720.8	52.95	-59.67	112.62	41.6	32.21	8.82	29.68	336	212	P	V
	*		5745	106.19	-	-	94.83	32.24	8.81	29.69	336	212	P	V
	*		5745	98.62	-	-	87.26	32.24	8.81	29.69	336	212	A	V
													V	
													V	



WIFI Ant. 1	Note	Frequency (MHz)	Level (dBμV/m)	Over Limit (dB)	Limit Line (dBμV/m)	Read Level (dBμV)	Antenna Factor (dB/m)	Path Loss (dB)	Preamp Factor (dB)	Ant Pos (cm)	Table Pos (deg)	Peak Avg. (P/A)	Pol. (H/V)
		5641.2	51.87	-16.33	68.2	40.59	32.09	8.84	29.65	100	179	P	H
		5697.6	52.45	-50.98	103.43	41.12	32.17	8.83	29.67	100	179	P	H
		5718.6	54.05	-56.36	110.41	42.7	32.21	8.82	29.68	100	179	P	H
		5722.2	53.97	-61.85	115.82	42.62	32.21	8.82	29.68	100	179	P	H
	*	5785	110.03	-	-	98.66	32.29	8.8	29.72	100	179	P	H
	*	5785	102.26	-	-	90.89	32.29	8.8	29.72	100	179	A	H
		5850.2	55.06	-66.68	121.74	43.57	32.38	8.85	29.74	100	179	P	H
		5856.2	54.16	-56.3	110.46	42.64	32.41	8.85	29.74	100	179	P	H
		5884.8	52.58	-45.34	97.92	41.03	32.43	8.88	29.76	100	179	P	H
		5938.6	53.49	-14.71	68.2	41.81	32.53	8.93	29.78	100	179	P	H
													H
													H
802.11a													
CH 157													
5785MHz		5618.6	51.45	-16.75	68.2	40.17	32.07	8.85	29.64	298	210	P	V
		5681.2	51.87	-39.46	91.33	40.57	32.14	8.83	29.67	298	210	P	V
		5700.4	52.92	-52.39	105.31	41.6	32.17	8.82	29.67	298	210	P	V
		5724.2	52.43	-67.95	120.38	41.08	32.21	8.82	29.68	298	210	P	V
	*	5785	106.08	-	-	94.71	32.29	8.8	29.72	298	210	P	V
	*	5785	98.28	-	-	86.91	32.29	8.8	29.72	298	210	A	V
		5852	52.8	-64.84	117.64	41.31	32.38	8.85	29.74	298	210	P	V
		5874	52.94	-52.54	105.48	41.39	32.43	8.87	29.75	298	210	P	V
		5879	52.14	-50.09	102.23	40.59	32.43	8.87	29.75	298	210	P	V
		5927	52.25	-15.95	68.2	40.61	32.5	8.91	29.77	298	210	P	V
													V
													V



WiFi Ant. 1	Note	Frequency (MHz)	Level (dBµV/m)	Over Limit (dB)	Limit Line (dBµV/m)	Read Level (dBµV)	Antenna Factor (dB/m)	Path Loss (dB)	Preamp Factor (dB)	Ant Pos (cm)	Table Pos (deg)	Peak Avg. (P/A)	Pol. (H/V)	
802.11a CH 165 5825MHz	*	5825	110.01	-	-	98.56	32.36	8.82	29.73	101	181	P	H	
	*	5825	102.23	-	-	90.78	32.36	8.82	29.73	101	181	A	H	
		5851.6	55.56	-62.99	118.55	44.07	32.38	8.85	29.74	101	181	P	H	
		5874.2	55.96	-49.46	105.42	44.41	32.43	8.87	29.75	101	181	P	H	
		5878.2	55.74	-47.08	102.82	44.19	32.43	8.87	29.75	101	181	P	H	
		5938.2	53.95	-14.25	68.2	42.3	32.5	8.93	29.78	101	181	P	H	
														H
														H
	*	5825	105.57	-	-	94.12	32.36	8.82	29.73	268	207	P	V	
	*	5825	97.99	-	-	86.54	32.36	8.82	29.73	268	207	A	V	
		5851.8	52.7	-65.4	118.1	41.21	32.38	8.85	29.74	268	207	P	V	
		5870.4	53.12	-53.37	106.49	41.59	32.41	8.87	29.75	268	207	P	V	
		5880.8	52.5	-48.39	100.89	40.94	32.43	8.88	29.75	268	207	P	V	
		5948.6	52.69	-15.51	68.2	41.01	32.53	8.93	29.78	268	207	P	V	
														V
														V
														V
Remark	1. No other spurious found. 2. All results are PASS against Peak and Average limit line.													



Band 4 5725~5850MHz

WIFI 802.11a (Harmonic @ 3m)

WIFI Ant. 1	Note	Frequency (MHz)	Level (dBµV/m)	Over Limit (dB)	Limit Line (dBµV/m)	Read Level (dBµV)	Antenna Factor (dB/m)	Path Loss (dB)	Preamp Factor (dB)	Ant Pos (cm)	Table Pos (deg)	Peak Avg. (P/A)	Pol. (H/V)	
802.11a CH 149 5745MHz		11490	46.87	-27.13	74	55.8	39.92	12.75	61.6	100	0	P	H	
		17235	49.01	-19.19	68.2	48.85	40.84	15.11	55.79	100	0	P	H	
													H	
													H	
			11490	46.08	-27.92	74	55.01	39.92	12.75	61.6	100	0	P	V
			17235	48.8	-19.4	68.2	48.64	40.84	15.11	55.79	100	0	P	V
														V
802.11a CH 157 5785MHz		11570	44.9	-29.1	74	54.1	39.76	12.79	61.75	100	0	P	H	
		17355	48.92	-19.28	68.2	48.04	41.26	15.15	55.53	100	0	P	H	
													H	
													H	
			11570	45.58	-28.42	74	54.78	39.76	12.79	61.75	100	0	P	V
			17355	48.54	-19.66	68.2	47.66	41.26	15.15	55.53	100	0	P	V
														V
802.11a CH 165 5825MHz		11650	46.15	-27.85	74	55.6	39.62	12.83	61.9	100	0	P	H	
		17475	49.64	-18.56	68.2	48.03	41.68	15.2	55.27	100	0	P	H	
													H	
													H	
			11650	46.17	-27.83	74	55.62	39.62	12.83	61.9	100	0	P	V
			17475	49.59	-18.61	68.2	47.98	41.68	15.2	55.27	100	0	P	V
														V
Remark	1. No other spurious found.													
	2. All results are PASS against Peak and Average limit line.													



Band 4 5725~5850MHz

WIFI 802.11n HT20 (Band Edge @ 3m)

WIFI Ant. 1	Note	Frequency (MHz)	Level (dBμV/m)	Over Limit (dB)	Limit Line (dBμV/m)	Read Level (dBμV)	Antenna Factor (dB/m)	Path Loss (dB)	Preamp Factor (dB)	Ant Pos (cm)	Table Pos (deg)	Peak Avg. (P/A)	Pol. (H/V)	
802.11n HT20 CH 149 5745MHz		5642.8	54.49	-13.71	68.2	43.21	32.09	8.84	29.65	106	181	P	H	
		5697.6	64.46	-38.97	103.43	53.13	32.17	8.83	29.67	106	181	P	H	
		5719.6	68.91	-41.78	110.69	57.56	32.21	8.82	29.68	106	181	P	H	
		5724.6	70.46	-50.83	121.29	59.11	32.21	8.82	29.68	106	181	P	H	
	*	5745	110.13	-	-	98.77	32.24	8.81	29.69	106	181	P	H	
	*	5745	102.46	-	-	91.1	32.24	8.81	29.69	106	181	A	H	
														H
														H
			5640.4	52.71	-15.49	68.2	41.43	32.09	8.84	29.65	337	213	P	V
			5697.2	60.46	-42.68	103.14	49.13	32.17	8.83	29.67	337	213	P	V
			5717.2	64.08	-45.94	110.02	52.75	32.19	8.82	29.68	337	213	P	V
			5725	56.41	-65.79	122.2	45.06	32.21	8.82	29.68	337	213	P	V
	*		5745	105.9	-	-	94.54	32.24	8.81	29.69	337	213	P	V
	*		5745	98.23	-	-	86.87	32.24	8.81	29.69	337	213	A	V
													V	
													V	



WIFI Ant. 1	Note	Frequency (MHz)	Level (dBμV/m)	Over Limit (dB)	Limit Line (dBμV/m)	Read Level (dBμV)	Antenna Factor (dB/m)	Path Loss (dB)	Preamp Factor (dB)	Ant Pos (cm)	Table Pos (deg)	Peak Avg. (P/A)	Pol. (H/V)
		5612.4	53.98	-14.22	68.2	42.73	32.04	8.85	29.64	105	180	P	H
		5698.8	55.27	-49.05	104.32	43.94	32.17	8.83	29.67	105	180	P	H
		5720	61.21	-49.59	110.8	49.86	32.21	8.82	29.68	105	180	P	H
		5723.4	62.07	-56.48	118.55	50.72	32.21	8.82	29.68	105	180	P	H
	*	5785	109.78	-	-	98.41	32.29	8.8	29.72	105	180	P	H
	*	5785	101.82	-	-	90.45	32.29	8.8	29.72	105	180	A	H
		5851.4	60.28	-58.73	119.01	48.79	32.38	8.85	29.74	105	180	P	H
		5856.8	60.01	-50.29	110.3	48.49	32.41	8.85	29.74	105	180	P	H
		5883.8	57.35	-41.32	98.67	45.8	32.43	8.88	29.76	105	180	P	H
		5950	52.74	-15.46	68.2	41.06	32.53	8.93	29.78	105	180	P	H
802.11n													H
HT20													H
CH 157		5622	52.19	-16.01	68.2	40.91	32.07	8.85	29.64	257	210	P	V
5785MHz		5686.2	52.65	-42.37	95.02	41.32	32.17	8.83	29.67	257	210	P	V
		5712.2	55.88	-52.74	108.62	44.55	32.19	8.82	29.68	257	210	P	V
		5724.4	56.36	-64.47	120.83	45.01	32.21	8.82	29.68	257	210	P	V
	*	5785	105.62	-	-	94.25	32.29	8.8	29.72	257	210	P	V
	*	5785	98.12	-	-	86.75	32.29	8.8	29.72	257	210	A	V
		5855	53.33	-57.47	110.8	41.81	32.41	8.85	29.74	257	210	P	V
		5870.4	54.07	-52.42	106.49	42.54	32.41	8.87	29.75	257	210	P	V
		5881.8	53.04	-47.11	100.15	41.48	32.43	8.88	29.75	257	210	P	V
		5936	51.99	-16.21	68.2	40.34	32.5	8.93	29.78	257	210	P	V
													V
													V



WiFi Ant. 1	Note	Frequency (MHz)	Level (dBμV/m)	Over Limit (dB)	Limit Line (dBμV/m)	Read Level (dBμV)	Antenna Factor (dB/m)	Path Loss (dB)	Preamp Factor (dB)	Ant Pos (cm)	Table Pos (deg)	Peak Avg. (P/A)	Pol. (H/V)	
802.11n HT20 CH 165 5825MHz	*	5825	109.64	-	-	98.19	32.36	8.82	29.73	106	181	P	H	
	*	5825	101.87	-	-	90.42	32.36	8.82	29.73	106	181	A	H	
		5852.4	63.93	-52.8	116.73	52.44	32.38	8.85	29.74	106	181	P	H	
		5868.8	65.52	-41.41	106.93	53.99	32.41	8.87	29.75	106	181	P	H	
		5878.4	63.09	-39.58	102.67	51.54	32.43	8.87	29.75	106	181	P	H	
		5935.2	54.14	-14.06	68.2	42.49	32.5	8.93	29.78	106	181	P	H	
														H
														H
	*	5825	105.47	-	-	94.02	32.36	8.82	29.73	269	209	P	V	
	*	5825	97.63	-	-	86.18	32.36	8.82	29.73	269	209	A	V	
		5855	60.94	-49.86	110.8	49.42	32.41	8.85	29.74	269	209	P	V	
		5861.4	61.23	-47.78	109.01	49.7	32.41	8.87	29.75	269	209	P	V	
		5879	57.28	-44.95	102.23	45.73	32.43	8.87	29.75	269	209	P	V	
		5945.4	52.49	-15.71	68.2	40.81	32.53	8.93	29.78	269	209	P	V	
														V
													V	
Remark	1. No other spurious found. 2. All results are PASS against Peak and Average limit line.													



Band 4 5725~5850MHz

WIFI 802.11n HT20 (Harmonic @ 3m)

WIFI Ant. 1	Note	Frequency (MHz)	Level (dBμV/m)	Over Limit (dB)	Limit Line (dBμV/m)	Read Level (dBμV)	Antenna Factor (dB/m)	Path Loss (dB)	Preamp Factor (dB)	Ant Pos (cm)	Table Pos (deg)	Peak Avg. (P/A)	Pol. (H/V)	
802.11n HT20 CH 149 5745MHz		11490	48.16	-25.84	74	57.09	39.92	12.75	61.6	100	0	P	H	
		17235	47.55	-20.65	68.2	47.39	40.84	15.11	55.79	100	0	P	H	
													H	
													H	
			11490	45.21	-28.79	74	54.14	39.92	12.75	61.6	100	0	P	V
			17235	48.16	-20.04	68.2	48	40.84	15.11	55.79	100	0	P	V
														V
802.11n HT20 CH 157 5785MHz		11570	44.64	-29.36	74	53.84	39.76	12.79	61.75	100	0	P	H	
		17355	49.18	-19.02	68.2	48.3	41.26	15.15	55.53	100	0	P	H	
													H	
													H	
			11570	46.36	-27.64	74	55.56	39.76	12.79	61.75	100	0	P	V
			17355	49.11	-19.09	68.2	48.23	41.26	15.15	55.53	100	0	P	V
														V
802.11n HT20 CH 165 5825MHz		11650	45.21	-28.79	74	54.66	39.62	12.83	61.9	100	0	P	H	
		17475	49.4	-18.8	68.2	47.79	41.68	15.2	55.27	100	0	P	H	
													H	
													H	
			11650	45.59	-28.41	74	55.04	39.62	12.83	61.9	100	0	P	V
			17475	49.33	-18.87	68.2	47.72	41.68	15.2	55.27	100	0	P	V
														V
Remark	1. No other spurious found.													
	2. All results are PASS against Peak and Average limit line.													



Band 4 5725~5850MHz

WIFI 802.11n HT40 (Band Edge @ 3m)

WIFI Ant. 1	Note	Frequency (MHz)	Level (dBμV/m)	Over Limit (dB)	Limit Line (dBμV/m)	Read Level (dBμV)	Antenna Factor (dB/m)	Path Loss (dB)	Preamp Factor (dB)	Ant Pos (cm)	Table Pos (deg)	Peak Avg. (P/A)	Pol. (H/V)
		5646.4	56.69	-11.51	68.2	45.41	32.09	8.84	29.65	101	183	P	H
		5697.2	65.86	-37.28	103.14	54.53	32.17	8.83	29.67	101	183	P	H
		5717.8	67.96	-42.22	110.18	56.61	32.21	8.82	29.68	101	183	P	H
		5721.2	68.9	-44.64	113.54	57.55	32.21	8.82	29.68	101	183	P	H
	*	5755	107.39	-	-	96.01	32.26	8.81	29.69	101	183	P	H
	*	5755	100.27	-	-	88.89	32.26	8.81	29.69	101	183	A	H
		5851.4	58.6	-60.41	119.01	47.11	32.38	8.85	29.74	101	183	P	H
		5860	57.58	-51.82	109.4	46.07	32.41	8.85	29.75	101	183	P	H
		5880.8	55	-45.89	100.89	43.44	32.43	8.88	29.75	101	183	P	H
		5937.2	52.66	-15.54	68.2	41.01	32.5	8.93	29.78	101	183	P	H
802.11n													H
HT40													H
CH 151		5636.6	52.3	-15.9	68.2	41.02	32.09	8.84	29.65	318	210	P	V
5755MHz		5695.2	59.56	-42.1	101.66	48.23	32.17	8.83	29.67	318	210	P	V
		5719.6	64.02	-46.67	110.69	52.67	32.21	8.82	29.68	318	210	P	V
		5720.8	63.54	-49.08	112.62	52.19	32.21	8.82	29.68	318	210	P	V
	*	5755	103.45	-	-	92.07	32.26	8.81	29.69	318	210	P	V
	*	5755	96.24	-	-	84.86	32.26	8.81	29.69	318	210	A	V
		5850.8	53.76	-66.62	120.38	42.27	32.38	8.85	29.74	318	210	P	V
		5858.4	54.79	-55.06	109.85	43.28	32.41	8.85	29.75	318	210	P	V
		5880.8	53.17	-47.72	100.89	41.61	32.43	8.88	29.75	318	210	P	V
		5932.4	51.88	-16.32	68.2	40.24	32.5	8.91	29.77	318	210	P	V
													V
													V



WIFI Ant. 1	Note	Frequency (MHz)	Level (dBμV/m)	Over Limit (dB)	Limit Line (dBμV/m)	Read Level (dBμV)	Antenna Factor (dB/m)	Path Loss (dB)	Preamp Factor (dB)	Ant Pos (cm)	Table Pos (deg)	Peak Avg. (P/A)	Pol. (H/V)
		5610.2	52.83	-15.37	68.2	41.58	32.04	8.85	29.64	101	183		H
		5685.8	57.58	-37.14	94.72	46.25	32.17	8.83	29.67	101	183		H
		5719	61.45	-49.07	110.52	50.1	32.21	8.82	29.68	101	183		H
		5720.6	62.19	-49.98	112.17	50.84	32.21	8.82	29.68	101	183		H
	*	5795	107.35	-	-	95.96	32.31	8.8	29.72	101	183		H
	*	5795	100.07	-	-	88.68	32.31	8.8	29.72	101	183		H
		5854	65.45	-47.63	113.08	53.93	32.41	8.85	29.74	101	183		H
		5857.6	66.22	-43.85	110.07	54.7	32.41	8.85	29.74	101	183		H
		5875.4	62.87	-42.03	104.9	51.32	32.43	8.87	29.75	101	183		H
		5931.6	54.56	-13.64	68.2	42.92	32.5	8.91	29.77	101	183		H
802.11n													H
HT40													H
CH 159		5649	52.56	-15.64	68.2	41.28	32.09	8.84	29.65	295	209		V
5795MHz		5698.8	52.87	-51.45	104.32	41.54	32.17	8.83	29.67	295	209		V
		5703.2	55.82	-50.28	106.1	44.48	32.19	8.82	29.67	295	209		V
		5721.4	57.45	-56.54	113.99	46.1	32.21	8.82	29.68	295	209		V
	*	5795	103.6	-	-	92.21	32.31	8.8	29.72	295	209		V
	*	5795	96.07	-	-	84.68	32.31	8.8	29.72	295	209		V
		5851.6	62.25	-56.3	118.55	50.76	32.38	8.85	29.74	295	209		V
		5858.4	61.24	-48.61	109.85	49.73	32.41	8.85	29.75	295	209		V
		5881.2	56.54	-44.05	100.59	44.98	32.43	8.88	29.75	295	209		V
		5925	52.79	-15.41	68.2	41.15	32.5	8.91	29.77	295	209		V
													V
													V
Remark	1. No other spurious found. 2. All results are PASS against Peak and Average limit line.												



Band 4 5725~5850MHz

WIFI 802.11n HT40 (Harmonic @ 3m)

WIFI Ant. 1	Note	Frequency (MHz)	Level (dBμV/m)	Over Limit (dB)	Limit Line (dBμV/m)	Read Level (dBμV)	Antenna Factor (dB/m)	Path Loss (dB)	Preamp Factor (dB)	Ant Pos (cm)	Table Pos (deg)	Peak Avg. (P/A)	Pol. (H/V)
802.11n HT40 CH 151 5755MHz		11510	45.54	-28.46	74	54.48	39.9	12.76	61.6	100	0	P	H
		17265	47.81	-20.39	68.2	47.44	40.96	15.12	55.71	100	0	P	H
													H
													H
		11510	45.62	-28.38	74	54.56	39.9	12.76	61.6	100	0	P	V
		17265	48.08	-20.12	68.2	47.71	40.96	15.12	55.71	100	0	P	V
													V
													V
802.11n HT40 CH 159 5795MHz		11590	45.46	-28.54	74	54.73	39.73	12.79	61.79	100	0	P	H
		17385	48.81	-19.39	68.2	47.72	41.38	15.17	55.46	100	0	P	H
													H
													H
		11590	46.23	-27.77	74	55.5	39.73	12.79	61.79	100	0	P	V
		17385	48.77	-19.43	68.2	47.68	41.38	15.17	55.46	100	0	P	V
													V
													V
Remark	1. No other spurious found. 2. All results are PASS against Peak and Average limit line.												



Band 4 5725~5850MHz

WIFI 802.11ac VHT80 (Band Edge @ 3m)

WIFI Ant. 1	Note	Frequency (MHz)	Level (dBμV/m)	Over Limit (dB)	Limit Line (dBμV/m)	Read Level (dBμV)	Antenna Factor (dB/m)	Path Loss (dB)	Preamp Factor (dB)	Ant Pos (cm)	Table Pos (deg)	Peak Avg. (P/A)	Pol. (H/V)
		5645.6	53.72	-14.48	68.2	42.44	32.09	8.84	29.65	100	182	P	H
		5699.4	61.72	-43.04	104.76	50.39	32.17	8.83	29.67	100	182	P	H
		5719.4	66.26	-44.37	110.63	54.91	32.21	8.82	29.68	100	182	P	H
		5720.6	66.76	-45.41	112.17	55.41	32.21	8.82	29.68	100	182	P	H
	*	5775	104.53	-	-	93.15	32.29	8.8	29.71	100	182	P	H
	*	5775	96.87	-	-	85.49	32.29	8.8	29.71	100	182	A	H
		5852.8	59.23	-56.59	115.82	47.74	32.38	8.85	29.74	100	182	P	H
		5856.8	59.48	-50.82	110.3	47.96	32.41	8.85	29.74	100	182	P	H
		5911	55.96	-22.57	78.53	44.35	32.48	8.9	29.77	100	182	P	H
		5928.4	53.04	-15.16	68.2	41.4	32.5	8.91	29.77	100	182	P	H
802.11ac													H
VHT80													H
CH 155		5633.8	52.34	-15.86	68.2	41.06	32.09	8.84	29.65	105	124	P	V
5775MHz		5699	56.43	-48.03	104.46	45.1	32.17	8.83	29.67	105	124	P	V
		5718.8	60.18	-50.28	110.46	48.83	32.21	8.82	29.68	105	124	P	V
		5721.6	59.74	-54.71	114.45	48.39	32.21	8.82	29.68	105	124	P	V
	*	5775	98.13	-	-	86.75	32.29	8.8	29.71	105	124	P	V
	*	5775	91.23	-	-	79.85	32.29	8.8	29.71	105	124	A	V
		5851.2	53.75	-65.71	119.46	42.26	32.38	8.85	29.74	105	124	P	V
		5861.2	55.19	-53.87	109.06	43.68	32.41	8.85	29.75	105	124	P	V
		5878.6	53.23	-49.3	102.53	41.68	32.43	8.87	29.75	105	124	P	V
		5932.2	52.35	-15.85	68.2	40.71	32.5	8.91	29.77	105	124	P	V
													V
													V
Remark	1. No other spurious found. 2. All results are PASS against Peak and Average limit line.												



Band 4 5725~5850MHz

WIFI 802.11ac VHT80 (Harmonic @ 3m)

WIFI Ant. 1	Note	Frequency (MHz)	Level (dBμV/m)	Over Limit (dB)	Limit Line (dBμV/m)	Read Level (dBμV)	Antenna Factor (dB/m)	Path Loss (dB)	Preamp Factor (dB)	Ant Pos (cm)	Table Pos (deg)	Peak Avg. (P/A)	Pol. (H/V)	
802.11ac VHT80 CH 155 5775MHz		11550	44.41	-29.59	74	53.54	39.8	12.78	61.71	100	0	P	H	
		17325	49.79	-18.41	68.2	49.11	41.14	15.14	55.6	100	0	P	H	
													H	
													H	
			11550	44.66	-29.34	74	53.79	39.8	12.78	61.71	100	0	P	V
			17325	48.59	-19.61	68.2	47.91	41.14	15.14	55.6	100	0	P	V
														V
Remark	1. No other spurious found. 2. All results are PASS against Peak and Average limit line.													



Emission below 1GHz

5GHz WIFI 802.11n HT40 (LF @ 3m)

WIFI	Note	Frequency	Level	Over	Limit	Read	Antenna	Path	Preamp	Ant	Table	Peak	Pol.	
Ant.				Limit	Line	Level	Factor	Loss	Factor	Pos	Pos	Avg.		
1		(MHz)	(dBμV/m)	(dB)	(dBμV/m)	(dBμV)	(dB/m)	(dB)	(dB)	(cm)	(deg)	(P/A)	(H/V)	
5GHz 802.11n HT40 LF		30.54	23.5	-16.5	40	31.09	23.96	0.79	32.34	-	-	P	H	
		100.74	23.73	-19.77	43.5	38.43	16.23	1.36	32.29	-	-	P	H	
		124.77	22.05	-21.45	43.5	35.37	17.58	1.38	32.28	-	-	P	H	
		714.4	31.6	-14.4	46	33.65	26.92	3.17	32.14	-	-	P	H	
		721.4	31.72	-14.28	46	33.54	27.14	3.17	32.13	-	-	P	H	
		956.6	33.11	-12.89	46	29.43	30.96	3.71	30.99	100	0	P	H	
														H
														H
														H
														H
														H
														H
														H
														H
														H
			30.54	34.23	-5.77	40	41.82	23.96	0.79	32.34	100	0	P	V
			60.24	22.1	-17.9	40	41.31	12.06	1.04	32.31	-	-	P	V
			124.77	22.29	-21.21	43.5	35.61	17.58	1.38	32.28	-	-	P	V
		717.2	32.21	-13.79	46	34.2	26.98	3.17	32.14	-	-	P	V	
		847.4	31.64	-14.36	46	30.9	29.01	3.49	31.76	-	-	P	V	
		959.4	33.53	-12.47	46	29.67	31.12	3.71	30.97	-	-	P	V	
													V	
													V	
													V	
													V	
													V	
													V	
													V	
Remark	1. No other spurious found. 2. All results are PASS against limit line.													



Band 4 - 5725~5850MHz

WIFI 802.11a (Band Edge @ 3m)

WIFI	Note	Frequency	Level	Over	Limit	Read	Antenna	Path	Preamp	Ant	Table	Peak	Pol.	
Ant.				Limit	Line	Level	Factor	Loss	Factor	Pos	Pos	Avg.		
2		(MHz)	(dBμV/m)	(dB)	(dBμV/m)	(dBμV)	(dB/m)	(dB)	(dB)	(cm)	(deg)	(P/A)	(H/V)	
802.11a CH 149 5745MHz		5626.2	52.44	-15.76	68.2	41.16	32.07	8.85	29.64	277	3	P	H	
		5696.6	56.14	-46.55	102.69	44.81	32.17	8.83	29.67	277	3	P	H	
		5717.6	60.7	-49.43	110.13	49.35	32.21	8.82	29.68	277	3	P	H	
		5724.2	58.19	-62.19	120.38	46.84	32.21	8.82	29.68	277	3	P	H	
	*	5745	109.67	-	-	98.31	32.24	8.81	29.69	277	3	P	H	
	*	5745	101.78	-	-	90.42	32.24	8.81	29.69	277	3	A	H	
														H
														H
			5642.6	52.22	-15.98	68.2	40.94	32.09	8.84	29.65	297	328	P	V
			5696.6	54.42	-48.27	102.69	43.09	32.17	8.83	29.67	297	328	P	V
			5717.4	56.66	-53.41	110.07	45.33	32.19	8.82	29.68	297	328	P	V
			5723.6	58.8	-60.21	119.01	47.45	32.21	8.82	29.68	297	328	P	V
	*		5745	106.49	-	-	95.13	32.24	8.81	29.69	297	328	P	V
	*		5745	99.05	-	-	87.69	32.24	8.81	29.69	297	328	A	V
														V
													V	



WIFI Ant. 2	Note	Frequency (MHz)	Level (dBμV/m)	Over Limit (dB)	Limit Line (dBμV/m)	Read Level (dBμV)	Antenna Factor (dB/m)	Path Loss (dB)	Preamp Factor (dB)	Ant Pos (cm)	Table Pos (deg)	Peak Avg. (P/A)	Pol. (H/V)
		5629.2	52.05	-16.15	68.2	40.79	32.07	8.84	29.65	288	4	P	H
		5687.2	52.27	-43.49	95.76	40.94	32.17	8.83	29.67	288	4	P	H
		5711.4	51.88	-56.51	108.39	40.55	32.19	8.82	29.68	288	4	P	H
		5721.2	52.57	-60.97	113.54	41.22	32.21	8.82	29.68	288	4	P	H
	*	5785	109.07	-	-	97.7	32.29	8.8	29.72	288	4	P	H
	*	5785	101.46	-	-	90.09	32.29	8.8	29.72	288	4	A	H
		5854.4	53.21	-58.96	112.17	41.69	32.41	8.85	29.74	288	4	P	H
		5868.6	53.21	-53.78	106.99	41.68	32.41	8.87	29.75	288	4	P	H
		5877.2	53.16	-50.41	103.57	41.61	32.43	8.87	29.75	288	4	P	H
		5934.4	52.65	-15.55	68.2	41	32.5	8.93	29.78	288	4	P	H
													H
													H
802.11a													
CH 157													
5785MHz		5647.4	51.44	-16.76	68.2	40.16	32.09	8.84	29.65	280	329	P	V
		5653.6	53.07	-17.8	70.87	41.76	32.12	8.84	29.65	280	329	P	V
		5716.4	52.42	-57.37	109.79	41.09	32.19	8.82	29.68	280	329	P	V
		5724.2	52.04	-68.34	120.38	40.69	32.21	8.82	29.68	280	329	P	V
	*	5785	106.81	-	-	95.44	32.29	8.8	29.72	280	329	P	V
	*	5785	99.03	-	-	87.66	32.29	8.8	29.72	280	329	A	V
		5852	52.01	-65.63	117.64	40.52	32.38	8.85	29.74	280	329	P	V
		5863.4	52.43	-56.02	108.45	40.9	32.41	8.87	29.75	280	329	P	V
		5889.8	52.36	-41.86	94.22	40.78	32.46	8.88	29.76	280	329	P	V
		5927.6	52.26	-15.94	68.2	40.62	32.5	8.91	29.77	280	329	P	V
													V
													V



WiFi Ant. 2	Note	Frequency (MHz)	Level (dBµV/m)	Over Limit (dB)	Limit Line (dBµV/m)	Read Level (dBµV)	Antenna Factor (dB/m)	Path Loss (dB)	Preamp Factor (dB)	Ant Pos (cm)	Table Pos (deg)	Peak Avg. (P/A)	Pol. (H/V)	
802.11a CH 165 5825MHz	*	5825	109.12	-	-	97.67	32.36	8.82	29.73	273	4	P	H	
	*	5825	101.6	-	-	90.15	32.36	8.82	29.73	273	4	A	H	
		5853	59.3	-56.06	115.36	47.81	32.38	8.85	29.74	273	4	P	H	
		5872.8	58.52	-47.3	105.82	46.97	32.43	8.87	29.75	273	4	P	H	
		5881.4	55.95	-44.5	100.45	44.39	32.43	8.88	29.75	273	4	P	H	
		5928.8	52.16	-16.04	68.2	40.52	32.5	8.91	29.77	273	4	P	H	
														H
														H
	*	5825	106.69	-	-	95.24	32.36	8.82	29.73	305	328	P	V	
	*	5825	98.95	-	-	87.5	32.36	8.82	29.73	305	328	A	V	
		5851.4	55.41	-63.6	119.01	43.92	32.38	8.85	29.74	305	328	P	V	
		5857.6	55.16	-54.91	110.07	43.64	32.41	8.85	29.74	305	328	P	V	
		5876.4	57.13	-47.03	104.16	45.58	32.43	8.87	29.75	305	328	P	V	
		5929.8	51.32	-16.88	68.2	39.68	32.5	8.91	29.77	305	328	P	V	
														V
														V
													V	
Remark	1. No other spurious found. 2. All results are PASS against Peak and Average limit line.													



Band 4 5725~5850MHz

WIFI 802.11a (Harmonic @ 3m)

WIFI Ant. 2	Note	Frequency (MHz)	Level (dBμV/m)	Over Limit (dB)	Limit Line (dBμV/m)	Read Level (dBμV)	Antenna Factor (dB/m)	Path Loss (dB)	Preamp Factor (dB)	Ant Pos (cm)	Table Pos (deg)	Peak Avg. (P/A)	Pol. (H/V)
802.11a CH 149 5745MHz		11490	47.47	-26.53	74	56.4	39.92	12.75	61.6	100	0	P	H
		17235	47.17	-21.03	68.2	47.01	40.84	15.11	55.79	100	0	P	H
													H
													H
		11490	47.55	-26.45	74	56.48	39.92	12.75	61.6	100	0	P	V
		17235	47.23	-20.97	68.2	47.07	40.84	15.11	55.79	100	0	P	V
													V
													V
802.11a CH 157 5785MHz		11570	44.84	-29.16	74	54.04	39.76	12.79	61.75	100	0	P	H
		17355	47.19	-21.01	68.2	46.31	41.26	15.15	55.53	100	0	P	H
													H
													H
		11570	45.51	-28.49	74	54.71	39.76	12.79	61.75	100	0	P	V
		17355	47.21	-20.99	68.2	46.33	41.26	15.15	55.53	100	0	P	V
													V
													V
802.11a CH 165 5825MHz		11650	45.66	-28.34	74	55.11	39.62	12.83	61.9	100	0	P	H
		17475	48.15	-20.05	68.2	46.54	41.68	15.2	55.27	100	0	P	H
													H
													H
		11650	44.94	-29.06	74	54.39	39.62	12.83	61.9	100	0	P	V
		17475	49.35	-18.85	68.2	47.74	41.68	15.2	55.27	100	0	P	V
													V
													V
Remark	1. No other spurious found. 2. All results are PASS against Peak and Average limit line.												



Band 4 5725~5850MHz

WIFI 802.11n HT20 (Band Edge @ 3m)

WIFI Ant. 2	Note	Frequency (MHz)	Level (dBμV/m)	Over Limit (dB)	Limit Line (dBμV/m)	Read Level (dBμV)	Antenna Factor (dB/m)	Path Loss (dB)	Preamp Factor (dB)	Ant Pos (cm)	Table Pos (deg)	Peak Avg. (P/A)	Pol. (H/V)	
802.11n HT20 CH 149 5745MHz		5605.6	52.57	-15.63	68.2	41.32	32.04	8.85	29.64	267	1	P	H	
		5697.6	58.74	-44.69	103.43	47.41	32.17	8.83	29.67	267	1	P	H	
		5718.2	62.64	-47.66	110.3	51.29	32.21	8.82	29.68	267	1	P	H	
		5722.6	62.48	-54.25	116.73	51.13	32.21	8.82	29.68	267	1	P	H	
	*	5745	109.21	-	-	97.85	32.24	8.81	29.69	267	1	P	H	
	*	5745	101.79	-	-	90.43	32.24	8.81	29.69	267	1	A	H	
														H
														H
			5631.2	51.73	-16.47	68.2	40.47	32.07	8.84	29.65	296	329	P	V
			5700	55.52	-49.68	105.2	44.2	32.17	8.82	29.67	296	329	P	V
			5700	55.52	-49.68	105.2	44.2	32.17	8.82	29.67	296	329	P	V
			5723.2	59.41	-58.69	118.1	48.06	32.21	8.82	29.68	296	329	P	V
	*		5745	106.32	-	-	94.96	32.24	8.81	29.69	296	329	P	V
	*		5745	98.84	-	-	87.48	32.24	8.81	29.69	296	329	A	V
														V
														V



WIFI Ant. 2	Note	Frequency (MHz)	Level (dBμV/m)	Over Limit (dB)	Limit Line (dBμV/m)	Read Level (dBμV)	Antenna Factor (dB/m)	Path Loss (dB)	Preamp Factor (dB)	Ant Pos (cm)	Table Pos (deg)	Peak Avg. (P/A)	Pol. (H/V)
		5635.2	53.39	-14.81	68.2	42.11	32.09	8.84	29.65	289	2	P	H
		5686	52.08	-42.79	94.87	40.75	32.17	8.83	29.67	289	2	P	H
		5718.4	53.14	-57.21	110.35	41.79	32.21	8.82	29.68	289	2	P	H
		5720.4	52.75	-58.96	111.71	41.4	32.21	8.82	29.68	289	2	P	H
	*	5785	108.93	-	-	97.56	32.29	8.8	29.72	289	2	P	H
	*	5785	101.26	-	-	89.89	32.29	8.8	29.72	289	2	A	H
		5852	53.5	-64.14	117.64	42.01	32.38	8.85	29.74	289	2	P	H
		5874	53.95	-51.53	105.48	42.4	32.43	8.87	29.75	289	2	P	H
		5884.4	53.02	-45.2	98.22	41.47	32.43	8.88	29.76	289	2	P	H
		5929.2	52.01	-16.19	68.2	40.37	32.5	8.91	29.77	289	2	P	H
802.11n													H
HT20													H
CH 157		5644.8	51.77	-16.43	68.2	40.49	32.09	8.84	29.65	322	328	P	V
5785MHz		5686.6	52.56	-42.76	95.32	41.23	32.17	8.83	29.67	322	328	P	V
		5710.8	52.49	-55.74	108.23	41.16	32.19	8.82	29.68	322	328	P	V
		5722	51.11	-64.25	115.36	39.76	32.21	8.82	29.68	322	328	P	V
	*	5785	106.14	-	-	94.77	32.29	8.8	29.72	322	328	P	V
	*	5785	98.87	-	-	87.5	32.29	8.8	29.72	322	328	A	V
		5852.4	51.77	-64.96	116.73	40.28	32.38	8.85	29.74	322	328	P	V
		5863.8	52.4	-55.93	108.33	40.87	32.41	8.87	29.75	322	328	P	V
		5881.2	52.62	-47.97	100.59	41.06	32.43	8.88	29.75	322	328	P	V
		5943.4	51.63	-16.57	68.2	39.95	32.53	8.93	29.78	322	328	P	V
													V
													V



WIFI Ant. 2	Note	Frequency (MHz)	Level (dBμV/m)	Over Limit (dB)	Limit Line (dBμV/m)	Read Level (dBμV)	Antenna Factor (dB/m)	Path Loss (dB)	Preamp Factor (dB)	Ant Pos (cm)	Table Pos (deg)	Peak Avg. (P/A)	Pol. (H/V)	
802.11n HT20 CH 165 5825MHz	*	5825	108.62	-	-	97.17	32.36	8.82	29.73	273	4	P	H	
	*	5825	100.94	-	-	89.49	32.36	8.82	29.73	273	4	A	H	
		5850	58.48	-63.72	122.2	46.99	32.38	8.85	29.74	273	4	P	H	
		5872.8	58.96	-46.86	105.82	47.41	32.43	8.87	29.75	273	4	P	H	
		5878.4	57.03	-45.64	102.67	45.48	32.43	8.87	29.75	273	4	P	H	
		5948.2	52.46	-15.74	68.2	40.78	32.53	8.93	29.78	273	4	P	H	
														H
														H
	*	5825	106.08	-	-	94.63	32.36	8.82	29.73	321	328	P	V	
	*	5825	98.53	-	-	87.08	32.36	8.82	29.73	321	328	A	V	
		5851.4	56.94	-62.07	119.01	45.45	32.38	8.85	29.74	321	328	P	V	
		5861.4	56.52	-52.49	109.01	44.99	32.41	8.87	29.75	321	328	P	V	
		5880.2	55.55	-45.79	101.34	43.99	32.43	8.88	29.75	321	328	P	V	
		5942	52.74	-15.46	68.2	41.06	32.53	8.93	29.78	321	328	P	V	
														V
													V	
Remark	1. No other spurious found. 2. All results are PASS against Peak and Average limit line.													



Band 4 5725~5850MHz

WIFI 802.11n HT20 (Harmonic @ 3m)

WIFI Ant. 2	Note	Frequency (MHz)	Level (dBμV/m)	Over Limit (dB)	Limit Line (dBμV/m)	Read Level (dBμV)	Antenna Factor (dB/m)	Path Loss (dB)	Preamp Factor (dB)	Ant Pos (cm)	Table Pos (deg)	Peak Avg. (P/A)	Pol. (H/V)
802.11n HT20 CH 149 5745MHz		11570	44.89	-29.11	74	54.09	39.76	12.79	61.75	100	0	P	H
		17355	47.81	-20.39	68.2	46.93	41.26	15.15	55.53	100	0	P	H
													H
													H
		11570	45.83	-28.17	74	55.03	39.76	12.79	61.75	100	0	P	V
		17355	48.06	-20.14	68.2	47.18	41.26	15.15	55.53	100	0	P	V
													V
													V
802.11n HT20 CH 157 5785MHz		11570	45.95	-28.05	74	55.15	39.76	12.79	61.75	100	0	P	H
		17355	47.79	-20.41	68.2	46.91	41.26	15.15	55.53	100	0	P	H
													H
													H
		11570	45.79	-28.21	74	54.99	39.76	12.79	61.75	100	0	P	V
		17355	47.17	-21.03	68.2	46.29	41.26	15.15	55.53	100	0	P	V
													V
													V
802.11n HT20 CH 165 5825MHz		11650	46.1	-27.9	74	55.55	39.62	12.83	61.9	100	0	P	H
		17475	48.18	-20.02	68.2	46.57	41.68	15.2	55.27	100	0	P	H
													H
													H
		11650	45.94	-28.06	74	55.39	39.62	12.83	61.9	100	0	P	V
		17475	47.98	-20.22	68.2	46.37	41.68	15.2	55.27	100	0	P	V
													V
													V
Remark	1. No other spurious found. 2. All results are PASS against Peak and Average limit line.												



Band 4 5725~5850MHz

WIFI 802.11n HT40 (Band Edge @ 3m)

WIFI Ant. 2	Note	Frequency (MHz)	Level (dBμV/m)	Over Limit (dB)	Limit Line (dBμV/m)	Read Level (dBμV)	Antenna Factor (dB/m)	Path Loss (dB)	Preamp Factor (dB)	Ant Pos (cm)	Table Pos (deg)	Peak Avg. (P/A)	Pol. (H/V)
		5625	53.03	-15.17	68.2	41.75	32.07	8.85	29.64	262	2	P	H
		5696.6	57.69	-45	102.69	46.36	32.17	8.83	29.67	262	2	P	H
		5720	61.63	-49.17	110.8	50.28	32.21	8.82	29.68	262	2	P	H
		5720.2	61.65	-49.61	111.26	50.3	32.21	8.82	29.68	262	2	P	H
	*	5755	106.58	-	-	95.2	32.26	8.81	29.69	262	2	P	H
	*	5755	99.55	-	-	88.17	32.26	8.81	29.69	262	2	A	H
		5853.2	53.43	-61.47	114.9	41.94	32.38	8.85	29.74	262	2	P	H
		5871.6	56.09	-50.06	106.15	44.54	32.43	8.87	29.75	262	2	P	H
		5892.2	53.35	-39.09	92.44	41.77	32.46	8.88	29.76	262	2	P	H
		5943.8	52.78	-15.42	68.2	41.1	32.53	8.93	29.78	262	2	P	H
													H
													H
802.11n HT40 CH 151 5755MHz		5612.6	52.55	-15.65	68.2	41.3	32.04	8.85	29.64	362	328	P	V
		5697.8	54.4	-49.18	103.58	43.07	32.17	8.83	29.67	362	328	P	V
		5711	56.73	-51.55	108.28	45.4	32.19	8.82	29.68	362	328	P	V
		5722.8	58.71	-58.47	117.18	47.36	32.21	8.82	29.68	362	328	P	V
	*	5755	104.82	-	-	93.44	32.26	8.81	29.69	362	328	P	V
	*	5755	97.09	-	-	85.71	32.26	8.81	29.69	362	328	A	V
		5851.8	51.84	-66.26	118.1	40.35	32.38	8.85	29.74	362	328	P	V
		5856.4	52.9	-57.51	110.41	41.38	32.41	8.85	29.74	362	328	P	V
		5903.6	53.75	-30.25	84	42.15	32.46	8.9	29.76	362	328	P	V
		5928.2	52.28	-15.92	68.2	40.64	32.5	8.91	29.77	362	328	P	V
													V
													V



WIFI Ant. 2	Note	Frequency (MHz)	Level (dBμV/m)	Over Limit (dB)	Limit Line (dBμV/m)	Read Level (dBμV)	Antenna Factor (dB/m)	Path Loss (dB)	Preamp Factor (dB)	Ant Pos (cm)	Table Pos (deg)	Peak Avg. (P/A)	Pol. (H/V)
		5646.2	52.61	-15.59	68.2	41.33	32.09	8.84	29.65	279	3	P	H
		5687.8	52.95	-43.25	96.2	41.62	32.17	8.83	29.67	279	3	P	H
		5708.8	55.38	-52.29	107.67	44.05	32.19	8.82	29.68	279	3	P	H
		5724.2	55.57	-64.81	120.38	44.22	32.21	8.82	29.68	279	3	P	H
	*	5795	106.19	-	-	94.8	32.31	8.8	29.72	279	3	P	H
	*	5795	99.19	-	-	87.8	32.31	8.8	29.72	279	3	A	H
		5851	59.49	-60.43	119.92	48	32.38	8.85	29.74	279	3	P	H
		5859.8	58.88	-50.57	109.45	47.37	32.41	8.85	29.75	279	3	P	H
		5876.4	56.15	-48.01	104.16	44.6	32.43	8.87	29.75	279	3	P	H
		5933.8	53.08	-15.12	68.2	41.42	32.5	8.93	29.77	279	3	P	H
802.11n													H
HT40													H
CH 159		5615.8	52.23	-15.97	68.2	40.95	32.07	8.85	29.64	298	327	P	V
5795MHz		5657	52.09	-21.31	73.4	40.79	32.12	8.84	29.66	298	327	P	V
		5717.8	52.33	-57.85	110.18	40.98	32.21	8.82	29.68	298	327	P	V
		5724.4	53.03	-67.8	120.83	41.68	32.21	8.82	29.68	298	327	P	V
	*	5795	103.58	-	-	92.19	32.31	8.8	29.72	298	327	P	V
	*	5795	96.33	-	-	84.94	32.31	8.8	29.72	298	327	A	V
		5850.2	56.66	-65.08	121.74	45.17	32.38	8.85	29.74	298	327	P	V
		5856	56.85	-53.67	110.52	45.33	32.41	8.85	29.74	298	327	P	V
		5875.2	52.75	-52.3	105.05	41.2	32.43	8.87	29.75	298	327	P	V
		5936.2	52.41	-15.79	68.2	40.76	32.5	8.93	29.78	298	327	P	V
													V
													V
Remark	1. No other spurious found. 2. All results are PASS against Peak and Average limit line.												



Band 4 5725~5850MHz

WIFI 802.11n HT40 (Harmonic @ 3m)

WIFI Ant. 2	Note	Frequency (MHz)	Level (dBμV/m)	Over Limit (dB)	Limit Line (dBμV/m)	Read Level (dBμV)	Antenna Factor (dB/m)	Path Loss (dB)	Preamp Factor (dB)	Ant Pos (cm)	Table Pos (deg)	Peak Avg. (P/A)	Pol. (H/V)
802.11n HT40 CH 151 5755MHz		11510	45.71	-28.29	74	54.65	39.9	12.76	61.6	100	0	P	H
		17265	47.82	-20.38	68.2	47.45	40.96	15.12	55.71	100	0	P	H
													H
													H
		11510	46.69	-27.31	74	55.63	39.9	12.76	61.6	100	0	P	V
		17265	47.44	-20.76	68.2	47.07	40.96	15.12	55.71	100	0	P	V
													V
													V
802.11n HT40 CH 159 5795MHz		11590	45.33	-28.67	74	54.6	39.73	12.79	61.79	100	0	P	H
		17385	48.54	-19.66	68.2	47.45	41.38	15.17	55.46	100	0	P	H
													H
													H
		11590	46.06	-27.94	74	55.33	39.73	12.79	61.79	100	0	P	V
		17385	47.61	-20.59	68.2	46.52	41.38	15.17	55.46	100	0	P	V
													V
													V
Remark	1. No other spurious found. 2. All results are PASS against Peak and Average limit line.												



Band 4 5725~5850MHz

WIFI 802.11ac VHT80 (Band Edge @ 3m)

WIFI Ant. 2	Note	Frequency (MHz)	Level (dBμV/m)	Over Limit (dB)	Limit Line (dBμV/m)	Read Level (dBμV)	Antenna Factor (dB/m)	Path Loss (dB)	Preamp Factor (dB)	Ant Pos (cm)	Table Pos (deg)	Peak Avg. (P/A)	Pol. (H/V)
		5630.2	52.73	-15.47	68.2	41.47	32.07	8.84	29.65	252	0	P	H
		5696.6	55.43	-47.26	102.69	44.1	32.17	8.83	29.67	252	0	P	H
		5715.4	56.4	-53.11	109.51	45.07	32.19	8.82	29.68	252	0	P	H
		5724.2	55.8	-64.58	120.38	44.45	32.21	8.82	29.68	252	0	P	H
	*	5775	103.87	-	-	92.49	32.29	8.8	29.71	252	0	P	H
	*	5775	95.91	-	-	84.53	32.29	8.8	29.71	252	0	A	H
		5850.6	55.95	-64.88	120.83	44.46	32.38	8.85	29.74	252	0	P	H
		5859.8	54.79	-54.66	109.45	43.28	32.41	8.85	29.75	252	0	P	H
		5883.2	53.06	-46.05	99.11	41.5	32.43	8.88	29.75	252	0	P	H
		5932	52.07	-16.13	68.2	40.43	32.5	8.91	29.77	252	0	P	H
802.11ac													H
VHT80													H
CH 155		5619.4	52.14	-16.06	68.2	40.86	32.07	8.85	29.64	100	188	P	V
5775MHz		5672.4	51.82	-33	84.82	40.51	32.14	8.83	29.66	100	188	P	V
		5713.6	52.3	-56.71	109.01	40.97	32.19	8.82	29.68	100	188	P	V
		5725	52.38	-69.82	122.2	41.03	32.21	8.82	29.68	100	188	P	V
	*	5775	98.3	-	-	86.92	32.29	8.8	29.71	100	188	P	V
	*	5775	90.41	-	-	79.03	32.29	8.8	29.71	100	188	A	V
		5850.4	52.4	-68.89	121.29	40.91	32.38	8.85	29.74	100	188	P	V
		5858.8	53.57	-56.16	109.73	42.06	32.41	8.85	29.75	100	188	P	V
		5878.6	51.08	-51.45	102.53	39.53	32.43	8.87	29.75	100	188	P	V
		5937.8	51.79	-16.41	68.2	40.14	32.5	8.93	29.78	100	188	P	V
													V
													V
Remark	1. No other spurious found. 2. All results are PASS against Peak and Average limit line.												



Band 4 5725~5850MHz

WIFI 802.11ac VHT80 (Harmonic @ 3m)

WIFI Ant. 2	Note	Frequency (MHz)	Level (dBμV/m)	Over Limit (dB)	Limit Line (dBμV/m)	Read Level (dBμV)	Antenna Factor (dB/m)	Path Loss (dB)	Preamp Factor (dB)	Ant Pos (cm)	Table Pos (deg)	Peak Avg. (P/A)	Pol. (H/V)	
802.11ac VHT80 CH 155 5775MHz		11550	44.33	-29.67	74	53.46	39.8	12.78	61.71	100	0	P	H	
		17325	48.08	-20.12	68.2	47.4	41.14	15.14	55.6	100	0	P	H	
													H	
													H	
			11550	44.6	-29.4	74	53.73	39.8	12.78	61.71	100	0	P	V
			17325	47.72	-20.48	68.2	47.04	41.14	15.14	55.6	100	0	P	V
														V
Remark	1. No other spurious found. 2. All results are PASS against Peak and Average limit line.													



Band 4 - 5725~5850MHz

WIFI 802.11a (Band Edge @ 3m)

WIFI	Note	Frequency	Level	Over	Limit	Read	Antenna	Path	Preamp	Ant	Table	Peak	Pol.	
Ant.				Limit	Line	Level	Factor	Loss	Factor	Pos	Pos	Avg.		
1+2		(MHz)	(dBμV/m)	(dB)	(dBμV/m)	(dBμV)	(dB/m)	(dB)	(dB)	(cm)	(deg)	(P/A)	(H/V)	
802.11a CH 149 5745MHz		5621	52.1	-16.1	68.2	40.82	32.07	8.85	29.64	100	360	P	H	
		5692	55.36	-43.94	99.3	44.03	32.17	8.83	29.67	100	360	P	H	
		5720	56.91	-53.89	110.8	45.56	32.21	8.82	29.68	100	360	P	H	
		5720.2	58.1	-53.16	111.26	46.75	32.21	8.82	29.68	100	360	P	H	
	*	5745	112.88	-	-	101.52	32.24	8.81	29.69	100	360	P	H	
	*	5745	105.25	-	-	93.89	32.24	8.81	29.69	100	360	A	H	
														H
														H
			5631.6	51.8	-16.4	68.2	40.54	32.07	8.84	29.65	119	264	P	V
			5685.2	53.4	-40.88	94.28	42.07	32.17	8.83	29.67	119	264	P	V
			5712	55.2	-53.36	108.56	43.87	32.19	8.82	29.68	119	264	P	V
			5725	58.54	-63.66	122.2	47.19	32.21	8.82	29.68	119	264	P	V
	*		5745	109.55	-	-	98.19	32.24	8.81	29.69	119	264	P	V
	*		5745	102.5	-	-	91.14	32.24	8.81	29.69	119	264	A	V
														V
														V



WIFI Ant. 1+2	Note	Frequency (MHz)	Level (dBμV/m)	Over Limit (dB)	Limit Line (dBμV/m)	Read Level (dBμV)	Antenna Factor (dB/m)	Path Loss (dB)	Preamp Factor (dB)	Ant Pos (cm)	Table Pos (deg)	Peak Avg. (P/A)	Pol. (H/V)	
802.11a CH 157 5785MHz		5606.6	52.34	-15.86	68.2	41.09	32.04	8.85	29.64	100	334	P	H	
		5693.6	52.98	-47.5	100.48	41.65	32.17	8.83	29.67	100	334	P	H	
		5710.2	53.36	-54.7	108.06	42.03	32.19	8.82	29.68	100	334	P	H	
		5722.4	53.84	-62.43	116.27	42.49	32.21	8.82	29.68	100	334	P	H	
	*	5785	112.39	-	-	101.02	32.29	8.8	29.72	100	334	P	H	
	*	5785	105.21	-	-	93.84	32.29	8.8	29.72	100	334	A	H	
		5850.4	53.62	-67.67	121.29	42.13	32.38	8.85	29.74	100	334	P	H	
		5857.8	54.64	-55.37	110.01	43.13	32.41	8.85	29.75	100	334	P	H	
		5918.4	52.75	-20.32	73.07	41.13	32.48	8.91	29.77	100	334	P	H	
		5931.4	52.36	-15.84	68.2	40.72	32.5	8.91	29.77	100	334	P	H	
														H
														H
			5621.6	51.69	-16.51	68.2	40.41	32.07	8.85	29.64	118	269	P	V
			5698.4	52.43	-51.59	104.02	41.1	32.17	8.83	29.67	118	269	P	V
			5717.6	53.65	-56.48	110.13	42.3	32.21	8.82	29.68	118	269	P	V
			5722	52.14	-63.22	115.36	40.79	32.21	8.82	29.68	118	269	P	V
	*		5785	109.18	-	-	97.81	32.29	8.8	29.72	118	269	P	V
	*		5785	101.39	-	-	90.02	32.29	8.8	29.72	118	269	A	V
			5852.6	53.27	-63	116.27	41.78	32.38	8.85	29.74	118	269	P	V
			5857.6	52.93	-57.14	110.07	41.41	32.41	8.85	29.74	118	269	P	V
		5913.6	52.94	-23.67	76.61	41.33	32.48	8.9	29.77	118	269	P	V	
		5948.6	52.38	-15.82	68.2	40.7	32.53	8.93	29.78	118	269	P	V	
													V	
													V	



WiFi Ant. 1+2	Note	Frequency (MHz)	Level (dBµV/m)	Over Limit (dB)	Limit Line (dBµV/m)	Read Level (dBµV)	Antenna Factor (dB/m)	Path Loss (dB)	Preamp Factor (dB)	Ant Pos (cm)	Table Pos (deg)	Peak Avg. (P/A)	Pol. (H/V)	
802.11a CH 165 5825MHz	*	5825	112.47	-	-	101.02	32.36	8.82	29.73	100	332	P	H	
	*	5825	105.13	-	-	93.68	32.36	8.82	29.73	100	332	A	H	
		5851.8	56.14	-61.96	118.1	44.65	32.38	8.85	29.74	100	332	P	H	
		5856.2	55.23	-55.23	110.46	43.71	32.41	8.85	29.74	100	332	P	H	
		5882.6	55.44	-44.12	99.56	43.88	32.43	8.88	29.75	100	332	P	H	
		5934.8	52.93	-15.27	68.2	41.28	32.5	8.93	29.78	100	332	P	H	
														H
														H
	*	5825	109.5	-	-	98.05	32.36	8.82	29.73	100	270	P	V	
	*	5825	101.85	-	-	90.4	32.36	8.82	29.73	100	270	A	V	
		5850.4	53.01	-68.28	121.29	41.52	32.38	8.85	29.74	100	270	P	V	
		5874.2	53.55	-51.87	105.42	42	32.43	8.87	29.75	100	270	P	V	
		5876.6	53.52	-50.49	104.01	41.97	32.43	8.87	29.75	100	270	P	V	
		5937.2	51.58	-16.62	68.2	39.93	32.5	8.93	29.78	100	270	P	V	
														V
														V
													V	
Remark	1. No other spurious found. 2. All results are PASS against Peak and Average limit line.													



Band 4 5725~5850MHz

WIFI 802.11a (Harmonic @ 3m)

WIFI Ant. 1+2	Note	Frequency (MHz)	Level (dBμV/m)	Over Limit (dB)	Limit Line (dBμV/m)	Read Level (dBμV)	Antenna Factor (dB/m)	Path Loss (dB)	Preamp Factor (dB)	Ant Pos (cm)	Table Pos (deg)	Peak Avg. (P/A)	Pol. (H/V)	
802.11a CH 149 5745MHz		11490	46.2	-27.8	74	54.94	39.91	12.24	61.4	100	0	P	H	
		17235	45.04	-23.16	68.2	46.99	40.45	14.47	57.51	100	0	P	H	
													H	
													H	
			11490	46.11	-27.89	74	54.85	39.91	12.24	61.4	100	0	P	V
			17235	45.49	-22.71	68.2	47.44	40.45	14.47	57.51	100	0	P	V
														V
802.11a CH 157 5785MHz		11570	47.77	-26.23	74	56.97	39.76	12.28	61.75	100	0	P	H	
		17355	48.84	-19.36	68.2	47.96	41.26	14.52	55.53	100	0	P	H	
													H	
													H	
			11570	47.74	-26.26	74	56.94	39.76	12.28	61.75	100	0	P	V
			17355	49.76	-18.44	68.2	48.88	41.26	14.52	55.53	100	0	P	V
														V
802.11a CH 165 5825MHz		11650	46.41	-27.59	74	55.86	39.62	12.32	61.9	100	0	P	H	
		17475	49.98	-18.22	68.2	48.37	41.68	14.58	55.27	100	0	P	H	
													H	
													H	
			11650	45.55	-28.45	74	55	39.62	12.32	61.9	100	0	P	V
			17475	49.06	-19.14	68.2	47.45	41.68	14.58	55.27	100	0	P	V
														V
Remark	1. No other spurious found.													
	2. All results are PASS against Peak and Average limit line.													



Band 4 5725~5850MHz

WIFI 802.11n HT20 (Band Edge @ 3m)

WIFI Ant. 1+2	Note	Frequency (MHz)	Level (dBμV/m)	Over Limit (dB)	Limit Line (dBμV/m)	Read Level (dBμV)	Antenna Factor (dB/m)	Path Loss (dB)	Preamp Factor (dB)	Ant Pos (cm)	Table Pos (deg)	Peak Avg. (P/A)	Pol. (H/V)	
802.11n HT20 CH 149 5745MHz		5645.6	56.37	-11.83	68.2	45.09	32.09	8.84	29.65	100	338	P	H	
		5700	65.11	-40.09	105.2	53.79	32.17	8.82	29.67	100	338	P	H	
		5715.2	68	-41.46	109.46	56.67	32.19	8.82	29.68	100	338	P	H	
		5723.2	68.44	-49.66	118.1	57.09	32.21	8.82	29.68	100	338	P	H	
	*	5745	112.78	-	-	101.42	32.24	8.81	29.69	100	338	P	H	
	*	5745	105.38	-	-	94.02	32.24	8.81	29.69	100	338	A	H	
														H
														H
			5635.2	52.52	-15.68	68.2	41.24	32.09	8.84	29.65	100	262	P	V
			5695.4	61.36	-40.45	101.81	50.03	32.17	8.83	29.67	100	262	P	V
			5715.8	63.22	-46.41	109.63	51.89	32.19	8.82	29.68	100	262	P	V
			5723.8	64.36	-55.1	119.46	53.01	32.21	8.82	29.68	100	262	P	V
	*		5745	109.9	-	-	98.54	32.24	8.81	29.69	100	262	P	V
	*		5745	101.85	-	-	90.49	32.24	8.81	29.69	100	262	A	V
														V
														V



WIFI Ant. 1+2	Note	Frequency (MHz)	Level (dBµV/m)	Over Limit (dB)	Limit Line (dBµV/m)	Read Level (dBµV)	Antenna Factor (dB/m)	Path Loss (dB)	Preamp Factor (dB)	Ant Pos (cm)	Table Pos (deg)	Peak Avg. (P/A)	Pol. (H/V)
		5633	52.68	-15.52	68.2	41.4	32.09	8.84	29.65	180	0	P	H
		5685.4	54.53	-39.9	94.43	43.2	32.17	8.83	29.67	180	0	P	H
		5720	57.45	-53.35	110.8	46.1	32.21	8.82	29.68	180	0	P	H
		5721.4	59.64	-54.35	113.99	48.29	32.21	8.82	29.68	180	0	P	H
	*	5785	111.71	-	-	100.34	32.29	8.8	29.72	180	0	P	H
	*	5785	103.91	-	-	92.54	32.29	8.8	29.72	180	0	A	H
		5852.2	59.58	-57.6	117.18	48.09	32.38	8.85	29.74	180	0	P	H
		5855.8	59.95	-50.63	110.58	48.43	32.41	8.85	29.74	180	0	P	H
		5892.8	54.93	-37.06	91.99	43.35	32.46	8.88	29.76	180	0	P	H
		5942.8	52.68	-15.52	68.2	41	32.53	8.93	29.78	180	0	P	H
802.11n													H
HT20													H
CH 157		5608.6	52.04	-16.16	68.2	40.79	32.04	8.85	29.64	264	167	P	V
5785MHz		5699.8	54.22	-50.83	105.05	42.9	32.17	8.82	29.67	264	167	P	V
		5719	57.09	-53.43	110.52	45.74	32.21	8.82	29.68	264	167	P	V
		5723.8	57.95	-61.51	119.46	46.6	32.21	8.82	29.68	264	167	P	V
	*	5785	109.56	-	-	98.19	32.29	8.8	29.72	264	167	P	V
	*	5785	102.11	-	-	90.74	32.29	8.8	29.72	264	167	A	V
		5853.4	57.14	-57.31	114.45	45.65	32.38	8.85	29.74	264	167	P	V
		5862.4	56.68	-52.05	108.73	45.15	32.41	8.87	29.75	264	167	P	V
		5875.8	54.62	-49.99	104.61	43.07	32.43	8.87	29.75	264	167	P	V
		5942	52.36	-15.84	68.2	40.68	32.53	8.93	29.78	264	167	P	V
													V
													V



WiFi Ant. 1+2	Note	Frequency (MHz)	Level (dBμV/m)	Over Limit (dB)	Limit Line (dBμV/m)	Read Level (dBμV)	Antenna Factor (dB/m)	Path Loss (dB)	Preamp Factor (dB)	Ant Pos (cm)	Table Pos (deg)	Peak Avg. (P/A)	Pol. (H/V)	
802.11n HT20 CH 165 5825MHz	*	5825	112.33	-	-	100.88	32.36	8.82	29.73	158	1	P	H	
	*	5825	104.33	-	-	92.88	32.36	8.82	29.73	158	1	A	H	
		5852.8	63.69	-52.13	115.82	52.2	32.38	8.85	29.74	158	1	P	H	
		5855.6	65.1	-45.53	110.63	53.58	32.41	8.85	29.74	158	1	P	H	
		5879.6	61.46	-40.32	101.78	49.9	32.43	8.88	29.75	158	1	P	H	
		5933	53.37	-14.83	68.2	41.73	32.5	8.91	29.77	158	1	P	H	
														H
														H
	*	5825	109.31	-	-	97.86	32.36	8.82	29.73	260	166	P	V	
	*	5825	101.93	-	-	90.48	32.36	8.82	29.73	260	166	A	V	
		5852.8	61.82	-54	115.82	50.33	32.38	8.85	29.74	260	166	P	V	
		5858.8	62.53	-47.2	109.73	51.02	32.41	8.85	29.75	260	166	P	V	
		5877.4	59.58	-43.84	103.42	48.03	32.43	8.87	29.75	260	166	P	V	
		5937.2	52.49	-15.71	68.2	40.84	32.5	8.93	29.78	260	166	P	V	
														V
													V	
Remark	1. No other spurious found. 2. All results are PASS against Peak and Average limit line.													



Band 4 5725~5850MHz

WIFI 802.11n HT20 (Harmonic @ 3m)

WIFI Ant. 1+2	Note	Frequency (MHz)	Level (dBμV/m)	Over Limit (dB)	Limit Line (dBμV/m)	Read Level (dBμV)	Antenna Factor (dB/m)	Path Loss (dB)	Preamp Factor (dB)	Ant Pos (cm)	Table Pos (deg)	Peak Avg. (P/A)	Pol. (H/V)
802.11n HT20 CH 149 5745MHz		11490	51.68	-22.32	74	60.61	39.92	12.24	61.6	100	103	P	H
		11490	42.27	-11.73	54	51.2	39.92	12.24	61.6	100	103	A	H
		17235	48.34	-19.86	68.2	48.18	40.84	14.47	55.79	100	0	P	H
													H
		11490	47.79	-26.21	74	56.72	39.92	12.24	61.6	100	0	P	V
		17235	47.66	-20.54	68.2	47.5	40.84	14.47	55.79	100	0	P	V
													V
802.11n HT20 CH 157 5785MHz		11570	47.77	-26.23	74	56.97	39.76	12.28	61.75	100	0	P	H
		17355	48.07	-20.13	68.2	47.19	41.26	14.52	55.53	100	0	P	H
													H
													H
		11570	45.92	-28.08	74	55.12	39.76	12.28	61.75	100	0	P	V
		17355	48.47	-19.73	68.2	47.59	41.26	14.52	55.53	100	0	P	V
													V
802.11n HT20 CH 165 5825MHz		11650	46.91	-27.09	74	56.36	39.62	12.32	61.9	100	0	P	H
		17475	49.23	-18.97	68.2	47.62	41.68	14.58	55.27	100	0	P	H
													H
													H
		11650	45.35	-28.65	74	54.8	39.62	12.32	61.9	100	0	P	V
		17475	49.07	-19.13	68.2	47.46	41.68	14.58	55.27	100	0	P	V
													V
Remark	1. No other spurious found.												
	2. All results are PASS against Peak and Average limit line.												



Band 4 5725~5850MHz

WIFI 802.11n HT40 (Band Edge @ 3m)

WIFI Ant. 1+2	Note	Frequency (MHz)	Level (dBμV/m)	Over Limit (dB)	Limit Line (dBμV/m)	Read Level (dBμV)	Antenna Factor (dB/m)	Path Loss (dB)	Preamp Factor (dB)	Ant Pos (cm)	Table Pos (deg)	Peak Avg. (P/A)	Pol. (H/V)
		5640.8	52.69	-15.51	68.2	41.41	32.09	8.84	29.65	128	2	P	H
		5695.8	59	-43.1	102.1	47.67	32.17	8.83	29.67	128	2	P	H
		5718.8	64.14	-46.32	110.46	52.79	32.21	8.82	29.68	128	2	P	H
		5724.6	66.47	-54.82	121.29	55.12	32.21	8.82	29.68	128	2	P	H
	*	5755	110.41	-	-	99.03	32.26	8.81	29.69	128	2	P	H
	*	5755	103.09	-	-	91.71	32.26	8.81	29.69	128	2	A	H
		5851.4	52.82	-66.19	119.01	41.33	32.38	8.85	29.74	128	2	P	H
		5859.4	53.62	-55.95	109.57	42.11	32.41	8.85	29.75	128	2	P	H
		5878.6	53.54	-48.99	102.53	41.99	32.43	8.87	29.75	128	2	P	H
		5930.8	52.57	-15.63	68.2	40.93	32.5	8.91	29.77	128	2	P	H
802.11n													H
HT40													H
CH 151		5610.2	53.5	-14.7	68.2	42.25	32.04	8.85	29.64	121	266	P	V
5755MHz		5692.4	59.9	-39.7	99.6	48.57	32.17	8.83	29.67	121	266	P	V
		5715.4	62.74	-46.77	109.51	51.41	32.19	8.82	29.68	121	266	P	V
		5724.2	63.12	-57.26	120.38	51.77	32.21	8.82	29.68	121	266	P	V
	*	5755	107.74	-	-	96.36	32.26	8.81	29.69	121	266	P	V
	*	5755	100.42	-	-	89.04	32.26	8.81	29.69	121	266	A	V
		5850	52.77	-69.43	122.2	41.28	32.38	8.85	29.74	121	266	P	V
		5857.8	53.04	-56.97	110.01	41.53	32.41	8.85	29.75	121	266	P	V
		5924.4	53.1	-15.54	68.64	41.46	32.5	8.91	29.77	121	266	P	V
		5928	52.34	-15.86	68.2	40.7	32.5	8.91	29.77	121	266	P	V
													V
													V



WIFI Ant. 1+2	Note	Frequency (MHz)	Level (dBμV/m)	Over Limit (dB)	Limit Line (dBμV/m)	Read Level (dBμV)	Antenna Factor (dB/m)	Path Loss (dB)	Preamp Factor (dB)	Ant Pos (cm)	Table Pos (deg)	Peak Avg. (P/A)	Pol. (H/V)	
802.11n HT40 CH 159 5795MHz		5620.6	52.18	-16.02	68.2	40.9	32.07	8.85	29.64	128	1	P	H	
		5666.4	52.39	-27.98	80.37	41.1	32.12	8.83	29.66	128	1	P	H	
		5712.8	55.98	-52.81	108.79	44.65	32.19	8.82	29.68	128	1	P	H	
		5724.2	57.55	-62.83	120.38	46.2	32.21	8.82	29.68	128	1	P	H	
	*	5795	109.86	-	-	98.47	32.31	8.8	29.72	128	1	P	H	
	*	5795	102.88	-	-	91.49	32.31	8.8	29.72	128	1	A	H	
		5852	59.97	-57.67	117.64	48.48	32.38	8.85	29.74	128	1	P	H	
		5861.6	60.16	-48.79	108.95	48.63	32.41	8.87	29.75	128	1	P	H	
		5876.8	57.73	-46.13	103.86	46.18	32.43	8.87	29.75	128	1	P	H	
		5933.8	53.11	-15.09	68.2	41.45	32.5	8.93	29.77	128	1	P	H	
														H
														H
			5637.8	52.29	-15.91	68.2	41.01	32.09	8.84	29.65	118	271	P	V
			5699.4	52.95	-51.81	104.76	41.62	32.17	8.83	29.67	118	271	P	V
			5708.8	55.92	-51.75	107.67	44.59	32.19	8.82	29.68	118	271	P	V
			5724.2	57.56	-62.82	120.38	46.21	32.21	8.82	29.68	118	271	P	V
	*		5795	107.31	-	-	95.92	32.31	8.8	29.72	118	271	P	V
	*		5795	100.18	-	-	88.79	32.31	8.8	29.72	118	271	A	V
			5850	59.67	-62.53	122.2	48.18	32.38	8.85	29.74	118	271	P	V
			5861.2	59.78	-49.28	109.06	48.27	32.41	8.85	29.75	118	271	P	V
		5880.8	56.78	-44.11	100.89	45.22	32.43	8.88	29.75	118	271	P	V	
		5943.6	52.88	-15.32	68.2	41.2	32.53	8.93	29.78	118	271	P	V	
													V	
													V	
Remark	1. No other spurious found. 2. All results are PASS against Peak and Average limit line.													



Band 4 5725~5850MHz

WIFI 802.11n HT40 (Harmonic @ 3m)

WIFI Ant. 1+2	Note	Frequency (MHz)	Level (dBμV/m)	Over Limit (dB)	Limit Line (dBμV/m)	Read Level (dBμV)	Antenna Factor (dB/m)	Path Loss (dB)	Preamp Factor (dB)	Ant Pos (cm)	Table Pos (deg)	Peak Avg. (P/A)	Pol. (H/V)
802.11n HT40 CH 151 5755MHz		11510	46.04	-27.96	74	54.98	39.9	12.25	61.6	100	0	P	H
		17265	47.6	-20.6	68.2	47.23	40.96	14.48	55.71	100	0	P	H
													H
													H
		11510	47.09	-26.91	74	56.03	39.9	12.25	61.6	100	0	P	V
		17265	48.13	-20.07	68.2	47.76	40.96	14.48	55.71	100	0	P	V
													V
													V
802.11n HT40 CH 159 5795MHz		11590	45.1	-28.9	74	54.37	39.73	12.28	61.79	100	0	P	H
		17385	49.09	-19.11	68.2	48	41.38	14.54	55.46	100	0	P	H
													H
													H
		11590	45.26	-28.74	74	54.53	39.73	12.28	61.79	100	0	P	V
		17385	48.96	-19.24	68.2	47.87	41.38	14.54	55.46	100	0	P	V
													V
													V
Remark	1. No other spurious found. 2. All results are PASS against Peak and Average limit line.												



Band 4 5725~5850MHz

WIFI 802.11ac VHT80 (Band Edge @ 3m)

WIFI Ant. 1+2	Note	Frequency (MHz)	Level (dBμV/m)	Over Limit (dB)	Limit Line (dBμV/m)	Read Level (dBμV)	Antenna Factor (dB/m)	Path Loss (dB)	Preamp Factor (dB)	Ant Pos (cm)	Table Pos (deg)	Peak Avg. (P/A)	Pol. (H/V)	
		5611.4	53.02	-15.18	68.2	41.77	32.04	8.85	29.64	100	333	P	H	
		5695.2	65.39	-36.27	101.66	54.06	32.17	8.83	29.67	100	333	P	H	
		5707.2	66.9	-40.32	107.22	55.57	32.19	8.82	29.68	100	333	P	H	
		5723.2	67.38	-50.72	118.1	56.03	32.21	8.82	29.68	100	333	P	H	
	*	5775	107.66	-	-	96.28	32.29	8.8	29.71	100	333	P	H	
	*	5775	100.32	-	-	88.94	32.29	8.8	29.71	100	333	A	H	
		5852.6	66.65	-49.62	116.27	55.16	32.38	8.85	29.74	100	333	P	H	
		5864.6	65.64	-42.47	108.11	54.11	32.41	8.87	29.75	100	333	P	H	
		5875.2	59.16	-45.89	105.05	47.61	32.43	8.87	29.75	100	333	P	H	
		5928.4	52.27	-15.93	68.2	40.63	32.5	8.91	29.77	100	333	P	H	
802.11ac VHT80 CH 155 5775MHz													H	
													H	
			5605.8	52.43	-15.77	68.2	41.18	32.04	8.85	29.64	105	271	P	V
			5697.8	62.43	-41.15	103.58	51.1	32.17	8.83	29.67	105	271	P	V
			5718.8	63.96	-46.5	110.46	52.61	32.21	8.82	29.68	105	271	P	V
			5720.2	63.6	-47.66	111.26	52.25	32.21	8.82	29.68	105	271	P	V
		*	5775	104.26	-	-	92.88	32.29	8.8	29.71	105	271	P	V
		*	5775	97.12	-	-	85.74	32.29	8.8	29.71	105	271	A	V
			5851.2	62.5	-56.96	119.46	51.01	32.38	8.85	29.74	105	271	P	V
			5858.2	60.21	-49.69	109.9	48.7	32.41	8.85	29.75	105	271	P	V
			5878.8	54.63	-47.75	102.38	43.08	32.43	8.87	29.75	105	271	P	V
			5949.6	51.9	-16.3	68.2	40.22	32.53	8.93	29.78	105	271	P	V
														V
														V
	Remark	1. No other spurious found. 2. All results are PASS against Peak and Average limit line.												



Band 4 5725~5850MHz

WIFI 802.11ac VHT80 (Harmonic @ 3m)

WIFI Ant. 1+2	Note	Frequency (MHz)	Level (dBμV/m)	Over Limit (dB)	Limit Line (dBμV/m)	Read Level (dBμV)	Antenna Factor (dB/m)	Path Loss (dB)	Preamp Factor (dB)	Ant Pos (cm)	Table Pos (deg)	Peak Avg. (P/A)	Pol. (H/V)	
802.11ac VHT80 CH 155 5775MHz		11550	44.67	-29.33	74	53.8	39.8	12.27	61.71	100	0	P	H	
		17325	48.53	-19.67	68.2	47.85	41.14	14.51	55.6	100	0	P	H	
													H	
													H	
			11550	44.86	-29.14	74	53.99	39.8	12.27	61.71	100	0	P	V
			17325	48.52	-19.68	68.2	47.84	41.14	14.51	55.6	100	0	P	V
														V
Remark	1. No other spurious found. 2. All results are PASS against Peak and Average limit line.													



<TXBF Mode>

Band 4 - 5725~5850MHz

WIFI 802.11ac VHT20 (Band Edge @ 3m)

WIFI Ant. 1+2	Note	Frequency (MHz)	Level (dBμV/m)	Over Limit (dB)	Limit Line (dBμV/m)	Read Level (dBμV)	Antenna Factor (dB/m)	Path Loss (dB)	Preamp Factor (dB)	Ant Pos (cm)	Table Pos (deg)	Peak Avg. (P/A)	Pol. (H/V)	
802.11ac VHT20 CH 149 5745MHz		5634.4	53.56	-14.64	68.2	42.28	32.09	8.84	29.65	229	13	P	H	
		5696.4	65.1	-37.45	102.55	53.77	32.17	8.83	29.67	229	13	P	H	
		5717.4	69.03	-41.04	110.07	57.7	32.19	8.82	29.68	229	13	P	H	
		5725	70.09	-52.11	122.2	58.74	32.21	8.82	29.68	229	13	P	H	
	*	5745	115.13	-	-	103.77	32.24	8.81	29.69	229	13	P	H	
	*	5745	106.81	-	-	95.45	32.24	8.81	29.69	229	13	A	H	
														H
														H
			5648	52.82	-15.38	68.2	41.54	32.09	8.84	29.65	234	265	P	V
			5697.4	61.02	-42.26	103.28	49.69	32.17	8.83	29.67	234	265	P	V
			5718.4	64.4	-45.95	110.35	53.05	32.21	8.82	29.68	234	265	P	V
			5725	65.13	-57.07	122.2	53.78	32.21	8.82	29.68	234	265	P	V
	*		5745	111.35	-	-	99.99	32.24	8.81	29.69	234	265	P	V
	*		5745	102.84	-	-	91.48	32.24	8.81	29.69	234	265	A	V
														V
														V



WIFI Ant. 1+2	Note	Frequency (MHz)	Level (dBμV/m)	Over Limit (dB)	Limit Line (dBμV/m)	Read Level (dBμV)	Antenna Factor (dB/m)	Path Loss (dB)	Preamp Factor (dB)	Ant Pos (cm)	Table Pos (deg)	Peak Avg. (P/A)	Pol. (H/V)
		5646.4	52.89	-15.31	68.2	41.61	32.09	8.84	29.65	233	15	P	H
		5695.6	54.84	-47.12	101.96	43.51	32.17	8.83	29.67	233	15	P	H
		5717.2	58.76	-51.26	110.02	47.43	32.19	8.82	29.68	233	15	P	H
		5723.2	60.09	-58.01	118.1	48.74	32.21	8.82	29.68	233	15	P	H
	*	5785	114.65	-	-	103.28	32.29	8.8	29.72	233	15	P	H
	*	5785	106.45	-	-	95.08	32.29	8.8	29.72	233	15	A	H
		5852.8	58.08	-57.74	115.82	46.59	32.38	8.85	29.74	233	15	P	H
		5860	56.52	-52.88	109.4	45.01	32.41	8.85	29.75	233	15	P	H
		5892.2	53.11	-39.33	92.44	41.53	32.46	8.88	29.76	233	15	P	H
		5942.4	53.67	-14.53	68.2	41.99	32.53	8.93	29.78	233	15	P	H
802.11ac													H
VHT20													H
CH 157		5645	53.25	-14.95	68.2	41.97	32.09	8.84	29.65	227	262	P	V
5785MHz		5694.4	54.25	-46.82	101.07	42.92	32.17	8.83	29.67	227	262	P	V
		5711.2	57.95	-50.39	108.34	46.62	32.19	8.82	29.68	227	262	P	V
		5723	59.21	-58.43	117.64	47.86	32.21	8.82	29.68	227	262	P	V
	*	5785	111.05	-	-	99.68	32.29	8.8	29.72	227	262	P	V
	*	5785	103.01	-	-	91.64	32.29	8.8	29.72	227	262	A	V
		5850.8	56	-64.38	120.38	44.51	32.38	8.85	29.74	227	262	P	V
		5855.4	56.95	-53.74	110.69	45.43	32.41	8.85	29.74	227	262	P	V
		5896.6	54.36	-34.82	89.18	42.78	32.46	8.88	29.76	227	262	P	V
		5936.4	52.25	-15.95	68.2	40.6	32.5	8.93	29.78	227	262	P	V
													V
													V



WiFi Ant. 1+2	Note	Frequency (MHz)	Level (dBμV/m)	Over Limit (dB)	Limit Line (dBμV/m)	Read Level (dBμV)	Antenna Factor (dB/m)	Path Loss (dB)	Preamp Factor (dB)	Ant Pos (cm)	Table Pos (deg)	Peak Avg. (P/A)	Pol. (H/V)	
802.11ac VHT20 CH 165 5825MHz	*	5825	114.62	-	-	103.17	32.36	8.82	29.73	232	15	P	H	
	*	5825	106.57	-	-	95.12	32.36	8.82	29.73	232	15	A	H	
		5853.2	64.78	-50.12	114.9	53.29	32.38	8.85	29.74	232	15	P	H	
		5856.4	63.76	-46.65	110.41	52.24	32.41	8.85	29.74	232	15	P	H	
		5875.6	61.71	-43.04	104.75	50.16	32.43	8.87	29.75	232	15	P	H	
		5928.6	54.08	-14.12	68.2	42.44	32.5	8.91	29.77	232	15	P	H	
														H
														H
	*	5825	112.21	-	-	100.76	32.36	8.82	29.73	230	262	P	V	
	*	5825	102.69	-	-	91.24	32.36	8.82	29.73	230	262	A	V	
		5853.8	63.36	-50.18	113.54	51.84	32.41	8.85	29.74	230	262	P	V	
		5873.6	62.08	-43.51	105.59	50.53	32.43	8.87	29.75	230	262	P	V	
		5875.8	59.98	-44.63	104.61	48.43	32.43	8.87	29.75	230	262	P	V	
		5931.8	52.63	-15.57	68.2	40.99	32.5	8.91	29.77	230	262	P	V	
														V
													V	
Remark	1. No other spurious found. 2. All results are PASS against Peak and Average limit line.													



Band 4 5725~5850MHz

WIFI 802.11ac VHT20 (Harmonic @ 3m)

WIFI Ant. 1+2	Note	Frequency (MHz)	Level (dBμV/m)	Over Limit (dB)	Limit Line (dBμV/m)	Read Level (dBμV)	Antenna Factor (dB/m)	Path Loss (dB)	Preamp Factor (dB)	Ant Pos (cm)	Table Pos (deg)	Peak Avg. (P/A)	Pol. (H/V)
802.11ac VHT20 CH 149 5745MHz		11490	47.16	-26.84	74	56.09	39.92	12.75	61.6	100	0	P	H
		17235	48.23	-19.97	68.2	48.07	40.84	15.11	55.79	100	0	P	H
													H
													H
		11490	45.93	-28.07	74	54.86	39.92	12.75	61.6	100	0	P	V
		17235	48.66	-19.54	68.2	48.5	40.84	15.11	55.79	100	0	P	V
802.11ac VHT20 CH 157 5785MHz		11570	45.04	-28.96	74	54.24	39.76	12.79	61.75	100	0	P	H
		17355	48.43	-19.77	68.2	47.55	41.26	15.15	55.53	100	0	P	H
													H
													H
		11570	45.14	-28.86	74	54.34	39.76	12.79	61.75	100	0	P	V
		17355	48.25	-19.95	68.2	47.37	41.26	15.15	55.53	100	0	P	V
802.11ac VHT20 CH 165 5825MHz		11650	46.32	-27.68	74	55.77	39.62	12.83	61.9	100	0	P	H
		17475	49.65	-18.55	68.2	48.04	41.68	15.2	55.27	100	0	P	H
													H
													H
		11650	45.77	-28.23	74	55.22	39.62	12.83	61.9	100	0	P	V
		17475	49.07	-19.13	68.2	47.46	41.68	15.2	55.27	100	0	P	V
Remark	1. No other spurious found.												
	2. All results are PASS against Peak and Average limit line.												



Band 4 5725~5850MHz

WIFI 802.11ac VHT40 (Band Edge @ 3m)

WIFI Ant. 1+2	Note	Frequency (MHz)	Level (dBμV/m)	Over Limit (dB)	Limit Line (dBμV/m)	Read Level (dBμV)	Antenna Factor (dB/m)	Path Loss (dB)	Preamp Factor (dB)	Ant Pos (cm)	Table Pos (deg)	Peak Avg. (P/A)	Pol. (H/V)	
		5606	53.37	-14.83	68.2	42.12	32.04	8.85	29.64	230	9	P	H	
		5699.8	61.5	-43.55	105.05	50.18	32.17	8.82	29.67	230	9	P	H	
		5719.8	70.56	-40.18	110.74	59.21	32.21	8.82	29.68	230	9	P	H	
		5724.2	73.12	-47.26	120.38	61.77	32.21	8.82	29.68	230	9	P	H	
	*	5755	112.76	-	-	101.38	32.26	8.81	29.69	230	9	P	H	
	*	5755	103.93	-	-	92.55	32.26	8.81	29.69	230	9	A	H	
		5854.4	53.98	-58.19	112.17	42.46	32.41	8.85	29.74	230	9	P	H	
		5868.4	54.27	-52.78	107.05	42.74	32.41	8.87	29.75	230	9	P	H	
		5887	54.29	-42	96.29	42.74	32.43	8.88	29.76	230	9	P	H	
		5928.6	53.22	-14.98	68.2	41.58	32.5	8.91	29.77	230	9	P	H	
802.11ac VHT40 CH 151 5755MHz													H	
													H	
			5648	53.52	-14.68	68.2	42.24	32.09	8.84	29.65	235	265	P	V
			5693.6	63.41	-37.07	100.48	52.08	32.17	8.83	29.67	235	265	P	V
			5714.4	66.76	-42.47	109.23	55.43	32.19	8.82	29.68	235	265	P	V
			5721	68.4	-44.68	113.08	57.05	32.21	8.82	29.68	235	265	P	V
		*	5755	109	-	-	97.62	32.26	8.81	29.69	235	265	P	V
		*	5755	100.23	-	-	88.85	32.26	8.81	29.69	235	265	A	V
			5853.8	57.71	-55.83	113.54	46.19	32.41	8.85	29.74	235	265	P	V
			5866.2	56.6	-51.06	107.66	45.07	32.41	8.87	29.75	235	265	P	V
			5882.2	54.79	-45.06	99.85	43.23	32.43	8.88	29.75	235	265	P	V
			5926.4	52.73	-15.47	68.2	41.09	32.5	8.91	29.77	235	265	P	V
														V
														V



WIFI Ant. 1+2	Note	Frequency (MHz)	Level (dBμV/m)	Over Limit (dB)	Limit Line (dBμV/m)	Read Level (dBμV)	Antenna Factor (dB/m)	Path Loss (dB)	Preamp Factor (dB)	Ant Pos (cm)	Table Pos (deg)	Peak Avg. (P/A)	Pol. (H/V)
		5633	52.9	-15.3	68.2	41.62	32.09	8.84	29.65	215	12	P	H
		5692.6	57.14	-42.6	99.74	45.81	32.17	8.83	29.67	215	12	P	H
		5718.8	61.78	-48.68	110.46	50.43	32.21	8.82	29.68	215	12	P	H
		5724.8	62.73	-59.01	121.74	51.38	32.21	8.82	29.68	215	12	P	H
	*	5795	112.7	-	-	101.31	32.31	8.8	29.72	215	12	P	H
	*	5795	103.56	-	-	92.17	32.31	8.8	29.72	215	12	A	H
		5854.4	64.52	-47.65	112.17	53	32.41	8.85	29.74	215	12	P	H
		5863.4	64.49	-43.96	108.45	52.96	32.41	8.87	29.75	215	12	P	H
		5877.8	60.87	-42.25	103.12	49.32	32.43	8.87	29.75	215	12	P	H
		5925	55.52	-12.68	68.2	43.88	32.5	8.91	29.77	215	12	P	H
802.11ac													H
VHT40													H
CH 159		5640.6	53.43	-14.77	68.2	42.15	32.09	8.84	29.65	222	261	P	V
5795MHz		5696.2	54.49	-47.91	102.4	43.16	32.17	8.83	29.67	222	261	P	V
		5718.6	58.25	-52.16	110.41	46.9	32.21	8.82	29.68	222	261	P	V
		5720.6	59.3	-52.87	112.17	47.95	32.21	8.82	29.68	222	261	P	V
	*	5795	108.13	-	-	96.74	32.31	8.8	29.72	222	261	P	V
	*	5795	99.35	-	-	87.96	32.31	8.8	29.72	222	261	A	V
		5851	62.33	-57.59	119.92	50.84	32.38	8.85	29.74	222	261	P	V
		5856.8	62.09	-48.21	110.3	50.57	32.41	8.85	29.74	222	261	P	V
		5876.2	59.24	-45.07	104.31	47.69	32.43	8.87	29.75	222	261	P	V
		5933	52.79	-15.41	68.2	41.15	32.5	8.91	29.77	222	261	P	V
													V
													V
Remark	1. No other spurious found. 2. All results are PASS against Peak and Average limit line.												



Band 4 5725~5850MHz

WIFI 802.11ac VHT40 (Harmonic @ 3m)

WIFI Ant. 1+2	Note	Frequency (MHz)	Level (dBμV/m)	Over Limit (dB)	Limit Line (dBμV/m)	Read Level (dBμV)	Antenna Factor (dB/m)	Path Loss (dB)	Preamp Factor (dB)	Ant Pos (cm)	Table Pos (deg)	Peak Avg. (P/A)	Pol. (H/V)	
802.11ac VHT40 CH 151 5755MHz		11510	46.08	-27.92	74	55.02	39.9	12.76	61.6	100	0	P	H	
		17265	49.57	-18.63	68.2	49.2	40.96	15.12	55.71	100	0	P	H	
													H	
													H	
			11510	45.92	-28.08	74	54.86	39.9	12.76	61.6	100	0	P	V
			17265	49.36	-18.84	68.2	48.99	40.96	15.12	55.71	100	0	P	V
														V
802.11ac VHT40 CH 159 5795MHz		11590	45.62	-28.38	74	54.89	39.73	12.79	61.79	100	0	P	H	
		17385	48.69	-19.51	68.2	47.6	41.38	15.17	55.46	100	0	P	H	
													H	
													H	
			11590	45.34	-28.66	74	54.61	39.73	12.79	61.79	100	0	P	V
			17385	48.46	-19.74	68.2	47.37	41.38	15.17	55.46	100	0	P	V
														V
Remark	1. No other spurious found.													
	2. All results are PASS against Peak and Average limit line.													



Band 4 5725~5850MHz

WIFI 802.11ac VHT80 (Band Edge @ 3m)

WIFI Ant. 1+2	Note	Frequency (MHz)	Level (dBμV/m)	Over Limit (dB)	Limit Line (dBμV/m)	Read Level (dBμV)	Antenna Factor (dB/m)	Path Loss (dB)	Preamp Factor (dB)	Ant Pos (cm)	Table Pos (deg)	Peak Avg. (P/A)	Pol. (H/V)
		5632.4	54.04	-14.16	68.2	42.78	32.07	8.84	29.65	217	9	P	H
		5699	59.88	-44.58	104.46	48.55	32.17	8.83	29.67	217	9	P	H
		5716.8	62.8	-47.11	109.91	51.47	32.19	8.82	29.68	217	9	P	H
		5724.4	62.73	-58.1	120.83	51.38	32.21	8.82	29.68	217	9	P	H
	*	5775	106.95	-	-	95.57	32.29	8.8	29.71	217	9	P	H
	*	5775	97.86	-	-	86.48	32.29	8.8	29.71	217	9	A	H
		5851.4	62.18	-56.83	119.01	50.69	32.38	8.85	29.74	217	9	P	H
		5861	62.16	-46.96	109.12	50.65	32.41	8.85	29.75	217	9	P	H
		5876	57.43	-47.03	104.46	45.88	32.43	8.87	29.75	217	9	P	H
		5939.8	53.16	-15.04	68.2	41.48	32.53	8.93	29.78	217	9	P	H
802.11ac													H
VHT80													H
CH 155		5647.8	53.15	-15.05	68.2	41.87	32.09	8.84	29.65	224	261	P	V
5775MHz		5699.2	56.75	-47.86	104.61	45.42	32.17	8.83	29.67	224	261	P	V
		5716.8	60.53	-49.38	109.91	49.2	32.19	8.82	29.68	224	261	P	V
		5721.6	61.94	-52.51	114.45	50.59	32.21	8.82	29.68	224	261	P	V
	*	5775	103.67	-	-	92.29	32.29	8.8	29.71	224	261	P	V
	*	5775	94.9	-	-	83.52	32.29	8.8	29.71	224	261	A	V
		5852.8	59.21	-56.61	115.82	47.72	32.38	8.85	29.74	224	261	P	V
		5855	58.87	-51.93	110.8	47.35	32.41	8.85	29.74	224	261	P	V
		5875.4	54.13	-50.77	104.9	42.58	32.43	8.87	29.75	224	261	P	V
		5930.4	52.56	-15.64	68.2	40.92	32.5	8.91	29.77	224	261	P	V
													V
													V
Remark	1. No other spurious found. 2. All results are PASS against Peak and Average limit line.												



Band 4 5725~5850MHz

WIFI 802.11ac VHT80 (Harmonic @ 3m)

WIFI Ant. 1+2	Note	Frequency (MHz)	Level (dBμV/m)	Over Limit (dB)	Limit Line (dBμV/m)	Read Level (dBμV)	Antenna Factor (dB/m)	Path Loss (dB)	Preamp Factor (dB)	Ant Pos (cm)	Table Pos (deg)	Peak Avg. (P/A)	Pol. (H/V)	
802.11ac VHT80 CH 155 5775MHz		11550	45.72	-28.28	74	54.85	39.8	12.78	61.71	100	0	P	H	
		17325	48.68	-19.52	68.2	48	41.14	15.14	55.6	100	0	P	H	
													H	
													H	
			11550	44.85	-29.15	74	53.98	39.8	12.78	61.71	100	0	P	V
			17325	48.68	-19.52	68.2	48	41.14	15.14	55.6	100	0	P	V
														V
Remark	1. No other spurious found. 2. All results are PASS against Peak and Average limit line.													



Emission below 1GHz

5GHz WIFI 802.11ac VHT40 (LF @ 3m)

WIFI	Note	Frequency	Level	Over	Limit	Read	Antenna	Path	Preamp	Ant	Table	Peak	Pol.	
Ant.				Limit	Line	Level	Factor	Loss	Factor	Pos	Pos	Avg.		
1+2		(MHz)	(dBμV/m)	(dB)	(dBμV/m)	(dBμV)	(dB/m)	(dB)	(dB)	(cm)	(deg)	(P/A)	(H/V)	
5GHz 802.11ac VHT40 LF		65.64	28.65	-11.35	40	47.7	12.13	1.13	32.31	-	-	P	H	
		156.63	31.83	-11.67	43.5	45.75	16.8	1.56	32.28	-	-	P	H	
		237.36	42.96	-3.04	46	56.15	17.08	1.95	32.22	100	0	P	H	
		312.6	27.46	-18.54	46	38.02	19.42	2.15	32.13	-	-	P	H	
		403.6	27.57	-18.43	46	35.27	21.99	2.46	32.15	-	-	P	H	
		719.3	36.06	-9.94	46	37.97	27.06	3.17	32.14	-	-	P	H	
													H	
													H	
													H	
													H	
													H	
													H	
													H	
													H	
													H	
													H	
													H	
			30.54	30.26	-9.74	40	37.85	23.96	0.79	32.34	100	0	P	V
			66.18	27.71	-12.29	40	46.76	12.13	1.13	32.31	-	-	P	V
		237.63	35.21	-10.79	46	48.4	17.08	1.95	32.22	-	-	P	V	
		407.8	28.42	-17.58	46	35.97	22.14	2.46	32.15	-	-	P	V	
		720.7	31.37	-14.63	46	33.23	27.1	3.17	32.13	-	-	P	V	
		897.1	35.05	-10.95	46	34	29.02	3.55	31.52	-	-	P	V	
													V	
													V	
													V	
													V	
													V	
													V	
													V	
Remark	1. No other spurious found. 2. All results are PASS against limit line.													



Note symbol

*	Fundamental Frequency which can be ignored. However, the level of any unwanted emissions shall not exceed the level of the fundamental frequency.
!	Test result is over limit line.
P/A	Peak or Average
H/V	Horizontal or Vertical



A calculation example for radiated spurious emission is shown as below:

WIFI	Note	Frequency	Level	Over	Limit	Read	Antenna	Path	Preamp	Ant	Table	Peak	Pol.
Ant.				Limit	Line	Level	Factor	Loss	Factor	Pos	Pos	Avg.	
1+2		(MHz)	(dBμV/m)	(dB)	(dBμV/m)	(dBμV)	(dB/m)	(dB)	(dB)	(cm)	(deg)	(P/A)	(H/V)
802.11b		2390	55.45	-18.55	74	54.51	32.22	4.58	35.86	103	308	P	H
CH 01													
2412MHz		2390	43.54	-10.46	54	42.6	32.22	4.58	35.86	103	308	A	H

1. Path Loss(dB) = Cable loss(dB) + Filter loss(dB) + Attenuator loss(dB)
2. Level(dBμV/m) = Antenna Factor(dB/m) + Path Loss(dB) + Read Level(dBμV) - Preamp Factor(dB)
3. Over Limit(dB) = Level(dBμV/m) – Limit Line(dBμV/m)

For Peak Limit @ 2390MHz:

1. Level(dBμV/m)
= Antenna Factor(dB/m) + Path Loss(dB) + Read Level(dBμV) - Preamp Factor(dB)
= 32.22(dB/m) + 4.58(dB) + 54.51(dBμV) – 35.86 (dB)
= 55.45 (dBμV/m)
2. Over Limit(dB)
= Level(dBμV/m) – Limit Line(dBμV/m)
= 55.45(dBμV/m) – 74(dBμV/m)
= -18.55(dB)

For Average Limit @ 2390MHz:

1. Level(dBμV/m)
= Antenna Factor(dB/m) + Path Loss(dB) + Read Level(dBμV) - Preamp Factor(dB)
= 32.22(dB/m) + 4.58(dB) + 42.6(dBμV) – 35.86 (dB)
= 43.54 (dBμV/m)
2. Over Limit(dB) = Level(dBμV/m) – Limit Line(dBμV/m)
= 43.54(dBμV/m) – 54(dBμV/m)
= -10.46(dB)

Both peak and average measured complies with the limit line, so test result is “PASS”.



Appendix C. Radiated Spurious Emission Plots

Test Engineer :	Fu Chen, Alex Jheng, and Wilson Wu	Temperature :	24~25°C
		Relative Humidity :	48~52%

Note symbol

-L	Low channel location
-R	High channel location



<For Sample 1>

<CDD Mode>

Band 4 - 5725~5850MHz

WIFI 802.11a (Band Edge @ 3m)

WIFI	Band 4 5725~5850MHz Band Edge @ 3m	
ANT	802.11a CH149 5745MHz	
1	Horizontal	Fundamental
Peak	<p>Site : 03CH13-44V Condition : PEAK_BE(B4)_16-24 3m HORN_91200_1241 HORIZONTAL RBW:1000.0000 Hz VSW:3000.0000 Hz SWT:Auto Detector : Peak Project : 860204 Mode : 11</p>	<p>Site : 03CH13-44V Condition : PEAK(LIN)11 3m HORN_91200_1241 HORIZONTAL RBW:1000.0000 Hz VSW:3000.0000 Hz SWT:Auto Detector : Peak Project : 860204 Mode : 11</p>

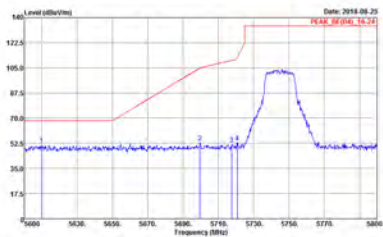
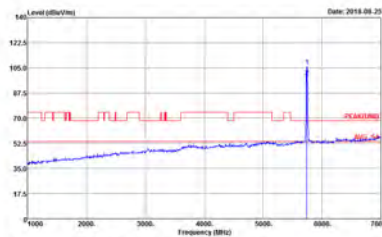

WIFI	Band 4 5725~5850MHz Band Edge @ 3m	
ANT	802.11a CH149 5745MHz	
1	Vertical	Fundamental
Peak	 <p>Site : 03CHE34W Condition : PEAK_8E[04]_16-24 3m HORN_91200_1241 VERTICAL RBW:1000.0000 Hz VSW:3000.0000 Hz SWT:Auto Detector : Peak Project : 860204 Mode : II</p>	 <p>Site : 03CHE34W Condition : PEAK(LINII) 3m HORN_91200_1241 VERTICAL RBW:1000.0000 Hz VSW:3000.0000 Hz SWT:Auto Detector : Peak Project : 860204 Mode : II</p>



WIFI	Band 4 5725~5850MHz Band Edge @ 3m	
ANT	802.11a CH157 5785MHz	
1	Horizontal	Fundamental
Peak	<p>Site : 03CH13-HV Condition : PEAK_86(04)_16-24 3m HORN_91200_1241 HORIZONTAL RBW:1000.0000Hz VSW:3000.0000Hz SWT:Auto Detector : Peak Project : 860204 Mode : 12</p>	<p>Site : 03CH13-HV Condition : PEAK(LINE) 3m HORN_91200_1241 HORIZONTAL RBW:1000.0000Hz VSW:3000.0000Hz SWT:Auto Detector : Peak Project : 860204 Mode : 12</p>
Peak	<p>Site : 03CH13-HV Condition : PEAK_86(04)_16-24 3m HORN_91200_1241 HORIZONTAL RBW:1000.0000Hz VSW:3000.0000Hz SWT:Auto Detector : Peak Project : 860204 Mode : 12</p>	Left blank



WIFI	Band 4 5725~5850MHz Band Edge @ 3m	
ANT	802.11a CH157 5785MHz	
1	Vertical	Fundamental
Peak	<p>Site : 03CH13-HV Condition : PEAK_86(04)_16-24 3m HORN_91200_1241 VERTICAL RBW:1000.0000Hz VSW:3000.0000Hz SWT:Auto Detector : Peak Project : 860204 Mode : 12</p>	<p>Site : 03CH13-HV Condition : PEAK(LINE) 3m HORN_91200_1241 VERTICAL RBW:1000.0000Hz VSW:3000.0000Hz SWT:Auto Detector : Peak Project : 860204 Mode : 12</p>
Peak	<p>Site : 03CH13-HV Condition : PEAK_86(04)_16-24 3m HORN_91200_1241 VERTICAL RBW:1000.0000Hz VSW:3000.0000Hz SWT:Auto Detector : Peak Project : 860204 Mode : 12</p>	Left blank



WIFI	Band 4 5725~5850MHz Band Edge @ 3m	
ANT	802.11a CH165 5825MHz	
1	Horizontal	Fundamental
Peak	<p>Site : 03CH1E14V Condition : PEAK_86[04]_16-24 3m HORN_91200_1241 HORIZONTAL RBW:1000.0000 Hz VSW:3000.0000 Hz SWT:Auto Detector : Peak Project : 860204 Mode : IS</p>	<p>Site : 03CH1E14V Condition : PEAK(LIN1) 3m HORN_91200_1241 HORIZONTAL RBW:1000.0000 Hz VSW:3000.0000 Hz SWT:Auto Detector : Peak Project : 860204 Mode : IS</p>



WIFI	Band 4 5725~5850MHz Band Edge @ 3m	
ANT	802.11a CH165 5825MHz	
1	Vertical	Fundamental
Peak	<p>Site : 03CHE344V Condition : PEAK_86[04]_16-24 3m HORN_91200_1241 VERTICAL RBW:1000.0000 Hz VSW:3000.0000 Hz SWT:Auto Detector : Peak Project : 860204 Mode : IS</p>	<p>Site : 03CHE344V Condition : PEAK(LIN1) 3m HORN_91200_1241 VERTICAL RBW:1000.0000 Hz VSW:3000.0000 Hz SWT:Auto Detector : Peak Project : 860204 Mode : IS</p>



Band 4 5725~5850MHz
WIFI 802.11n HT20 (Band Edge @ 3m)

WIFI	Band 4 5725~5850MHz Band Edge @ 3m	
ANT	802.11n HT20 CH149 5745MHz	
1	Horizontal	Fundamental
Peak	<p>Site : 03CH13-HY Condition : PEAK_86(84)_16-24 3m HORN_91200_1241 HORIZONTAL Detector : Peak Project : 860204 Mode : 37</p>	<p>Site : 03CH13-HY Condition : PEAK(UNIT) 3m HORN_91200_1241 HORIZONTAL Detector : Peak Project : 860204 Mode : 37</p>



WIFI	Band 4 5725~5850MHz Band Edge @ 3m	
ANT	802.11n HT20 CH149 5745MHz	
1	Vertical	Fundamental
Peak	<p>Site : 03CHE14V Condition : PEAK_86[04]_16-24 3m HORN_91200_1241 VERTICAL RBW:1000.0000 Hz VSW:3000.0000 Hz SWT:Auto Detector : Peak Project : 860204 Mode : 37</p>	<p>Site : 03CHE14V Condition : PEAK(LIN1) 3m HORN_91200_1241 VERTICAL RBW:1000.0000 Hz VSW:3000.0000 Hz SWT:Auto Detector : Peak Project : 860204 Mode : 37</p>



WIFI	Band 4 5725~5850MHz Band Edge @ 3m	
ANT	802.11n HT20 CH157 5785MHz	
1	Horizontal	Fundamental
Peak	<p>Site : 03CH13-HV Condition : PEAK_86(04)_16-24 3m HORN_91200_1241 HORIZONTAL RBW:1000.0000Hz VSW:3000.0000Hz SWT:Auto Detector : Peak Project : 860204 Mode : IS</p>	<p>Site : 03CH13-HV Condition : PEAK(LINE) 3m HORN_91200_1241 HORIZONTAL RBW:1000.0000Hz VSW:3000.0000Hz SWT:Auto Detector : Peak Project : 860204 Mode : IS</p>
Peak	<p>Site : 03CH13-HV Condition : PEAK_86(04)_16-24 3m HORN_91200_1241 HORIZONTAL RBW:1000.0000Hz VSW:3000.0000Hz SWT:Auto Detector : Peak Project : 860204 Mode : IS</p>	Left blank



WIFI	Band 4 5725~5850MHz Band Edge @ 3m	
ANT	802.11n HT20 CH157 5785MHz	
1	Vertical	Fundamental
Peak	<p>Site : 03CH13-HV Condition : PEAK_86(04)_16-24 3m HORN_91200_1241 VERTICAL RBW:1000.0000Hz VSW:3000.0000Hz SWT:Auto Detector : Peak Project : 860204 Mode : IS</p>	<p>Site : 03CH13-HV Condition : PEAK(LINE) 3m HORN_91200_1241 VERTICAL RBW:1000.0000Hz VSW:3000.0000Hz SWT:Auto Detector : Peak Project : 860204 Mode : IS</p>
Peak	<p>Site : 03CH13-HV Condition : PEAK_86(04)_16-24 3m HORN_91200_1241 VERTICAL RBW:1000.0000Hz VSW:3000.0000Hz SWT:Auto Detector : Peak Project : 860204 Mode : IS</p>	Left blank



WIFI	Band 4 5725~5850MHz Band Edge @ 3m	
ANT	802.11n HT20 CH165 5825MHz	
1	Horizontal	Fundamental
Peak	<p>Site : 03CH13-44V Condition : PEAK_86[04]_16-24 3m HORN_91200_1241 HORIZONTAL RBW:1000.0000 Hz VSW:3000.0000 Hz SWT:Auto Detector : Peak Project : 860204 Mode : 39</p>	<p>Site : 03CH13-44V Condition : PEAK(LIN11) 3m HORN_91200_1241 HORIZONTAL RBW:1000.0000 Hz VSW:3000.0000 Hz SWT:Auto Detector : Peak Project : 860204 Mode : 39</p>



WIFI	Band 4 5725~5850MHz Band Edge @ 3m	
ANT	802.11n HT20 CH165 5825MHz	
1	Vertical	Fundamental
Peak	<p>Site : 03CHE144V Condition : PEAK_86[04]_16-24 3m HORN_91200_1241 VERTICAL RBW:1000.0000 Hz VSW:3000.0000 Hz SWT:Auto Detector : Peak Project : 860204 Mode : 39</p>	<p>Site : 03CHE144V Condition : PEAK(LIN1) 3m HORN_91200_1241 VERTICAL RBW:1000.0000 Hz VSW:3000.0000 Hz SWT:Auto Detector : Peak Project : 860204 Mode : 39</p>



Band 4 5725~5850MHz

WIFI 802.11n HT40 (Band Edge @ 3m)

WIFI	Band 4 5725~5850MHz Band Edge @ 3m	
ANT	802.11n HT40 CH151 5755MHz	
1	Horizontal	Fundamental
Peak	<p>Site : 03CH13-HY Condition : PEAK_BE[84]_16-24 3m HORN_91200_1241 HORIZONTAL RBW:3000.0000Hz VSW:3000.0000Hz SWT:Auto Detector : Peak Project : 860204 Mode : 40</p>	<p>Site : 03CH13-HY Condition : PEAK(UNIT) 3m HORN_91200_1241 HORIZONTAL RBW:3000.0000Hz VSW:3000.0000Hz SWT:Auto Detector : Peak Project : 860204 Mode : 40</p>
Peak	<p>Site : 03CH13-HY Condition : PEAK_BE[84]_16-24 3m HORN_91200_1241 HORIZONTAL RBW:3000.0000Hz VSW:3000.0000Hz SWT:Auto Detector : Peak Project : 860204 Mode : 40</p>	Left blank



WIFI	Band 4 5725~5850MHz Band Edge @ 3m	
ANT	802.11n HT40 CH151 5755MHz	
1	Vertical	Fundamental
Peak	<p>Site : 03CH13-HV Condition : PEAK_86(04)_16-24 3m HORN_91200_1241 VERTICAL RBW:1000.0000Hz VSW:3000.0000Hz SWT:Auto Detector : Peak Project : 860204 Mode : 40</p>	<p>Site : 03CH13-HV Condition : PEAK(LINE) 3m HORN_91200_1241 VERTICAL RBW:1000.0000Hz VSW:3000.0000Hz SWT:Auto Detector : Peak Project : 860204 Mode : 40</p>
Peak	<p>Site : 03CH13-HV Condition : PEAK_86(04)_16-24 3m HORN_91200_1241 VERTICAL RBW:1000.0000Hz VSW:3000.0000Hz SWT:Auto Detector : Peak Project : 860204 Mode : 40</p>	Left blank



WIFI	Band 4 5725~5850MHz Band Edge @ 3m	
ANT	802.11n HT40 CH159 5795MHz	
1	Horizontal	Fundamental
Peak	<p>Site : 03CH13-HV Condition : PEAK_86(84)_16-24 3m HORN_91200_1241 HORIZONTAL RBW:3000.0000Hz VSW:3000.0000Hz SWT:Auto Detector : Peak Project : 860204 Mode : -41</p>	<p>Site : 03CH13-HV Condition : PEAK(UNIT) 3m HORN_91200_1241 HORIZONTAL RBW:3000.0000Hz VSW:3000.0000Hz SWT:Auto Detector : Peak Project : 860204 Mode : -41</p>
Peak	<p>Site : 03CH13-HV Condition : PEAK_86(84)_16-24 3m HORN_91200_1241 HORIZONTAL RBW:3000.0000Hz VSW:3000.0000Hz SWT:Auto Detector : Peak Project : 860204 Mode : -41</p>	Left blank

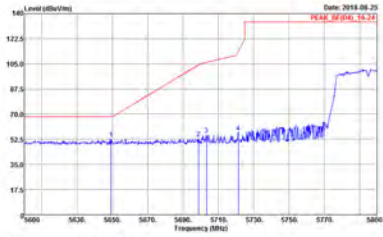
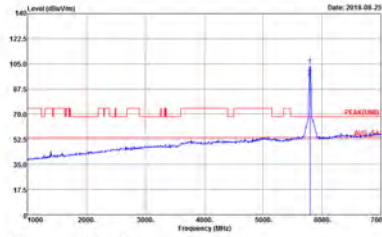
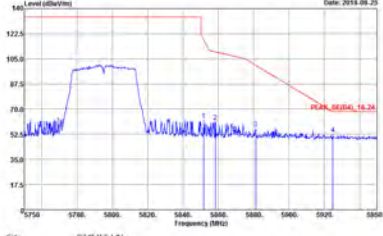

WIFI	Band 4 5725~5850MHz Band Edge @ 3m	
ANT	802.11n HT40 CH159 5795MHz	
1	Vertical	Fundamental
Peak	 <p>Site : 03CH13-HV Condition : PEAK_SE(BM)_16-24 3m HORN_91200_1241 VERTICAL RBW:3000.0000Hz VSW:3000.0000Hz SWT:Auto Detector : Peak Project : 860204 Mode : -41</p>	 <p>Site : 03CH13-HV Condition : PEAK(UNIT) 3m HORN_91200_1241 VERTICAL RBW:1000.0000Hz VSW:3000.0000Hz SWT:Auto Detector : Peak Project : 860204 Mode : -41</p>
Peak	 <p>Site : 03CH13-HV Condition : PEAK_SE(BM)_16-24 3m HORN_91200_1241 VERTICAL RBW:3000.0000Hz VSW:3000.0000Hz SWT:Auto Detector : Peak Project : 860204 Mode : -41</p>	Left blank



Band 4 5725~5850MHz

WIFI 802.11ac VHT80 (Band Edge @ 3m)

WIFI	Band 4 5725~5850MHz Band Edge @ 3m	
ANT	802.11ac VHT80 CH155 5775MHz	
1	Horizontal	Fundamental
Peak	<p>Site : 03CH13-HV Condition : PEAK_BE[04]_16-24 3m HORN_91200_1241 HORIZONTAL RBW:3000.0000Hz VSW:3000.0000Hz SWT:Auto Detector : Peak Project : 860204 Mode : 42 Power : 21.5</p>	<p>Site : 03CH13-HV Condition : PEAK(UNIT) 3m HORN_91200_1241 HORIZONTAL RBW:3000.0000Hz VSW:3000.0000Hz SWT:Auto Detector : Peak Project : 860204 Mode : 42 Power : 21.5</p>
Peak	<p>Site : 03CH13-HV Condition : PEAK_BE[04]_16-24 3m HORN_91200_1241 HORIZONTAL RBW:3000.0000Hz VSW:3000.0000Hz SWT:Auto Detector : Peak Project : 860204 Mode : 42 Power : 21.5</p>	Left blank

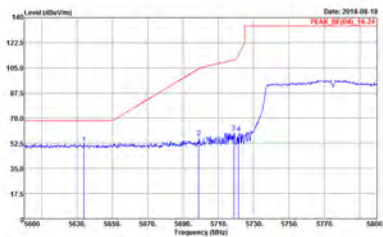
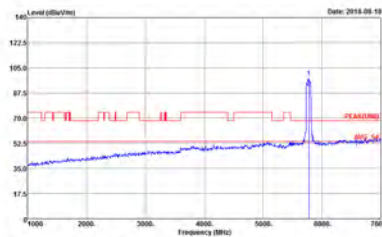
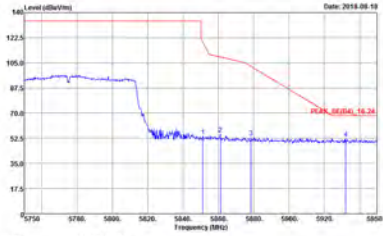

WIFI	Band 4 5725~5850MHz Band Edge @ 3m	
ANT	802.11ac VHT80 CH155 5775MHz	
1	Vertical	Fundamental
Peak	 <p>Site : 03CH13-HV Condition : PEAK_86(04)_16-24 3m HORN_91200_1241 VERTICAL RBW:1000.0000Hz VSW:3000.0000Hz SWT:Auto Detector : Peak Project : 860204 Mode : 42 Power : 21.5</p>	 <p>Site : 03CH13-HV Condition : PEAK(LINE) 3m HORN_91200_1241 VERTICAL RBW:1000.0000Hz VSW:3000.0000Hz SWT:Auto Detector : Peak Project : 860204 Mode : 42 Power : 21.5</p>
Peak	 <p>Site : 03CH13-HV Condition : PEAK_86(04)_16-24 3m HORN_91200_1241 VERTICAL RBW:1000.0000Hz VSW:3000.0000Hz SWT:Auto Detector : Peak Project : 860204 Mode : 42 Power : 21.5</p>	Left blank



Band 4 - 5725~5850MHz

WIFI 802.11a (Harmonic @ 3m)

WIFI	Band 4 5725~5850MHz Harmonic @ 3m	
ANT	802.11a CH149 5745MHz	
1	Horizontal	Vertical
Peak Avg.	<p>Site : 03CH18-HY Condition : PEAK(AV11) 3m SHF_HORN_576 HORIZONTAL Detector : Peak Project : 860204 Mode : 11 Power : 20</p> <p>Site : 03CH18-HY Condition : PEAK(AV11) 3m SHF_HORN_576 VERTICAL Detector : Peak Project : 860204 Mode : 11 Power : 20</p>	

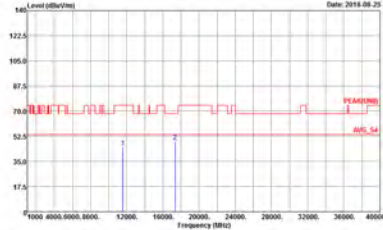
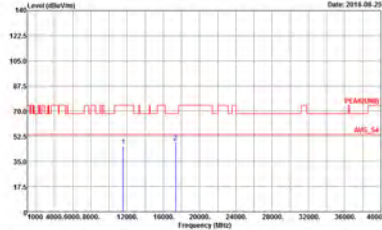

WIFI	Band 4 5725~5850MHz Harmonic @ 3m	
ANT	802.11a CH157 5785MHz	
1	Horizontal	Vertical
Peak Avg.	 <p>Site : 03CH157-44V Condition : PEAK(LINE) 3m SHF_HORN_576 HORIZONTAL Detector : Peak Project : 860204 Mode : 1E Power : 1Z0</p>	 <p>Site : 03CH157-44V Condition : PEAK(LINE) 3m SHF_HORN_576 VERTICAL Detector : Peak Project : 860204 Mode : 1E Power : 1Z0</p>

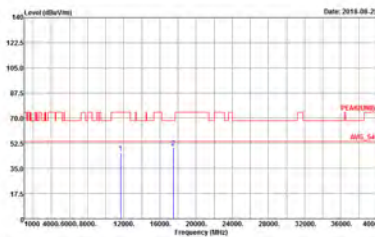
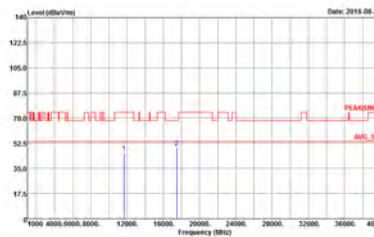

WIFI	Band 4 5725~5850MHz Harmonic @ 3m	
ANT	802.11a CH165 5825MHz	
1	Horizontal	Vertical
Peak Avg.	 <p>Site : 03CH1E-44V Condition : PEAK(LINE) 3m SHF_HORN_576 HORIZONTAL Detector : Peak Project : 860204 Mode : 13 Power : 20</p>	 <p>Site : 03CH1E-44V Condition : PEAK(LINE) 3m SHF_HORN_576 VERTICAL Detector : Peak Project : 860204 Mode : 13 Power : 20</p>



Band 4 5725~5850MHz
WIFI 802.11n HT20 (Harmonic @ 3m)

WIFI	Band 4 5725~5850MHz Harmonic @ 3m	
ANT	802.11n HT20 CH149 5745MHz	
1	Horizontal	Vertical
Peak Avg.	<p>Site : 03CH13-HY Condition : PEAK(UNII) 3m SHF_HORN_576 HORIZONTAL Detector : Peak Project : 860204 Mode : 37 Power : 20</p>	<p>Site : 03CH13-HY Condition : PEAK(UNII) 3m SHF_HORN_576 VERTICAL Detector : Peak Project : 860204 Mode : 37 Power : 20</p>



WIFI	Band 4 5725~5850MHz Harmonic @ 3m	
ANT	802.11n HT20 CH157 5785MHz	
1	Horizontal	Vertical
Peak Avg.	<div style="display: flex; justify-content: space-around;"> <div style="width: 45%;"> <p>Site : 03CHEE-44Y Condition : PEAK(LINE) 3m SHF_HORN_576 HORIZONTAL Detector : Peak Project : 860204 Mode : 3B Power : 20</p> </div> <div style="width: 45%;"> <p>Site : 03CHEE-44Y Condition : PEAK(LINE) 3m SHF_HORN_576 VERTICAL Detector : Peak Project : 860204 Mode : 3B Power : 20</p> </div> </div>	



WIFI	Band 4 5725~5850MHz Harmonic @ 3m	
ANT	802.11n HT20 CH165 5825MHz	
1	Horizontal	Vertical
Peak Avg.	<p>Site : 03CH1E-44V Condition : PEAK(LINE) 3m SHF_HORN_576 HORIZONTAL Detector : Peak Project : 860204 Mode : 39 Power : 20</p> <p>Site : 03CH1E-44V Condition : PEAK(LINE) 3m SHF_HORN_576 VERTICAL Detector : Peak Project : 860204 Mode : 39 Power : 20</p>	



Band 4 5725~5850MHz
WIFI 802.11n HT40 (Harmonic @ 3m)

WIFI	Band 4 5725~5850MHz Harmonic @ 3m	
ANT	802.11n HT40 CH151 5755MHz	
1	Horizontal	Vertical
Peak Avg.	<p>Site : 03CHE3-HY Condition : PEAK(UNII) 3m SHF_HORN_576 HORIZONTAL Detector : Peak Project : 860204 Mode : 40 Power : 20</p>	<p>Site : 03CHE3-HY Condition : PEAK(UNII) 3m SHF_HORN_576 VERTICAL Detector : Peak Project : 860204 Mode : 40 Power : 20</p>

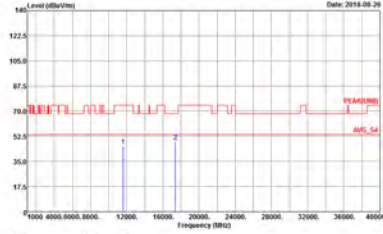
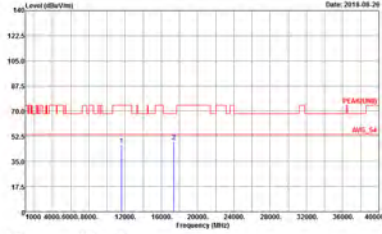

WIFI	Band 4 5725~5850MHz Harmonic @ 3m	
ANT	802.11n HT40 CH159 5795MHz	
1	Horizontal	Vertical
Peak Avg.	 <p>Site : 03CH1E3-4V Condition : PEAK(UNII) 3m SHF_HORN_576 HORIZONTAL Detector : Peak Project : 860204 Mode : 41 Power : 20</p>	 <p>Site : 03CH1E3-4V Condition : PEAK(UNII) 3m SHF_HORN_576 VERTICAL Detector : Peak Project : 860204 Mode : 41 Power : 20</p>

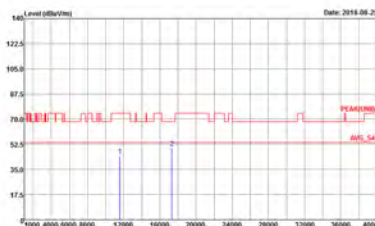
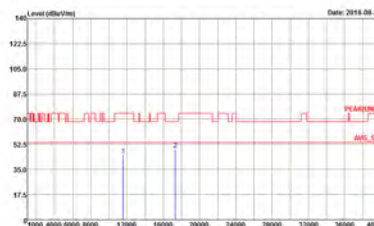

Band 4 5725~5850MHz
WIFI 802.11ac VHT80 (Harmonic @ 3m)

WIFI	Band 4 5725~5850MHz Harmonic @ 3m	
ANT	802.11ac VHT80 CH155 5775MHz	
1	Horizontal	Vertical
<p>Peak Avg.</p>	 <p>Site : 03CHE3-HY Condition : PEAK(UNII) 3m SHF_HORN_576 HORIZONTAL Detector : Peak Project : 860204 Mode : 42 Power : 21.5</p>	 <p>Site : 03CHE3-HY Condition : PEAK(UNII) 3m SHF_HORN_576 VERTICAL Detector : Peak Project : 860204 Mode : 42 Power : 21.5</p>



Emission below 1GHz

5GHz WIFI 802.11n HT40 (LF)

WIFI	5GHz 5725~5850MHz	
ANT	802.11n HT40 LF	
1	Horizontal	Vertical
QP / Peak	<p>Site : 03CH13-HY Condition : QP in BLOC_40103 HORIZONTAL Detector : Peak Project : 860204 Mode : -40</p>	<p>Site : 03CH13-HY Condition : QP in BLOC_40103 VERTICAL Detector : Peak Project : 860204 Mode : -40</p>



Band 4 - 5725~5850MHz

WIFI 802.11a (Band Edge @ 3m)

WIFI	Band 4 5725~5850MHz Band Edge @ 3m	
ANT	802.11a CH149 5745MHz	
2	Horizontal	Fundamental
Peak	<p>Site : 03SCH13-HV Condition : PEAK_36(36)_16-24 3m HORN_91200_1241 HORIZONTAL RBW:1000.0000Hz VSW:3000.0000Hz SWT:Auto Detector : Peak Project : 860204 Mode : 53</p>	<p>Site : 03SCH13-HV Condition : FCAR(LINE) 3m HORN_91200_1241 HORIZONTAL RBW:1000.0000Hz VSW:3000.0000Hz SWT:Auto Detector : Peak Project : 860204 Mode : 53</p>

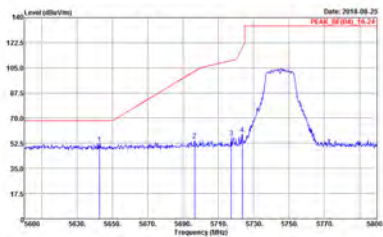
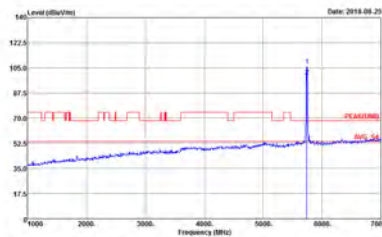

WIFI	Band 4 5725~5850MHz Band Edge @ 3m	
ANT	802.11a CH149 5745MHz	
2	Vertical	Fundamental
Peak	 <p>Site : 03CHE344V Condition : PEAK_86[04]_16-24 3m HORN_91200_1241 VERTICAL RBW:1000.0000 Hz VSW:3000.0000 Hz SWT:Auto Detector : Peak Project : 860204 Mode : 53</p>	 <p>Site : 03CHE344V Condition : PEAK(LIN1) 3m HORN_91200_1241 VERTICAL RBW:1000.0000 Hz VSW:3000.0000 Hz SWT:Auto Detector : Peak Project : 860204 Mode : 53</p>



WIFI	Band 4 5725~5850MHz Band Edge @ 3m	
ANT	802.11a CH157 5785MHz	
2	Horizontal	Fundamental
Peak	<p>Site : 03CH13-HV Condition : PEAK_86(04)_16-24 3m HORN_91200_1241 HORIZONTAL RBW:1000.0000Hz VSW:3000.0000Hz SWT:Auto Detector : Peak Project : 860204 Mode : 54</p>	<p>Site : 03CH13-HV Condition : PEAK(UNII) 3m HORN_91200_1241 HORIZONTAL RBW:1000.0000Hz VSW:3000.0000Hz SWT:Auto Detector : Peak Project : 860204 Mode : 54</p>
Peak	<p>Site : 03CH13-HV Condition : PEAK_86(04)_16-24 3m HORN_91200_1241 HORIZONTAL RBW:1000.0000Hz VSW:3000.0000Hz SWT:Auto Detector : Peak Project : 860204 Mode : 54</p>	Left blank



WIFI	Band 4 5725~5850MHz Band Edge @ 3m	
ANT	802.11a CH157 5785MHz	
2	Vertical	Fundamental
Peak	<p>Site : 03CH13-HV Condition : PEAK_86(04)_16-24 3m HORN_91200_1241 VERTICAL RBW:1000.0000Hz VSW:3000.0000Hz SWT:Auto Detector : Peak Project : 860204 Mode : 54</p>	<p>Site : 03CH13-HV Condition : PEAK(LINE) 3m HORN_91200_1241 VERTICAL RBW:1000.0000Hz VSW:3000.0000Hz SWT:Auto Detector : Peak Project : 860204 Mode : 54</p>
Peak	<p>Site : 03CH13-HV Condition : PEAK_86(04)_16-24 3m HORN_91200_1241 VERTICAL RBW:1000.0000Hz VSW:3000.0000Hz SWT:Auto Detector : Peak Project : 860204 Mode : 54</p>	Left blank



WIFI	Band 4 5725~5850MHz Band Edge @ 3m	
ANT	802.11a CH165 5825MHz	
2	Horizontal	Fundamental
Peak	<p>Site : 03CHE3-44V Condition : PEAK_86[04]_16-24 3m HORN_91200_1241 HORIZONTAL RBW:1000.0000Hz VSW:3000.0000Hz SWT:Auto Detector : Peak Project : 860204 Mode : 55</p>	<p>Site : 03CHE3-44V Condition : PEAK(LIN11) 3m HORN_91200_1241 HORIZONTAL RBW:1000.0000Hz VSW:3000.0000Hz SWT:Auto Detector : Peak Project : 860204 Mode : 55</p>

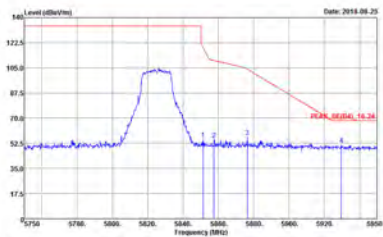
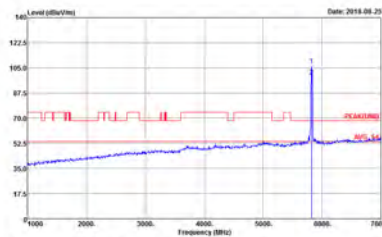

WIFI	Band 4 5725~5850MHz Band Edge @ 3m	
ANT	802.11a CH165 5825MHz	
2	Vertical	Fundamental
Peak	 <p>Site : 03CHE144V Condition : PEAK_86[04]_16-24 3m HORN_91200_1241 VERTICAL RBW:1000.0000 Hz VSW:3000.0000 Hz SWT:Auto Detector : Peak Project : 860204 Mode : 55</p>	 <p>Site : 03CHE144V Condition : PEAK(LINII) 3m HORN_91200_1241 VERTICAL RBW:1000.0000 Hz VSW:3000.0000 Hz SWT:Auto Detector : Peak Project : 860204 Mode : 55</p>



Band 4 5725~5850MHz

WIFI 802.11n HT20 (Band Edge @ 3m)

WIFI	Band 4 5725~5850MHz Band Edge @ 3m	
ANT	802.11n HT20 CH149 5745MHz	
2	Horizontal	Fundamental
Peak	<p>Site : 03CH13-HY Condition : PEAK_86(84)_16-24 3m HORN_91200_1241 HORIZONTAL RBW:3000.000Hz VBW:3000.000Hz SWT:Auto Detector : Peak Project : 860204 Mode : /79</p>	<p>Site : 03CH13-HY Condition : PEAK(UNIT) 3m HORN_91200_1241 HORIZONTAL RBW:3000.000Hz VBW:3000.000Hz SWT:Auto Detector : Peak Project : 860204 Mode : /79</p>



WIFI	Band 4 5725~5850MHz Band Edge @ 3m	
ANT	802.11n HT20 CH149 5745MHz	
2	Vertical	Fundamental
Peak	<p>Site : 03CHES44V Condition : PEAK_85[04]_16-24 3m HORN_91200_1241 VERTICAL RBW:1000.0000Hz VSW:3000.0000Hz SWT:Auto Detector : Peak Project : 860204 Mode : /79</p>	<p>Site : 03CHES44V Condition : PEAK(LIN1) 3m HORN_91200_1241 VERTICAL RBW:1000.0000Hz VSW:3000.0000Hz SWT:Auto Detector : Peak Project : 860204 Mode : /79</p>



WIFI	Band 4 5725~5850MHz Band Edge @ 3m	
ANT	802.11n HT20 CH157 5785MHz	
2	Horizontal	Fundamental
Peak	<p>Site : 03CH13-HV Condition : PEAK_86(04)_16-24 3m HORN_91200_1241 HORIZONTAL RBW:1000.0000Hz VSW:3000.0000Hz SWT:Auto Detector : Peak Project : 860204 Mode : 80</p>	<p>Site : 03CH13-HV Condition : PEAK(LINE) 3m HORN_91200_1241 HORIZONTAL RBW:1000.0000Hz VSW:3000.0000Hz SWT:Auto Detector : Peak Project : 860204 Mode : 80</p>
Peak	<p>Site : 03CH13-HV Condition : PEAK_86(04)_16-24 3m HORN_91200_1241 HORIZONTAL RBW:1000.0000Hz VSW:3000.0000Hz SWT:Auto Detector : Peak Project : 860204 Mode : 80</p>	Left blank



WIFI	Band 4 5725~5850MHz Band Edge @ 3m	
ANT	802.11n HT20 CH157 5785MHz	
2	Vertical	Fundamental
Peak	<p>Site : 03CH13-HV Condition : PEAK_86(04)_16-24 3m HORN_91200_1241 VERTICAL RBW:1000.0000Hz VSW:3000.0000Hz SWT:Auto Detector : Peak Project : 860204 Mode : 80</p>	<p>Site : 03CH13-HV Condition : PEAK(LIN1) 3m HORN_91200_1241 VERTICAL RBW:1000.0000Hz VSW:3000.0000Hz SWT:Auto Detector : Peak Project : 860204 Mode : 80</p>
Peak	<p>Site : 03CH13-HV Condition : PEAK_86(04)_16-24 3m HORN_91200_1241 VERTICAL RBW:1000.0000Hz VSW:3000.0000Hz SWT:Auto Detector : Peak Project : 860204 Mode : 80</p>	Left blank



WIFI	Band 4 5725~5850MHz Band Edge @ 3m	
ANT	802.11n HT20 CH165 5825MHz	
2	Horizontal	Fundamental
Peak	<p>Site : 03CHE144V Condition : PEAK_86[04]_16-24 3m HORN_91200_1241 HORIZONTAL RBW:1000.0000 Hz VSW:3000.0000 Hz SWT:Auto Detector : Peak Project : 860204 Mode : R1</p>	<p>Site : 03CHE144V Condition : PEAK[UNII] 3m HORN_91200_1241 HORIZONTAL RBW:1000.0000 Hz VSW:3000.0000 Hz SWT:Auto Detector : Peak Project : 860204 Mode : R1</p>



WIFI	Band 4 5725~5850MHz Band Edge @ 3m	
ANT	802.11n HT20 CH165 5825MHz	
2	Vertical	Fundamental
Peak	<p>Site : 03CHE14V Condition : PEAK_86[04]_16-24 3m HORN_91200_1241 VERTICAL RBW:1000.0000 Hz VSW:3000.0000 Hz SWT:Auto Detector : Peak Project : 860204 Mode : 181</p>	<p>Site : 03CHE14V Condition : PEAK(LIN1) 3m HORN_91200_1241 VERTICAL RBW:1000.0000 Hz VSW:3000.0000 Hz SWT:Auto Detector : Peak Project : 860204 Mode : 181</p>



Band 4 5725~5850MHz

WIFI 802.11n HT40 (Band Edge @ 3m)

WIFI	Band 4 5725~5850MHz Band Edge @ 3m	
ANT	802.11n HT40 CH151 5755MHz	
2	Horizontal	Fundamental
Peak	<p>Site : 03CH13-HY Condition : PEAK_BE[84]_16-24 3m HORN_91200_1241 HORIZONTAL RBW:3000.0000Hz VSW:3000.0000Hz SWT:Auto Detector : Peak Project : 860204 Mode : 8Z</p>	<p>Site : 03CH13-HY Condition : PEAK(UNIT) 3m HORN_91200_1241 HORIZONTAL RBW:3000.0000Hz VSW:3000.0000Hz SWT:Auto Detector : Peak Project : 860204 Mode : 8Z</p>
Peak	<p>Site : 03CH13-HY Condition : PEAK_BE[84]_16-24 3m HORN_91200_1241 HORIZONTAL RBW:3000.0000Hz VSW:3000.0000Hz SWT:Auto Detector : Peak Project : 860204 Mode : 8Z</p>	Left blank



WIFI	Band 4 5725~5850MHz Band Edge @ 3m	
ANT	802.11n HT40 CH151 5755MHz	
2	Vertical	Fundamental
Peak	<p>Site : 03CH13-HV Condition : PEAK_86(04)_16-24 3m HORN_91200_1241 VERTICAL RBW:1000.0000Hz VSW:3000.0000Hz SWT:Auto Detector : Peak Project : 860204 Mode : 82</p>	<p>Site : 03CH13-HV Condition : PEAK(LINE) 3m HORN_91200_1241 VERTICAL RBW:1000.0000Hz VSW:3000.0000Hz SWT:Auto Detector : Peak Project : 860204 Mode : 82</p>
Peak	<p>Site : 03CH13-HV Condition : PEAK_86(04)_16-24 3m HORN_91200_1241 VERTICAL RBW:1000.0000Hz VSW:3000.0000Hz SWT:Auto Detector : Peak Project : 860204 Mode : 82</p>	Left blank

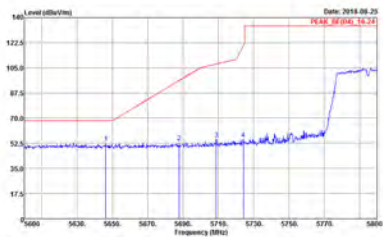
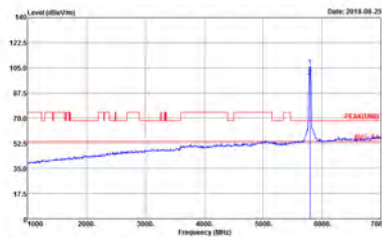
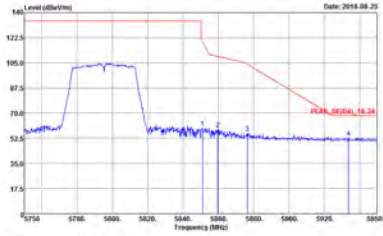

WIFI	Band 4 5725~5850MHz Band Edge @ 3m	
ANT	802.11n HT40 CH159 5795MHz	
2	Horizontal	Fundamental
Peak	 <p>Site : 03CH13-HV Condition : PEAK_86(04)_16-24 3m HORN_91200_1241 HORIZONTAL RBW:1000.0000Hz VSW:3000.0000Hz SWT:Auto Detector : Peak Project : 860204 Mode : RS</p>	 <p>Site : 03CH13-HV Condition : PEAK(LINE) 3m HORN_91200_1241 HORIZONTAL RBW:1000.0000Hz VSW:3000.0000Hz SWT:Auto Detector : Peak Project : 860204 Mode : RS</p>
Peak	 <p>Site : 03CH13-HV Condition : PEAK_86(04)_16-24 3m HORN_91200_1241 HORIZONTAL RBW:1000.0000Hz VSW:3000.0000Hz SWT:Auto Detector : Peak Project : 860204 Mode : RS</p>	Left blank



WIFI	Band 4 5725~5850MHz Band Edge @ 3m	
ANT	802.11n HT40 CH159 5795MHz	
2	Vertical	Fundamental
Peak	<p>Site : 03CH13-HV Condition : PEAK_86(04)_16-24 3m HORN_91200_1241 VERTICAL RBW:1000.0000Hz VSW:3000.0000Hz SWT:Auto Detector : Peak Project : 860204 Mode : RS</p>	<p>Site : 03CH13-HV Condition : PEAK(LINE) 3m HORN_91200_1241 VERTICAL RBW:1000.0000Hz VSW:3000.0000Hz SWT:Auto Detector : Peak Project : 860204 Mode : RS</p>
Peak	<p>Site : 03CH13-HV Condition : PEAK_86(04)_16-24 3m HORN_91200_1241 VERTICAL RBW:1000.0000Hz VSW:3000.0000Hz SWT:Auto Detector : Peak Project : 860204 Mode : RS</p>	Left blank



Band 4 5725~5850MHz

WIFI 802.11ac VHT80 (Band Edge @ 3m)

WIFI	Band 4 5725~5850MHz Band Edge @ 3m	
ANT	802.11ac VHT80 CH155 5775MHz	
2	Horizontal	Fundamental
Peak	<p>Site : 03CH13-HV Condition : PEAK_8E[84]_16-24 3m HORN_91200_1241 HORIZONTAL RBW:3000.0000Hz VSW:3000.0000Hz SWT:Auto Detector : Peak Project : 860204 Mode : 84 Power : 21.5</p>	<p>Site : 03CH13-HV Condition : PEAK(UNIT) 3m HORN_91200_1241 HORIZONTAL RBW:3000.0000Hz VSW:3000.0000Hz SWT:Auto Detector : Peak Project : 860204 Mode : 84 Power : 21.5</p>
Peak	<p>Site : 03CH13-HV Condition : PEAK_8E[84]_16-24 3m HORN_91200_1241 HORIZONTAL RBW:3000.0000Hz VSW:3000.0000Hz SWT:Auto Detector : Peak Project : 860204 Mode : 84 Power : 21.5</p>	Left blank



WIFI	Band 4 5725~5850MHz Band Edge @ 3m	
ANT	802.11ac VHT80 CH155 5775MHz	
2	Vertical	Fundamental
Peak	<p>Site : 03CH13-HV Condition : PEAK_86(04)_16-24 3m HORN_91200_1241 VERTICAL RBW:1000.0000Hz VSW:3000.0000Hz SWT:Auto Detector : Peak Project : 860204 Mode : 84 Power : 21.5</p>	<p>Site : 03CH13-HV Condition : PEAK(LINE) 3m HORN_91200_1241 VERTICAL RBW:1000.0000Hz VSW:3000.0000Hz SWT:Auto Detector : Peak Project : 860204 Mode : 84 Power : 21.5</p>
Peak	<p>Site : 03CH13-HV Condition : PEAK_86(04)_16-24 3m HORN_91200_1241 VERTICAL RBW:1000.0000Hz VSW:3000.0000Hz SWT:Auto Detector : Peak Project : 860204 Mode : 84 Power : 21.5</p>	Left blank



Band 4 - 5725~5850MHz

WIFI 802.11a (Harmonic @ 3m)

WIFI	Band 4 5725~5850MHz Harmonic @ 3m	
ANT	802.11a CH149 5745MHz	
2	Horizontal	Vertical
Peak Avg.		

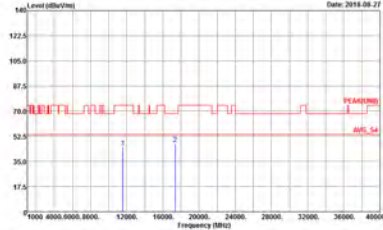
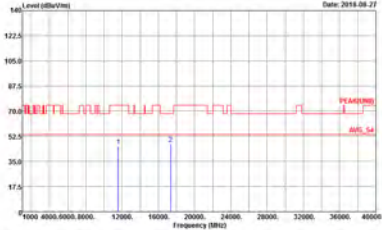

WIFI	Band 4 5725~5850MHz Harmonic @ 3m	
ANT	802.11a CH157 5785MHz	
2	Horizontal	Vertical
Peak Avg.	<div style="display: flex; justify-content: space-around;"> <div style="width: 45%;">  <p>Site : 03CH157-4#Y Condition : PEAK(LINE) 3m SHF_HORN_576 HORIZONTAL Detector : Peak Project : 860204 Mode : 5A Power : 20</p> </div> <div style="width: 45%;">  <p>Site : 03CH157-4#Y Condition : PEAK(LINE) 3m SHF_HORN_576 VERTICAL Detector : Peak Project : 860204 Mode : 5A Power : 20</p> </div> </div>	

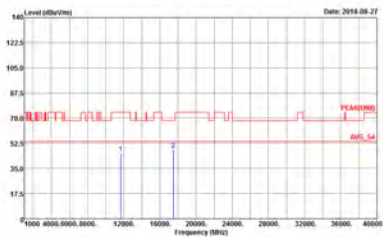
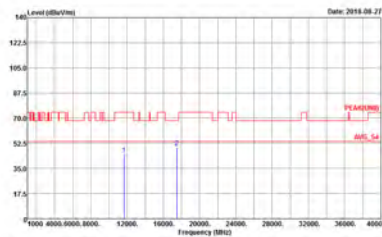

WIFI	Band 4 5725~5850MHz Harmonic @ 3m	
ANT	802.11a CH165 5825MHz	
2	Horizontal	Vertical
Peak Avg.	 <p>Site : 03CH165-4M Condition : PEAK(LINE) 3m SHF_HORN_576 HORIZONTAL Detector : Peak Project : 860204 Mode : 55 Power : 20</p>	 <p>Site : 03CH165-4M Condition : PEAK(LINE) 3m SHF_HORN_576 VERTICAL Detector : Peak Project : 860204 Mode : 55 Power : 20</p>



Band 4 5725~5850MHz
WIFI 802.11n HT20 (Harmonic @ 3m)

WIFI	Band 4 5725~5850MHz Harmonic @ 3m	
ANT	802.11n HT20 CH149 5745MHz	
2	Horizontal	Vertical
Peak Avg.	<p>Site : 03CHE3-HY Condition : PEAK(UNII) 3m SHF_HORN_576 HORIZONTAL Detector : Peak Project : 860204 Mode : 79 Power : 20</p>	<p>Site : 03CHE3-HY Condition : PEAK(UNII) 3m SHF_HORN_576 VERTICAL Detector : Peak Project : 860204 Mode : 79 Power : 20</p>

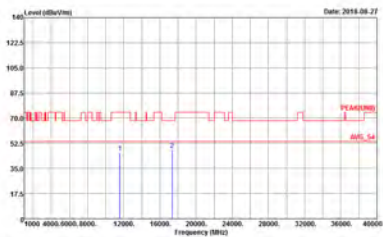
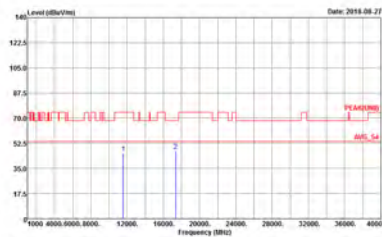

WIFI	Band 4 5725~5850MHz Harmonic @ 3m	
ANT	802.11n HT20 CH157 5785MHz	
2	Horizontal	Vertical
Peak Avg.	 <p>Site : 03CH1E-44Y Condition : PEAK(LINE) 3m SHF_HORN_576 HORIZONTAL Detector : Peak Project : 860204 Mode : IS Power : 20</p>	 <p>Site : 03CH1E-44Y Condition : PEAK(LINE) 3m SHF_HORN_576 VERTICAL Detector : Peak Project : 860204 Mode : IS Power : 20</p>

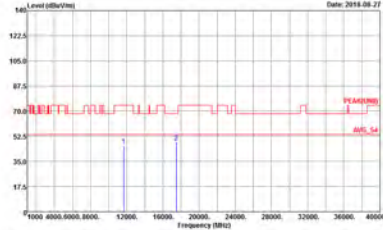
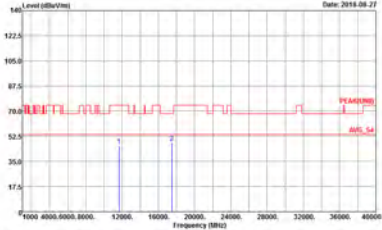

WIFI	Band 4 5725~5850MHz Harmonic @ 3m	
ANT	802.11n HT20 CH165 5825MHz	
2	Horizontal	Vertical
Peak Avg.	<div style="display: flex; justify-content: space-around;"> <div style="width: 45%;">  <p>Site : 03CH1E-44V Condition : PEAK(LINE) 3m SHF_HORN_576 HORIZONTAL Detector : Peak Project : 860204 Mode : RS Power : -20</p> </div> <div style="width: 45%;">  <p>Site : 03CH1E-44V Condition : PEAK(LINE) 3m SHF_HORN_576 VERTICAL Detector : Peak Project : 860204 Mode : RS Power : -20</p> </div> </div>	



Band 4 5725~5850MHz
WIFI 802.11n HT40 (Harmonic @ 3m)

WIFI	Band 4 5725~5850MHz Harmonic @ 3m	
ANT	802.11n HT40 CH151 5755MHz	
2	Horizontal	Vertical
Peak Avg.	<p>Site : 03CH13-HY Condition : PEAK(UNII) 3m SHF_HORN_576 HORIZONTAL Detector : Peak Project : 860204 Mode : R2 Power : 20</p>	<p>Site : 03CH13-HY Condition : PEAK(UNII) 3m SHF_HORN_576 VERTICAL Detector : Peak Project : 860204 Mode : R2 Power : 20</p>

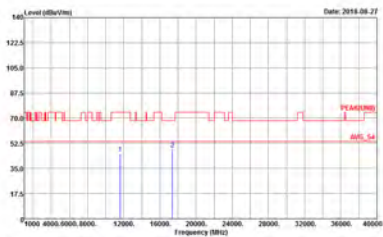
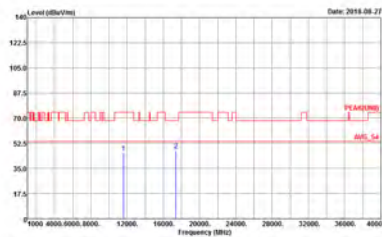

WIFI	Band 4 5725~5850MHz Harmonic @ 3m	
ANT	802.11n HT40 CH159 5795MHz	
2	Horizontal	Vertical
Peak Avg.	 <p>Site : 03CHEE-44V Condition : PEAK(LINE) 3m SHF_HORN_576 HORIZONTAL Detector : Peak Project : 860204 Mode : 83 Power : 20</p>	 <p>Site : 03CHEE-44V Condition : PEAK(LINE) 3m SHF_HORN_576 VERTICAL Detector : Peak Project : 860204 Mode : 83 Power : 20</p>



Band 4 5725~5850MHz
WIFI 802.11ac VHT80 (Harmonic @ 3m)

WIFI	Band 4 5725~5850MHz Harmonic @ 3m	
ANT	802.11ac VHT80 CH155 5775MHz	
2	Horizontal	Vertical
Peak Avg.	<p>Site : 03CH3-HY Condition : PEAK(UNII) 3m SHF_HORN_576 HORIZONTAL Detector : Peak Project : 860204 Mode : 84 Power : 20</p>	<p>Site : 03CH3-HY Condition : PEAK(UNII) 3m SHF_HORN_576 VERTICAL Detector : Peak Project : 860204 Mode : 84 Power : 20</p>



Emission below 1GHz

5GHz WIFI 802.11n HT20 (LF)

WIFI	5GHz 5725~5850MHz	
ANT	802.11n HT20 LF	
2	Horizontal	Vertical
QP / Peak	<p>Site : 03CH13-HY Condition : QP 1m BIL04_40103 HORIZONTAL Detector : Peak Project : 860204 Mode : 80</p>	<p>Site : 03CH13-HY Condition : QP 1m BIL04_40103 VERTICAL Detector : Peak Project : 860204 Mode : 80</p>



Band 4 - 5725~5850MHz

WIFI 802.11a (Band Edge @ 3m)

WIFI	Band 4 5725~5850MHz Band Edge @ 3m	
ANT	802.11a CH149 5745MHz	
1+2	Horizontal	Fundamental
Peak	<p>Site : 03SCH13-HV Condition : PEAK_860204_16-24 3m HORN_91200_1241 HORIZONTAL RBW:1000.0000Hz VSW:3000.0000Hz SWT:Auto Detector : Peak Project : 860204 Mode : 147</p>	<p>Site : 03SCH13-HV Condition : FCAR(LINE) 3m HORN_91200_1241 HORIZONTAL RBW:1000.0000Hz VSW:3000.0000Hz SWT:Auto Detector : Peak Project : 860204 Mode : 147</p>



WIFI	Band 4 5725~5850MHz Band Edge @ 3m	
ANT	802.11a CH149 5745MHz	
1+2	Vertical	Fundamental
Peak	<p>Site : 03CHE149V Condition : PEAK_85[04]_16-24 3m HORN_91200_1241 VERTICAL RBW:1000.0000Hz VSW:3000.0000Hz SWT:Auto Detector : Peak Project : 860204 Mode : 147</p>	<p>Site : 03CHE149V Condition : PEAK(LINII) 3m HORN_91200_1241 VERTICAL RBW:1000.0000Hz VSW:3000.0000Hz SWT:Auto Detector : Peak Project : 860204 Mode : 147</p>



WIFI	Band 4 5725~5850MHz Band Edge @ 3m	
ANT	802.11a CH157 5785MHz	
1+2	Horizontal	Fundamental
Peak	<p>Site : 03CH13-HV Condition : PEAK_86(04)_16-24 3m HORN_91200_1241 HORIZONTAL RBW:1000.0000Hz VSW:3000.0000Hz SWT:Auto Detector : Peak Project : 860204 Mode : 148</p>	<p>Site : 03CH13-HV Condition : PEAK(LINE) 3m HORN_91200_1241 HORIZONTAL RBW:1000.0000Hz VSW:3000.0000Hz SWT:Auto Detector : Peak Project : 860204 Mode : 148</p>
Peak	<p>Site : 03CH13-HV Condition : PEAK_86(04)_16-24 3m HORN_91200_1241 HORIZONTAL RBW:1000.0000Hz VSW:3000.0000Hz SWT:Auto Detector : Peak Project : 860204 Mode : 148</p>	Left blank



WIFI	Band 4 5725~5850MHz Band Edge @ 3m	
ANT	802.11a CH157 5785MHz	
1+2	Vertical	Fundamental
Peak	<p>Site : 03CH13-HV Condition : PEAK_86(04)_16-24 3m HORN_91200_1241 VERTICAL RBW:1000.0000Hz VSW:3000.0000Hz SWT:Auto Detector : Peak Project : 860204 Mode : 148</p>	<p>Site : 03CH13-HV Condition : PEAK(UNII) 3m HORN_91200_1241 VERTICAL RBW:1000.0000Hz VSW:3000.0000Hz SWT:Auto Detector : Peak Project : 860204 Mode : 148</p>
Peak	<p>Site : 03CH13-HV Condition : PEAK_86(04)_16-24 3m HORN_91200_1241 VERTICAL RBW:1000.0000Hz VSW:3000.0000Hz SWT:Auto Detector : Peak Project : 860204 Mode : 148</p>	Left blank

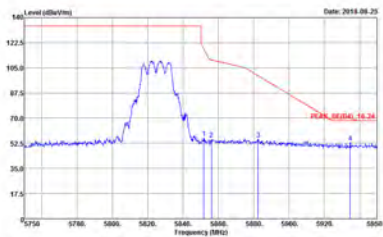
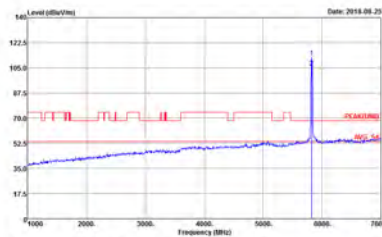

WIFI	Band 4 5725~5850MHz Band Edge @ 3m	
ANT	802.11a CH165 5825MHz	
1+2	Horizontal	Fundamental
Peak	 <p>Site : 03CH13-44V Condition : PEAK_86[04]_16-24 3m HORN_91200_1241 HORIZONTAL RBW:1000.0000 Hz VSW:3000.0000 Hz SWT:Auto Detector : Peak Project : 860204 Mode : 149</p>	 <p>Site : 03CH13-44V Condition : PEAK(LIN11) 3m HORN_91200_1241 HORIZONTAL RBW:1000.0000 Hz VSW:3000.0000 Hz SWT:Auto Detector : Peak Project : 860204 Mode : 149</p>

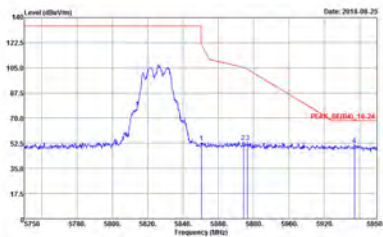
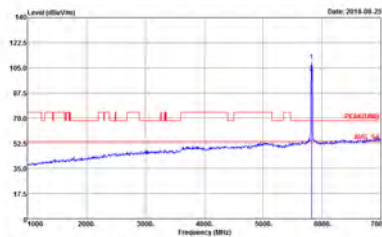

WIFI	Band 4 5725~5850MHz Band Edge @ 3m	
ANT	802.11a CH165 5825MHz	
1+2	Vertical	Fundamental
Peak	 <p>Site : 03CH13-44V Condition : PEAK_85[04]_16-24 3m HORN_91200_1241 VERTICAL RBW:1000.0000 Hz VSW:3000.0000 Hz SWT:Auto Detector : Peak Project : 860204 Mode : 149</p>	 <p>Site : 03CH13-44V Condition : PEAK(LIN11) 3m HORN_91200_1241 VERTICAL RBW:1000.0000 Hz VSW:3000.0000 Hz SWT:Auto Detector : Peak Project : 860204 Mode : 149</p>



Band 4 5725~5850MHz
WIFI 802.11n HT20 (Band Edge @ 3m)

WIFI	Band 4 5725~5850MHz Band Edge @ 3m	
ANT	802.11n HT20 CH149 5745MHz	
1+2	Horizontal	Fundamental
Peak	<p>Site : 03CH13-HY Condition : PEAK_86(84)_16-24 3m HORN_91200_1241 HORIZONTAL RBW:3000.0000Hz VBW:3000.0000Hz SWT:Auto Detector : Peak Project : 860204 Mode : 150</p>	<p>Site : 03CH13-HY Condition : PEAK(UNIT) 3m HORN_91200_1241 HORIZONTAL RBW:3000.0000Hz VBW:3000.0000Hz SWT:Auto Detector : Peak Project : 860204 Mode : 150</p>

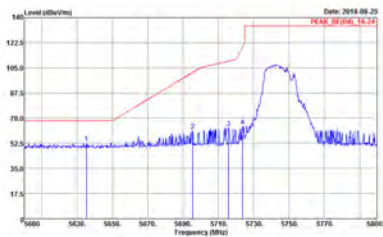
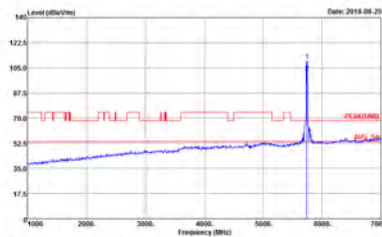

WIFI	Band 4 5725~5850MHz Band Edge @ 3m	
ANT	802.11n HT20 CH149 5745MHz	
1+2	Vertical	Fundamental
Peak	 <p>Site : 03CHE14W Condition : PEAK_86[04]_16-24 3m HORN_91200_1241 VERTICAL RBW:1000.0000 Hz VSW:3000.0000 Hz SWT:Auto Detector : Peak Project : 860204 Mode : 150</p>	 <p>Site : 03CHE14W Condition : PEAK(LIN1) 3m HORN_91200_1241 VERTICAL RBW:1000.0000 Hz VSW:3000.0000 Hz SWT:Auto Detector : Peak Project : 860204 Mode : 150</p>



WIFI	Band 4 5725~5850MHz Band Edge @ 3m	
ANT	802.11n HT20 CH157 5785MHz	
1+2	Horizontal	Fundamental
<p>Peak</p>	<p>Site : 03CH13-HV Condition : PEAK_86(04)_16-24 3m HORN_91200_1241 HORIZONTAL RBW:1000.0000Hz VSW:3000.0000Hz SWT:Auto Detector : Peak Project : 860204 Mode : ISJ</p>	<p>Site : 03CH13-HV Condition : PEAK(LINE) 3m HORN_91200_1241 HORIZONTAL RBW:1000.0000Hz VSW:3000.0000Hz SWT:Auto Detector : Peak Project : 860204 Mode : ISJ</p>
<p>Peak</p>	<p>Site : 03CH13-HV Condition : PEAK_86(04)_16-24 3m HORN_91200_1241 HORIZONTAL RBW:1000.0000Hz VSW:3000.0000Hz SWT:Auto Detector : Peak Project : 860204 Mode : ISJ</p>	<p>Left blank</p>



WIFI	Band 4 5725~5850MHz Band Edge @ 3m	
ANT	802.11n HT20 CH157 5785MHz	
1+2	Vertical	Fundamental
<p>Peak</p>	<p>Site : 03CH13-HV Condition : PEAK_86(04)_16-24 3m HORN_91200_1241 VERTICAL RBW:1000.0000Hz VSW:3000.0000Hz SWT:Auto Detector : Peak Project : 860204 Mode : ISJ</p>	<p>Site : 03CH13-HV Condition : PEAK(UNII) 3m HORN_91200_1241 VERTICAL RBW:1000.0000Hz VSW:3000.0000Hz SWT:Auto Detector : Peak Project : 860204 Mode : ISJ</p>
<p>Peak</p>	<p>Site : 03CH13-HV Condition : PEAK_86(04)_16-24 3m HORN_91200_1241 VERTICAL RBW:1000.0000Hz VSW:3000.0000Hz SWT:Auto Detector : Peak Project : 860204 Mode : ISJ</p>	<p>Left blank</p>



WIFI	Band 4 5725~5850MHz Band Edge @ 3m	
ANT	802.11n HT20 CH165 5825MHz	
1+2	Horizontal	Fundamental
Peak	<p>Site : 03CHE344V Condition : PEAK_86[04]_16-24 3m HORN_91200_1241 HORIZONTAL RBW:1000.0000 Hz VSW:3000.0000 Hz SWT:Auto Detector : Peak Project : 860204 Mode : IS2</p>	<p>Site : 03CHE344V Condition : PEAK(LINE) 3m HORN_91200_1241 HORIZONTAL RBW:1000.0000 Hz VSW:3000.0000 Hz SWT:Auto Detector : Peak Project : 860204 Mode : IS2</p>



WIFI	Band 4 5725~5850MHz Band Edge @ 3m	
ANT	802.11n HT20 CH165 5825MHz	
1+2	Vertical	Fundamental
Peak	<p>Site : 03CHE344V Condition : PEAK_86[04]_16-24 3m HORN_91200_1241 VERTICAL RBW:1000.0000 Hz VSW:3000.0000 Hz SWT:Auto Detector : Peak Project : 860204 Mode : IS2</p>	<p>Site : 03CHE344V Condition : PEAK(LIN1) 3m HORN_91200_1241 VERTICAL RBW:1000.0000 Hz VSW:3000.0000 Hz SWT:Auto Detector : Peak Project : 860204 Mode : IS2</p>



Band 4 5725~5850MHz

WIFI 802.11n HT40 (Band Edge @ 3m)

WIFI	Band 4 5725~5850MHz Band Edge @ 3m	
ANT	802.11n HT40 CH151 5755MHz	
1+2	Horizontal	Fundamental
Peak	<p>Site : 03CH13-HY Condition : PEAK_BE[04]_16-24 3m HORN_91200_1241 HORIZONTAL Detector : Peak Project : 860204 Mode : 153</p>	<p>Site : 03CH13-HY Condition : PEAK(UNIT) 3m HORN_91200_1241 HORIZONTAL Detector : Peak Project : 860204 Mode : 153</p>
Peak	<p>Site : 03CH13-HY Condition : PEAK_BE[04]_16-24 3m HORN_91200_1241 HORIZONTAL Detector : Peak Project : 860204 Mode : 153</p>	Left blank

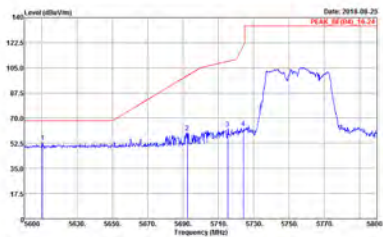
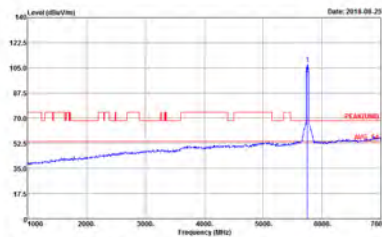
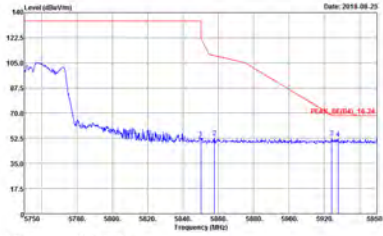

WIFI	Band 4 5725~5850MHz Band Edge @ 3m	
ANT	802.11n HT40 CH151 5755MHz	
1+2	Vertical	Fundamental
Peak	 <p>Site : 03CH13-HV Condition : PEAK_86(04)_16-24 3m HORN_91200_1241 VERTICAL RBW:1000.0000Hz VSW:3000.0000Hz SWT:Auto Detector : Peak Project : 860204 Mode : 153</p>	 <p>Site : 03CH13-HV Condition : PEAK(LINE) 3m HORN_91200_1241 VERTICAL RBW:1000.0000Hz VSW:3000.0000Hz SWT:Auto Detector : Peak Project : 860204 Mode : 153</p>
Peak	 <p>Site : 03CH13-HV Condition : PEAK_86(04)_16-24 3m HORN_91200_1241 VERTICAL RBW:1000.0000Hz VSW:3000.0000Hz SWT:Auto Detector : Peak Project : 860204 Mode : 153</p>	Left blank



WIFI	Band 4 5725~5850MHz Band Edge @ 3m	
ANT	802.11n HT40 CH159 5795MHz	
1+2	Horizontal	Fundamental
Peak	<p>Site : 03CH13-HV Condition : PEAK_86(04)_16-24 3m HORN_91200_1241 HORIZONTAL RBW:1000.0000Hz VSW:3000.0000Hz SWT:Auto Detector : Peak Project : 860204 Mode : 150</p>	<p>Site : 03CH13-HV Condition : PEAK(UNII) 3m HORN_91200_1241 HORIZONTAL RBW:1000.0000Hz VSW:3000.0000Hz SWT:Auto Detector : Peak Project : 860204 Mode : 150</p>
Peak	<p>Site : 03CH13-HV Condition : PEAK_86(04)_16-24 3m HORN_91200_1241 HORIZONTAL RBW:1000.0000Hz VSW:3000.0000Hz SWT:Auto Detector : Peak Project : 860204 Mode : 150</p>	Left blank

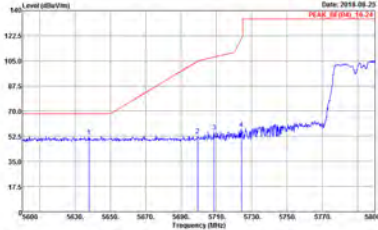
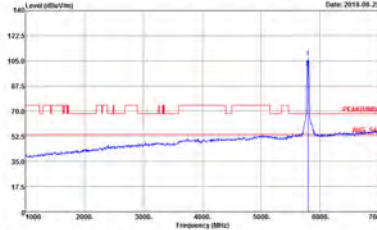
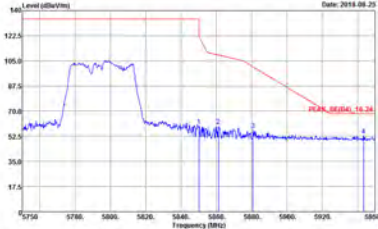

WIFI	Band 4 5725~5850MHz Band Edge @ 3m	
ANT	802.11n HT40 CH159 5795MHz	
1+2	Vertical	Fundamental
Peak	 <p>Site : 03CH13-HV Condition : PEAK_86(04)_16-24 3m HORN_91200_1241 VERTICAL RBW:1000.0000Hz VSW:3000.0000Hz SWT:Auto Detector : Peak Project : 860204 Mode : 150</p>	 <p>Site : 03CH13-HV Condition : PEAK(UNII) 3m HORN_91200_1241 VERTICAL RBW:1000.0000Hz VSW:3000.0000Hz SWT:Auto Detector : Peak Project : 860204 Mode : 150</p>
Peak	 <p>Site : 03CH13-HV Condition : PEAK_86(04)_16-24 3m HORN_91200_1241 VERTICAL RBW:1000.0000Hz VSW:3000.0000Hz SWT:Auto Detector : Peak Project : 860204 Mode : 150</p>	Left blank



Band 4 5725~5850MHz

WIFI 802.11ac VHT80 (Band Edge @ 3m)

WIFI	Band 4 5725~5850MHz Band Edge @ 3m	
ANT	802.11ac VHT80 CH155 5775MHz	
1+2	Horizontal	Fundamental
Peak	<p>Site : 03CH13-HY Condition : PEAK_BE(B4)_16-24 3m HORN_91200_1241 HORIZONTAL RBW:3000.0000Hz VSW:3000.0000Hz SWT:Auto Detector : Peak Project : 860204 Mode : 159</p>	<p>Site : 03CH13-HY Condition : PEAK(FUNTI) 3m HORN_91200_1241 HORIZONTAL RBW:3000.0000Hz VSW:3000.0000Hz SWT:Auto Detector : Peak Project : 860204 Mode : 159</p>
Peak	<p>Site : 03CH13-HY Condition : PEAK_BE(B4)_16-24 3m HORN_91200_1241 HORIZONTAL RBW:3000.0000Hz VSW:3000.0000Hz SWT:Auto Detector : Peak Project : 860204 Mode : 159</p>	Left blank



WIFI	Band 4 5725~5850MHz Band Edge @ 3m	
ANT	802.11ac VHT80 CH155 5775MHz	
1+2	Vertical	Fundamental
Peak	<p>Site : 03CH13-HV Condition : PEAK_86(04)_16-24 3m HORN_91200_1241 VERTICAL RBW:1000.0000Hz VSW:3000.0000Hz SWT:Auto Detector : Peak Project : 860204 Mode : 159</p>	<p>Site : 03CH13-HV Condition : PEAK(LINE) 3m HORN_91200_1241 VERTICAL RBW:1000.0000Hz VSW:3000.0000Hz SWT:Auto Detector : Peak Project : 860204 Mode : 159</p>
Peak	<p>Site : 03CH13-HV Condition : PEAK_86(04)_16-24 3m HORN_91200_1241 VERTICAL RBW:1000.0000Hz VSW:3000.0000Hz SWT:Auto Detector : Peak Project : 860204 Mode : 159</p>	Left blank



Band 4 - 5725~5850MHz

WIFI 802.11a (Harmonic @ 3m)

WIFI	Band 4 5725~5850MHz Harmonic @ 3m	
ANT	802.11a CH149 5745MHz	
1+2	Horizontal	Vertical
Peak Avg.		



WIFI	Band 4 5725~5850MHz Harmonic @ 3m	
ANT	802.11a CH157 5785MHz	
1+2	Horizontal	Vertical
Peak Avg.	<p>Site : 03CH157-4M Condition : PEAK(LINE) 3m SHF_HORN_576 HORIZONTAL Detector : Peak Project : 860204 Mode : 1dB Power : 20</p>	<p>Site : 03CH157-4M Condition : PEAK(LINE) 3m SHF_HORN_576 VERTICAL Detector : Peak Project : 860204 Mode : 1dB Power : 20</p>

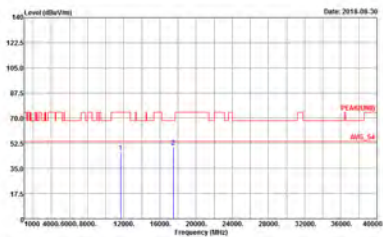
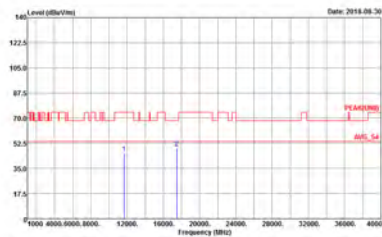

WIFI	Band 4 5725~5850MHz Harmonic @ 3m	
ANT	802.11a CH165 5825MHz	
1+2	Horizontal	Vertical
Peak Avg.	<div style="display: flex; justify-content: space-around;"> <div style="width: 45%;">  <p>Site : 03CH1E-44V Condition : PEAK(LINE) 3m SHF_HORN_576 HORIZONTAL Detector : Peak Project : 860204 Mode : 149 Power : -20</p> </div> <div style="width: 45%;">  <p>Site : 03CH1E-44V Condition : PEAK(LINE) 3m SHF_HORN_576 VERTICAL Detector : Peak Project : 860204 Mode : 149 Power : -20</p> </div> </div>	

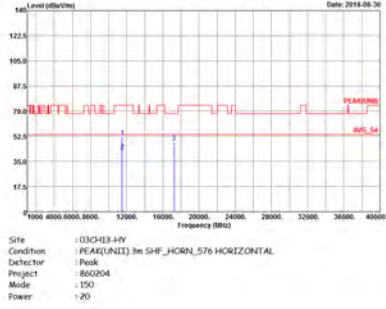
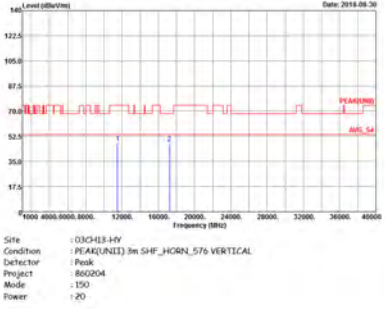

Band 4 5725~5850MHz
WIFI 802.11n HT20 (Harmonic @ 3m)

WIFI	Band 4 5725~5850MHz Harmonic @ 3m	
ANT	802.11n HT20 CH149 5745MHz	
1+2	Horizontal	Vertical
Peak Avg.		



WIFI	Band 4 5725~5850MHz Harmonic @ 3m	
ANT	802.11n HT20 CH157 5785MHz	
1+2	Horizontal	Vertical
Peak Avg.	<p>Site : 03CH157-44Y Condition : PEAK(LINE) 3m SHF_HORN_576 HORIZONTAL Defector : Peak Project : 860204 Mode : TS1 Power : -20</p>	<p>Site : 03CH157-44Y Condition : PEAK(LINE) 3m SHF_HORN_576 VERTICAL Defector : Peak Project : 860204 Mode : TS1 Power : -20</p>



WIFI	Band 4 5725~5850MHz Harmonic @ 3m	
ANT	802.11n HT20 CH165 5825MHz	
1+2	Horizontal	Vertical
Peak Avg.	<div style="display: flex; justify-content: space-around;"> <div style="width: 45%;"> <p>Site : 03CH1E-44V Condition : PEAK(LINE) 3m SHF_HORN_576 HORIZONTAL Detector : Peak Project : 860204 Mode : 152 Power : 120</p> </div> <div style="width: 45%;"> <p>Site : 03CH1E-44V Condition : PEAK(LINE) 3m SHF_HORN_576 VERTICAL Detector : Peak Project : 860204 Mode : 152 Power : 120</p> </div> </div>	



Band 4 5725~5850MHz
WIFI 802.11n HT40 (Harmonic @ 3m)

WIFI	Band 4 5725~5850MHz Harmonic @ 3m	
ANT	802.11n HT40 CH151 5755MHz	
1+2	Horizontal	Vertical
Peak Avg.	<p>Site : 03CHE3-HY Condition : PEAK(UNII) 3m SHF_HORN_576 HORIZONTAL Detector : Peak Project : 860204 Mode : 153 Power : 20</p>	<p>Site : 03CHE3-HY Condition : PEAK(UNII) 3m SHF_HORN_576 VERTICAL Detector : Peak Project : 860204 Mode : 153 Power : 20</p>



WIFI	Band 4 5725~5850MHz Harmonic @ 3m	
ANT	802.11n HT40 CH159 5795MHz	
1+2	Horizontal	Vertical
Peak Avg.	<p>Site : 03CHEE-44V Condition : PEAK(LINE) 3m SHF_HORN_576 HORIZONTAL Detector : Peak Project : 860204 Mode : 154 Power : -20</p>	<p>Site : 03CHEE-44V Condition : PEAK(LINE) 3m SHF_HORN_576 VERTICAL Detector : Peak Project : 860204 Mode : 154 Power : -20</p>



Band 4 5725~5850MHz
WIFI 802.11ac VHT80 (Harmonic @ 3m)

WIFI	Band 4 5725~5850MHz Harmonic @ 3m	
ANT	802.11ac VHT80 CH155 5775MHz	
1+2	Horizontal	Vertical
Peak Avg.	<p>Site : 03CHE3-HY Condition : PEAK(UNII) 3m SHF_HORN_576 HORIZONTAL Detector : Peak Project : 860204 Mode : 155 Power : 19.5</p>	<p>Site : 03CHE3-HY Condition : PEAK(UNII) 3m SHF_HORN_576 VERTICAL Detector : Peak Project : 860204 Mode : 155 Power : 19.5</p>



Emission below 1GHz

5GHz WIFI 802.11n HT20 (LF)

WIFI	5GHz 5725~5850MHz	
ANT	802.11n HT20 LF	
1+2	Horizontal	Vertical
QP / Peak	<p>Site : 03CH13-HY Condition : QP 1m B1LOG_40103 HORIZONTAL Detector : Peak Project : 860204 Mode : 150</p>	<p>Site : 03CH13-HY Condition : QP 1m B1LOG_40103 VERTICAL Detector : Peak Project : 860204 Mode : 150</p>



<TXBF Mode>

Band 4 - 5725~5850MHz

WIFI 802.11ac VHT20 (Band Edge @ 3m)

WIFI	Band 4 5725~5850MHz Band Edge @ 3m	
ANT	802.11ac VHT20 CH149 5745MHz	
1+2	Horizontal	Fundamental
Peak	<p>Site : 03CH13-HY Condition : PEAK_86(84)_16-24 3m HORN_91200_1241 HORIZONTAL Detector : RBW:3000.000Hz VBW:3000.000Hz SWT:Auto Defector : Peak Project : 860204 Mode : ISB Power : 135.5</p>	<p>Site : 03CH13-HY Condition : PEAK(UNIT) 3m HORN_91200_1241 HORIZONTAL Detector : RBW:3000.000Hz VBW:3000.000Hz SWT:Auto Defector : Peak Project : 860204 Mode : ISB Power : 135.5</p>

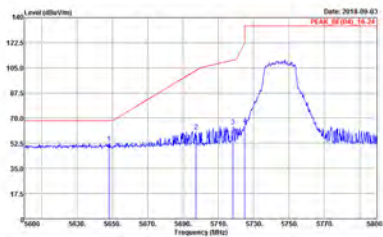
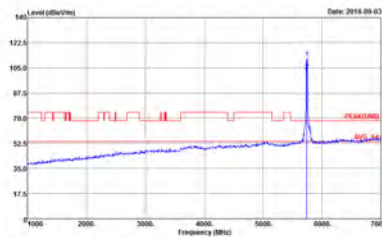

WIFI	Band 4 5725~5850MHz Band Edge @ 3m	
ANT	802.11ac VHT20 CH149 5745MHz	
1+2	Vertical	Fundamental
Peak Avg.	<div style="display: flex; justify-content: space-around;"> <div style="width: 45%;">  <p>Site : 03CHEE44V Condition : PEAK_86[04]_16-24 3m HORN_91200_1241 VERTICAL RBW:1000.0000 Hz VSW:3000.0000 Hz SWT:Auto Detector : Peak Project : 860204 Mode : I08 Power : 18.5</p> </div> <div style="width: 45%;">  <p>Site : 03CHEE44V Condition : PEAK(LINII) 3m HORN_91200_1241 VERTICAL RBW:1000.0000 Hz VSW:3000.0000 Hz SWT:Auto Detector : Peak Project : 860204 Mode : I08 Power : 18.5</p> </div> </div>	



WIFI	Band 4 5725~5850MHz Band Edge @ 3m	
ANT	802.11ac VHT20 CH157 5785MHz	
1+2	Horizontal	Fundamental
Peak	<p>Site : 03CH13-HV Condition : PEAK_86(04)_16-24 3m HORN_91200_1241 HORIZONTAL RBW:1000.0000Hz VSW:3000.0000Hz SWT:Auto Detector : Peak Project : 860204 Mode : 109 Power : 138.5</p>	<p>Site : 03CH13-HV Condition : PEAK(LINE) 3m HORN_91200_1241 HORIZONTAL RBW:1000.0000Hz VSW:3000.0000Hz SWT:Auto Detector : Peak Project : 860204 Mode : 109 Power : 138.5</p>
Peak	<p>Site : 03CH13-HV Condition : PEAK_86(04)_16-24 3m HORN_91200_1241 HORIZONTAL RBW:1000.0000Hz VSW:3000.0000Hz SWT:Auto Detector : Peak Project : 860204 Mode : 109 Power : 138.5</p>	Left blank

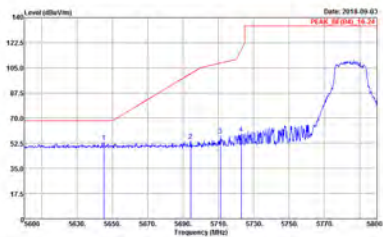
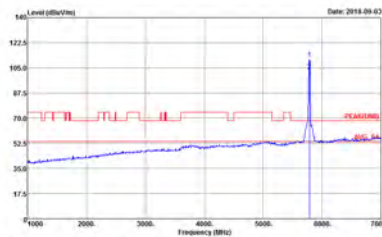
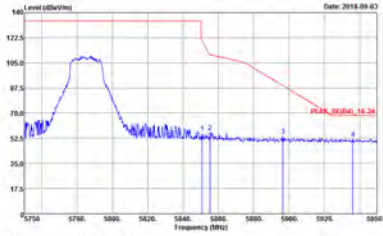

WIFI	Band 4 5725~5850MHz Band Edge @ 3m	
ANT	802.11ac VHT20 CH157 5785MHz	
1+2	Vertical	Fundamental
Peak	 <p>Site : 03CH13-HV Condition : PEAK_86(04)_16-24 3m HORN_91200_1241 VERTICAL RBW:1000.0000Hz VSW:3000.0000Hz SWT:Auto Detector : Peak Project : 860204 Mode : 109 Power : 18.5</p>	 <p>Site : 03CH13-HV Condition : PEAK(LINE) 3m HORN_91200_1241 VERTICAL RBW:1000.0000Hz VSW:3000.0000Hz SWT:Auto Detector : Peak Project : 860204 Mode : 109 Power : 18.5</p>
Peak	 <p>Site : 03CH13-HV Condition : PEAK_86(04)_16-24 3m HORN_91200_1241 VERTICAL RBW:1000.0000Hz VSW:3000.0000Hz SWT:Auto Detector : Peak Project : 860204 Mode : 109 Power : 18.5</p>	Left blank

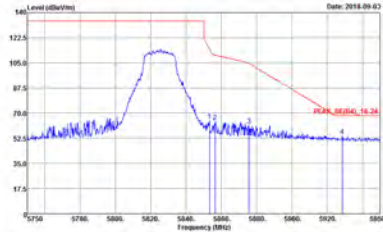
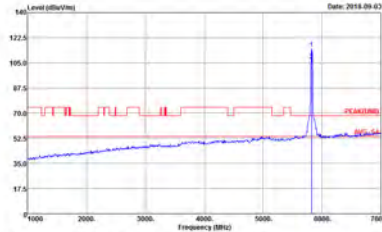

WIFI	Band 4 5725~5850MHz Band Edge @ 3m	
ANT	802.11ac VHT20 CH165 5825MHz	
1+2	Horizontal	Fundamental
Peak	 <p>Site : 03CH13-44V Condition : PEAK_86[04]_16-24 3m HORN_91200_1241 HORIZONTAL RBW:1000.0000 Hz VSW:3000.0000 Hz SWT:Auto Detector : Peak Project : 860204 Mode : 110 Power : 18.5</p>	 <p>Site : 03CH13-44V Condition : PEAK(LIN11) 3m HORN_91200_1241 HORIZONTAL RBW:1000.0000 Hz VSW:3000.0000 Hz SWT:Auto Detector : Peak Project : 860204 Mode : 110 Power : 18.5</p>



WIFI	Band 4 5725~5850MHz Band Edge @ 3m	
ANT	802.11ac VHT20 CH165 5825MHz	
1+2	Vertical	Fundamental
Peak Avg.	<p>Site : 03CH13-44V Condition : PEAK_86[04]_16-24 3m HORN_91200_1241 VERTICAL RBW:1000.0000 Hz VSW:3000.0000 Hz SWT:Auto Detector : Peak Project : 860204 Mode : 110 Power : 18.5</p>	<p>Site : 03CH13-44V Condition : PEAK(LIN11) 3m HORN_91200_1241 VERTICAL RBW:1000.0000 Hz VSW:3000.0000 Hz SWT:Auto Detector : Peak Project : 860204 Mode : 110 Power : 18.5</p>



Band 4 5725~5850MHz

WIFI 802.11ac VHT40 (Band Edge @ 3m)

WIFI	Band 4 5725~5850MHz Band Edge @ 3m	
ANT	802.11ac VHT40 CH151 5755MHz	
1+2	Horizontal	Fundamental
Peak	<p>Site : 03CH13-HY Condition : PEAK_BE(B4)_16-24 3m HORN_91200_1241 HORIZONTAL RBW:3000.0000Hz VSW:3000.0000Hz SWT:Auto Detector : Peak Project : 860204 Mode : 111 Power : 18.5</p>	<p>Site : 03CH13-HY Condition : PEAK(UNIT) 3m HORN_91200_1241 HORIZONTAL RBW:3000.0000Hz VSW:3000.0000Hz SWT:Auto Detector : Peak Project : 860204 Mode : 111 Power : 18.5</p>
Peak	<p>Site : 03CH13-HY Condition : PEAK_BE(B4)_16-24 3m HORN_91200_1241 HORIZONTAL RBW:3000.0000Hz VSW:3000.0000Hz SWT:Auto Detector : Peak Project : 860204 Mode : 111 Power : 18.5</p>	Left blank

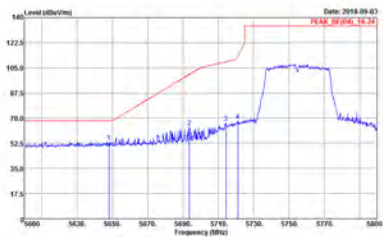
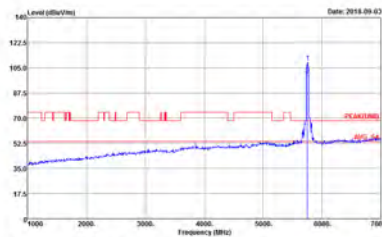
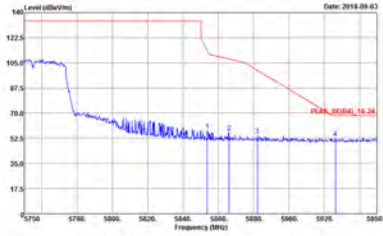

WIFI	Band 4 5725~5850MHz Band Edge @ 3m	
ANT	802.11ac VHT40 CH151 5755MHz	
1+2	Vertical	Fundamental
Peak	 <p>Site : 03CH13-HV Condition : PEAK_86(04)_16-24 3m HORN_91200_1241 VERTICAL RBW:1000.0000Hz VSW:3000.0000Hz SWT:Auto Detector : Peak Project : 860204 Mode : 111 Power : 18.5</p>	 <p>Site : 03CH13-HV Condition : PEAK(UNII) 3m HORN_91200_1241 VERTICAL RBW:1000.0000Hz VSW:3000.0000Hz SWT:Auto Detector : Peak Project : 860204 Mode : 111 Power : 18.5</p>
Peak	 <p>Site : 03CH13-HV Condition : PEAK_86(04)_16-24 3m HORN_91200_1241 VERTICAL RBW:1000.0000Hz VSW:3000.0000Hz SWT:Auto Detector : Peak Project : 860204 Mode : 111 Power : 18.5</p>	Left blank



WIFI	Band 4 5725~5850MHz Band Edge @ 3m	
ANT	802.11ac VHT40 CH159 5795MHz	
1+2	Horizontal	Fundamental
Peak	<p>Site : 03CH3-HV Condition : PEAK_86(04)_16-24 3m HORN_91200_1241 HORIZONTAL RBW:1000.0000Hz VSW:3000.0000Hz SWT:Auto Detector : Peak Project : 860204 Mode : 112 Power : 18.5</p>	<p>Site : 03CH3-HV Condition : PEAK(UNII) 3m HORN_91200_1241 HORIZONTAL RBW:1000.0000Hz VSW:3000.0000Hz SWT:Auto Detector : Peak Project : 860204 Mode : 112 Power : 18.5</p>
Peak	<p>Site : 03CH3-HV Condition : PEAK_86(04)_16-24 3m HORN_91200_1241 HORIZONTAL RBW:1000.0000Hz VSW:3000.0000Hz SWT:Auto Detector : Peak Project : 860204 Mode : 112 Power : 18.5</p>	Left blank



WIFI	Band 4 5725~5850MHz Band Edge @ 3m	
ANT	802.11ac VHT40 CH159 5795MHz	
1+2	Vertical	Fundamental
Peak	<p>Site : 03CH13-HV Condition : PEAK_86(04)_16-24 3m HORN_91200_1241 VERTICAL RBW:1000.0000Hz VSW:3000.0000Hz SWT:Auto Detector : Peak Project : 860204 Mode : 112 Power : 18.5</p>	<p>Site : 03CH13-HV Condition : PEAK(LINE1) 3m HORN_91200_1241 VERTICAL RBW:1000.0000Hz VSW:3000.0000Hz SWT:Auto Detector : Peak Project : 860204 Mode : 112 Power : 18.5</p>
Peak	<p>Site : 03CH13-HV Condition : PEAK_86(04)_16-24 3m HORN_91200_1241 VERTICAL RBW:1000.0000Hz VSW:3000.0000Hz SWT:Auto Detector : Peak Project : 860204 Mode : 112 Power : 18.5</p>	Left blank



Band 4 5725~5850MHz

WIFI 802.11ac VHT80 (Band Edge @ 3m)

WIFI	Band 4 5725~5850MHz Band Edge @ 3m	
ANT	802.11ac VHT80 CH155 5775MHz	
1+2	Horizontal	Fundamental
Peak	<p>Site : 03CH13-HY Condition : PEAK_38(04)_16-24 3m HORN_91200_1241 HORIZONTAL RBW:3000.0000Hz VSW:3000.0000Hz SWT:Auto Detector : Peak Project : 860204 Mode : 113 Power : 18.5</p>	<p>Site : 03CH13-HY Condition : PEAK(UNIT) 3m HORN_91200_1241 HORIZONTAL RBW:3000.0000Hz VSW:3000.0000Hz SWT:Auto Detector : Peak Project : 860204 Mode : 113 Power : 18.5</p>
Peak	<p>Site : 03CH13-HY Condition : PEAK_38(04)_16-24 3m HORN_91200_1241 HORIZONTAL RBW:3000.0000Hz VSW:3000.0000Hz SWT:Auto Detector : Peak Project : 860204 Mode : 113 Power : 18.5</p>	Left blank



WIFI	Band 4 5725~5850MHz Band Edge @ 3m	
ANT	802.11ac VHT80 CH155 5775MHz	
1+2	Vertical	Fundamental
Peak	<p>Site : 03CH13-HV Condition : PEAK_86(04)_16-24 3m HORN_91200_1241 VERTICAL RBW:1000.0000Hz VSW:3000.0000Hz SWT:Auto Detector : Peak Project : 860204 Mode : 113 Power : 18.5</p>	<p>Site : 03CH13-HV Condition : PEAK(UNII) 3m HORN_91200_1241 VERTICAL RBW:1000.0000Hz VSW:3000.0000Hz SWT:Auto Detector : Peak Project : 860204 Mode : 113 Power : 18.5</p>
Peak	<p>Site : 03CH13-HV Condition : PEAK_86(04)_16-24 3m HORN_91200_1241 VERTICAL RBW:1000.0000Hz VSW:3000.0000Hz SWT:Auto Detector : Peak Project : 860204 Mode : 113 Power : 18.5</p>	Left blank



Band 4 - 5725~5850MHz

WIFI 802.11ac VHT20 (Harmonic @ 3m)

WIFI	Band 4 5725~5850MHz Harmonic @ 3m	
ANT	802.11ac VHT20 CH149 5745MHz	
1+2	Horizontal	Vertical
Peak Avg.		

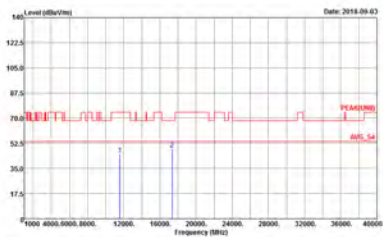
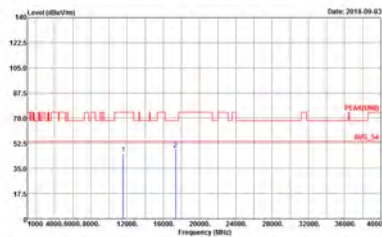

WIFI	Band 4 5725~5850MHz Harmonic @ 3m	
ANT	802.11ac VHT20 CH157 5785MHz	
1+2	Horizontal	Vertical
Peak Avg.	<div style="display: flex; justify-content: space-around;"> <div style="width: 45%;">  <p>Site : 03CH157-44Y Condition : PEAK(LINE) 3m SHF_HORN_576 HORIZONTAL Detector : Peak Project : 860204 Mode : 109 Power : 18.5</p> </div> <div style="width: 45%;">  <p>Site : 03CH157-44Y Condition : PEAK(LINE) 3m SHF_HORN_576 VERTICAL Detector : Peak Project : 860204 Mode : 109 Power : 18.5</p> </div> </div>	



WIFI	Band 4 5725~5850MHz Harmonic @ 3m	
ANT	802.11ac VHT20 CH165 5825MHz	
1+2	Horizontal	Vertical
Peak Avg.	<div style="display: flex; justify-content: space-around;"> <div style="width: 45%;"> <p>Site : 03CH1E-44V Condition : PEAK(LINE) 3m SHF_HORN_576 VERTICAL Detector : Peak Project : 860204 Mode : 110 Power : 18.5</p> </div> <div style="width: 45%;"> <p>Site : 03CH1E-44V Condition : PEAK(LINE) 3m SHF_HORN_576 VERTICAL Detector : Peak Project : 860204 Mode : 110 Power : 18.5</p> </div> </div>	



Band 4 5725~5850MHz
WIFI 802.11ac VHT40 (Harmonic @ 3m)

WIFI	Band 4 5725~5850MHz Harmonic @ 3m	
ANT	802.11ac VHT40 CH151 5755MHz	
1+2	Horizontal	Vertical
Peak Avg.	<p>Site : 03CH13-HY Condition : PEAK(UNII) 3m SHF_HORN_576 HORIZONTAL Detector : Peak Project : 860204 Mode : 111 Power : 18.5</p>	<p>Site : 03CH13-HY Condition : PEAK(UNII) 3m SHF_HORN_576 VERTICAL Detector : Peak Project : 860204 Mode : 111 Power : 18.5</p>



WIFI	Band 4 5725~5850MHz Harmonic @ 3m	
ANT	802.11ac VHT40 CH159 5795MHz	
1+2	Horizontal	Vertical
Peak Avg.	<div style="display: flex; justify-content: space-around;"> <div data-bbox="427 495 810 806"> <p>Site : 03CH159-4#Y Condition : PEAK(LINE) 3m SHF_HORN_576 HORIZONTAL Detector : Peak Project : 860204 Mode : 112 Power : 18.5</p> </div> <div data-bbox="906 495 1289 806"> <p>Site : 03CH159-4#Y Condition : PEAK(LINE) 3m SHF_HORN_576 VERTICAL Detector : Peak Project : 860204 Mode : 112 Power : 18.5</p> </div> </div>	



Band 4 5725~5850MHz
WIFI 802.11ac VHT80 (Harmonic @ 3m)

WIFI	Band 4 5725~5850MHz Harmonic @ 3m	
ANT	802.11ac VHT80 CH155 5775MHz	
1+2	Horizontal	Vertical
Peak Avg.	<p>Site : 03CHE3-HY Condition : PEAK(UNII) 3m SHF_HORN_576 HORIZONTAL Detector : Peak Project : 860204 Mode : 113 Power : 18.5</p>	<p>Site : 03CHE3-HY Condition : PEAK(UNII) 3m SHF_HORN_576 VERTICAL Detector : Peak Project : 860204 Mode : 113 Power : 18.5</p>



Emission below 1GHz

5GHz WIFI 802.11ac VHT40 (LF)

WIFI	5GHz 5725~5850MHz	
ANT	802.11ac VHT40 LF	
1+2	Horizontal	Vertical
QP / Peak	<p>Site : 03CH13-HY Condition : QP in BLOC_40103 HORIZONTAL Detector : Peak Project : 860204 Mode : 112</p>	<p>Site : 03CH13-HY Condition : QP in BLOC_40103 VERTICAL Detector : Peak Project : 860204 Mode : 112</p>



Appendix D. Duty Cycle Plots

Antenna	Band	Duty Cycle(%)	T(us)	1/T(kHz)	VBW Setting	Duty Factor(dB)
1	802.11a	95.31	2030.00	0.49	1kHz	95.31
2	802.11a	95.31	2030.00	0.49	1kHz	95.31
1+2	802.11a for Ant. 1	95.33	2040.00	0.49	1kHz	95.33
1+2	802.11a for Ant. 2	95.77	2040.00	0.49	1kHz	95.77
1	5GHz 802.11n HT20	94.97	1890.00	0.53	1kHz	94.97
2	5GHz 802.11n HT20	95.00	1900.00	0.53	1kHz	95.00
1+2	5GHz 802.11n HT20 for Ant. 1	95.00	1900.00	0.53	1kHz	95.00
1+2	5GHz 802.11n HT20 for Ant. 2	94.97	1890.00	0.53	1kHz	94.97
1	5GHz 802.11n HT40	91.18	930.00	1.08	3kHz	91.18
2	5GHz 802.11n HT40	91.09	920.00	1.09	3kHz	91.09
1+2	5GHz 802.11n HT40 for Ant. 1	90.29	930.00	1.08	3kHz	90.29
1+2	5GHz 802.11n HT40 for Ant. 2	91.18	930.00	1.08	3kHz	91.18
1	5GHz 802.11ac VHT20	95.50	1910.00	0.52	1kHz	95.50
2	5GHz 802.11ac VHT20	95.00	1900.00	0.53	1kHz	95.00
1+2	5GHz 802.11ac VHT20 for Ant. 1	95.50	1910.00	0.52	1kHz	95.50
1+2	5GHz 802.11ac VHT20 for Ant. 2	95.00	1900.00	0.53	1kHz	95.00
1	5GHz 802.11ac VHT40	90.29	930.00	1.08	3kHz	90.29
2	5GHz 802.11ac VHT40	90.29	930.00	1.08	3kHz	90.29
1+2	5GHz 802.11ac VHT40 for Ant. 1	91.18	930.00	1.08	3kHz	91.18
1+2	5GHz 802.11ac VHT40 for Ant. 2	90.29	930.00	1.08	3kHz	90.29
1	5GHz 802.11ac VHT80	89.09	735.00	1.36	3kHz	89.09
2	5GHz 802.11ac VHT80	90.24	740.00	1.35	3kHz	90.24
1+2	5GHz 802.11ac VHT80 for Ant. 1	87.95	730.00	1.37	3kHz	87.95
1+2	5GHz 802.11ac VHT80 for Ant. 2	87.95	730.00	1.37	3kHz	87.95



<Ant. 1>

802.11a

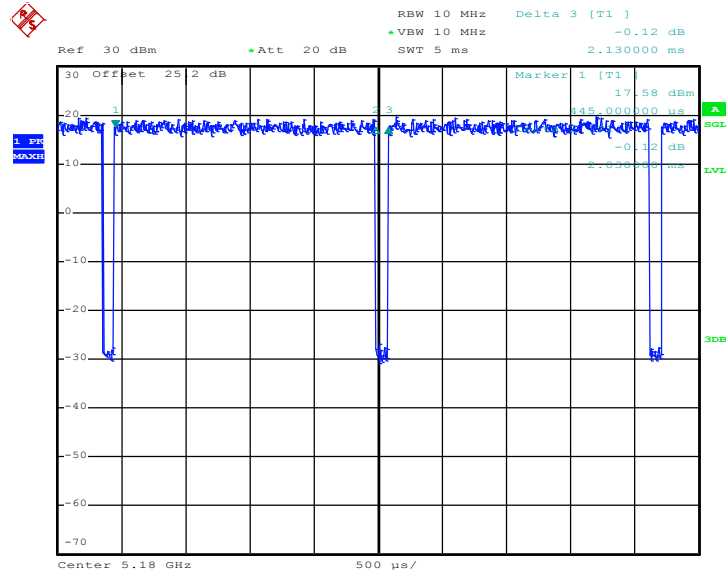

Date: 7.JUN.2018 20:20:25

802.11n HT20

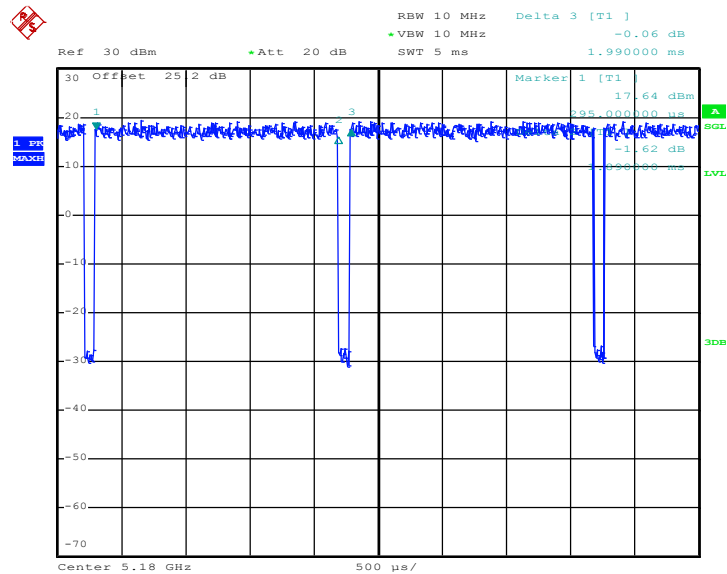

Date: 7.JUN.2018 20:50:07



802.11n HT40

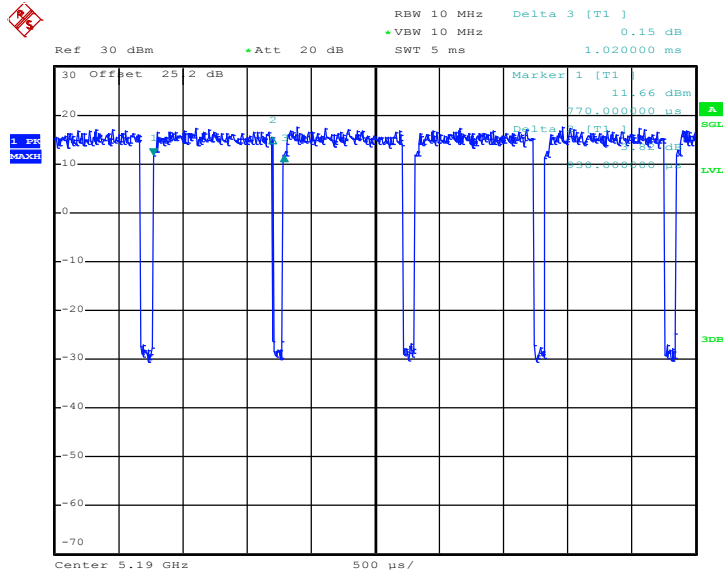

Date: 7.JUN.2018 22:18:30

802.11ac VHT20

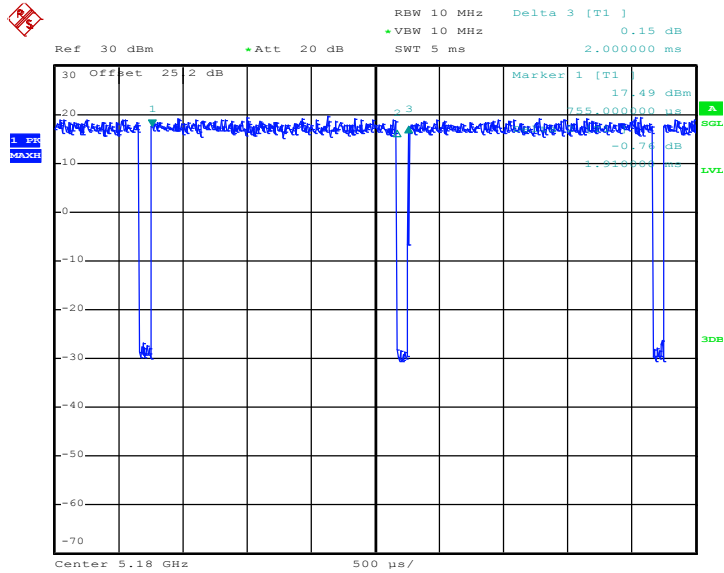

Date: 7.JUN.2018 22:50:48



802.11ac VHT40

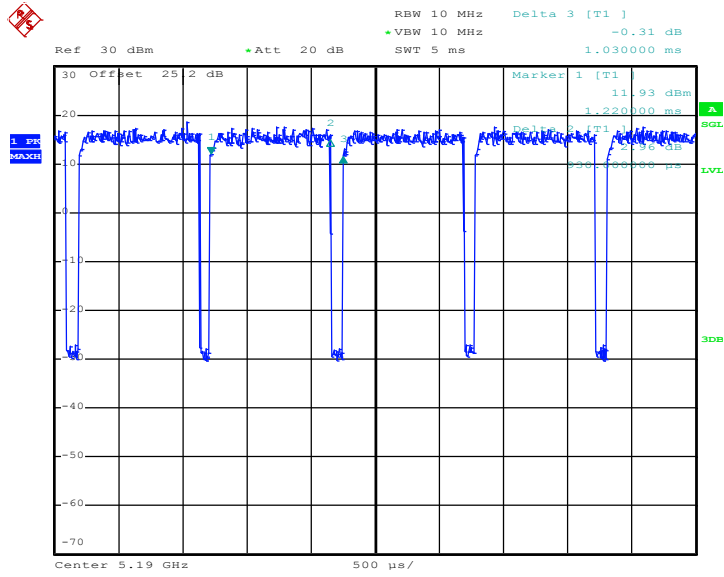

Date: 7.JUN.2018 23:16:35

802.11ac VHT80

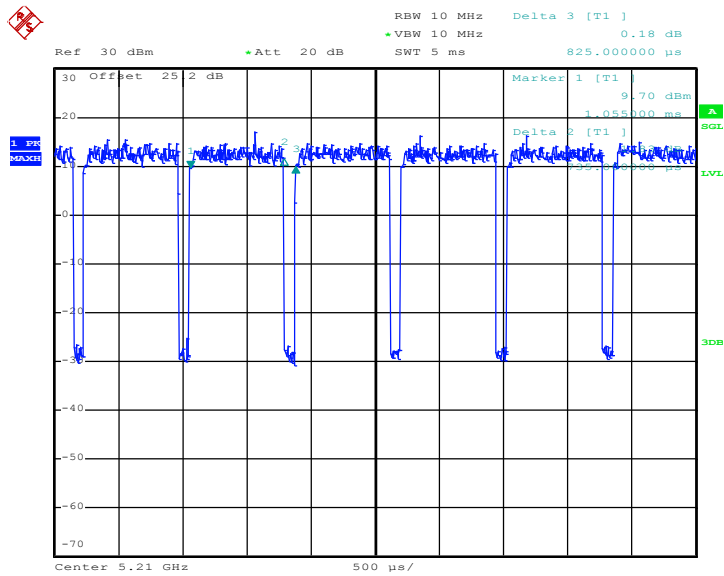

Date: 8.JUN.2018 00:05:12



<Ant. 2>

802.11a

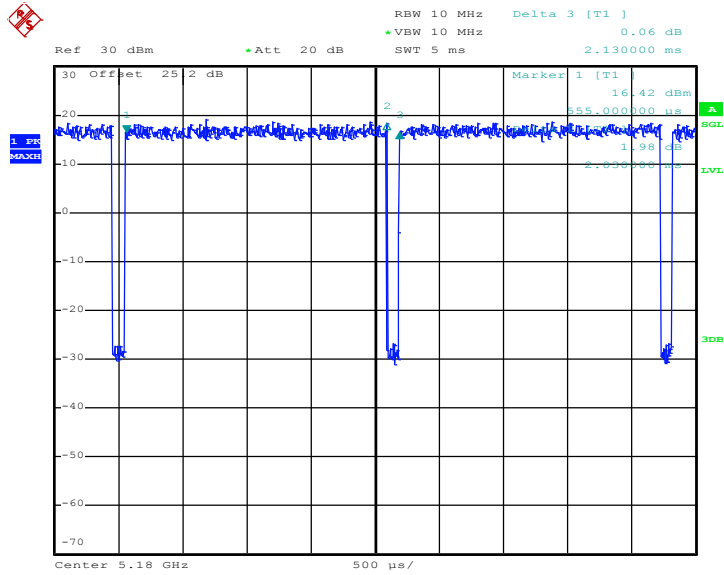

Date: 7.JUN.2018 20:25:06

802.11n HT20

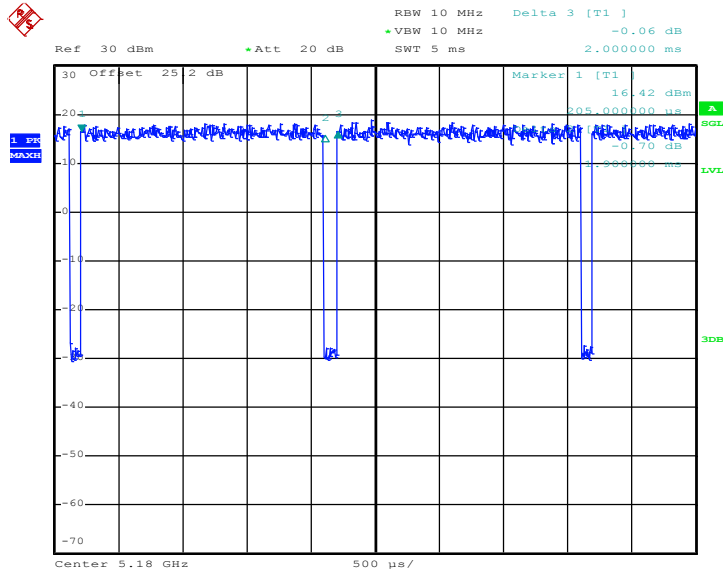

Date: 7.JUN.2018 20:54:55



802.11n HT40

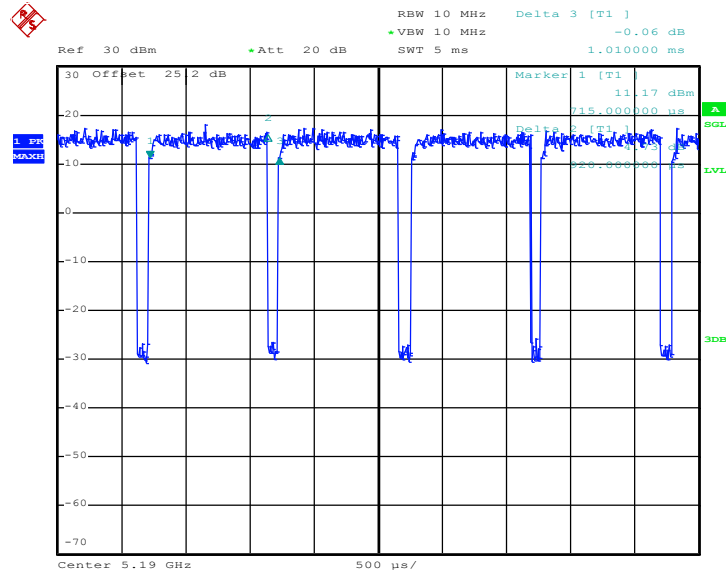

Date: 7.JUN.2018 22:22:05

802.11ac VHT20

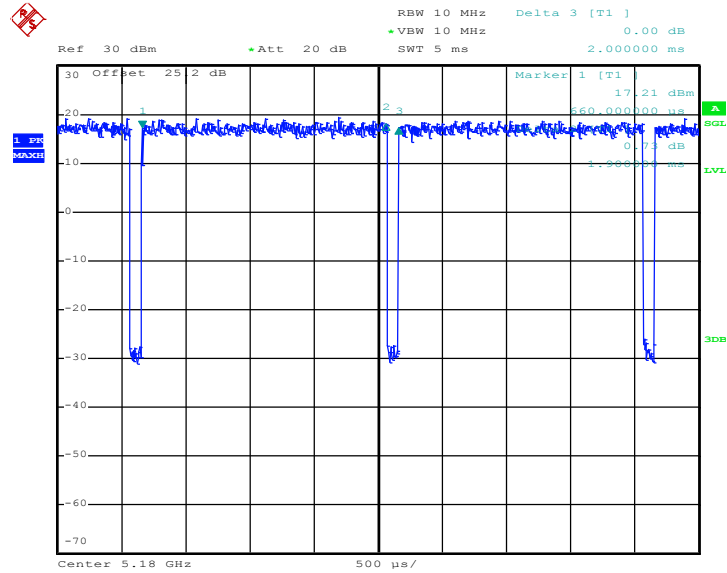

Date: 7.JUN.2018 22:45:31



802.11ac VHT40

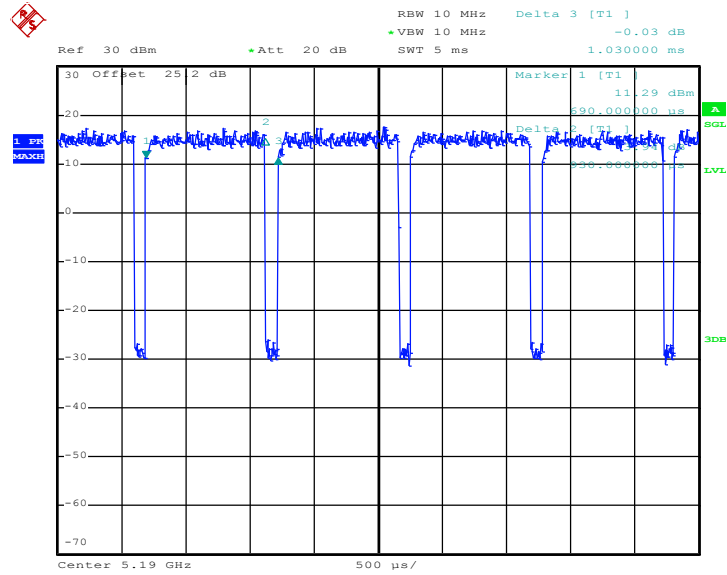

Date: 7.JUN.2018 23:17:22

802.11ac VHT80

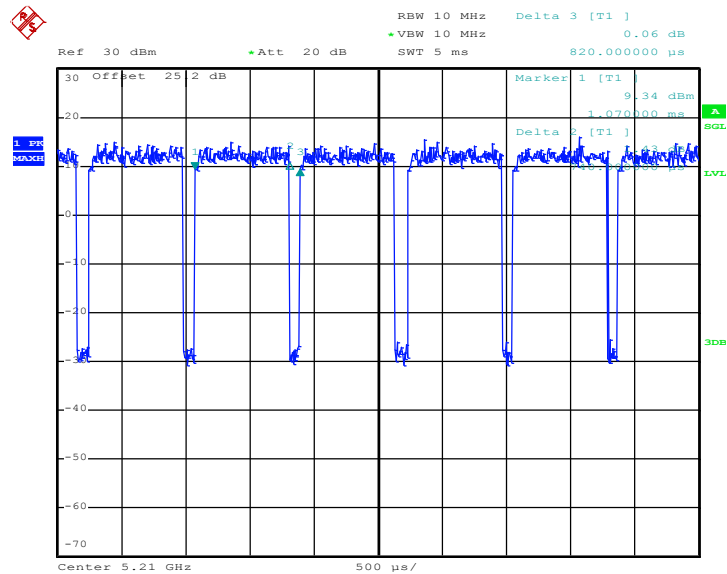

Date: 8.JUN.2018 00:07:45



MIMO <Ant. 1>

802.11a

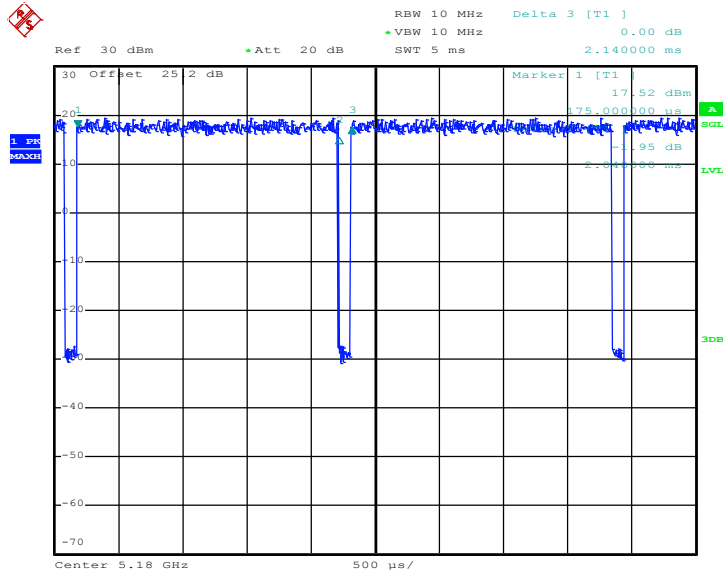

Date: 7.JUN.2018 19:42:22

802.11n HT20

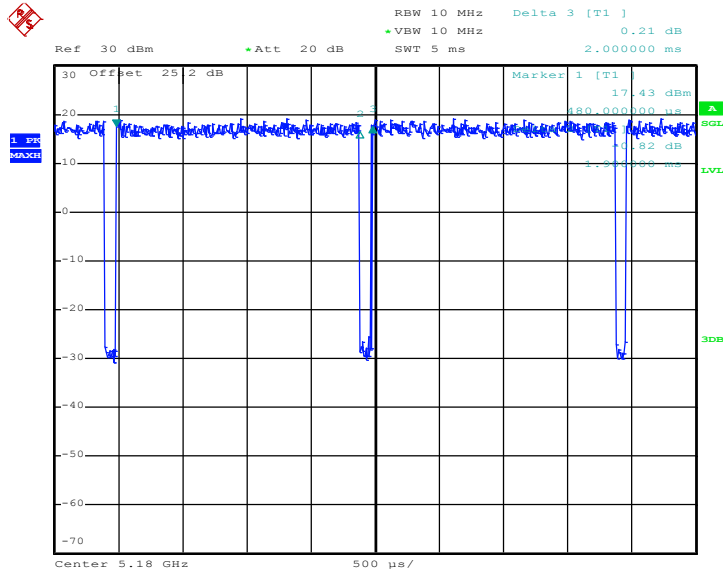

Date: 7.JUN.2018 20:33:06



802.11n HT40

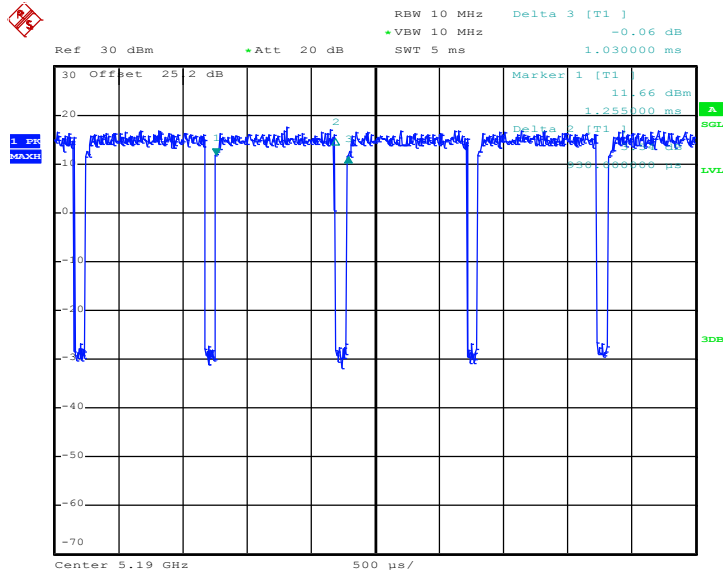

Date: 7.JUN.2018 21:01:37

802.11ac VHT20

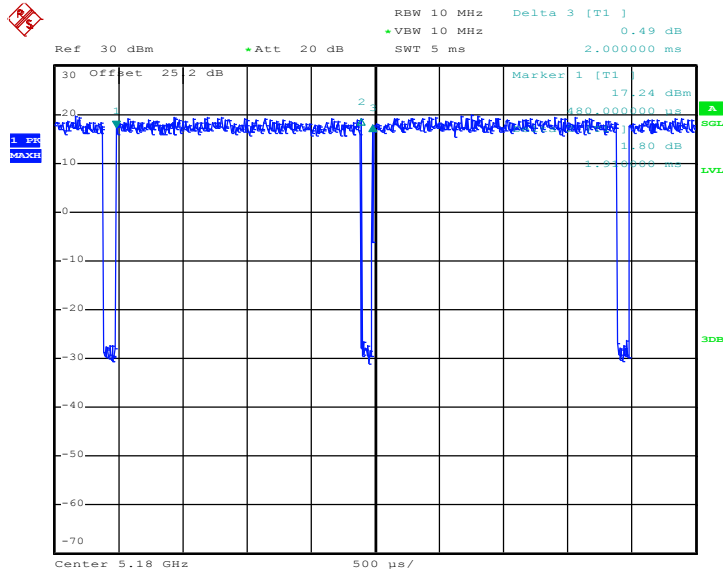

Date: 7.JUN.2018 23:02:44



802.11ac VHT40

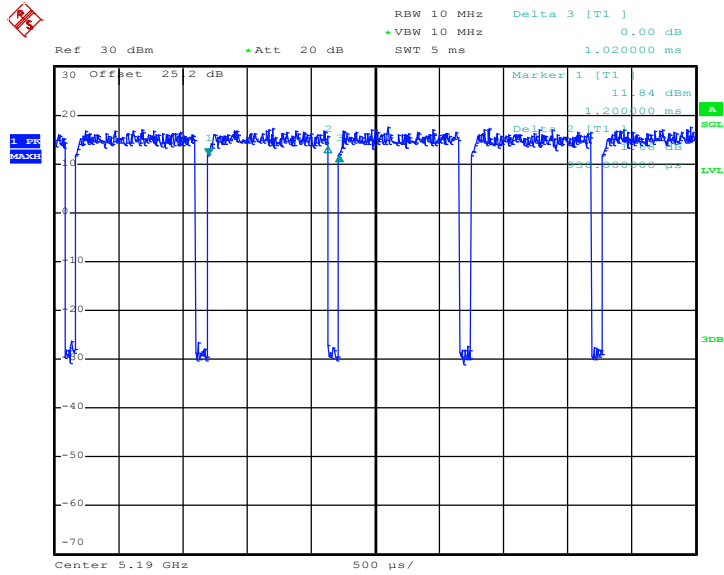

Date: 7.JUN.2018 23:09:04

802.11ac VHT80

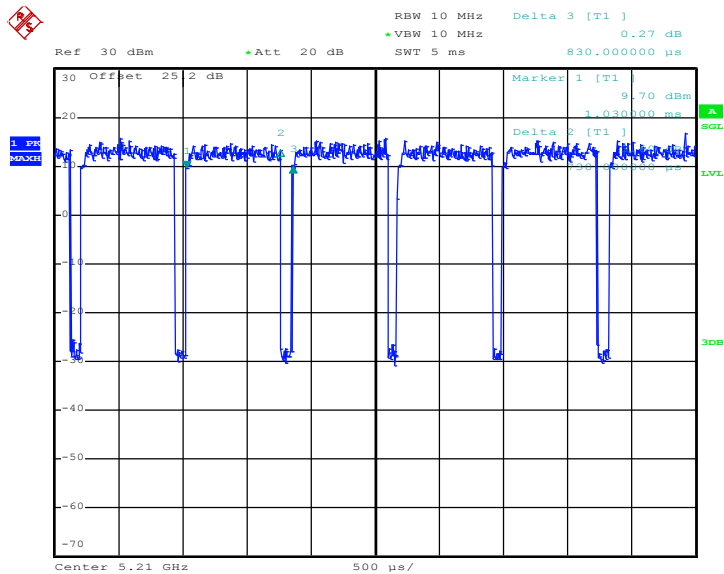

Date: 7.JUN.2018 23:30:54



MIMO <Ant. 2>

802.11a

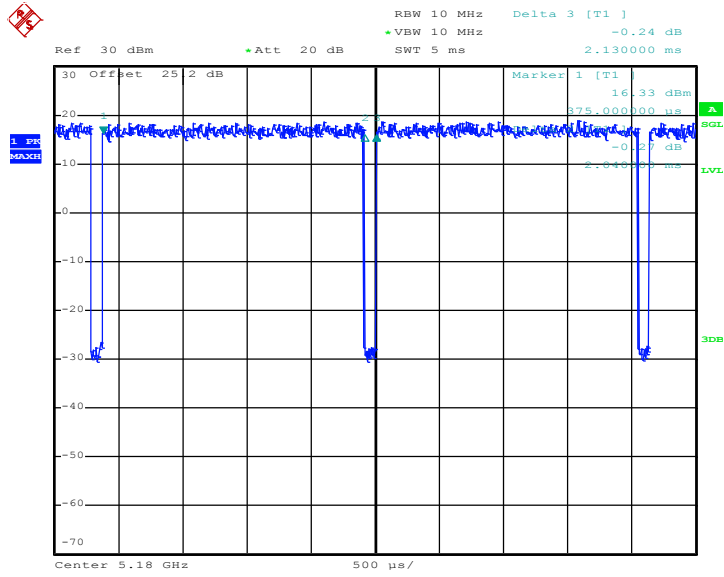

Date: 7.JUN.2018 19:43:34

802.11n HT20

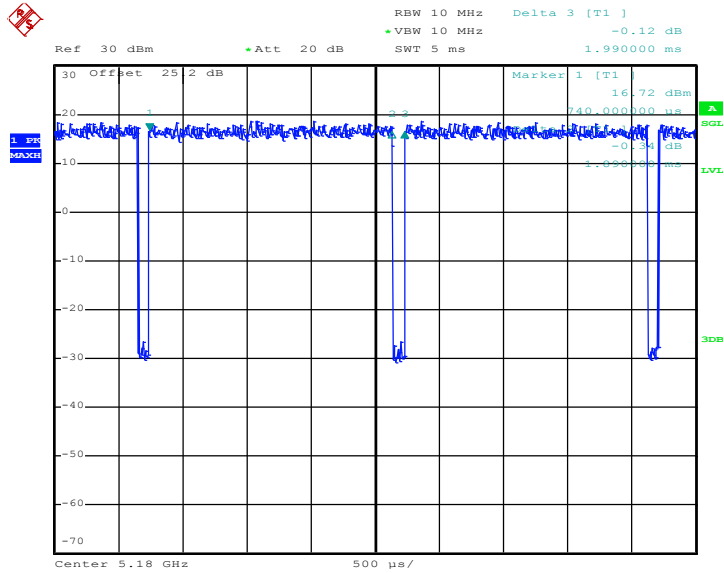

Date: 7.JUN.2018 20:32:08



802.11n HT40

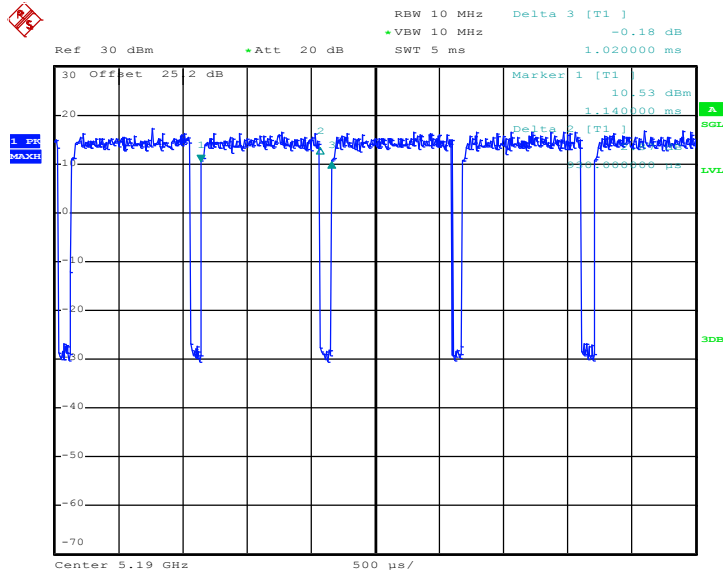

Date: 7.JUN.2018 21:02:47

802.11ac VHT20

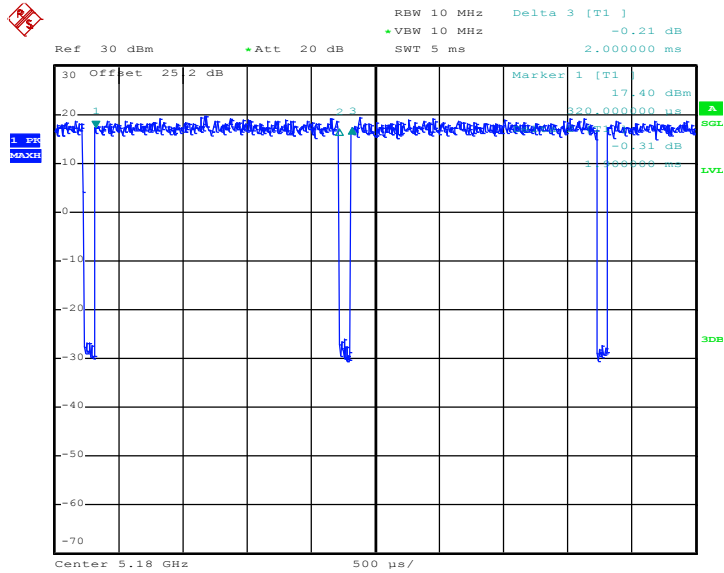

Date: 7.JUN.2018 22:28:23



802.11ac VHT40

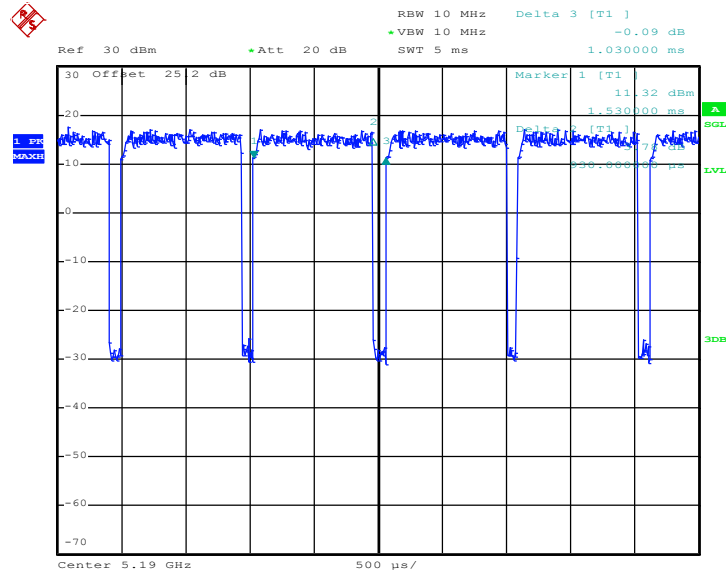

Date: 7.JUN.2018 23:09:49

802.11ac VHT80

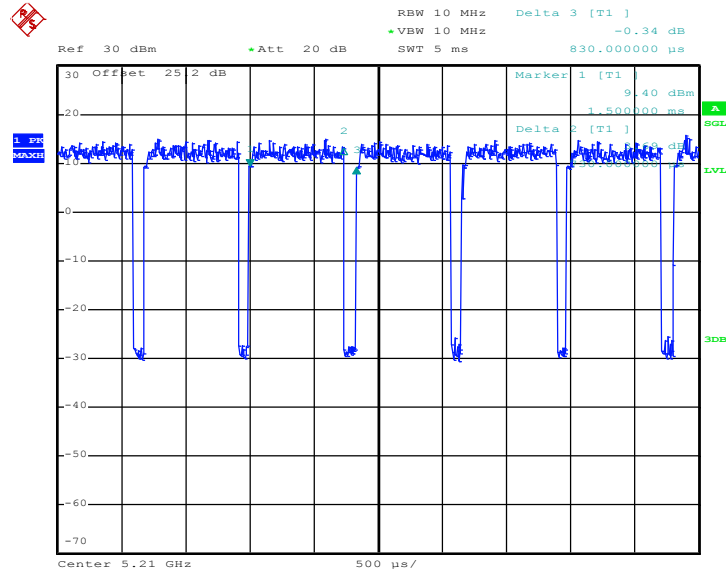

Date: 7.JUN.2018 23:29:36