



# FCC TEST REPORT (RFID)

**REPORT NO.:** RF110922C14

**MODEL NO.:** MPM-100

**FCC ID:** UZ7MPM100

**RECEIVED:** Sep. 22, 2011

**TESTED:** Oct. 01 ~ Oct. 26, 2011

**ISSUED:** Oct. 27, 2011

**APPLICANT:** Motorola Solutions, Inc.

**ADDRESS:** 1 Motorola Plaza, Holtsville, NY 11742-1300 USA

**ISSUED BY:** Bureau Veritas Consumer Products Services (H.K.)  
Ltd., Taoyuan Branch

**LAB ADDRESS:** No. 47, 14th Ling, Chia Pau Vil., Lin Kou Dist., New  
Taipei City, Taiwan ( R.O.C )

**TEST LOCATION:** No. 19, Hwa Ya 2nd Rd, Wen Hwa Tsuen, Kwei Shan  
Hsiang, Taoyuan Hsien 333, Taiwan, R.O.C.

This test report consists of 58 pages in total. It may be duplicated completely for legal use with the approval of the applicant. It should not be reproduced except in full, without the written approval of our laboratory. The client should not use it to claim product, certification, approval or endorsement by TAF or any government agency. The test results in the report only apply to the tested sample. The test results in this report are traceable to the national or international standards.





## Table of Contents

RELEASE CONTROL RECORD .....	4
1. CERTIFICATION .....	5
2. SUMMARY OF TEST RESULTS .....	6
2.1 MEASUREMENT UNCERTAINTY .....	6
3. GENERAL INFORMATION.....	7
3.1 GENERAL DESCRIPTION OF EUT.....	7
3.2 DESCRIPTION OF TEST MODES.....	9
3.2.1 CONFIGURATION OF SYSTEM UNDER TEST .....	9
3.2.2 TEST MODE APPLICABILITY AND TESTED CHANNEL DETAIL.....	11
3.3 GENERAL DESCRIPTION OF APPLIED STANDARDS .....	13
3.4 DESCRIPTION OF SUPPORT UNITS .....	13
4. TEST TYPES AND RESULTS .....	14
4.1 RADIATED EMISSION MEASUREMENT .....	14
4.1.1 LIMITS OF RADIATED EMISSION MEASUREMENT.....	14
4.1.2 TEST INSTRUMENTS .....	15
4.1.3 TEST PROCEDURES .....	17
4.1.4 DEVIATION FROM TEST STANDARD .....	17
4.1.5 TEST SETUP .....	18
4.1.6 EUT OPERATING CONDITIONS.....	18
4.1.7 TEST RESULTS .....	19
4.2 CONDUCTED EMISSION MEASUREMENT .....	35
4.2.1 LIMITS OF CONDUCTED EMISSION MEASUREMENT.....	35
4.2.2 TEST INSTRUMENTS .....	35
4.2.3 TEST PROCEDURES .....	36
4.2.4 DEVIATION FROM TEST STANDARD .....	36
4.2.5 TEST SETUP .....	37
4.2.6 EUT OPERATING CONDITIONS.....	37
4.2.7 TEST RESULTS .....	38
4.3 FREQUENCY STABILITY .....	46
4.3.1 LIMITS OF FREQUENCY STABILITY MEASUREMENT .....	46
4.3.2 TEST INSTRUMENTS .....	46
4.3.3 TEST PROCEDURE .....	46
4.3.4 DEVIATION FROM TEST STANDARD .....	47
4.3.5 TEST SETUP .....	47



A D T

4.3.6	EUT OPERATING CONDITION .....	47
4.3.7	TEST RESULTS .....	48
4.4	20DB BANDWIDTH.....	51
4.4.1	LIMITS OF 20DB BANDWIDTH MEASUREMENT .....	51
4.4.2	TEST INSTRUMENTS .....	51
4.4.3	TEST PROCEDURE .....	51
4.4.4	DEVIATION FROM TEST STANDARD .....	51
4.4.5	TEST SETUP .....	51
4.4.6	EUT OPERATING CONDITION .....	51
4.4.7	TEST RESULTS .....	52
5.	PHOTOGRAPHS OF THE TEST CONFIGURATION.....	56
6.	INFORMATION ON THE TESTING LABORATORIES .....	57
7.	APPENDIX A - MODIFICATIONS RECORDERS FOR ENGINEERING CHANGES TO THE EUT BY THE LAB.....	58



A D T

## RELEASE CONTROL RECORD

ISSUE NO.	REASON FOR CHANGE	DATE ISSUED
Original release	NA	Oct. 27, 2011



# 1. CERTIFICATION

**PRODUCT:** Mobile Payment Module  
**MODEL NO.:** MPM-100  
**BRAND:** MOTOROLA  
**APPLICANT:** Motorola Solutions, Inc.  
**TEST SAMPLE:** ENGINEERING SAMPLE  
**TESTED:** Oct. 01 ~ Oct. 26, 2011  
**STANDARDS:** **FCC Part 15, Subpart C (Section 15.225)**  
**FCC Part 15, Subpart C (Section 15.215)**  
ANSI C63.4-2003  
ANSI C63.10-2009

The above equipment (model: MPM-100) has been tested by **Bureau Veritas Consumer Products Services (H.K.) Ltd., Taoyuan Branch**. The test record, data evaluation & Equipment Under Test (EUT) configurations represented herein are true and accurate accounts of the measurements of the sample's EMC characteristics under the conditions specified in this report.

**PREPARED BY** : Ivy Lin , **DATE:** Oct. 27, 2011  
Ivy Lin / Specialist

**APPROVED BY** : Gary Chang , **DATE:** Oct. 27, 2011  
Gary Chang / Technical Manager

## 2. SUMMARY OF TEST RESULTS

The EUT has been tested according to the following specifications:

APPLIED STANDARD: FCC PART 15, SUBPART C (SECTION 15.225, 15.215)			
STANDARD SECTION	TEST TYPE AND LIMIT	RESULT	REMARK
15.207	Conducted emission test	PASS	Meet the requirement of limit. Minimum passing margin is -12.18dB at 17.410MHz.
15.225 (a)	The field strength of any emissions within the band 13.553-13.567 MHz	PASS	Meet the requirement of limit. Minimum passing margin is -47.6dB at 13.56MHz.
15.225 (d)	The field strength of any emissions appearing outside of the 13.110-14.010 MHz band	PASS	Meet the requirement of limit. Minimum passing margin is -10.4dB at 142.67MHz.
15.225 (e)	The frequency tolerance	PASS	Meet the requirement of limit.
15.215 (c)	20dB Bandwidth	PASS	Meet the requirement of limit.

### 2.1 MEASUREMENT UNCERTAINTY

Where relevant, the following measurement uncertainty levels have been estimated for tests performed on the EUT as specified in CISPR 16-4-2:

MEASUREMENT	FREQUENCY	UNCERTAINTY
Conducted Emission	150kHz ~ 30MHz	2.44 dB
Radiated emissions	30MHz ~ 200MHz	2.44 dB
	200MHz ~1000MHz	3.19 dB

This uncertainty represents an expanded uncertainty expressed at approximately the 95% confidence level using a coverage factor of k=2.

### 3. GENERAL INFORMATION

#### 3.1 GENERAL DESCRIPTION OF EUT

<b>EUT</b>	Mobile Payment Module
<b>MODEL NO.</b>	MPM-100
<b>FCC ID</b>	UZ7MPM100
<b>POWER SUPPLY</b>	5Vdc (adapter or host equipment) 3.7Vdc (battery)
<b>MODULATION TYPE</b>	ASK
<b>OPERATING FREQUENCY</b>	13.56MHz
<b>ANTENNA TYPE</b>	Fix internal antenna
<b>DATA CABLE</b>	Refer to note as below
<b>I/O PORTS</b>	Refer to user's manual
<b>ACCESSORY DEVICES</b>	Adapter, battery

**NOTE:**

1. The RFID module (brand: VeriFone) module is collocated in this EUT.
2. The EUT uses the following USB cables.

USB Cable	Brand Name	Model No.	Cable length
Cable 1	HUIZHOU SHENGHUA INDUSTRY CO., Ltd.	CBL000-021-01-A	1m non-shielded USB cable without core
Cable 2	MOTOROLA	25-128458-01R	1.7m non-shielded USB cable without core

3. The EUT uses following adapters and battery.

Adapter 1	
<b>Brand</b>	MOTOROLA
<b>Model</b>	IU08-2050120-WP
<b>Input Power</b>	100-240Vac, 50/60Hz, 0.2A
<b>Output Power</b>	5Vdc, 1.2A

Adapter 2	
<b>Brand</b>	VeriFone
<b>Model</b>	AU1050501u
<b>Input Power</b>	100-240Vac, 50/60Hz, 0.2A
<b>Output Power</b>	5Vdc, 1A



A D T

<b>Battery</b>	
<b>Brand</b>	VeriFone
<b>Model</b>	BPK087-201
<b>Power Rating</b>	3.7Vdc, 1380mAh
<b>Type</b>	Li-ion

4. The above EUT information is declared by manufacturer and for more detailed feature description, please refer to the manufacturer's specifications or user's manual.



### 3.2 DESCRIPTION OF TEST MODES

The EUT only have one channel.

CHANNEL	FREQUENCY (MHz)
1	13.56

#### 3.2.1 CONFIGURATION OF SYSTEM UNDER TEST

##### TEST MODE A

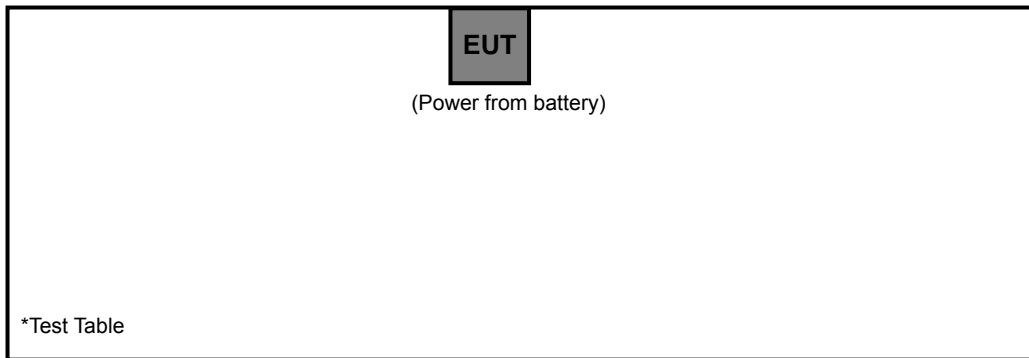

##### TEST MODE B & C

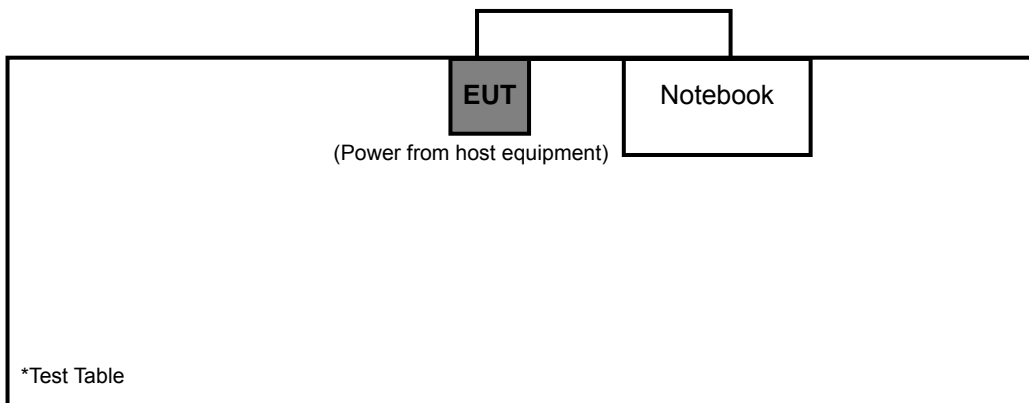



A D T

## TEST MODE D

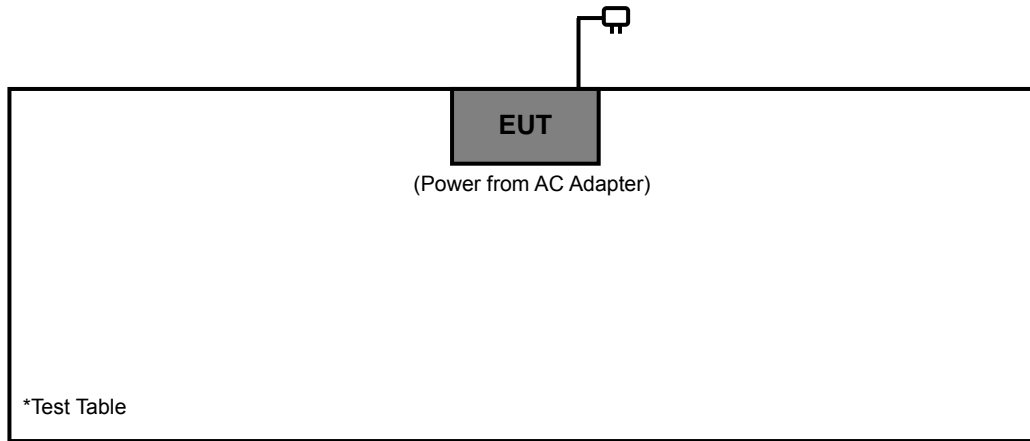

### 3.2.2 TEST MODE APPLICABILITY AND TESTED CHANNEL DETAIL

EUT CONFIGURE MODE	APPLICABLE TO				DESCRIPTION
	RE	PLC	FT	BW	
A	√	-	√	√	MPM-100 standalone + RFID on + BT off + smart card looping + battery standby
B	√	√	√	√	MPM-100 + USB cable-1 (VeriFone) + notebook + RFID on + BT off + smart card looping + battery charging
C	√	√	-	√	MPM-100 + USB cable-2 (MOTO) + notebook + RFID on + BT off + smart card looping + battery charging
D	√	√	√	√	MPM-100 + Adapter-2 (VeriFone) + USB Cable-2 (MOTO) + RFID on + BT off + smart card looping + battery charging

Where **RE**: Radiated Emission **FT**: Frequency Tolerance  
**BW**: 20dB Bandwidth **NOTE**: "-": Means no effect.

\*The EUT was tested the above modes which are defined by client.

#### **RADIATED EMISSION TEST:**

- Pre-Scan has been conducted to determine the worst-case mode from all possible combinations between available modulations, XYZ axis, antenna ports (if EUT with antenna diversity architecture).
- Following channel(s) was (were) selected for the final test as listed below.

EUT CONFIGURE MODE	AVAILABLE CHANNEL	TESTED CHANNEL	MODULATION TYPE	AXIS
A, B, C, D	1	1	ASK	Z

#### **POWER LINE CONDUCTED EMISSION TEST:**

- Pre-Scan has been conducted to determine the worst-case mode from all possible combinations between available modulations and antenna ports (if EUT with antenna diversity architecture).
- Following channel(s) was (were) selected for the final test as listed below.

EUT CONFIGURE MODE	AVAILABLE CHANNEL	TESTED CHANNEL	MODULATION TYPE
B, C, D	1	1	ASK

#### **FREQUENCY TOLERANCE:**

- Pre-Scan has been conducted to determine the worst-case mode from all possible combinations between available modulations, XYZ axis, antenna ports (if EUT with antenna diversity architecture).
- Following channel(s) was (were) selected for the final test as listed below.

EUT CONFIGURE MODE	AVAILABLE CHANNEL	TESTED CHANNEL	MODULATION TYPE	AXIS
A, B, D	1	1	ASK	Z

**20dB BANDWIDTH:**

- Pre-Scan has been conducted to determine the worst-case mode from all possible combinations between available modulations, antenna ports (if EUT with antenna diversity architecture).
- Following channel(s) was (were) selected for the final test as listed below.

EUT CONFIGURE MODE	AVAILABLE CHANNEL	TESTED CHANNEL	MODULATION TYPE
A, B, C, D	1	1	ASK

**TEST CONDITION:**

APPLICABLE TO	TEST MODE	ENVIRONMENTAL CONDITIONS	INPUT POWER	TESTED BY
RE	A	25deg. C, 65%RH	3.7Vdc	David Huang
	B		120Vac, 60Hz (System)	
	C	24deg. C, 64%RH, 25deg. C, 65%RH	120Vac, 60Hz (System)	Match Tsui, David Huang
	D	24deg. C, 64%RH, 25deg. C, 68%RH	120Vac, 60Hz	Match Tsui, Sun Lin
PLC	B	20deg. C, 60%RH	120Vac, 60Hz (System)	Match Tsui
	C	24deg. C, 64%RH	120Vac, 60Hz (System)	Match Tsui
	D		120Vac, 60Hz	
FT	A	25deg. C, 65%RH	3.7Vdc	David Huang
	B		120Vac, 60Hz (System)	
	D	20deg. C, 60%RH	120Vac, 60Hz	Long Chen
BW	A	20deg. C, 65%RH	3.7Vdc	Long Chen
	B		120Vac, 60Hz (System)	
	C	20deg. C, 60%RH	120Vac, 60Hz (System)	Long Chen
	D		120Vac, 60Hz	



### 3.3 GENERAL DESCRIPTION OF APPLIED STANDARDS

The EUT is a RFID Product. According to the specifications of the manufacturer, it must comply with the requirements of the following standards:

**FCC Part 15, Subpart C (15.225)**

**FCC Part 15, Subpart C (15.215)**

ANSI C63.4-2003

ANSI C63.10-2009

All test items have been performed and recorded as per the above standards.

**NOTE:** The EUT is also considered as a kind of computer peripheral, because the connection to computer is necessary for typical use. It has been verified to comply with the requirements of FCC Part 15, Subpart B, Class B. The test report has been issued separately.

### 3.4 DESCRIPTION OF SUPPORT UNITS

NO.	PRODUCT	BRAND	MODEL NO.	SERIAL NO.	FCC ID
1	NOTEBOOK	DELL	E5420	CHHYLQ1	NA

NO.	SIGNAL CABLE DESCRIPTION OF THE ABOVE SUPPORT UNITS
1	NA

**NOTE:** All power cords of the above support units are non-shielded (1.8m).

## 4. TEST TYPES AND RESULTS

### 4.1 RADIATED EMISSION MEASUREMENT

#### 4.1.1 LIMITS OF RADIATED EMISSION MEASUREMENT

The field strength of any emissions within the band 13.553-13.567 MHz shall not exceed 15,848 microvolts/meter at 30 meters.

The field strength of any emissions appearing outside of the 13.110-14.010 MHz band shall not exceed the general radiated emission limits in § 15.209.

FREQUENCIES (MHz)	FIELD STRENGTH (microvolts/meter)	MEASUREMENT DISTANCE (meters)
0.009 ~ 0.490	2400/F(kHz)	300
0.490 ~ 1.705	24000/F(kHz)	30
1.705 ~ 30.0	30	30
30 ~ 88	100	3
88 ~ 216	150	3
216 ~ 960	200	3
Above 960	500	3

**NOTE:**

1. The lower limit shall apply at the transition frequencies.
2. Emission level (dBuV/m) = 20 log Emission level (uV/m).
3. As shown in 15.35(b), for frequencies above 1000MHz, the field strength limits are based on average detector, however, the peak field strength of any emission shall not exceed the maximum permitted average limits, specified above by more than 20dB under any condition of modulation.

#### 4.1.2 TEST INSTRUMENTS

##### For test mode A ~ B

DESCRIPTION & MANUFACTURER	MODEL NO.	SERIAL NO.	DATE OF CALIBRATION	DUE DATE OF CALIBRATION
Test Receiver ROHDE & SCHWARZ	ESI7	838496/016	Dec. 27, 2010	Dec. 26, 2011
Spectrum Analyzer ROHDE & SCHWARZ	FSP40	100039	Feb. 23, 2011	Feb. 22, 2012
BILOG Antenna SCHWARZBECK	VULB9168	9168-155	Apr. 12, 2011	Apr. 11, 2012
HORN Antenna SCHWARZBECK	BBHA 9120D	9120D-408	Jan. 06, 2011	Jan. 05, 2012
HORN Antenna SCHWARZBECK	BBHA 9170	BBHA9170243	Dec. 27, 2010	Dec. 26, 2011
Preamplifier Agilent	8449B	3008A01961	Nov. 02, 2010	Nov. 01, 2011
Preamplifier Agilent	8447D	2944A10738	Nov. 02, 2010	Nov. 01, 2011
RF signal cable HUBER+SUHNNER	SUCOFLEX 104	250792/4	Aug. 19, 2011	Aug. 18, 2012
RF signal cable HUBER+SUHNNER	SUCOFLEX 104	283397/4	Aug. 19, 2011	Aug. 18, 2012
RF signal cable HUBER+SUHNNER	SUCOFLEX 104	295012/4	Aug. 19, 2011	Aug. 18, 2012
Software ADT.	ADT_Radiated_ V7.6.15.9.2	NA	NA	NA
Antenna Tower inn-co GmbH	MA 4000	010303	NA	NA
Antenna Tower Controller inn-co GmbH	CO2000	019303	NA	NA
Turn Table ADT.	TT100.	TT93021704	NA	NA
Turn Table Controller ADT.	SC100.	SC93021704	NA	NA

- NOTE:**
1. The calibration interval of the above test instruments is 12 months and the calibrations are traceable to NML/ROC and NIST/USA.
  2. The test was performed in HwaYa Chamber 4.
  3. The horn antenna and HP preamplifier (model: 8449B) are used only for the measurement of emission frequency above 1GHz if tested.
  4. The FCC Site Registration No. is 988962.
  5. The IC Site Registration No. is IC7450F-4.



**For test mode C ~ D**

DESCRIPTION & MANUFACTURER	MODEL NO.	SERIAL NO.	DATE OF CALIBRATION	DUE DATE OF CALIBRATION
Test Receiver ROHDE & SCHWARZ	ESCI	100744	Apr. 19, 2011	Apr. 18, 2012
Spectrum Analyzer ROHDE & SCHWARZ	FSP40	100269	Jan. 06, 2011	Jan. 05, 2012
BILOG Antenna SCHWARZBECK	VULB9168	9168-156	Apr. 12, 2011	Apr. 11, 2012
HORN Antenna SCHWARZBECK	BBHA 9120 D	9120D-563	Sep. 06, 2011	Sep. 05, 2012
HORN Antenna SCHWARZBECK	BBHA 9170	BBHA9170243	Dec. 27, 2010	Dec. 26, 2011
Preamplifier Agilent	8449B	3008A01911	Nov. 03, 2010	Nov. 02, 2011
Preamplifier Agilent	8447D	2944A10638	Nov. 03, 2010	Nov. 02, 2011
RF signal cable HUBER+SUHNNER	SUCOFLEX 104	295013/4 283403/4	Aug. 19, 2011	Aug. 18, 2012
RF signal cable Worken	8D-FB	Cable-HYCH9-0 1	Aug. 13, 2011	Aug. 12, 2012
Software	ADT_Radiated_ V7.6.15.9.2	NA	NA	NA
Antenna Tower EMCO	2070/2080	512.835.4684	NA	NA
Turn Table EMCO	2087-2.03	NA	NA	NA
Antenna Tower & Turn Table Controller EMCO	2090	NA	NA	NA

- NOTE:**
1. The calibration interval of the above test instruments is 12 months and the calibrations are traceable to NML/ROC and NIST/USA.
  2. The test was performed in HwaYa Chamber 9.
  3. The horn antenna and HP preamplifier (model: 8449B) are used only for the measurement of emission frequency above 1GHz if tested.
  4. The FCC Site Registration No. is 460141.
  5. The IC Site Registration No. is IC 7450F-4.



#### 4.1.3 TEST PROCEDURES

- a. The EUT was placed on the top of a rotating table 0.8 meters above the ground at a 3 meter semi-anechoic chamber. The table was rotated 360 degrees to determine the position of the highest radiation.
- b. The EUT was set 3 meters away from the interference-receiving antenna, which was mounted on the top of a variable-height antenna tower.
- c. The antenna is a broadband antenna, and its height is varied from one meter to four meters above the ground to determine the maximum value of the field strength. Both horizontal and vertical polarizations of the antenna are set to make the measurement.
- d. For each suspected emission, the EUT was arranged to its worst case and then the antenna was tuned to heights from 1 meter to 4 meters and the rotatable table was turned from 0 degrees to 360 degrees to find the maximum reading.
- e. The test-receiver system was set to Peak Detect Function and Specified Bandwidth with Maximum Hold Mode.
- f. If the emission level of the EUT in peak mode was lower than the limit specified, then testing could be stopped and the peak values of the EUT would be reported. Otherwise the emissions would be re-tested one by one using peak, quasi-peak or average method as specified and then reported in a data sheet.

**NOTE:**

1. The resolution bandwidth and video bandwidth of test receiver/spectrum analyzer is 120kHz for Quasi-peak detection at frequency below 1GHz.
2. The resolution bandwidth of test receiver/spectrum analyzer is 1 MHz and video bandwidth is 3MHz for Peak detection at frequency above 1GHz.
3. All modes of operation were investigated and the worst-case emissions are reported.

#### 4.1.4 DEVIATION FROM TEST STANDARD

No deviation.

#### 4.1.5 TEST SETUP

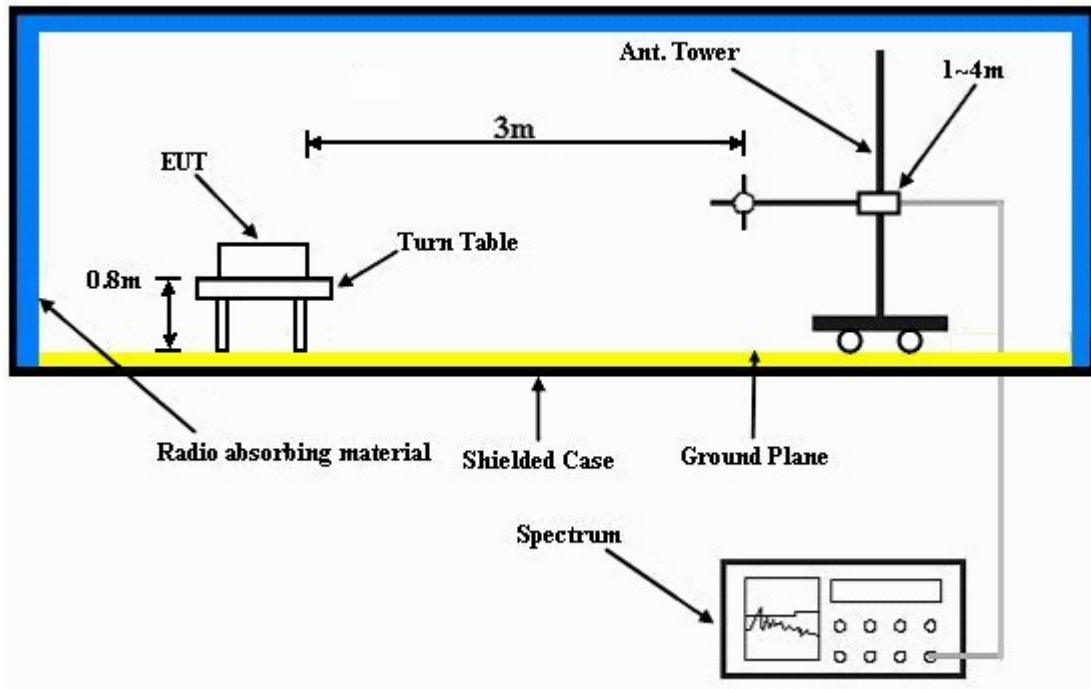

For the actual test configuration, please refer to the attached file (Test Setup Photo).

#### 4.1.6 EUT OPERATING CONDITIONS

Set the EUT under transmission condition continuously at specific channel frequency.

### 4.1.7 TEST RESULTS

EUT TEST CONDITION		MEASUREMENT DETAIL	
CHANNEL	Channel 1	FREQUENCY RANGE	13.553 ~ 13.567MHz
INPUT POWER	3.7Vdc	DETECTOR FUNCTION	Quasi-Peak
ENVIRONMENTAL CONDITIONS	25deg. C, 65%RH	TESTED BY	Match Tsui
TEST MODE	A		

ANTENNA POLARITY & TEST DISTANCE: LOOP ANTENNA OPEN AT 3m								
No.	Freq. (MHz)	Emission Level (dBuV/m)	Limit (dBuV/m)	Margin (dB)	Antenna Height (m)	Table Angle (Degree)	Raw Value (dBuV)	Correction Factor (dB/m)
1	13.56	76.3	124.0	-47.7	1.00	360	56.4	19.9

- REMARKS:**
1. Emission level(dBuV/m)=Raw Value(dBuV) + Correction Factor(dB/m)
  2. Correction Factor(dB/m) = Antenna Factor (dB/m) + Cable Factor (dB)
  3. The other emission levels were very low against the limit.
  4. Margin value = Emission level – Limit value.
  5. Above limits have been translated by the formula

The measured field strength was extrapolated to distance 30 meters, using the formula that the limit of field strength varies as the inverse distance square (40dB per decade of distance)

Example:

$$\begin{aligned}
 13.56\text{MHz} &= 15848\mu\text{V/m} && 30\text{m} \\
 &= 84\text{dBuV/m} && 30\text{m} \\
 &= 84+20\log(30/3)^2 && 3\text{m} \\
 &= 124\text{dBuV/m}
 \end{aligned}$$

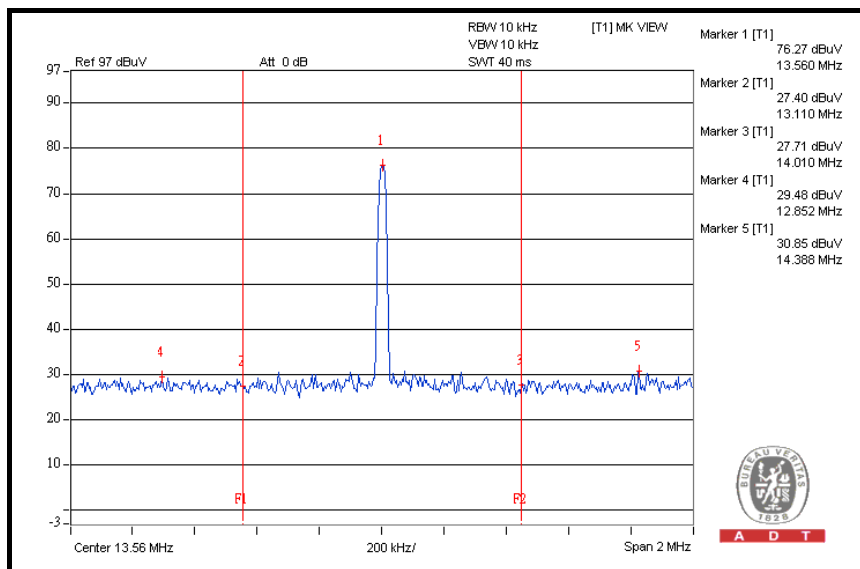



A D T

EUT TEST CONDITION		MEASUREMENT DETAIL	
CHANNEL	Channel 1	FREQUENCY RANGE	13.553 ~ 13.567MHz
INPUT POWER	3.7Vdc	DETECTOR FUNCTION	Quasi-Peak
ENVIRONMENTAL CONDITIONS	25deg. C, 65%RH	TESTED BY	Match Tsui
TEST MODE	A		

ANTENNA POLARITY & TEST DISTANCE: LOOP ANTENNA CLOSE AT 3m								
No.	Freq. (MHz)	Emission Level (dBuV/m)	Limit (dBuV/m)	Margin (dB)	Antenna Height (m)	Table Angle (Degree)	Raw Value (dBuV)	Correction Factor (dB/m)
1	13.56	71.7	124.0	-52.3	1.00	92	51.8	19.9

- REMARKS:**
1. Emission level(dBuV/m)=Raw Value(dBuV) + Correction Factor(dB/m)
  2. Correction Factor(dB/m) = Antenna Factor (dB/m) + Cable Factor (dB)
  3. The other emission levels were very low against the limit.
  4. Margin value = Emission level – Limit value.
  5. Above limits have been translated by the formula

The measured field strength was extrapolated to distance 30 meters, using the formula that the limit of field strength varies as the inverse distance square (40dB per decade of distance)

Example:

$$\begin{aligned}
 13.56\text{MHz} &= 15848\mu\text{V/m} && 30\text{m} \\
 &= 84\text{dBuV/m} && 30\text{m} \\
 &= 84+20\log(30/3)^2 && 3\text{m} \\
 &= 124\text{dBuV/m}
 \end{aligned}$$

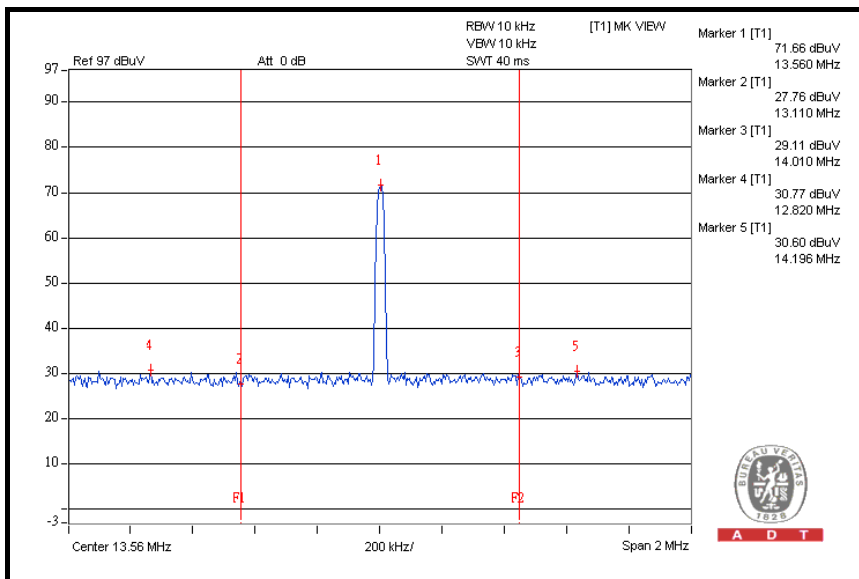



A D T

EUT TEST CONDITION		MEASUREMENT DETAIL	
CHANNEL	Channel 1	FREQUENCY RANGE	13.553 ~ 13.567MHz
INPUT POWER (SYSTEM)	120Vac, 60Hz	DETECTOR FUNCTION	Quasi-Peak
ENVIRONMENTAL CONDITIONS	25deg. C, 65%RH	TESTED BY	Match Tsui
TEST MODE	B		

ANTENNA POLARITY & TEST DISTANCE: LOOP ANTENNA OPEN AT 3m								
No.	Freq. (MHz)	Emission Level (dBuV/m)	Limit (dBuV/m)	Margin (dB)	Antenna Height (m)	Table Angle (Degree)	Raw Value (dBuV)	Correction Factor (dB/m)
1	13.56	76.4	124.0	-47.6	1.00	0	56.5	19.9

- REMARKS:**
1. Emission level(dBuV/m)=Raw Value(dBuV) + Correction Factor(dB/m)
  2. Correction Factor(dB/m) = Antenna Factor (dB/m) + Cable Factor (dB)
  3. The other emission levels were very low against the limit.
  4. Margin value = Emission level – Limit value.
  5. Above limits have been translated by the formula

The measured field strength was extrapolated to distance 30 meters, using the formula that the limit of field strength varies as the inverse distance square (40dB per decade of distance)

Example:

$$\begin{aligned}
 13.56\text{MHz} &= 15848\mu\text{V/m} && 30\text{m} \\
 &= 84\text{dBuV/m} && 30\text{m} \\
 &= 84+20\log(30/3)^2 && 3\text{m} \\
 &= 124\text{dBuV/m}
 \end{aligned}$$

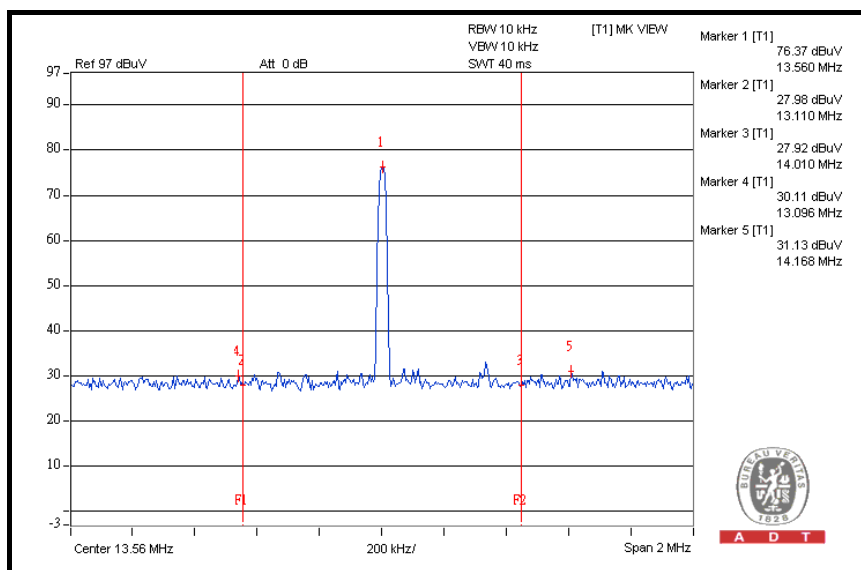



A D T

EUT TEST CONDITION		MEASUREMENT DETAIL	
CHANNEL	Channel 1	FREQUENCY RANGE	13.553 ~ 13.567MHz
INPUT POWER (SYSTEM)	120Vac, 60Hz	DETECTOR FUNCTION	Quasi-Peak
ENVIRONMENTAL CONDITIONS	25deg. C, 65%RH	TESTED BY	Match Tsui
TEST MODE	B		

ANTENNA POLARITY & TEST DISTANCE: LOOP ANTENNA CLOSE AT 3m								
No.	Freq. (MHz)	Emission Level (dBuV/m)	Limit (dBuV/m)	Margin (dB)	Antenna Height (m)	Table Angle (Degree)	Raw Value (dBuV)	Correction Factor (dB/m)
1	13.56	72.0	124.0	-52.0	1.00	312	52.1	19.9

- REMARKS:**
1. Emission level(dBuV/m)=Raw Value(dBuV) + Correction Factor(dB/m)
  2. Correction Factor(dB/m) = Antenna Factor (dB/m) + Cable Factor (dB)
  3. The other emission levels were very low against the limit.
  4. Margin value = Emission level – Limit value.
  5. Above limits have been translated by the formula

The measured field strength was extrapolated to distance 30 meters, using the formula that the limit of field strength varies as the inverse distance square (40dB per decade of distance)

Example:

$$\begin{aligned}
 13.56\text{MHz} &= 15848\mu\text{V/m} && 30\text{m} \\
 &= 84\text{dBuV/m} && 30\text{m} \\
 &= 84+20\log(30/3)^2 && 3\text{m} \\
 &= 124\text{dBuV/m}
 \end{aligned}$$

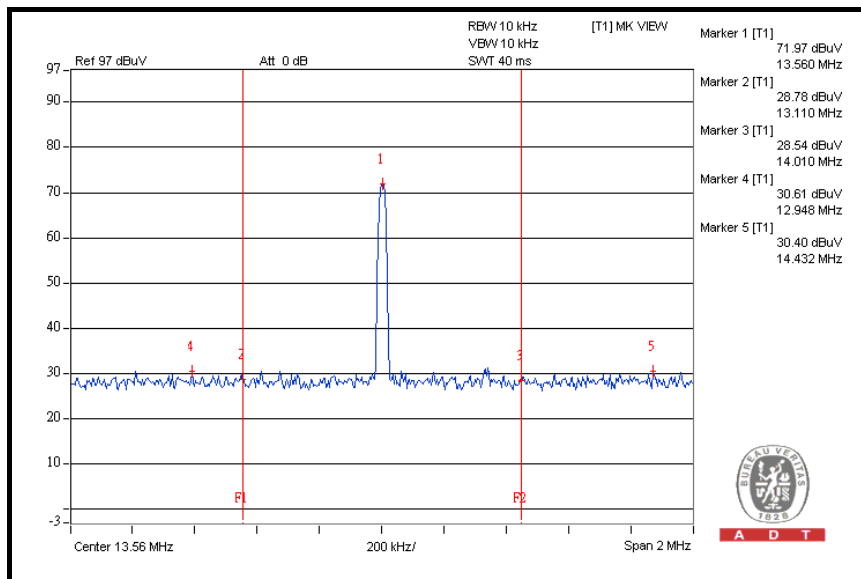



A D T

EUT TEST CONDITION		MEASUREMENT DETAIL	
CHANNEL	Channel 1	FREQUENCY RANGE	13.553 ~ 13.567MHz
INPUT POWER (SYSTEM)	120Vac, 60Hz	DETECTOR FUNCTION	Quasi-Peak
ENVIRONMENTAL CONDITIONS	24deg. C, 64%RH	TESTED BY	Match Tsui
TEST MODE	C		

ANTENNA POLARITY & TEST DISTANCE: LOOP ANTENNA OPEN AT 3m								
No.	Freq. (MHz)	Emission Level (dBuV/m)	Limit (dBuV/m)	Margin (dB)	Antenna Height (m)	Table Angle (Degree)	Raw Value (dBuV)	Correction Factor (dB/m)
1	13.56	75.2	124.0	-48.8	1.00	120	55.3	19.9

- REMARKS:**
1. Emission level(dBuV/m)=Raw Value(dBuV) + Correction Factor(dB/m)
  2. Correction Factor(dB/m) = Antenna Factor (dB/m) + Cable Factor (dB)
  3. The other emission levels were very low against the limit.
  4. Margin value = Emission level – Limit value.
  5. Above limits have been translated by the formula

The measured field strength was extrapolated to distance 30 meters, using the formula that the limit of field strength varies as the inverse distance square (40dB per decade of distance)

Example:

$$\begin{aligned}
 13.56\text{MHz} &= 15848\mu\text{V/m} && 30\text{m} \\
 &= 84\text{dBuV/m} && 30\text{m} \\
 &= 84+20\log(30/3)^2 && 3\text{m} \\
 &= 124\text{dBuV/m}
 \end{aligned}$$

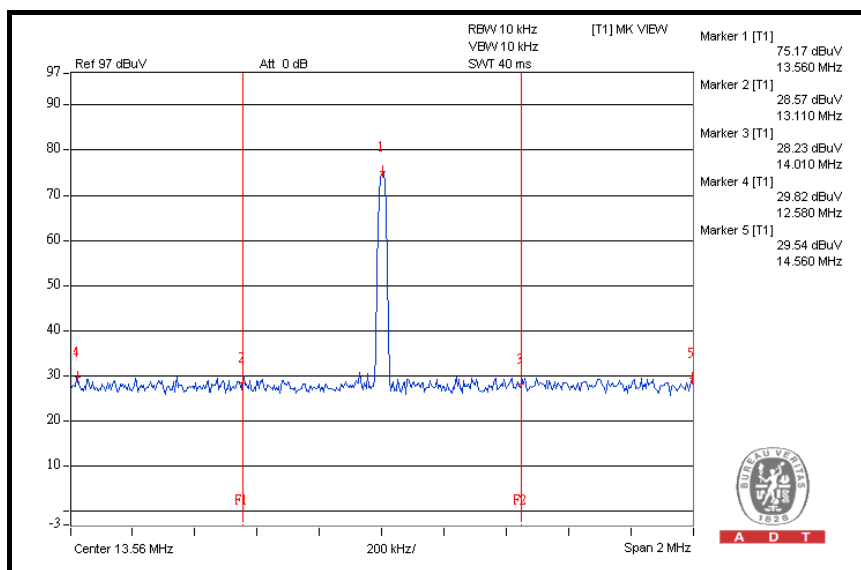



A D T

EUT TEST CONDITION		MEASUREMENT DETAIL	
CHANNEL	Channel 1	FREQUENCY RANGE	13.553 ~ 13.567MHz
INPUT POWER (SYSTEM)	120Vac, 60Hz	DETECTOR FUNCTION	Quasi-Peak
ENVIRONMENTAL CONDITIONS	24deg. C, 64%RH	TESTED BY	Match Tsui
TEST MODE	C		

ANTENNA POLARITY & TEST DISTANCE: LOOP ANTENNA CLOSE AT 3m								
No.	Freq. (MHz)	Emission Level (dBuV/m)	Limit (dBuV/m)	Margin (dB)	Antenna Height (m)	Table Angle (Degree)	Raw Value (dBuV)	Correction Factor (dB/m)
1	13.56	70.9	124.0	-53.1	1.00	300	51.0	19.9

- REMARKS:**
1. Emission level(dBuV/m)=Raw Value(dBuV) + Correction Factor(dB/m)
  2. Correction Factor(dB/m) = Antenna Factor (dB/m) + Cable Factor (dB)
  3. The other emission levels were very low against the limit.
  4. Margin value = Emission level – Limit value.
  5. Above limits have been translated by the formula

The measured field strength was extrapolated to distance 30 meters, using the formula that the limit of field strength varies as the inverse distance square (40dB per decade of distance)

Example:

$$\begin{aligned}
 13.56\text{MHz} &= 15848\text{uV/m} && 30\text{m} \\
 &= 84\text{dBuV/m} && 30\text{m} \\
 &= 84+20\log(30/3)^2 && 3\text{m} \\
 &= 124\text{dBuV/m}
 \end{aligned}$$

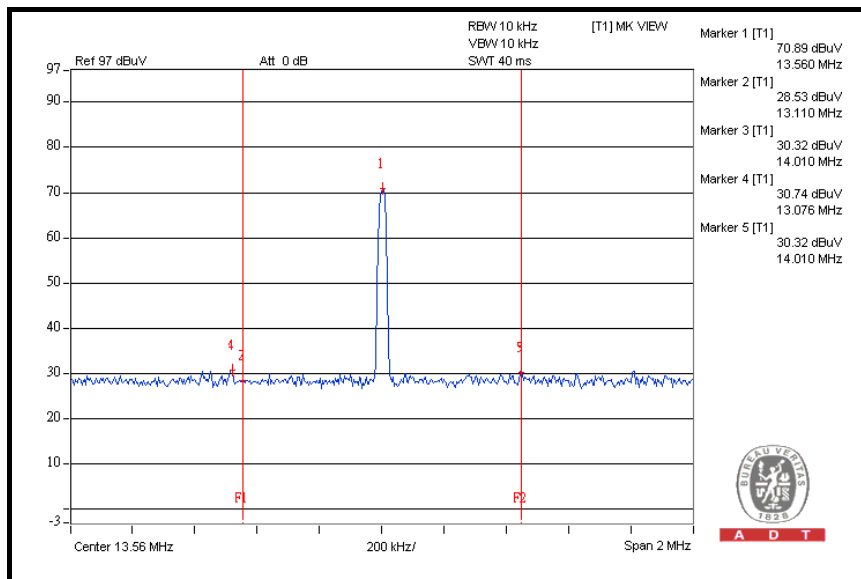





A D T

EUT TEST CONDITION		MEASUREMENT DETAIL	
CHANNEL	Channel 1	FREQUENCY RANGE	13.553 ~ 13.567MHz
INPUT POWER (SYSTEM)	120Vac, 60Hz	DETECTOR FUNCTION	Quasi-Peak
ENVIRONMENTAL CONDITIONS	24deg. C, 64%RH	TESTED BY	Match Tsui
TEST MODE	D		

ANTENNA POLARITY & TEST DISTANCE: LOOP ANTENNA OPEN AT 3m								
No.	Freq. (MHz)	Emission Level (dBuV/m)	Limit (dBuV/m)	Margin (dB)	Antenna Height (m)	Table Angle (Degree)	Raw Value (dBuV)	Correction Factor (dB/m)
1	13.56	75.0	124.0	-49.0	1.00	360	55.1	19.9

- REMARKS:**
1. Emission level(dBuV/m)=Raw Value(dBuV) + Correction Factor(dB/m)
  2. Correction Factor(dB/m) = Antenna Factor (dB/m) + Cable Factor (dB)
  3. The other emission levels were very low against the limit.
  4. Margin value = Emission level – Limit value.
  5. Above limits have been translated by the formula

The measured field strength was extrapolated to distance 30 meters, using the formula that the limit of field strength varies as the inverse distance square (40dB per decade of distance)

Example:

$$\begin{aligned}
 13.56\text{MHz} &= 15848\mu\text{V/m} && 30\text{m} \\
 &= 84\text{dBuV/m} && 30\text{m} \\
 &= 84+20\log(30/3)^2 && 3\text{m} \\
 &= 124\text{dBuV/m}
 \end{aligned}$$

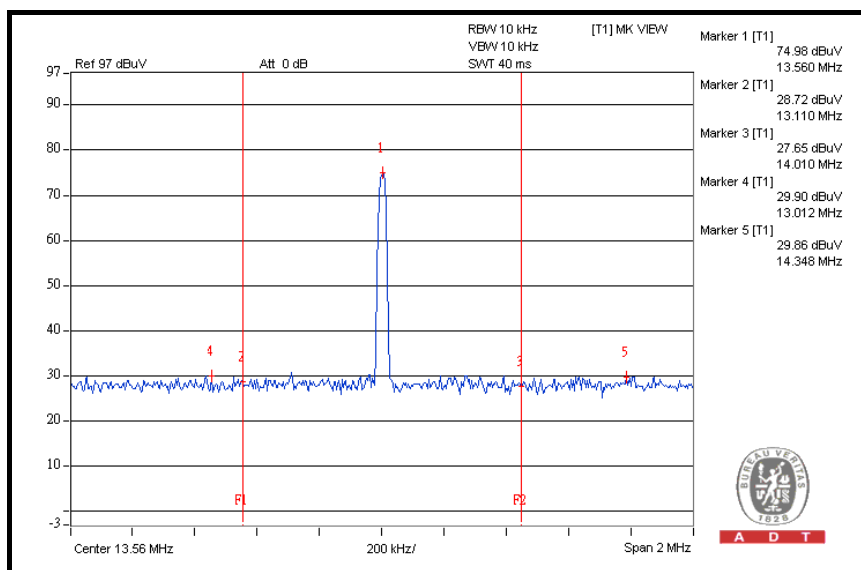



A D T

EUT TEST CONDITION		MEASUREMENT DETAIL	
CHANNEL	Channel 1	FREQUENCY RANGE	13.553 ~ 13.567MHz
INPUT POWER (SYSTEM)	120Vac, 60Hz	DETECTOR FUNCTION	Quasi-Peak
ENVIRONMENTAL CONDITIONS	24deg. C, 64%RH	TESTED BY	Match Tsui
TEST MODE	D		

ANTENNA POLARITY & TEST DISTANCE: LOOP ANTENNA CLOSE AT 3m								
No.	Freq. (MHz)	Emission Level (dBuV/m)	Limit (dBuV/m)	Margin (dB)	Antenna Height (m)	Table Angle (Degree)	Raw Value (dBuV)	Correction Factor (dB/m)
1	13.56	70.6	124.0	-53.4	1.00	188	50.7	19.9

- REMARKS:**
1. Emission level(dBuV/m)=Raw Value(dBuV) + Correction Factor(dB/m)
  2. Correction Factor(dB/m) = Antenna Factor (dB/m) + Cable Factor (dB)
  3. The other emission levels were very low against the limit.
  4. Margin value = Emission level – Limit value.
  5. Above limits have been translated by the formula

The measured field strength was extrapolated to distance 30 meters, using the formula that the limit of field strength varies as the inverse distance square (40dB per decade of distance)

Example:

$$\begin{aligned}
 13.56\text{MHz} &= 15848\text{uV/m} && 30\text{m} \\
 &= 84\text{dBuV/m} && 30\text{m} \\
 &= 84+20\log(30/3)^2 && 3\text{m} \\
 &= 124\text{dBuV/m}
 \end{aligned}$$

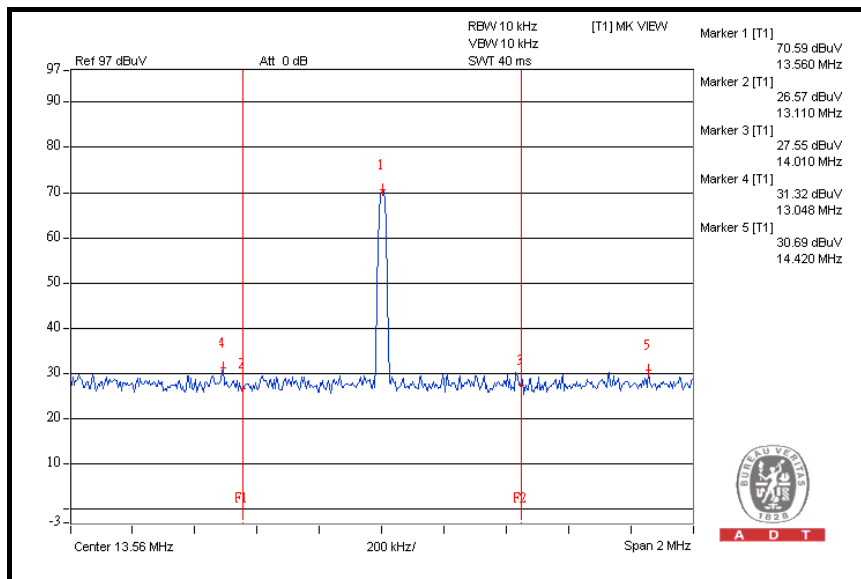



A D T

EUT TEST CONDITION		MEASUREMENT DETAIL	
CHANNEL	Channel 1	FREQUENCY RANGE	Below 30MHz
INPUT POWER	3.7Vdc	DETECTOR FUNCTION	Quasi-Peak
ENVIRONMENTAL CONDITIONS	25deg. C, 65%RH	TESTED BY	Match Tsui
TEST MODE	A		

ANTENNA POLARITY & TEST DISTANCE: LOOP ANTENNA OPEN AT 3m								
No.	Freq. (MHz)	Emission Level (dBuV/m)	Limit (dBuV/m)	Margin (dB)	Antenna Height (m)	Table Angle (Degree)	Raw Value (dBuV)	Correction Factor (dB/m)
1	0.970	44.9	67.9	-23.0	1.00	316	25.0	19.9
2	3.550	47.5	69.5	-22.1	1.00	0	27.5	20.0
3	13.110	27.4	69.5	-42.2	1.00	360	7.5	19.9
4	14.010	27.7	69.5	-41.9	1.00	360	7.8	19.9
5	27.120	40.3	69.5	-29.3	1.00	360	20.0	20.3
ANTENNA POLARITY & TEST DISTANCE: LOOP ANTENNA CLOSE AT 3m								
No.	Freq. (MHz)	Emission Level (dBuV/m)	Limit (dBuV/m)	Margin (dB)	Antenna Height (m)	Table Angle (Degree)	Raw Value (dBuV)	Correction Factor (dB/m)
1	0.970	45.9	67.9	-22.0	1.00	100	26.0	19.9
2	3.550	35.6	69.5	-34.0	1.00	301	15.6	20.0
3	13.110	27.8	69.5	-41.8	1.00	360	7.9	19.9
4	14.010	29.1	69.5	-40.5	1.00	360	9.2	19.9
5	27.120	32.4	69.5	-37.2	1.00	233	12.1	20.3

- REMARKS:**
1. Emission level(dBuV/m)=Raw Value(dBuV) + Correction Factor(dB/m)
  2. Correction Factor(dB/m) = Antenna Factor (dB/m) + Cable Factor (dB)
  3. The other emission levels were very low against the limit.
  4. Margin value = Emission level – Limit value.



A D T

EUT TEST CONDITION		MEASUREMENT DETAIL	
CHANNEL	Channel 1	FREQUENCY RANGE	Below 30MHz
INPUT POWER (SYSTEM)	120Vac, 60Hz	DETECTOR FUNCTION	Quasi-Peak
ENVIRONMENTAL CONDITIONS	25deg. C, 65%RH	TESTED BY	Match Tsui
TEST MODE	B		

ANTENNA POLARITY & TEST DISTANCE: LOOP ANTENNA OPEN AT 3m								
No.	Freq. (MHz)	Emission Level (dBuV/m)	Limit (dBuV/m)	Margin (dB)	Antenna Height (m)	Table Angle (Degree)	Raw Value (dBuV)	Correction Factor (dB/m)
1	0.970	45.2	67.9	-22.7	1.00	178	25.3	19.9
2	3.580	47.8	69.5	-21.8	1.00	360	27.8	20.0
3	13.110	28.0	69.5	-41.6	1.00	0	8.1	19.9
4	14.010	27.9	69.5	-41.7	1.00	0	8.0	19.9
5	27.120	40.3	69.5	-29.3	1.00	100	20.0	20.3

ANTENNA POLARITY & TEST DISTANCE: LOOP ANTENNA CLOSE AT 3m								
No.	Freq. (MHz)	Emission Level (dBuV/m)	Limit (dBuV/m)	Margin (dB)	Antenna Height (m)	Table Angle (Degree)	Raw Value (dBuV)	Correction Factor (dB/m)
1	0.980	50.1	67.8	-17.8	1.00	200	30.2	19.9
2	3.580	43.4	69.5	-26.2	1.00	346	23.4	20.0
3	13.110	28.8	69.5	-40.8	4.00	0	8.9	19.9
4	14.010	28.5	69.5	-41.1	1.00	312	8.6	19.9
5	27.120	36.4	69.5	-33.2	1.00	360	16.1	20.3

- REMARKS:**
1. Emission level(dBuV/m)=Raw Value(dBuV) + Correction Factor(dB/m)
  2. Correction Factor(dB/m) = Antenna Factor (dB/m) + Cable Factor (dB)
  3. The other emission levels were very low against the limit.
  4. Margin value = Emission level – Limit value.



A D T

EUT TEST CONDITION		MEASUREMENT DETAIL	
CHANNEL	Channel 1	FREQUENCY RANGE	Below 30MHz
INPUT POWER (SYSTEM)	120Vac, 60Hz	DETECTOR FUNCTION	Quasi-Peak
ENVIRONMENTAL CONDITIONS	24deg. C, 64%RH	TESTED BY	Match Tsui
TEST MODE	C		

ANTENNA POLARITY & TEST DISTANCE: LOOP ANTENNA OPEN AT 3m								
No.	Freq. (MHz)	Emission Level (dBuV/m)	Limit (dBuV/m)	Margin (dB)	Antenna Height (m)	Table Angle (Degree)	Raw Value (dBuV)	Correction Factor (dB/m)
1	2.47	44.9	69.50	-24.7	1.00	187	24.9	20.0
2	13.11	28.6	69.50	-41.0	1.00	291	8.7	19.9
3	14.01	28.2	69.50	-41.4	1.00	180	8.3	19.9

ANTENNA POLARITY & TEST DISTANCE: LOOP ANTENNA CLOSE AT 3m								
No.	Freq. (MHz)	Emission Level (dBuV/m)	Limit (dBuV/m)	Margin (dB)	Antenna Height (m)	Table Angle (Degree)	Raw Value (dBuV)	Correction Factor (dB/m)
1	2.47	40.7	69.5	-28.9	1.00	118	20.7	20.0
2	13.11	28.5	69.5	-41.1	1.00	190	8.6	19.9
3	14.01	30.3	69.5	-39.3	1.00	147	10.4	19.9

- REMARKS:**
1. Emission level(dBuV/m)=Raw Value(dBuV) + Correction Factor(dB/m)
  2. Correction Factor(dB/m) = Antenna Factor (dB/m) + Cable Factor (dB)
  3. The other emission levels were very low against the limit.
  4. Margin value = Emission level – Limit value.



A D T

EUT TEST CONDITION		MEASUREMENT DETAIL	
CHANNEL	Channel 1	FREQUENCY RANGE	Below 30MHz
INPUT POWER (SYSTEM)	120Vac, 60Hz	DETECTOR FUNCTION	Quasi-Peak
ENVIRONMENTAL CONDITIONS	24deg. C, 64%RH	TESTED BY	Match Tsui
TEST MODE	D		

ANTENNA POLARITY & TEST DISTANCE: LOOP ANTENNA OPEN AT 3m								
No.	Freq. (MHz)	Emission Level (dBuV/m)	Limit (dBuV/m)	Margin (dB)	Antenna Height (m)	Table Angle (Degree)	Raw Value (dBuV)	Correction Factor (dB/m)
1	2.47	45.0	69.5	-24.6	1.00	360	25.0	20.0
2	13.11	28.7	69.5	-40.9	1.00	360	8.8	19.9
3	14.01	27.7	69.5	-41.9	1.00	187	7.8	19.9
ANTENNA POLARITY & TEST DISTANCE: LOOP ANTENNA CLOSE AT 3m								
No.	Freq. (MHz)	Emission Level (dBuV/m)	Limit (dBuV/m)	Margin (dB)	Antenna Height (m)	Table Angle (Degree)	Raw Value (dBuV)	Correction Factor (dB/m)
1	2.47	39.6	69.5	-30.0	1.00	177	19.6	20.0
2	13.11	26.6	69.5	-43.0	1.00	210	6.7	19.9
3	14.01	27.6	69.5	-42.0	1.00	130	7.7	19.9

- REMARKS:**
1. Emission level(dBuV/m)=Raw Value(dBuV) + Correction Factor(dB/m)
  2. Correction Factor(dB/m) = Antenna Factor (dB/m) + Cable Factor (dB)
  3. The other emission levels were very low against the limit.
  4. Margin value = Emission level – Limit value.



A D T

EUT TEST CONDITION		MEASUREMENT DETAIL	
CHANNEL	Channel 1	FREQUENCY RANGE	Below 1000MHz
INPUT POWER	3.7Vdc	DETECTOR FUNCTION	Quasi-Peak
ENVIRONMENTAL CONDITIONS	25deg. C, 65%RH	TESTED BY	David Huang
TEST MODE	A		

ANTENNA POLARITY & TEST DISTANCE: HORIZONTAL AT 3 M								
NO.	FREQ. (MHz)	EMISSION LEVEL (dBuV/m)	LIMIT (dBuV/m)	MARGIN (dB)	ANTENNA HEIGHT (m)	TABLE ANGLE (Degree)	RAW VALUE (dBuV)	CORRECTION FACTOR (dB/m)
1	39.62	19.20 QP	40.00	-20.80	2.00 H	346	5.20	14.00
2	61.01	20.80 QP	40.00	-19.20	1.00 H	70	6.70	14.10
3	132.95	15.70 QP	43.50	-27.80	2.00 H	34	1.60	14.10
4	255.44	14.00 QP	46.00	-32.00	2.00 H	40	0.30	13.70
5	434.31	20.40 QP	46.00	-25.60	1.00 H	103	0.80	19.60
6	584.02	24.60 QP	46.00	-21.40	1.00 H	10	1.30	23.30

ANTENNA POLARITY & TEST DISTANCE: VERTICAL AT 3 M								
NO.	FREQ. (MHz)	EMISSION LEVEL (dBuV/m)	LIMIT (dBuV/m)	MARGIN (dB)	ANTENNA HEIGHT (m)	TABLE ANGLE (Degree)	RAW VALUE (dBuV)	CORRECTION FACTOR (dB/m)
1	39.62	26.00 QP	40.00	-14.00	1.00 V	256	12.00	14.00
2	97.95	16.30 QP	43.50	-27.20	1.00 V	145	5.40	10.90
3	171.83	14.80 QP	43.50	-28.70	2.00 V	175	0.70	14.10
4	294.32	15.70 QP	46.00	-30.30	1.00 V	19	0.60	15.10
5	494.58	22.60 QP	46.00	-23.40	1.00 V	10	1.40	21.20
6	718.18	25.40 QP	46.00	-20.60	2.00 V	190	-0.10	25.50

- REMARKS:**
1. Emission level (dBuV/m) = Raw Value (dBuV) + Correction Factor (dB/m).
  2. Correction Factor (dB/m) = Antenna Factor (dB/m) + Cable Factor (dB).
  3. The other emission levels were very low against the limit.
  4. Margin value = Emission level – Limit value.



A D T

EUT TEST CONDITION		MEASUREMENT DETAIL	
CHANNEL	Channel 1	FREQUENCY RANGE	Below 1000MHz
INPUT POWER (SYSTEM)	120Vac, 60Hz	DETECTOR FUNCTION	Quasi-Peak
ENVIRONMENTAL CONDITIONS	25deg. C, 65%RH	TESTED BY	David Huang
TEST MODE	B		

ANTENNA POLARITY & TEST DISTANCE: HORIZONTAL AT 3 M								
NO.	FREQ. (MHz)	EMISSION LEVEL (dBuV/m)	LIMIT (dBuV/m)	MARGIN (dB)	ANTENNA HEIGHT (m)	TABLE ANGLE (Degree)	RAW VALUE (dBuV)	CORRECTION FACTOR (dB/m)
1	142.67	33.10 QP	43.5	-10.4	2.00 H	262	18.20	14.90
2	232.11	29.40 QP	46.0	-16.6	1.00 H	226	16.40	13.00
3	300.16	27.00 QP	46.0	-19.0	1.00 H	226	11.70	15.30
4	337.10	30.10 QP	46.0	-15.9	1.00 H	175	13.60	16.50
5	512.08	29.00 QP	46.0	-17.0	2.00 H	313	7.30	21.70
6	665.68	31.00 QP	46.0	-15.0	1.00 H	235	6.40	24.60
ANTENNA POLARITY & TEST DISTANCE: VERTICAL AT 3 M								
NO.	FREQ. (MHz)	EMISSION LEVEL (dBuV/m)	LIMIT (dBuV/m)	MARGIN (dB)	ANTENNA HEIGHT (m)	TABLE ANGLE (Degree)	RAW VALUE (dBuV)	CORRECTION FACTOR (dB/m)
1	53.23	27.70 QP	40.0	-12.3	1.00 V	223	13.5	14.20
2	142.67	29.90 QP	43.5	-13.6	2.00 V	10	15.0	14.90
3	234.05	22.80 QP	46.0	-23.2	1.00 V	286	9.7	13.10
4	337.10	23.30 QP	46.0	-22.7	2.00 V	226	6.8	16.50
5	366.26	23.50 QP	46.0	-22.5	1.00 V	250	6.0	17.50
6	432.37	28.80 QP	46.0	-17.2	1.00 V	208	9.3	19.50

- REMARKS:**
1. Emission level (dBuV/m) = Raw Value (dBuV) + Correction Factor (dB/m).
  2. Correction Factor (dB/m) = Antenna Factor (dB/m) + Cable Factor (dB).
  3. The other emission levels were very low against the limit.
  4. Margin value = Emission level – Limit value.





A D T

EUT TEST CONDITION		MEASUREMENT DETAIL	
CHANNEL	Channel 1	FREQUENCY RANGE	Below 1000MHz
INPUT POWER (SYSTEM)	120Vac, 60Hz	DETECTOR FUNCTION	Quasi-Peak
ENVIRONMENTAL CONDITIONS	25deg. C, 65%RH	TESTED BY	David Huang
TEST MODE	C		

ANTENNA POLARITY & TEST DISTANCE: HORIZONTAL AT 3 M								
NO.	FREQ. (MHz)	EMISSION LEVEL (dBuV/m)	LIMIT (dBuV/m)	MARGIN (dB)	ANTENNA HEIGHT (m)	TABLE ANGLE (Degree)	RAW VALUE (dBuV)	CORRECTION FACTOR (dB/m)
1	119.34	23.80 QP	43.5	-19.7	2.00 H	247	11.30	12.50
2	239.88	26.30 QP	46.0	-19.7	1.00 H	10	13.80	12.50
3	298.21	25.90 QP	46.0	-20.1	1.00 H	109	11.10	14.80
4	335.15	27.60 QP	46.0	-18.4	1.00 H	109	11.80	15.80
5	432.37	29.50 QP	46.0	-16.5	1.00 H	139	11.20	18.30
6	663.74	29.10 QP	46.0	-16.9	1.00 H	322	5.60	23.50
ANTENNA POLARITY & TEST DISTANCE: VERTICAL AT 3 M								
NO.	FREQ. (MHz)	EMISSION LEVEL (dBuV/m)	LIMIT (dBuV/m)	MARGIN (dB)	ANTENNA HEIGHT (m)	TABLE ANGLE (Degree)	RAW VALUE (dBuV)	CORRECTION FACTOR (dB/m)
1	142.67	25.10 QP	43.5	-18.4	2.00 V	10	10.90	14.20
2	335.15	22.10 QP	46.0	-23.9	2.00 V	217	6.30	15.80
3	432.37	34.00 QP	46.0	-12.0	1.00 V	319	15.70	18.30
4	504.31	25.00 QP	46.0	-21.0	2.00 V	262	4.70	20.30
5	574.30	25.80 QP	46.0	-20.2	1.00 V	331	4.00	21.80
6	663.74	27.20 QP	46.0	-18.8	2.00 V	91	3.70	23.50

- REMARKS:**
1. Emission level (dBuV/m) = Raw Value (dBuV) + Correction Factor (dB/m).
  2. Correction Factor (dB/m) = Antenna Factor (dB/m) + Cable Factor (dB).
  3. The other emission levels were very low against the limit.
  4. Margin value = Emission level – Limit value.



A D T

EUT TEST CONDITION		MEASUREMENT DETAIL	
CHANNEL	Channel 1	FREQUENCY RANGE	Below 1000MHz
INPUT POWER (SYSTEM)	120Vac, 60Hz	DETECTOR FUNCTION	Quasi-Peak
ENVIRONMENTAL CONDITIONS	25deg. C, 68%RH	TESTED BY	Sun Lin
TEST MODE	D		

ANTENNA POLARITY & TEST DISTANCE: HORIZONTAL AT 3 M								
NO.	FREQ. (MHz)	EMISSION LEVEL (dBuV/m)	LIMIT (dBuV/m)	MARGIN (dB)	ANTENNA HEIGHT (m)	TABLE ANGLE (Degree)	RAW VALUE (dBuV)	CORRECTION FACTOR (dB/m)
1	101.84	21.10 QP	43.5	-22.4	1.25 H	220	-6.20	27.30
2	136.84	17.30 QP	43.5	-26.2	2.00 H	274	-10.00	27.30
3	259.33	25.20 QP	46.0	-20.8	1.25 H	208	-2.10	27.30
4	430.42	21.10 QP	46.0	-24.9	2.00 H	316	-6.20	27.30
5	543.19	24.70 QP	46.0	-21.3	1.00 H	355	-2.60	27.30
6	634.57	21.40 QP	46.0	-24.6	1.50 H	106	-5.90	27.30
ANTENNA POLARITY & TEST DISTANCE: VERTICAL AT 3 M								
NO.	FREQ. (MHz)	EMISSION LEVEL (dBuV/m)	LIMIT (dBuV/m)	MARGIN (dB)	ANTENNA HEIGHT (m)	TABLE ANGLE (Degree)	RAW VALUE (dBuV)	CORRECTION FACTOR (dB/m)
1	39.62	23.60 QP	40.0	-16.4	1.00 V	91	-3.7	27.30
2	66.84	23.70 QP	40.0	-16.3	1.00 V	151	-3.6	27.30
3	101.84	22.10 QP	43.5	-21.4	1.25 V	343	-5.2	27.30
4	364.32	16.10 QP	46.0	-29.9	1.25 V	175	-11.2	27.30
5	515.97	18.90 QP	46.0	-27.1	1.00 V	34	-8.4	27.30
6	634.57	22.70 QP	46.0	-23.3	1.25 V	313	-4.6	27.30

- REMARKS:**
1. Emission level (dBuV/m) = Raw Value (dBuV) + Correction Factor (dB/m).
  2. Correction Factor (dB/m) = Antenna Factor (dB/m) + Cable Factor (dB).
  3. The other emission levels were very low against the limit.
  4. Margin value = Emission level – Limit value.

## 4.2 CONDUCTED EMISSION MEASUREMENT

### 4.2.1 LIMITS OF CONDUCTED EMISSION MEASUREMENT

FREQUENCY OF EMISSION (MHz)	CONDUCTED LIMIT (dB $\mu$ V)	
	Quasi-peak	Average
0.15 ~ 0.5	66 to 56	56 to 46
0.5 ~ 5	56	46
5 ~ 30	60	50

- NOTE:**
1. The lower limit shall apply at the transition frequencies.
  2. The limit decreases in line with the logarithm of the frequency in the range of 0.15 to 0.50 MHz.
  3. All emanations from a class A/B digital device or system, including any network of conductors and apparatus connected thereto, shall not exceed the level of field strengths specified above.

### 4.2.2 TEST INSTRUMENTS

DESCRIPTION & MANUFACTURER	MODEL NO.	SERIAL NO.	DATE OF CALIBRATION	DUE DATE OF CALIBRATION
Test Receiver ROHDE & SCHWARZ	ESCS30	100291	Nov. 30, 2010	Nov. 29, 2011
RF signal cable Woken	5D-FB	Cable-HYC01-01	Dec. 30, 2010	Dec. 29, 2011
LISN ROHDE & SCHWARZ	ESH3-Z5	100312	Jul. 07, 2011	Jul. 06, 2012
V-LISN SCHWARZBECK	NNBL 8226-2	8226-142	Jun. 30, 2011	Jun. 29, 2012
Software ADT	ADT_Cond_ V7.3.7	NA	NA	NA

- NOTE:**
1. The calibration interval of the above test instruments is 12 months and the calibrations are traceable to NML/ROC and NIST/USA.
  2. The test was performed in HwaYa Shielded Room 1.
  3. The VCCI Site Registration No. is C-2040.

#### 4.2.3 TEST PROCEDURES

- a. The EUT was placed 0.4 meters from the conducting wall of the shielded room with EUT being connected to the power mains through a line impedance stabilization network (LISN). Other support units were connected to the power mains through another LISN. The two LISNs provide 50 ohm/ 50uH of coupling impedance for the measuring instrument.
- b. Both lines of the power mains connected to the EUT were checked for maximum conducted interference.
- c. The frequency range from 150kHz to 30MHz was searched. Emission levels under (Limit - 20dB) was not recorded.

**NOTE:** All modes of operation were investigated and the worst-case emissions are reported.

#### 4.2.4 DEVIATION FROM TEST STANDARD

No deviation.

#### 4.2.5 TEST SETUP

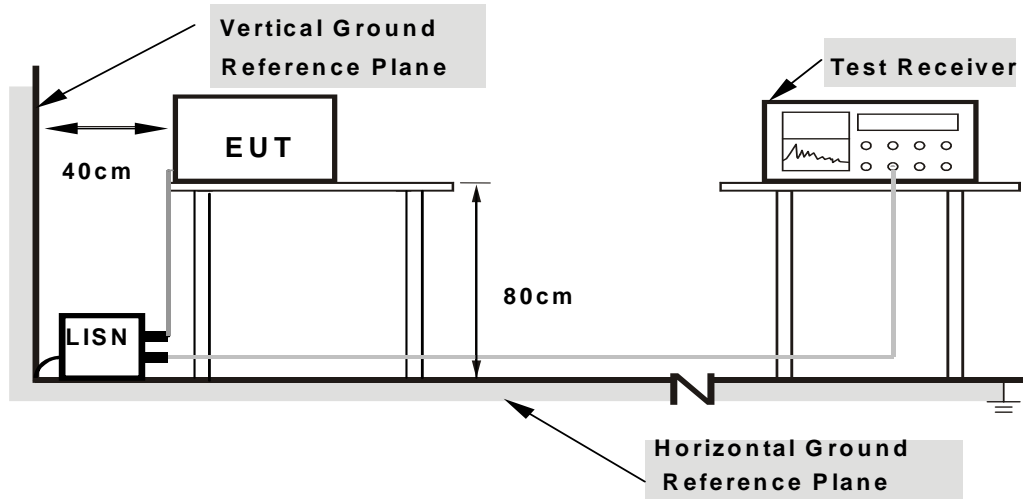

- Note:**
1. Support units were connected to second LISN.
  2. Both of LISNs (AMN) are 80 cm from EUT and at least 80 from other units and other metal planes

For the actual test configuration, please refer to the attached file (Test Setup Photo).

#### 4.2.6 EUT OPERATING CONDITIONS

Same as 4.1.6.

### 4.2.7 TEST RESULTS

	Line 1	<b>6dB BANDWIDTH</b>	9 kHz
<b>TEST MODE</b>	B		

No	Freq. [MHz]	Corr. Factor (dB)	Reading Value [dB (uV)]		Emission Level [dB (uV)]		Limit [dB (uV)]		Margin (dB)	
			Q.P.	AV.	Q.P.	AV.	Q.P.	AV.	Q.P.	AV.
1	0.150	0.11	26.83	14.58	26.94	14.70	66.00	56.00	-39.06	-41.30
2	0.568	0.13	25.19	10.42	25.32	10.55	56.00	46.00	-30.68	-35.45
3	0.916	0.15	27.05	15.19	27.20	15.34	56.00	46.00	-28.80	-30.66
4	3.777	0.30	35.31	28.37	35.61	28.67	56.00	46.00	-20.39	-17.33
5	5.254	0.38	34.93	28.76	35.31	29.14	60.00	50.00	-24.69	-20.86
6	17.277	0.99	34.28	27.94	35.27	28.93	60.00	50.00	-24.73	-21.07

- REMARKS:**
1. Q.P. and AV. are abbreviations of quasi-peak and average individually.
  2. "-": The Quasi-peak reading value also meets average limit and measurement with the average detector is unnecessary.
  3. The emission levels of other frequencies were very low against the limit.
  4. Margin value = Emission level - Limit value
  5. Correction factor = Insertion loss + Cable loss
  6. Emission Level = Correction Factor + Reading Value.
  7. This is RFID signal inductive with measurement system. Please check P44-45 to see test result for EUT with a suitable dummy load.

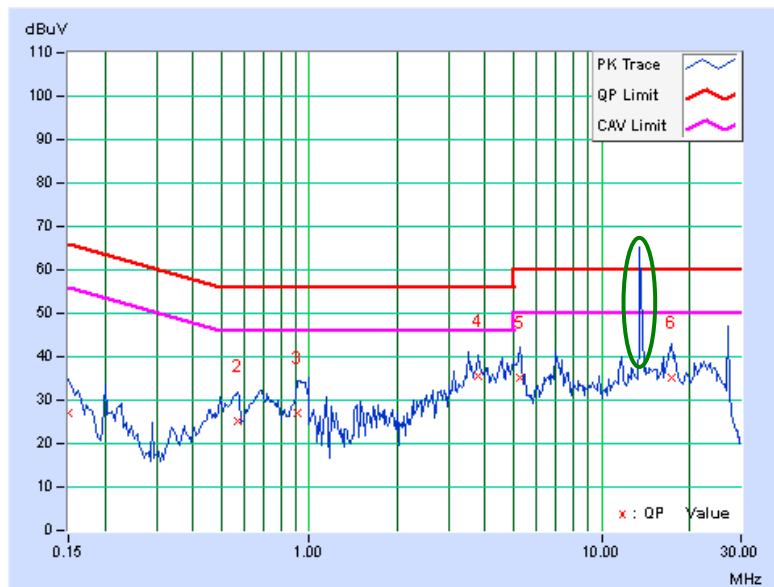

PHASE	Line 2	6dB BANDWIDTH	9kHz
TEST MODE	B		

No	Freq. [MHz]	Corr. Factor (dB)	Reading Value [dB (uV)]		Emission Level [dB (uV)]		Limit [dB (uV)]		Margin (dB)	
			Q.P.	AV.	Q.P.	AV.	Q.P.	AV.	Q.P.	AV.
1	0.150	0.12	32.46	23.98	32.58	24.10	66.00	56.00	-33.42	-31.90
2	0.611	0.15	32.95	17.29	33.10	17.44	56.00	46.00	-22.90	-28.56
3	0.994	0.18	30.58	18.36	30.76	18.54	56.00	46.00	-25.24	-27.46
4	3.605	0.30	37.74	32.96	38.04	33.26	56.00	46.00	-17.96	-12.74
5	5.000	0.37	35.45	30.10	35.82	30.47	56.00	46.00	-20.18	-15.53
6	17.410	0.83	42.64	36.99	43.47	37.82	60.00	50.00	-16.53	-12.18

- REMARKS:**
1. Q.P. and AV. are abbreviations of quasi-peak and average individually.
  2. "-": The Quasi-peak reading value also meets average limit and measurement with the average detector is unnecessary.
  3. The emission levels of other frequencies were very low against the limit.
  4. Margin value = Emission level - Limit value
  5. Correction factor = Insertion loss + Cable loss
  6. Emission Level = Correction Factor + Reading Value.
  7. This is RFID signal inductive with measurement system. Please check P44-45 to see test result for EUT with a suitable dummy load.

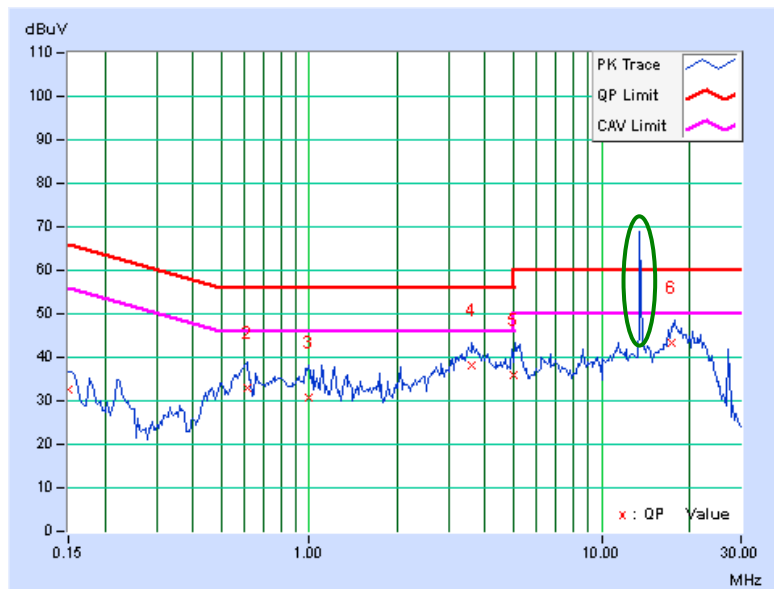

PHASE	Line 1	6dB BANDWIDTH	9 kHz
TEST MODE	C		

No	Freq. [MHz]	Corr. Factor (dB)	Reading Value		Emission Level		Limit		Margin	
			[dB (uV)]		[dB (uV)]		[dB (uV)]		(dB)	
			Q.P.	AV.	Q.P.	AV.	Q.P.	AV.	Q.P.	AV.
1	0.158	0.16	45.65	24.46	45.81	24.62	65.58	55.58	-19.77	-30.96
2	0.427	0.25	35.27	18.36	35.52	18.61	57.30	47.30	-21.79	-28.70
3	0.662	0.23	38.63	20.48	38.86	20.71	56.00	46.00	-17.14	-25.29
4	2.555	0.28	32.49	23.19	32.77	23.47	56.00	46.00	-23.23	-22.53
5	8.453	0.63	27.90	19.60	28.53	20.23	60.00	50.00	-31.47	-29.77
6	15.707	0.99	30.34	24.62	31.33	25.61	60.00	50.00	-28.67	-24.39

- REMARKS:**
1. Q.P. and AV. are abbreviations of quasi-peak and average individually.
  2. "-": The Quasi-peak reading value also meets average limit and measurement with the average detector is unnecessary.
  3. The emission levels of other frequencies were very low against the limit.
  4. Margin value = Emission level - Limit value
  5. Correction factor = Insertion loss + Cable loss
  6. Emission Level = Correction Factor + Reading Value.
  7. This is RFID signal inductive with measurement system. Please check P44-45 to see test result for EUT with a suitable dummy load.

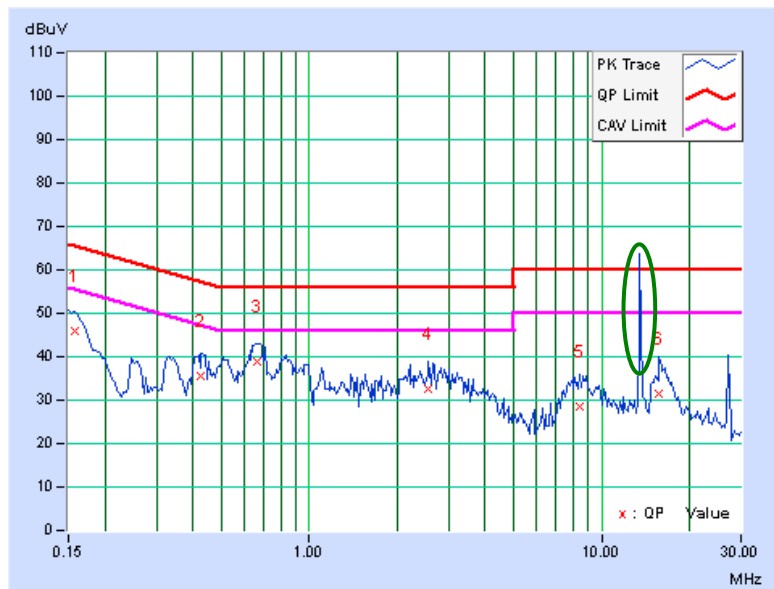



PHASE	Line 2	6dB BANDWIDTH	9kHz
TEST MODE	C		

No	Freq. [MHz]	Corr.	Reading Value		Emission Level		Limit		Margin	
		Factor (dB)	Q.P. [dB (uV)]	AV. [dB (uV)]	Q.P. [dB (uV)]	AV. [dB (uV)]	Q.P. [dB (uV)]	AV. [dB (uV)]	Q.P. (dB)	AV. (dB)
1	0.150	0.23	46.12	20.81	46.35	21.04	66.00	56.00	-19.65	-34.96
2	0.513	0.24	35.96	20.63	36.20	20.87	56.00	46.00	-19.80	-25.13
3	0.670	0.25	37.88	21.19	38.13	21.44	56.00	46.00	-17.87	-24.56
4	2.488	0.33	33.12	22.81	33.45	23.14	56.00	46.00	-22.55	-22.86
5	8.477	0.62	29.09	20.42	29.71	21.04	60.00	50.00	-30.29	-28.96
6	15.746	0.87	31.31	24.71	32.18	25.58	60.00	50.00	-27.82	-24.42

- REMARKS:**
1. Q.P. and AV. are abbreviations of quasi-peak and average individually.
  2. "-": The Quasi-peak reading value also meets average limit and measurement with the average detector is unnecessary.
  3. The emission levels of other frequencies were very low against the limit.
  4. Margin value = Emission level - Limit value
  5. Correction factor = Insertion loss + Cable loss
  6. Emission Level = Correction Factor + Reading Value.
  7. This is RFID signal inductive with measurement system. Please check P44-45 to see test result for EUT with a suitable dummy load.

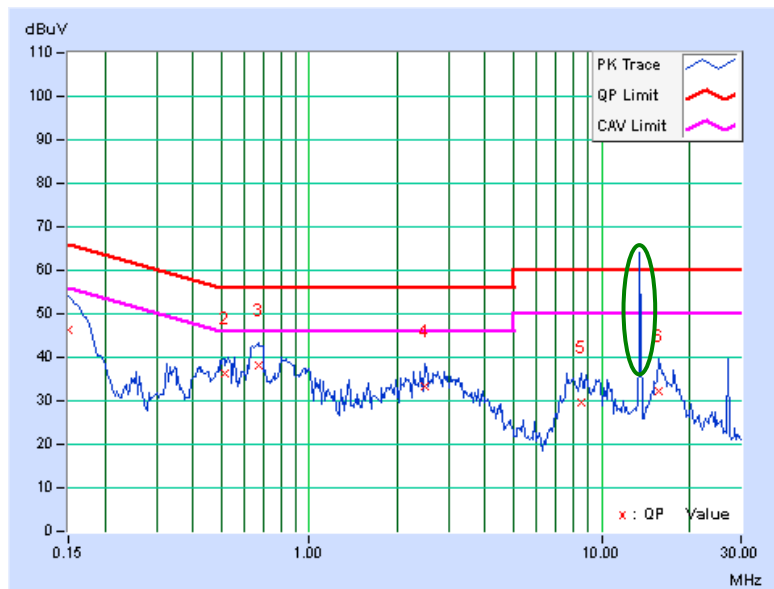

PHASE	Line 1	6dB BANDWIDTH	9 kHz
TEST MODE	D		

No	Freq. [MHz]	Corr. Factor (dB)	Reading Value		Emission Level		Limit		Margin	
			[dB (uV)]		[dB (uV)]		[dB (uV)]		(dB)	
			Q.P.	AV.	Q.P.	AV.	Q.P.	AV.	Q.P.	AV.
1	0.162	0.12	35.00	25.06	35.12	25.18	65.38	55.38	-30.26	-30.20
2	0.322	0.12	35.16	26.76	35.28	26.88	59.66	49.66	-24.38	-22.78
3	0.604	0.13	31.57	24.76	31.70	24.89	56.00	46.00	-24.30	-21.11
4	0.845	0.15	31.99	24.53	32.14	24.68	56.00	46.00	-23.86	-21.32
5	1.535	0.18	33.24	25.45	33.42	25.63	56.00	46.00	-22.58	-20.37
6	3.688	0.29	25.96	18.01	26.25	18.30	56.00	46.00	-29.75	-27.70

- REMARKS:**
1. Q.P. and AV. are abbreviations of quasi-peak and average individually.
  2. "-": The Quasi-peak reading value also meets average limit and measurement with the average detector is unnecessary.
  3. The emission levels of other frequencies were very low against the limit.
  4. Margin value = Emission level - Limit value
  5. Correction factor = Insertion loss + Cable loss
  6. Emission Level = Correction Factor + Reading Value.
  7. This is RFID signal inductive with measurement system. Please check P44-45 to see test result for EUT with a suitable dummy load.

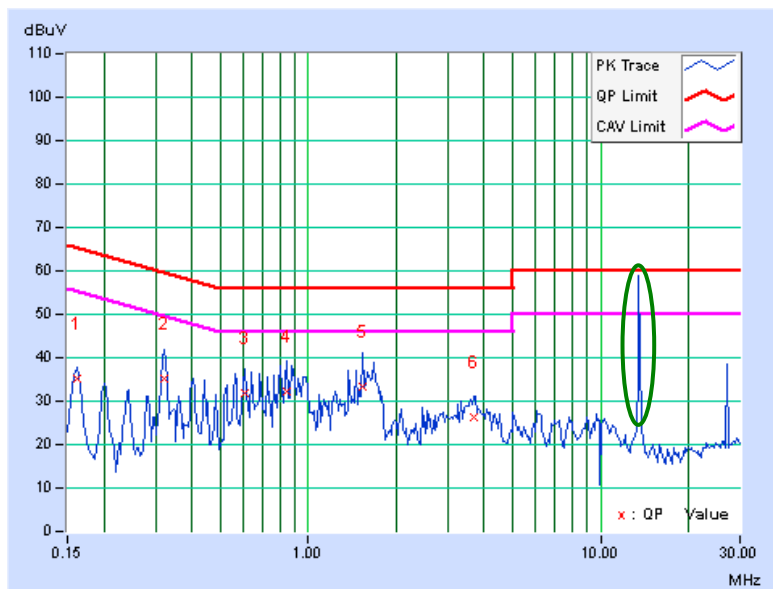

PHASE	Line 2	6dB BANDWIDTH	9kHz
TEST MODE	D		

No	Freq. [MHz]	Corr. Factor (dB)	Reading Value [dB (uV)]		Emission Level [dB (uV)]		Limit [dB (uV)]		Margin (dB)	
			Q.P.	AV.	Q.P.	AV.	Q.P.	AV.	Q.P.	AV.
1	0.162	0.13	35.00	25.06	35.13	25.19	65.38	55.38	-30.25	-30.19
2	0.322	0.14	35.16	26.76	35.30	26.90	59.66	49.66	-24.36	-22.76
3	0.604	0.15	31.57	24.76	31.72	24.91	56.00	46.00	-24.28	-21.09
4	0.845	0.17	31.99	24.53	32.16	24.70	56.00	46.00	-23.84	-21.30
5	1.535	0.19	33.24	25.45	33.43	25.64	56.00	46.00	-22.57	-20.36
6	3.688	0.30	25.96	18.01	26.26	18.31	56.00	46.00	-29.74	-27.69

- REMARKS:**
1. Q.P. and AV. are abbreviations of quasi-peak and average individually.
  2. "-": The Quasi-peak reading value also meets average limit and measurement with the average detector is unnecessary.
  3. The emission levels of other frequencies were very low against the limit.
  4. Margin value = Emission level - Limit value
  5. Correction factor = Insertion loss + Cable loss
  6. Emission Level = Correction Factor + Reading Value.
  7. This is RFID signal inductive with measurement system. Please check P44-45 to see test result for EUT with a suitable dummy load.

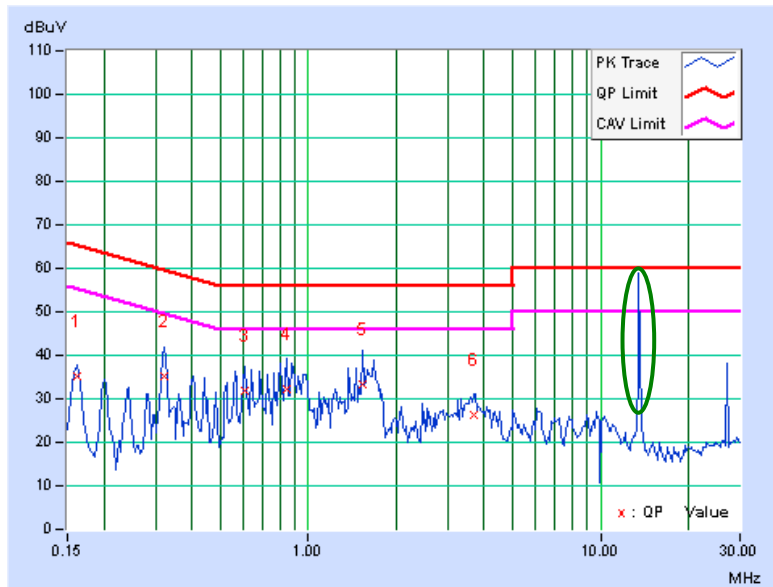



A D T

**Test with a suitable dummy load**

PHASE	Line 1	6dB BANDWIDTH	9 kHz
-------	--------	---------------	-------

No	Freq. [MHz]	Corr.	Reading Value		Emission Level		Limit		Margin	
		Factor	[dB (uV)]		[dB (uV)]		[dB (uV)]		(dB)	
		(dB)	Q.P.	AV.	Q.P.	AV.	Q.P.	AV.	Q.P.	AV.
1	0.150	0.11	27.32	19.85	27.43	19.96	66.00	56.00	-38.56	-36.03
2	0.677	0.14	34.23	17.82	34.37	17.96	56.00	46.00	-21.63	-28.04
3	1.133	0.16	32.76	15.83	32.92	15.99	56.00	46.00	-23.08	-30.01
4	3.594	0.29	35.41	28.49	35.70	28.78	56.00	46.00	-20.30	-17.22
5	5.152	0.38	32.61	26.08	32.99	26.46	60.00	50.00	-27.01	-23.54
6	17.793	1.01	40.61	34.14	41.62	35.15	60.00	50.00	-18.38	-14.85

- REMARKS:**
1. Q.P. and AV. are abbreviations of quasi-peak and average individually.
  2. "-": The Quasi-peak reading value also meets average limit and measurement with the average detector is unnecessary.
  3. The emission levels of other frequencies were very low against the limit.
  4. Margin value = Emission level - Limit value
  5. Correction factor = Insertion loss + Cable loss
  6. Emission Level = Correction Factor + Reading Value.

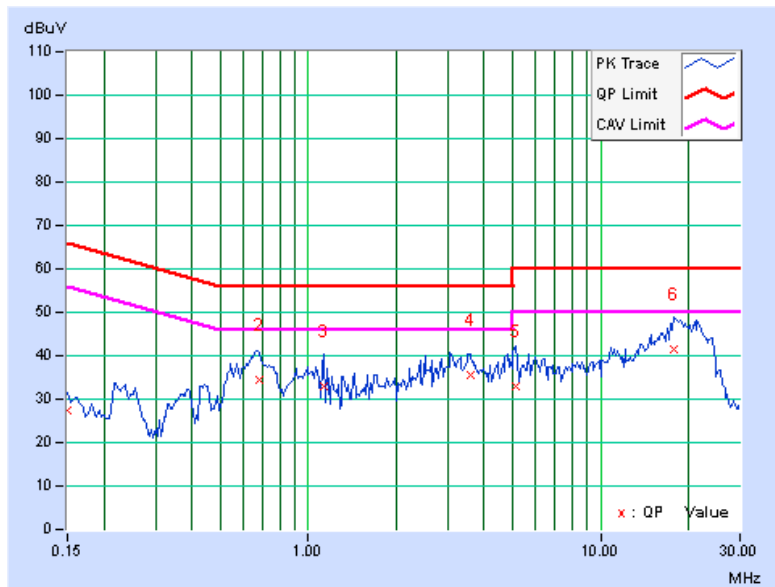



A D T

PHASE	Line 2	6dB BANDWIDTH	9 kHz
-------	--------	---------------	-------

No	Freq. [MHz]	Corr.	Reading Value		Emission Level		Limit		Margin	
		Factor (dB)	Q.P. [dB (uV)]	AV. [dB (uV)]	Q.P. [dB (uV)]	AV. [dB (uV)]	Q.P. [dB (uV)]	AV. [dB (uV)]	Q.P. (dB)	AV. (dB)
1	0.150	0.12	26.40	18.27	26.52	18.39	66.00	56.00	-39.48	-37.61
2	0.662	0.16	35.69	21.52	35.85	21.68	56.00	46.00	-20.15	-24.32
3	1.086	0.18	29.98	16.47	30.16	16.65	56.00	46.00	-25.84	-29.35
4	3.055	0.26	35.90	29.96	36.16	30.22	56.00	46.00	-19.84	-15.78
5	5.148	0.38	32.22	25.99	32.60	26.37	60.00	50.00	-27.40	-23.63
6	17.684	0.84	42.10	33.64	42.94	34.48	60.00	50.00	-17.06	-15.52

- REMARKS:**
1. Q.P. and AV. are abbreviations of quasi-peak and average individually.
  2. "-": The Quasi-peak reading value also meets average limit and measurement with the average detector is unnecessary.
  3. The emission levels of other frequencies were very low against the limit.
  4. Margin value = Emission level - Limit value
  5. Correction factor = Insertion loss + Cable loss
  6. Emission Level = Correction Factor + Reading Value.

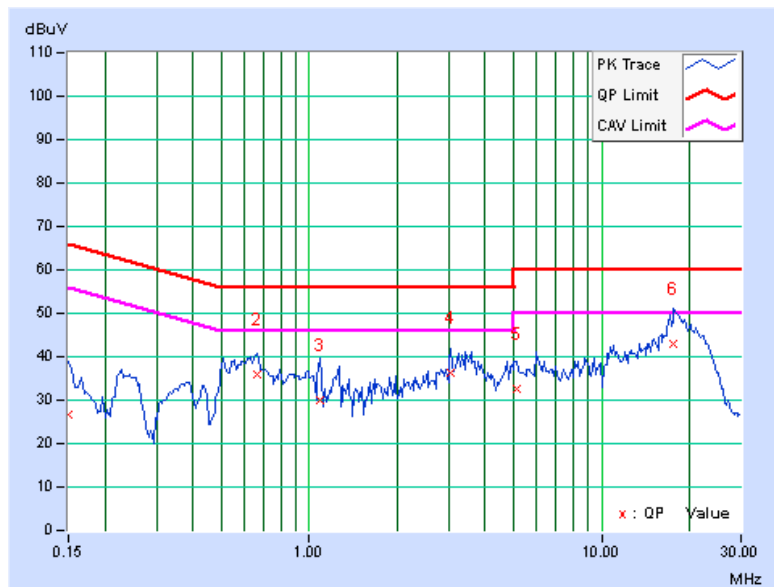

### 4.3 FREQUENCY STABILITY

#### 4.3.1 LIMITS OF FREQUENCY STABILITY MEASUREMENT

The frequency tolerance of the carrier signal shall be maintained within +/- 0.01% of the operating frequency over a temperature variation of -20 degrees to 50 degrees C at normal supply voltage, and for a variation in the primary supply voltage from 85% to 115% of the rated supply voltage at a temperature of 20 degrees C.

#### 4.3.2 TEST INSTRUMENTS

DESCRIPTION & MANUFACTURER	MODEL NO.	SERIAL NO.	DATE OF CALIBRATION	DUE DATE OF CALIBRATION
SPECTRUM ANALYZER R&S	FSP40	100040	Aug. 01, 2011	Jul. 31, 2012
WIT STANDARD TEMPERATURE AND HUMIDITY CHAMBER	TH-4S-C	W981030	Jun. 15, 2011	Jun. 14, 2012

**NOTE:** The calibration interval of the above test instruments is 12 months and the calibrations are traceable to NML/ROC and NIST/USA.

#### 4.3.3 TEST PROCEDURE

- a. The EUT was placed inside the environmental test chamber and powered by nominal DC voltage.
- b. Turn the EUT on and couple its output to a spectrum analyzer.
- c. Turn the EUT off and set the chamber to the highest temperature specified.
- d. Allow sufficient time (approximately 30 min) for the temperature of the chamber to stabilize, turn the EUT on and measure the operating frequency after 2, 5, and 10 minutes.
- e. Repeat step 2 and 3 with the temperature chamber set to the lowest temperature.
- f. The test chamber was allowed to stabilize at +20 degree C for a minimum of 30 minutes. The supply voltage was then adjusted on the EUT from 85% to 115% and the frequency record.

#### 4.3.4 DEVIATION FROM TEST STANDARD

No deviation.

#### 4.3.5 TEST SETUP

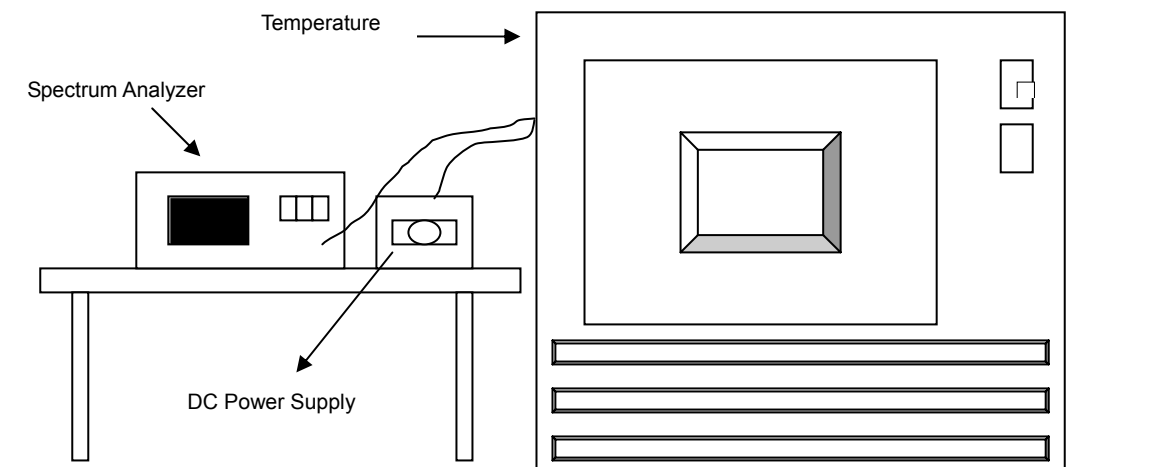

#### 4.3.6 EUT OPERATING CONDITION

Same as Item 4.1.6.



### 4.3.7 TEST RESULTS

#### TEST MODE A

FREQUENCY STABILITY VERSUS TEMP.									
TEMP. (°C)	POWER SUPPLY (Vdc)	0 MINUTE		2 MINUTE		5 MINUTE		10 MINUTE	
		Measured Frequency	Frequency Drift	Measured Frequency	Frequency Drift	Measured Frequency	Frequency Drift	Measured Frequency	Frequency Drift
		(MHz)	%	(MHz)	%	(MHz)	%	(MHz)	%
55	3.7	13.560263	0.0019395	13.560210	0.0015487	13.560247	0.0018215	13.560228	0.0016814
50	3.7	13.560021	0.0001549	13.560005	0.0000369	13.560025	0.0001844	13.560047	0.0003466
40	3.7	13.560225	0.0016593	13.560207	0.0015265	13.560210	0.0015487	13.560214	0.0015782
30	3.7	13.560162	0.0011947	13.560175	0.0012906	13.560170	0.0012537	13.560160	0.0011799
20	3.7	13.560215	0.0015855	13.560228	0.0016814	13.560185	0.0013643	13.560251	0.0018510
10	3.7	13.560165	0.0012168	13.560224	0.0016519	13.560239	0.0017625	13.560225	0.0016593
0	3.7	13.560145	0.0010693	13.560133	0.0009808	13.560138	0.0010177	13.560086	0.0006342
-10	3.7	13.560202	0.0014897	13.560204	0.0015044	13.560185	0.0013643	13.560217	0.0016003
-20	3.7	13.560276	0.0020354	13.560248	0.0018289	13.560289	0.0021313	13.560252	0.0018584

FREQUENCY STABILITY VERSUS VOLTAGE									
TEMP. (°C)	POWER SUPPLY (Vac)	0 MINUTE		2 MINUTE		5 MINUTE		10 MINUTE	
		Measured Frequency	Frequency Drift	Measured Frequency	Frequency Drift	Measured Frequency	Frequency Drift	Measured Frequency	Frequency Drift
		(MHz)	%	(MHz)	%	(MHz)	%	(MHz)	%
20	4.250	13.560251	0.0018510	13.560182	0.0013422	13.560197	0.0014528	13.560195	0.0014381
	3.7	13.560261	0.0019248	13.560229	0.0016888	13.560234	0.0017257	13.560187	0.0013791
	3.145	13.560216	0.0015929	13.560219	0.0016150	13.560222	0.0016372	13.560207	0.0015265





**TEST MODE B**

FREQUENCY STABILITY VERSUS TEMP.									
TEMP. (°C)	POWER SUPPLY (Vdc)	0 MINUTE		2 MINUTE		5 MINUTE		10 MINUTE	
		Measured Frequency	Frequency Drift	Measured Frequency	Frequency Drift	Measured Frequency	Frequency Drift	Measured Frequency	Frequency Drift
		(MHz)	%	(MHz)	%	(MHz)	%	(MHz)	%
55	110.0	13.560265	0.0019543	13.560246	0.0018142	13.560250	0.0018437	13.560286	0.0021091
50	110.0	13.560006	0.0000442	13.559989	-0.0000811	13.560000	0.0000000	13.560056	0.0004130
40	110.0	13.560174	0.0012832	13.560241	0.0017773	13.560270	0.0019912	13.560274	0.0020206
30	110.0	13.560124	0.0009145	13.560171	0.0012611	13.560192	0.0014159	13.560175	0.0012906
20	110.0	13.560206	0.0015192	13.560183	0.0013496	13.560219	0.0016150	13.560199	0.0014676
10	110.0	13.560182	0.0013422	13.560146	0.0010767	13.560127	0.0009366	13.560173	0.0012758
0	110.0	13.560106	0.0007817	13.560187	0.0013791	13.560164	0.0012094	13.560157	0.0011578
-10	110.0	13.560197	0.0014528	13.560225	0.0016593	13.560212	0.0015634	13.560196	0.0014454
-20	110.0	13.560296	0.0021829	13.560256	0.0018879	13.560291	0.0021460	13.560249	0.0018363

FREQUENCY STABILITY VERSUS VOLTAGE									
TEMP. (°C)	POWER SUPPLY (Vac)	0 MINUTE		2 MINUTE		5 MINUTE		10 MINUTE	
		Measured Frequency	Frequency Drift	Measured Frequency	Frequency Drift	Measured Frequency	Frequency Drift	Measured Frequency	Frequency Drift
		(MHz)	%	(MHz)	%	(MHz)	%	(MHz)	%
20	126.500	13.560214	0.0015782	13.560161	0.0011873	13.560192	0.0014159	13.560220	0.0016224
	110.0	13.560178	0.0013127	13.560173	0.0012758	13.560195	0.0014381	13.560244	0.0017994
	93.500	13.560202	0.0014897	13.560198	0.0014602	13.560175	0.0012906	13.560180	0.0013274



A D T

**TEST MODE D**

FREQUENCY STABILITY VERSUS TEMP.									
TEMP. (°C)	POWER SUPPLY (Vdc)	0 MINUTE		2 MINUTE		5 MINUTE		10 MINUTE	
		Measured Frequency	Frequency Drift	Measured Frequency	Frequency Drift	Measured Frequency	Frequency Drift	Measured Frequency	Frequency Drift
		(MHz)	%	(MHz)	%	(MHz)	%	(MHz)	%
55	110.0	13.560290	0.0021386	13.560298	0.0021976	13.560234	0.0017257	13.560272	0.0020059
50	110.0	13.560029	0.0002139	13.560009	0.0000664	13.560032	0.0002360	13.560033	0.0002434
40	110.0	13.560183	0.0013496	13.560176	0.0012979	13.560166	0.0012242	13.560215	0.0015855
30	110.0	13.560129	0.0009513	13.560117	0.0008628	13.560149	0.0010988	13.560127	0.0009366
20	110.0	13.560179	0.0013201	13.560238	0.0017552	13.560197	0.0014528	13.560175	0.0012906
10	110.0	13.560146	0.0010767	13.560195	0.0014381	13.560177	0.0013053	13.560137	0.0010103
0	110.0	13.560092	0.0006785	13.560104	0.0007670	13.560130	0.0009587	13.560101	0.0007448
-10	110.0	13.560192	0.0014159	13.560194	0.0014307	13.560175	0.0012906	13.560217	0.0016003
-20	110.0	13.560297	0.0021903	13.560293	0.0021608	13.560271	0.0019985	13.560268	0.0019764

FREQUENCY STABILITY VERSUS VOLTAGE									
TEMP. (°C)	POWER SUPPLY (Vac)	0 MINUTE		2 MINUTE		5 MINUTE		10 MINUTE	
		Measured Frequency	Frequency Drift	Measured Frequency	Frequency Drift	Measured Frequency	Frequency Drift	Measured Frequency	Frequency Drift
		(MHz)	%	(MHz)	%	(MHz)	%	(MHz)	%
20	126.500	13.560180	0.0013274	13.560168	0.0012389	13.560139	0.0010251	13.560187	0.0013791
	110.0	13.560211	0.0015560	13.560199	0.0014676	13.560190	0.0014012	13.560224	0.0016519
	93.500	13.560157	0.0011578	13.560159	0.0011726	13.560185	0.0013643	13.560149	0.0010988

## **4.4 20dB BANDWIDTH**

### **4.4.1 LIMITS OF 20dB BANDWIDTH MEASUREMENT**

The 20dB bandwidth shall be specified in operating frequency band.

### **4.4.2 TEST INSTRUMENTS**

Same as Item 4.1.2.

### **4.4.3 TEST PROCEDURE**

The bandwidth of the fundamental frequency was measured by spectrum analyzer with 1kHz RBW and 1kHz VBW. The 20dB bandwidth is defined as the total spectrum the power of which is higher than peak power minus 20dB.

### **4.4.4 DEVIATION FROM TEST STANDARD**

No deviation.

### **4.4.5 TEST SETUP**

Same as Item 4.1.5.

### **4.4.6 EUT OPERATING CONDITION**

Same as Item 4.1.6.



A D T

### 4.4.7 TEST RESULTS

#### TEST MODE A

20dBc point (Low)	20dBc point (HIGH)	Operating frequency band (MHz)	PASS/FAIL
13.559 MHz	13.56168 MHz	13.553~13.567	PASS

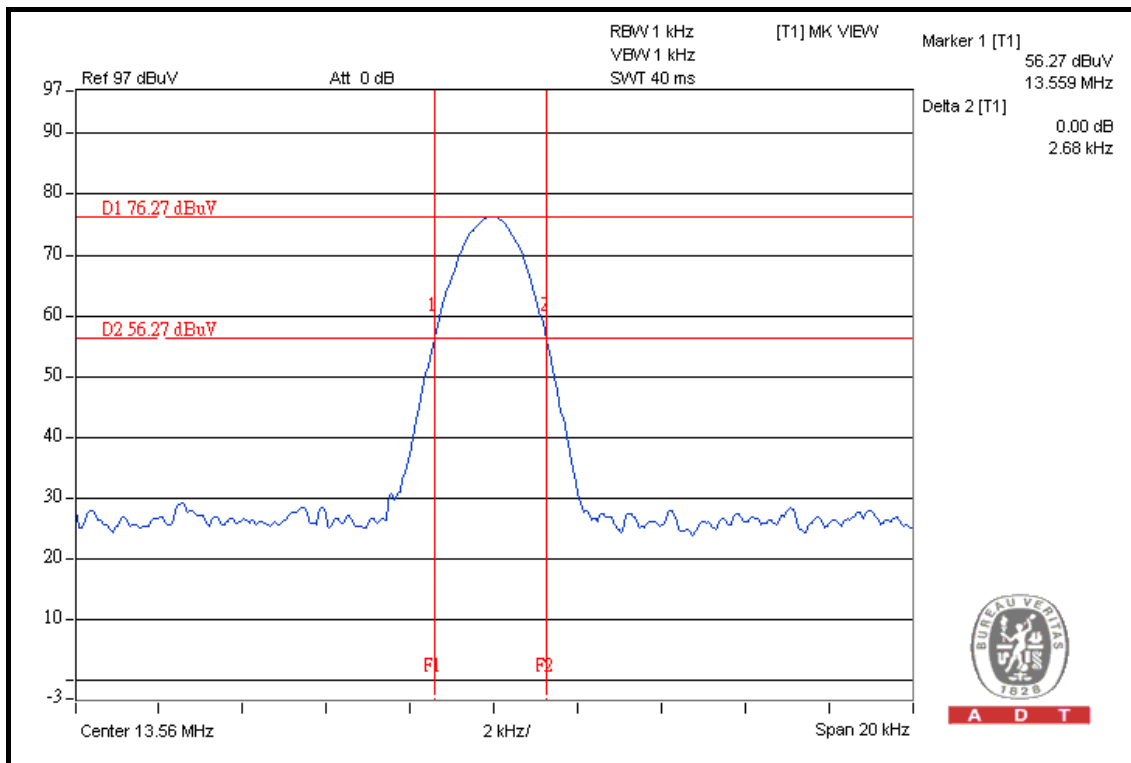



A D T

### TEST MODE B

20dBc point (Low)	20dBc point (HIGH)	Operating frequency band (MHz)	PASS/FAIL
13.559 MHz	13.56168 MHz	13.553~13.567	PASS

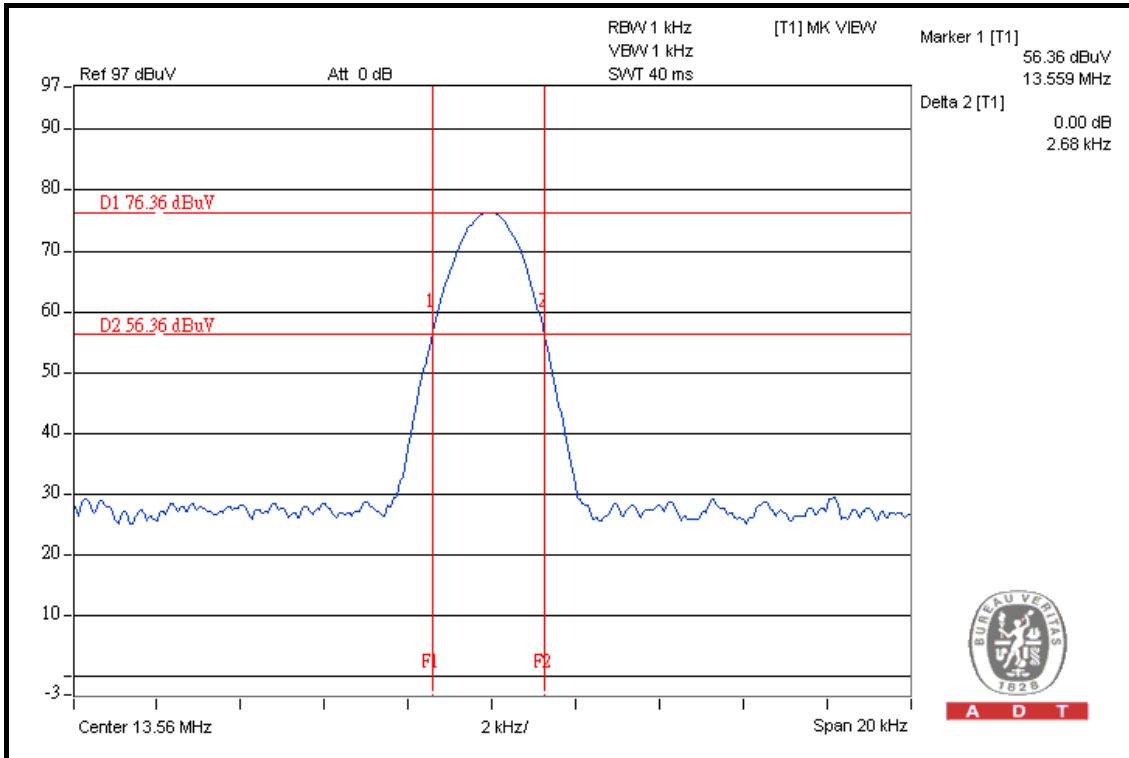



A D T

### TEST MODE C

20dBc point (Low)	20dBc point (HIGH)	Operating frequency band (MHz)	PASS/FAIL
13.559 MHz	13.56170 MHz	13.553~13.567	PASS

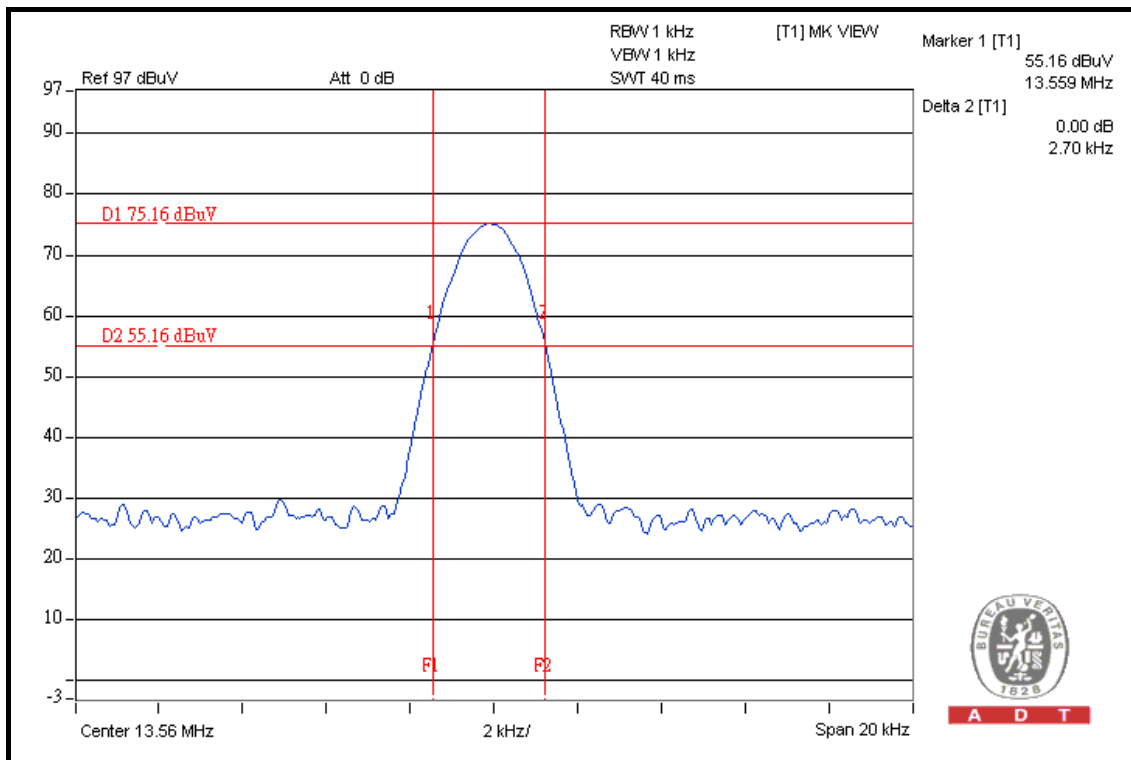



A D T

### TEST MODE D

20dBc point (Low)	20dBc point (HIGH)	Operating frequency band (MHz)	PASS/FAIL
13.559 MHz	13.56169MHz	13.553~13.567	PASS

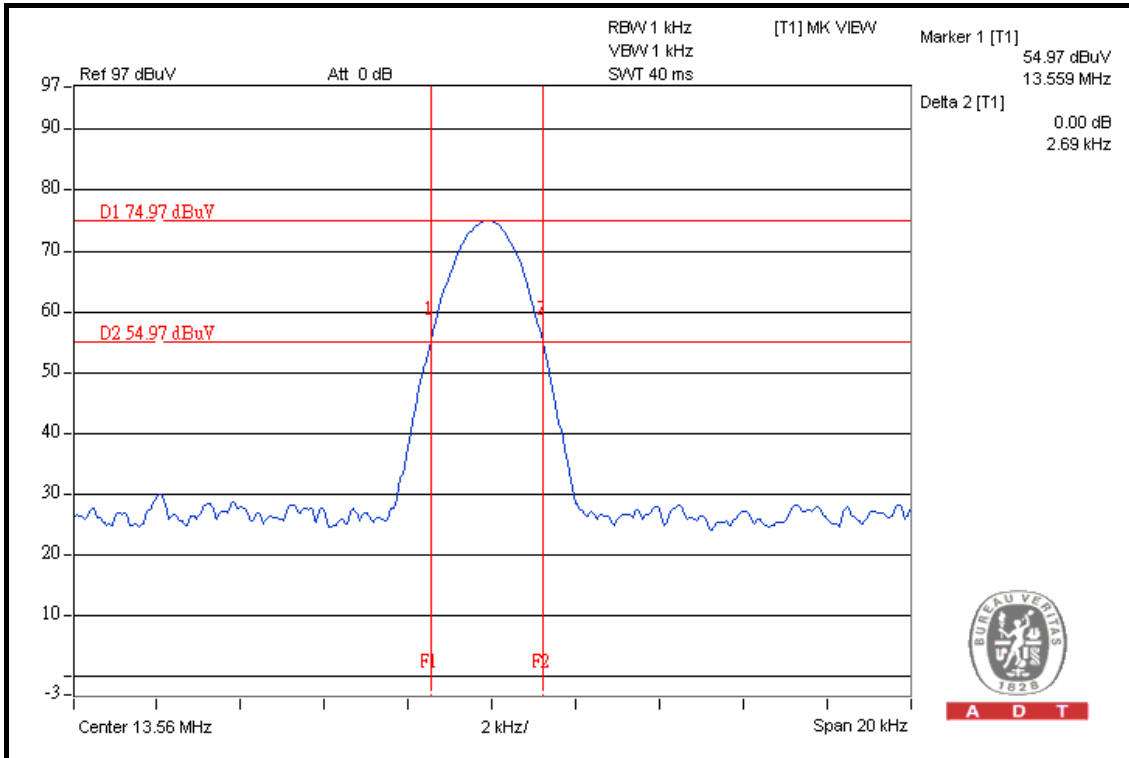



## 5. PHOTOGRAPHS OF THE TEST CONFIGURATION

Please refer to the attached file (Test Setup Photo).





## 6. INFORMATION ON THE TESTING LABORATORIES

We, Bureau Veritas Consumer Products Services (H.K.) Ltd., Taoyuan Branch, were founded in 1988 to provide our best service in EMC, Radio, Telecom and Safety consultation. Our laboratories are accredited and approved according to ISO/IEC 17025.

Copies of accreditation and authorization certificates of our laboratories obtained from approval agencies can be downloaded from our web site: [www.adt.com.tw/index.5.phtml](http://www.adt.com.tw/index.5.phtml).

If you have any comments, please feel free to contact us at the following:

**Linko EMC/RF Lab**

Tel: 886-2-26052180

Fax: 886-2-26051924

**Hsin Chu EMC/RF Lab**

Tel: 886-3-5935343

Fax: 886-3-5935342

**Hwa Ya EMC/RF/Safety/Telecom Lab**

Tel: 886-3-3183232

Fax: 886-3-3185050

**Email:** [service.adt@tw.bureauveritas.com](mailto:service.adt@tw.bureauveritas.com)

**Web Site:** [www.adt.com.tw](http://www.adt.com.tw)

The address and road map of all our labs can be found in our web site also.

## **7. APPENDIX A - MODIFICATIONS RECORDERS FOR ENGINEERING CHANGES TO THE EUT BY THE LAB**

No any modifications are made to the EUT by the lab during the test.

**--- END ---**