



FCC RF Test Report

APPLICANT : Zebra Technologies Corporation
EQUIPMENT : Personnel Badge
BRAND NAME : ZEBRA
MODEL NAME : MPACT-BRDGM
FCC ID : UZ7MPACTBRDGM
STANDARD : FCC Part 15 Subpart C §15.247
CLASSIFICATION : (DTS) Digital Transmission System

The product was received on Oct. 06, 2016 and testing was completed on Nov. 18, 2016. We, SPORTON INTERNATIONAL INC., would like to declare that the tested sample has been evaluated in accordance with the test procedures and has been in compliance with the applicable technical standards.

The test results in this report apply exclusively to the tested model / sample. Without written approval of SPORTON INTERNATIONAL INC., the test report shall not be reproduced except in full.

Reviewed by: Joseph Lin / Supervisor

Approved by: Jones Tsai / Manager



SPORTON INTERNATIONAL INC.

No. 52, Hwa Ya 1st Rd., Hwa Ya Technology Park, Kwei-Shan District, Tao Yuan City, Taiwan, R.O.C.



TABLE OF CONTENTS

REVISION HISTORY 3

SUMMARY OF TEST RESULT 4

1 GENERAL DESCRIPTION 5

 1.1 Applicant 5

 1.2 Manufacturer 5

 1.3 Product Feature of Equipment Under Test 5

 1.4 Product Specification of Equipment Under Test 6

 1.5 Modification of EUT 6

 1.6 Testing Location 7

 1.7 Applicable Standards 7

2 TEST CONFIGURATION OF EQUIPMENT UNDER TEST 8

 2.1 Carrier Frequency and Channel 8

 2.2 Test Mode 8

 2.3 Connection Diagram of Test System 9

 2.4 Support Unit used in test configuration and system 10

 2.5 EUT Operation Test Setup 10

 2.6 Measurement Results Explanation Example 10

3 TEST RESULT 11

 3.1 6dB and 99% Bandwidth Measurement 11

 3.2 Output Power Measurement 13

 3.3 Power Spectral Density Measurement 14

 3.4 Conducted Band Edges and Spurious Emission Measurement 16

 3.5 Radiated Band Edges and Spurious Emission Measurement 26

 3.6 AC Conducted Emission Measurement 30

 3.7 Antenna Requirements 34

4 LIST OF MEASURING EQUIPMENT 35

5 UNCERTAINTY OF EVALUATION 36

APPENDIX A. CONDUCTED TEST RESULTS

APPENDIX B. RADIATED SPURIOUS EMISSION

APPENDIX C. RADIATED SPURIOUS EMISSION PLOTS

APPENDIX D. DUTY CYCLE PLOTS

APPENDIX E. SETUP PHOTOGRAPHS



REVISION HISTORY

REPORT NO.	VERSION	DESCRIPTION	ISSUED DATE
FR6O0724B	Rev. 01	Initial issue of report	Dec. 08, 2016



SUMMARY OF TEST RESULT

Report Section	FCC Rule	Description	Limit	Result	Remark
3.1	15.247(a)(2)	6dB Bandwidth	≥ 0.5MHz	Pass	-
3.1	-	99% Bandwidth	-	Pass	-
3.2	15.247(b)	Power Output Measurement	≤ 30dBm	Pass	-
3.3	15.247(e)	Power Spectral Density	≤ 8dBm/3kHz	Pass	-
3.4	15.247(d)	Conducted Band Edges	≤ 20dBc	Pass	-
		Conducted Spurious Emission		Pass	-
3.5	15.247(d)	Radiated Band Edges and Radiated Spurious Emission	15.209(a) & 15.247(d)	Pass	Under limit 1.00 dB at 2390.000 MHz
3.6	15.207	AC Conducted Emission	15.207(a)	Pass	Under limit 12.30 dB at 0.150 MHz
3.7	15.203 & 15.247(b)	Antenna Requirement	N/A	Pass	-



1 General Description

1.1 Applicant

Zebra Technologies Corporation
1 Zebra Plaza, Holtsville, NY 11742

1.2 Manufacturer

Zebra Technologies Corporation
1 Zebra Plaza, Holtsville, NY 11742

1.3 Product Feature of Equipment Under Test

Product Feature	
Equipment	Personnel Badge
Brand Name	ZEBRA
Model Name	MPACT-BRDGM
FCC ID	UZ7MPACTBRDGM
EUT supports Radios application	WLAN 11 a/b/g/n HT20 Bluetooth LE
Wifi Code version	6.0.109.9
Wifi Tools version	9.0.0.341360
EUT Stage	Identical Prototype

Remark: The above EUT's information was declared by manufacturer. Please refer to the specifications or user's manual for more detailed description.



1.4 Product Specification of Equipment Under Test

Standards-related Product Specification	
Tx/Rx Channel Frequency Range	2412 MHz ~ 2462 MHz
Maximum (Peak) Output Power to antenna	<p><EUT with J300 Antenna> 802.11b : 21.25 dBm (0.1334 W) 802.11g : 22.83 dBm (0.1919 W) 802.11n HT20 : 22.78 dBm (0.1897 W)</p> <p><EUT with J301 Antenna> 802.11b : 21.08 dBm (0.1282 W) 802.11g : 22.37 dBm (0.1726 W) 802.11n HT20 : 22.40 dBm (0.1738 W)</p>
99% Occupied Bandwidth	<p><EUT with J300 Antenna> 802.11b : 12.70MHz 802.11g : 18.10MHz 802.11n HT20 : 19.00MHz</p>
Antenna Type / Gain	Dipole Antenna with gain 2.90 dBi
Type of Modulation	802.11b : DSSS (DBPSK / DQPSK / CCK) 802.11g/n : OFDM (BPSK / QPSK / 16QAM / 64QAM)

Remark: This device has two kinds of WLAN antenna (J300 Antenna and J301 Antenna), and the J300 has max RF Power. Thus, all tests were performed with J300 Antenna.

1.5 Modification of EUT

No modifications are made to the EUT during all test items.



1.6 Testing Location

Sporton Lab is accredited to ISO 17025 by Taiwan Accreditation Foundation (TAF code : 1190) and the FCC designation No. TW1022 under the FCC 2.948(e) by Mutual Recognition Agreement (MRA) in FCC Test.

Test Site	SPORTON INTERNATIONAL INC.		
Test Site Location	No. 52, Hwa Ya 1 st Rd., Hwa Ya Technology Park, Kwei-Shan District, Tao Yuan City, Taiwan, R.O.C. TEL: +886-3-327-3456 FAX: +886-3-328-4978		
Test Site No.	Sporton Site No.		
	TH05-HY	CO05-HY	03CH07-HY

Note: The test site complies with ANSI C63.4 2014 requirement.

1.7 Applicable Standards

According to the specifications of the manufacturer, the EUT must comply with the requirements of the following standards:

- ♦ FCC Part 15 Subpart C §15.247
- ♦ FCC KDB Publication No. 558074 D01 DTS Meas. Guidance v03r05
- ♦ ANSI C63.10-2013

Remark:

1. All test items were verified and recorded according to the standards and without any deviation during the test.
2. This EUT has also been tested and complied with the requirements of FCC Part 15, Subpart B, recorded in a separate test report.



2 Test Configuration of Equipment Under Test

The EUT has been associated with peripherals and configuration operated in a manner tended to maximize its emission characteristics in a typical application. Frequency range investigated: conducted emission (150 kHz to 30 MHz) and radiated emission (9 kHz to the 10th harmonic of the highest fundamental frequency or to 40 GHz, whichever is lower). For radiated measurement, pre-scanned in three orthogonal panels, X, Y, Z. The worst cases (X plane) were recorded in this report.

2.1 Carrier Frequency and Channel

Frequency Band	Channel	Freq. (MHz)	Channel	Freq. (MHz)
2400-2483.5 MHz	1	2412	7	2442
	2	2417	8	2447
	3	2422	9	2452
	4	2427	10	2457
	5	2432	11	2462
	6	2437	-	-

2.2 Test Mode

Final test mode of conducted test items and radiated spurious emissions are considering the modulation and worse data rates as below table.

Modulation	Data Rate
802.11b	1 Mbps
802.11g	6 Mbps
802.11n HT20	MCS0

Test Cases	
AC Conducted Emission	Mode 1 : Jamaica charging from Toaster + Bluetooth Idle + WLAN Idle + AC Adapter (PS000084A01)

2.3 Connection Diagram of Test System

<WLAN Tx Mode>

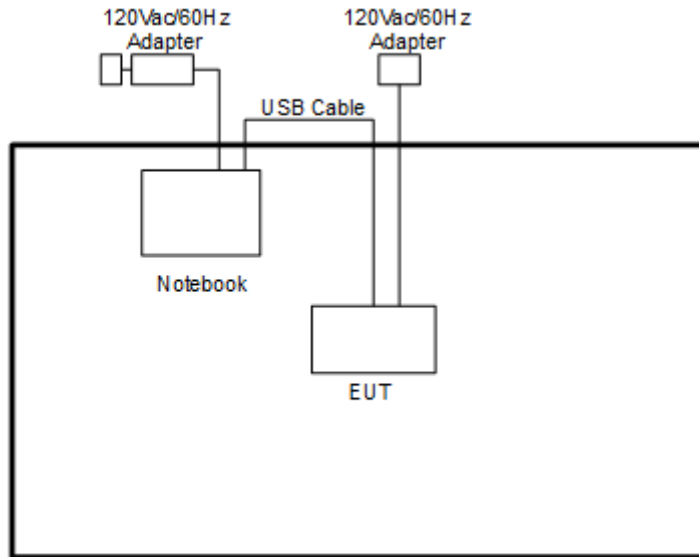

<AC Conducted Emission Mode>

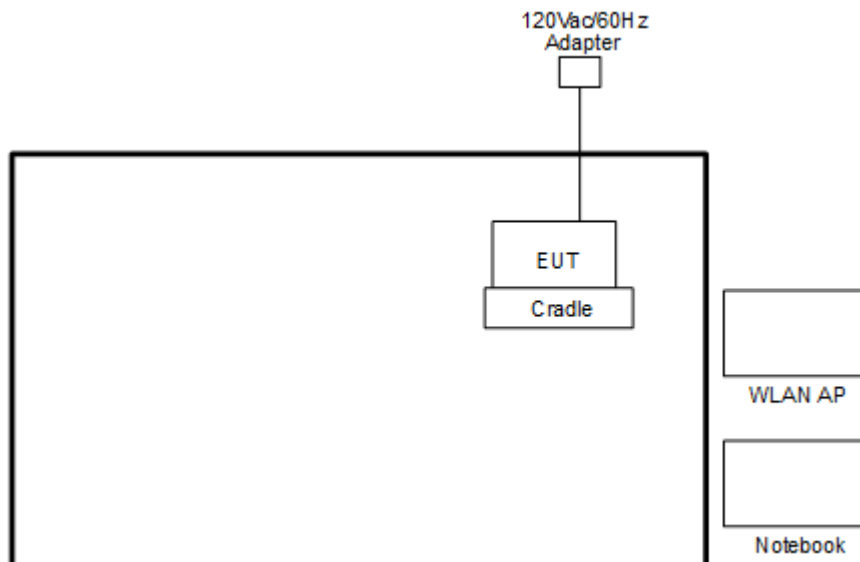



2.4 Support Unit used in test configuration and system

Item	Equipment	Trade Name	Model Name	FCC ID	Data Cable	Power Cord
1.	WLAN AP	D-Link	DIR-628	KA2DIR628A2	N/A	Unshielded, 1.8 m
2.	Notebook	DELL	Latitude E3340	FCC DoC/ Contains FCC ID: PD97260NGU	N/A	AC I/P: Unshielded, 1.2 m DC O/P: Shielded, 1.8 m
3.	Notebook	Lenovo	E335	FCC DoC	N/A	AC I/P: Unshielded, 1.2 m DC O/P: Shielded, 1.8 m
4.	Cradle (Toaster)	Zebra	MPACT-CRADLE	FCC DoC	Shielded, 1.0 m	AC I/P: Unshielded, 1.8 m DC O/P: Unshielded, 1.0 m

2.5 EUT Operation Test Setup

For WLAN function, programmed RF utility, “Tx Tool” installed in the notebook make the EUT provide functions like channel selection and power level for continuous transmitting and receiving signals.

2.6 Measurement Results Explanation Example

For all conducted test items:

The offset level is set in the spectrum analyzer to compensate the RF cable loss and attenuator factor between EUT conducted output port and spectrum analyzer. With the offset compensation, the spectrum analyzer reading level is exactly the EUT RF output level.

Example :

The spectrum analyzer offset is derived from RF cable loss and attenuator factor.

Offset = RF cable loss + attenuator factor.

Following shows an offset computation example with cable loss 4.2 dB and 10dB attenuator.

$$\begin{aligned}
 \text{Offset(dB)} &= \text{RF cable loss(dB)} + \text{attenuator factor(dB)}. \\
 &= 4.2 + 10 = 14.2 \text{ (dB)}
 \end{aligned}$$

3 Test Result

3.1 6dB and 99% Bandwidth Measurement

3.1.1 Limit of 6dB and 99% Bandwidth

The minimum 6 dB bandwidth shall be at least 500 kHz.

3.1.2 Measuring Instruments

The measuring equipment is listed in the section 4 of this test report.

3.1.3 Test Procedures

1. The testing follows FCC KDB Publication No. 558074 DTS D01 Meas. Guidance v03r05.
2. The RF output of EUT was connected to the spectrum analyzer by RF cable and attenuator. The path loss was compensated to the results for each measurement.
3. Set to the maximum power setting and enable the EUT transmit continuously.
4. Make the measurement with the spectrum analyzer's resolution bandwidth (RBW) = 100 kHz. Set the Video bandwidth (VBW) = 300 kHz. In order to make an accurate measurement. The 6 dB bandwidth must be greater than 500 kHz.
5. For 99% Bandwidth Measurement, the spectrum analyzer's resolution bandwidth (RBW) = 1MHz and set the Video bandwidth (VBW) = 3MHz.
6. Measure and record the results in the test report.

3.1.4 Test Setup





3.1.5 Test Result of 6dB and 99% Occupied Bandwidth

Please refer to Appendix A.

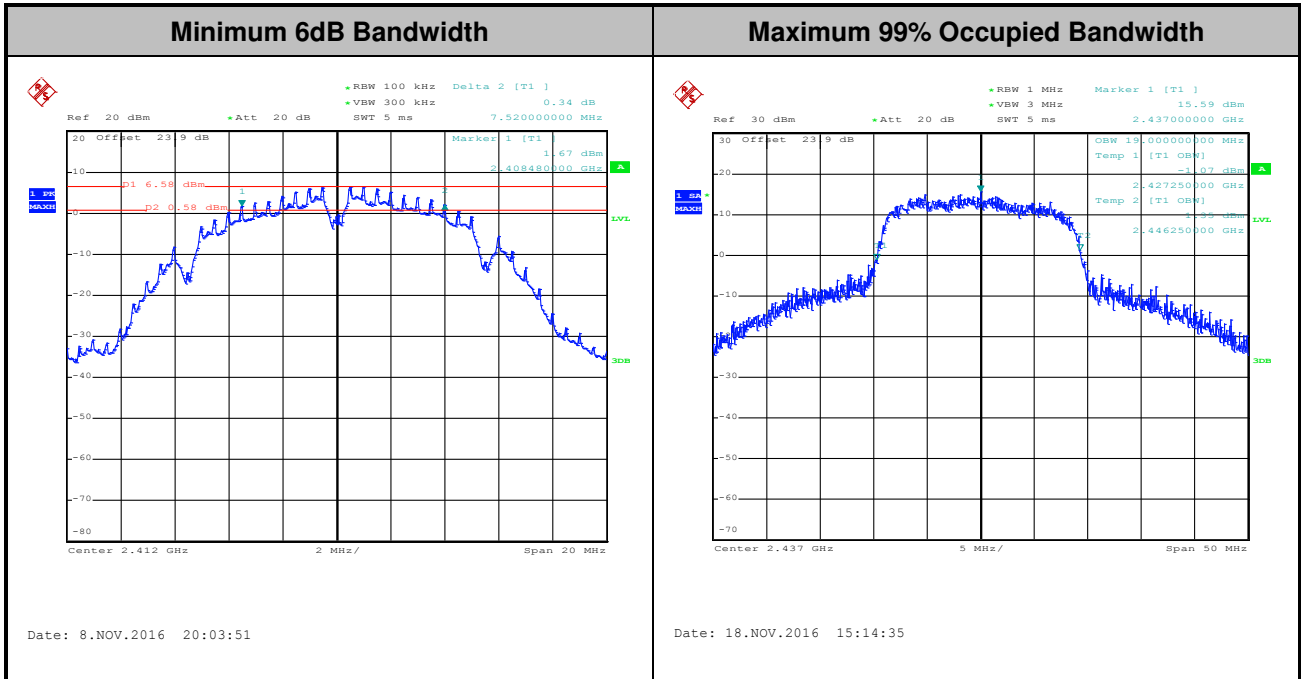

Note : The occupied channel bandwidth is maintained within the band of operation for all of the modulations.

3.2 Output Power Measurement

3.2.1 Limit of Output Power

For systems using digital modulation in the 2400-2483.5MHz, the limit for peak output power is 30dBm. If transmitting antenna of directional gain greater than 6dBi are used the peak output power from the intentional radiator shall be reduced below the above stated value by the amount in dB that the directional gain of the antenna exceeds 6 dBi. In case of point-to-point operation, the limit has to be reduced by 1dB for every 3dB that the directional gain of the antenna exceeds 6dBi.

3.2.2 Measuring Instruments

The measuring equipment is listed in the section 4 of this test report.

3.2.3 Test Procedures

1. The testing follows the Measurement Procedure of FCC KDB No. 558074 DTS D01 Meas. Guidance v03r05 section 9.1.2 PKPM1 Peak power meter method.
2. The RF output of EUT was connected to the power meter by RF cable and attenuator. The path loss was compensated to the results for each measurement.
3. Set to the maximum power setting and enable the EUT transmit continuously.
4. Measure the conducted output power and record the results in the test report.

3.2.4 Test Setup

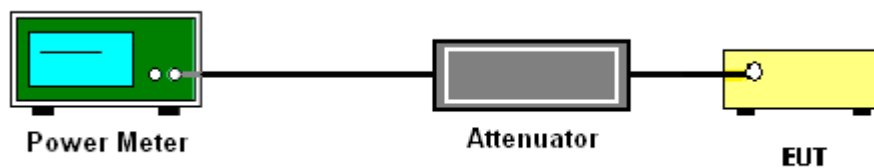

3.2.5 Test Result of Peak Output Power

Please refer to Appendix A.

3.2.6 Test Result of Average output Power (Reporting Only)

Please refer to Appendix A.

3.3 Power Spectral Density Measurement

3.3.1 Limit of Power Spectral Density

The peak power spectral density shall not be greater than 8dBm in any 3kHz band at any time interval of continuous transmission.

3.3.2 Measuring Instruments

The measuring equipment is listed in the section 4 of this test report.

3.3.3 Test Procedures

1. The testing follows Measurement Procedure 10.2 Method PKPSD of FCC KDB Publication No. 558074 D01 DTS Meas. Guidance v03r05
2. The RF output of EUT was connected to the spectrum analyzer by RF cable and attenuator. The path loss was compensated to the results for each measurement.
3. Set to the maximum power setting and enable the EUT transmit continuously.
4. Make the measurement with the spectrum analyzer's resolution bandwidth (RBW) = 3 kHz. Video bandwidth VBW = 10 kHz In order to make an accurate measurement, set the span to 1.5 times DTS Channel Bandwidth. (6dB BW)
5. Detector = peak, Sweep time = auto couple, Trace mode = max hold, Allow trace to fully stabilize. Use the peak marker function to determine the maximum power level.
6. Measure and record the results in the test report.

3.3.4 Test Setup





3.3.5 Test Result of Power Spectral Density

Please refer to Appendix A.

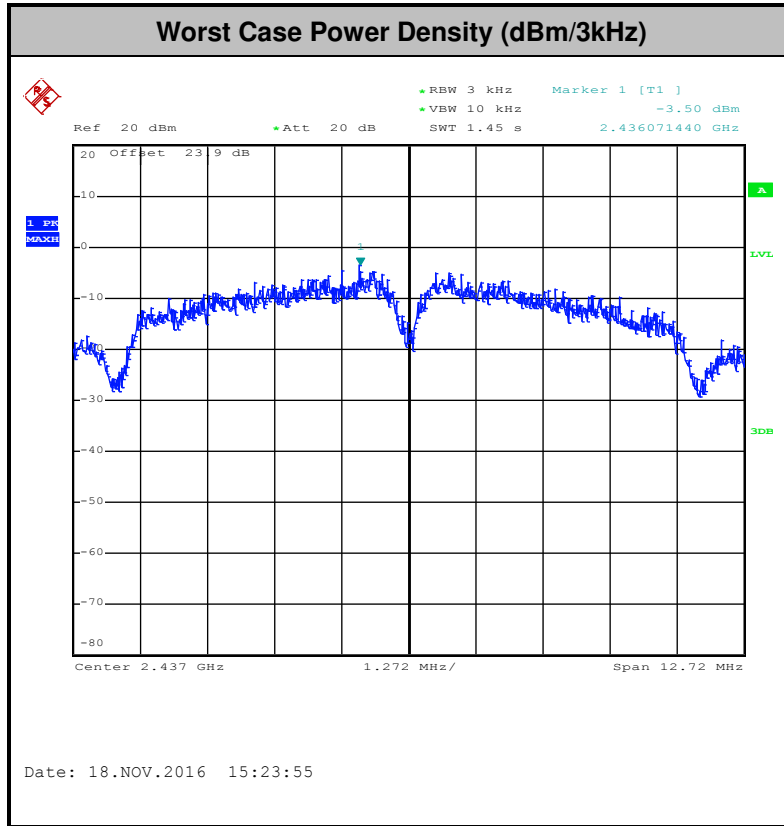

3.4 Conducted Band Edges and Spurious Emission Measurement

3.4.1 Limit of Conducted Band Edges and Spurious Emission Measurement

In any 100 kHz bandwidth outside of the authorized frequency band, the emissions which fall in the non-restricted bands shall be attenuated at least 20 dB / 30dB relative to the maximum PSD level in 100 kHz by RF conducted measurement and radiated emissions which fall in the restricted bands, as defined in Section 15.205(a), must also comply with the radiated emission limits specified in Section 15.209(a).

3.4.2 Measuring Instruments

The measuring equipment is listed in the section 4 of this test report.

3.4.3 Test Procedures

1. The testing follows FCC KDB Publication No. 558074 D01 DTS Meas. Guidance v03r05.
2. The RF output of EUT was connected to the spectrum analyzer by RF cable and attenuator. The path loss was compensated to the results for each measurement.
3. Set to the maximum power setting and enable the EUT transmit continuously.
4. Set RBW = 100 kHz, VBW=300 kHz, Peak Detector. Unwanted Emissions measured in any 100 kHz bandwidth outside of the authorized frequency band shall be attenuated by at least 20 dB relative to the maximum in-band peak PSD level in 100 kHz when maximum peak conducted output power procedure is used. If the transmitter complies with the conducted power limits based on the use of RMS averaging over a time interval, the attenuation required under this paragraph shall be 30 dB instead of 20 dB per 15.247(d).
5. Measure and record the results in the test report.
6. The RF fundamental frequency should be excluded against the limit line in the operating frequency band.

3.4.4 Test Setup

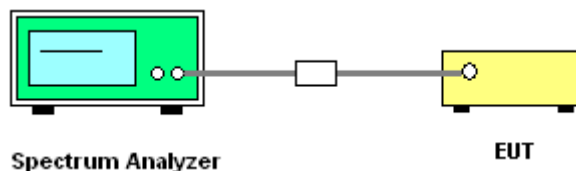



3.4.5 Test Result of Conducted Band Edges and Spurious Emission

Test Mode :	802.11b	Temperature :	21~25°C
Test Band :	2.4GHz Low	Relative Humidity :	51~54%
Test Channel :	01	Test Engineer :	Tommy Lee

WLAN 802.11b Channel 01

100kHz PSD reference Level	Low Channel Plot
-----------------------------------	-------------------------

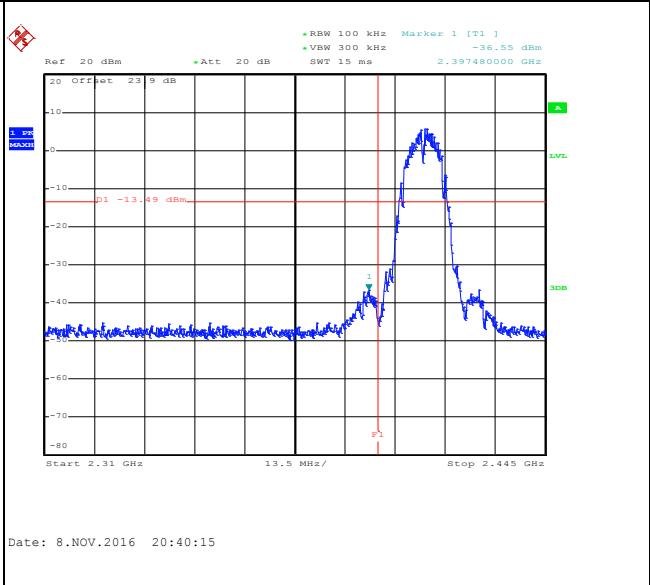
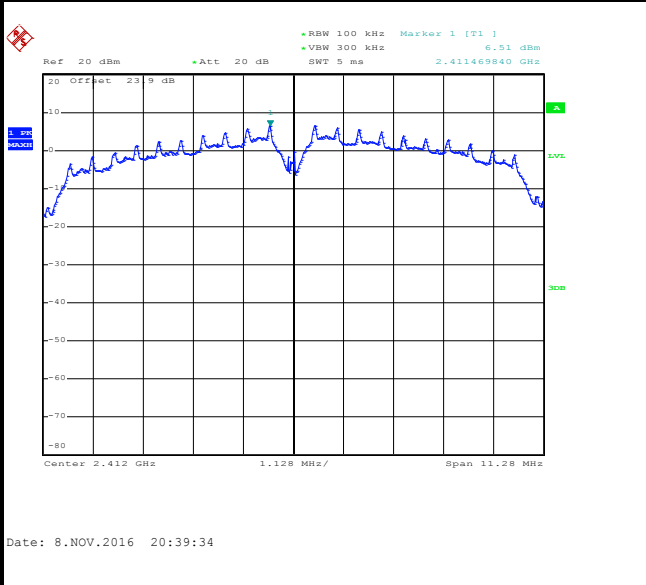

Spurious Emission 30MHz~3GHz

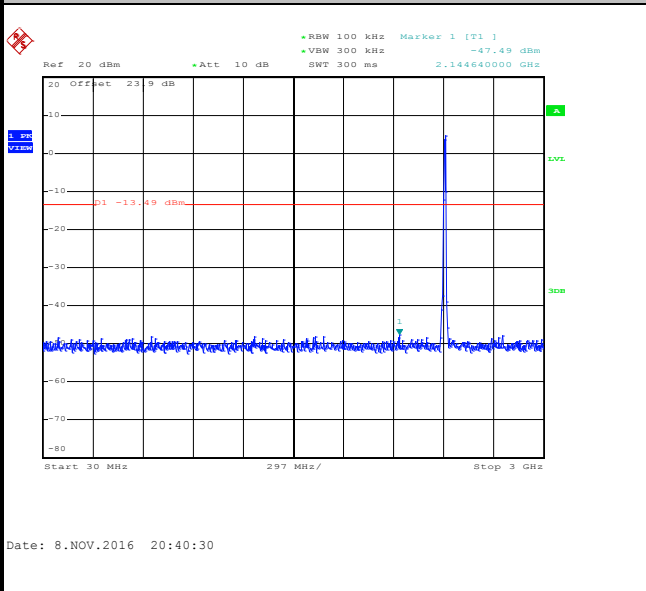

Spurious Emission 2GHz~25GHz

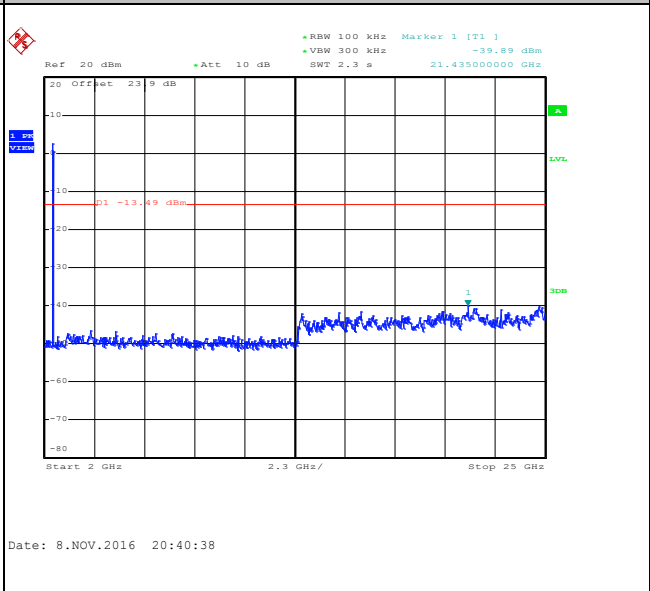



Test Mode :	802.11b	Temperature :	21~25°C
Test Band :	2.4GHz Mid	Relative Humidity :	51~54%
Test Channel :	06	Test Engineer :	Tommy Lee

WLAN 802.11b Channel 06

100kHz PSD reference Level

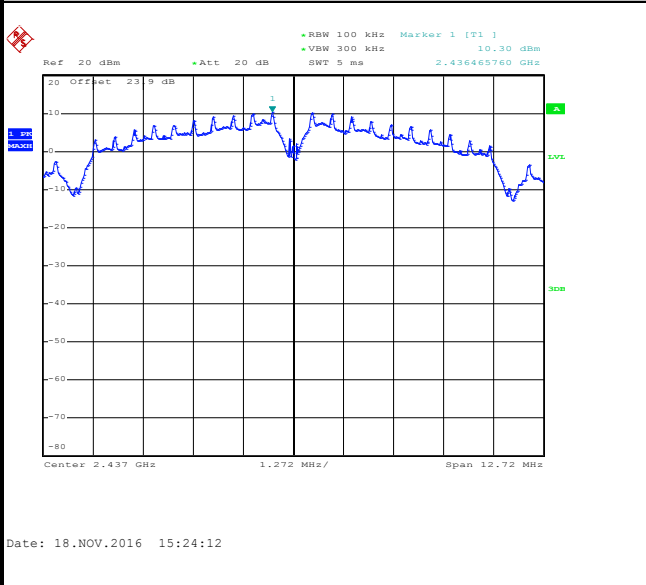

Spurious Emission 30MHz~3GHz

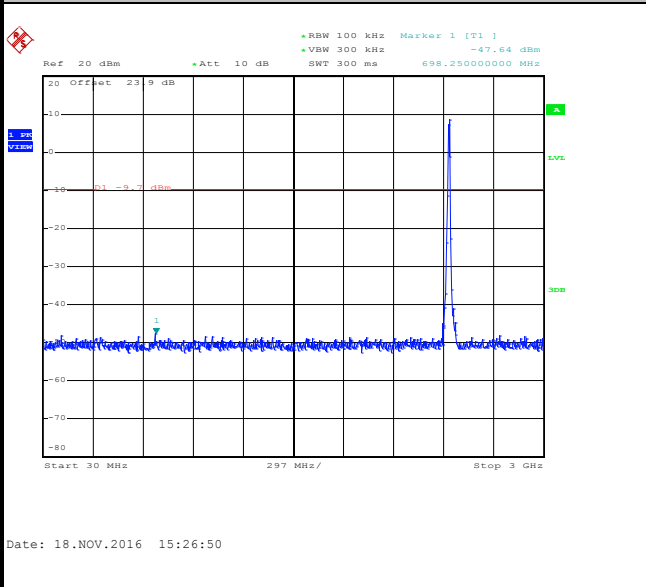

Spurious Emission 2GHz~25GHz

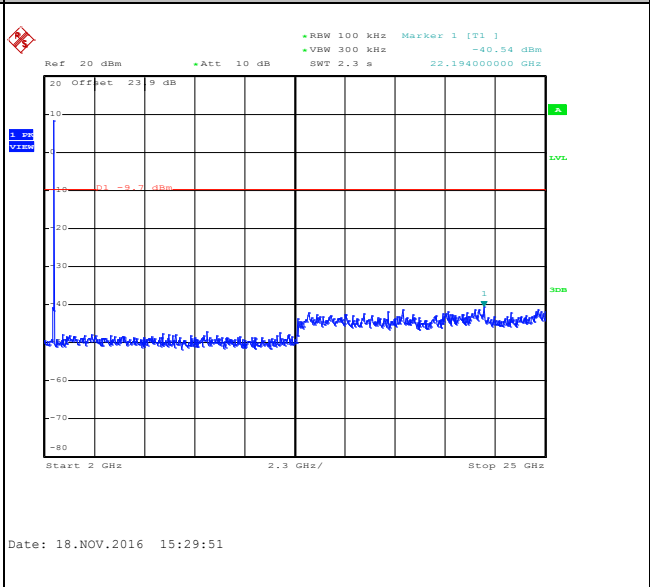



Test Mode :	802.11b	Temperature :	21~25°C
Test Band :	2.4GHz High	Relative Humidity :	51~54%
Test Channel :	11	Test Engineer :	Tommy Lee

WLAN 802.11b Channel 11

100kHz PSD reference Level

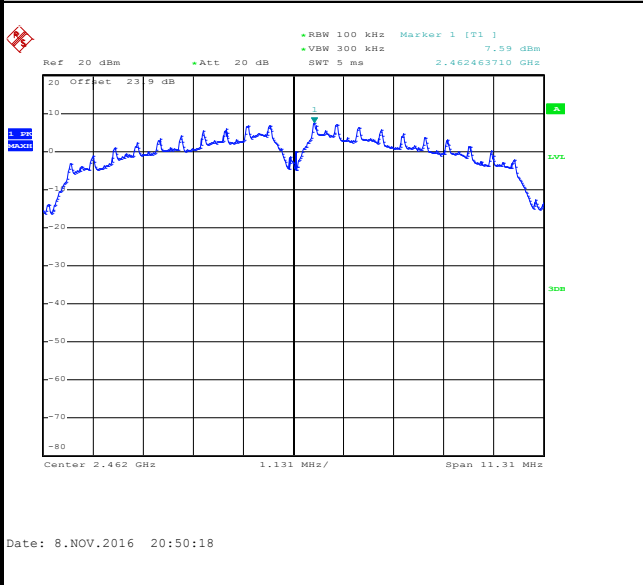

High Channel Plot

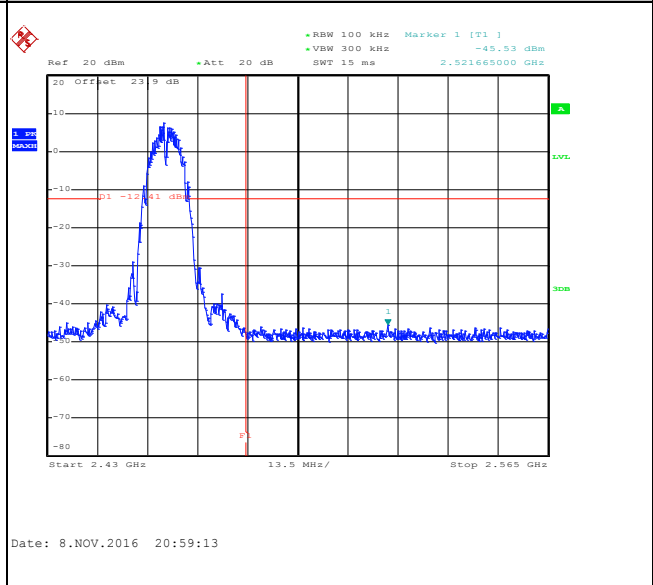

Spurious Emission 30MHz~3GHz

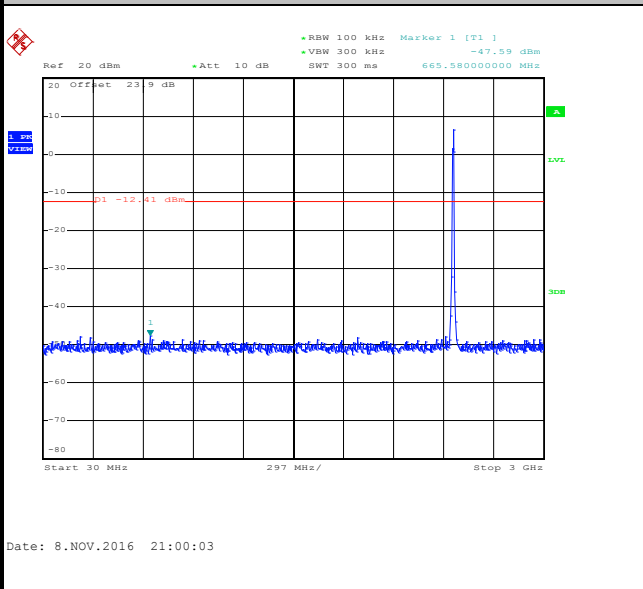

Spurious Emission 2GHz~25GHz

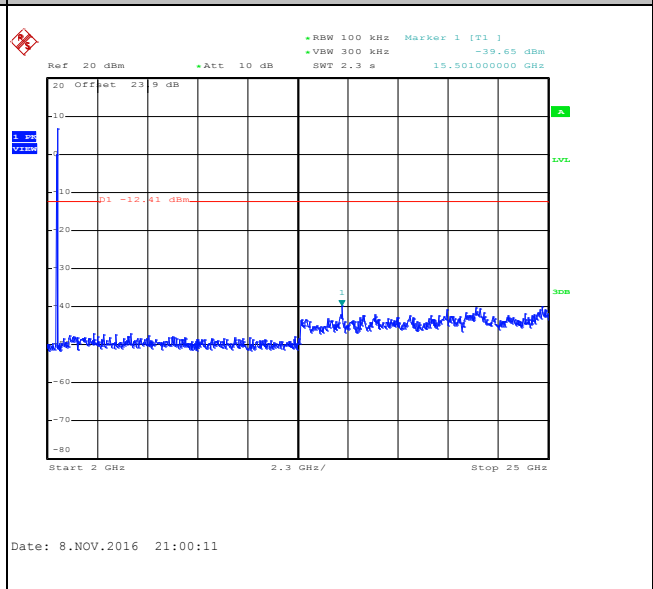



Test Mode :	802.11g	Temperature :	21~25°C
Test Band :	2.4GHz Low	Relative Humidity :	51~54%
Test Channel :	01	Test Engineer :	Tommy Lee

WLAN 802.11g Channel 01

100kHz PSD reference Level

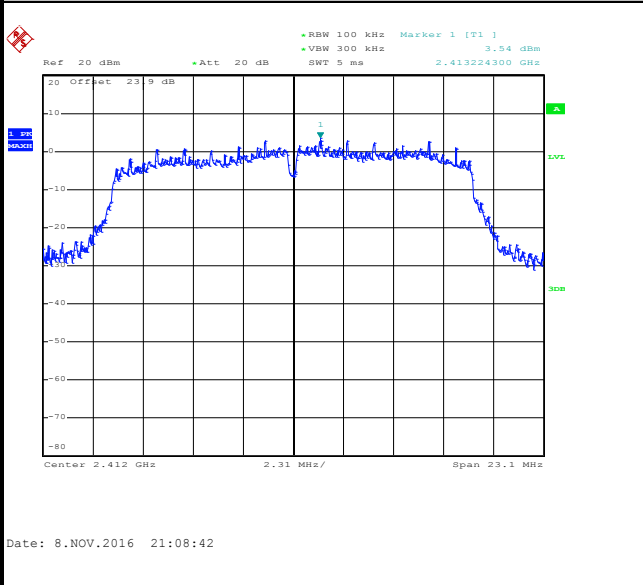

Low Channel Plot

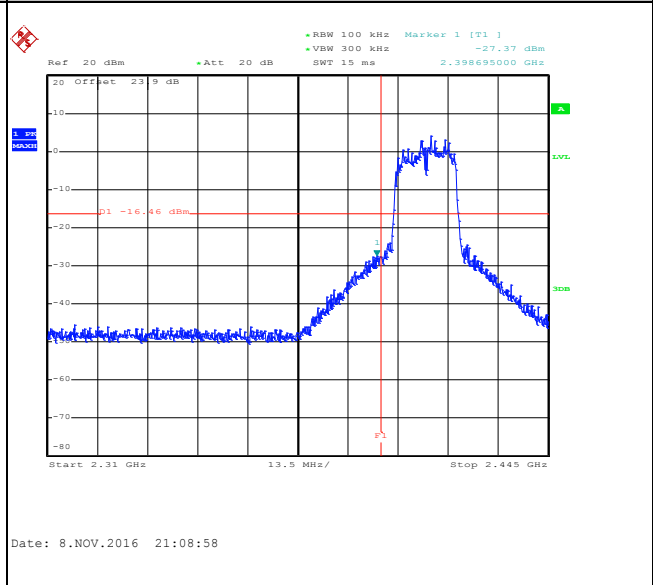

Spurious Emission 30MHz~3GHz

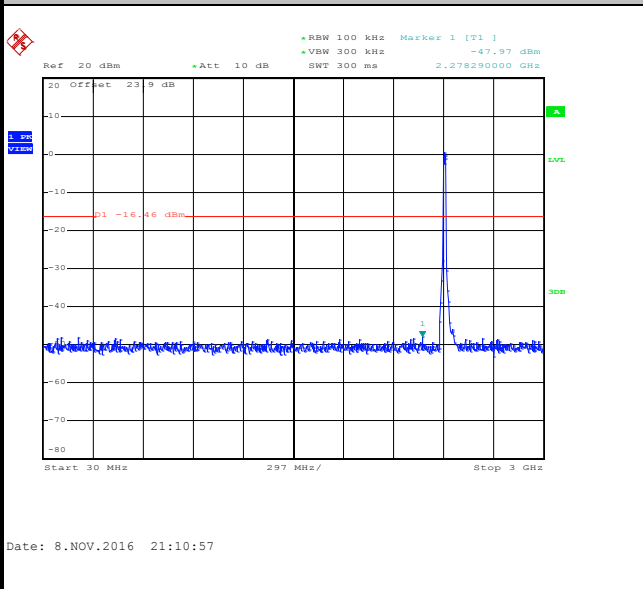

Spurious Emission 2GHz~25GHz

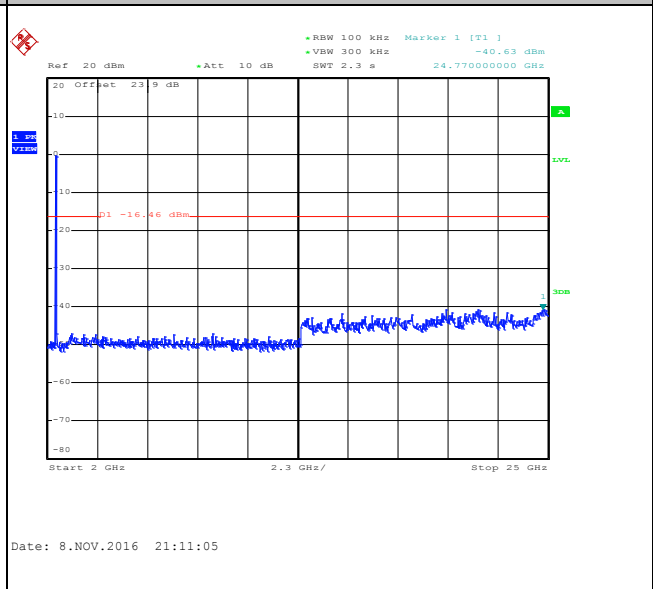



Test Mode :	802.11g	Temperature :	21~25°C
Test Band :	2.4GHz Mid	Relative Humidity :	51~54%
Test Channel :	06	Test Engineer :	Tommy Lee

WLAN 802.11g Channel 06

100kHz PSD reference Level

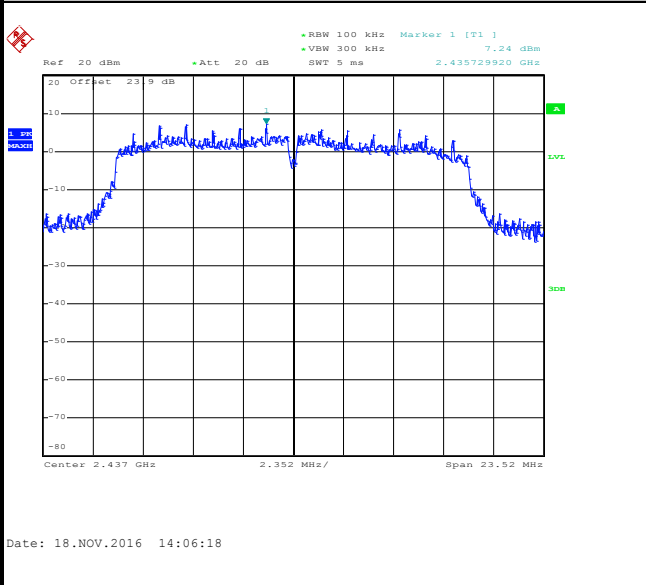

Spurious Emission 30MHz~3GHz

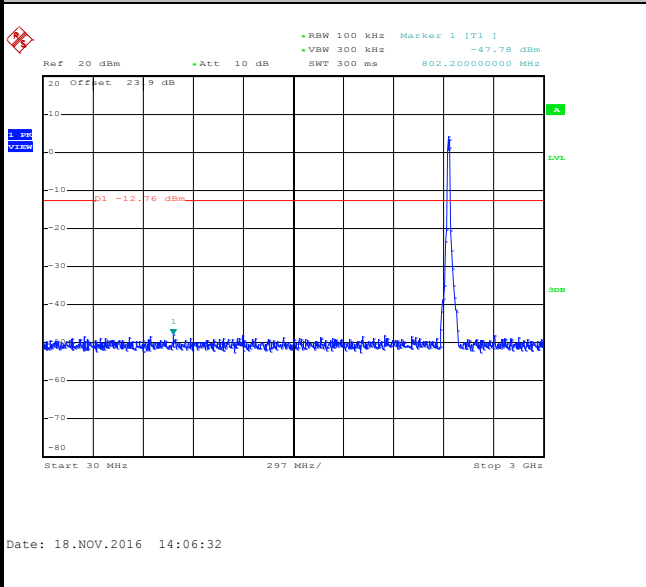

Spurious Emission 2GHz~25GHz

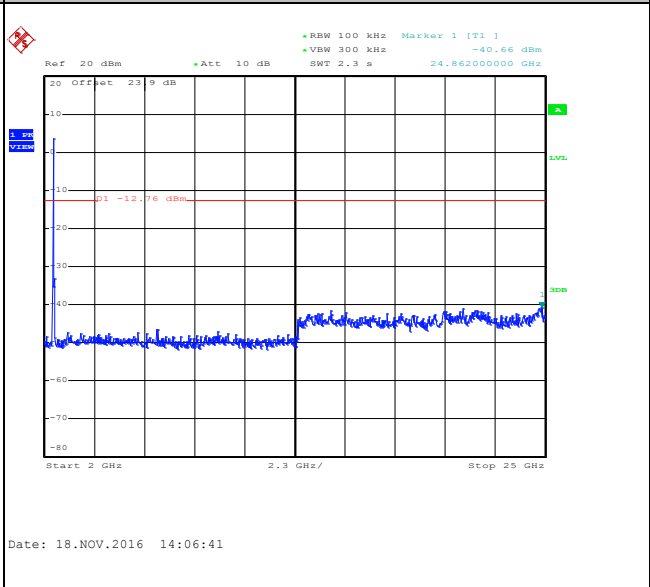



Test Mode :	802.11g	Temperature :	21~25°C
Test Band :	2.4GHz High	Relative Humidity :	51~54%
Test Channel :	11	Test Engineer :	Tommy Lee

WLAN 802.11g Channel 11

100kHz PSD reference Level

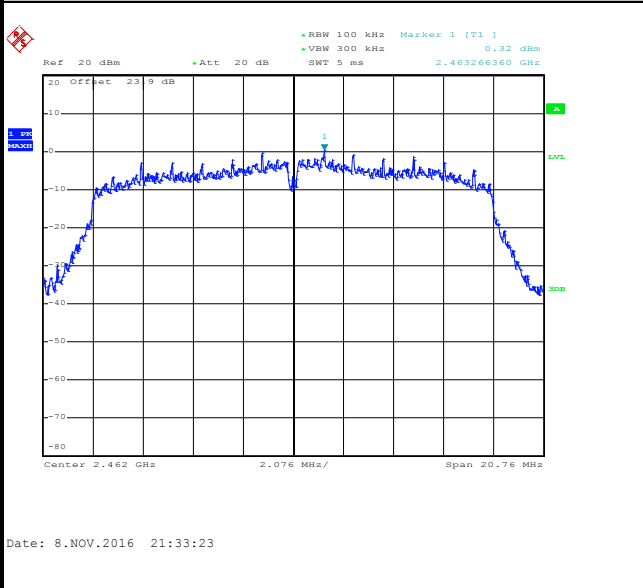

High Channel Plot

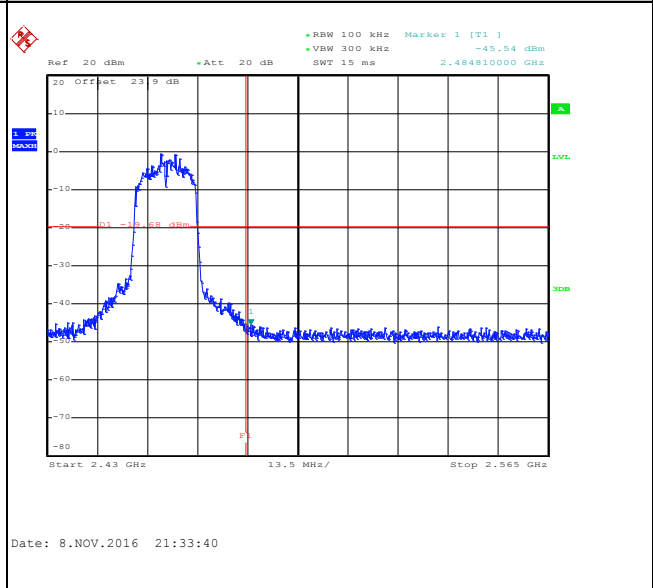

Spurious Emission 30MHz~3GHz

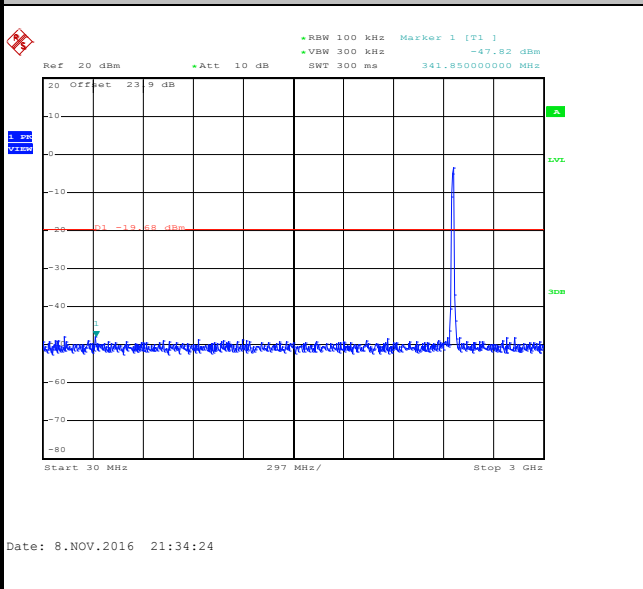

Spurious Emission 2GHz~25GHz

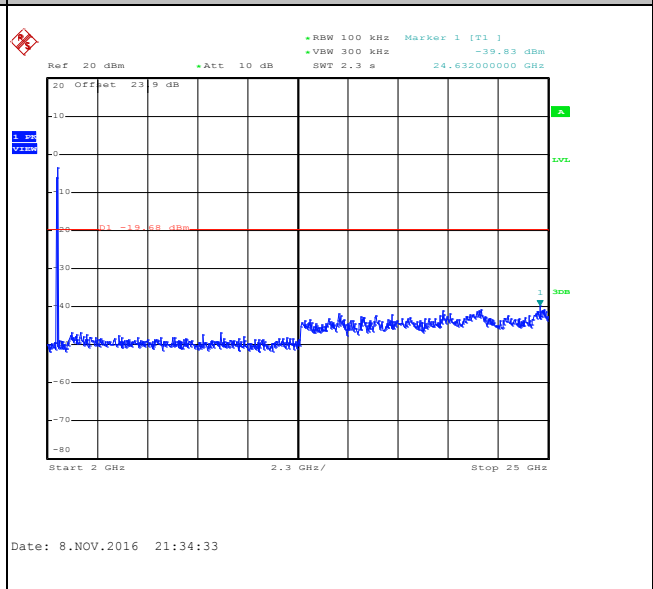



Test Mode :	802.11n HT20	Temperature :	21~25°C
Test Band :	2.4GHz Low	Relative Humidity :	51~54%
Test Channel :	01	Test Engineer :	Tommy Lee

WLAN 802.11n HT20 Channel 01

100kHz PSD reference Level

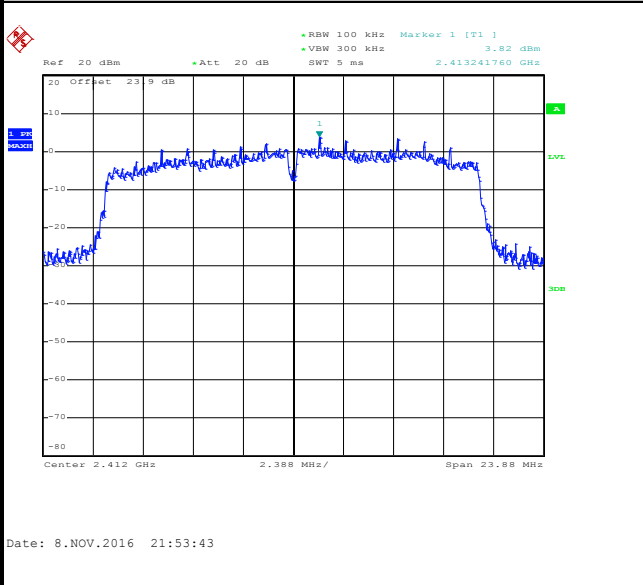

Low Channel Plot

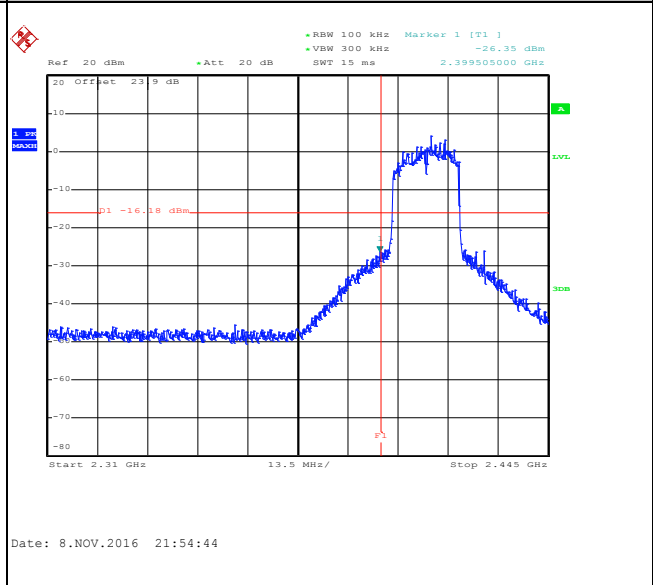

Spurious Emission 30MHz~3GHz

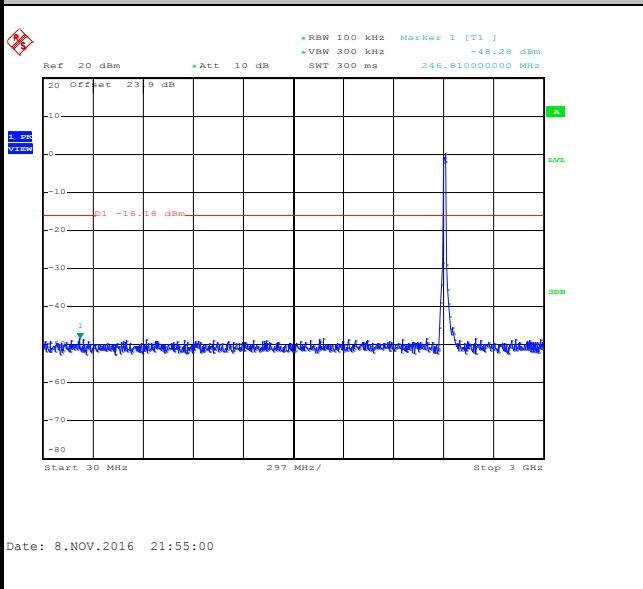

Spurious Emission 2GHz~25GHz

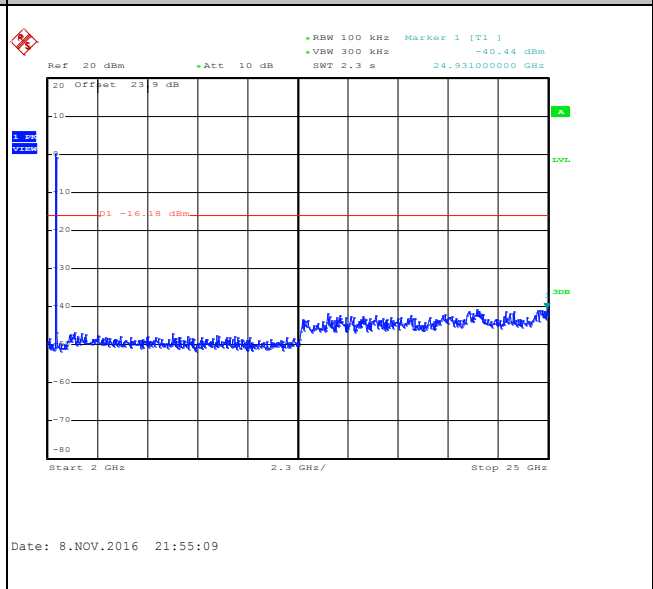



Test Mode :	802.11n HT20	Temperature :	21~25°C
Test Band :	2.4GHz Mid	Relative Humidity :	51~54%
Test Channel :	06	Test Engineer :	Tommy Lee

WLAN 802.11n HT20 Channel 06

100kHz PSD reference Level

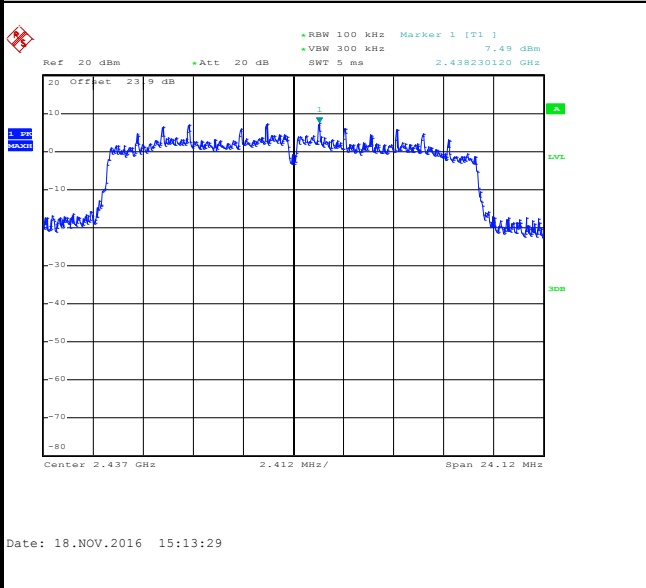

Spurious Emission 30MHz~3GHz

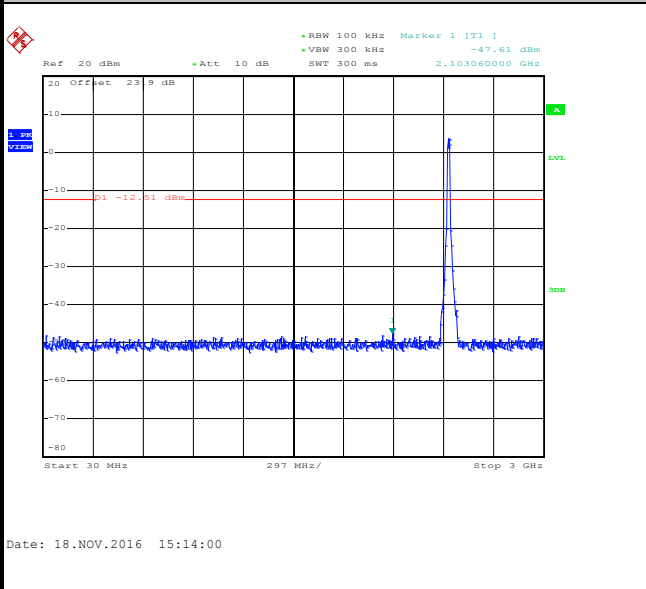

Spurious Emission 2GHz~25GHz

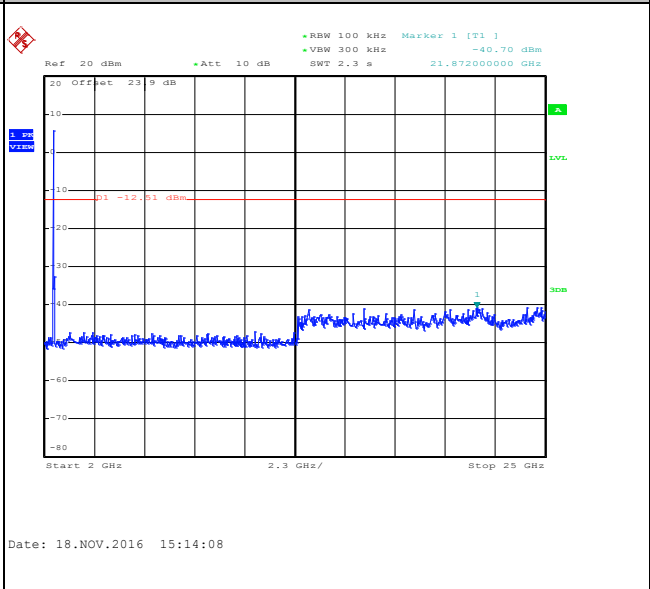



Test Mode :	802.11n HT20	Temperature :	21~25°C
Test Band :	2.4GHz High	Relative Humidity :	51~54%
Test Channel :	11	Test Engineer :	Tommy Lee

WLAN 802.11n HT20 Channel 11

100kHz PSD reference Level

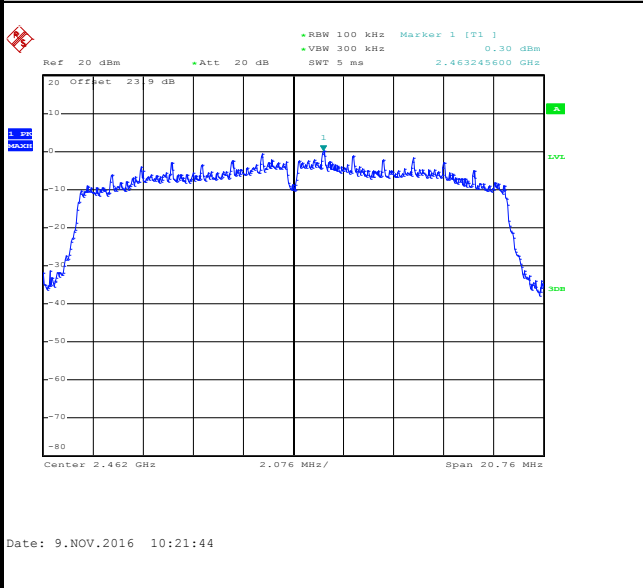

High Channel Plot

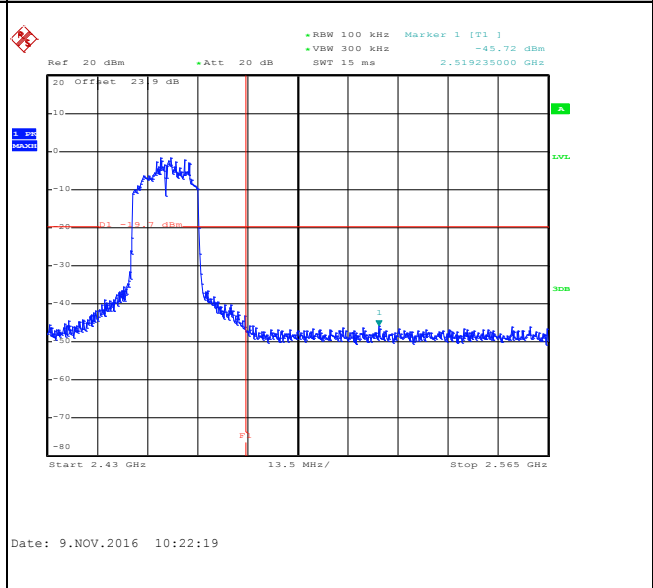

Spurious Emission 30MHz~3GHz

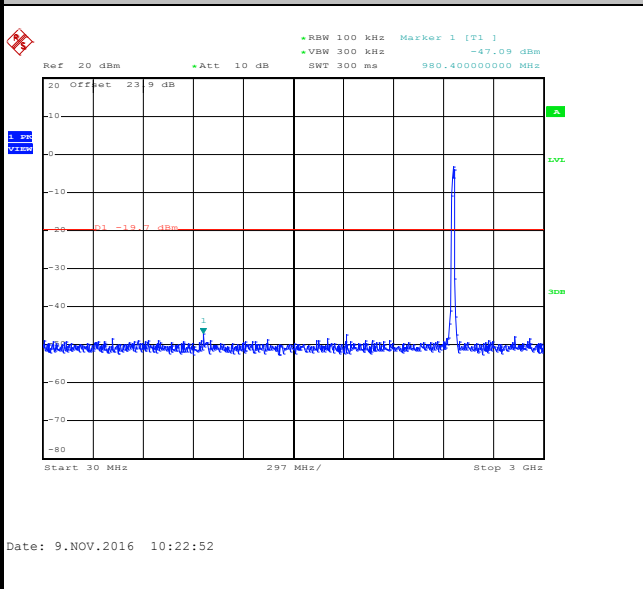

Spurious Emission 2GHz~25GHz

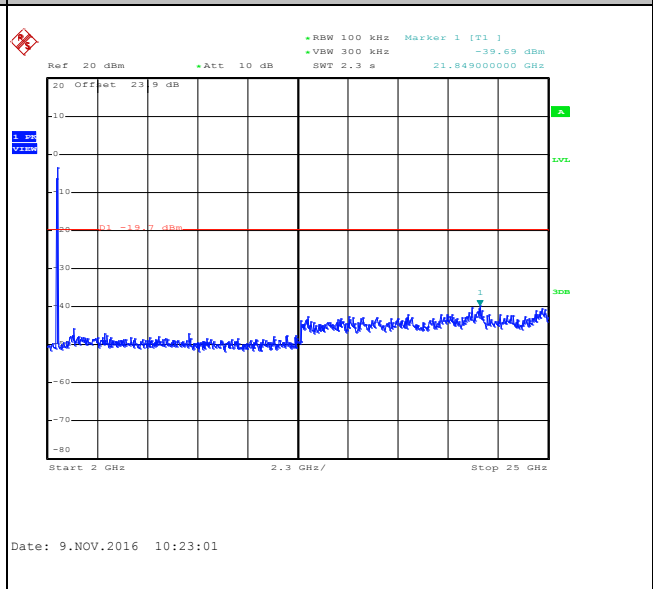



3.5 Radiated Band Edges and Spurious Emission Measurement

3.5.1 Limit of Radiated band edge and Spurious Emission Measurement

In any 100 kHz bandwidth outside the intentional radiator frequency band, all harmonics/spurious must be at least 20 dB below the highest emission level within the authorized band. If the output power of this device was measured by spectrum analyzer, the attenuation under this paragraph shall be 30 dB instead of 20 dB. In addition, radiated emissions which fall in the restricted bands must also comply with the FCC section 15.209 limits as below.

Frequency (MHz)	Field Strength (microvolts/meter)	Measurement Distance (meters)
0.009 – 0.490	2400/F(kHz)	300
0.490 – 1.705	24000/F(kHz)	30
1.705 – 30.0	30	30
30 – 88	100	3
88 – 216	150	3
216 - 960	200	3
Above 960	500	3

3.5.2 Measuring Instruments

The measuring equipment is listed in the section 4 of this test report.



3.5.3 Test Procedures

1. The testing follows FCC KDB Publication No. 558074 D01 DTS Meas. Guidance v03r05.
2. The EUT was arranged to its worst case and then tune the antenna tower (from 1 m to 4 m) and turntable (from 0 degree to 360 degrees) to find the maximum reading. A pre-amp and a high pass filter are used for the test in order to get better signal level.
3. The EUT was placed on a turntable with 0.8 meter for frequency below 1GHz and 1.5 meter for frequency above 1GHz respectively above ground.
4. The EUT was set 3 meters from the interference receiving antenna, which was mounted on the top of a variable height antenna tower.
5. Corrected Reading: Antenna Factor + Cable Loss + Read Level - Preamp Factor = Level
6. For measurement below 1GHz, If the emission level of the EUT measured by the peak detector is 3 dB lower than the applicable limit, the peak emission level will be reported. Otherwise, the emission measurement will be repeated using the quasi-peak detector and reported.
7. Use the following spectrum analyzer settings:
 - (1) Span shall wide enough to fully capture the emission being measured;
 - (2) Set RBW=100 kHz for $f < 1$ GHz; VBW \geq RBW; Sweep = auto; Detector function = peak; Trace = max hold;
 - (3) Set RBW = 1 MHz, VBW= 3MHz for $f \geq 1$ GHz for peak measurement.
For average measurement:
 - VBW = 10 Hz, when duty cycle is no less than 98 percent.
 - VBW $\geq 1/T$, when duty cycle is less than 98 percent where T is the minimum transmission duration over which the transmitter is on and is transmitting at its maximum power control level for the tested mode of operation.

3.5.4 Test Setup

For radiated emissions below 30MHz



For radiated emissions from 30MHz to 1GHz

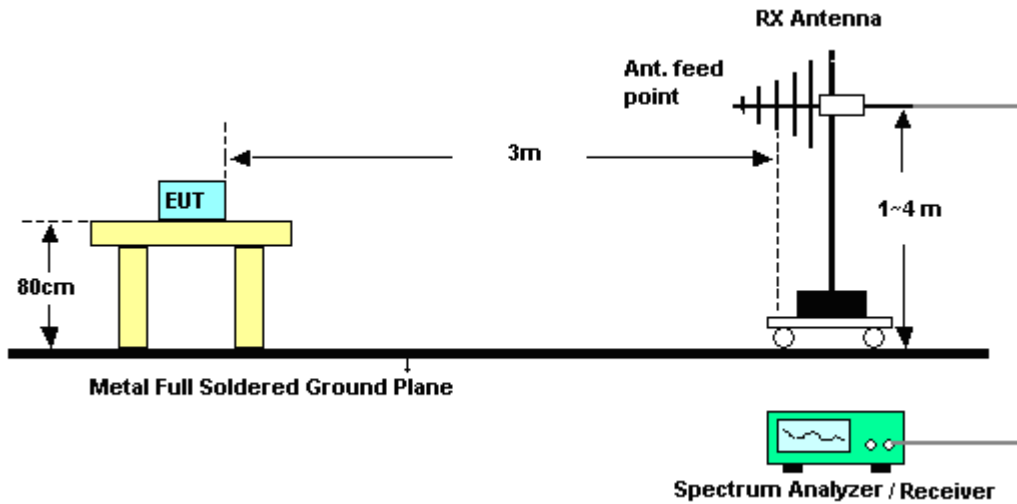

For radiated emissions above 1GHz

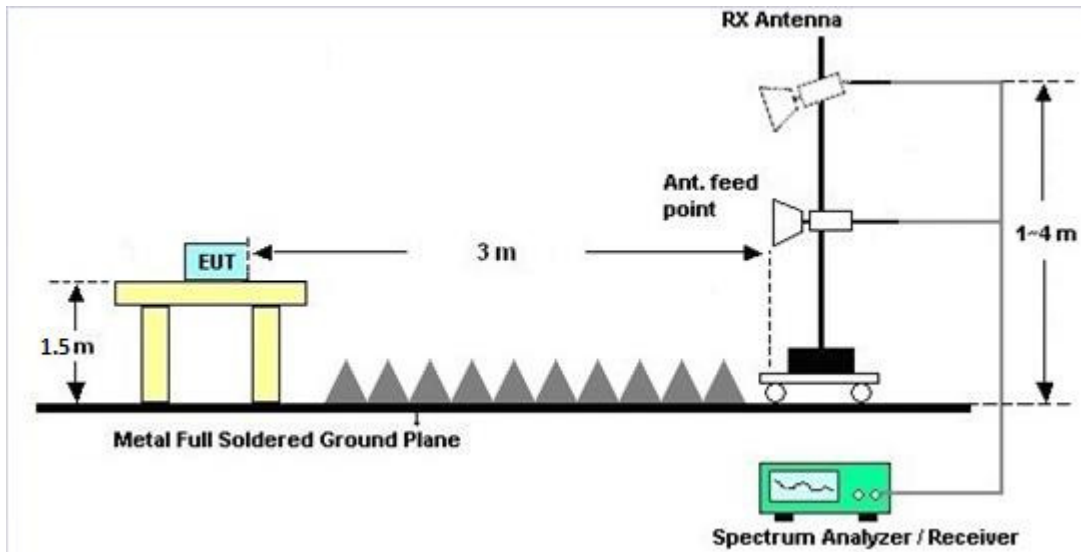

3.5.5 Test Results of Radiated Spurious Emissions (9kHz ~ 30MHz)

The low frequency, which started from 9 kHz to 30MHz, was pre-scanned and the result which was 20dB lower than the limit line per 15.31(o) was not reported.

3.5.6 Test Result of Radiated Spurious at Band Edges

Please refer to Appendix B and C.

3.5.7 Duty Cycle

Please refer to Appendix D.

3.5.8 Test Result of Radiated Spurious Emission (30MHz ~ 10th Harmonic)

Please refer to Appendix B and C.



3.6 AC Conducted Emission Measurement

3.6.1 Limit of AC Conducted Emission

For equipment that is designed to be connected to the public utility (AC) power line, the radio frequency voltage that is conducted back onto the AC power line on any frequency or frequencies within the band 150 kHz to 30 MHz shall not exceed the limits in the following table.

Frequency of Emission (MHz)	Conducted Limit (dB μ V)	
	Quasi-Peak	Average
0.15-0.5	66 to 56*	56 to 46*
0.5-5	56	46
5-30	60	50

*Decreases with the logarithm of the frequency.

3.6.2 Measuring Instruments

The measuring equipment is listed in the section 4 of this test report.

3.6.3 Test Procedures

1. The EUT was placed 0.4 meter from the conducting wall of the shielding room, and it was kept at least 80 centimeters from any other grounded conducting surface.
2. Connect EUT to the power mains through a line impedance stabilization network (LISN).
3. All the support units are connecting to the other LISN.
4. The LISN provides 50 ohm coupling impedance for the measuring instrument.
5. The FCC states that a 50 ohm, 50 microhenry LISN should be used.
6. Both sides of AC line were checked for maximum conducted interference.
7. The frequency range from 150 kHz to 30 MHz was searched.
8. Set the test-receiver system to Peak Detect Function and specified bandwidth (IF bandwidth = 9kHz) with Maximum Hold Mode.

3.6.4 Test Setup

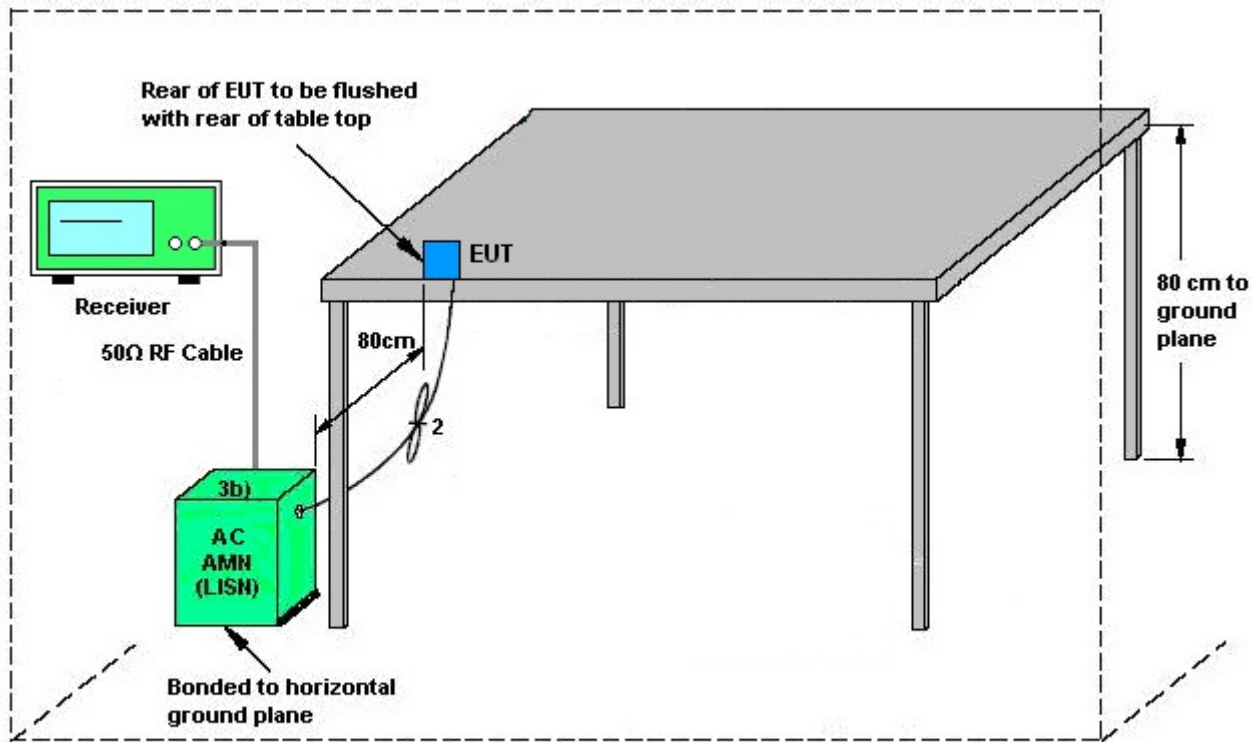

AMN = Artificial mains network (LISH)
 AE = Associated equipment
 EUT = Equipment under test
 ISN = Impedance stabilization network

3.6.5 Test Result of AC Conducted Emission

Test Mode :	Mode 1	Temperature :	24~25°C
Test Engineer :	Kai-Chun Chu	Relative Humidity :	49~50%
Test Voltage :	120Vac / 60Hz	Phase :	Line
Function Type :	Jamaica charging from Toaster + Bluetooth Idle + WLAN Idle + AC Adapter (PS000084A01)		

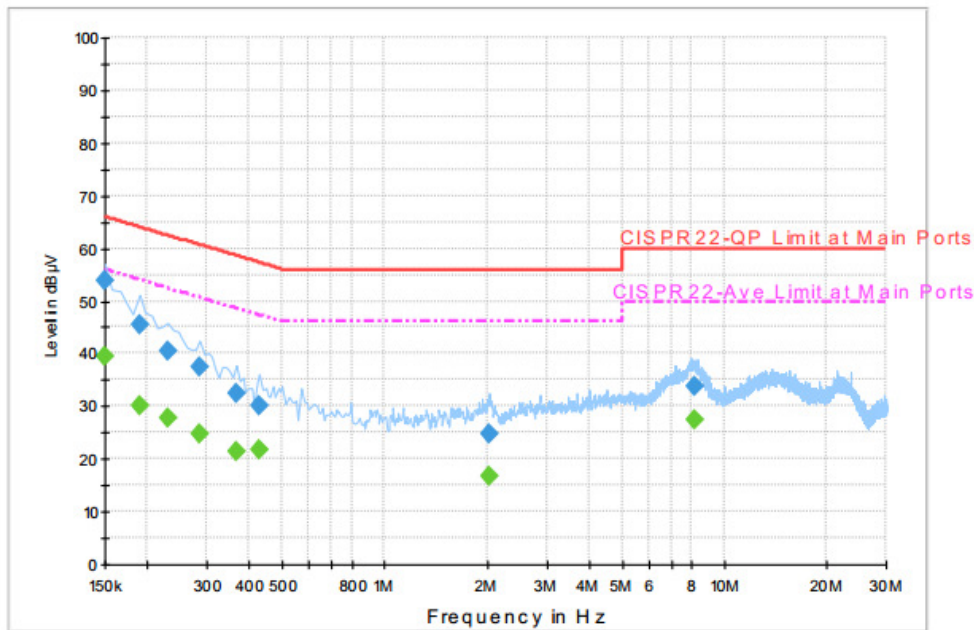

Final Result : Quasi-Peak

Frequency (MHz)	Quasi-Peak (dBµV)	Filter	Line	Corr. (dB)	Margin (dB)	Limit (dBµV)
0.150000	53.7	Off	L1	19.6	12.3	66.0
0.190000	45.5	Off	L1	19.6	18.5	64.0
0.230000	40.4	Off	L1	19.6	22.0	62.4
0.286000	37.5	Off	L1	19.6	23.1	60.6
0.366000	32.6	Off	L1	19.6	26.0	58.6
0.430000	30.1	Off	L1	19.6	27.2	57.3
2.038000	24.7	Off	L1	19.1	31.3	56.0
8.150000	33.7	Off	L1	20.0	26.3	60.0

Final Result : Average

Frequency (MHz)	Average (dBµV)	Filter	Line	Corr. (dB)	Margin (dB)	Limit (dBµV)
0.150000	39.6	Off	L1	19.6	16.4	56.0
0.190000	30.2	Off	L1	19.6	23.8	54.0
0.230000	27.8	Off	L1	19.6	24.6	52.4
0.286000	24.8	Off	L1	19.6	25.8	50.6
0.366000	21.3	Off	L1	19.6	27.3	48.6
0.430000	21.6	Off	L1	19.6	25.7	47.3
2.038000	16.6	Off	L1	19.1	29.4	46.0
8.150000	27.5	Off	L1	20.0	22.5	50.0



Test Mode :	Mode 1	Temperature :	24~25°C
Test Engineer :	Kai-Chun Chu	Relative Humidity :	49~50%
Test Voltage :	120Vac / 60Hz	Phase :	Neutral
Function Type :	Jamaica charging from Toaster + Bluetooth Idle + WLAN Idle + AC Adapter (PS000084A01)		

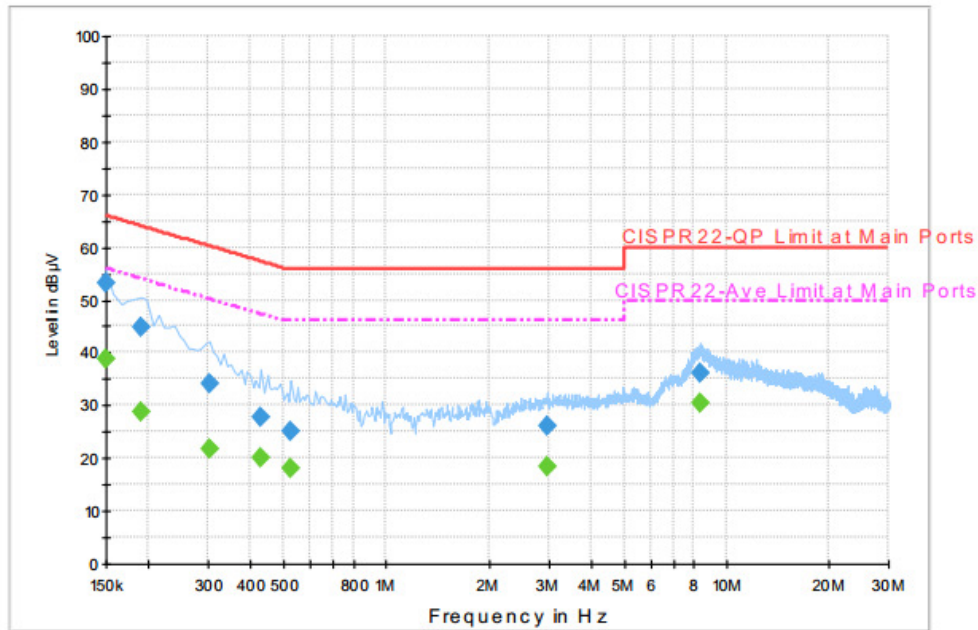

Final Result : Quasi-Peak

Frequency (MHz)	Quasi-Peak (dBµV)	Filter	Line	Corr. (dB)	Margin (dB)	Limit (dBµV)
0.150000	53.2	Off	N	19.6	12.8	66.0
0.190000	44.8	Off	N	19.6	19.2	64.0
0.302000	34.1	Off	N	19.6	26.1	60.2
0.430000	27.7	Off	N	19.6	29.6	57.3
0.526000	24.9	Off	N	19.6	31.1	56.0
2.974000	26.3	Off	N	19.6	29.7	56.0
8.374000	36.1	Off	N	20.0	23.9	60.0

Final Result : Average

Frequency (MHz)	Average (dBµV)	Filter	Line	Corr. (dB)	Margin (dB)	Limit (dBµV)
0.150000	38.7	Off	N	19.6	17.3	56.0
0.190000	28.9	Off	N	19.6	25.1	54.0
0.302000	21.8	Off	N	19.6	28.4	50.2
0.430000	20.1	Off	N	19.6	27.2	47.3
0.526000	18.0	Off	N	19.6	28.0	46.0
2.974000	18.4	Off	N	19.6	27.6	46.0
8.374000	30.5	Off	N	20.0	19.5	50.0



3.7 Antenna Requirements

3.7.1 Standard Applicable

If directional gain of transmitting antennas is greater than 6dBi, the power shall be reduced by the same level in dB comparing to gain minus 6dBi. For the fixed point-to-point operation, the power shall be reduced by one dB for every 3 dB that the directional gain of the antenna exceeds 6 dBi. The use of a permanently attached antenna or of an antenna that uses a unique coupling to the intentional radiator shall be considered sufficient to comply with the FCC rule.

3.7.2 Antenna Anti-Replacement Construction

An embedded-in antenna design is used.

3.7.3 Antenna Gain

The antenna peak gain of EUT is less than 6 dBi. Therefore, it is not necessary to reduce maximum peak output power limit.



4 List of Measuring Equipment

Instrument	Manufacturer	Model No.	Serial No.	Characteristics	Calibration Date	Test Date	Due Date	Remark
Power Meter	Anritsu	ML2495A	0932001	300MHz~40GHz	Sep. 29, 2016	Nov. 08, 2016 ~ Nov. 18, 2016	Sep. 28, 2017	Conducted (TH05-HY)
Power Sensor	Anritsu	MA2411B	0846202	300MHz~40GHz	Sep. 29, 2016	Nov. 08, 2016 ~ Nov. 18, 2016	Sep. 28, 2017	Conducted (TH05-HY)
Spectrum Analyzer	Rohde & Schwarz	FSP40	100057	9kHz-40GHz	Nov. 23, 2015	Nov. 08, 2016 ~ Nov. 18, 2016	Nov. 22, 2016	Conducted (TH05-HY)
Programmable Power Supply	GW Instek	PSS-2005	EL890094	1V~20V 0.5A~5A	Oct. 11, 2016	Nov. 08, 2016 ~ Nov. 18, 2016	Oct. 10, 2017	Conducted (TH05-HY)
AC Power Source	ChainTek	APC-1000W	N/A	N/A	N/A	Oct. 18, 2016	N/A	Conduction (CO05-HY)
EMI Test Receiver	Rohde & Schwarz	ESCI 7	100724	9kHz~7GHz	Aug. 30, 2016	Oct. 18, 2016	Aug. 29, 2017	Conduction (CO05-HY)
LISN	Rohde & Schwarz	ENV216	100080	9kHz~30MHz	Dec. 02, 2015	Oct. 18, 2016	Dec. 01, 2016	Conduction (CO05-HY)
Bilog Antenna	TESEQ	CBL 6111D&00800 N1D01N-06	35419&03	30MHz to 1GHz	Jan. 13, 2016	Oct. 30, 2016 ~ Nov. 05, 2016	Jan. 12, 2017	Radiation (03CH07-HY)
Double Ridge Horn Antenna	ESCO	3117	00075962	1GHz ~ 18GHz	Aug. 19, 2016	Oct. 30, 2016 ~ Nov. 05, 2016	Aug. 18, 2017	Radiation (03CH07-HY)
EMI Test Receiver	Keysight	N9038A (MXE)	MY541300 85	20Hz ~ 8.4GHz	Oct. 26, 2016	Oct. 30, 2016 ~ Nov. 05, 2016	Oct. 25, 2017	Radiation (03CH07-HY)
Loop Antenna	Rohde & Schwarz	HFH2-Z2	100315	9 kHz~30 MHz	Sep. 02, 2015	Oct. 30, 2016 ~ Nov. 05, 2016	Sep. 01, 2017	Radiation (03CH07-HY)
Preamplifier	MITEQ	AMF-7D-0010 1800-30-10P	1590075	1GHz ~ 18GHz	Apr. 15, 2016	Oct. 30, 2016 ~ Nov. 05, 2016	Apr. 14, 2017	Radiation (03CH07-HY)
Preamplifier	COM-POWER	PA-103A	161241	10MHz-1GHz	Mar. 18, 2016	Oct. 30, 2016 ~ Nov. 05, 2016	Mar. 17, 2017	Radiation (03CH07-HY)
Preamplifier	Agilent	8449B	3008A023 62	1GHz~ 26.5GHz	Oct. 12, 2016	Oct. 30, 2016 ~ Nov. 05, 2016	Oct. 11, 2017	Radiation (03CH07-HY)
Spectrum Analyzer	Agilent	N9010A	MY534701 18	10Hz~44GHz	Feb. 27, 2016	Oct. 30, 2016 ~ Nov. 05, 2016	Feb. 26, 2017	Radiation (03CH07-HY)
Antenna Mast	Max-Full	MFA520BS	N/A	1m~4m	N/A	Oct. 30, 2016 ~ Nov. 05, 2016	N/A	Radiation (03CH07-HY)
Turn Table	ChainTek	Chaintek 3000	N/A	0~360 Degree	N/A	Oct. 30, 2016 ~ Nov. 05, 2016	N/A	Radiation (03CH07-HY)
Preamplifier	MITEQ	JS44-180040 00-33-8P	1840917	18GHz ~ 40GHz	Jun. 14, 2016	Oct. 30, 2016 ~ Nov. 05, 2016	Jun. 13, 2017	Radiation (03CH07-HY)
SHF-EHF Horn Antenna	SCHWARZBECK	BBHA 9170	BBHA9170 251	18GHz- 40GHz	Oct. 07, 2016	Oct. 30, 2016 ~ Nov. 05, 2016	Oct. 06, 2017	Radiation (03CH07-HY)



5 Uncertainty of Evaluation

Uncertainty of Conducted Emission Measurement (150kHz ~ 30MHz)

Measuring Uncertainty for a Level of Confidence of 95% ($U = 2Uc(y)$)	2.7
---	-----

Uncertainty of Radiated Emission Measurement (30 MHz ~ 1000 MHz)

Measuring Uncertainty for a Level of Confidence of 95% ($U = 2Uc(y)$)	5.7
---	-----

Uncertainty of Radiated Emission Measurement (1000 MHz ~ 18000 MHz)

Measuring Uncertainty for a Level of Confidence of 95% ($U = 2Uc(y)$)	5.5
---	-----

Uncertainty of Radiated Emission Measurement (18000 MHz ~ 40000 MHz)

Measuring Uncertainty for a Level of Confidence of 95% ($U = 2Uc(y)$)	5.2
---	-----



Appendix A. Conducted Test Results

<EUT with J300 Antenna>

A1 - DTS Part

Test Engineer:	Tommy Lee	Temperature:	21~25	°C
Test Date:	2016/11/08~2016/11/18	Relative Humidity:	51~54	%

TEST RESULTS DATA
6dB and 99% Occupied Bandwidth

2.4GHz Band								
Mod.	Data Rate	N _{TX}	CH.	Freq. (MHz)	99% Occupied BW (MHz)	6dB BW (MHz)	6dB BW Limit (MHz)	Pass/Fail
11b	1Mbps	1	1	2412	11.90	7.52	0.50	Pass
11b	1Mbps	1	6	2437	12.70	8.48	0.50	Pass
11b	1Mbps	1	11	2462	11.60	7.54	0.50	Pass
11g	6Mbps	1	1	2412	17.25	15.40	0.50	Pass
11g	6Mbps	1	6	2437	18.10	15.68	0.50	Pass
11g	6Mbps	1	11	2462	16.75	13.84	0.50	Pass
HT20	MCS0	1	1	2412	18.05	15.92	0.50	Pass
HT20	MCS0	1	6	2437	19.00	16.08	0.50	Pass
HT20	MCS0	1	11	2462	17.75	13.84	0.50	Pass

TEST RESULTS DATA
Peak Power Table

2.4GHz Band										
Mod.	Data Rate	N _{TX}	CH.	Freq. (MHz)	Peak Conducted Power (dBm)	Conducted Power Limit (dBm)	DG (dBi)	EIRP Power (dBm)	EIRP Power Limit (dBm)	Pass /Fail
11b	1Mbps	1	1	2412	17.38	30.00	2.90	20.28	36.00	Pass
11b	1Mbps	1	6	2437	21.25	30.00	2.90	24.15	36.00	Pass
11b	1Mbps	1	11	2462	18.20	30.00	2.90	21.10	36.00	Pass
11g	6Mbps	1	1	2412	22.75	30.00	2.90	25.65	36.00	Pass
11g	6Mbps	1	6	2437	22.83	30.00	2.90	25.73	36.00	Pass
11g	6Mbps	1	11	2462	21.42	30.00	2.90	24.32	36.00	Pass
HT20	MCS0	1	1	2412	22.55	30.00	2.90	25.45	36.00	Pass
HT20	MCS0	1	6	2437	22.78	30.00	2.90	25.68	36.00	Pass
HT20	MCS0	1	11	2462	21.25	30.00	2.90	24.15	36.00	Pass

TEST RESULTS DATA
Average Power Table
(Reporting Only)

2.4GHz Band						
Mod.	Data Rate	N _{TX}	CH.	Freq. (MHz)	Duty Factor (dB)	Average Conducted Power (dBm)
11b	1Mbps	1	1	2412	0.00	14.00
11b	1Mbps	1	6	2437	0.00	18.78
11b	1Mbps	1	11	2462	0.00	14.97
11g	6Mbps	1	1	2412	0.15	14.29
11g	6Mbps	1	6	2437	0.15	17.95
11g	6Mbps	1	11	2462	0.15	10.42
HT20	MCS0	1	1	2412	0.16	14.16
HT20	MCS0	1	6	2437	0.16	17.67
HT20	MCS0	1	11	2462	0.16	10.23

TEST RESULTS DATA
Peak Power Density

2.4GHz Band								
Mod.	Data Rate	N _{TX}	CH.	Freq. (MHz)	Peak PSD (dBm /3kHz)	DG (dBi)	Peak PSD Limit (dBm /3kHz)	Pass/Fail
11b	1Mbps	1	1	2412	-7.77	2.90	8.00	Pass
11b	1Mbps	1	6	2437	-3.50	2.90	8.00	Pass
11b	1Mbps	1	11	2462	-7.59	2.90	8.00	Pass
11g	6Mbps	1	1	2412	-10.51	2.90	8.00	Pass
11g	6Mbps	1	6	2437	-7.81	2.90	8.00	Pass
11g	6Mbps	1	11	2462	-13.61	2.90	8.00	Pass
HT20	MCS0	1	1	2412	-10.54	2.90	8.00	Pass
HT20	MCS0	1	6	2437	-7.52	2.90	8.00	Pass
HT20	MCS0	1	11	2462	-15.13	2.90	8.00	Pass



<EUT with J301 Antenna>

A2 - DTS Part

Test Engineer:	Tommy Lee	Temperature:	21~25	°C
Test Date:	2016/11/08~2016/11/18	Relative Humidity:	51~54	%

TEST RESULTS DATA
Peak Power Table

2.4GHz Band										
Mod.	Data Rate	N _{TX}	CH.	Freq. (MHz)	Peak Conducted Power (dBm)	Conducted Power Limit (dBm)	DG (dBi)	EIRP Power (dBm)	EIRP Power Limit (dBm)	Pass /Fail
11b	1Mbps	1	1	2412	17.13	30.00	2.90	20.03	36.00	Pass
11b	1Mbps	1	6	2437	21.08	30.00	2.90	23.98	36.00	Pass
11b	1Mbps	1	11	2462	18.10	30.00	2.90	21.00	36.00	Pass
11g	6Mbps	1	1	2412	22.37	30.00	2.90	25.27	36.00	Pass
11g	6Mbps	1	6	2437	22.28	30.00	2.90	25.18	36.00	Pass
11g	6Mbps	1	11	2462	21.26	30.00	2.90	24.16	36.00	Pass
HT20	MCS0	1	1	2412	22.40	30.00	2.90	25.30	36.00	Pass
HT20	MCS0	1	6	2437	22.33	30.00	2.90	25.23	36.00	Pass
HT20	MCS0	1	11	2462	21.18	30.00	2.90	24.08	36.00	Pass

TEST RESULTS DATA
Average Power Table
(Reporting Only)

2.4GHz Band						
Mod.	Data Rate	N _{TX}	CH.	Freq. (MHz)	Duty Factor (dB)	Average Conducted Power (dBm)
11b	1Mbps	1	1	2412	0.00	13.85
11b	1Mbps	1	6	2437	0.00	18.70
11b	1Mbps	1	11	2462	0.00	14.85
11g	6Mbps	1	1	2412	0.12	14.07
11g	6Mbps	1	6	2437	0.12	17.50
11g	6Mbps	1	11	2462	0.12	10.29
HT20	MCS0	1	1	2412	0.13	14.00
HT20	MCS0	1	6	2437	0.13	17.55
HT20	MCS0	1	11	2462	0.13	10.13



Appendix B. Radiated Spurious Emission

Test Engineer :	Jesse Wang and Ken Wu	Temperature :	21~24°C
		Relative Humidity :	50~54%

2.4GHz 2400~2483.5MHz

WIFI 802.11b (Band Edge @ 3m)

WIFI Ant. 2	Note	Frequency (MHz)	Level (dBμV/m)	Over Limit (dB)	Limit Line (dBμV/m)	Read Level (dBμV)	Antenna Factor (dB/m)	Cable Loss (dB)	Preamp Factor (dB)	Ant Pos (cm)	Table Pos (deg)	Peak Avg. (P/A)	Pol. (H/V)	
802.11b CH 01 2412MHz		2370.69	56.05	-17.95	74	51.64	32.14	7.24	34.97	304	344	P	H	
		2389.905	44.36	-9.64	54	39.84	32.19	7.31	34.98	304	344	P	H	
	*	2412	102.82	-	-	98.25	32.24	7.31	34.98	304	344	P	H	
	*	2412	99.47	-	-	94.9	32.24	7.31	34.98	304	344	P	H	
													H	
														H
			2387.595	54.66	-19.34	74	50.13	32.19	7.31	34.97	350	129	P	V
			2390	44.73	-9.27	54	40.21	32.19	7.31	34.98	350	129	A	V
	*		2412	105	-	-	100.43	32.24	7.31	34.98	350	129	P	V
	*		2412	101.6	-	-	97.03	32.24	7.31	34.98	350	129	A	V
														V
														V
802.11b CH 06 2437MHz		2382.94	54.79	-19.21	74	50.31	32.14	7.31	34.97	150	208	P	H	
		2389.38	45.46	-8.54	54	40.93	32.19	7.31	34.97	150	208	A	H	
	*	2437	109.62	-	-	104.91	32.34	7.36	34.99	150	208	P	H	
	*	2437	105.03	-	-	100.32	32.34	7.36	34.99	150	208	A	H	
			2484.25	56.74	-17.26	74	51.89	32.45	7.4	35	150	208	P	H
			2484.74	46.44	-7.56	54	41.59	32.45	7.4	35	150	208	A	H
			2335.48	54.6	-19.4	74	50.35	32.03	7.18	34.96	304	118	P	V
			2389.24	44.51	-9.49	54	39.98	32.19	7.31	34.97	304	118	A	V
	*		2437	109.42	-	-	104.71	32.34	7.36	34.99	304	118	P	V
	*		2437	104.91	-	-	100.2	32.34	7.36	34.99	304	118	A	V
			2485.3	55.87	-18.13	74	51.02	32.45	7.4	35	304	118	P	V
			2484.67	46.05	-7.95	54	41.2	32.45	7.4	35	304	118	A	V



802.11b CH 11 2462MHz	*	2462	103.66	-	-	98.85	32.4	7.4	34.99	376	178	P	H
	*	2462	99.75	-	-	94.94	32.4	7.4	34.99	376	178	A	H
		2489.16	55.41	-18.59	74	50.51	32.5	7.4	35	376	178	P	H
		2483.52	45	-9	54	40.15	32.45	7.4	35	376	178	A	H
													H
													H
	*	2462	104.19	-	-	99.38	32.4	7.4	34.99	380	129	P	V
	*	2462	101.21	-	-	96.4	32.4	7.4	34.99	380	129	A	V
		2487.52	56.48	-17.52	74	51.58	32.5	7.4	35	380	129	P	V
		2483.52	44.97	-9.03	54	40.12	32.45	7.4	35	380	129	A	V
													V
													V
802.11b CH 12 2467MHz	*	2467	107.53	-	-	102.73	32.4	7.4	35	150	208	P	H
	*	2467	104.5	-	-	99.7	32.4	7.4	35	150	208	A	H
		2484.44	58.72	-15.28	74	53.87	32.45	7.4	35	150	208	P	H
		2483.52	52.28	-1.72	54	47.43	32.45	7.4	35	150	208	A	H
													H
													H
	*	2467	108.01	-	-	103.21	32.4	7.4	35	302	117	P	V
	*	2467	104.99	-	-	100.19	32.4	7.4	35	302	117	A	V
		2484.52	59.05	-14.95	74	54.2	32.45	7.4	35	302	117	P	V
		2483.52	52.09	-1.91	54	47.24	32.45	7.4	35	302	117	A	V
													V
													V
Remark	1. No other spurious found. 2. All results are PASS against Peak and Average limit line.												



802.11b CH 13 2472MHz	*	2472	100.77	-	-	95.92	32.45	7.4	35	150	208	P	H
	*	2472	97.67	-	-	92.82	32.45	7.4	35	150	208	A	H
		2486.52	59.91	-14.09	74	55.06	32.45	7.4	35	150	208	P	H
		2486.56	52.25	-1.75	54	47.4	32.45	7.4	35	150	208	A	H
													H
													H
	*	2472	100.85	-	-	96	32.45	7.4	35	302	117	P	V
	*	2472	97.72	-	-	92.87	32.45	7.4	35	302	117	A	V
		2484.76	59.64	-14.36	74	54.79	32.45	7.4	35	302	117	P	V
		2486.12	52.05	-1.95	54	47.2	32.45	7.4	35	302	117	A	V
													V
													V
Remark	3. No other spurious found. 4. All results are PASS against Peak and Average limit line.												



2.4GHz 2400~2483.5MHz

WIFI 802.11b (Harmonic @ 3m)

WIFI Ant. 2	Note	Frequency (MHz)	Level (dBμV/m)	Over Limit (dB)	Limit Line (dBμV/m)	Read Level (dBμV)	Antenna Factor (dB/m)	Cable Loss (dB)	Preamp Factor (dB)	Ant Pos (cm)	Table Pos (deg)	Peak Avg. (P/A)	Pol. (H/V)
802.11b CH 01 2412MHz		4824	52.77	-21.23	74	66.49	33.64	11.68	59.04	236	269	P	H
		4824	50.88	-3.12	54	64.6	33.64	11.68	59.04	236	269	A	H
													H
													H
		4824	51.89	-22.11	74	65.61	33.64	11.68	59.04	327	256	P	V
		4824	49.94	-4.06	54	63.66	33.64	11.68	59.04	327	256	A	V
													V
													V
802.11b CH 06 2437MHz		4874	49.57	-24.43	74	63.44	33.54	11.53	58.94	100	0	P	H
		7311	45.74	-28.26	74	55.17	34.69	13.81	57.93	100	0	P	H
													H
													H
		4874	47.06	-26.94	74	60.93	33.54	11.53	58.94	100	0	P	V
		7311	45.43	-28.57	74	54.86	34.69	13.81	57.93	100	0	P	V
													V
													V
802.11b CH 11 2462MHz		4924	52.02	-21.98	74	66.05	33.44	11.37	58.84	340	275	P	H
		4924	50.73	-3.27	54	64.76	33.44	11.37	58.84	340	275	A	H
		7386	42.93	-31.07	74	52.57	34.47	13.95	58.06	100	0	P	H
													H
		4924	52.73	-21.27	74	66.76	33.44	11.37	58.84	351	277	P	V
		4924	49.87	-4.13	54	63.9	33.44	11.37	58.84	351	277	A	V
		7386	43.27	-30.73	74	52.91	34.47	13.95	58.06	100	0	P	V
													V
Remark	1. No other spurious found. 2. All results are PASS against Peak and Average limit line.												



802.11b CH 12 2467MHz		4934	49.31	-24.69	74	63.34	33.44	11.37	58.84	100	0	P	H
		7401	40.72	-33.28	74	50.43	34.42	13.95	58.08	100	0	P	H
													H
													H
		4934	48.18	-25.82	74	62.21	33.44	11.37	58.84	100	0	P	V
		7401	41.8	-32.2	74	51.51	34.42	13.95	58.08	100	0	P	V
													V
													V
802.11b CH 13 2472MHz		4944	43.59	-30.41	74	57.77	33.4	11.22	58.8	100	0	P	H
		7416	39.53	-34.47	74	49.24	34.42	13.95	58.08	100	0	P	H
													H
													H
		4944	45.94	-28.06	74	60.12	33.4	11.22	58.8	100	0	P	V
		7416	38.83	-35.17	74	48.54	34.42	13.95	58.08	100	0	P	V
													V
													V
Remark	3. No other spurious found. 4. All results are PASS against Peak and Average limit line.												



2.4GHz 2400~2483.5MHz

WIFI 802.11g (Band Edge @ 3m)

WIFI Ant. 2	Note	Frequency (MHz)	Level (dBμV/m)	Over Limit (dB)	Limit Line (dBμV/m)	Read Level (dBμV)	Antenna Factor (dB/m)	Cable Loss (dB)	Preamp Factor (dB)	Ant Pos (cm)	Table Pos (deg)	Peak Avg. (P/A)	Pol. (H/V)	
802.11g CH 01 2412MHz		2389.275	64.26	-9.74	74	59.73	32.19	7.31	34.97	300	304	P	H	
		2389.8	51.64	-2.36	54	47.12	32.19	7.31	34.98	300	304	A	H	
	*	2412	105.65	-	-	101.08	32.24	7.31	34.98	300	304	P	H	
	*	2412	98.45	-	-	93.88	32.24	7.31	34.98	300	304	A	H	
													H	
														H
			2390	65.74	-8.26	74	61.22	32.19	7.31	34.98	345	102	P	V
			2390	51.76	-2.24	54	47.24	32.19	7.31	34.98	345	102	A	V
	*		2412	106.26	-	-	101.69	32.24	7.31	34.98	345	102	P	V
	*		2412	98.64	-	-	94.07	32.24	7.31	34.98	345	102	A	V
														V
														V
802.11g CH 06 2437MHz		2389.94	57.21	-16.79	74	52.69	32.19	7.31	34.98	333	304	P	H	
		2389.94	47.52	-6.48	54	43	32.19	7.31	34.98	333	304	A	H	
	*	2437	109.78	-	-	105.07	32.34	7.36	34.99	333	304	P	H	
	*	2437	102.28	-	-	97.57	32.34	7.36	34.99	333	304	A	H	
			2485.09	60.4	-13.6	74	55.55	32.45	7.4	35	333	304	P	H
			2484.53	49.02	-4.98	54	44.17	32.45	7.4	35	333	304	A	H
			2387.84	57.82	-16.18	74	53.29	32.19	7.31	34.97	380	198	P	V
			2389.8	47.24	-6.76	54	42.72	32.19	7.31	34.98	380	198	A	V
	*		2437	109.08	-	-	104.37	32.34	7.36	34.99	380	198	P	V
	*		2437	101.76	-	-	97.05	32.34	7.36	34.99	380	198	A	V
			2484.04	60.99	-13.01	74	56.14	32.45	7.4	35	380	198	P	V
			2484.25	49.93	-4.07	54	45.08	32.45	7.4	35	380	198	A	V



802.11g CH 11 2462MHz	*	2462	102.67	-	-	97.86	32.4	7.4	34.99	336	180	P	H
	*	2462	95.24	-	-	90.43	32.4	7.4	34.99	336	180	A	H
		2483.96	66.94	-7.06	74	62.09	32.45	7.4	35	336	180	P	H
		2483.84	51.64	-2.36	54	46.79	32.45	7.4	35	336	180	A	H
													H
													H
	*	2462	103.07	-	-	98.26	32.4	7.4	34.99	337	119	P	V
	*	2462	95.03	-	-	90.22	32.4	7.4	34.99	337	119	A	V
		2483.76	68.17	-5.83	74	63.32	32.45	7.4	35	337	119	P	V
		2483.6	51.79	-2.21	54	46.94	32.45	7.4	35	337	119	A	V
													V
													V
802.11g CH 12 2467MHz	*	2467	101.89	-	-	97.09	32.4	7.4	35	360	298	P	H
	*	2467	94.79	-	-	89.99	32.4	7.4	35	360	298	A	H
		2484.8	65.11	-8.89	74	60.26	32.45	7.4	35	360	298	P	H
		2483.76	51.35	-2.65	54	46.5	32.45	7.4	35	360	298	A	H
													H
													H
	*	2467	103.45	-	-	98.65	32.4	7.4	35	374	120	P	V
	*	2467	96	-	-	91.2	32.4	7.4	35	374	120	A	V
		2485.6	66.26	-7.74	74	61.41	32.45	7.4	35	374	120	P	V
		2483.88	52.45	-1.55	54	47.6	32.45	7.4	35	374	120	A	V
													V
													V
Remark	1. No other spurious found. 2. All results are PASS against Peak and Average limit line.												



802.11g CH 13 2472MHz	*	2472	103.43	-	-	98.58	32.45	7.4	35	336	179	P	H
	*	2472	95.38	-	-	90.53	32.45	7.4	35	336	179	A	H
		2487.32	64.99	-9.01	74	60.14	32.45	7.4	35	336	179	P	H
		2483.56	51.31	-2.69	54	46.46	32.45	7.4	35	336	179	A	H
													H
													H
	*	2472	103.3	-	-	98.45	32.45	7.4	35	333	120	P	V
	*	2472	95.81	-	-	90.96	32.45	7.4	35	333	120	A	V
		2484	68.17	-5.83	74	63.32	32.45	7.4	35	333	120	P	V
		2483.8	52.7	-1.3	54	47.85	32.45	7.4	35	333	120	A	V
													V
													V
Remark	3. No other spurious found. 4. All results are PASS against Peak and Average limit line.												



2.4GHz 2400~2483.5MHz

WIFI 802.11g (Harmonic @ 3m)

WIFI Ant. 2	Note	Frequency (MHz)	Level (dBμV/m)	Over Limit (dB)	Limit Line (dBμV/m)	Read Level (dBμV)	Antenna Factor (dB/m)	Cable Loss (dB)	Preamp Factor (dB)	Ant Pos (cm)	Table Pos (deg)	Peak Avg. (P/A)	Pol. (H/V)	
802.11g CH 01 2412MHz		4824	45.92	-28.08	74	59.64	33.64	11.68	59.04	100	0	P	H	
													H	
													H	
													H	
			4824	46.05	-27.95	74	59.77	33.64	11.68	59.04	100	0	P	V
														V
														V
802.11g CH 06 2437MHz		4874	46.74	-27.26	74	60.61	33.54	11.53	58.94	100	0	P	H	
		7311	43.18	-30.82	74	52.61	34.69	13.81	57.93	100	0	P	H	
													H	
													H	
			4874	48.56	-25.44	74	62.43	33.54	11.53	58.94	100	0	P	V
			7311	45.55	-28.45	74	54.98	34.69	13.81	57.93	100	0	P	V
														V
802.11g CH 11 2462MHz		4924	43.69	-30.31	74	57.72	33.44	11.37	58.84	100	0	P	H	
		7386	38.76	-35.24	74	48.4	34.47	13.95	58.06	100	0	P	H	
													H	
													H	
			4924	43.47	-30.53	74	57.5	33.44	11.37	58.84	100	0	P	V
			7386	39.31	-34.69	74	48.95	34.47	13.95	58.06	100	0	P	V
														V
Remark	1. No other spurious found.													
	2. All results are PASS against Peak and Average limit line.													



802.11g CH 12 2467MHz		4934	40.9	-33.1	74	54.93	33.44	11.37	58.84	100	0	P	H
		7401	39.43	-34.57	74	49.14	34.42	13.95	58.08	100	0	P	H
													H
													H
		4934	41.35	-32.65	74	55.38	33.44	11.37	58.84	100	0	P	V
		7401	40.51	-33.49	74	50.22	34.42	13.95	58.08	100	0	P	V
													V
													V
802.11g CH 13 2472MHz		4944	40.56	-33.44	74	54.74	33.4	11.22	58.8	100	0	P	H
		7416	38.24	-35.76	74	47.95	34.42	13.95	58.08	100	0	P	H
													H
													H
		4944	42.66	-31.34	74	56.84	33.4	11.22	58.8	100	0	P	V
		7416	38.9	-35.1	74	48.61	34.42	13.95	58.08	100	0	P	V
													V
													V
Remark	3. No other spurious found. 4. All results are PASS against Peak and Average limit line.												



2.4GHz 2400~2483.5MHz

WIFI 802.11n HT20 (Band Edge @ 3m)

WIFI Ant. 2	Note	Frequency (MHz)	Level (dBμV/m)	Over Limit (dB)	Limit Line (dBμV/m)	Read Level (dBμV)	Antenna Factor (dB/m)	Cable Loss (dB)	Preamp Factor (dB)	Ant Pos (cm)	Table Pos (deg)	Peak Avg. (P/A)	Pol. (H/V)	
802.11n HT20 CH 01 2412MHz		2389.695	65.58	-8.42	74	61.05	32.19	7.31	34.97	300	304	P	H	
		2390	53	-1	54	48.48	32.19	7.31	34.98	300	304	A	H	
	*	2412	105.34	-	-	100.77	32.24	7.31	34.98	300	304	P	H	
	*	2412	98	-	-	93.43	32.24	7.31	34.98	300	304	A	H	
													H	
														H
			2389.905	62.85	-11.15	74	58.33	32.19	7.31	34.98	345	102	P	V
			2390	51.45	-2.55	54	46.93	32.19	7.31	34.98	345	102	A	V
		*	2412	105.62	-	-	101.05	32.24	7.31	34.98	345	102	P	V
		*	2412	98.13	-	-	93.56	32.24	7.31	34.98	345	102	A	V
													V	
													V	
802.11n HT20 CH 06 2437MHz		2389.94	55.74	-18.26	74	51.22	32.19	7.31	34.98	333	304	P	H	
		2389.94	47.08	-6.92	54	42.56	32.19	7.31	34.98	333	304	A	H	
	*	2437	109.23	-	-	104.52	32.34	7.36	34.99	333	304	P	H	
	*	2437	101.8	-	-	97.09	32.34	7.36	34.99	333	304	A	H	
			2483.62	60.51	-13.49	74	55.66	32.45	7.4	35	333	304	P	H
			2484.46	48.27	-5.73	54	43.42	32.45	7.4	35	333	304	A	H
			2389.8	55.96	-18.04	74	51.44	32.19	7.31	34.98	380	198	P	V
			2389.94	46.64	-7.36	54	42.12	32.19	7.31	34.98	380	198	A	V
		*	2437	109.03	-	-	104.32	32.34	7.36	34.99	380	198	P	V
		*	2437	101.34	-	-	96.63	32.34	7.36	34.99	380	198	A	V
		2483.62	59.24	-14.76	74	54.39	32.45	7.4	35	380	198	P	V	
		2483.69	48.98	-5.02	54	44.13	32.45	7.4	35	380	198	A	V	



802.11n HT20 CH 11 2462MHz	*	2462	102.7	-	-	97.89	32.4	7.4	34.99	336	180	P	H
	*	2462	94.71	-	-	89.9	32.4	7.4	34.99	336	180	A	H
		2484.44	66.14	-7.86	74	61.29	32.45	7.4	35	336	180	P	H
		2483.52	51.68	-2.32	54	46.83	32.45	7.4	35	336	180	A	H
													H
													H
	*	2462	102.04	-	-	97.23	32.4	7.4	34.99	337	119	P	V
	*	2462	94.7	-	-	89.89	32.4	7.4	34.99	337	119	A	V
		2484.32	66.55	-7.45	74	61.7	32.45	7.4	35	337	119	P	V
		2483.6	52.3	-1.7	54	47.45	32.45	7.4	35	337	119	A	V
												V	
												V	
802.11n HT20 CH 12 2467MHz	*	2467	103.41	-	-	98.61	32.4	7.4	35	334	180	P	H
	*	2467	95.93	-	-	91.13	32.4	7.4	35	334	180	A	H
		2486.08	66.23	-7.77	74	61.38	32.45	7.4	35	334	180	P	H
		2484.2	52.54	-1.46	54	47.69	32.45	7.4	35	334	180	A	H
													H
													H
	*	2467	103.15	-	-	98.35	32.4	7.4	35	374	120	P	V
	*	2467	95.71	-	-	90.91	32.4	7.4	35	374	120	A	V
		2484.96	67.91	-6.09	74	63.06	32.45	7.4	35	374	120	P	V
		2483.52	52.67	-1.33	54	47.82	32.45	7.4	35	374	120	A	V
												V	
												V	
Remark	1. No other spurious found. 2. All results are PASS against Peak and Average limit line.												



802.11n HT20 CH 13 2472MHz	*	2472	102.75	-	-	97.9	32.45	7.4	35	335	180	P	H
	*	2472	95.33	-	-	90.48	32.45	7.4	35	335	180	A	H
		2483.56	65.52	-8.48	74	60.67	32.45	7.4	35	335	180	P	H
		2484.72	51.77	-2.23	54	46.92	32.45	7.4	35	335	180	A	H
													H
													H
	*	2472	103.19	-	-	98.34	32.45	7.4	35	374	120	P	V
	*	2472	95.74	-	-	90.89	32.45	7.4	35	374	120	A	V
		2483.8	66.02	-7.98	74	61.17	32.45	7.4	35	374	120	P	V
		2483.88	52.87	-1.13	54	48.02	32.45	7.4	35	374	120	A	V
													V
													V
Remark	3. No other spurious found. 4. All results are PASS against Peak and Average limit line.												



2.4GHz 2400~2483.5MHz

WIFI 802.11n HT20 (Harmonic @ 3m)

WIFI Ant. 2	Note	Frequency (MHz)	Level (dBμV/m)	Over Limit (dB)	Limit Line (dBμV/m)	Read Level (dBμV)	Antenna Factor (dB/m)	Cable Loss (dB)	Preamp Factor (dB)	Ant Pos (cm)	Table Pos (deg)	Peak Avg. (P/A)	Pol. (H/V)	
802.11n HT20 CH 01 2412MHz		4824	45.97	-28.03	74	59.69	33.64	11.68	59.04	100	0	P	H	
													H	
													H	
													H	
			4824	47.21	-26.79	74	60.93	33.64	11.68	59.04	100	0	P	V
														V
														V
802.11n HT20 CH 06 2437MHz		4874	45.88	-28.12	74	59.75	33.54	11.53	58.94	100	0	P	H	
													H	
			7311	43.51	-30.49	74	52.94	34.69	13.81	57.93	100	0	P	H
														H
			4874	46.91	-27.09	74	60.78	33.54	11.53	58.94	100	0	P	V
			7311	43.63	-30.37	74	53.06	34.69	13.81	57.93	100	0	P	V
														V
802.11n HT20 CH 11 2462MHz		4924	44.16	-29.84	74	58.19	33.44	11.37	58.84	100	0	P	H	
													H	
			7386	38.61	-35.39	74	48.25	34.47	13.95	58.06	100	0	P	H
														H
			4924	43.3	-30.7	74	57.33	33.44	11.37	58.84	100	0	P	V
			7386	38.45	-35.55	74	48.09	34.47	13.95	58.06	100	0	P	V
														V
Remark	1. No other spurious found.													
	2. All results are PASS against Peak and Average limit line.													



802.11n HT20 CH 12 2467MHz		4934	41.33	-32.67	74	55.36	33.44	11.37	58.84	100	0	P	H
		7401	40.02	-33.98	74	49.73	34.42	13.95	58.08	100	0	P	H
													H
													H
		4934	41.19	-32.81	74	55.22	33.44	11.37	58.84	100	0	P	V
		7401	38.73	-35.27	74	48.44	34.42	13.95	58.08	100	0	P	V
													V
													V
802.11n HT20 CH 13 2472MHz		4944	41.71	-32.29	74	55.89	33.4	11.22	58.8	100	0	P	H
		7416	38.96	-35.04	74	48.67	34.42	13.95	58.08	100	0	P	H
													H
													H
		4944	41.26	-32.74	74	55.44	33.4	11.22	58.8	100	0	P	V
		7416	38.85	-35.15	74	48.56	34.42	13.95	58.08	100	0	P	V
													V
													V
Remark	3. No other spurious found. 4. All results are PASS against Peak and Average limit line.												



2.4GHz 2400~2483.5MHz

Emission below 1GHz

2.4GHz WIFI 802.11n HT20 (LF)

WIFI Ant.	Note	Frequency	Level	Over Limit	Limit Line	Read Level	Antenna Factor	Cable Loss	Preamp Factor	Ant Pos	Table Pos	Peak Avg.	Pol.	
2		(MHz)	(dBμV/m)	(dB)	(dBμV/m)	(dBμV)	(dB/m)	(dB)	(dB)	(cm)	(deg)	(P/A)	(H/V)	
2.4GHz 802.11n HT20 LF		55.38	35.36	-4.64	40	51.94	13.55	1.07	31.2	-	-	P	H	
		98.04	38.36	-5.14	43.5	52.04	16.14	1.28	31.1	-	-	P	H	
		145.56	40.31	-3.19	43.5	51.79	17.84	1.78	31.1	100	331	P	H	
		355.3	38.22	-7.78	46	45.48	21.32	2.5	31.08	-	-	P	H	
		479.9	36.66	-9.34	46	40.66	23.76	3.04	30.8	-	-	P	H	
		720	37.83	-8.17	46	37.78	26.71	3.74	30.4	-	-	P	H	
														H
														H
														H
														H
														H
														H
														H
			53.22	33.87	-6.13	40	50.22	14.17	1.07	31.59	-	-	P	V
			98.04	36.6	-6.9	43.5	50.7	16.14	1.28	31.52	-	-	P	V
			151.77	40.22	-3.28	43.5	52.38	17.56	1.78	31.5	100	278	P	V
			358.1	31.12	-14.88	46	38.44	21.39	2.5	31.21	-	-	P	V
			720	32.79	-13.21	46	33.03	26.71	3.74	30.69	-	-	P	V
			960.1	35.08	-18.92	54	31.32	30.22	4.07	30.53	-	-	P	V
														V
													V	
													V	
													V	
													V	
													V	
Remark	1. No other spurious found. 2. All results are PASS against limit line.													



Note symbol

*	Fundamental Frequency which can be ignored. However, the level of any unwanted emissions shall not exceed the level of the fundamental frequency.
!	Test result is over limit line.
P/A	Peak or Average
H/V	Horizontal or Vertical



A calculation example for radiated spurious emission is shown as below:

WIFI	Note	Frequency	Level	Over	Limit	Read	Antenna	Cable	Preamp	Ant	Table	Peak	Pol.
Ant.				Limit	Line	Level	Factor	Loss	Factor	Pos	Pos	Avg.	
2		(MHz)	(dBμV/m)	(dB)	(dBμV/m)	(dBμV)	(dB/m)	(dB)	(dB)	(cm)	(deg)	(P/A)	(H/V)
802.11b		2390	55.45	-18.55	74	54.51	32.22	4.58	35.86	103	308	P	H
CH 01													
2412MHz		2390	43.54	-10.46	54	42.6	32.22	4.58	35.86	103	308	A	H

- Level(dBμV/m) =
Antenna Factor(dB/m) + Cable Loss(dB) + Read Level(dBμV) - Preamp Factor(dB)
- Over Limit(dB) = Level(dBμV/m) – Limit Line(dBμV/m)

For Peak Limit @ 2390MHz:

- Level(dBμV/m)
= Antenna Factor(dB/m) + Cable Loss(dB) + Read Level(dBμV) - Preamp Factor(dB)
= 32.22(dB/m) + 4.58(dB) + 54.51(dBμV) – 35.86 (dB)
= 55.45 (dBμV/m)
- Over Limit(dB)
= Level(dBμV/m) – Limit Line(dBμV/m)
= 55.45(dBμV/m) – 74(dBμV/m)
= -18.55(dB)

For Average Limit @ 2390MHz:

- Level(dBμV/m)
= Antenna Factor(dB/m) + Cable Loss(dB) + Read Level(dBμV) - Preamp Factor(dB)
= 32.22(dB/m) + 4.58(dB) + 42.6(dBμV) – 35.86 (dB)
= 43.54 (dBμV/m)
- Over Limit(dB)
= Level(dBμV/m) – Limit Line(dBμV/m)
= 43.54(dBμV/m) – 54(dBμV/m)
= -10.46(dB)

Both peak and average measured complies with the limit line, so test result is “PASS”.



Appendix C. Radiated Spurious Emission Plots

Test Engineer :	Jesse Wang and Ken Wu	Temperature :	21~24°C
		Relative Humidity :	50~54%

Note symbol

-L	Low channel location
-R	High channel location



2.4GHz 2400~2483.5MHz

WIFI 802.11b (Band Edge @ 3m)

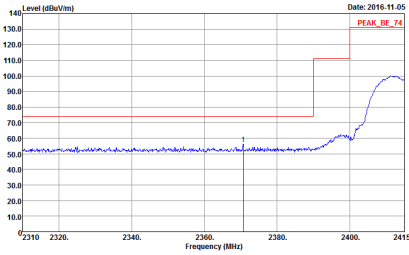
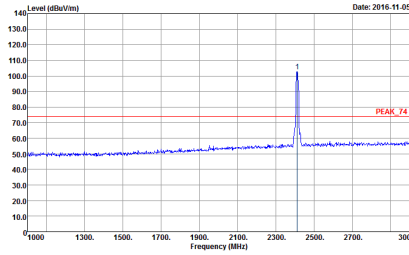
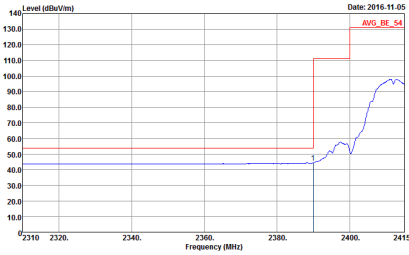
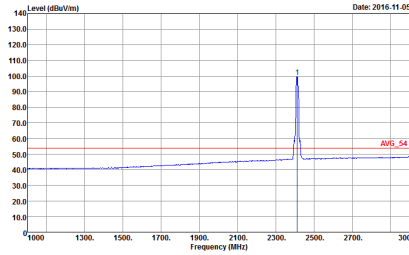
WIFI	2.4GHz 2400~2483.5MHz Band Edge @ 3m	
ANT	802.11b CH01 2412MHz	
2	Horizontal	Fundamental
Peak	 <p>Level (dBuV/m) vs Frequency (MHz) plot showing a peak at 2412 MHz. The y-axis ranges from 10.0 to 140.0 dBuV/m, and the x-axis ranges from 2310 to 2415 MHz. A red line indicates the peak level at approximately 105 dBuV/m.</p> <p>Site : 03CH07-HY Condition : PEAK_BE_74 3m HF-ANT_130829 HORIZONTAL REW:1000.000kHz VBW:3000.000kHz SWT:Auto Detector : Peak Project : 600724 Mode : 1 Plane : X Ant : 1 Setting : 15.5</p>	 <p>Level (dBuV/m) vs Frequency (MHz) plot showing a sharp peak at 2412 MHz. The y-axis ranges from 10.0 to 140.0 dBuV/m, and the x-axis ranges from 1900 to 3000 MHz. A red line indicates the peak level at approximately 105 dBuV/m.</p> <p>Site : 03CH07-HY Condition : PEAK_74 3m HF-ANT_130829 HORIZONTAL REW:1000.000kHz VBW:3000.000kHz SWT:Auto Detector : Peak Project : 600724 Mode : 1 Plane : X Ant : 1 Setting : 15.5</p>
Avg.	 <p>Level (dBuV/m) vs Frequency (MHz) plot showing the average spectrum. The y-axis ranges from 10.0 to 140.0 dBuV/m, and the x-axis ranges from 2310 to 2415 MHz. A red line indicates the average level at approximately 55 dBuV/m.</p> <p>Site : 03CH07-HY Condition : AVG_BE_54 3m HF-ANT_130829 HORIZONTAL REW:1000.000kHz VBW:0.010kHz SWT:Auto Detector : Peak Project : 600724 Mode : 1 Plane : X Ant : 1 Setting : 15.5</p>	 <p>Level (dBuV/m) vs Frequency (MHz) plot showing the average spectrum. The y-axis ranges from 10.0 to 140.0 dBuV/m, and the x-axis ranges from 1900 to 3000 MHz. A red line indicates the average level at approximately 55 dBuV/m.</p> <p>Site : 03CH07-HY Condition : AVG_54 3m HF-ANT_130829 HORIZONTAL REW:1000.000kHz VBW:0.010kHz SWT:Auto Detector : Peak Project : 600724 Mode : 1 Plane : X Ant : 1 Setting : 15.5</p>

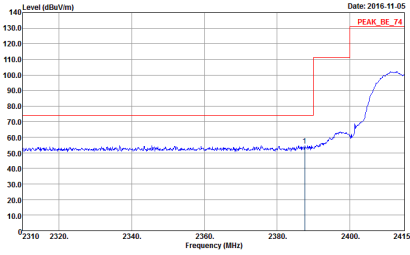
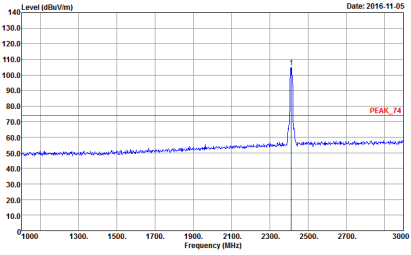
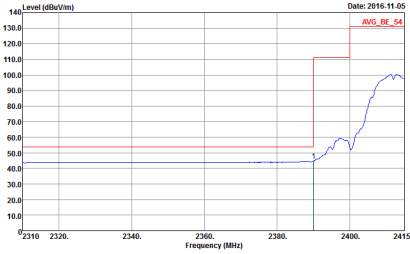
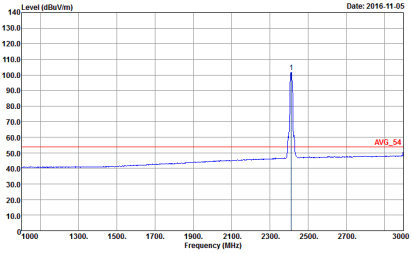

WIFI	2.4GHz 2400~2483.5MHz Band Edge @ 3m	
ANT	802.11b CH01 2412MHz	
2	Vertical	Fundamental
Peak	 <p>Level (dBuV/m) vs Frequency (MHz) plot showing a peak at 2412 MHz. The y-axis ranges from 10.0 to 140.0 dBuV/m, and the x-axis ranges from 2310 to 2415 MHz. A red line indicates the peak level at approximately 135 dBuV/m.</p> <p>Site : 03CH07-HY Condition : PEAK_BE_74 3m HF-ANT_130829 VERTICAL : RBW:1000.000kHz VBW:3000.000kHz SWT:Auto Detector : Peak Project : 600724 Mode : 1 Plane : X Ant : 1 Setting : 15.5</p>	 <p>Level (dBuV/m) vs Frequency (MHz) plot showing a sharp peak at 2412 MHz. The y-axis ranges from 10.0 to 140.0 dBuV/m, and the x-axis ranges from 1900 to 3000 MHz. A red line indicates the peak level at approximately 105 dBuV/m.</p> <p>Site : 03CH07-HY Condition : PEAK_74 3m HF-ANT_130829 VERTICAL : RBW:1000.000kHz VBW:3000.000kHz SWT:Auto Detector : Peak Project : 600724 Mode : 1 Plane : X Ant : 1 Setting : 15.5</p>
Avg.	 <p>Level (dBuV/m) vs Frequency (MHz) plot showing the average level across the band. The y-axis ranges from 10.0 to 140.0 dBuV/m, and the x-axis ranges from 2310 to 2415 MHz. A red line indicates the average level at approximately 55 dBuV/m.</p> <p>Site : 03CH07-HY Condition : AVG_BE_54 3m HF-ANT_130829 VERTICAL : RBW:1000.000kHz VBW:0.010kHz SWT:Auto Detector : Peak Project : 600724 Mode : 1 Plane : X Ant : 1 Setting : 15.5</p>	 <p>Level (dBuV/m) vs Frequency (MHz) plot showing the average level across the band. The y-axis ranges from 10.0 to 140.0 dBuV/m, and the x-axis ranges from 1900 to 3000 MHz. A red line indicates the average level at approximately 55 dBuV/m.</p> <p>Site : 03CH07-HY Condition : AVG_54 3m HF-ANT_130829 VERTICAL : RBW:1000.000kHz VBW:0.010kHz SWT:Auto Detector : Peak Project : 600724 Mode : 1 Plane : X Ant : 1 Setting : 15.5</p>

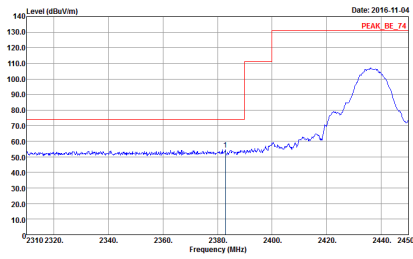
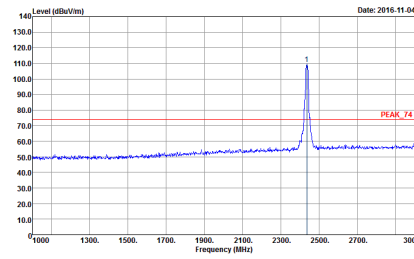
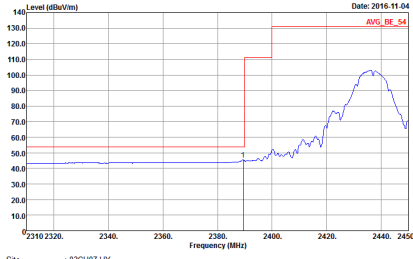
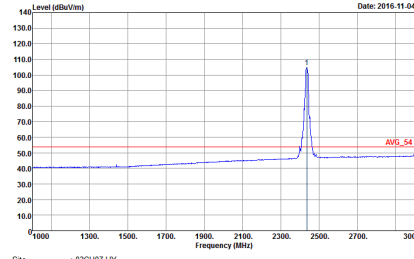

WIFI	2.4GHz 2400~2483.5MHz Band Edge @ 3m	
ANT	802.11b CH06 2437MHz - L	
2	Horizontal	Fundamental
Peak	 <p>Date: 2016-11-04</p> <p>Site : 03CH07-HY Condition : PEAK_BE_74 3m HF-ANT_130829 HORIZONTAL : RBW:1000.000kHz VBW:3000.000kHz SWT:Auto Detector : Peak Project : 600724 Mode : 2 Plane : X Ant : 1 Setting : 19.5</p>	 <p>Date: 2016-11-04</p> <p>Site : 03CH07-HY Condition : PEAK_74 3m HF-ANT_130829 HORIZONTAL : RBW:1000.000kHz VBW:3000.000kHz SWT:Auto Detector : Peak Project : 600724 Mode : 2 Plane : X Ant : 1 Setting : 19.5</p>
Avg.	 <p>Date: 2016-11-04</p> <p>Site : 03CH07-HY Condition : AVG_BE_54 3m HF-ANT_130829 HORIZONTAL : RBW:1000.000kHz VBW:0.010kHz SWT:Auto Detector : Peak Project : 600724 Mode : 2 Plane : X Ant : 1 Setting : 19.5</p>	 <p>Date: 2016-11-04</p> <p>Site : 03CH07-HY Condition : AVG_54 3m HF-ANT_130829 HORIZONTAL : RBW:1000.000kHz VBW:0.010kHz SWT:Auto Detector : Peak Project : 600724 Mode : 2 Plane : X Ant : 1 Setting : 19.5</p>

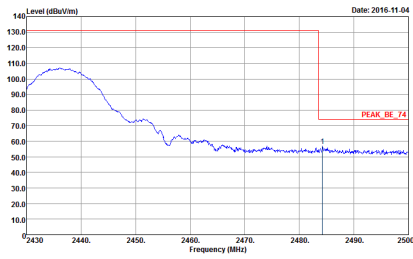
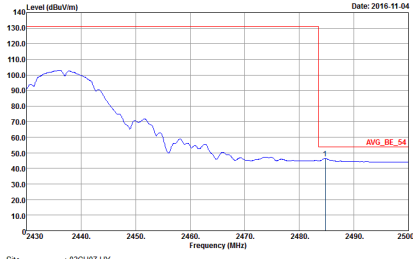

WIFI	2.4GHz 2400~2483.5MHz Band Edge @ 3m	
ANT	802.11b CH06 2437MHz - R	
2	Horizontal	Fundamental
Peak	 <p>Date: 2016.11.04</p> <p>Site : 03CH07-HY Condition : PEAK_BE_74 3m HF-ANT_130829 HORIZONTAL RBW: 1000.000kHz VBW: 3000.000kHz SWT: Auto Detector : Peak Project : 600724 Mode : 2 Plane : X Ant : 1 Setting : 19.5</p>	Left blank
Avg.	 <p>Date: 2016.11.04</p> <p>Site : 03CH07-HY Condition : AVG_BE_54 3m HF-ANT_130829 HORIZONTAL RBW: 1000.000kHz VBW: 0.010kHz SWT: Auto Detector : Peak Project : 600724 Mode : 2 Plane : X Ant : 1 Setting : 19.5</p>	Left blank

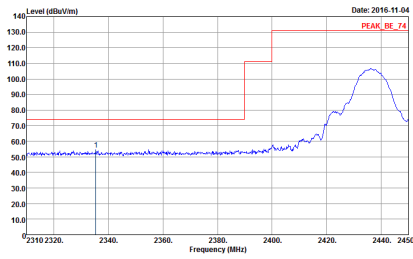
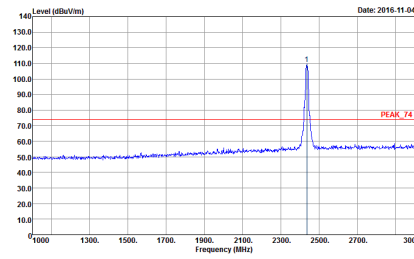
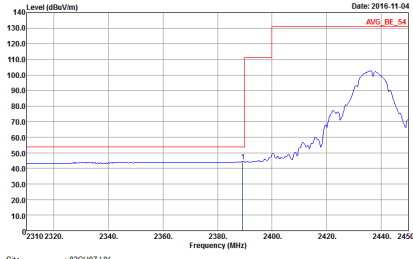
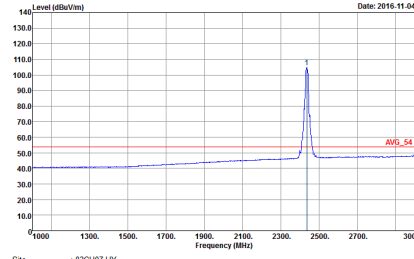

WIFI	2.4GHz 2400~2483.5MHz Band Edge @ 3m	
ANT	802.11b CH06 2437MHz - L	
2	Vertical	Fundamental
Peak	 <p>Date: 2016-11-04</p> <p>Site : 03CH07-HY Condition : PEAK_BE_74 3m HF-ANT_130829 VERTICAL : RBW:1000.000kHz VBW:3000.000kHz SWT:Auto Detector : Peak Project : 600724 Mode : 2 Plane : X Ant : 1 Setting : 19.5</p>	 <p>Date: 2016-11-04</p> <p>Site : 03CH07-HY Condition : PEAK_74 3m HF-ANT_130829 VERTICAL : RBW:1000.000kHz VBW:3000.000kHz SWT:Auto Detector : Peak Project : 600724 Mode : 2 Plane : X Ant : 1 Setting : 19.5</p>
Avg.	 <p>Date: 2016-11-04</p> <p>Site : 03CH07-HY Condition : AVG_BE_54 3m HF-ANT_130829 VERTICAL : RBW:1000.000kHz VBW:0.010kHz SWT:Auto Detector : Peak Project : 600724 Mode : 2 Plane : X Ant : 1 Setting : 19.5</p>	 <p>Date: 2016-11-04</p> <p>Site : 03CH07-HY Condition : AVG_54 3m HF-ANT_130829 VERTICAL : RBW:1000.000kHz VBW:0.010kHz SWT:Auto Detector : Peak Project : 600724 Mode : 2 Plane : X Ant : 1 Setting : 19.5</p>

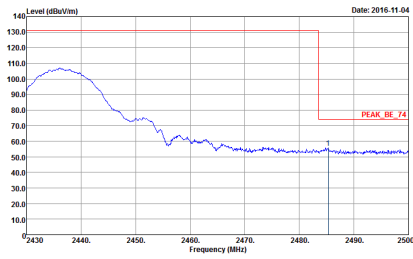
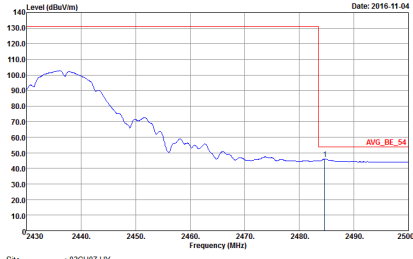

WIFI	2.4GHz 2400~2483.5MHz Band Edge @ 3m	
ANT	802.11b CH06 2437MHz - R	
2	Vertical	Fundamental
Peak	 <p>Date: 2016.11.04</p> <p>Site : 03CH07-HY Condition : PEAK_BE_74 3m HF-ANT_130829 VERTICAL RBW: 1000.000kHz VBW: 3000.000kHz SWT: Auto Detector : Peak Project : 600724 Mode : 2 Plane : X Ant : 1 Setting : 19.5</p>	Left blank
Avg.	 <p>Date: 2016.11.04</p> <p>Site : 03CH07-HY Condition : AVG_BE_54 3m HF-ANT_130829 VERTICAL RBW: 1000.000kHz VBW: 0.010kHz SWT: Auto Detector : Peak Project : 600724 Mode : 2 Plane : X Ant : 1 Setting : 19.5</p>	Left blank

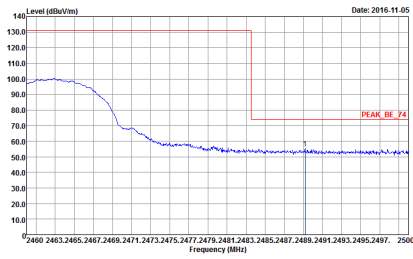
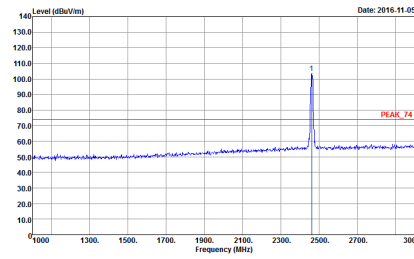
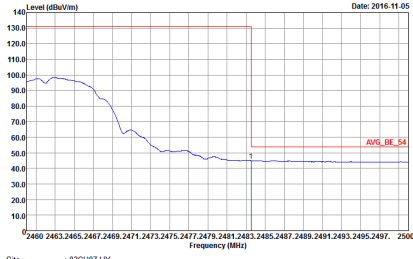
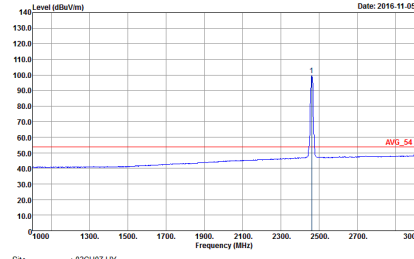

WIFI	2.4GHz 2400~2483.5MHz Band Edge @ 3m	
ANT	802.11b CH11 2462MHz	
2	Horizontal	Fundamental
Peak	 <p>Site : 03CH07-HY Condition : PEAK_BE_74 3m HF-ANT_130829 HORIZONTAL : RBW:1000.000kHz VBW:3000.000kHz SWT:Auto Detector : Peak Project : 600724 Mode : 3 Plane : X Ant : 1 Setting : 16.5</p>	 <p>Site : 03CH07-HY Condition : PEAK_74 3m HF-ANT_130829 HORIZONTAL : RBW:1000.000kHz VBW:3000.000kHz SWT:Auto Detector : Peak Project : 600724 Mode : 3 Plane : X Ant : 1 Setting : 16.5</p>
Avg.	 <p>Site : 03CH07-HY Condition : AVG_BE_54 3m HF-ANT_130829 HORIZONTAL : RBW:1000.000kHz VBW:0.010kHz SWT:Auto Detector : Peak Project : 600724 Mode : 3 Plane : X Ant : 1 Setting : 16.5</p>	 <p>Site : 03CH07-HY Condition : AVG_54 3m HF-ANT_130829 HORIZONTAL : RBW:1000.000kHz VBW:0.010kHz SWT:Auto Detector : Peak Project : 600724 Mode : 3 Plane : X Ant : 1 Setting : 16.5</p>

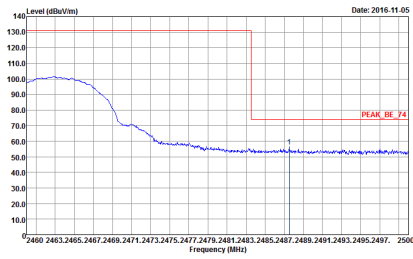
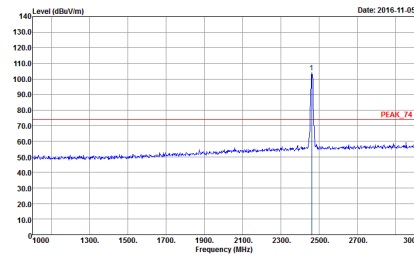
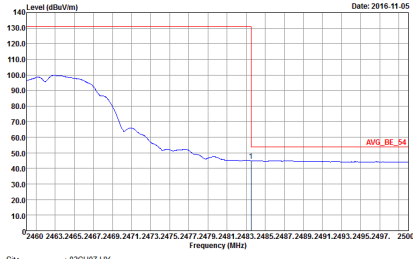
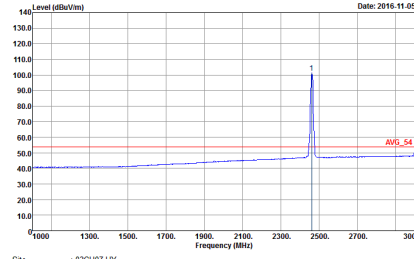

WIFI	2.4GHz 2400~2483.5MHz Band Edge @ 3m	
ANT	802.11b CH11 2462MHz	
2	Vertical	Fundamental
Peak	 <p>Level (dBuV/m) vs Frequency (MHz) plot showing a peak at 2462 MHz. The y-axis ranges from 10.0 to 140.0 dBuV/m, and the x-axis ranges from 2450 to 2500 MHz. A red box highlights the peak area, labeled 'PEAK_BE_74'.</p> <p>Site : 03CH07-HY Condition : PEAK_BE_74 3m HF-ANT_130829 VERTICAL RBW: 1000.000kHz VBW:3000.000kHz SWT:Auto Detector : Peak Project : 600724 Mode : 3 Plane : X Ant : 1 Setting : 16.5</p>	 <p>Level (dBuV/m) vs Frequency (MHz) plot showing a sharp peak at 2462 MHz. The y-axis ranges from 10.0 to 140.0 dBuV/m, and the x-axis ranges from 1000 to 3000 MHz. A red box highlights the peak area, labeled 'PEAK_74'.</p> <p>Site : 03CH07-HY Condition : PEAK_74 3m HF-ANT_130829 VERTICAL RBW: 1000.000kHz VBW:3000.000kHz SWT:Auto Detector : Peak Project : 600724 Mode : 3 Plane : X Ant : 1 Setting : 16.5</p>
Avg.	 <p>Level (dBuV/m) vs Frequency (MHz) plot showing the average level across the band. The y-axis ranges from 10.0 to 140.0 dBuV/m, and the x-axis ranges from 2450 to 2500 MHz. A red box highlights the average level, labeled 'AVG_BE_54'.</p> <p>Site : 03CH07-HY Condition : AVG_BE_54 3m HF-ANT_130829 VERTICAL RBW: 1000.000kHz VBW:0.010kHz SWT:Auto Detector : Peak Project : 600724 Mode : 3 Plane : X Ant : 1 Setting : 16.5</p>	 <p>Level (dBuV/m) vs Frequency (MHz) plot showing the average level across the band. The y-axis ranges from 10.0 to 140.0 dBuV/m, and the x-axis ranges from 1000 to 3000 MHz. A red box highlights the average level, labeled 'AVG_54'.</p> <p>Site : 03CH07-HY Condition : AVG_54 3m HF-ANT_130829 VERTICAL RBW: 1000.000kHz VBW:0.010kHz SWT:Auto Detector : Peak Project : 600724 Mode : 3 Plane : X Ant : 1 Setting : 16.5</p>

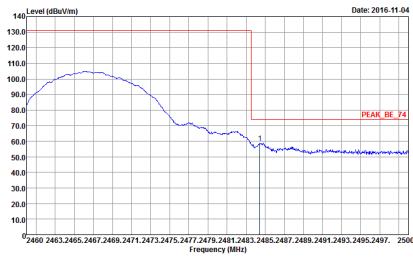
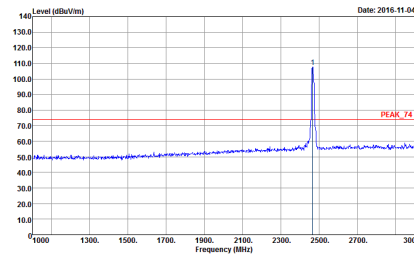
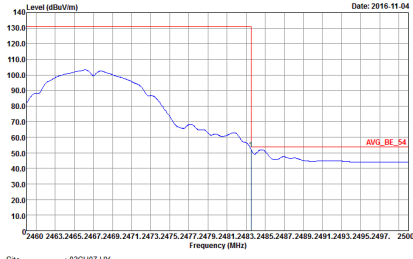
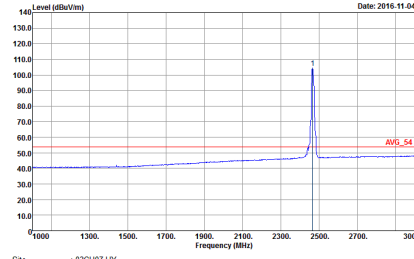

WIFI	2.4GHz 2400~2483.5MHz Band Edge @ 3m	
ANT	802.11b CH12 2467MHz	
2	Horizontal	Fundamental
Peak	 <p>Site : 03CH07-HY Condition : PEAK_BE_74 3m HF-ANT_130829 HORIZONTAL : RBW:1000.000kHz VBW:3000.000kHz SWT:Auto Detector : Peak Project : 600724 Mode : 4 Plane : X Ant : 1 Setting : 19.5</p>	 <p>Site : 03CH07-HY Condition : PEAK_74 3m HF-ANT_130829 HORIZONTAL : RBW:1000.000kHz VBW:3000.000kHz SWT:Auto Detector : Peak Project : 600724 Mode : 4 Plane : X Ant : 1 Setting : 19.5</p>
Avg.	 <p>Site : 03CH07-HY Condition : AVG_BE_54 3m HF-ANT_130829 HORIZONTAL : RBW:1000.000kHz VBW:0.010kHz SWT:Auto Detector : Peak Project : 600724 Mode : 4 Plane : X Ant : 1 Setting : 19.5</p>	 <p>Site : 03CH07-HY Condition : AVG_54 3m HF-ANT_130829 HORIZONTAL : RBW:1000.000kHz VBW:0.010kHz SWT:Auto Detector : Peak Project : 600724 Mode : 4 Plane : X Ant : 1 Setting : 19.5</p>

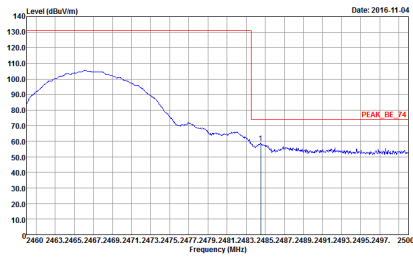
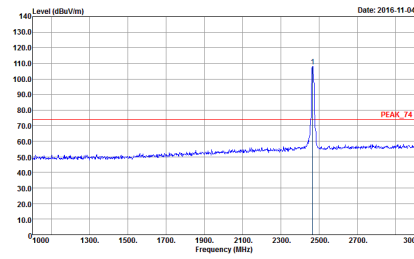
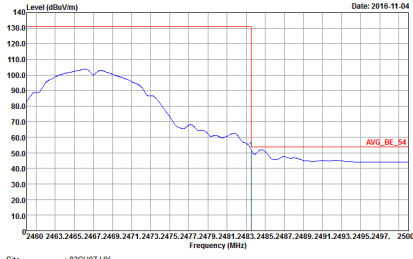
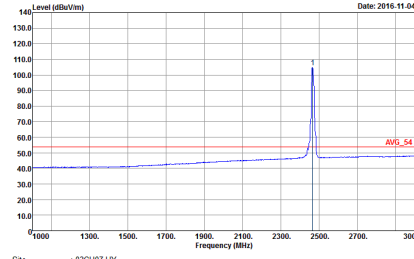

WIFI	2.4GHz 2400~2483.5MHz Band Edge @ 3m	
ANT	802.11b CH12 2467MHz	
2	Vertical	Fundamental
Peak	 <p>Level (dBuV/m) vs Frequency (MHz) plot showing a peak at 2467 MHz. The y-axis ranges from 10.0 to 140.0 dBuV/m, and the x-axis ranges from 2460 to 2500 MHz. A red box highlights the peak area, and a red line indicates the peak level at approximately 135 dBuV/m.</p> <p>Site : 03CH07-HY Condition : PEAK_BE_74 3m HF-ANT_130829 VERTICAL : RBW:1000.000kHz VBW:3000.000kHz SWT:Auto Detector : Peak Project : 600724 Mode : 4 Plane : X Ant : 1 Setting : 19.5</p>	 <p>Level (dBuV/m) vs Frequency (MHz) plot showing a sharp peak at 2467 MHz. The y-axis ranges from 10.0 to 140.0 dBuV/m, and the x-axis ranges from 1000 to 3000 MHz. A red box highlights the peak area, and a red line indicates the peak level at approximately 135 dBuV/m.</p> <p>Site : 03CH07-HY Condition : PEAK_74 3m HF-ANT_130829 VERTICAL : RBW:1000.000kHz VBW:3000.000kHz SWT:Auto Detector : Peak Project : 600724 Mode : 4 Plane : X Ant : 1 Setting : 19.5</p>
Avg.	 <p>Level (dBuV/m) vs Frequency (MHz) plot showing the average spectrum. The y-axis ranges from 10.0 to 140.0 dBuV/m, and the x-axis ranges from 2460 to 2500 MHz. A red box highlights the average level at approximately 55 dBuV/m.</p> <p>Site : 03CH07-HY Condition : AVG_BE_54 3m HF-ANT_130829 VERTICAL : RBW:1000.000kHz VBW:0.010kHz SWT:Auto Detector : Peak Project : 600724 Mode : 4 Plane : X Ant : 1 Setting : 19.5</p>	 <p>Level (dBuV/m) vs Frequency (MHz) plot showing the average spectrum. The y-axis ranges from 10.0 to 140.0 dBuV/m, and the x-axis ranges from 1000 to 3000 MHz. A red box highlights the average level at approximately 55 dBuV/m.</p> <p>Site : 03CH07-HY Condition : AVG_54 3m HF-ANT_130829 VERTICAL : RBW:1000.000kHz VBW:0.010kHz SWT:Auto Detector : Peak Project : 600724 Mode : 4 Plane : X Ant : 1 Setting : 19.5</p>

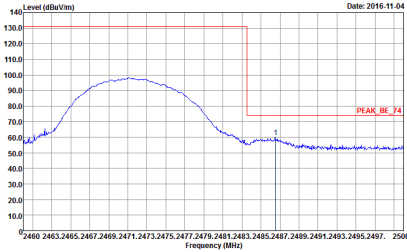
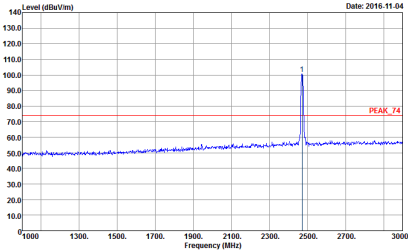
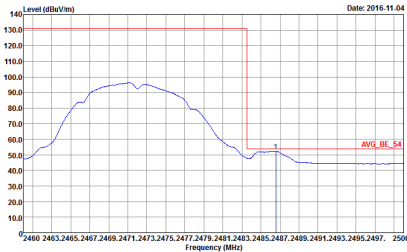
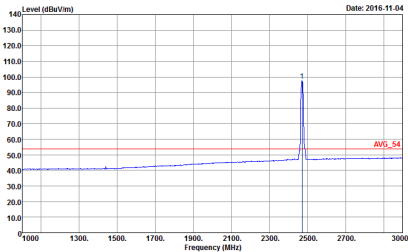

WIFI	2.4GHz 2400~2483.5MHz Band Edge @ 3m	
ANT	802.11b CH13 2472MHz	
2	Horizontal	Fundamental
Peak	 <p>Level (dBuV/m) vs Frequency (MHz) plot showing a peak at 2472 MHz. The y-axis ranges from 10.0 to 140.0 dBuV/m, and the x-axis ranges from 2460 to 2500 MHz. A red box highlights the peak area, and a red line indicates the peak level at approximately 74 dBuV/m.</p> <p>Site : 03CH07-HY Condition : PEAK_BE_74 3m HF-ANT_130829 HORIZONTAL RBW:1000.000kHz VBW:3000.000kHz SWT:Auto Detector : Peak Project : 600724 Mode : 5 Plane : X Ant : 1 Setting : 12.5</p>	 <p>Level (dBuV/m) vs Frequency (MHz) plot showing a sharp peak at 2472 MHz. The y-axis ranges from 10.0 to 140.0 dBuV/m, and the x-axis ranges from 1000 to 3000 MHz. A red box highlights the peak area, and a red line indicates the peak level at approximately 74 dBuV/m.</p> <p>Site : 03CH07-HY Condition : PEAK_74 3m HF-ANT_130829 HORIZONTAL RBW:1000.000kHz VBW:3000.000kHz SWT:Auto Detector : Peak Project : 600724 Mode : 5 Plane : X Ant : 1 Setting : 12.5</p>
Avg.	 <p>Level (dBuV/m) vs Frequency (MHz) plot showing the average spectrum. The y-axis ranges from 10.0 to 140.0 dBuV/m, and the x-axis ranges from 2460 to 2500 MHz. A red box highlights the average level area, and a red line indicates the average level at approximately 54 dBuV/m.</p> <p>Site : 03CH07-HY Condition : AVG_BE_54 3m HF-ANT_130829 HORIZONTAL RBW:1000.000kHz VBW:0.010kHz SWT:Auto Detector : Peak Project : 600724 Mode : 5 Plane : X Ant : 1 Setting : 12.5</p>	 <p>Level (dBuV/m) vs Frequency (MHz) plot showing the average spectrum. The y-axis ranges from 10.0 to 140.0 dBuV/m, and the x-axis ranges from 1000 to 3000 MHz. A red box highlights the average level area, and a red line indicates the average level at approximately 54 dBuV/m.</p> <p>Site : 03CH07-HY Condition : AVG_54 3m HF-ANT_130829 HORIZONTAL RBW:1000.000kHz VBW:0.010kHz SWT:Auto Detector : Peak Project : 600724 Mode : 5 Plane : X Ant : 1 Setting : 12.5</p>

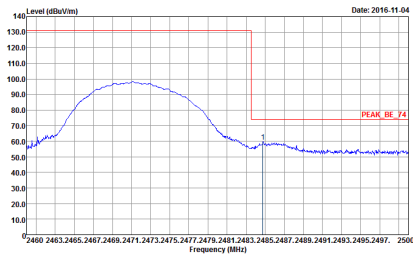
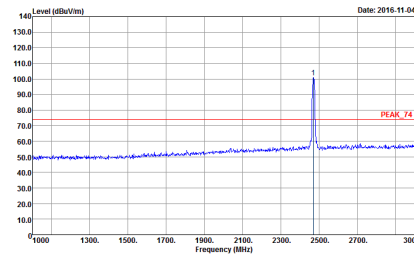
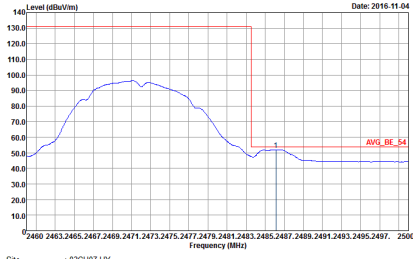
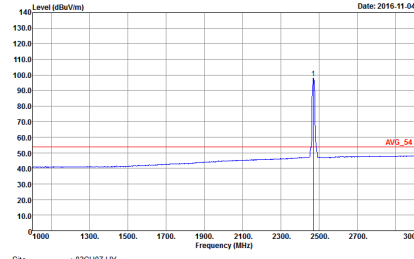

WIFI	2.4GHz 2400~2483.5MHz Band Edge @ 3m	
ANT	802.11b CH13 2472MHz	
2	Vertical	Fundamental
Peak	 <p>Date: 2016.11.04</p> <p>Site : 03CH07-HY Condition : PEAK_BE_74 3m HF-ANT_130829 VERTICAL RBW: 1000.000kHz VBW:3000.000kHz SWT:Auto Detector : Peak Project : 600724 Mode : 5 Plane : X Ant : 1 Setting : 12.5</p>	 <p>Date: 2016.11.04</p> <p>Site : 03CH07-HY Condition : PEAK_74 3m HF-ANT_130829 VERTICAL RBW: 1000.000kHz VBW:3000.000kHz SWT:Auto Detector : Peak Project : 600724 Mode : 5 Plane : X Ant : 1 Setting : 12.5</p>
Avg.	 <p>Date: 2016.11.04</p> <p>Site : 03CH07-HY Condition : AVG_BE_54 3m HF-ANT_130829 VERTICAL RBW: 1000.000kHz VBW:0.010kHz SWT:Auto Detector : Peak Project : 600724 Mode : 5 Plane : X Ant : 1 Setting : 12.5</p>	 <p>Date: 2016.11.04</p> <p>Site : 03CH07-HY Condition : AVG_54 3m HF-ANT_130829 VERTICAL RBW: 1000.000kHz VBW:0.010kHz SWT:Auto Detector : Peak Project : 600724 Mode : 5 Plane : X Ant : 1 Setting : 12.5</p>



2.4GHz 2400~2483.5MHz

WIFI 802.11g (Band Edge @ 3m)

WIFI	2.4GHz 2400~2483.5MHz Band Edge @ 3m	
ANT	802.11g CH01 2412MHz	
2	Horizontal	Fundamental
Peak	<p>Site : 03CH07-HY Condition : PEAK_BE_74 3m HF-ANT_130829 HORIZONTAL : REW:1000.000kHz VBW:3000.000kHz SWT:Auto Detector : Peak Project : 600724 Mode : 6 Plane : X Ant : 1 Setting : 15.5</p>	<p>Site : 03CH07-HY Condition : PEAK_74 3m HF-ANT_130829 HORIZONTAL : REW:1000.000kHz VBW:3000.000kHz SWT:Auto Detector : Peak Project : 600724 Mode : 6 Plane : X Ant : 1 Setting : 15.5</p>
Avg.	<p>Site : 03CH07-HY Condition : AVG_BE_54 3m HF-ANT_130829 HORIZONTAL : REW:1000.000kHz VBW:1.000kHz SWT:Auto Detector : Peak Project : 600724 Mode : 6 Plane : X Ant : 1 Setting : 15.5</p>	<p>Site : 03CH07-HY Condition : AVG_54 3m HF-ANT_130829 HORIZONTAL : REW:1000.000kHz VBW:1.000kHz SWT:Auto Detector : Peak Project : 600724 Mode : 6 Plane : X Ant : 1 Setting : 15.5</p>

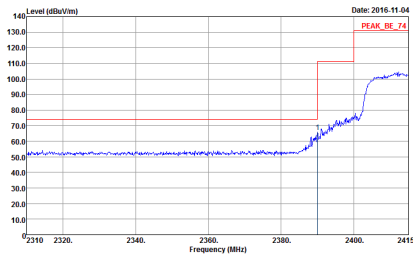
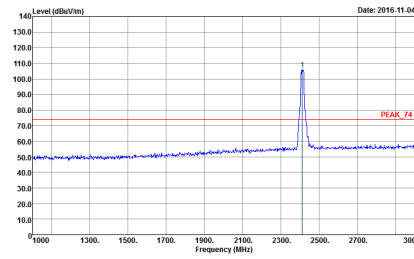
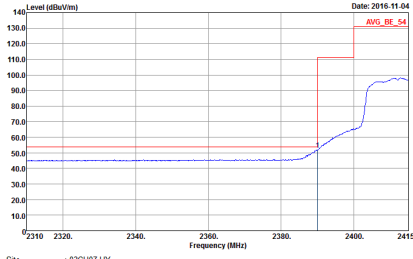
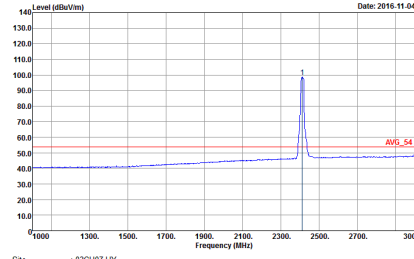

WIFI	2.4GHz 2400~2483.5MHz Band Edge @ 3m	
ANT	802.11g CH01 2412MHz	
2	Vertical	Fundamental
Peak	 <p>Level (dBuV/m) vs Frequency (MHz) plot showing a peak at 2412 MHz. The y-axis ranges from 10.0 to 140.0 dBuV/m, and the x-axis ranges from 2310 to 2415 MHz. A red line indicates the peak level at approximately 135 dBuV/m.</p> <p>Site : 03CH07-HY Condition : PEAK_BE_74 3m HF-ANT_130829 VERTICAL : RBW:1000.000kHz VBW:3000.000kHz SWT:Auto Detector : Peak Project : 600724 Mode : 6 Plane : X Ant : 1 Setting : 15.5</p>	 <p>Level (dBuV/m) vs Frequency (MHz) plot showing a sharp peak at 2412 MHz. The y-axis ranges from 10.0 to 140.0 dBuV/m, and the x-axis ranges from 1900 to 3000 MHz. A red line indicates the peak level at approximately 105 dBuV/m.</p> <p>Site : 03CH07-HY Condition : PEAK_74 3m HF-ANT_130829 VERTICAL : RBW:1000.000kHz VBW:3000.000kHz SWT:Auto Detector : Peak Project : 600724 Mode : 6 Plane : X Ant : 1 Setting : 15.5</p>
Avg.	 <p>Level (dBuV/m) vs Frequency (MHz) plot showing the average level across the band. The y-axis ranges from 10.0 to 140.0 dBuV/m, and the x-axis ranges from 2310 to 2415 MHz. A red line indicates the average level at approximately 105 dBuV/m.</p> <p>Site : 03CH07-HY Condition : AVG_BE_54 3m HF-ANT_130829 VERTICAL : RBW:1000.000kHz VBW:1.000kHz SWT:Auto Detector : Peak Project : 600724 Mode : 6 Plane : X Ant : 1 Setting : 15.5</p>	 <p>Level (dBuV/m) vs Frequency (MHz) plot showing the average level across the band. The y-axis ranges from 10.0 to 140.0 dBuV/m, and the x-axis ranges from 1900 to 3000 MHz. A red line indicates the average level at approximately 55 dBuV/m.</p> <p>Site : 03CH07-HY Condition : AVG_54 3m HF-ANT_130829 VERTICAL : RBW:1000.000kHz VBW:1.000kHz SWT:Auto Detector : Peak Project : 600724 Mode : 6 Plane : X Ant : 1 Setting : 15.5</p>



WIFI	2.4GHz 2400~2483.5MHz Band Edge @ 3m	
ANT	802.11g CH06 2437MHz - L	
2	Horizontal	Fundamental
Peak	<p>Date: 2016-11-04</p> <p>Level (dBuV/m)</p> <p>Frequency (MHz)</p> <p>PEAK_BE_74</p> <pre> Site : 03CH07-HY Condition : PEAK_BE_74 3m HF-ANT_130829 HORIZONTAL : RBW:1000.000kHz VBW:3000.000kHz SWT:Auto Detector : Peak Project : 600724 Mode : 7 Plane : X Ant : 1 Setting : 20 </pre>	<p>Date: 2016-11-04</p> <p>Level (dBuV/m)</p> <p>Frequency (MHz)</p> <p>PEAK_74</p> <pre> Site : 03CH07-HY Condition : PEAK_74 3m HF-ANT_130829 HORIZONTAL : RBW:1000.000kHz VBW:3000.000kHz SWT:Auto Detector : Peak Project : 600724 Mode : 7 Plane : X Ant : 1 Setting : 20 </pre>
Avg.	<p>Date: 2016-11-04</p> <p>Level (dBuV/m)</p> <p>Frequency (MHz)</p> <p>AVG_BE_54</p> <pre> Site : 03CH07-HY Condition : AVG_BE_54 3m HF-ANT_130829 HORIZONTAL : RBW:1000.000kHz VBW:1.000kHz SWT:Auto Detector : Peak Project : 600724 Mode : 7 Plane : X Ant : 1 Setting : 20 </pre>	<p>Date: 2016-11-04</p> <p>Level (dBuV/m)</p> <p>Frequency (MHz)</p> <p>AVG_54</p> <pre> Site : 03CH07-HY Condition : AVG_54 3m HF-ANT_130829 HORIZONTAL : RBW:1000.000kHz VBW:1.000kHz SWT:Auto Detector : Peak Project : 600724 Mode : 7 Plane : X Ant : 1 Setting : 20 </pre>

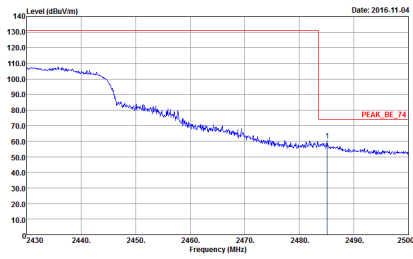
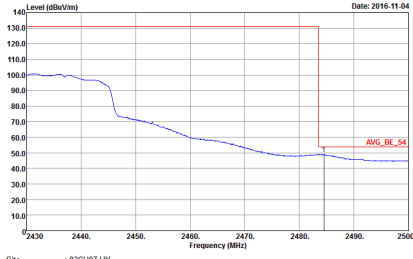

WIFI	2.4GHz 2400~2483.5MHz Band Edge @ 3m	
ANT	802.11g CH06 2437MHz - R	
2	Horizontal	Fundamental
Peak	 <p>Date: 2016.11.04</p> <p>Site : 03CH07-HY Condition : PEAK_BE_74 3m HF-ANT_130829 HORIZONTAL RBW: 1000.000kHz VBW: 3000.000kHz SWT: Auto Detector : Peak Project : 600724 Mode : F Plane : X Ant : 1 Setting : 20</p>	Left blank
Avg.	 <p>Date: 2016.11.04</p> <p>Site : 03CH07-HY Condition : AVG_BE_54 3m HF-ANT_130829 HORIZONTAL RBW: 1000.000kHz VBW: 1.000kHz SWT: Auto Detector : Peak Project : 600724 Mode : F Plane : X Ant : 1 Setting : 20</p>	Left blank

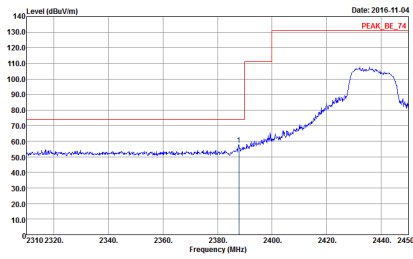
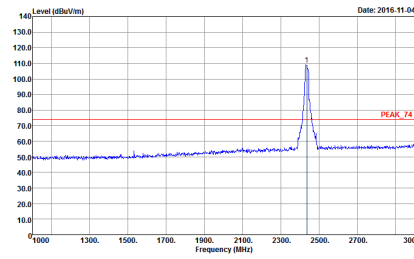
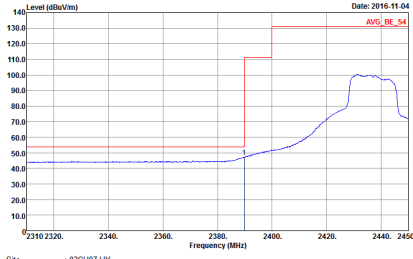
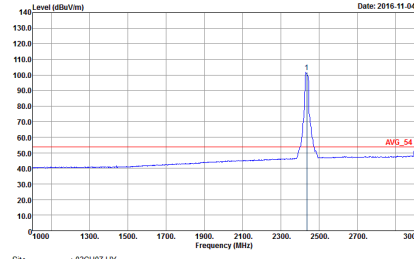

WIFI	2.4GHz 2400~2483.5MHz Band Edge @ 3m	
ANT	802.11g CH06 2437MHz - L	
2	Vertical	Fundamental
Peak	 <p>Date: 2016-11-04 PEAK_BE_74</p> <p>Site : 03CH07-HY Condition : PEAK_BE_74 3m HF-ANT_130829 VERTICAL RBW: 1000.000kHz VBW: 3000.000kHz SWT: Auto Detector : Peak Project : 600724 Mode : 7 Plane : X Ant : 1 Setting : 20</p>	 <p>Date: 2016-11-04 PEAK_74</p> <p>Site : 03CH07-HY Condition : PEAK_74 3m HF-ANT_130829 VERTICAL RBW: 1000.000kHz VBW: 3000.000kHz SWT: Auto Detector : Peak Project : 600724 Mode : 7 Plane : X Ant : 1 Setting : 20</p>
Avg.	 <p>Date: 2016-11-04 AVG_BE_54</p> <p>Site : 03CH07-HY Condition : AVG_BE_54 3m HF-ANT_130829 VERTICAL RBW: 1000.000kHz VBW: 1.000kHz SWT: Auto Detector : Peak Project : 600724 Mode : 7 Plane : X Ant : 1 Setting : 20</p>	 <p>Date: 2016-11-04 AVG_54</p> <p>Site : 03CH07-HY Condition : AVG_54 3m HF-ANT_130829 VERTICAL RBW: 1000.000kHz VBW: 1.000kHz SWT: Auto Detector : Peak Project : 600724 Mode : 7 Plane : X Ant : 1 Setting : 20</p>

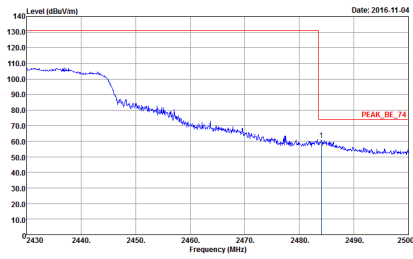
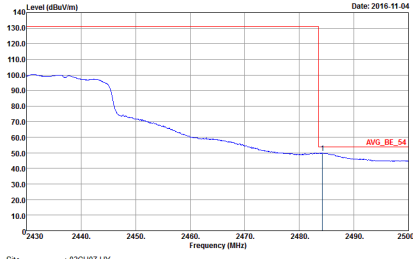

WIFI	2.4GHz 2400~2483.5MHz Band Edge @ 3m	
ANT	802.11g CH06 2437MHz - R	
2	Vertical	Fundamental
Peak	 <p>Date: 2016.11.04</p> <p>Site : 03CH07-HY Condition : PEAK_BE_74 3m HF-ANT_130829 VERTICAL RBW: 1000.000kHz VBW: 3000.000kHz SWT: Auto Detector : Peak Project : 600724 Mode : F Plane : X Ant : 1 Setting : 20</p>	Left Blank
Avg.	 <p>Date: 2016.11.04</p> <p>Site : 03CH07-HY Condition : AVG_BE_54 3m HF-ANT_130829 VERTICAL RBW: 1000.000kHz VBW: 1.000kHz SWT: Auto Detector : Peak Project : 600724 Mode : F Plane : X Ant : 1 Setting : 20</p>	Left Blank

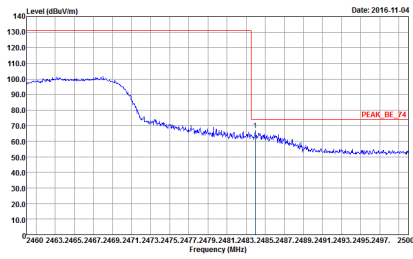
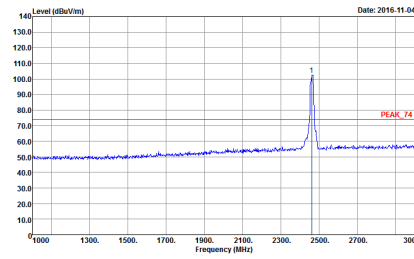
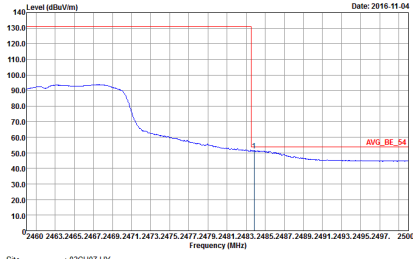
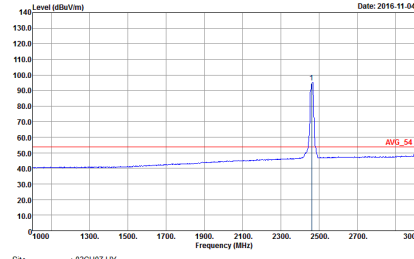

WIFI	2.4GHz 2400~2483.5MHz Band Edge @ 3m	
ANT	802.11g CH11 2462MHz	
2	Horizontal	Fundamental
Peak	 <p>Level (dBu/m) vs Frequency (MHz) graph. The y-axis ranges from 10.0 to 140.0 dBu/m, and the x-axis ranges from 2460 to 2500 MHz. A blue line shows the signal level, which drops from approximately 100 dBu/m at 2460 MHz to about 60 dBu/m at 2462 MHz. A red horizontal line marks the peak level at approximately 75 dBu/m, labeled 'PEAK_BE_74'.</p> <p>Site : 03CH07-HY Condition : PEAK_BE_74 3m HF-ANT_130829 HORIZONTAL : RBW:1000.000kHz VBW:3000.000kHz SWT:Auto Detector : Peak Project : 600724 Mode : 8 Plane : X Ant : 1 Setting : 11.5</p>	 <p>Level (dBu/m) vs Frequency (MHz) graph. The y-axis ranges from 10.0 to 140.0 dBu/m, and the x-axis ranges from 1000 to 3000 MHz. A blue line shows the signal level, which is flat at approximately 50 dBu/m until 2462 MHz, where it spikes to about 100 dBu/m. A red horizontal line marks the peak level at approximately 75 dBu/m, labeled 'PEAK_74'.</p> <p>Site : 03CH07-HY Condition : PEAK_74 3m HF-ANT_130829 HORIZONTAL : RBW:1000.000kHz VBW:3000.000kHz SWT:Auto Detector : Peak Project : 600724 Mode : 8 Plane : X Ant : 1 Setting : 11.5</p>
Avg.	 <p>Level (dBu/m) vs Frequency (MHz) graph. The y-axis ranges from 10.0 to 140.0 dBu/m, and the x-axis ranges from 2460 to 2500 MHz. A blue line shows the signal level, which drops from approximately 100 dBu/m at 2460 MHz to about 50 dBu/m at 2462 MHz. A red horizontal line marks the average level at approximately 55 dBu/m, labeled 'AVG_BE_54'.</p> <p>Site : 03CH07-HY Condition : AVG_BE_54 3m HF-ANT_130829 HORIZONTAL : RBW:1000.000kHz VBW:1.000kHz SWT:Auto Detector : Peak Project : 600724 Mode : 8 Plane : X Ant : 1 Setting : 11.5</p>	 <p>Level (dBu/m) vs Frequency (MHz) graph. The y-axis ranges from 10.0 to 140.0 dBu/m, and the x-axis ranges from 1000 to 3000 MHz. A blue line shows the signal level, which is flat at approximately 50 dBu/m until 2462 MHz, where it spikes to about 100 dBu/m. A red horizontal line marks the average level at approximately 55 dBu/m, labeled 'AVG_54'.</p> <p>Site : 03CH07-HY Condition : AVG_54 3m HF-ANT_130829 HORIZONTAL : RBW:1000.000kHz VBW:1.000kHz SWT:Auto Detector : Peak Project : 600724 Mode : 8 Plane : X Ant : 1 Setting : 11.5</p>

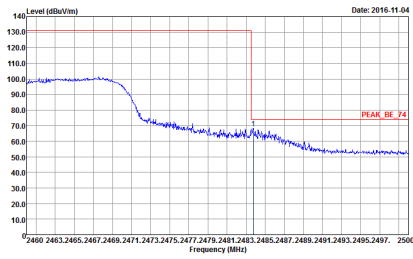
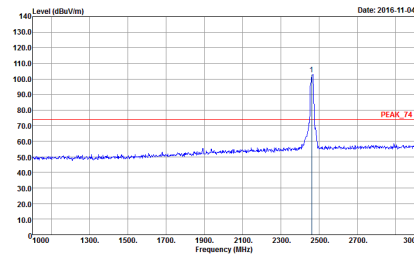
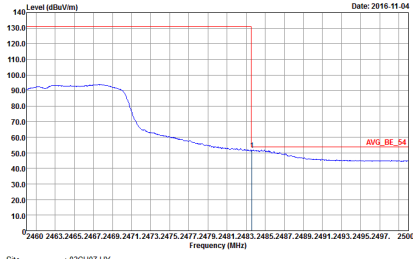
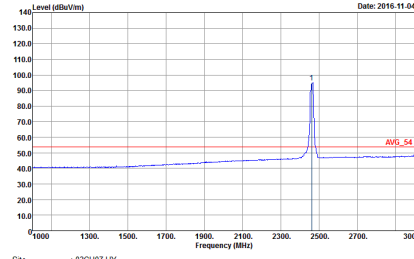

WIFI	2.4GHz 2400~2483.5MHz Band Edge @ 3m	
ANT	802.11g CH11 2462MHz	
2	Vertical	Fundamental
Peak	 <p>Level (dBu/m) vs Frequency (MHz) graph for Vertical band edge. The y-axis ranges from 10.0 to 140.0 dBu/m, and the x-axis ranges from 2460 to 2500 MHz. A peak is observed at 2462 MHz, labeled 'PEAK_BE_74'.</p> <pre> Site : 03CH07-HY Condition : PEAK_BE_74 3m HF-ANT_130829 VERTICAL : RBW:1000.000kHz VBW:3000.000kHz SWT:Auto Detector : Peak Project : 600724 Mode : 8 Plane : X Ant : 1 Setting : 11.5 </pre>	 <p>Level (dBu/m) vs Frequency (MHz) graph for Fundamental band edge. The y-axis ranges from 10.0 to 140.0 dBu/m, and the x-axis ranges from 1000 to 3000 MHz. A peak is observed at 2462 MHz, labeled 'PEAK_74'.</p> <pre> Site : 03CH07-HY Condition : PEAK_74 3m HF-ANT_130829 VERTICAL : RBW:1000.000kHz VBW:3000.000kHz SWT:Auto Detector : Peak Project : 600724 Mode : 8 Plane : X Ant : 1 Setting : 11.5 </pre>
Avg.	 <p>Level (dBu/m) vs Frequency (MHz) graph for Vertical band edge. The y-axis ranges from 10.0 to 140.0 dBu/m, and the x-axis ranges from 2460 to 2500 MHz. An average level is indicated at 2462 MHz, labeled 'AVG_BE_54'.</p> <pre> Site : 03CH07-HY Condition : AVG_BE_54 3m HF-ANT_130829 VERTICAL : RBW:1000.000kHz VBW:1.000kHz SWT:Auto Detector : Peak Project : 600724 Mode : 8 Plane : X Ant : 1 Setting : 11.5 </pre>	 <p>Level (dBu/m) vs Frequency (MHz) graph for Fundamental band edge. The y-axis ranges from 10.0 to 140.0 dBu/m, and the x-axis ranges from 1000 to 3000 MHz. An average level is indicated at 2462 MHz, labeled 'AVG_54'.</p> <pre> Site : 03CH07-HY Condition : AVG_54 3m HF-ANT_130829 VERTICAL : RBW:1000.000kHz VBW:1.000kHz SWT:Auto Detector : Peak Project : 600724 Mode : 8 Plane : X Ant : 1 Setting : 11.5 </pre>

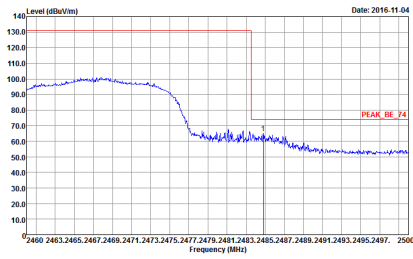
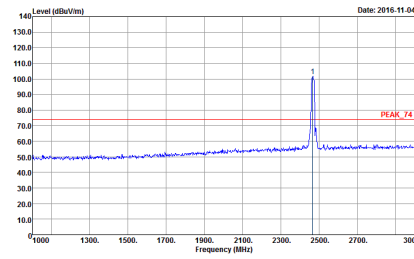
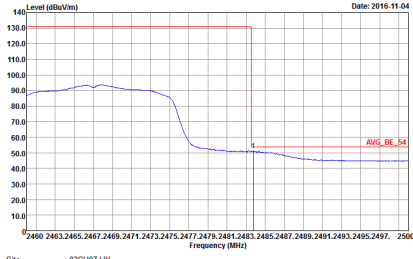
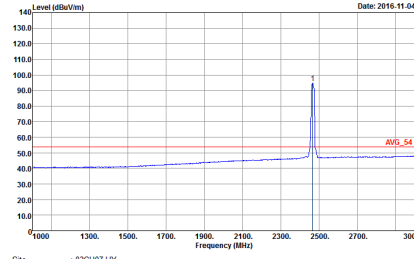

WIFI	2.4GHz 2400~2483.5MHz Band Edge @ 3m	
ANT	802.11g CH12 2467MHz	
2	Horizontal	Fundamental
Peak	 <p>Level (dBuV/m) vs Frequency (MHz) plot. The y-axis ranges from 10.0 to 140.0 dBuV/m, and the x-axis ranges from 2450 to 2500 MHz. A red line indicates a peak level of approximately 135 dBuV/m at 2467 MHz. The plot shows a signal level that drops from about 100 dBuV/m at 2400 MHz to about 60 dBuV/m at 2467 MHz, then rises to the peak level.</p> <p>Site : 03CH07-HY Condition : PEAK_BE_74 3m HF-ANT_130829 HORIZONTAL : RBW:1000.000kHz VBW:3000.000kHz SWT:Auto Detector : Peak Project : 600724 Mode : 9 Plane : X Ant : 1 Setting : 11.5</p>	 <p>Level (dBuV/m) vs Frequency (MHz) plot. The y-axis ranges from 10.0 to 140.0 dBuV/m, and the x-axis ranges from 1000 to 3000 MHz. A red line indicates a peak level of approximately 100 dBuV/m at 2467 MHz. The plot shows a signal level that is relatively flat around 60 dBuV/m until 2400 MHz, then rises to the peak level.</p> <p>Site : 03CH07-HY Condition : PEAK_74 3m HF-ANT_130829 HORIZONTAL : RBW:1000.000kHz VBW:3000.000kHz SWT:Auto Detector : Peak Project : 600724 Mode : 9 Plane : X Ant : 1 Setting : 11.5</p>
Avg.	 <p>Level (dBuV/m) vs Frequency (MHz) plot. The y-axis ranges from 10.0 to 140.0 dBuV/m, and the x-axis ranges from 2450 to 2500 MHz. A red line indicates an average level of approximately 60 dBuV/m at 2467 MHz. The plot shows a signal level that drops from about 90 dBuV/m at 2400 MHz to about 50 dBuV/m at 2467 MHz, then rises to the average level.</p> <p>Site : 03CH07-HY Condition : AVG_BE_54 3m HF-ANT_130829 HORIZONTAL : RBW:1000.000kHz VBW:1.000kHz SWT:Auto Detector : Peak Project : 600724 Mode : 9 Plane : X Ant : 1 Setting : 11.5</p>	 <p>Level (dBuV/m) vs Frequency (MHz) plot. The y-axis ranges from 10.0 to 140.0 dBuV/m, and the x-axis ranges from 1000 to 3000 MHz. A red line indicates an average level of approximately 50 dBuV/m at 2467 MHz. The plot shows a signal level that is relatively flat around 40 dBuV/m until 2400 MHz, then rises to the average level.</p> <p>Site : 03CH07-HY Condition : AVG_54 3m HF-ANT_130829 HORIZONTAL : RBW:1000.000kHz VBW:1.000kHz SWT:Auto Detector : Peak Project : 600724 Mode : 9 Plane : X Ant : 1 Setting : 11.5</p>

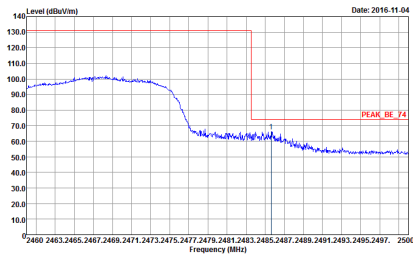
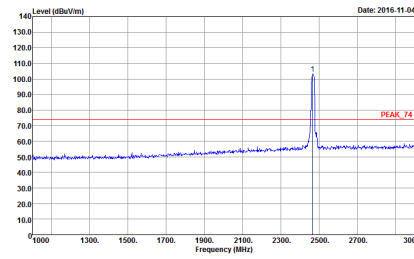
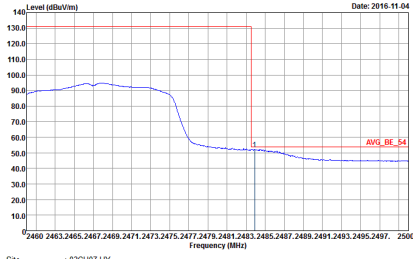
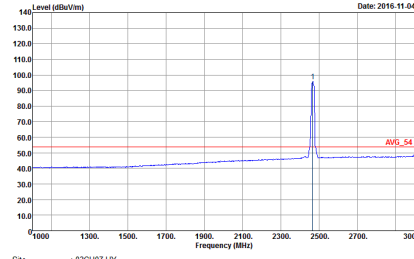

WIFI	2.4GHz 2400~2483.5MHz Band Edge @ 3m	
ANT	802.11g CH12 2467MHz	
2	Vertical	Fundamental
Peak	 <p>Date: 2016.11.04</p> <p>Site : 03CH07-HY Condition : PEAK_BE_74 3m HF-ANT_130829 VERTICAL : RBW:1000.000kHz VBW:3000.000kHz SWT:Auto Detector : Peak Project : 600724 Mode : 9 Plane : X Ant : 1 Setting : 11.5</p>	 <p>Date: 2016.11.04</p> <p>Site : 03CH07-HY Condition : PEAK_74 3m HF-ANT_130829 VERTICAL : RBW:1000.000kHz VBW:3000.000kHz SWT:Auto Detector : Peak Project : 600724 Mode : 9 Plane : X Ant : 1 Setting : 11.5</p>
Avg.	 <p>Date: 2016.11.04</p> <p>Site : 03CH07-HY Condition : AVG_BE_54 3m HF-ANT_130829 VERTICAL : RBW:1000.000kHz VBW:1.000kHz SWT:Auto Detector : Peak Project : 600724 Mode : 9 Plane : X Ant : 1 Setting : 11.5</p>	 <p>Date: 2016.11.04</p> <p>Site : 03CH07-HY Condition : AVG_54 3m HF-ANT_130829 VERTICAL : RBW:1000.000kHz VBW:1.000kHz SWT:Auto Detector : Peak Project : 600724 Mode : 9 Plane : X Ant : 1 Setting : 11.5</p>



WIFI	2.4GHz 2400~2483.5MHz Band Edge @ 3m	
ANT	802.11g CH13 2472MHz	
2	Horizontal	Fundamental
Peak	<p>Site : 03CH07-HY Condition : PEAK_BE_74 3m HF-ANT_130829 HORIZONTAL : RBW:1000.000kHz VBW:3000.000kHz SWT:Auto Detector : Peak Project : 600724 Mode : 10 Plane : X Ant : 1 Setting : 11.5</p>	<p>Site : 03CH07-HY Condition : PEAK_74 3m HF-ANT_130829 HORIZONTAL : RBW:1000.000kHz VBW:3000.000kHz SWT:Auto Detector : Peak Project : 600724 Mode : 10 Plane : X Ant : 1 Setting : 11.5</p>
Avg.	<p>Site : 03CH07-HY Condition : AVG_BE_54 3m HF-ANT_130829 HORIZONTAL : RBW:1000.000kHz VBW:1.000kHz SWT:Auto Detector : Peak Project : 600724 Mode : 10 Plane : X Ant : 1 Setting : 11.5</p>	<p>Site : 03CH07-HY Condition : AVG_54 3m HF-ANT_130829 HORIZONTAL : RBW:1000.000kHz VBW:1.000kHz SWT:Auto Detector : Peak Project : 600724 Mode : 10 Plane : X Ant : 1 Setting : 11.5</p>

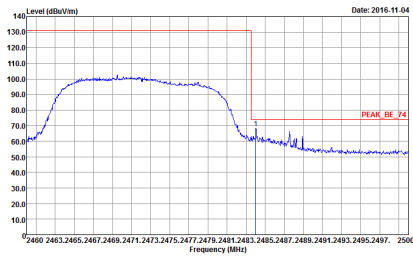
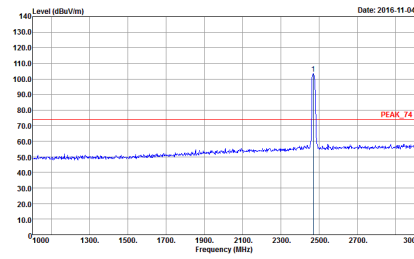
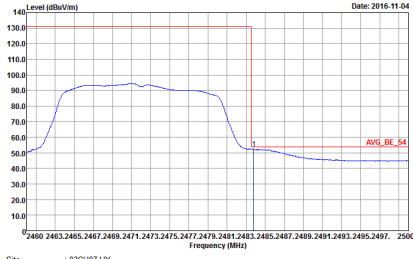
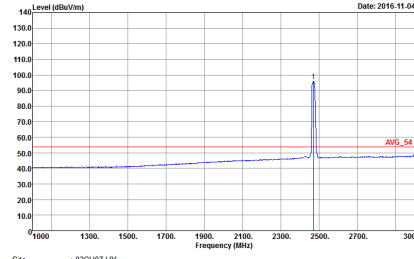

WIFI	2.4GHz 2400~2483.5MHz Band Edge @ 3m	
ANT	802.11g CH13 2472MHz	
2	Vertical	Fundamental
Peak	 <p>Level (dBu/m) vs Frequency (MHz) plot showing a peak at 2472 MHz. The y-axis ranges from 10.0 to 140.0 dBu/m, and the x-axis ranges from 2460 to 2500 MHz. A red line indicates the peak level at approximately 135 dBu/m.</p> <p>Site : 03CH07-HY Condition : PEAK_BE_74 3m HF-ANT_130829 VERTICAL : RBW:1000.000kHz VBW:3000.000kHz SWT:Auto Detector : Peak Project : 600724 Mode : 10 Plane : X Ant : 1 Setting : 11.5</p>	 <p>Level (dBu/m) vs Frequency (MHz) plot showing a sharp peak at 2472 MHz. The y-axis ranges from 10.0 to 140.0 dBu/m, and the x-axis ranges from 1900 to 3000 MHz. A red line indicates the peak level at approximately 105 dBu/m.</p> <p>Site : 03CH07-HY Condition : PEAK_74 3m HF-ANT_130829 VERTICAL : RBW:1000.000kHz VBW:3000.000kHz SWT:Auto Detector : Peak Project : 600724 Mode : 10 Plane : X Ant : 1 Setting : 11.5</p>
Avg.	 <p>Level (dBu/m) vs Frequency (MHz) plot showing the average level across the band. The y-axis ranges from 10.0 to 140.0 dBu/m, and the x-axis ranges from 2460 to 2500 MHz. A red line indicates the average level at approximately 55 dBu/m.</p> <p>Site : 03CH07-HY Condition : AVG_BE_54 3m HF-ANT_130829 VERTICAL : RBW:1000.000kHz VBW:1.000kHz SWT:Auto Detector : Peak Project : 600724 Mode : 10 Plane : X Ant : 1 Setting : 11.5</p>	 <p>Level (dBu/m) vs Frequency (MHz) plot showing the average level across the band. The y-axis ranges from 10.0 to 140.0 dBu/m, and the x-axis ranges from 1900 to 3000 MHz. A red line indicates the average level at approximately 55 dBu/m.</p> <p>Site : 03CH07-HY Condition : AVG_54 3m HF-ANT_130829 VERTICAL : RBW:1000.000kHz VBW:1.000kHz SWT:Auto Detector : Peak Project : 600724 Mode : 10 Plane : X Ant : 1 Setting : 11.5</p>



2.4GHz 2400~2483.5MHz

WIFI 802.11n HT20 (Band Edge @ 3m)

WIFI	2.4GHz 2400~2483.5MHz Band Edge @ 3m	
ANT	802.11n HT20 CH01 2412MHz	
2	Horizontal	Fundamental
Peak	<p>Site : 03CH07-HY Condition : PEAK_BE_74 3m HF-ANT_130829 HORIZONTAL REBW:1000.000kHz VBW:3000.000kHz SWT:Auto Detector : Peak Project : 600724 Mode : T1 Plane : X Ant : 1 Setting : 15.5</p>	<p>Site : 03CH07-HY Condition : PEAK_74 3m HF-ANT_130829 HORIZONTAL REBW:1000.000kHz VBW:3000.000kHz SWT:Auto Detector : Peak Project : 600724 Mode : T1 Plane : X Ant : 1 Setting : 15.5</p>
Avg.	<p>Site : 03CH07-HY Condition : AVG_BE_54 3m HF-ANT_130829 HORIZONTAL REBW:1000.000kHz VBW:1.000kHz SWT:Auto Detector : Peak Project : 600724 Mode : T1 Plane : X Ant : 1 Setting : 15.5</p>	<p>Site : 03CH07-HY Condition : AVG_54 3m HF-ANT_130829 HORIZONTAL REBW:1000.000kHz VBW:1.000kHz SWT:Auto Detector : Peak Project : 600724 Mode : T1 Plane : X Ant : 1 Setting : 15.5</p>

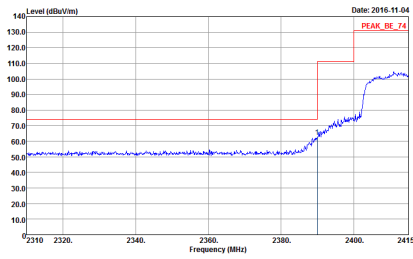
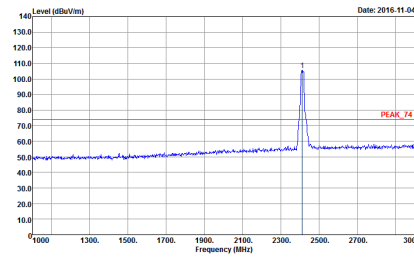
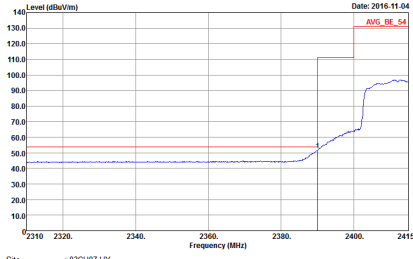
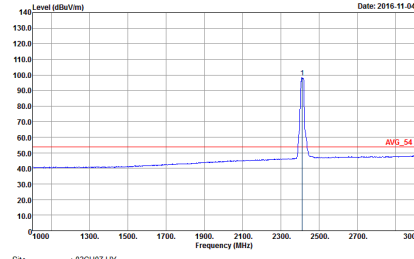

WIFI	2.4GHz 2400~2483.5MHz Band Edge @ 3m	
ANT	802.11n HT20 CH01 2412MHz	
2	Vertical	Fundamental
Peak	 <p>Date: 2016-11-04 PEAK_BE_74</p> <p>Site : 03CH07-HY Condition : PEAK_BE_74 3m HF-ANT_130829 VERTICAL RBW:1000.000kHz VBW:3000.000kHz SWT:Auto Detector : Peak Project : 600724 Mode : 11 Plane : X Ant : 1 Setting : 15.5</p>	 <p>Date: 2016-11-04 PEAK_74</p> <p>Site : 03CH07-HY Condition : PEAK_74 3m HF-ANT_130829 VERTICAL RBW:1000.000kHz VBW:3000.000kHz SWT:Auto Detector : Peak Project : 600724 Mode : 11 Plane : X Ant : 1 Setting : 15.5</p>
Avg.	 <p>Date: 2016-11-04 AVG_BE_54</p> <p>Site : 03CH07-HY Condition : AVG_BE_54 3m HF-ANT_130829 VERTICAL RBW:1000.000kHz VBW:1.000kHz SWT:Auto Detector : Peak Project : 600724 Mode : 11 Plane : X Ant : 1 Setting : 15.5</p>	 <p>Date: 2016-11-04 AVG_54</p> <p>Site : 03CH07-HY Condition : AVG_54 3m HF-ANT_130829 VERTICAL RBW:1000.000kHz VBW:1.000kHz SWT:Auto Detector : Peak Project : 600724 Mode : 11 Plane : X Ant : 1 Setting : 15.5</p>

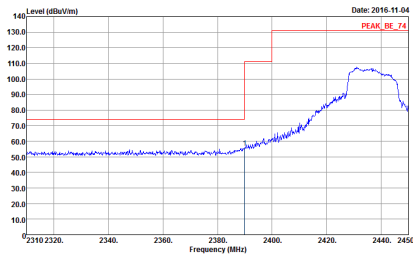
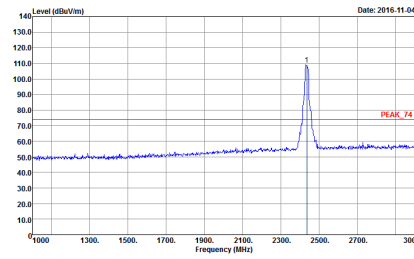
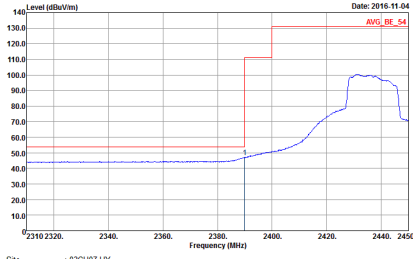
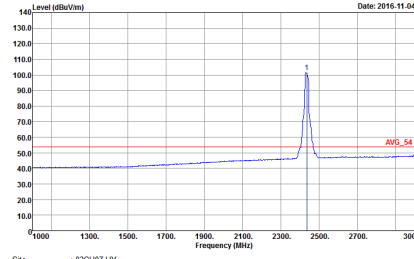

WIFI	2.4GHz 2400~2483.5MHz Band Edge @ 3m	
ANT	802.11n HT20 CH06 2437MHz - L	
2	Horizontal	Fundamental
Peak	 <p>Date: 2016-11-04</p> <p>Level (dBuV/m)</p> <p>Frequency (MHz)</p> <p>PEAK_BE_74</p> <pre> Site : 03CH07-HY Condition : PEAK_BE_74 3m HF-ANT_130829 HORIZONTAL : RBW:1000.000kHz VBW:3000.000kHz SWT:Auto Detector : Peak Project : 600724 Mode : 12 Plane : X Ant : 1 Setting : 20 </pre>	 <p>Date: 2016-11-04</p> <p>Level (dBuV/m)</p> <p>Frequency (MHz)</p> <p>PEAK_74</p> <pre> Site : 03CH07-HY Condition : PEAK_74 3m HF-ANT_130829 HORIZONTAL : RBW:1000.000kHz VBW:3000.000kHz SWT:Auto Detector : Peak Project : 600724 Mode : 12 Plane : X Ant : 1 Setting : 20 </pre>
Avg.	 <p>Date: 2016-11-04</p> <p>Level (dBuV/m)</p> <p>Frequency (MHz)</p> <p>AVG_BE_54</p> <pre> Site : 03CH07-HY Condition : AVG_BE_54 3m HF-ANT_130829 HORIZONTAL : RBW:1000.000kHz VBW:1.000kHz SWT:Auto Detector : Peak Project : 600724 Mode : 12 Plane : X Ant : 1 Setting : 20 </pre>	 <p>Date: 2016-11-04</p> <p>Level (dBuV/m)</p> <p>Frequency (MHz)</p> <p>AVG_54</p> <pre> Site : 03CH07-HY Condition : AVG_54 3m HF-ANT_130829 HORIZONTAL : RBW:1000.000kHz VBW:1.000kHz SWT:Auto Detector : Peak Project : 600724 Mode : 12 Plane : X Ant : 1 Setting : 20 </pre>



WIFI	2.4GHz 2400~2483.5MHz Band Edge @ 3m	
ANT	802.11n HT20 CH06 2437MHz - R	
2	Horizontal	Fundamental
Peak	<p>Date: 2016.11.04</p> <p>Site : 03CH07-HY Condition : PEAK_BE_74 3m HF-ANT_130829 HORIZONTAL : RBW:1000.000kHz VBW:3000.000kHz SWT:Auto Detector : Peak Project : 600724 Mode : 12 Plane : X Ant : 1 Setting : 20</p>	Left blank
Avg.	<p>Date: 2016.11.04</p> <p>Site : 03CH07-HY Condition : AVG_BE_54 3m HF-ANT_130829 HORIZONTAL : RBW:1000.000kHz VBW:1.000kHz SWT:Auto Detector : Peak Project : 600724 Mode : 12 Plane : X Ant : 1 Setting : 20</p>	Left blank

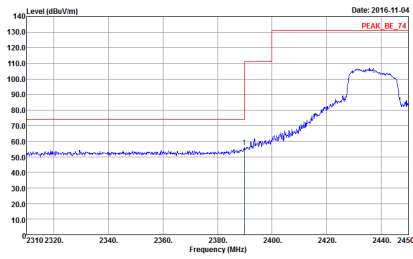
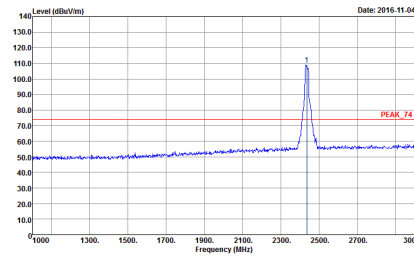
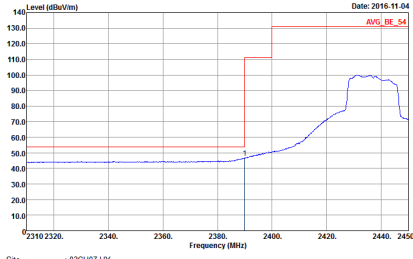
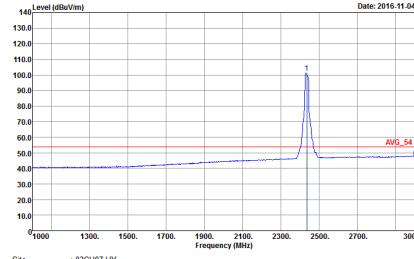

WIFI	2.4GHz 2400~2483.5MHz Band Edge @ 3m	
ANT	802.11n HT20 CH06 2437MHz - L	
2	Vertical	Fundamental
Peak	 <p>Level (dBuV/m) vs Frequency (MHz) plot showing a peak at 2437 MHz. The y-axis ranges from 10.0 to 140.0 dBuV/m, and the x-axis ranges from 2310 to 2450 MHz. A red line indicates the peak level at approximately 135 dBuV/m.</p> <p>Site : 03CH07-HY Condition : PEAK_BE_74 3m HF-ANT_130829 VERTICAL RBW:1000.000kHz VBW:3000.000kHz SWT:Auto Detector : Peak Project : 600724 Mode : 12 Plane : X Ant : 1 Setting : 20</p>	 <p>Level (dBuV/m) vs Frequency (MHz) plot showing a sharp peak at 2437 MHz. The y-axis ranges from 10.0 to 140.0 dBuV/m, and the x-axis ranges from 1000 to 3000 MHz. A red line indicates the peak level at approximately 75 dBuV/m.</p> <p>Site : 03CH07-HY Condition : PEAK_74 3m HF-ANT_130829 VERTICAL RBW:1000.000kHz VBW:3000.000kHz SWT:Auto Detector : Peak Project : 600724 Mode : 12 Plane : X Ant : 1 Setting : 20</p>
Avg.	 <p>Level (dBuV/m) vs Frequency (MHz) plot showing the average signal level. The y-axis ranges from 10.0 to 140.0 dBuV/m, and the x-axis ranges from 2310 to 2450 MHz. A red line indicates the average level at approximately 135 dBuV/m.</p> <p>Site : 03CH07-HY Condition : AVG_BE_54 3m HF-ANT_130829 VERTICAL RBW:1000.000kHz VBW:1.000kHz SWT:Auto Detector : Peak Project : 600724 Mode : 12 Plane : X Ant : 1 Setting : 20</p>	 <p>Level (dBuV/m) vs Frequency (MHz) plot showing the average signal level. The y-axis ranges from 10.0 to 140.0 dBuV/m, and the x-axis ranges from 1000 to 3000 MHz. A red line indicates the average level at approximately 75 dBuV/m.</p> <p>Site : 03CH07-HY Condition : AVG_54 3m HF-ANT_130829 VERTICAL RBW:1000.000kHz VBW:1.000kHz SWT:Auto Detector : Peak Project : 600724 Mode : 12 Plane : X Ant : 1 Setting : 20</p>



WIFI	2.4GHz 2400~2483.5MHz Band Edge @ 3m	
ANT	802.11n HT20 CH06 2437MHz - R	
2	Vertical	Fundamental
Peak	<p>Level (dBuV/m) vs Frequency (MHz) plot. The y-axis ranges from 10.0 to 140.0 dBuV/m, and the x-axis ranges from 2430 to 2500 MHz. A blue line shows the signal level, which is around 100 dBuV/m at 2430 MHz and drops to about 50 dBuV/m at 2483.5 MHz. A red box highlights the peak at 2483.5 MHz, labeled 'PEAK_BE_74'. The date is 2016.11.04.</p> <p>Site : 03CH07-HY Condition : PEAK_BE_74 3m HF-ANT_130829 VERTICAL RBW: 1000.000kHz VBW: 3000.000kHz SWT: Auto Detector : Peak Project : 600724 Mode : 12 Plane : X Ant : 1 Setting : 20</p>	Left Blank
Avg.	<p>Level (dBuV/m) vs Frequency (MHz) plot. The y-axis ranges from 10.0 to 140.0 dBuV/m, and the x-axis ranges from 2430 to 2500 MHz. A blue line shows the average signal level, which is around 100 dBuV/m at 2430 MHz and drops to about 50 dBuV/m at 2483.5 MHz. A red box highlights the average level at 2483.5 MHz, labeled 'AVG_BE_54'. The date is 2016.11.04.</p> <p>Site : 03CH07-HY Condition : AVG_BE_54 3m HF-ANT_130829 VERTICAL RBW: 1000.000kHz VBW: 1.000kHz SWT: Auto Detector : Peak Project : 600724 Mode : 12 Plane : X Ant : 1 Setting : 20</p>	Left Blank

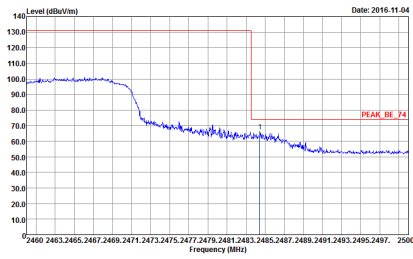
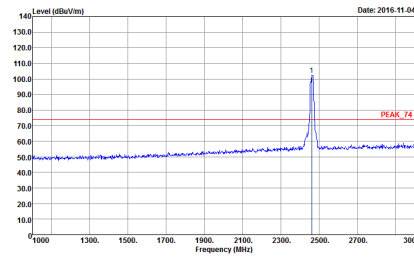
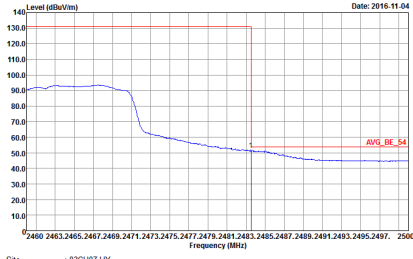
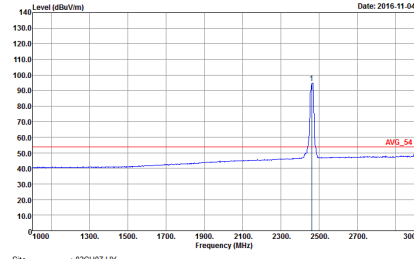

WIFI	2.4GHz 2400~2483.5MHz Band Edge @ 3m	
ANT	802.11n HT20 CH11 2462MHz	
2	Horizontal	Fundamental
Peak	 <p>Date: 2016.11.04</p> <p>Site : 03CH07-HY Condition : PEAK_BE_74 3m HF-ANT_130829 HORIZONTAL : RBW:1000.000kHz VBW:3000.000kHz SWT:Auto Detector : Peak Project : 600724 Mode : 13 Plane : X Ant : 1 Setting : 11.5</p>	 <p>Date: 2016.11.04</p> <p>Site : 03CH07-HY Condition : PEAK_74 3m HF-ANT_130829 HORIZONTAL : RBW:1000.000kHz VBW:3000.000kHz SWT:Auto Detector : Peak Project : 600724 Mode : 13 Plane : X Ant : 1 Setting : 11.5</p>
Avg.	 <p>Date: 2016.11.04</p> <p>Site : 03CH07-HY Condition : AVG_BE_54 3m HF-ANT_130829 HORIZONTAL : RBW:1000.000kHz VBW:1.000kHz SWT:Auto Detector : Peak Project : 600724 Mode : 13 Plane : X Ant : 1 Setting : 11.5</p>	 <p>Date: 2016.11.04</p> <p>Site : 03CH07-HY Condition : AVG_54 3m HF-ANT_130829 HORIZONTAL : RBW:1000.000kHz VBW:1.000kHz SWT:Auto Detector : Peak Project : 600724 Mode : 13 Plane : X Ant : 1 Setting : 11.5</p>

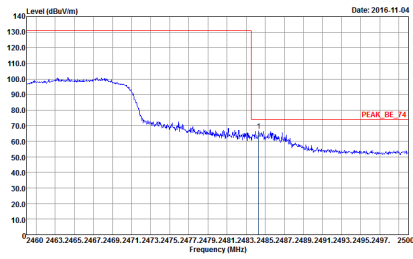
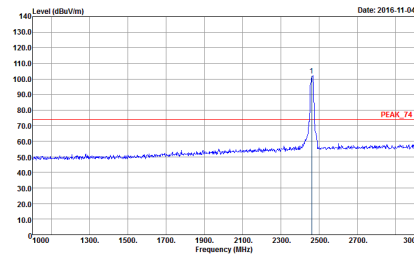
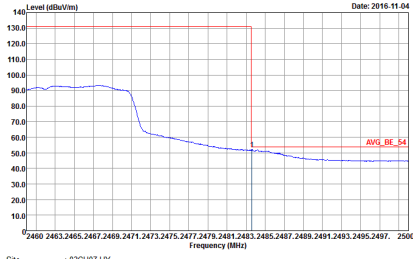
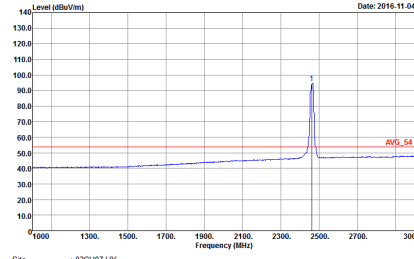

WIFI	2.4GHz 2400~2483.5MHz Fundamental @ 3m	
ANT	802.11n HT20 CH11 2462MHz	
2	Vertical	Fundamental
Peak	 <p>Date: 2016.11.04</p> <p>Site : 03CH07-HY Condition : PEAK_BE_74 3m HF-ANT_130829 VERTICAL : RBW:1000.000kHz VBW:3000.000kHz SWT:Auto Detector : Peak Project : 600724 Mode : 13 Plane : X Ant : 1 Setting : 11.5</p>	 <p>Date: 2016.11.04</p> <p>Site : 03CH07-HY Condition : PEAK_74 3m HF-ANT_130829 VERTICAL : RBW:1000.000kHz VBW:3000.000kHz SWT:Auto Detector : Peak Project : 600724 Mode : 13 Plane : X Ant : 1 Setting : 11.5</p>
Avg.	 <p>Date: 2016.11.04</p> <p>Site : 03CH07-HY Condition : AVG_BE_54 3m HF-ANT_130829 VERTICAL : RBW:1000.000kHz VBW:1.000kHz SWT:Auto Detector : Peak Project : 600724 Mode : 13 Plane : X Ant : 1 Setting : 11.5</p>	 <p>Date: 2016.11.04</p> <p>Site : 03CH07-HY Condition : AVG_54 3m HF-ANT_130829 VERTICAL : RBW:1000.000kHz VBW:1.000kHz SWT:Auto Detector : Peak Project : 600724 Mode : 13 Plane : X Ant : 1 Setting : 11.5</p>

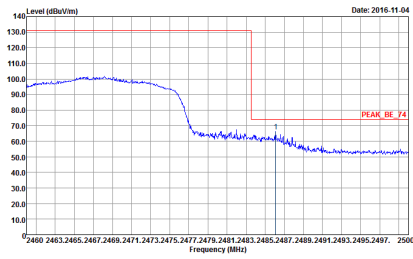
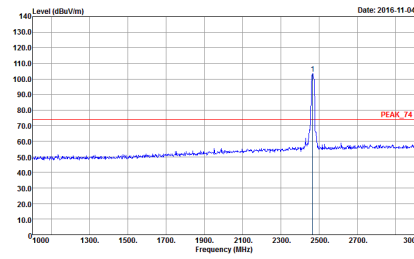
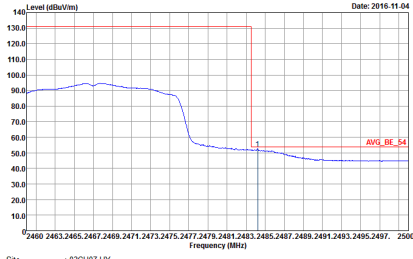
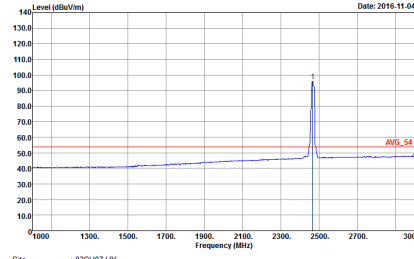

WIFI	2.4GHz 2400~2483.5MHz Band Edge @ 3m	
ANT	802.11n HT20 CH12 2467MHz	
2	Horizontal	Fundamental
Peak	 <p>Site : 03CH07-HY Condition : PEAK_BE_74 3m HF-ANT_130829 HORIZONTAL RBW: 1000.000kHz VBW:3000.000kHz SWT:Auto Detector : Peak Project : 600724 Mode : 14 Plane : X Ant : 1 Setting : 11</p>	 <p>Site : 03CH07-HY Condition : PEAK_74 3m HF-ANT_130829 HORIZONTAL RBW: 1000.000kHz VBW:3000.000kHz SWT:Auto Detector : Peak Project : 600724 Mode : 14 Plane : X Ant : 1 Setting : 11</p>
Avg.	 <p>Site : 03CH07-HY Condition : AVG_BE_54 3m HF-ANT_130829 HORIZONTAL RBW: 1000.000kHz VBW:1.000kHz SWT:Auto Detector : Peak Project : 600724 Mode : 14 Plane : X Ant : 1 Setting : 11</p>	 <p>Site : 03CH07-HY Condition : AVG_54 3m HF-ANT_130829 HORIZONTAL RBW: 1000.000kHz VBW:1.000kHz SWT:Auto Detector : Peak Project : 600724 Mode : 14 Plane : X Ant : 1 Setting : 11</p>

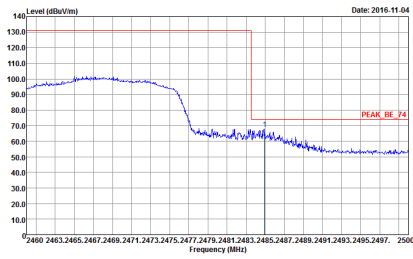
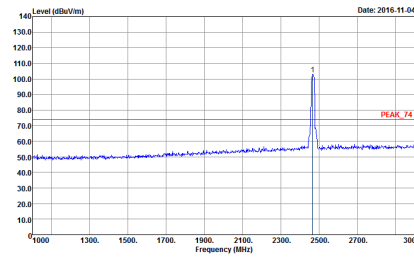
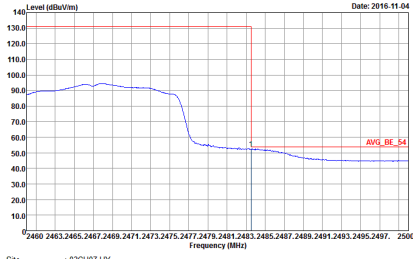
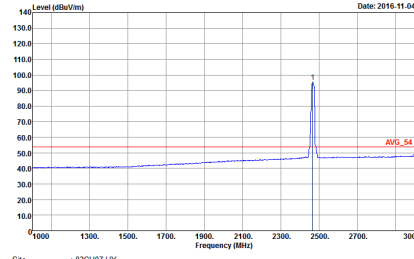

WIFI	2.4GHz 2400~2483.5MHz Fundamental @ 3m	
ANT	802.11n HT20 CH12 2467MHz	
2	Vertical	Fundamental
Peak	 <p>Level (dBu/m) vs Frequency (MHz) plot showing a peak at 2467 MHz. The y-axis ranges from 10.0 to 140.0 dBu/m, and the x-axis ranges from 2450 to 2500 MHz. A red horizontal line indicates the peak level at approximately 74 dBu/m.</p> <p>Site : 03CH07-HY Condition : PEAK_BE_74 3m HF-ANT_130829 VERTICAL : RBW:1000.000kHz VBW:3000.000kHz SWT:Auto Detector : Peak Project : 600724 Mode : 14 Plane : X Ant : 1 Setting : 11</p>	 <p>Level (dBu/m) vs Frequency (MHz) plot showing a peak at 2467 MHz. The y-axis ranges from 10.0 to 140.0 dBu/m, and the x-axis ranges from 1900 to 3000 MHz. A red horizontal line indicates the peak level at approximately 74 dBu/m.</p> <p>Site : 03CH07-HY Condition : PEAK_74 3m HF-ANT_130829 VERTICAL : RBW:1000.000kHz VBW:3000.000kHz SWT:Auto Detector : Peak Project : 600724 Mode : 14 Plane : X Ant : 1 Setting : 11</p>
Avg.	 <p>Level (dBu/m) vs Frequency (MHz) plot showing the average level. The y-axis ranges from 10.0 to 140.0 dBu/m, and the x-axis ranges from 2450 to 2500 MHz. A red horizontal line indicates the average level at approximately 54 dBu/m.</p> <p>Site : 03CH07-HY Condition : AVG_BE_54 3m HF-ANT_130829 VERTICAL : RBW:1000.000kHz VBW:1.000kHz SWT:Auto Detector : Peak Project : 600724 Mode : 14 Plane : X Ant : 1 Setting : 11</p>	 <p>Level (dBu/m) vs Frequency (MHz) plot showing the average level. The y-axis ranges from 10.0 to 140.0 dBu/m, and the x-axis ranges from 1900 to 3000 MHz. A red horizontal line indicates the average level at approximately 54 dBu/m.</p> <p>Site : 03CH07-HY Condition : AVG_54 3m HF-ANT_130829 VERTICAL : RBW:1000.000kHz VBW:1.000kHz SWT:Auto Detector : Peak Project : 600724 Mode : 14 Plane : X Ant : 1 Setting : 11</p>

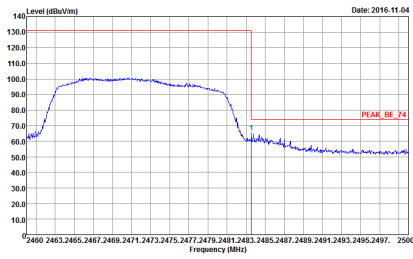
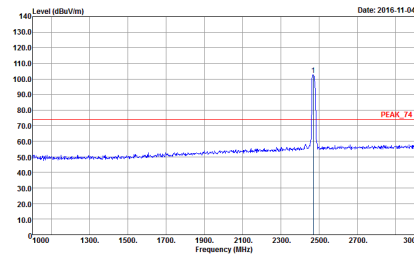
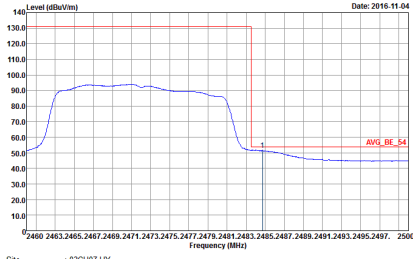
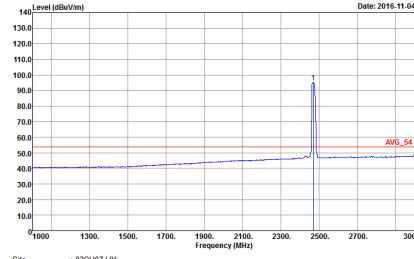

WIFI	2.4GHz 2400~2483.5MHz Band Edge @ 3m	
ANT	802.11n HT20 CH13 2472MHz	
2	Horizontal	Fundamental
Peak	 <p>Date: 2016.11.04</p> <p>Level (dBuV/m)</p> <p>Frequency (MHz)</p> <p>PEAK_BE_74</p> <pre> Site : 03CH07-HY Condition : PEAK_BE_74 3m HF-ANT_130829 HORIZONTAL : RBW:1000.000kHz VBW:3000.000kHz SWT:Auto Detector : Peak Project : 600724 Mode : 15 Plane : X Ant : 1 Setting : 11 </pre>	 <p>Date: 2016.11.04</p> <p>Level (dBuV/m)</p> <p>Frequency (MHz)</p> <p>PEAK_74</p> <pre> Site : 03CH07-HY Condition : PEAK_74 3m HF-ANT_130829 HORIZONTAL : RBW:1000.000kHz VBW:3000.000kHz SWT:Auto Detector : Peak Project : 600724 Mode : 15 Plane : X Ant : 1 Setting : 11 </pre>
Avg.	 <p>Date: 2016.11.04</p> <p>Level (dBuV/m)</p> <p>Frequency (MHz)</p> <p>AVG_BE_54</p> <pre> Site : 03CH07-HY Condition : AVG_BE_54 3m HF-ANT_130829 HORIZONTAL : RBW:1000.000kHz VBW:1.000kHz SWT:Auto Detector : Peak Project : 600724 Mode : 15 Plane : X Ant : 1 Setting : 11 </pre>	 <p>Date: 2016.11.04</p> <p>Level (dBuV/m)</p> <p>Frequency (MHz)</p> <p>AVG_54</p> <pre> Site : 03CH07-HY Condition : AVG_54 3m HF-ANT_130829 HORIZONTAL : RBW:1000.000kHz VBW:1.000kHz SWT:Auto Detector : Peak Project : 600724 Mode : 15 Plane : X Ant : 1 Setting : 11 </pre>

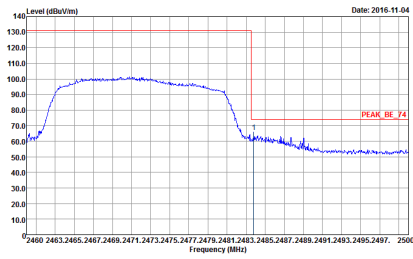
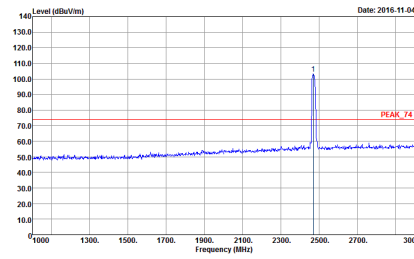
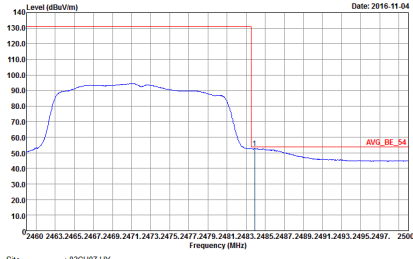
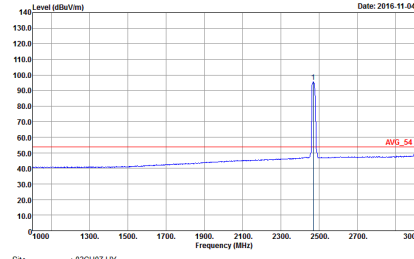

WIFI	2.4GHz 2400~2483.5MHz Fundamental @ 3m	
ANT	802.11n HT20 CH13 2472MHz	
2	Vertical	Fundamental
Peak	 <p>Site : 03CH07-HY Condition : PEAK_BE_74 3m HF-ANT_130829 VERTICAL RBW:1000.000kHz VBW:3000.000kHz SWT:Auto Detector : Peak Project : 600724 Mode : 15 Plane : X Ant : 1 Setting : 11</p>	 <p>Site : 03CH07-HY Condition : PEAK_74 3m HF-ANT_130829 VERTICAL RBW:1000.000kHz VBW:3000.000kHz SWT:Auto Detector : Peak Project : 600724 Mode : 15 Plane : X Ant : 1 Setting : 11</p>
Avg.	 <p>Site : 03CH07-HY Condition : AVG_BE_54 3m HF-ANT_130829 VERTICAL RBW:1000.000kHz VBW:1.000kHz SWT:Auto Detector : Peak Project : 600724 Mode : 15 Plane : X Ant : 1 Setting : 11</p>	 <p>Site : 03CH07-HY Condition : AVG_54 3m HF-ANT_130829 VERTICAL RBW:1000.000kHz VBW:1.000kHz SWT:Auto Detector : Peak Project : 600724 Mode : 15 Plane : X Ant : 1 Setting : 11</p>



2.4GHz 2400~2483.5MHz

WIFI 802.11b (Harmonic @ 3m)

WIFI	2.4GHz 2400~2483.5MHz Harmonic @ 3m	
ANT	802.11b CH01 2412MHz	
2	Horizontal	Vertical
<p>Peak</p> <p>Avg.</p>	<p>Site : 03CH07-HY Condition : PEAK_74 3m HF-ANT_130829 HORIZONTAL Detector : Peak Project : 600724 Mode : 1 Plane : X Ant : 1 Setting : 19.5</p>	<p>Site : 03CH07-HY Condition : PEAK_74 3m HF-ANT_130829 VERTICAL Detector : Peak Project : 600724 Mode : 1 Plane : X Ant : 1 Setting : 19.5</p>

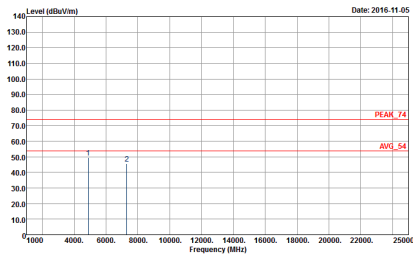
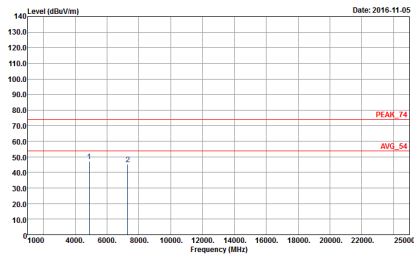

WIFI	2.4GHz 2400~2483.5MHz Harmonic @ 3m	
ANT	802.11b CH06 2437MHz	
2	Horizontal	Vertical
Peak Avg.	 <p>Site : 03CH07-HY Condition : PEAK_74 3m SHF-EHF_131029 HORIZONTAL Detector : Peak Project : 600724 Mode : 2 Plane : X Ant : 1 Setting : 19.5</p>	 <p>Site : 03CH07-HY Condition : PEAK_74 3m SHF-EHF_131029 VERTICAL Detector : Peak Project : 600724 Mode : 2 Plane : X Ant : 1 Setting : 19.5</p>



WIFI	2.4GHz 2400~2483.5MHz Harmonic @ 3m	
ANT	802.11b CH11 2462MHz	
2	Horizontal	Vertical
Peak Avg.		



WIFI	2.4GHz 2400~2483.5MHz Harmonic @ 3m	
ANT	802.11b CH12 2467MHz	
2	Horizontal	Vertical
<p>Peak Avg.</p>		



WIFI	2.4GHz 2400~2483.5MHz Harmonic @ 3m	
ANT	802.11b CH13 2472MHz	
2	Horizontal	Vertical
Peak Avg.		



2.4GHz 2400~2483.5MHz

WIFI 802.11g (Harmonic @ 3m)

WIFI	2.4GHz 2400~2483.5MHz Harmonic @ 3m	
ANT	802.11g CH01 2412MHz	
2	Horizontal	Vertical
Peak Avg.		



WIFI	2.4GHz 2400~2483.5MHz Harmonic @ 3m	
ANT	802.11g CH06 2437MHz	
2	Horizontal	Vertical
Peak Avg.		



WIFI	2.4GHz 2400~2483.5MHz Harmonic @ 3m	
ANT	802.11g CH11 2462MHz	
2	Horizontal	Vertical
Peak Avg.		

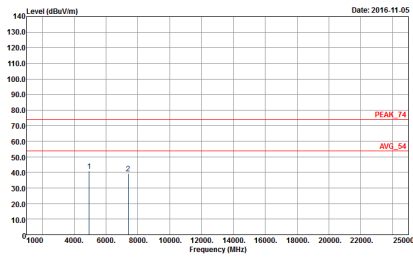
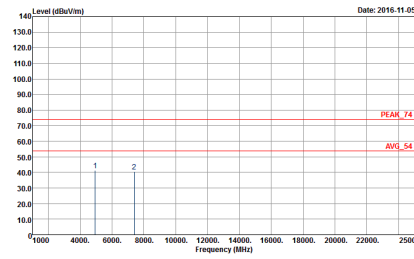

WIFI	2.4GHz 2400~2483.5MHz Harmonic @ 3m	
ANT	802.11g CH12 2467MHz	
2	Horizontal	Vertical
Peak Avg.	 <p>Site : 03CH07-HY Condition : PEAK_74 3m SHF-EHF_131029 HORIZONTAL Detector : Peak Project : 600724 Mode : 9 Plane : X Ant : 1 Setting : 11.5</p>	 <p>Site : 03CH07-HY Condition : PEAK_74 3m SHF-EHF_131029 VERTICAL Detector : Peak Project : 600724 Mode : 9 Plane : X Ant : 1 Setting : 11.5</p>



WIFI	2.4GHz 2400~2483.5MHz Harmonic @ 3m	
ANT	802.11g CH13 2472MHz	
2	Horizontal	Vertical
Peak Avg.		



2.4GHz 2400~2483.5MHz

WIFI 802.11n HT20 (Harmonic @ 3m)

WIFI	2.4GHz 2400~2483.5MHz Harmonic @ 3m	
ANT	802.11n HT20 CH01 2412MHz	
2	Horizontal	Vertical
Peak Avg.	<p>Site : 03CH07-HY Condition : PEAK_74 3m SHF-EHF_131029 HORIZONTAL Detector : Peak Project : 600724 Mode : 11 Plane : X Ant : 1 Setting : 15.5</p>	<p>Site : 03CH07-HY Condition : PEAK_74 3m SHF-EHF_131029 VERTICAL Detector : Peak Project : 600724 Mode : 11 Plane : X Ant : 1 Setting : 15.5</p>



WIFI	2.4GHz 2400~2483.5MHz Harmonic @ 3m	
ANT	802.11n HT20 CH06 2437MHz	
2	Horizontal	Vertical
Peak Avg.		



WIFI	2.4GHz 2400~2483.5MHz Harmonic @ 3m	
ANT	802.11n HT20 CH11 2462MHz	
2	Horizontal	Vertical
Peak Avg.		

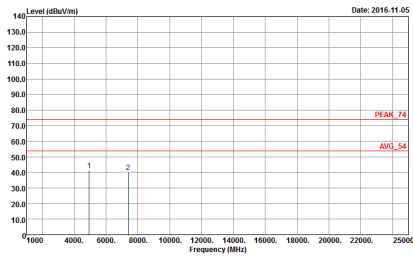
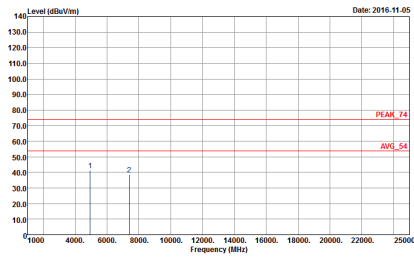

WIFI	2.4GHz 2400~2483.5MHz Harmonic @ 3m	
ANT	802.11n HT20 CH12 2467MHz	
2	Horizontal	Vertical
Peak Avg.	 <p>Site : 03CH07-HY Condition : PEAK_74 3m SHF-EHF_131029 HORIZONTAL Detector : Peak Project : 600724 Mode : 14 Plane : X Ant : 1 Setting : 11</p>	 <p>Site : 03CH07-HY Condition : PEAK_74 3m SHF-EHF_131029 VERTICAL Detector : Peak Project : 600724 Mode : 14 Plane : X Ant : 1 Setting : 11</p>



WIFI	2.4GHz 2400~2483.5MHz Harmonic @ 3m	
ANT	802.11n HT20 CH13 2472MHz	
2	Horizontal	Vertical
Peak Avg.		



Emission below 1GHz
2.4GHz WIFI 802.11n HT20 (LF)

Table with 2 columns: Horizontal and Vertical. Each column contains a graph of Level (dBuV/m) vs Frequency (MHz) and associated test parameters like Site, Condition, Project, Mode, Plane, and Ant.

QP / Peak



Appendix D. Duty Cycle Plots

<EUT with J300 Antenna>

Band	Duty Cycle(%)	T(us)	1/T(kHz)	VBW Setting
802.11b	100	-	-	10Hz
802.11g	96.55	1400	0.71	1kHz
2.4GHz 802.11n HT20	96.32	0.76	1kHz	

802.11b

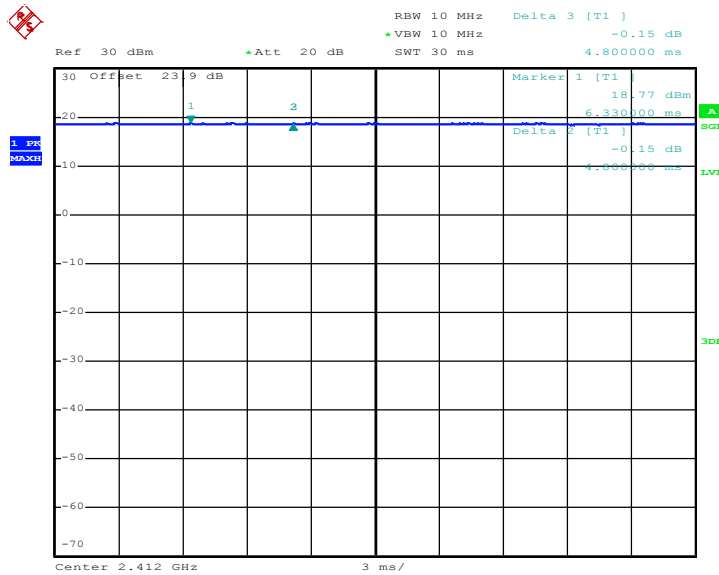

Date: 8.NOV.2016 15:45:43



802.11g

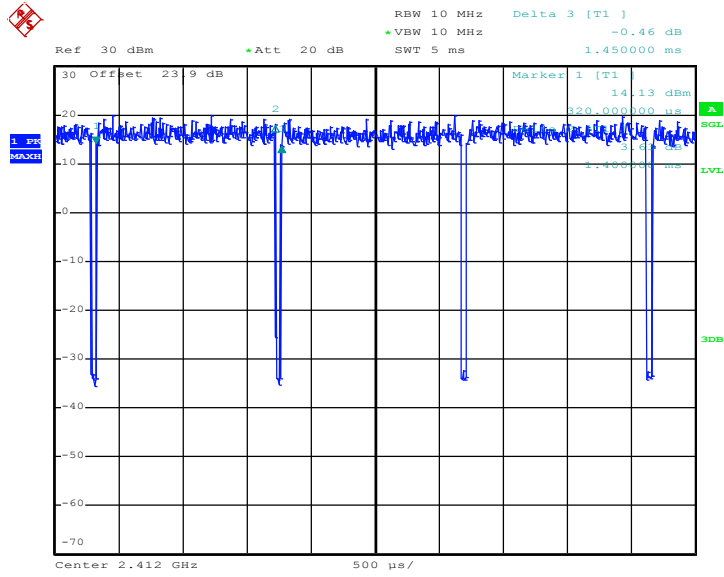

Date: 8.NOV.2016 16:34:32

802.11n HT20

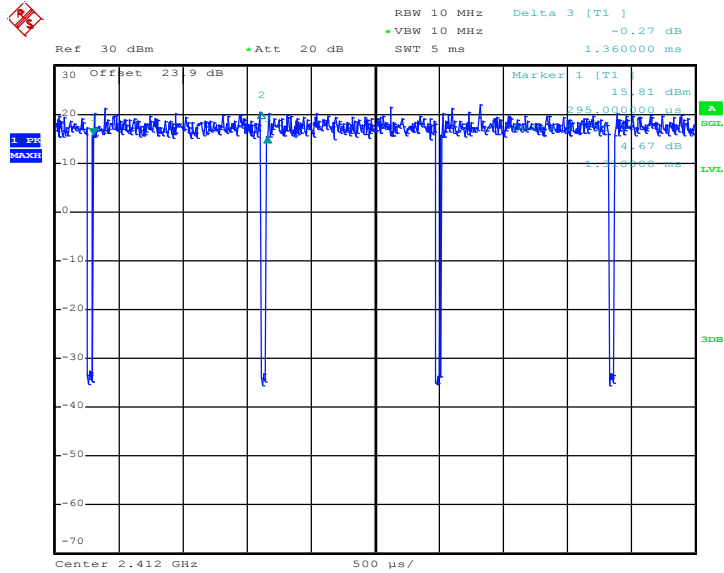

Date: 8.NOV.2016 17:33:23



<EUT with J301 Antenna>

Band	Duty Cycle(%)	T(us)	1/T(kHz)	VBW Setting
802.11b	100	-	-	10Hz
802.11g	97.22	1400	0.71	1kHz
2.4GHz 802.11n HT20	97.04	1310	0.76	1kHz

802.11b

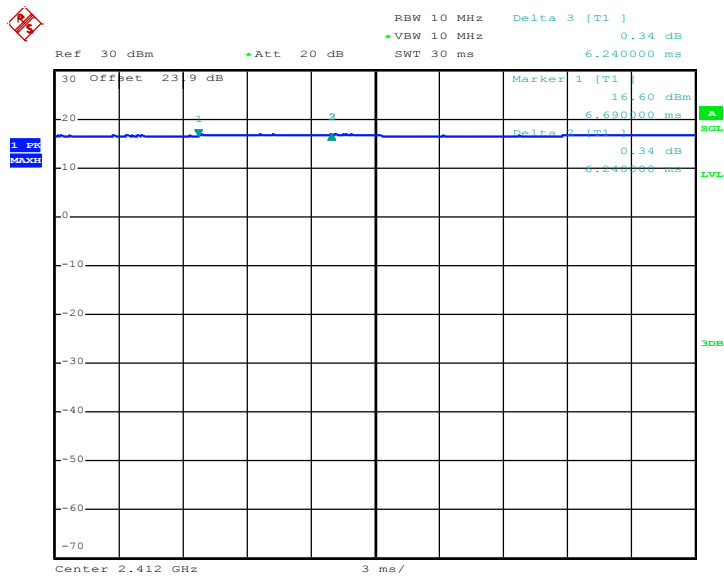

Date: 8.NOV.2016 17:42:56



802.11g

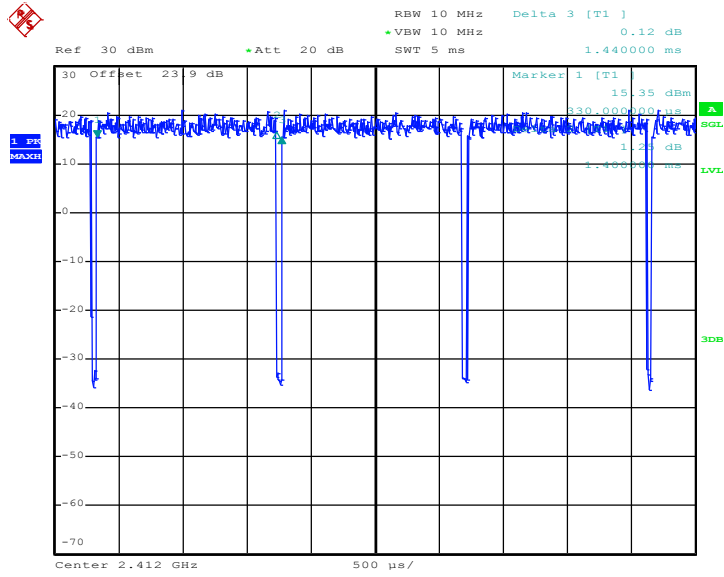

Date: 8.NOV.2016 17:49:55

802.11n HT20

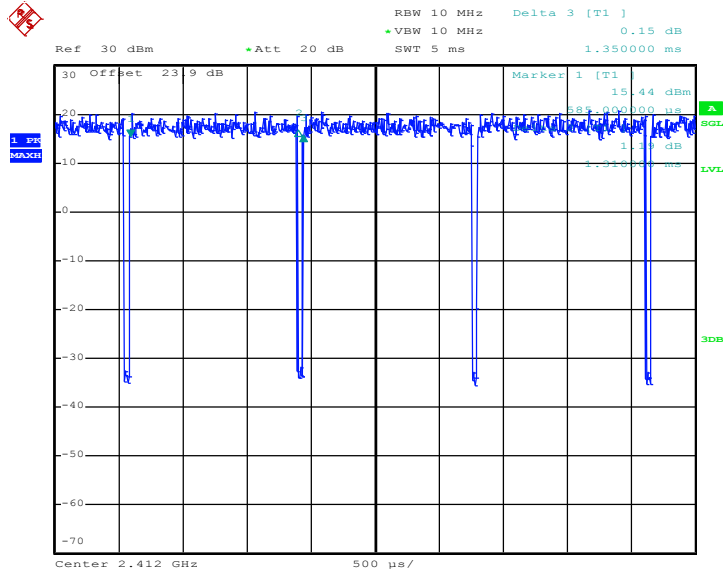

Date: 8.NOV.2016 18:00:39