



FCC RF Test Report

APPLICANT : Zebra Technologies Corporation
EQUIPMENT : Personnel Badge
BRAND NAME : ZEBRA
MODEL NAME : MPACT-BRDGM
FCC ID : UZ7MPACTBRDGM
STANDARD : FCC Part 15 Subpart E §15.407
CLASSIFICATION : (NII) Unlicensed National Information Infrastructure

The product was received on Oct. 06, 2016 and testing was completed on Nov. 07, 2016. We, SPORTON INTERNATIONAL INC., would like to declare that the tested sample has been evaluated in accordance with the test procedures and has been in compliance with the applicable technical standards.

The test results in this report apply exclusively to the tested model / sample. Without written approval of SPORTON INTERNATIONAL INC., the test report shall not be reproduced except in full.

Reviewed by: Joseph Lin / Supervisor

Approved by: Jones Tsai / Manager



Testing Laboratory
1190

SPORTON INTERNATIONAL INC.

No. 52, Hwa Ya 1st Rd., Hwa Ya Technology Park, Kwei-Shan District, Tao Yuan City, Taiwan, R.O.C.



TABLE OF CONTENTS

REVISION HISTORY 3

SUMMARY OF TEST RESULT 4

1 GENERAL DESCRIPTION 5

 1.1 Applicant 5

 1.2 Manufacturer 5

 1.3 Product Feature of Equipment Under Test 5

 1.4 Product Specification of Equipment Under Test 5

 1.5 Modification of EUT 6

 1.6 Testing Location 6

 1.7 Applicable Standards 6

2 TEST CONFIGURATION OF EQUIPMENT UNDER TEST 7

 2.1 Carrier Frequency and Channel 7

 2.2 Test Mode 7

 2.3 Connection Diagram of Test System 8

 2.4 Support Unit used in test configuration and system 9

 2.5 EUT Operation Test Setup 9

 2.6 Measurement Results Explanation Example 9

3 TEST RESULT 10

 3.1 6dB and 26dB and 99% Occupied Bandwidth Measurement 10

 3.2 Maximum Conducted Output Power Measurement 13

 3.3 Power Spectral Density Measurement 14

 3.4 Unwanted Emissions Measurement 16

 3.5 AC Conducted Emission Measurement 20

 3.6 Frequency Stability Measurement 24

 3.7 Automatically Discontinue Transmission 25

 3.8 Antenna Requirements 26

4 LIST OF MEASURING EQUIPMENT 27

5 UNCERTAINTY OF EVALUATION 28

APPENDIX A. CONDUCTED TEST RESULTS

APPENDIX B. RADIATED SPURIOUS EMISSION

APPENDIX C. RADIATED SPURIOUS EMISSION PLOTS

APPENDIX D. DUTY CYCLE PLOTS

APPENDIX E. SETUP PHOTOGRAPHS



SUMMARY OF TEST RESULT

Report Section	FCC Rule	Description	Limit	Result	Remark
3.1	15.403(i)	6dB, 26dB and 99% Occupied Bandwidth	> 500kHz	Pass	-
3.2	15.407(a)	Maximum Conducted Output Power	≤ 30 dBm	Pass	-
3.3	15.407(a)	Power Spectral Density	≤ 30 dBm/500kHz	Pass	-
3.4	15.407(b)	Unwanted Emissions	15.407(b)(4)(i) & 15.209(a)	Pass	Under limit 3.85 dB at 96.690 MHz
3.5	15.207	AC Conducted Emission	15.207(a)	Pass	Under limit 12.30 dB at 0.150 MHz
3.6	15.407(g)	Frequency Stability	Within Operation Band	Pass	-
3.7	15.407(c)	Automatically Discontinue Transmission	Discontinue Transmission	Pass	-
3.8	15.203 & 15.407(a)	Antenna Requirement	N/A	Pass	-



1 General Description

1.1 Applicant

Zebra Technologies Corporation
1 Zebra Plaza, Holtsville, NY 11742

1.2 Manufacturer

Zebra Technologies Corporation
1 Zebra Plaza, Holtsville, NY 11742

1.3 Product Feature of Equipment Under Test

Product Feature	
Equipment	Personnel Badge
Brand Name	ZEBRA
Model Name	MPACT-BRDGM
FCC ID	UZ7MPACTBRDGM
EUT supports Radios application	WLAN 11a/b/g/n HT20 Bluetooth LE
Wifi Code version	6.0.109.9
Wifi Tools version	9.0.0.341360
EUT Stage	Identical Prototype

Remark: The above EUT's information was declared by manufacturer. Please refer to the specifications or user's manual for more detailed description.

1.4 Product Specification of Equipment Under Test

Standards-related Product Specification	
Tx/Rx Channel Frequency Range	5745 MHz ~ 5825 MHz
Maximum Output Power	<EUT with J300 Antenna> 802.11a : 15.23 dBm / 0.0333 W 802.11n HT20 : 15.13 dBm / 0.0326 W <EUT with J301 Antenna> 802.11a : 15.20 dBm / 0.0331 W 802.11n HT20 : 15.11 dBm / 0.0324 W
99% Occupied Bandwidth	<EUT with J300 Antenna> 802.11a : 17.90 MHz 802.11n HT20 : 19.05 MHz
Antenna Type / Gain	Dipole Antenna with gain 4.30 dBi
Type of Modulation	802.11a/n : OFDM (BPSK / QPSK / 16QAM / 64QAM)

Remark: This device has two kinds of WLAN antenna (J300 Antenna and J301 Antenna), and the J300 has max RF Power. Thus, all tests were performed with J300 Antenna.



1.5 Modification of EUT

No modifications are made to the EUT during all test items.

1.6 Testing Location

Sporton Lab is accredited to ISO 17025 by Taiwan Accreditation Foundation (TAF code : 1190) and the FCC designation No. TW1022 under the FCC 2.948(e) by Mutual Recognition Agreement (MRA) in FCC Test.

Test Site	SPORTON INTERNATIONAL INC.		
Test Site Location	No. 52, Hwa Ya 1 st Rd., Hwa Ya Technology Park, Kwei-Shan District, Tao Yuan City, Taiwan, R.O.C. TEL: +886-3-327-3456 FAX: +886-3-328-4978		
Test Site No.	Sporton Site No.		
	TH05-HY	CO05-HY	03CH07-HY

Note: The test site complies with ANSI C63.4 2014 requirement.

1.7 Applicable Standards

According to the specifications of the manufacturer, the EUT must comply with the requirements of the following standards:

- FCC Part 15 Subpart E
- FCC KDB 789033 D02 General UNII Test Procedures New Rules v01r03
- ANSI C63.10-2013

Remark:

1. All test items were verified and recorded according to the standards and without any deviation during the test.
2. This EUT has also been tested and complied with the requirements of FCC Part 15, Subpart B, recorded in a separate test report.



2 Test Configuration of Equipment Under Test

The EUT has been associated with peripherals and configuration operated in a manner tended to maximize its emission characteristics in a typical application. Frequency range investigated: conducted emission (150 kHz to 30 MHz) and radiated emission (9 kHz to the 10th harmonic of the highest fundamental frequency or to 40 GHz, whichever is lower). For radiated measurement, pre-scanned in three orthogonal panels, X, Y, Z. The worst cases (Y plane) were recorded in this report.

2.1 Carrier Frequency and Channel

Frequency Band	Channel	Freq. (MHz)	Channel	Freq. (MHz)
5725-5850 MHz Band 4 (U-NII-3)	149	5745	161	5805
	153	5765	165	5825
	157	5785		

2.2 Test Mode

Final test mode of conducted test items and radiated spurious emissions are considering the modulation and worse data rates as below table.

Modulation	Data Rate
802.11a	6 Mbps
802.11n HT20	MCS0

Test Cases	
AC Conducted Emission	Mode 1 : Jamaica charging from Toaster + Bluetooth Idle + WLAN Idle + AC Adapter (PS000084A01)

Ch. #		Band IV : 5725-5850 MHz	
		802.11a	802.11n HT20
L	Low	149	149
M	Middle	157	157
H	High	165	165

2.3 Connection Diagram of Test System

<WLAN Tx Mode>

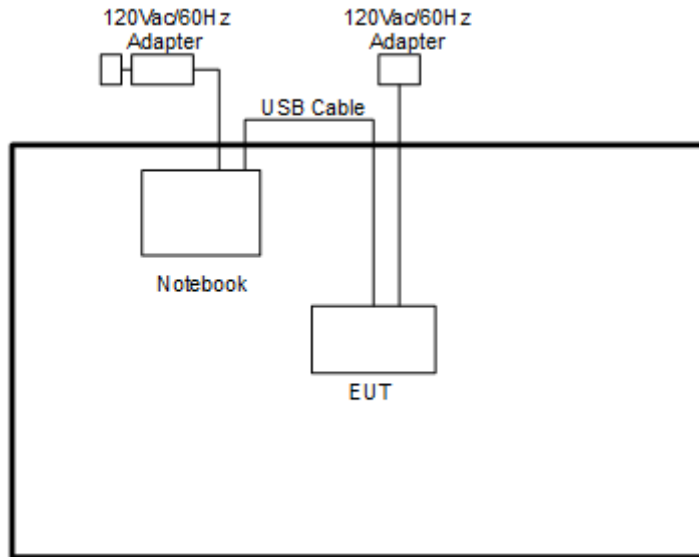

<AC Conducted Emission Mode>

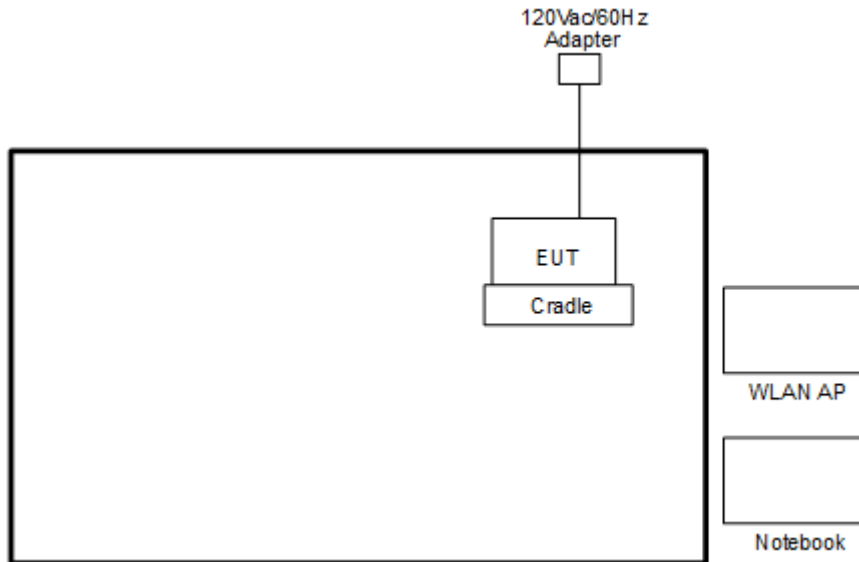



2.4 Support Unit used in test configuration and system

Item	Equipment	Trade Name	Model Name	FCC ID	Data Cable	Power Cord
1.	WLAN AP	D-Link	DIR-628	KA2DIR628A2	N/A	Unshielded, 1.8 m
2.	Notebook	DELL	Latitude E3340	FCC DoC/ Contains FCC ID: PD97260NGU	N/A	AC I/P: Unshielded, 1.2 m DC O/P: Shielded, 1.8 m
3.	Notebook	Lenovo	E335	FCC DoC	N/A	AC I/P: Unshielded, 1.2 m DC O/P: Shielded, 1.8 m
4.	Cradle (Toaster)	Zebra	MPACT-CRADLE	FCC DoC	Shielded, 1.0 m	AC I/P: Unshielded, 1.8 m DC O/P: Unshielded, 1.0 m

2.5 EUT Operation Test Setup

For WLAN function, programmed RF utility, “Tx Tool” installed in the notebook make the EUT provide functions like channel selection and power level for continuous transmitting and receiving signals.

2.6 Measurement Results Explanation Example

For all conducted test items:

The offset level is set in the spectrum analyzer to compensate the RF cable loss and attenuator factor between EUT conducted output port and spectrum analyzer. With the offset compensation, the spectrum analyzer reading level is exactly the EUT RF output level.

Example :

The spectrum analyzer offset is derived from RF cable loss and attenuator factor.

Offset = RF cable loss + attenuator factor.

Following shows an offset computation example with cable loss 4.2 dB and 10dB attenuator.

$$\begin{aligned}
 \text{Offset(dB)} &= \text{RF cable loss(dB)} + \text{attenuator factor(dB)}. \\
 &= 4.2 + 10 = 14.2 \text{ (dB)}
 \end{aligned}$$

3 Test Result

3.1 6dB and 26dB and 99% Occupied Bandwidth Measurement

3.1.1 Description of 6dB and 26dB and 99% Occupied Bandwidth

The minimum 6 dB bandwidth shall be at least 500 kHz.

26dB and 99% Occupied bandwidth are reporting only.

3.1.2 Measuring Instruments

The measuring equipment is listed in the section 4 of this test report.

3.1.3 Test Procedures

1. The testing follows FCC KDB 789033 D02 General UNII Test Procedures New Rules v01r03.
Section C) Emission bandwidth for the band 5.725-5.85GHz
2. Set RBW = 100kHz.
3. Set the VBW $\geq 3 \times$ RBW.
4. Detector = Peak.
5. Trace mode = max hold
6. Measure the maximum width of the emission that is 6 dB down from the peak of the emission.
7. Measure and record the results in the test report.

3.1.4 Test Setup

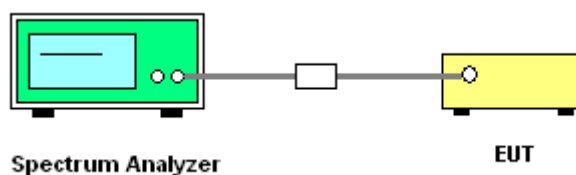



3.1.5 Test Result of 6dB Bandwidth

Please refer to Appendix A.

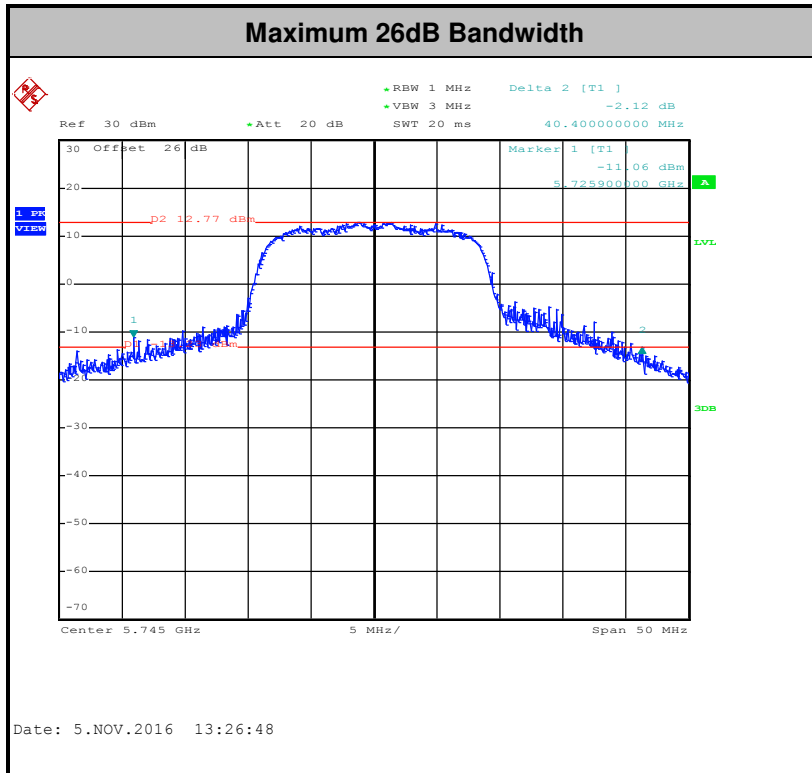
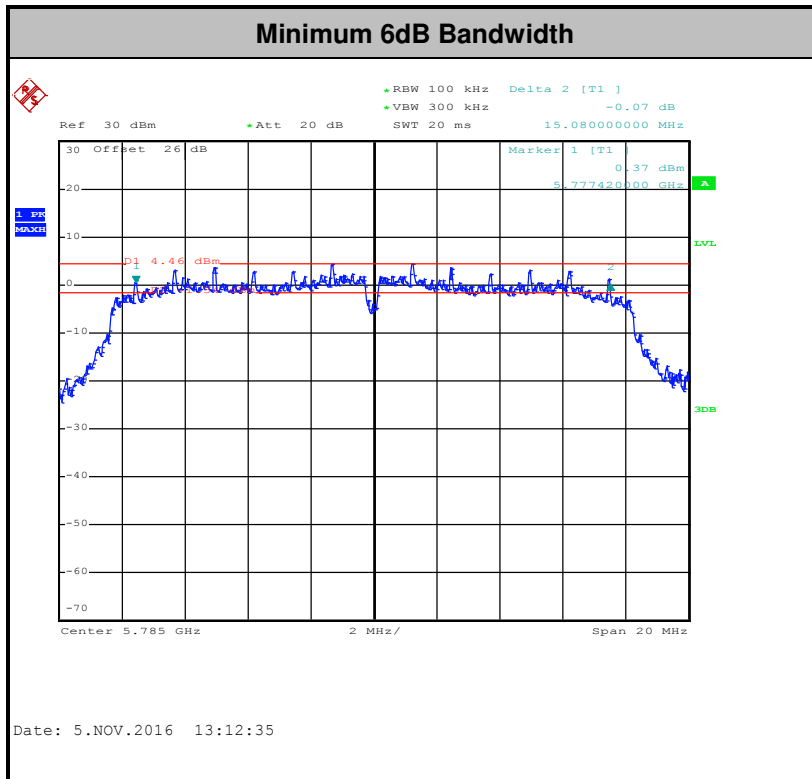

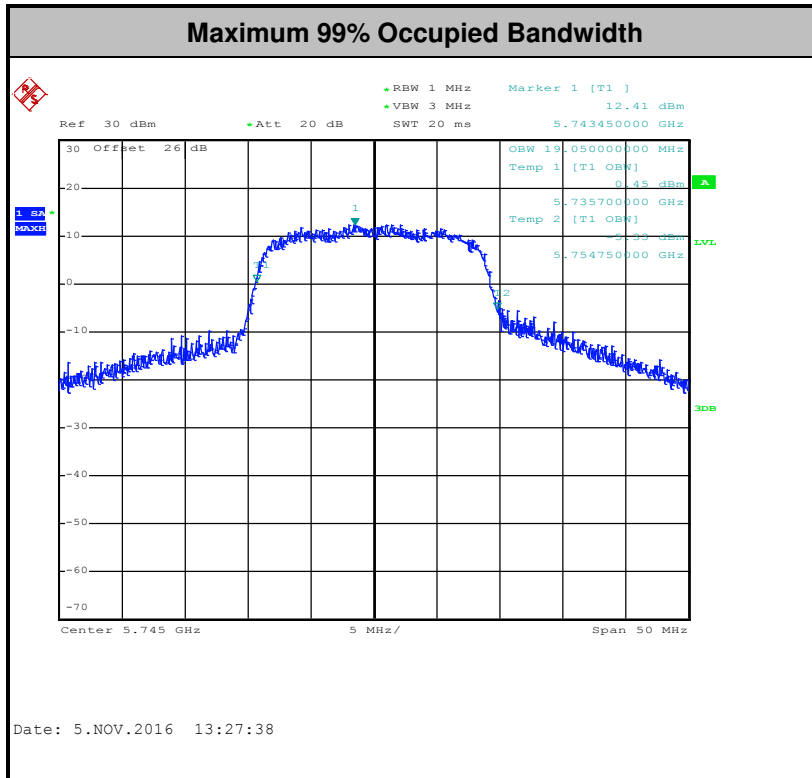

Note: The occupied channel bandwidth is maintained within the band of operation for all of the modulations.

3.2 Maximum Conducted Output Power Measurement

3.2.1 Limit of Maximum Conducted Output Power

For the band 5.725–5.85 GHz, the maximum conducted output power over the frequency band of operation shall not exceed 1 W.

If transmitting antennas of directional gain greater than 6 dBi are used, the peak output power shall be reduced by the amount in dB that the directional gain of the antenna exceeds 6 dBi.

3.2.2 Measuring Instruments

The measuring equipment is listed in the section 4 of this test report.

3.2.3 Test Procedures

The testing follows Method PM of FCC KDB 789033 D02 General UNII Test Procedures New Rules v01r03.

Method PM (Measurement using an RF average power meter):

1. Measurement is performed using a wideband RF power meter.
2. The EUT is configured to transmit continuously with a consistent duty cycle at its maximum power control level.
3. Measure the average power of the transmitter, and the average power is corrected with duty factor, $10 \log(1/x)$, where x is the duty cycle.

3.2.4 Test Setup

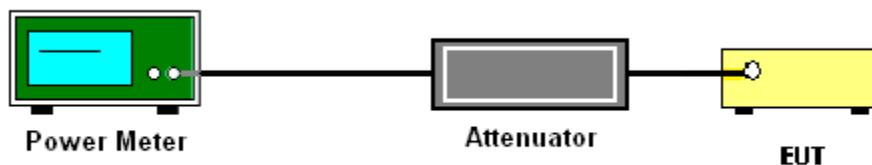

3.2.5 Test Result of Maximum Conducted Output Power

Please refer to Appendix A.



3.3 Power Spectral Density Measurement

3.3.1 Limit of Power Spectral Density

For the band 5.725–5.85 GHz, the maximum power spectral density shall not exceed 30 dBm in any 500-kHz band.

If transmitting antennas of directional gain greater than 6 dBi are used, the peak output power shall be reduced by the amount in dB that the directional gain of the antenna exceeds 6 dBi.

3.3.2 Measuring Instruments

The measuring equipment is listed in the section 4 of this test report.

3.3.3 Test Procedures

The testing follows FCC KDB 789033 D02 General UNII Test Procedures New Rules v01r03. Section F) Maximum power spectral density.

Method SA-2

(trace averaging across on and off times of the EUT transmissions, followed by duty cycle correction).

- Measure the duty cycle.
 - Set span to encompass the entire emission bandwidth (EBW) of the signal.
 - Set RBW = 300 kHz.
 - Set VBW \geq 1 MHz.
 - Number of points in sweep \geq 2 Span / RBW.
 - Sweep time = auto.
 - Detector = RMS
 - Trace average at least 100 traces in power averaging mode.
 - Add $10 \log(500\text{kHz}/\text{RBW})$ to the test result.
 - Add $10 \log(1/x)$, where x is the duty cycle, to the measured power in order to compute the average power during the actual transmission times. For example, add $10 \log(1/0.25) = 6$ dB if the duty cycle is 25 percent.
1. The RF output of EUT was connected to the spectrum analyzer by a low loss cable.
 2. Each plot has already offset with cable loss, and attenuator loss. Measure the PPSD and record it.

3.3.4 Test Setup



3.3.5 Test Result of Power Spectral Density

Please refer to Appendix A.

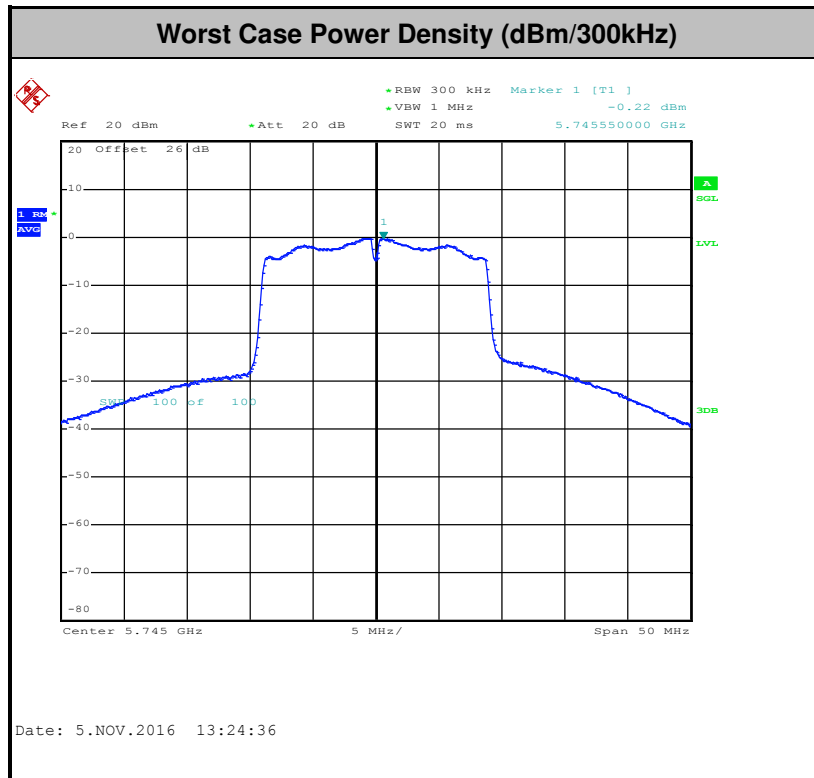



3.4 Unwanted Emissions Measurement

This section as specified in FCC Part 15.407(b) is to measure unwanted emissions through radiated measurement for band edge spurious emissions and out of band emissions measurement. The unwanted emissions shall comply with 15.407(b)(1) to (6), and restricted bands per FCC Part15.205.

3.4.1 Limit of Unwanted Emissions

- (1) For transmitters operating in the 5.725-5.85 GHz band:
15.407(b)(4)(i) All emissions shall be limited to a level of -27 dBm/MHz at 75 MHz or more above or below the band edge increasing linearly to 10 dBm/MHz at 25 MHz above or below the band edge, and from 25 MHz above or below the band edge increasing linearly to a level of 15.6 dBm/MHz at 5 MHz above or below the band edge, and from 5 MHz above or below the band edge increasing linearly to a level of 27 dBm/MHz at the band edge.
- (2) Unwanted spurious emissions fallen in restricted bands per FCC Part15.205 shall comply with the general field strength limits set forth in § 15.209 as below table,

Frequency (MHz)	Field Strength (microvolts/meter)	Measurement Distance (meters)
0.009 – 0.490	2400/F(kHz)	300
0.490 – 1.705	24000/F(kHz)	30
1.705 – 30.0	30	30
30 – 88	100	3
88 – 216	150	3
216 - 960	200	3
Above 960	500	3

Note: The following formula is used to convert the EIRP to field strength.

$$E = \frac{1000000\sqrt{30P}}{3} \mu\text{V/m, where P is the eirp (Watts)}$$

EIRP (dBm)	Field Strength at 3m (dBμV/m)
-17	78.3
- 27	68.3



- (3) KDB 789033 D02 General UNII Test Procedures New Rules v01r03 G)2)c) As specified in 15.407(b), emissions above 1000 MHz that are outside of the restricted bands are subject to a peak emission limit of -27 dBm/MHz (or -17 dBm/MHz as specified in 15.407(b)(4)). However, an out-of-band emission that complies with both the average and peak limits of 15.209 is not required to satisfy the -27 dBm/MHz or -17 dBm/MHz peak emission limit.

3.4.2 Measuring Instruments

The measuring equipment is listed in the section 4 of this test report.

3.4.3 Test Procedures

1. The testing follows FCC KDB 789033 D02 General UNII Test Procedures New Rules v01r03. Section G) Unwanted emissions measurement.
 - (1) Procedure for Unwanted Emissions Measurements Below 1000MHz
 - RBW = 120 kHz
 - VBW = 300 kHz
 - Detector = Peak
 - Trace mode = max hold
 - (2) Procedure for Peak Unwanted Emissions Measurements Above 1000 MHz
 - RBW = 1 MHz
 - VBW \geq 3 MHz
 - Detector = Peak
 - Sweep time = auto
 - Trace mode = max hold
 - (3) Procedures for Average Unwanted Emissions Measurements Above 1000MHz
 - RBW = 1 MHz
 - VBW = 10 Hz, when duty cycle is no less than 98 percent.
 - VBW \geq 1/T, when duty cycle is less than 98 percent where T is the minimum transmission duration over which the transmitter is on and is transmitting at its maximum power control level for the tested mode of operation.
2. The EUT was placed on a turntable with 0.8 meter for frequency below 1GHz and 1.5 meter for frequency above 1GHz respectively above ground.
3. The EUT was set 3 meters from the interference receiving antenna which was mounted on the top of a variable height antenna tower.
4. The antenna is a broadband antenna and its height is adjusted between one meter and four meters above ground to find the maximum value of the field strength for both horizontal polarization and vertical polarization of the antenna.

5. For each suspected emission, the EUT was arranged to its worst case and then adjust the antenna tower (from 1 m to 4 m) and turntable (from 0 degree to 360 degrees) to find the maximum reading.
6. For testing below 1GHz, if the emission level of the EUT in peak mode was 3 dB lower than the limit specified, then peak values of EUT will be reported, otherwise, the emissions will be repeated one by one using the CISPR quasi-peak method and reported.
7. For testing above 1GHz, the emission level of the EUT in peak mode was 20dB lower than average limit (that means the emission level in average mode also complies with the limit in average mode), then peak values of EUT will be reported, otherwise, the emissions will be measured in average mode again and reported.

3.4.4 Test Setup

For radiated emissions below 30MHz

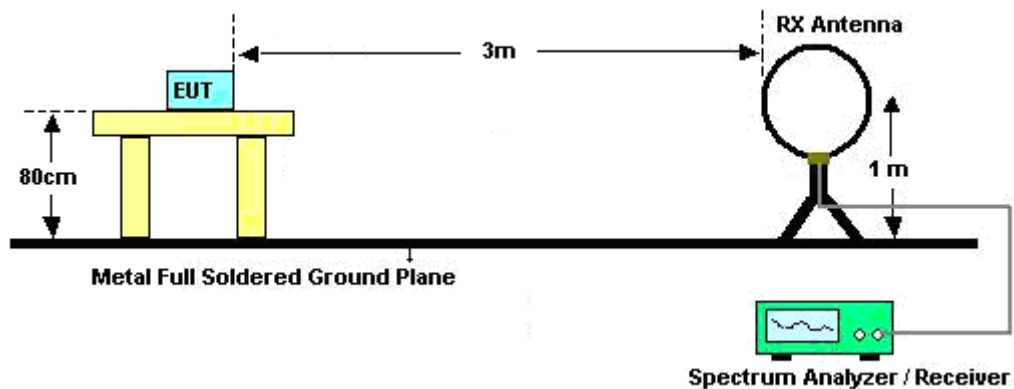

For radiated emissions from 30MHz to 1GHz

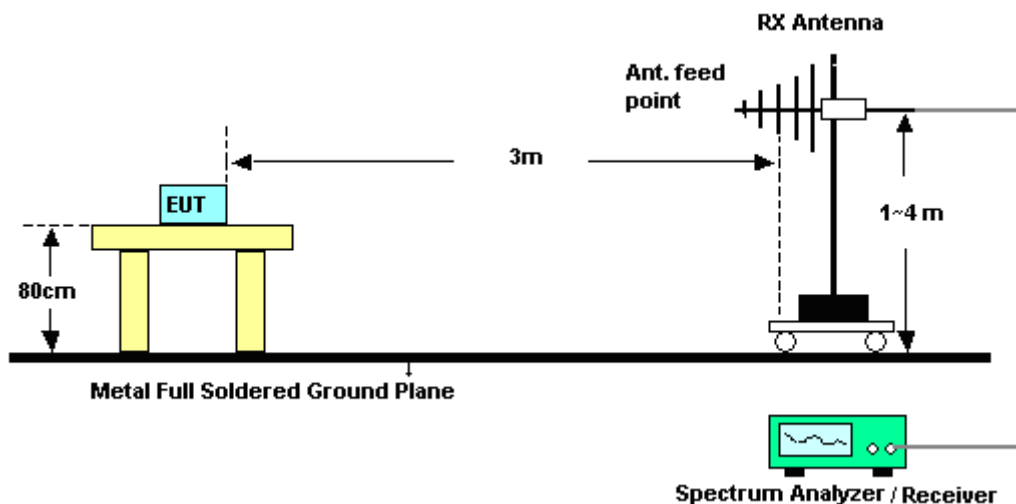

For radiated emissions above 1GHz

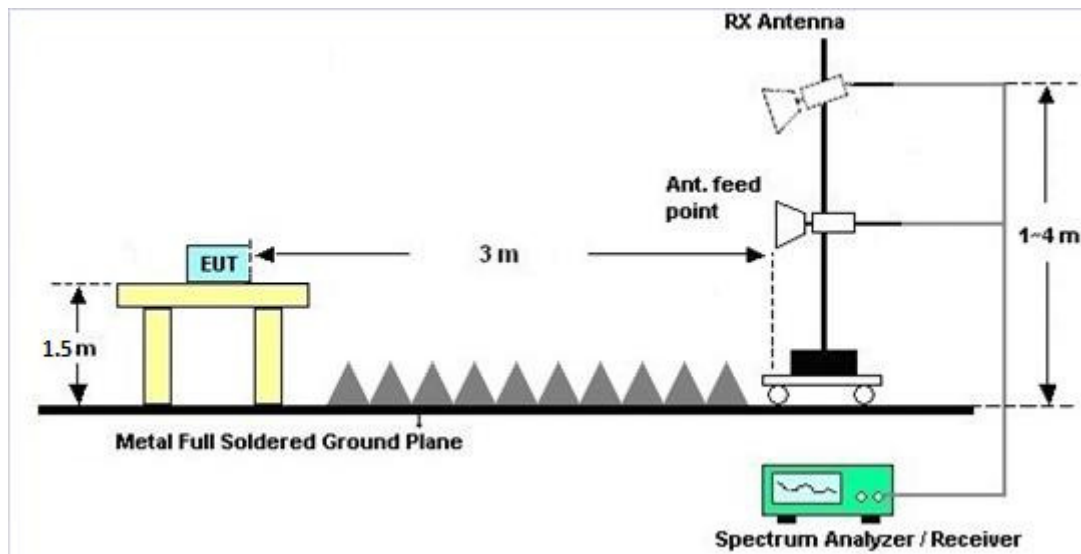

3.4.5 Test Results of Radiated Spurious Emissions (9 kHz ~ 30 MHz)

The low frequency, which started from 9 kHz to 30MHz, was pre-scanned and the result which was 20dB lower than the limit line per 15.31(o) was not reported.

3.4.6 Test Result of Radiated Spurious at Band Edges

Please refer to Appendix B and C.

3.4.7 Duty Cycle

Please refer to Appendix D.

3.4.8 Test Result of Radiated Spurious Emissions (30MHz ~ 10th Harmonic)

Please refer to Appendix B and C.



3.5 AC Conducted Emission Measurement

3.5.1 Limit of AC Conducted Emission

For equipment that is designed to be connected to the public utility (AC) power line, the radio frequency voltage that is conducted back onto the AC power line on any frequency or frequencies within the band 150 kHz to 30 MHz shall not exceed the limits in the following table.

Frequency of emission (MHz)	Conducted limit (dB μ V)	
	Quasi-peak	Average
0.15-0.5	66 to 56*	56 to 46*
0.5-5	56	46
5-30	60	50

*Decreases with the logarithm of the frequency.

3.5.2 Measuring Instruments

The measuring equipment is listed in the section 4 of this test report.

3.5.3 Test Procedures

1. The EUT was placed 0.4 meter from the conducting wall of the shielding room was kept at least 80 centimeters from any other grounded conducting surface.
2. Connect EUT to the power mains through a line impedance stabilization network (LISN).
3. All the support units are connecting to the other LISN.
4. The LISN provides 50 ohm coupling impedance for the measuring instrument.
5. The FCC states that a 50 ohm, 50 microhenry LISN should be used.
6. Both sides of AC line were checked for maximum conducted interference.
7. The frequency range from 150 kHz to 30 MHz was searched.
8. Set the test-receiver system to Peak Detect Function and specified bandwidth with Maximum Hold Mode.

3.5.4 Test Setup

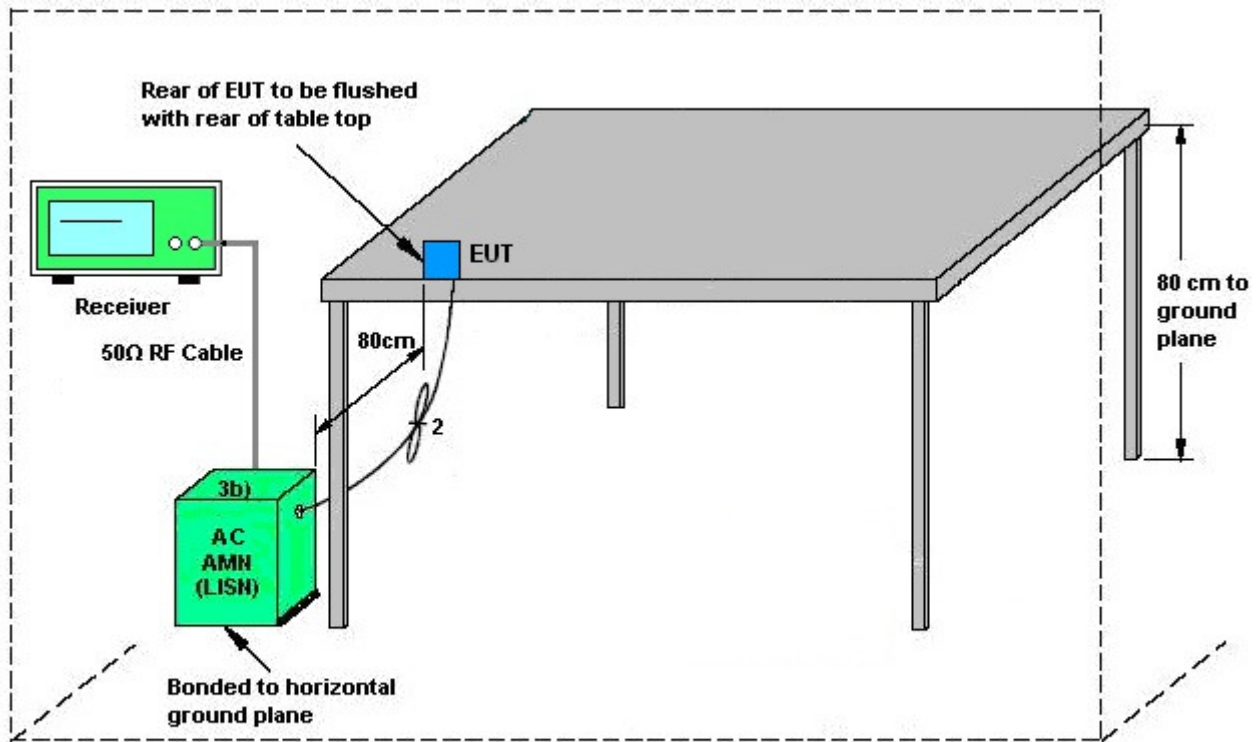

AMN = Artificial mains network (LISH)
AE = Associated equipment
EUT = Equipment under test
ISN = Impedance stabilization network

3.5.5 Test Result of AC Conducted Emission

Test Mode :	Mode 1	Temperature :	24~25°C
Test Engineer :	Kai-Chun Chu	Relative Humidity :	49~50%
Test Voltage :	120Vac / 60Hz	Phase :	Line
Function Type :	Jamaica charging from Toaster + Bluetooth Idle + WLAN Idle + AC Adapter (PS000084A01)		

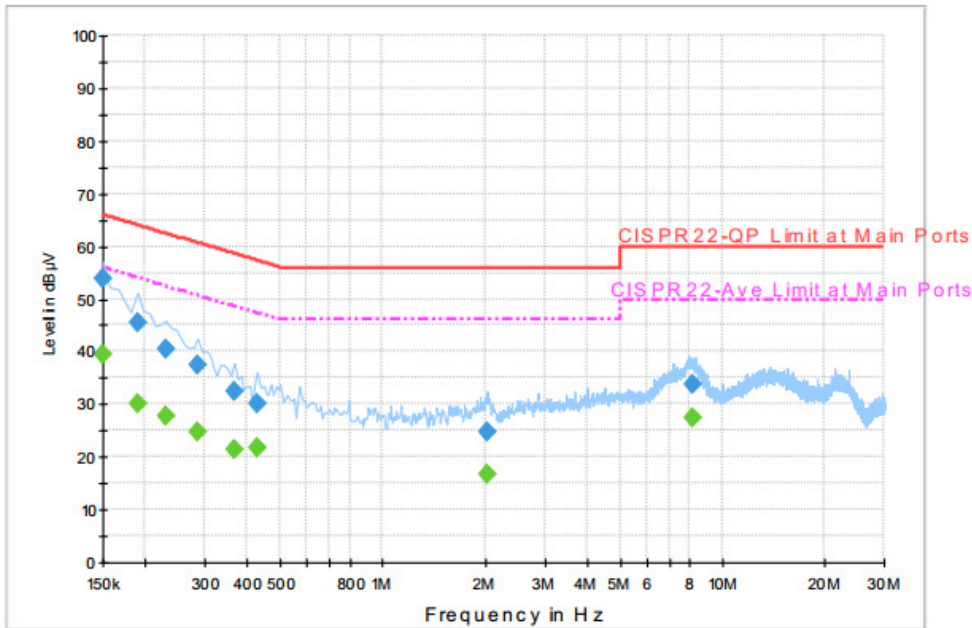

Final Result : Quasi-Peak

Frequency (MHz)	Quasi-Peak (dBµV)	Filter	Line	Corr. (dB)	Margin (dB)	Limit (dBµV)
0.150000	53.7	Off	L1	19.6	12.3	66.0
0.190000	45.5	Off	L1	19.6	18.5	64.0
0.230000	40.4	Off	L1	19.6	22.0	62.4
0.286000	37.5	Off	L1	19.6	23.1	60.6
0.366000	32.6	Off	L1	19.6	26.0	58.6
0.430000	30.1	Off	L1	19.6	27.2	57.3
2.038000	24.7	Off	L1	19.1	31.3	56.0
8.150000	33.7	Off	L1	20.0	26.3	60.0

Final Result : Average

Frequency (MHz)	Average (dBµV)	Filter	Line	Corr. (dB)	Margin (dB)	Limit (dBµV)
0.150000	39.6	Off	L1	19.6	16.4	56.0
0.190000	30.2	Off	L1	19.6	23.8	54.0
0.230000	27.8	Off	L1	19.6	24.6	52.4
0.286000	24.8	Off	L1	19.6	25.8	50.6
0.366000	21.3	Off	L1	19.6	27.3	48.6
0.430000	21.6	Off	L1	19.6	25.7	47.3
2.038000	16.6	Off	L1	19.1	29.4	46.0
8.150000	27.5	Off	L1	20.0	22.5	50.0



Test Mode :	Mode 1	Temperature :	24~25°C
Test Engineer :	Kai-Chun Chu	Relative Humidity :	49~50%
Test Voltage :	120Vac / 60Hz	Phase :	Neutral
Function Type :	Jamaica charging from Toaster + Bluetooth Idle + WLAN Idle + AC Adapter (PS000084A01)		

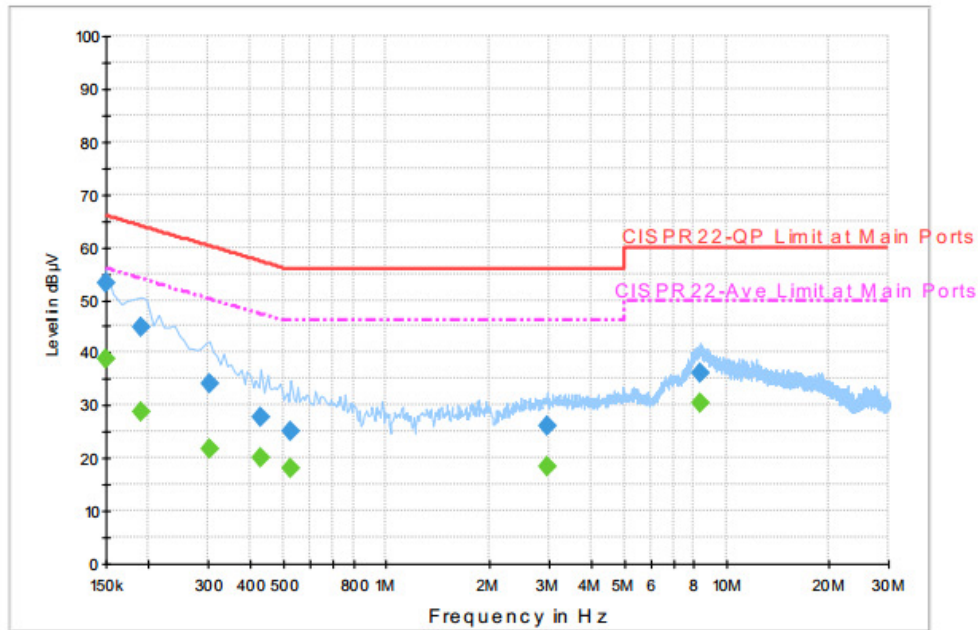

Final Result : Quasi-Peak

Frequency (MHz)	Quasi-Peak (dBµV)	Filter	Line	Corr. (dB)	Margin (dB)	Limit (dBµV)
0.150000	53.2	Off	N	19.6	12.8	66.0
0.190000	44.8	Off	N	19.6	19.2	64.0
0.302000	34.1	Off	N	19.6	26.1	60.2
0.430000	27.7	Off	N	19.6	29.6	57.3
0.526000	24.9	Off	N	19.6	31.1	56.0
2.974000	26.3	Off	N	19.6	29.7	56.0
8.374000	36.1	Off	N	20.0	23.9	60.0

Final Result : Average

Frequency (MHz)	Average (dBµV)	Filter	Line	Corr. (dB)	Margin (dB)	Limit (dBµV)
0.150000	38.7	Off	N	19.6	17.3	56.0
0.190000	28.9	Off	N	19.6	25.1	54.0
0.302000	21.8	Off	N	19.6	28.4	50.2
0.430000	20.1	Off	N	19.6	27.2	47.3
0.526000	18.0	Off	N	19.6	28.0	46.0
2.974000	18.4	Off	N	19.6	27.6	46.0
8.374000	30.5	Off	N	20.0	19.5	50.0

3.6 Frequency Stability Measurement

3.6.1 Limit of Frequency Stability

Manufacturers of U-NII devices are responsible for ensuring frequency stability such that an emission is maintained within the band of operation under all conditions of normal operation as specified in the user's manual.

3.6.2 Measuring Instruments

The measuring equipment is listed in the section 4 of this test report.

3.6.3 Test Procedures

1. To ensure emission at the band edge is maintained within the authorized band, those values shall be measured by radiation emissions at upper and lower frequency points, and finally compensated by frequency deviation as procedures below.
2. The EUT was operated at the maximum output power, and connected to the spectrum analyzer, which is set to maximum hold function and peak detector. The peak value of the power envelope was measured and noted. The upper and lower frequency points were respectively measured relatively 10dB lower than the measured peak value.
3. The frequency deviation was calculated by adding the upper frequency point and the lower frequency point divided by two. Those detailed values of frequency deviation are provided in table below.

3.6.4 Test Setup

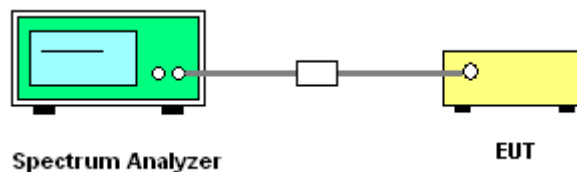

3.6.5 Test Result of Frequency Stability

Please refer to Appendix A.



3.7 Automatically Discontinue Transmission

3.7.1 Limit of Automatically Discontinue Transmission

The device shall automatically discontinue transmission in case of either absence of information to transmit or operational failure. These provisions are not intended to preclude the transmission of control or signaling information or the use of repetitive codes used by certain digital technologies to complete frame or burst intervals. Applicants shall include in their application for equipment authorization to describe how this requirement is met.

3.7.2 Measuring Instruments

The measuring equipment is listed in the section 4 of this test report.

3.7.3 Test Result of Automatically Discontinue Transmission

While the EUT is not transmitting any information, the EUT can automatically discontinue transmission and become standby mode for power saving. The EUT can detect the controlling signal of ACK message transmitting from remote device and verify whether it shall resend or discontinue transmission.



3.8 Antenna Requirements

3.8.1 Standard Applicable

According to FCC 47 CFR Section 15.407(a)(1)(2) ,if transmitting antenna directional gain is greater than 6 dBi, both the peak transmit power and the peak power spectral density shall be reduced by the amount in dB that the directional gain of the antenna exceeds 6 dBi.

3.8.2 Antenna Anti-Replacement Construction

An embedded-in antenna design is used.

3.8.3 Antenna Gain

The antenna peak gain of EUT is less than 6 dBi. Therefore, it is not necessary to reduce maximum peak output power limit.



4 List of Measuring Equipment

Instrument	Manufacturer	Model No.	Serial No.	Characteristics	Calibration Date	Test Date	Due Date	Remark
Power Meter	Anritsu	ML2495A	0932001	300MHz~40GHz	Sep. 29, 2016	Nov. 03, 2016 ~ Nov. 07, 2016	Sep. 28, 2017	Conducted (TH05-HY)
Power Sensor	Anritsu	MA2411B	0846202	300MHz~40GHz	Sep. 29, 2016	Nov. 03, 2016 ~ Nov. 07, 2016	Sep. 28, 2017	Conducted (TH05-HY)
Spectrum Analyzer	Rohde & Schwarz	FSP40	100055	9kHz-40GHz	Jul. 17, 2016	Nov. 03, 2016 ~ Nov. 07, 2016	Jul. 16, 2017	Conducted (TH05-HY)
Temperature Chamber	ESPEC	SH-641	92013720	-40℃ ~90℃	Sep. 01, 2016	Nov. 03, 2016 ~ Nov. 07, 2016	Aug. 31, 2017	Conducted (TH05-HY)
Programmable Power Supply	GW Instek	PSS-2005	EL890094	1V~20V 0.5A~5A	Oct. 11, 2016	Nov. 03, 2016 ~ Nov. 07, 2016	Oct. 10, 2017	Conducted (TH05-HY)
AC Power Source	ChainTek	APC-1000W	N/A	N/A	N/A	Oct. 18, 2016	N/A	Conduction (CO05-HY)
EMI Test Receiver	Rohde & Schwarz	ESCI 7	100724	9kHz~7GHz	Aug. 30, 2016	Oct. 18, 2016	Aug. 29, 2017	Conduction (CO05-HY)
LISN	Rohde & Schwarz	ENV216	100080	9kHz~30MHz	Dec. 02, 2015	Oct. 18, 2016	Dec. 01, 2016	Conduction (CO05-HY)
Bilog Antenna	TESEQ	CBL 6111D&00800 N1D01N-06	35419&03	30MHz to 1GHz	Jan. 13, 2016	Oct. 30, 2016 ~ Nov. 05, 2016	Jan. 12, 2017	Radiation (03CH07-HY)
Double Ridge Horn Antenna	ESCO	3117	00075962	1GHz ~ 18GHz	Aug. 19, 2016	Oct. 30, 2016 ~ Nov. 05, 2016	Aug. 18, 2017	Radiation (03CH07-HY)
EMI Test Receiver	Keysight	N9038A (MXE)	MY54130085	20Hz ~ 8.4GHz	Oct. 26, 2016	Oct. 30, 2016 ~ Nov. 05, 2016	Oct. 25, 2017	Radiation (03CH07-HY)
Loop Antenna	Rohde & Schwarz	HFH2-Z2	100315	9 kHz~30 MHz	Sep. 02, 2015	Oct. 30, 2016 ~ Nov. 05, 2016	Sep. 01, 2017	Radiation (03CH07-HY)
Preamplifier	MITEQ	AMF-7D-0010 1800-30-10P	1590075	1GHz ~ 18GHz	Apr. 15, 2016	Oct. 30, 2016 ~ Nov. 05, 2016	Apr. 14, 2017	Radiation (03CH07-HY)
Preamplifier	COM-POWER	PA-103A	161241	10MHz-1GHz	Mar. 18, 2016	Oct. 30, 2016 ~ Nov. 05, 2016	Mar. 17, 2017	Radiation (03CH07-HY)
Preamplifier	Agilent	8449B	3008A02362	1GHz~ 26.5GHz	Oct. 12, 2016	Oct. 30, 2016 ~ Nov. 05, 2016	Oct. 11, 2017	Radiation (03CH07-HY)
Spectrum Analyzer	Agilent	N9010A	MY53470118	10Hz~44GHz	Feb. 27, 2016	Oct. 30, 2016 ~ Nov. 05, 2016	Feb. 26, 2017	Radiation (03CH07-HY)
Antenna Mast	Max-Full	MFA520BS	N/A	1m~4m	N/A	Oct. 30, 2016 ~ Nov. 05, 2016	N/A	Radiation (03CH07-HY)
Turn Table	ChainTek	Chaintek 3000	N/A	0~360 Degree	N/A	Oct. 30, 2016 ~ Nov. 05, 2016	N/A	Radiation (03CH07-HY)
Preamplifier	MITEQ	JS44-1800400 0-33-8P	1840917	18GHz ~ 40GHz	Jun. 14, 2016	Oct. 30, 2016 ~ Nov. 05, 2016	Jun. 13, 2017	Radiation (03CH07-HY)
SHF-EHF Horn Antenna	SCHWARZBE CK	BBHA 9170	BBHA917025 1	18GHz- 40GHz	Oct. 07, 2016	Oct. 30, 2016 ~ Nov. 05, 2016	Oct. 06, 2017	Radiation (03CH07-HY)



5 Uncertainty of Evaluation

Uncertainty of Conducted Emission Measurement (150kHz ~ 30MHz)

Measuring Uncertainty for a Level of Confidence of 95% ($U = 2Uc(y)$)	2.7
---	-----

Uncertainty of Radiated Emission Measurement (30 MHz ~ 1000 MHz)

Measuring Uncertainty for a Level of Confidence of 95% ($U = 2Uc(y)$)	5.7
---	-----

Uncertainty of Radiated Emission Measurement (1000 MHz ~ 18000 MHz)

Measuring Uncertainty for a Level of Confidence of 95% ($U = 2Uc(y)$)	5.5
---	-----

Uncertainty of Radiated Emission Measurement (18000 MHz ~ 40000 MHz)

Measuring Uncertainty for a Level of Confidence of 95% ($U = 2Uc(y)$)	5.2
---	-----



Appendix A. Conducted Test Results

<EUT with J300 Antenna>

Test Engineer:	Luffy Lin and Tommy Lee	Temperature:	21~25	°C
Test Date:	2016/11/03 ~ 2016/11/07	Relative Humidity:	51~54	%

TEST RESULTS DATA
6dB and 26dB EBW and 99% OBW

Band IV									
Mod.	Data Rate	NTX	CH.	Freq. (MHz)	99% Bandwidth (MHz)	26 dB Bandwidth (MHz)	6 dB Bandwidth (MHz)	6dB Bandwidth min. Limit (MHz)	Pass/Fail
11a	6M bps	1	149	5745	17.55	36.7	15.12	0.5	Pass
11a	6Mbps	1	157	5785	17.85	38.4	15.08	0.5	Pass
11a	6Mbps	1	165	5825	17.9	36.7	15.08	0.5	Pass
HT20	MCS 0	1	149	5745	19.05	40.4	15.1	0.5	Pass
HT20	MCS 0	1	157	5785	18.6	38.3	15.12	0.5	Pass
HT20	MCS 0	1	165	5825	18.75	40.4	15.12	0.5	Pass

TEST RESULTS DATA
Average Power Table

Band IV										
Mod.	Data Rate	NTX	CH.	Freq. (MHz)	Duty Factor (dB)	Average Conducted Power (dBm)	FCC Conducted Power Limit (dBm)	DG (dBi)		Pass/Fail
11a	6M bps	1	149	5745	0.15	14.35	30.00	4.30		Pass
11a	6Mbps	1	157	5785	0.15	15.23	30.00	4.30		Pass
11a	6Mbps	1	165	5825	0.15	14.85	30.00	4.30		Pass
HT20	MCS 0	1	149	5745	0.13	15.13	30.00	4.30		Pass
HT20	MCS 0	1	157	5785	0.13	15.12	30.00	4.30		Pass
HT20	MCS 0	1	165	5825	0.13	14.78	30.00	4.30		Pass

TEST RESULTS DATA
Power Spectral Density

Band IV										
Mod.	Data Rate	NTX	CH.	Freq. (MHz)	Duty Factor (dB)	10log (500kHz /RBW) Factor (dB)	Average Power Density (dBm/500kHz)	Average PSD Limit (dBm/500kHz)	DG (dBi)	Pass/Fail
11a	6M bps	1	149	5745	0.15	2.22	1.57	30.00	4.30	Pass
11a	6Mbps	1	157	5785	0.15	2.22	2.04	30.00	4.30	Pass
11a	6Mbps	1	165	5825	0.15	2.22	1.20	30.00	4.30	Pass
HT20	MCS 0	1	149	5745	0.13	2.22	2.13	30.00	4.30	Pass
HT20	MCS 0	1	157	5785	0.13	2.22	1.58	30.00	4.30	Pass
HT20	MCS 0	1	165	5825	0.13	2.22	0.97	30.00	4.30	Pass

TEST RESULTS DATA
Frequency Stability

Band IV										
Mod.	Data Rate	NTX	CH.	Freq. (MHz)	Center Frequency (MHz)	Frequency Deviation (MHz)	Frequency Stability (ppm)	Temperature (°C)	Voltage (V)	Note
11a	6M bps	1	149	5745	5744.950	-0.050	-8.70	50	3.7	
11a	6M bps	1	149	5745	5745.000	0.000	0.00	-30	3.7	
11a	6M bps	1	149	5745	5744.950	-0.050	-8.70	20	4.2	
11a	6M bps	1	149	5745	5745.000	0.000	0.00	20	3.1	
11a	6M bps	1	149	5745	5744.950	-0.050	-8.70	20	3.7	



<EUT with J301 Antenna>

Test Engineer:	Luffy Lin and Tommy Lee	Temperature:	21~25	°C
Test Date:	2016/11/4	Relative Humidity:	51~54	%

TEST RESULTS DATA
Average Power Table

Band IV										
Mod.	Data Rate	NTX	CH.	Freq. (MHz)	Duty Factor (dB)	Average Conducted Power (dBm)	FCC Conducted Power Limit (dBm)	DG (dBi)		Pass/Fail
11a	6M bps	1	149	5745	0.12	14.33	30.00	4.30		Pass
11a	6Mbps	1	157	5785	0.12	15.20	30.00	4.30		Pass
11a	6Mbps	1	165	5825	0.12	14.65	30.00	4.30		Pass
HT20	MCS 0	1	149	5745	0.16	15.11	30.00	4.30		Pass
HT20	MCS 0	1	157	5785	0.16	15.10	30.00	4.30		Pass
HT20	MCS 0	1	165	5825	0.16	14.63	30.00	4.30		Pass



Appendix B. Radiated Spurious Emission

Test Engineer :	Jesse Wang and Ken Wu	Temperature :	21~24°C
		Relative Humidity :	50~54%

Band 4 - 5725~5850MHz

WIFI 802.11a (Band Edge @ 3m)

WIFI Ant. 2	Note	Frequency (MHz)	Level (dBμV/m)	Over Limit (dB)	Limit Line (dBμV/m)	Read Level (dBμV)	Antenna Factor (dB/m)	Cable Loss (dB)	Preamp Factor (dB)	Ant Pos (cm)	Table Pos (deg)	Peak Avg. (P/A)	Pol. (H/V)	
802.11a CH 149 5745MHz		5649.8	52.44	-15.76	68.2	41.16	34.6	11.95	35.27	376	320	P	H	
		5699.6	60.59	-44.32	104.91	49.27	34.6	12	35.28	376	320	P	H	
		5718.8	77.13	-33.33	110.46	65.75	34.6	12.06	35.28	376	320	P	H	
		5724.4	79.65	-41.18	120.83	68.27	34.6	12.06	35.28	376	320	P	H	
	*	5745	109.62	-	-	98.2	34.6	12.11	35.29	376	320	P	H	
	*	5745	102.31	-	-	90.89	34.6	12.11	35.29	376	320	A	H	
														H
														H
			5627.2	49.47	-18.73	68.2	38.19	34.6	11.95	35.27	377	108	P	V
			5699.2	55.14	-49.47	104.61	43.82	34.6	12	35.28	377	108	P	V
			5720	68.63	-42.17	110.8	57.25	34.6	12.06	35.28	377	108	P	V
			5721.8	71.72	-43.18	114.9	60.34	34.6	12.06	35.28	377	108	P	V
	*		5745	107.5	-	-	96.08	34.6	12.11	35.29	377	108	P	V
	*		5745	100.61	-	-	89.19	34.6	12.11	35.29	377	108	A	V
														V
													V	



WIFI Ant. 2	Note	Frequency (MHz)	Level (dBμV/m)	Over Limit (dB)	Limit Line (dBμV/m)	Read Level (dBμV)	Antenna Factor (dB/m)	Cable Loss (dB)	Preamp Factor (dB)	Ant Pos (cm)	Table Pos (deg)	Peak Avg. (P/A)	Pol. (H/V)
		5611.2	49.04	-19.16	68.2	37.81	34.6	11.89	35.26	373	321	P	H
		5692.6	49.05	-50.69	99.74	37.73	34.6	12	35.28	373	321	P	H
		5716.2	53.55	-56.19	109.74	42.17	34.6	12.06	35.28	373	321	P	H
		5724	54.49	-65.43	119.92	43.11	34.6	12.06	35.28	373	321	P	H
	*	5785	108.97	-	-	97.5	34.6	12.17	35.3	373	321	P	H
	*	5785	101.48	-	-	90.01	34.6	12.17	35.3	373	321	A	H
		5852.2	53.69	-63.49	117.18	42.12	34.6	12.28	35.31	373	321	P	H
		5865	51.6	-56.4	108	39.92	34.6	12.39	35.31	373	321	P	H
		5891.2	50.54	-42.64	93.18	38.87	34.6	12.39	35.32	373	321	P	H
		5928.8	49.65	-18.55	68.2	37.87	34.6	12.51	35.33	373	321	P	H
													H
													H
802.11a													
CH 157													
5785MHz		5601.6	48.37	-19.83	68.2	37.14	34.6	11.89	35.26	371	108	P	V
		5679.2	50.77	-39.08	89.85	39.45	34.6	12	35.28	371	108	P	V
		5716.8	48.92	-60.99	109.91	37.54	34.6	12.06	35.28	371	108	P	V
		5722.6	50.43	-66.3	116.73	39.05	34.6	12.06	35.28	371	108	P	V
	*	5785	106.78	-	-	95.31	34.6	12.17	35.3	371	108	P	V
	*	5785	99.59	-	-	88.12	34.6	12.17	35.3	371	108	A	V
		5851.2	48.51	-70.95	119.46	36.94	34.6	12.28	35.31	371	108	P	V
		5861	50.34	-58.78	109.12	38.66	34.6	12.39	35.31	371	108	P	V
		5879.6	49.15	-52.63	101.78	37.48	34.6	12.39	35.32	371	108	P	V
		5941.8	50.28	-17.92	68.2	38.39	34.6	12.62	35.33	371	108	P	V
													V
													V



WiFi Ant. 2	Note	Frequency (MHz)	Level (dBμV/m)	Over Limit (dB)	Limit Line (dBμV/m)	Read Level (dBμV)	Antenna Factor (dB/m)	Cable Loss (dB)	Preamp Factor (dB)	Ant Pos (cm)	Table Pos (deg)	Peak Avg. (P/A)	Pol. (H/V)	
802.11a CH 165 5825MHz	*	5825	107.93	-	-	96.36	34.6	12.28	35.31	364	324	P	H	
	*	5825	100.18	-	-	88.61	34.6	12.28	35.31	364	324	A	H	
		5853.8	66.2	-47.34	113.54	54.63	34.6	12.28	35.31	364	324	P	H	
		5855.6	62.26	-48.37	110.63	50.69	34.6	12.28	35.31	364	324	P	H	
		5881.6	54.18	-46.12	100.3	42.51	34.6	12.39	35.32	364	324	P	H	
		5936	49.39	-18.81	68.2	37.61	34.6	12.51	35.33	364	324	P	H	
														H
														H
	*	5825	107.08	-	-	95.51	34.6	12.28	35.31	380	44	P	V	
	*	5825	100.13	-	-	88.56	34.6	12.28	35.31	380	44	A	V	
		5850.2	66.51	-55.23	121.74	54.94	34.6	12.28	35.31	380	44	P	V	
		5855.2	61.64	-49.1	110.74	50.07	34.6	12.28	35.31	380	44	P	V	
		5875	54.07	-51.13	105.2	42.4	34.6	12.39	35.32	380	44	P	V	
		5939.4	49.95	-18.25	68.2	38.17	34.6	12.51	35.33	380	44	P	V	
														V
														V
													V	
Remark	1. No other spurious found. 2. All results are PASS against Peak and Average limit line.													



Band 4 5725~5850MHz

WIFI 802.11a (Harmonic @ 3m)

WIFI Ant. 2	Note	Frequency (MHz)	Level (dBμV/m)	Over Limit (dB)	Limit Line (dBμV/m)	Read Level (dBμV)	Antenna Factor (dB/m)	Cable Loss (dB)	Preamp Factor (dB)	Ant Pos (cm)	Table Pos (deg)	Peak Avg. (P/A)	Pol. (H/V)
802.11a CH 149 5745MHz		11490	50.37	-23.63	74	51.28	39.27	17.16	57.34	100	0	P	H
		17235	63.56	-4.64	68.2	56.26	42.43	20.76	55.89	100	0	P	H
													H
													H
		11490	62.1	-11.9	74	63.01	39.27	17.16	57.34	100	25	P	V
		11490	49.7	-4.3	54	50.61	39.27	17.16	57.34	100	25	A	V
		17235	51.51	-16.69	68.2	44.21	42.43	20.76	55.89	100	0	P	V
802.11a CH 157 5785MHz		11570	49.36	-24.64	74	50.19	39.2	17.16	57.19	100	0	P	H
		17355	62.2	-6	68.2	55.06	42.24	20.84	55.94	100	0	P	H
													H
													H
		11570	59.94	-14.06	74	60.77	39.2	17.16	57.19	100	49	P	V
		11570	48.71	-5.29	54	49.54	39.2	17.16	57.19	100	49	A	V
		17355	50.56	-17.64	68.2	43.42	42.24	20.84	55.94	100	0	P	V
802.11a CH 165 5825MHz		11650	49.17	-24.83	74	49.98	39.11	17.16	57.08	100	0	P	H
		17475	60.93	-7.27	68.2	53.94	42.05	20.93	55.99	100	53	P	H
													H
													H
		11650	61.98	-12.02	74	62.79	39.11	17.16	57.08	100	331	P	V
		11650	49.88	-4.12	54	50.69	39.11	17.16	57.08	100	331	A	V
		17475	51.16	-17.04	68.2	44.17	42.05	20.93	55.99	100	0	P	V
Remark	1. No other spurious found. 2. All results are PASS against Peak and Average limit line.												



Band 4 5725~5850MHz

WIFI 802.11n HT20 (Band Edge @ 3m)

WIFI Ant. 2	Note	Frequency (MHz)	Level (dBμV/m)	Over Limit (dB)	Limit Line (dBμV/m)	Read Level (dBμV)	Antenna Factor (dB/m)	Cable Loss (dB)	Preamp Factor (dB)	Ant Pos (cm)	Table Pos (deg)	Peak Avg. (P/A)	Pol. (H/V)	
802.11n HT20 CH 149 5745MHz		5634.4	49.12	-19.08	68.2	37.84	34.6	11.95	35.27	377	320	P	H	
		5694.4	57.36	-43.71	101.07	46.04	34.6	12	35.28	377	320	P	H	
		5719.6	67.8	-42.89	110.69	56.42	34.6	12.06	35.28	377	320	P	H	
		5723.8	75.85	-43.61	119.46	64.47	34.6	12.06	35.28	377	320	P	H	
	*	5745	109.61	-	-	98.19	34.6	12.11	35.29	377	320	P	H	
	*	5745	102.31	-	-	90.89	34.6	12.11	35.29	377	320	A	H	
														H
														H
			5623.2	48.53	-19.67	68.2	37.24	34.6	11.95	35.26	377	108	P	V
			5699.4	57.81	-46.95	104.76	46.49	34.6	12	35.28	377	108	P	V
			5719.8	67.08	-43.66	110.74	55.7	34.6	12.06	35.28	377	108	P	V
			5724.8	74.62	-47.12	121.74	63.24	34.6	12.06	35.28	377	108	P	V
	*		5745	107.55	-	-	96.13	34.6	12.11	35.29	377	108	P	V
	*		5745	100.6	-	-	89.18	34.6	12.11	35.29	377	108	A	V
														V
														V



WIFI Ant. 2	Note	Frequency (MHz)	Level (dBμV/m)	Over Limit (dB)	Limit Line (dBμV/m)	Read Level (dBμV)	Antenna Factor (dB/m)	Cable Loss (dB)	Preamp Factor (dB)	Ant Pos (cm)	Table Pos (deg)	Peak Avg. (P/A)	Pol. (H/V)
		5631	49.57	-18.63	68.2	38.29	34.6	11.95	35.27	370	322	P	H
		5669.4	50.62	-31.97	82.59	39.29	34.6	12	35.27	370	322	P	H
		5720	53.1	-57.7	110.8	41.72	34.6	12.06	35.28	370	322	P	H
		5724.2	53.98	-66.4	120.38	42.6	34.6	12.06	35.28	370	322	P	H
	*	5785	109.11	-	-	97.64	34.6	12.17	35.3	370	322	P	H
	*	5785	101.73	-	-	90.26	34.6	12.17	35.3	370	322	A	H
		5851	53.12	-66.8	119.92	41.55	34.6	12.28	35.31	370	322	P	H
		5861.2	50.16	-58.9	109.06	38.48	34.6	12.39	35.31	370	322	P	H
		5884.6	50.34	-47.73	98.07	38.67	34.6	12.39	35.32	370	322	P	H
		5931	49.83	-18.37	68.2	38.05	34.6	12.51	35.33	370	322	P	H
802.11n													H
HT20													H
CH 157		5639	49.22	-18.98	68.2	37.94	34.6	11.95	35.27	368	42	P	V
5785MHz		5680.2	49.22	-41.37	90.59	37.9	34.6	12	35.28	368	42	P	V
		5719	51.59	-58.93	110.52	40.21	34.6	12.06	35.28	368	42	P	V
		5721.2	53.69	-59.85	113.54	42.31	34.6	12.06	35.28	368	42	P	V
	*	5785	108.35	-	-	96.88	34.6	12.17	35.3	368	42	P	V
	*	5785	101.05	-	-	89.58	34.6	12.17	35.3	368	42	A	V
		5852	51.61	-66.03	117.64	40.04	34.6	12.28	35.31	368	42	P	V
		5855.4	50.16	-60.53	110.69	38.59	34.6	12.28	35.31	368	42	P	V
		5890.6	50.83	-42.79	93.62	39.16	34.6	12.39	35.32	368	42	P	V
		5936	50.39	-17.81	68.2	38.61	34.6	12.51	35.33	368	42	P	V
													V
													V



WIFI Ant. 2	Note	Frequency (MHz)	Level (dBμV/m)	Over Limit (dB)	Limit Line (dBμV/m)	Read Level (dBμV)	Antenna Factor (dB/m)	Cable Loss (dB)	Preamp Factor (dB)	Ant Pos (cm)	Table Pos (deg)	Peak Avg. (P/A)	Pol. (H/V)	
802.11n HT20 CH 165 5825MHz	*	5825	107.18	-	-	95.61	34.6	12.28	35.31	347	321	P	H	
	*	5825	100.05	-	-	88.48	34.6	12.28	35.31	347	321	A	H	
		5850.2	65.5	-56.24	121.74	53.93	34.6	12.28	35.31	347	321	P	H	
		5855.8	63.31	-47.27	110.58	51.74	34.6	12.28	35.31	347	321	P	H	
		5881.8	53.53	-46.62	100.15	41.86	34.6	12.39	35.32	347	321	P	H	
		5932.4	48.94	-19.26	68.2	37.16	34.6	12.51	35.33	347	321	P	H	
														H
														H
	*	5825	107.19	-	-	95.62	34.6	12.28	35.31	380	44	P	V	
	*	5825	100.03	-	-	88.46	34.6	12.28	35.31	380	44	A	V	
		5850.6	64.64	-56.19	120.83	53.07	34.6	12.28	35.31	380	44	P	V	
		5856	62.52	-48	110.52	50.95	34.6	12.28	35.31	380	44	P	V	
		5875.8	52.09	-52.52	104.61	40.42	34.6	12.39	35.32	380	44	P	V	
		5943.2	50.58	-17.62	68.2	38.69	34.6	12.62	35.33	380	44	P	V	
														V
													V	
Remark	1. No other spurious found. 2. All results are PASS against Peak and Average limit line.													



Band 4 5725~5850MHz

WIFI 802.11n HT20 (Harmonic @ 3m)

WIFI Ant. 2	Note	Frequency (MHz)	Level (dBμV/m)	Over Limit (dB)	Limit Line (dBμV/m)	Read Level (dBμV)	Antenna Factor (dB/m)	Cable Loss (dB)	Preamp Factor (dB)	Ant Pos (cm)	Table Pos (deg)	Peak Avg. (P/A)	Pol. (H/V)	
802.11n HT20 CH 149 5745MHz		11490	50.12	-23.88	74	51.03	39.27	17.16	57.34	100	0	P	H	
		17235	63.67	-4.53	68.2	56.37	42.43	20.76	55.89	100	0	P	H	
													H	
													H	
			11490	58.85	-15.15	74	59.76	39.27	17.16	57.34	100	333	P	V
			11490	49.7	-4.3	54	50.61	39.27	17.16	57.34	100	333	A	V
			17235	51.19	-17.01	68.2	43.89	42.43	20.76	55.89	100	0	P	V
													V	
802.11n HT20 CH 157 5785MHz		11570	49.74	-24.26	74	50.57	39.2	17.16	57.19	100	0	P	H	
		17355	61.73	-6.47	68.2	54.59	42.24	20.84	55.94	100	0	P	H	
													H	
													H	
			11570	58.52	-15.48	74	59.35	39.2	17.16	57.19	100	327	P	V
			11570	48.54	-5.46	54	49.37	39.2	17.16	57.19	100	327	A	V
			17352	49.25	-18.95	68.2	42.11	42.24	20.84	55.94	100	0	P	V
													V	
802.11n HT20 CH 165 5825MHz		11650	48.13	-25.87	74	48.94	39.11	17.16	57.08	100	0	P	H	
		17475	60.2	-8	68.2	53.21	42.05	20.93	55.99	100	0	P	H	
													H	
													H	
			11650	56.92	-17.08	74	57.73	39.11	17.16	57.08	100	335	P	V
			11650	49.03	-4.97	54	49.84	39.11	17.16	57.08	100	335	A	V
			17475	49.01	-19.19	68.2	42.02	42.05	20.93	55.99	100	0	P	V
													V	
Remark	1. No other spurious found. 2. All results are PASS against Peak and Average limit line.													



Band 4 5725~5850MHz

Emission below 1GHz

5GHz WIFI 802.11n HT20 (LF @ 3m)

WIFI Ant.	Note	Frequency	Level	Over Limit	Limit Line	Read Level	Antenna Factor	Cable Loss	Preamp Factor	Ant Pos	Table Pos	Peak Avg.	Pol.	
2		(MHz)	(dBμV/m)	(dB)	(dBμV/m)	(dBμV)	(dB/m)	(dB)	(dB)	(cm)	(deg)	(P/A)	(H/V)	
5GHz 802.11n HT20 LF		32.43	30.92	-9.08	40	36.85	24.38	1.07	31.38	-	-	P	H	
		96.69	39.65	-3.85	43.5	53.46	16.01	1.28	31.1	100	317	P	H	
		151.77	38.46	-5.04	43.5	50.24	17.56	1.78	31.12	-	-	P	H	
		367.9	37.07	-8.93	46	44.01	21.62	2.5	31.06	-	-	P	H	
		479.9	35.61	-10.39	46	39.61	23.76	3.04	30.8	-	-	P	H	
		720	37.27	-8.73	46	37.22	26.71	3.74	30.4	-	-	P	H	
														H
														H
														H
														H
														H
			49.17	30.14	-9.86	40	44.75	15.52	1.07	31.2	-	-	P	V
			96.69	37.64	-5.86	43.5	51.45	16.01	1.28	31.1	-	-	P	V
			151.77	38.19	-5.31	43.5	49.97	17.56	1.78	31.12	100	265	P	V
			409.9	30.11	-15.89	46	35.74	22.55	2.67	30.85	-	-	P	V
			720	32.36	-13.64	46	32.31	26.71	3.74	30.4	-	-	P	V
			960.1	35.69	-18.31	54	31.76	30.22	4.07	30.36	-	-	P	V
														V
													V	
													V	
													V	
													V	
													V	
Remark	1. No other spurious found. 2. All results are PASS against limit line.													



Note symbol

*	Fundamental Frequency which can be ignored. However, the level of any unwanted emissions shall not exceed the level of the fundamental frequency.
!	Test result is over limit line.
P/A	Peak or Average
H/V	Horizontal or Vertical



A calculation example for radiated spurious emission is shown as below:

WIFI	Note	Frequency	Level	Over	Limit	Read	Antenna	Cable	Preamp	Ant	Table	Peak	Pol.
Ant.				Limit	Line	Level	Factor	Loss	Factor	Pos	Pos	Avg.	
2		(MHz)	(dBμV/m)	(dB)	(dBμV/m)	(dBμV)	(dB/m)	(dB)	(dB)	(cm)	(deg)	(P/A)	(H/V)
802.11b		2390	55.45	-18.55	74	54.51	32.22	4.58	35.86	103	308	P	H
CH 01													
2412MHz		2390	43.54	-10.46	54	42.6	32.22	4.58	35.86	103	308	A	H

- Level(dBμV/m) =
Antenna Factor(dB/m) + Cable Loss(dB) + Read Level(dBμV) - Preamp Factor(dB)
- Over Limit(dB) = Level(dBμV/m) – Limit Line(dBμV/m)

For Peak Limit @ 2390MHz:

- Level(dBμV/m)
= Antenna Factor(dB/m) + Cable Loss(dB) + Read Level(dBμV) - Preamp Factor(dB)
= 32.22(dB/m) + 4.58(dB) + 54.51(dBμV) – 35.86 (dB)
= 55.45 (dBμV/m)
- Over Limit(dB)
= Level(dBμV/m) – Limit Line(dBμV/m)
= 55.45(dBμV/m) – 74(dBμV/m)
= -18.55(dB)

For Average Limit @ 2390MHz:

- Level(dBμV/m)
= Antenna Factor(dB/m) + Cable Loss(dB) + Read Level(dBμV) - Preamp Factor(dB)
= 32.22(dB/m) + 4.58(dB) + 42.6(dBμV) – 35.86 (dB)
= 43.54 (dBμV/m)
- Over Limit(dB)
= Level(dBμV/m) – Limit Line(dBμV/m)
= 43.54(dBμV/m) – 54(dBμV/m)
= -10.46(dB)

Both peak and average measured complies with the limit line, so test result is “PASS”.



Appendix C. Radiated Spurious Emission Plots

Test Engineer :	Jesse Wang and Ken Wu	Temperature :	21~24°C
		Relative Humidity :	50~54%

Band 4 - 5725~5850MHz WIFI 802.11a (Band Edge @ 3m)

WIFI	Band 4 5725~5850MHz Band Edge @ 3m	
ANT	802.11a CH149 5745MHz	
2	Horizontal	Fundamental
Peak	<p>Site : 03CH07-HY Condition : PEAK_BE(B4)_16-24 3m HF-ANT_130829 HORIZONTAL Detector : Peak Project : 600724 Mode : 19 Setting : 19.5</p>	<p>Site : 03CH07-HY Condition : PEAK(LNB) 3m HF-ANT_130829 HORIZONTAL Detector : Peak Project : 600724 Mode : 19 Setting : 19.5</p>

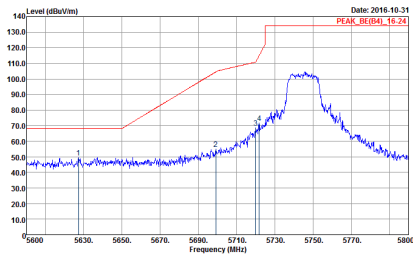
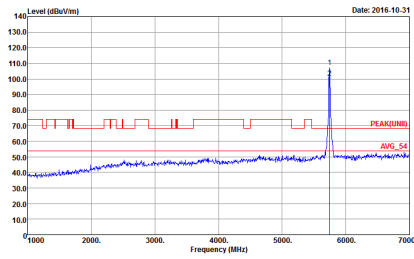

WIFI	Band 4 5725~5850MHz Band Edge @ 3m	
ANT	802.11a CH149 5745MHz	
2	Vertical	Fundamental
Peak	 <p style="font-size: small;">Date: 2016.10.31 PEAK_BE(B4)_16.24</p> <p style="font-size: x-small;">Site : 03CH07-HY Condition : PEAK_BE(B4)_16.24 3m HF-ANT_130829 VERTICAL RBW: 1000.000kHz VBW: 3000.000kHz SVWT: Auto Detector : Peak Project : 600724 Mode : 19 Setting : 19.5</p>	 <p style="font-size: small;">Date: 2016.10.31 PEAK(LNB) AVG_54</p> <p style="font-size: x-small;">Site : 03CH07-HY Condition : PEAK(LNB) 3m HF-ANT_130829 VERTICAL RBW: 1000.000kHz VBW: 3000.000kHz SVWT: Auto Detector : Peak Project : 600724 Mode : 19 Setting : 19.5</p>



WIFI	Band 4 5725~5850MHz Band Edge @ 3m	
ANT	802.11a CH157 5785MHz	
2	Horizontal	Fundamental
<p>Peak</p>	<p>Site : 03CH07-HY Condition : PEAK_BE(B4)_16-24 3m HF-ANT_130829 HORIZONTAL RBW:1000.000kHz VBW:3000.000kHz SVWT:Auto Detector : Peak Project : 600724 Mode : 11 Setting : 20</p>	<p>Site : 03CH07-HY Condition : PEAK(LNB) 3m HF-ANT_130829 HORIZONTAL RBW:1000.000kHz VBW:3000.000kHz SVWT:Auto Detector : Peak Project : 600724 Mode : 11 Setting : 20</p>
<p>Peak</p>	<p>Site : 03CH07-HY Condition : PEAK_BE(B4)_16-24 3m HF-ANT_130829 HORIZONTAL RBW:1000.000kHz VBW:3000.000kHz SVWT:Auto Detector : Peak Project : 600724 Mode : 11 Setting : 20</p>	<p>Left blank</p>

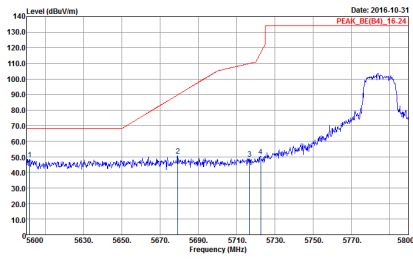
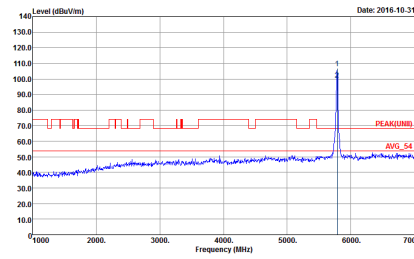
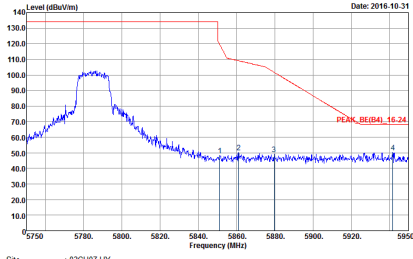

WIFI	Band 4 5725~5850MHz Band Edge @ 3m	
ANT	802.11a CH157 5785MHz	
2	Vertical	Fundamental
Peak	 <p>Date: 2016-10-31</p> <p>Site : 03CH07-HY Condition : PEAK_BE(B4)_16-24 3m HF-ANT_130829 VERTICAL RBW: 1000.000kHz VBW: 3000.000kHz SWT: Auto Detector : Peak Project : 600724 Mode : 11 Setting : 20</p>	 <p>Date: 2016-10-31</p> <p>Site : 03CH07-HY Condition : PEAK(LIN) 3m HF-ANT_130829 VERTICAL RBW: 1000.000kHz VBW: 3000.000kHz SWT: Auto Detector : Peak Project : 600724 Mode : 11 Setting : 20</p>
Peak	 <p>Date: 2016-10-31</p> <p>Site : 03CH07-HY Condition : PEAK_BE(B4)_16-24 3m HF-ANT_130829 VERTICAL RBW: 1000.000kHz VBW: 3000.000kHz SWT: Auto Detector : Peak Project : 600724 Mode : 11 Setting : 20</p>	Left blank

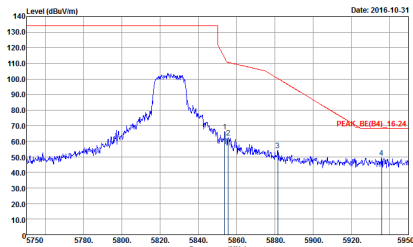
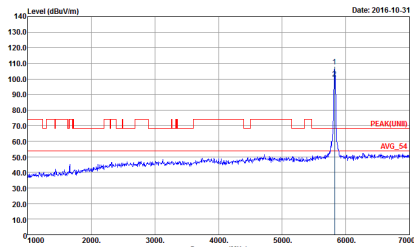

WIFI	Band 4 5725~5850MHz Band Edge @ 3m	
ANT	802.11a CH165 5825MHz	
2	Horizontal	Fundamental
<p>Peak</p>	 <p>Date: 2016.10.31</p> <p>Site : 03CH07-HY Condition : PEAK_BE(B4)_16-24 3m HF-ANT_130829 HORIZONTAL : RBW:1000.000kHz VBW:3000.000kHz SVWT:Auto Detector : Peak Project : 600724 Mode : 12 Setting : 20</p>	 <p>Date: 2016.10.31</p> <p>Site : 03CH07-HY Condition : PEAK(FUN) 3m HF-ANT_130829 HORIZONTAL : RBW:1000.000kHz VBW:3000.000kHz SVWT:Auto Detector : Peak Project : 600724 Mode : 12 Setting : 20</p>

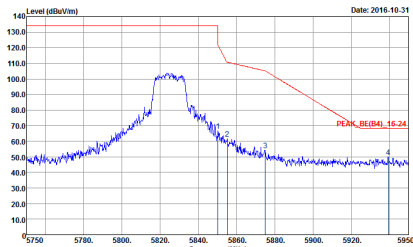
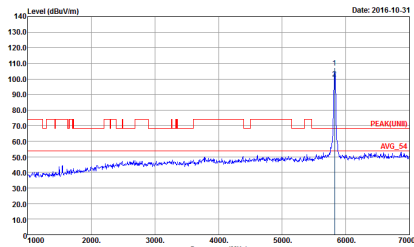

WIFI	Band 4 5725~5850MHz Band Edge @ 3m	
ANT	802.11a CH165 5825MHz	
2	Vertical	Fundamental
Peak	 <p>Date: 2016.10.31</p> <p>Site : 03CH07-HY Condition : PEAK_BE(B4)_16-24 3m HF-ANT_130829 VERTICAL : RBW:1000.000kHz VBW:3000.000kHz SWT:Auto Detector : Peak Project : 600724 Mode : 12 Setting : 20</p>	 <p>Date: 2016.10.31</p> <p>Site : 03CH07-HY Condition : PEAK(FUN) 3m HF-ANT_130829 VERTICAL : RBW:1000.000kHz VBW:3000.000kHz SWT:Auto Detector : Peak Project : 600724 Mode : 12 Setting : 20</p>

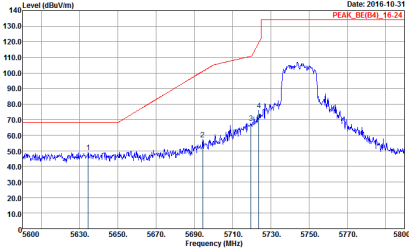
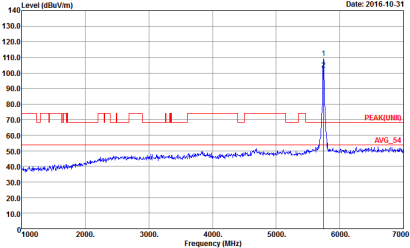

Band 4 5725~5850MHz
WIFI 802.11n HT20 (Band Edge @ 3m)

WIFI	Band 4 5725~5850MHz Band Edge @ 3m	
ANT	802.11n HT20 CH149 5745MHz	
2	Horizontal	Fundamental
Peak	 <p>Site : 03CH07HY Condition : PEAK_BE(B4)_16-24 3m HF-ANT_130829 HORIZONTAL Detector : Peak Project : 600724 Mode : 13 Setting : 20</p>	 <p>Site : 03CH07HY Condition : PEAK(LNB) 3m HF-ANT_130829 HORIZONTAL Detector : Peak Project : 600724 Mode : 13 Setting : 20</p>

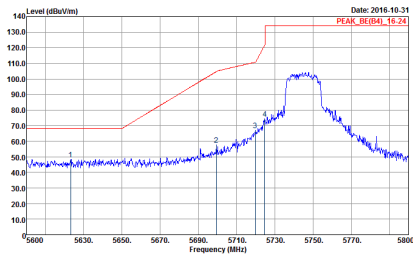
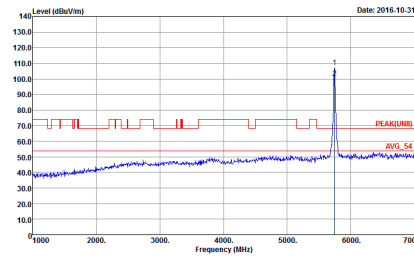

WIFI	Band 4 5725~5850MHz Band Edge @ 3m	
ANT	802.11n HT20 CH149 5745MHz	
2	Vertical	Fundamental
Peak	 <p>Date: 2016.10.31</p> <p>Site : 03CH07-HY Condition : PEAK_BE(B4)_16_24 3m HF-ANT_130829 VERTICAL : RBW:1000.000kHz VBW:3000.000kHz SVWT:Auto Detector : Peak Project : 600724 Mode : 13 Setting : 20</p>	 <p>Date: 2016.10.31</p> <p>Site : 03CH07-HY Condition : PEAK(LNB) 3m HF-ANT_130829 VERTICAL : RBW:1000.000kHz VBW:3000.000kHz SVWT:Auto Detector : Peak Project : 600724 Mode : 13 Setting : 20</p>

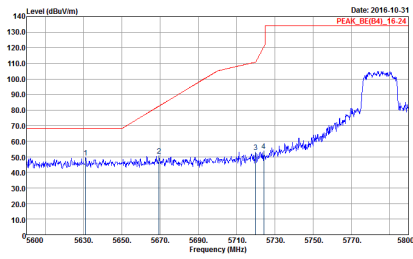
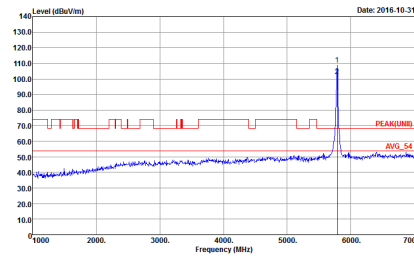
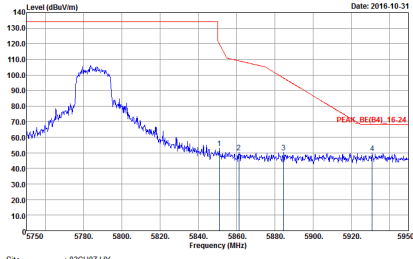

WIFI	Band 4 5725~5850MHz Band Edge @ 3m	
ANT	802.11n HT20 CH157 5785MHz	
2	Horizontal	Fundamental
Peak	 <p>Date: 2016-10-31</p> <p>Site : 03CH07-HY Condition : PEAK_BE(B4)_16-24 3m HF-ANT_130829 HORIZONTAL RBW: 1000.000kHz VBW: 3000.000kHz SWT: Auto Detector : Peak Project : 600724 Mode : 14 Setting : 20</p>	 <p>Date: 2016-10-31</p> <p>Site : 03CH07-HY Condition : PEAK(LIN) 3m HF-ANT_130829 HORIZONTAL RBW: 1000.000kHz VBW: 3000.000kHz SWT: Auto Detector : Peak Project : 600724 Mode : 14 Setting : 20</p>
Peak	 <p>Date: 2016-10-31</p> <p>Site : 03CH07-HY Condition : PEAK_BE(B4)_16-24 3m HF-ANT_130829 HORIZONTAL RBW: 1000.000kHz VBW: 3000.000kHz SWT: Auto Detector : Peak Project : 600724 Mode : 14 Setting : 20</p>	Left blank



WIFI	Band 4 5725~5850MHz Band Edge @ 3m	
ANT	802.11n HT20 CH157 5785MHz	
2	Vertical	Fundamental
<p>Peak</p>	<p>Date: 2016-10-31</p> <p>Site : 03CH07-HY Condition : PEAK_BE(B4)_16-24 3m HF-ANT_130829 VERTICAL RBW:1000.000kHz VBW:3000.000kHz SWT:Auto Detector : Peak Project : 600724 Mode : 14 Setting : 20</p>	<p>Date: 2016-10-31</p> <p>Site : 03CH07-HY Condition : PEAK(LNB) 3m HF-ANT_130829 VERTICAL RBW:1000.000kHz VBW:3000.000kHz SWT:Auto Detector : Peak Project : 600724 Mode : 14 Setting : 20</p>
<p>Peak</p>	<p>Date: 2016-10-31</p> <p>Site : 03CH07-HY Condition : PEAK_BE(B4)_16-24 3m HF-ANT_130829 VERTICAL RBW:1000.000kHz VBW:3000.000kHz SWT:Auto Detector : Peak Project : 600724 Mode : 14 Setting : 20</p>	<p>Left blank</p>

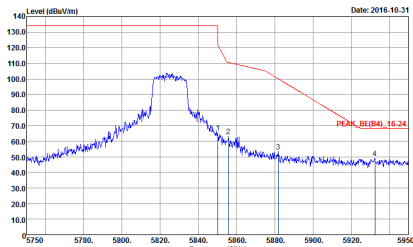
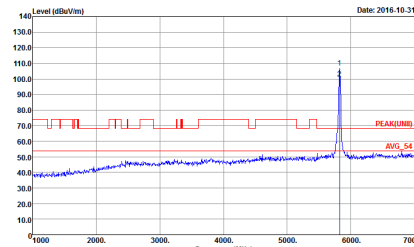

WIFI	Band 4 5725~5850MHz Band Edge @ 3m	
ANT	802.11n HT20 CH165 5825MHz	
2	Horizontal	Fundamental
Peak	 <p>Date: 2016.10.31</p> <p>Site : 03CH07-HY Condition : PEAK_BE(B4)_16-24 3m HF-ANT_130829 HORIZONTAL : RBW:1000.000kHz VBW:3000.000kHz SVWT:Auto Detector : Peak Project : 600724 Mode : 15 Setting : 20</p>	 <p>Date: 2016.10.31</p> <p>Site : 03CH07-HY Condition : PEAK(LIN) 3m HF-ANT_130829 HORIZONTAL : RBW:1000.000kHz VBW:3000.000kHz SVWT:Auto Detector : Peak Project : 600724 Mode : 15 Setting : 20</p>

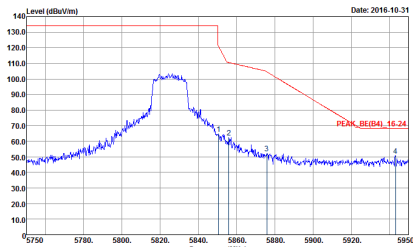
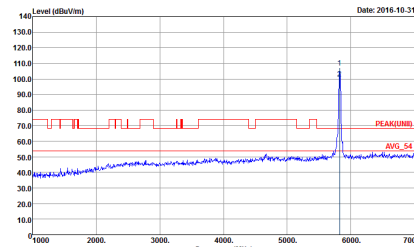

WIFI	Band 4 5725~5850MHz Band Edge @ 3m	
ANT	802.11n HT20 CH165 5825MHz	
2	Vertical	Fundamental
Peak	 <p>Date: 2016.10.31</p> <p>Site : 03CH07-HY Condition : PEAK_BE(B4)_16-24 3m HF-ANT_130829 VERTICAL : RBW:1000.000kHz VBW:3000.000kHz SVWT:Auto Detector : Peak Project : 600724 Mode : 15 Setting : 20</p>	 <p>Date: 2016.10.31</p> <p>Site : 03CH07-HY Condition : PEAK(LIN) 3m HF-ANT_130829 VERTICAL : RBW:1000.000kHz VBW:3000.000kHz SVWT:Auto Detector : Peak Project : 600724 Mode : 15 Setting : 20</p>



Band 4 5725~5850MHz

Band 4 - 5725~5850MHz

WIFI 802.11a (Harmonic @ 3m)

WIFI	Band 4 5725~5850MHz Harmonic @ 3m	
ANT	802.11a CH149 5745MHz	
2	Horizontal	Vertical
<p>Peak Avg.</p>	<p>Site : 03CH07.HY Condition : PEAK(LIM) 3m SHF-EHF_131029 HORIZONTAL Detector : Peak Project : 600724 Mode : 10 Setting : 19.5</p>	<p>Site : 03CH07.HY Condition : PEAK(LIM) 3m SHF-EHF_131029 VERTICAL Detector : Peak Project : 600724 Mode : 10 Setting : 19.5</p>

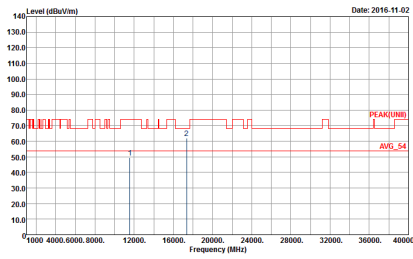
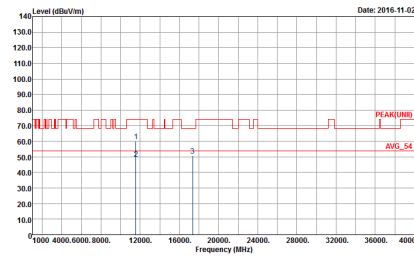

WIFI	Band 4 5725~5850MHz Harmonic @ 3m	
ANT	802.11a CH157 5785MHz	
2	Horizontal	Vertical
<p>Peak Avg.</p>	 <p>Site : 03CH07-HY Condition : PEAK(LNII) 3m SHF-EHF_131029 HORIZONTAL Detector : Peak Project : 600724 Mode : 11 Setting : 20</p>	 <p>Site : 03CH07-HY Condition : PEAK(LNII) 3m SHF-EHF_131029 VERTICAL Detector : Peak Project : 600724 Mode : 11 Setting : 20</p>

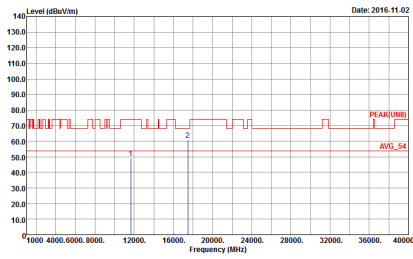
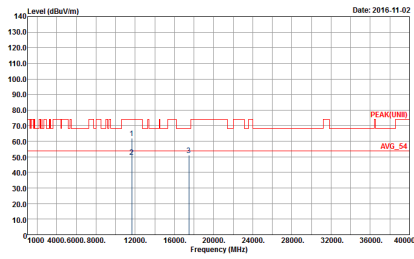

WIFI	Band 4 5725~5850MHz Harmonic @ 3m	
ANT	802.11a CH165 5825MHz	
2	Horizontal	Vertical
<p>Peak</p> <p>Avg.</p>	 <p>Site : 03CH07-HY Condition : PEAK(LNII) 3m SHF-EHF_131029 HORIZONTAL Detector : Peak Project : 600724 Mode : 12 Setting : 20</p>	 <p>Site : 03CH07-HY Condition : PEAK(LNII) 3m SHF-EHF_131029 VERTICAL Detector : Peak Project : 600724 Mode : 12 Setting : 20</p>



Band 4 5725~5850MHz
WIFI 802.11n HT20 (Harmonic @ 3m)

Table with 2 columns: Horizontal and Vertical. Contains spectral plots of Level (dBuV/m) vs Frequency (MHz) for Peak and Avg. measurements. Includes technical details like Site, Condition, Detector, Project, Mode, and Setting.

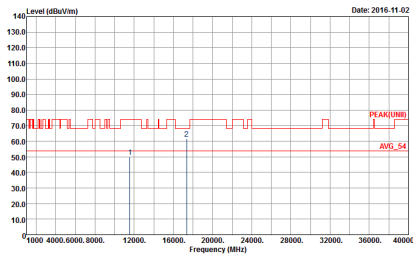
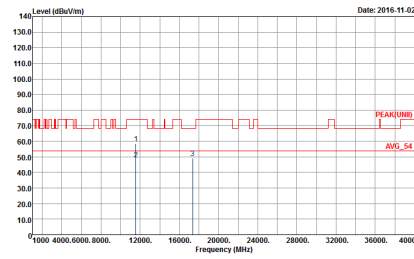

WIFI	Band 4 5725~5850MHz Harmonic @ 3m	
ANT	802.11n HT20 CH157 5785MHz	
2	Horizontal	Vertical
<p>Peak Avg.</p>	 <p>Site : 03CH07-HY Condition : PEAK(LNII) 3m SHF-EHF_131029 HORIZONTAL Detector : Peak Project : 600724 Mode : 14 Setting : 20</p>	 <p>Site : 03CH07-HY Condition : PEAK(LNII) 3m SHF-EHF_131029 VERTICAL Detector : Peak Project : 600724 Mode : 14 Setting : 20</p>

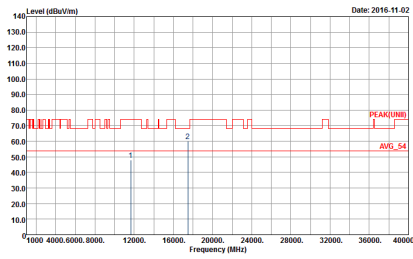
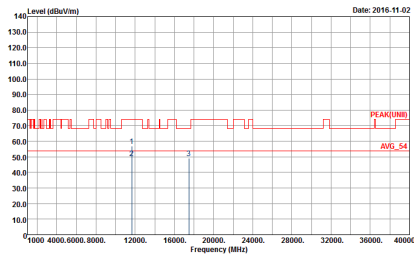

WIFI	Band 4 5725~5850MHz Harmonic @ 3m	
ANT	802.11n HT20 CH165 5825MHz	
2	Horizontal	Vertical
<p>Peak</p> <p>Avg.</p>	 <p>Site : 03CH07-HY Condition : PEAK(LNII) 3m SHF-EHF_131029 HORIZONTAL Detector : Peak Project : 600724 Mode : 15 Setting : 20</p>	 <p>Site : 03CH07-HY Condition : PEAK(LNII) 3m SHF-EHF_131029 VERTICAL Detector : Peak Project : 600724 Mode : 15 Setting : 20</p>



Band 4 5725~5850MHz

Emission below 1GHz

5GHz WIFI 802.11n HT20 (LF)

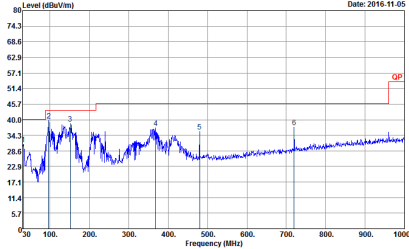
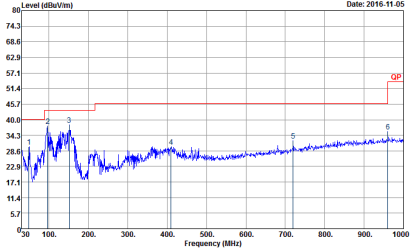
WIFI	5GHz 5725~5850MHz	
ANT	802.11n HT20 LF	
2	Horizontal	Vertical
QP / Peak	 <p>Site : 03CH07-HY Condition : QP 3m LF-ANT-35419(6) HORIZONTAL Project : 606724 Mode : 25 Plane : Y Ant : 1</p>	 <p>Site : 03CH07-HY Condition : QP 3m LF-ANT-35419(6) VERTICAL Project : 606724 Mode : 25 Plane : Y Ant : 1</p>



5GHz 802.11n HT20

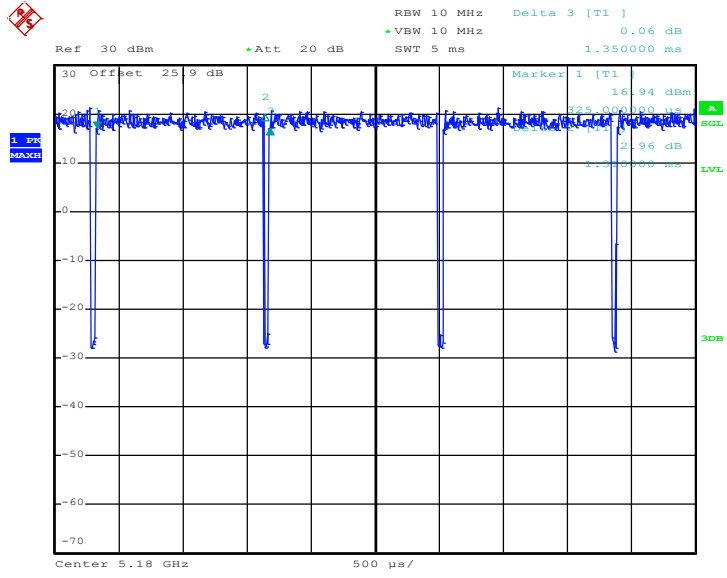

Date: 3.NOV.2016 16:28:08



<EUT with J301 Antenna>

Band	Duty Cycle(%)	T(us)	1/T(kHz)	VBW Setting
802.11a	97.222	1400	0.71	1kHz
5GHz 802.11n HT20	96.362	1310	0.76	1kHz

802.11a

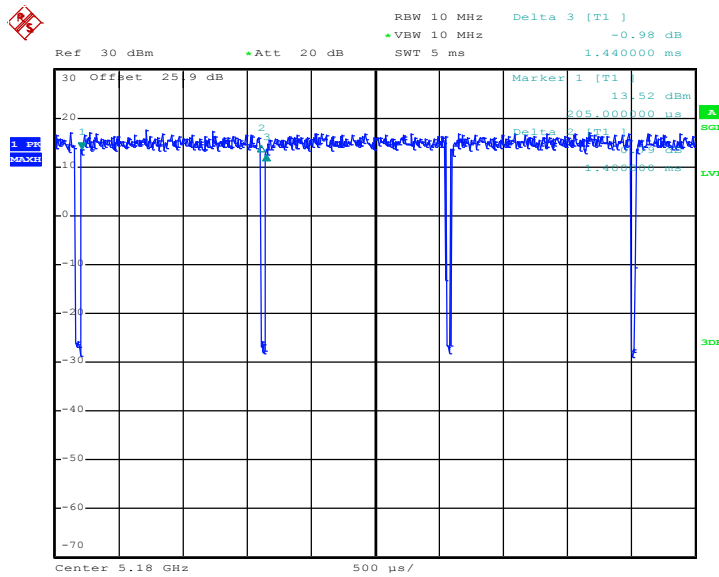

Date: 4.NOV.2016 16:56:02



5GHz 802.11n HT20

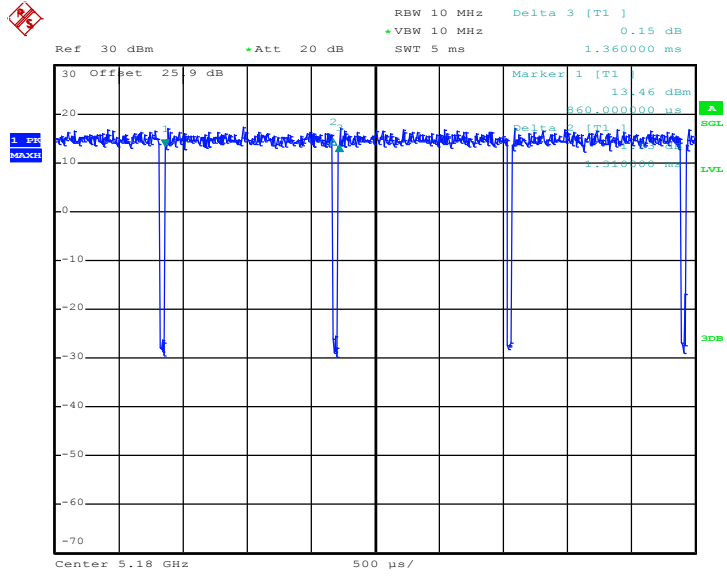

Date: 4.NOV.2016 16:51:51