



FCC RADIO TEST REPORT

FCC ID : UZ7MC945B
Equipment : Mobile Computer
Brand Name : ZEBRA
Model Name : MC945B
Applicant : Zebra Technologies Corporation
1 Zebra Plaza, Holtsville, NY 11742
Manufacturer : Zebra Technologies Corporation
1 Zebra Plaza, Holtsville, NY 11742
Standard : FCC Part 15 Subpart E §15.407

The product was received on Nov. 06, 2023 and testing was performed from Nov. 10, 2023 to Jan. 23, 2024. We, Sporton International Inc. Wensan Laboratory, would like to declare that the tested sample has been evaluated in accordance with the test procedures and has been in compliance with the applicable technical standards.

The test results in this report apply exclusively to the tested model / sample. Without written approval from Sporton International Inc. Wensan Laboratory, the test report shall not be reproduced except in full.

Approved by: Louis Wu

Sporton International Inc. Wensan Laboratory

No.58, Aly. 75, Ln. 564, Wenhua 3rd, Rd., Guishan Dist., Taoyuan City 333010, Taiwan (R.O.C.)



Table of Contents

History of this test report.....	3
Summary of Test Result.....	4
1 General Description	5
1.1 Product Feature of Equipment Under Test.....	5
1.2 Product Specification of Equipment Under Test.....	6
1.3 Modification of EUT	9
1.4 Testing Location	10
1.5 Applicable Standards.....	10
2 Test Configuration of Equipment Under Test	11
2.1 Carrier Frequency and Channel	11
2.2 Test Mode.....	13
2.3 Connection Diagram of Test System.....	15
2.4 Support Unit used in test configuration and system	16
2.5 EUT Operation Test Setup	16
2.6 Measurement Results Explanation Example.....	16
3 Test Result	17
3.1 26dB & 99% Occupied Bandwidth Measurement	17
3.2 Fundamental Maximum EIRP Measurement	18
3.3 Fundamental Power Spectral Density Measurement.....	19
3.4 In-Band Emissions (Channel Mask)	21
3.5 Unwanted Emissions Measurement.....	23
3.6 AC Conducted Emission Measurement.....	26
3.7 Antenna Requirements	28
4 List of Measuring Equipment.....	29
5 Measurement Uncertainty	30
Appendix A. Conducted Test Results	
Appendix B. AC Conducted Emission Test Result	
Appendix C. Radiated Spurious Emission	
Appendix D. Radiated Spurious Emission Plots	
Appendix E. Duty Cycle Plots	
Appendix F. Setup Photographs	



History of this test report

Report No.	Version	Description	Issue Date
FR3N2803G	01	Initial issue of report	Feb. 02, 2024



Summary of Test Result

Report Clause	Ref Std. Clause	Test Items	Result (PASS/FAIL)	Remark
3.1	15.407(a)(10)	26dB Emission Bandwidth	Pass	-
3.1	2.1049	99% Occupied Bandwidth	Reporting only	-
3.2	15.407(a)(7)	Fundamental Maximum EIRP	Pass	-
3.3	15.407(a)(7)	Fundamental Power Spectral Density	Pass	-
3.4	15.407(b)(6)	In-Band Emissions (Channel Mask)	Pass	-
-	15.407(d)(6)	Contention Based Protocol	Not Required	Dual Client Standard Client
-	15.407 KDB 987594 D02 Section II. K.	Dual Client Test	Not Required	Dual Client EIRP < 24dBm
3.5	15.407(b)	Unwanted Emissions	Pass	2.21 dB under the limit at 5896.36 MHz
3.6	15.207	AC Conducted Emission	Pass	11.34 dB under the limit at 0.40 MHz
3.7	15.203 15.407(a)	Antenna Requirement	Pass	-

Note: Not required means after assessing, test items are not necessary to carry out.

Conformity Assessment Condition:

- The test results (PASS/FAIL) with all measurement uncertainty excluded are presented against the regulation limits or in accordance with the requirements stipulated by the applicant/manufacturer who shall bear all the risks of non-compliance that may potentially occur if measurement uncertainty is taken into account.
- The measurement uncertainty please refer to each test result in the section "Measurement Uncertainty".

Disclaimer:

The product specifications of the EUT presented in the test report that may affect the test assessments are declared by the manufacturer who shall take full responsibility for the authenticity.

Reviewed by: Keven Cheng

Report Producer: Lucy Wu



1 General Description

1.1 Product Feature of Equipment Under Test

Product Feature	
Equipment	Mobile Computer
Brand Name	ZEBRA
Model Name	MC945B
FCC ID	UZ7MC945B
Sample 1	SE5800 + with Camera
Sample 2	SE4770 + without Camera
EUT supports Radios application	WCDMA/LTE/5G NR/GNSS/NFC WLAN 11a/b/g/n HT20/HT40 WLAN 11ac VHT20/VHT40/VHT80/VHT160 WLAN 11ax HE20/HE40/HE80/HE160 Bluetooth BR/EDR/LE
HW Version	DV2
SW Version	13-10-31.00-TN-U00-PRD-NEM-04
FW Version	FUSION_QA_6_1.1.0.004_T
MFD	10NOV23
EUT Stage	Identical Prototype

Remark: The EUT's information above is declared by manufacturer.

Specification of Accessories				
Adapter USB Wall Charger	Brand Name	Zebra	Part Number	PWR-WUA5V12W0US
Battery 1 Standard Battery (7000mAh)	Brand Name	Zebra	Model Number	BT-000370
Battery 2 Standard Battery (7000mAh)	Brand Name	Zebra	Model Number	BT-000370B
Earphone USB-C Audio Headset	Brand Name	Zebra	Part Number	HDST-USBC-PTT1-01
USB Cable (Type C to Type A)	Brand Name	Zebra	Part Number	CBL-TC2X-USBC-01
Holster	Brand Name	Zebra	Part Number	SG-MC9X-SHLSTG-01
USB Cable (CUP)	Brand Name	Zebra	Part Number	CBL-MC93-USBCHG-01



1.2 Product Specification of Equipment Under Test

Product Specification is subject to this standard	
Tx/Rx Channel Frequency Range	5925 MHz ~ 6425 MHz 6525 MHz ~ 6875 MHz
Maximum Output Power to Antenna	MIMO <Ant. 6+7>: <5925 MHz ~ 6425 MHz> 802.11a: 17.91 dBm / 0.0618 W 802.11ax: HE20: 18.01 dBm / 0.0632 W 802.11ax: HE40: 17.86 dBm / 0.0611 W 802.11ax: HE80: 17.96 dBm / 0.0625 W 802.11ax: HE160: 17.66 dBm / 0.0583 W <6525 MHz ~ 6875 MHz> 802.11a: 16.27 dBm / 0.0424 W 802.11ax: HE20: 16.36 dBm / 0.0433 W 802.11ax: HE40: 16.21 dBm / 0.0418 W 802.11ax: HE80: 16.36 dBm / 0.0433 W 802.11ax: HE160: 16.31 dBm / 0.0428 W
99% Occupied Bandwidth	MIMO <Ant. 6> 802.11a: 16.33 MHz 802.11ax: HE20: 18.83 MHz 802.11ax: HE40: 37.86 MHz 802.11ax: HE80: 76.96 MHz 802.11ax: HE160: 156.08 MHz MIMO <Ant. 7> 802.11a: 16.33 MHz 802.11ax: HE20: 18.88 MHz 802.11ax: HE40: 37.86 MHz 802.11ax: HE80: 76.84 MHz 802.11ax: HE160: 156.08 MHz
Antenna Type / Gain	<5925 MHz ~ 6425 MHz> <Ant. 6>: PIFA Antenna with gain 1.78 dBi <Ant. 7>: PIFA Antenna with gain 1.65 dBi <6525 MHz ~ 6875 MHz> <Ant. 6>: PIFA Antenna with gain 1.28 dBi <Ant. 7>: PIFA Antenna with gain 1.85 dBi
Type of Modulation	802.11a : OFDM (BPSK/QPSK/16QAM/64QAM) 802.11ax : OFDMA (BPSK/QPSK/16QAM/64QAM/256QAM/1024QAM)



Product Specification is subject to this standard			
Antenna Function Description		Ant. 6	Ant. 7
	802.11a/ax MIMO	V	V
	802.11ax TXBF	V	V

Remark:

1. MIMO Ant. 6+7 Directional Gain is a calculated result from MIMO Ant. 6 and MIMO Ant. 7. The formula used in calculation is documented in section 1.2.1.
2. Power of MIMO Ant. 6 + Ant. 7 is a calculated result from sum of the power MIMO Ant. 6 and MIMO Ant. 7.
3. 802.11ax Support Tx Beamforming mode, and the manufacturer declares that Tx Beamforming power/EIRP/PSD is less than CDD mode 3dbm, so CDD mode cover Tx Beamforming mode.
4. 802.11ax support full RU tone and partial RU tone, both full RU and partial RU-left (for low CH) and partial RU-right (for high CH) are tested for conducted power/PSD/Channel Mask in appendix A, all the other test case were performed with full RU with its maximum power/PSD.
5. The EUT does not support channel puncturing mode.
6. The EUT's information above is declared by manufacturer. Please refer to Disclaimer in report summary.

1.2.1 Antenna Directional Gain

<For CDD Mode>

Follows FCC KDB 662911 D01 Multiple Transmitter Output v02r01 F2)f)ii)

Directional gain = G_{ANT} + Array Gain, where Array Gain is as follows:

For power measurements on IEEE 802.11 devices,

Array Gain = 0 dB (i.e., no array gain) for $N_{ANT} \leq 4$.

G_{ANT} is set equal to the gain of the antenna having the highest gain.

For PSD measurements, the directional gain calculation.

$$DirectionalGain = 10 \cdot \log \left[\frac{\sum_{j=1}^{N_{SS}} \left\{ \sum_{k=1}^{N_{ANT}} g_{j,k} \right\}^2}{N_{ANT}} \right]$$

where

Each antenna is driven by no more than one spatial stream;

N_{SS} = the number of independent spatial streams of data;

N_{ANT} = the total number of antennas

$g_{j,k} = 10^{G_k / 20}$ if the k th antenna is being fed by spatial stream j , or zero if it is not;
 G_k is the gain in dBi of the k th antenna.

As minimum $N_{SS}=1$ is supported by EUT, the formula can be simplified as:

$$Directional\ gain = 10 \cdot \log \left[\left(10^{G_1 / 20} + 10^{G_2 / 20} + \dots + 10^{G_N / 20} \right)^2 / N_{ANT} \right] \text{ dBi}$$

Where G_1, G_2, \dots, G_N denote single antenna gain.

The directional gain "DG" is calculated as following table.

			DG	DG
			for	for
	Ant 6	Ant 7	Power	PSD
	(dBi)	(dBi)	(dBi)	(dBi)
5925 MHz ~ 6425 MHz	1.78	1.65	1.78	4.73
6525 MHz ~ 6875 MHz	1.28	1.85	1.85	4.58

Calculation example:

If a device has two antenna, $G_{ANT1}= 1.78\text{dBi}$; $G_{ANT2}= 1.65\text{dBi}$

Directional gain of power measurement = $\max(1.78, 1.65) + 0 = 1.78 \text{ dBi}$

Directional gain of PSD derived from formula which is

$$10 \times \log \left\{ \left[\left(10^{(1.78 \text{ dBi} / 20)} + 10^{(1.65 \text{ dBi} / 20)} \right)^2 \right] / 2 \right\}$$

$$= 4.73 \text{ dBi}$$

<For TXBF Modes>

The EUT supports beamforming modes then

Follows FCC KDB 662911 D01 Multiple Transmitter Output v02r01 F)2)e)ii)

$$DirectionalGain = 10 \cdot \log \left[\frac{\sum_{j=1}^{N_{SS}} \left\{ \sum_{k=1}^{N_{ANT}} g_{j,k} \right\}^2}{N_{ANT}} \right]$$

where

Each antenna is driven by no more than one spatial stream;

N_{SS} = the number of independent spatial streams of data;

N_{ANT} = the total number of antennas

$g_{j,k} = 10^{G_k / 20}$ if the k th antenna is being fed by spatial stream j , or zero if it is not;
 G_k is the gain in dBi of the k th antenna.

The directional gain “DG” is calculated as following table.

				DG	DG
		Ant 6	Ant 7	for	for
		(dBi)	(dBi)	Power	PSD
				(dBi)	(dBi)
5925 MHz ~ 6425 MHz		1.78	1.65	4.73	4.73
6525 MHz ~ 6875 MHz		1.28	1.85	4.58	4.58

Calculation example:

Directional gain is derived from formula which is

$$10 \times \log \left\{ \left[10^{(1.78 \text{ dBi} / 20)} + 10^{(1.65 \text{ dBi} / 20)} \right]^2 / 2 \right\} = 4.73 \text{ dBi}$$

1.3 Modification of EUT

No modifications made to the EUT during the testing.



1.4 Testing Location

Test Site	Sporton International Inc. Wensan Laboratory
Test Site Location	No.58, Aly. 75, Ln. 564, Wenhua 3rd, Rd., Guishan Dist., Taoyuan City 333010, Taiwan (R.O.C.) TEL: +886-3-327-0868 FAX: +886-3-327-0855
Test Site No.	Sporton Site No. TH05-HY, CO07-HY, 03CH20-HY

Note: The test site complies with ANSI C63.4 2014 requirement.

FCC designation No.: TW3786

1.5 Applicable Standards

According to the specifications declared by the manufacturer, the EUT must comply with the requirements of the following standards:

- ♦ FCC Part 15 Subpart E
- ♦ FCC KDB 789033 D02 General UNII Test Procedures New Rules v02r01.
- ♦ FCC KDB 987594 D02 U-NII 6 GHz EMC Measurement v02r01
- ♦ FCC KDB 662911 D01 Multiple Transmitter Output v02r01.
- ♦ ANSI C63.10-2013

Remark:

1. All the test items were validated and recorded in accordance with the standards without any modification during the testing.
2. The TAF code is not including all the FCC KDB listed without accreditation.
3. This EUT has also been tested and complied with the requirements of FCC Part 15, Subpart B, recorded in a separate test report.



2 Test Configuration of Equipment Under Test

- a. The EUT has been associated with peripherals and configuration operated in a manner tended to maximize its emission characteristics in a typical application. Frequency range investigated: conduction emission (150 kHz to 30 MHz), radiation emission (1 GHz to the 10th harmonic of the highest fundamental frequency or to 40 GHz, whichever is lower). For radiated measurement, the measured emission level of the EUT was maximized by rotating the EUT on a turntable, adjusting the orientation of the EUT antenna in three orthogonal axis (X: flat, Y: portrait, Z: landscape), and adjusting the measurement antenna orientation, following C63.10 exploratory test procedures and only the worst case emissions were reported in this report.
- b. AC power line Conducted Emission was tested under maximum output power.

2.1 Carrier Frequency and Channel

BW 20M	Channel	1	5	9	13	17	21	25	29
	Freq. (MHz)	5955	5975	5995	6015	6035	6055	6075	6095
BW 40M	Channel	3		11		19		27	
	Freq. (MHz)	5965		6005		6045		6085	
BW 80M	Channel	7				23			
	Freq. (MHz)	5985				6065			
BW 160M	Channel	15							
	Freq. (MHz)	6025							

BW 20M	Channel	33	37	41	45	49	53	57	61
	Freq. (MHz)	6115	6135	6155	6175	6195	6215	6235	6255
BW 40M	Channel	35		43		51		59	
	Freq. (MHz)	6125		6165		6205		6245	
BW 80M	Channel	39				55			
	Freq. (MHz)	6145				6225			
BW 160M	Channel	47							
	Freq. (MHz)	6185							



BW 20M	Channel	65	69	73	77	81	85	89	93
	Freq. (MHz)	6275	6295	6315	6335	6355	6375	6395	6415
BW 40M	Channel	67		75		83		91	
	Freq. (MHz)	6285		6325		6365		6405	
BW 80M	Channel	71				87			
	Freq. (MHz)	6305				6385			
BW 160M	Channel	79							
	Freq. (MHz)	6345							

BW 20M	Channel	117		121		125	
	Freq. (MHz)	6535		6555		6575	
BW 40M	Channel	-				123	
	Freq. (MHz)	-				6565	

BW 20M	Channel	129	133	137	141	145	149	153	157
	Freq. (MHz)	6595	6615	6635	6655	6675	6695	6715	6735
BW 40M	Channel	131		139		147		155	
	Freq. (MHz)	6605		6645		6685		6725	
BW 80M	Channel	135				151			
	Freq. (MHz)	6625				6705			
BW 160M	Channel	143							
	Freq. (MHz)	6665							

BW 20M	Channel	161	165	169	173	177	181
	Freq. (MHz)	6755	6775	6795	6815	6835	6855
BW 40M	Channel	163		171		179	
	Freq. (MHz)	6765		6805		6845	
BW 80M	Channel	167				-	
	Freq. (MHz)	6785				-	



2.2 Test Mode

This device support 26/52/106/242/484/996-tone RU.

The PSD of partial RU is reduced to be smaller than full RU according to TCB workshop interim guidance Oct. 2018.

The 802.11ax mode is investigated among different tones, full resource units (RU), partial resource units. The partial RU has no higher power than full RU's, thus the full RU is chosen as main test configuration.

The 242-tone RU is covered by 20MHz channel, 484-tone RU is covered by 40MHz channel and 996-tone RU is covered by 80MHz channel.

The SISO mode conducted power is covered by MIMO mode per chain, so only the MIMO mode is tested.

The final test modes include the worst data rates for each modulation shown in the table below.

MIMO Mode

Modulation	Data Rate
802.11a	6 Mbps
802.11ax HE20	MCS0
802.11ax HE40	MCS0
802.11ax HE80	MCS0
802.11ax HE160	MCS0

Remark: The conducted power level of each chain in MIMO mode is equal or higher than SISO mode.

Test Cases	
AC Conducted Emission	Mode 1 : Keypad (53key) + MP3 play + WLAN (5GHz) Link + Bluetooth Link + Battery 2 Standard Battery (7000mAh) + Scan + USB Cable (Type C to Type A) with USB Cable (CUP) (Charging from Adapter USB Wall Charger) for Sample 1
Remark: For Radiated Test Cases, the tests were performed with Battery 1 Standard Battery (7000mAh) and Sample 1.	



Ch. #		UNII-5 (5925-6425 MHz)	UNII-7 (6525-6875 MHz)
		802.11a	802.11a
L	Low	001	117
M	Middle	049	149
H	High	093	181

Ch. #		UNII-5 (5925-6425 MHz)			
		802.11ax HE20	802.11ax HE40	802.11ax HE80	802.11ax HE160
L	Low	001	003	007	015
M	Middle	049	051	055	047
H	High	093	091	087	079

Ch. #		UNII-7 (6525-6875 MHz)			
		802.11ax HE20	802.11ax HE40	802.11ax HE80	802.11ax HE160
L	Low	117	123	135	143
M	Middle	149	147	151	
H	High	181	179	167	

Remark: Based on ANSI C63.10 clause 5.6.2.2, b) Spurious emissions, measure the mode with the highest output power and the mode with highest output power spectral density for each modulation family.

2.3 Connection Diagram of Test System

<AC Conducted Emission Mode>

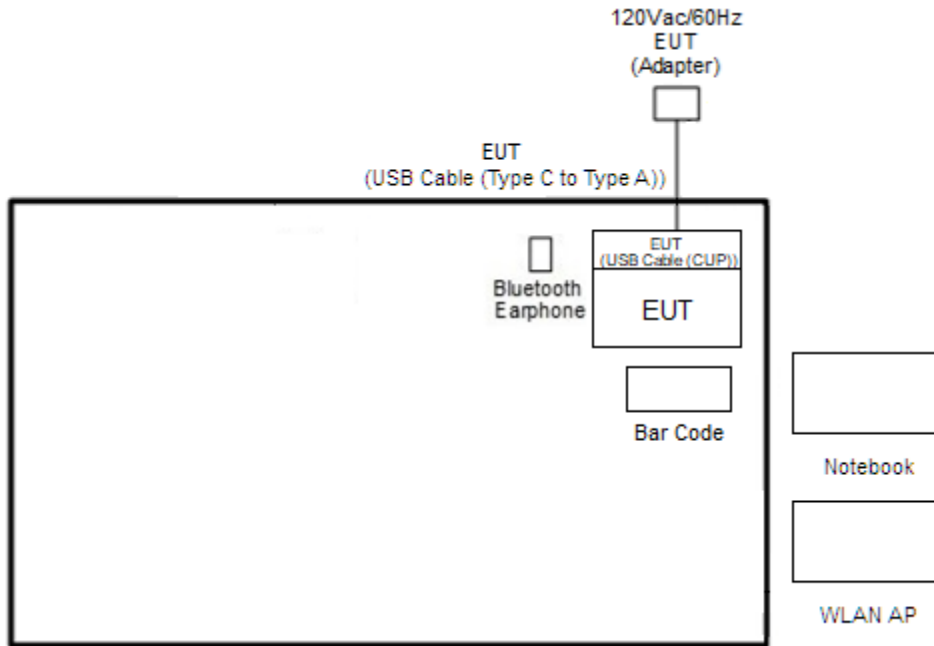

<WLAN Tx Mode>

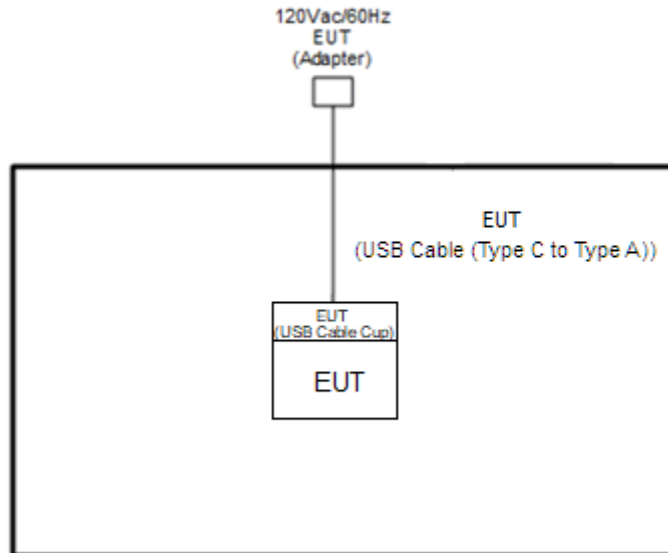



2.4 Support Unit used in test configuration and system

Item	Equipment	Brand Name	Model Name	FCC ID	Data Cable	Power Cord
1.	Bluetooth Earphone	Sony Ericsson	MW600	PY700A2029	N/A	N/A
2.	WLAN AP	ASUS	RT-AC52	MSQ-RTAC4 A00	N/A	Unshielded, 1.8 m
3.	Notebook	Dell	Latitude 3420	FCC DoC	N/A	AC I/P: Unshielded, 1.2 m DC O/P: Shielded, 1.8 m
4.	Bar Code	N/A	N/A	N/A	N/A	N/A

2.5 EUT Operation Test Setup

The RF test items, utility “QRCT v 4.0.211.0” was installed in Notebook which was programmed in order to make the EUT get into the engineering modes to provide channel selection, power level, data rate and the application type and for continuous transmitting signals.

2.6 Measurement Results Explanation Example

For all conducted test items:

The offset level is set in the spectrum analyzer to compensate the RF cable loss and attenuator factor between EUT conducted output port and spectrum analyzer. With the offset compensation, the spectrum analyzer reading level is exactly the EUT RF output level.

Example :

The spectrum analyzer offset is derived from RF cable loss and attenuator factor.

Offset = RF cable loss + attenuator factor.

Following shows an offset computation example with cable loss 4.2 dB and 10dB attenuator.

$$\begin{aligned} \text{Offset(dB)} &= \text{RF cable loss(dB)} + \text{attenuator factor(dB)}. \\ &= 4.2 + 10 = 14.2 \text{ (dB)} \end{aligned}$$

3 Test Result

3.1 26dB & 99% Occupied Bandwidth Measurement

3.1.1 Limit of 26dB & 99% Occupied Bandwidth

<FCC 14-30 CFR 15.407>

(a)(10) The maximum transmitter channel bandwidth for U-NII devices in the 5.925-7.125 GHz band is 320 megahertz.

3.1.2 Measuring Instruments

Please refer to the measuring equipment list in this test report.

3.1.3 Test Procedures

1. The testing follows FCC KDB 789033 D02 General UNII Test Procedures New Rules v02r01. Section C) Emission bandwidth
2. Set RBW = approximately 1% of the emission bandwidth.
3. Set the VBW > RBW.
4. Detector = Peak.
5. Trace mode = max hold
6. Measure the maximum width of the emission that is 26 dB down from the peak of the emission. Compare this with the RBW setting of the analyzer. Readjust RBW and repeat measurement as needed until the RBW/EBW ratio is approximately 1%.
7. For 99% Bandwidth Measurement, the spectrum analyzer's resolution bandwidth (RBW) is set 1-5% of the emission bandwidth and set the Video bandwidth (VBW) $\geq 3 * RBW$.
8. Measure and record the results in the test report.

3.1.4 Test Setup

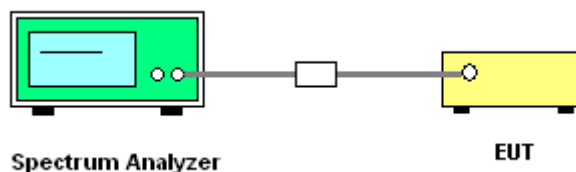

3.1.5 Test Result of 26dB & 99% Occupied Bandwidth

Please refer to Appendix A.

3.2 Fundamental Maximum EIRP Measurement

3.2.1 Limit of Fundamental Maximum EIRP

<FCC 14-30 CFR 15.407>

(a)(7) For client devices, except for fixed client devices as defined in this subpart, operating under the control of a standard power access point in 5.925-6.425 GHz and 6.525-6.875 GHz bands, the maximum power spectral density must not exceed 17 dBm e.i.r.p. in any 1-megahertz band, and the maximum e.i.r.p. over the frequency band of operation must not exceed 30 dBm and the device must limit its power to no more than 6 dB below its associated standard power access point's authorized transmit power.

3.2.2 Measuring Instruments

Please refer to the measuring equipment list in this test report.

3.2.3 Test Procedures

The testing follows Method PM-G of FCC KDB 789033 D02 General UNII Test Procedures New Rules v02r01.

Method PM-G (Measurement using a gated RF average power meter):

1. Measurement is performed using a wideband RF power meter.
2. The EUT is configured to transmit at its maximum power control level.
3. Measure the average power of the transmitter.
4. Since the measurement is made only during the ON time of the transmitter, no duty cycle correction factor is required.
5. For MIMO mode, calculation method follows FCC KDB 662911 D01 Multiple Transmitter Output v02r01.

3.2.4 Test Setup

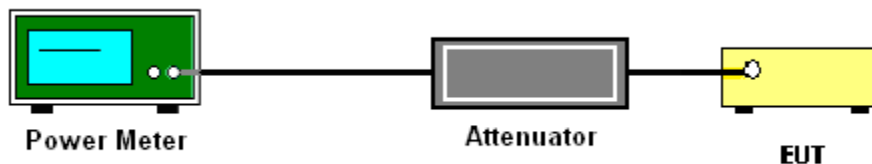

3.2.5 Test Result of Fundamental Maximum EIRP

Please refer to Appendix A.



3.3 Fundamental Power Spectral Density Measurement

3.3.1 Limit of Fundamental Power Spectral Density

<FCC 14-30 CFR 15.407>

(a)(7) For client devices, except for fixed client devices as defined in this subpart, operating under the control of a standard power access point in 5.925-6.425 GHz and 6.525-6.875 GHz bands, the maximum power spectral density must not exceed 17 dBm e.i.r.p. in any 1-megahertz band.

3.3.2 Measuring Instruments

Please refer to the measuring equipment list in this test report.

3.3.3 Test Procedures

The testing follows FCC KDB 789033 D02 General UNII Test Procedures New Rules v02r01.

Section F) Maximum power spectral density.

Method SA-2

(trace averaging across on and off times of the EUT transmissions, followed by duty cycle correction).

- Measure the duty cycle.
 - Set span to encompass the entire emission bandwidth (EBW) of the signal.
 - Set RBW = 1 MHz.
 - Set VBW \geq 3 MHz.
 - Number of points in sweep \geq 2 Span / RBW.
 - Sweep time = auto.
 - Detector = RMS
 - Trace average at least 100 traces in power averaging mode.
 - Add $10 \log(1/x)$, where x is the duty cycle, to the measured power in order to compute the average power during the actual transmission times. For example, add $10 \log(1/0.25) = 6$ dB if the duty cycle is 25 percent.
1. The RF output of EUT was connected to the spectrum analyzer by a low loss cable.
 2. Each plot has already offset with cable loss, and attenuator loss. Measure the PPSD and record it.
 3. For MIMO mode, calculation method follows FCC KDB 662911 D01 Multiple Transmitter Output v02r01.

Method (a): Measure and sum the spectra across the outputs.

The total final Power Spectral Density is from a device with 2 transmitter outputs. The spectrum measurements of the individual outputs are all performed with the same span and number of points; the spectrum value in the first spectral bin of output 1 is summed with that in the first spectral bin of output 2 to obtain the value for the first frequency bin of the summed spectrum.

3.3.4 Test Setup

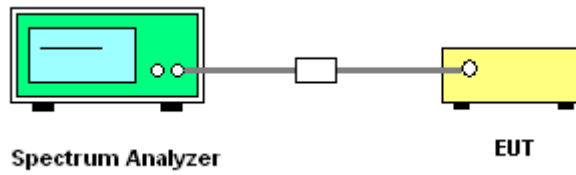

3.3.5 Test Result of Power Spectral Density

Please refer to Appendix A.



3.4 In-Band Emissions (Channel Mask)

3.4.1 Limit of Unwanted Emissions

<FCC 14-30 CFR 15.407>

(a)(6) For transmitters operating within the 5.925-7.125 GHz bands: Power spectral density must be suppressed by 20 dB at 1 MHz outside of channel edge, by 28 dB at one channel bandwidth from the channel center, and by 40 dB at one- and one-half times the channel bandwidth away from channel center. At frequencies between one megahertz outside an unlicensed device's channel edge and one channel bandwidth from the center of the channel, the limits must be linearly interpolated between 20 dB and 28 dB suppression, and at frequencies between one and one- and one-half times an unlicensed device's channel bandwidth, the limits must be linearly interpolated between 28 dB and 40 dB suppression. Emissions removed from the channel center by more than one- and one-half times the channel bandwidth must be suppressed by at least 40 dB.

3.4.2 Measuring Instruments

Please refer to the measuring equipment list in this test report.

3.4.3 Test Procedures

The testing follows FCC KDB 987594 D02 U-NII 6GHz EMC Measurement v02r01.

Section J) In-Band Emissions.

1. Take nominal bandwidth as reference channel bandwidth provided that 26 dB emission bandwidth is always larger than nominal bandwidth
2. Measure the power spectral density (which will be used for emissions mask reference) using the following procedure:
 - a) Set the span to encompass the entire 26 dB EBW of the signal.
 - b) Set RBW = same RBW used for 26 dB EBW measurement.
 - c) Set VBW $\geq 3 \times$ RBW
 - d) Number of points in sweep $\geq [2 \times \text{span} / \text{RBW}]$.
 - e) Sweep time = auto.
 - f) Detector = RMS (i.e., power averaging)
 - g) Trace average at least 100 traces in power averaging (rms) mode.
 - h) Use the peak search function on the instrument to find the peak of the spectrum.
3. Using the measuring equipment limit line function, develop the emissions mask based on the following requirements. The emissions power spectral density must be reduced below the peak power spectral density (in dB) as follows:
 - a. Suppressed by 20 dB at 1 MHz outside of the channel edge.
 - b. Suppressed by 28 dB at one channel bandwidth from the channel center.
 - c. Suppressed by 40 dB at one- and one-half times the channel bandwidth from the channel center.
4. Adjust the span to encompass the entire mask as necessary.
5. Clear trace.
6. Trace average at least 100 traces in power averaging (rms) mode.
7. Adjust the reference level as necessary so that the crest of the channel touches the top of the emission mask.

3.4.4 Test Setup

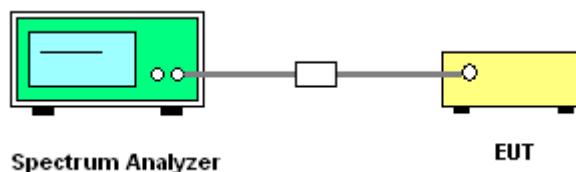



3.5 Unwanted Emissions Measurement

This section is to measure unwanted emissions through radiated measurement for band edge spurious emissions and out of band emissions measurement.

3.5.1 Limit of Unwanted Emissions

- (1) For transmitters operating within the 5.925-7.125 GHz band: Any emissions outside of the 5.925-7.125 GHz band must not exceed an e.i.r.p. of -27 dBm/MHz.

EIRP (dBm)	Field Strength at 3m (dBµV/m)
- 27 (RMS)	68.3
- 7 (Peak)	88.3

According 987594 D02 U-NII 6GHz EMC Measurement v02r01 section G:

Unwanted emissions outside of restricted bands are measured with a RMS detector.

In addition, 15.35(b) applies where the peak emissions must be limited to no more than 20 dB above the average limit

- (2) Unwanted spurious emissions fallen in restricted bands shall comply with the general field strength limits as below table:

Frequency (MHz)	Field Strength (microvolts/meter)	Measurement Distance (meters)
0.009 – 0.490	2400/F(kHz)	300
0.490 – 1.705	24000/F(kHz)	30
1.705 – 30.0	30	30
30 – 88	100	3
88 – 216	150	3
216 - 960	200	3
Above 960	500	3

Note: The following formula is used to convert the EIRP to field strength.

$$E = \frac{1000000\sqrt{30P}}{3} \mu\text{V/m, where P is the eirp (Watts)}$$

3.5.2 Measuring Instruments

Please refer to the measuring equipment list in this test report.



3.5.3 Test Procedures

1. The testing follows FCC KDB 789033 D02 General UNII Test Procedures New Rules v02r01. Section G) Unwanted emissions measurement.
 - (1) Procedure for Peak Unwanted Emissions Measurements Above 1000 MHz
 - RBW = 1 MHz
 - VBW \geq 3 MHz
 - Detector = Peak
 - Sweep time = auto
 - Trace mode = max hold
 - (2) Procedures for Average Unwanted Emissions Measurements Above 1000MHz
 - RBW = 1 MHz
 - VBW = 10 Hz, when duty cycle is no less than 98 percent.
 - VBW \geq 1/T, when duty cycle is less than 98 percent where T is the minimum transmission duration over which the transmitter is on and is transmitting at its maximum power control level for the tested mode of operation.
2. The EUT is placed on a turntable with 1.5 meter for frequency above 1 GHz respectively above ground.
3. The EUT is set 3 meters away from the receiving antenna which is mounted on the top of a variable height antenna tower.
4. The antenna is a broadband antenna and its height is adjusted between one meter and four meters above ground to find the maximum value of the field strength for both horizontal polarization and vertical polarization of the antenna.
5. For each suspected emission, the EUT is arranged to its worst case and then adjust the antenna tower (from 1 m to 4 m) and turntable (from 0 degree to 360 degrees) to find the maximum reading.
6. Radiated testing above 1 GHz is performed by adjusting the antenna tower from 1 m to 4 m and by rotating the turn table from 0 degree to 360 degrees to find the peak maximum hold reading for scanning all frequencies. When there is no suspected emission found and the harmonic emission level is with at least 6 dB margin against average limit line, the position is marked as “-“..

3.5.4 Test Setup

For radiated test from 1GHz to 18GHz

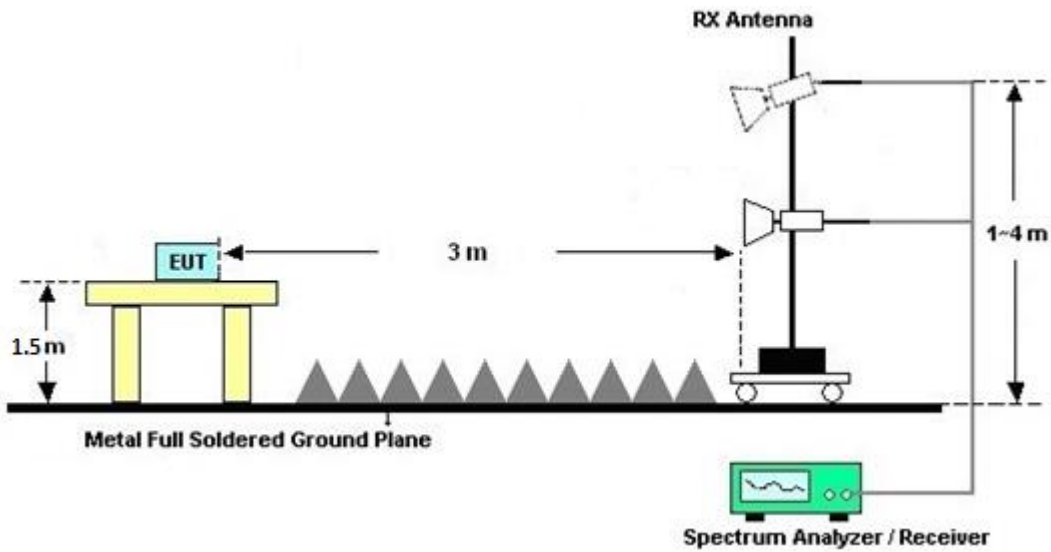

For radiated test above 18GHz

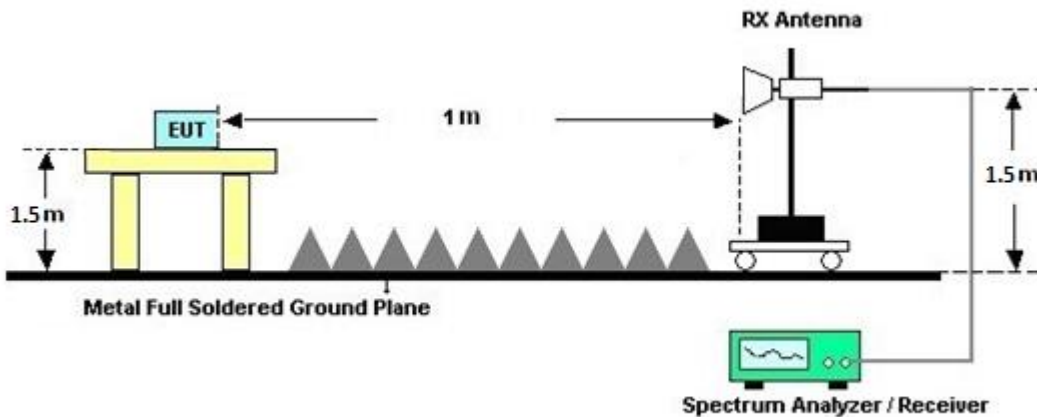

3.5.5 Test Result of Radiated Spurious at Band Edges

Please refer to Appendix C and D.

3.5.6 Duty Cycle

Please refer to Appendix E.

3.5.7 Test Result of Radiated Spurious Emissions

Please refer to Appendix C and D.



3.6 AC Conducted Emission Measurement

3.6.1 Limit of AC Conducted Emission

For equipment that is designed to be connected to the public utility (AC) power line, the radio frequency voltage that is conducted back onto the AC power line on any frequency or frequencies within the band 150 kHz to 30 MHz shall not exceed the limits in the following table.

Frequency of emission (MHz)	Conducted limit (dB μ V)	
	Quasi-peak	Average
0.15-0.5	66 to 56*	56 to 46*
0.5-5	56	46
5-30	60	50

*Decreases with the logarithm of the frequency.

3.6.2 Measuring Instruments

Please refer to the measuring equipment list in this test report.

3.6.3 Test Procedures

1. The EUT is placed 0.4 meter away from the conducting wall of the shielding room, and is kept at least 80 centimeters from any other grounded conducting surface.
2. Connect EUT to the power mains through a line impedance stabilization network (LISN).
3. All the support units are connecting to the other LISN.
4. The LISN provides 50 ohm coupling impedance for the measuring instrument.
5. The FCC states that a 50 ohm, 50 microhenry LISN should be used.
6. Both Line and Neutral shall be tested in order to find out the maximum conducted emission.
7. The frequency range from 150 kHz to 30 MHz is scanned.
8. Set the test-receiver system to Peak Detect Function and specified bandwidth with Maximum Hold Mode.

3.6.4 Test Setup



3.6.5 Test Result of AC Conducted Emission

Please refer to Appendix B.



3.7 Antenna Requirements

3.7.1 Standard Applicable

The use of a permanently attached antenna or of an antenna that uses a unique coupling to the intentional radiator shall be considered sufficient to comply with the rule.

3.7.2 Antenna Anti-Replacement Construction

An embedded-in antenna design is used.



4 List of Measuring Equipment

Instrument	Brand Name	Model No.	Serial No.	Characteristics	Calibration Date	Test Date	Due Date	Remark
EMI Test Receiver	Keysight	N9038A(MXE)	MY54130085	N/A	Oct. 06, 2023	Dec. 01, 2023~ Jan. 19, 2024	Oct. 05, 2024	Radiation (03CH20-HY)
Preamplifier	EMEC	EM18G40G	060873	18GHz~40GHz	Sep. 06, 2023	Dec. 01, 2023~ Jan. 19, 2024	Sep. 05, 2024	Radiation (03CH20-HY)
Controller	ChainTek	3000-1	N/A	Control Turn table & Ant Mast	N/A	Dec. 01, 2023~ Jan. 19, 2024	N/A	Radiation (03CH20-HY)
Antenna Mast	ChainTek	MBS-520-1	N/A	1m~4m	N/A	Dec. 01, 2023~ Jan. 19, 2024	N/A	Radiation (03CH20-HY)
Turn Table	ChainTek	T-200-S-1	N/A	0~360 Degree	N/A	Dec. 01, 2023~ Jan. 19, 2024	N/A	Radiation (03CH20-HY)
Signal Analyzer	Keysight	N9010B	MY60240520	N/A	Dec. 22, 2022	Dec. 01, 2023~ Dec. 11, 2023	Dec. 21, 2023	Radiation (03CH20-HY)
Signal Analyzer	Keysight	N9010B	MY60240520	N/A	Dec. 12, 2023	Dec. 12, 2023~ Jan. 19, 2024	Dec. 11, 2024	Radiation (03CH20-HY)
Horn Antenna	SCHWARZBE CK	BBHA 9120 D	02360	1GHz-18GHz	Oct. 30, 2023	Dec. 01, 2023~ Jan. 19, 2024	Oct. 29, 2024	Radiation (03CH20-HY)
SHF-EHF Horn Antenna	SCHWARZBE CK	BBHA 9170	1224	18GHz-40GHz	Jul. 10, 2023	Dec. 01, 2023~ Jan. 19, 2024	Jul. 09, 2024	Radiation (03CH20-HY)
Amplifier	EMCI	EMC118A45S E	980792	N/A	Nov. 13, 2023	Dec. 01, 2023~ Jan. 19, 2024	Nov. 12, 2024	Radiation (03CH20-HY)
RF Cable	HUBER + SUHNER	SUCOFLEX 102	519229/2,804 015/2,804027 /2	N/A	Jan. 18, 2023	Dec. 01, 2023~ Jan. 16, 2024	Jan. 17, 2024	Radiation (03CH20-HY)
RF Cable	HUBER + SUHNER	SUCOFLEX 102	519229/2,804 015/2,804027 /2	N/A	Jan. 17, 2024	Jan. 17, 2024~ Jan. 19, 2024	Jan. 16, 2025	Radiation (03CH20-HY)
Hygrometer	TECPEL	DTM-303B	TP200728	N/A	Mar. 28, 2023	Dec. 01, 2023~ Jan. 19, 2024	Mar. 27, 2024	Radiation (03CH20-HY)
Software	Audix	N/A	RK-002156	N/A	N/A	Dec. 01, 2023~ Jan. 19, 2024	N/A	Radiation (03CH20-HY)
Hygrometer	TECPEL	DTM-303A	TP201996	N/A	Nov. 07, 2023	Nov. 10, 2023~ Jan. 23, 2024	Nov. 06, 2024	Conducted (TH05-HY)
Power Sensor	DARE	RPR3008W	RPR8W-2301 001(NO:146)	10MHz~8GHz	Feb. 07, 2023	Nov. 10, 2023~ Jan. 23, 2024	Feb. 06, 2024	Conducted (TH05-HY)
Signal Analyzer	Rohde & Schwarz	FSV40	101564	10Hz ~ 40GHz	Sep. 12, 2023	Nov. 10, 2023~ Jan. 23, 2024	Sep. 11, 2024	Conducted (TH05-HY)
AC Power Source	ACPOWER	AFC-11003G	F317040033	N/A	N/A	Dec. 20, 2023	N/A	Conduction (CO07-HY)
Software	Rohde & Schwarz	EMC32 V10.30	N/A	N/A	N/A	Dec. 20, 2023	N/A	Conduction (CO07-HY)
Pulse Limiter	SCHWARZBE CK	VTSD 9561-F N	9561-F N00373	9kHz-200MHz	Oct. 20, 2023	Dec. 20, 2023	Oct. 19, 2024	Conduction (CO07-HY)
RF Cable	HUBER + SUHNER	RG 214/U	1358175	9kHz~30MHz	Mar. 15, 2023	Dec. 20, 2023	Mar. 14, 2024	Conduction (CO07-HY)
Two-Line V-Network	TESEQ	NNB 51	45051	N/A	Mar. 05, 2023	Dec. 20, 2023	Mar. 04, 2024	Conduction (CO07-HY)
Four-Line V-Network	TESEQ	NNB 52	36122	N/A	Mar. 13, 2023	Dec. 20, 2023	Mar. 12, 2024	Conduction (CO07-HY)
EMI Test Receiver	Rohde & Schwarz	ESR3	102317	9kHz~3.6GHz	Sep. 20, 2023	Dec. 20, 2023	Sep. 19, 2024	Conduction (CO07-HY)



5 Measurement Uncertainty

Uncertainty of Conducted Emission Measurement (150kHz ~ 30MHz)

Measuring Uncertainty for a Level of Confidence of 95% ($U = 2Uc(y)$)	3.44 dB
---	---------

Uncertainty of Radiated Emission Measurement (1000 MHz ~ 6000 MHz)

Measuring Uncertainty for a Level of Confidence of 95% ($U = 2Uc(y)$)	4.5 dB
---	--------

Uncertainty of Radiated Emission Measurement (6000 MHz ~ 18000 MHz)

Measuring Uncertainty for a Level of Confidence of 95% ($U = 2Uc(y)$)	4.6 dB
---	--------

Uncertainty of Radiated Emission Measurement (18000 MHz ~ 40000 MHz)

Measuring Uncertainty for a Level of Confidence of 95% ($U = 2Uc(y)$)	5.4 dB
---	--------

Appendix A. Test Result of Conducted Test Items

Test Engineer:	Mina Liu	Temperature:	21~25	°C
Test Date:	2023/11/10~2024/01/23	Relative Humidity:	51~54	%

TEST RESULTS DATA
26dB and 99% OBW

U-NII-5 MIMO										
Mod.	Data Rate	N _{TX}	CH.	Freq. (MHz)	99% Bandwidth (MHz)		26 dB Bandwidth (MHz)		Emission Bandwidth Limit (MHz)	Pass /Fail
					Ant 6	Ant 7	Ant 6	Ant 7		
11a	6Mbps	2	001	5955	16.33	16.33	19.58	19.73	320.00	Pass
11a	6Mbps	2	049	6195	16.33	16.33	19.46	19.50	320.00	Pass
11a	6Mbps	2	093	6415	16.33	16.33	19.42	19.30	320.00	Pass

TEST RESULTS DATA
EIRP Power Table

U-NII-5 MIMO												
Mod.	Data Rate	NTX	CH.	Freq. (MHz)	Conducted Power (dBm)			DG (dBi)		EIRP Power (dBm)	EIRP Power Limit (dBm)	Pass /Fail
					Ant 6	Ant 7	SUM	Ant 6	Ant 7			
11a	6Mbps	2	001	5955	15.00	14.80	17.91	1.78		19.69	30dBm	Pass
11a	6Mbps	2	049	6195	14.80	14.60	17.71	1.78		19.49	30dBm	Pass
11a	6Mbps	2	093	6415	14.90	14.60	17.76	1.78		19.54	30dBm	Pass

TEST RESULTS DATA
EIRP Power Spectral Density

U-NII-5 MIMO														
Mod.	Data Rate	NTX	CH.	Freq. (MHz)	Duty Factor (dB)		Conducted Power Density with Duty Factor (dBm/MHz)			DG (dBi)		EIRP Power Density (dBm/MHz)	EIRP Power Density Limit (dBm/MHz)	Pass /Fail
					Ant 6	Ant 7	Ant 6	Ant 7	SUM	Ant 6	Ant 7			
11a	6Mbps	2	001	5955	0.67	0.67			7.86	4.73	12.58	17.00	Pass	
11a	6Mbps	2	049	6195	0.67	0.67			7.01	4.73	11.73	17.00	Pass	
11a	6Mbps	2	093	6415	0.67	0.67			7.47	4.73	12.20	17.00	Pass	

TEST RESULTS DATA
26dB and 99% OBW

U-NII-7 MIMO										
Mod.	Data Rate	N _{TX}	CH.	Freq. (MHz)	99% Bandwidth (MHz)		26 dB Bandwidth (MHz)		Emission Bandwidth Limit (MHz)	Pass /Fail
					Ant 6	Ant 7	Ant 6	Ant 7		
11a	6Mbps	2	117	6535	16.33	16.33	19.32	19.42	320.00	Pass
11a	6Mbps	2	149	6695	16.33	16.33	19.29	19.38	320.00	Pass
11a	6Mbps	2	181	6855	16.33	16.33	19.24	19.41	320.00	Pass

TEST RESULTS DATA
EIRP Power Table

U-NII-7 MIMO												
Mod.	Data Rate	NTX	CH.	Freq. (MHz)	Conducted Power (dBm)			DG (dBi)		EIRP Power (dBm)	EIRP Power Limit (dBm)	Pass /Fail
					Ant 6	Ant 7	SUM	Ant 6	Ant 7			
11a	6Mbps	2	117	6535	13.40	13.00	16.21	1.85		18.06	30dBm	Pass
11a	6Mbps	2	149	6695	13.30	13.10	16.21	1.85		18.06	30dBm	Pass
11a	6Mbps	2	181	6855	13.00	13.50	16.27	1.85		18.12	30dBm	Pass

TEST RESULTS DATA
EIRP Power Spectral Density

U-NII-7 MIMO														
Mod.	Data Rate	NTX	CH.	Freq. (MHz)	Duty Factor (dB)		Conducted Power Density with Duty Factor (dBm/MHz)			DG (dBi)		EIRP Power Density (dBm/MHz)	EIRP Power Density Limit (dBm/MHz)	Pass /Fail
					Ant 6	Ant 7	Ant 6	Ant 7	SUM	Ant 6	Ant 7	SUM		
11a	6Mbps	2	117	6535	0.67	0.67			6.12		4.58	10.70	17.00	Pass
11a	6Mbps	2	149	6695	0.67	0.67			5.79		4.58	10.37	17.00	Pass
11a	6Mbps	2	181	6855	0.67	0.67			6.28		4.58	10.86	17.00	Pass

TEST RESULTS DATA
26dB and 99% OBW

U-NII-5 MIMO											
Mod.	Data Rate	NTx	CH.	Freq. (MHz)	RU Config.	99% Bandwidth (MHz)		26 dB Bandwidth (MHz)		Emission Bandwidth Limit (MHz)	Pass /Fail
						Ant 6	Ant 7	Ant 6	Ant 7		
HE20	MCS0	2	001	5955	Full	18.83	18.83	20.78	20.70	320.00	Pass
HE20	MCS0	2	049	6195	Full	18.83	18.83	20.98	21.18	320.00	Pass
HE20	MCS0	2	093	6415	Full	18.83	18.88	21.03	21.18	320.00	Pass
HE40	MCS0	2	003	5965	Full	37.66	37.76	40.91	41.50	320.00	Pass
HE40	MCS0	2	051	6205	Full	37.76	37.76	41.55	40.93	320.00	Pass
HE40	MCS0	2	091	6405	Full	37.76	37.86	41.28	41.15	320.00	Pass
HE80	MCS0	2	007	5985	Full	76.72	76.84	81.09	82.08	320.00	Pass
HE80	MCS0	2	055	6225	Full	76.96	76.72	81.50	81.63	320.00	Pass
HE80	MCS0	2	087	6385	Full	76.96	76.72	81.88	81.25	320.00	Pass
HE160	MCS0	2	015	6025	Full	155.84	155.60	164.45	164.35	320.00	Pass
HE160	MCS0	2	047	6185	Full	155.60	155.36	164.50	164.40	320.00	Pass
HE160	MCS0	2	079	6345	Full	156.08	155.60	164.50	163.73	320.00	Pass

TEST RESULTS DATA
EIRP Power Table

U-NII-5 MIMO													
Mod.	Data Rate	NTX	CH.	Freq. (MHz)	RU Config.	Conducted Power (dBm)			DG (dBi)		EIRP Power (dBm)	EIRP Power Limit (dBm)	Pass /Fail
						Ant 6	Ant 7	SUM	Ant 6	Ant 7	SUM		
HE20	MCS0	2	001	5955	Full	15.00	15.00	18.01	1.78		19.79	30dBm	Pass
HE20	MCS0	2	001	5955	26/0	7.40	7.80	10.61	1.78		12.39	30dBm	Pass
HE20	MCS0	2	001	5955	52/37	8.40	9.00	11.72	1.78		13.50	30dBm	Pass
HE20	MCS0	2	001	5955	106/53	12.30	12.90	15.62	1.78		17.40	30dBm	Pass
HE20	MCS0	2	049	6195	Full	14.80	14.60	17.71	1.78		19.49	30dBm	Pass
HE20	MCS0	2	049	6195	26/4	7.60	7.00	10.32	1.78		12.10	30dBm	Pass
HE20	MCS0	2	049	6195	52/38	9.20	9.20	12.21	1.78		13.99	30dBm	Pass
HE20	MCS0	2	049	6195	106/53	12.20	12.00	15.11	1.78		16.89	30dBm	Pass
HE20	MCS0	2	093	6415	Full	14.80	14.60	17.71	1.78		19.49	30dBm	Pass
HE20	MCS0	2	093	6415	26/8	8.20	8.40	11.31	1.78		13.09	30dBm	Pass
HE20	MCS0	2	093	6415	52/40	10.30	10.30	13.31	1.78		15.09	30dBm	Pass
HE20	MCS0	2	093	6415	106/54	12.80	13.10	15.96	1.78		17.74	30dBm	Pass
HE40	MCS0	2	003	5965	Full	14.90	14.80	17.86	1.78		19.64	30dBm	Pass
HE40	MCS0	2	003	5965	242/61	13.00	13.60	16.32	1.78		18.10	30dBm	Pass
HE40	MCS0	2	051	6205	Full	14.80	14.60	17.71	1.78		19.49	30dBm	Pass
HE40	MCS0	2	051	6205	242/61	13.00	13.00	16.01	1.78		17.79	30dBm	Pass
HE40	MCS0	2	091	6405	Full	14.80	14.60	17.71	1.78		19.49	30dBm	Pass
HE40	MCS0	2	091	6405	242/62	12.70	13.10	15.91	1.78		17.69	30dBm	Pass
HE80	MCS0	2	007	5985	Full	14.90	15.00	17.96	1.78		19.74	30dBm	Pass
HE80	MCS0	2	007	5985	484/65	13.40	14.00	16.72	1.78		18.50	30dBm	Pass
HE80	MCS0	2	055	6225	Full	14.60	14.50	17.56	1.78		19.34	30dBm	Pass
HE80	MCS0	2	055	6225	484/65	12.90	12.90	15.91	1.78		17.69	30dBm	Pass
HE80	MCS0	2	087	6385	Full	14.80	15.00	17.91	1.78		19.69	30dBm	Pass
HE80	MCS0	2	087	6385	484/66	13.00	13.20	16.11	1.78		17.89	30dBm	Pass
HE160	MCS0	2	015	6025	Full	14.60	14.50	17.56	1.78		19.34	30dBm	Pass
HE160	MCS0	2	015	6025	996/67	14.00	14.60	17.32	1.78		19.10	30dBm	Pass
HE160	MCS0	2	047	6185	Full	14.40	14.40	17.41	1.78		19.19	30dBm	Pass
HE160	MCS0	2	047	6185	996/67	13.80	14.00	16.91	1.78		18.69	30dBm	Pass
HE160	MCS0	2	079	6345	Full	14.80	14.50	17.66	1.78		19.44	30dBm	Pass
HE160	MCS0	2	079	6345	996/S67	12.90	13.40	16.17	1.78		17.95	30dBm	Pass

TEST RESULTS DATA
EIRP Power Spectral Density

U-NII-5 MIMO															
Mod.	Data Rate	NTX	CH.	Freq. (MHz)	RU Config.	Duty Factor (dB)		Conducted Power Density with Duty Factor (dBm/MHz)			DG (dBi)		EIRP Power Density (dBm/MHz)	EIRP Power Density Limit (dBm/MHz)	Pass /Fail
						Ant 6	Ant 7	Ant 6	Ant 7	SUM	Ant 6	Ant 7			
HE20	MCS0	2	001	5955	Full	0.60	0.60			7.33	4.73	12.05	17.00	Pass	
HE20	MCS0	2	001	5955	26/0	0.64	0.64			6.97	4.73	11.70	17.00	Pass	
HE20	MCS0	2	001	5955	52/37	0.64	0.64			6.91	4.73	11.63	17.00	Pass	
HE20	MCS0	2	001	5955	106/53	0.67	0.67			7.01	4.73	11.74	17.00	Pass	
HE20	MCS0	2	049	6195	Full	0.60	0.60			6.74	4.73	11.46	17.00	Pass	
HE20	MCS0	2	049	6195	26/4	0.64	0.64			6.29	4.73	11.02	17.00	Pass	
HE20	MCS0	2	049	6195	52/38	0.64	0.64			6.58	4.73	11.31	17.00	Pass	
HE20	MCS0	2	049	6195	106/53	0.67	0.67			6.31	4.73	11.04	17.00	Pass	
HE20	MCS0	2	093	6415	Full	0.60	0.60			7.13	4.73	11.85	17.00	Pass	
HE20	MCS0	2	093	6415	26/8	0.64	0.64			6.75	4.73	11.47	17.00	Pass	
HE20	MCS0	2	093	6415	52/40	0.64	0.64			6.81	4.73	11.54	17.00	Pass	
HE20	MCS0	2	093	6415	106/54	0.67	0.67			7.04	4.73	11.77	17.00	Pass	
HE40	MCS0	2	003	5965	Full	0.60	0.60			4.52	4.73	9.24	17.00	Pass	
HE40	MCS0	2	003	5965	242/61	0.66	0.67			4.42	4.73	9.15	17.00	Pass	
HE40	MCS0	2	051	6205	Full	0.60	0.60			4.03	4.73	8.76	17.00	Pass	
HE40	MCS0	2	051	6205	242/61	0.66	0.67			3.63	4.73	8.35	17.00	Pass	
HE40	MCS0	2	091	6405	Full	0.60	0.60			4.16	4.73	8.88	17.00	Pass	
HE40	MCS0	2	091	6405	242/62	0.66	0.67			3.69	4.73	8.41	17.00	Pass	
HE80	MCS0	2	007	5985	Full	0.65	0.60			2.44	4.73	7.17	17.00	Pass	
HE80	MCS0	2	007	5985	484/65	0.66	0.66			2.33	4.73	7.05	17.00	Pass	
HE80	MCS0	2	055	6225	Full	0.65	0.60			1.85	4.73	6.58	17.00	Pass	
HE80	MCS0	2	055	6225	484/65	0.66	0.66			1.48	4.73	6.20	17.00	Pass	
HE80	MCS0	2	087	6385	Full	0.65	0.60			2.42	4.73	7.15	17.00	Pass	
HE80	MCS0	2	087	6385	484/66	0.66	0.66			1.95	4.73	6.68	17.00	Pass	
HE160	MCS0	2	015	6025	Full	0.62	0.60			-0.10	4.73	4.63	17.00	Pass	
HE160	MCS0	2	015	6025	996/67	0.66	0.69			-0.23	4.73	4.50	17.00	Pass	
HE160	MCS0	2	047	6185	Full	0.62	0.60			-0.77	4.73	3.95	17.00	Pass	
HE160	MCS0	2	047	6185	996/67	0.66	0.69			-0.88	4.73	3.84	17.00	Pass	
HE160	MCS0	2	079	6345	Full	0.62	0.60			-1.01	4.73	3.72	17.00	Pass	
HE160	MCS0	2	079	6345	996/S67	0.66	0.69			-1.31	4.73	3.42	17.00	Pass	

TEST RESULTS DATA
26dB and 99% OBW

U-NII-7 MIMO											
Mod.	Data Rate	NTx	CH.	Freq. (MHz)	RU Config.	99% Bandwidth (MHz)		26 dB Bandwidth (MHz)		Emission Bandwidth Limit (MHz)	Pass /Fail
						Ant 6	Ant 7	Ant 6	Ant 7		
HE20	MCS0	2	117	6535	Full	18.83	18.83	20.78	20.71	320.00	Pass
HE20	MCS0	2	149	6695	Full	18.83	18.83	20.84	20.88	320.00	Pass
HE20	MCS0	2	181	6855	Full	18.83	18.88	20.75	20.97	320.00	Pass
HE40	MCS0	2	123	6565	Full	37.86	37.76	41.36	41.31	320.00	Pass
HE40	MCS0	2	147	6685	Full	37.86	37.76	41.41	41.28	320.00	Pass
HE40	MCS0	2	179	6845	Full	37.76	37.86	40.99	41.66	320.00	Pass
HE80	MCS0	2	135	6625	Full	76.96	76.84	81.86	81.92	320.00	Pass
HE80	MCS0	2	151	6705	Full	76.84	76.84	81.79	81.79	320.00	Pass
HE80	MCS0	2	167	6785	Full	76.72	76.72	81.92	82.05	320.00	Pass
HE160	MCS0	2	143	6665	Full	155.60	156.08	165.12	164.64	320.00	Pass

TEST RESULTS DATA
EIRP Power Table

U-NII-7 MIMO													
Mod.	Data Rate	NTX	CH.	Freq. (MHz)	RU Config.	Conducted Power (dBm)			DG (dBi)		EIRP Power (dBm)	EIRP Power Limit (dBm)	Pass /Fail
						Ant 6	Ant 7	SUM	Ant 6	Ant 7	SUM		
HE20	MCS0	2	117	6535	Full	13.50	13.10	16.31	1.85		18.16	30dBm	Pass
HE20	MCS0	2	117	6535	26/0	5.30	5.60	8.46	1.85		10.31	30dBm	Pass
HE20	MCS0	2	117	6535	52/37	8.50	8.20	11.36	1.85		13.21	30dBm	Pass
HE20	MCS0	2	117	6535	106/53	11.20	11.00	14.11	1.85		15.96	30dBm	Pass
HE20	MCS0	2	149	6695	Full	13.10	13.00	16.06	1.85		17.91	30dBm	Pass
HE20	MCS0	2	149	6695	26/4	6.30	6.20	9.26	1.85		11.11	30dBm	Pass
HE20	MCS0	2	149	6695	52/38	8.20	8.20	11.21	1.85		13.06	30dBm	Pass
HE20	MCS0	2	149	6695	106/53	11.60	11.80	14.71	1.85		16.56	30dBm	Pass
HE20	MCS0	2	181	6855	Full	13.20	13.50	16.36	1.85		18.21	30dBm	Pass
HE20	MCS0	2	181	6855	26/8	4.90	5.60	8.27	1.85		10.12	30dBm	Pass
HE20	MCS0	2	181	6855	52/40	8.50	8.90	11.71	1.85		13.56	30dBm	Pass
HE20	MCS0	2	181	6855	106/54	11.50	12.20	14.87	1.85		16.72	30dBm	Pass
HE40	MCS0	2	123	6565	Full	13.20	13.10	16.16	1.85		18.01	30dBm	Pass
HE40	MCS0	2	123	6565	242/61	12.60	12.30	15.46	1.85		17.31	30dBm	Pass
HE40	MCS0	2	147	6685	Full	13.20	12.80	16.01	1.85		17.86	30dBm	Pass
HE40	MCS0	2	147	6685	242/61	12.20	12.20	15.21	1.85		17.06	30dBm	Pass
HE40	MCS0	2	179	6845	Full	13.30	13.10	16.21	1.85		18.06	30dBm	Pass
HE40	MCS0	2	179	6845	242/62	12.80	12.40	15.61	1.85		17.46	30dBm	Pass
HE80	MCS0	2	135	6625	Full	13.50	13.20	16.36	1.85		18.21	30dBm	Pass
HE80	MCS0	2	135	6625	484/65	12.80	12.30	15.57	1.85		17.42	30dBm	Pass
HE80	MCS0	2	151	6705	Full	13.50	13.00	16.27	1.85		18.12	30dBm	Pass
HE80	MCS0	2	151	6705	484/65	12.30	12.30	15.31	1.85		17.16	30dBm	Pass
HE80	MCS0	2	167	6785	Full	13.20	13.00	16.11	1.85		17.96	30dBm	Pass
HE80	MCS0	2	167	6785	484/66	11.70	12.60	15.18	1.85		17.03	30dBm	Pass
HE160	MCS0	2	143	6665	Full	13.40	13.20	16.31	1.85		18.16	30dBm	Pass
HE160	MCS0	2	143	6665	996/67	12.90	12.50	15.71	1.85		17.56	30dBm	Pass

TEST RESULTS DATA
EIRP Power Spectral Density

U-NII-7 MIMO															
Mod.	Data Rate	NTx	CH.	Freq. (MHz)	RU Config.	Duty Factor (dB)		Conducted Power Density with Duty Factor (dBm/MHz)			DG (dBi)		EIRP Power Density (dBm/MHz)	EIRP Power Density Limit (dBm/MHz)	Pass /Fail
						Ant 6	Ant 7	Ant 6	Ant 7	SUM	Ant 6	Ant 7	SUM		
HE20	MCS0	2	117	6535	Full	0.60	0.60			5.58	4.58	10.16	17.00	Pass	
HE20	MCS0	2	117	6535	26/0	0.64	0.64			5.29	4.58	9.87	17.00	Pass	
HE20	MCS0	2	117	6535	52/37	0.64	0.64			5.12	4.58	9.70	17.00	Pass	
HE20	MCS0	2	117	6535	106/53	0.67	0.67			4.93	4.58	9.51	17.00	Pass	
HE20	MCS0	2	149	6695	Full	0.60	0.60			5.20	4.58	9.78	17.00	Pass	
HE20	MCS0	2	149	6695	26/4	0.64	0.64			4.84	4.58	9.42	17.00	Pass	
HE20	MCS0	2	149	6695	52/38	0.64	0.64			4.70	4.58	9.28	17.00	Pass	
HE20	MCS0	2	149	6695	106/53	0.67	0.67			5.11	4.58	9.69	17.00	Pass	
HE20	MCS0	2	181	6855	Full	0.60	0.60			5.65	4.58	10.23	17.00	Pass	
HE20	MCS0	2	181	6855	26/8	0.64	0.64			5.04	4.58	9.62	17.00	Pass	
HE20	MCS0	2	181	6855	52/40	0.64	0.64			5.40	4.58	9.98	17.00	Pass	
HE20	MCS0	2	181	6855	106/54	0.67	0.67			5.49	4.58	10.07	17.00	Pass	
HE40	MCS0	2	123	6565	Full	0.60	0.60			2.84	4.58	7.42	17.00	Pass	
HE40	MCS0	2	123	6565	242/61	0.66	0.67			2.45	4.58	7.03	17.00	Pass	
HE40	MCS0	2	147	6685	Full	0.60	0.60			2.53	4.58	7.11	17.00	Pass	
HE40	MCS0	2	147	6685	242/61	0.66	0.67			2.20	4.58	6.77	17.00	Pass	
HE40	MCS0	2	179	6845	Full	0.60	0.60			3.01	4.58	7.59	17.00	Pass	
HE40	MCS0	2	179	6845	242/62	0.66	0.67			2.66	4.58	7.24	17.00	Pass	
HE80	MCS0	2	135	6625	Full	0.65	0.60			0.59	4.58	5.17	17.00	Pass	
HE80	MCS0	2	135	6625	484/65	0.66	0.66			0.47	4.58	5.05	17.00	Pass	
HE80	MCS0	2	151	6705	Full	0.65	0.60			0.65	4.58	5.23	17.00	Pass	
HE80	MCS0	2	151	6705	484/65	0.66	0.66			0.51	4.58	5.09	17.00	Pass	
HE80	MCS0	2	167	6785	Full	0.65	0.60			0.50	4.58	5.08	17.00	Pass	
HE80	MCS0	2	167	6785	484/66	0.66	0.66			0.08	4.58	4.65	17.00	Pass	
HE160	MCS0	2	143	6665	Full	0.62	0.60			-2.14	4.58	2.44	17.00	Pass	
HE160	MCS0	2	143	6665	996/67	0.66	0.69			-2.57	4.58	2.01	17.00	Pass	



Test Result of 26dB & 99% Occupied Bandwidth

MIMO <Ant. 6+7>

<802.11a>

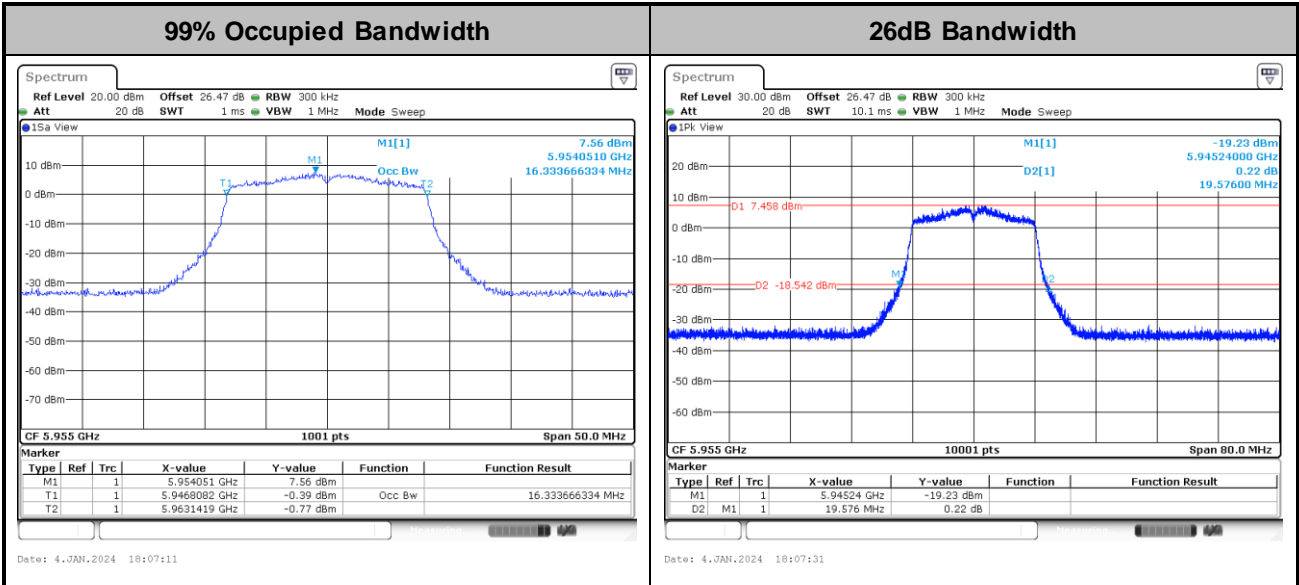

Note: The occupied channel bandwidth is maintained within the band of operation for all of the modulations.

<802.11ax HE20>

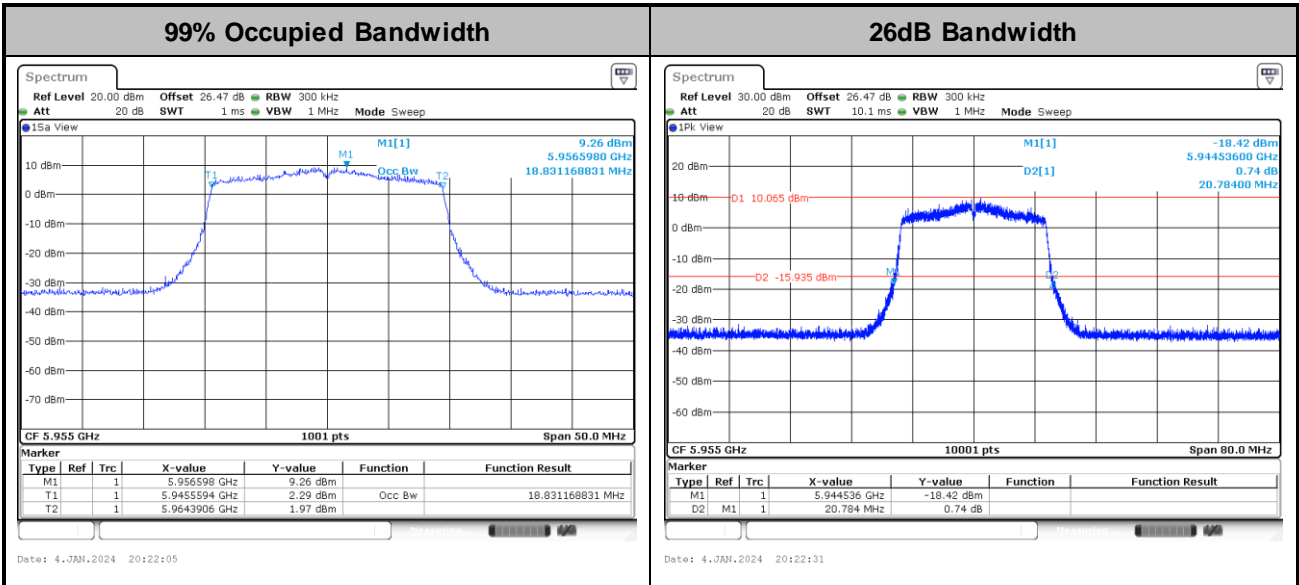

Note: The occupied channel bandwidth is maintained within the band of operation for all of the modulations.



<802.11ax HE40>

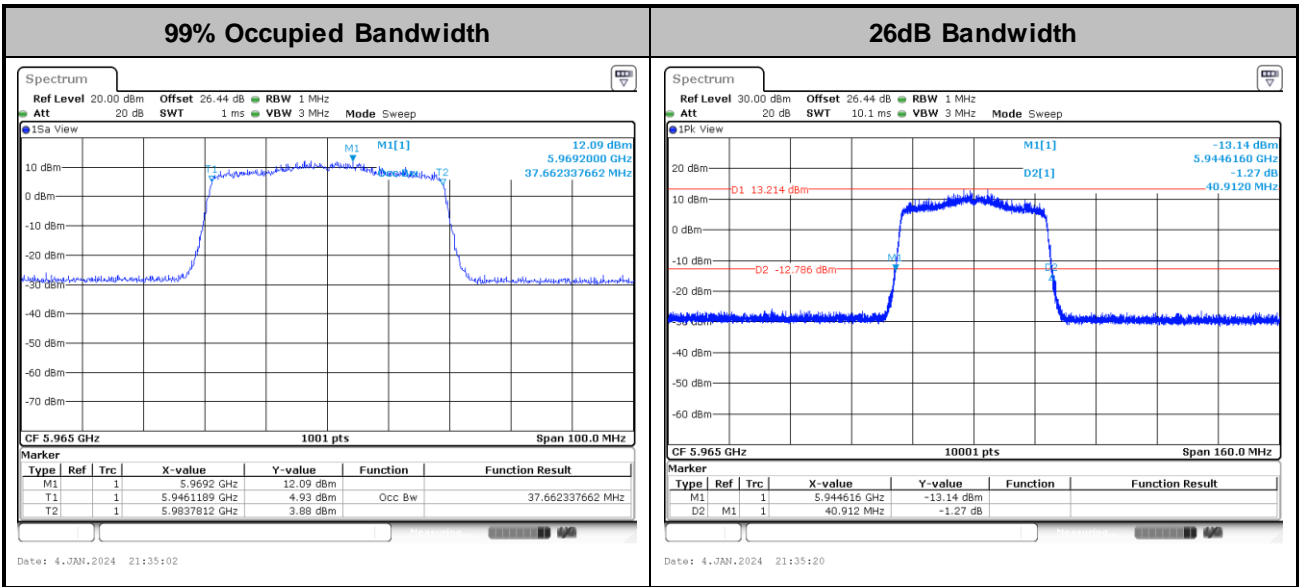

Note: The occupied channel bandwidth is maintained within the band of operation for all of the modulations.

<802.11ax HE80>

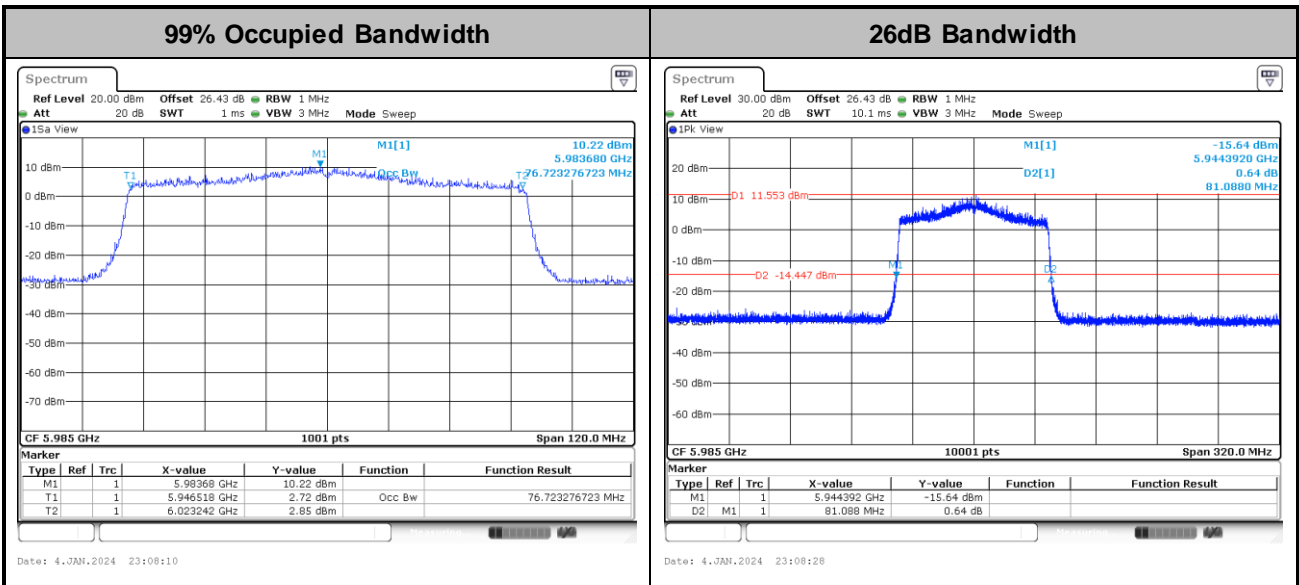

Note: The occupied channel bandwidth is maintained within the band of operation for all of the modulations.



<802.11ax HE160>

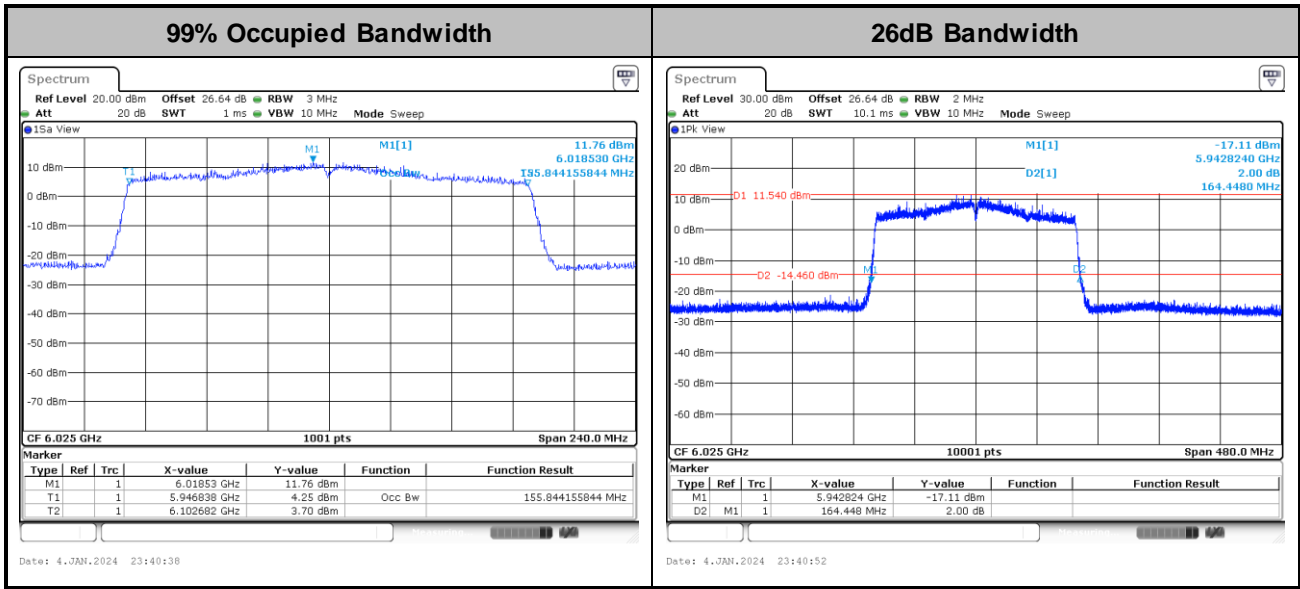

Note: The occupied channel bandwidth is maintained within the band of operation for all of the modulations.



Test Result of Power Spectral Density

<802.11a>

Maximum Power Density Plot (dBm/MHz)

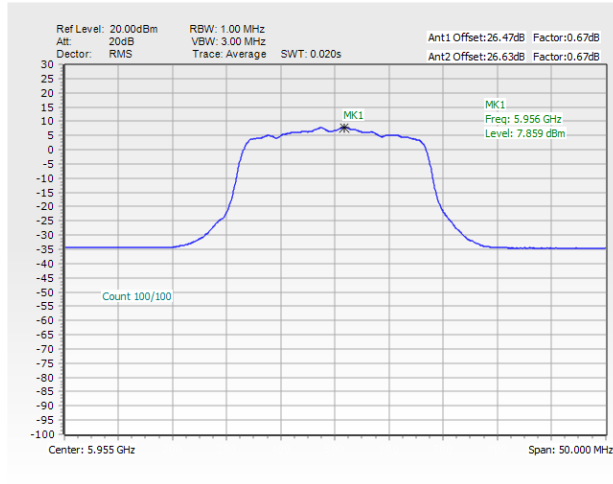

Note:

- 1 EIRP Power Density (dBm/MHz) = Measured value+ Duty Factor + Directional Gain
- 2 The test plot is showing a bin by bin combined result mathematically adds two traces.

Power Density Plot Trace 1 (Ant 6)

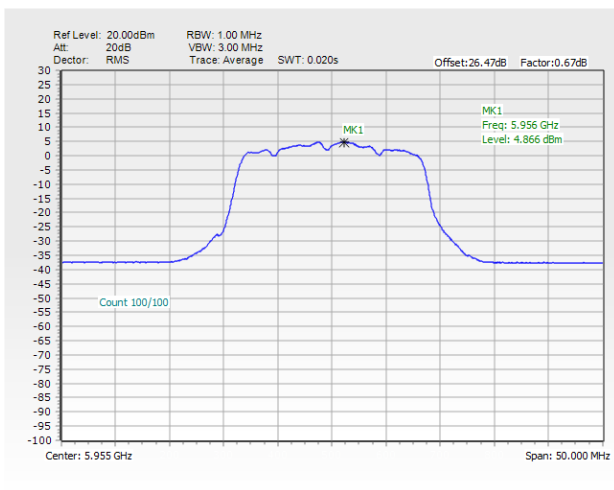

Power Density Plot Trace 2 (Ant 7)

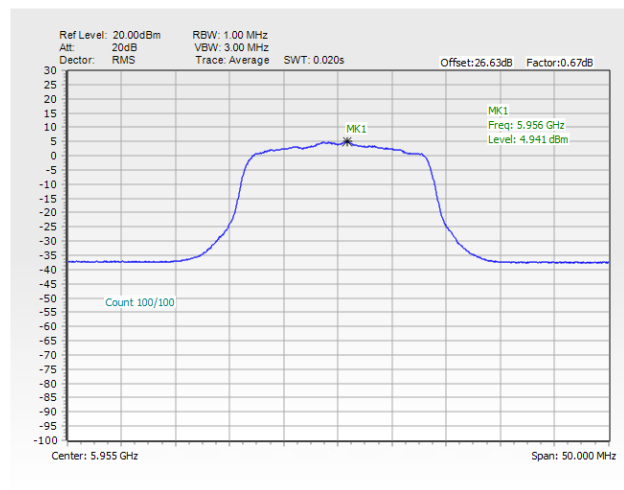



<802.11ax HE20>

Maximum Power Density Plot (dBm/MHz)

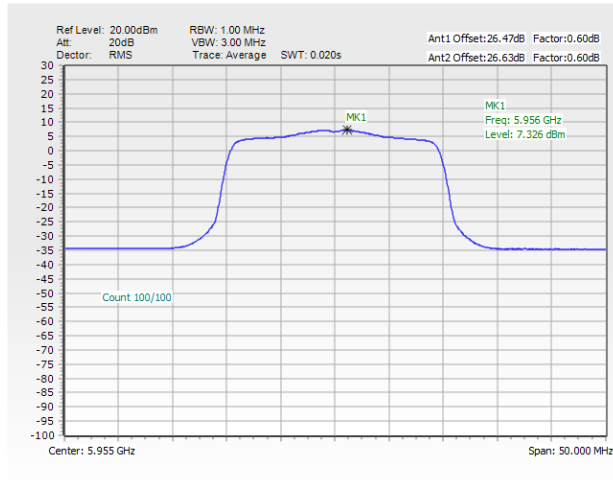

Note:

- 1 EIRP Power Density (dBm/MHz) = Measured value+ Duty Factor + Directional Gain
- 2 The test plot is showing a bin by bin combined result mathematically adds two traces.

Power Density Plot Trace 1 (Ant 6)

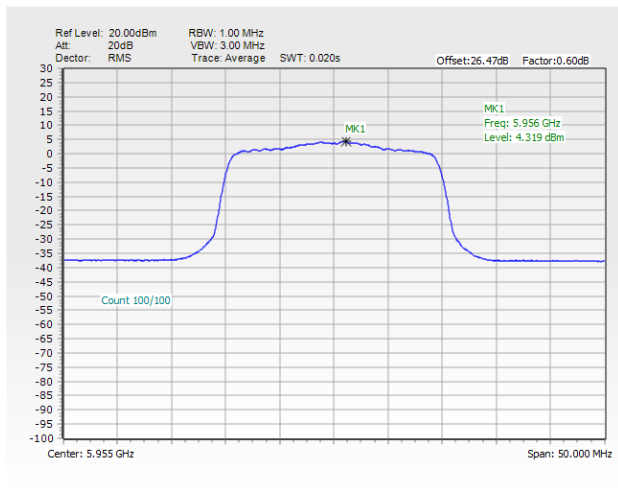

Power Density Plot Trace 2 (Ant 7)

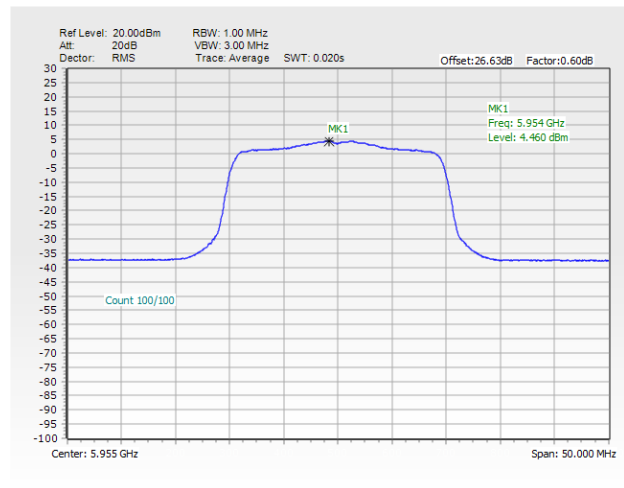



<802.11ax HE40>

Maximum Power Density Plot (dBm/MHz)

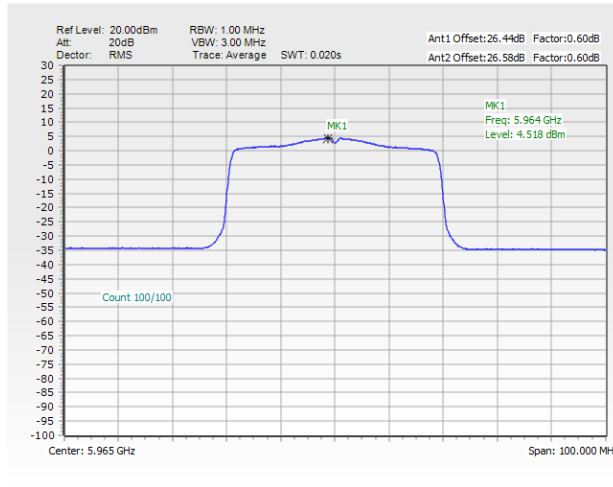

Note:

- 1 EIRP Power Density (dBm/MHz) = Measured value+ Duty Factor + Directional Gain
- 2 The test plot is showing a bin by bin combined result mathematically adds two traces.

Power Density Plot Trace 1 (Ant 6)

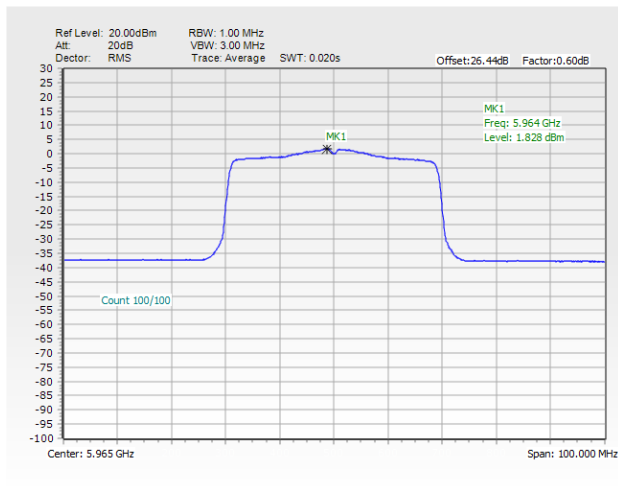

Power Density Plot Trace 2 (Ant 7)

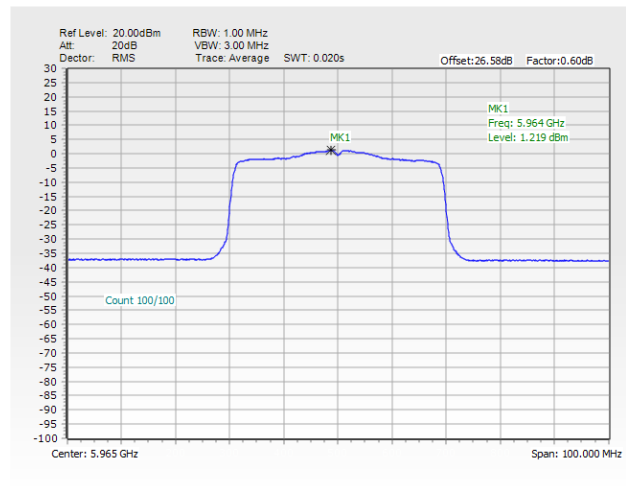



<802.11ax HE80>

Maximum Power Density Plot (dBm/MHz)

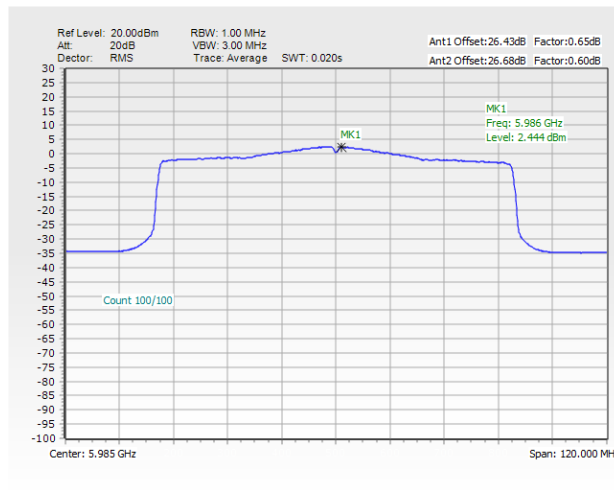

Note:

- 1 EIRP Power Density (dBm/MHz) = Measured value+ Duty Factor + Directional Gain
- 2 The test plot is showing a bin by bin combined result mathematically adds two traces.

Power Density Plot Trace 1 (Ant 6)

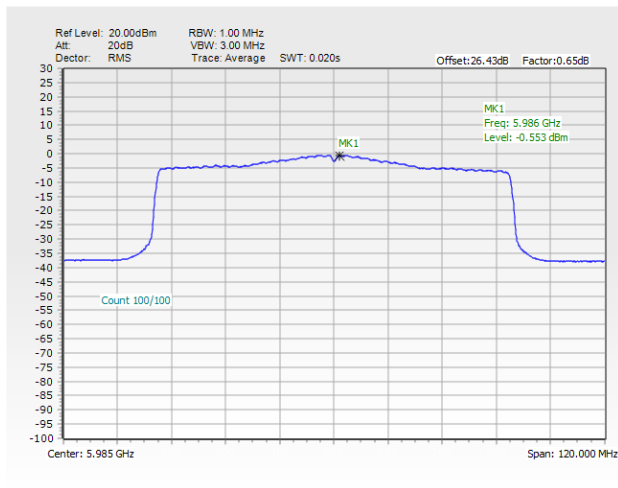

Power Density Plot Trace 2 (Ant 7)

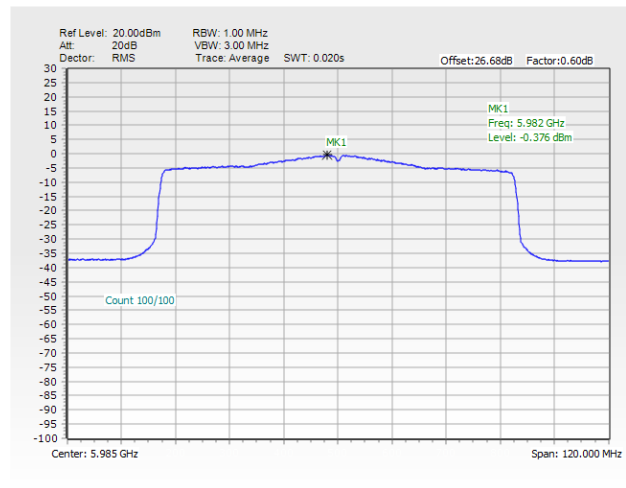



<802.11ax HE160>

Maximum Power Density Plot (dBm/MHz)

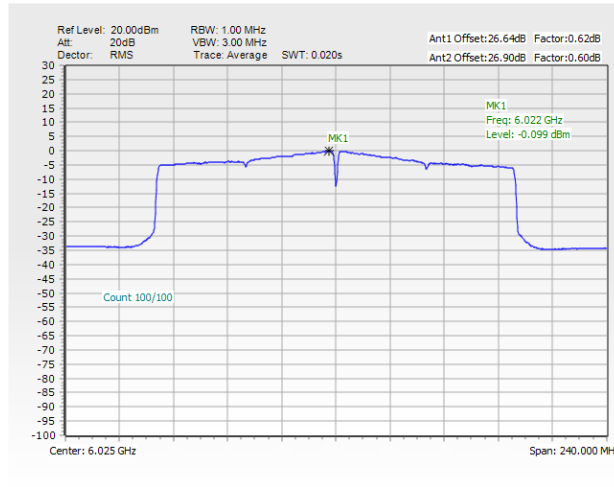

Note:

- 1 EIRP Power Density (dBm/MHz) = Measured value+ Duty Factor + Directional Gain
- 2 The test plot is showing a bin by bin combined result mathematically adds two traces.

Power Density Plot Trace 1 (Ant 6)

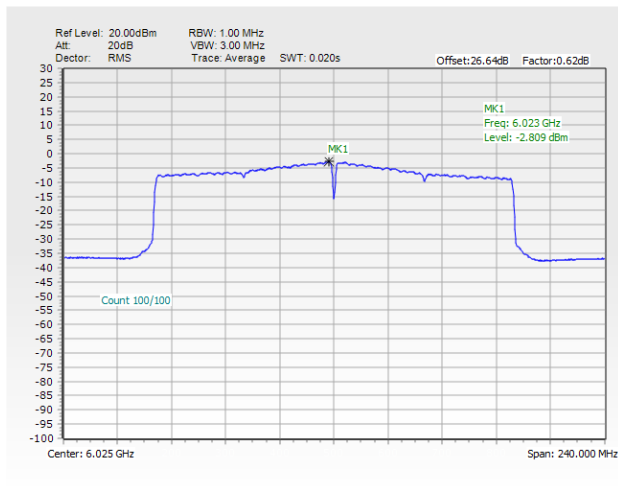

Power Density Plot Trace 2 (Ant 7)

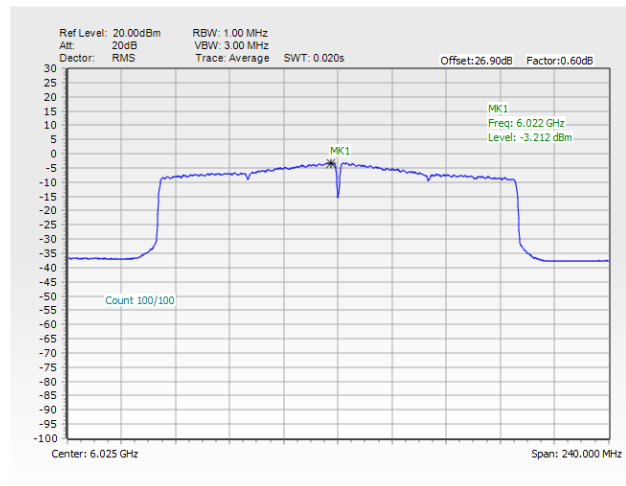



In-Band Emissions (Channel Mask)

MIMO <Ant. 6+7(6)>

EUT Mode 802.11a

Plot on Channel 5955 MHz

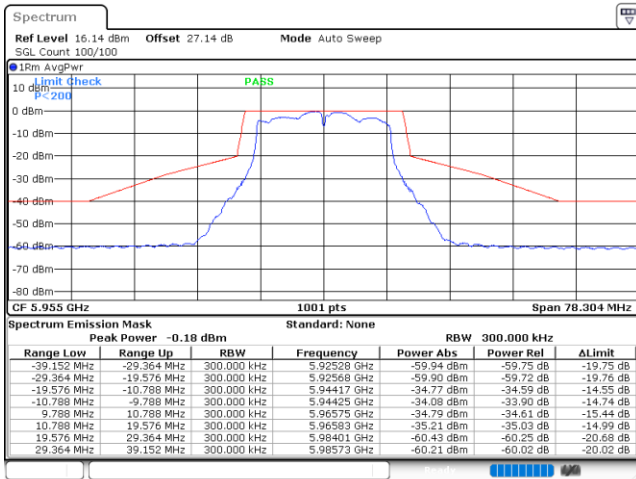

Date: 4.JAN.2024 18:08:25

Plot on Channel 6195 MHz

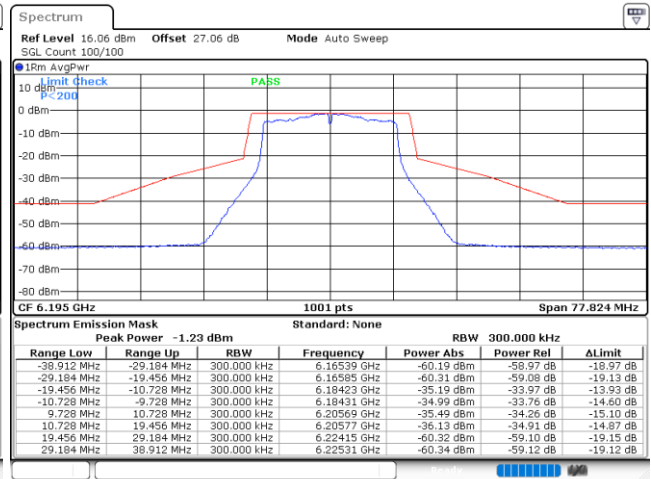

Date: 4.JAN.2024 18:18:54

Plot on Channel 6415 MHz

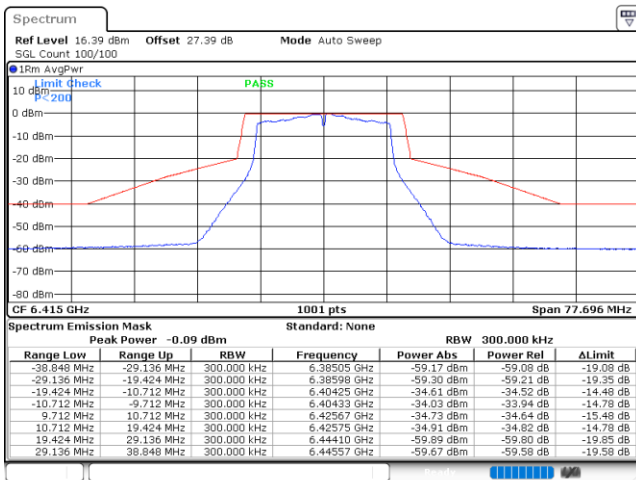

Date: 4.JAN.2024 18:49:02



Plot on Channel 6535 MHz

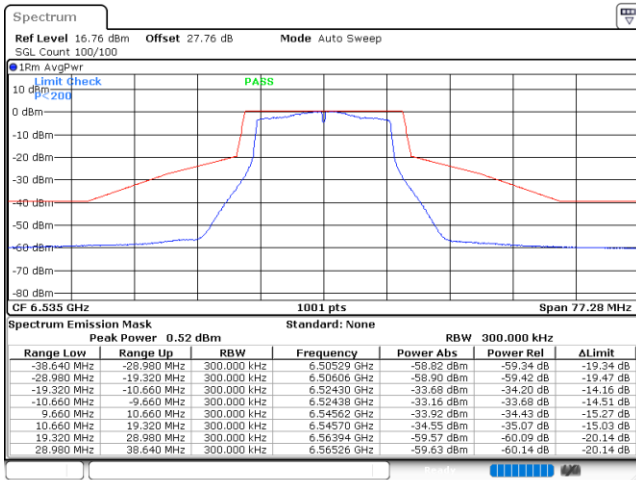

Date: 4.JAN.2024 19:55:09

Plot on Channel 6695 MHz

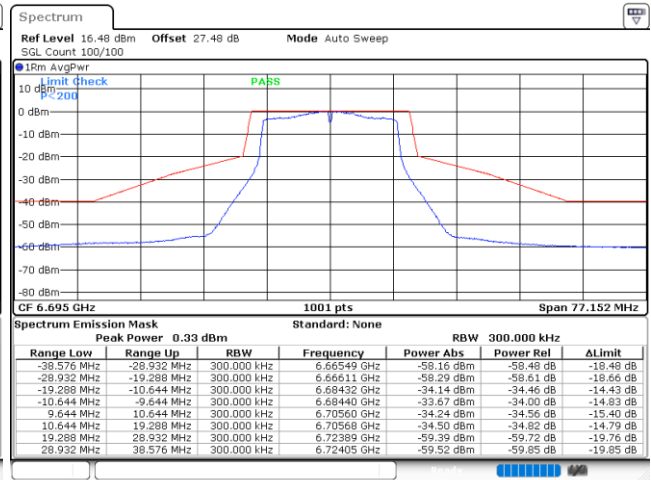

Date: 4.JAN.2024 20:03:51

Plot on Channel 6855 MHz

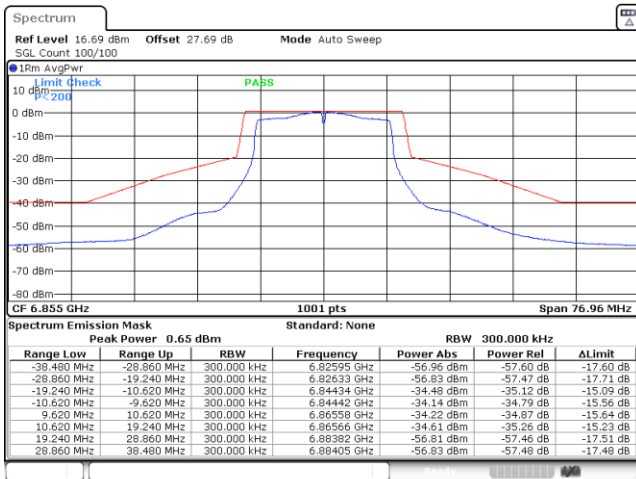

Date: 17.JAN.2024 19:28:41



MIMO <Ant. 6+7(7)>

EUT Mode	802.11a
----------	---------

Plot on Channel 5955 MHz

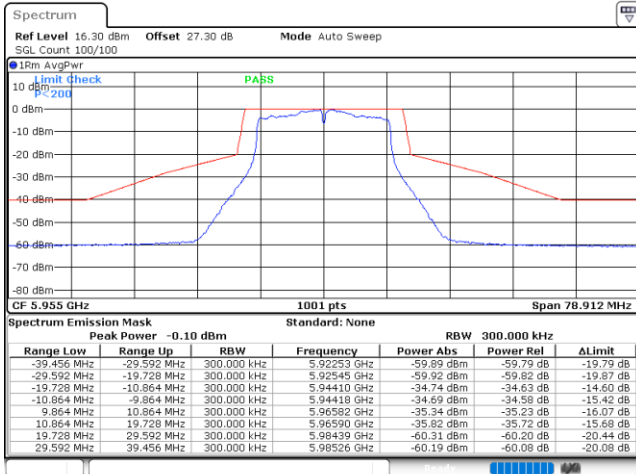

Date: 4.JAN.2024 18:13:48

Plot on Channel 6195 MHz

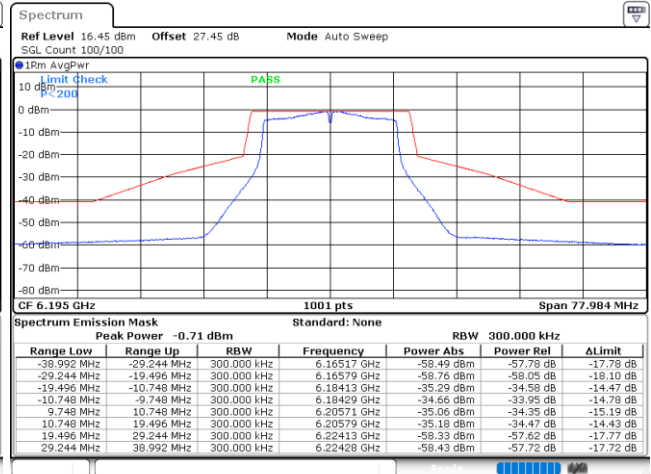

Date: 4.JAN.2024 18:38:55

Plot on Channel 6415 MHz

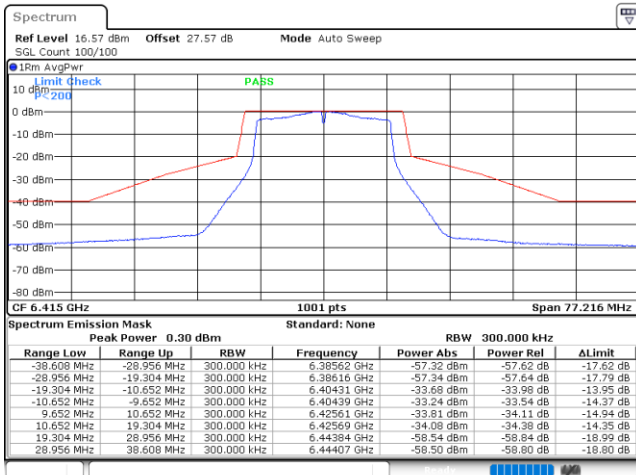

Date: 4.JAN.2024 18:55:45



Plot on Channel 6535 MHz

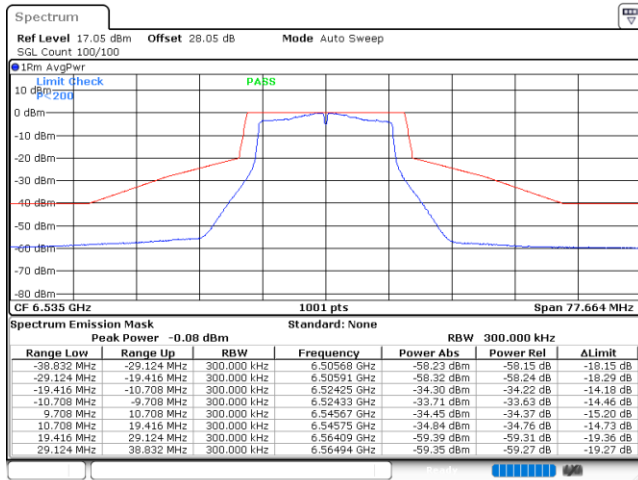

Date: 4.JAN.2024 19:58:13

Plot on Channel 6695 MHz

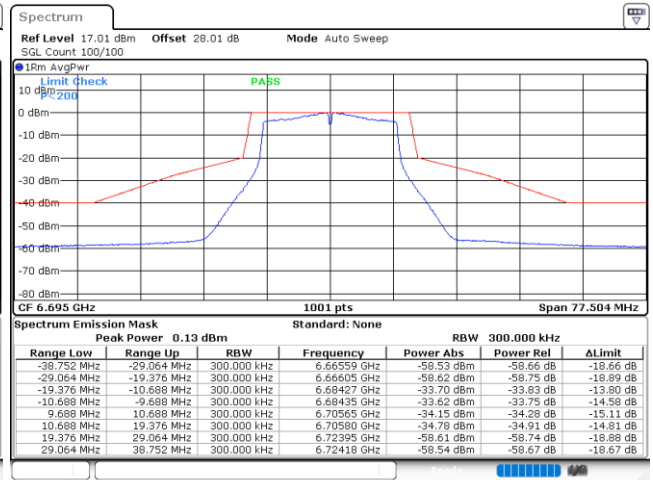

Date: 4.JAN.2024 20:08:54

Plot on Channel 6855 MHz

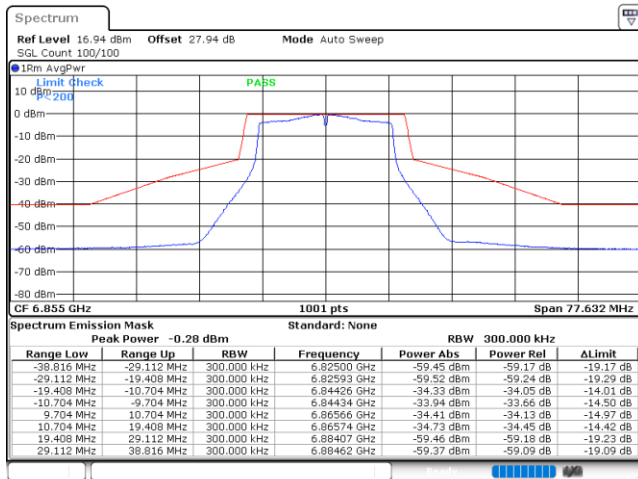

Date: 4.JAN.2024 20:15:19



MIMO <Ant. 6+7(6)>

EUT Mode	802.11ax HE20 Full RU
----------	-----------------------

Plot on Channel 5955 MHz

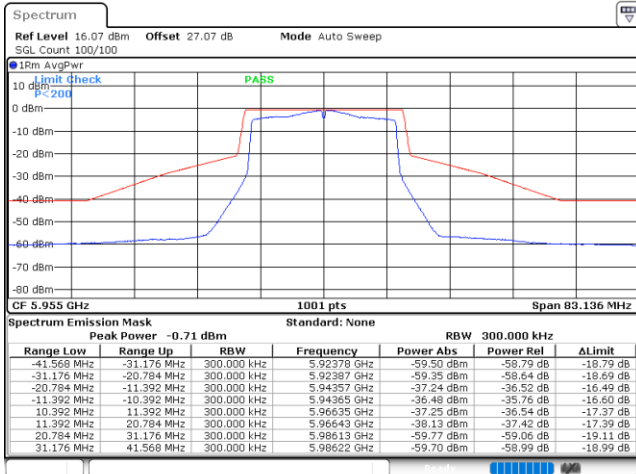

Date: 4.JAN.2024 20:22:53

Plot on Channel 6195 MHz

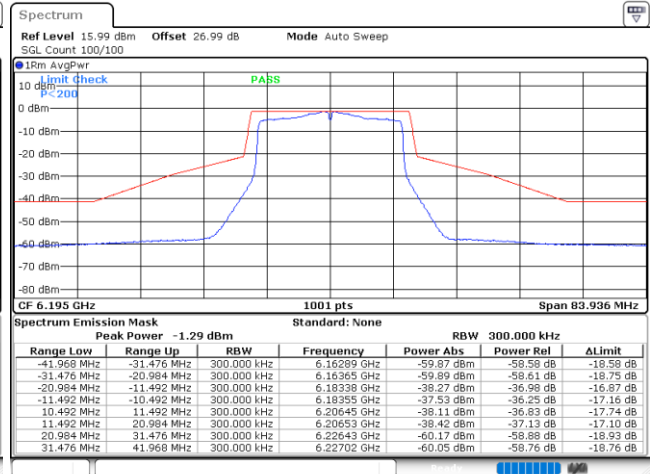

Date: 4.JAN.2024 20:29:30

Plot on Channel 6415 MHz

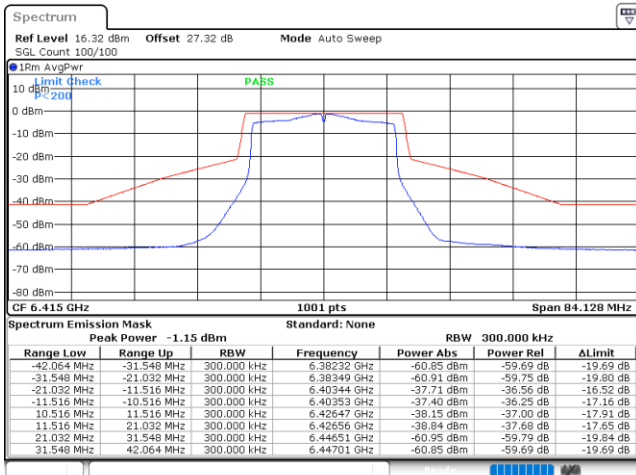

Date: 4.JAN.2024 20:34:11



Plot on Channel 6535 MHz

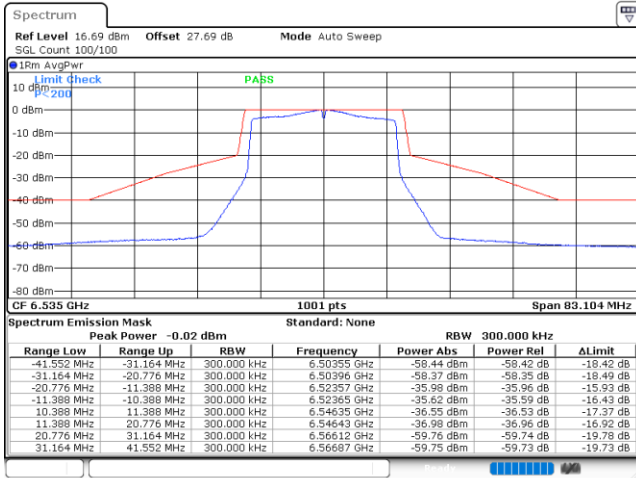

Date: 4.JAN.2024 21:01:03

Plot on Channel 6695 MHz

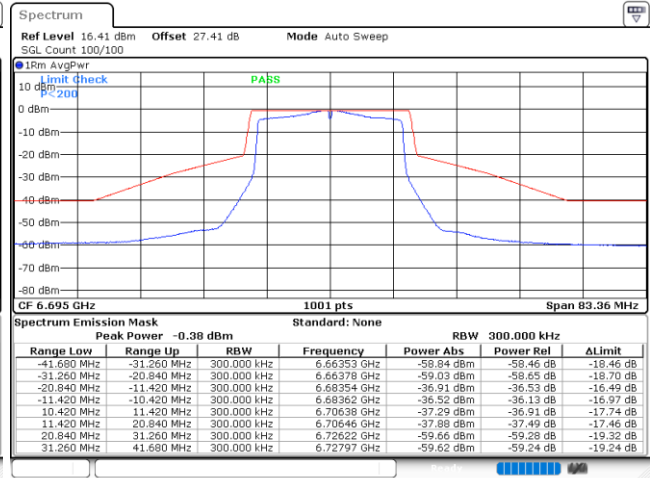

Date: 4.JAN.2024 21:08:24

Plot on Channel 6855 MHz

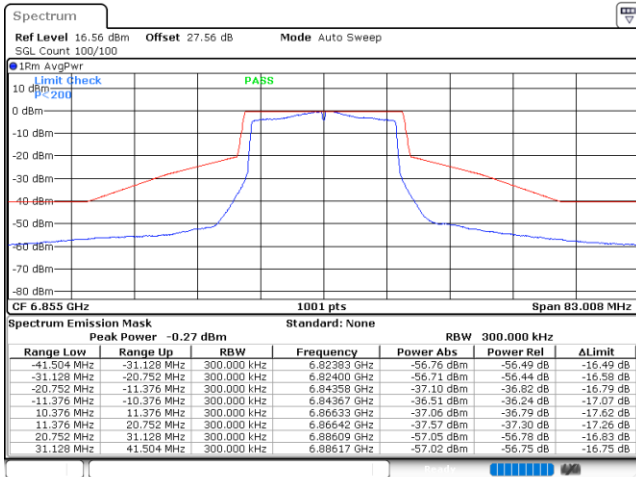

Date: 4.JAN.2024 21:12:46



EUT Mode 802.11ax HE20 26RU0

Plot on Channel 5955 MHz

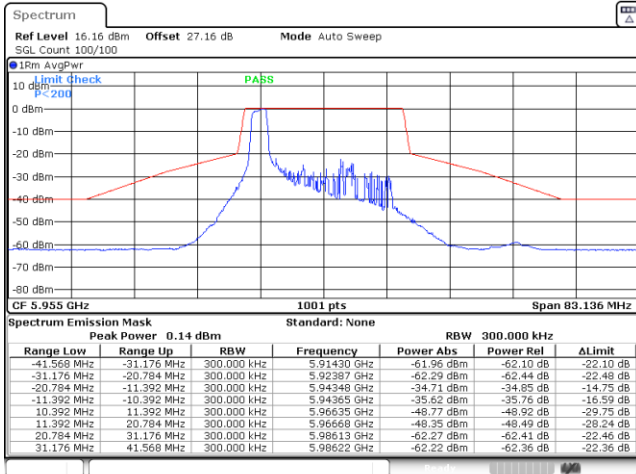

Date: 17.JAN.2024 17:36:39

Plot on Channel 6535 MHz

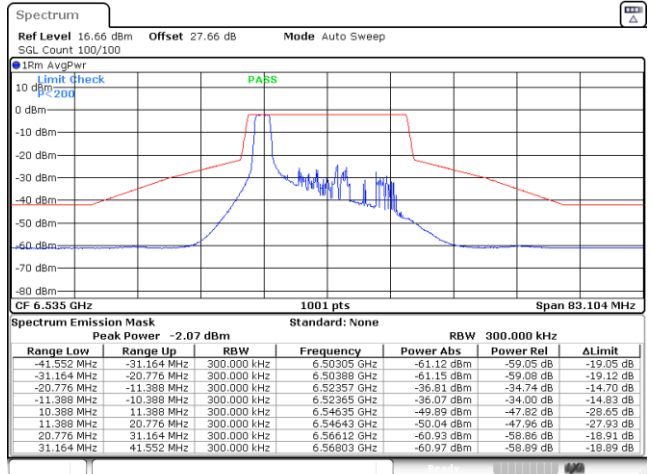

Date: 17.JAN.2024 21:45:30

EUT Mode 802.11ax HE20 26RU4

Plot on Channel 6195 MHz

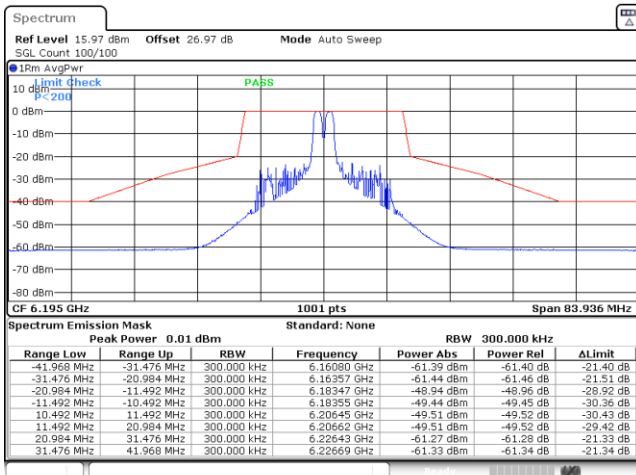

Date: 17.JAN.2024 20:32:58

Plot on Channel 6695 MHz

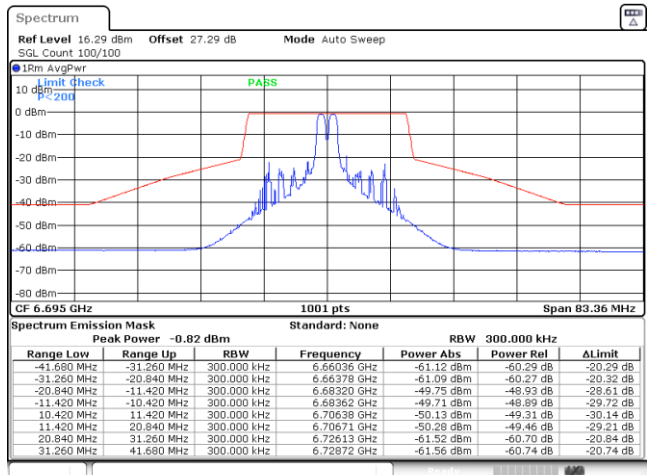

Date: 17.JAN.2024 22:44:35



EUT Mode 802.11ax HE20 26RU8

Plot on Channel 6415 MHz

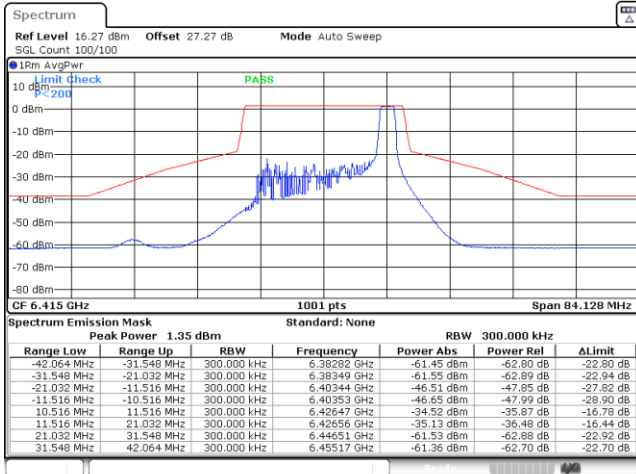

Date: 17.JAN.2024 20:44:03

Plot on Channel 6855 MHz

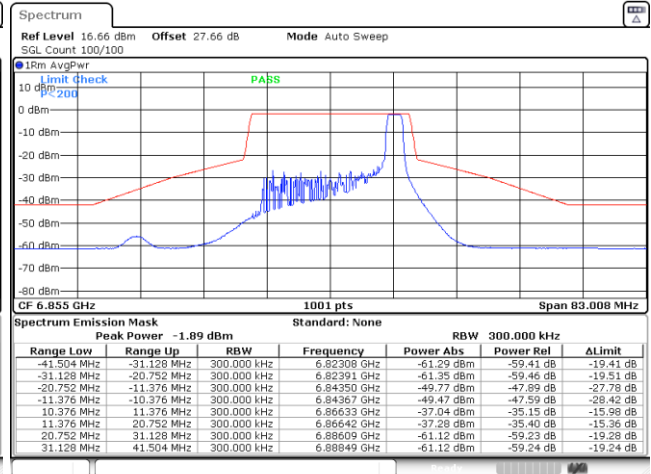

Date: 17.JAN.2024 22:58:13

EUT Mode 802.11ax HE20 52RU37

Plot on Channel 5955 MHz

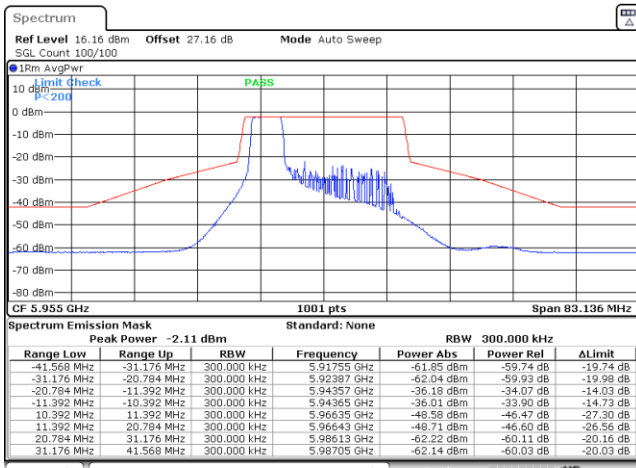

Date: 17.JAN.2024 17:34:32

Plot on Channel 6535 MHz

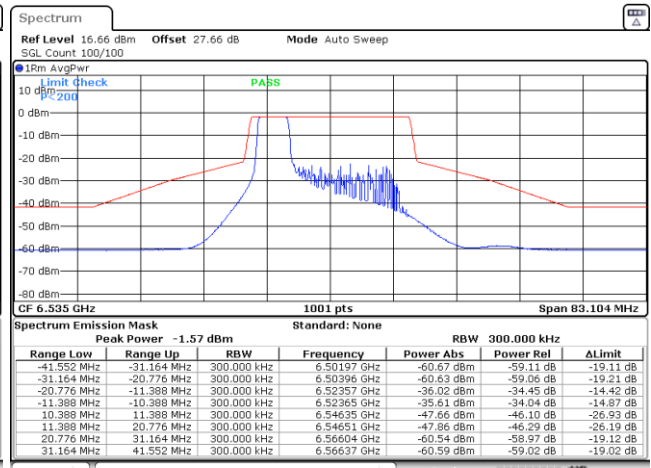

Date: 17.JAN.2024 22:30:28



EUT Mode 802.11ax HE20 52RU38

Plot on Channel 6195 MHz

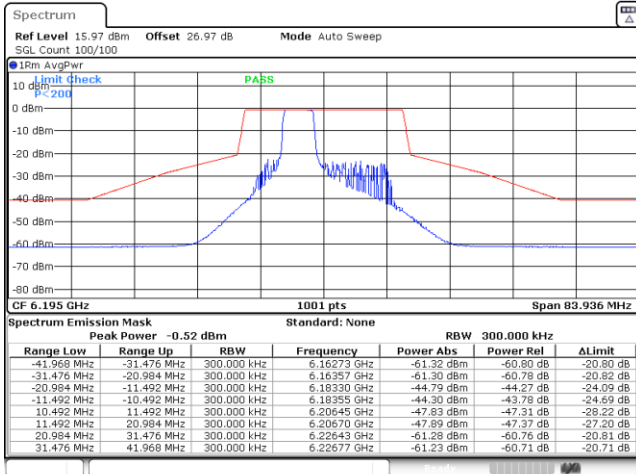

Date: 17.JAN.2024 20:36:01

Plot on Channel 6695 MHz

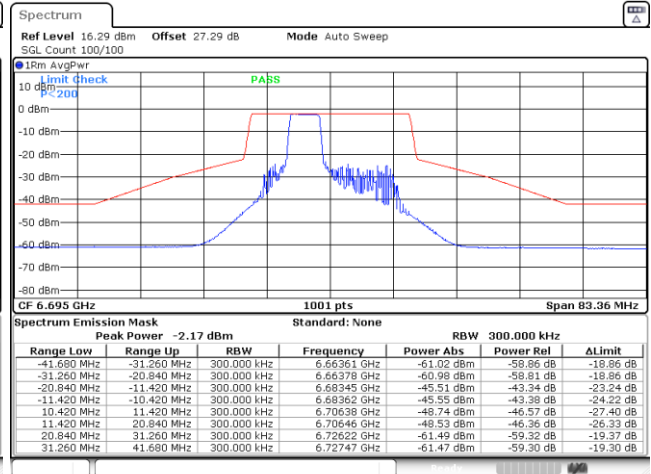

Date: 17.JAN.2024 22:14:09

EUT Mode 802.11ax HE20 52RU40

Plot on Channel 6415 MHz

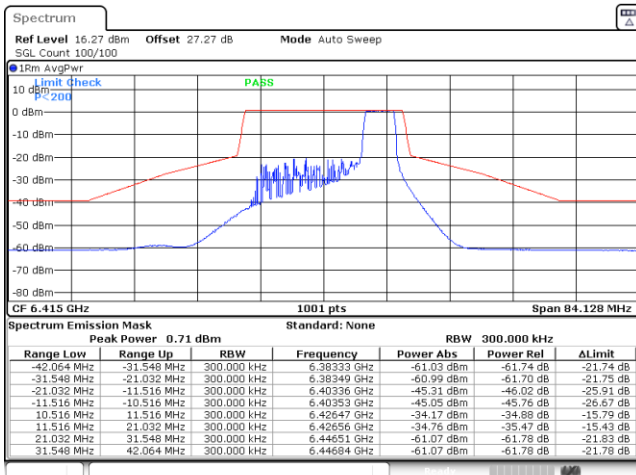

Date: 17.JAN.2024 20:48:12

Plot on Channel 6855 MHz

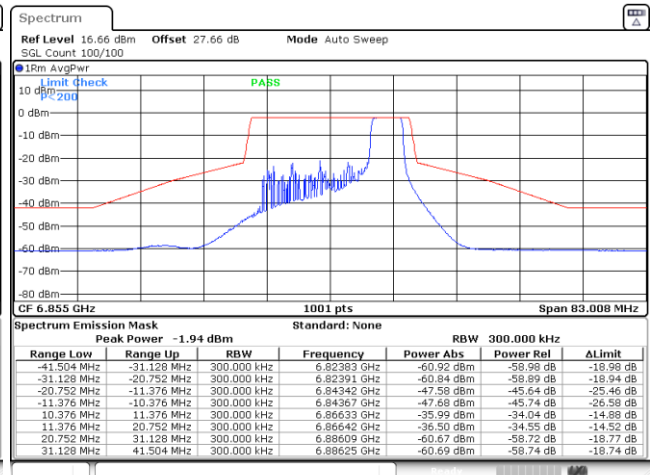

Date: 17.JAN.2024 23:01:29



EUT Mode 802.11ax HE20 106RU53

Plot on Channel 5955 MHz

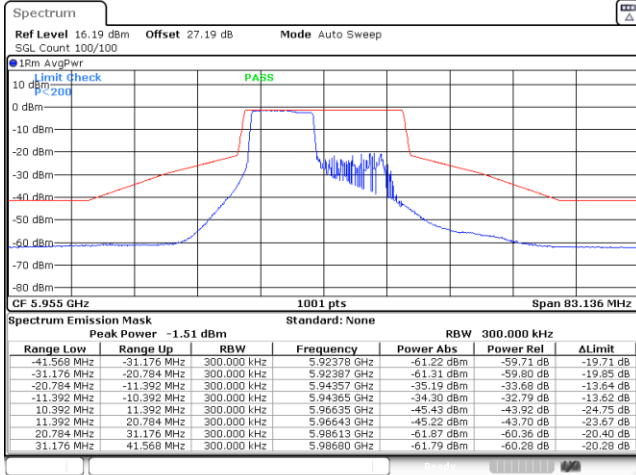

Date: 17.JAN.2024 17:43:32

Plot on Channel 6195 MHz

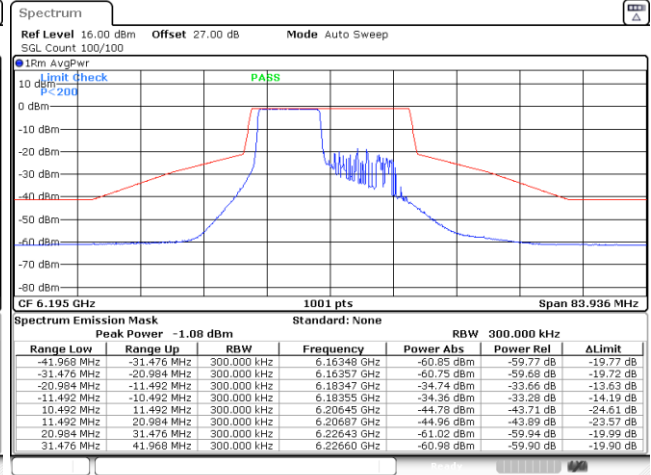

Date: 17.JAN.2024 20:38:58

Plot on Channel 6535 MHz

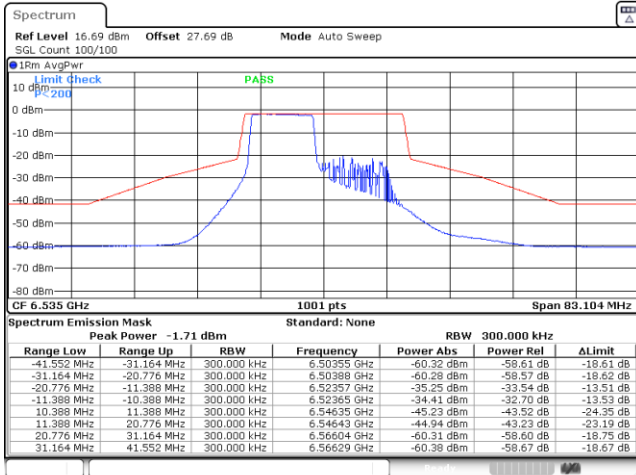

Date: 17.JAN.2024 22:38:01

Plot on Channel 6695 MHz

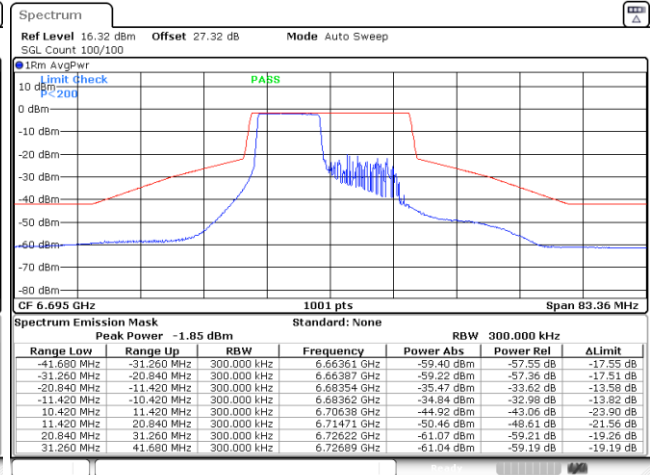

Date: 17.JAN.2024 22:52:47



EUT Mode 802.11ax HE20 106RU54

Plot on Channel 6415 MHz

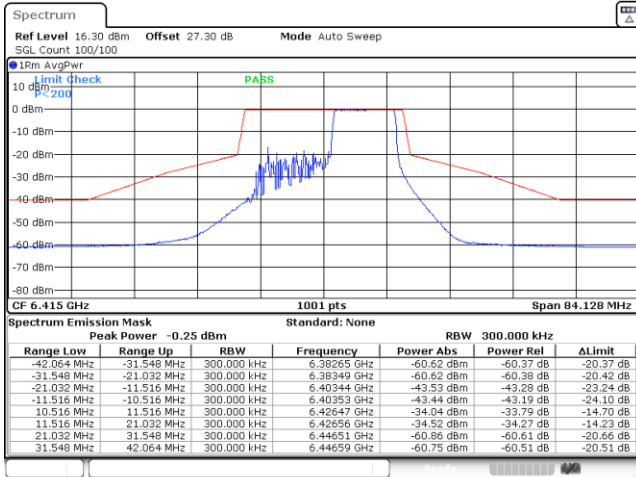

Date: 17.JAN.2024 20:52:08

Plot on Channel 6855 MHz

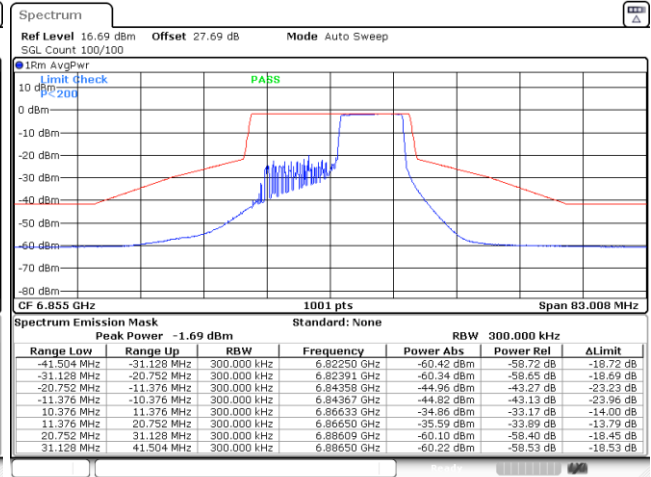

Date: 17.JAN.2024 23:04:04



MIMO <Ant. 6+7(7)>

EUT Mode 802.11ax HE20 Full RU

Plot on Channel 5955 MHz

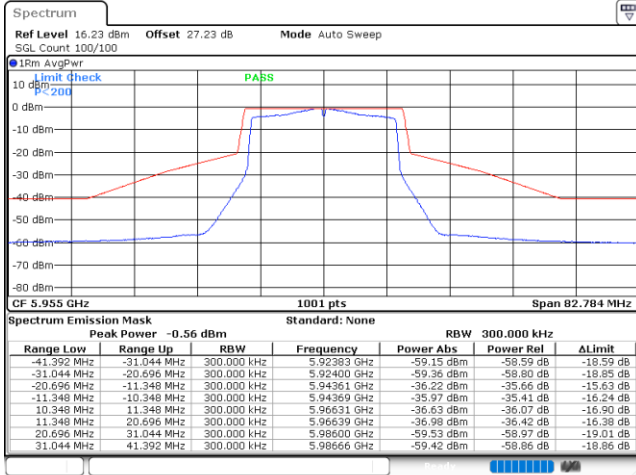

Date: 4.JAN.2024 20:27:07

Plot on Channel 6195 MHz

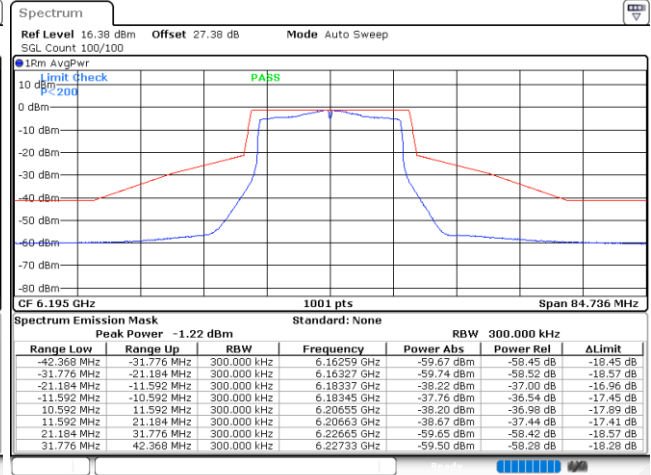

Date: 4.JAN.2024 20:32:34

Plot on Channel 6415 MHz

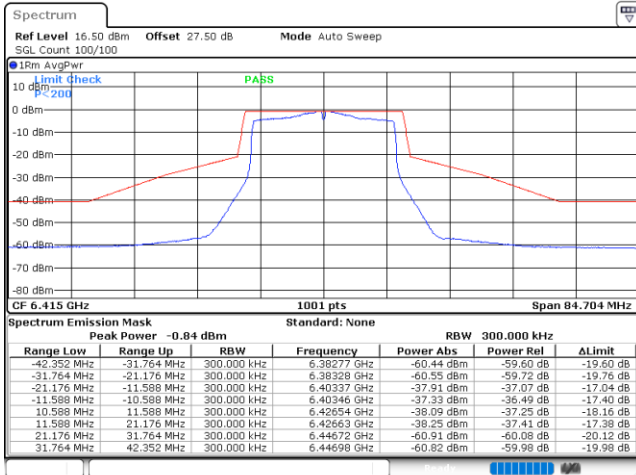

Date: 4.JAN.2024 20:36:30



Plot on Channel 6535 MHz

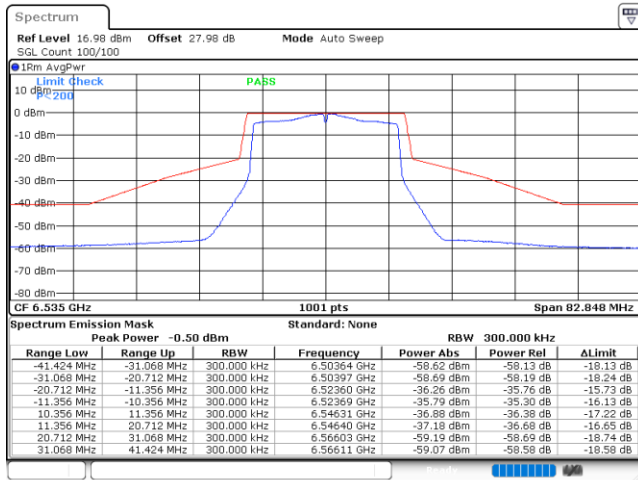

Date: 4.JAN.2024 21:06:15

Plot on Channel 6695 MHz

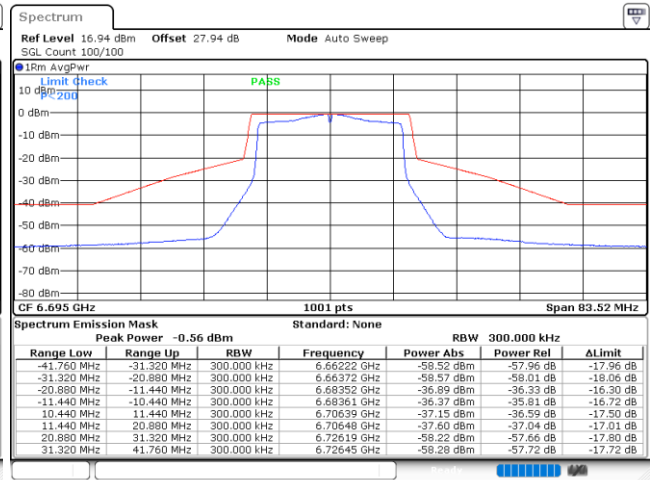

Date: 4.JAN.2024 21:10:58

Plot on Channel 6855 MHz

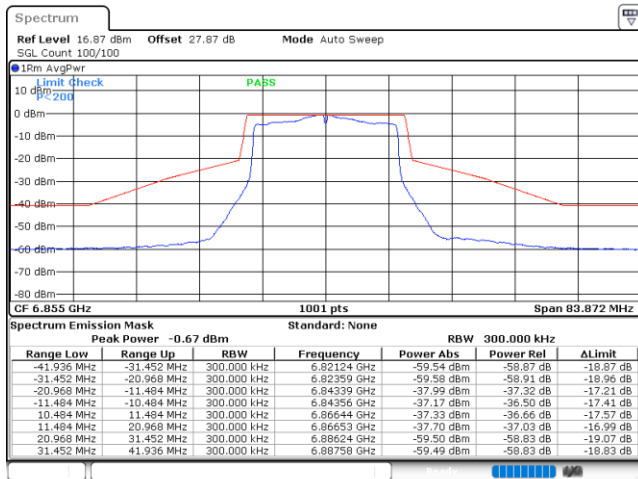

Date: 4.JAN.2024 21:15:42



EUT Mode 802.11ax HE20 26RU0

Plot on Channel 5955 MHz

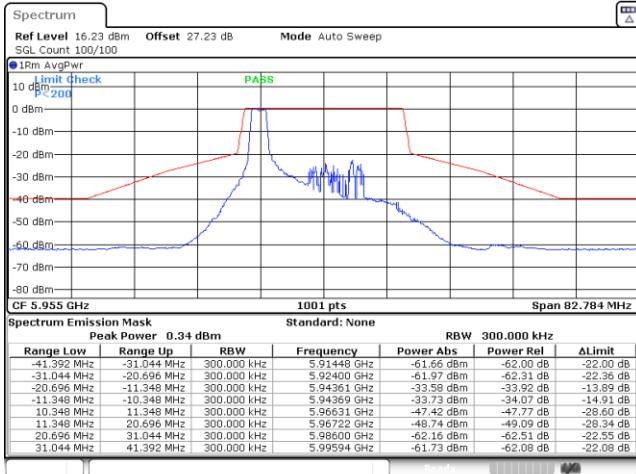

Date: 17.JAN.2024 17:38:18

Plot on Channel 6535 MHz

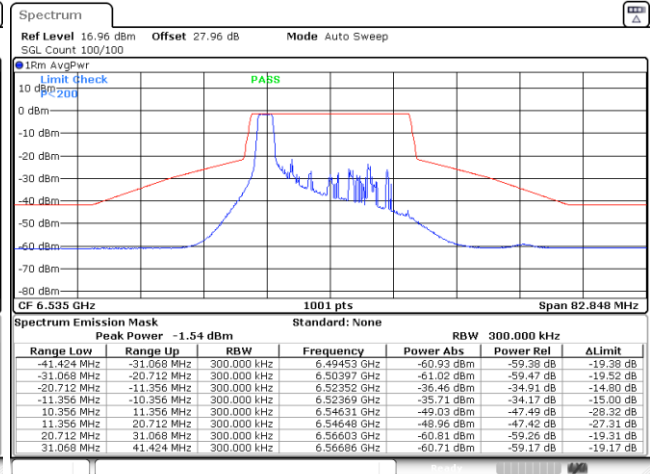

Date: 17.JAN.2024 21:46:49

EUT Mode 802.11ax HE20 26RU4

Plot on Channel 6195 MHz

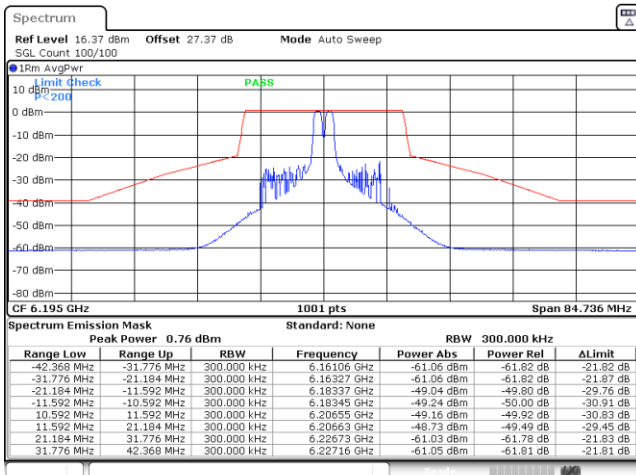

Date: 17.JAN.2024 20:34:03

Plot on Channel 6695 MHz

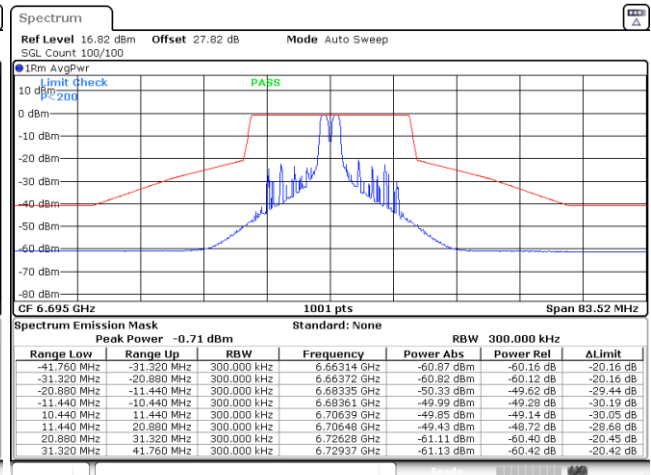

Date: 17.JAN.2024 22:45:58



EUT Mode 802.11ax HE20 26RU8

Plot on Channel 6415 MHz

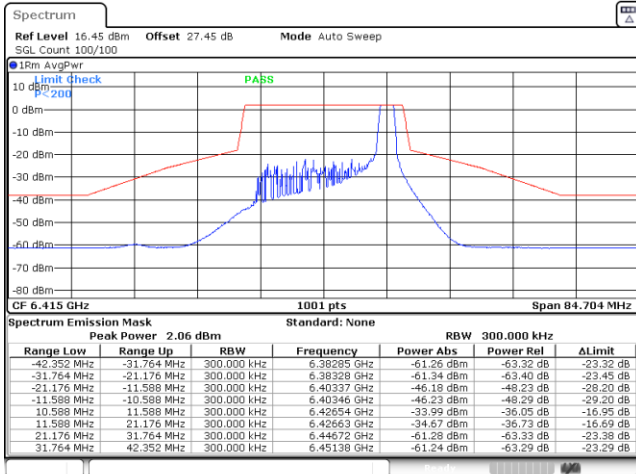

Date: 17.JAN.2024 20:44:57

Plot on Channel 6855 MHz

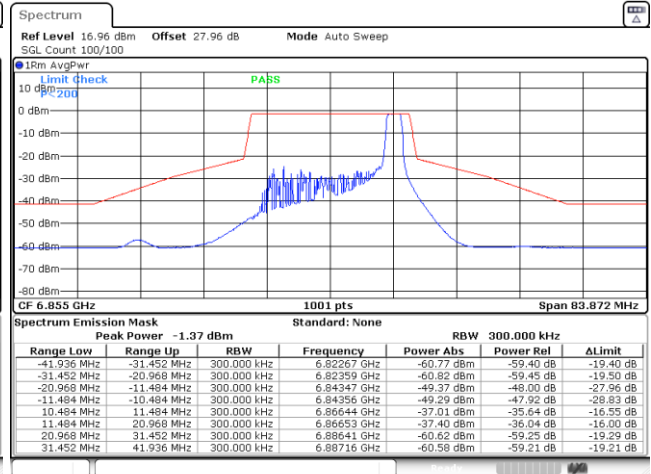

Date: 17.JAN.2024 22:59:01

EUT Mode 802.11ax HE20 52RU37

Plot on Channel 5955 MHz

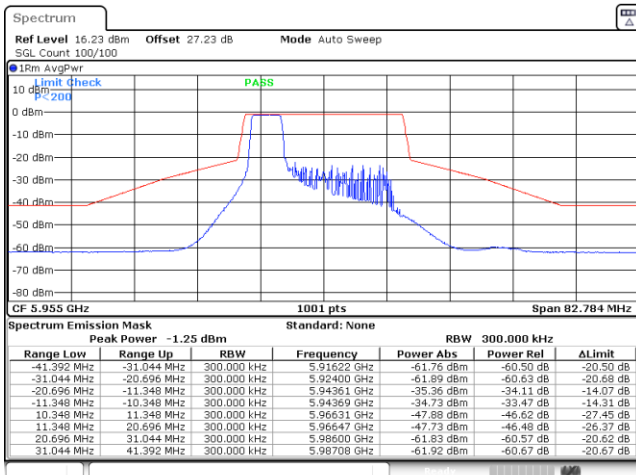

Date: 17.JAN.2024 17:35:20

Plot on Channel 6535 MHz

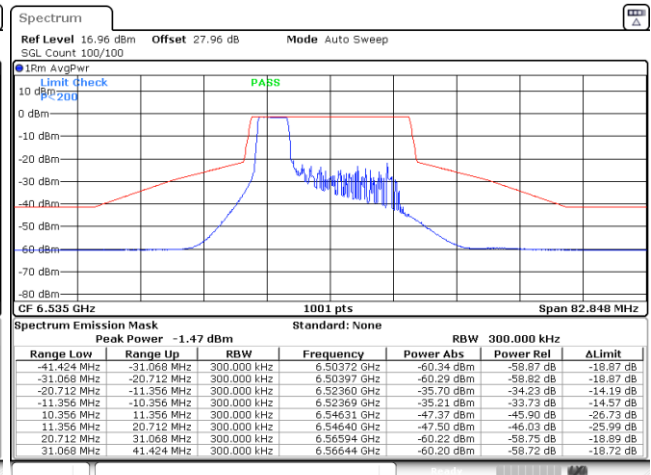

Date: 17.JAN.2024 22:32:24



EUT Mode 802.11ax HE20 52RU38

Plot on Channel 6195 MHz

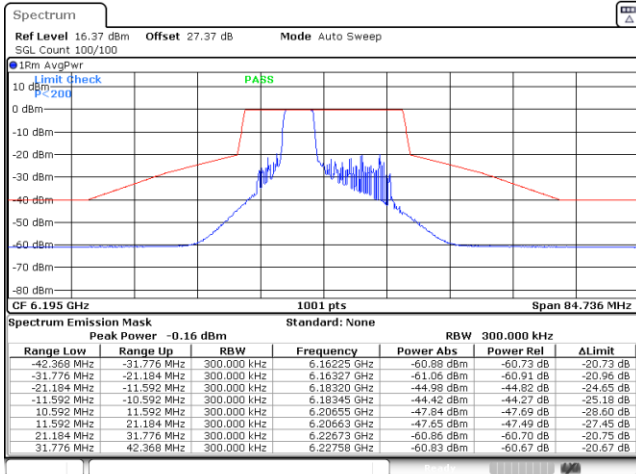

Date: 17.JAN.2024 20:37:02

Plot on Channel 6695 MHz

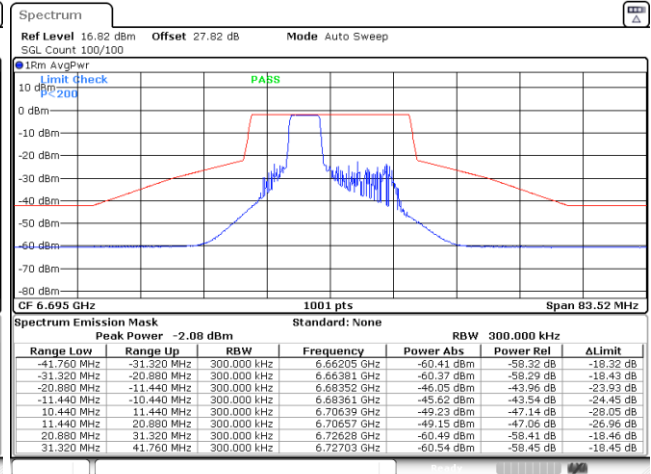

Date: 17.JAN.2024 22:49:57

EUT Mode 802.11ax HE20 52RU40

Plot on Channel 6415 MHz

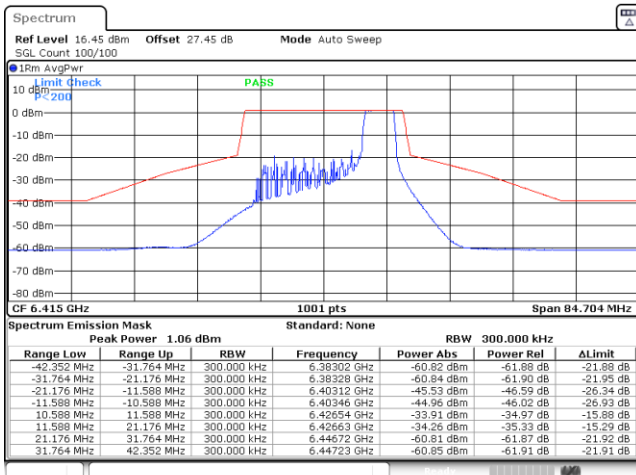

Date: 17.JAN.2024 20:49:47

Plot on Channel 6855 MHz

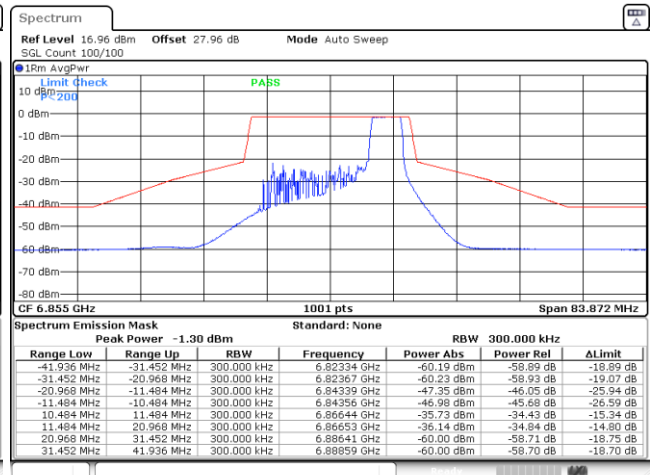

Date: 17.JAN.2024 23:02:29