



# FCC RADIO TEST REPORT

**FCC ID** : UZ7MC945B  
**Equipment** : Mobile Computer  
**Brand Name** : ZEBRA  
**Model Name** : MC945B  
**Applicant** : Zebra Technologies Corporation  
1 Zebra Plaza, Holtsville, NY 11742  
**Manufacturer** : Zebra Technologies Corporation  
1 Zebra Plaza, Holtsville, NY 11742  
**Standard** : FCC Part 15 Subpart E §15.407

The product was received on Nov. 06, 2023 and testing was performed from Nov. 10, 2023 to Jan. 19, 2024. We, Sporton International Inc. Wensan Laboratory, would like to declare that the tested sample has been evaluated in accordance with the test procedures and has been in compliance with the applicable technical standards.

The test results in this report apply exclusively to the tested model / sample. Without written approval from Sporton International Inc. Wensan Laboratory, the test report shall not be reproduced except in full.

*Louis Wu*

Approved by: Louis Wu

**Sporton International Inc. Wensan Laboratory**

No.58, Aly. 75, Ln. 564, Wenhua 3rd, Rd., Guishan Dist., Taoyuan City 333010, Taiwan (R.O.C.)



## Table of Contents

**History of this test report..... 3**

**Summary of Test Result..... 4**

**1 General Description ..... 5**

    1.1 Product Feature of Equipment Under Test..... 5

    1.2 Product Specification of Equipment Under Test..... 6

    1.3 Modification of EUT ..... 11

    1.4 Testing Location ..... 11

    1.5 Applicable Standards..... 11

**2 Test Configuration of Equipment Under Test ..... 12**

    2.1 Carrier Frequency and Channel ..... 12

    2.2 Test Mode..... 15

    2.3 Connection Diagram of Test System ..... 18

    2.4 Support Unit used in test configuration and system ..... 19

    2.5 EUT Operation Test Setup ..... 19

    2.6 Measurement Results Explanation Example..... 19

**3 Test Result ..... 20**

    3.1 26dB & 99% Occupied Bandwidth Measurement ..... 20

    3.2 Fundamental Maximum EIRP Measurement ..... 21

    3.3 Fundamental Power Spectral Density Measurement ..... 22

    3.4 In-Band Emissions (Channel Mask) ..... 24

    3.5 Contention Based Protocol ..... 26

    3.6 Unwanted Emissions Measurement ..... 50

    3.7 AC Conducted Emission Measurement..... 54

    3.8 Antenna Requirements ..... 56

**4 List of Measuring Equipment..... 57**

**5 Measurement Uncertainty ..... 59**

**Appendix A. Conducted Test Results**

**Appendix B. AC Conducted Emission Test Result**

**Appendix C. Radiated Spurious Emission**

**Appendix D. Radiated Spurious Emission Plots**

**Appendix E. Duty Cycle Plots**

**Appendix F. Setup Photographs**



### History of this test report

Report No.	Version	Description	Issue Date
FR3N2803H	01	Initial issue of report	Feb. 02, 2024



### Summary of Test Result

Report Clause	Ref Std. Clause	Test Items	Result (PASS/FAIL)	Remark
3.1	15.407(a)(10)	26dB Emission Bandwidth	Pass	-
3.1	2.1049	99% Occupied Bandwidth	Reporting only	-
3.2	15.407(a)(8)	Fundamental Maximum EIRP	Pass	-
3.3	15.407(a)(8)	Fundamental Power Spectral Density	Pass	-
3.4	15.407(b)(6)	In-Band Emissions (Channel Mask)	Pass	-
3.5	15.407(d)(6)	Contention Based Protocol	Pass	-
3.6	15.407(b)	Unwanted Emissions	Pass	1.15 dB under the limit at 7125.02 MHz
3.7	15.207	AC Conducted Emission	Pass	11.34 dB under the limit at 0.40 MHz
3.8	15.203 15.407(a)	Antenna Requirement	Pass	-

**Conformity Assessment Condition:**

1. The test results (PASS/FAIL) with all measurement uncertainty excluded are presented against the regulation limits or in accordance with the requirements stipulated by the applicant/manufacturer who shall bear all the risks of non-compliance that may potentially occur if measurement uncertainty is taken into account.
2. The measurement uncertainty please refer to each test result in the section "Measurement Uncertainty".

**Disclaimer:**

The product specifications of the EUT presented in the test report that may affect the test assessments are declared by the manufacturer who shall take full responsibility for the authenticity.

**Reviewed by: Keven Cheng**  
**Report Producer: Ming Chen**



# 1 General Description

## 1.1 Product Feature of Equipment Under Test

Product Feature	
Equipment	Mobile Computer
Brand Name	ZEBRA
Model Name	MC945B
FCC ID	UZ7MC945B
Sample 1	SE5800 + with Camera
Sample 2	SE4770 + without Camera
EUT supports Radios application	WCDMA/LTE/5G NR/GNSS/NFC WLAN 11a/b/g/n HT20/HT40 WLAN 11ac VHT20/VHT40/VHT80/VHT160 WLAN 11ax HE20/HE40/HE80/HE160 Bluetooth BR/EDR/LE
HW Version	DV2
SW Version	13-10-31.00-TN-U00-PRD-NEM-04
FW Version	FUSION_QA_6_1.1.0.004_T
MFD	10NOV23
EUT Stage	Identical Prototype

**Remark:** The EUT's information above is declared by manufacturer.

Specification of Accessories				
Adapter USB Wall Charger	Brand Name	Zebra	Part Number	PWR-WUA5V12W0US
Battery 1 Standard Battery (7000mAh)	Brand Name	Zebra	Model Number	BT-000370
Battery 2 Standard Battery (7000mAh)	Brand Name	Zebra	Model Number	BT-000370B
Earphone USB-C Audio Headset	Brand Name	Zebra	Part Number	HDST-USBC-PTT1-01
USB Cable (Type C to Type A)	Brand Name	Zebra	Part Number	CBL-TC2X-USBC-01
Holster	Brand Name	Zebra	Part Number	SG-MC9X-SHLSTG-01
USB Cable (CUP)	Brand Name	Zebra	Part Number	CBL-MC93-USBCHG-01



## 1.2 Product Specification of Equipment Under Test

Product Specification is subject to this standard	
<b>Tx/Rx Channel Frequency Range</b>	5925 MHz ~ 6425 MHz 6425 MHz ~ 6525 MHz 6525 MHz ~ 6875 MHz 6875 MHz ~ 7125 MHz
<b>Maximum Output Power to Antenna &lt;CDD Modes&gt;</b>	<b>MIMO &lt;Ant. 6+7&gt;:</b> <b>&lt;5925 MHz ~ 6425 MHz&gt;</b> 802.11a: 4.41 dBm / 0.0028 W <b>&lt;6425 MHz ~ 6525 MHz&gt;</b> 802.11a: 4.66 dBm / 0.0030 W <b>&lt;6525 MHz ~ 6875 MHz&gt;</b> 802.11a: 4.72 dBm / 0.0032 W <b>&lt;6875 MHz ~ 7125 MHz&gt;</b> 802.11a: 4.87 dBm / 0.0034 W
<b>Maximum Output Power to Antenna &lt;SDM Modes&gt;</b>	<b>MIMO &lt;Ant. 6+7&gt;:</b> <b>&lt;5925 MHz ~ 6425 MHz&gt;</b> 802.11ax: HE20: 8.37 dBm / 0.0069 W 802.11ax: HE40: 10.51 dBm / 0.0112 W 802.11ax: HE80: 12.71 dBm / 0.0187 W 802.11ax: HE160: 15.87 dBm / 0.0386 W <b>&lt;6425 MHz ~ 6525 MHz&gt;</b> 802.11ax: HE20: 7.46 dBm / 0.0056 W 802.11ax: HE40: 10.51 dBm / 0.0112 W 802.11ax: HE80: 12.74 dBm / 0.0188 W 802.11ax: HE160: 15.48 dBm / 0.0353 W <b>&lt;6525 MHz ~ 6875 MHz&gt;</b> 802.11ax: HE20: 7.96 dBm / 0.0060 W 802.11ax: HE40: 10.77 dBm / 0.0119 W 802.11ax: HE80: 13.07 dBm / 0.0190 W 802.11ax: HE160: 15.82 dBm / 0.0382 W <b>&lt;6875 MHz ~ 7125 MHz&gt;</b> 802.11ax: HE20: 8.61 dBm / 0.0073 W 802.11ax: HE40: 10.64 dBm / 0.0116 W 802.11ax: HE80: 13.02 dBm / 0.0200 W 802.11ax: HE160: 15.93 dBm / 0.0392 W
<b>99% Occupied Bandwidth &lt;CDD Modes&gt;</b>	<b>MIMO &lt;Ant. 6&gt;</b> 802.11a: 17.43 MHz <b>MIMO &lt;Ant. 7&gt;</b> 802.11a: 16.98 MHz
<b>99% Occupied Bandwidth &lt;SDM Modes&gt;</b>	<b>MIMO &lt;Ant. 6&gt;</b> 802.11ax: HE20: 18.98 MHz 802.11ax: HE40: 38.06 MHz 802.11ax: HE80: 76.96 MHz 802.11ax: HE160: 156.32 MHz <b>MIMO &lt;Ant. 7&gt;</b> 802.11ax: HE20: 18.93 MHz 802.11ax: HE40: 37.96 MHz 802.11ax: HE80: 76.96 MHz 802.11ax: HE160: 156.08 MHz



Product Specification is subject to this standard			
Antenna Type / Gain	<5925 MHz ~ 6425 MHz> <Ant. 6>: PIFA Antenna with gain 1.78 dBi <Ant. 7>: PIFA Antenna with gain 1.65 dBi		
	<6425 MHz ~ 6525 MHz> <Ant. 6>: PIFA Antenna with gain 1.11 dBi <Ant. 7>: PIFA Antenna with gain 1.85 dBi		
	<6525 MHz ~ 6875 MHz> <Ant. 6>: PIFA Antenna with gain 1.28 dBi <Ant. 7>: PIFA Antenna with gain 1.85 dBi		
Type of Modulation	<6875 MHz ~ 7125 MHz> <Ant. 6>: PIFA Antenna with gain 1.51 dBi <Ant. 7>: PIFA Antenna with gain 0.67 dBi		
	802.11a : OFDM (BPSK/QPSK/16QAM/64QAM) 802.11ax : OFDMA (BPSK/QPSK/16QAM/64QAM/256QAM/1024QAM)		
Antenna Function Description		Ant. 6	Ant. 7
	802.11a/ax MIMO	V	V
	802.11ax TXBF	V	V

Remark:

1. MIMO Ant. 6+7 Directional Gain is a calculated result from MIMO Ant. 6 and MIMO Ant. 7. The formula used in calculation is documented in section 1.2.1.
2. Power of MIMO Ant. 6 + Ant. 7 is a calculated result from sum of the power MIMO Ant. 6 and MIMO Ant. 7.
3. The device WIFI MIMO support 1S2T (CDD & Tx Beamforming) (Nss=1) mode& SDM (2S2T :Nss=2) mode, 1S2T: Nss=1, MIMO 2Tx; 2S2T: Nss=2, MIMO 2Tx.by manufacturer declared.
4. For 802.11a, it does not support SDM & Tx Beamforming so the correlated gain for CDD is applied.
5. 802.11ax support Tx Beamforming mode, and the manufacturer declares that Tx Beamforming power/EIRP/PSD is not greater than CDD&SDM mode, so CDD&SDM mode covers Tx Beamforming mode. In SDM mode, the conducted power is set to 3dB higher than TXBF/CDD. Since the maximum array gain for the two antenna system is 3dB, the TXBF/CDD compliance is met by testing SDM mode as worst mode for LPI power mode.
6. 802.11ax supports both full RU tones and partial RU tones, which are both conducted power/PSD/ channel masking tested in Appendix A, all the other test case were performed with full RU with its maximum power/PSD.
7. The EUT does not support channel puncturing mode.
8. The EUT's information above is declared by manufacturer. Please refer to Disclaimer in report summary.



### 1.2.1 Antenna Directional Gain

<For CDD Mode>

Follows FCC KDB 662911 D01 Multiple Transmitter Output v02r01 F)2)f)ii)

Directional gain = G<sub>ANT</sub> + Array Gain, where Array Gain is as follows:

For power measurements on IEEE 802.11 devices,

Array Gain = 0 dB (i.e., no array gain) for N<sub>ANT</sub> ≤ 4.

G<sub>ANT</sub> is set equal to the gain of the antenna having the highest gain.

For PSD measurements, the directional gain calculation.

$$DirectionalGain = 10 \cdot \log \left[ \frac{\sum_{j=1}^{N_{SS}} \left\{ \sum_{k=1}^{N_{ANT}} g_{j,k} \right\}^2}{N_{ANT}} \right]$$

where

Each antenna is driven by no more than one spatial stream;

N<sub>SS</sub> = the number of independent spatial streams of data;

N<sub>ANT</sub> = the total number of antennas

$g_{j,k} = 10^{G_k / 20}$  if the kth antenna is being fed by spatial stream j, or zero if it is not; G<sub>k</sub> is the gain in dBi of the kth antenna.

As minimum N<sub>SS</sub>=1 is supported by EUT, the formula can be simplified as:

$$Directional\ gain = 10 \cdot \log \left[ \left( 10^{G_1 / 20} + 10^{G_2 / 20} + \dots + 10^{G_N / 20} \right)^2 / N_{ANT} \right] \text{ dBi}$$

Where G<sub>1</sub>, G<sub>2</sub>...G<sub>N</sub> denote single antenna gain.

The directional gain "DG" is calculated as following table.

	Ant 6 (dBi)	Ant 7 (dBi)	DG for Power (dBi)	DG for PSD (dBi)
5925 MHz ~ 6425 MHz	1.78	1.65	1.78	4.73
6425 MHz ~ 6525 MHz	1.11	1.85	1.85	4.50
6525 MHz ~ 6875 MHz	1.28	1.85	1.85	4.58
6875 MHz ~ 7125 MHz	1.51	0.67	1.51	4.11

Calculation example:

If a device has two antenna, G<sub>ANT1</sub>= 1.78dBi; G<sub>ANT2</sub>= 1.65dBi

Directional gain of power measurement = max(1.78, 1.65) + 0 =1.78 dBi

Directional gain of PSD derived from formula which is

$$10 \times \log \left\{ \left[ \left( 10^{(1.78 \text{ dBi} / 20)} + 10^{(1.65 \text{ dBi} / 20)} \right)^2 \right] / 2 \right\}$$

=4.73 dBi





<For SDM Modes>

SDM Modes all transmit signals are completely uncorrelated, then

Follows FCC KDB 662911 D01 Multiple Transmitter Output v02r01 F)2)d)ii)

The Directional gain =  $10 \cdot \log \left[ \frac{10^{G_1/10} + 10^{G_2/10} + \dots + 10^{G_N/10}}{N_{ANT}} \right]$  dBi

Where G1, G2....GN denote single antenna gain.

The directional gain "DG" is calculated as following table.

				DG for Power (dBi)	DG for PSD (dBi)
		Ant 6 (dBi)	Ant 7 (dBi)		
5925 MHz ~ 6425 MHz		1.78	1.65	1.72	1.72
6425 MHz ~ 6525 MHz		1.11	1.85	1.50	1.50
6525 MHz ~ 6875 MHz		1.28	1.85	1.57	1.57
6875 MHz ~ 7125 MHz		1.51	0.67	1.11	1.11

Calculation example:

If a device has two antenna,  $G_{ANT1} = 1.78\text{dBi}$ ;  $G_{ANT2} = 1.65\text{dBi}$

Directional gain is derived from formula which is

$$10 \times \log \left\{ \left[ 10^{(1.78 \text{ dBi} / 10)} + 10^{(1.65 \text{ dBi} / 10)} \right] / 2 \right\}$$

$$= 1.72 \text{ dBi}$$

**<For TXBF Modes>**

The EUT supports beamforming modes then

Follows FCC KDB 662911 D01 Multiple Transmitter Output v02r01 F)2)e)ii)

$$DirectionalGain = 10 \cdot \log \left[ \frac{\sum_{j=1}^{N_{SS}} \left\{ \sum_{k=1}^{N_{ANT}} g_{j,k} \right\}^2}{N_{ANT}} \right]$$

where

Each antenna is driven by no more than one spatial stream;

$N_{SS}$  = the number of independent spatial streams of data;

$N_{ANT}$  = the total number of antennas

$g_{j,k} = 10^{G_k / 20}$  if the  $k$ th antenna is being fed by spatial stream  $j$ , or zero if it is not;  
 $G_k$  is the gain in dBi of the  $k$ th antenna.

The directional gain “DG” is calculated as following table.

				<b>DG</b>	<b>DG</b>
				<b>for</b>	<b>for</b>
		<b>Ant 6</b>	<b>Ant 7</b>	<b>Power</b>	<b>PSD</b>
		<b>(dBi)</b>	<b>(dBi)</b>	<b>(dBi)</b>	<b>(dBi)</b>
<b>5925 MHz ~ 6425 MHz</b>	1.78	1.65	4.73	4.73	
<b>6425 MHz ~ 6525 MHz</b>	1.11	1.85	4.50	4.50	
<b>6525 MHz ~ 6875 MHz</b>	1.28	1.85	4.58	4.58	
<b>6875 MHz ~ 7125 MHz</b>	1.51	0.67	4.11	4.11	

Calculation example:

Directional gain is derived from formula which is

$$10 \times \log \left\{ \left[ 10^{1.78 / 20} + 10^{1.65 / 20} \right]^2 / 2 \right\} = 4.73 \text{ dBi}$$



### 1.3 Modification of EUT

No modifications made to the EUT during the testing.

### 1.4 Testing Location

<b>Test Site</b>	Sporton International Inc. EMC & Wireless Communications Laboratory
<b>Test Site Location</b>	No.52, Huaya 1st Rd., Guishan Dist., Taoyuan City 333, Taiwan (R.O.C.) TEL: +886-3-327-3456 FAX: +886-3-328-4978
<b>Test Site No.</b>	<b>Sporton Site No.</b> DF02-HY (TAF Code: 1190)
<b>Remark</b>	The Contention Based Protocol test items subcontracted to Sporton International Inc. EMC & Wireless Communications Laboratory.

<b>Test Site</b>	Sporton International Inc. Wensan Laboratory
<b>Test Site Location</b>	No.58, Aly. 75, Ln. 564, Wenhua 3rd, Rd., Guishan Dist., Taoyuan City 333010, Taiwan (R.O.C.) TEL: +886-3-327-0868 FAX: +886-3-327-0855
<b>Test Site No.</b>	<b>Sporton Site No.</b> TH05-HY, CO07-HY, 03CH20-HY

**Note:** The test site complies with ANSI C63.4 2014 requirement.

FCC designation No.: TW1190 and TW3786

### 1.5 Applicable Standards

According to the specifications declared by the manufacturer, the EUT must comply with the requirements of the following standards:

- ♦ FCC Part 15 Subpart E
- ♦ FCC KDB 789033 D02 General UNII Test Procedures New Rules v02r01.
- ♦ FCC KDB 987594 D02 U-NII 6 GHz EMC Measurement v02r01
- ♦ FCC KDB 414788 D01 Radiated Test Site v01r01.
- ♦ FCC KDB 662911 D01 Multiple Transmitter Output v02r01.
- ♦ ANSI C63.10-2013

**Remark:**

1. All the test items were validated and recorded in accordance with the standards without any modification during the testing.
2. The TAF code is not including all the FCC KDB listed without accreditation.
3. This EUT has also been tested and complied with the requirements of FCC Part 15, Subpart B, recorded in a separate test report.



## 2 Test Configuration of Equipment Under Test

- a. The EUT has been associated with peripherals and configuration operated in a manner tended to maximize its emission characteristics in a typical application. Frequency range investigated: conduction emission (150 kHz to 30 MHz), radiation emission (9 kHz to the 10th harmonic of the highest fundamental frequency or to 40 GHz, whichever is lower). For radiated measurement, the measured emission level of the EUT was maximized by rotating the EUT on a turntable, adjusting the orientation of the EUT and EUT antenna in three orthogonal axis (X: flat, Y: portrait, Z: landscape), and adjusting the measurement antenna orientation, following C63.10 exploratory test procedures and only the worst case emissions were reported in this report.
- b. AC power line Conducted Emission was tested under maximum output power.

### 2.1 Carrier Frequency and Channel

BW 20M	Channel	1	5	9	13	17	21	25	29
	Freq. (MHz)	5955	5975	5995	6015	6035	6055	6075	6095
BW 40M	Channel	3		11		19		27	
	Freq. (MHz)	5965		6005		6045		6085	
BW 80M	Channel	7				23			
	Freq. (MHz)	5985				6065			
BW 160M	Channel	15							
	Freq. (MHz)	6025							

BW 20M	Channel	33	37	41	45	49	53	57	61
	Freq. (MHz)	6115	6135	6155	6175	6195	6215	6235	6255
BW 40M	Channel	35		43		51		59	
	Freq. (MHz)	6125		6165		6205		6245	
BW 80M	Channel	39				55			
	Freq. (MHz)	6145				6225			
BW 160M	Channel	47							
	Freq. (MHz)	6185							



<b>BW 20M</b>	<b>Channel</b>	65	69	73	77	81	85	89	93
	<b>Freq. (MHz)</b>	6275	6295	6315	6335	6355	6375	6395	6415
<b>BW 40M</b>	<b>Channel</b>	67		75		83		91	
	<b>Freq. (MHz)</b>	6285		6325		6365		6405	
<b>BW 80M</b>	<b>Channel</b>	71				87			
	<b>Freq. (MHz)</b>	6305				6385			
<b>BW 160M</b>	<b>Channel</b>	79							
	<b>Freq. (MHz)</b>	6345							

<b>BW 20M</b>	<b>Channel</b>	97	101	105	109	113	117	121	125
	<b>Freq. (MHz)</b>	6435	6455	6475	6495	6515	6535	6555	6575
<b>BW 40M</b>	<b>Channel</b>	99		107		115		123	
	<b>Freq. (MHz)</b>	6445		6485		6525		6565	
<b>BW 80M</b>	<b>Channel</b>	103				119			
	<b>Freq. (MHz)</b>	6465				6545			
<b>BW 160M</b>	<b>Channel</b>	111							
	<b>Freq. (MHz)</b>	6505							

<b>BW 20M</b>	<b>Channel</b>	129	133	137	141	145	149	153	157
	<b>Freq. (MHz)</b>	6595	6615	6635	6655	6675	6695	6715	6735
<b>BW 40M</b>	<b>Channel</b>	131		139		147		155	
	<b>Freq. (MHz)</b>	6605		6645		6685		6725	
<b>BW 80M</b>	<b>Channel</b>	135				151			
	<b>Freq. (MHz)</b>	6625				6705			
<b>BW 160M</b>	<b>Channel</b>	143							
	<b>Freq. (MHz)</b>	6665							

<b>BW 20M</b>	<b>Channel</b>	161	165	169	173	177	181	185	189
	<b>Freq. (MHz)</b>	6755	6775	6795	6815	6835	6855	6875	6895
<b>BW 40M</b>	<b>Channel</b>	163		171		179		187	
	<b>Freq. (MHz)</b>	6765		6805		6845		6885	
<b>BW 80M</b>	<b>Channel</b>	167				183			
	<b>Freq. (MHz)</b>	6785				6865			
<b>BW 160M</b>	<b>Channel</b>	175							
	<b>Freq. (MHz)</b>	6825							



<b>BW 20M</b>	<b>Channel</b>	193	197	201	205	209	213	217	221
	<b>Freq. (MHz)</b>	6915	6935	6955	6975	6995	7015	7035	7055
<b>BW 40M</b>	<b>Channel</b>	195		203		211		219	
	<b>Freq. (MHz)</b>	6925		6965		7005		7045	
<b>BW 80M</b>	<b>Channel</b>	199				215			
	<b>Freq. (MHz)</b>	6945				7025			
<b>BW 160M</b>	<b>Channel</b>	207							
	<b>Freq. (MHz)</b>	6985							
<b>BW 20M</b>	<b>Channel</b>	225				229			
	<b>Freq. (MHz)</b>	7075				7095			
<b>BW 40M</b>	<b>Channel</b>	227							
	<b>Freq. (MHz)</b>	7085							
<b>BW 20M</b>	<b>Channel</b>	233							
	<b>Freq. (MHz)</b>	7115							



## 2.2 Test Mode

This device support 26/52/106/242/484/996-tone RU.

The PSD of partial RU is reduced to be smaller than full RU according to TCB workshop interim guidance Oct. 2018.

The 802.11ax mode is investigated among different tones, full resource units (RU), partial resource units. The partial RU has no higher power than full RU's, thus the full RU is chosen as main test configuration.

The 242-tone RU is covered by 20MHz channel, 484-tone RU is covered by 40MHz channel and 996-tone RU is covered by 80MHz channel.

The SISO mode conducted power is covered by MIMO mode per chain, so only the MIMO mode is tested.

The final test modes include the worst data rates for each modulation shown in the table below.

### MIMO Mode

Modulation	Data Rate
802.11a	6 Mbps
802.11ax HE20	MCS0
802.11ax HE40	MCS0
802.11ax HE80	MCS0
802.11ax HE160	MCS0

**Remark:** The conducted power level of each chain in MIMO mode is equal or higher than SISO mode.

Test Cases	
<b>AC Conducted Emission</b>	Mode 1 : Keypad (53key) + MP3 play + WLAN (5GHz) Link + Bluetooth Link + Battery 2 Standard Battery (7000mAh) + Scan + USB Cable (Type C to Type A) with USB Cable (CUP) (Charging from Adapter USB Wall Charger) for Sample 1
<b>Remark:</b>	
<ol style="list-style-type: none"> <li>For Band U-NII-5&amp;7, the conducted power and PSD for indoor client mode is smaller than standard client mode, so all the RSE test data is covered by standard client mode.</li> <li>For Radiated Test Cases, the tests were performed with Battery 1 Standard Battery (7000mAh) and Sample 1 and Sample 2.</li> </ol>	



MIMO <Ant. 6+7>

Ch. #		UNII-5 (5925-6425 MHz)	UNII-6 (6425-6525 MHz)	UNII-7 (6525-6875 MHz)	UNII-8 (6875-7125 MHz)
		802.11a	802.11a	802.11a	802.11a
L	Low	001	097	117	189
M	Middle	049	105	149	209
H	High	093	113	-	233
Straddle		-	-	185	-

Ch. #		UNII-5 (5925-6425 MHz)	UNII-6 (6425-6525 MHz)	UNII-7 (6525-6875 MHz)	UNII-8 (6875-7125 MHz)
		802.11ax HE20	802.11ax HE20	802.11ax HE20	802.11ax HE20
L	Low	001	097	117	189
M	Middle	049	105	149	209
H	High	093	113	-	-
					233
Straddle		-	-	185	-

Ch. #		UNII-5 (5925-6425 MHz)	UNII-6 (6425-6525 MHz)	UNII-7 (6525-6875 MHz)	UNII-8 (6875-7125 MHz)
		802.11ax HE40	802.11ax HE40	802.11ax HE40	802.11ax HE40
L	Low	003	099	123	195
M	Middle	051	-	147	211
H	High	091	107	-	227
Straddle		-	115	187	-

Ch. #		UNII-5 (5925-6425 MHz)	UNII-6 (6425-6525 MHz)	UNII-7 (6525-6875 MHz)	UNII-8 (6875-7125 MHz)
		802.11ax HE80	802.11ax HE80	802.11ax HE80	802.11ax HE80
L	Low	007	103	135	199
M	Middle	055		151	-
H	High	087		-	215
Straddle		-	-	183	-





Ch. #		UNII-5 (5925-6425 MHz)	UNII-6 (6425-6525 MHz)	UNII-7 (6525-6875 MHz)	UNII-8 (6875-7125 MHz)
		802.11ax HE160	802.11ax HE160	802.11ax HE160	802.11ax HE160
L	Low	015	-	143	207
M	Middle	047			
H	High	079			
Straddle		-	111	175	-

**Remark:** Based on ANSI C63.10 clause 5.6.2.2, b) Spurious emissions, measure the mode with the highest output power and the mode with highest output power spectral density for each modulation family.

## 2.3 Connection Diagram of Test System

<AC Conducted Emission Mode>

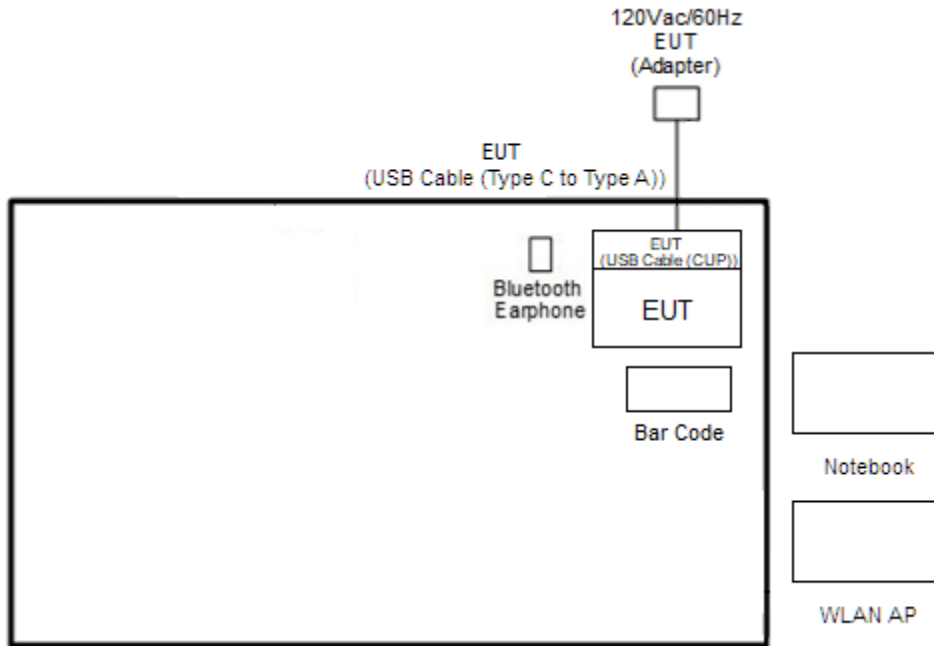

<WLAN Tx Mode>

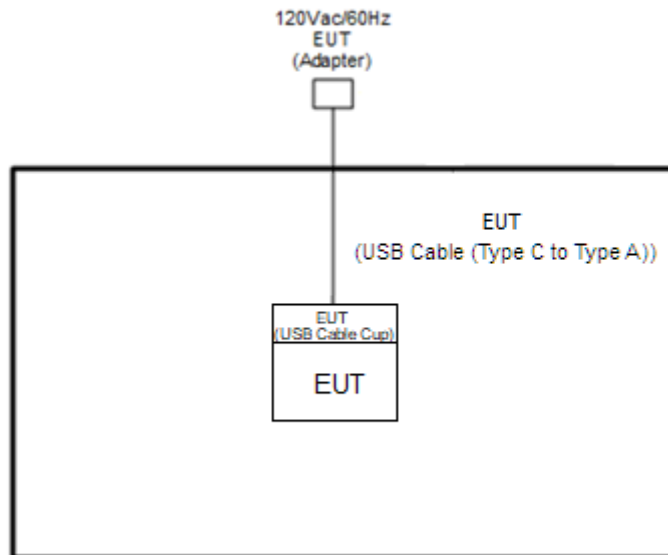



## 2.4 Support Unit used in test configuration and system

Item	Equipment	Brand Name	Model Name	FCC ID	Data Cable	Power Cord
1.	Bluetooth Earphone	Sony Ericsson	MW600	PY700A2029	N/A	N/A
2.	WLAN AP	ASUS	RT-AC52	MSQ-RTAC4A00	N/A	Unshielded, 1.8 m
3.	Notebook	Dell	Latitude 3420	FCC DoC	N/A	AC I/P: Unshielded, 1.2 m DC O/P: Shielded, 1.8 m
4.	Bar Code	N/A	N/A	N/A	N/A	N/A

## 2.5 EUT Operation Test Setup

The RF test items, utility “QRCT v 4.0.211.0” was installed in Notebook which was programmed in order to make the EUT get into the engineering modes to provide channel selection, power level, data rate and the application type and for continuous transmitting signals.

## 2.6 Measurement Results Explanation Example

For all conducted test items:

The offset level is set in the spectrum analyzer to compensate the RF cable loss and attenuator factor between EUT conducted output port and spectrum analyzer. With the offset compensation, the spectrum analyzer reading level is exactly the EUT RF output level.

Example :

The spectrum analyzer offset is derived from RF cable loss and attenuator factor.

*Offset = RF cable loss + attenuator factor.*

Following shows an offset computation example with cable loss 4.2 dB and 10dB attenuator.

$$\begin{aligned} \text{Offset(dB)} &= \text{RF cable loss(dB)} + \text{attenuator factor(dB)}. \\ &= 4.2 + 10 = 14.2 \text{ (dB)} \end{aligned}$$

### 3 Test Result

#### 3.1 26dB & 99% Occupied Bandwidth Measurement

##### 3.1.1 Limit of 26dB & 99% Occupied Bandwidth

<FCC 14-30 CFR 15.407>

(a)(10) The maximum transmitter channel bandwidth for U-NII devices in the 5.925-7.125 GHz band is 320 megahertz.

##### 3.1.2 Measuring Instruments

Please refer to the measuring equipment list in this test report.

##### 3.1.3 Test Procedures

1. The testing follows FCC KDB 789033 D02 General UNII Test Procedures New Rules v02r01. Section C) Emission bandwidth
2. Set RBW = approximately 1% of the emission bandwidth.
3. Set the VBW > RBW.
4. Detector = Peak.
5. Trace mode = max hold
6. Measure the maximum width of the emission that is 26 dB down from the peak of the emission. Compare this with the RBW setting of the analyzer. Readjust RBW and repeat measurement as needed until the RBW/EBW ratio is approximately 1%.
7. For 99% Bandwidth Measurement, the spectrum analyzer's resolution bandwidth (RBW) is set 1-5% of the emission bandwidth and set the Video bandwidth (VBW)  $\geq 3 * RBW$ .
8. Measure and record the results in the test report.

##### 3.1.4 Test Setup

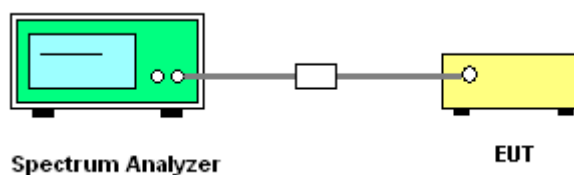

##### 3.1.5 Test Result of 26dB & 99% Occupied Bandwidth

Please refer to Appendix A.

## 3.2 Fundamental Maximum EIRP Measurement

### 3.2.1 Limit of Fundamental Maximum EIRP

<FCC 14-30 CFR 15.407>

(a)(8) For client devices operating under the control of an indoor access point in the 5.925-7.125 GHz bands, the maximum e.i.r.p. over the frequency band of operation must not exceed 24 dBm.

### 3.2.2 Measuring Instruments

Please refer to the measuring equipment list in this test report.

### 3.2.3 Test Procedures

<CDD and SDM Modes>

The testing follows Method PM-G of FCC KDB 789033 D02 General UNII Test Procedures New Rules v02r01.

Method PM-G (Measurement using a gated RF average power meter):

1. Measurement is performed using a wideband RF power meter.
2. The EUT is configured to transmit at its maximum power control level.
3. Measure the average power of the transmitter.
4. Since the measurement is made only during the ON time of the transmitter, no duty cycle correction factor is required.
5. For MIMO mode, calculation method follows FCC KDB 662911 D01 Multiple Transmitter Output v02r01.

### 3.2.4 Test Setup

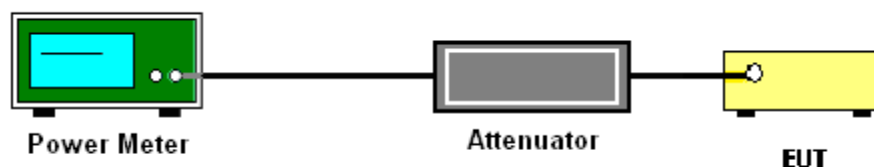

### 3.2.5 Test Result of Fundamental Maximum EIRP

Please refer to Appendix A.



### 3.3 Fundamental Power Spectral Density Measurement

#### 3.3.1 Limit of Fundamental Power Spectral Density

<FCC 14-30 CFR 15.407>

(a)(8) For client devices operating under the control of an indoor access point in the 5.925-7.125 GHz bands, the maximum power spectral density must not exceed -1 dBm e.i.r.p. in any 1-megahertz band.

#### 3.3.2 Measuring Instruments

Please refer to the measuring equipment list in this test report.

#### 3.3.3 Test Procedures

The testing follows FCC KDB 789033 D02 General UNII Test Procedures New Rules v02r01.

Section F) Maximum power spectral density.

<CDD and SDM Modes>

# Method SA-2 #

(trace averaging across on and off times of the EUT transmissions, followed by duty cycle correction).

- Measure the duty cycle.
  - Set span to encompass the entire emission bandwidth (EBW) of the signal.
  - Set RBW = 1 MHz.
  - Set VBW  $\geq$  3 MHz.
  - Number of points in sweep  $\geq$  2 Span / RBW.
  - Sweep time = auto.
  - Detector = RMS
  - Trace average at least 100 traces in power averaging mode.
  - Add  $10 \log(1/x)$ , where x is the duty cycle, to the measured power in order to compute the average power during the actual transmission times. For example, add  $10 \log(1/0.25) = 6$  dB if the duty cycle is 25 percent.
1. The RF output of EUT was connected to the spectrum analyzer by a low loss cable.
  2. Each plot has already offset with cable loss, and attenuator loss. Measure the PPSD and record it.
  3. For MIMO mode, calculation method follows FCC KDB 662911 D01 Multiple Transmitter Output v02r01.

Method (a): Measure and sum the spectra across the outputs.

The total final Power Spectral Density is from a device with 2 transmitter outputs. The spectrum measurements of the individual outputs are all performed with the same span and number of points; the spectrum value in the first spectral bin of output 1 is summed with that in the first spectral bin of output 2 to obtain the value for the first frequency bin of the summed spectrum.

### 3.3.4 Test Setup

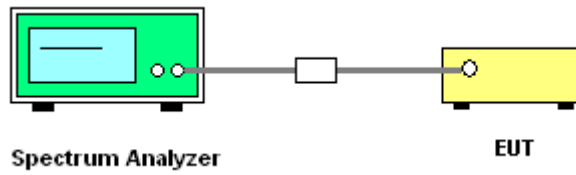

### 3.3.5 Test Result of Power Spectral Density

Please refer to Appendix A.



## **3.4 In-Band Emissions (Channel Mask)**

### **3.4.1 Limit of Unwanted Emissions**

**<FCC 14-30 CFR 15.407>**

(a)(6) For transmitters operating within the 5.925-7.125 GHz bands: Power spectral density must be suppressed by 20 dB at 1 MHz outside of channel edge, by 28 dB at one channel bandwidth from the channel center, and by 40 dB at one- and one-half times the channel bandwidth away from channel center. At frequencies between one megahertz outside an unlicensed device's channel edge and one channel bandwidth from the center of the channel, the limits must be linearly interpolated between 20 dB and 28 dB suppression, and at frequencies between one and one- and one-half times an unlicensed device's channel bandwidth, the limits must be linearly interpolated between 28 dB and 40 dB suppression. Emissions removed from the channel center by more than one- and one-half times the channel bandwidth must be suppressed by at least 40 dB.

### **3.4.2 Measuring Instruments**

Please refer to the measuring equipment list in this test report.



### 3.4.3 Test Procedures

The testing follows FCC KDB 987594 D02 U-NII 6GHz EMC Measurement v02r01.

Section J) In-Band Emissions.

1. Take nominal bandwidth as reference channel bandwidth provided that 26 dB emission bandwidth is always larger than nominal bandwidth
2. Measure the power spectral density (which will be used for emissions mask reference) using the following procedure:
  - a) Set the span to encompass the entire 26 dB EBW of the signal.
  - b) Set RBW = same RBW used for 26 dB EBW measurement.
  - c) Set VBW  $\geq 3 \times$  RBW
  - d) Number of points in sweep  $\geq [2 \times \text{span} / \text{RBW}]$ .
  - e) Sweep time = auto.
  - f) Detector = RMS (i.e., power averaging)
  - g) Trace average at least 100 traces in power averaging (rms) mode.
  - h) Use the peak search function on the instrument to find the peak of the spectrum.
3. Using the measuring equipment limit line function, develop the emissions mask based on the following requirements. The emissions power spectral density must be reduced below the peak power spectral density (in dB) as follows:
  - a. Suppressed by 20 dB at 1 MHz outside of the channel edge.
  - b. Suppressed by 28 dB at one channel bandwidth from the channel center.
  - c. Suppressed by 40 dB at one- and one-half times the channel bandwidth from the channel center.
4. Adjust the span to encompass the entire mask as necessary.
5. Clear trace.
6. Trace average at least 100 traces in power averaging (rms) mode.
7. Adjust the reference level as necessary so that the crest of the channel touches the top of the emission mask.

### 3.4.4 Test Setup

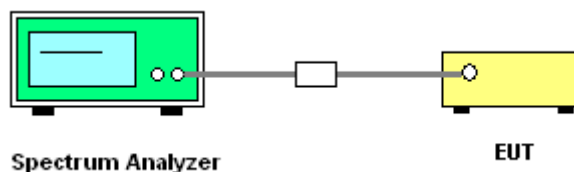

### 3.4.5 Test Result

Please refer to Appendix A.



### 3.5 Contention Based Protocol

#### 3.5.1 Limit of Contention Based Protocol

**<FCC 14-30 CFR 15.407>**

(d)(6) Indoor access points, subordinate devices and client devices operating in the 5.925-7.125 GHz band must employ a contention-based protocol.

FCC KDB 987594 D02 U-NII 6GHz EMC Measurement v02r01

Unlicensed low-power indoor devices must detect co-channel radio frequency power that is at least -62 dBm or lower. Upon detection of energy in the band, unlicensed low power indoor devices must vacate the channel and stay off the channel as long as detected radio frequency power is equal to or greater than the threshold (-62 dBm). The -62 dBm (or lower) threshold is referenced to a 0 dBi antenna gain. To ensure incumbent operations are reliably detected in the band, low power indoor devices must detect RF energy throughout their intended operating channel. For example, an 802.11 device that plans to transmit a 40 MHz- wide signal (on a primary 20 MHz channel and a secondary 20 MHz channel) must detect energy throughout the entire 40 MHz channel. Additionally, low-power indoor devices must detect co-channel energy with 90% or greater certainty.

**Table 1. Criteria to determine number of times detection threshold test may be performed**

<b>If</b>	<b>Number of Tests</b>	<b>Placement of Incumbent Transmission</b>
$BW_{EUT} \leq BW_{Inc}$	Once	Tune incumbent and EUT transmissions ( $f_{c1} = f_{c2}$ )
$BW_{Inc} < BW_{EUT} \leq 2BW_{Inc}$	Once	Incumbent transmission is contained within $BW_{EUT}$
$2BW_{Inc} < BW_{EUT} \leq 4BW_{Inc}$	Twice. Incumbent transmission is contained within $BW_{EUT}$	Incumbent transmission is located as closely as possible to the lower edge and upper edge, respectively, of the EUT channel
$BW_{EUT} > 4BW_{Inc}$	Three times	Incumbent transmission is located as closely as possible to the lower edge of the EUT channel, in the middle of EUT channel, and as closely as possible to the upper edge of the EUT channel

where:

$BW_{EUT}$ : Transmission bandwidth of EUT signal

$BW_{Inc}$ : Transmission bandwidth of the simulated incumbent signal (10 MHz wide AWGN signal)

$f_{c1}$ : Center frequency of EUT transmission

$f_{c2}$ : Center frequency of simulated incumbent signal

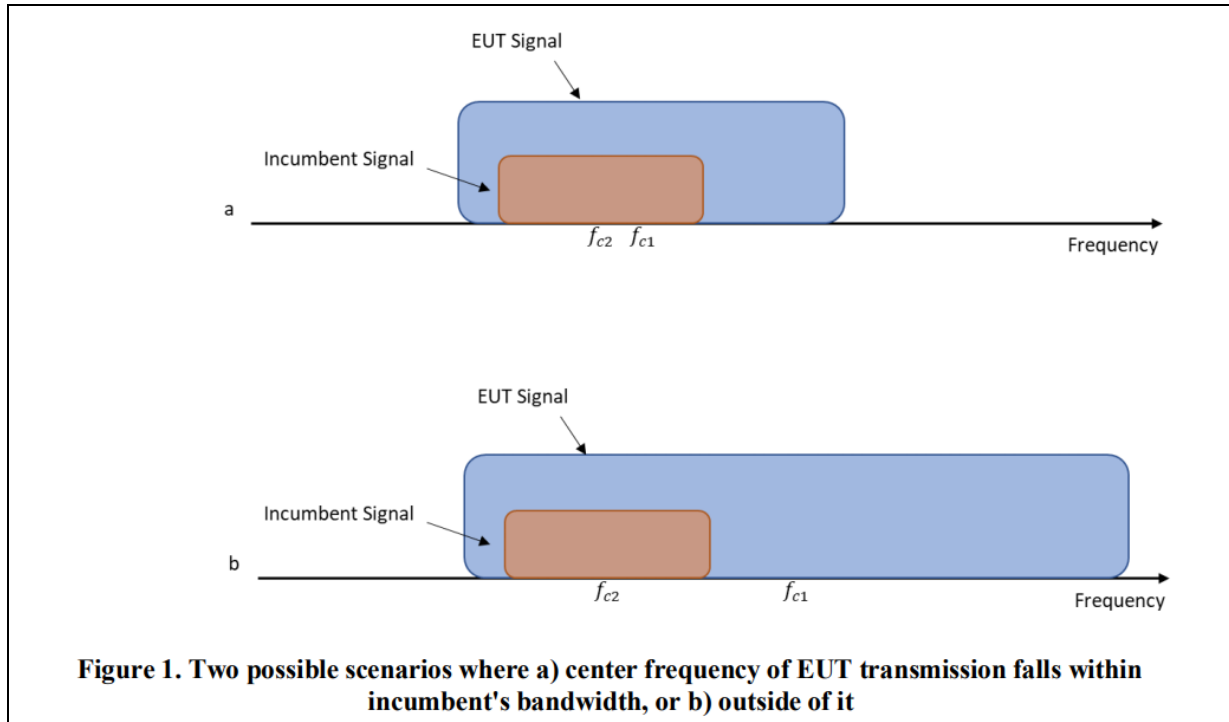

### 3.5.2 Measuring Instruments

Please refer to the measuring equipment list in this test report.

### 3.5.3 Test Procedures

The testing follows FCC KDB 987594 D02 U-NII 6GHz EMC Measurement v02r01.

Section I) Contention Based Protocol

Conducted method Step-by-Step Procedure, Conducted Setup

1. Configure the EUT to transmit with a constant duty cycle.
2. Set the operating parameters of the EUT including power level, operating frequency, modulation and bandwidth.
3. Set the signal analyzer center frequency to the nominal EUT channel center frequency. The span range of the signal analyzer shall be between two times and five times the OBW of the EUT.
4. Connect the output port of the EUT to the signal analyzer 2, as shown in test setup Figure 2. Ensure that the attenuator 2 provides enough attenuation to not overload the signal analyzer 2 receiver.
5. Monitoring the signal analyzer 2, verify the EUT is operating and transmitting with the parameters set at step two.
6. Using an AWGN signal source, generate (but do not transmit, i.e., RF OFF) a 10 MHz-wide AWGN signal. Use Table 1 to determine the center frequency of the 10 MHz AWGN signal relative to the EUT's channel bandwidth and center frequency.
7. Set the AWGN signal power to an extremely low level (more than 20 dB below the -62 dBm threshold). Connect the AWGN signal source, via a 3-dB splitter, to the signal analyzer 1 and the EUT as shown in test setup Figure 2.
8. Transmit the AWGN signal (RF ON) and verify its characteristics on the signal analyzer 1.

9. Monitor the signal analyzer 2 to verify if the AWGN signal has been detected and the EUT has ceased transmission. If the EUT continues to transmit, then incrementally increase the AWGN signal power level until the EUT stops transmitting.
10. (Including all losses in the RF paths) Determine and record the AWGN signal power level (at the EUT's antenna port) at which the EUT ceased transmission. Repeat the procedure at least 10 times to verify the EUT can detect an AWGN signal with 90% (or better) level of certainty.
11. Refer to Table 1 to determine number of times the detection threshold testing needs to be repeated. If testing is required more than once, then go back to step 5, choose a different center frequency for the AWGN signal and repeat the process.
12. For the contention-based protocol test where only one channel in each supported sub-band needs to be tested. The narrowest and widest bandwidth in each channel shall be measured EUT was driven in MIMO mode, the interferer level was injected to both chains to monitor the performance, while the interferer level is determined according the lowest antenna gain among both antennas (i.e, lower interferer level).

**3.5.4 Test Setup**

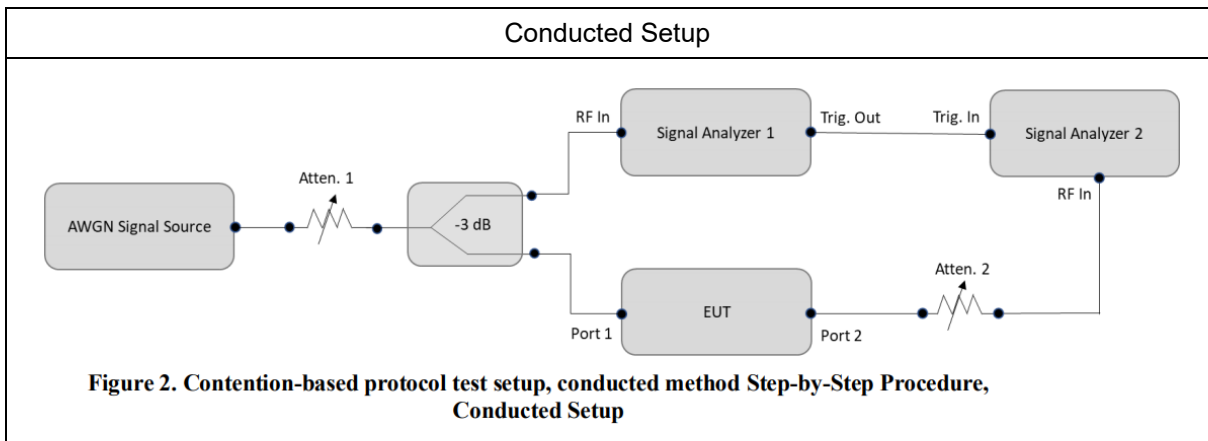

**3.5.5 Support Unit used in test configuration and system**

Instrument	Brand Name	Model No.	Characteristics
WLAN AP	ASUS	GT-AXE11000	Dual Band AP
Notebook	DELL	Latitude 3400	LAN

**3.5.6 Minimum Antenna gain for Contention Based Protocol Test**

CBP Antenna Gain	<UNII-5>: 1.08 dBi
	<UNII-6>: 1.08 dBi
	<UNII-7>: 0.67 dBi
	<UNII-8>: 0.39 dBi

**Note:** The CBP antenna gain is considering the minimum gain from closed mode as worse case.



3.5.7 Test Summary of Contention Based Protocol Test

Test Engineer :	Kai Liao	Temperature :	22.9~24.7°C
		Relative Humidity :	49.3~53.3%

Band	Channel Freq. (MHz)	Channel BW (MHz)	Incumbent freq. (MHz)	Injected AWGN Level (dBm)	Detection Rate (%)	Regulated Threshold level (dBm)	Adjusted Power (dBm)	Margin (dB)	
UNII Band 5	6135	20	6135	-74.84	100	-62	-75.92	13.92	
				Result: Stop Transmission					
				-78.84	< 90	-62	-79.92	17.92	
				Result: Minimal Operation					
				-79.84	0	-62	-80.92	18.92	
				Result: Normal Operation					
	6185	160	6110	-74.02	100	-62	-75.10	13.10	
				Result: Stop Transmission					
				-80.02	< 90	-62	-81.10	19.10	
				Result: Minimal Operation					
				-81.02	0	-62	-82.10	20.10	
				Result: Normal Operation					
			6260	6185	-68.90	100	-62	-69.98	7.98
					Result: Stop Transmission				
					-72.90	< 90	-62	-73.98	11.98
					Result: Minimal Operation				
					-73.90	0	-62	-74.98	12.98
					Result: Normal Operation				
6260	6185	-73.66	100	-62	-74.74	12.74			
		Result: Stop Transmission							
		-78.66	< 90	-62	-79.74	17.74			
		Result: Minimal Operation							
6260	6185	-79.66	0	-62	-80.74	18.74			
		Result: Normal Operation							

**Note 1:** Adjusted Power = Injected AWGN Level - minimum antenna gain (1.08 dBi).

**Note 2:** The antenna gain has included the path loss between RF connector and antenna.

**Note 3:** Margin = Regulated Threshold level - Adjusted Power.



Band	Channel Freq. (MHz)	Channel BW (MHz)	Incumbent freq. (MHz)	Injected AWGN Level (dBm)	Detection Rate (%)	Regulated Threshold level (dBm)	Adjusted Power (dBm)	Margin (dB)		
UNII Band 6	6455	20	6455	-67.28	100	-62	-68.36	6.36		
				Result: Stop Transmission						
				-72.28	< 90	-62	-73.36	11.36		
				Result: Minimal Operation						
				-73.28	0	-62	-74.36	12.36		
				Result: Normal Operation						
	6505	160	6430	-74.68	100	-62	-75.76	13.76		
				Result: Stop Transmission						
				-76.68	< 90	-62	-77.76	15.76		
				Result: Minimal Operation						
				-77.68	0	-62	-78.76	16.76		
				Result: Normal Operation						
			6505	160	6505	-68.28	100	-62	-69.36	7.36
						Result: Stop Transmission				
						-70.28	< 90	-62	-71.36	9.36
						Result: Minimal Operation				
						-71.28	0	-62	-72.36	10.36
						Result: Normal Operation				
	6580	160	6580	-72.20	100	-62	-73.28	11.28		
				Result: Stop Transmission						
				-75.20	< 90	-62	-76.28	14.28		
				Result: Minimal Operation						
				-76.20	0	-62	-77.28	15.28		
				Result: Normal Operation						

**Note 1:** Adjusted Power = Injected AWGN Level - minimum antenna gain (1.08 dBi).

**Note 2:** The antenna gain has included the path loss between RF connector and antenna.

**Note 3:** Margin = Regulated Threshold level - Adjusted Power.



Band	Channel Freq. (MHz)	Channel BW (MHz)	Incumbent freq. (MHz)	Injected AWGN Level (dBm)	Detection Rate (%)	Regulated Threshold level (dBm)	Adjusted Power (dBm)	Margin (dB)	
UNII Band 7	6695	20	6695	-69.10	100	-62	-69.77	7.77	
				Result: Stop Transmission					
				-75.10	< 90	-62	-75.77	13.77	
				Result: Minimal Operation					
				-76.10	0	-62	-76.77	14.77	
				Result: Normal Operation					
	6665	160	6590	-73.75	100	-62	-74.42	12.42	
				Result: Stop Transmission					
				-76.75	< 90	-62	-77.42	15.42	
				Result: Minimal Operation					
				-77.75	0	-62	-78.42	16.42	
				Result: Normal Operation					
			6740	6665	-68.96	100	-62	-69.63	7.63
					Result: Stop Transmission				
					-70.96	< 90	-62	-71.63	9.63
					Result: Minimal Operation				
					-71.96	0	-62	-72.63	10.63
					Result: Normal Operation				
6740	6665	-74.37	100	-62	-75.04	13.04			
		Result: Stop Transmission							
		-77.37	< 90	-62	-78.04	16.04			
		Result: Minimal Operation							
6740	6665	-78.37	0	-62	-79.04	17.04			
		Result: Normal Operation							

**Note 1:** Adjusted Power = Injected AWGN Level - minimum antenna gain (0.67 dBi).

**Note 2:** The antenna gain has included the path loss between RF connector and antenna.

**Note 3:** Margin = Regulated Threshold level - Adjusted Power.



Band	Channel Freq. (MHz)	Channel BW (MHz)	Incumbent freq. (MHz)	Injected AWGN Level (dBm)	Detection Rate (%)	Regulated Threshold level (dBm)	Adjusted Power (dBm)	Margin (dB)		
UNII Band 8	7015	20	7015	-67.96	100	-62	-68.35	6.35		
				Result: Stop Transmission						
				-69.96	< 90	-62	-70.35	8.35		
				Result: Minimal Operation						
				-70.96	0	-62	-71.35	9.35		
				Result: Normal Operation						
	6985	160	6910	-67.56	100	-62	-67.95	5.95		
				Result: Stop Transmission						
				-69.56	< 90	-62	-69.95	7.95		
				Result: Minimal Operation						
				-70.56	0	-62	-70.95	8.95		
				Result: Normal Operation						
			6985	160	6985	-65.45	100	-62	-65.84	3.84
						Result: Stop Transmission				
						-67.45	< 90	-62	-67.84	5.84
						Result: Minimal Operation				
						-68.45	0	-62	-68.84	6.84
						Result: Normal Operation				
7060	160	7060	-66.25	100	-62	-66.84	4.64			
			Result: Stop Transmission							
			-68.25	< 90	-62	-68.64	6.64			
			Result: Minimal Operation							
-69.25	0	-62	-69.64	7.64						
Result: Normal Operation										

**Note 1:** Adjusted Power = Injected AWGN Level - minimum antenna gain (0.39 dBi).

**Note 2:** The antenna gain has included the path loss between RF connector and antenna.

**Note 3:** Margin = Regulated Threshold level - Adjusted Power.





### 3.5.8 Test Plots of Contention Based Protocol Test

CBP verify with frequency domain plots

The device does not support channel puncturing with regards to Contention Based Protocol.

The entire bandwidth 160MHz stops transmission after the incumbent signal appears.

Otherwise, the entire 160MHz bandwidth is reduced to 20MHz or 80MHz.

Before incumbent injected on 160MHz channel

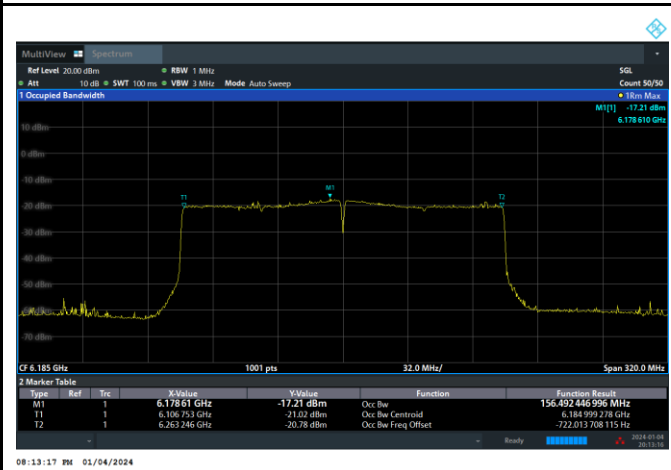

After 10MHz incumbent injected on center of channel, the entire 160MHz bandwidth stops transmission.

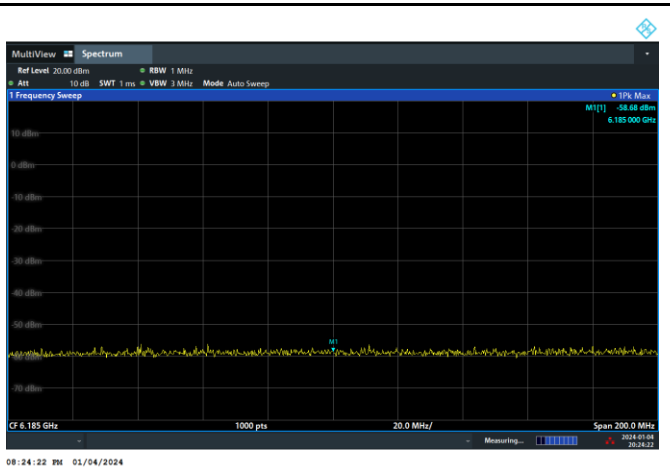

After 10MHz incumbent injected on bottom of channel, the EUT bandwidth is reduced from 160MHz to 20MHz channel.

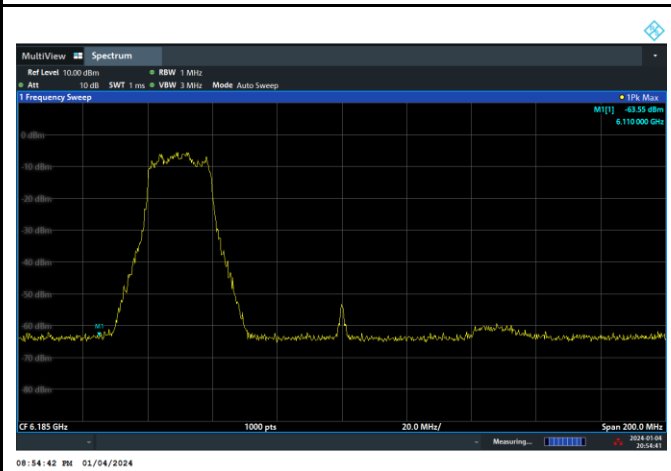

After 10MHz incumbent injected on top of channel, the EUT bandwidth is reduced from 160MHz to 80MHz channel.

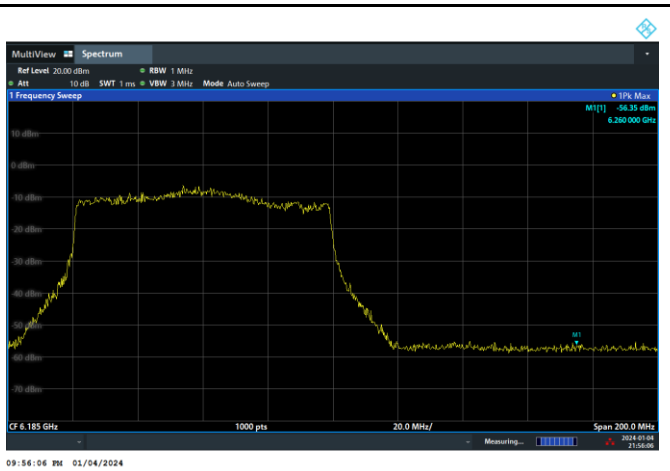



Contention Based Protocol Result Plots on U-NII 5 (AWGN Interference)

802.11ax (HE20) / 6135MHz  
Threshold Level (TL) = -74.84dBm

802.11ax (HE20) / CH37  
Test result is pass due to no transmission occur.

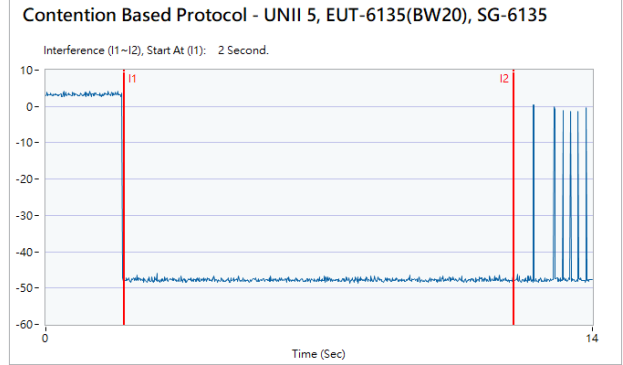
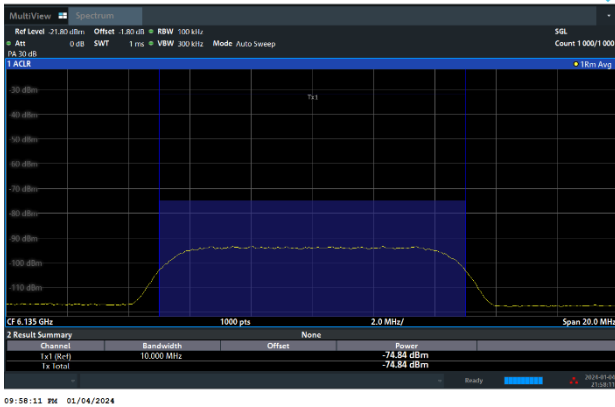

802.11ax (HE20) / 6135MHz  
Threshold Level (TL) = -75.84dBm

802.11ax (HE20) / CH37  
Transmit when the interferer is 1dB lower.

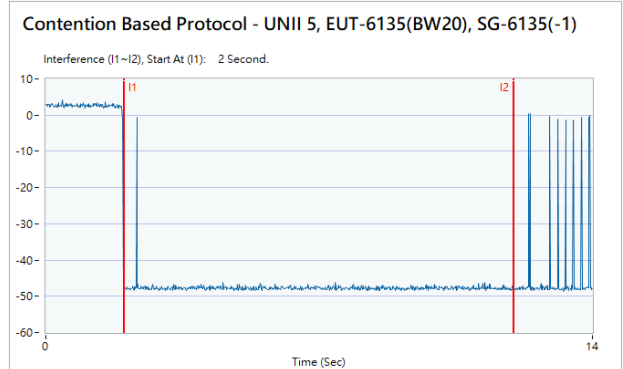
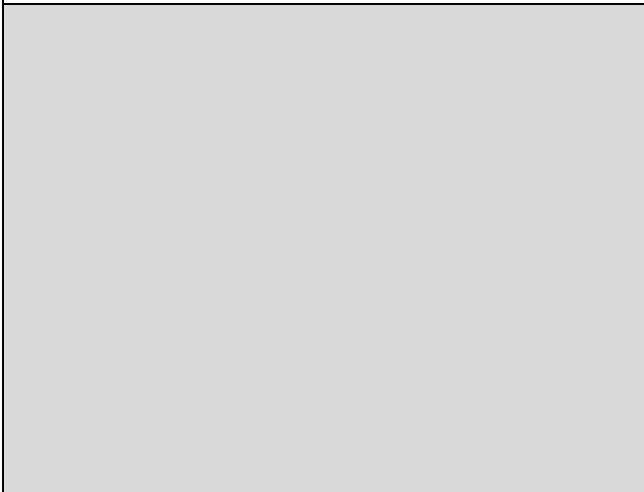



Contention Based Protocol Result Plots on U-NII 5 (AWGN Interference)

802.11ax (HE160) / 6110MHz (Lower edge)  
Threshold Level (TL) = -74.02dBm

802.11ax (HE160) / CH47 (Lower edge)  
Test result is pass due to no transmission occur.

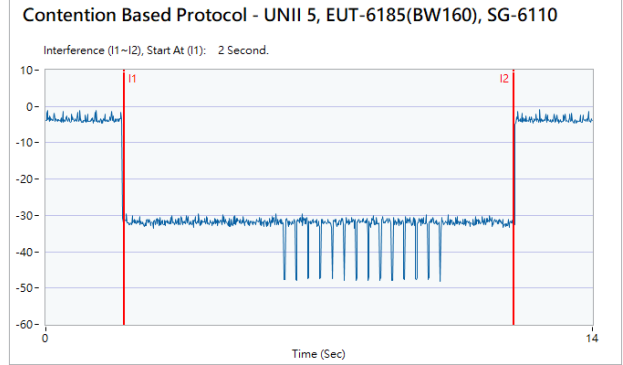
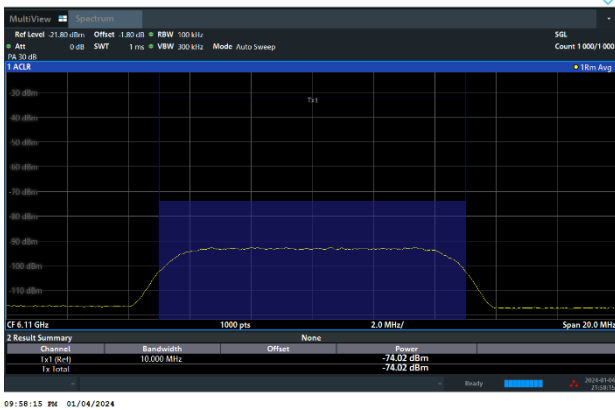

802.11ax (HE160) / 6110MHz (Lower edge)  
Threshold Level (TL) = -75.02dBm

802.11ax (HE160) / CH47 (Lower edge)  
Transmit when the interferer is 1dB lower.

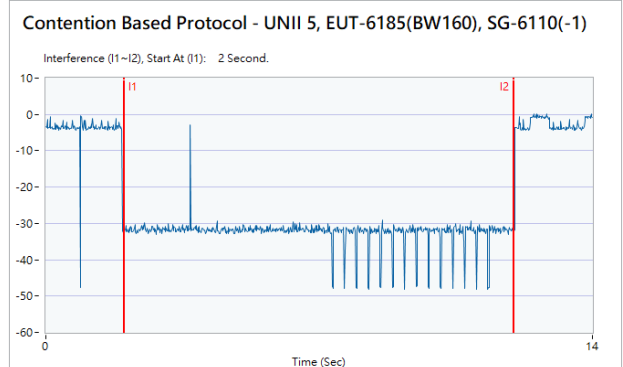
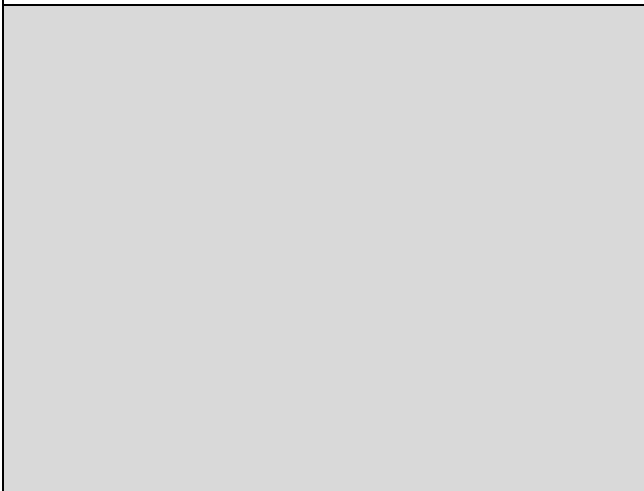



Contention Based Protocol Result Plots on U-NII 5 (AWGN Interference)

802.11ax (HE160) / 6185MHz (Middle)  
Threshold Level (TL) = -68.90dBm

802.11ax (HE160) / CH47 (Middle)

Test result is pass due to no transmission occur.

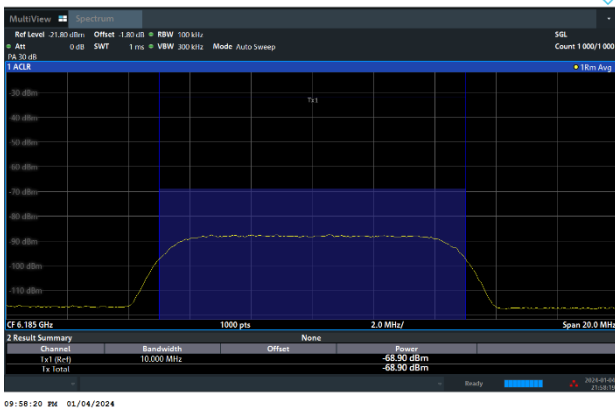

Contention Based Protocol - UNII 5, EUT-6185(BW160), SG-6185

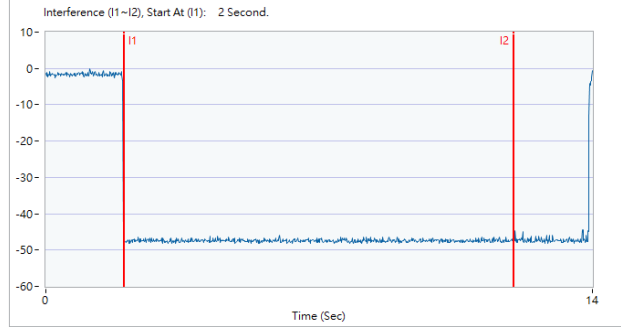

802.11ax (HE160) / 6185MHz (Middle)  
Threshold Level (TL) = -69.90dBm

802.11ax (HE160) / CH47 (Middle)

Transmit when the interferer is 1dB lower.

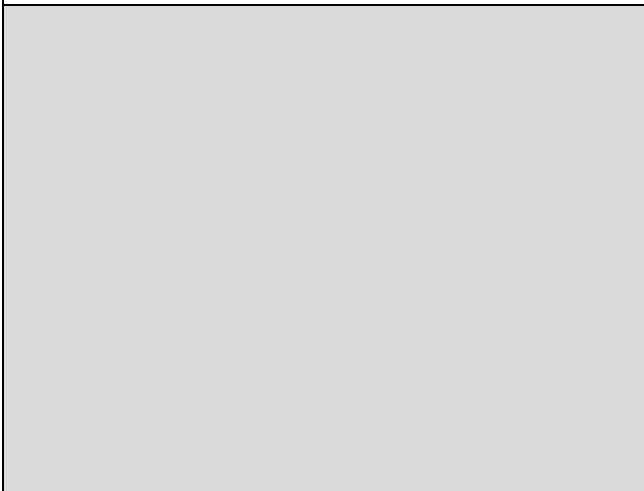

Contention Based Protocol - UNII 5, EUT-6185(BW160), SG-6185(-1)

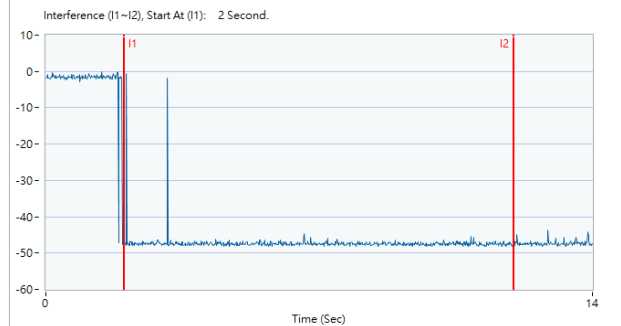



Contention Based Protocol Result Plots on U-NII 5 (AWGN Interference)

802.11ax (HE160) / 6260MHz (Upper edge)  
Threshold Level (TL) = -73.66dBm

802.11ax (HE160) / CH47 (Upper edge)  
Test result is pass due to no transmission occur.

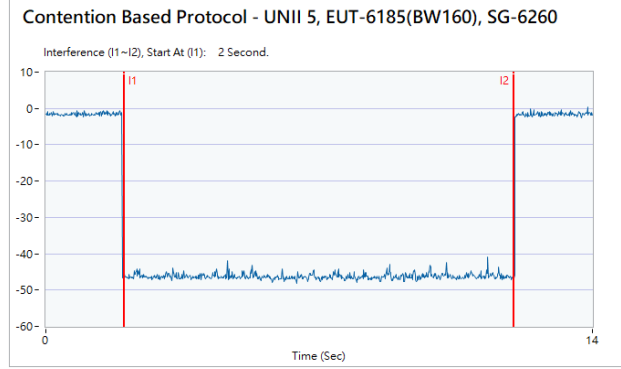

802.11ax (HE160) / 6260MHz (Upper edge)  
Threshold Level (TL) = -74.66dBm

802.11ax (HE160) / CH47 (Upper edge)  
Transmit when the interferer is 1dB lower.

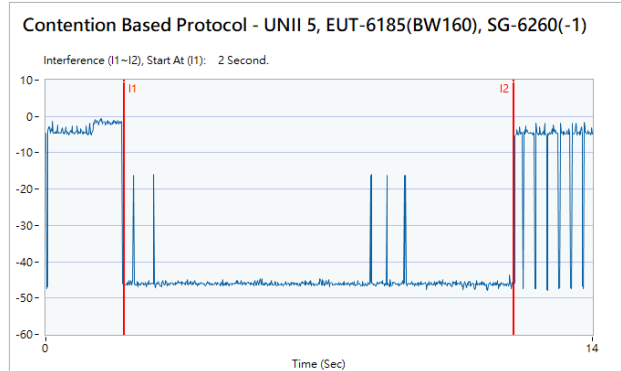
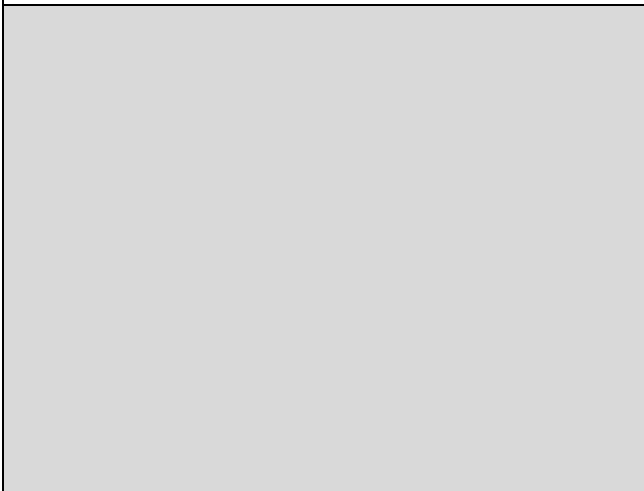



Contention Based Protocol Result Plots on U-NII 6 (AWGN Interference)

802.11ax (HE20) / 6455MHz  
Threshold Level (TL) = -67.28dBm

802.11ax (HE20) / CH101  
Test result is pass due to no transmission occur.

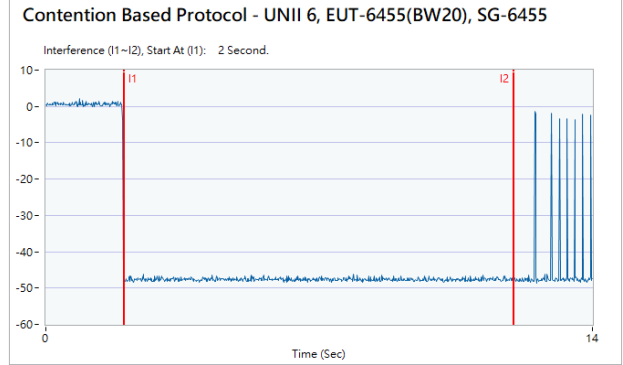
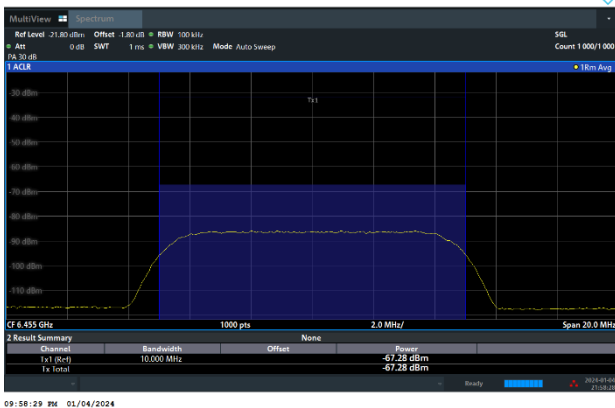

802.11ax (HE20) / 6455MHz  
Threshold Level (TL) = -68.28dBm

802.11ax (HE20) / CH101  
Transmit when the interferer is 1dB lower.

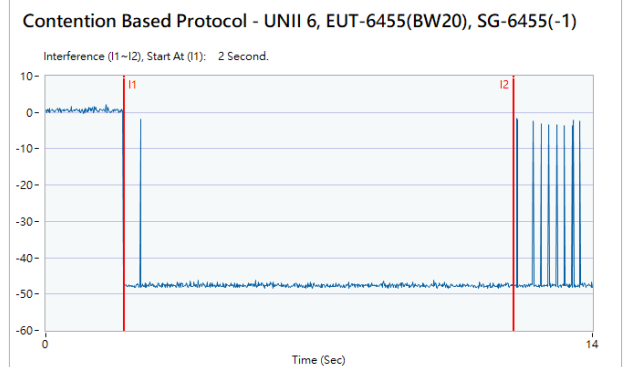



Contention Based Protocol Result Plots on U-NII 6 (AWGN Interference)

802.11ax (HE160) / 6430MHz (Lower edge)  
Threshold Level (TL) = -74.68dBm

802.11ax (HE160) / CH111 (Lower edge)  
Test result is pass due to no transmission occur.

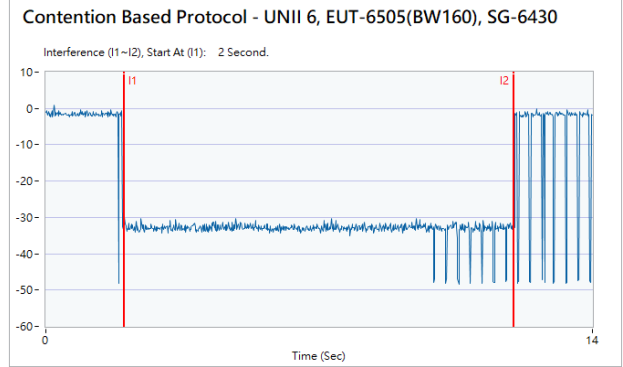
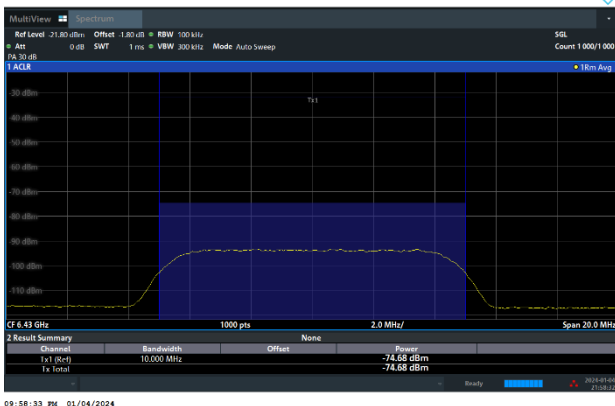

802.11ax (HE160) / 6430MHz (Lower edge)  
Threshold Level (TL) = -75.68dBm

802.11ax (HE160) / CH111 (Lower edge)  
Transmit when the interferer is 1dB lower.

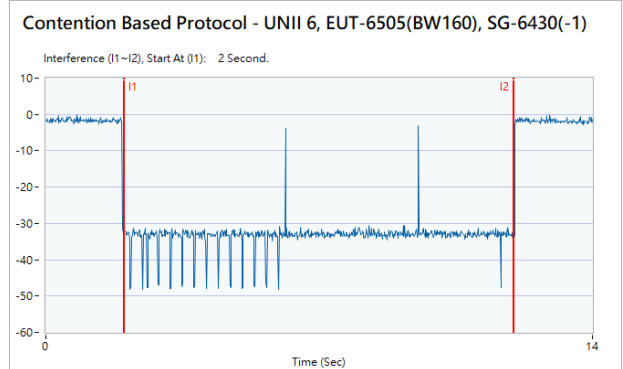
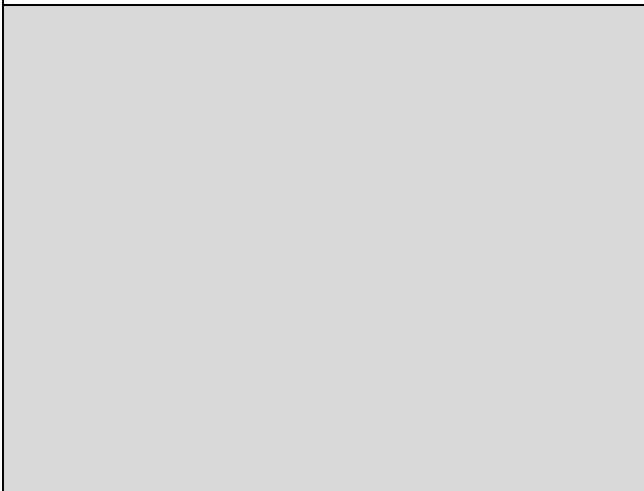



Contention Based Protocol Result Plots on U-NII 6 (AWGN Interference)

802.11ax (HE160) / 6505MHz (Middle)  
Threshold Level (TL) = -68.28dBm

802.11ax (HE160) / CH111 (Middle)  
Test result is pass due to no transmission occur.

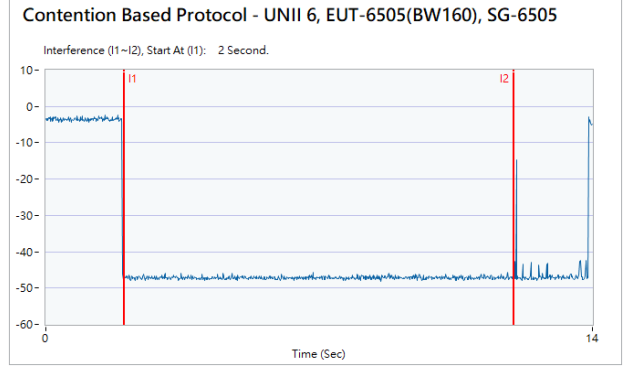

802.11ax (HE160) / 6505MHz (Middle)  
Threshold Level (TL) = -69.28dBm

802.11ax (HE160) / CH111 (Middle)  
Transmit when the interferer is 1dB lower.

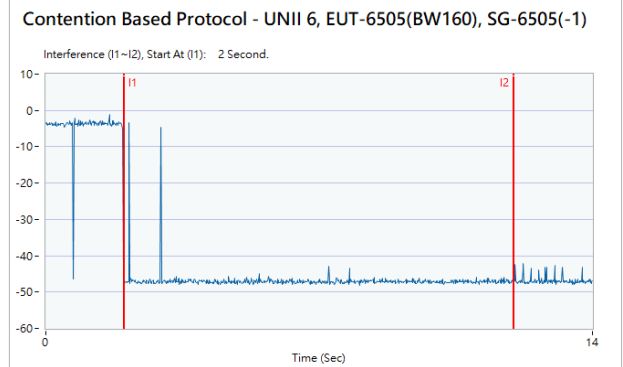





Contention Based Protocol Result Plots on U-NII 6 (AWGN Interference)

802.11ax (HE160) / 6580MHz (Upper edge)  
Threshold Level (TL) = -72.20dBm

802.11ax (HE160) / CH111 (Upper edge)  
Test result is pass due to no transmission occur.

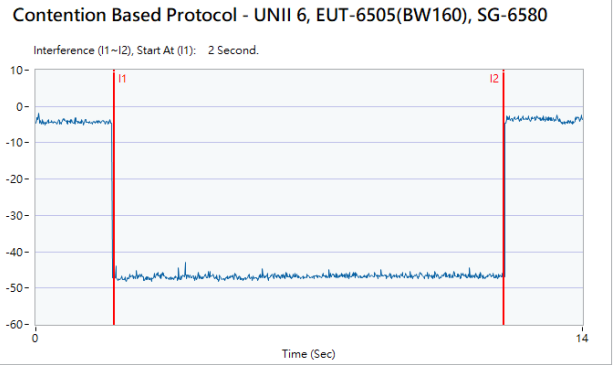
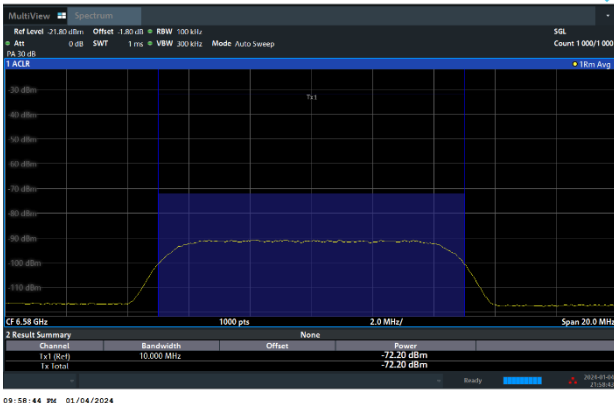

802.11ax (HE160) / 6580MHz (Upper edge)  
Threshold Level (TL) = -73.20dBm

802.11ax (HE160) / CH111 (Upper edge)  
Transmit when the interferer is 1dB lower.

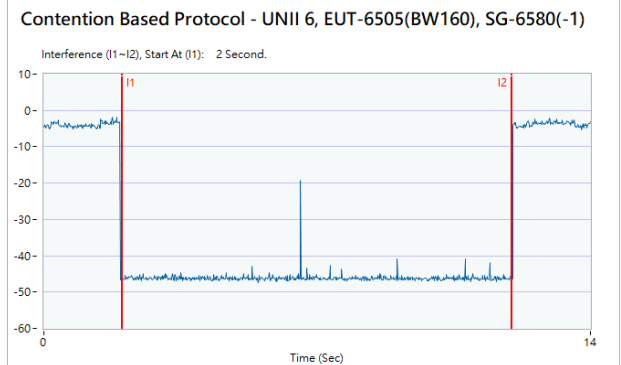
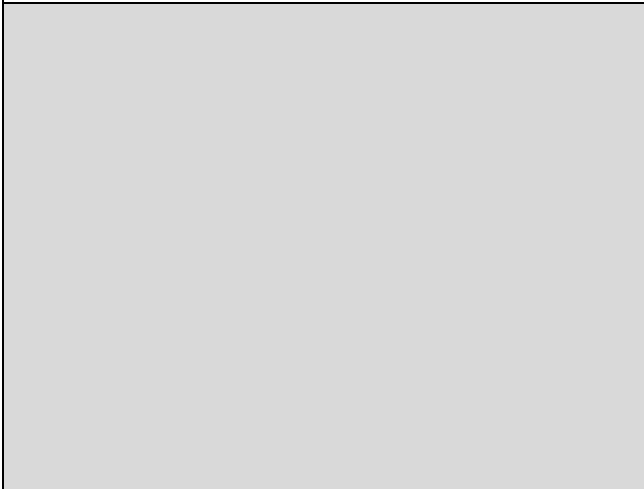



Contention Based Protocol Result Plots on U-NII 7 (AWGN Interference)

802.11ax (HE20) / 6695MHz  
Threshold Level (TL) = -69.10dBm

802.11ax (HE20) / CH149  
Test result is pass due to no transmission occur.

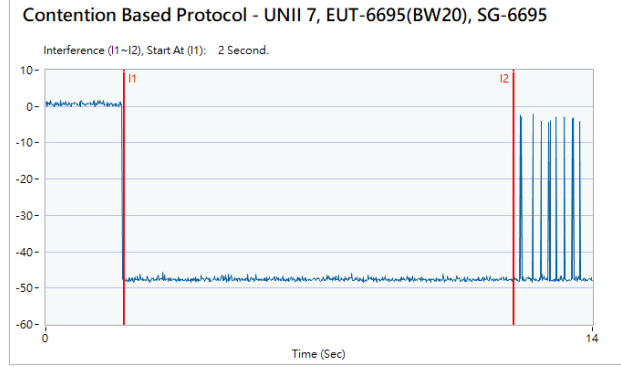
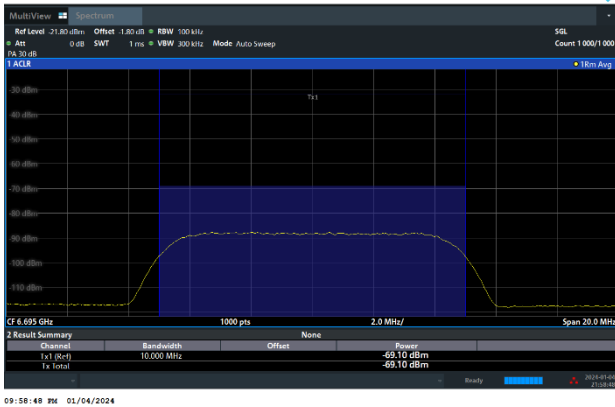

802.11ax (HE20) / 6695MHz  
Threshold Level (TL) = -70.10dBm

802.11ax (HE20) / CH149  
Transmit when the interferer is 1dB lower.

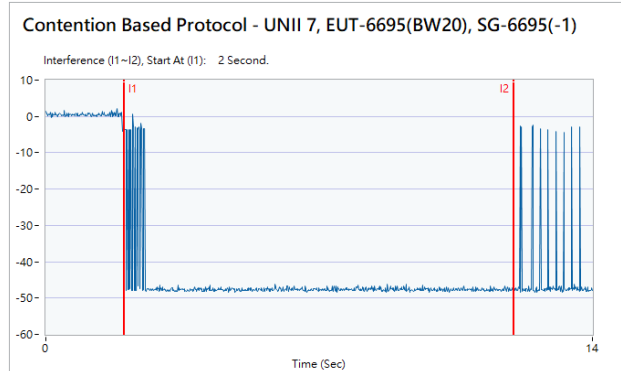
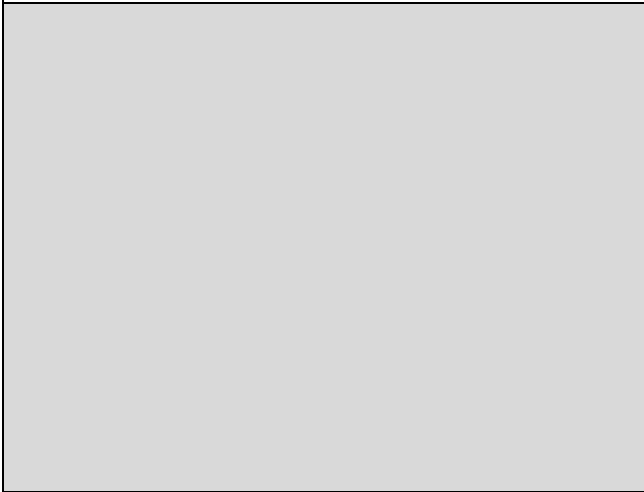



Contention Based Protocol Result Plots on U-NII 7 (AWGN Interference)

802.11ax (HE160) / 6590MHz (Lower edge)  
Threshold Level (TL) = -73.75dBm

802.11ax (HE160) / CH143 (Lower edge)  
Test result is pass due to no transmission occur.

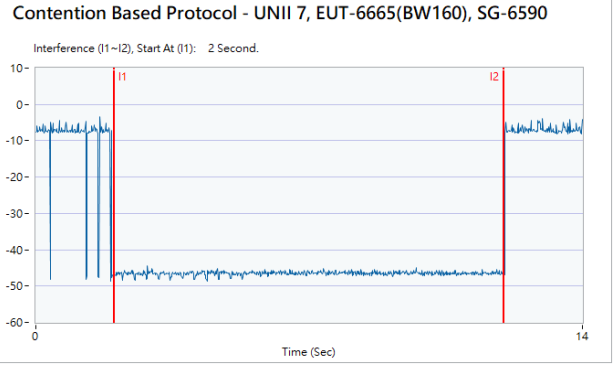
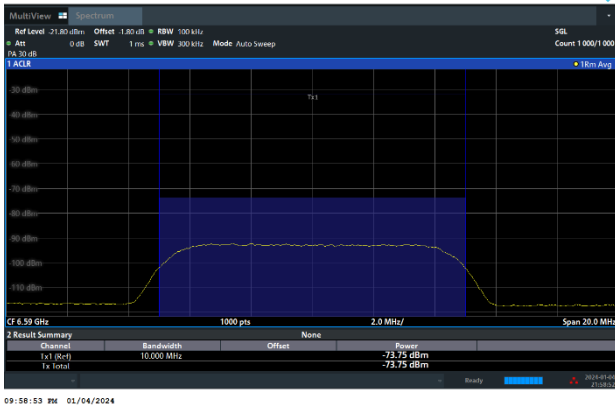

802.11ax (HE160) / 6590MHz (Lower edge)  
Threshold Level (TL) = -74.75dBm

802.11ax (HE160) / CH143 (Lower edge)  
Transmit when the interferer is 1dB lower.

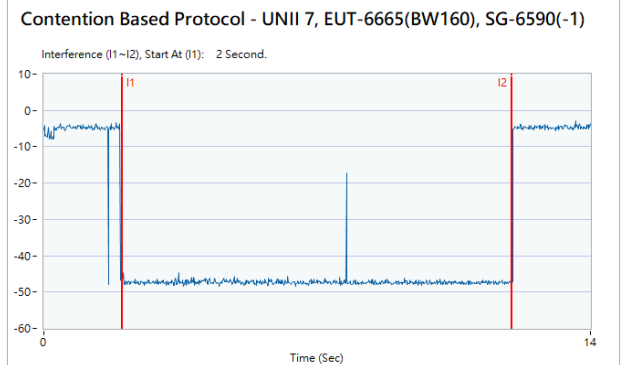



Contention Based Protocol Result Plots on U-NII 7 (AWGN Interference)

802.11ax (HE160) / 6665MHz (Middle)  
Threshold Level (TL) = -68.96dBm

802.11ax (HE160) / CH143 (Middle)  
Test result is pass due to no transmission occur.

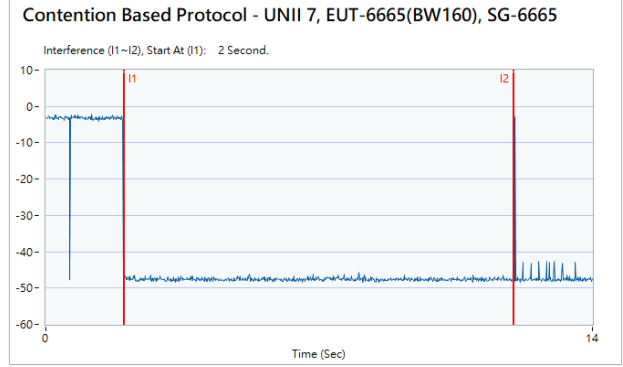
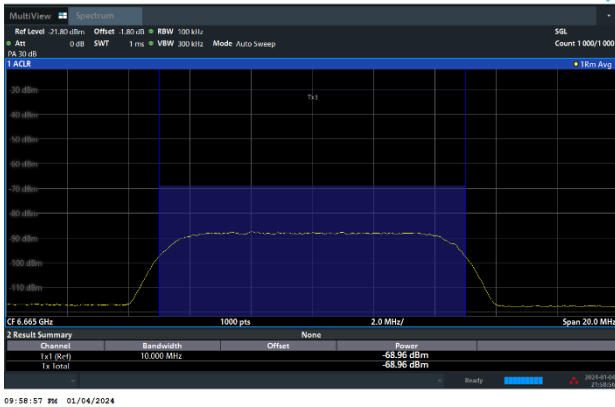

802.11ax (HE160) / 6665MHz (Middle)  
Threshold Level (TL) = -69.96dBm

802.11ax (HE160) / CH143 (Middle)  
Transmit when the interferer is 1dB lower.

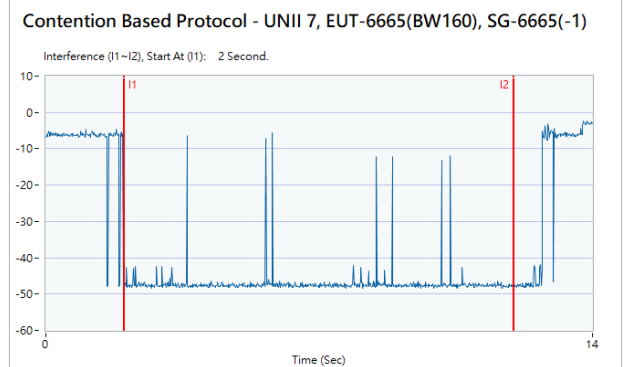



Contention Based Protocol Result Plots on U-NII 7 (AWGN Interference)

802.11ax (HE160) / 6740MHz (Upper edge)  
Threshold Level (TL) = -74.37dBm

802.11ax (HE160) / CH143 (Upper edge)  
Test result is pass due to no transmission occur.

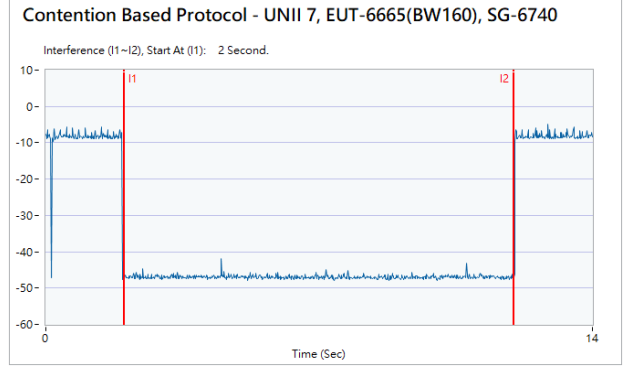
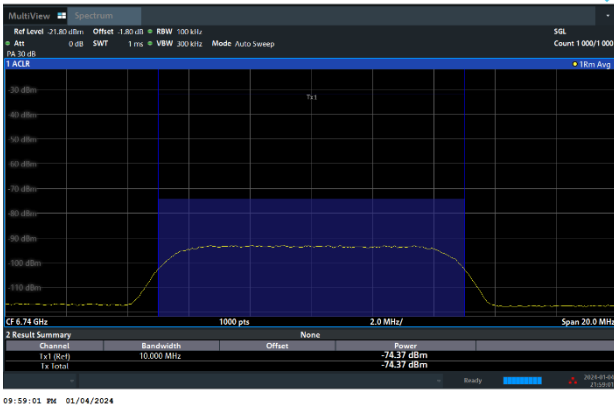

802.11ax (HE160) / 6740MHz (Upper edge)  
Threshold Level (TL) = -75.37dBm

802.11ax (HE160) / CH143 (Upper edge)  
Transmit when the interferer is 1dB lower.

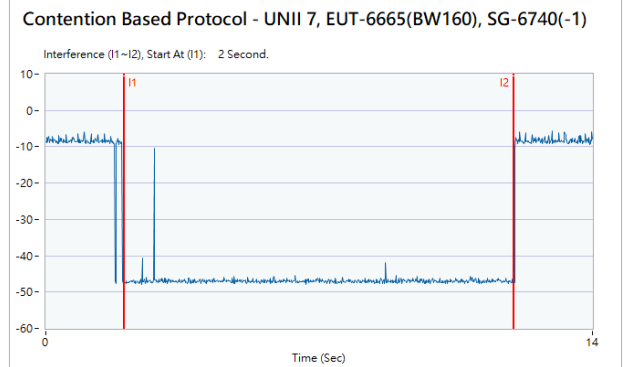



Contention Based Protocol Result Plots on U-NII 8 (AWGN Interference)

802.11ax (HE20) / 7015MHz  
Threshold Level (TL) = -67.96dBm

802.11ax (HE20) / CH213  
Test result is pass due to no transmission occur.

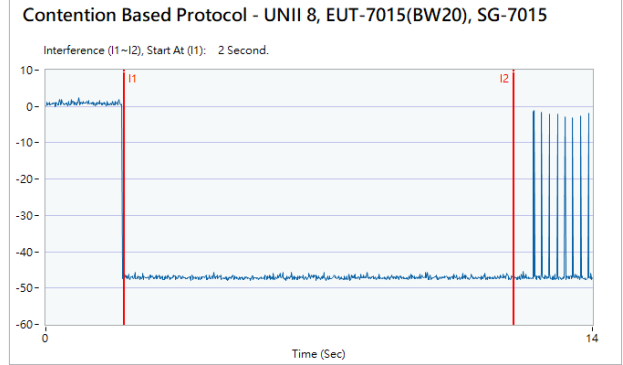
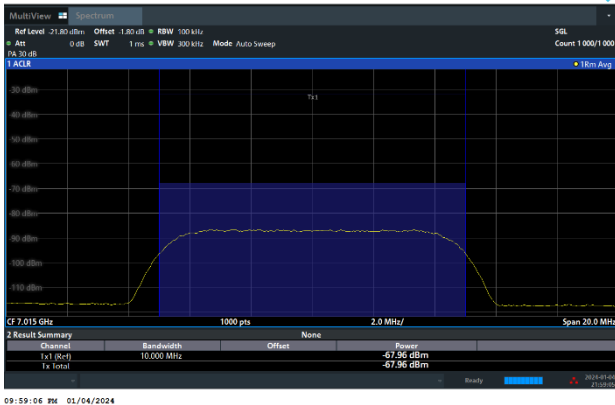

802.11ax (HE20) / 7015MHz  
Threshold Level (TL) = -68.96dBm

802.11ax (HE20) / CH213  
Transmit when the interferer is 1dB lower.

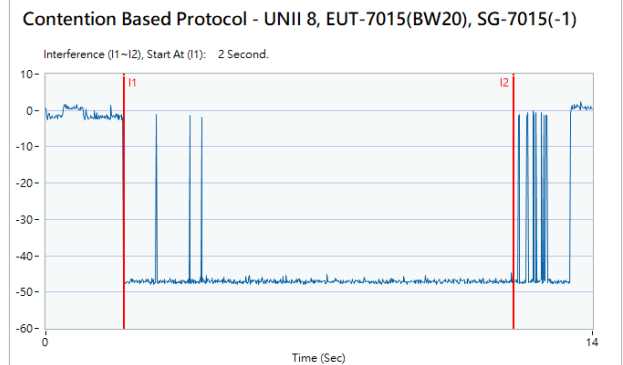



Contention Based Protocol Result Plots on U-NII 8 (AWGN Interference)

802.11ax (HE160) / 6910MHz (Lower edge)  
Threshold Level (TL) = -67.56dBm

802.11ax (HE160) / CH207 (Lower edge)  
Test result is pass due to no transmission occur.

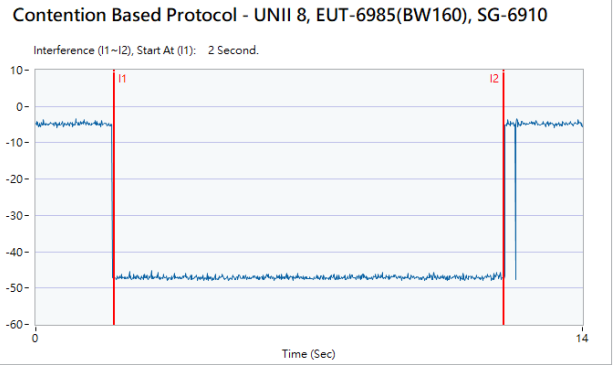
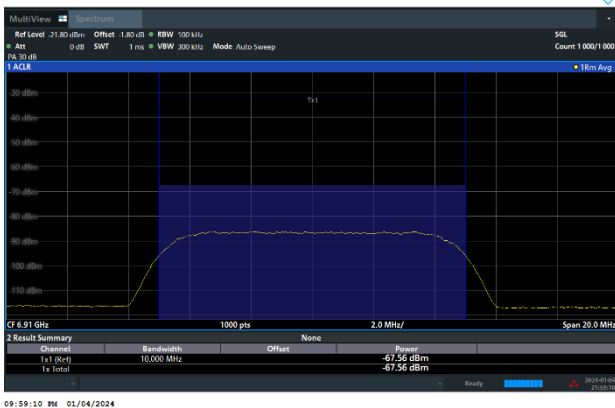

802.11ax (HE160) / 6910MHz (Lower edge)  
Threshold Level (TL) = -68.56dBm

802.11ax (HE160) / CH207 (Lower edge)  
Transmit when the interferer is 1dB lower.

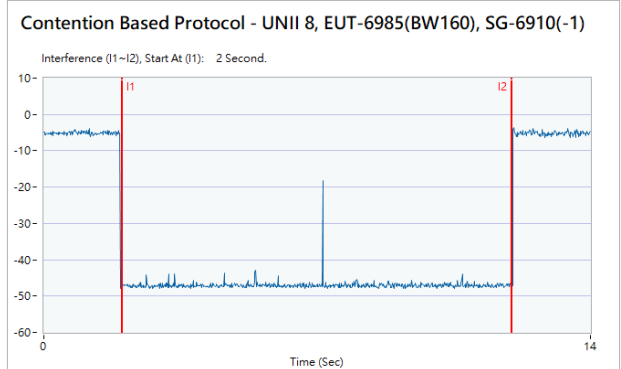
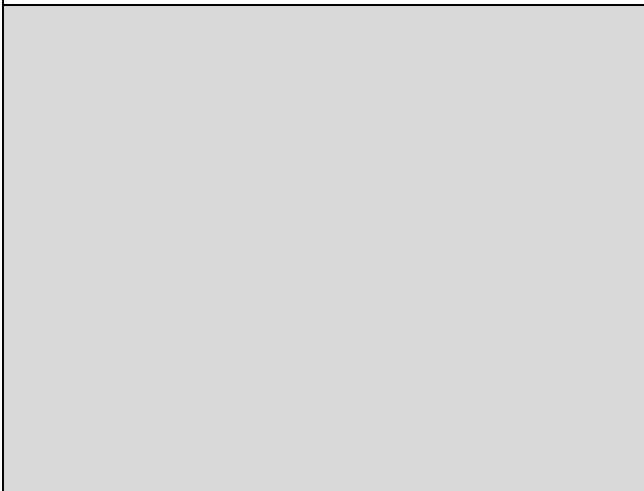



Contention Based Protocol Result Plots on U-NII 8 (AWGN Interference)

802.11ax (HE160) / 6985MHz (Middle)  
Threshold Level (TL) = -65.45dBm

802.11ax (HE160) / CH207 (Middle)  
Test result is pass due to no transmission occur.

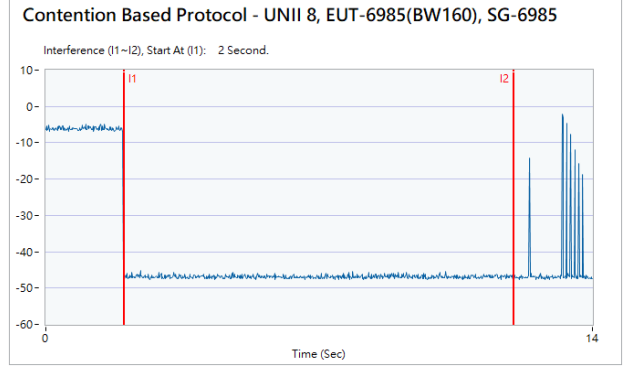

802.11ax (HE160) / 6985MHz (Middle)  
Threshold Level (TL) = -66.45dBm

802.11ax (HE160) / CH207 (Middle)  
Transmit when the interferer is 1dB lower.

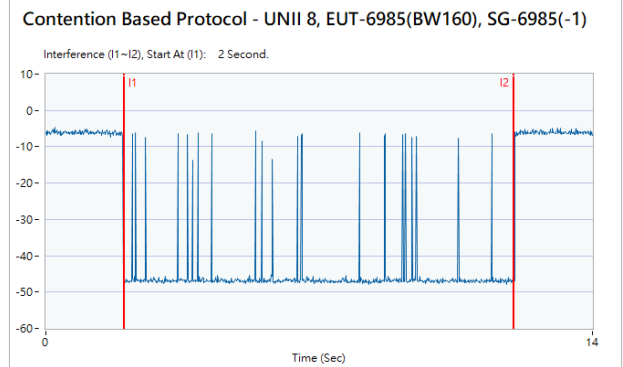





Contention Based Protocol Result Plots on U-NII 8 (AWGN Interference)

802.11ax (HE160) / 7060MHz (Upper edge)  
Threshold Level (TL) = -66.25dBm

802.11ax (HE160) / CH207 (Upper edge)  
Test result is pass due to no transmission occur.

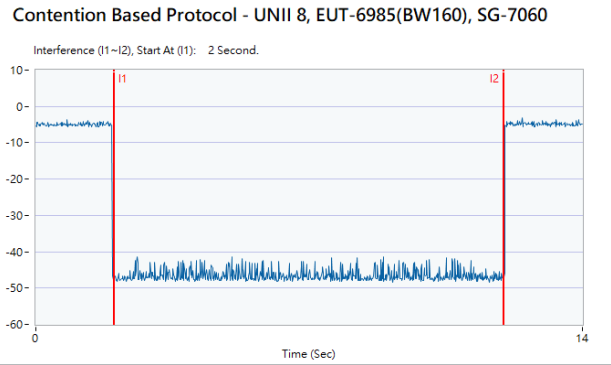
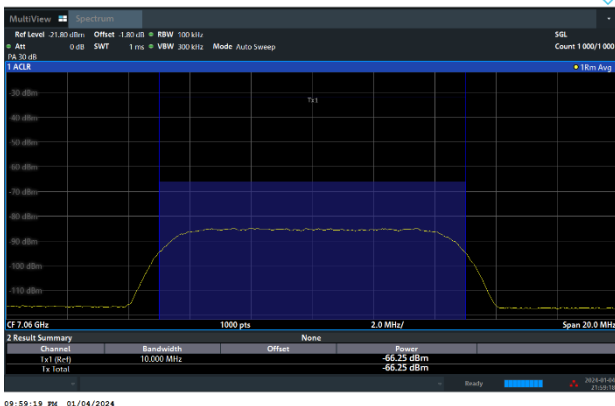

802.11ax (HE160) / 7060MHz (Upper edge)  
Threshold Level (TL) = -67.25dBm

802.11ax (HE160) / CH207 (Upper edge)  
Transmit when the interferer is 1dB lower.

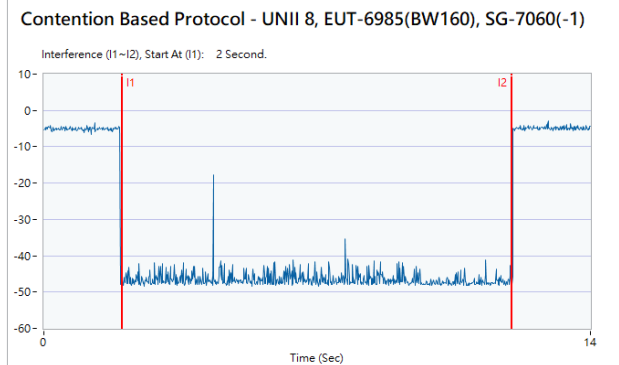



### 3.6 Unwanted Emissions Measurement

This section is to measure unwanted emissions through radiated measurement for band edge spurious emissions and out of band emissions measurement.

#### 3.6.1 Limit of Unwanted Emissions

- (1) For transmitters operating within the 5.925-7.125 GHz band: Any emissions outside of the 5.925-7.125 GHz band must not exceed an e.i.r.p. of -27 dBm/MHz.

EIRP (dBm)	Field Strength at 3m (dBµV/m)
- 27 (RMS)	68.3
- 7 (Peak)	88.3

According 987594 D02 U-NII 6GHz EMC Measurement v02r01 section G:

Unwanted emissions outside of restricted bands are measured with a RMS detector.

In addition, 15.35(b) applies where the peak emissions must be limited to no more than 20 dB above the average limit

- (2) Unwanted spurious emissions fallen in restricted bands shall comply with the general field strength limits as below table:

Frequency (MHz)	Field Strength (microvolts/meter)	Measurement Distance (meters)
0.009 – 0.490	2400/F(kHz)	300
0.490 – 1.705	24000/F(kHz)	30
1.705 – 30.0	30	30
30 – 88	100	3
88 – 216	150	3
216 - 960	200	3
Above 960	500	3

Note: The following formula is used to convert the EIRP to field strength.

$$E = \frac{1000000\sqrt{30P}}{3} \mu V/m, \text{ where } P \text{ is the eirp (Watts)}$$

#### 3.6.2 Measuring Instruments

Please refer to the measuring equipment list in this test report.



### 3.6.3 Test Procedures

1. The testing follows FCC KDB 789033 D02 General UNII Test Procedures New Rules v02r01. Section G) Unwanted emissions measurement.
  - (1) Procedure for Unwanted Emissions Measurements Below 1000MHz
    - RBW = 120 kHz
    - VBW = 300 kHz
    - Detector = Peak
    - Trace mode = max hold
  - (2) Procedure for Peak Unwanted Emissions Measurements Above 1000 MHz
    - RBW = 1 MHz
    - VBW  $\geq$  3 MHz
    - Detector = Peak
    - Sweep time = auto
    - Trace mode = max hold
  - (3) Procedures for Average Unwanted Emissions Measurements Above 1000MHz
    - RBW = 1 MHz
    - VBW = 10 Hz, when duty cycle is no less than 98 percent.
    - VBW  $\geq$  1/T, when duty cycle is less than 98 percent where T is the minimum transmission duration over which the transmitter is on and is transmitting at its maximum power control level for the tested mode of operation.
2. The EUT is placed on a turntable with 0.8 meter for frequency below 1 GHz and 1.5 meter for frequency above 1 GHz respectively above ground.
3. The EUT is set 3 meters away from the receiving antenna which is mounted on the top of a variable height antenna tower.
4. The antenna is a broadband antenna and its height is adjusted between one meter and four meters above ground to find the maximum value of the field strength for both horizontal polarization and vertical polarization of the antenna.
5. For each suspected emission, the EUT is arranged to its worst case and then adjust the antenna tower (from 1 m to 4 m) and turntable (from 0 degree to 360 degrees) to find the maximum reading.
6. Radiated testing below 1 GHz is performed by adjusting the antenna tower from 1 m to 4 m and by rotating the turn table from 0 degree to 360 degrees to find the peak maximum hold reading. When there is no suspected emission found and the emission level is with at least 6 dB margin against QP limit line, the position is marked as “-“.
7. Radiated testing above 1 GHz is performed by adjusting the antenna tower from 1 m to 4 m and by rotating the turn table from 0 degree to 360 degrees to find the peak maximum hold reading for scanning all frequencies. When there is no suspected emission found and the harmonic emission level is with at least 6 dB margin against average limit line, the position is marked as “-“..

### 3.6.4 Test Setup

For radiated emissions below 30MHz

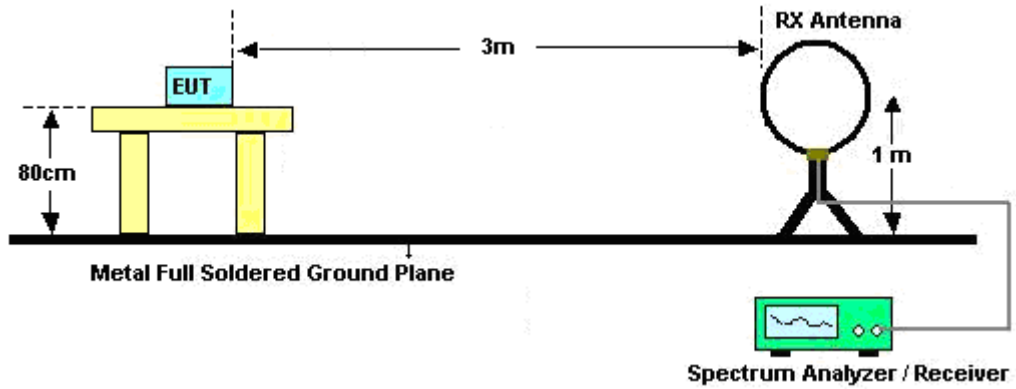

For radiated emissions from 30MHz to 1GHz

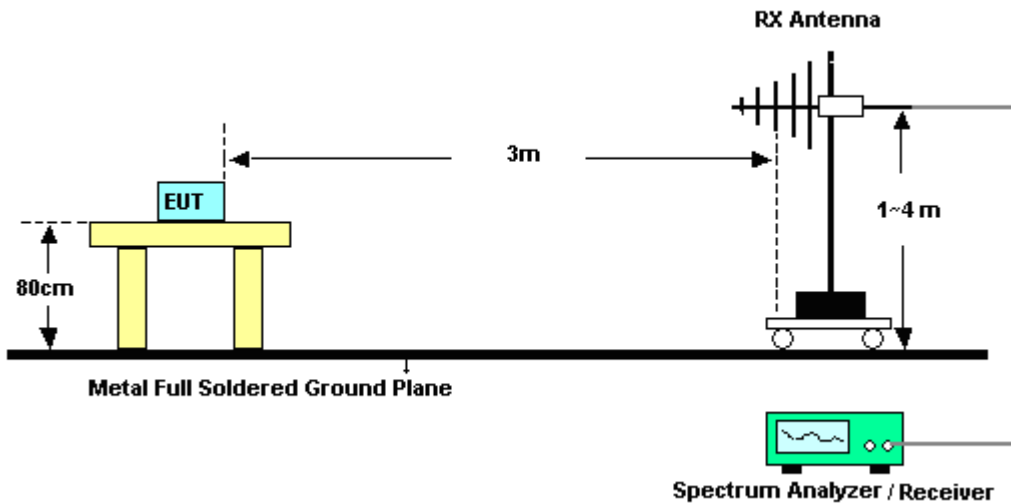

For radiated test from 1GHz to 18GHz

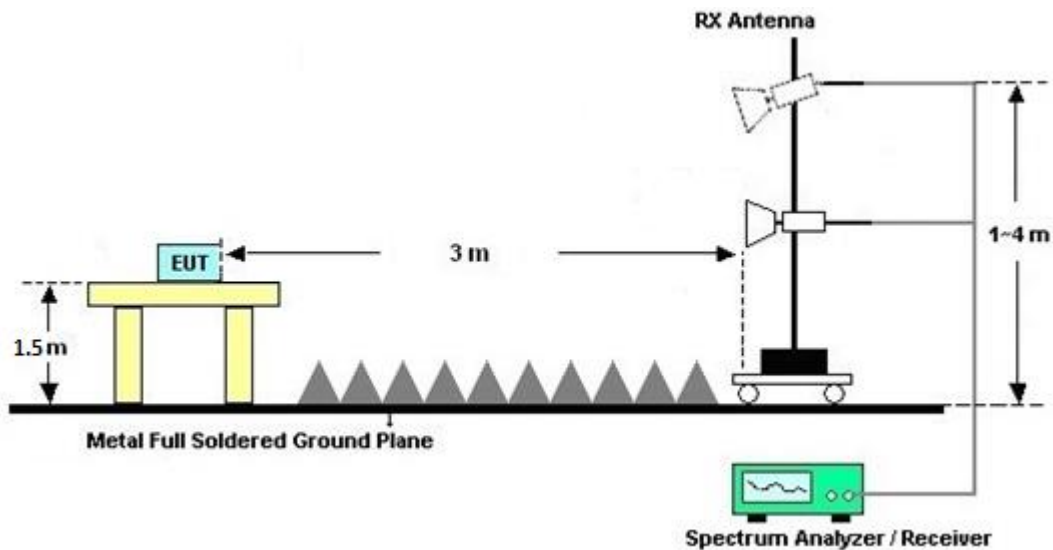

For radiated test above 18GHz

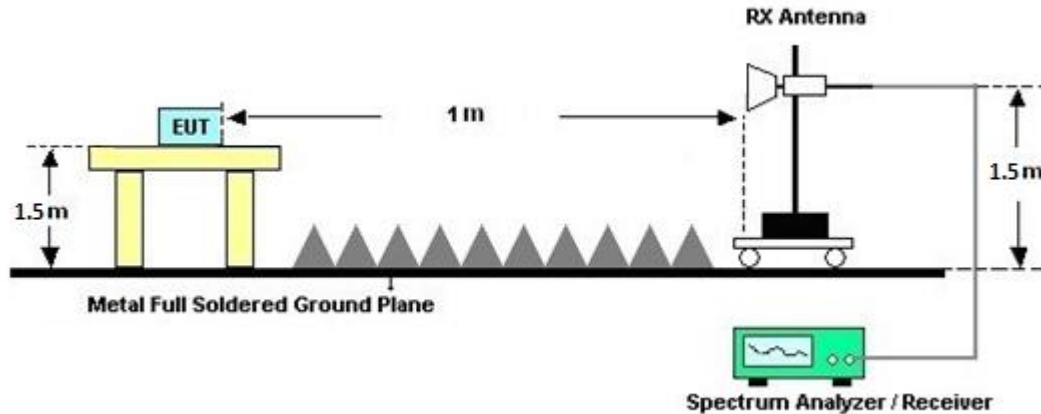

### 3.6.5 Test Results of Radiated Spurious Emissions (9 kHz ~ 30 MHz)

The low frequency, which starts from 9 kHz to 30 MHz, is pre-scanned and the result which is 20 dB lower than the limit line is not reported.

There is adequate comparison measurement of both open-field test site and alternative test site - semi-Anechoic chamber according to 414788 D01 Radiated Test Site v02r01, and the result came out very similar.

### 3.6.6 Test Result of Radiated Spurious at Band Edges

Please refer to Appendix C and D.

### 3.6.7 Duty Cycle

Please refer to Appendix E.

### 3.6.8 Test Result of Radiated Spurious Emissions (30MHz ~ 10th Harmonic)

Please refer to Appendix C and D.



### 3.7 AC Conducted Emission Measurement

#### 3.7.1 Limit of AC Conducted Emission

For equipment that is designed to be connected to the public utility (AC) power line, the radio frequency voltage that is conducted back onto the AC power line on any frequency or frequencies within the band 150 kHz to 30 MHz shall not exceed the limits in the following table.

Frequency of emission (MHz)	Conducted limit (dB $\mu$ V)	
	Quasi-peak	Average
0.15-0.5	66 to 56*	56 to 46*
0.5-5	56	46
5-30	60	50

\*Decreases with the logarithm of the frequency.

#### 3.7.2 Measuring Instruments

Please refer to the measuring equipment list in this test report.

#### 3.7.3 Test Procedures

1. The EUT is placed 0.4 meter away from the conducting wall of the shielding room, and is kept at least 80 centimeters from any other grounded conducting surface.
2. Connect EUT to the power mains through a line impedance stabilization network (LISN).
3. All the support units are connecting to the other LISN.
4. The LISN provides 50 ohm coupling impedance for the measuring instrument.
5. The FCC states that a 50 ohm, 50 microhenry LISN should be used.
6. Both Line and Neutral shall be tested in order to find out the maximum conducted emission.
7. The frequency range from 150 kHz to 30 MHz is scanned.
8. Set the test-receiver system to Peak Detect Function and specified bandwidth with Maximum Hold Mode.

### 3.7.4 Test Setup

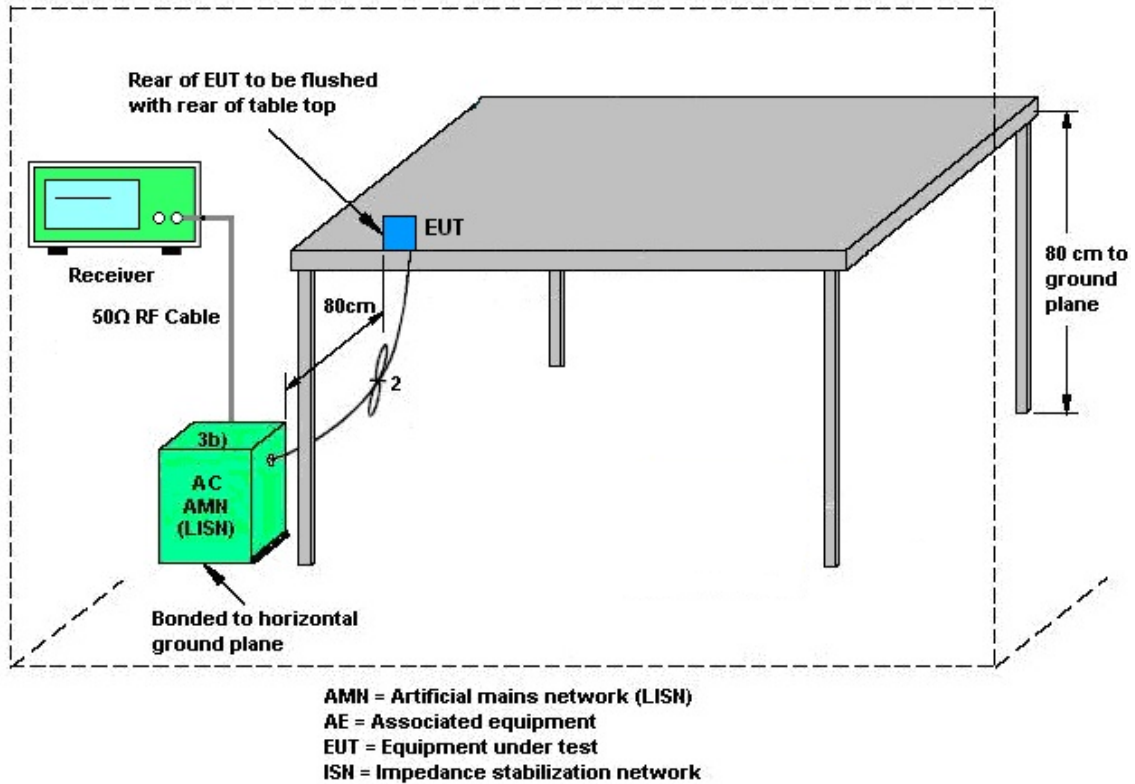

### 3.7.5 Test Result of AC Conducted Emission

Please refer to Appendix B.



## **3.8 Antenna Requirements**

### **3.8.1 Standard Applicable**

The use of a permanently attached antenna or of an antenna that uses a unique coupling to the intentional radiator shall be considered sufficient to comply with the rule.

### **3.8.2 Antenna Anti-Replacement Construction**

An embedded-in antenna design is used.





## 4 List of Measuring Equipment

Instrument	Brand Name	Model No.	Serial No.	Characteristics	Calibration Date	Test Date	Due Date	Remark
Hygrometer	TECPEL	DTM-303A	TP201996	N/A	Nov. 07, 2023	Nov. 10, 2023~ Jan. 18, 2024	Nov. 06, 2024	Conducted (TH05-HY)
Power Sensor	DARE	RPR3008W	RPR8W-2301 001(NO:146)	10MHz~8GHz	Feb. 07, 2023	Nov. 10, 2023~ Jan. 18, 2024	Feb. 06, 2024	Conducted (TH05-HY)
Signal Analyzer	Rohde & Schwarz	FSV40	101564	10Hz ~ 40GHz	Sep. 12, 2023	Nov. 10, 2023~ Jan. 18, 2024	Sep. 11, 2024	Conducted (TH05-HY)
EMI Test Receiver	Keysight	N9038A(MXE)	MY54130085	N/A	Oct. 06, 2023	Dec. 01, 2023~ Jan. 19, 2024	Oct. 05, 2024	Radiation (03CH20-HY)
Loop Antenna	Rohde & Schwarz	HFH2-Z2	100488	9 kHz~30 MHz	Sep. 12, 2023	Dec. 01, 2023~ Jan. 19, 2024	Sep. 11, 2024	Radiation (03CH20-HY)
Preamplifier	EMEC	EM18G40G	060873	18GHz~40GHz	Sep. 06, 2023	Dec. 01, 2023~ Jan. 19, 2024	Sep. 05, 2024	Radiation (03CH20-HY)
Controller	ChainTek	3000-1	N/A	Control Turn table & Ant Mast	N/A	Dec. 01, 2023~ Jan. 19, 2024	N/A	Radiation (03CH20-HY)
Antenna Mast	ChainTek	MBS-520-1	N/A	1m~4m	N/A	Dec. 01, 2023~ Jan. 19, 2024	N/A	Radiation (03CH20-HY)
Turn Table	ChainTek	T-200-S-1	N/A	0~360 Degree	N/A	Dec. 01, 2023~ Jan. 19, 2024	N/A	Radiation (03CH20-HY)
Signal Analyzer	Keysight	N9010B	MY60240520	N/A	Dec. 22, 2022	Dec. 01, 2023~ Dec. 11, 2023	Dec. 21, 2023	Radiation (03CH20-HY)
Signal Analyzer	Keysight	N9010B	MY60240520	N/A	Dec. 12, 2023	Dec. 12, 2023~ Jan. 19, 2024	Dec. 11, 2024	Radiation (03CH20-HY)
Bilog Antenna	TESEQ	CBL 6111D&00802N1 D01N-06	55606 & 08	30MHz~1GHz	Oct. 20, 2023	Dec. 01, 2023~ Jan. 19, 2024	Oct. 19, 2024	Radiation (03CH20-HY)
Horn Antenna	SCHWARZBE CK	BBHA 9120 D	02360	1GHz-18GHz	Oct. 30, 2023	Dec. 01, 2023~ Jan. 19, 2024	Oct. 29, 2024	Radiation (03CH20-HY)
SHF-EHF Horn Antenna	SCHWARZBE CK	BBHA 9170	1224	18GHz-40GHz	Jul. 10, 2023	Dec. 01, 2023~ Jan. 19, 2024	Jul. 09, 2024	Radiation (03CH20-HY)
Preamplifier	COM-POWER	PAM-103	18020201	1MHz-1000MHz	Jan. 02, 2023	Dec. 01, 2023~ Dec. 31, 2023	Jan. 01, 2024	Radiation (03CH20-HY)
Preamplifier	COM-POWER	PAM-103	18020201	1MHz-1000MHz	Jan. 01, 2024	Jan. 01, 2024~ Jan. 19, 2024	Dec. 31, 2024	Radiation (03CH20-HY)
Amplifier	EMCI	EMC118A45SE	980792	N/A	Nov. 13, 2023	Dec. 01, 2023~ Jan. 19, 2024	Nov. 12, 2024	Radiation (03CH20-HY)
RF Cable	HUBER + SUHNER	SUCOFLEX 102	519229/2,804 015/2,804027 /2	N/A	Jan. 18, 2023	Dec. 01, 2023~ Jan. 16, 2024	Jan. 17, 2024	Radiation (03CH20-HY)
RF Cable	HUBER + SUHNER	SUCOFLEX 102	519229/2,804 015/2,804027 /2	N/A	Jan. 17, 2024	Jan. 17, 2024~ Jan. 19, 2024	Jan. 16, 2025	Radiation (03CH20-HY)
Hygrometer	TECPEL	DTM-303B	TP200728	N/A	Mar. 28, 2023	Dec. 01, 2023~ Jan. 19, 2024	Mar. 27, 2024	Radiation (03CH20-HY)
Software	Audix	N/A	RK-002156	N/A	N/A	Dec. 01, 2023~ Jan. 19, 2024	N/A	Radiation (03CH20-HY)
Signal Generator (Interferer)	Rohde & Schwarz	SMW200A	109425	100kHz~7.5GHz z	Dec. 20, 2023	Jan. 03, 2024~ Jan. 04, 2024	Dec. 19, 2024	CBP (DF02-HY)
Spectrum Analyzer	Rohde & Schwarz	FSV3013	101549	10Hz~44GHz	Jan. 31, 2023	Jan. 03, 2024~ Jan. 04, 2024	Jan. 30, 2024	CBP (DF02-HY)
Power Divider	Woken	2Way Divider	DCMB1KW7A 1	0.5GHz-18GHz	Calibration from System	Jan. 03, 2024~ Jan. 04, 2024	Calibration from System	CBP (DF02-HY)
Power Divider	Woken	3Way SMA Power Divder Rated to 20W	STI08-0010(# 2)	2GHz-8GHz	Calibration from System	Jan. 03, 2024~ Jan. 04, 2024	Calibration from System	CBP (DF02-HY)
Power Divider	Woken	0120A04051801 O	DCMB1CW3 A7	0.5-18GHz	Calibration from System	Jan. 03, 2024~ Jan. 04, 2024	Calibration from System	CBP (DF02-HY)
Coupler	Woken	10dB 30W SMA	DOM5CIW3A 1	0.5-18GHz	Calibration from System	Jan. 03, 2024~ Jan. 04, 2024	Calibration from System	CBP (DF02-HY)



Instrument	Brand Name	Model No.	Serial No.	Characteristics	Calibration Date	Test Date	Due Date	Remark
AC Power Source	ACPOWER	AFC-11003G	F317040033	N/A	N/A	Dec. 20, 2023	N/A	Conduction (CO07-HY)
Software	Rohde & Schwarz	EMC32 V10.30	N/A	N/A	N/A	Dec. 20, 2023	N/A	Conduction (CO07-HY)
Pulse Limiter	SCHWARZBECK	VTSD 9561-F N	9561-F N00373	9kHz-200MHz	Oct. 20, 2023	Dec. 20, 2023	Oct. 19, 2024	Conduction (CO07-HY)
RF Cable	HUBER + SUHNER	RG 214/U	1358175	9kHz~30MHz	Mar. 15, 2023	Dec. 20, 2023	Mar. 14, 2024	Conduction (CO07-HY)
Two-Line V-Network	TESEQ	NNB 51	45051	N/A	Mar. 05, 2023	Dec. 20, 2023	Mar. 04, 2024	Conduction (CO07-HY)
Four-Line V-Network	TESEQ	NNB 52	36122	N/A	Mar. 13, 2023	Dec. 20, 2023	Mar. 12, 2024	Conduction (CO07-HY)
EMI Test Receiver	Rohde & Schwarz	ESR3	102317	9kHz~3.6GHz	Sep. 20, 2023	Dec. 20, 2023	Sep. 19, 2024	Conduction (CO07-HY)



## 5 Measurement Uncertainty

### Uncertainty of Conducted Emission Measurement (150kHz ~ 30MHz)

Measuring Uncertainty for a Level of Confidence of 95% ( $U = 2Uc(y)$ )	3.44 dB
-------------------------------------------------------------------------	---------

### Uncertainty of Radiated Emission Measurement (30 MHz ~ 1000 MHz)

Measuring Uncertainty for a Level of Confidence of 95% ( $U = 2Uc(y)$ )	6.40 dB
-------------------------------------------------------------------------	---------

### Uncertainty of Radiated Emission Measurement (1000 MHz ~ 6000 MHz)

Measuring Uncertainty for a Level of Confidence of 95% ( $U = 2Uc(y)$ )	4.50 dB
-------------------------------------------------------------------------	---------

### Uncertainty of Radiated Emission Measurement (6000 MHz ~ 18000 MHz)

Measuring Uncertainty for a Level of Confidence of 95% ( $U = 2Uc(y)$ )	4.60 dB
-------------------------------------------------------------------------	---------

### Uncertainty of Radiated Emission Measurement (18000 MHz ~ 40000 MHz)

Measuring Uncertainty for a Level of Confidence of 95% ( $U = 2Uc(y)$ )	5.40 dB
-------------------------------------------------------------------------	---------

**Appendix A. Test Result of Conducted Test Items**

Test Engineer:	Mina Liu	Temperature:	21~25	°C
Test Date:	2023/11/10~2024/01/18	Relative Humidity:	51~54	%

**TEST RESULTS DATA**  
**26dB and 99% OBW**

U-NII-5 MIMO										
Mod.	Data Rate	N <sub>TX</sub>	CH.	Freq. (MHz)	99% Bandwidth (MHz)		26 dB Bandwidth (MHz)		Emission Bandwidth Limit (MHz)	Pass /Fail
					Ant 6	Ant 7	Ant 6	Ant 7		
11a	6Mbps	2	001	5955	16.73	16.68	19.46	19.37	320.00	Pass
11a	6Mbps	2	049	6195	16.98	16.73	19.62	19.60	320.00	Pass
11a	6Mbps	2	093	6415	17.13	16.73	19.58	19.42	320.00	Pass

**TEST RESULTS DATA**  
**EIRP Power Table**

&lt;CDD Mode&gt;

U-NII-5 MIMO												
Mod.	Data Rate	NTX	CH.	Freq. (MHz)	Conducted Power (dBm)			DG (dBi)		EIRP Power (dBm)	EIRP Power Limit (dBm)	Pass /Fail
					Ant 6	Ant 7	SUM	Ant 6	Ant 7			
11a	6Mbps	2	001	5955	1.50	1.30	4.41	1.78		6.19	24.00	Pass
11a	6Mbps	2	049	6195	0.60	1.70	4.20	1.78		5.98	24.00	Pass
11a	6Mbps	2	093	6415	1.00	1.70	4.37	1.78		6.15	24.00	Pass

**TEST RESULTS DATA**  
**EIRP Power Spectral Density**

U-NII-5 MIMO														
Mod.	Data Rate	NTX	CH.	Freq. (MHz)	Duty Factor (dB)		Conducted Power Density with Duty Factor (dBm/MHz)			DG (dBi)		EIRP Power Density (dBm/MHz)	EIRP Power Density Limit (dBm/MHz)	Pass /Fail
					Ant 6	Ant 7	Ant 6	Ant 7	SUM	Ant 6	Ant 7	SUM		
11a	6Mbps	2	001	5955	0.67	0.67			-6.18	4.73	-1.45	-1.00	Pass	
11a	6Mbps	2	049	6195	0.67	0.67			-6.14	4.73	-1.42	-1.00	Pass	
11a	6Mbps	2	093	6415	0.67	0.67			-6.12	4.73	-1.40	-1.00	Pass	

**TEST RESULTS DATA**  
**26dB and 99% OBW**

U-NII-6 MIMO										
Mod.	Data Rate	NTX	CH.	Freq. (MHz)	99% Bandwidth (MHz)		26 dB Bandwidth (MHz)		Emission Bandwidth Limit (MHz)	Pass /Fail
					Ant 6	Ant 7	Ant 6	Ant 7		
11a	6Mbps	2	097	6435	17.18	16.78	19.61	19.22	320.00	Pass
11a	6Mbps	2	105	6475	16.93	16.93	19.24	19.52	320.00	Pass
11a	6Mbps	2	113	6515	17.13	16.88	19.49	19.47	320.00	Pass



**TEST RESULTS DATA**  
**EIRP Power Table**

U-NII-6 MIMO												
Mod.	Data Rate	NTX	CH.	Freq. (MHz)	Conducted Power (dBm)			DG (dBi)		EIRP Power (dBm)	EIRP Power Limit (dBm)	Pass /Fail
					Ant 6	Ant 7	SUM	Ant 6	Ant 7	SUM		
11a	6Mbps	2	097	6435	1.00	2.20	4.65	1.85		6.50	24.00	Pass
11a	6Mbps	2	105	6475	1.50	1.20	4.36	1.85		6.21	24.00	Pass
11a	6Mbps	2	113	6515	1.60	1.70	4.66	1.85		6.51	24.00	Pass

**TEST RESULTS DATA**  
**EIRP Power Spectral Density**

U-NII-6 MIMO														
Mod.	Data Rate	NTX	CH.	Freq. (MHz)	Duty Factor (dB)		Conducted Power Density with Duty Factor (dBm/MHz)			DG (dBi)		EIRP Power Density (dBm/MHz)	EIRP Power Density Limit (dBm/MHz)	Pass /Fail
					Ant 6	Ant 7	Ant 6	Ant 7	SUM	Ant 6	Ant 7	SUM		
11a	6Mbps	2	097	6435	0.67	0.67			-5.87	4.50	-1.38	-1.00	Pass	
11a	6Mbps	2	105	6475	0.67	0.67			-6.37	4.50	-1.87	-1.00	Pass	
11a	6Mbps	2	113	6515	0.67	0.67			-5.80	4.50	-1.30	-1.00	Pass	

**TEST RESULTS DATA**  
**26dB and 99% OBW**

U-NII-7 MIMO										
Mod.	Data Rate	NTX	CH.	Freq. (MHz)	99% Bandwidth (MHz)		26 dB Bandwidth (MHz)		Emission Bandwidth Limit (MHz)	Pass /Fail
					Ant 6	Ant 7	Ant 6	Ant 7		
11a	6Mbps	2	117	6535	17.08	16.88	19.99	19.37	320.00	Pass
11a	6Mbps	2	149	6695	16.88	16.88	19.58	19.46	320.00	Pass
11a	6Mbps	2	181	6855	17.13	16.83	19.46	19.78	320.00	Pass

U-NII-7 straddle channel MIMO										
Mod.	Data Rate	NTX	CH.	Freq. (MHz)	99% Bandwidth (MHz)		26 dB Bandwidth (MHz)		Emission Bandwidth Limit (MHz)	Pass /Fail
					Ant 6	Ant 7	Ant 6	Ant 7		
11a	6Mbps	2	185	6875	17.18	16.83	19.34	19.30	320.00	Pass

**TEST RESULTS DATA**  
**EIRP Power Table**

U-NII-7 MIMO												
Mod.	Data Rate	NTX	CH.	Freq. (MHz)	Conducted Power (dBm)			DG (dBi)		EIRP Power (dBm)	EIRP Power Limit (dBm)	Pass /Fail
					Ant 6	Ant 7	SUM	Ant 6	Ant 7			
11a	6Mbps	2	117	6535	1.60	1.00	4.32	1.85		6.17	24.00	Pass
11a	6Mbps	2	149	6695	2.00	1.40	4.72	1.85		6.57	24.00	Pass
11a	6Mbps	2	181	6855	1.10	1.50	4.31	1.85		6.16	24.00	Pass

U-NII-7 straddle channel MIMO												
Mod.	Data Rate	NTX	CH.	Freq. (MHz)	Conducted Power (dBm)			DG (dBi)		EIRP Power (dBm)	EIRP Power Limit (dBm)	Pass /Fail
					Ant 6	Ant 7	SUM	Ant 6	Ant 7			
11a	6Mbps	2	185	6875	1.20	1.60	4.41	1.85		6.26	24.00	Pass

**TEST RESULTS DATA**  
**EIRP Power Spectral Density**

U-NII-7 MIMO														
Mod.	Data Rate	NTX	CH.	Freq. (MHz)	Duty Factor (dB)		Conducted Power Density with Duty Factor (dBm/MHz)			DG (dBi)		EIRP Power Density (dBm/MHz)	EIRP Power Density Limit (dBm/MHz)	Pass /Fail
					Ant 6	Ant 7	Ant 6	Ant 7	SUM	Ant 6	Ant 7	SUM		
11a	6Mbps	2	117	6535	0.67	0.67			-6.07	4.58	-1.49	-1.00	Pass	
11a	6Mbps	2	149	6695	0.67	0.67			-5.98	4.58	-1.40	-1.00	Pass	
11a	6Mbps	2	181	6855	0.67	0.67			-5.90	4.58	-1.32	-1.00	Pass	

FCC U-NII-7 straddle channel MIMO														
Mod.	Data Rate	NTX	CH.	Freq. (MHz)	Duty Factor (dB)		Conducted Power Density with Duty Factor (dBm/MHz)			DG (dBi)		EIRP Power Density (dBm/MHz)	EIRP Power Density Limit (dBm/MHz)	Pass /Fail
					Ant 6	Ant 7	Ant 6	Ant 7	SUM	Ant 6	Ant 7	SUM		
11a	6Mbps	2	185	6875	0.67	0.67			-5.86	4.58	-1.28	-1.00	Pass	

**TEST RESULTS DATA**  
**26dB EBW and 99% OBW**

U-NII-8 MIMO										
Mod.	Data Rate	N <sub>TX</sub>	CH.	Freq. (MHz)	99% Bandwidth (MHz)		26 dB Bandwidth (MHz)		Emission Bandwidth Limit (MHz)	Pass /Fail
					Ant 6	Ant 7	Ant 6	Ant 7		
11a	6Mbps	2	189	6895	17.43	16.98	19.65	19.77	320.00	Pass
11a	6Mbps	2	209	6995	16.58	16.53	19.18	18.94	320.00	Pass
11a	6Mbps	2	233	7095	16.48	16.43	19.25	19.45	320.00	Pass
11a	6Mbps	2	233	7115	16.43	16.43	19.40	19.36	320.00	Pass

**TEST RESULTS DATA**  
**EIRP Power Table**

U-NII-8 MIMO												
Mod.	Data Rate	NTX	CH.	Freq. (MHz)	Conducted Power (dBm)			DG (dBi)		EIRP Power (dBm)	EIRP Power Limit (dBm)	Pass /Fail
					Ant 6	Ant 7	SUM	Ant 6	Ant 7			
11a	6Mbps	2	189	6895	1.30	1.80	4.57	1.51		6.08	24.00	Pass
11a	6Mbps	2	209	6995	1.90	1.60	4.76	1.51		6.27	24.00	Pass
11a	6Mbps	2	229	7095	1.80	1.70	4.76	1.51		6.27	24.00	Pass
11a	6Mbps	2	233	7115	2.20	1.50	4.87	1.51		6.38	24.00	Pass

**TEST RESULTS DATA**  
**EIRP Power Spectral Density**

U-NII-8 MIMO														
Mod.	Data Rate	NTX	CH.	Freq. (MHz)	Duty Factor (dB)		Conducted Power Density with Duty Factor (dBm/MHz)			DG (dBi)		EIRP Power Density (dBm/MHz)	EIRP Power Density Limit (dBm/MHz)	Pass /Fail
					Ant 6	Ant 7	Ant 6	Ant 7	SUM	Ant 6	Ant 7	SUM		
11a	6Mbps	2	189	6895	0.67	0.67			-5.66		4.11	-1.55	-1.00	Pass
11a	6Mbps	2	209	6995	0.67	0.67			-5.39		4.11	-1.28	-1.00	Pass
11a	6Mbps	2	229	7095	0.67	0.67			-5.67		4.11	-1.56	-1.00	Pass
11a	6Mbps	2	233	7115	0.67	0.67			-5.75		4.11	-1.64	-1.00	Pass



**TEST RESULTS DATA**  
**26dB and 99% OBW**

&lt;SDM Mode&gt;

U-NII-5 MIMO											
Mod.	Data Rate	NTX	CH.	Freq. (MHz)	RU Config.	99% Bandwidth (MHz)		26 dB Bandwidth (MHz)		Emission Bandwidth Limit (MHz)	Pass /Fail
						Ant 6	Ant 7	Ant 6	Ant 7		
HE20	MCS0	2	001	5955	Full	18.93	18.93	21.02	20.89	320.00	Pass
HE20	MCS0	2	049	6195	Full	18.93	18.93	21.15	21.23	320.00	Pass
HE20	MCS0	2	093	6415	Full	18.98	18.93	21.17	21.14	320.00	Pass
HE40	MCS0	2	003	5965	Full	37.86	37.86	41.38	41.28	320.00	Pass
HE40	MCS0	2	051	6205	Full	37.86	37.86	41.62	41.25	320.00	Pass
HE40	MCS0	2	091	6405	Full	37.86	37.86	41.84	40.93	320.00	Pass
HE80	MCS0	2	007	5985	Full	76.96	76.96	81.70	81.76	320.00	Pass
HE80	MCS0	2	055	6225	Full	76.96	76.84	81.63	81.66	320.00	Pass
HE80	MCS0	2	087	6385	Full	76.96	76.84	82.14	81.79	320.00	Pass
HE160	MCS0	2	015	6025	Full	155.84	155.60	167.09	166.03	320.00	Pass
HE160	MCS0	2	047	6185	Full	156.08	155.84	164.78	165.07	320.00	Pass
HE160	MCS0	2	079	6345	Full	155.60	155.60	165.65	166.46	320.00	Pass

**TEST RESULTS DATA**  
**EIRP Power Table**

U-NII-5 MIMO													
Mod.	Data Rate	NTX	CH.	Freq. (MHz)	RU Config.	Conducted Power (dBm)			DG (dBi)		EIRP Power (dBm)	EIRP Power Limit (dBm)	Pass /Fail
						Ant 6	Ant 7	SUM	Ant 6	Ant 7			
HE20	MCS0	2	001	5955	Full	5.10	5.60	8.37	1.78		10.15	24.00	Pass
HE20	MCS0	2	001	5955	26/0	-3.40	-2.90	-0.13	1.78		1.65	24.00	Pass
HE20	MCS0	2	001	5955	52/37	-0.90	-1.40	1.87	1.78		3.65	24.00	Pass
HE20	MCS0	2	001	5955	106/53	2.10	3.00	5.58	1.78		7.36	24.00	Pass
HE20	MCS0	2	049	6195	Full	4.90	5.00	7.96	1.78		9.74	24.00	Pass
HE20	MCS0	2	049	6195	26/4	-2.20	-1.20	1.34	1.78		3.12	24.00	Pass
HE20	MCS0	2	049	6195	52/38	-1.40	0.60	2.72	1.78		4.50	24.00	Pass
HE20	MCS0	2	049	6195	106/53	3.10	3.30	6.21	1.78		7.99	24.00	Pass
HE20	MCS0	2	093	6415	Full	4.10	4.70	7.42	1.78		9.20	24.00	Pass
HE20	MCS0	2	093	6415	26/8	-3.40	-2.60	0.03	1.78		1.81	24.00	Pass
HE20	MCS0	2	093	6415	52/40	-0.70	0.10	2.73	1.78		4.51	24.00	Pass
HE20	MCS0	2	093	6415	106/54	2.00	2.80	5.43	1.78		7.21	24.00	Pass
HE40	MCS0	2	003	5965	Full	7.40	7.10	10.26	1.78		12.04	24.00	Pass
HE40	MCS0	2	003	5965	242/61	5.10	5.70	8.42	1.78		10.20	24.00	Pass
HE40	MCS0	2	051	6205	Full	7.70	7.30	10.51	1.78		12.29	24.00	Pass
HE40	MCS0	2	051	6205	242/61	5.60	5.80	8.71	1.78		10.49	24.00	Pass
HE40	MCS0	2	091	6405	Full	7.10	7.20	10.16	1.78		11.94	24.00	Pass
HE40	MCS0	2	091	6405	242/62	5.00	5.80	8.43	1.78		10.21	24.00	Pass
HE80	MCS0	2	007	5985	Full	9.80	9.40	12.61	1.78		14.39	24.00	Pass
HE80	MCS0	2	007	5985	484/65	7.20	7.70	10.47	1.78		12.25	24.00	Pass
HE80	MCS0	2	055	6225	Full	9.90	9.50	12.71	1.78		14.49	24.00	Pass
HE80	MCS0	2	055	6225	484/65	7.20	7.10	10.16	1.78		11.94	24.00	Pass
HE80	MCS0	2	087	6385	Full	9.60	9.00	12.32	1.78		14.10	24.00	Pass
HE80	MCS0	2	087	6385	484/66	6.50	7.10	9.82	1.78		11.60	24.00	Pass
HE160	MCS0	2	015	6025	Full	13.00	12.50	15.77	1.78		17.55	24.00	Pass
HE160	MCS0	2	015	6025	996/67	12.10	11.70	14.91	1.78		16.69	24.00	Pass
HE160	MCS0	2	047	6185	Full	13.10	12.60	15.87	1.78		17.65	24.00	Pass
HE160	MCS0	2	047	6185	996/67	12.20	11.80	15.01	1.78		16.79	24.00	Pass
HE160	MCS0	2	079	6345	Full	12.60	12.00	15.32	1.78		17.10	24.00	Pass
HE160	MCS0	2	079	6345	996/S67	11.60	11.30	14.46	1.78		16.24	24.00	Pass

**TEST RESULTS DATA**  
**EIRP Power Spectral Density**

U-NII-5 MIMO															
Mod.	Data Rate	NTX	CH.	Freq. (MHz)	RU Config.	Duty Factor (dB)		Conducted Power Density (dBm/MHz)			DG (dBi)		EIRP Power Density (dBm/MHz)	EIRP Power Density Limit (dBm/MHz)	Pass /Fail
						Ant 6	Ant 7	Ant 6	Ant 7	SUM	Ant 6	Ant 7	SUM		
HE20	MCS0	2	001	5955	Full	0.60	0.60			-3.02	1.72	-1.30	-1.00	Pass	
HE20	MCS0	2	001	5955	26/0	0.64	0.64			-3.26	1.72	-1.54	-1.00	Pass	
HE20	MCS0	2	001	5955	52/37	0.64	0.64			-4.10	1.72	-2.38	-1.00	Pass	
HE20	MCS0	2	001	5955	106/53	0.67	0.67			-3.50	1.72	-1.78	-1.00	Pass	
HE20	MCS0	2	049	6195	Full	0.60	0.60			-2.83	1.72	-1.11	-1.00	Pass	
HE20	MCS0	2	049	6195	26/4	0.64	0.64			-3.07	1.72	-1.35	-1.00	Pass	
HE20	MCS0	2	049	6195	52/38	0.64	0.64			-3.43	1.72	-1.71	-1.00	Pass	
HE20	MCS0	2	049	6195	106/53	0.67	0.67			-2.88	1.72	-1.16	-1.00	Pass	
HE20	MCS0	2	093	6415	Full	0.60	0.60			-2.79	1.72	-1.07	-1.00	Pass	
HE20	MCS0	2	093	6415	26/8	0.64	0.64			-3.06	1.72	-1.34	-1.00	Pass	
HE20	MCS0	2	093	6415	52/40	0.64	0.64			-3.01	1.72	-1.29	-1.00	Pass	
HE20	MCS0	2	093	6415	106/54	0.67	0.67			-3.14	1.72	-1.42	-1.00	Pass	
HE40	MCS0	2	003	5965	Full	0.60	0.60			-3.56	1.72	-1.84	-1.00	Pass	
HE40	MCS0	2	003	5965	242/61	0.66	0.67			-3.95	1.72	-2.23	-1.00	Pass	
HE40	MCS0	2	051	6205	Full	0.60	0.60			-3.59	1.72	-1.87	-1.00	Pass	
HE40	MCS0	2	051	6205	242/61	0.66	0.67			-4.00	1.72	-2.28	-1.00	Pass	
HE40	MCS0	2	091	6405	Full	0.60	0.60			-3.51	1.72	-1.79	-1.00	Pass	
HE40	MCS0	2	091	6405	242/62	0.66	0.67			-3.76	1.72	-2.04	-1.00	Pass	
HE80	MCS0	2	007	5985	Full	0.65	0.60			-4.09	1.72	-2.37	-1.00	Pass	
HE80	MCS0	2	007	5985	484/65	0.66	0.66			-4.41	1.72	-2.69	-1.00	Pass	
HE80	MCS0	2	055	6225	Full	0.65	0.60			-4.50	1.72	-2.78	-1.00	Pass	
HE80	MCS0	2	055	6225	484/65	0.66	0.66			-4.63	1.72	-2.91	-1.00	Pass	
HE80	MCS0	2	087	6385	Full	0.65	0.60			-4.59	1.72	-2.87	-1.00	Pass	
HE80	MCS0	2	087	6385	484/66	0.66	0.66			-4.92	1.72	-3.20	-1.00	Pass	
HE160	MCS0	2	015	6025	Full	0.62	0.60			-3.39	1.72	-1.67	-1.00	Pass	
HE160	MCS0	2	015	6025	996/67	0.66	0.69			-3.81	1.72	-2.09	-1.00	Pass	
HE160	MCS0	2	047	6185	Full	0.62	0.60			-3.38	1.72	-1.66	-1.00	Pass	
HE160	MCS0	2	047	6185	996/67	0.66	0.69			-3.60	1.72	-1.88	-1.00	Pass	
HE160	MCS0	2	079	6345	Full	0.62	0.60			-3.40	1.72	-1.68	-1.00	Pass	
HE160	MCS0	2	079	6345	996/S67	0.66	0.69			-3.88	1.72	-2.16	-1.00	Pass	

**TEST RESULTS DATA**  
**26dB and 99% OBW**

U-NII-6 MIMO											
Mod.	Data Rate	NTx	CH.	Freq. (MHz)	RU Config.	99% Bandwidth (MHz)		26 dB Bandwidth (MHz)		Emission Bandwidth Limit (MHz)	Pass /Fail
						Ant 6	Ant 7	Ant 6	Ant 7		
HE20	MCS0	2	097	6435	Full	18.93	18.93	20.97	21.11	320.00	Pass
HE20	MCS0	2	105	6475	Full	18.98	18.93	21.02	21.25	320.00	Pass
HE20	MCS0	2	113	6515	Full	18.93	18.93	21.25	21.06	320.00	Pass
HE40	MCS0	2	099	6445	Full	37.96	37.86	41.14	41.42	320.00	Pass
HE40	MCS0	2	107	6485	Full	37.96	37.86	41.23	40.98	320.00	Pass
HE80	MCS0	2	103	6465	Full	76.72	76.96	81.88	82.02	320.00	Pass

U-NII-6 straddle channel MIMO											
Mod.	Data Rate	NTx	CH.	Freq. (MHz)	RU Config.	99% Bandwidth (MHz)		26 dB Bandwidth (MHz)		Emission Bandwidth Limit (MHz)	Pass /Fail
						Ant 6	Ant 7	Ant 6	Ant 7		
HE40	MCS0	2	115	6525	Full	38.06	37.86	41.42	41.57	320.00	Pass
HE80	MCS0	2	119	6545	Full	76.72	76.84	81.66	81.98	320.00	Pass
HE160	MCS0	2	111	6505	Full	156.32	155.84	166.37	164.98	320.00	Pass

**TEST RESULTS DATA**  
**EIRP Power Table**

U-NII-6 MIMO													
Mod.	Data Rate	NTX	CH.	Freq. (MHz)	RU Config	Conducted Power (dBm)			DG (dBi)		EIRP Power (dBm)	EIRP Power Limit (dBm)	Pass /Fail
						Ant 6	Ant 7	SUM	Ant 6	Ant 7			
HE20	MCS0	2	097	6435	Full	4.20	4.30	7.26	1.85		9.11	24.00	Pass
HE20	MCS0	2	097	6435	26/0	-4.60	-3.60	-1.06	1.85		0.79	24.00	Pass
HE20	MCS0	2	097	6435	52/37	-1.30	-0.80	1.97	1.85		3.82	24.00	Pass
HE20	MCS0	2	097	6435	106/53	1.80	2.70	5.28	1.85		7.13	24.00	Pass
HE20	MCS0	2	105	6475	Full	4.60	4.30	7.46	1.85		9.31	24.00	Pass
HE20	MCS0	2	105	6475	26/4	-3.40	-2.70	-0.03	1.85		1.82	24.00	Pass
HE20	MCS0	2	105	6475	52/38	-0.70	-2.20	1.62	1.85		3.47	24.00	Pass
HE20	MCS0	2	105	6475	106/53	2.00	2.60	5.32	1.85		7.17	24.00	Pass
HE20	MCS0	2	113	6515	Full	4.40	4.20	7.31	1.85		9.16	24.00	Pass
HE20	MCS0	2	113	6515	26/8	-4.20	-3.80	-0.99	1.85		0.86	24.00	Pass
HE20	MCS0	2	113	6515	52/40	-1.30	-0.60	2.07	1.85		3.92	24.00	Pass
HE20	MCS0	2	113	6515	106/54	1.60	2.20	4.92	1.85		6.77	24.00	Pass
HE40	MCS0	2	099	6445	Full	7.20	6.90	10.06	1.85		11.91	24.00	Pass
HE40	MCS0	2	099	6445	242/61	5.00	5.50	8.27	1.85		10.12	24.00	Pass
HE40	MCS0	2	107	6485	Full	7.60	7.40	10.51	1.85		12.36	24.00	Pass
HE40	MCS0	2	107	6485	242/62	5.20	5.70	8.47	1.85		10.32	24.00	Pass
HE80	MCS0	2	103	6465	Full	9.50	8.70	12.13	1.85		13.98	24.00	Pass
HE80	MCS0	2	103	6465	484/65	6.60	7.50	10.08	1.85		11.93	24.00	Pass

U-NII-6 straddle channel MIMO													
Mod.	Data Rate	NTX	CH.	Freq. (MHz)	RU Config	Conducted Power (dBm)			DG (dBi)		EIRP Power (dBm)	EIRP Power Limit (dBm)	Pass /Fail
						Ant 6	Ant 7	SUM	Ant 6	Ant 7			
HE40	MCS0	2	115	6525	Full	7.70	7.10	10.42	1.85		12.27	24.00	Pass
HE40	MCS0	2	115	6525	242/62	4.80	5.50	8.17	1.85		10.02	24.00	Pass
HE80	MCS0	2	119	6545	Full	10.20	9.20	12.74	1.85		14.59	24.00	Pass
HE80	MCS0	2	119	6545	484/65	7.40	8.00	10.72	1.85		12.57	24.00	Pass
HE160	MCS0	2	111	6505	Full	12.90	12.00	15.48	1.85		17.33	24.00	Pass
HE160	MCS0	2	111	6505	996/67	12.00	11.30	14.67	1.85		16.52	24.00	Pass
HE160	MCS0	2	111	6505	996/S67	11.70	11.50	14.61	1.85		16.46	24.00	Pass

**TEST RESULTS DATA**  
**EIRP Power Spectral Density**

U-NII-6 MIMO															
Mod.	Data Rate	NTX	CH.	Freq. (MHz)	RU Config.	Duty Factor (dB)		Conducted Power Density (dBm/MHz)			DG (dBi)		EIRP Power Density (dBm/MHz)	EIRP Power Density Limit (dBm/MHz)	Pass /Fail
						Ant 6	Ant 7	Ant 6	Ant 7	SUM	Ant 6	Ant 7	SUM		
HE20	MCS0	2	097	6435	Full	0.60	0.60			-2.62	1.50	-1.12	-1.00	Pass	
HE20	MCS0	2	097	6435	26/0	0.64	0.64			-3.04	1.50	-1.54	-1.00	Pass	
HE20	MCS0	2	097	6435	52/37	0.64	0.64			-3.14	1.50	-1.64	-1.00	Pass	
HE20	MCS0	2	097	6435	106/53	0.67	0.67			-2.94	1.50	-1.44	-1.00	Pass	
HE20	MCS0	2	105	6475	Full	0.60	0.60			-2.95	1.50	-1.45	-1.00	Pass	
HE20	MCS0	2	105	6475	26/4	0.64	0.64			-3.40	1.50	-1.90	-1.00	Pass	
HE20	MCS0	2	105	6475	52/38	0.64	0.64			-3.56	1.50	-2.06	-1.00	Pass	
HE20	MCS0	2	105	6475	106/53	0.67	0.67			-3.19	1.50	-1.69	-1.00	Pass	
HE20	MCS0	2	113	6515	Full	0.60	0.60			-2.82	1.50	-1.32	-1.00	Pass	
HE20	MCS0	2	113	6515	26/8	0.64	0.64			-3.12	1.50	-1.62	-1.00	Pass	
HE20	MCS0	2	113	6515	52/40	0.64	0.64			-2.87	1.50	-1.37	-1.00	Pass	
HE20	MCS0	2	113	6515	106/54	0.67	0.67			-3.33	1.50	-1.83	-1.00	Pass	
HE40	MCS0	2	099	6445	Full	0.60	0.60			-3.46	1.50	-1.96	-1.00	Pass	
HE40	MCS0	2	099	6445	242/61	0.66	0.67			-3.61	1.50	-2.11	-1.00	Pass	
HE40	MCS0	2	107	6485	Full	0.60	0.60			-3.39	1.50	-1.89	-1.00	Pass	
HE40	MCS0	2	107	6485	242/62	0.66	0.67			-3.44	1.50	-1.94	-1.00	Pass	
HE80	MCS0	2	103	6465	Full	0.65	0.60			-4.49	1.50	-2.99	-1.00	Pass	
HE80	MCS0	2	103	6465	484/65	0.66	0.66			-4.88	1.50	-3.38	-1.00	Pass	

U-NII-6 straddle channel MIMO															
Mod.	Data Rate	NTX	CH.	Freq. (MHz)	RU Config.	Duty Factor (dB)		Conducted Power Density (dBm/MHz)			DG (dBi)		EIRP Power Density (dBm/MHz)	EIRP Power Density Limit (dBm/MHz)	Pass /Fail
						Ant 6	Ant 7	Ant 6	Ant 7	SUM	Ant 6	Ant 7	SUM		
HE40	MCS0	2	115	6525	Full	0.60	0.60			-3.66	1.50	-2.16	-1.00	Pass	
HE40	MCS0	2	115	6525	242/62	0.66	0.67			-3.91	1.50	-2.41	-1.00	Pass	
HE80	MCS0	2	119	6545	Full	0.65	0.60			-3.97	1.50	-2.47	-1.00	Pass	
HE80	MCS0	2	119	6545	484/65	0.66	0.66			-4.57	1.50	-3.07	-1.00	Pass	
HE160	MCS0	2	111	6505	Full	0.62	0.60			-3.47	1.50	-1.97	-1.00	Pass	
HE160	MCS0	2	111	6505	996/67	0.66	0.69			-3.62	1.50	-2.12	-1.00	Pass	
HE160	MCS0	2	111	6505	996/S67	0.66	0.69			-3.63	1.50	-2.13	-1.00	Pass	

**TEST RESULTS DATA**  
**26dB and 99% OBW**

U-NII-7 MIMO											
Mod.	Data Rate	NTX	CH.	Freq. (MHz)	RU Config.	99% Bandwidth (MHz)		26 dB Bandwidth (MHz)		Emission Bandwidth Limit (MHz)	Pass /Fail
						Ant 6	Ant 7	Ant 6	Ant 7		
HE20	MCS0	2	117	6535	Full	18.93	18.93	20.95	20.89	320.00	Pass
HE20	MCS0	2	149	6695	Full	18.88	18.93	20.87	20.93	320.00	Pass
HE20	MCS0	2	181	6855	Full	18.93	18.93	20.82	20.84	320.00	Pass
HE40	MCS0	2	123	6565	Full	37.86	37.96	41.56	41.10	320.00	Pass
HE40	MCS0	2	147	6685	Full	37.96	37.96	41.46	41.54	320.00	Pass
HE40	MCS0	2	179	6845	Full	37.96	37.96	41.28	41.39	320.00	Pass
HE80	MCS0	2	135	6625	Full	76.84	76.96	82.50	82.18	320.00	Pass
HE80	MCS0	2	151	6705	Full	76.96	76.84	81.50	81.73	320.00	Pass
HE80	MCS0	2	167	6785	Full	76.96	76.84	81.86	81.47	320.00	Pass
HE160	MCS0	2	143	6665	Full	156.08	156.08	165.46	164.88	320.00	Pass

U-NII-7 straddle channel MIMO											
Mod.	Data Rate	NTX	CH.	Freq. (MHz)	RU Config.	99% Bandwidth (MHz)		26 dB Bandwidth (MHz)		Emission Bandwidth Limit (MHz)	Pass /Fail
						Ant 6	Ant 7	Ant 6	Ant 7		
HE20	MCS0	2	185	6875	Full	18.98	18.93	21.22	20.95	320.00	Pass
HE40	MCS0	2	187	6885	Full	38.06	37.86	41.71	41.15	320.00	Pass
HE80	MCS0	2	183	6865	Full	76.84	76.96	81.18	82.62	320.00	Pass
HE160	MCS0	2	175	6825	Full	156.08	155.60	165.41	163.87	320.00	Pass

**TEST RESULTS DATA**  
**EIRP Power Table**

U-NII-7 MIMO													
Mod.	Data Rate	NTX	CH.	Freq. (MHz)	RU Config.	Conducted Power (dBm)			DG (dBi)		EIRP Power (dBm)	EIRP Power Limit (dBm)	Pass /Fail
						Ant 6	Ant 7	SUM	Ant 6	Ant 7			
HE20	MCS0	2	117	6535	Full	4.60	4.10	7.37	1.85		9.22	24.00	Pass
HE20	MCS0	2	117	6535	26/0	-4.10	-3.80	-0.94	1.85		0.91	24.00	Pass
HE20	MCS0	2	117	6535	52/37	-0.90	-1.20	1.96	1.85		3.81	24.00	Pass
HE20	MCS0	2	117	6535	106/53	2.20	2.30	5.26	1.85		7.11	24.00	Pass
HE20	MCS0	2	149	6695	Full	5.00	4.40	7.72	1.85		9.57	24.00	Pass
HE20	MCS0	2	149	6695	26/4	-2.40	-3.50	0.10	1.85		1.95	24.00	Pass
HE20	MCS0	2	149	6695	52/38	-0.50	-1.80	1.91	1.85		3.76	24.00	Pass
HE20	MCS0	2	149	6695	106/53	2.00	1.50	4.77	1.85		6.62	24.00	Pass
HE20	MCS0	2	181	6855	Full	4.60	4.90	7.76	1.85		9.61	24.00	Pass
HE20	MCS0	2	181	6855	26/8	-3.80	-3.80	-0.79	1.85		1.06	24.00	Pass
HE20	MCS0	2	181	6855	52/40	-0.70	-1.00	2.16	1.85		4.01	24.00	Pass
HE20	MCS0	2	181	6855	106/54	1.70	2.20	4.97	1.85		6.82	24.00	Pass
HE40	MCS0	2	123	6565	Full	8.00	7.50	10.77	1.85		12.62	24.00	Pass
HE40	MCS0	2	123	6565	242/61	5.20	5.90	8.57	1.85		10.42	24.00	Pass
HE40	MCS0	2	147	6685	Full	8.00	7.00	10.54	1.85		12.39	24.00	Pass
HE40	MCS0	2	147	6685	242/61	5.60	5.30	8.46	1.85		10.31	24.00	Pass
HE40	MCS0	2	179	6845	Full	8.00	7.20	10.63	1.85		12.48	24.00	Pass
HE40	MCS0	2	179	6845	242/62	4.70	5.70	8.24	1.85		10.09	24.00	Pass
HE80	MCS0	2	135	6625	Full	10.10	9.10	12.64	1.85		14.49	24.00	Pass
HE80	MCS0	2	135	6625	484/65	7.40	7.70	10.56	1.85		12.41	24.00	Pass
HE80	MCS0	2	151	6705	Full	10.00	9.10	12.58	1.85		14.43	24.00	Pass
HE80	MCS0	2	151	6705	484/65	7.60	7.70	10.66	1.85		12.51	24.00	Pass
HE80	MCS0	2	167	6785	Full	10.20	9.30	12.78	1.85		14.63	24.00	Pass
HE80	MCS0	2	167	6785	484/66	7.50	8.10	10.82	1.85		12.67	24.00	Pass
HE160	MCS0	2	143	6665	Full	13.00	12.00	15.54	1.85		17.39	24.00	Pass
HE160	MCS0	2	143	6665	996/67	11.90	11.40	14.67	1.85		16.52	24.00	Pass

U-NII-7 straddle channel MIMO													
Mod.	Data Rate	NTX	CH.	Freq. (MHz)	RU Config.	Conducted Power (dBm)			DG (dBi)		EIRP Power (dBm)	EIRP Power Limit (dBm)	Pass /Fail
						Ant 6	Ant 7	SUM	Ant 6	Ant 7			
HE20	MCS0	2	185	6875	Full	4.90	5.00	7.96	1.85		9.81	24.00	Pass
HE20	MCS0	2	185	6875	26/8	-3.90	-3.60	-0.74	1.85		1.11	24.00	Pass
HE20	MCS0	2	185	6875	52/40	-1.40	-1.00	1.81	1.85		3.66	24.00	Pass
HE20	MCS0	2	185	6875	106/54	1.80	2.40	5.12	1.85		6.97	24.00	Pass
HE40	MCS0	2	187	6885	Full	7.80	7.20	10.52	1.85		12.37	24.00	Pass
HE40	MCS0	2	187	6885	242/62	4.40	5.10	7.77	1.85		9.62	24.00	Pass
HE80	MCS0	2	183	6865	Full	10.30	9.80	13.07	1.85		14.92	24.00	Pass
HE80	MCS0	2	183	6865	484/66	7.80	8.40	11.12	1.85		12.97	24.00	Pass
HE160	MCS0	2	175	6825	Full	13.10	12.50	15.82	1.85		17.67	24.00	Pass
HE160	MCS0	2	175	6825	996/67	11.50	11.60	14.56	1.85		16.41	24.00	Pass
HE160	MCS0	2	175	6825	996/S67	11.60	11.60	14.61	1.85		16.46	24.00	Pass



**TEST RESULTS DATA**  
**EIRP Power Spectral Density**

U-NII-7 MIMO															
Mod.	Data Rate	NTX	CH.	Freq. (MHz)	RU Config.	Duty Factor (dB)		Conducted Power Density (dBm/MHz)			DG (dBi)		EIRP Power Density (dBm/MHz)	EIRP Power Density Limit (dBm/MHz)	Pass /Fail
						Ant 6	Ant 7	Ant 6	Ant 7	SUM	Ant 6	Ant 7	SUM		
HE20	MCS0	2	117	6535	Full	0.60	0.60			-2.91	1.57	-1.34	-1.00	Pass	
HE20	MCS0	2	117	6535	26/0	0.64	0.64			-3.56	1.57	-1.99	-1.00	Pass	
HE20	MCS0	2	117	6535	52/37	0.64	0.64			-3.29	1.57	-1.72	-1.00	Pass	
HE20	MCS0	2	117	6535	106/53	0.67	0.67			-3.10	1.57	-1.53	-1.00	Pass	
HE20	MCS0	2	149	6695	Full	0.60	0.60			-3.29	1.57	-1.72	-1.00	Pass	
HE20	MCS0	2	149	6695	26/4	0.64	0.64			-3.50	1.57	-1.93	-1.00	Pass	
HE20	MCS0	2	149	6695	52/38	0.64	0.64			-3.37	1.57	-1.80	-1.00	Pass	
HE20	MCS0	2	149	6695	106/53	0.67	0.67			-3.58	1.57	-2.01	-1.00	Pass	
HE20	MCS0	2	181	6855	Full	0.60	0.60			-2.95	1.57	-1.38	-1.00	Pass	
HE20	MCS0	2	181	6855	26/8	0.64	0.64			-3.39	1.57	-1.82	-1.00	Pass	
HE20	MCS0	2	181	6855	52/40	0.64	0.64			-3.15	1.57	-1.58	-1.00	Pass	
HE20	MCS0	2	181	6855	106/54	0.67	0.67			-3.19	1.57	-1.62	-1.00	Pass	
HE40	MCS0	2	123	6565	Full	0.60	0.60			-3.04	1.57	-1.47	-1.00	Pass	
HE40	MCS0	2	123	6565	242/61	0.66	0.67			-3.53	1.57	-1.96	-1.00	Pass	
HE40	MCS0	2	147	6685	Full	0.60	0.60			-3.23	1.57	-1.66	-1.00	Pass	
HE40	MCS0	2	147	6685	242/61	0.66	0.67			-3.27	1.57	-1.70	-1.00	Pass	
HE40	MCS0	2	179	6845	Full	0.60	0.60			-3.45	1.57	-1.88	-1.00	Pass	
HE40	MCS0	2	179	6845	242/62	0.66	0.67			-3.65	1.57	-2.08	-1.00	Pass	
HE80	MCS0	2	135	6625	Full	0.65	0.60			-4.33	1.57	-2.76	-1.00	Pass	
HE80	MCS0	2	135	6625	484/65	0.66	0.66			-4.44	1.57	-2.87	-1.00	Pass	
HE80	MCS0	2	151	6705	Full	0.65	0.60			-4.01	1.57	-2.44	-1.00	Pass	
HE80	MCS0	2	151	6705	484/65	0.66	0.66			-4.50	1.57	-2.93	-1.00	Pass	
HE80	MCS0	2	167	6785	Full	0.65	0.60			-4.22	1.57	-2.65	-1.00	Pass	
HE80	MCS0	2	167	6785	484/66	0.66	0.66			-4.47	1.57	-2.90	-1.00	Pass	
HE160	MCS0	2	143	6665	Full	0.62	0.60			-3.47	1.57	-1.90	-1.00	Pass	
HE160	MCS0	2	143	6665	996/67	0.66	0.69			-3.97	1.57	-2.40	-1.00	Pass	

U-NII-7 straddle channel MIMO															
Mod.	Data Rate	NTX	CH.	Freq. (MHz)	RU Config.	Duty Factor (dB)		Conducted Power Density (dBm/MHz)			DG (dBi)		EIRP Power Density (dBm/MHz)	EIRP Power Density Limit (dBm/MHz)	Pass /Fail
						Ant 6	Ant 7	Ant 6	Ant 7	SUM	Ant 6	Ant 7	SUM		
HE20	MCS0	2	185	6875	Full	0.60	0.60			-3.08	1.57	-1.51	-1.00	Pass	
HE20	MCS0	2	185	6875	26/8	0.64	0.64			-3.26	1.57	-1.69	-1.00	Pass	
HE20	MCS0	2	185	6875	52/40	0.64	0.64			-3.54	1.57	-1.97	-1.00	Pass	
HE20	MCS0	2	185	6875	106/54	0.67	0.67			-3.30	1.57	-1.73	-1.00	Pass	
HE40	MCS0	2	187	6885	Full	0.60	0.60			-3.38	1.57	-1.81	-1.00	Pass	
HE40	MCS0	2	187	6885	242/62	0.66	0.67			-3.60	1.57	-2.03	-1.00	Pass	
HE80	MCS0	2	183	6865	Full	0.65	0.60			-3.92	1.57	-2.35	-1.00	Pass	
HE80	MCS0	2	183	6865	484/66	0.66	0.66			-4.41	1.57	-2.84	-1.00	Pass	
HE160	MCS0	2	175	6825	Full	0.62	0.60			-3.48	1.57	-1.91	-1.00	Pass	
HE160	MCS0	2	175	6825	996/67	0.66	0.69			-3.89	1.57	-2.32	-1.00	Pass	
HE160	MCS0	2	175	6825	996/S67	0.66	0.69			-3.90	1.57	-2.33	-1.00	Pass	

**TEST RESULTS DATA**  
**26dB EBW and 99% OBW**

U-NII-8 MIMO											
Mod.	Data Rate	NTX	CH.	Freq. (MHz)	RU Config.	99% Bandwidth (MHz)		26 dB Bandwidth (MHz)		Emission Bandwidth Limit (MHz)	Pass /Fail
						Ant 6	Ant 7	Ant 6	Ant 7		
HE20	MCS0	2	189	6895	Full	18.98	18.93	20.77	20.89	320.00	Pass
HE20	MCS0	2	209	6995	Full	18.93	18.88	20.86	20.45	320.00	Pass
HE20	MCS0	2	233	7095	Full	18.88	18.83	20.98	20.96	320.00	Pass
HE20	MCS0	2	233	7115	Full	18.88	18.83	20.90	20.59	320.00	Pass
HE40	MCS0	2	195	6925	Full	37.96	37.96	41.15	41.15	320.00	Pass
HE40	MCS0	2	211	7005	Full	37.96	37.86	41.55	40.85	320.00	Pass
HE40	MCS0	2	227	7085	Full	37.76	37.76	41.10	41.14	320.00	Pass
HE80	MCS0	2	199	6945	Full	76.72	76.96	81.54	81.54	320.00	Pass
HE80	MCS0	2	215	7025	Full	76.84	76.72	80.90	81.63	320.00	Pass
HE160	MCS0	2	207	6985	Full	156.08	155.84	165.84	163.68	320.00	Pass

**TEST RESULTS DATA**  
**EIRP Power Table**

U-NII-8 MIMO													
Mod.	Data Rate	NTX	CH.	Freq. (MHz)	RU Config.	Conducted Power (dBm)			DG (dBi)		EIRP Power (dBm)	EIRP Power Limit (dBm)	Pass /Fail
						Ant 6	Ant 7	SUM	Ant 6	Ant 7			
HE20	MCS0	2	189	6895	Full	5.20	5.10	8.16	1.51		9.67	24.00	Pass
HE20	MCS0	2	189	6895	26/0	-3.40	-3.70	-0.54	1.51		0.97	24.00	Pass
HE20	MCS0	2	189	6895	52/37	-1.30	-0.80	1.97	1.51		3.48	24.00	Pass
HE20	MCS0	2	189	6895	106/53	1.60	2.20	4.92	1.51		6.43	24.00	Pass
HE20	MCS0	2	209	6995	Full	5.50	4.50	8.04	1.51		9.55	24.00	Pass
HE20	MCS0	2	209	6995	26/4	-2.70	-3.10	0.11	1.51		1.62	24.00	Pass
HE20	MCS0	2	209	6995	52/38	-1.10	-0.90	2.01	1.51		3.52	24.00	Pass
HE20	MCS0	2	209	6995	106/53	2.00	2.30	5.16	1.51		6.67	24.00	Pass
HE20	MCS0	2	229	7095	Full	6.10	5.70	8.61	1.51		10.12	24.00	Pass
HE20	MCS0	2	229	7095	26/8	-2.70	-3.30	0.02	1.51		1.53	24.00	Pass
HE20	MCS0	2	229	7095	52/40	-0.40	-0.50	2.22	1.51		3.73	24.00	Pass
HE20	MCS0	2	229	7095	106/54	2.60	2.80	5.43	1.51		6.94	24.00	Pass
HE20	MCS0	2	233	7115	Full	6.10	5.00	8.60	1.51		10.11	24.00	Pass
HE20	MCS0	2	233	7115	26/8	-2.20	-3.10	0.38	1.51		1.89	24.00	Pass
HE20	MCS0	2	233	7115	52/40	0.30	-0.30	3.02	1.51		4.53	24.00	Pass
HE20	MCS0	2	233	7115	106/54	1.10	0.30	3.73	1.51		5.24	24.00	Pass
HE40	MCS0	2	195	6925	Full	8.10	7.10	10.64	1.51		12.15	24.00	Pass
HE40	MCS0	2	195	6925	242/61	4.70	5.30	8.02	1.51		9.53	24.00	Pass
HE40	MCS0	2	211	7005	Full	7.90	6.70	10.35	1.51		11.86	24.00	Pass
HE40	MCS0	2	211	7005	242/62	5.30	5.30	8.31	1.51		9.82	24.00	Pass
HE40	MCS0	2	227	7085	Full	7.50	6.50	10.04	1.51		11.55	24.00	Pass
HE40	MCS0	2	227	7085	242/62	4.90	4.40	7.67	1.51		9.18	24.00	Pass
HE80	MCS0	2	199	6945	Full	10.30	9.70	13.02	1.51		14.53	24.00	Pass
HE80	MCS0	2	199	6945	484/65	8.80	9.00	11.91	1.51		13.42	24.00	Pass
HE80	MCS0	2	215	7025	Full	9.60	8.80	12.23	1.51		13.74	24.00	Pass
HE80	MCS0	2	215	7025	484/66	7.90	8.20	11.06	1.51		12.57	24.00	Pass
HE160	MCS0	2	207	6985	Full	13.30	12.50	15.93	1.51		17.44	24.00	Pass
HE160	MCS0	2	207	6985	996/67	11.40	11.50	14.46	1.51		15.97	24.00	Pass
HE160	MCS0	2	207	6985	996/S67	11.30	11.60	14.46	1.51		15.97	24.00	Pass

**TEST RESULTS DATA**  
**EIRP Power Spectral Density**

U-NII-8 MIMO															
Mod.	Data Rate	NTX	CH.	Freq. (MHz)	RU Config.	Duty Factor (dB)		Conducted Power Density (dBm/MHz)			DG (dBi)		EIRP Power Density (dBm/MHz)	EIRP Power Density Limit (dBm/MHz)	Pass /Fail
						Ant 6	Ant 7	Ant 6	Ant 7	SUM	Ant 6	Ant 7			
HE20	MCS0	2	189	6895	Full	0.60	0.60			-2.56	1.11	-1.45	-1.00	Pass	
HE20	MCS0	2	189	6895	26/0	0.64	0.64			-2.76	1.11	-1.65	-1.00	Pass	
HE20	MCS0	2	189	6895	52/37	0.64	0.64			-2.95	1.11	-1.84	-1.00	Pass	
HE20	MCS0	2	189	6895	106/53	0.67	0.67			-2.82	1.11	-1.71	-1.00	Pass	
HE20	MCS0	2	209	6995	Full	0.60	0.60			-2.75	1.11	-1.64	-1.00	Pass	
HE20	MCS0	2	209	6995	26/4	0.64	0.64			-3.13	1.11	-2.02	-1.00	Pass	
HE20	MCS0	2	209	6995	52/38	0.64	0.64			-2.93	1.11	-1.82	-1.00	Pass	
HE20	MCS0	2	209	6995	106/53	0.67	0.67			-3.03	1.11	-1.92	-1.00	Pass	
HE20	MCS0	2	229	7095	Full	0.60	0.60			-2.39	1.11	-1.28	-1.00	Pass	
HE20	MCS0	2	229	7095	26/8	0.64	0.64			-2.69	1.11	-1.58	-1.00	Pass	
HE20	MCS0	2	229	7095	52/40	0.64	0.64			-2.71	1.11	-1.60	-1.00	Pass	
HE20	MCS0	2	229	7095	106/54	0.67	0.67			-2.63	1.11	-1.52	-1.00	Pass	
HE20	MCS0	2	233	7115	Full	0.60	0.60			-2.13	1.11	-1.02	-1.00	Pass	
HE20	MCS0	2	233	7115	26/8	0.64	0.64			-2.53	1.11	-1.42	-1.00	Pass	
HE20	MCS0	2	233	7115	52/40	0.64	0.64			-2.65	1.11	-1.54	-1.00	Pass	
HE20	MCS0	2	233	7115	106/54	0.67	0.67			-5.11	1.11	-4.00	-1.00	Pass	
HE40	MCS0	2	195	6925	Full	0.60	0.60			-3.45	1.11	-2.34	-1.00	Pass	
HE40	MCS0	2	195	6925	242/61	0.66	0.67			-3.83	1.11	-2.72	-1.00	Pass	
HE40	MCS0	2	211	7005	Full	0.60	0.60			-3.40	1.11	-2.29	-1.00	Pass	
HE40	MCS0	2	211	7005	242/62	0.66	0.67			-3.73	1.11	-2.62	-1.00	Pass	
HE40	MCS0	2	227	7085	Full	0.60	0.60			-3.91	1.11	-2.80	-1.00	Pass	
HE40	MCS0	2	227	7085	242/62	0.66	0.67			-4.38	1.11	-3.27	-1.00	Pass	
HE80	MCS0	2	199	6945	Full	0.65	0.60			-3.12	1.11	-2.01	-1.00	Pass	
HE80	MCS0	2	199	6945	484/65	0.66	0.67			-3.43	1.11	-2.32	-1.00	Pass	
HE80	MCS0	2	215	7025	Full	0.65	0.60			-4.36	1.11	-3.25	-1.00	Pass	
HE80	MCS0	2	215	7025	484/66	0.66	0.67			-4.38	1.11	-3.27	-1.00	Pass	
HE160	MCS0	2	207	6985	Full	0.62	0.60			-3.66	1.11	-2.55	-1.00	Pass	
HE160	MCS0	2	207	6985	996/67	0.66	0.69			-3.80	1.11	-2.69	-1.00	Pass	
HE160	MCS0	2	207	6985	996/S67	0.66	0.69			-3.95	1.11	-2.84	-1.00	Pass	



<CDD Mode>

Test Result of 26dB & 99% Occupied Bandwidth

MIMO <Ant. 6+7>

<802.11a>

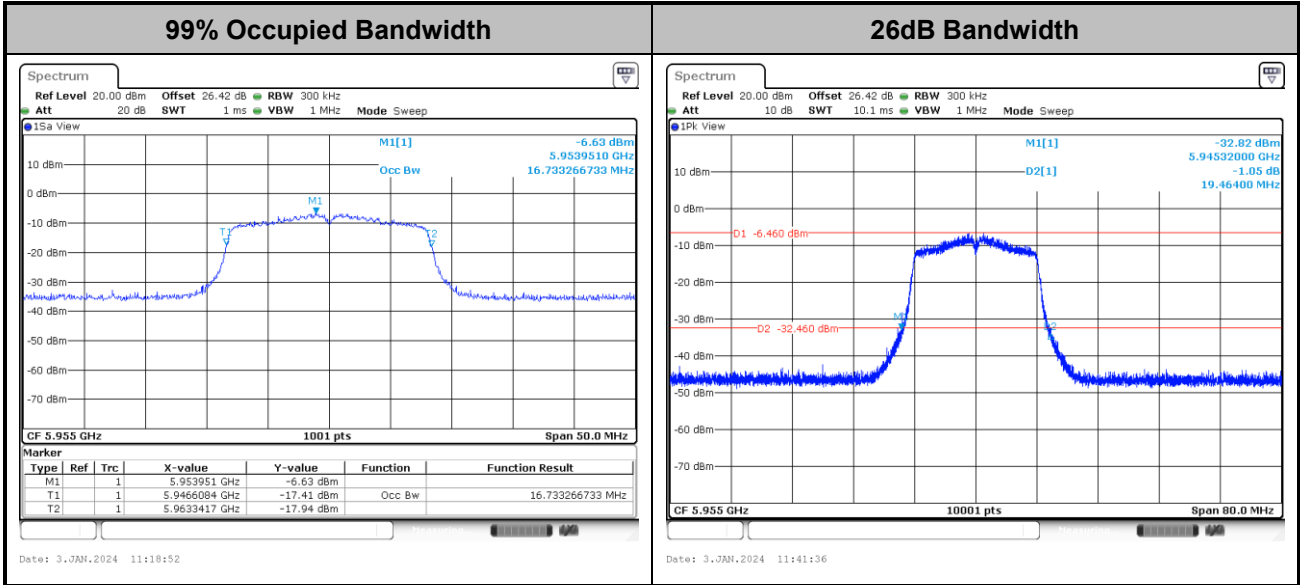

Note: The occupied channel bandwidth is maintained within the band of operation for all of the modulations.



Test Result of Power Spectral Density

<802.11a>

Maximum Power Density Plot (dBm/MHz)

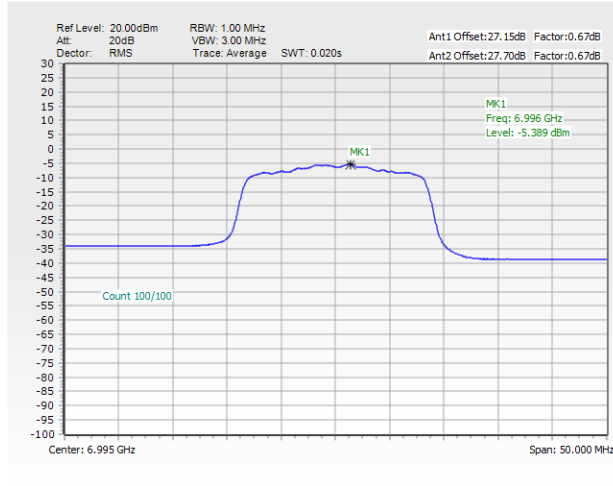

Note:

- 1 EIRP Power Density (dBm/MHz) = Measured value+ Duty Factor + Directional Gain
- 2 The test plot is showing a bin by bin combined result mathematically adds two traces.

Power Density Plot Trace 1 (Ant. 6)

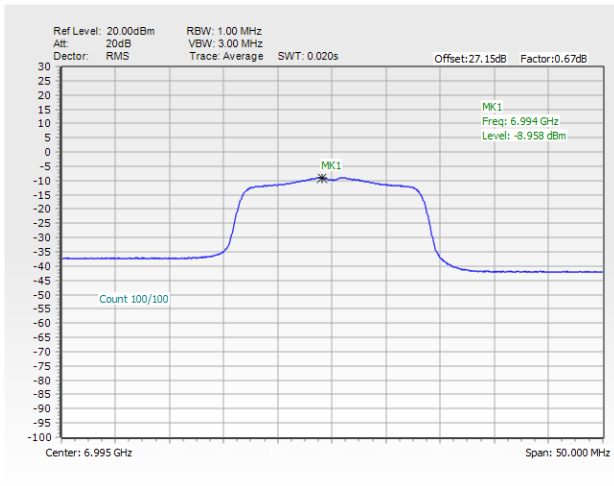

Power Density Plot Trace 2 (Ant. 7)

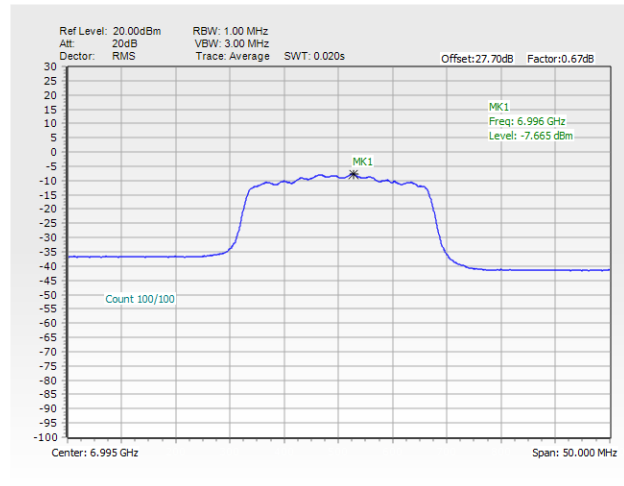



# In-Band Emissions (Channel Mask)

MIMO <Ant. 6+7(6)>

EUT Mode

802.11a

### Plot on Channel 5955 MHz

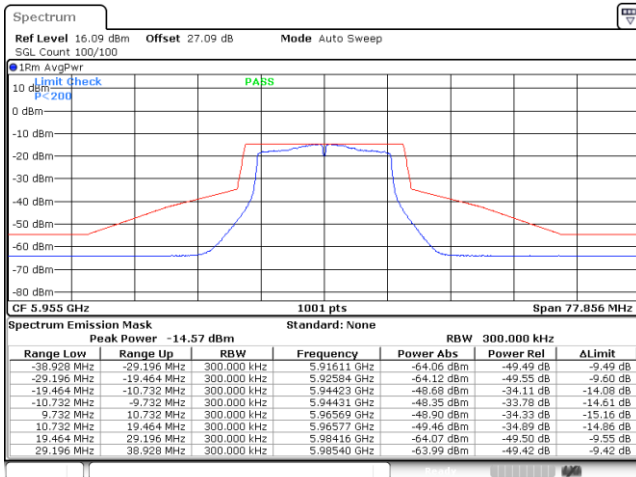

Date: 3.JAN.2024 11:42:09

### Plot on Channel 6195 MHz

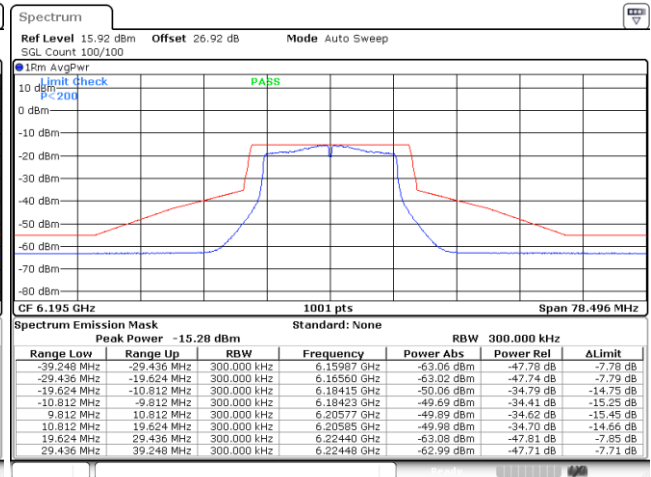

Date: 3.JAN.2024 11:38:23

### Plot on Channel 6415 MHz

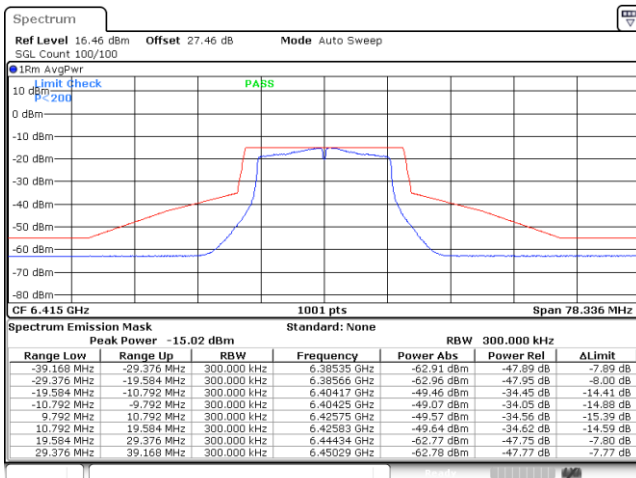

Date: 3.JAN.2024 11:49:51

### Plot on Channel 6435 MHz

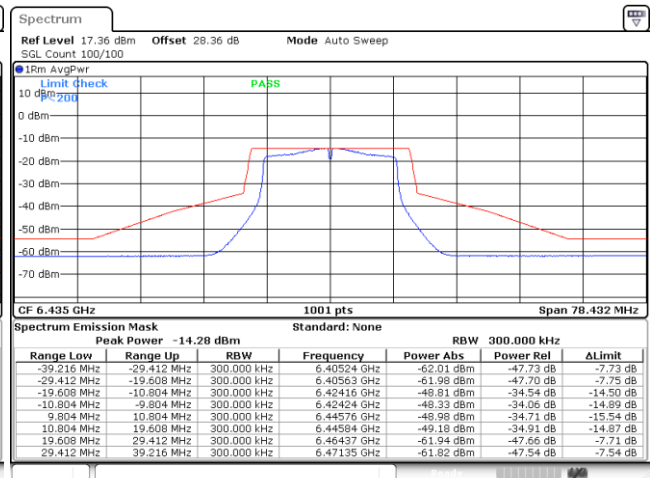

Date: 3.JAN.2024 11:57:27



Plot on Channel 6475 MHz

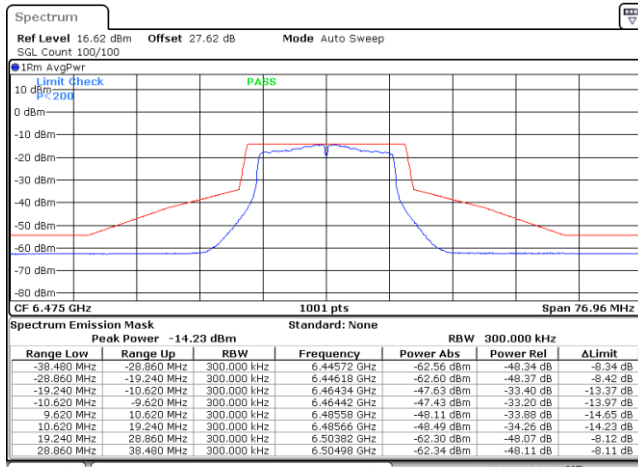

Date: 3.JAN.2024 13:53:50

Plot on Channel 6515 MHz

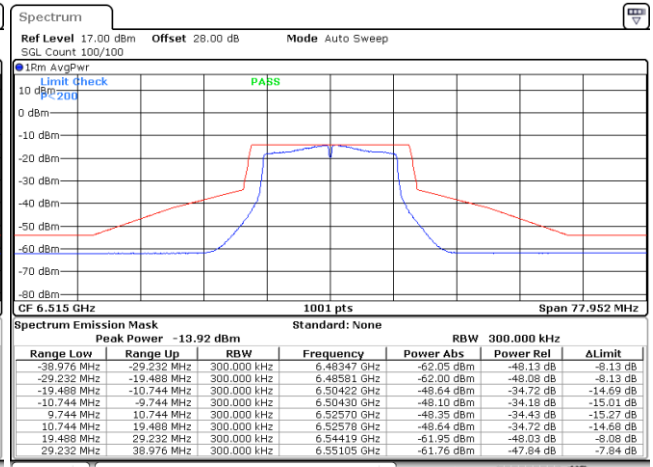

Date: 3.JAN.2024 14:00:06

Plot on Channel 6535 MHz

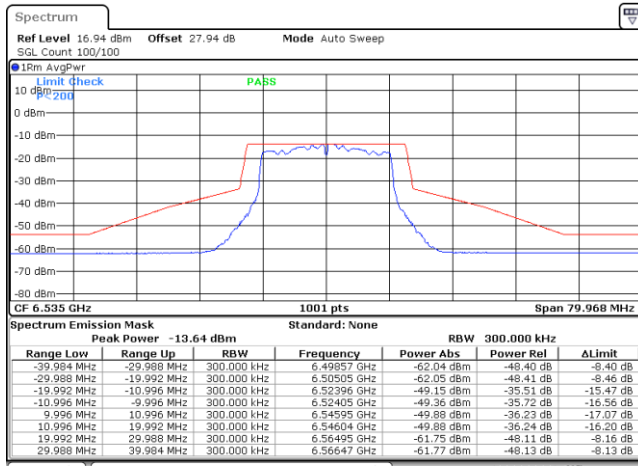

Date: 3.JAN.2024 14:08:59

Plot on Channel 6695 MHz

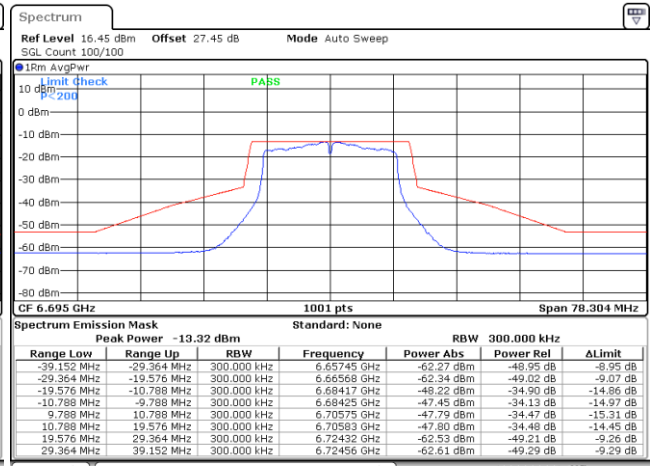

Date: 3.JAN.2024 14:15:32

Plot on Channel 6855 MHz

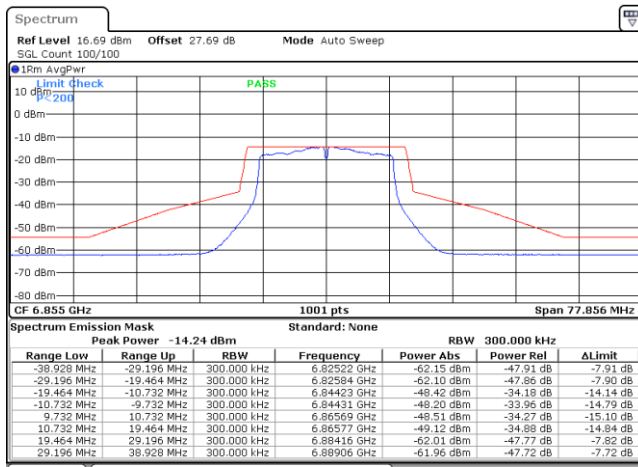

Date: 3.JAN.2024 16:09:15

Plot on Channel 6875 MHz

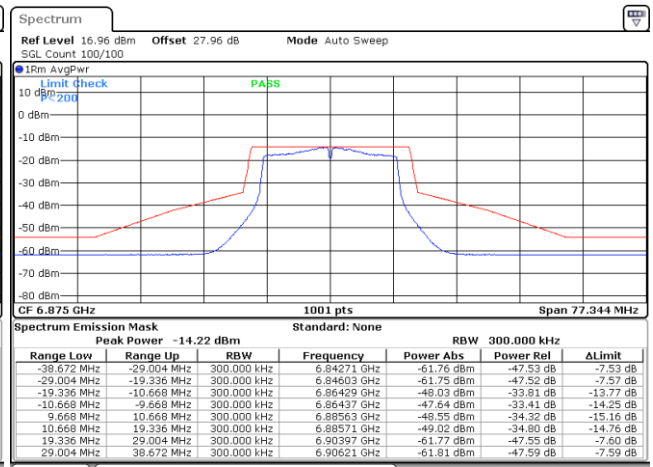

Date: 3.JAN.2024 14:29:29





Plot on Channel 6895 MHz

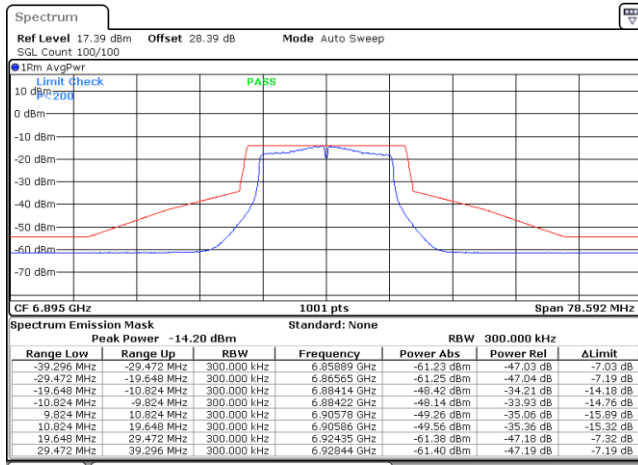

Date: 3.JAN.2024 14:37:41

Plot on Channel 6995 MHz

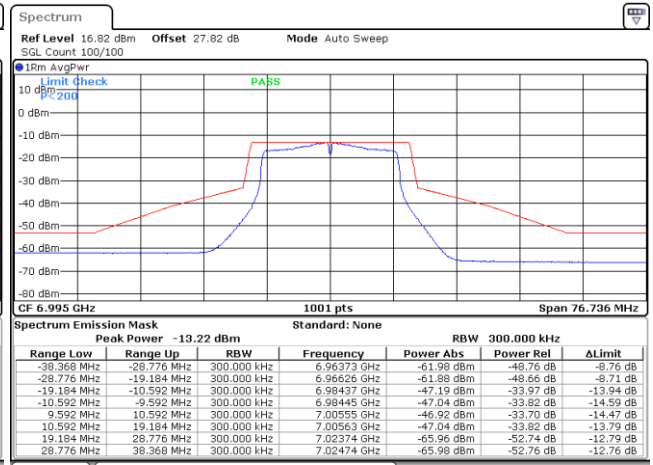

Date: 3.JAN.2024 15:58:26

Plot on Channel 7095 MHz

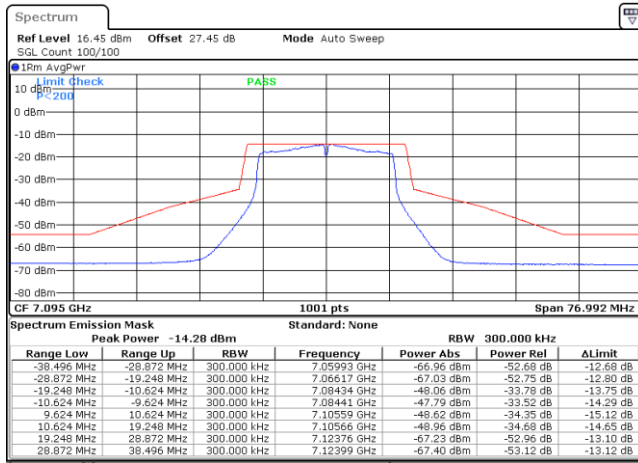

Date: 3.JAN.2024 15:25:26

Plot on Channel 7115 MHz

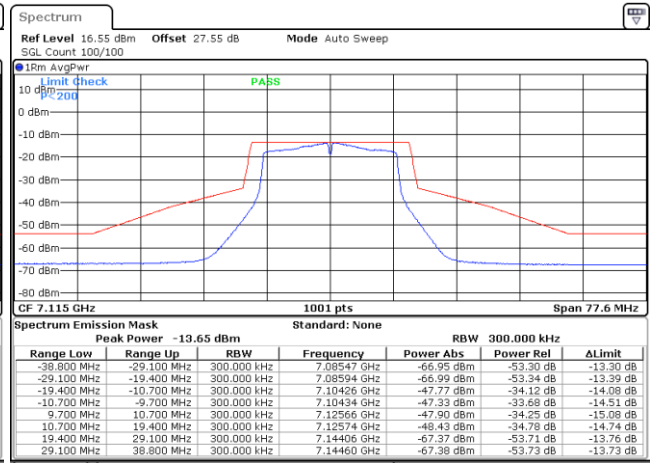

Date: 3.JAN.2024 15:50:59



MIMO <Ant. 6+7(7)>

EUT Mode	802.11a
----------	---------

Plot on Channel 5955 MHz

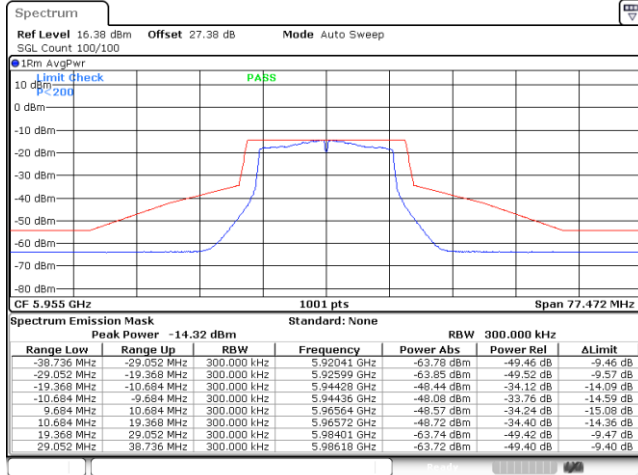

Date: 3.JAN.2024 11:43:28

Plot on Channel 6195 MHz

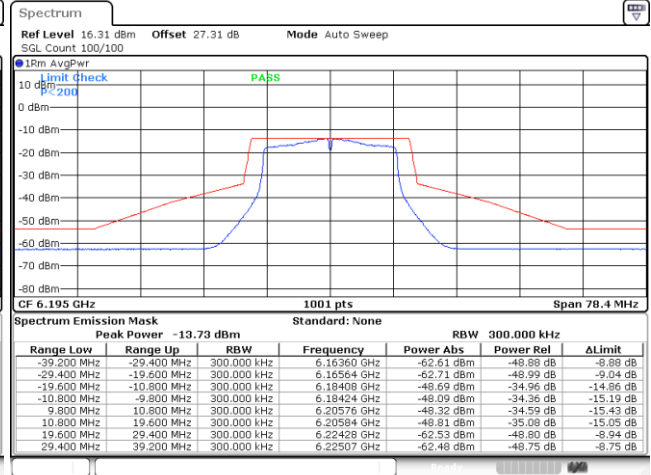

Date: 3.JAN.2024 11:41:03

Plot on Channel 6415 MHz

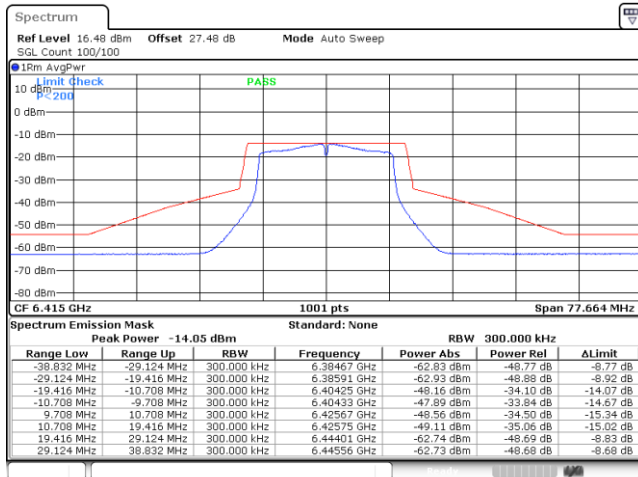

Date: 3.JAN.2024 11:51:06

Plot on Channel 6435 MHz

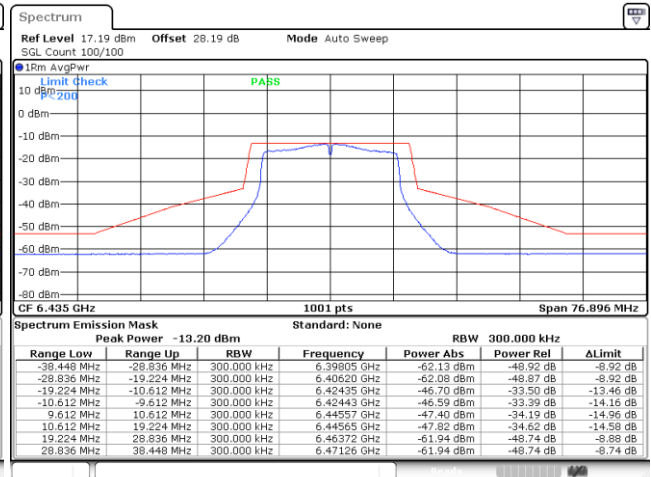

Date: 3.JAN.2024 11:59:14



Plot on Channel 6475 MHz

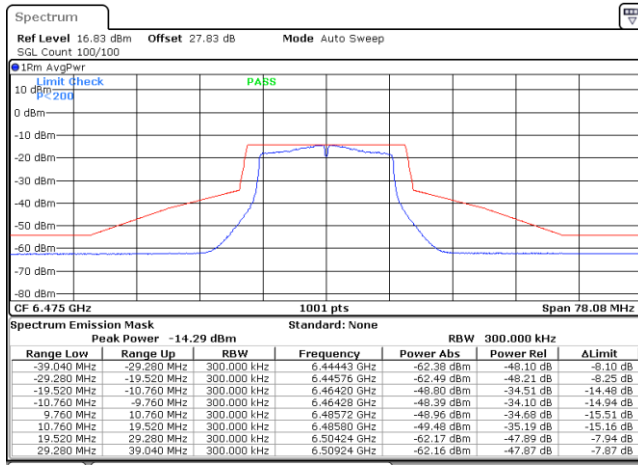

Date: 3.JAN.2024 13:55:16

Plot on Channel 6515 MHz

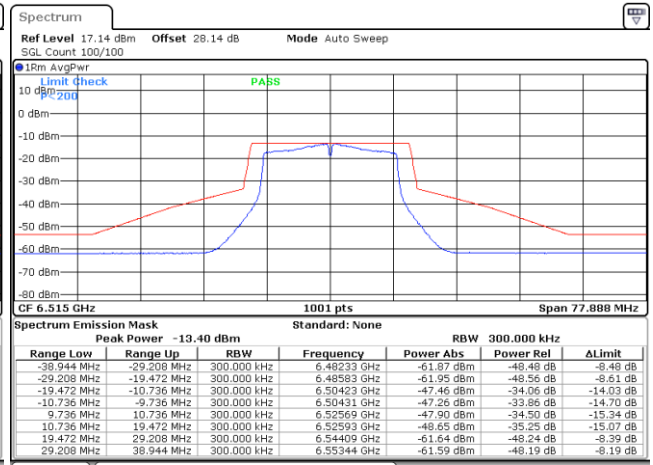

Date: 3.JAN.2024 14:02:00

Plot on Channel 6535 MHz

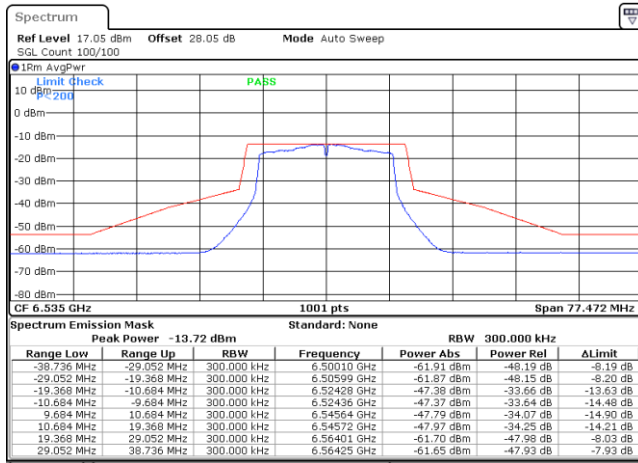

Date: 3.JAN.2024 14:10:23

Plot on Channel 6695 MHz

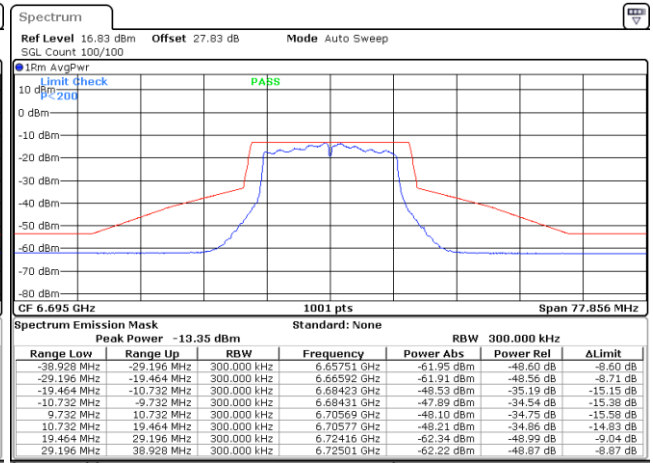

Date: 3.JAN.2024 14:16:52

Plot on Channel 6855 MHz

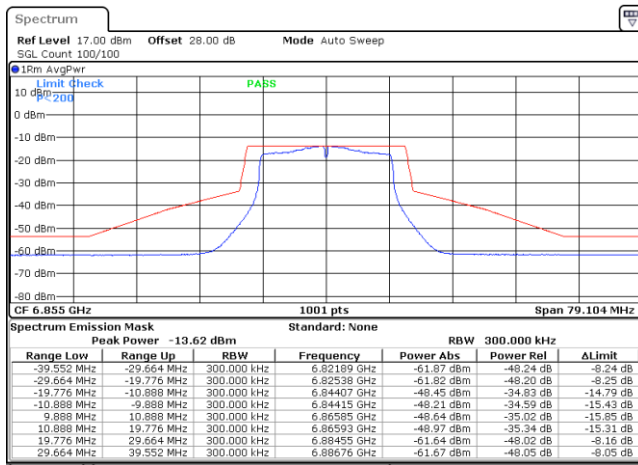

Date: 3.JAN.2024 16:10:46

Plot on Channel 6875 MHz

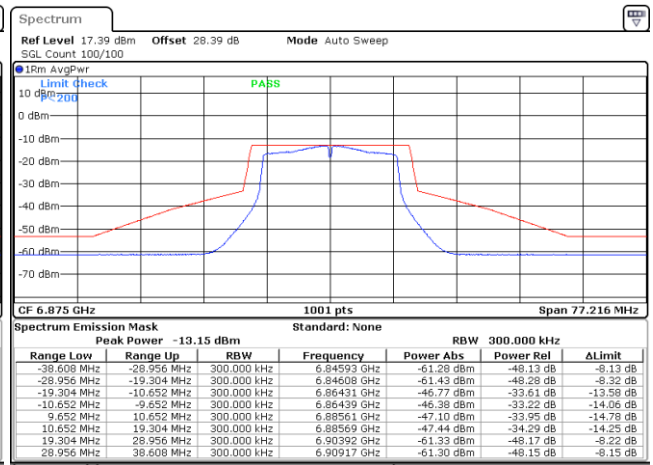

Date: 3.JAN.2024 14:31:07



Plot on Channel 6895 MHz

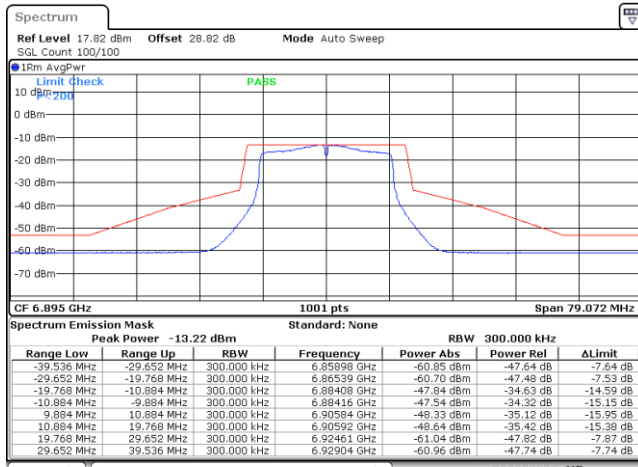

Date: 3.JAN.2024 14:39:14

Plot on Channel 6995 MHz

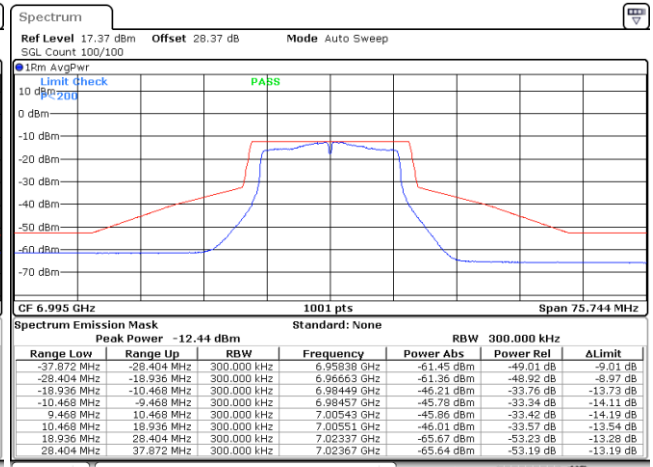

Date: 3.JAN.2024 15:59:56

Plot on Channel 7095 MHz

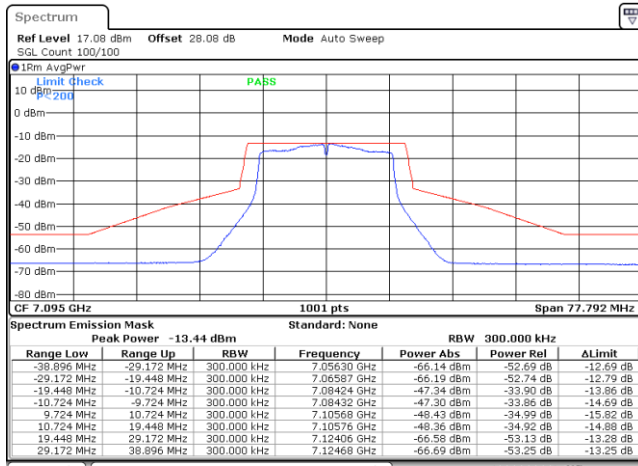

Date: 3.JAN.2024 15:30:54

Plot on Channel 7115 MHz

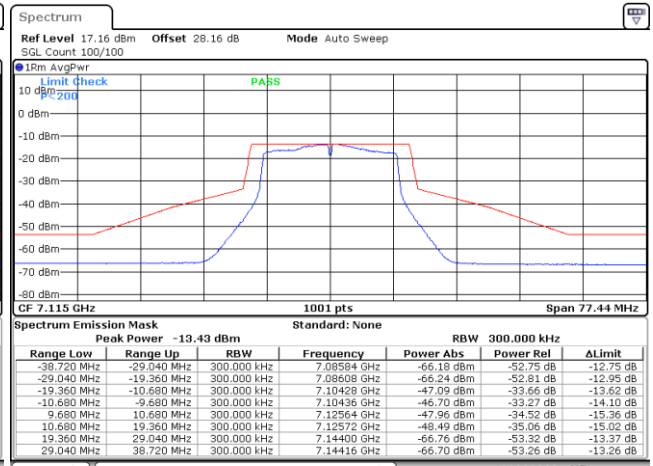

Date: 3.JAN.2024 15:53:22



<SDM Mode>

Test Result of 26dB & 99% Occupied Bandwidth

MIMO <Ant. 6+7>

<802.11ax HE20>

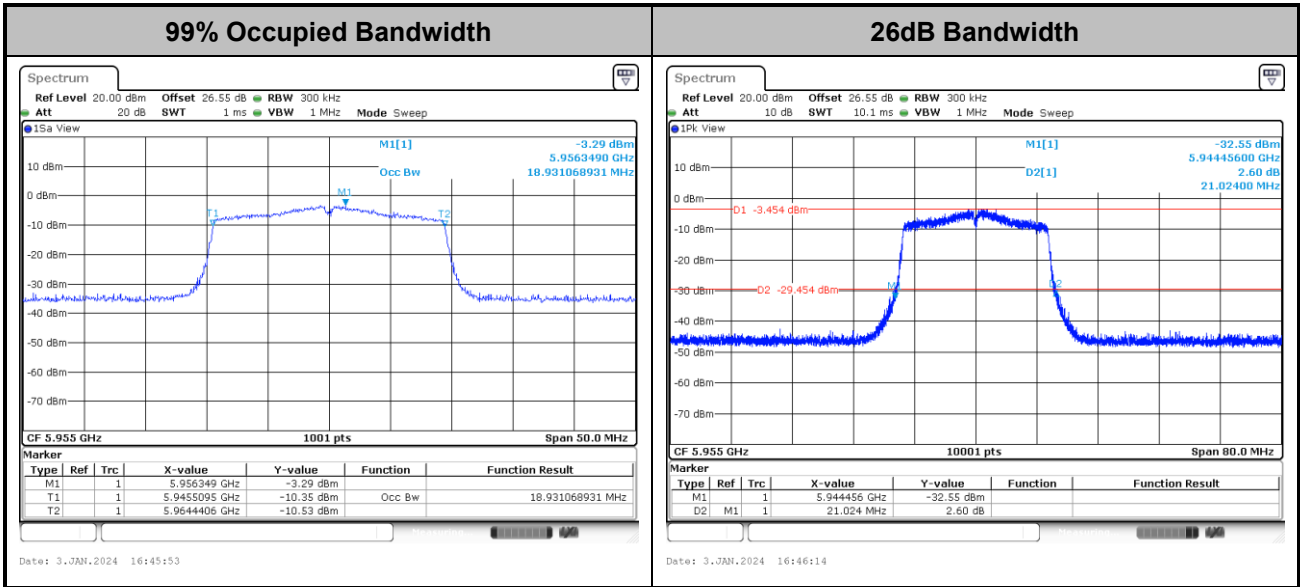

Note: The occupied channel bandwidth is maintained within the band of operation for all of the modulations.

<802.11ax HE40>

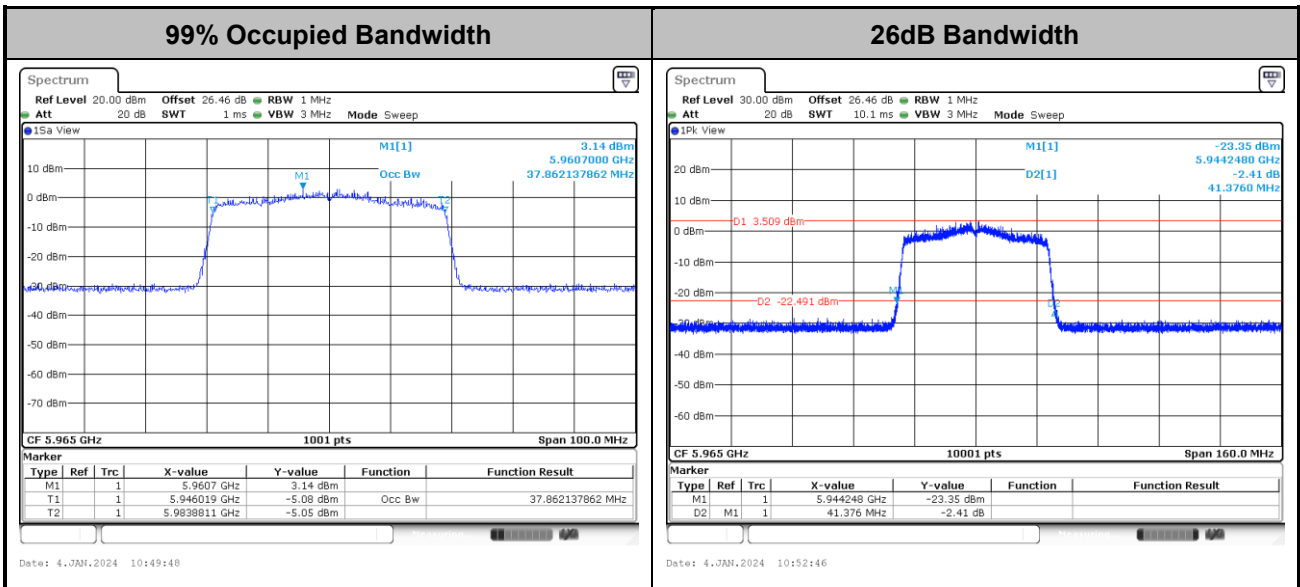

Note: The occupied channel bandwidth is maintained within the band of operation for all of the modulations.



<802.11ax HE80>

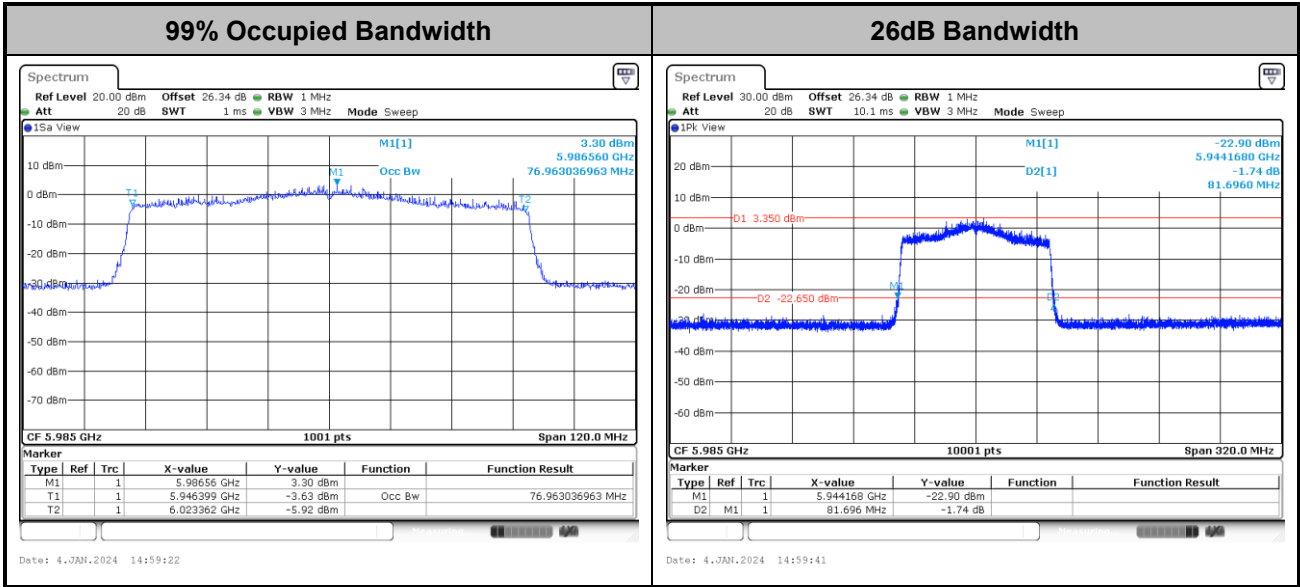

Note: The occupied channel bandwidth is maintained within the band of operation for all of the modulations.

<802.11ax HE160>

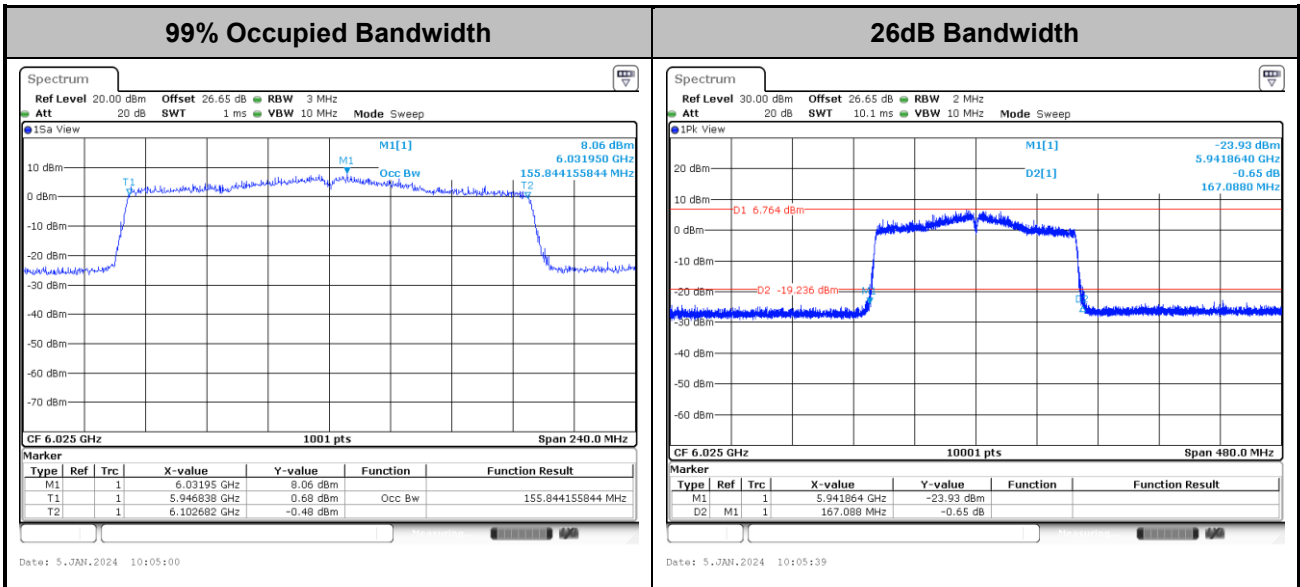

Note: The occupied channel bandwidth is maintained within the band of operation for all of the modulations.



Test Result of Power Spectral Density

<802.11ax HE20 Full RU>

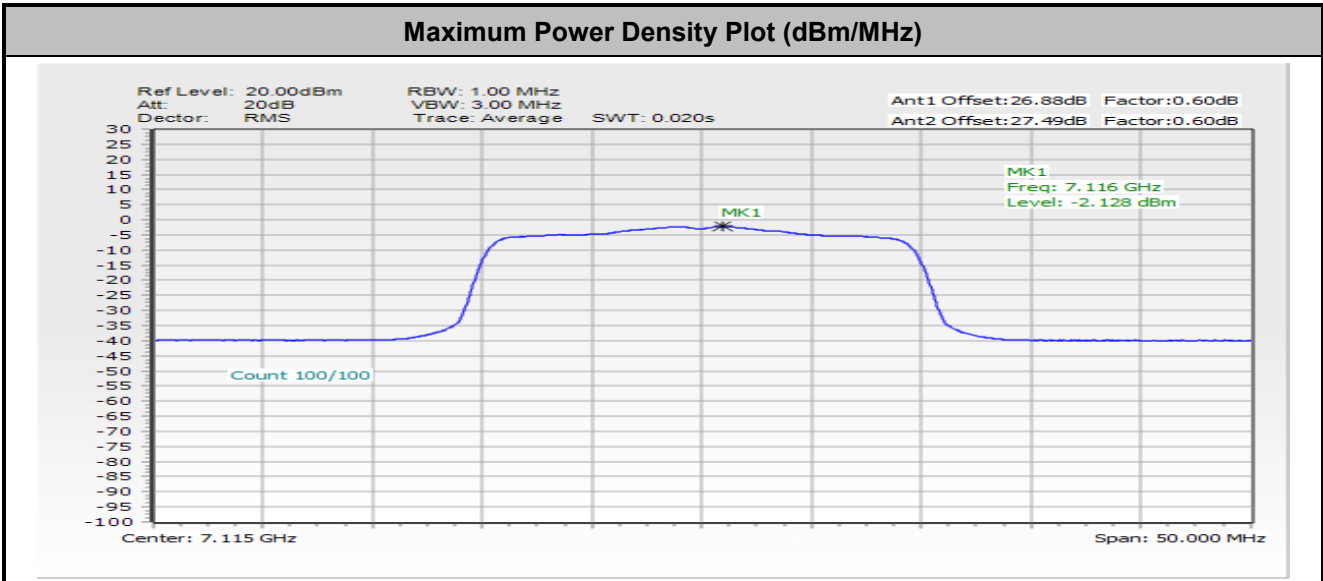

Note:

- 1 EIRP Power Density (dBm/MHz) = Measured value+ Duty Factor + Directional Gain
- 2 The test plot is showing a bin by bin combined result mathematically adds two traces.

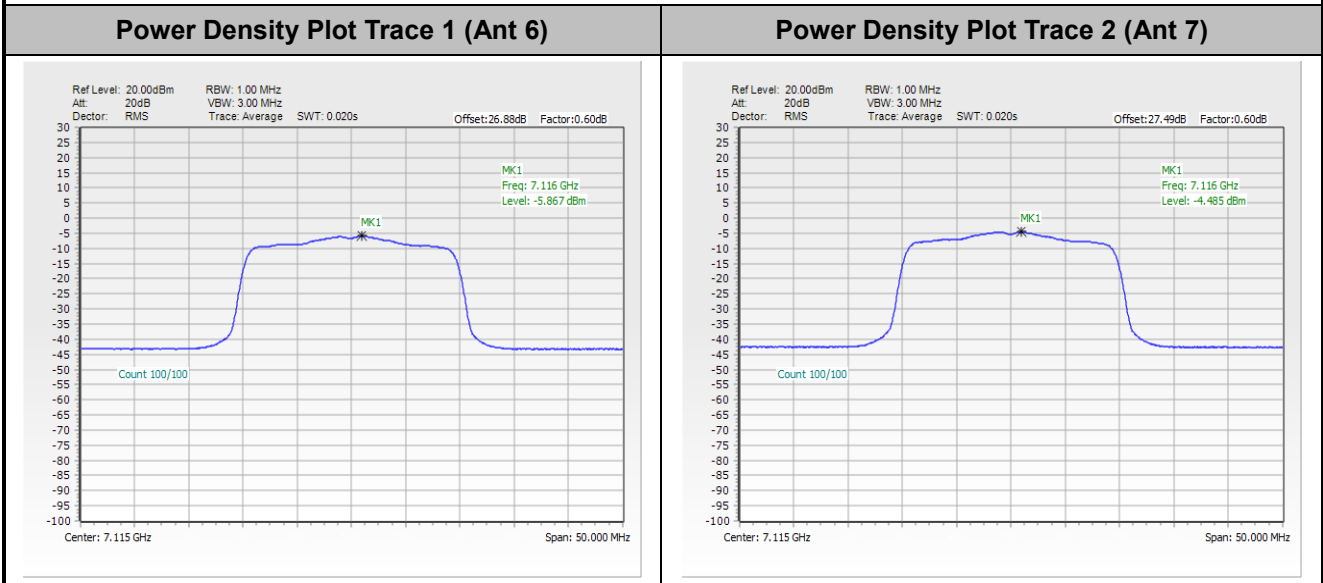



<802.11ax HE40 Full RU>

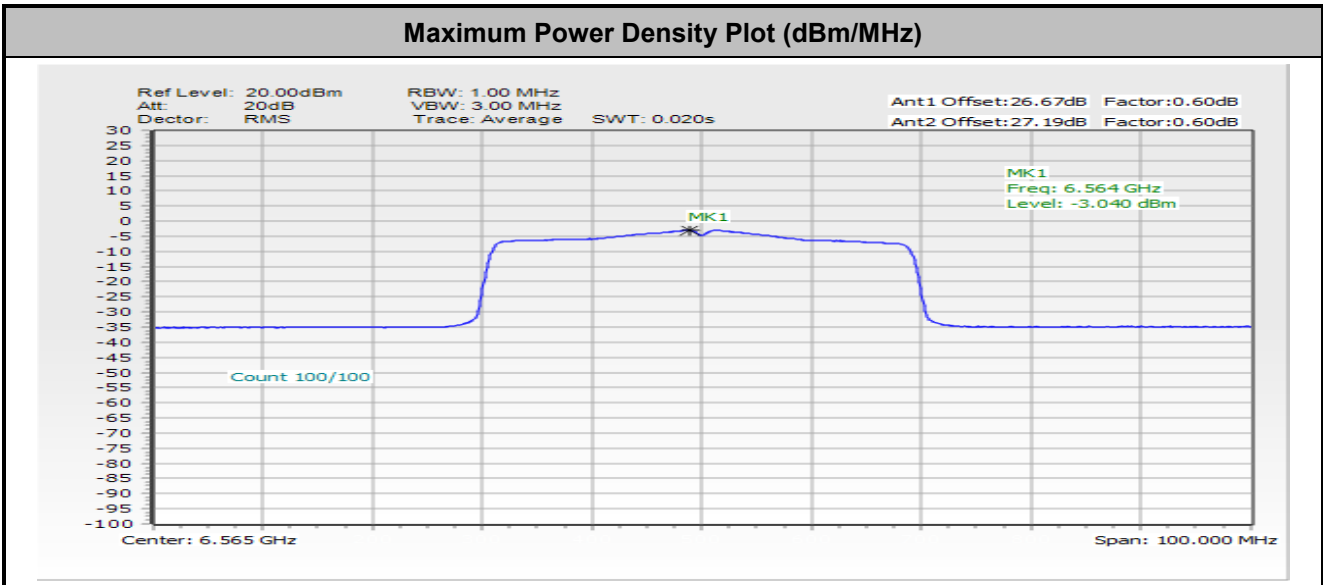

Note:

- 3    EIRP Power Density (dBm/MHz) = Measured value+ Duty Factor + Directional Gain
- 4    The test plot is showing a bin by bin combined result mathematically adds two traces.

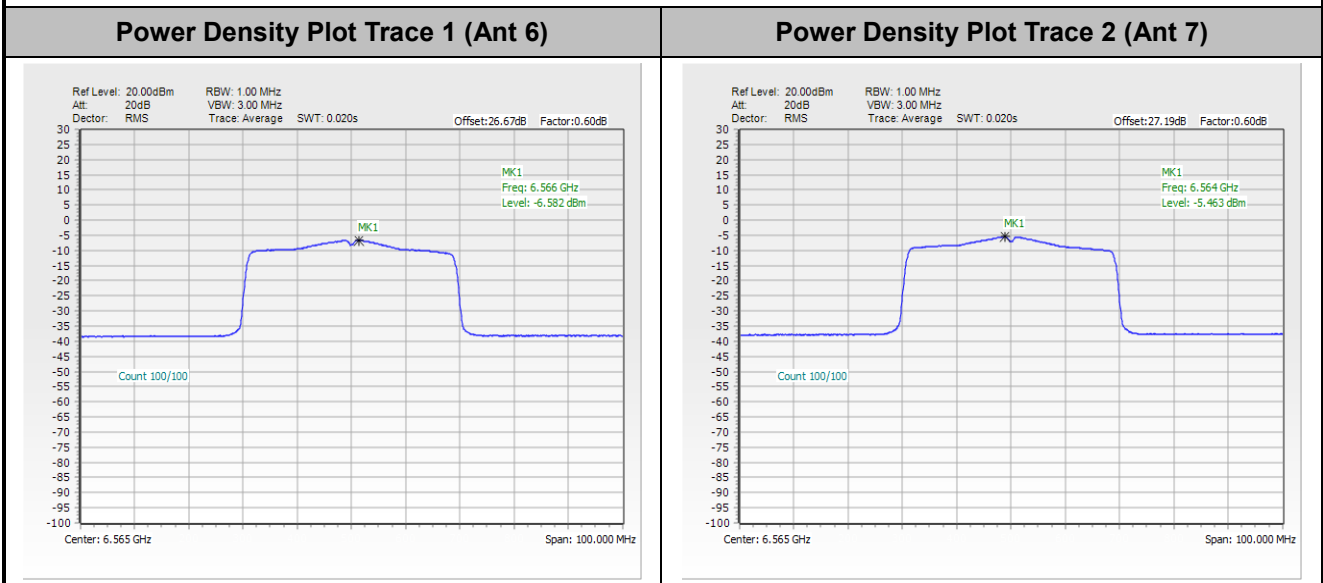





<802.11ax HE80 Full RU>

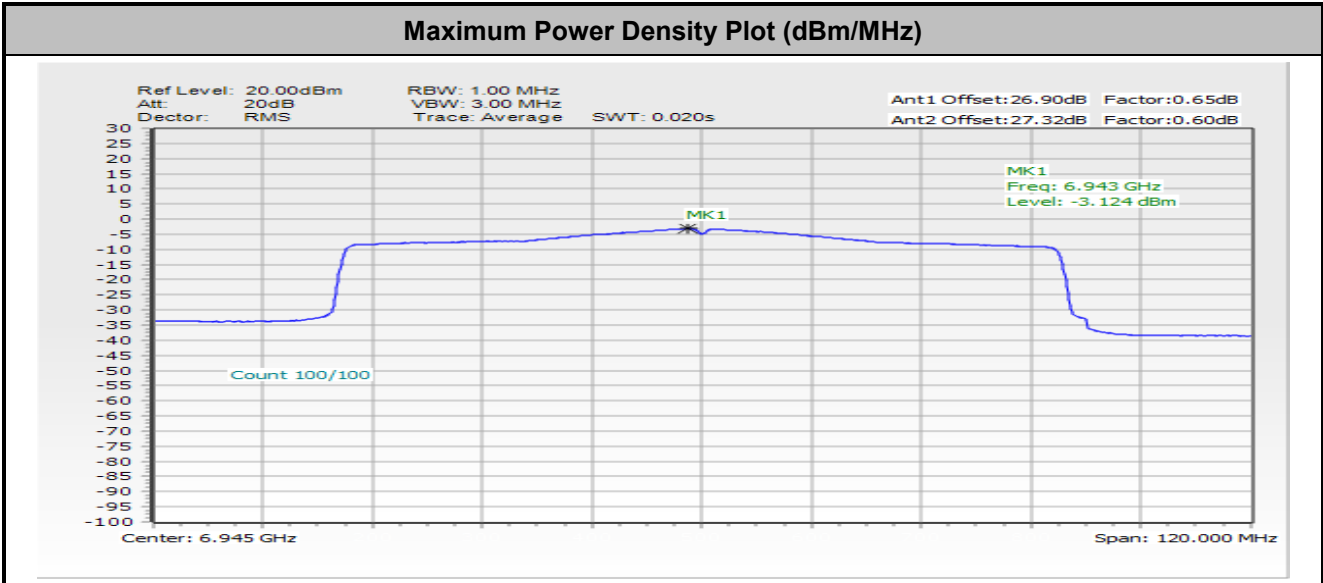

Note:

- 5    EIRP Power Density (dBm/MHz) = Measured value+ Duty Factor + Directional Gain
- 6    The test plot is showing a bin by bin combined result mathematically adds two traces.

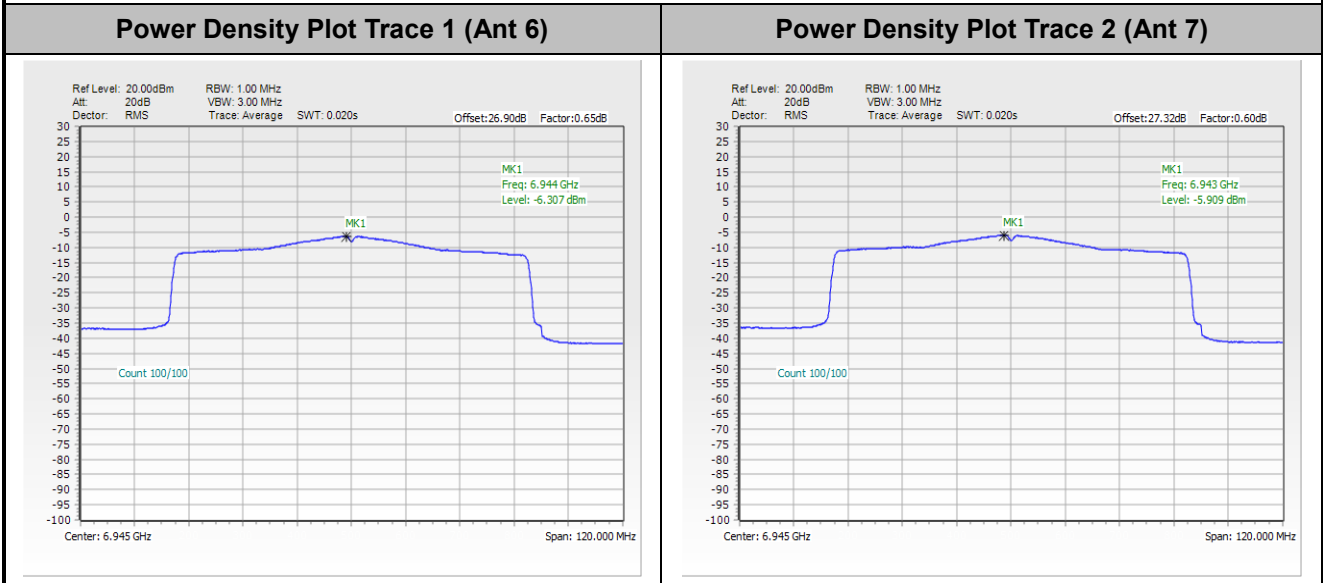



<802.11ax HE160 Full RU>

Maximum Power Density Plot (dBm/MHz)

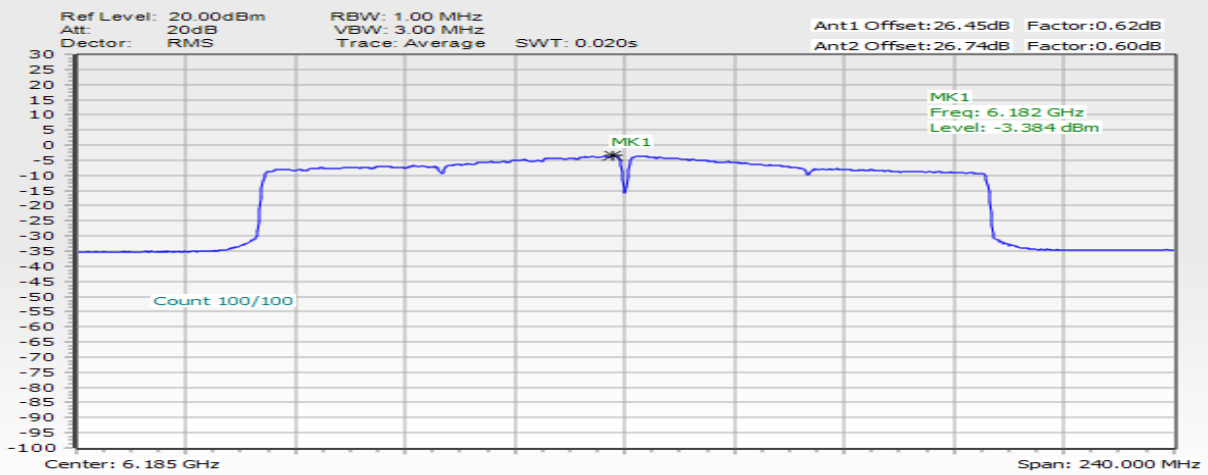

Note:

7 EIRP Power Density (dBm/MHz) = Measured value+ Duty Factor + Directional Gain

8 The test plot is showing a bin by bin combined result mathematically adds two traces.

Power Density Plot Trace 1 (Ant 6)

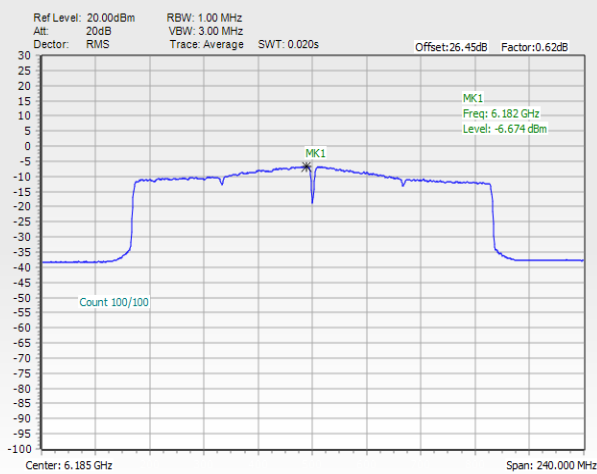

Power Density Plot Trace 2 (Ant 7)

