



FCC RADIO TEST REPORT

FCC ID : UZ7MC945B
Equipment : Mobile Computer
Brand Name : ZEBRA
Model Name : MC945B
Applicant : Zebra Technologies Corporation
1 Zebra Plaza, Holtsville, NY 11742
Manufacturer : Zebra Technologies Corporation
1 Zebra Plaza, Holtsville, NY 11742
Standard : FCC 47 CFR Part 2, 22(H), 24(E), 27(L)

The product was received on Nov. 08, 2023 and testing was performed from Dec. 13, 2023 to Jan. 22, 2024. We, Sporton International Inc. EMC & Wireless Communications Laboratory, would like to declare that the tested sample has been evaluated in accordance with the test procedures given in ANSI / TIA-603-E and has been in compliance with the applicable technical standards.

The test results in this report apply exclusively to the tested model / sample. Without written approval from Sporton International Inc. EMC & Wireless Communications Laboratory, the test report shall not be reproduced except in full.

Louis Wu

Approved by: Louis Wu

Sporton International Inc. EMC & Wireless Communications Laboratory

No. 52, Huaya 1st Rd., Guishan Dist., Taoyuan City 333, Taiwan (R.O.C.)



Table of Contents

History of this test report..... 3

Summary of Test Result..... 4

1 General Description 5

 1.1 Product Specification of Equipment Under Test 6

 1.2 Modification of EUT 6

 1.3 Testing Location 7

 1.4 Applicable Standards 7

2 Test Configuration of Equipment Under Test 8

 2.1 Test Mode..... 8

 2.2 Connection Diagram of Test System 9

 2.3 Support Unit used in test configuration 9

 2.4 Measurement Results Explanation Example 9

 2.5 Frequency List of Low/Middle/High Channels 10

3 Conducted Test Result 11

 3.1 Measuring Instruments 11

 3.2 Conducted Output Power and ERP/EIRP 12

 3.3 Peak-to-Average Ratio 13

 3.4 99% Occupied Bandwidth and 26dB Bandwidth Measurement..... 14

 3.5 Conducted Band Edge 15

 3.6 Conducted Spurious Emission 16

 3.7 Frequency Stability 17

4 Radiated Test Items 18

 4.1 Measuring Instruments 18

 4.2 Test Setup 18

 4.3 Test Result of Radiated Test..... 19

 4.4 Field Strength of Spurious Radiation Measurement 20

5 List of Measuring Equipment..... 21

6 Measurement Uncertainty 22

Appendix A. Test Results of Conducted Test

Appendix B. Test Results of Radiated Test

Appendix C. Test Setup Photographs



History of this test report

Report No.	Version	Description	Issue Date
FG3N2803A	01	Initial issue of report	Jan. 31, 2024



Summary of Test Result

Report Clause	Ref Std. Clause	Test Items	Result (PASS/FAIL)	Remark
3.2	§2.1046	Conducted Output Power	Pass	-
	§22.913 (a)(5)	Effective Radiated Power (WCDMA Band V)		
	§24.232 (c)	Equivalent Isotropic Radiated Power (WCDMA Band II)		
	§27.50 (d)(4)	Equivalent Isotropic Radiated Power (WCDMA Band IV)		
3.3	§24.232 (d)	Peak-to-Average Ratio	Pass	-
3.4	§2.1049 §22.917 (b) §24.238 (b) §27.53 (g)	Occupied Bandwidth (WCDMA Band V) (WCDMA Band II) (WCDMA Band IV)	Pass	-
3.5	§2.1051 §22.917 (a) §24.238 (a) §27.53 (g)	Band Edge Measurement (WCDMA Band V) (WCDMA Band II) (WCDMA Band IV)	Pass	-
3.6	§2.1051 §22.917 (a) §24.238 (a) §27.53 (g)	Conducted Emission (WCDMA Band V) (WCDMA Band II) (WCDMA Band IV)	Pass	-
3.7	§2.1055 §22.355 §24.235 §27.54	Frequency Stability Temperature & Voltage	Pass	-
4.4	§2.1053 §22.917 (a) §24.238 (a) §27.53 (h)	Field Strength of Spurious Radiation (WCDMA Band V) (WCDMA Band II) (WCDMA Band IV)	Pass	32.60 dB under the limit at 2509.00 MHz

Conformity Assessment Condition:

- The test results (PASS/FAIL) with all measurement uncertainty excluded are presented against the regulation limits or in accordance with the requirements stipulated by the applicant/manufacturer who shall bear all the risks of non-compliance that may potentially occur if measurement uncertainty is taken into account.
- The measurement uncertainty please refer to each test result in the section "Measurement Uncertainty".

Disclaimer:

The product specifications of the EUT presented in the test report that may affect the test assessments are declared by the manufacturer who shall take full responsibility for the authenticity.

Reviewed by: Keven Cheng

Report Producer: Michelle Chen



1 General Description

Product Feature	
Equipment	Mobile Computer
Brand Name	ZEBRA
Model Name	MC945B
FCC ID	UZ7MC945B
Sample 1	SE5800 + with Camera
Sample 2	SE4770 + without Camera
EUT supports Radios application	WCDMA/LTE/5G NR/GNSS/NFC WLAN 11a/b/g/n HT20/HT40 WLAN 11ac VHT20/VHT40/VHT80/VHT160 WLAN 11ax HE20/HE40/HE80/HE160 Bluetooth BR/EDR/LE
HW Version	DV2
SW Version	13-10-31.00-TN-U00-PRD-NEM-04
MFD	10NOV23
DUT Stage	Identical Prototype

Remark: The above EUT's information was declared by manufacturer.

Specification of Accessories				
Adapter USB Wall Charger	Brand Name	Zebra	Part Number	PWR-WUA5V12W0US
Battery 1 Standard Battery (7000mAh)	Brand Name	Zebra	Model Number	BT-000370
Battery 2 Standard Battery (7000mAh)	Brand Name	Zebra	Model Number	BT-000370B
Earphone USB-C Audio Headset	Brand Name	Zebra	Part Number	HDST-USBC-PTT1-01
USB Cable (Type C to Type A)	Brand Name	Zebra	Part Number	CBL-TC2X-USBC-01
Holster	Brand Name	Zebra	Part Number	SG-MC9X-SHLSTG-01
USB Cable (CUP)	Brand Name	Zebra	Part Number	CBL-MC93-USBCHG-01



1.1 Product Specification of Equipment Under Test

Product Specification is subject to this standard	
Tx Frequency	WCDMA: Band V: 826.4 MHz ~ 846.6 MHz Band II: 1852.4 MHz ~ 1907.6 MHz Band IV: 1712.4 MHz ~ 1752.6 MHz
Rx Frequency	WCDMA: Band V: 871.4 MHz ~ 891.6 MHz Band II: 1932.4 MHz ~ 1987.6 MHz Band IV: 2112.4 MHz ~ 2152.6 MHz
Maximum Output Power to Antenna	WCDMA: Band V: 24.62 dBm Band II: 24.94 dBm Band IV: 24.59 dBm
Antenna Type	PIFA Antenna
Antenna Gain	Cellular Band: -1.57 dBi PCS Band: -1.37 dBi AWS Band: -0.30 dBi
Type of Modulation	WCDMA: QPSK (Uplink) HSDPA: 64QAM (Downlink) HSUPA: QPSK (Uplink)

Remark: The EUT's information above is declared by manufacturer. Please refer to Disclaimer in report summary.

1.2 Modification of EUT

No modifications made to the EUT during the testing.



1.3 Testing Location

Test Site	Sporton International Inc. EMC & Wireless Communications Laboratory
Test Site Location	No.52, Huaya 1st Rd., Guishan Dist., Taoyuan City 333, Taiwan (R.O.C.) TEL: +886-3-327-3456 FAX: +886-3-328-4978
Test Site No.	Sporton Site No.
	TH03-HY
Test Engineer	Eric Wu
Temperature (°C)	20.9~22.9
Relative Humidity (%)	35.6~37.6

Test Site	Sporton International Inc. Wensan Laboratory
Test Site Location	No.58, Aly. 75, Ln. 564, Wenhua 3rd, Rd., Guishan Dist., Taoyuan City 333010, Taiwan (R.O.C.) TEL: +886-3-327-0868 FAX: +886-3-327-0855
Test Site No.	Sporton Site No.
	03CH11-HY (TAF Code: 3786)
Test Engineer	Yuan Lee, Fu Chen, Sam Chau and Troye Hsieh
Temperature (°C)	19.1~21.1
Relative Humidity (%)	52.7~66.7
Remark	The Radiated Spurious Emission test item subcontracted to Sporton International Inc. Wensan Laboratory.

Note: The test site complies with ANSI C63.4 2014 requirement.

FCC Designation No.: TW1190 and TW3786

1.4 Applicable Standards

According to the specifications declared by the manufacturer, the EUT must comply with the requirements of the following standards:

- ♦ ANSI C63.26-2015
- ♦ ANSI / TIA-603-E
- ♦ FCC 47 CFR Part 2, 22(H), 24(E), 27(L)
- ♦ FCC KDB 971168 D01 Power Meas. License Digital Systems v03r01
- ♦ FCC KDB 412172 D01 Determining ERP and EIRP v01r01
- ♦ FCC KDB 414788 D01 Radiated Test Site v01r01

Remark:

1. All the test items were validated and recorded in accordance with the standards without any modification during the testing.
2. The TAF code is not including all the FCC KDB listed without accreditation.



2 Test Configuration of Equipment Under Test

2.1 Test Mode

Antenna port conducted and radiated test items were performed according to KDB 971168 D01 Power Meas. License Digital Systems v03r01 with maximum output power.

For radiated measurement, the measured emission level of the EUT was maximized by rotating the EUT on a turntable, adjusting the orientation of the EUT and EUT antenna in three orthogonal axis (X: flat, Y: portrait, Z: landscape) and accessory (Adapter or Earphone), and adjusting the measurement antenna orientation, following C63.26 exploratory test procedures and find Y plane with Adapter as worst plane.

Radiated emissions were investigated as following frequency range:

1. 30 MHz to 9000 MHz for WCDMA Band V
2. 30 MHz to 18000 MHz for WCDMA Band IV
3. 30 MHz to 19100 MHz for WCDMA Band II

All modes, data rates and positions were investigated.

Test modes are chosen to be reported as the worst case configuration below:

Test Modes		
Band	Radiated TCs	Conducted TCs
WCDMA Band V	■ RMC 12.2Kbps Link	■ RMC 12.2Kbps Link
WCDMA Band II	■ RMC 12.2Kbps Link	■ RMC 12.2Kbps Link
WCDMA Band IV	■ RMC 12.2Kbps Link	■ RMC 12.2Kbps Link

Remark: All the radiated test cases were performed with Battery 1 Standard Battery (7000mAh) and Sample 1.

2.2 Connection Diagram of Test System

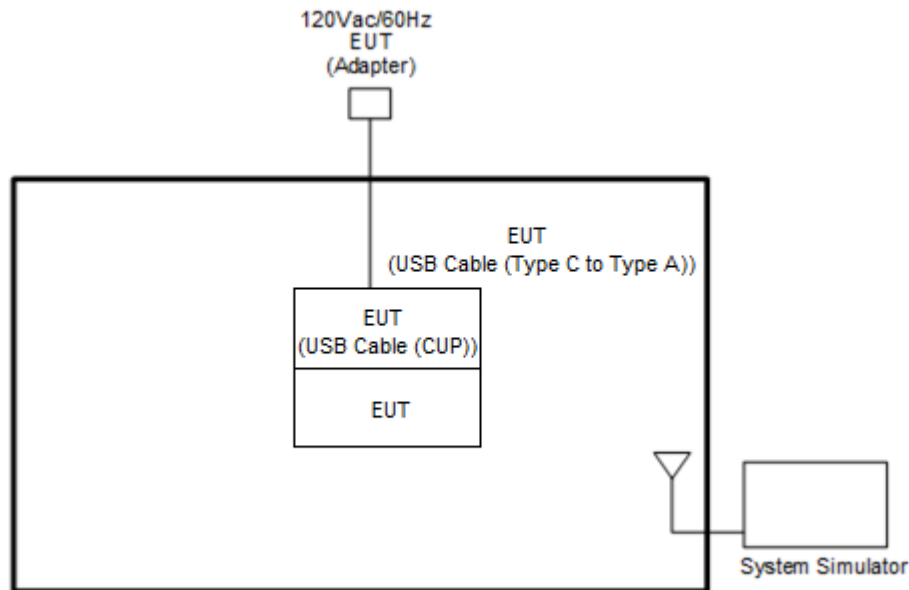

2.3 Support Unit used in test configuration

Item	Equipment	Brand Name	Model No.	FCC ID	Data Cable	Power Cord
1.	System Simulator	Anritsu	MT8821C	N/A	N/A	Unshielded, 1.8 m

2.4 Measurement Results Explanation Example

For all conducted test items:

The offset level is set in the spectrum analyzer to compensate the RF cable loss and attenuator factor between RF conducted output port and spectrum analyzer. With the offset compensation, the spectrum analyzer reading level will be exactly the RF output level.

The spectrum analyzer offset is derived from RF cable loss and attenuator factor.

Offset = RF cable loss + attenuator factor.

The following shows an offset computation example with RF cable loss 4.2 dB and a 10 dB attenuator.

Example:

$$\begin{aligned} \text{Offset(dB)} &= \text{RF cable loss(dB)} + \text{attenuator factor(dB)}. \\ &= 4.2 + 10 = 14.2 \text{ (dB)} \end{aligned}$$



2.5 Frequency List of Low/Middle/High Channels

Frequency List				
Band	Channel/Frequency(MHz)	Lowest	Middle	Highest
WCDMA Band V	Channel	4132	4182	4233
	Frequency	826.4	836.4	846.6
WCDMA Band II	Channel	9262	9400	9538
	Frequency	1852.4	1880.0	1907.6
WCDMA Band IV	Channel	1312	1413	1513
	Frequency	1712.4	1732.6	1752.6

3 Conducted Test Result

3.1 Measuring Instruments

Please refer to the measuring equipment list in this test report.

3.1.1 Test Setup

3.1.2 Conducted Output Power

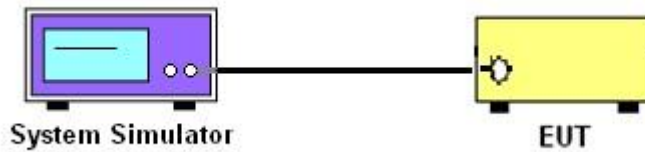

3.1.3 Peak-to-Average Ratio, Occupied Bandwidth, Conducted Band-Edge and Conducted Spurious Emission

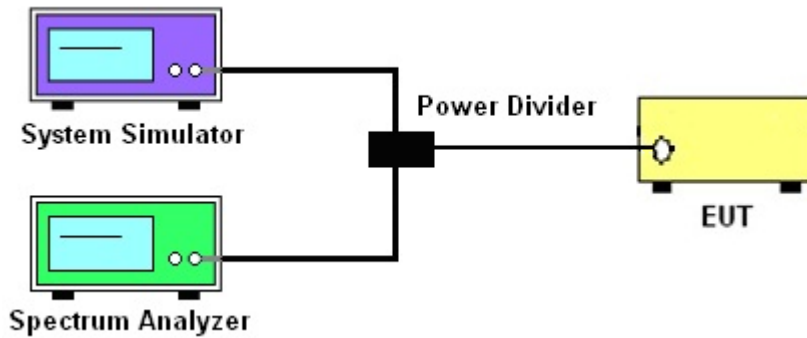

3.1.4 Frequency Stability

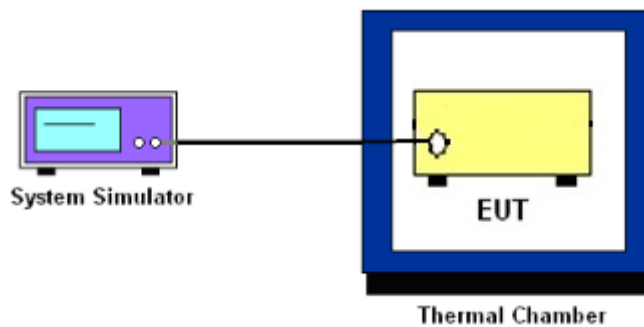

3.1.5 Test Result of Conducted Test

Please refer to Appendix A.



3.2 Conducted Output Power and ERP/EIRP

3.2.1 Description of the Conducted Output Power and ERP/EIRP

A system simulator was used to establish communication with the EUT. Its parameters were set to enforce EUT transmitting at the maximum power. The measured power in the radio frequency on the transmitter output terminals shall be reported.

The ERP of mobile transmitters must not exceed 7 Watts for WCDMA Band V

The EIRP of mobile transmitters must not exceed 2 Watts for WCDMA Band II

The EIRP of mobile transmitters must not exceed 1 Watts for WCDMA Band IV

According to KDB 412172 D01 Power Approach,

$EIRP = P_T + G_T - L_C$, $ERP = EIRP - 2.15$, where

P_T = transmitter output power in dBm

G_T = gain of the transmitting antenna in dBi

L_C = signal attenuation in the connecting cable between the transmitter and antenna in dB

3.2.2 Test Procedures

1. The transmitter output port is connected to the system simulator.
2. Set EUT at maximum power through system simulator.
3. Select the lowest, middle, and the highest channels for each band and different modulation.
4. Measure the maximum burst average power for GSM and maximum average power for other modulation signal.



3.3 Peak-to-Average Ratio

3.3.1 Description of the PAR Measurement

The peak-to-average ratio (PAR) of the transmission may not exceed 13 dB.

3.3.2 Test Procedures

The testing follows ANSI C63.26-2015 Section 5.2.6

1. The EUT is connected to spectrum analyzer and system simulator via a power divider.
2. Set EUT to transmit at maximum output power.
3. When the duty cycle is less than 98%, then signal gating will be implemented on the spectrum analyzer by triggering from the system simulator.
4. Set the CCDF (Complementary Cumulative Distribution Function) option of the spectrum analyzer.
5. Record the maximum PAPR level associated with a probability of 0.1%.



3.4 99% Occupied Bandwidth and 26dB Bandwidth Measurement

3.4.1 Description of 99% Occupied Bandwidth and 26dB Bandwidth Measurement

The occupied bandwidth is the width of a frequency band such that, below the lower and above the upper frequency limits, the mean powers emitted are each equal to a specified percentage 0.5% of the total mean transmitted power.

The 26 dB emission bandwidth is defined as the frequency range between two points, one above and one below the carrier frequency, at which the spectral density of the emission is attenuated 26 dB below the maximum in-band spectral density of the modulated signal. Spectral density (power per unit bandwidth) is to be measured with a detector of resolution bandwidth equal to approximately 1.0% of the emission bandwidth.

3.4.2 Test Procedures

The testing follows ANSI C63.26-2015 Section 5.4.3 (26dB) and Section 5.4.4 (99OB)

1. The EUT is connected to spectrum analyzer and system simulator via a power divider.
2. The spectrum analyzer center frequency is set to the nominal EUT channel center frequency. The span range for the spectrum analyzer shall be between two and five times the anticipated OBW.
3. The nominal resolution bandwidth (RBW) shall be in the range of 1 to 5 % of the anticipated OBW, and the VBW shall be at least 3 times the RBW.
4. Set the detection mode to peak, and the trace mode to max hold.
5. Determine the reference value: Set the EUT to transmit a modulated signal. Allow the trace to stabilize. Set the spectrum analyzer marker to the highest level of the displayed trace.
(This is the reference value)
6. Determine the “-26 dB down amplitude” as equal to (Reference Value – X).
7. Place two markers, one at the lowest and the other at the highest frequency of the envelope of the spectral display such that each marker is at or slightly below the “-X dB down amplitude” determined in step 6. If a marker is below this “-X dB down amplitude” value it shall be placed as close as possible to this value. The OBW is the positive frequency difference between the two markers.
8. Use the 99 % power bandwidth function of the spectrum analyzer and report the measured bandwidth.



3.5 Conducted Band Edge

3.5.1 Description of Conducted Band Edge Measurement

The power of any emission outside of the authorized operating frequency ranges must be lower than the transmitter power (P) by a factor of at least $43 + 10 \log (P)$ dB.

3.5.2 Test Procedures

The testing follows FCC KDB 971168 D01 v03r01 Section 6.1.

1. The EUT is connected to the spectrum analyzer and system simulator via a power divider.
2. The RF output of EUT is connected to the spectrum analyzer by an RF cable and attenuator. The path loss is compensated to the results for each measurement.
3. The band edges of low and high channels for the highest RF powers are measured.
4. The RF fundamental frequency shall be excluded against the limit line in the operating frequency band.
5. The limit line is derived from $43 + 10\log(P)$ dB below the transmitter power P(Watts)



3.6 Conducted Spurious Emission

3.6.1 Description of Conducted Spurious Emission Measurement

The power of any emission outside of the authorized operating frequency ranges must be lower than the transmitter power (P) by a factor of at least $43 + 10 \log (P)$ dB.

It is measured by means of a calibrated spectrum analyzer and scanned from 30 MHz up to a frequency including its 10th harmonic.

3.6.2 Test Procedures

The testing follows FCC KDB 971168 D01 v03r01 Section 6.1.

1. The EUT is connected to the spectrum analyzer and system simulator via a power divider.
2. The RF output of EUT is connected to the spectrum analyzer by an RF cable and attenuator. The path loss is compensated to the results for each measurement.
3. The middle channel for the highest RF power within the transmitting frequency is measured.
4. The conducted spurious emission for the whole frequency range is taken.
5. The RF fundamental frequency shall be excluded against the limit line in the operating frequency band.
6. The limit line is derived from $43 + 10\log(P)$ dB below the transmitter power P(Watts)



3.7 Frequency Stability

3.7.1 Description of Frequency Stability Measurement

22.355

The frequency stability shall be measured by variation of ambient temperature and variation of primary supply voltage to ensure that the fundamental emission stays within the authorized frequency block. The frequency stability of the transmitter shall be maintained within $\pm 0.00025\%$ ($\pm 2.5\text{ppm}$) of the center frequency.

24.235 & 27.54

The frequency stability shall be sufficient to ensure that the fundamental emission stays within the authorized frequency block.

3.7.2 Test Procedures for Temperature Variation

The testing follows FCC KDB 971168 D01 v03r01 Section 9.0.

1. The EUT is set up in the thermal chamber and connected with the system simulator.
2. With power OFF, the temperature is decreased to -30°C and the EUT is stabilized before testing. Power is applied and the maximum change in frequency is recorded within one minute.
3. With power OFF, the temperature is raised in 10°C steps up to 50°C . The EUT is stabilized at each step for at least half an hour. Power is applied and the maximum frequency change is recorded within one minute.

3.7.3 Test Procedures for Voltage Variation

The testing follows FCC KDB 971168 D01 v03r01 Section 9.0.

1. The EUT is placed in a temperature chamber at $20\pm 5^{\circ}\text{C}$ and connected with the system simulator.
2. The power supply voltage to the EUT is varied from 85% to 115% of the nominal value measured at the input to the EUT.
3. The variation in frequency is measured for the worst case.

4 Radiated Test Items

4.1 Measuring Instruments

Please refer to the measuring equipment list in this test report.

4.2 Test Setup

For radiated test below 30MHz

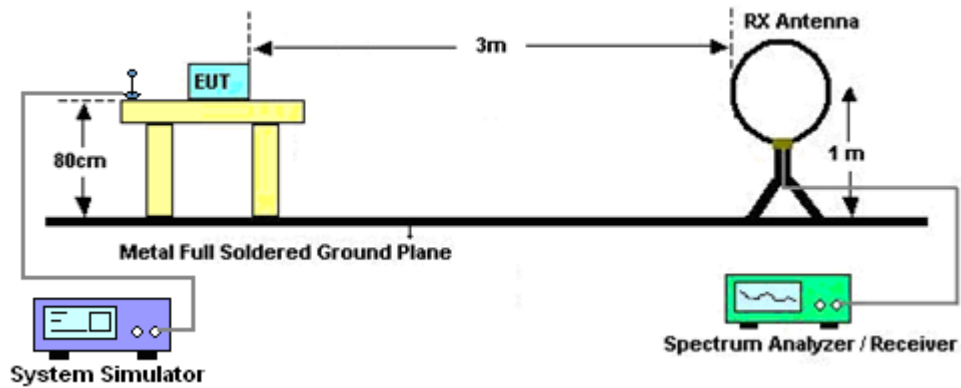

For radiated test from 30MHz to 1GHz

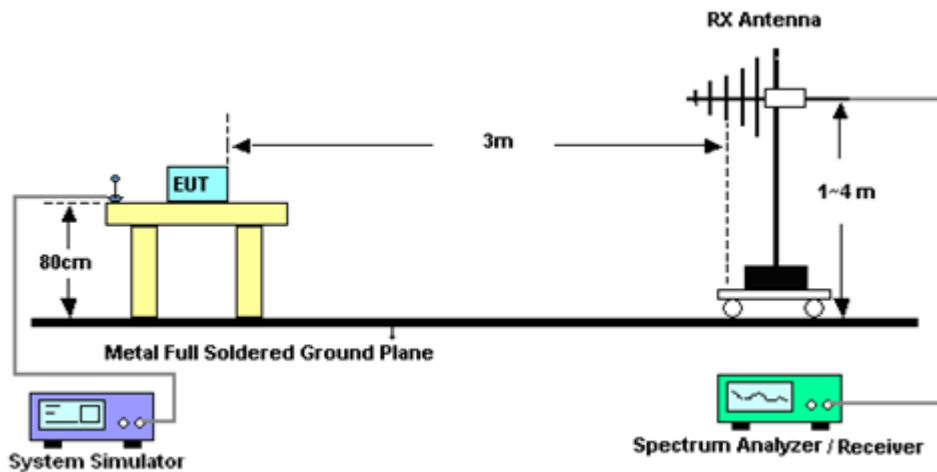

For radiated test from 1GHz to 18GHz

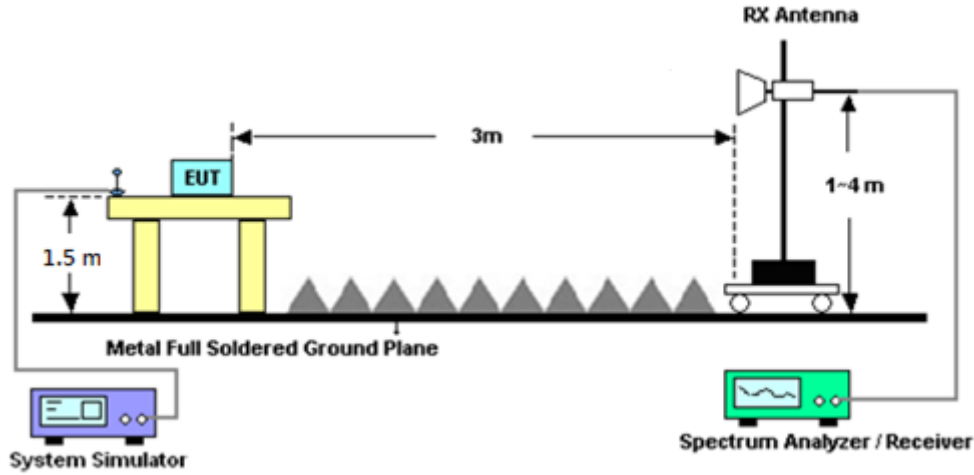

For radiated test above 18GHz

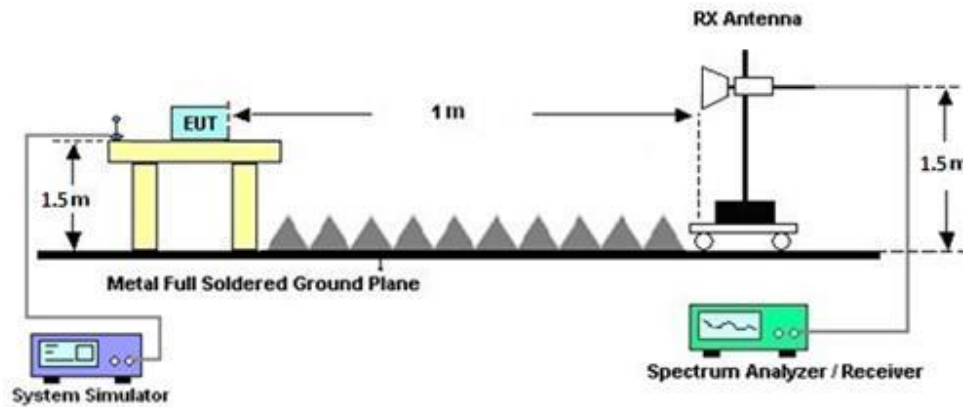

4.3 Test Result of Radiated Test

Please refer to Appendix B.

Note:

The low frequency, which starts from 9 kHz to 30 MHz, is pre-scanned and the result which is 20 dB lower than the limit line is not reported.

There is adequate comparison measurement of both open-field test site and alternative test site - semi-Anechoic chamber according to 414788 D01 Radiated Test Site v01r01, and the result came out very similar.



4.4 Field Strength of Spurious Radiation Measurement

4.4.1 Description of Field Strength of Spurious Radiated Measurement

The power of any emission outside of the authorized operating frequency ranges must be attenuated below the transmitter power (P) by a factor of at least $43 + 10 \log(P)$ dB. The spectrum is scanned from 30 MHz up to a frequency including its 10th harmonic.

4.4.2 Test Procedures

The testing follows FCC KDB 971168 D01 v03r01 Section 7 and ANSI C63.26-2015 section 5.5.4 Radiated measurement using the field strength method.

1. The EUT is placed on a rotatable wooden table 0.8 meters for frequency below 1 GHz and 1.5 meter for frequency above 1 GHz above the ground.
2. The EUT is set 3 meters away from the receiving antenna, which is mounted on the antenna tower.
3. The table is rotated 360 degrees to determine the position of the highest spurious emission.
4. The height of the receiving antenna is varied between one meter and four meters to search for the maximum spurious emission for both horizontal and vertical polarizations.
5. Make the measurement with the spectrum analyzer's RBW = 1 MHz, VBW = 3 MHz, taking record of maximum spurious emission.
6. To convert spectrum reading E(dBuV/m) to EIRP(dBm)
 $EIRP(dBm) = Level (dBuV/m) + 20\log(d) - 104.77$, where d is the distance at which field strength limit is specified in the rules
7. Field Strength Level (dBm) = Spectrum Reading (dBm) + Antenna Factor + Cable Loss + Read Level - Preamp Factor.
8. ERP (dBm) = EIRP (dBm) - 2.15
9. The RF fundamental frequency shall be excluded against the limit line in the operating frequency band.
10. The limit line is derived from $43 + 10\log(P)$ dB below the transmitter power P(Watts)



5 List of Measuring Equipment

Instrument	Brand Name	Model No.	Serial No.	Characteristics	Calibration Date	Test Date	Due Date	Remark
Bilog Antenna	TESEQ	CBL 6111D & N-6-06	35414 & AT-N0602	30MHz~1GHz	Oct. 07, 2023	Dec. 13, 2023~Jan. 22, 2024	Oct. 06, 2024	Radiation (03CH11-HY)
Loop Antenna	Rohde & Schwarz	HFH2-Z2	100488	9 kHz~30 MHz	Sep. 12, 2023	Dec. 13, 2023~Jan. 22, 2024	Sep. 11, 2024	Radiation (03CH11-HY)
Horn Antenna	SCHWARZBECK	BBHA 9120 D	9120D-01620	1GHz~18GHz	Aug. 17, 2023	Dec. 13, 2023~Jan. 22, 2024	Aug. 16, 2024	Radiation (03CH11-HY)
SHF-EHF Horn Antenna	SCHWARZBECK	BBHA9170	1224	18GHz~40GHz	Jul. 10, 2023	Dec. 13, 2023~Jan. 22, 2024	Jul. 09, 2024	Radiation (03CH11-HY)
SHF-EHF Horn Antenna	SCHWARZBECK	BBHA9170	1223	18GHz~40GHz	Jul. 10, 2023	Dec. 13, 2023~Jan. 22, 2024	Jul. 09, 2024	Radiation (03CH11-HY)
Amplifier	SONOMA	310N	187312	9kHz~1GHz	Dec. 08, 2023	Dec. 13, 2023~Jan. 22, 2024	Dec. 07, 2024	Radiation (03CH11-HY)
Preamplifier	Keysight	83017A	MY53270078	1GHz~26.5GHz	Oct. 23, 2023	Dec. 13, 2023~Jan. 22, 2024	Oct. 22, 2024	Radiation (03CH11-HY)
Preamplifier	EMEC	EM18G40G	060801	18GHz~40GHz	Jun. 27, 2023	Dec. 13, 2023~Jan. 22, 2024	Jun. 26, 2024	Radiation (03CH11-HY)
Spectrum Analyzer	Keysight	N9010A	MY54200486	10Hz~44GHz	Oct. 05, 2023	Dec. 13, 2023~Jan. 22, 2024	Oct. 04, 2024	Radiation (03CH11-HY)
EMI Test Receiver	Keysight	N9038A(MXE)	MY53290045	20MHz~8.4GHz	Apr. 25, 2023	Dec. 13, 2023~Jan. 22, 2024	Apr. 24, 2024	Radiation (03CH11-HY)
Controller	EMEC	EM 1000	N/A	Control Turn table & Ant Mast	N/A	Dec. 13, 2023~Jan. 22, 2024	N/A	Radiation (03CH11-HY)
Antenna Mast	EMEC	AM-BS-4500-B	N/A	1~4m	N/A	Dec. 13, 2023~Jan. 22, 2024	N/A	Radiation (03CH11-HY)
Turn Table	EMEC	TT 2000	N/A	0~360 Degree	N/A	Dec. 13, 2023~Jan. 22, 2024	N/A	Radiation (03CH11-HY)
Software	Audix	E3 6.2009-8-24	RK-001053	N/A	N/A	Dec. 13, 2023~Jan. 22, 2024	N/A	Radiation (03CH11-HY)
RF Cable	HUBER + SUHNER	SUCOFLEX 102	MY2859/2	30MHz~40GHz	Mar. 07, 2023	Dec. 13, 2023~Jan. 22, 2024	Mar. 06, 2024	Radiation (03CH11-HY)
RF Cable	HUBER + SUHNER	SUCOFLEX 102	803951/2	9K~30M	Mar. 07, 2023	Dec. 13, 2023~Jan. 22, 2024	Mar. 06, 2024	Radiation (03CH11-HY)
RF Cable	HUBER + SUHNER	SUCOFLEX 102	803951/2	30M~40G	Mar. 07, 2023	Dec. 13, 2023~Jan. 22, 2024	Mar. 06, 2024	Radiation (03CH11-HY)
Filter	Wainwright	WLK4-1000-1530-8000-40SS	SN11	1.53G Low Pass	Sep. 11, 2023	Dec. 13, 2023~Jan. 22, 2024	Sep. 10, 2024	Radiation (03CH11-HY)
Filter	Wainwright	WHKX12-2700-3000-18000-60SS	SN3	3GHz High Pass Filter	Sep. 11, 2023	Dec. 13, 2023~Jan. 22, 2024	Sep. 10, 2024	Radiation (03CH11-HY)
Filter	Wainwright	WHKX8-5872.5-6750-18000-40SS	SN3	6.75GHz High Pass Filter	Sep. 11, 2023	Dec. 13, 2023~Jan. 22, 2024	Sep. 10, 2024	Radiation (03CH11-HY)
Spectrum Analyzer	Rohde & Schwarz	FSP30	101329	9kHz~30GHz	Sep. 20, 2023	Jan. 03, 2024~Jan. 11, 2024	Sep. 19, 2024	Conducted (TH03-HY)
Programmable Power Supply	GW Instek	PSS-2005	EL890001	1V~20V 0.5A~4A	Sep. 12, 2023	Jan. 03, 2024~Jan. 11, 2024	Sep. 11, 2024	Conducted (TH03-HY)
Base Station (Measure)	Rohde & Schwarz	CMU200	117995	GSM / GPRS / WCDMA / CDMA	Aug. 06, 2023	Jan. 03, 2024~Jan. 11, 2024	Aug. 05, 2024	Conducted (TH03-HY)
Thermal Chamber	ESPEC	SU-241	92003713	-30℃ ~95℃	May 17, 2023	Jan. 03, 2024~Jan. 11, 2024	May 16, 2024	Conducted (TH03-HY)
Hygrometer	TECEP	DTM-303A	TP201996	N/A	Nov. 17, 2023	Jan. 03, 2024~Jan. 11, 2024	Nov. 06, 2024	Conducted (TH03-HY)



6 Measurement Uncertainty

Uncertainty of Radiated Emission Measurement (30 MHz ~ 1000 MHz)

Measuring Uncertainty for a Level of Confidence of 95% ($U = 2Uc(y)$)	3.22 dB
---	---------

Uncertainty of Radiated Emission Measurement (1 GHz ~ 18 GHz)

Measuring Uncertainty for a Level of Confidence of 95% ($U = 2Uc(y)$)	3.53 dB
---	---------

Uncertainty of Radiated Emission Measurement (18 GHz ~ 40 GHz)

Measuring Uncertainty for a Level of Confidence of 95% ($U = 2Uc(y)$)	3.61 dB
---	---------



Appendix A. Test Results of Conducted Test

Conducted Output Power(Average power) & ERP / EIRP

WCDMA Band V Maximum Average Power [dBm] (GT - LC = -1.57 dB)					
Channel	4132	4182	4233	ERP (dBm)	ERP (W)
Frequency	826.4	836.4	846.6		
RMC 12.2K	24.62	24.57	24.33	20.90	0.1230
HSDPA Subtest-1	23.61	23.59	23.33		
HSDPA Subtest-2	23.65	23.55	23.34		
HSDPA Subtest-3	23.13	23.04	22.84		
HSDPA Subtest-4	23.09	23.07	22.82		
HSUPA Subtest-1	23.61	23.54	23.30		
HSUPA Subtest-2	21.60	21.52	21.29		
HSUPA Subtest-3	22.60	22.56	22.32		
HSUPA Subtest-4	21.60	21.50	21.35		
HSUPA Subtest-5	23.60	23.50	23.30		
Limit	ERP < 7W				

WCDMA Band II Maximum Average Power [dBm] (GT - LC = -1.37 dB)					
Channel	9262	9400	9538	EIRP (dBm)	EIRP (W)
Frequency	1852.4	1880	1907.6		
RMC 12.2K	24.48	24.76	24.94	23.57	0.2275
HSDPA Subtest-1	23.51	23.75	23.93		
HSDPA Subtest-2	23.52	23.78	23.93		
HSDPA Subtest-3	23.03	23.28	23.45		
HSDPA Subtest-4	23.07	23.26	23.46		
HSUPA Subtest-1	23.50	23.83	23.95		
HSUPA Subtest-2	21.57	21.85	21.98		
HSUPA Subtest-3	22.51	22.81	22.92		
HSUPA Subtest-4	21.56	21.79	21.32		
HSUPA Subtest-5	23.50	23.80	24.00		
Limit	EIRP < 2W				

WCDMA Band IV Maximum Average Power [dBm] (GT - LC = -0.3 dB)					
Channel	1312	1413	1513	EIRP (dBm)	EIRP (W)
Frequency	1712.4	1732.6	1752.6		
RMC 12.2K	24.30	24.48	24.59	24.29	0.2685
HSDPA Subtest-1	23.37	23.51	23.59		
HSDPA Subtest-2	23.39	23.43	23.59		
HSDPA Subtest-3	22.93	22.92	23.08		
HSDPA Subtest-4	22.85	22.95	23.12		
HSUPA Subtest-1	23.34	23.46	23.57		
HSUPA Subtest-2	21.34	21.48	21.61		
HSUPA Subtest-3	22.32	22.46	22.62		
HSUPA Subtest-4	21.34	21.43	21.62		
HSUPA Subtest-5	23.30	23.50	23.60		
Limit	EIRP < 1W				



A2. WCDMA

Peak-to-Average Ratio

Mode	WCDMA Band V	WCDMA Band II	WCDMA Band IV	Limit: 13dB
Mod.	RMC 12.2Kbps	RMC 12.2Kbps	RMC 12.2Kbps	Result
Lowest CH	2.32	3.00	3.20	PASS
Middle CH	2.76	2.88	3.16	
Highest CH	2.72	2.76	3.32	

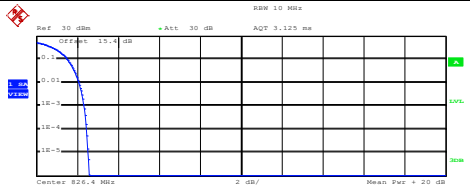
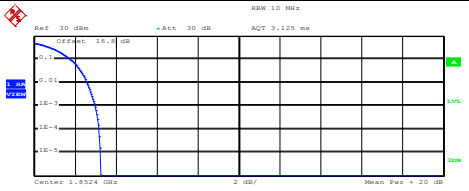
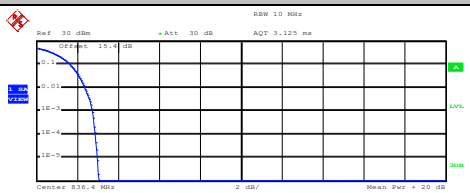
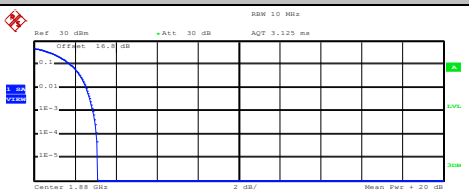
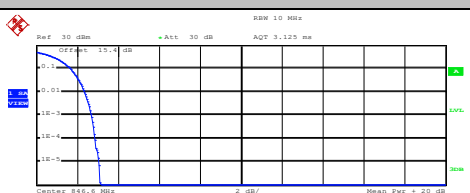
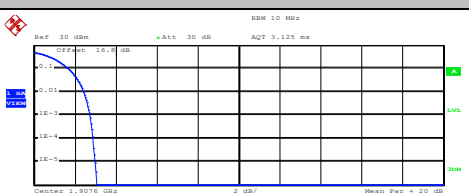

WCDMA Band V (RMC 12.2Kbps)	WCDMA Band II (RMC 12.2Kbps)
<p style="text-align: center;">Lowest Channel</p>  <p>Center 826.4 MHz 2 dB/ Mean Pwr + 20 dB</p> <p>Complementary Cumulative Distribution Function (100000 samples)</p> <p>Trace 1</p> <p>Mean 24.35 dBm Peak 26.94 dBm Crest 2.59 dB</p> <p>10 % 1.52 dB 1 % 2.08 dB .1 % 2.32 dB .01 % 2.48 dB</p> <p>Date: 3.JAN.2024 11:42:34</p>	<p style="text-align: center;">Lowest Channel</p>  <p>Center 1.8524 GHz 2 dB/ Mean Pwr + 20 dB</p> <p>Complementary Cumulative Distribution Function (100000 samples)</p> <p>Trace 1</p> <p>Mean 23.74 dBm Peak 27.01 dBm Crest 3.27 dB</p> <p>10 % 1.80 dB 1 % 2.60 dB .1 % 3.00 dB .01 % 3.16 dB</p> <p>Date: 3.JAN.2024 10:28:01</p>
<p style="text-align: center;">Middle Channel</p>  <p>Center 826.4 MHz 2 dB/ Mean Pwr + 20 dB</p> <p>Complementary Cumulative Distribution Function (100000 samples)</p> <p>Trace 1</p> <p>Mean 23.89 dBm Peak 26.94 dBm Crest 3.05 dB</p> <p>10 % 1.64 dB 1 % 2.40 dB .1 % 2.76 dB .01 % 2.88 dB</p> <p>Date: 3.JAN.2024 11:42:51</p>	<p style="text-align: center;">Middle Channel</p>  <p>Center 1.85 GHz 2 dB/ Mean Pwr + 20 dB</p> <p>Complementary Cumulative Distribution Function (100000 samples)</p> <p>Trace 1</p> <p>Mean 22.84 dBm Peak 25.95 dBm Crest 3.11 dB</p> <p>10 % 1.80 dB 1 % 2.56 dB .1 % 2.88 dB .01 % 3.04 dB</p> <p>Date: 3.JAN.2024 10:28:18</p>
<p style="text-align: center;">Highest Channel</p>  <p>Center 846.6 MHz 2 dB/ Mean Pwr + 20 dB</p> <p>Complementary Cumulative Distribution Function (100000 samples)</p> <p>Trace 1</p> <p>Mean 23.81 dBm Peak 26.94 dBm Crest 3.12 dB</p> <p>10 % 1.68 dB 1 % 2.36 dB .1 % 2.72 dB .01 % 2.88 dB</p> <p>Date: 3.JAN.2024 11:43:08</p>	<p style="text-align: center;">Highest Channel</p>  <p>Center 1.9076 GHz 2 dB/ Mean Pwr + 20 dB</p> <p>Complementary Cumulative Distribution Function (100000 samples)</p> <p>Trace 1</p> <p>Mean 24.02 dBm Peak 27.08 dBm Crest 3.06 dB</p> <p>10 % 1.68 dB 1 % 2.44 dB .1 % 2.76 dB .01 % 2.88 dB</p> <p>Date: 3.JAN.2024 10:28:42</p>



WCDMA Band IV (RMC 12.2Kbps)

Lowest Channel

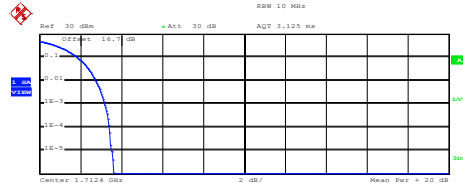

Complementary Cumulative Distribution Function (100000 samples)

Trace 1
Mean 23.67 dBm
Peak 27.29 dBm
Crest 3.62 dB

10 % 1.84 dB
1 % 2.76 dB
.1 % 3.20 dB
.01 % 3.40 dB

Date: 3.JAN.2024 11:22:48

Middle Channel

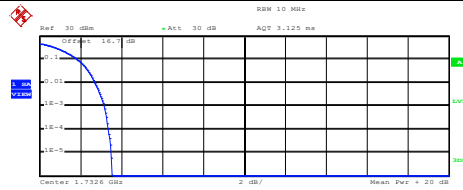

Complementary Cumulative Distribution Function (100000 samples)

Trace 1
Mean 23.97 dBm
Peak 27.50 dBm
Crest 3.53 dB

10 % 1.88 dB
1 % 2.72 dB
.1 % 3.16 dB
.01 % 3.36 dB

Date: 3.JAN.2024 11:23:09

Highest Channel

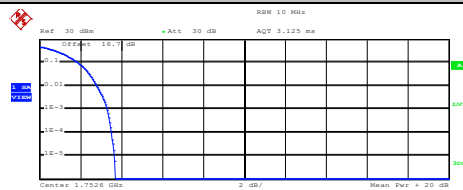

Complementary Cumulative Distribution Function (100000 samples)

Trace 1
Mean 24.02 dBm
Peak 27.71 dBm
Crest 3.70 dB

10 % 1.88 dB
1 % 2.80 dB
.1 % 3.32 dB
.01 % 3.52 dB

Date: 3.JAN.2024 11:23:30



26dB Bandwidth

Mode	WCDMA Band V 26dB BW(MHz)	WCDMA Band II 26dB BW(MHz)	WCDMA Band IV 26dB BW(MHz)
Mod.	RMC 12.2Kbps	RMC 12.2Kbps	RMC 12.2Kbps
Lowest CH	4.74	4.76	4.74
Middle CH	4.74	4.80	4.73
Highest CH	4.75	4.78	4.73

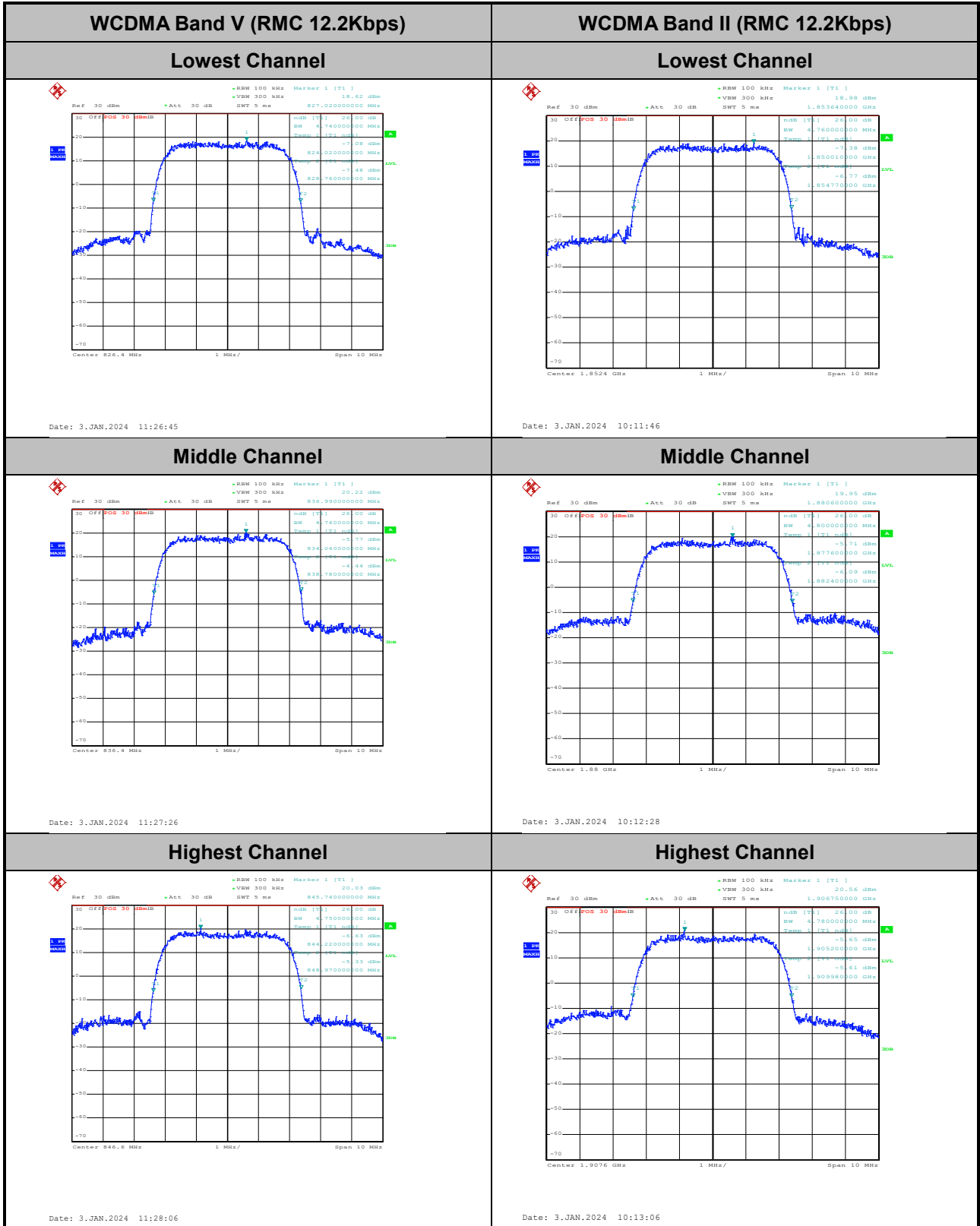



WCDMA Band IV (RMC 12.2Kbps)

Lowest Channel

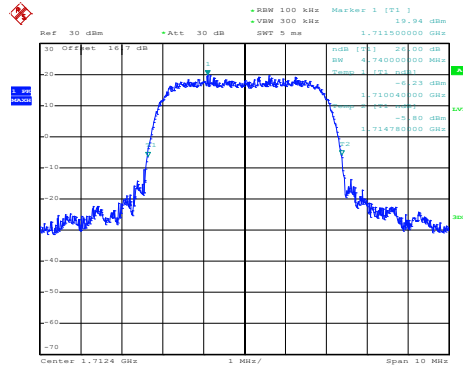

Date: 3.JAN.2024 11:06:49

Middle Channel

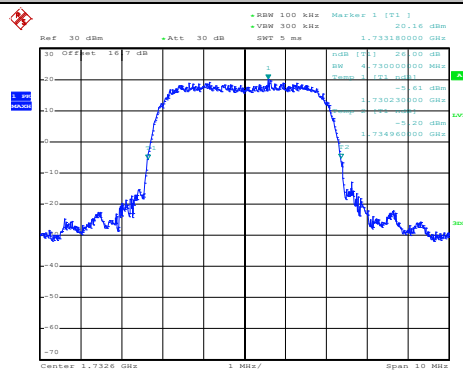

Date: 3.JAN.2024 11:07:36

Highest Channel

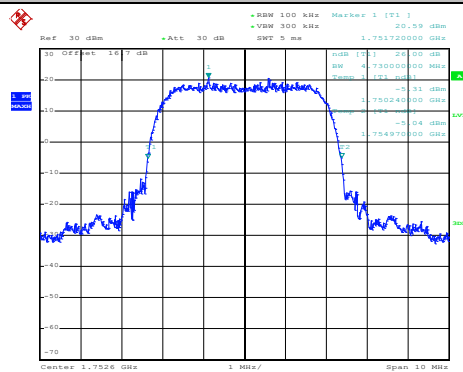

Date: 3.JAN.2024 11:08:15



Occupied Bandwidth

Mode	WCDMA Band V 99%OBW(MHz)	WCDMA Band II 99%OBW(MHz)	WCDMA Band IV 99%OBW(MHz)
Mod.	RMC 12.2Kbps	RMC 12.2Kbps	RMC 12.2Kbps
Lowest CH	4.18	4.17	4.16
Middle CH	4.15	4.16	4.16
Highest CH	4.16	4.19	4.16

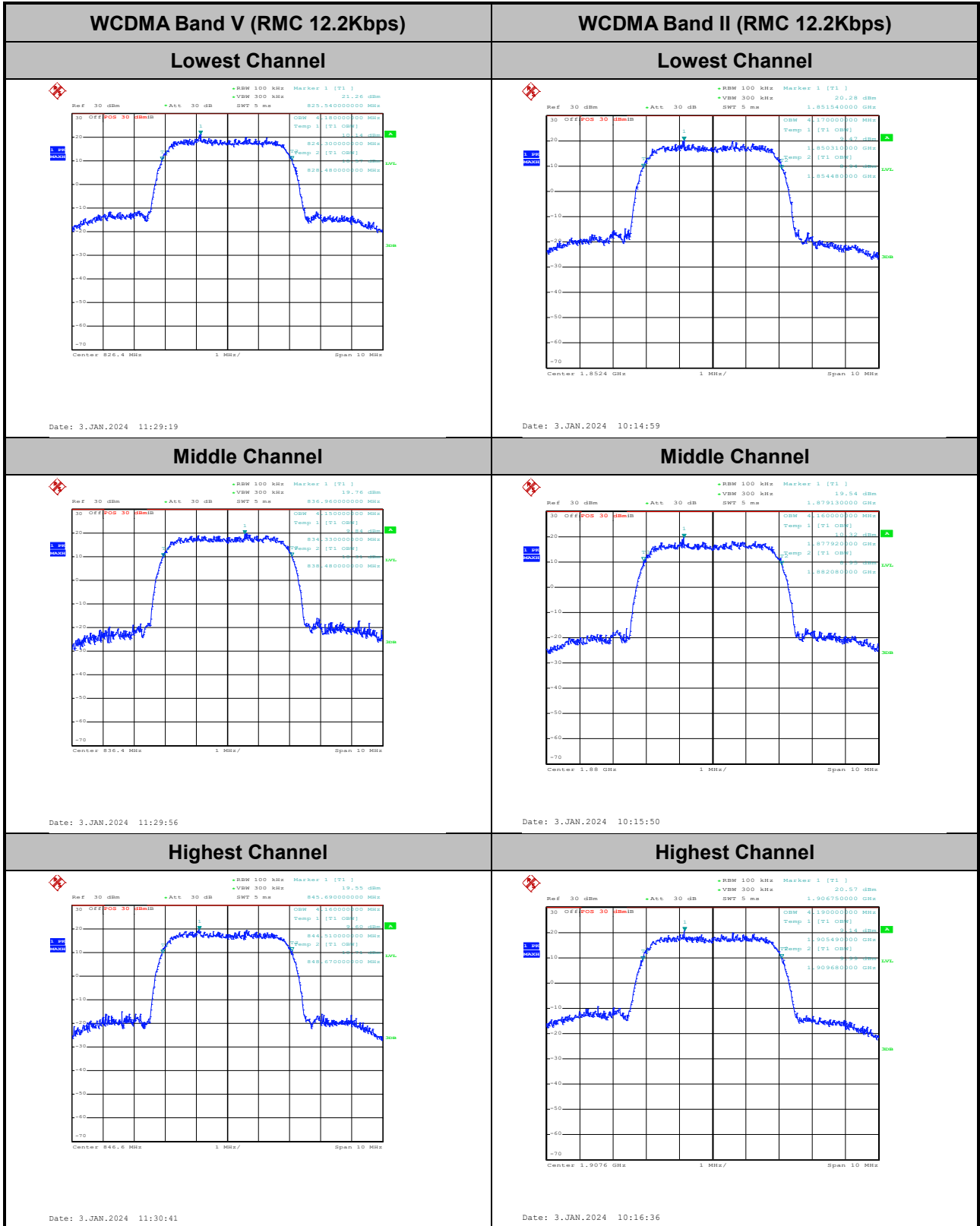

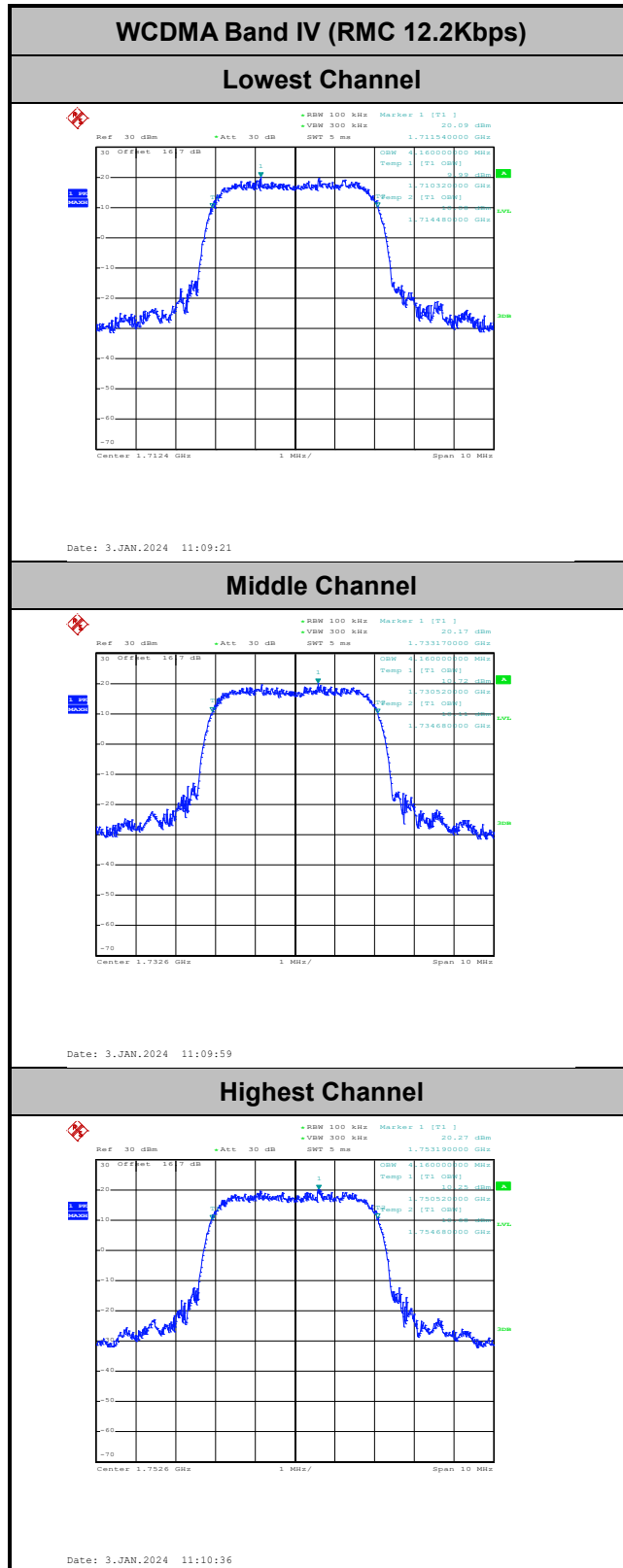



Conducted Band Edge

WCDMA Band V (RMC 12.2Kbps)

Lowest Band Edge

Highest Band Edge

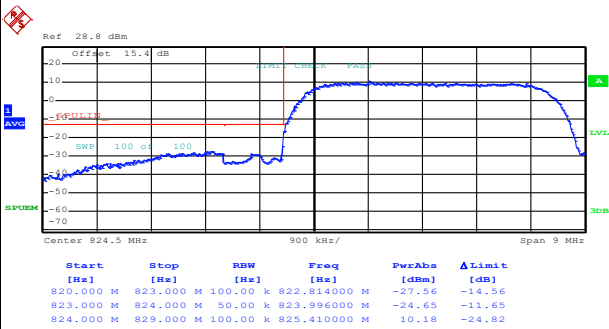

Date: 3.JAN.2024 11:34:23

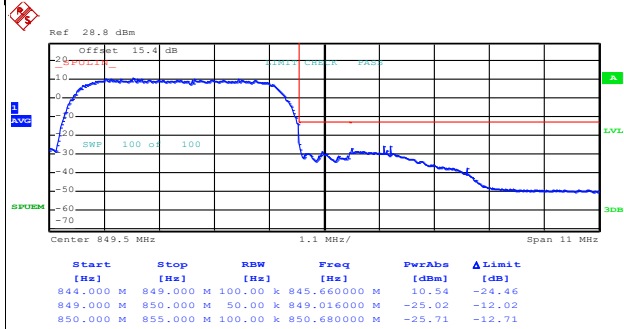

Date: 3.JAN.2024 11:37:47



WCDMA Band II (RMC 12.2Kbps)

Lowest Band Edge

Highest Band Edge

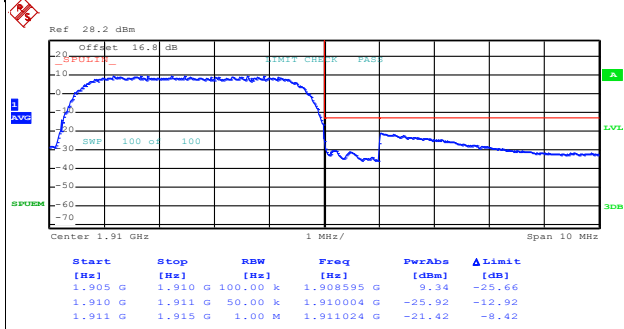
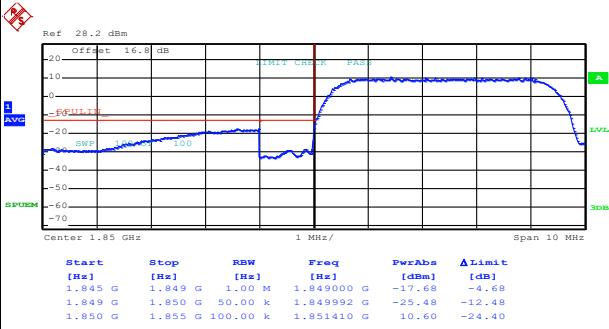

Date: 3.JAN.2024 10:19:51

Date: 3.JAN.2024 10:22:47



WCDMA Band IV (RMC 12.2Kbps)

Lowest Band Edge

Highest Band Edge

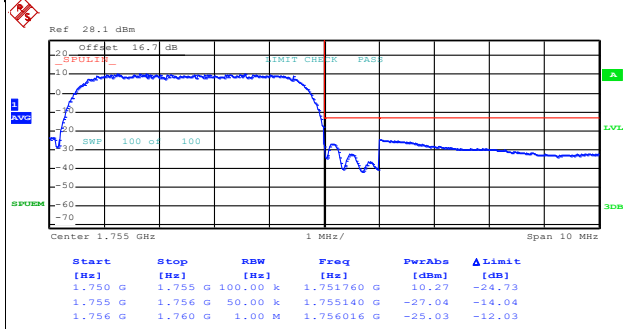
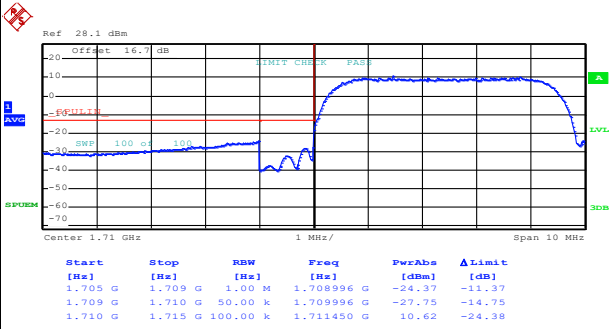

Date: 3.JAN.2024 11:16:05

Date: 3.JAN.2024 11:19:01



Conducted Spurious Emission

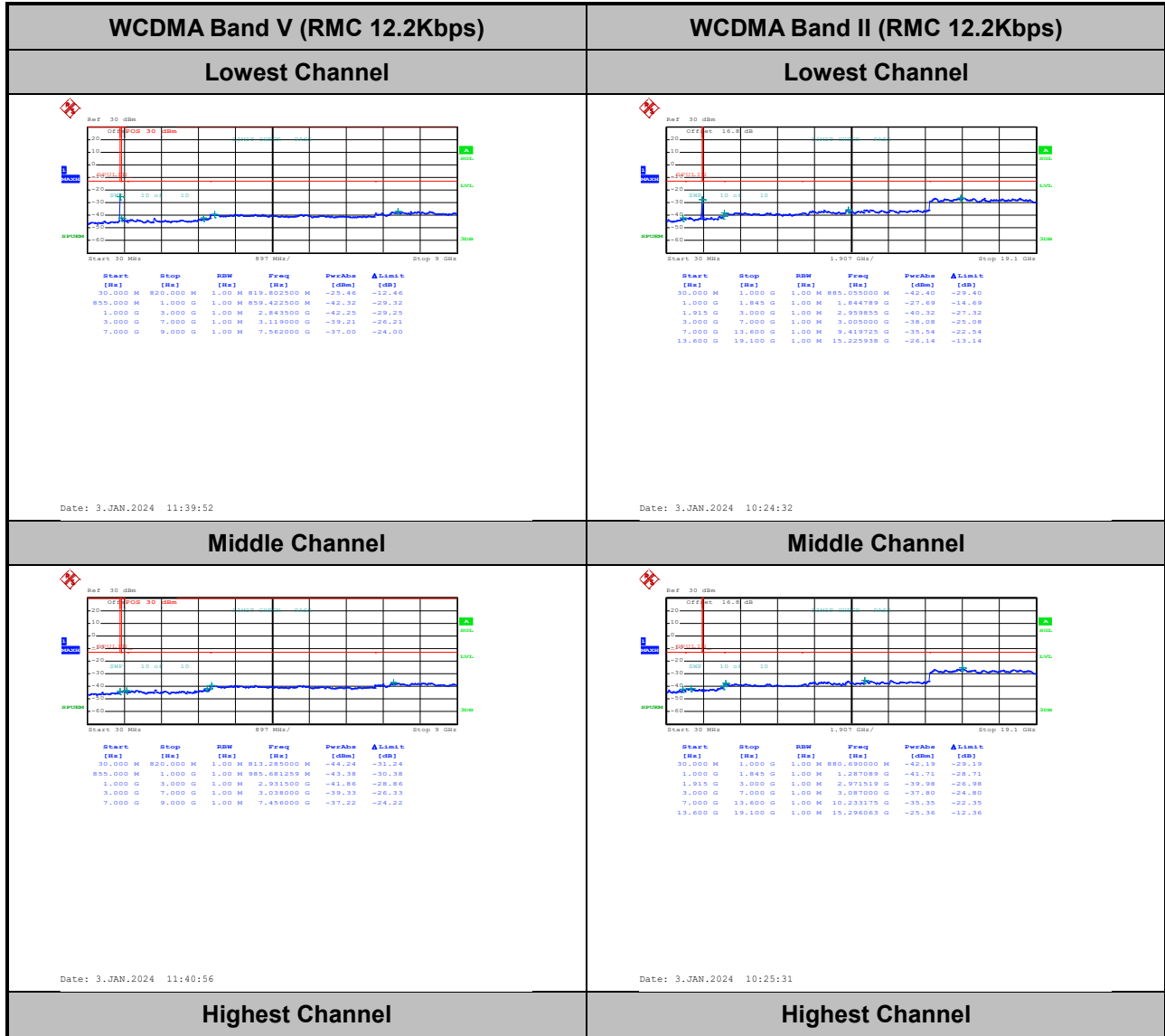

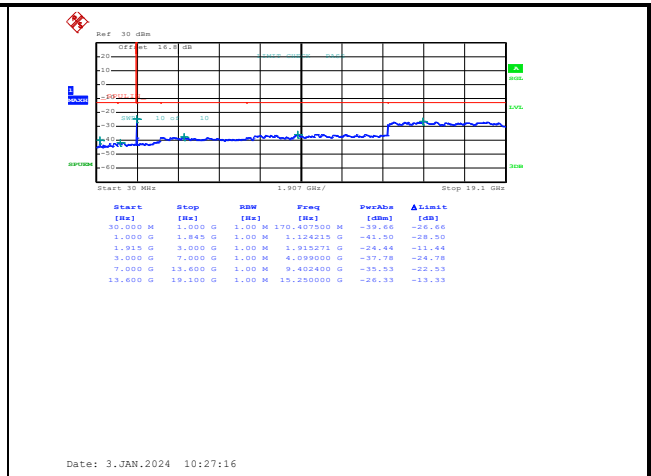
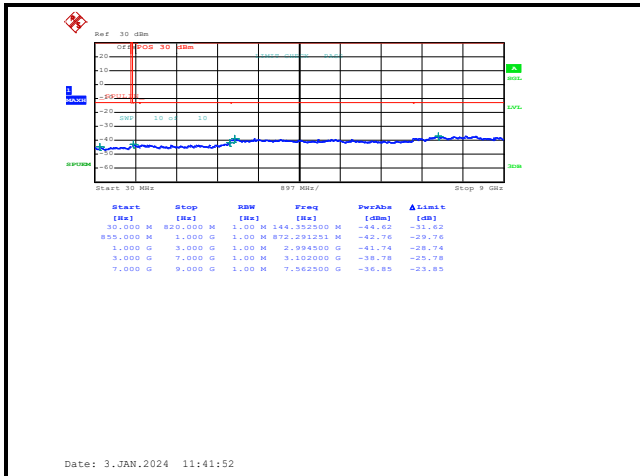

WCDMA Band IV (RMC 12.2Kbps)

Lowest Channel

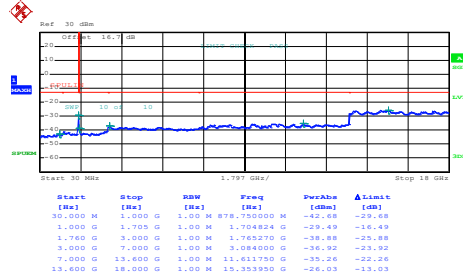

Date: 3.JAN.2024 11:20:10

Middle Channel

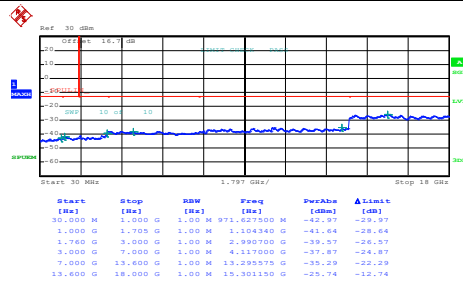

Date: 3.JAN.2024 11:21:07

Highest Channel

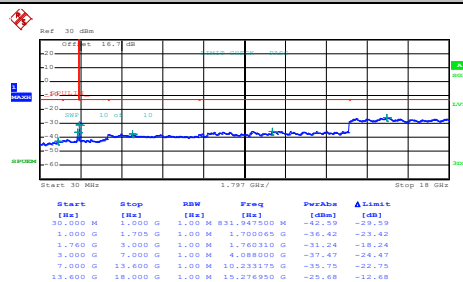

Date: 3.JAN.2024 11:22:04



Frequency Stability

Test Conditions	Middle Channel	WCDMA Band V (RMC 12.2Kbps)	Limit
			2.5ppm
Temperature (°C)	Voltage (Volt)	Deviation (ppm)	Result
50	Normal Voltage	0.0024	PASS
40	Normal Voltage	0.0036	
30	Normal Voltage	0.0060	
20(Ref.)	Normal Voltage	0.0000	
10	Normal Voltage	0.0120	
0	Normal Voltage	0.0084	
-10	Normal Voltage	0.0155	
-20	Normal Voltage	0.0108	
20	Maximum Voltage	0.0060	
20	Normal Voltage	0.0024	
20	Battery End Point	0.0048	

Test Conditions	Middle Channel	WCDMA Band II (RMC 12.2Kbps)	Limit
			Note 2.
Temperature (°C)	Voltage (Volt)	Deviation (ppm)	Result
50	Normal Voltage	0.0011	PASS
40	Normal Voltage	0.0005	
30	Normal Voltage	0.0021	
20(Ref.)	Normal Voltage	0.0000	
10	Normal Voltage	0.0085	
0	Normal Voltage	0.0074	
-10	Normal Voltage	0.0106	
-20	Normal Voltage	0.0090	
20	Maximum Voltage	0.0005	
20	Normal Voltage	0.0016	
20	Battery End Point	0.0027	



Test Conditions	Middle Channel	WCDMA Band IV (RMC 12.2Kbps)	Limit
			Note 2.
Temperature (°C)	Voltage (Volt)	Deviation (ppm)	Result
50	Normal Voltage	0.0063	PASS
40	Normal Voltage	0.0046	
30	Normal Voltage	0.0023	
20(Ref.)	Normal Voltage	0.0000	
10	Normal Voltage	0.0162	
0	Normal Voltage	0.0190	
-10	Normal Voltage	0.0208	
-20	Normal Voltage	0.0219	
20	Maximum Voltage	0.0012	
20	Normal Voltage	0.0006	
20	Battery End Point	0.0006	

Note:

1. Normal Voltage = 3.8V. ; Battery End Point (BEP) = 3.6 V. ; Maximum Voltage =4.2 V
2. The frequency fundamental emissions stay within the authorized frequency block based on the frequency deviation measured is small.



Appendix B. Test Results of Radiated Test

B1. Summary of each worse mode

Mode	Part	Band	Ch	Freq (MHz)	Level (dBm)	Det	Ant Factor (dB)	Amp\Cbl (dB)	Filter (dB)	EIRPCF (dB)	Reading (dBuV)	Limit (dBm)	Margin (dB)	Pol	Ant
1	Part 22H	WCDMA B5	M	2509	-45.60	RMS	27.79	-24.56	0.21	-95.23	46.19	-13.00	-32.60	V	1
1	Part 24E	WCDMA B2	H	5722	-45.90	RMS	33.59	-18.69	0.50	-95.23	33.93	-13.00	-32.90	H	1
1	Part 27L	WCDMA B4	H	7010	-47.70	RMS	35.94	-17.96	0.48	-95.23	29.07	-13.00	-34.70	V	1



1

Part 22H Mode 1

WCDMA B5 Ch4132

L

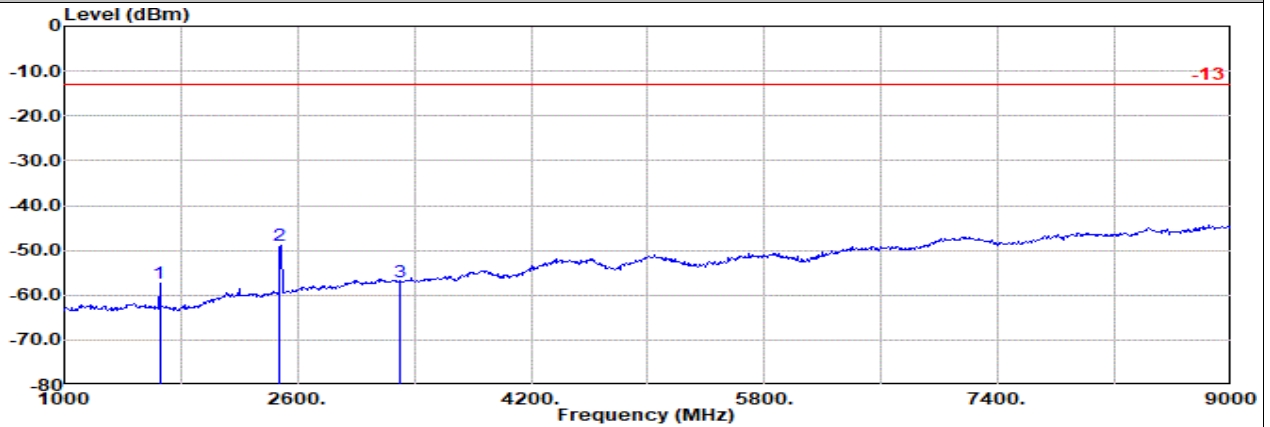

Site : 03CH11-HY
 Condition: -13 3m 9120D_01620_230817 Horizontal
 : WCDMA 850 CH4132

Freq	Level	Detector	Ant Amp\Cb Filter		EIRPCF	Readin	Limit	Margin		Pol
			Factor	1				g	dB	
MHz	dBm		dB/m	dB	dB	dBuV	dBm	dB		
1	1652.80	-57.26 RMS	25.20	-27.05	0.35	-95.23	39.47	-13.00	-44.26	Horizontal
2	2479.20	-48.81 RMS	27.69	-24.64	0.22	-95.23	43.15	-13.00	-35.81	Horizontal
3	3305.60	-57.02 RMS	29.60	-22.77	0.25	-95.23	31.13	-13.00	-44.02	Horizontal

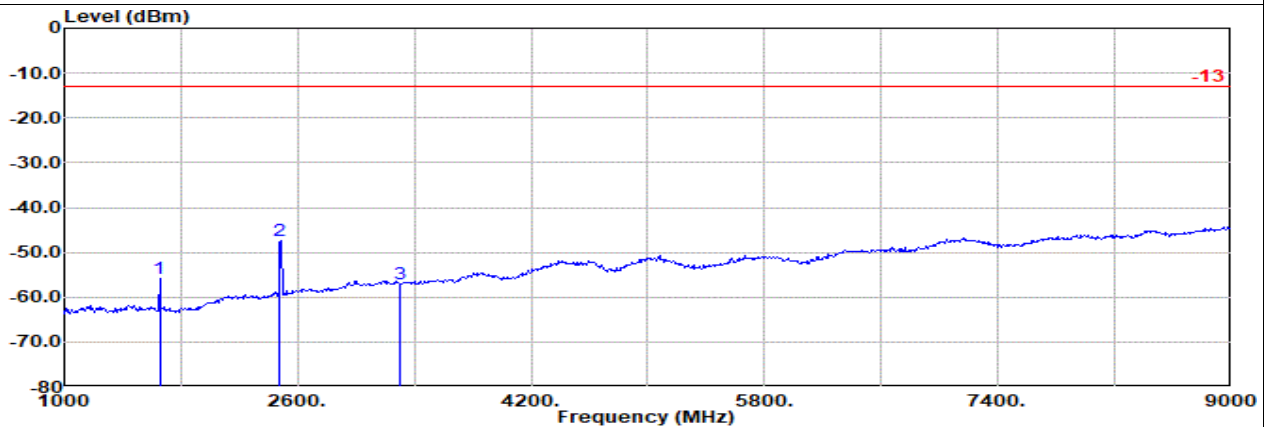

Site : 03CH11-HY
 Condition: -13 3m 9120D_01620_230817 Vertical
 : WCDMA 850 CH4132

Freq	Level	Detector	Ant Amp\Cb Filter		EIRPCF	Readin	Limit	Margin		Pol
			Factor	1				g	dB	
MHz	dBm		dB/m	dB	dB	dBuV	dBm	dB		
1	1652.80	-55.85 RMS	25.20	-27.05	0.35	-95.23	40.88	-13.00	-42.85	Vertical
2	2479.20	-47.25 RMS	27.69	-24.64	0.22	-95.23	44.71	-13.00	-34.25	Vertical
3	3305.60	-57.07 RMS	29.60	-22.77	0.25	-95.23	31.08	-13.00	-44.07	Vertical



1

Part 22H Mode 1

WCDMA B5 Ch4182

M

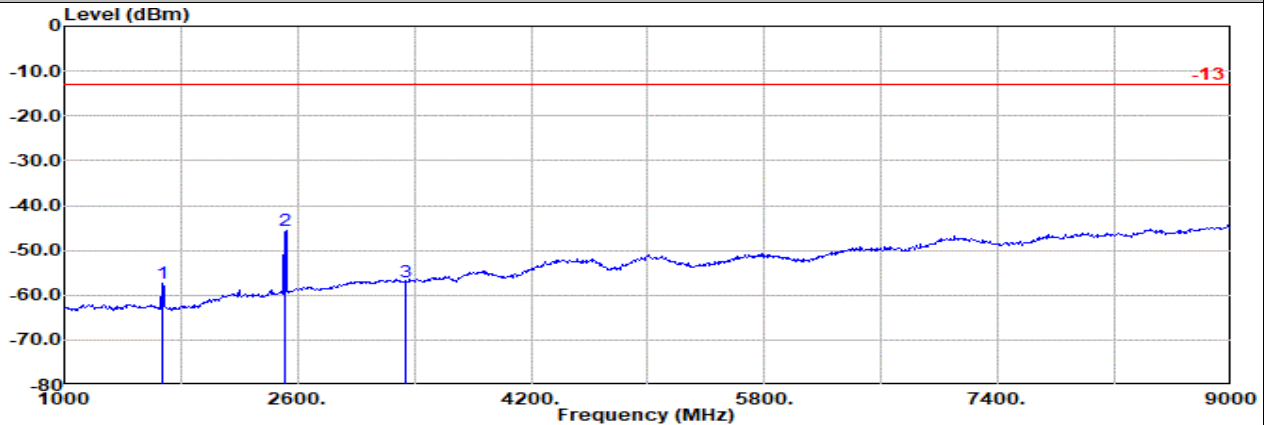

Site : 03CH11-HY
 Condition: -13 3m 9120D_01620_230817 Horizontal
 : WCDMA 850 CH4182

Freq	Level	Detector	Ant Amp\Cb Filter		EIRPCF	Readin	Limit	Margin		Pol
			Factor	1				g	dB	
MHz	dBm		dB/m	dB	dB	dBuV	dBm	dB		
1 1672.80	-57.39	RMS	25.30	-26.99	0.33	-95.23	39.20	-13.00	-44.39	Horizontal
2 2509.20	-45.64	RMS	27.79	-24.56	0.21	-95.23	46.15	-13.00	-32.64	Horizontal
3 3345.60	-56.95	RMS	29.60	-22.69	0.24	-95.23	31.13	-13.00	-43.95	Horizontal

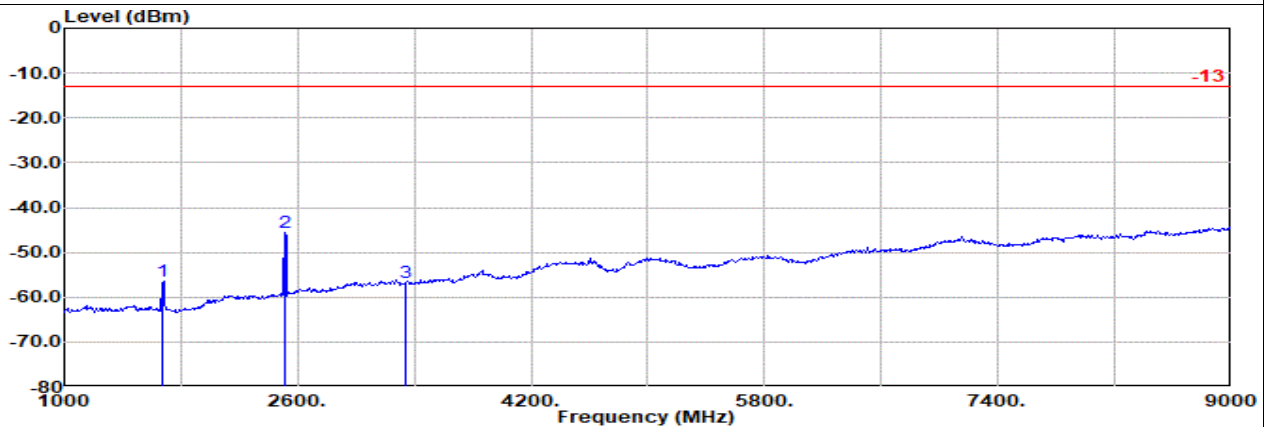

Site : 03CH11-HY
 Condition: -13 3m 9120D_01620_230817 Vertical
 : WCDMA 850 CH4182

Freq	Level	Detector	Ant Amp\Cb Filter		EIRPCF	Readin	Limit	Margin		Pol
			Factor	1				g	dB	
MHz	dBm		dB/m	dB	dB	dBuV	dBm	dB		
1 1672.80	-56.32	RMS	25.30	-26.99	0.33	-95.23	40.27	-13.00	-43.32	Vertical
2 2509.20	-45.60	RMS	27.79	-24.56	0.21	-95.23	46.19	-13.00	-32.60	Vertical
3 3345.60	-56.67	RMS	29.60	-22.69	0.24	-95.23	31.41	-13.00	-43.67	Vertical



1

Part 22H Mode 1

WCDMA B5 Ch4233

H

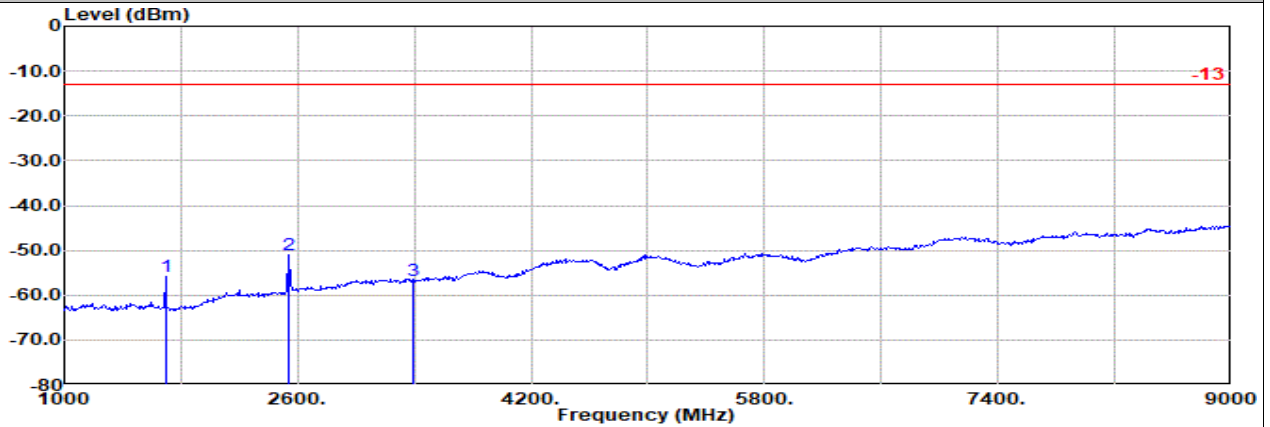

Site : 03CH11-HY
 Condition: -13 3m 9120D_01620_230817 Horizontal
 : WCDMA 850 CH4233

Freq	Level	Detector	Ant Amp\Cb Filter		EIRPCF	Readin	Limit	Margin		Pol
			Factor	1				g	dB	
MHz	dBm		dB/m	dB	dB	dBuV	dBm	dB		
1 1693.20	-55.84	RMS	25.17	-26.93	0.31	-95.23	40.84	-13.00	-42.84	Horizontal
2 2539.80	-51.01	RMS	28.00	-24.49	0.21	-95.23	40.50	-13.00	-38.01	Horizontal
3 3386.40	-56.75	RMS	29.53	-22.60	0.23	-95.23	31.32	-13.00	-43.75	Horizontal

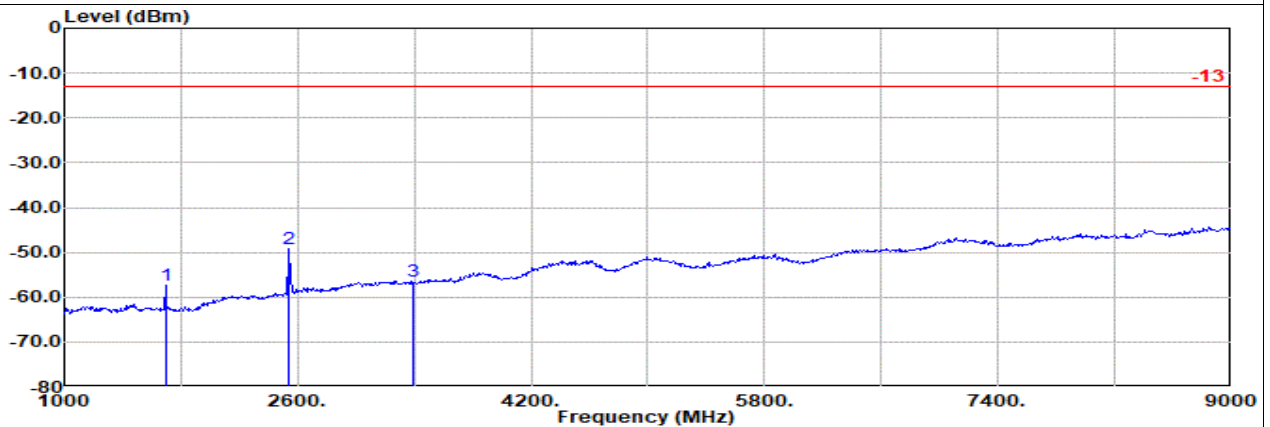

Site : 03CH11-HY
 Condition: -13 3m 9120D_01620_230817 Vertical
 : WCDMA 850 CH4233

Freq	Level	Detector	Ant Amp\Cb Filter		EIRPCF	Readin	Limit	Margin		Pol
			Factor	1				g	dB	
MHz	dBm		dB/m	dB	dB	dBuV	dBm	dB		
1 1693.20	-57.28	RMS	25.17	-26.93	0.31	-95.23	39.40	-13.00	-44.28	Vertical
2 2539.80	-49.27	RMS	28.00	-24.49	0.21	-95.23	42.24	-13.00	-36.27	Vertical
3 3386.40	-56.51	RMS	29.53	-22.60	0.23	-95.23	31.56	-13.00	-43.51	Vertical



1

Part 24E Mode 1

WCDMA B2 Ch9262

L

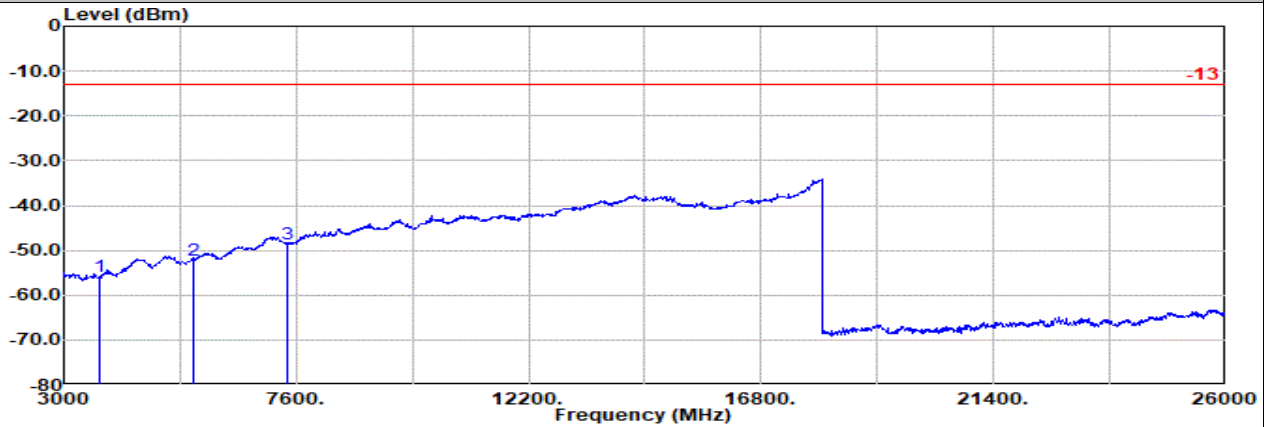

Site : 03CH11-HY
 Condition: -13 1m SHF_1223_230710 Horizontal
 : WCDMA 1900 Ch9262

Freq	Level	Detector	Ant Amp\Cb Filter		EIRPCF	Reading	Limit		Margin	Pol
			Factor	1			g			
MHz	dBm		dB/m	dB	dB	dBuV	dBm	dB		
1 3704.80	-55.96	RMS	29.64	-21.86	0.75	-95.23	30.74	-13.00	-42.96	Horizontal
2 5557.20	-52.13	RMS	32.91	-18.75	0.51	-95.23	28.43	-13.00	-39.13	Horizontal
3 7409.60	-48.66	RMS	36.38	-18.58	0.64	-95.23	28.13	-13.00	-35.66	Horizontal

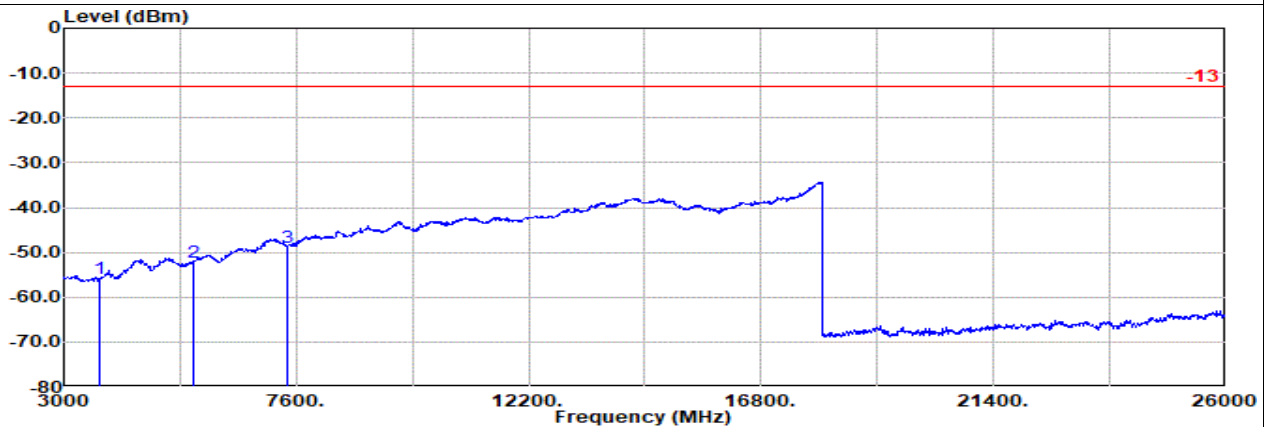

Site : 03CH11-HY
 Condition: -13 1m SHF_1223_230710 Vertical
 : WCDMA 1900 Ch9262

Freq	Level	Detector	Ant Amp\Cb Filter		EIRPCF	Reading	Limit		Margin	Pol
			Factor	1			g			
MHz	dBm		dB/m	dB	dB	dBuV	dBm	dB		
1 3704.80	-55.98	RMS	29.64	-21.86	0.75	-95.23	30.72	-13.00	-42.98	Vertical
2 5557.20	-52.24	RMS	32.91	-18.75	0.51	-95.23	28.32	-13.00	-39.24	Vertical
3 7409.60	-48.79	RMS	36.38	-18.58	0.64	-95.23	28.00	-13.00	-35.79	Vertical



1

Part 24E Mode 1

WCDMA B2 Ch9400

M

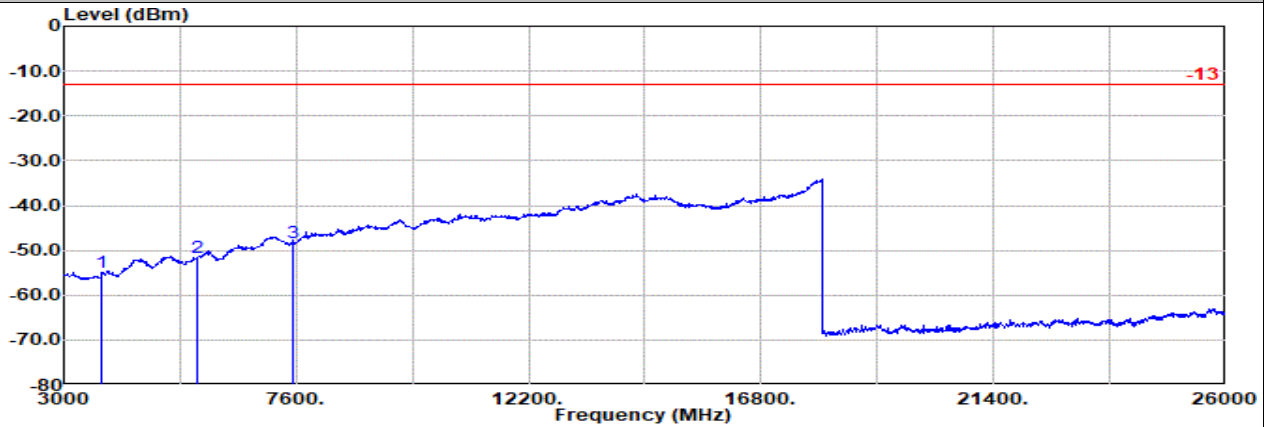

Site : 03CH11-HY
 Condition: -13 1m SHF_1223_230710 Horizontal
 : WCDMA 1900 Ch9400

1	2	3	Freq Level		Detector	Ant Amp\Cb Filter		EIRPCF	Readin g	Limit	Margin Pol		
			MHz	dBm		Factor	1				dB	dB	dB
1	2	3	3760.00	-54.80	RMS	30.10	-21.78	0.69	-95.23	31.42	-13.00	-41.80	Horizontal
2	3	1	5640.00	-51.67	RMS	33.08	-18.73	0.49	-95.23	28.72	-13.00	-38.67	Horizontal
3	1	2	7520.00	-48.29	RMS	36.12	-18.47	0.58	-95.23	28.71	-13.00	-35.29	Horizontal

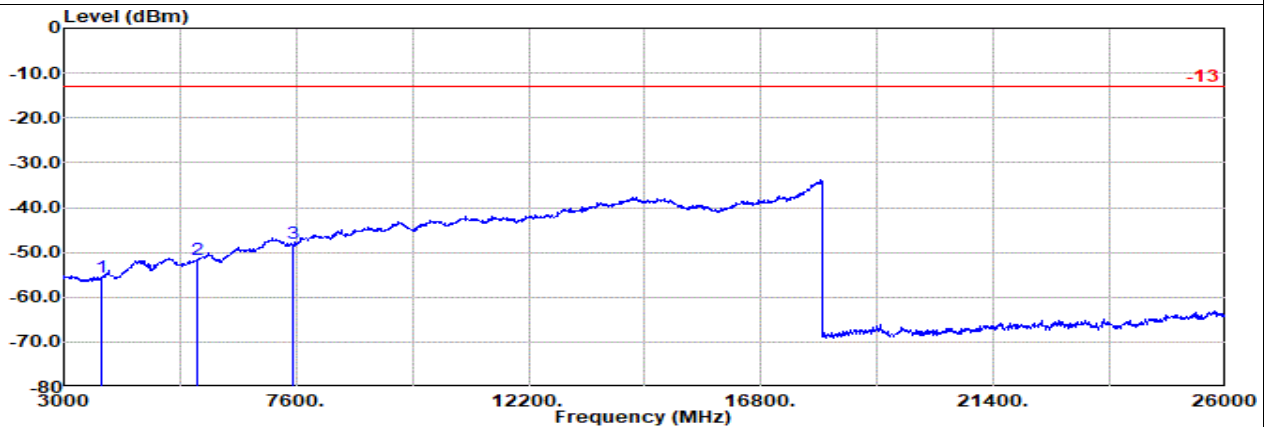

Site : 03CH11-HY
 Condition: -13 1m SHF_1223_230710 Vertical
 : WCDMA 1900 Ch9400

1	2	3	Freq Level		Detector	Ant Amp\Cb Filter		EIRPCF	Readin g	Limit	Margin Pol		
			MHz	dBm		Factor	1				dB	dB	dB
1	2	3	3760.00	-55.53	RMS	30.10	-21.78	0.69	-95.23	30.69	-13.00	-42.53	Vertical
2	3	1	5640.00	-51.65	RMS	33.08	-18.73	0.49	-95.23	28.74	-13.00	-38.65	Vertical
3	1	2	7520.00	-48.04	RMS	36.12	-18.47	0.58	-95.23	28.96	-13.00	-35.04	Vertical



1

Part 24E Mode 1

WCDMA B2 Ch9538

H

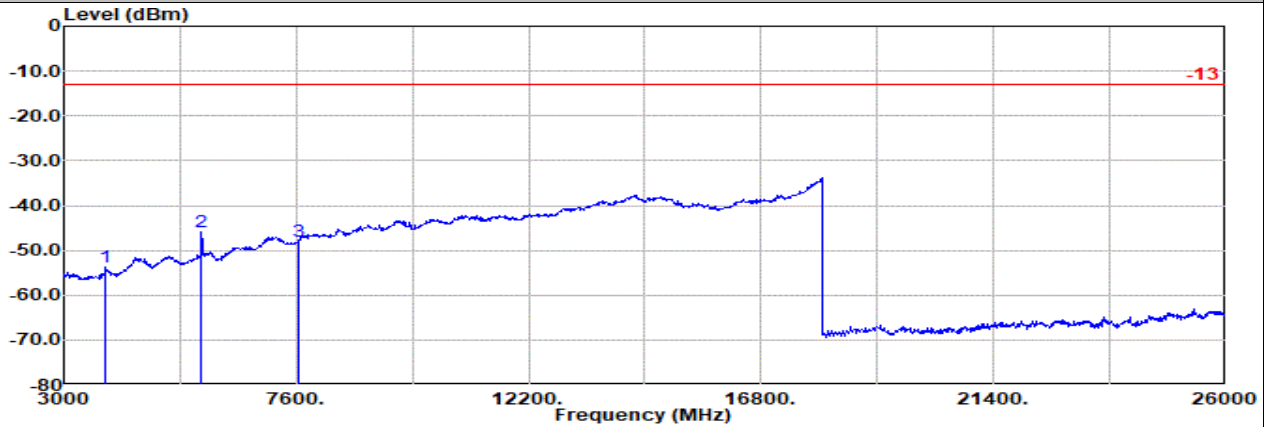

Site : 03CH11-HY
 Condition: -13 1m SHF_1223_230710 Horizontal
 : WCDMA 1900 Ch9538

	Freq	Level	Detector	Ant Amp\Cb Filter		EIRPCF	Reading	Limit	Margin Pol	
				Factor	1				dB	dB
1	3815.20	-53.70	RMS	30.62	-21.72	0.66	-95.23	31.97	-13.00	-40.70 Horizontal
2	5722.80	-45.90	RMS	33.59	-18.69	0.50	-95.23	33.93	-13.00	-32.90 Horizontal
3	7630.40	-47.96	RMS	36.22	-18.29	0.54	-95.23	28.80	-13.00	-34.96 Horizontal

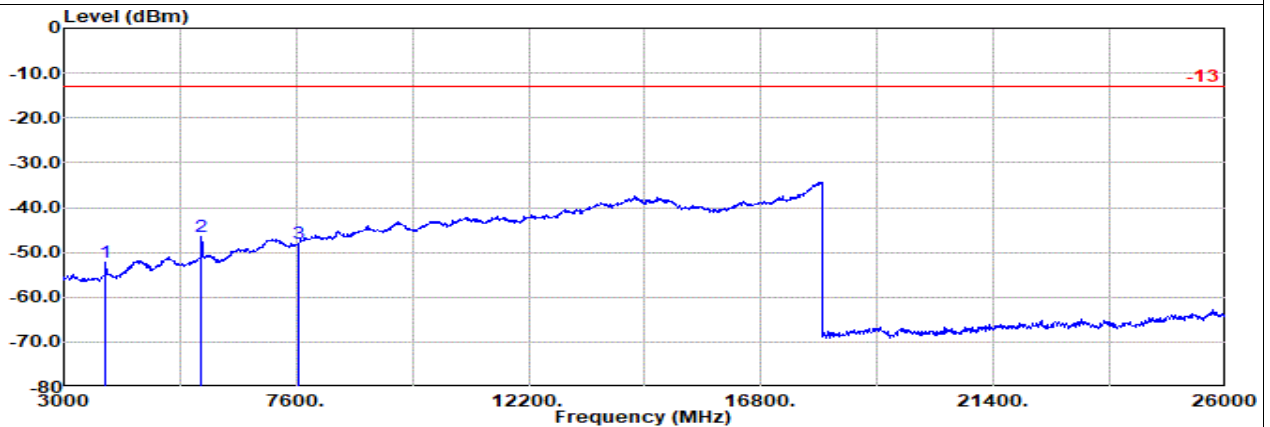

Site : 03CH11-HY
 Condition: -13 1m SHF_1223_230710 Vertical
 : WCDMA 1900 Ch9538

	Freq	Level	Detector	Ant Amp\Cb Filter		EIRPCF	Reading	Limit	Margin Pol	
				Factor	1				dB	dB
1	3815.20	-52.14	RMS	30.62	-21.72	0.66	-95.23	33.53	-13.00	-39.14 Vertical
2	5722.80	-46.46	RMS	33.59	-18.69	0.50	-95.23	33.37	-13.00	-33.46 Vertical
3	7630.40	-48.15	RMS	36.22	-18.29	0.54	-95.23	28.61	-13.00	-35.15 Vertical



1

Part 27L Mode 1

WCDMA B4 Ch1312

L

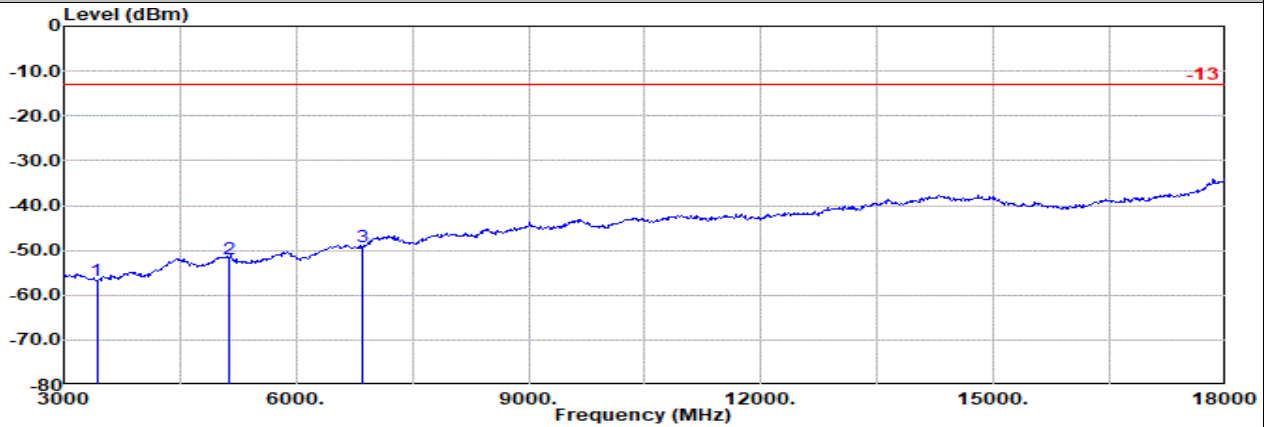

Site : 03CH11-HY
 Condition: -13 3m 9120D_01620_230817 Horizontal
 : WCDMA 1700 Ch1312

	Freq	Level	Detector	Ant Amp\Cb Filter		EIRPCF	Readin	Limit	Margin Pol	
				Factor	1				g	
	MHz	dBm		dB/m	dB	dB	dBuV	dBm	dB	
1	3424.80	-56.68	RMS	29.50	-22.49	0.91	-95.23	30.63	-13.00	-43.68 Horizontal
2	5137.20	-51.91	RMS	33.20	-19.37	0.51	-95.23	28.98	-13.00	-38.91 Horizontal
3	6849.60	-49.29	RMS	35.80	-18.26	0.45	-95.23	27.95	-13.00	-36.29 Horizontal

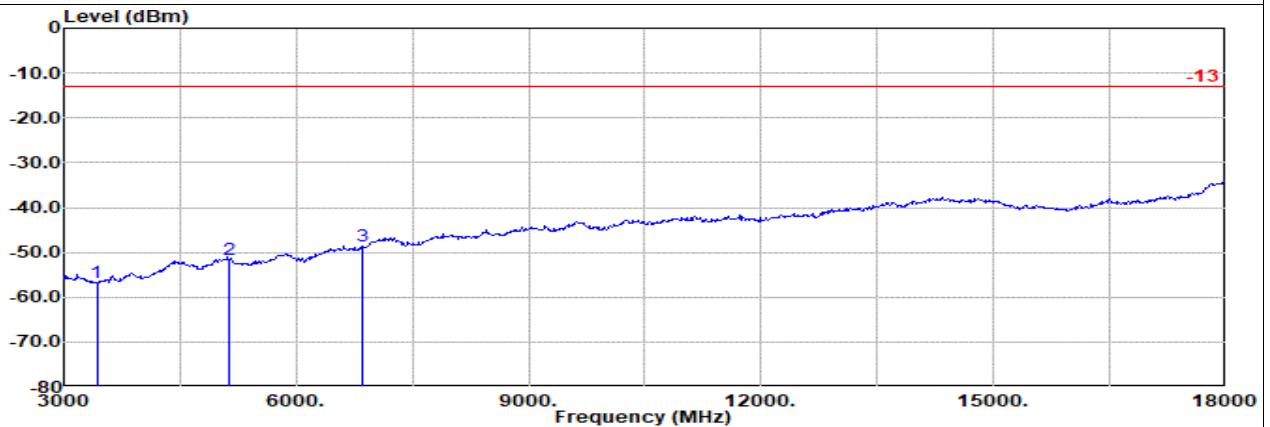

Site : 03CH11-HY
 Condition: -13 3m 9120D_01620_230817 Vertical
 : WCDMA 1700 Ch1312

	Freq	Level	Detector	Ant Amp\Cb Filter		EIRPCF	Readin	Limit	Margin Pol	
				Factor	1				g	
	MHz	dBm		dB/m	dB	dB	dBuV	dBm	dB	
1	3424.80	-56.65	RMS	29.50	-22.49	0.91	-95.23	30.66	-13.00	-43.65 Vertical
2	5137.20	-51.68	RMS	33.20	-19.37	0.51	-95.23	29.21	-13.00	-38.68 Vertical
3	6849.60	-48.72	RMS	35.80	-18.26	0.45	-95.23	28.52	-13.00	-35.72 Vertical



1

Part 27L Mode 1

WCDMA B4 Ch1413

M

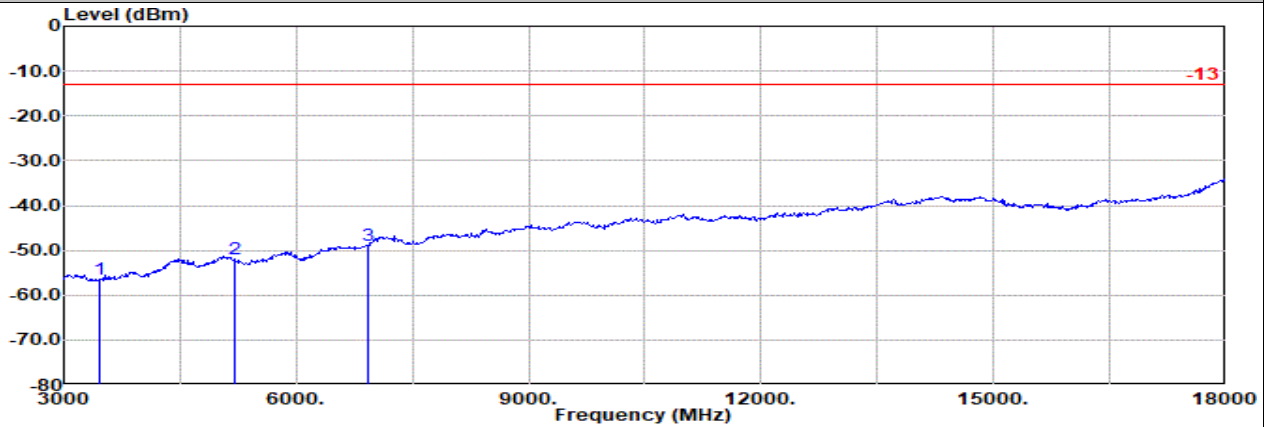

Site : 03CH11-HY
 Condition: -13 3m 9120D_01620_230817 Horizontal
 : WCDMA 1700 Ch1413

	Freq	Level	Detector	Ant Amp\Cb Filter		EIRPCF	Readin	Limit	Margin Pol	
				Factor	1				g	
	MHz	dBm		dB/m	dB	dB	dBuV	dBm	dB	
1	3465.20	-56.37	RMS	29.53	-22.37	0.90	-95.23	30.80	-13.00	-43.37 Horizontal
2	5197.80	-51.93	RMS	33.10	-19.34	0.51	-95.23	29.03	-13.00	-38.93 Horizontal
3	6930.40	-48.89	RMS	35.80	-18.09	0.46	-95.23	28.17	-13.00	-35.89 Horizontal

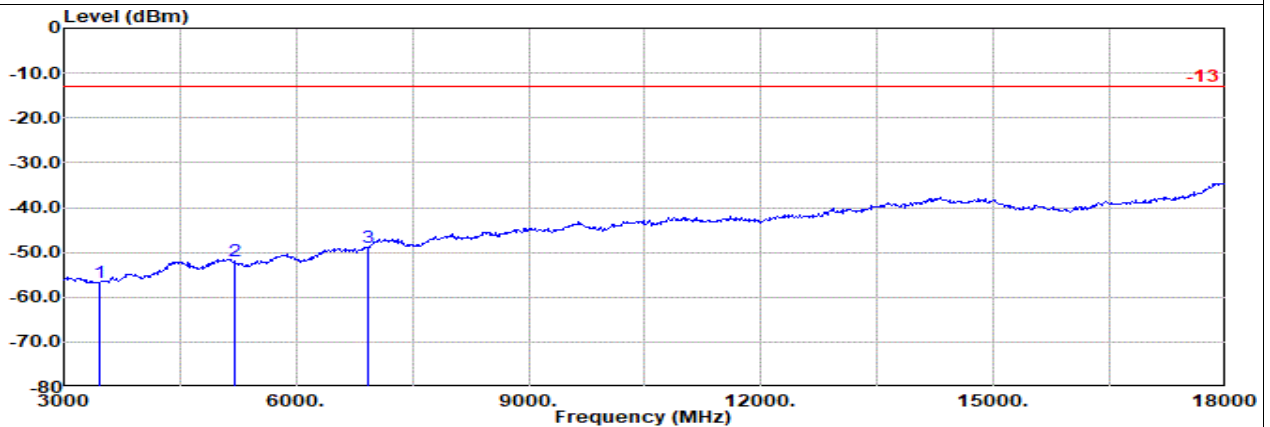

Site : 03CH11-HY
 Condition: -13 3m 9120D_01620_230817 Vertical
 : WCDMA 1700 Ch1413

	Freq	Level	Detector	Ant Amp\Cb Filter		EIRPCF	Readin	Limit	Margin Pol	
				Factor	1				g	
	MHz	dBm		dB/m	dB	dB	dBuV	dBm	dB	
1	3465.20	-56.74	RMS	29.53	-22.37	0.90	-95.23	30.43	-13.00	-43.74 Vertical
2	5197.80	-51.88	RMS	33.10	-19.34	0.51	-95.23	29.08	-13.00	-38.88 Vertical
3	6930.40	-48.78	RMS	35.80	-18.09	0.46	-95.23	28.28	-13.00	-35.78 Vertical



1

Part 27L Mode 1

WCDMA B4 Ch1513

H

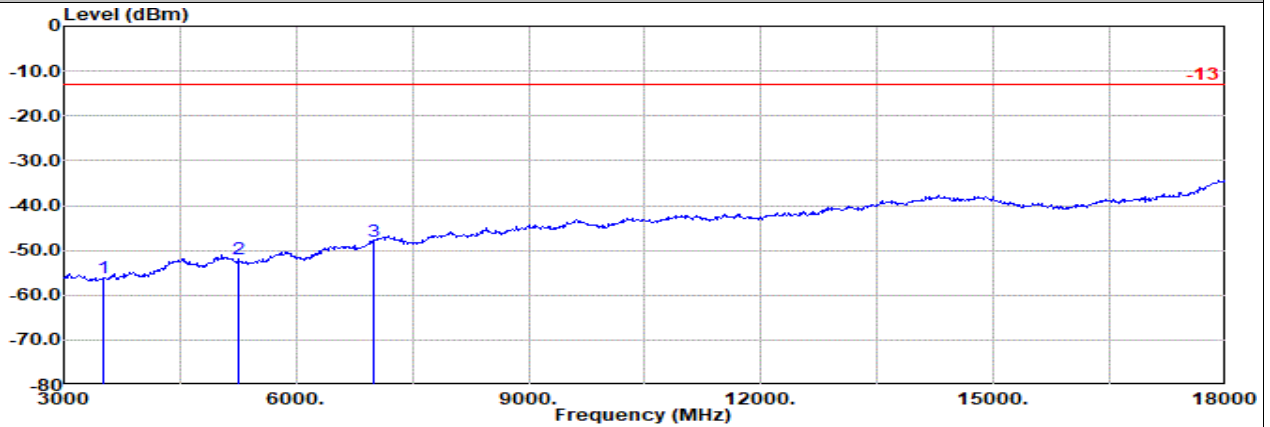

Site : 03CH11-HY
 Condition: -13 3m 9120D_01620_230817 Horizontal
 : WCDMA 1700 Ch1513

	Freq MHz	Level dBm	Detector	Ant Amp\Cb Filter		EIRPCF	Readin g	Limit		Margin	Pol
				Factor	1			dB	dBm		
1	3505.20	-56.24	RMS	29.61	-22.25	0.89	-95.23	30.74	-13.00	-43.24	Horizontal
2	5257.80	-51.94	RMS	32.98	-19.19	0.53	-95.23	28.97	-13.00	-38.94	Horizontal
3	7010.40	-47.90	RMS	35.94	-17.96	0.48	-95.23	28.87	-13.00	-34.90	Horizontal

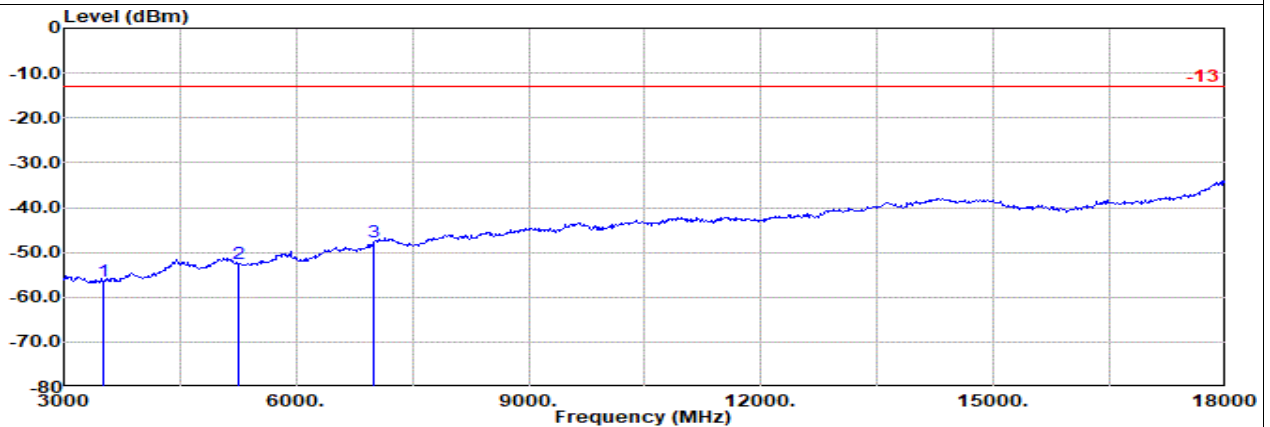

Site : 03CH11-HY
 Condition: -13 3m 9120D_01620_230817 Vertical
 : WCDMA 1700 Ch1513

	Freq MHz	Level dBm	Detector	Ant Amp\Cb Filter		EIRPCF	Readin g	Limit		Margin	Pol
				Factor	1			dB	dBm		
1	3505.20	-56.54	RMS	29.61	-22.25	0.89	-95.23	30.44	-13.00	-43.54	Vertical
2	5257.80	-52.66	RMS	32.98	-19.19	0.53	-95.23	28.25	-13.00	-39.66	Vertical
3	7010.40	-47.70	RMS	35.94	-17.96	0.48	-95.23	29.07	-13.00	-34.70	Vertical



1

Part 22H Mode 1
WCDMA B5 Ch4182
M

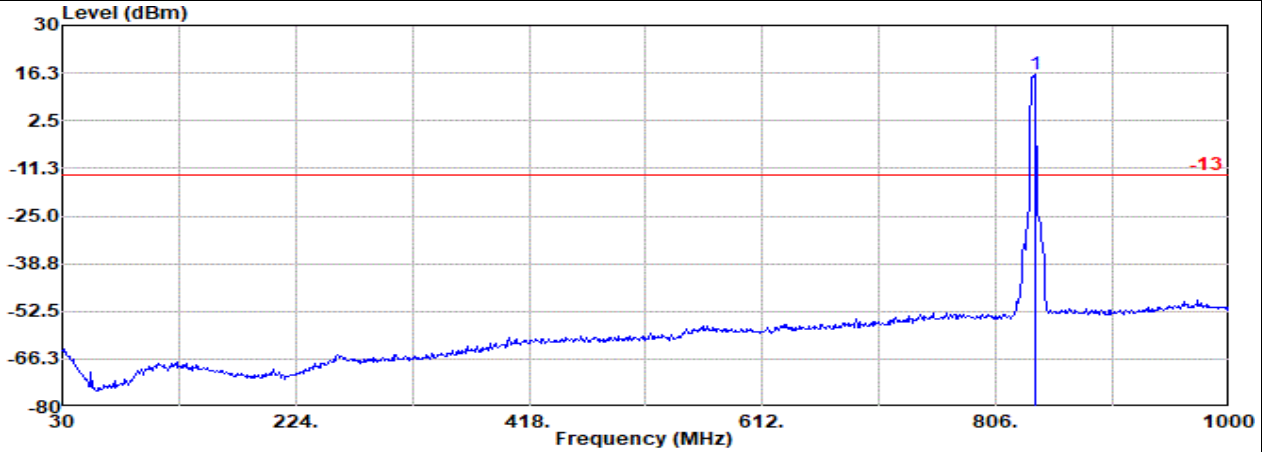

Site : 03CH11-HY
Condition: -13 3m BILOG_35414_231007 Horizontal
: WCDMA 850 CH4182

1	Freq	Level	Detector	Ant Amp\Cb Filter		EIRPCF	Readin Limit		Margin	Pol
	MHz	dBm		Factor	1		dB	dB		
	838.01	16.09	RMS	28.53	4.17	0.00	-95.23	78.62-500.00	516.09	Horizontal

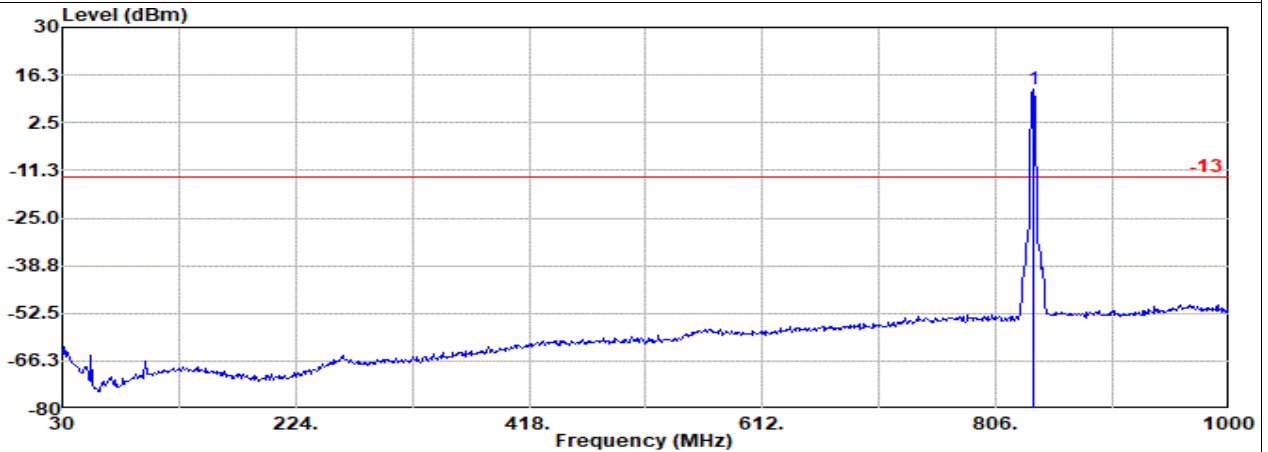

Site : 03CH11-HY
Condition: -13 3m BILOG_35414_231007 Vertical
: WCDMA 850 CH4182

1	Freq	Level	Detector	Ant Amp\Cb Filter		EIRPCF	Readin Limit		Margin	Pol
	MHz	dBm		Factor	1		dB	dB		
	837.04	12.10	RMS	28.50	4.17	0.00	-95.23	74.66 -13.00	25.10	Vertical

Remark: The over limit signal #1 is fundamental signal which can be ignored.