



FCC RADIO TEST REPORT

FCC ID : UZ7MC9401
Equipment : Mobile Computer
Brand Name : ZEBRA
Model Name : MC9401
Applicant : Zebra Technologies Corporation
1 Zebra Plaza, Holtsville, NY 11742
Manufacturer : Zebra Technologies Corporation
1 Zebra Plaza, Holtsville, NY 11742
Standard : FCC Part 15 Subpart E §15.407

The product was received on Jun. 21, 2023 and testing was performed from Jul. 07, 2023 to Sep. 22, 2023. We, Sporton International Inc. Wensan Laboratory, would like to declare that the tested sample has been evaluated in accordance with the test procedures and has been in compliance with the applicable technical standards.

The test results in this report apply exclusively to the tested model / sample. Without written approval from Sporton International Inc. Wensan Laboratory, the test report shall not be reproduced except in full.

Louis Wu

Approved by: Louis Wu

Sporton International Inc. Wensan Laboratory

No.58, Aly. 75, Ln. 564, Wenhua 3rd, Rd., Guishan Dist., Taoyuan City 333010, Taiwan (R.O.C.)



Table of Contents

History of this test report.....	3
Summary of Test Result.....	4
1 General Description	5
1.1 Product Feature of Equipment Under Test.....	5
1.2 Product Specification of Equipment Under Test.....	5
1.3 Modification of EUT	9
1.4 Testing Location	10
1.5 Applicable Standards.....	10
2 Test Configuration of Equipment Under Test	11
2.1 Carrier Frequency and Channel	11
2.2 Test Mode.....	13
2.3 Connection Diagram of Test System.....	15
2.4 Support Unit used in test configuration and system	16
2.5 EUT Operation Test Setup	16
2.6 Measurement Results Explanation Example.....	16
3 Test Result	17
3.1 26dB & 99% Occupied Bandwidth Measurement	17
3.2 Fundamental Maximum EIRP Measurement	21
3.3 Fundamental Power Spectral Density Measurement.....	22
3.4 In-Band Emissions (Channel Mask)	29
3.5 Unwanted Emissions Measurement.....	71
3.6 AC Conducted Emission Measurement.....	75
3.7 Antenna Requirements	77
4 List of Measuring Equipment.....	78
5 Measurement Uncertainty	80
Appendix A. Conducted Test Results	
Appendix B. AC Conducted Emission Test Result	
Appendix C. Radiated Spurious Emission	
Appendix D. Radiated Spurious Emission Plots	
Appendix E. Duty Cycle Plots	
Appendix F. Setup Photographs	



History of this test report

Report No.	Version	Description	Issue Date
FR362117-01A	01	Initial issue of report	Sep. 28, 2023



Summary of Test Result

Report Clause	Ref Std. Clause	Test Items	Result (PASS/FAIL)	Remark
3.1	15.407(a)(10)	26dB Emission Bandwidth	Pass	-
3.1	2.1049	99% Occupied Bandwidth	Reporting only	-
3.2	15.407(a)(7)	Fundamental Maximum EIRP	Pass	-
3.3	15.407(a)(7)	Fundamental Power Spectral Density	Pass	-
3.4	15.407(b)(6)	In-Band Emissions (Channel Mask)	Pass	-
-	15.407(d)(6)	Contention Based Protocol	Not Required	Dual Client Standard Client
-	15.407 KDB 987594 D02 Section II. K.	Dual Client Test	Not Required	Dual Client EIRP < 24dBm
3.5	15.407(b)	Unwanted Emissions	Pass	5.42 dB under the limit at 5900.20 MHz
3.6	15.207	AC Conducted Emission	Pass	16.65 dB under the limit at 0.17 MHz
3.7	15.203 15.407(a)	Antenna Requirement	Pass	-

Note:

1. Not required means after assessing, test items are not necessary to carry out.
2. Except AC Conducted Emission is carrying out, FR362117-01A report reuses test data from the FR362117I report.

Conformity Assessment Condition:

1. The test results (PASS/FAIL) with all measurement uncertainty excluded are presented against the regulation limits or in accordance with the requirements stipulated by the applicant/manufacture who shall bear all the risks of non-compliance that may potentially occur if measurement uncertainty is taken into account.
2. The measurement uncertainty please refer to each test result in the section "Measurement Uncertainty".

Disclaimer:

The product specifications of the EUT presented in the test report that may affect the test assessments are declared by the manufacturer who shall take full responsibility for the authenticity.

Reviewed by: Keven Cheng

Report Producer: Michelle Chen



1 General Description

1.1 Product Feature of Equipment Under Test

Product Feature	
Equipment	Mobile Computer
Brand Name	ZEBRA
Model Name	MC9401
FCC ID	UZ7MC9401
EUT supports Radios application	NFC WLAN 11a/b/g/n HT20/HT40 WLAN 11ac VHT20/VHT40/VHT80/VHT160 WLAN 11ax HE20/HE40/HE80/HE160 Bluetooth BR/EDR/LE
HW Version	EV
SW Version	13-05-28.00-TG-U00-PRD-NEM-04
FW Version	FUSION_QA_6_1.0.0.001_T
MFD	08JUN23
EUT Stage	Identical Prototype

Remark: The EUT's information above is declared by manufacturer.

Specification of Accessories				
Adapter USB Wall Charger	Brand Name	Zebra	Model Number	PWR-WUA5V12W0US
Battery Standard Battery (7000mAh)	Brand Name	Zebra	Model Number	BT-000370
Earphone USB-C Audio Headset	Brand Name	Zebra	Model Number	HDST-USBC-PTT1-01
USB Cable (Type C to Type A)	Brand Name	Zebra	Model Number	CBL-TC2X-USBC-01
Holster	Brand Name	Zebra	Model Number	SG-MC9X-SHLSTG-01
USB Cable (CUP)	Brand Name	Zebra	Model Number	CBL-MC93-USBCHG-01

1.2 Product Specification of Equipment Under Test

Product Specification is subject to this standard	
Tx/Rx Channel Frequency Range	5925 MHz ~ 6425 MHz 6525 MHz ~ 6875 MHz
Maximum Output Power to Antenna	MIMO <Ant. 6+7>: <5925 MHz ~ 6425 MHz> 802.11a: 18.16 dBm / 0.0655 W 802.11ax: HE20: 18.31 dBm / 0.0678 W 802.11ax: HE40: 18.11 dBm / 0.0647 W 802.11ax: HE80: 18.26 dBm / 0.0670 W 802.11ax: HE160: 18.31 dBm / 0.0678 W <6525 MHz ~ 6875 MHz> 802.11a: 18.86 dBm / 0.0769 W 802.11ax: HE20: 18.81 dBm / 0.0760 W 802.11ax: HE40: 18.77 dBm / 0.0753 W 802.11ax: HE80: 18.81 dBm / 0.0760 W 802.11ax: HE160: 18.81 dBm / 0.0760 W



Product Specification is subject to this standard			
99% Occupied Bandwidth	MIMO <Ant. 6> 802.11a: 16.33 MHz 802.11ax: HE20: 18.88 MHz 802.11ax: HE40: 37.76 MHz 802.11ax: HE80: 76.84 MHz 802.11ax: HE160: 156.32 MHz MIMO <Ant. 7> 802.11a: 16.33 MHz 802.11ax: HE20: 18.88 MHz 802.11ax: HE40: 37.86 MHz 802.11ax: HE80: 76.96 MHz 802.11ax: HE160: 156.08 MHz		
Antenna Type / Gain	<5925 MHz ~ 6425 MHz> <Ant. 6>: Coupling Antenna with gain 1.59 dBi <Ant. 7>: Coupling Antenna with gain 1.49 dBi <6525 MHz ~ 6875 MHz> <Ant. 6>: Coupling Antenna with gain 1.25 dBi <Ant. 7>: Coupling Antenna with gain 1.46 dBi		
Type of Modulation	802.11a : OFDM (BPSK/QPSK/16QAM/64QAM) 802.11ax : OFDMA (BPSK/QPSK/16QAM/64QAM/256QAM/1024QAM)		
Antenna Function Description		Ant. 6	Ant. 7
	802.11a/ax MIMO	V	V
	802.11ax TXBF	V	V

Remark:

- MIMO Ant. 6+7 Directional Gain is a calculated result from MIMO Ant. 6 and MIMO Ant. 7. The formula used in calculation is documented in section 1.2.1.
- Power of MIMO Ant. 6 + Ant. 7 is a calculated result from sum of the power MIMO Ant. 6 and MIMO Ant. 7.
- The device WIFI MIMO support 1S2T (CDD & Tx Beamforming) (Nss=1) mode& SDM (2S2T :Nss=2) mode, 1S2T: Nss=1, MIMO 2Tx; 2S2T: Nss=2, MIMO 2Tx.by manufacturer declared.
- For 802.11a, it does not support SDM & Tx Beamforming so the correlated gain for CDD is applied.
- For 802.11ax Support CDD&SDM &Tx Beamforming mode, and the manufacturer declares that Tx Beamforming power/EIRP is less than CDD mode 3dbm, so CDD mode cover Tx Beamforming mode, the whole testing has assessed CDD mode by referring to higher normal conducted power.
- 802.11ax supports both full RU tones and partial RU tones, which are both conducted power/PSD tested in Appendix A, for channel masking in Section 3.4.5, all the other test case were performed with full RU with its maximum power/PSD.
- The EUT does not support channel puncturing mode.
- The EUT's information above is declared by manufacturer. Please refer to Disclaimer in report summary.

1.2.1 Antenna Directional Gain

<For CDD Mode>

Follows FCC KDB 662911 D01 Multiple Transmitter Output v02r01 F)2)f)ii)

Directional gain = G_{ANT} + Array Gain, where Array Gain is as follows:

For power measurements on IEEE 802.11 devices,

Array Gain = 0 dB (i.e., no array gain) for $N_{ANT} \leq 4$.

G_{ANT} is set equal to the gain of the antenna having the highest gain.

For PSD measurements, the directional gain calculation.

$$DirectionalGain = 10 \cdot \log \left[\frac{\sum_{j=1}^{N_{SS}} \left\{ \sum_{k=1}^{N_{ANT}} g_{j,k} \right\}^2}{N_{ANT}} \right]$$

where

Each antenna is driven by no more than one spatial stream;

N_{SS} = the number of independent spatial streams of data;

N_{ANT} = the total number of antennas

$g_{j,k} = 10^{G_k / 20}$ if the k th antenna is being fed by spatial stream j , or zero if it is not;
 G_k is the gain in dBi of the k th antenna.

As minimum $N_{SS}=1$ is supported by EUT, the formula can be simplified as:

$$Directional\ gain = 10 \cdot \log \left[\left(10^{G_1 / 20} + 10^{G_2 / 20} + \dots + 10^{G_N / 20} \right)^2 / N_{ANT} \right] \text{ dBi}$$

Where G_1, G_2, \dots, G_N denote single antenna gain.

The directional gain "DG" is calculated as following table.

			DG for Power (dBi)	DG for PSD (dBi)
	Ant 6 (dBi)	Ant 7 (dBi)		
5925 MHz ~ 6425 MHz	1.59	1.49	1.59	4.55
6525 MHz ~ 6875 MHz	1.25	1.46	1.46	4.37

Calculation example:

If a device has two antenna, $G_{ANT1}= 1.59\text{dBi}$; $G_{ANT2}= 1.49\text{dBi}$

Directional gain of power measurement = $\max(1.59, 1.49) + 0 = 1.59 \text{ dBi}$

Directional gain of PSD derived from formula which is

$$10 \times \log \left\{ \left[\left(10^{(1.59 \text{ dBi} / 20)} + 10^{(1.49 \text{ dBi} / 20)} \right)^2 \right] / 2 \right\}$$

= 4.55 dBi



<For SDM Modes>

SDM Modes all transmit signals are completely uncorrelated, then

Follows FCC KDB 662911 D01 Multiple Transmitter Output v02r01 F)2)d)ii)

The Directional gain = $10 \cdot \log[(10^{G1/10} + 10^{G2/10} + \dots + 10^{GN/10}) / N_{ANT}]$ dBi

Where G1, G2....GN denote single antenna gain.

The directional gain "DG" is calculated as following table.

	Ant 6 (dBi)	Ant 7 (dBi)	DG for Power (dBi)	DG for PSD (dBi)
5925 MHz ~6425 MHz	1.59	1.49	1.54	1.54
6525 MHz ~6875MHz	1.25	1.46	1.36	1.36

Calculation example:

If a device has two antenna, $G_{ANT1} = 1.59\text{dBi}$; $G_{ANT2} = 1.49\text{dBi}$

Directional gain is derived from formula which is

$$10 \times \log \left\{ \left[10^{(1.59 \text{ dBi} / 10)} + 10^{(1.49 \text{ dBi} / 10)} \right] / 2 \right\}$$

$$= 1.54 \text{ dBi}$$

<For TXBF Modes>

The EUT supports beamforming modes then

Follows FCC KDB 662911 D01 Multiple Transmitter Output v02r01 F)2)e)ii)

$$DirectionalGain = 10 \cdot \log \left[\frac{\sum_{j=1}^{N_{SS}} \left\{ \sum_{k=1}^{N_{ANT}} g_{j,k} \right\}^2}{N_{ANT}} \right]$$

where

Each antenna is driven by no more than one spatial stream;

N_{SS} = the number of independent spatial streams of data;

N_{ANT} = the total number of antennas

$g_{j,k} = 10^{G_k / 20}$ if the k th antenna is being fed by spatial stream j , or zero if it is not;
 G_k is the gain in dBi of the k th antenna.

The directional gain “DG” is calculated as following table.

				DG	DG
		Ant 6	Ant 7	for	for
		(dBi)	(dBi)	Power	PSD
				(dBi)	(dBi)
5925 MHz ~ 6425 MHz		1.59	1.49	4.55	4.55
6525 MHz ~ 6875 MHz		1.25	1.46	4.37	4.37

Calculation example:

Directional gain is derived from formula which is

$$10 \times \log \left\{ \left[10^{1.59 / 20} + 10^{1.49 / 20} \right]^2 / 2 \right\} = 4.55 \text{ dBi}$$

1.3 Modification of EUT

No modifications made to the EUT during the testing.



1.4 Testing Location

Test Site	Sporton International Inc. EMC & Wireless Communications Laboratory
Test Site Location	No.52, Huaya 1st Rd., Guishan Dist., Taoyuan City 333, Taiwan (R.O.C.) TEL: +886-3-327-3456 FAX: +886-3-328-4978
Test Site No.	Sporton Site No. CO05-HY (TAF Code: 1190)
Remark	The AC Conducted Emission test item subcontracted to Sporton International Inc. EMC & Wireless Communications Laboratory.

Note: The test site complies with ANSI C63.4 2014 requirement.

Test Site	Sporton International Inc. Wensan Laboratory
Test Site Location	No.58, Aly. 75, Ln. 564, Wenhua 3rd, Rd., Guishan Dist., Taoyuan City 333010, Taiwan (R.O.C.) TEL: +886-3-327-0868 FAX: +886-3-327-0855
Test Site No.	Sporton Site No. TH05-HY, 03CH11-HY

Note: The test site complies with ANSI C63.4 2014 requirement.

FCC designation No.: TW1190 and TW3786

1.5 Applicable Standards

According to the specifications declared by the manufacturer, the EUT must comply with the requirements of the following standards:

- ♦ FCC Part 15 Subpart E
- ♦ FCC KDB 789033 D02 General UNII Test Procedures New Rules v02r01.
- ♦ FCC KDB 987594 D02 U-NII 6 GHz EMC Measurement v02
- ♦ FCC KDB 414788 D01 Radiated Test Site v01r01.
- ♦ FCC KDB 662911 D01 Multiple Transmitter Output v02r01.
- ♦ ANSI C63.10-2013

Remark:

1. All the test items were validated and recorded in accordance with the standards without any modification during the testing.
2. The TAF code is not including all the FCC KDB listed without accreditation.
3. This EUT has also been tested and complied with the requirements of FCC Part 15, Subpart B, recorded in a separate test report.



2 Test Configuration of Equipment Under Test

- a. The EUT has been associated with peripherals and configuration operated in a manner tended to maximize its emission characteristics in a typical application. Frequency range investigated: conduction emission (150 kHz to 30 MHz), radiation emission (9 kHz to the 10th harmonic of the highest fundamental frequency or to 40 GHz, whichever is lower). For radiated measurement, the measured emission level of the EUT was maximized by rotating the EUT on a turntable, adjusting the orientation of the EUT antenna in three orthogonal axis (X: flat, Y: portrait, Z: landscape), and adjusting the measurement antenna orientation, following C63.10 exploratory test procedures and only the worst case emissions were reported in this report.
- b. AC power line Conducted Emission was tested under maximum output power.

2.1 Carrier Frequency and Channel

BW 20M	Channel	1	5	9	13	17	21	25	29
	Freq. (MHz)	5955	5975	5995	6015	6035	6055	6075	6095
BW 40M	Channel	3		11		19		27	
	Freq. (MHz)	5965		6005		6045		6085	
BW 80M	Channel	7				23			
	Freq. (MHz)	5985				6065			
BW 160M	Channel	15							
	Freq. (MHz)	6025							

BW 20M	Channel	33	37	41	45	49	53	57	61
	Freq. (MHz)	6115	6135	6155	6175	6195	6215	6235	6255
BW 40M	Channel	35		43		51		59	
	Freq. (MHz)	6125		6165		6205		6245	
BW 80M	Channel	39				55			
	Freq. (MHz)	6145				6225			
BW 160M	Channel	47							
	Freq. (MHz)	6185							



BW 20M	Channel	65	69	73	77	81	85	89	93
	Freq. (MHz)	6275	6295	6315	6335	6355	6375	6395	6415
BW 40M	Channel	67		75		83		91	
	Freq. (MHz)	6285		6325		6365		6405	
BW 80M	Channel	71				87			
	Freq. (MHz)	6305				6385			
BW 160M	Channel	79							
	Freq. (MHz)	6345							

BW 20M	Channel	117			121			125		
	Freq. (MHz)	6535			6555			6575		
BW 40M	Channel	115				123				
	Freq. (MHz)	6525				6565				
BW 80M	Channel	119								
	Freq. (MHz)	6545								

BW 20M	Channel	129	133	137	141	145	149	153	157
	Freq. (MHz)	6595	6615	6635	6655	6675	6695	6715	6735
BW 40M	Channel	131		139		147		155	
	Freq. (MHz)	6605		6645		6685		6725	
BW 80M	Channel	135				151			
	Freq. (MHz)	6625				6705			
BW 160M	Channel	143							
	Freq. (MHz)	6665							

BW 20M	Channel	161	165	169	173	177	181
	Freq. (MHz)	6755	6775	6795	6815	6835	6855
BW 40M	Channel	163		171		179	
	Freq. (MHz)	6765		6805		6845	
BW 80M	Channel	167					
	Freq. (MHz)	6785					



2.2 Test Mode

This device support 26/52/106/242/484/996-tone RU. but does not support 2x996-tone RU on 160MHz channel.

The PSD of partial RU is reduced to be smaller than full RU according to TCB workshop interim guidance Oct. 2018.

The 802.11ax mode is investigated among different tones, full resource units (RU), partial resource units. The partial RU has no higher power than full RU's, thus the full RU is chosen as main test configuration.

The 242-tone RU is covered by 20MHz channel, 484-tone RU is covered by 40MHz channel and 996-tone RU is covered by 80MHz channel.

The SISO mode conducted power is covered by MIMO mode per chain, so only the MIMO mode is tested.

The final test modes include the worst data rates for each modulation shown in the table below.

MIMO Mode

Modulation	Data Rate
802.11a	6 Mbps
802.11ax HE20	MCS0
802.11ax HE40	MCS0
802.11ax HE80	MCS0
802.11ax HE160	MCS0

Remark: The conducted power level of each chain in MIMO mode is equal or higher than SISO mode.

Test Cases	
AC Conducted Emission	Mode 1 : WLAN (6GHz) Link + Bluetooth Link + Battery Standard Battery (7000mAh) + Scan + USB Cable (Type C to Type A) with USB Cable (CUP) (Charging from Adapter USB Wall Charger)



Ch. #		UNII-5 (5925-6425 MHz)	UNII-7 (6525-6875 MHz)
		802.11a	802.11a
L	Low	001	117
M	Middle	049	149
H	High	093	181

Ch. #		UNII-5 (5925-6425 MHz)			
		802.11ax HE20	802.11ax HE40	802.11ax HE80	802.11ax HE160
L	Low	001	003	007	015
M	Middle	049	051	055	047
H	High	093	091	087	079

Ch. #		UNII-7 (6525-6875 MHz)			
		802.11ax HE20	802.11ax HE40	802.11ax HE80	802.11ax HE160
L	Low	117	123	135	143
M	Middle	149	147	151	
H	High	181	179	167	

Remark: Based on ANSI C63.10 clause 5.6.2.2, b) Spurious emissions, measure the mode with the highest output power and the mode with highest output power spectral density for each modulation family.

2.3 Connection Diagram of Test System

<AC Conducted Emission Mode>

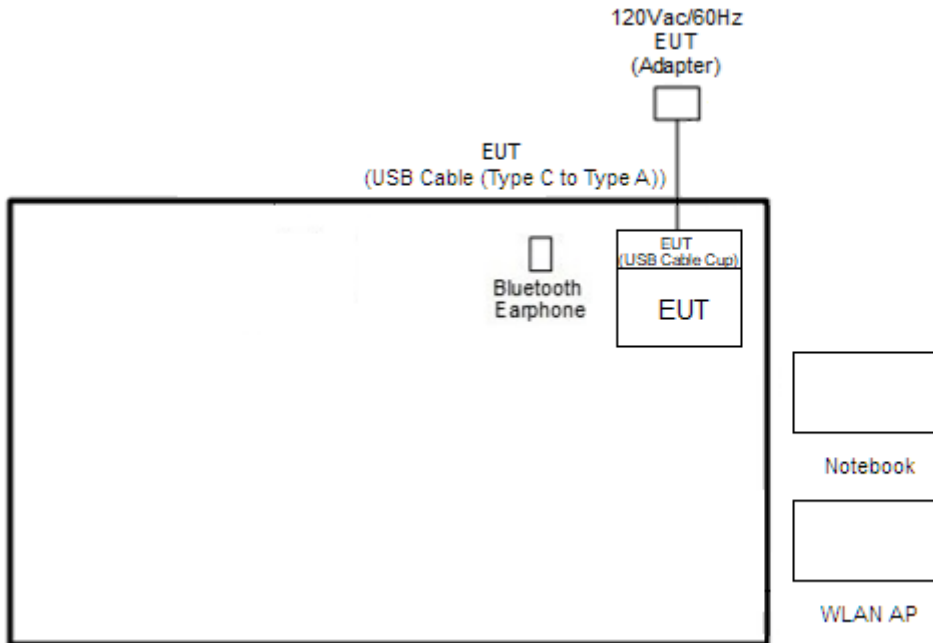

<WLAN Tx Mode>

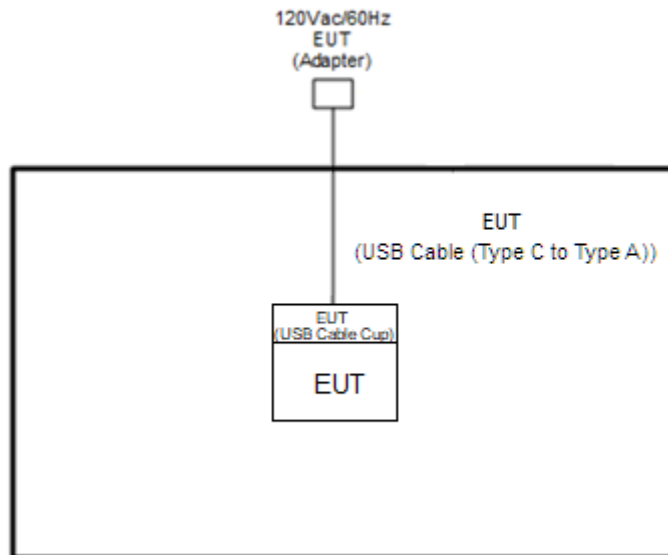



2.4 Support Unit used in test configuration and system

Item	Equipment	Brand Name	Model Name	FCC ID	Data Cable	Power Cord
1.	Bluetooth Earphone	Sony Ericsson	MW600	PY700A2029	N/A	N/A
2.	WLAN AP	NETGEAR64	RAXE500	N/A	N/A	Unshielded, 1.8 m
3.	Notebook	Dell	Latitude 3420	FCC DoC	N/A	AC I/P: Unshielded, 1.2 m DC O/P: Shielded, 1.8 m
4.	Notebook	Dell	Latitude 3400	FCC DoC	N/A	AC I/P: Unshielded, 1.2 m DC O/P: Shielded, 1.8 m

2.5 EUT Operation Test Setup

The RF test items, utility “QRCT Version 4.0.00211.0” was installed in Notebook which was programmed in order to make the EUT get into the engineering modes to provide channel selection, power level, data rate and the application type and for continuous transmitting signals.

2.6 Measurement Results Explanation Example

For all conducted test items:

The offset level is set in the spectrum analyzer to compensate the RF cable loss and attenuator factor between EUT conducted output port and spectrum analyzer. With the offset compensation, the spectrum analyzer reading level is exactly the EUT RF output level.

Example :

The spectrum analyzer offset is derived from RF cable loss and attenuator factor.

Offset = RF cable loss + attenuator factor.

Following shows an offset computation example with cable loss 4.2 dB and 10dB attenuator.

$$\begin{aligned} \text{Offset(dB)} &= \text{RF cable loss(dB)} + \text{attenuator factor(dB)}. \\ &= 4.2 + 10 = 14.2 \text{ (dB)} \end{aligned}$$

3 Test Result

3.1 26dB & 99% Occupied Bandwidth Measurement

3.1.1 Limit of 26dB & 99% Occupied Bandwidth

<FCC 14-30 CFR 15.407>

(a)(10) The maximum transmitter channel bandwidth for U-NII devices in the 5.925-7.125 GHz band is 320 megahertz.

3.1.2 Measuring Instruments

Please refer to the measuring equipment list in this test report.

3.1.3 Test Procedures

1. The testing follows FCC KDB 789033 D02 General UNII Test Procedures New Rules v02r01. Section C) Emission bandwidth
2. Set RBW = approximately 1% of the emission bandwidth.
3. Set the VBW > RBW.
4. Detector = Peak.
5. Trace mode = max hold
6. Measure the maximum width of the emission that is 26 dB down from the peak of the emission. Compare this with the RBW setting of the analyzer. Readjust RBW and repeat measurement as needed until the RBW/EBW ratio is approximately 1%.
7. For 99% Bandwidth Measurement, the spectrum analyzer's resolution bandwidth (RBW) is set 1-5% of the emission bandwidth and set the Video bandwidth (VBW) $\geq 3 * RBW$.
8. Measure and record the results in the test report.

3.1.4 Test Setup

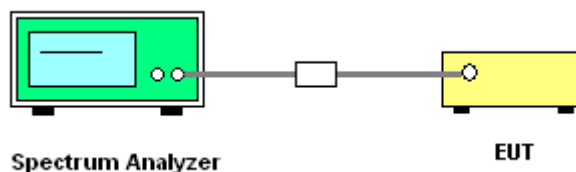

3.1.5 Test Result of 26dB & 99% Occupied Bandwidth

Please refer to Appendix A.



MIMO <Ant. 6+7>

<802.11a>

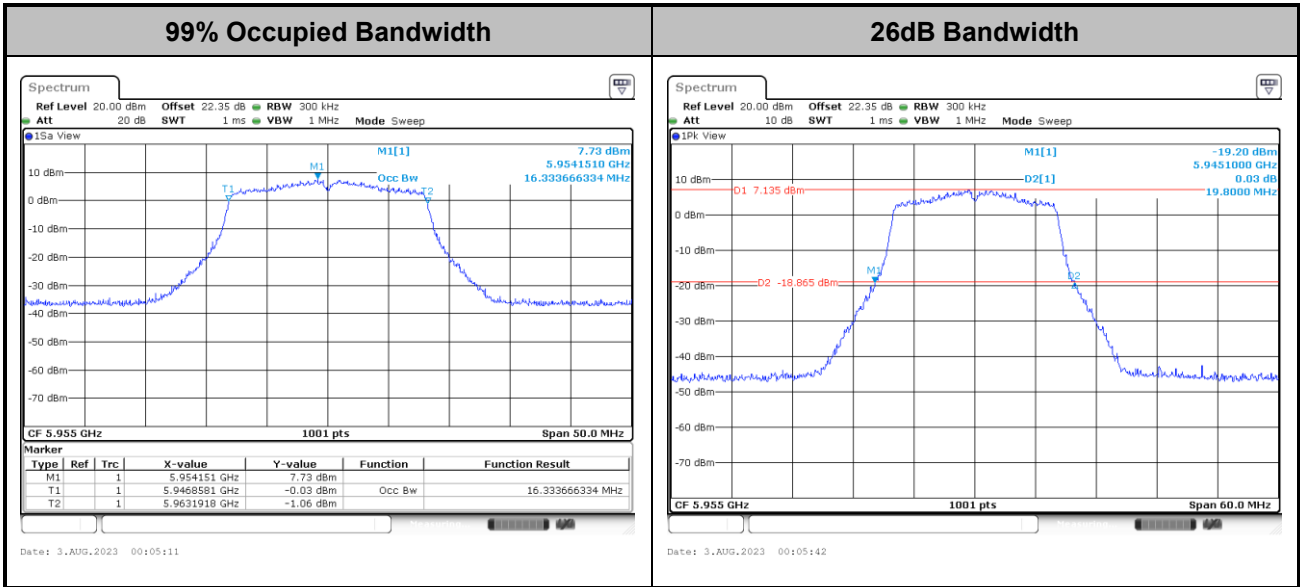

Note: The occupied channel bandwidth is maintained within the band of operation for all of the modulations.

<802.11ax HE20>

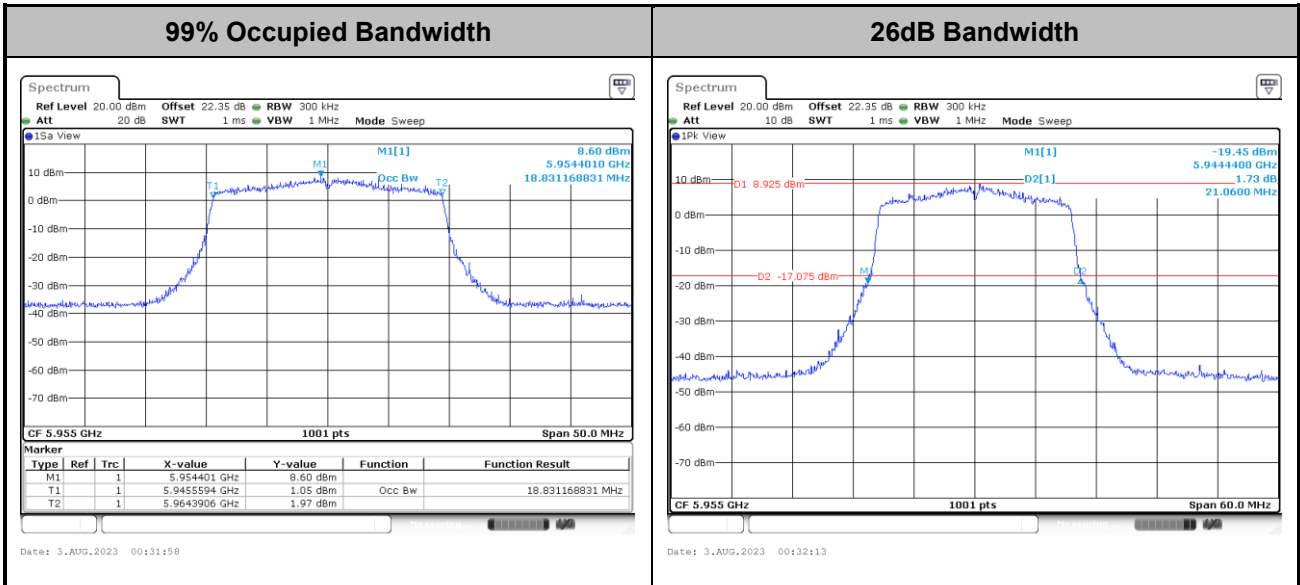

Note: The occupied channel bandwidth is maintained within the band of operation for all of the modulations.



<802.11ax HE40>

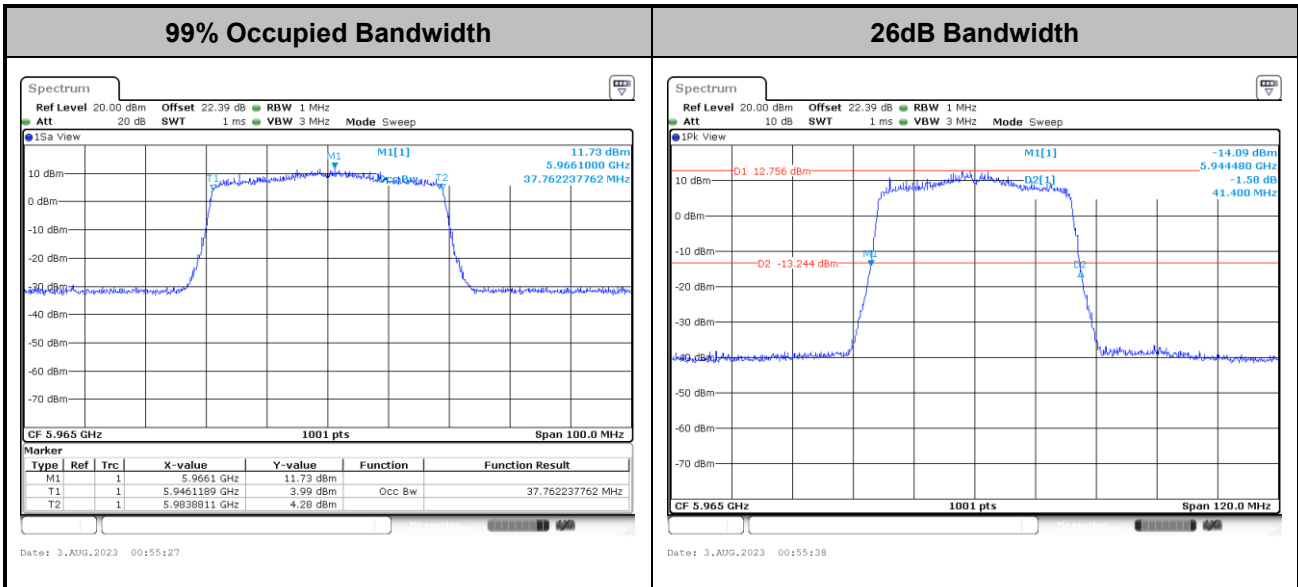

Note: The occupied channel bandwidth is maintained within the band of operation for all of the modulations.

<802.11ax HE80>

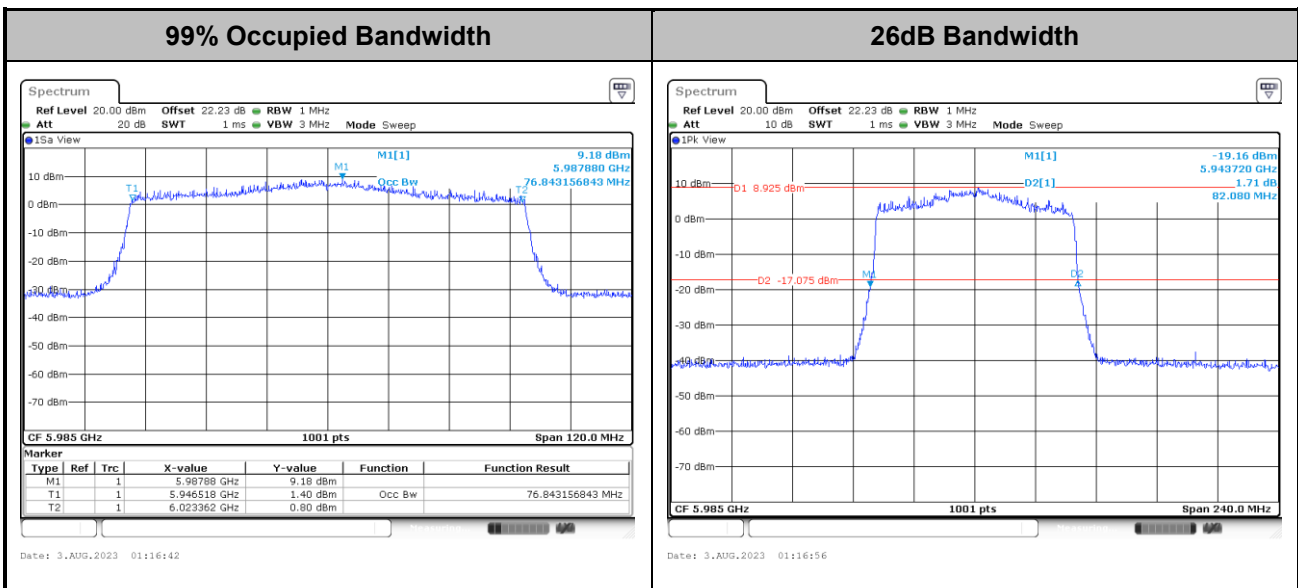

Note: The occupied channel bandwidth is maintained within the band of operation for all of the modulations.



<802.11ax HE160>

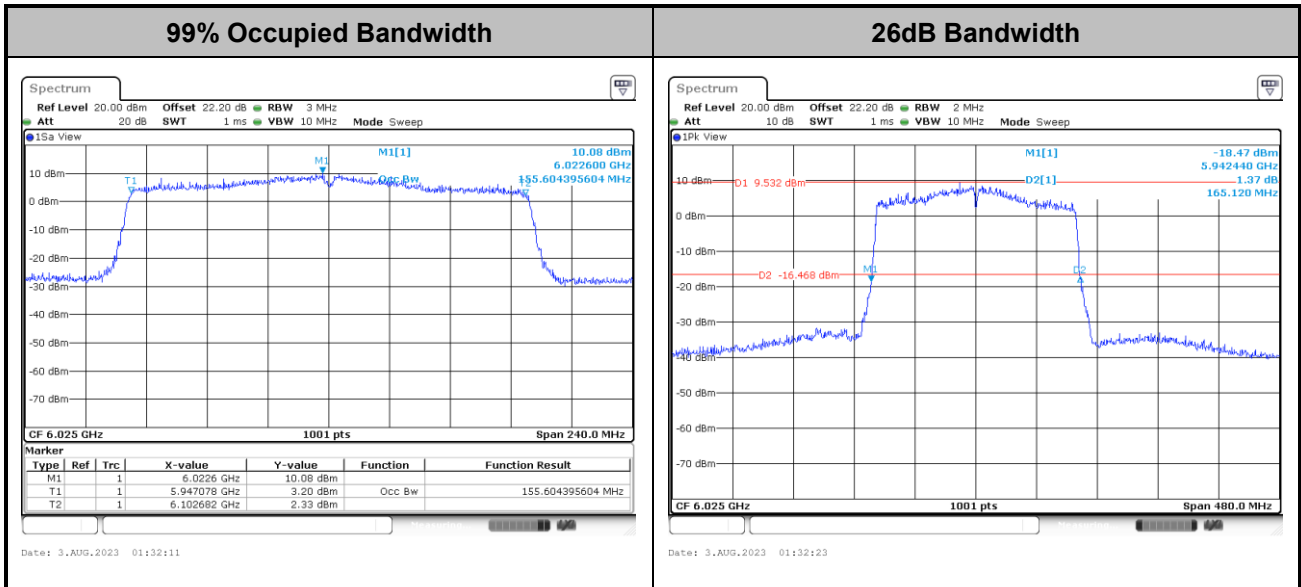

Note: The occupied channel bandwidth is maintained within the band of operation for all of the modulations.

3.2 Fundamental Maximum EIRP Measurement

3.2.1 Limit of Fundamental Maximum EIRP

<FCC 14-30 CFR 15.407>

(a)(7) For client devices, except for fixed client devices as defined in this subpart, operating under the control of a standard power access

point in 5.925-6.425 GHz and 6.525-6.875 GHz bands, the maximum power spectral density must not exceed 17 dBm e.i.r.p. in any 1-megahertz band, and the maximum e.i.r.p. over the frequency band of operation must not exceed 30 dBm and the device must limit its power to no more than 6 dB below its associated standard power access point's authorized transmit power.

3.2.2 Measuring Instruments

Please refer to the measuring equipment list in this test report.

3.2.3 Test Procedures

The testing follows Method PM-G of FCC KDB 789033 D02 General UNII Test Procedures New Rules v02r01.

Method PM-G (Measurement using a gated RF average power meter):

1. Measurement is performed using a wideband RF power meter.
2. The EUT is configured to transmit at its maximum power control level.
3. Measure the average power of the transmitter.
4. Since the measurement is made only during the ON time of the transmitter, no duty cycle correction factor is required.
5. For MIMO mode, calculation method follows FCC KDB 662911 D01 Multiple Transmitter Output v02r01.

3.2.4 Test Setup

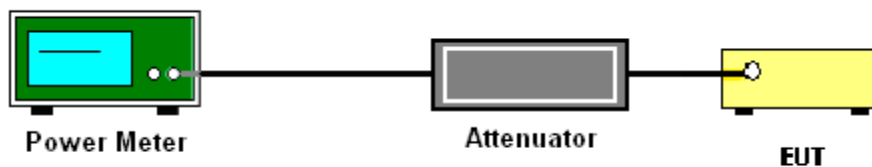

3.2.5 Test Result of Fundamental Maximum EIRP

Please refer to Appendix A.



3.3 Fundamental Power Spectral Density Measurement

3.3.1 Limit of Fundamental Power Spectral Density

<FCC 14-30 CFR 15.407>

(a)(7) For client devices, except for fixed client devices as defined in this subpart, operating under the control of a standard power access point in 5.925-6.425 GHz and 6.525-6.875 GHz bands, the maximum power spectral density must not exceed 17 dBm e.i.r.p. in any 1-megahertz band.

3.3.2 Measuring Instruments

Please refer to the measuring equipment list in this test report.

3.3.3 Test Procedures

The testing follows FCC KDB 789033 D02 General UNII Test Procedures New Rules v02r01.

Section F) Maximum power spectral density.

Method SA-2

(trace averaging across on and off times of the EUT transmissions, followed by duty cycle correction).

- Measure the duty cycle.
 - Set span to encompass the entire emission bandwidth (EBW) of the signal.
 - Set RBW = 1 MHz.
 - Set VBW \geq 3 MHz.
 - Number of points in sweep \geq 2 Span / RBW.
 - Sweep time = auto.
 - Detector = RMS
 - Trace average at least 100 traces in power averaging mode.
 - Add $10 \log(1/x)$, where x is the duty cycle, to the measured power in order to compute the average power during the actual transmission times. For example, add $10 \log(1/0.25) = 6$ dB if the duty cycle is 25 percent.
1. The RF output of EUT was connected to the spectrum analyzer by a low loss cable.
 2. Each plot has already offset with cable loss, and attenuator loss. Measure the PPSD and record it.
 3. For MIMO mode, calculation method follows FCC KDB 662911 D01 Multiple Transmitter Output v02r01.

Method (a): Measure and sum the spectra across the outputs.

The total final Power Spectral Density is from a device with 2 transmitter outputs. The spectrum measurements of the individual outputs are all performed with the same span and number of points; the spectrum value in the first spectral bin of output 1 is summed with that in the first spectral bin of output 2 to obtain the value for the first frequency bin of the summed spectrum.

3.3.4 Test Setup

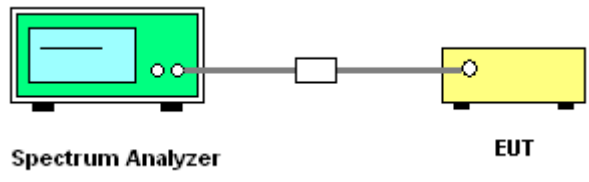

3.3.5 Test Result of Power Spectral Density

Please refer to Appendix A.



<802.11a>

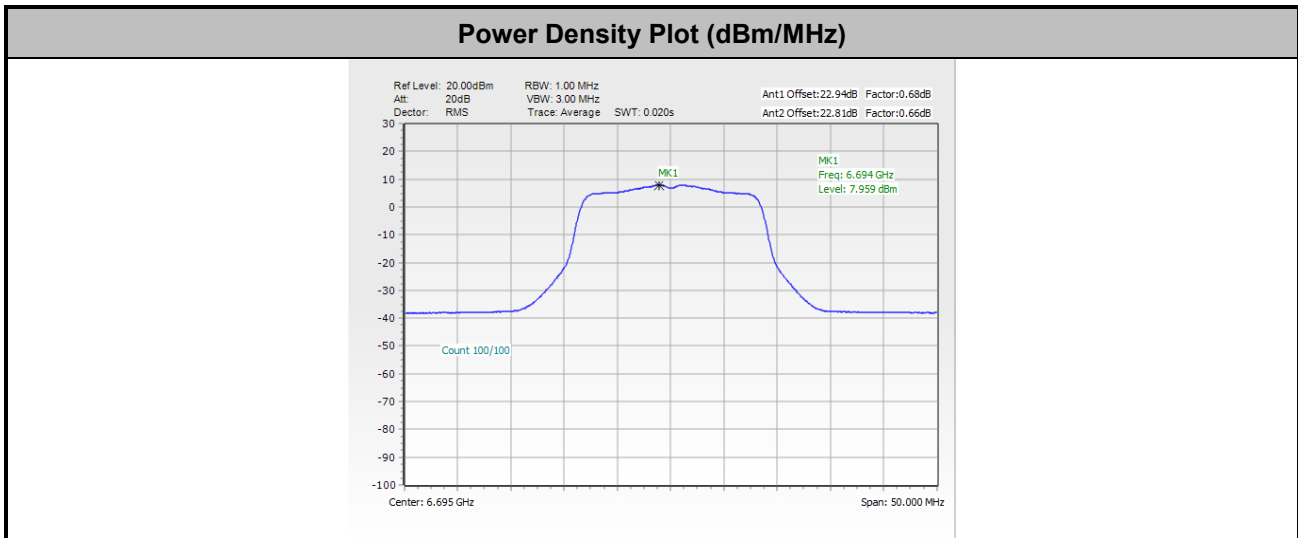

Note:

1. EIRP Power Density (dBm/MHz) = Measured value+ Duty Factor + Directional Gain
2. The test plot is showing a bin by bin combined result mathematically adds two traces.

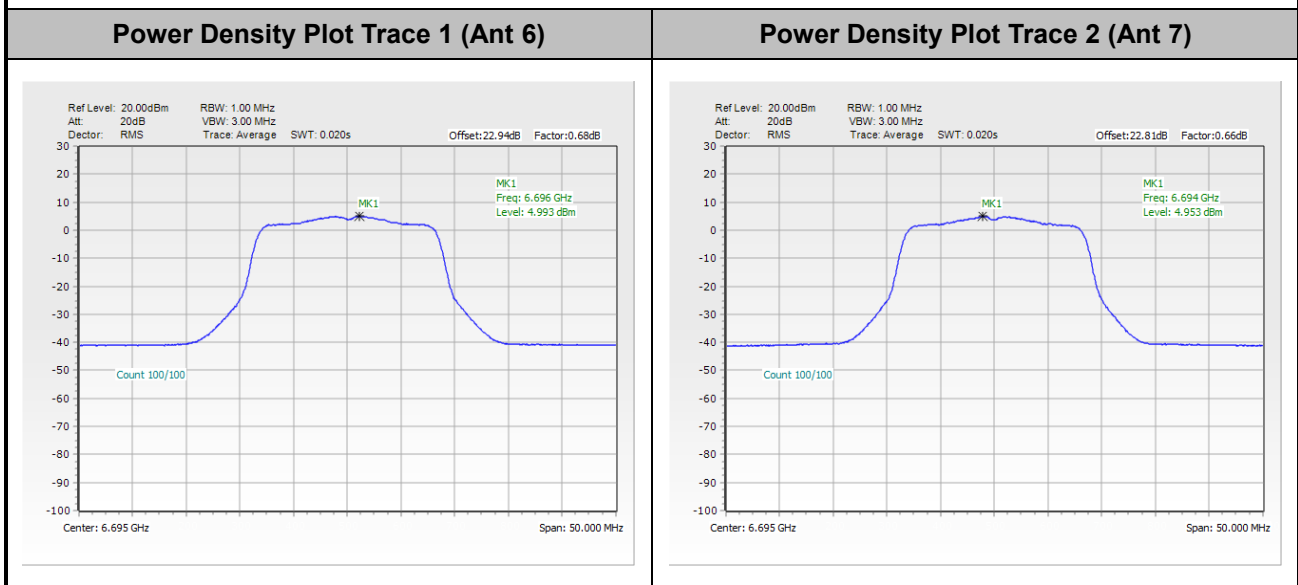



<802.11ax HE20 Full RU>

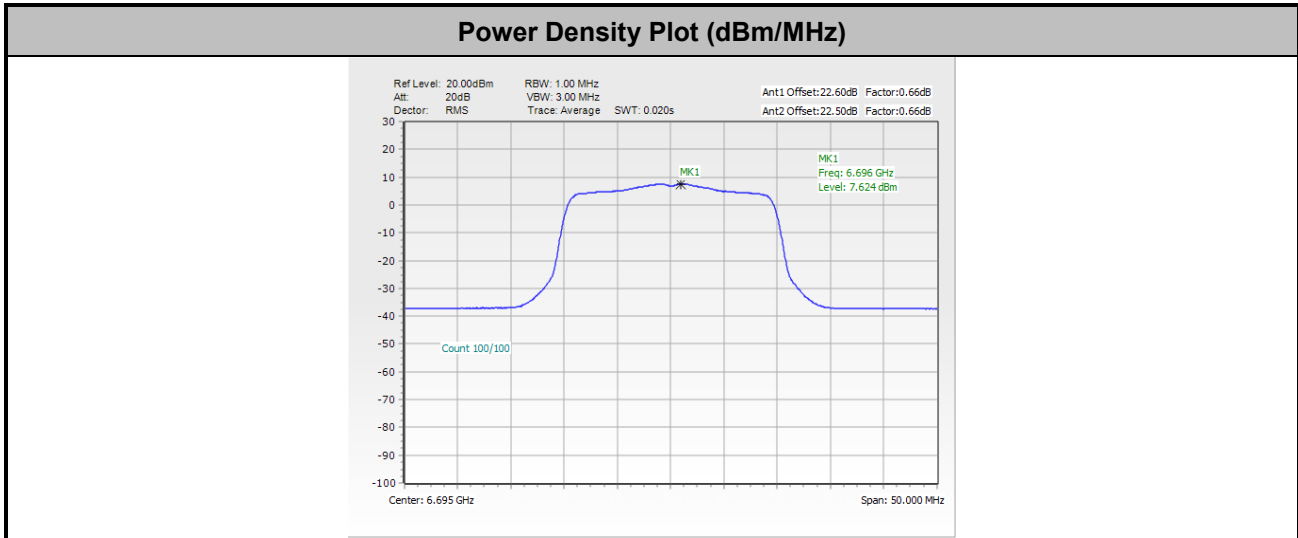

Note:

1. EIRP Power Density (dBm/MHz) = Measured value+ Duty Factor + Directional Gain
2. The test plot is showing a bin by bin combined result mathematically adds two traces.

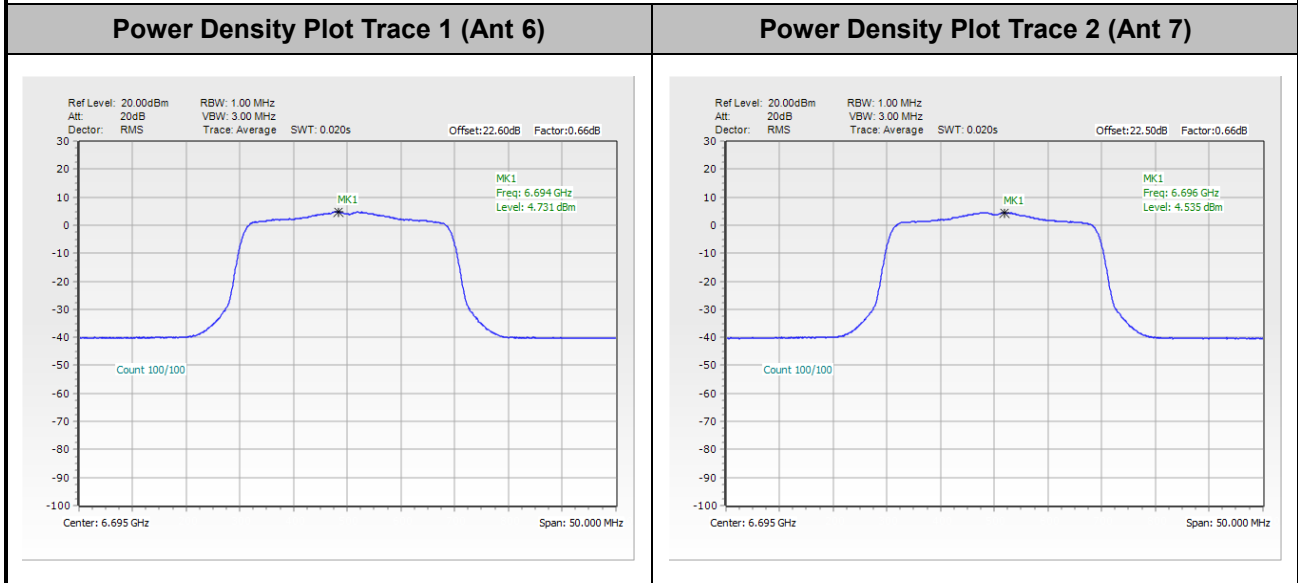



<802.11ax HE40 Full RU>

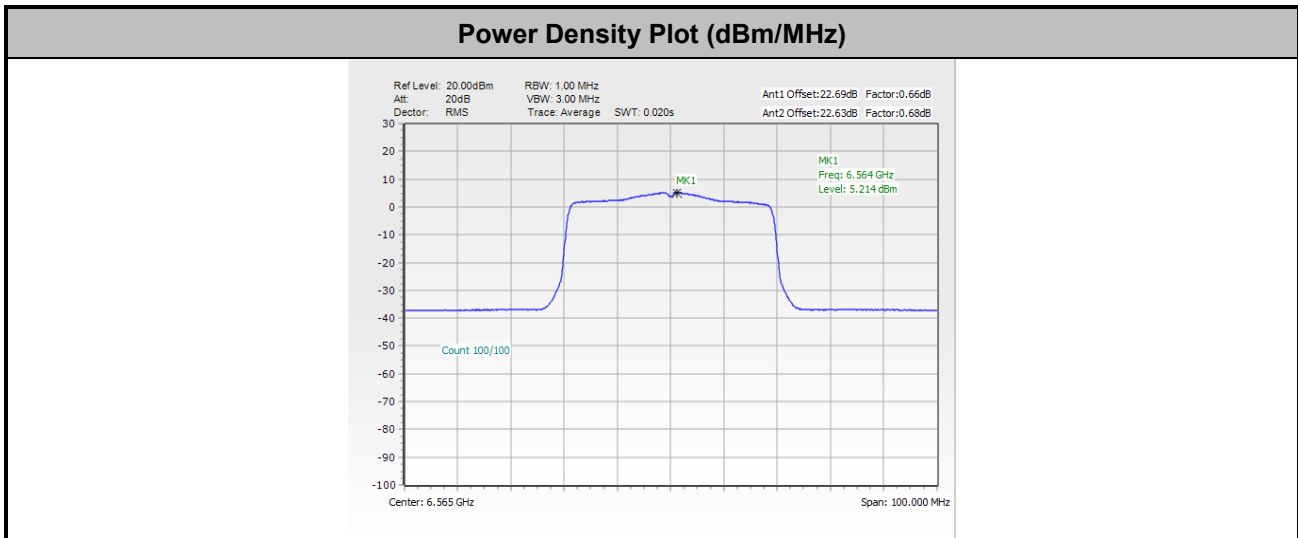

Note:

1. EIRP Power Density (dBm/MHz) = Measured value+ Duty Factor + Directional Gain
2. The test plot is showing a bin by bin combined result mathematically adds two traces.

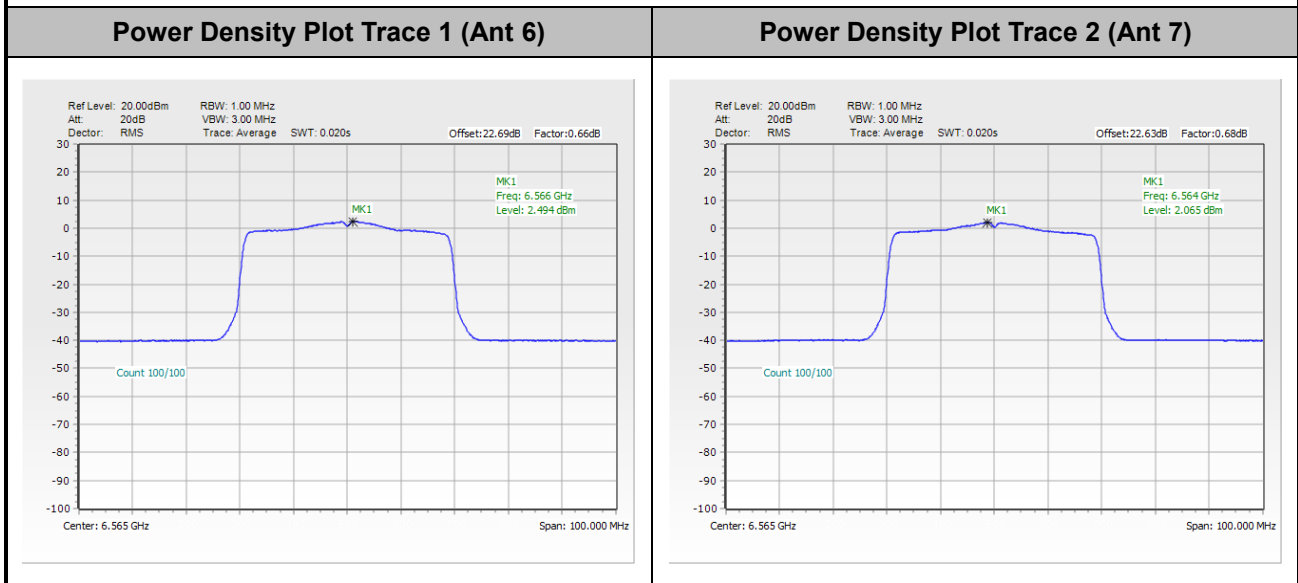



<802.11ax HE80 Full RU>

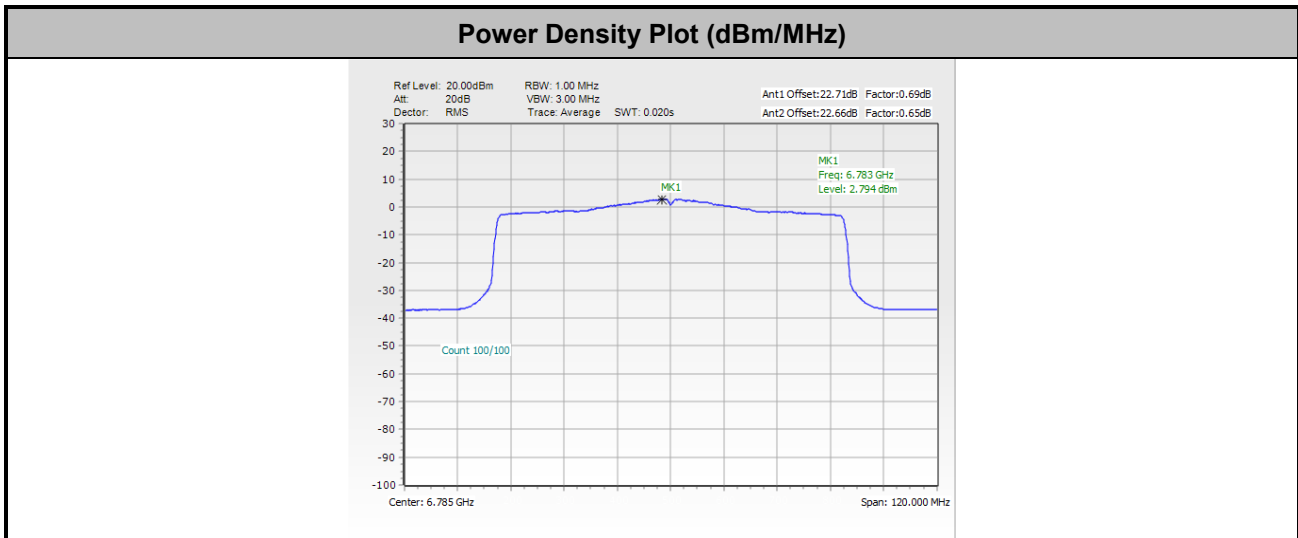

Note:

1. EIRP Power Density (dBm/MHz) = Measured value+ Duty Factor + Directional Gain
2. The test plot is showing a bin by bin combined result mathematically adds two traces.

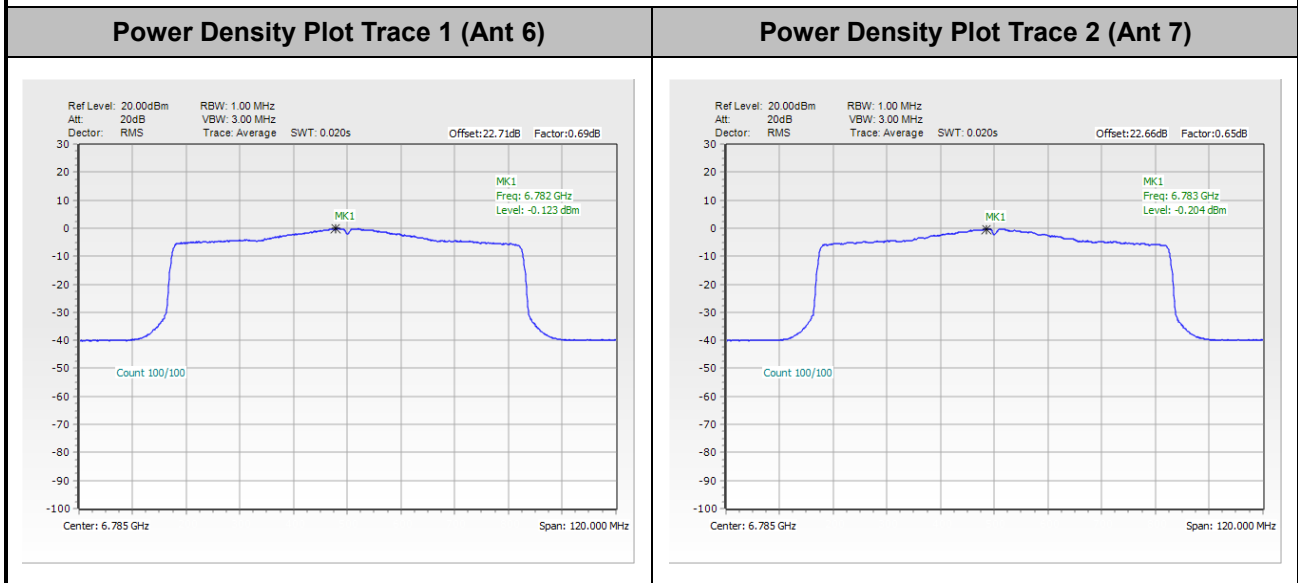



<802.11ax HE160 Full RU>

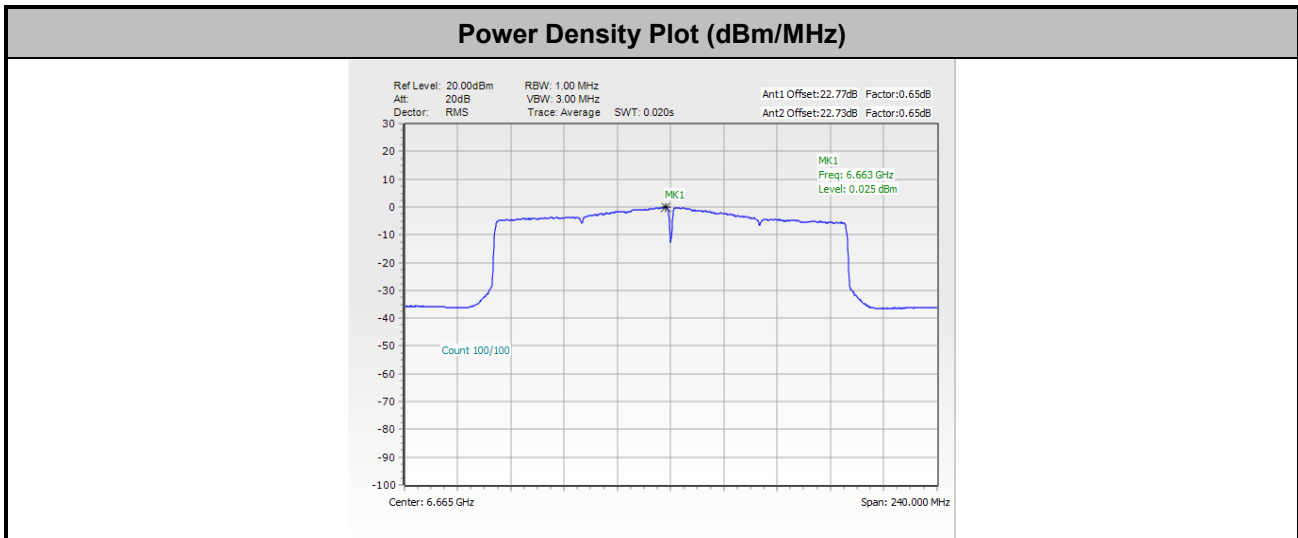

Note:

1. EIRP Power Density (dBm/MHz) = Measured value+ Duty Factor + Directional Gain
2. The test plot is showing a bin by bin combined result mathematically adds two traces.

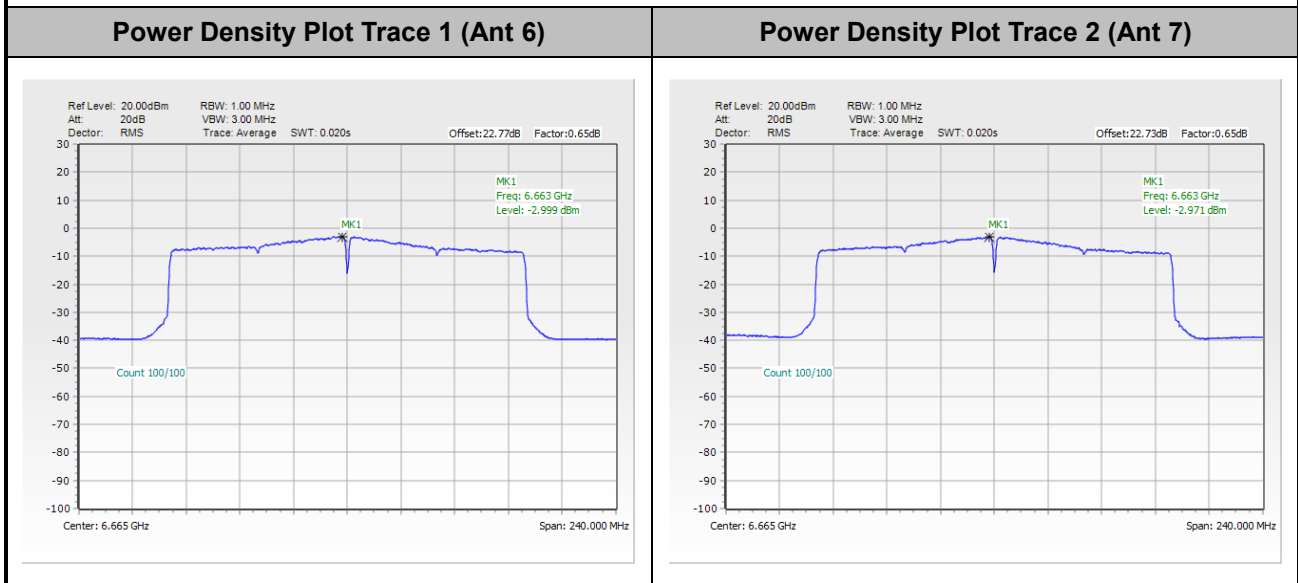



3.4 In-Band Emissions (Channel Mask)

3.4.1 Limit of Unwanted Emissions

<FCC 14-30 CFR 15.407>

(a)(6) For transmitters operating within the 5.925-7.125 GHz bands: Power spectral density must be suppressed by 20 dB at 1 MHz outside of channel edge, by 28 dB at one channel bandwidth from the channel center, and by 40 dB at one- and one-half times the channel bandwidth away from channel center. At frequencies between one megahertz outside an unlicensed device's channel edge and one channel bandwidth from the center of the channel, the limits must be linearly interpolated between 20 dB and 28 dB suppression, and at frequencies between one and one- and one-half times an unlicensed device's channel bandwidth, the limits must be linearly interpolated between 28 dB and 40 dB suppression. Emissions removed from the channel center by more than one- and one-half times the channel bandwidth must be suppressed by at least 40 dB.

3.4.2 Measuring Instruments

Please refer to the measuring equipment list in this test report.

3.4.3 Test Procedures

The testing follows FCC KDB 987594 D02 U-NII 6GHz EMC Measurement v01.

Section J) In-Band Emissions.

1. Take nominal bandwidth as reference channel bandwidth provided that 26 dB emission bandwidth is always larger than nominal bandwidth
2. Measure the power spectral density (which will be used for emissions mask reference) using the following procedure:
 - a) Set the span to encompass the entire 26 dB EBW of the signal.
 - b) Set RBW = same RBW used for 26 dB EBW measurement.
 - c) Set VBW $\geq 3 \times$ RBW
 - d) Number of points in sweep $\geq [2 \times \text{span} / \text{RBW}]$.
 - e) Sweep time = auto.
 - f) Detector = RMS (i.e., power averaging)
 - g) Trace average at least 100 traces in power averaging (rms) mode.
 - h) Use the peak search function on the instrument to find the peak of the spectrum.
3. Using the measuring equipment limit line function, develop the emissions mask based on the following requirements. The emissions power spectral density must be reduced below the peak power spectral density (in dB) as follows:
 - a. Suppressed by 20 dB at 1 MHz outside of the channel edge.
 - b. Suppressed by 28 dB at one channel bandwidth from the channel center.
 - c. Suppressed by 40 dB at one- and one-half times the channel bandwidth from the channel center.
4. Adjust the span to encompass the entire mask as necessary.
5. Clear trace.
6. Trace average at least 100 traces in power averaging (rms) mode.
7. Adjust the reference level as necessary so that the crest of the channel touches the top of the emission mask.

3.4.4 Test Setup

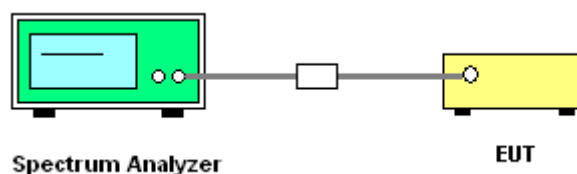



3.4.5 Test Result

MIMO <Ant. 6+7(6)>

EUT Mode	802.11a
----------	---------

Plot on Channel 5955 MHz

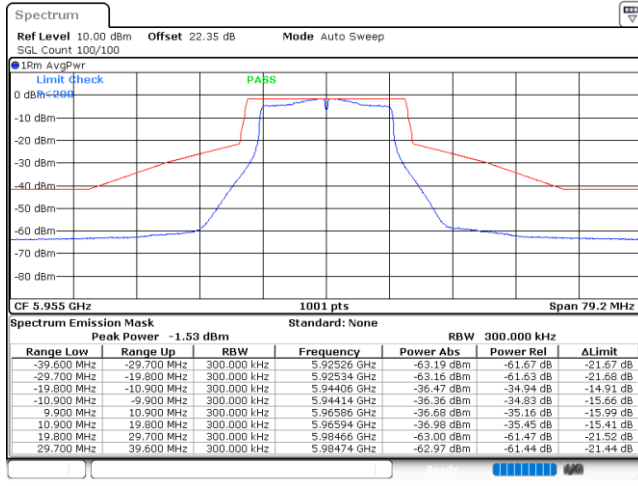

Date: 3.AUG.2023 00:06:13

Plot on Channel 6195 MHz

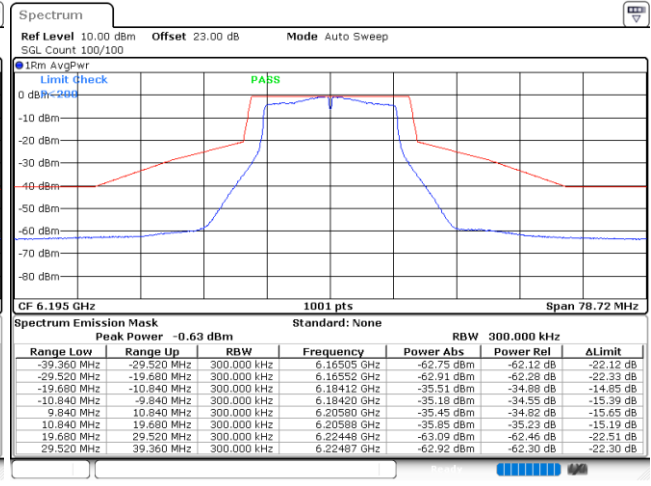

Date: 3.AUG.2023 00:10:11

Plot on Channel 6415 MHz

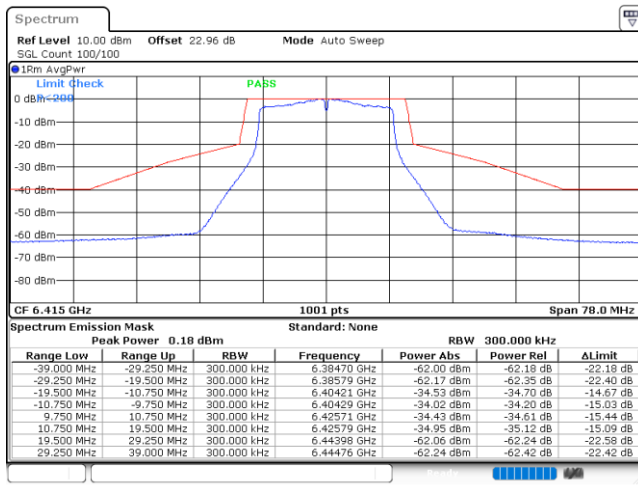

Date: 3.AUG.2023 00:13:46

Plot on Channel 6535 MHz

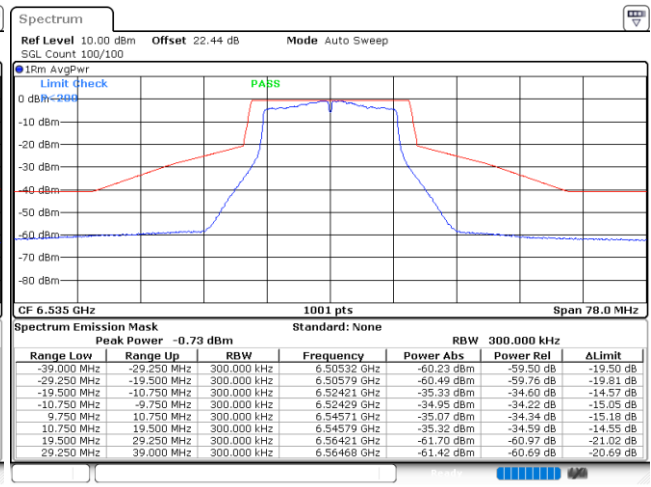

Date: 3.AUG.2023 00:19:30



Plot on Channel 6695 MHz

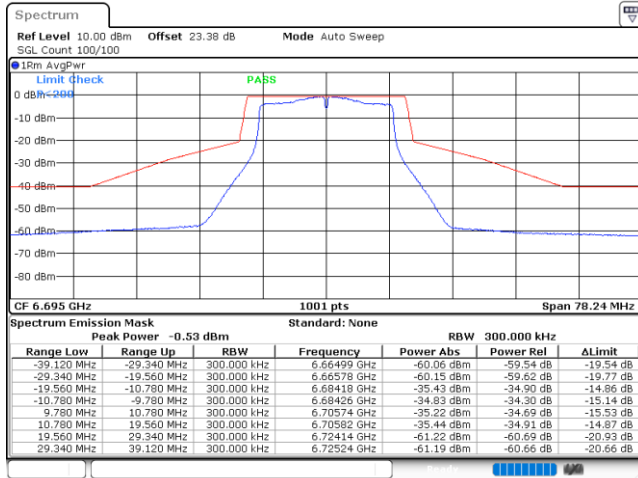

Date: 3.AUG.2023 00:22:08

Plot on Channel 6855 MHz

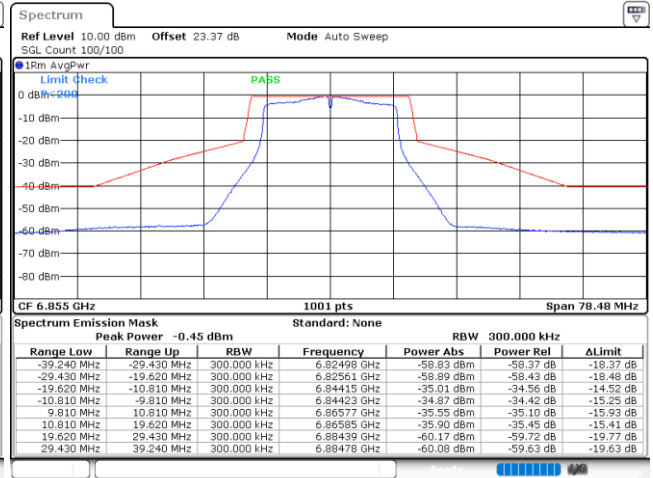

Date: 3.AUG.2023 00:25:07



EUT Mode 802.11ax HE20 Full RU

Plot on Channel 5955 MHz

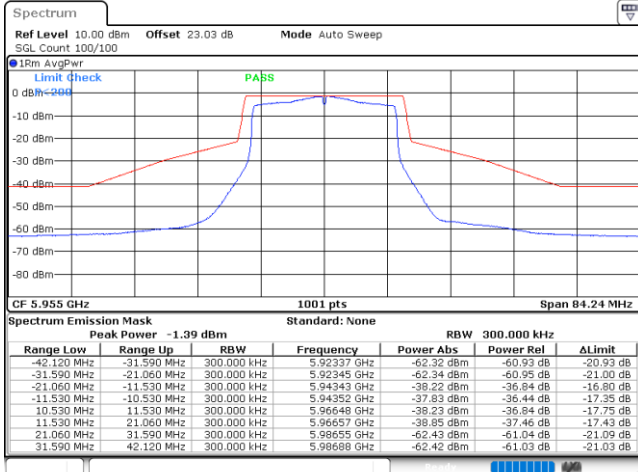

Date: 3.AUG.2023 00:32:57

Plot on Channel 6195 MHz

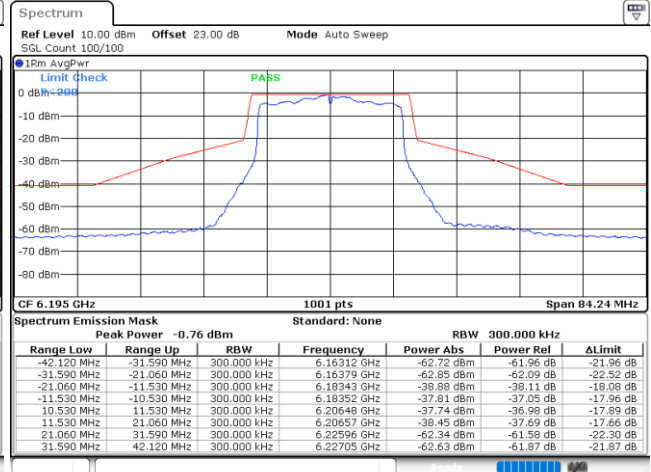

Date: 3.AUG.2023 00:35:58

Plot on Channel 6415 MHz

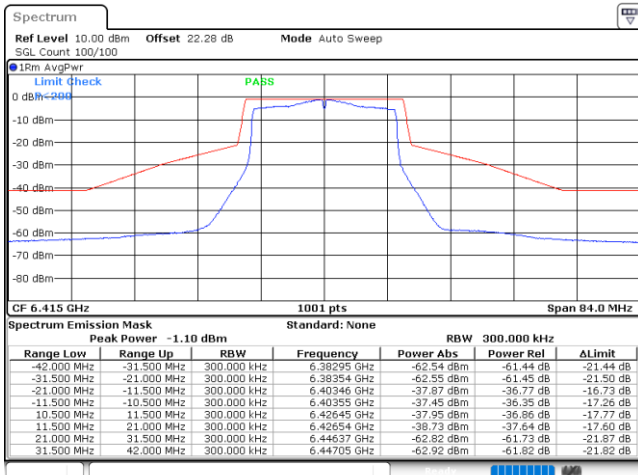

Date: 3.AUG.2023 00:38:44

Plot on Channel 6535 MHz

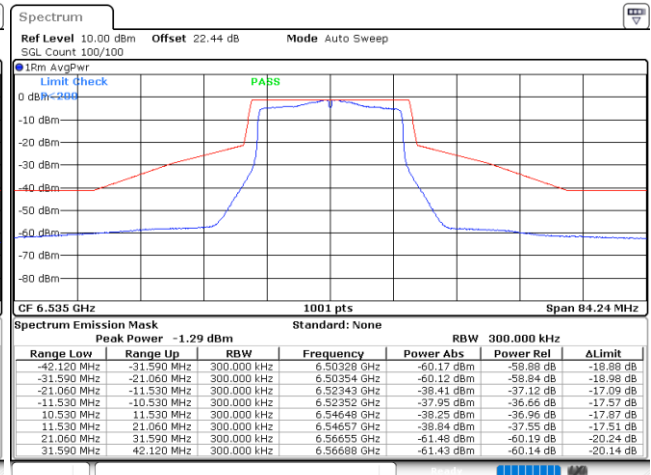

Date: 3.AUG.2023 00:42:03



Plot on Channel 6695 MHz

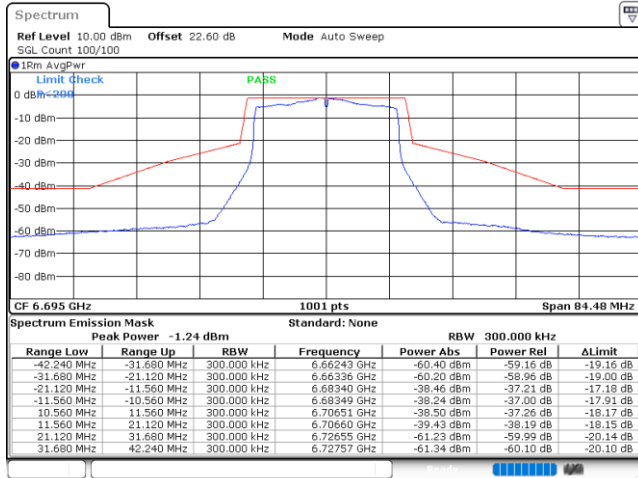

Date: 3.AUG.2023 00:44:50

Plot on Channel 6855 MHz

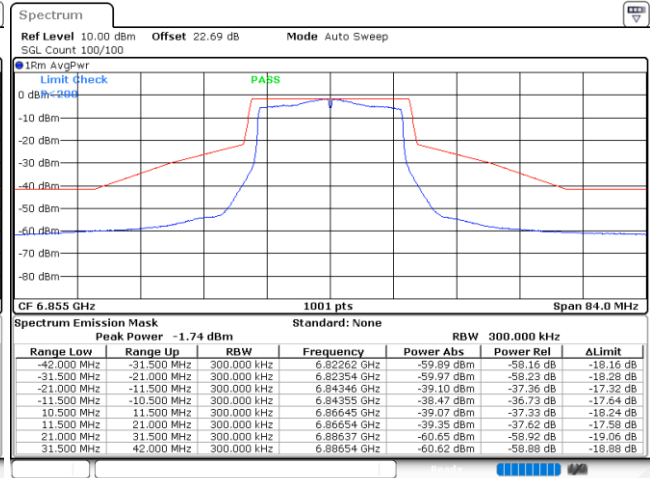

Date: 3.AUG.2023 00:47:36

EUT Mode 802.11ax HE20 26RU0

Plot on Channel 5955 MHz

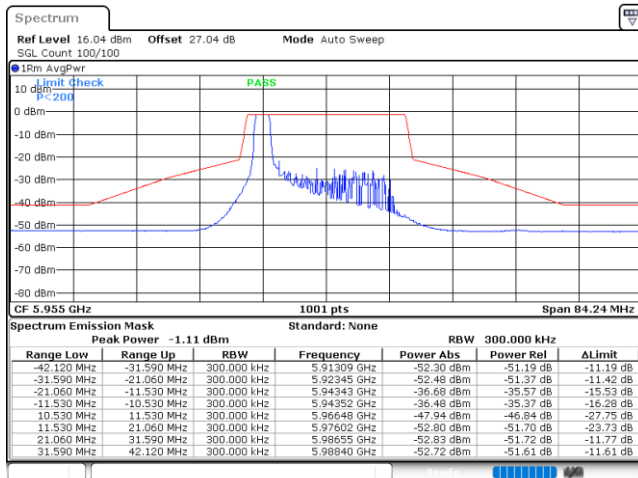

Date: 16.AUG.2023 01:02:35

Plot on Channel 6535 MHz

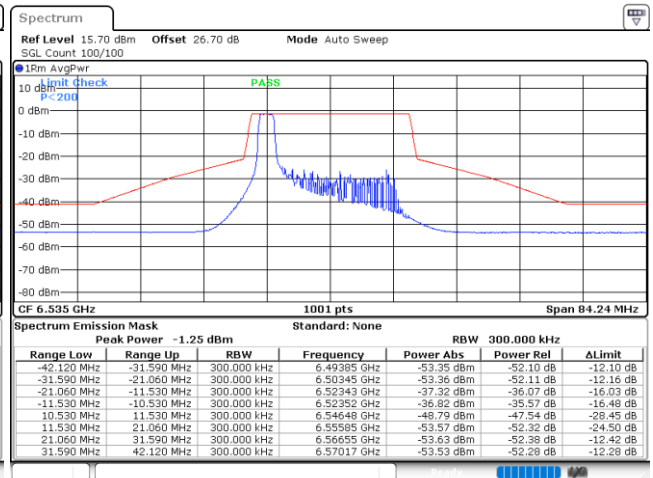

Date: 16.AUG.2023 20:19:23



EUT Mode 802.11ax HE20 26RU4

Plot on Channel 6195 MHz

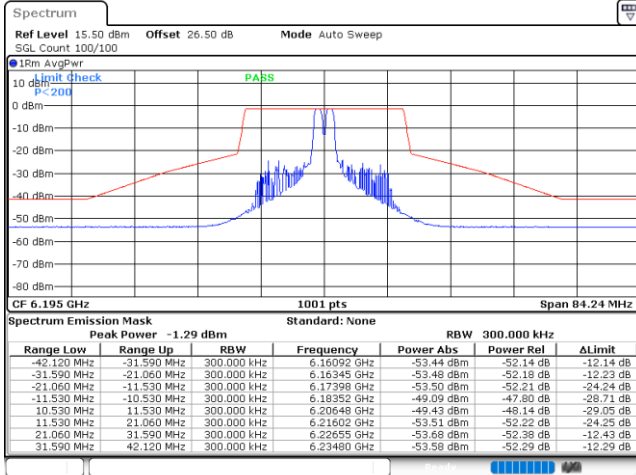

Date: 16.AUG.2023 01:17:52

Plot on Channel 6695 MHz

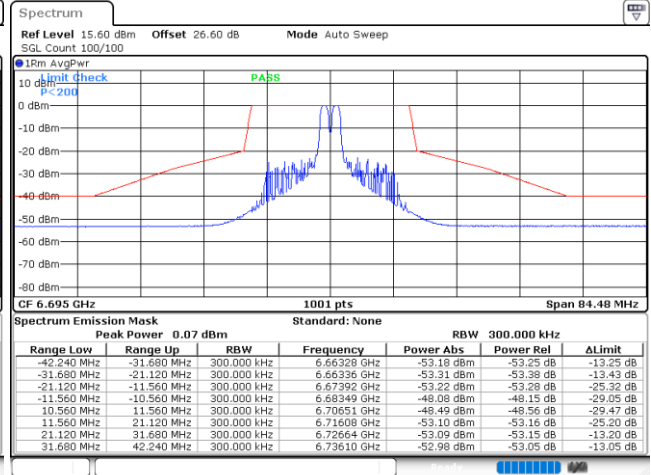

Date: 16.AUG.2023 21:14:47

EUT Mode 802.11ax HE20 26RU8

Plot on Channel 6415 MHz

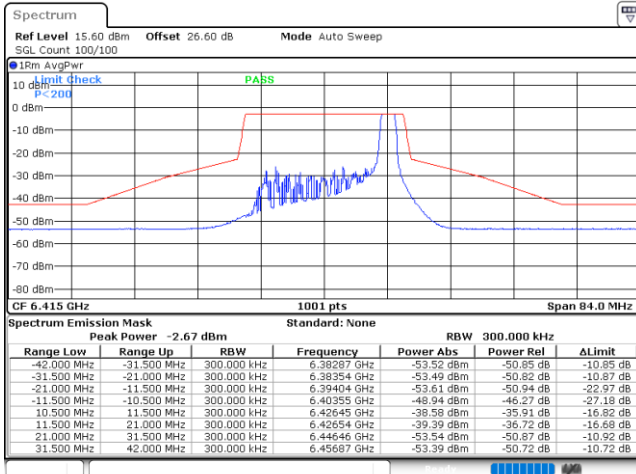

Date: 16.AUG.2023 20:14:49

Plot on Channel 6855 MHz

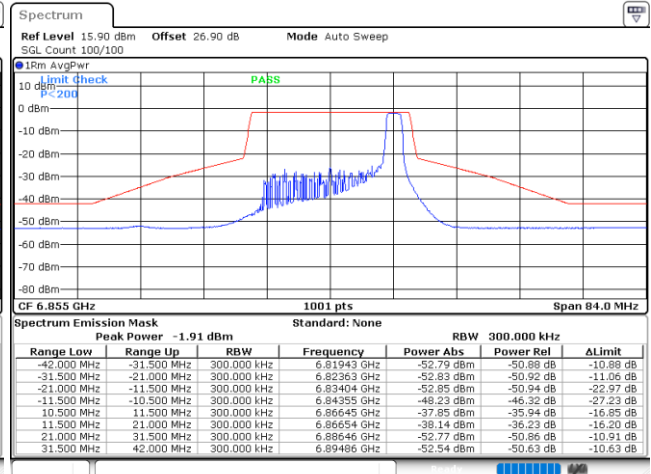

Date: 16.AUG.2023 22:05:55



EUT Mode 802.11ax HE20 52RU37

Plot on Channel 5955 MHz

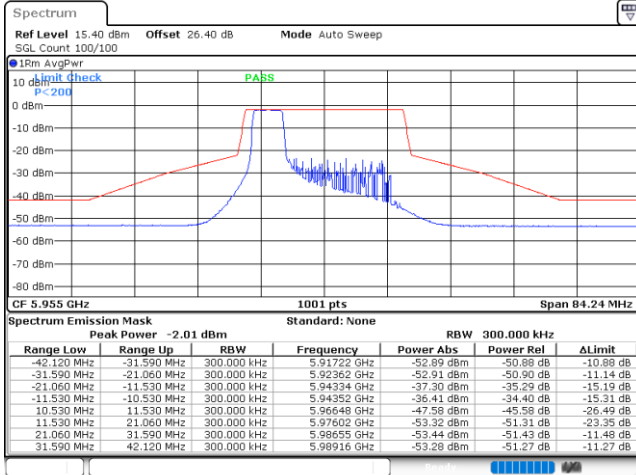

Date: 16.AUG.2023 01:07:13

Plot on Channel 6535 MHz

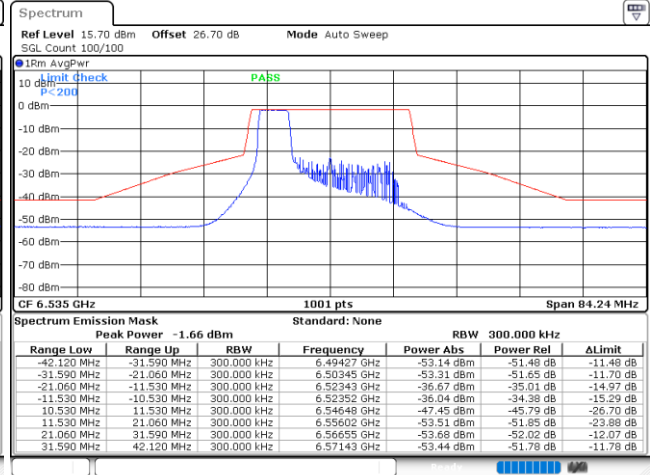

Date: 16.AUG.2023 20:56:01

EUT Mode 802.11ax HE20 52RU38

Plot on Channel 6195 MHz

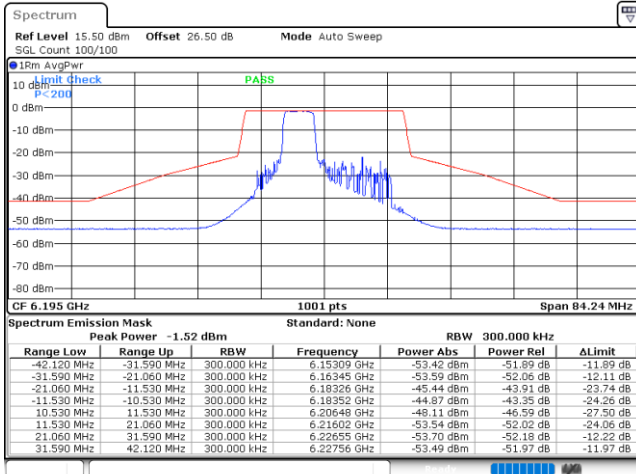

Date: 16.AUG.2023 01:26:45

Plot on Channel 6695 MHz

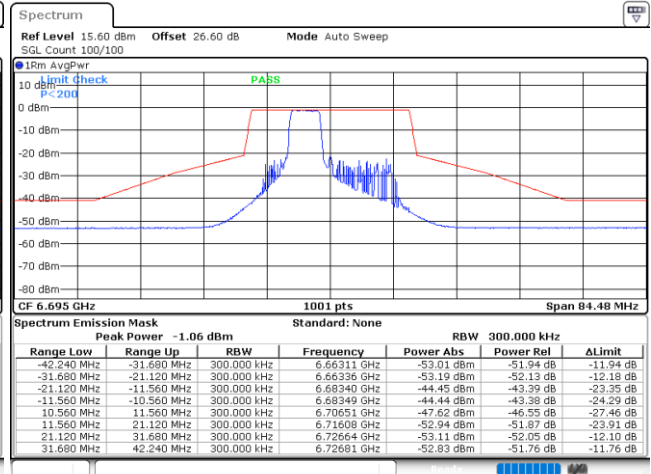

Date: 16.AUG.2023 21:50:13



EUT Mode

802.11ax HE20 52RU40

Plot on Channel 6415 MHz

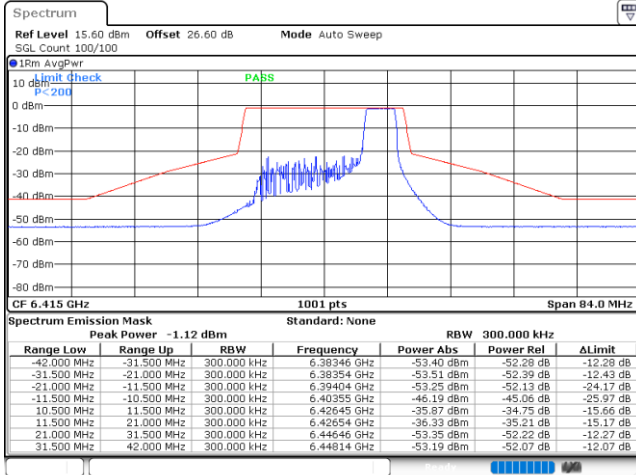

Date: 16.AUG.2023 20:27:56

Plot on Channel 6855 MHz

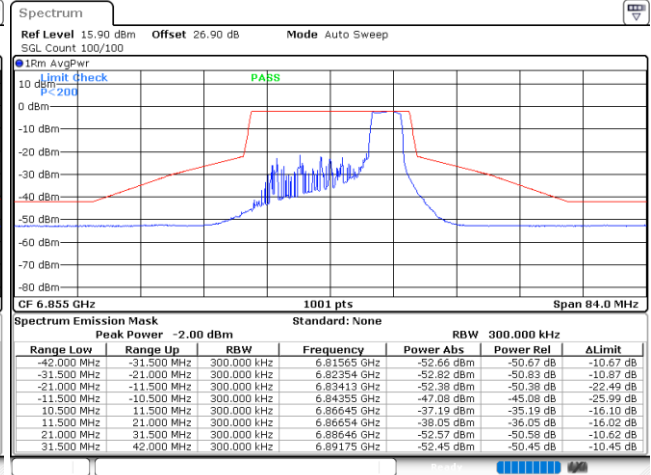

Date: 16.AUG.2023 22:17:11



EUT Mode 802.11ax HE20 106RU53

Plot on Channel 5955 MHz

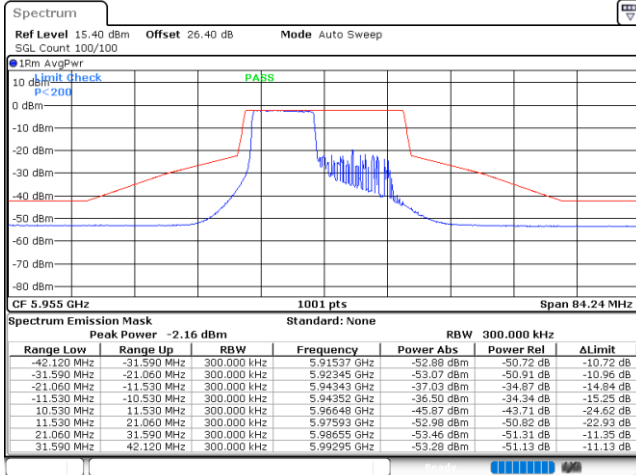

Date: 16.AUG.2023 01:11:10

Plot on Channel 6195 MHz

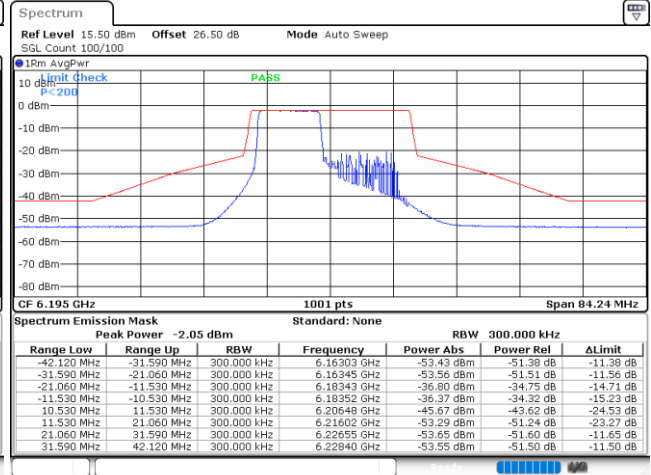

Date: 16.AUG.2023 01:33:26

Plot on Channel 6535 MHz

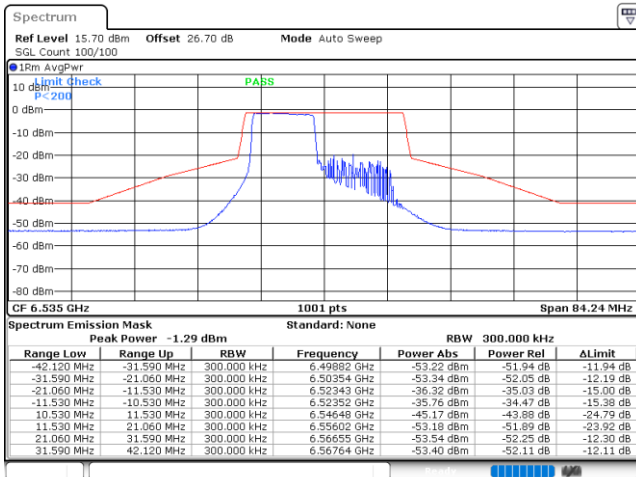

Date: 16.AUG.2023 21:06:14

Plot on Channel 6695 MHz

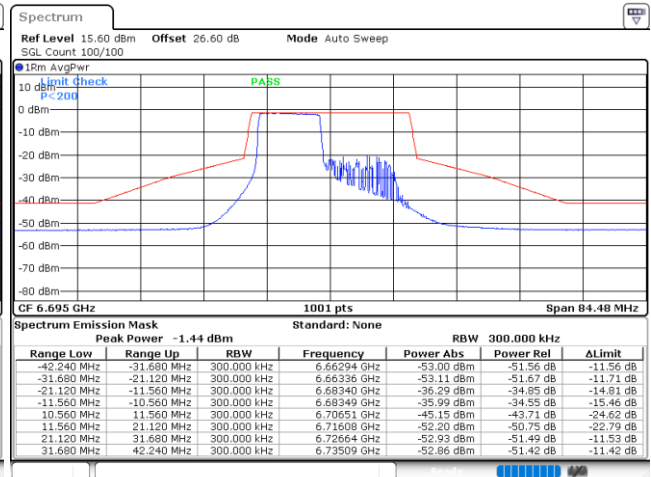

Date: 16.AUG.2023 21:57:25



EUT Mode

802.11ax HE20 106RU54

Plot on Channel 6415 MHz

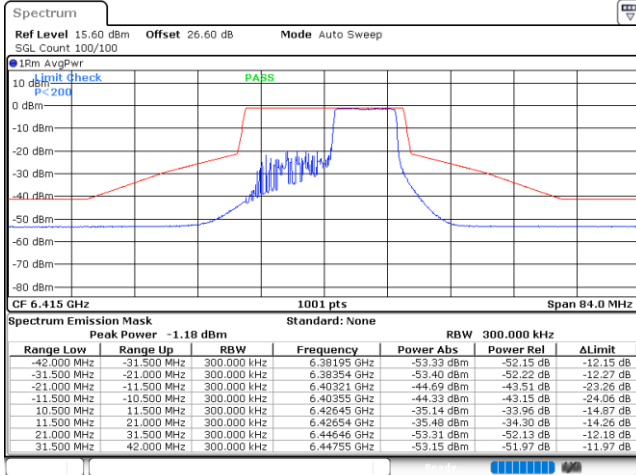

Date: 16.AUG.2023 20:32:20

Plot on Channel 6855 MHz

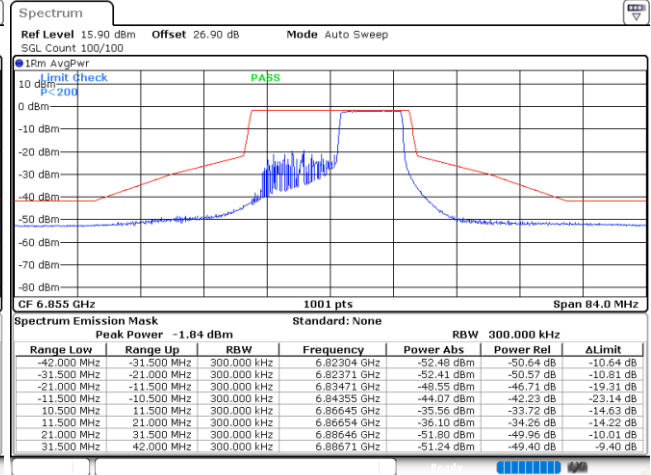

Date: 16.AUG.2023 22:26:42



EUT Mode 802.11ax HE40 Full RU

Plot on Channel 5965 MHz

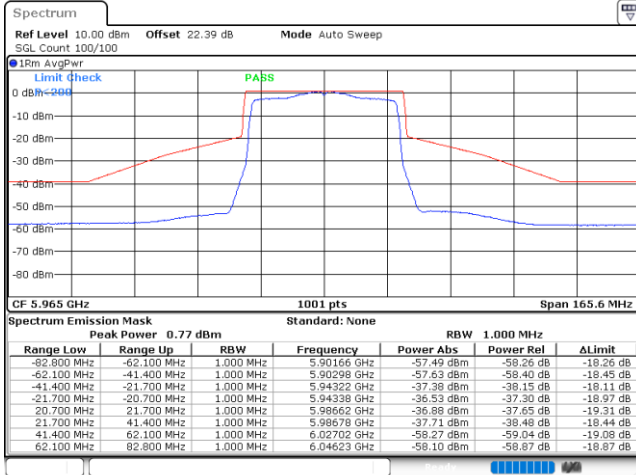

Date: 3.AUG.2023 00:56:07

Plot on Channel 6205 MHz

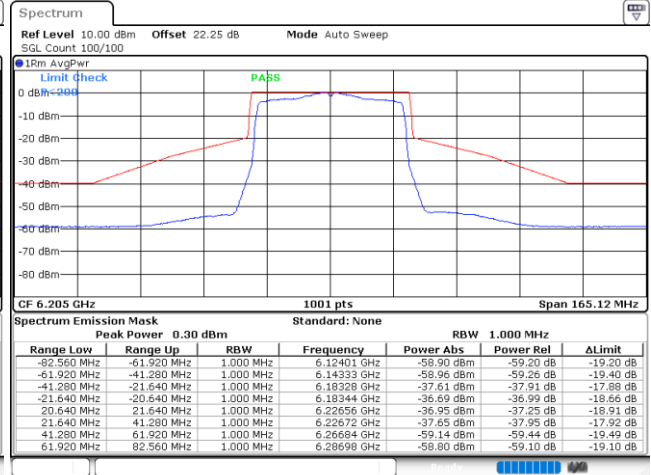

Date: 3.AUG.2023 00:58:36

Plot on Channel 6405 MHz

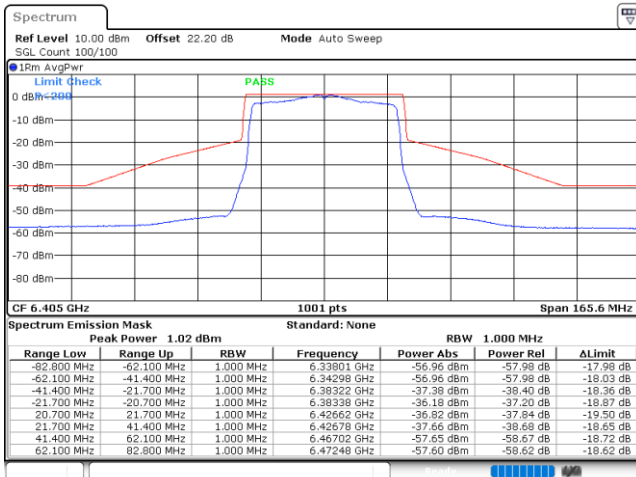

Date: 3.AUG.2023 01:01:14

Plot on Channel 6565 MHz

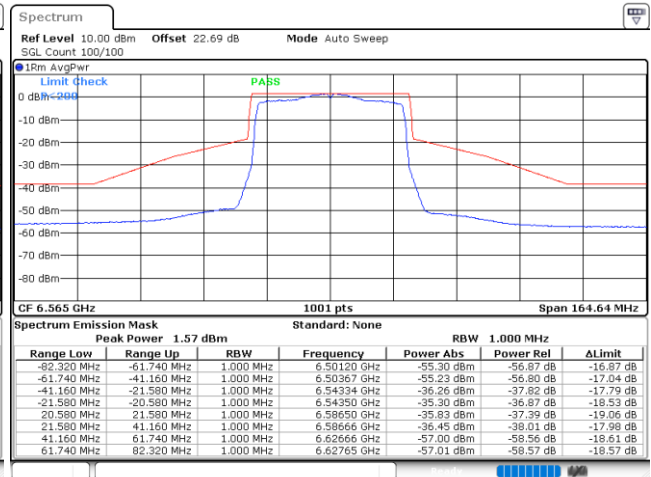

Date: 3.AUG.2023 01:04:24



Plot on Channel 6685 MHz

Plot on Channel 6845 MHz

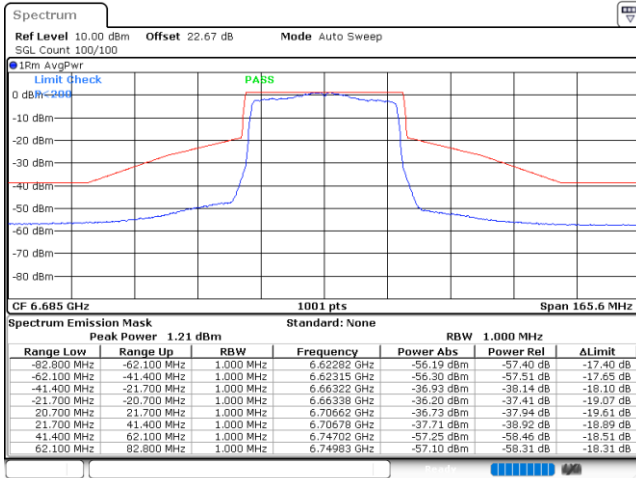

Date: 3.AUG.2023 01:07:31

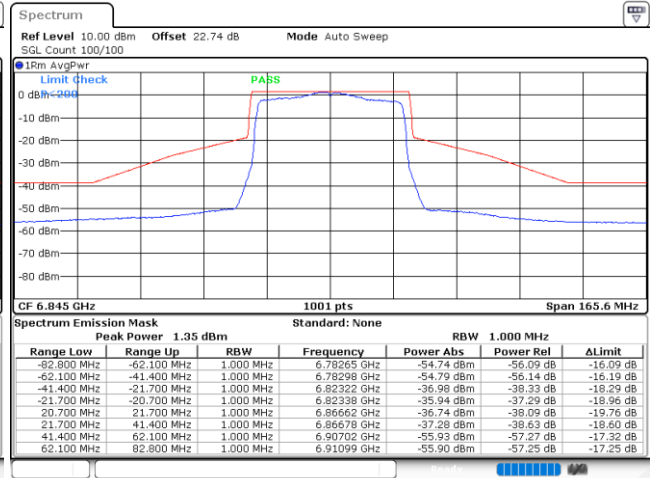

Date: 3.AUG.2023 01:10:01



EUT Mode 802.11ax HE40 242RU61

Plot on Channel 5965 MHz

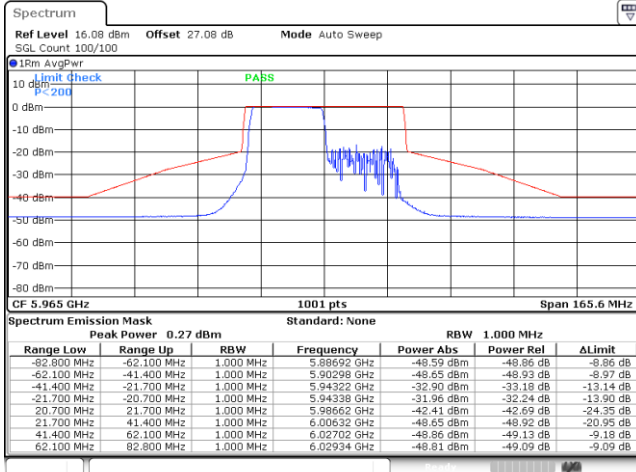

Date: 22.SEP.2023 23:41:26

Plot on Channel 6205 MHz

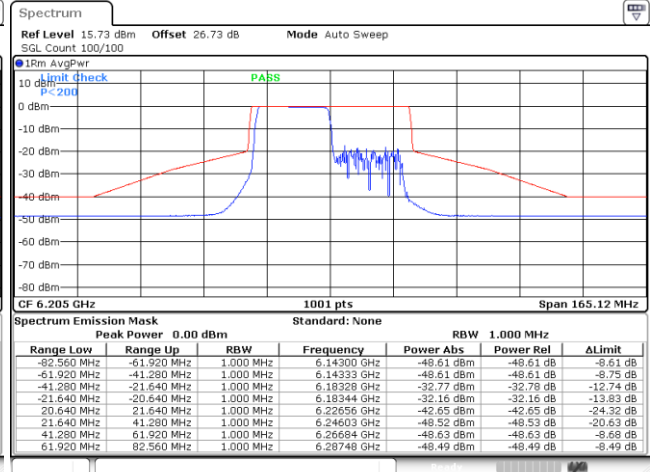

Date: 22.SEP.2023 23:45:00

Plot on Channel 6565 MHz

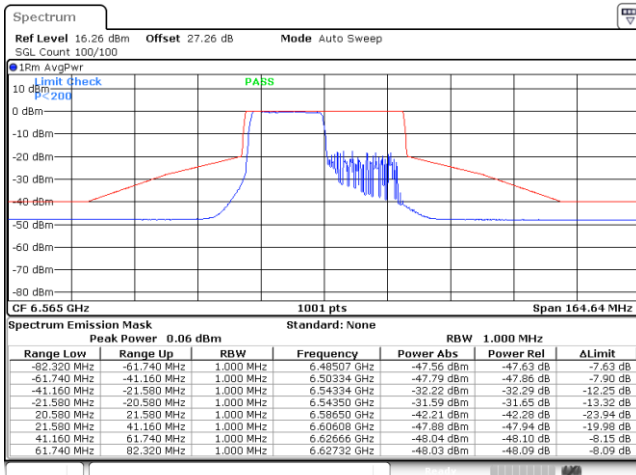

Date: 22.SEP.2023 23:58:58

Plot on Channel 6685 MHz

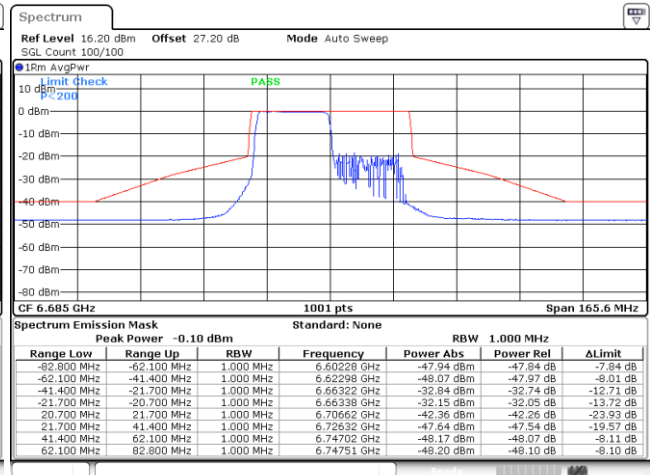

Date: 23.SEP.2023 00:14:20



EUT Mode

802.11ax HE40 242RU62

Plot on Channel 6405 MHz

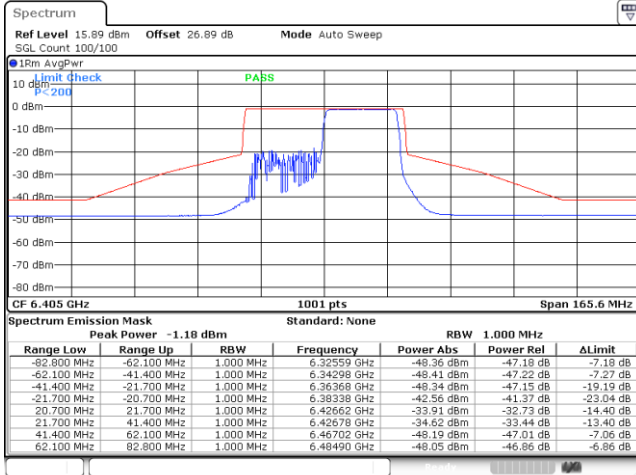

Date: 22.SEP.2023 23:51:33

Plot on Channel 6845 MHz

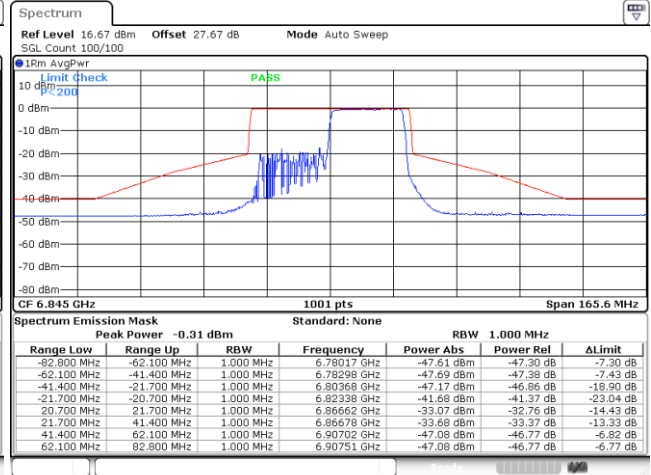

Date: 23.SEP.2023 00:25:00



EUT Mode

802.11ax HE80 Full RU

Plot on Channel 5985 MHz

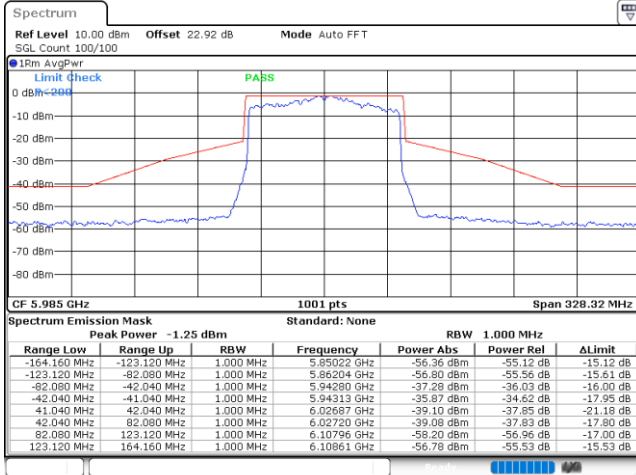

Date: 3.AUG.2023 01:17:07

Plot on Channel 6225 MHz

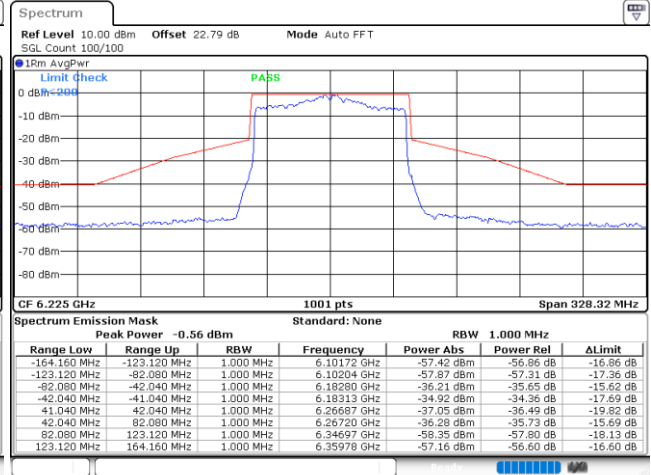

Date: 3.AUG.2023 01:19:19

Plot on Channel 6385 MHz

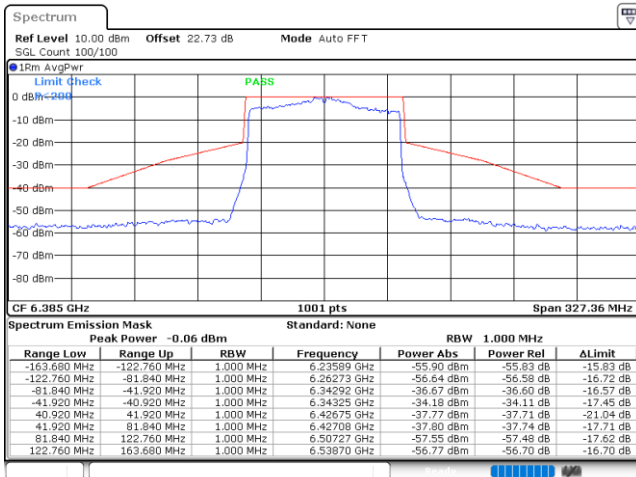

Date: 3.AUG.2023 01:21:25

Plot on Channel 6625 MHz

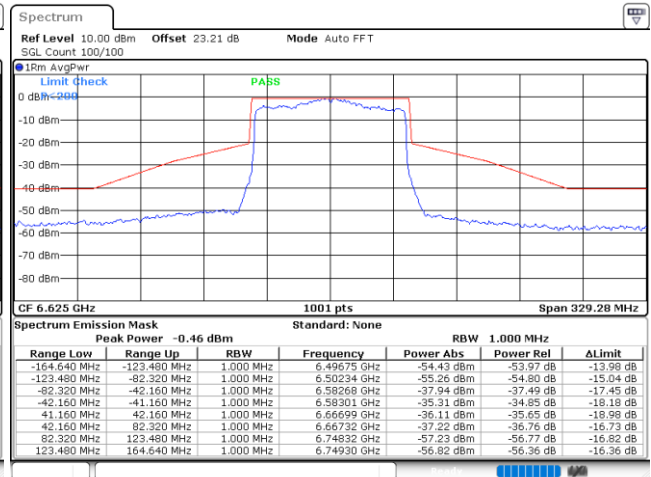

Date: 3.AUG.2023 01:24:10



Plot on Channel 6705 MHz

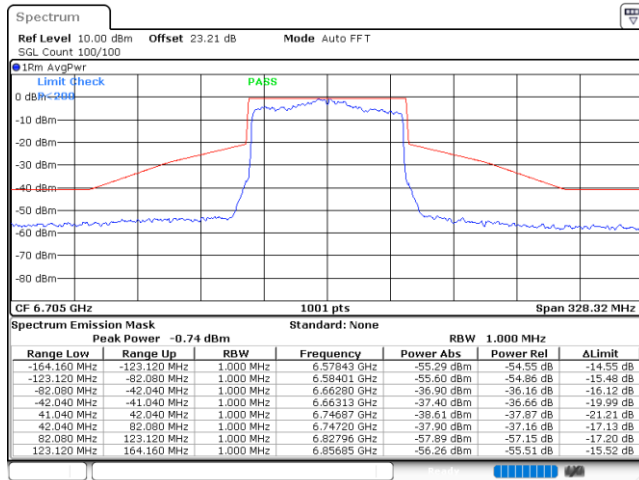

Date: 3.AUG.2023 01:26:02

Plot on Channel 6785 MHz

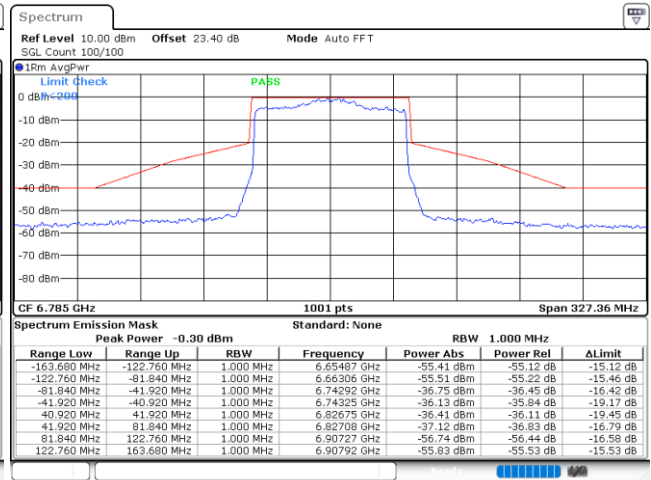

Date: 3.AUG.2023 01:28:21



EUT Mode 802.11ax HE80 484RU65

Plot on Channel 5985 MHz

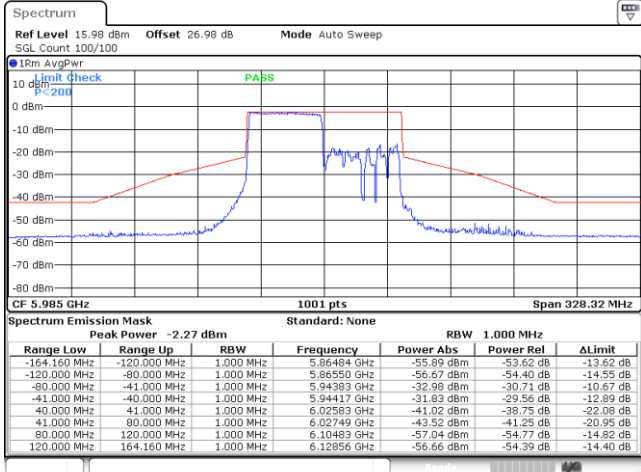

Date: 23_SEP.2023 00:35:00

Plot on Channel 6225 MHz

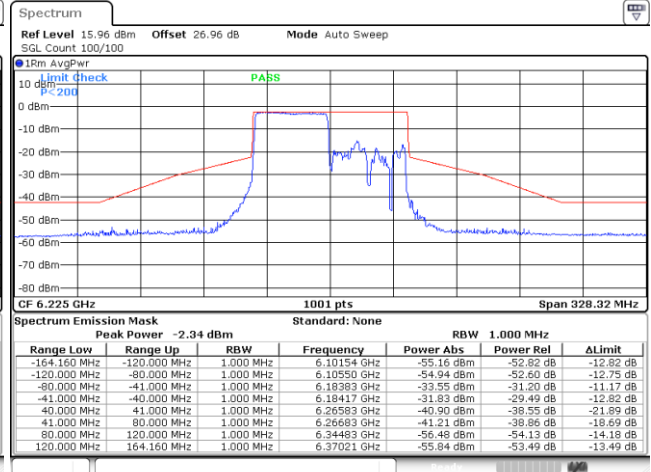

Date: 23_SEP.2023 00:40:17

Plot on Channel 6625 MHz

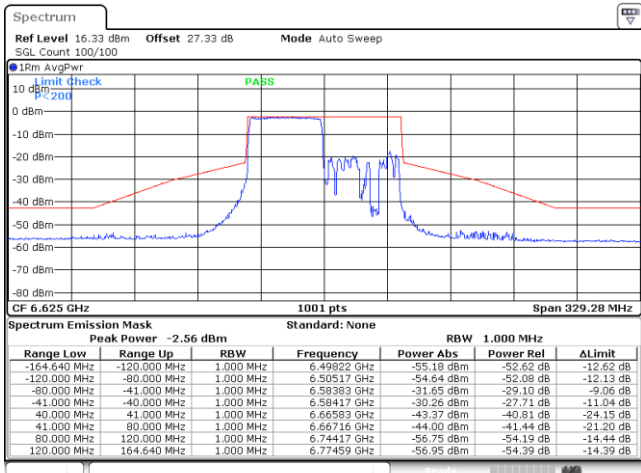

Date: 23_SEP.2023 00:45:34

Plot on Channel 6705 MHz

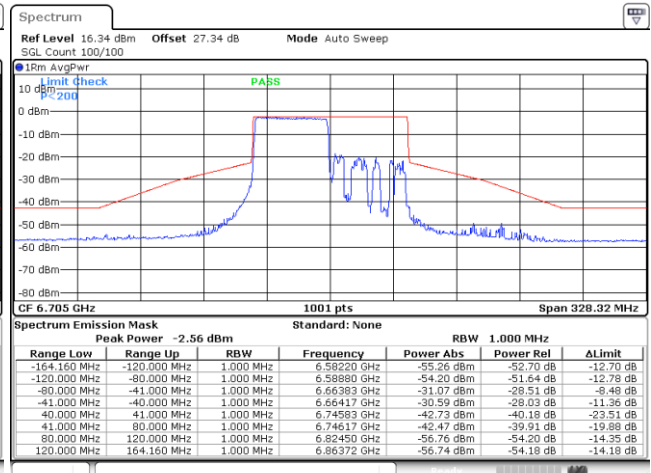

Date: 23_SEP.2023 00:47:45



EUT Mode

802.11ax HE80 484RU66

Plot on Channel 6385 MHz

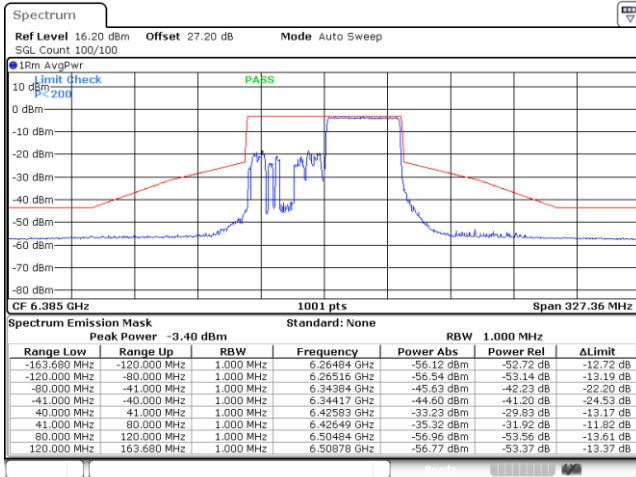

Date: 23.SEP.2023 00:43:48

Plot on Channel 6785 MHz

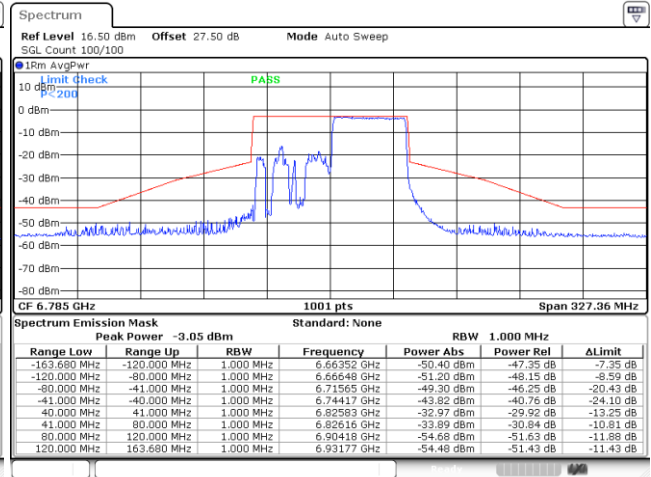

Date: 23.SEP.2023 00:49:42



EUT Mode 802.11ax HE160 Full RU

Plot on Channel 6025 MHz

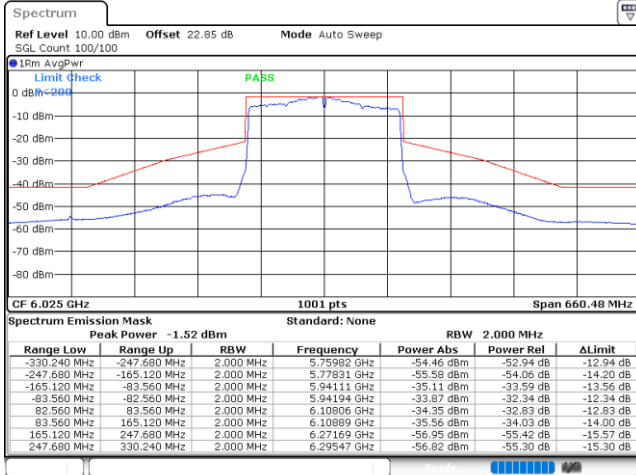

Date: 3.AUG.2023 01:32:42

Plot on Channel 6185 MHz

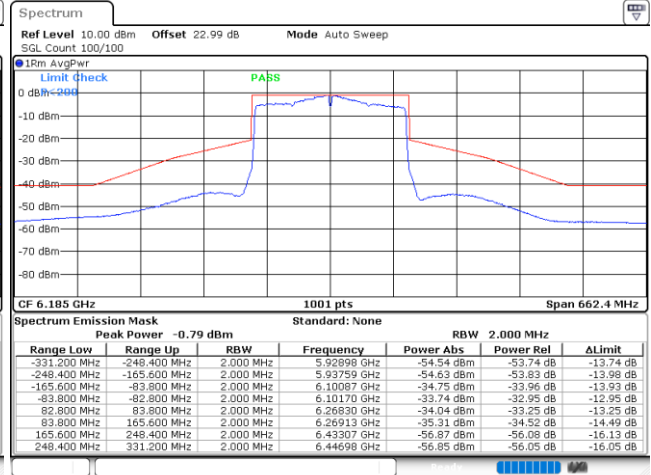

Date: 3.AUG.2023 01:34:46

Plot on Channel 6345 MHz

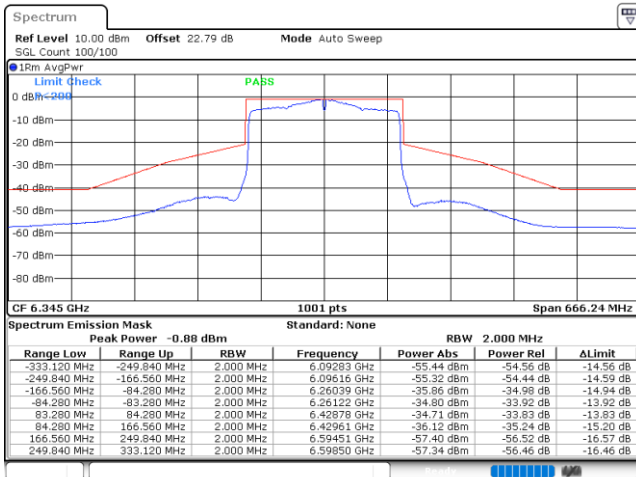

Date: 3.AUG.2023 01:36:31

Plot on Channel 6665 MHz

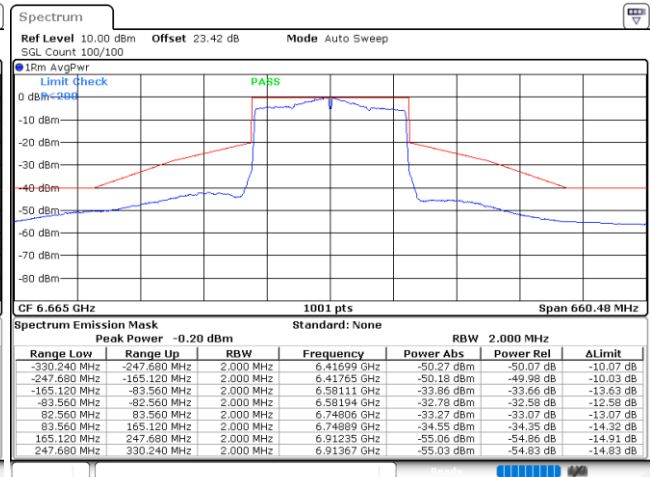

Date: 3.AUG.2023 01:38:29



EUT Mode 802.11ax HE160 996RU67

Plot on Channel 6025 MHz

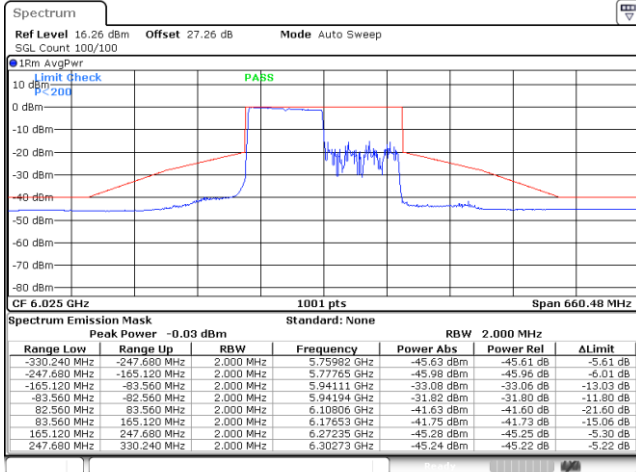

Date: 23.SEP.2023 01:05:42

Plot on Channel 6185 MHz

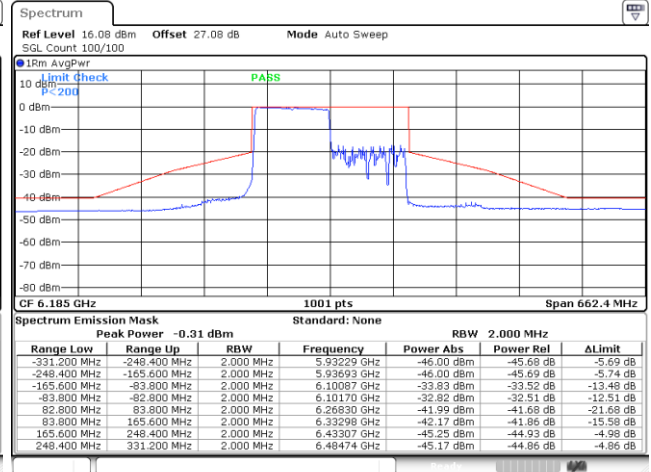

Date: 23.SEP.2023 01:08:12

Plot on Channel 6665 MHz

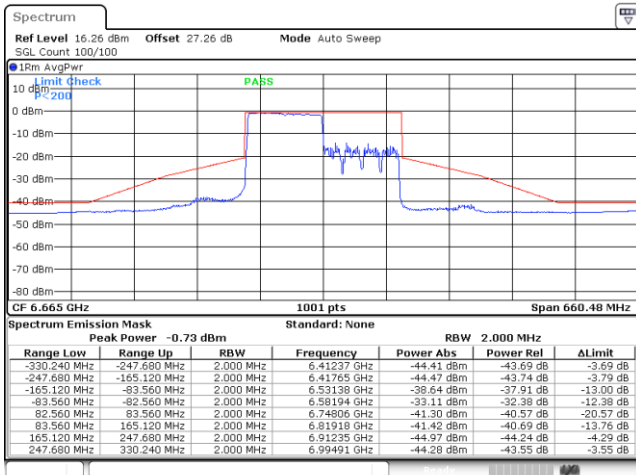

Date: 23.SEP.2023 01:16:47



EUT Mode 802.11ax HE160 996RUS67

Plot on Channel 6345 MHz

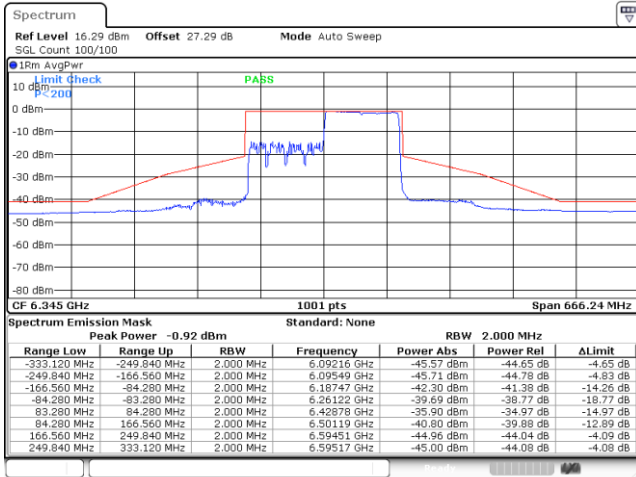

Date: 23.SEP.2023 01:12:43



MIMO <Ant. 6+7(7)>

EUT Mode	802.11a
----------	---------

Plot on Channel 5955 MHz

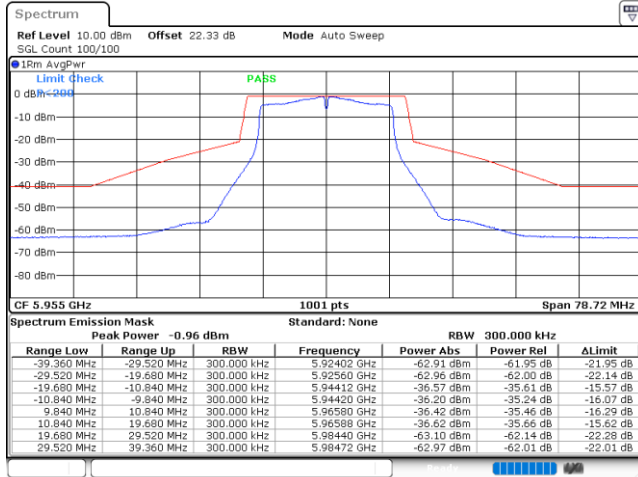

Date: 3.AUG.2023 00:07:24

Plot on Channel 6195 MHz

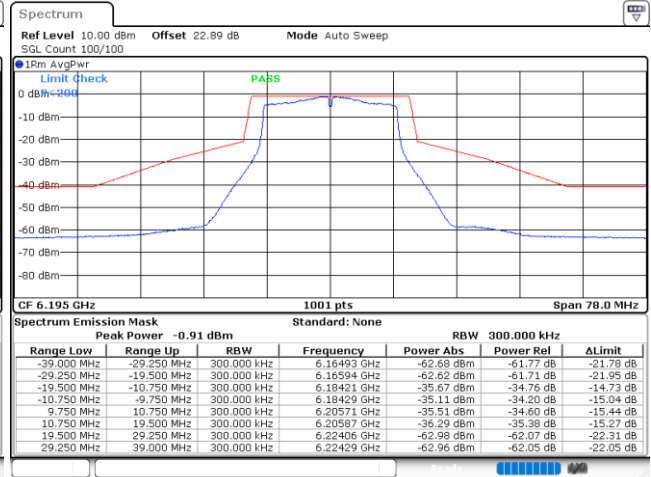

Date: 3.AUG.2023 00:11:21

Plot on Channel 6415 MHz

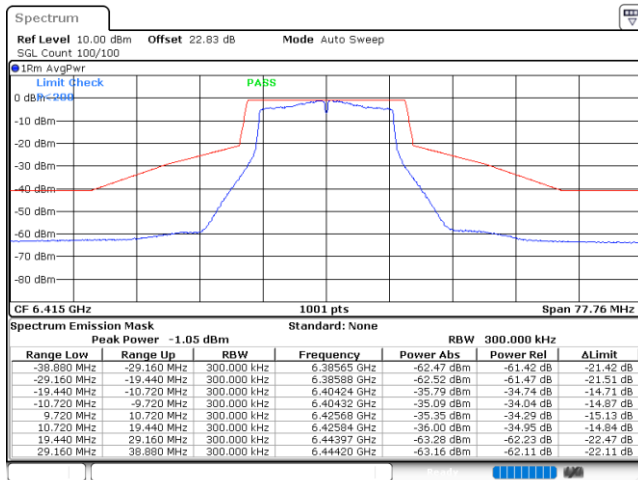

Date: 3.AUG.2023 00:14:47

Plot on Channel 6535 MHz

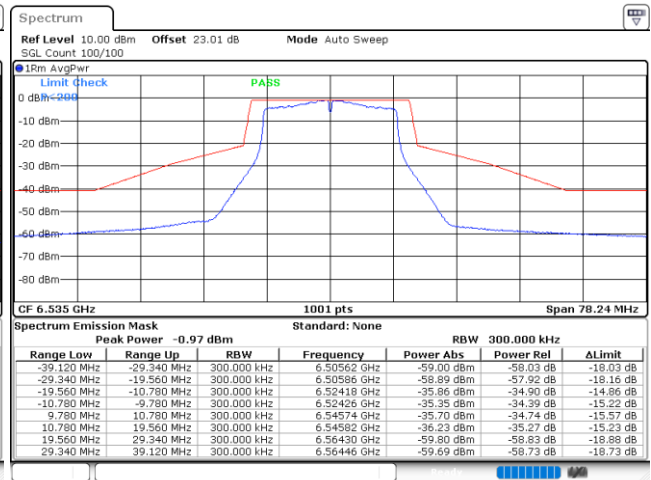

Date: 3.AUG.2023 00:20:47