



# FCC RADIO TEST REPORT

**FCC ID** : UZ7MC9401  
**Equipment** : Mobile Computer  
**Brand Name** : ZEBRA  
**Model Name** : MC9401  
**Applicant** : Zebra Technologies Corporation  
1 Zebra Plaza, Holtsville, NY 11742  
**Manufacturer** : Zebra Technologies Corporation  
1 Zebra Plaza, Holtsville, NY 11742  
**Standard** : FCC Part 15 Subpart C §15.225

The product was received on Jul. 10, 2023 and testing was performed from Jul. 12, 2023 to Jul. 20, 2023. We, Sporton International Inc. EMC & Wireless Communications Laboratory, would like to declare that the tested sample has been evaluated in accordance with the test procedures and has been in compliance with the applicable technical standards.

The test results in this report apply exclusively to the tested model / sample. Without written approval from Sporton International Inc. EMC & Wireless Communications Laboratory, the test report shall not be reproduced except in full.

*Louis Wu*

Approved by: Louis Wu

**Sporton International Inc. EMC & Wireless Communications Laboratory**  
No. 52, Huaya 1st Rd., Guishan Dist., Taoyuan City 333, Taiwan (R.O.C.)



## Table of Contents

|   |           |
|---|-----------|
| <b>History of this test report.....</b>                               | <b>3</b>  |
| <b>Summary of Test Result.....</b>                                    | <b>4</b>  |
| <b>1. General Description .....</b>                                   | <b>5</b>  |
| 1.1 Product Feature of Equipment Under Test .....                     | 5         |
| 1.2 Product Specification of Equipment Under Test .....               | 6         |
| 1.3 Modification of EUT .....   | 6         |
| 1.4 Testing Location .....  | 6         |
| 1.5 Applicable Standards.....   | 7         |
| <b>2. Test Configuration of Equipment Under Test.....</b>             | <b>8</b>  |
| 2.1 Descriptions of Test Mode .....                                   | 8         |
| 2.2 Connection Diagram of Test System .....                           | 9         |
| 2.3 Table for Supporting Units .....                                  | 10        |
| 2.4 EUT Operation Test Setup .....                                    | 10        |
| <b>3. Test Results .....</b>  | <b>11</b> |
| 3.1 AC Power Line Conducted Emissions Measurement .....               | 11        |
| 3.2 20dB and 99% OBW Spectrum Bandwidth Measurement.....              | 13        |
| 3.3 Frequency Stability Measurement .....                             | 14        |
| 3.4 Field Strength of Fundamental Emissions and Mask Measurement..... | 15        |
| 3.5 Radiated Emissions Measurement .....                              | 17        |
| 3.6 Antenna Requirements.....   | 20        |
| <b>4. List of Measuring Equipment .....</b>                           | <b>21</b> |
| <b>5. Measurement Uncertainty.....</b>                                | <b>22</b> |
| <b>Appendix A. Test Results of Conducted Emission Test</b>            |           |
| <b>Appendix B. Test Results of Near Field Test Items</b>              |           |
| B1. Test Result of 20dB Spectrum Bandwidth                            |           |
| B2. Test Result of Frequency Stability                                |           |
| <b>Appendix C. Test Results of Radiated Test Items</b>                |           |
| C1. Test Result of Field Strength of Fundamental Emissions            |           |
| C2. Results of Radiated Emissions (9 kHz~30MHz)                       |           |
| C3. Results of Radiated Emissions (30MHz~1GHz)                        |           |
| <b>Appendix D. Setup Photographs</b>                                  |           |





## Summary of Test Result

| Report Clause | Ref Std. Clause     | Test Items                              | Result (PASS/FAIL) | Remark                                    |
|---------------|---------------------|---|--------------------|---|
| 3.1           | 15.207              | AC Power Line Conducted Emissions       | Pass               | 15.09 dB under the limit at 0.18 MHz      |
| 3.2           | 15.215(c)           | 20dB Spectrum Bandwidth                 | Pass               | -   |
|               | 2.1049              | 99% OBW Spectrum Bandwidth              | Reporting only     | -   |
| 3.3           | 15.225(e)           | Frequency Stability                     | Pass               | -   |
| 3.4           | 15.225(a)(b)(c)     | Field Strength of Fundamental Emissions | Pass               | Max level 23.40 dB $\mu$ V/m at 13.56 MHz |
| 3.5           | 15.225(d)<br>15.209 | Radiated Spurious Emissions             | Pass               | 3.62 dB under the limit at 40.80 MHz      |
| 3.6           | 15.203              | Antenna Requirements                    | Pass               | -   |

**Conformity Assessment Condition:**

1. The test results (PASS/FAIL) with all measurement uncertainty excluded are presented against the regulation limits or in accordance with the requirements stipulated by the applicant/manufacturer who shall bear all the risks of non-compliance that may potentially occur if measurement uncertainty is taken into account.
2. The measurement uncertainty please refer to each test result in the section "Measurement Uncertainty".

**Disclaimer:**

The product specifications of the EUT presented in the test report that may affect the test assessments are declared by the manufacturer who shall take full responsibility for the authenticity.

**Reviewed by: Keven Cheng**

**Report Producer: Ming Chen**



# 1. General Description

## 1.1 Product Feature of Equipment Under Test

| Product Feature                 |  |
|---------------------------------|--|
| Equipment                       | Mobile Computer  |
| Brand Name                      | ZEBRA  |
| Model Name                      | MC9401   |
| FCC ID                          | UZ7MC9401  |
| EUT supports Radios application | NFC<br>WLAN 11a/b/g/n HT20/HT40<br>WLAN 11ac VHT20/VHT40/VHT80/VHT160<br>WLAN 11ax HE20/HE40/HE80/HE160<br>Bluetooth BR/EDR/LE |
| HW Version                      | EV   |
| SW Version                      | 13-05-28.00-TG-U00-PRD-NEM-04  |
| FW Version                      | FUSION_QA_6_1.0.0.001_T  |
| MFD                             | 08JUN23  |
| EUT Stage                       | Identical Prototype  |

Remark: The EUT's information above is declared by manufacturer.

| Specification of Accessories       |            |       |              |                    |
|------------------------------------|------------|-------|--------------|--------------------|
| Adapter USB Wall Charger           | Brand Name | Zebra | Model Number | PWR-WUA5V12W0US    |
| Battery Standard Battery (7000mAh) | Brand Name | Zebra | Model Number | BT-000370          |
| Earphone USB-C Audio Headset       | Brand Name | Zebra | Model Number | HDST-USBC-PTT1-01  |
| USB Cable (Type C to Type A)       | Brand Name | Zebra | Model Number | CBL-TC2X-USBC-01   |
| Holster                            | Brand Name | Zebra | Model Number | SG-MC9X-SHLSTG-01  |
| USB Cable (CUP)                    | Brand Name | Zebra | Model Number | CBL-MC93-USBCHG-01 |



## 1.2 Product Specification of Equipment Under Test

| Product Specification is subject to this standard |                    |
|---|--------------------|
| Tx/Rx Frequency Range                             | 13.553 ~ 13.567MHz |
| Channel Number                                    | 1                  |
| 20dBW   | 2.64 KHz           |
| 99%OBW  | 2.24 KHz           |
| Antenna Type                                      | Loop Antenna       |
| Type of Modulation                                | ASK                |

**Remark:** The EUT's information above is declared by manufacturer. Please refer to Disclaimer in report summary.

## 1.3 Modification of EUT

No modifications made to the EUT during the testing.

## 1.4 Testing Location

|                    |   |            |             |
|--------------------|---|------------|-------------|
| Test Site          | Sporton International Inc. EMC & Wireless Communications Laboratory   |            |             |
| Test Site Location | No.52, Huaya 1st Rd., Guishan Dist.,<br>Taoyuan City 333, Taiwan (R.O.C.)<br>TEL: +886-3-327-3456<br>FAX: +886-3-328-4978 |            |             |
| Test Site No.      | <b>Sporton Site No.</b>   |            |             |
|                    | TH03-HY   | CO05-HY    | 03CH07-HY   |
| Test Engineer      | Hank Chen   | LI YAN-XUN | Stan Hsieh  |
| Temperature        | 22~24°C   | 23~26°C    | 24.8~26.3°C |
| Relative Humidity  | 53~55%  | 45~55%     | 45.6~50.3%  |

**Note:** The test site complies with ANSI C63.4 2014 requirement.

FCC designation No.: TW1190



## 1.5 Applicable Standards

According to the specifications declared by the manufacturer, the EUT must comply with the requirements of the following standards:

- ♦ FCC Part 15 Subpart C §15.225
- ♦ FCC KDB 414788 D01 Radiated Test Site v01r01
- ♦ ANSI C63.10-2013

**Remark:**

1. All the test items were validated and recorded in accordance with the standards without any modification during the testing.
2. The TAF code is not including all the FCC KDB listed without accreditation.
3. This EUT has also been tested and complied with the requirements of FCC Part 15, Subpart B, recorded in a separate test report.



## 2. Test Configuration of Equipment Under Test

### 2.1 Descriptions of Test Mode

Investigation has been done on all the possible configurations.

The following table is a list of the test modes shown in this test report.

| Test Items                        |   |
|-----------------------------------|---|
| AC Power Line Conducted Emissions | Field Strength of Fundamental Emissions |
| 20dB Spectrum Bandwidth           | Frequency Stability                     |
| Radiated Emissions 9kHz~30MHz     | Radiated Emissions 30MHz~1GHz           |

The EUT pre-scanned in reader mode with NFC tag (four NFC type A, B, F, V) and without reading tag. Based on the highest field strength of fundamental and spurious emissions, the worst case type (type F) was recorded in this report.

The measured emission level of the EUT was maximized by rotating the EUT on a turntable, adjusting the orientation of the EUT and EUT antenna in three orthogonal axis (X: flat, Y: portrait, Z: landscape), and adjusting the measurement antenna orientation, following C63.10 exploratory test procedures and only the worst case emissions were reported in this report.

| Test Cases                   |   |
|------------------------------|---|
| <b>AC Conducted Emission</b> | Mode 1 : WLAN (2.4GHz) Link + Bluetooth Link + Battery Standard Battery (7000mAh) + USB Cable (Type C to Type A) with USB Cable (CUP) (Charging from Adapter USB Wall Charger) + NFC Link |



## 2.2 Connection Diagram of Test System

### <AC Conducted Emission Mode>

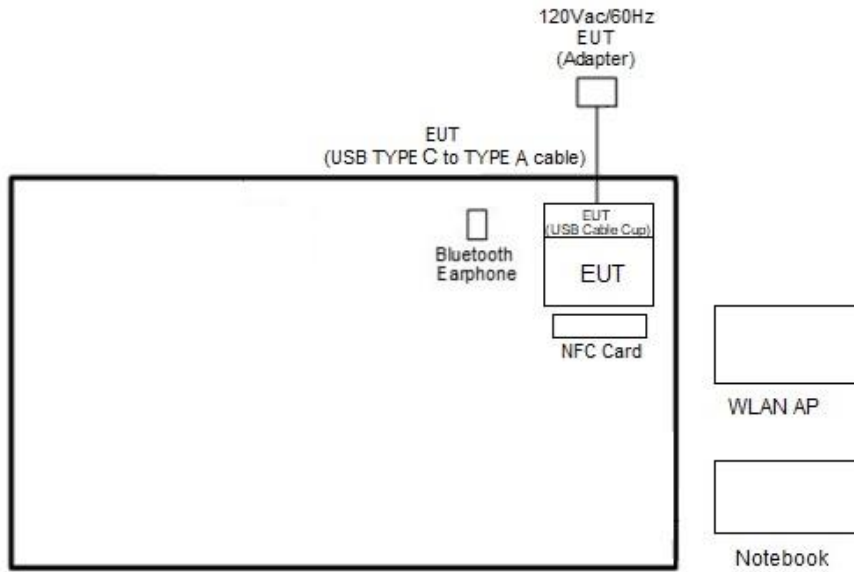

### <NFC Tx Mode>

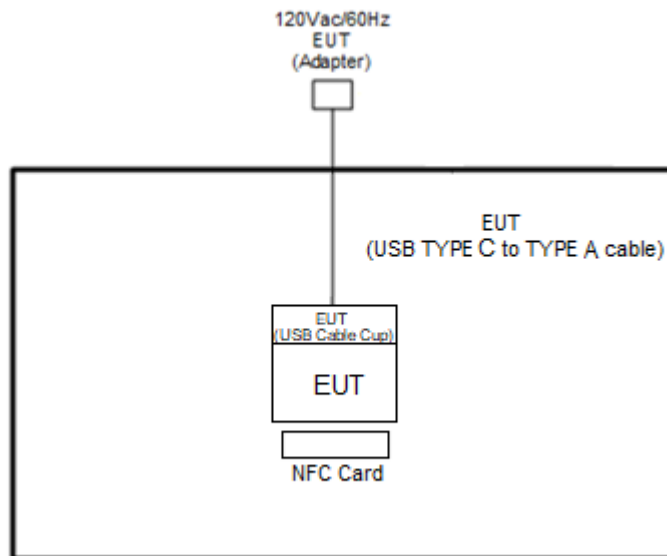



## 2.3 Table for Supporting Units

| Item | Equipment          | Brand Name    | Model Name     | FCC ID      | Data Cable | Power Cord   |
|------|--------------------|---------------|----------------|-------------|------------|--|
| 1.   | NFC Card           | N/A           | N/A            | N/A         | N/A        | N/A  |
| 2.   | Bluetooth Earphone | Sony Ericsson | MW600          | PY7DDA-2029 | N/A        | N/A  |
| 3.   | WLAN AP            | ASUS          | RT-AC66U       | MSQ-RTAC66U | N/A        | Unshielded, 1.8 m  |
| 4.   | Notebook           | Dell          | Latitude E3420 | FCC DoC     | N/A        | AC I/P:<br>Unshielded, 1.2 m<br>DC O/P:<br>Shielded, 1.8 m |

## 2.4 EUT Operation Test Setup

The EUT is programmed to be in continuously transmitting mode.

The ancillary equipment, NFC card, is used to make the EUT (NFC) continuously transmitting signal (Power Level: Default) at 13.56MHz and is placed around 0 cm gap to the EUT.



### 3. Test Results

#### 3.1 AC Power Line Conducted Emissions Measurement

##### 3.1.1 Limit of AC Conducted Emission

For equipment that is designed to be connected to the public utility (AC) power line, the radio frequency voltage that is conducted back onto the AC power line on any frequency or frequencies within the band 150 kHz to 30 MHz shall not exceed the limits in the following table.

| Frequency of Emission<br>(MHz) | Conducted Limit (dB $\mu$ V) |           |
|--------------------------------|------------------------------|-----------|
|                                | Quasi-Peak                   | Average   |
| 0.15-0.5                       | 66 to 56*                    | 56 to 46* |
| 0.5-5                          | 56                           | 46        |
| 5-30                           | 60                           | 50        |

\*Decreases with the logarithm of the frequency.

For terminal test result, the testing follows FCC KDB 174176.

##### 3.1.2 Measuring Instruments

Please refer to the measuring equipment list in this test report.

##### 3.1.3 Test Procedures

1. The EUT is placed 0.4 meter away from the conducting wall of the shielding room, and is kept at least 80 centimeters from any other grounded conducting surface.
2. Connect EUT to the power mains through a line impedance stabilization network (LISN).
3. All the support units are connecting to the other LISN.
4. The LISN provides 50 ohm coupling impedance for the measuring instrument.
5. The FCC states that a 50 ohm, 50 microhenry LISN shall be used.
6. Both Line and Neutral shall be tested in order to find out the maximum conducted emission.
7. The frequency range from 150 kHz to 30 MHz is scanned.
8. Set the test-receiver system to Peak Detect Function and specified bandwidth (IF Bandwidth = 9 kHz) with Maximum Hold Mode. Then measurement is also conducted by Average Detector and Quasi-Peak Detector Function respectively.

### 3.1.4 Test setup

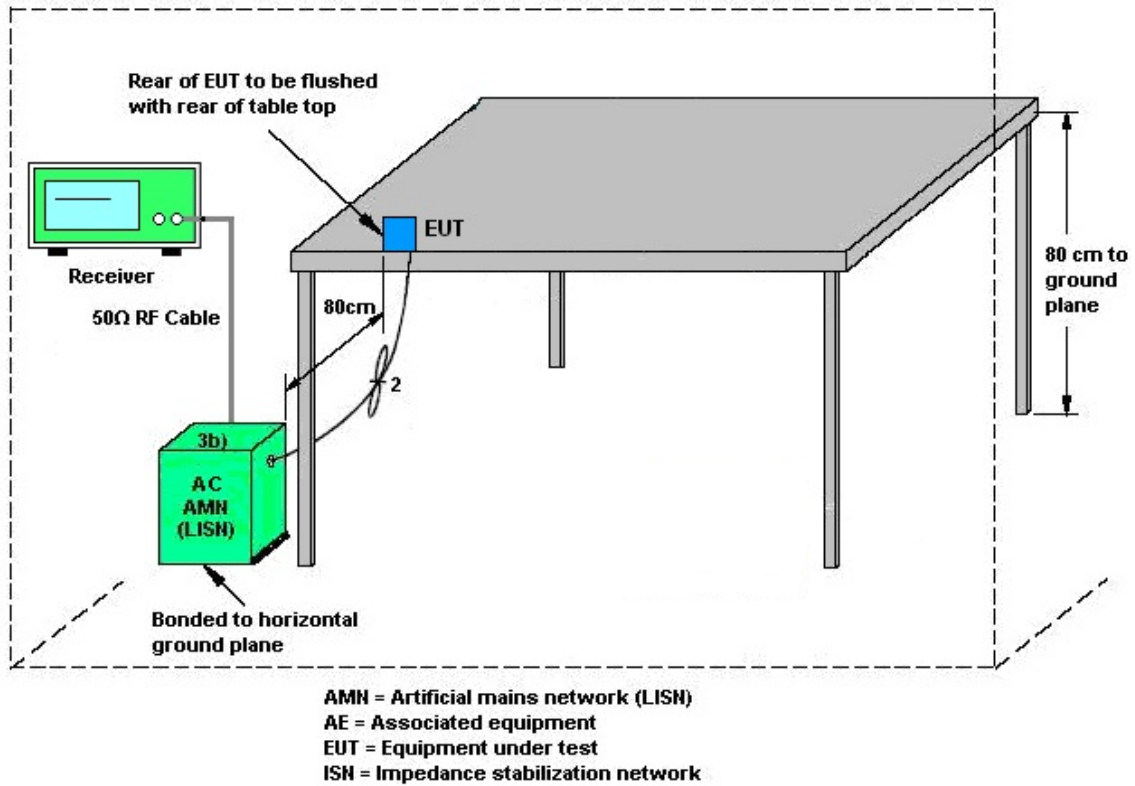

### 3.1.5 Test Result of AC Conducted Emission

Please refer to Appendix A.

**Note:**

(1) with antenna

Remark: 13.560MHz is the NFC RF fundamental signal.

(2) with dummy load

Remark: Only the fundamental NFC signal needs to be retested per C63.4.

## 3.2 20dB and 99% OBW Spectrum Bandwidth Measurement

### 3.2.1 Limit

Intentional radiators must be designed to ensure that the 20 dB and 99% emission bandwidth in the specific band 13.553~13.567 MHz.

### 3.2.2 Measuring Instruments

Please refer to the measuring equipment list in this test report.

### 3.2.3 Test Procedures

1. The spectrum analyzer connected via a receive antenna placed near the EUT in peak Max Hold Mode.
2. The resolution bandwidth of 1 kHz and the video bandwidth of 3 kHz were used.
3. Measured the spectrum width with power higher than 20 dB below carrier.
4. Measured the 99% OBW.

### 3.2.4 Test Setup



### 3.2.5 Test Result of Near Field Test Items

Please refer to Appendix B.

### 3.3 Frequency Stability Measurement

#### 3.3.1 Limit

The frequency tolerance of the carrier signal shall be maintained within +/- 0.01% (100ppm) of the operating frequency over a temperature variation of -20 degrees to +50 degrees C at normal supply voltage, and for a variation in the primary supply voltage from 85% to 115% of the rated supply voltage at a temperature of 20 degrees C. For battery operated equipment, the equipment tests shall be performed by using a new battery.

#### 3.3.2 Measuring Instruments

Please refer to the measuring equipment list in this test report.

#### 3.3.3 Test Procedures

1. The spectrum analyzer connected via a receive antenna placed near the EUT.
2. EUT has transmitted signal and fixed channelize.
3. Set the spectrum analyzer span to view the entire emissions bandwidth.
4. Set RBW = 1 kHz, VBW = 3 kHz with peak detector and maxhold settings.
5. The  $f_c$  is declaring of channel frequency. Then the frequency error formula is  $(f_c - f) / f_c \times 10^6$  ppm and the limit is less than  $\pm 100$ ppm.
6. Extreme temperature rule is -20°C~50°C.

#### 3.3.4 Test Setup

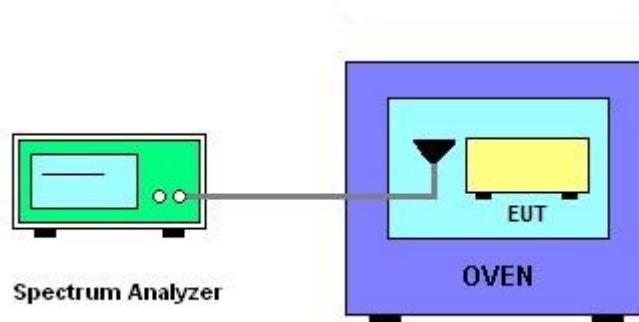

#### 3.3.5 Test Result of Near Field Test Items

Please refer to Appendix B.



### 3.4 Field Strength of Fundamental Emissions and Mask Measurement

#### 3.4.1 Limit

| Rules and specifications | FCC CFR 47 Part 15 section 15.225                                 |   |   |  |
|--------------------------|---|---|---|--|
| Description              | Compliance with the spectrum mask is tested with RBW set to 9kHz. |   |   |  |
| Freq. of Emission (MHz)  | Field Strength<br>( $\mu$ V/m) at 30m                             | Field Strength<br>(dB $\mu$ V/m) at 30m | Field Strength<br>(dB $\mu$ V/m) at 10m | Field Strength<br>(dB $\mu$ V/m) at 3m |
| 1.705~13.110             | 30  | 29.5                                    | 48.58                                   | 69.5                                   |
| 13.110~13.410            | 106   | 40.5                                    | 59.58                                   | 80.5                                   |
| 13.410~13.553            | 334   | 50.5                                    | 69.58                                   | 90.5                                   |
| 13.553~13.567            | 15848   | 84.0                                    | 103.08                                  | 124.0                                  |
| 13.567~13.710            | 334   | 50.5                                    | 69.58                                   | 90.5                                   |
| 13.710~14.010            | 106   | 40.5                                    | 59.58                                   | 80.5                                   |
| 14.010~30.000            | 30  | 29.5                                    | 48.58                                   | 69.5                                   |

**Remark:**

1. The field strength test result is in 3m test distance, follow test rules the test data use distance extrapolation factor and reported in this report at 30m test result.
2. Distance extrapolation factor =  $40 \log(\text{specific distance} / \text{test distance})$  (dB)

#### 3.4.2 Measuring Instruments

Please refer to the measuring equipment list in this test report.

### 3.4.3 Test Procedures

1. Configure the EUT according to ANSI C63.10. The EUT is placed on the top of the turntable 0.8 meter above ground. The phase center of the loop receiving antenna mounted antenna tower is placed 3 meters far away from the turntable.
2. Power on the EUT and all the supporting units. The turntable is rotated by 360 degrees to determine the position of the highest radiation.
3. The height of the receiving antenna is fixed at one meter above ground to find the maximum emissions field strength.
4. For Fundamental emissions, use the receiver to measure QP reading.
5. When the radiated emissions limits are expressed in terms of the average value of the emissions, and pulsed operation is employed, the measurement field strength shall be determined by averaging over one complete pulse train, including blanking intervals, as long as the pulse train does not exceed 0.1 seconds. As an alternative (provided the transmitter operates for longer than 0.1 seconds) or in cases where the pulse train exceeds 0.1 seconds, the measured field strength shall be determined from the average absolute voltage during a 0.1 second interval during which the field strength is at its maximum value.
6. Compliance with the spectrum mask is tested with RBW set to 9 kHz.  
Note: Emission level (dB $\mu$ V/m) = 20 log Emission level ( $\mu$ V/m).

### 3.4.4 Test Setup

For radiated test below 30MHz

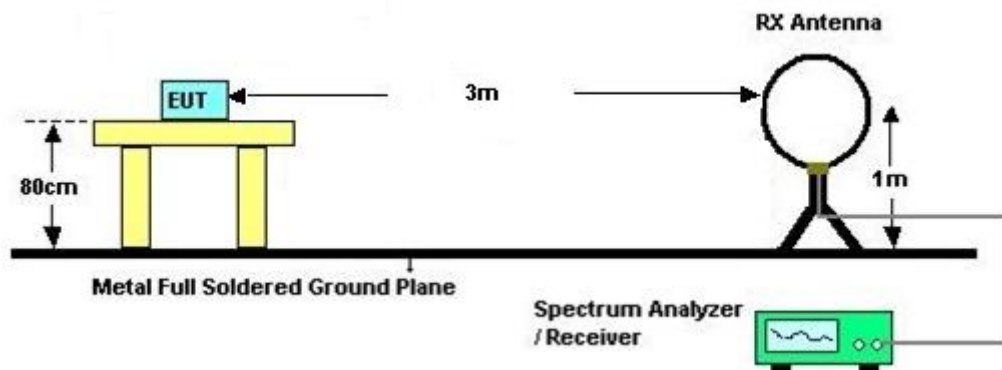

### 3.4.5 Test Result of Field Strength of Fundamental Emissions and Mask

Please refer to Appendix C.





### 3.5 Radiated Emissions Measurement

#### 3.5.1 Limit

The field strength of any emissions which appear outside of 13.110 ~14.010MHz band shall not exceed the general radiated emissions limits.

| Frequencies (MHz) | Field Strength (µV/m) | Measurement Distance (meters) |
|-------------------|-----------------------|-------------------------------|
| 0.009~0.490       | 2400/F(kHz)           | 300                           |
| 0.490~1.705       | 24000/F(kHz)          | 30                            |
| 1.705~30.0        | 30                    | 30                            |
| 30~88             | 100                   | 3                             |
| 88~216            | 150                   | 3                             |
| 216~960           | 200                   | 3                             |
| Above 960         | 500                   | 3                             |

#### 3.5.2 Measuring Instruments

Please refer to the measuring equipment list in this test report.

#### 3.5.3 Measuring Instrument Setting

The following table is the setting of receiver:

| Receiver Parameter             | Setting             |
|--------------------------------|---------------------|
| Attenuation                    | Auto                |
| Frequency Range: 9kHz~150kHz   | RBW 200Hz for QP    |
| Frequency Range: 150kHz~30MHz  | RBW 9kHz for QP     |
| Frequency Range: 30MHz~1000MHz | RBW 120kHz for Peak |

**Note:** The emission limits shown in the above table are based on measurements employing a CISPR quasi-peak detector except for the frequency bands 9-90 kHz and 110-490 kHz. Radiated emission limits in these two bands are based on measurements employing an average detector.



### 3.5.4 Test Procedures

1. Configure the EUT according to ANSI C63.10. The EUT is placed on the top of the turntable 0.8 meter above ground. The phase center of the receiving antenna mounted on the top of a height-variable antenna tower is placed 3 meters far away from the turntable.
2. Power on the EUT and all the supporting units. The turntable is rotated by 360 degrees to determine the position of the highest radiation.
3. The height of the broadband receiving antenna is varied between one meter and four meters above ground to find the maximum emissions field strength of both horizontal and vertical polarization.
4. For each suspected emissions, the antenna tower is scanned (from 1 M to 4 M) and then the turntable is rotated (from 0 degree to 360 degrees) to find the maximum reading.
5. Set the test-receiver system to Peak or CISPR quasi-peak Detect Function with specified bandwidth under Maximum Hold Mode.
6. When the radiated emissions limits are expressed in terms of the average value of the emissions, and pulsed operation is employed, the measurement field strength shall be determined by averaging over one complete pulse train, including blanking intervals, as long as the pulse train does not exceed 0.1 seconds. As an alternative (provided the transmitter operates for longer than 0.1 seconds) or in cases where the pulse train exceeds 0.1 seconds, the measured field strength shall be determined from the average absolute voltage during a 0.1 second interval during which the field strength is at its maximum value.
7. In case the emission is lower than 30 MHz, loop antenna has to be used for measurement and the recorded data shall be QP measured by receiver.
8. Radiated testing below 1 GHz is performed by adjusting the antenna tower from 1 m to 4 m and by rotating the turn table from 0 degree to 360 degrees to find the peak maximum hold reading. When there is no suspected emission found and the emission level is with at least 6 dB margin against QP limit line, the position is marked as “-“.

### 3.5.5 Test Setup

For radiated test below 30MHz

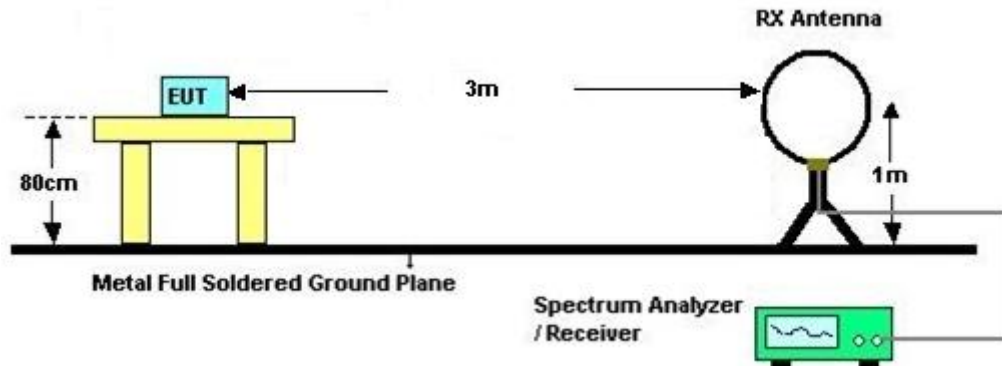

For radiated test above 30MHz

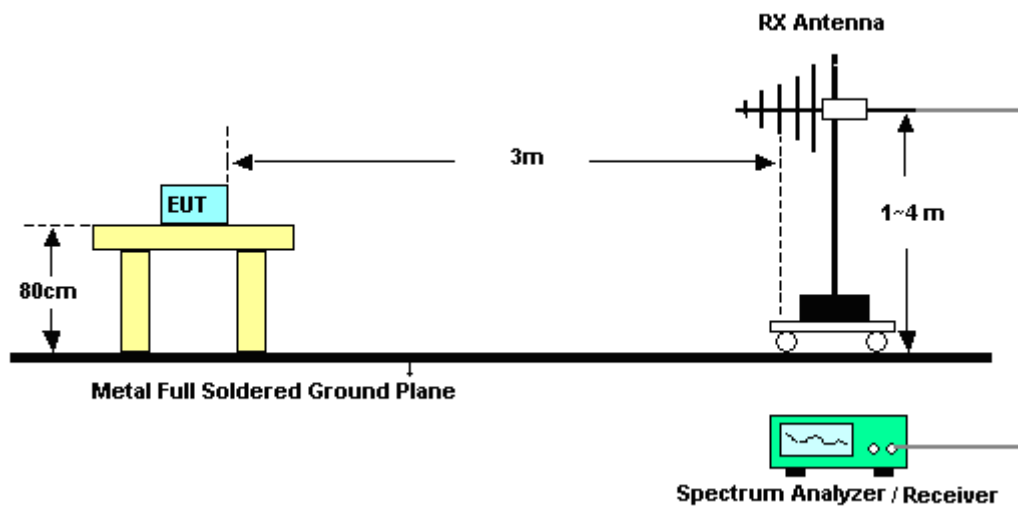

### 3.5.6 Test Result of Radiated Emissions Measurement

Please refer to Appendix C.

**Remark:** There is adequate comparison measurement of both open-field test site and alternative test site - semi-Anechoic chamber according to 414788 D01 Radiated Test Site v01r01, and the result came out very similar.



## **3.6 Antenna Requirements**

### **3.6.1 Standard Applicable**

Except for special regulations, the Low-power Radio-frequency Devices must not be equipped with any jacket for installing an antenna with extension cable. An intentional radiator shall be designed to ensure that no antenna other than that furnished by the responsible party shall be used with the device. The use of a permanently attached antenna or of an antenna that uses a unique coupling to the intentional radiator shall be considered sufficient to comply with the provisions of this Section. The manufacturer may design the unit so that the user can replace a broken antenna, but the use of a standard antenna jack or electrical connector is prohibited.

The use of a permanently attached antenna or of an antenna that uses a unique coupling to the intentional radiator shall be considered sufficient to comply with the rule.

### **3.6.2 Antenna Anti-Replacement Construction**

An embedded-in antenna design is used.



### 4. List of Measuring Equipment

| Instrument                | Brand Name      | Model No.                  | Serial No. | Characteristics      | Calibration Date | Test Date                       | Due Date      | Remark                |
|---------------------------|-----------------|----------------------------|------------|----------------------|------------------|---------------------------------|---------------|-----------------------|
| AC Power Source           | ChainTek        | APC-1000W                  | N/A        | N/A                  | N/A              | Jul. 14, 2023<br>Jul. 18, 2023  | N/A           | Conduction (CO05-HY)  |
| EMI Test Receiver         | Rohde & Schwarz | ESR3                       | 102388     | 9kHz~3.6GHz          | Dec. 01, 2022    | Jul. 14, 2023<br>Jul. 18, 2023  | Nov. 30, 2023 | Conduction (CO05-HY)  |
| Hygrometer                | Testo           | 608-H1                     | 34913912   | N/A                  | Nov. 17, 2022    | Jul. 14, 2023<br>Jul. 18, 2023  | Nov. 16, 2023 | Conduction (CO05-HY)  |
| LISN                      | Rohde & Schwarz | ENV216                     | 100081     | 9kHz~30MHz           | Nov. 17, 2022    | Jul. 14, 2023<br>Jul. 18, 2023  | Nov. 16, 2023 | Conduction (CO05-HY)  |
| Software                  | Rohde & Schwarz | EMC32                      | N/A        | N/A                  | N/A              | Jul. 14, 2023<br>Jul. 18, 2023  | N/A           | Conduction (CO05-HY)  |
| Pulse Limiter             | SCHWARZBECK     | VTSD 9561-F N              | 00691      | N/A                  | Aug. 01, 2022    | Jul. 14, 2023<br>Jul. 18, 2023  | Jul. 31, 2023 | Conduction (CO05-HY)  |
| LISN Cable                | MVE             | RG-400                     | 260260     | N/A                  | Dec. 29, 2022    | Jul. 14, 2023<br>Jul. 18, 2023  | Dec. 28, 2023 | Conduction (CO05-HY)  |
| Hygrometer                | TECPEL          | DTM-303A                   | TP201996   | N/A                  | Nov. 17, 2022    | Jul. 18, 2023~<br>Jul. 20, 2023 | Nov. 16, 2023 | Near Field (TH03-HY)  |
| Spectrum Analyzer         | Rohde & Schwarz | FSP30                      | 101329     | 9kHz~30GHz           | Sep. 27, 2022    | Jul. 18, 2023~<br>Jul. 20, 2023 | Sep. 26, 2023 | Near Field (TH03-HY)  |
| Thermal Chamber           | ESPEC           | SH-641                     | 92013720   | -40°C ~90°C          | Sep. 07, 2022    | Jul. 18, 2023~<br>Jul. 20, 2023 | Sep. 06, 2023 | Near Field (TH03-HY)  |
| Programmable Power Supply | GW Instek       | PSS-2005                   | EL890001   | 1V~20V<br>0.5A~4A    | Sep. 29, 2022    | Jul. 18, 2023~<br>Jul. 20, 2023 | Sep 28, 2023  | Near Field (TH03-HY)  |
| EMI Test Receiver         | Rohde & Schwarz | ESU26                      | 100472     | 20Hz~26.5GHz         | Feb. 13, 2023    | Jul. 12, 2023~<br>Jul. 13, 2023 | Feb. 12, 2024 | Radiation (03CH07-HY) |
| Bilog Antenna             | TESEQ           | CBL 6111D & 00800N1D01N-06 | 35419 & 03 | 30MHz~1GHz           | Apr. 23, 2023    | Jul. 12, 2023~<br>Jul. 13, 2023 | Apr. 22, 2024 | Radiation (03CH07-HY) |
| Loop Antenna              | Rohde & Schwarz | HFH2-Z2                    | 100315     | 9 kHz~30 MHz         | Feb. 28, 2023    | Jul. 12, 2023~<br>Jul. 13, 2023 | Feb. 27, 2024 | Radiation (03CH07-HY) |
| Preamplifier              | COM-POWER       | PA-103A                    | 161241     | 10MHz~1GHz           | Oct. 03, 2022    | Jul. 12, 2023~<br>Jul. 13, 2023 | Oct. 02, 2023 | Radiation (03CH07-HY) |
| RF Cable                  | HUBER + SUHNER  | SUCOFLEX 104               | MY15682/4  | 30MHz to 18GHz       | Feb. 22, 2023    | Jul. 12, 2023~<br>Jul. 13, 2023 | Feb. 21, 2024 | Radiation (03CH07-HY) |
| RF Cable                  | HUBER + SUHNER  | SUCOFLEX 104               | MY24971/4  | 9kHz to 18GHz        | Feb. 22, 2023    | Jul. 12, 2023~<br>Jul. 13, 2023 | Feb. 21, 2024 | Radiation (03CH07-HY) |
| RF Cable                  | HUBER + SUHNER  | SUCOFLEX 104               | MY28655/4  | 9kHz to 18GHz        | Feb. 22, 2023    | Jul. 12, 2023~<br>Jul. 13, 2023 | Feb. 21, 2024 | Radiation (03CH07-HY) |
| Controller                | EMEC            | EM1000                     | N/A        | Control Ant Mast     | N/A              | Jul. 12, 2023~<br>Jul. 13, 2023 | N/A           | Radiation (03CH07-HY) |
| Controller                | MF              | MF-7802                    | N/A        | Control Turn table   | N/A              | Jul. 12, 2023~<br>Jul. 13, 2023 | N/A           | Radiation (03CH07-HY) |
| Antenna Mast              | EMEC            | AM-BS-4500E                | N/A        | Boresight mast 1M~4M | N/A              | Jul. 12, 2023~<br>Jul. 13, 2023 | N/A           | Radiation (03CH07-HY) |
| Turn Table                | ChainTek        | Chaintek 3000              | N/A        | 0~360 Degree         | N/A              | Jul. 12, 2023~<br>Jul. 13, 2023 | N/A           | Radiation (03CH07-HY) |
| Software                  | Audix           | E3                         | N/A        | N/A                  | N/A              | Jul. 12, 2023~<br>Jul. 13, 2023 | N/A           | Radiation (03CH07-HY) |
| USB Data Logger           | TECPEL          | TR-32                      | HE17XB2495 | N/A                  | Mar. 14, 2023    | Jul. 12, 2023~<br>Jul. 13, 2023 | Mar. 13, 2024 | Radiation (03CH07-HY) |



## 5. Measurement Uncertainty

### Uncertainty of Conducted Emission Measurement (150 kHz ~ 30 MHz)

|   |        |
|---|--------|
| Measuring Uncertainty for a Level of Confidence of 95% ( $U = 2Uc(y)$ ) | 3.5 dB |
|---|--------|

### Uncertainty of Radiated Emission Measurement (9 kHz ~ 30 MHz)

|   |        |
|---|--------|
| Measuring Uncertainty for a Level of Confidence of 95% ( $U = 2Uc(y)$ ) | 3.8 dB |
|---|--------|

### Uncertainty of Radiated Emission Measurement (30 MHz ~ 1000 MHz)

|   |        |
|---|--------|
| Measuring Uncertainty for a Level of Confidence of 95% ( $U = 2Uc(y)$ ) | 6.5 dB |
|---|--------|



## **Appendix A. Test Results of Conducted Emission Test**

# Original

Report NO : 362117  
 Test Mode : Mode 1  
 Test Voltage : 120Vac/60Hz  
 Phase : Line

Full Spectrum

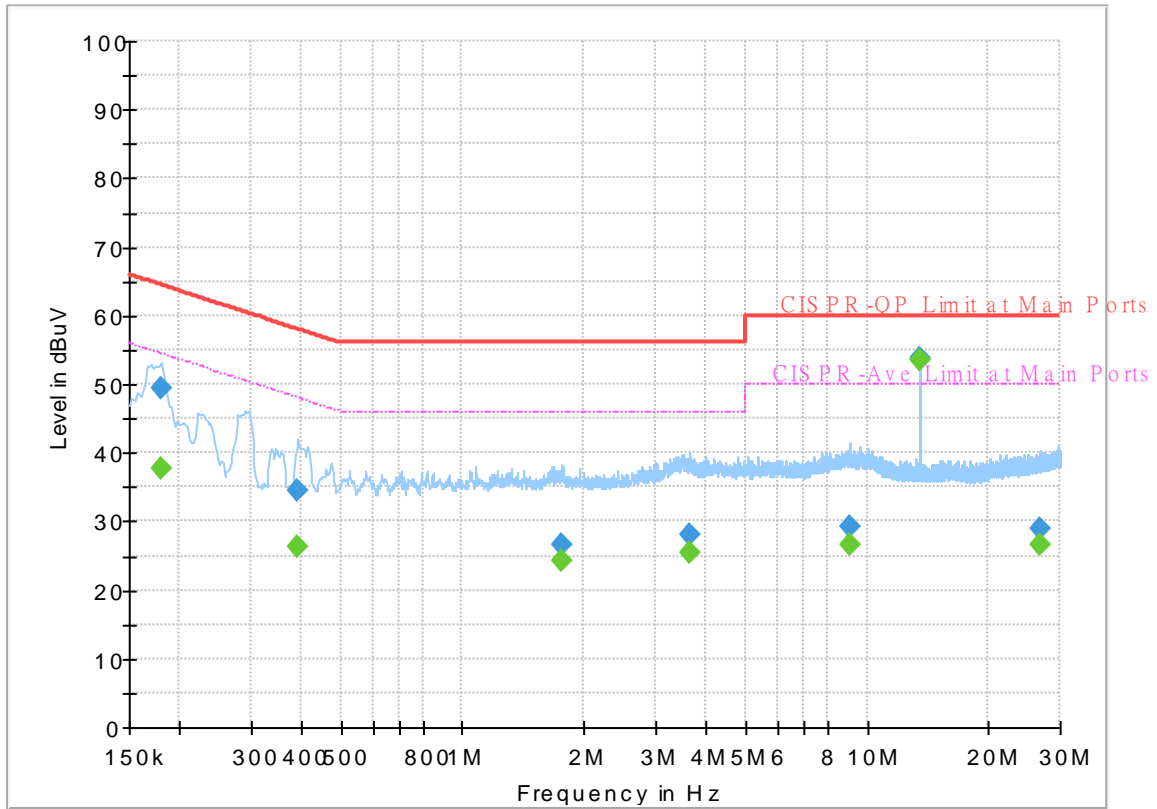

## Final\_Result

| Frequency (MHz) | QuasiPeak (dBuV) | CAverage (dBuV) | Limit (dBuV) | Margin (dB) | Line | Filter | Corr. (dB) |
|-----------------|------------------|-----------------|--------------|-------------|------|--------|------------|
| 0.179250        | ---              | 37.59           | 54.52        | 16.93       | L1   | OFF    | 19.8       |
| 0.179250        | 49.43            | ---             | 64.52        | 15.09       | L1   | OFF    | 19.8       |
| 0.390750        | ---              | 26.24           | 48.05        | 21.81       | L1   | OFF    | 19.9       |
| 0.390750        | 34.59            | ---             | 58.05        | 23.46       | L1   | OFF    | 19.9       |
| 1.754250        | ---              | 24.41           | 46.00        | 21.59       | L1   | OFF    | 19.9       |
| 1.754250        | 26.56            | ---             | 56.00        | 29.44       | L1   | OFF    | 19.9       |
| 3.653250        | ---              | 25.33           | 46.00        | 20.67       | L1   | OFF    | 20.0       |
| 3.653250        | 28.15            | ---             | 56.00        | 27.85       | L1   | OFF    | 20.0       |
| 9.030750        | ---              | 26.50           | 50.00        | 23.50       | L1   | OFF    | 20.1       |
| 9.030750        | 29.14            | ---             | 60.00        | 30.86       | L1   | OFF    | 20.1       |
| 13.560000       | ---              | 53.48           | 50.00        | -3.48       | L1   | OFF    | 20.3       |
| 13.560000       | 53.84            | ---             | 60.00        | 6.16        | L1   | OFF    | 20.3       |
| 26.646000       | ---              | 26.65           | 50.00        | 23.35       | L1   | OFF    | 20.6       |
| 26.646000       | 28.93            | ---             | 60.00        | 31.07       | L1   | OFF    | 20.6       |



Report NO : 362117  
 Test Mode : Mode 1  
 Test Voltage : 120Vac/60Hz  
 Phase : Neutral

Full Spectrum

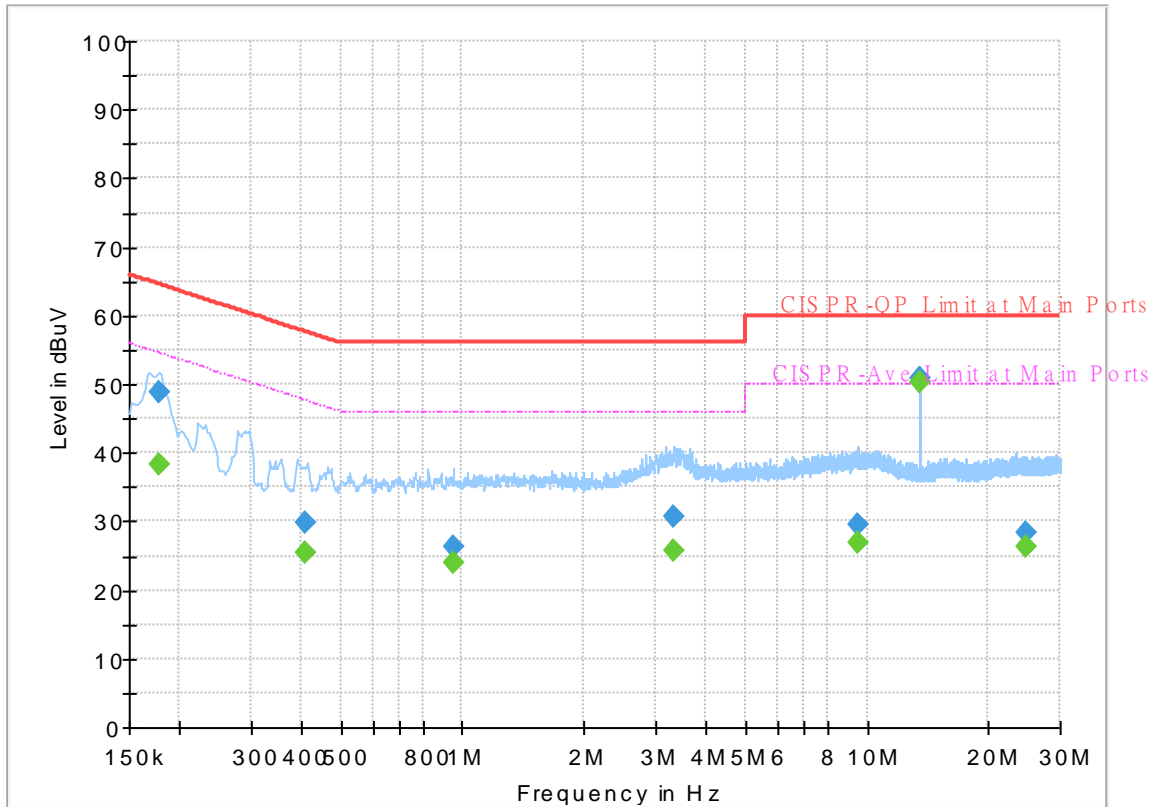

Final\_Result

| Frequency (MHz) | QuasiPeak (dBuV) | CAverage (dBuV) | Limit (dBuV) | Margin (dB) | Line | Filter | Corr. (dB) |
|-----------------|------------------|-----------------|--------------|-------------|------|--------|------------|
| 0.177000        | ---              | 38.17           | 54.63        | 16.46       | N    | OFF    | 19.8       |
| 0.177000        | 48.85            | ---             | 64.63        | 15.78       | N    | OFF    | 19.8       |
| 0.411000        | ---              | 25.58           | 47.63        | 22.05       | N    | OFF    | 19.9       |
| 0.411000        | 29.77            | ---             | 57.63        | 27.86       | N    | OFF    | 19.9       |
| 0.948750        | ---              | 23.95           | 46.00        | 22.05       | N    | OFF    | 19.9       |
| 0.948750        | 26.33            | ---             | 56.00        | 29.67       | N    | OFF    | 19.9       |
| 3.342750        | ---              | 25.66           | 46.00        | 20.34       | N    | OFF    | 20.0       |
| 3.342750        | 30.59            | ---             | 56.00        | 25.41       | N    | OFF    | 20.0       |
| 9.465000        | ---              | 26.79           | 50.00        | 23.21       | N    | OFF    | 20.2       |
| 9.465000        | 29.52            | ---             | 60.00        | 30.48       | N    | OFF    | 20.2       |
| 13.560000       | ---              | 50.25           | 50.00        | -0.25       | N    | OFF    | 20.3       |
| 13.560000       | 50.81            | ---             | 60.00        | 9.19        | N    | OFF    | 20.3       |
| 24.855000       | ---              | 26.41           | 50.00        | 23.59       | N    | OFF    | 20.7       |
| 24.855000       | 28.46            | ---             | 60.00        | 31.54       | N    | OFF    | 20.7       |

# Terminal

Report NO : 362117  
 Test Mode : Mode 1  
 Test Voltage : 120Vac/60Hz  
 Phase : Line

Full Spectrum

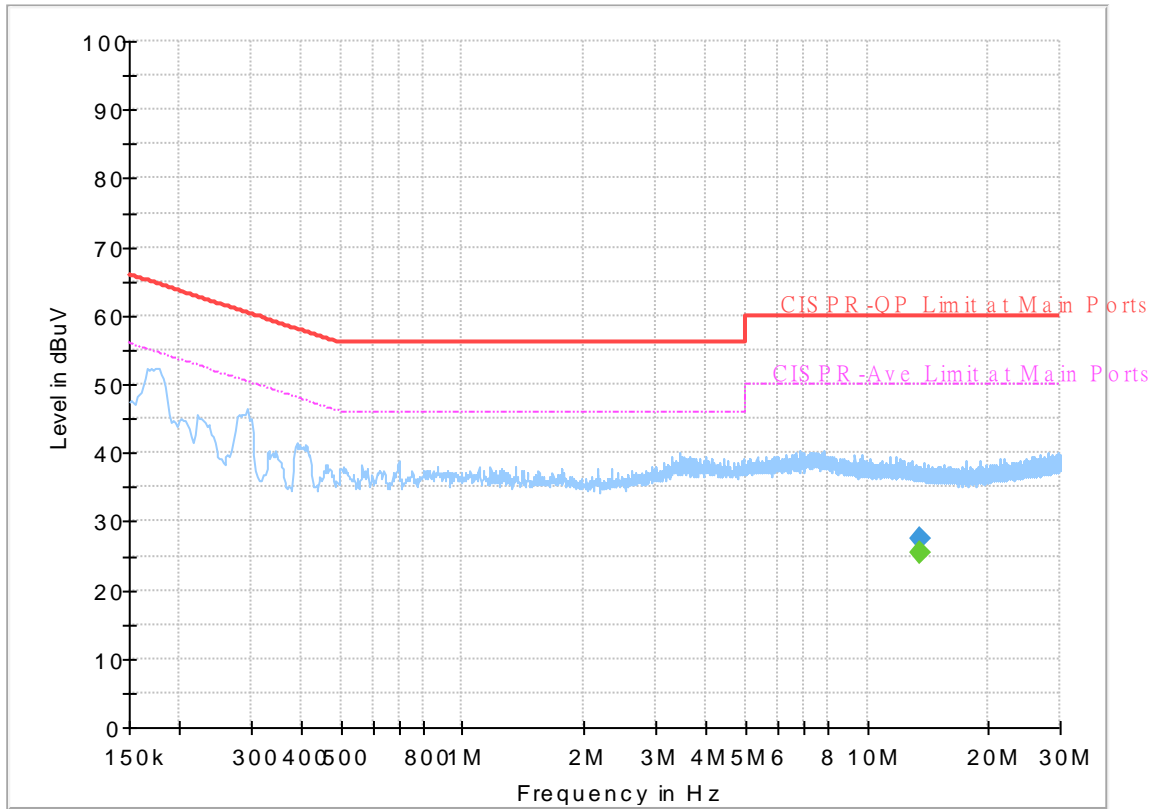

## Final\_Result

| Frequency (MHz) | QuasiPeak (dBuV) | CAverage (dBuV) | Limit (dBuV) | Margin (dB) | Line | Filter | Corr. (dB) |
|-----------------|------------------|-----------------|--------------|-------------|------|--------|------------|
| 13.560000       | ---              | 25.39           | 50.00        | 24.61       | L1   | OFF    | 20.3       |
| 13.560000       | 27.40            | ---             | 60.00        | 32.60       | L1   | OFF    | 20.3       |

Report NO : 362117  
 Test Mode : Mode 1  
 Test Voltage : 120Vac/60Hz  
 Phase : Neutral

Full Spectrum

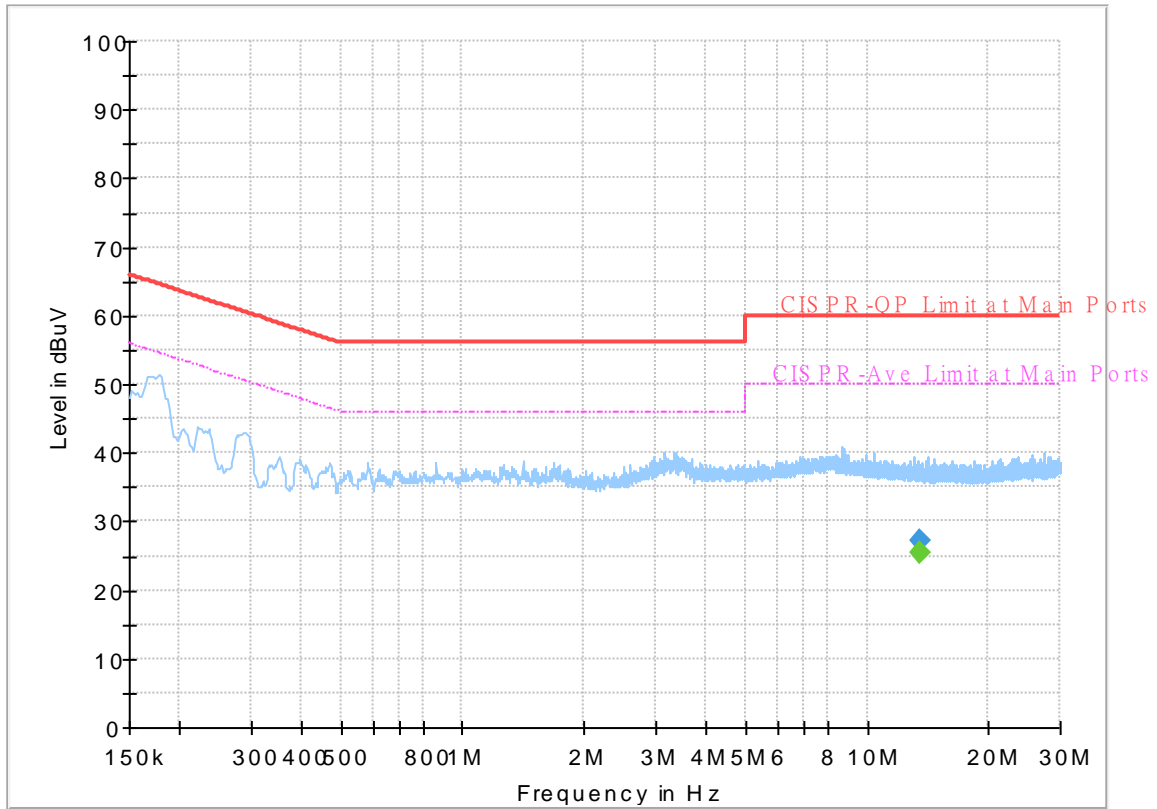

Final\_Result

| Frequency (MHz) | QuasiPeak (dBuV) | CAverage (dBuV) | Limit (dBuV) | Margin (dB) | Line | Filter | Corr. (dB) |
|-----------------|------------------|-----------------|--------------|-------------|------|--------|------------|
| 13.560000       | ---              | 25.35           | 50.00        | 24.65       | N    | OFF    | 20.3       |
| 13.560000       | 27.10            | ---             | 60.00        | 32.90       | N    | OFF    | 20.3       |



## Appendix B. Test Results of Near Field Test Items

### B1. Test Result of 20dB Spectrum Bandwidth

| Test mode                    | NFC Tx         | Test Frequency (MHz)       | 13.56              |
|------------------------------|----------------|----------------------------|--------------------|
|                              |                |                            |                    |
| <b>20dB Bandwidth (kHz)</b>  | 2.640          | <b>99% OccupiedBW(kHz)</b> | 2.240              |
| <b>Frequency range (MHz)</b> | $f_L > 13.553$ | 13.55892                   | <b>Test Result</b> |
|                              | $f_H < 13.567$ | 13.56156                   | <b>Complies</b>    |

**Remark:** Because the measured signal is CW adjusting the RBW per C63.10 would not be practical since measured bandwidth will always follow the RBW and the result will be approximately twice the RBW.



B2. Test Result of Frequency Stability

| Voltage vs. Frequency Stability |                             | Temperature vs. Frequency Stability |      |                             |
|---------------------------------|-----------------------------|-------------------------------------|------|-----------------------------|
| Voltage (Vdc)                   | Measurement Frequency (MHz) | Temperature (°C)                    | Time | Measurement Frequency (MHz) |
| 3.8                             | 13.560240                   | -20                                 | 0    | 13.560330                   |
|                                 |                             |                                     | 2    | 13.560340                   |
|                                 |                             |                                     | 5    | 13.560330                   |
|                                 |                             |                                     | 10   | 13.560340                   |
| 3.6                             | 13.560240                   | -10                                 | 0    | 13.560340                   |
|                                 |                             |                                     | 2    | 13.560340                   |
|                                 |                             |                                     | 5    | 13.560340                   |
|                                 |                             |                                     | 10   | 13.560340                   |
| 4.2                             | 13.560240                   | 0                                   | 0    | 13.560340                   |
|                                 |                             |                                     | 2    | 13.560340                   |
|                                 |                             |                                     | 5    | 13.560340                   |
|                                 |                             |                                     | 10   | 13.560340                   |
|                                 |                             | 10                                  | 0    | 13.560330                   |
|                                 |                             |                                     | 2    | 13.560320                   |
|                                 |                             |                                     | 5    | 13.560320                   |
|                                 |                             |                                     | 10   | 13.560320                   |
|                                 |                             | 20                                  | 0    | 13.560320                   |
|                                 |                             |                                     | 2    | 13.560320                   |
|                                 |                             |                                     | 5    | 13.560310                   |
|                                 |                             |                                     | 10   | 13.560310                   |
|                                 |                             | 30                                  | 0    | 13.560280                   |
|                                 |                             |                                     | 2    | 13.560280                   |
|                                 |                             |                                     | 5    | 13.560260                   |
|                                 |                             |                                     | 10   | 13.560270                   |
|                                 |                             | 40                                  | 0    | 13.560240                   |
|                                 |                             |                                     | 2    | 13.560240                   |
|                                 |                             |                                     | 5    | 13.560240                   |
|                                 |                             |                                     | 10   | 13.560240                   |



| Voltage vs. Frequency Stability |                             | Temperature vs. Frequency Stability |               |                             |
|---------------------------------|-----------------------------|-------------------------------------|---------------|-----------------------------|
| Voltage (Vdc)                   | Measurement Frequency (MHz) | Temperature (°C)                    | Time          | Measurement Frequency (MHz) |
|                                 |                             | 50                                  | 0             | 13.560220                   |
|                                 |                             |                                     | 2             | 13.560220                   |
|                                 |                             |                                     | 5             | 13.560220                   |
|                                 |                             |                                     | 10            | 13.560220                   |
| Max.Deviation (MHz)             | 0.000240                    | Max.Deviation (MHz)                 |               | 0.000340                    |
| Max.Deviation (ppm)             | 17.6991                     | Max.Deviation (ppm)                 |               | 25.0737                     |
| Limit                           | FS < ±100 ppm               | Limit                               | FS < ±100 ppm |                             |
| Test Result                     | PASS                        | Test Result                         | PASS          |                             |



## Appendix C. Test Results of Radiated Test Items

### C1. Test Result of Field Strength of Fundamental Emissions

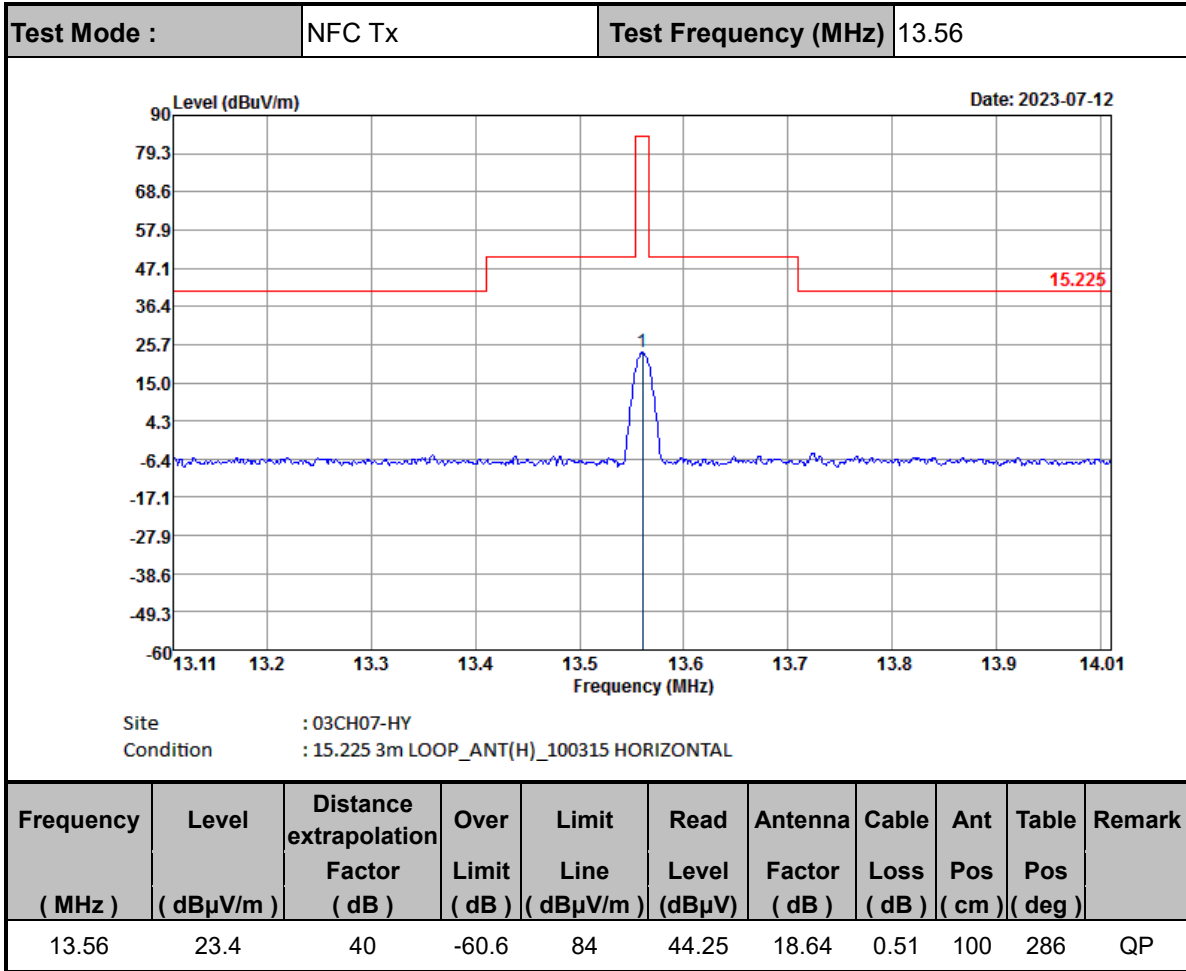



|             |        |                      |       |
|-------------|--------|----------------------|-------|
| Test Mode : | NFC Tx | Test Frequency (MHz) | 13.56 |
|-------------|--------|----------------------|-------|

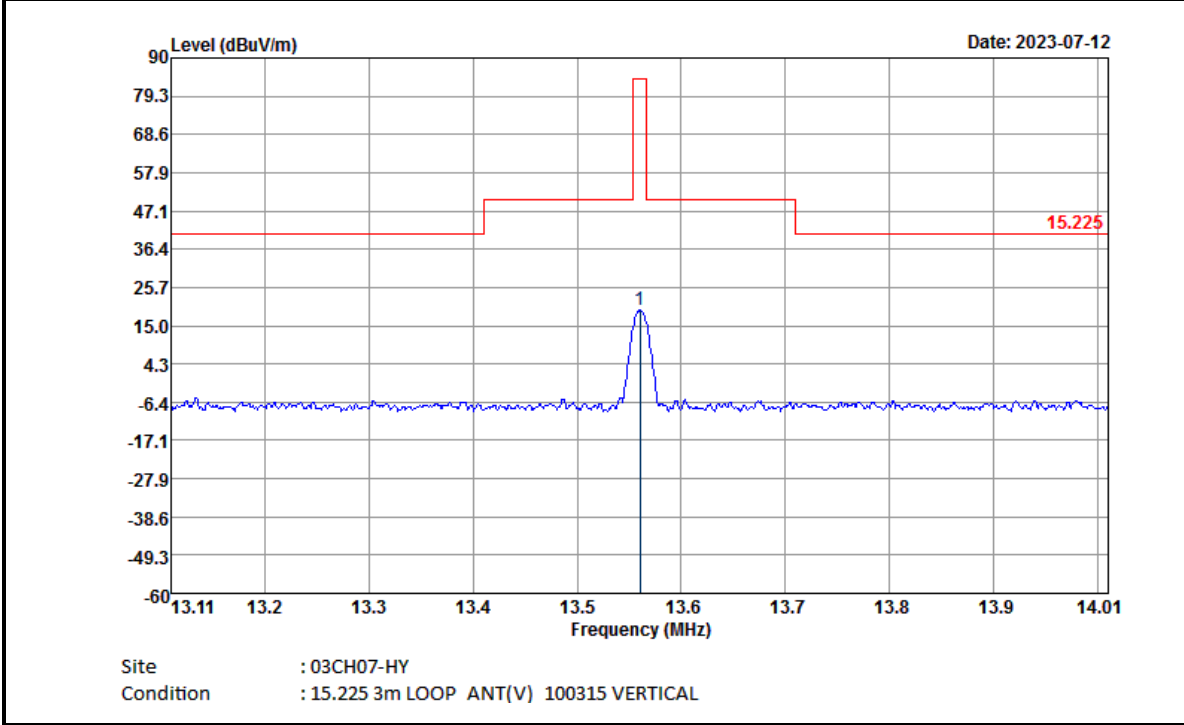

| Frequency (MHz) | Level (dBμV/m) | Distance extrapolation Factor (dB) | Over Limit (dB) | Limit Line (dBμV/m) | Read Level (dBμV) | Antenna Factor (dB) | Cable Loss (dB) | Ant Pos (cm) | Table Pos (deg) | Remark |
|-----------------|----------------|------------------------------------|-----------------|---------------------|-------------------|---------------------|-----------------|--------------|-----------------|--------|
| 13.56           | 19.25          | 40                                 | -64.75          | 84                  | 40.1              | 18.64               | 0.51            | 100          | 0               | QP     |

**Note :**

1. Distance extrapolation factor = 40 log (specific distance / test distance) (dB)
2. Level = Antenna Factor + Cable Loss + Read Level - Distance extrapolation factor.





**C2. Results of Radiated Spurious Emissions (9 kHz~30MHz)**

|                    |        |                       |            |
|--------------------|--------|-----------------------|------------|
| <b>Test Mode :</b> | NFC Tx | <b>Polarization :</b> | Horizontal |
|--------------------|--------|-----------------------|------------|

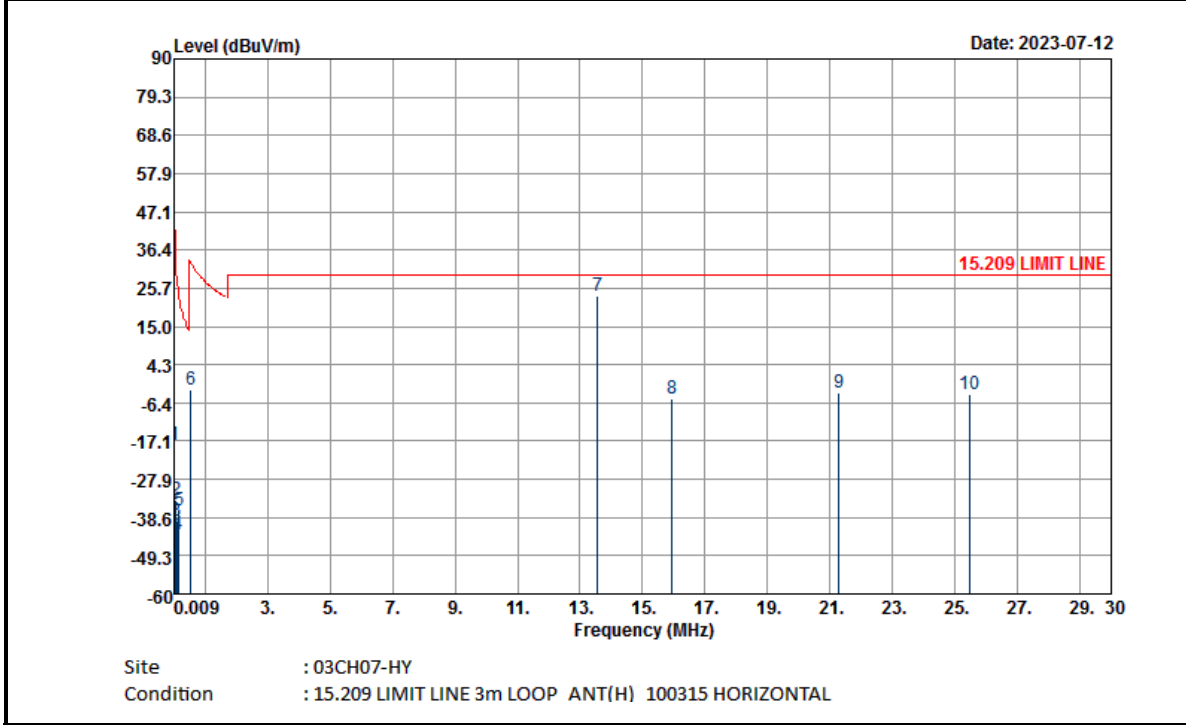

| Frequency ( MHz ) | Level ( dBμV/m ) | Distance extrapolation Factor ( dB ) | Over Limit ( dB ) | Limit Line ( dBμV/m ) | Read Level ( dBμV ) | Antenna Factor ( dB ) | Cable Loss ( dB ) | Ant Pos ( cm ) | Table Pos ( deg ) | Remark  |
|-------------------|------------------|--------------------------------------|-------------------|-----------------------|---------------------|-----------------------|-------------------|----------------|-------------------|---------|
| 0.02048           | -18.02           | 80                                   | -59.4             | 41.38                 | 42.54               | 18.93                 | 0.51              | -              | -                 | Average |
| 0.06336           | -33.77           | 80                                   | -65.34            | 31.57                 | 27.03               | 18.69                 | 0.51              | -              | -                 | Average |
| 0.09192           | -39.59           | 80                                   | -67.93            | 28.34                 | 21.27               | 18.63                 | 0.51              | -              | -                 | QP      |
| 0.12184           | -43.24           | 80                                   | -69.13            | 25.89                 | 17.66               | 18.59                 | 0.51              | -              | -                 | Average |
| 0.15238           | -36.56           | 80                                   | -60.51            | 23.95                 | 24.36               | 18.57                 | 0.51              | -              | -                 | Average |
| 0.54257           | -2.78            | 40                                   | -35.69            | 32.91                 | 18.22               | 18.49                 | 0.51              | -              | -                 | QP      |
| 13.56             | 23.4             | 40                                   | -6.1              | 29.5                  | 44.25               | 18.64                 | 0.51              | -              | -                 | QP      |
| 15.944            | -5.42            | 40                                   | -34.92            | 29.5                  | 15.31               | 18.76                 | 0.51              | -              | -                 | QP      |
| 21.292            | -3.74            | 40                                   | -33.24            | 29.5                  | 15.59               | 19.31                 | 1.36              | -              | -                 | QP      |
| 25.45             | -3.9             | 40                                   | -33.4             | 29.5                  | 15.01               | 19.73                 | 1.36              | -              | -                 | QP      |



|             |        |                |          |
|-------------|--------|----------------|----------|
| Test Mode : | NFC Tx | Polarization : | Vertical |
|-------------|--------|----------------|----------|

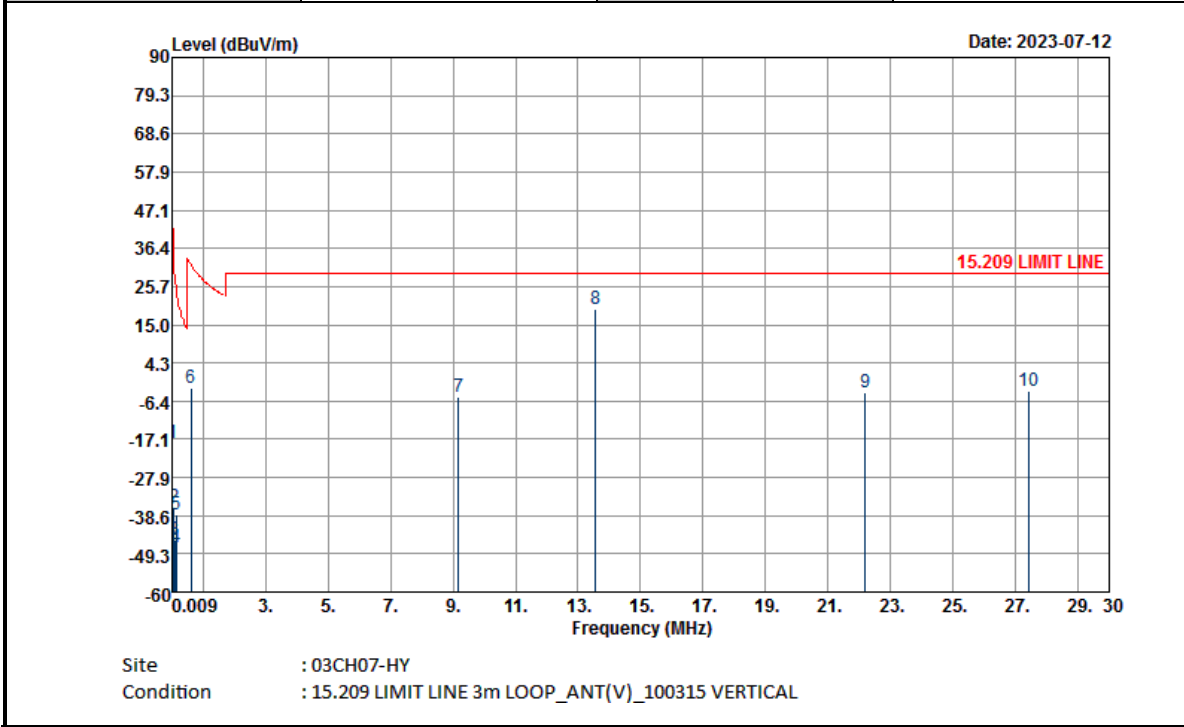

| Frequency ( MHz ) | Level ( dBμV/m ) | Distance extrapolation Factor ( dB ) | Over Limit ( dB ) | Limit Line ( dBμV/m ) | Read Level ( dBμV ) | Antenna Factor ( dB ) | Cable Loss ( dB ) | Ant Pos ( cm ) | Table Pos ( deg ) | Remark  |
|-------------------|------------------|--------------------------------------|-------------------|-----------------------|---------------------|-----------------------|-------------------|----------------|-------------------|---------|
| 0.02042           | -18.14           | 80                                   | -59.54            | 41.4                  | 42.41               | 18.94                 | 0.51              | -              | -                 | Average |
| 0.06831           | -36.36           | 80                                   | -67.27            | 30.91                 | 24.45               | 18.68                 | 0.51              | -              | -                 | Average |
| 0.09766           | -45.3            | 80                                   | -73.11            | 27.81                 | 15.58               | 18.61                 | 0.51              | -              | -                 | QP      |
| 0.11452           | -47.66           | 80                                   | -74.09            | 26.43                 | 13.23               | 18.6                  | 0.51              | -              | -                 | Average |
| 0.15136           | -38.22           | 80                                   | -62.22            | 24                    | 22.7                | 18.57                 | 0.51              | -              | -                 | Average |
| 0.61016           | -2.75            | 40                                   | -34.65            | 31.9                  | 18.26               | 18.48                 | 0.51              | -              | -                 | QP      |
| 9.168             | -5.15            | 40                                   | -34.65            | 29.5                  | 15.82               | 18.52                 | 0.51              | -              | -                 | QP      |
| 13.56             | 19.25            | 40                                   | -10.25            | 29.5                  | 40.1                | 18.64                 | 0.51              | -              | -                 | QP      |
| 22.201            | -4.1             | 40                                   | -33.6             | 29.5                  | 15.13               | 19.41                 | 1.36              | -              | -                 | QP      |
| 27.42             | -3.76            | 40                                   | -33.26            | 29.5                  | 15.11               | 19.77                 | 1.36              | -              | -                 | QP      |

**Note :**

1. The amplitude of spurious emissions which are attenuated by more than 20dB below the permissible value has no need to be reported.
2. Distance extrapolation factor = 40 log (specific distance / test distance) (dB)
3. Level = Antenna Factor + Cable Loss + Read Level - Distance extrapolation factor.
4. 13.56 MHz is fundamental signal which can be ignored



**C3. Results of Radiated Spurious Emissions (30MHz~1GHz)**

|                    |        |                       |            |
|--------------------|--------|-----------------------|------------|
| <b>Test Mode :</b> | NFC Tx | <b>Polarization :</b> | Horizontal |
|--------------------|--------|-----------------------|------------|

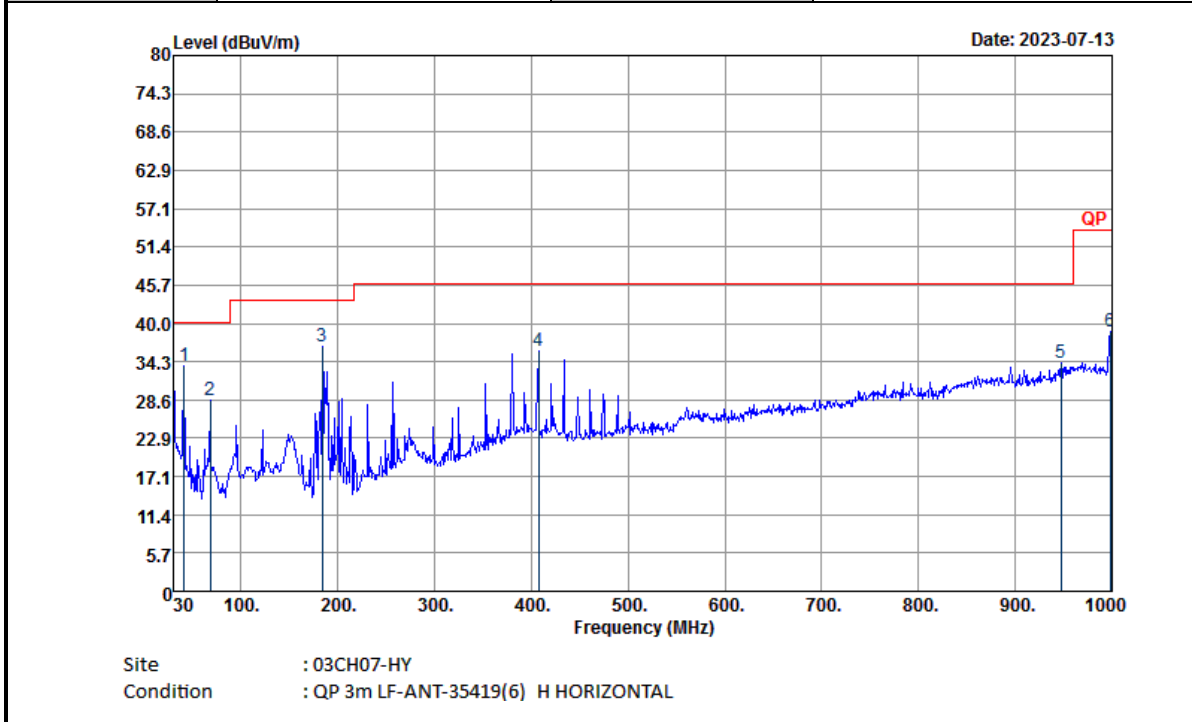

| Frequency ( MHz ) | Level ( dBμV/m ) | Over Limit ( dB ) | Limit Line ( dBμV/m ) | Read Level ( dBμV ) | Antenna Factor ( dB ) | Cable Loss ( dB ) | Preamp Factor ( dB ) | Ant Pos ( cm ) | Table Pos ( deg ) | Remark |
|-------------------|------------------|-------------------|-----------------------|---------------------|-----------------------|-------------------|----------------------|----------------|-------------------|--------|
| 40.8              | 33.7             | -6.3              | 40                    | 43.18               | 19.11                 | 1.36              | 29.95                | -              | -                 | Peak   |
| 67.8              | 28.55            | -11.45            | 40                    | 44.89               | 12.04                 | 1.52              | 29.9                 | -              | -                 | Peak   |
| 183.63            | 36.48            | -7.02             | 43.5                  | 49.34               | 14.88                 | 2.28              | 30.02                | -              | -                 | Peak   |
| 407.1             | 35.77            | -10.23            | 46                    | 40.24               | 22.16                 | 3.24              | 29.87                | -              | -                 | Peak   |
| 947.5             | 34.17            | -11.83            | 46                    | 27.73               | 30.14                 | 5.14              | 28.84                | -              | -                 | Peak   |
| 997.9             | 38.71            | -15.29            | 54                    | 31.76               | 30.25                 | 5.29              | 28.59                | -              | -                 | Peak   |



|             |        |                |          |
|-------------|--------|----------------|----------|
| Test Mode : | NFC Tx | Polarization : | Vertical |
|-------------|--------|----------------|----------|

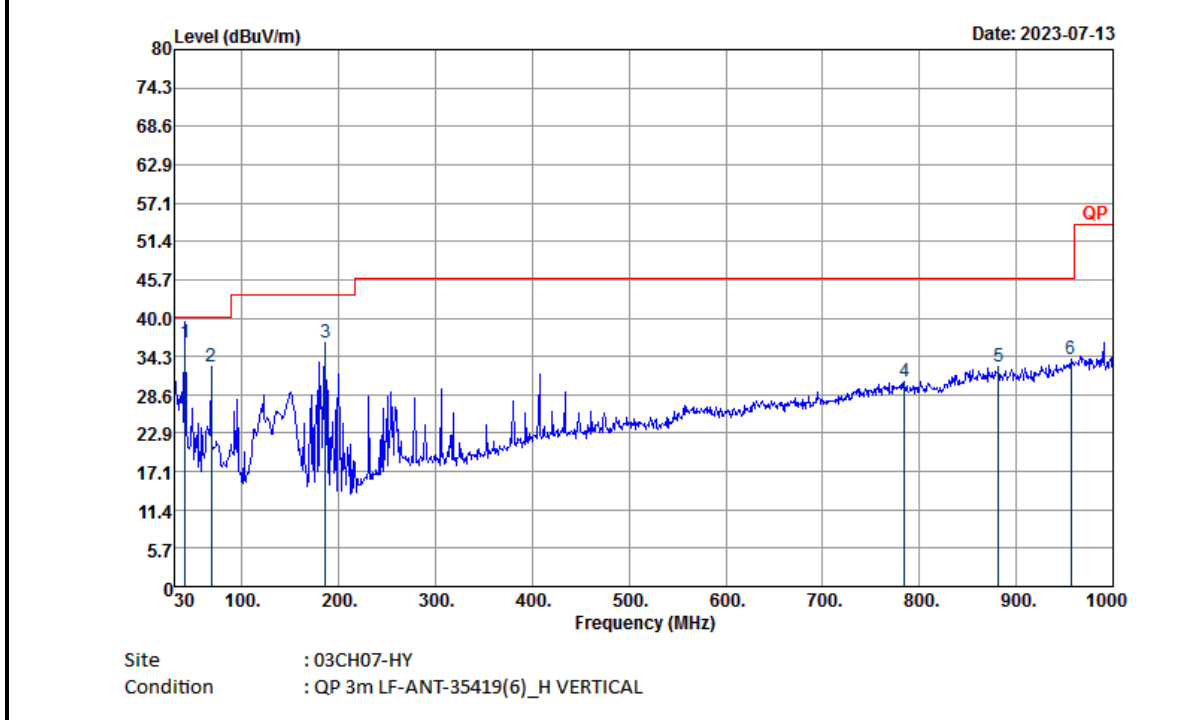

| Frequency ( MHz ) | Level ( dBμV/m ) | Over Limit ( dB ) | Limit Line ( dBμV/m ) | Read Level ( dBμV ) | Antenna Factor ( dB ) | Cable Loss ( dB ) | Preamp Factor ( dB ) | Ant Pos ( cm ) | Table Pos ( deg ) | Remark |
|-------------------|------------------|-------------------|-----------------------|---------------------|-----------------------|-------------------|----------------------|----------------|-------------------|--------|
| 40.8              | 36.38            | -3.62             | 40                    | 45.86               | 19.11                 | 1.36              | 29.95                | -              | -                 | QP     |
| 67.8              | 32.79            | -7.21             | 40                    | 49.13               | 12.04                 | 1.52              | 29.9                 | -              | -                 | Peak   |
| 186.06            | 36.31            | -7.19             | 43.5                  | 49.22               | 14.83                 | 2.28              | 30.02                | -              | -                 | Peak   |
| 784.4             | 30.47            | -15.53            | 46                    | 27.57               | 27.79                 | 4.74              | 29.63                | -              | -                 | Peak   |
| 881.7             | 32.79            | -13.21            | 46                    | 28.05               | 28.83                 | 5.03              | 29.12                | -              | -                 | Peak   |
| 956.6             | 33.89            | -12.11            | 46                    | 27.09               | 30.46                 | 5.14              | 28.8                 | -              | -                 | Peak   |

**Note:**

1. The amplitude of spurious emissions which are attenuated by more than 20dB below the permissible value has no need to be reported.
2. Emission level (dBμV/m) = 20 log Emission level (μV/m).
3. Corrected Reading: Antenna Factor + Cable Loss + Read Level - Preamp Factor= Level.
4. The emission position marked as "-" means no suspected emission found with sufficient margin against limit line or noise floor only.