



# FCC RADIO TEST REPORT

FCC ID : UZ7MC930P  
Equipment : Mobile computer  
Brand Name : Zebra  
Model Name : MC930P  
Applicant : Zebra Technologies Corporation  
1 Zebra Plaza, Holtsville, NY 11742  
Manufacturer : Zebra Technologies Corporation  
1 Zebra Plaza, Holtsville, NY 11742  
Standard : FCC Part 15 Subpart C §15.247

The product was received on Nov. 26, 2018 and testing was started from Dec. 25, 2018 and completed on Mar. 08, 2019. We, SPORTON INTERNATIONAL INC. EMC & Wireless Communications Laboratory, would like to declare that the tested sample has been evaluated in accordance with the test procedures and has been in compliance with the applicable technical standards.

The report must not be used by the client to claim product certification, approval, or endorsement by TAF or any agency of government.

The test results in this report apply exclusively to the tested model / sample. Without written approval of SPORTON INTERNATIONAL INC. EMC & Wireless Communications Laboratory, the test report shall not be reproduced except in full.

Reviewed by: Jones Tsai

**SPORTON INTERNATIONAL INC. EMC & Wireless Communications Laboratory**  
No. 52, Huaya 1st Rd., Guishan Dist., Taoyuan City, Taiwan (R.O.C.)



# Table of Contents

**History of this test report..... 3**

**Summary of Test Result..... 4**

**1 General Description..... 5**

    1.1 Product Feature of Equipment Under Test..... 5

    1.2 Product Specification of Equipment Under Test..... 6

    1.3 Modification of EUT ..... 6

    1.4 Testing Location ..... 7

    1.5 Applicable Standards..... 7

**2 Test Configuration of Equipment Under Test ..... 8**

    2.1 Carrier Frequency Channel ..... 8

    2.2 Test Mode..... 9

    2.3 Connection Diagram of Test System..... 12

    2.4 Support Unit used in test configuration and system ..... 13

    2.5 EUT Operation Test Setup ..... 13

    2.6 Measurement Results Explanation Example..... 13

**3 Test Result..... 14**

    3.1 Number of Channel Measurement ..... 14

    3.2 Hopping Channel Separation Measurement ..... 16

    3.3 Dwell Time Measurement..... 22

    3.4 20dB and 99% Bandwidth Measurement ..... 24

    3.5 Output Power Measurement..... 35

    3.6 Conducted Band Edges Measurement..... 37

    3.7 Conducted Spurious Emission Measurement ..... 44

    3.8 Radiated Band Edges and Spurious Emission Measurement ..... 54

    3.9 AC Conducted Emission Measurement..... 58

    3.10 Antenna Requirements ..... 60

**4 List of Measuring Equipment ..... 61**

**5 Uncertainty of Evaluation..... 63**

**Appendix A. AC Conducted Emission Test Result**

**Appendix B. Radiated Spurious Emission**

**Appendix C. Radiated Spurious Emission Plots**

**Appendix D. Duty Cycle Plots**

**Appendix E. Setup Photographs**





## Summary of Test Result

Report Clause	Ref Std. Clause	Test Items	Result (PASS/FAIL)	Remark
3.1	15.247(a)(1)	Number of Channels	Pass	-
3.2	15.247(a)(1)	Hopping Channel Separation	Pass	-
3.3	15.247(a)(1)	Dwell Time of Each Channel	Pass	-
3.4	15.247(a)(1)	20dB Bandwidth	Pass	-
3.4	2.1049	99% Occupied Bandwidth	Reporting only	-
3.5	15.247(b)(1)	Peak Output Power	Pass	-
3.6	15.247(d)	Conducted Band Edges	Pass	-
3.7	15.247(d)	Conducted Spurious Emission	Pass	-
3.8	15.247(d)	Radiated Band Edges and Radiated Spurious Emission	Pass	Under limit 3.20 dB at 947.500 MHz
3.9	15.207	AC Conducted Emission	Pass	Under limit 12.59 dB at 0.175 MHz
3.10	15.203 & 15.247(b)	Antenna Requirement	Pass	-

**Declaration of Conformity:**

The test results with all measurement uncertainty excluded are presented in accordance with the regulation limits or requirements declared by manufacturers.

**Comments and Explanations:**

The declared of product specification for EUT presented in the report are provided by the manufacturer, and the manufacturer takes all the responsibilities for the accuracy of product specification.

**Reviewed by: Wii Chang****Report Producer: Yimin Ho**



# 1 General Description

## 1.1 Product Feature of Equipment Under Test

Product Feature	
Equipment	Mobile computer
Brand Name	Zebra
Model Name	MC930P
FCC ID	UZ7MC930P
Sample 1	EUT with SKU 3
Sample 2	EUT with SKU 4
Sample 3	EUT with SKU 5
Sample 4	EUT with SKU 6
Sample 5	EUT with SKU 7
EUT supports Radios application	NFC WLAN 11a/b/g/n HT20/HT40 WLAN 11ac VHT20/VHT40/VHT80 Bluetooth BR/EDR/LE
HW Version	EV1
SW Version	01-14-11.00-OG
MFD	13NOV18
EUT Stage	Engineering Sample

**Remark:** The above EUT's information was declared by manufacturer.

Specification of Accessories				
Adapter (5V/2.5A)	Brand Name	Zebra	Part Number	PWR-WUA5V12W0US
USB-C Adapter	Brand Name	Zebra	Part Number	CBL-MC93-USBCHG-01
USB-C cable	Brand Name	Zebra	Part Number	CBL-TC2X-USBC-01
Std Battery	Brand Name	Zebra	Part Number	BT-000370-00
Fzr Battery	Brand Name	Zebra	Part Number	BT-000371-00
Holster	Brand Name	Zebra	Part Number	051607-79N1-18



<Sample Information>

Model Name	MC930P				
	SKU3	SKU4	SKU5	SKU6	SKU7
Organization / Function / Group	EV1a-G21	EV1a-G22	EV1a-G23	EV1a-F11	EV1a-F13
nm	G-2S-1D-53k	G-2S-2D-53k	G-2S-LRI-53k	G-1F-1D-53k	G-1F-LRI-53k
Product Number	MC930P-GSBDG 4NA	MC930P-GSDDG 4NA	MC930P-GSFDG 4NA	MC930P-GFADG 4NA	MC930P-GFEDG 4NA
Form factor	Gun	Gun	Gun	Gun	Gun
Package/ Component Category	Pkg2	Pkg2	Pkg2	Pkg1 CS	Pkg 1 CS
NFC	YES	YES	YES	YES	YES
Vib	YES	YES	YES	YES	YES
Camera	YES	YES	YES	NO	NO
NI	NO	NO	NO	NO	NO
Side Trigger	NO	NO	NO	NO	NO
Display + TP Stackup	Option2	Option2	Option2	Option5	Option5
Scanner	SE965	SE4750SR	SE4850	SE965	SE4850
Battery	Std	Std	Std	Fzr	Fzr
Keyboard	53 Key	53 Key	53 Key	53 Key	53 Key
Build Date	Oct 2018	Oct 2018	Oct 2018	Nov 2018	Nov 2018

1.2 Product Specification of Equipment Under Test

Standards-related Product Specification	
Tx/Rx Frequency Range	2402 MHz ~ 2480 MHz
Number of Channels	79
Carrier Frequency of Each Channel	2402+n*1 MHz; n=0~78
Maximum Output Power to Antenna	Bluetooth BR(1Mbps) : 3.69 dBm (0.0023 W) Bluetooth EDR (2Mbps) : 2.64 dBm (0.0018 W) Bluetooth EDR (3Mbps) : 2.98 dBm (0.0020 W)
99% Occupied Bandwidth	Bluetooth BR(1Mbps) : 0.834MHz Bluetooth EDR (2Mbps) : 1.166MHz Bluetooth EDR (3Mbps) : 1.149MHz
Antenna Type / Gain	Patch Antenna with gain 3.85 dBi
Type of Modulation	Bluetooth BR (1Mbps) : GFSK Bluetooth EDR (2Mbps) : $\pi/4$ -DQPSK Bluetooth EDR (3Mbps) : 8-DPSK

1.3 Modification of EUT

No modifications are made to the EUT during all test items.



### 1.4 Testing Location

<b>Test Site</b>	SPORTON INTERNATIONAL INC.		
<b>Test Site Location</b>	No.52, Huaya 1st Rd., Guishan Dist., Taoyuan City, Taiwan (R.O.C.) TEL: +886-3-327-3456 FAX: +886-3-328-4978		
<b>Test Site No.</b>	<b>Sporton Site No.</b>		
	TH05-HY	CO05-HY	03CH07-HY

**Note:** The test site complies with ANSI C63.4 2014 requirement.

FCC Designation No. TW1190

### 1.5 Applicable Standards

According to the specifications of the manufacturer, the EUT must comply with the requirements of the following standards:

- ♦ FCC Part 15 Subpart C §15.247
- ♦ FCC KDB Publication No. 558074 D01 DTS Meas. Guidance v05
- ♦ FCC KDB 414788 D01 Radiated Test Site v01r01.
- ♦ ANSI C63.10-2013

**Remark:**

1. All test items were verified and recorded according to the standards and without any deviation during the test.
2. This EUT has also been tested and complied with the requirements of FCC Part 15, Subpart B, recorded in a separate test report.



## 2 Test Configuration of Equipment Under Test

### 2.1 Carrier Frequency Channel

Frequency Band	Channel	Freq. (MHz)	Channel	Freq. (MHz)	Channel	Freq. (MHz)
2400-2483.5 MHz	0	2402	27	2429	54	2456
	1	2403	28	2430	55	2457
	2	2404	29	2431	56	2458
	3	2405	30	2432	57	2459
	4	2406	31	2433	58	2460
	5	2407	32	2434	59	2461
	6	2408	33	2435	60	2462
	7	2409	34	2436	61	2463
	8	2410	35	2437	62	2464
	9	2411	36	2438	63	2465
	10	2412	37	2439	64	2466
	11	2413	38	2440	65	2467
	12	2414	39	2441	66	2468
	13	2415	40	2442	67	2469
	14	2416	41	2443	68	2470
	15	2417	42	2444	69	2471
	16	2418	43	2445	70	2472
	17	2419	44	2446	71	2473
	18	2420	45	2447	72	2474
	19	2421	46	2448	73	2475
	20	2422	47	2449	74	2476
	21	2423	48	2450	75	2477
	22	2424	49	2451	76	2478
	23	2425	50	2452	77	2479
	24	2426	51	2453	78	2480
	25	2427	52	2454	-	-
	26	2428	53	2455	-	-





## 2.2 Test Mode

Channel	Frequency	Bluetooth Average Output Power		
		GFSK / 1Mbps		
		DH1	DH3	DH5
Ch00	2402MHz	1.57 dBm	1.54 dBm	1.55 dBm
Ch39	2441MHz	<b>3.17 dBm</b>	3.13 dBm	3.13 dBm
Ch78	2480MHz	2.89 dBm	2.85 dBm	2.85 dBm

Channel	Frequency	Bluetooth Average Output Power		
		$\pi/4$ -DQPSK / 2Mbps		
		2DH1	2DH3	2DH5
Ch00	2402MHz	-1.75 dBm	-1.90 dBm	-1.92 dBm
Ch39	2441MHz	<b>-0.26 dBm</b>	-0.40 dBm	-0.45 dBm
Ch78	2480MHz	-0.29 dBm	-0.44 dBm	-0.50 dBm

Channel	Frequency	Bluetooth Average Output Power		
		8-DPSK / 3Mbps		
		3DH1	3DH3	3DH5
Ch00	2402MHz	-1.75 dBm	-1.93 dBm	-1.96 dBm
Ch39	2441MHz	<b>-0.24 dBm</b>	-0.42 dBm	-0.47 dBm
Ch78	2480MHz	-0.27 dBm	-0.45 dBm	-0.51 dBm

Channel	Frequency	Bluetooth Peak Output Power		
		GFSK / 1Mbps		
		DH1	DH3	DH5
Ch00	2402MHz	2.27 dBm	2.25 dBm	2.22 dBm
Ch39	2441MHz	<b>3.69 dBm</b>	3.64 dBm	3.62 dBm
Ch78	2480MHz	3.42 dBm	3.40 dBm	3.38 dBm

Channel	Frequency	Bluetooth Peak Output Power		
		$\pi/4$ -DQPSK / 2Mbps		
		2DH1	2DH3	2DH5
Ch00	2402MHz	1.13 dBm	1.10 dBm	1.09 dBm
Ch39	2441MHz	<b>2.64 dBm</b>	2.62 dBm	2.60 dBm
Ch78	2480MHz	2.59 dBm	2.57 dBm	2.56 dBm

Channel	Frequency	Bluetooth Peak Output Power		
		8-DPSK / 3Mbps		
		3DH1	3DH3	3DH5
Ch00	2402MHz	1.59 dBm	1.54 dBm	1.52 dBm
Ch39	2441MHz	<b>2.98 dBm</b>	2.97 dBm	2.90 dBm
Ch78	2480MHz	2.91 dBm	2.87 dBm	2.85 dBm

**Remark:** The data rate was set in 1Mbps for all the test items due to the highest RF output power.

- a. The EUT has been associated with peripherals and configuration operated in a manner tended to maximize its emission characteristics in a typical application. Frequency range investigated: conduction emission (150 kHz to 30 MHz), radiation emission (9 kHz to the 10th harmonic of the highest fundamental frequency or to 40 GHz, whichever is lower). For radiated measurement, pre-scanned in three orthogonal panels, X, Y, Z. The worst cases (Y plane) were recorded in this report, and the worst mode of radiated spurious emissions is Bluetooth 1Mbps mode, and recorded in this report.
- b. AC power line Conducted Emission was tested under maximum output power.



The following summary table is showing all test modes to demonstrate in compliance with the standard.

<b>Summary table of Test Cases</b>			
<b>Test Item</b>	<b>Data Rate / Modulation</b>		
	<b>Bluetooth BR 1Mbps GFSK</b>	<b>Bluetooth EDR 2Mbps <math>\pi/4</math>-DQPSK</b>	<b>Bluetooth EDR 3Mbps 8-DPSK</b>
<b>Conducted Test Cases</b>	Mode 1: CH00_2402 MHz Mode 2: CH39_2441 MHz Mode 3: CH78_2480 MHz	Mode 4: CH00_2402 MHz Mode 5: CH39_2441 MHz Mode 6: CH78_2480 MHz	Mode 7: CH00_2402 MHz Mode 8: CH39_2441 MHz Mode 9: CH78_2480 MHz
<b>Radiated Test Cases</b>	<b>Bluetooth BR 1Mbps GFSK</b>		
	Mode 1: CH00_2402 MHz		
	Mode 2: CH39_2441 MHz		
	Mode 3: CH78_2480 MHz		
<b>Radiated Test Cases</b>	<b>Bluetooth BR 3Mbps 8-DPSK</b>		
	Mode 1: CH00_2402 MHz		
	Mode 2: CH39_2441 MHz		
	Mode 3: CH78_2480 MHz		
<b>AC Conducted Emission</b>	Mode 1: Bluetooth Link + WLAN (2.4GHz) Link + Scan + MP3 Play + Keypad (53) + Std Battery + USB-C Adapter + USB-C Cable + Data Link with Notebook (Notebook to SD Card) for Sample 2		
<b>Remark:</b>			
1. The conducted spurious emissions and conducted band edge measurement for other data rates were not worse than 1Mbps, and no other significantly frequencies found in conducted spurious emission.			
2. For Radiated Test Cases, the tests were performed with Std Battery and Sample 1.			

## 2.3 Connection Diagram of Test System

<Bluetooth Tx Mode>

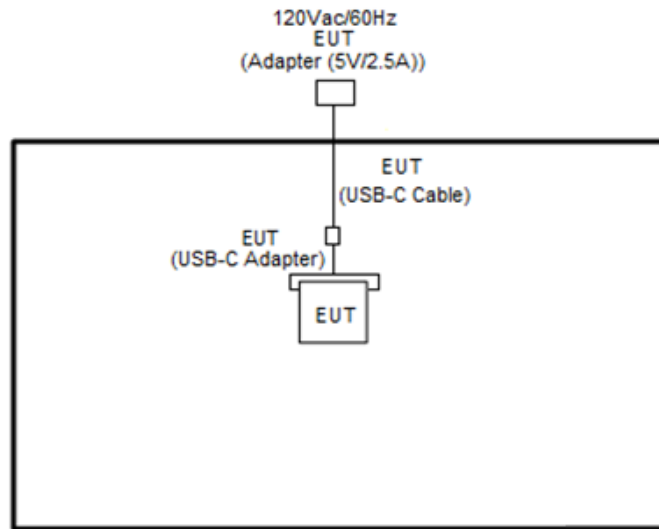

<AC Conducted Emission Mode>

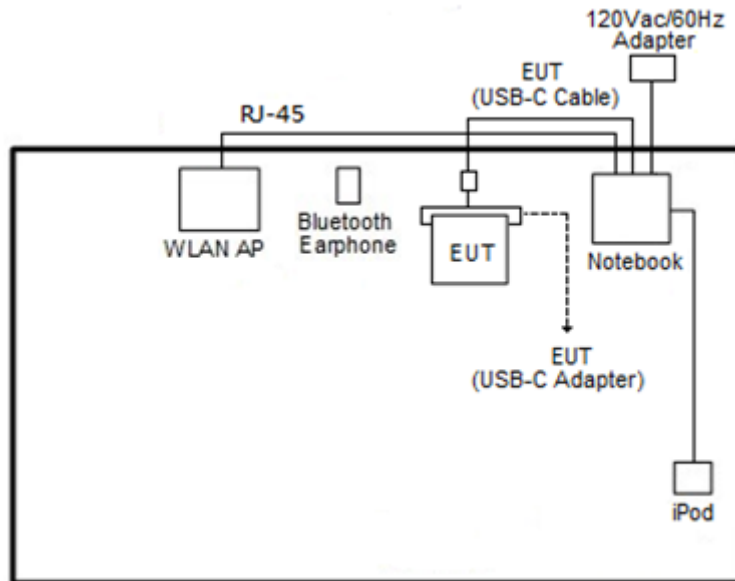



## 2.4 Support Unit used in test configuration and system

Item	Equipment	Trade Name	Model Name	FCC ID	Data Cable	Power Cord
1.	WLAN AP	ASUS	RT-AC66U	MSQ-RTAC66U	N/A	Unshielded, 1.8 m
2.	Bluetooth Earphone	Sony Ericsson	MW600	PY7DDA-2029	N/A	N/A
3.	Notebook	DELL	Latitude E6320	FCC DoC/ Contains FCC ID: QDS-BRCM1054	N/A	AC I/P: Unshielded, 1.2 m DC O/P: Shielded, 1.8 m
4.	iPod	Apple	A1285	FCC DoC	Shielded, 1.0 m	N/A
5.	SD Card	SanDisk	MicroSD HC	FCC DoC	N/A	N/A

## 2.5 EUT Operation Test Setup

The RF test items, utility “QRCT” was installed in Notebook which was programmed in order to make the EUT get into the engineering modes to provide channel selection, power level, data rate and the application type and for continuous transmitting signals.

## 2.6 Measurement Results Explanation Example

For all conducted test items:

The offset level is set in the spectrum analyzer to compensate the RF cable loss and attenuator factor between EUT conducted output port and spectrum analyzer. With the offset compensation, the spectrum analyzer reading level is exactly the EUT RF output level.

Example:

The spectrum analyzer offset is derived from RF cable loss and attenuator factor.

*Offset = RF cable loss + attenuator factor.*

Following shows an offset computation example with cable loss 4.2 dB and 10dB attenuator.

$$\begin{aligned} \text{Offset(dB)} &= \text{RF cable loss(dB)} + \text{attenuator factor(dB)}. \\ &= 4.2 + 10 = 14.2 \text{ (dB)} \end{aligned}$$

### 3 Test Result

#### 3.1 Number of Channel Measurement

##### 3.1.1 Limits of Number of Hopping Frequency

Frequency hopping systems in the 2400-2483.5 MHz band shall use at least 15 channels.

##### 3.1.2 Measuring Instruments

See list of measuring equipment of this test report.

##### 3.1.3 Test Procedure

1. The testing follows ANSI C63.10-2013 clause 7.8.3.
2. The RF output of EUT was connected to the spectrum analyzer by RF cable and attenuator. The path loss was compensated to the results for each measurement.
3. Set to the maximum power setting and enable the EUT transmit continuously.
4. Enable the EUT hopping function.
5. Use the following spectrum analyzer settings: Span = the frequency band of operation; RBW = 300kHz; VBW  $\geq$  RBW; Sweep = auto; Detector function = peak; Trace = max hold.
6. The number of hopping frequency used is defined as the number of total channel.
7. Record the measurement data derived from spectrum analyzer.

##### 3.1.4 Test Setup

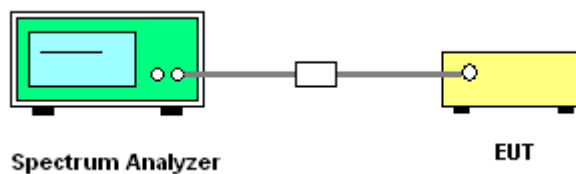



3.1.5 Test Result of Number of Hopping Frequency

Test Engineer :	Howard Lin, Tommy Lee and Kai Liao	Temperature :	21~25°C
		Relative Humidity :	51~54%

Number of Hopping (Channel)	Adaptive Frequency Hopping (Channel)	Limits (Channel)	Pass/Fail
79	20	> 15	Pass

Number of Hopping Channel Plot on Channel 00 - 78

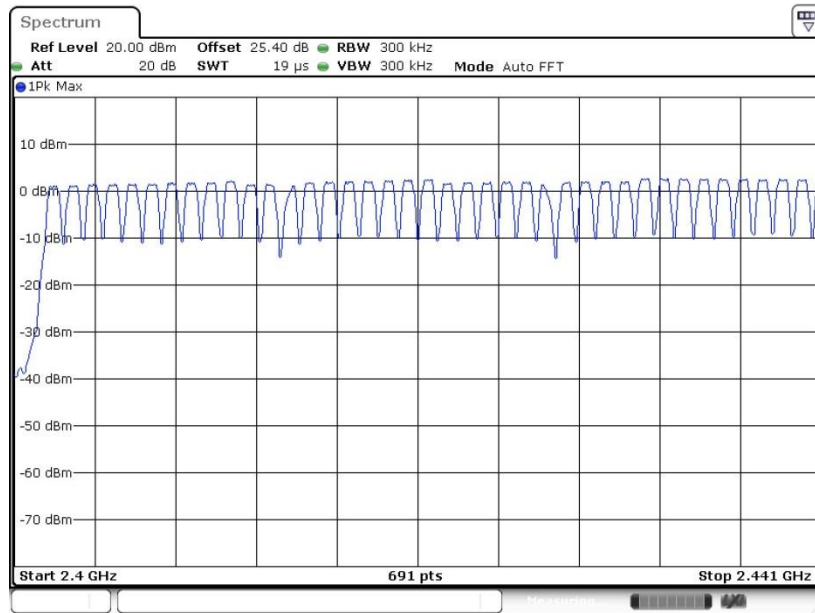

Date: 7.MAR.2019 10:39:43

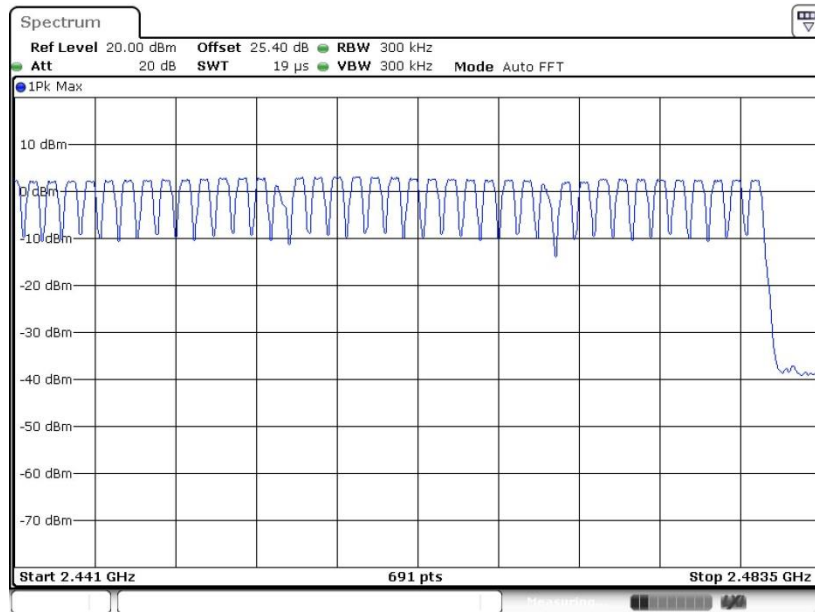

Date: 7.MAR.2019 10:41:22

## 3.2 Hopping Channel Separation Measurement

### 3.2.1 Limit of Hopping Channel Separation

Frequency hopping systems operating in the 2400-2483.5 MHz band may have hopping channel carrier frequencies that are separated by 25 kHz or two-thirds of the 20 dB bandwidth of the hopping channel, whichever is greater.

### 3.2.2 Measuring Instruments

See list of measuring equipment of this test report.

### 3.2.3 Test Procedures

1. The testing follows ANSI C63.10-2013 clause 7.8.2.
2. The RF output of EUT was connected to the spectrum analyzer by RF cable and attenuator. The path loss was compensated to the results for each measurement.
3. Set to the maximum power setting and enable the EUT transmit continuously.
4. Enable the EUT hopping function.
5. Use the following spectrum analyzer settings:  
Span = wide enough to capture the peaks of two adjacent channels;  
RBW = 300kHz; VBW  $\geq$  RBW; Sweep = auto; Detector function = peak; Trace = max hold.
6. Measure and record the results in the test report.

### 3.2.4 Test Setup

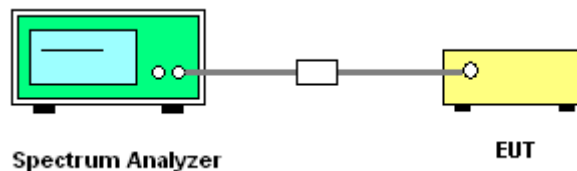





3.2.5 Test Result of Hopping Channel Separation

Test Engineer :	Howard Lin, Tommy Lee and Kai Liao	Temperature :	21~25°C
		Relative Humidity :	51~54%

Mod.	Data Rate	N <sub>TX</sub>	CH.	Freq. (MHz)	Hopping Channel Separation Measurement (MHz)	Hopping Channel Separation Measurement Limit (MHz)	Pass/Fail
DH	1Mbps	1	0	2402	1.025	0.5827	Pass
DH	1Mbps	1	39	2441	1.003	0.5827	Pass
DH	1Mbps	1	78	2480	1.003	0.5827	Pass
2DH	2Mbps	1	0	2402	1.003	0.8365	Pass
2DH	2Mbps	1	39	2441	1.003	0.8336	Pass
2DH	2Mbps	1	78	2480	1.012	0.8365	Pass
3DH	3Mbps	1	0	2402	1.007	0.8278	Pass
3DH	3Mbps	1	39	2441	1.003	0.8278	Pass
3DH	3Mbps	1	78	2480	1.003	0.8278	Pass

<1Mbps>

Channel Separation Plot on Channel 00 - 01

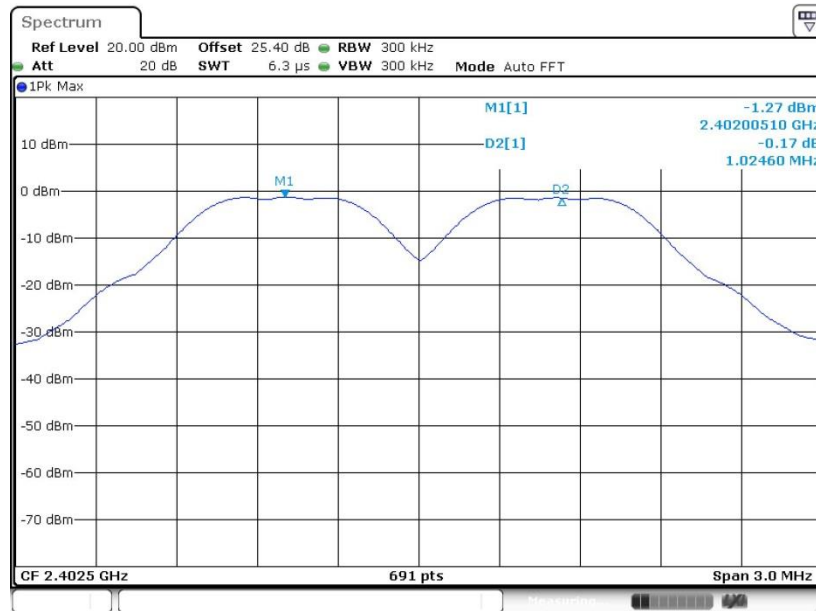

Date: 7.MAR.2019 09:10:58



Channel Separation Plot on Channel 39 - 40

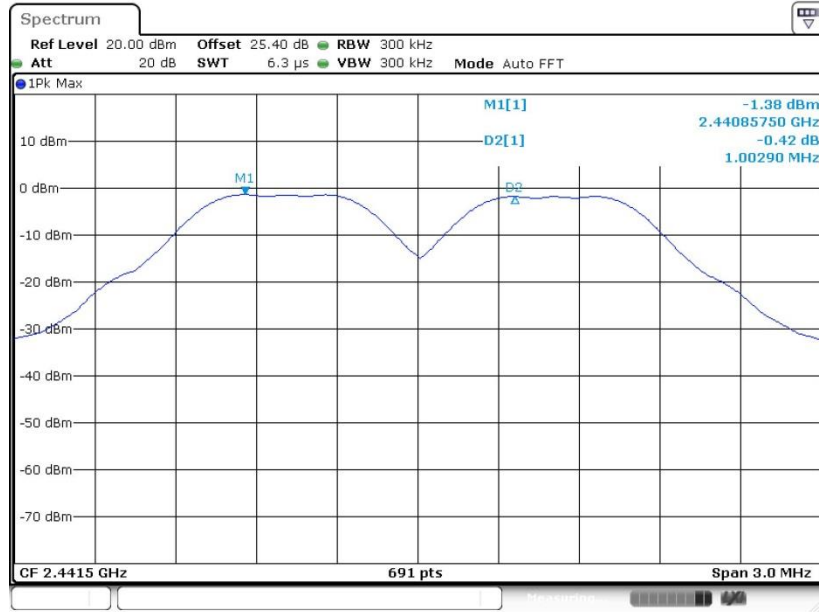

Date: 7.MAR.2019 09:20:57

Channel Separation Plot on Channel 77 - 78

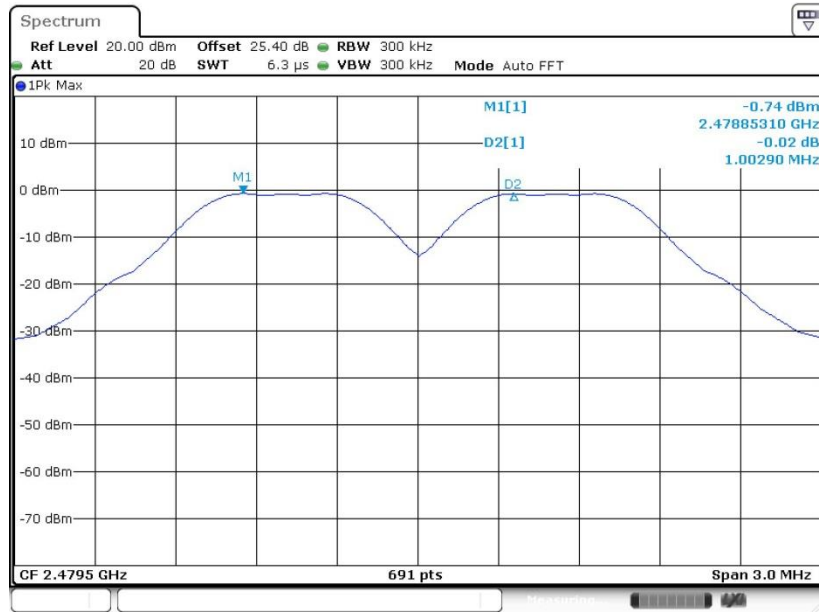

Date: 7.MAR.2019 09:36:56



<2Mbps>

Channel Separation Plot on Channel 00 - 01

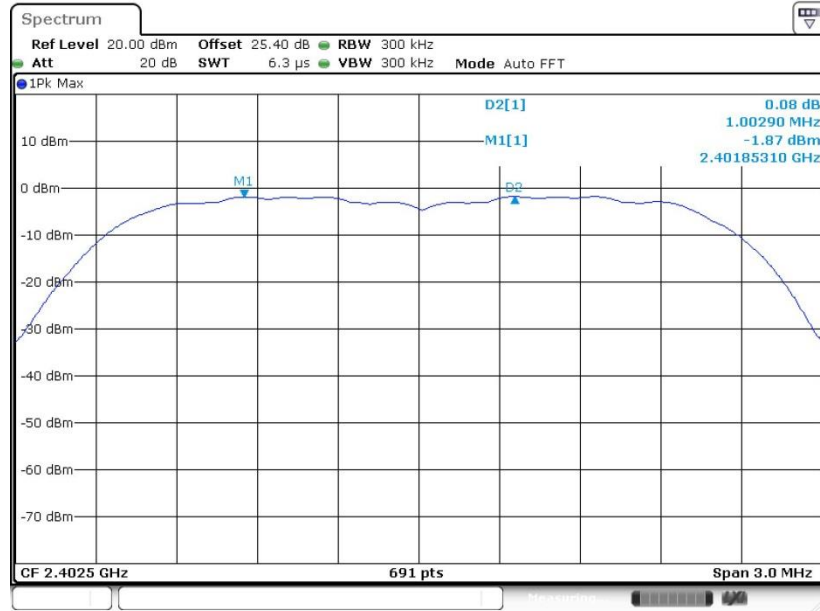

Date: 7.MAR.2019 10:55:27

Channel Separation Plot on Channel 39 - 40

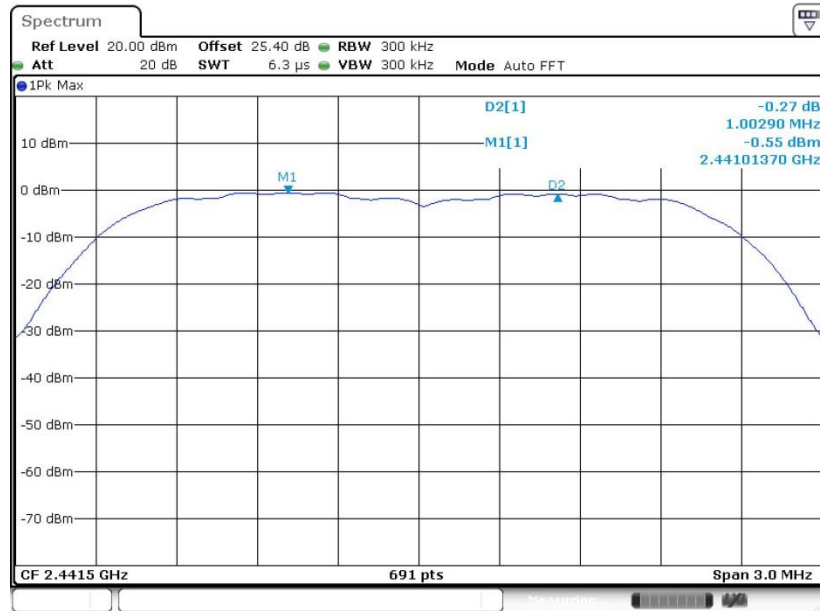

Date: 7.MAR.2019 11:13:39



Channel Separation Plot on Channel 77 - 78

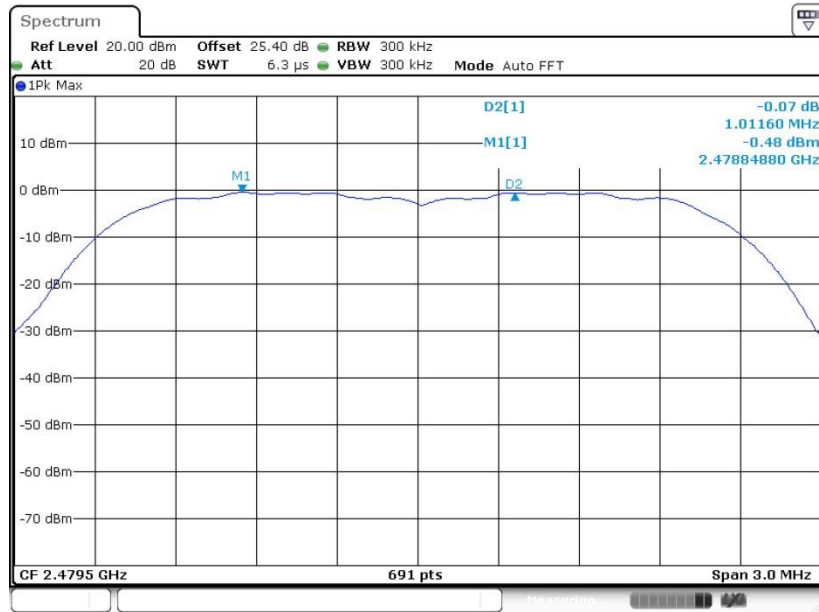

Date: 7.MAR.2019 11:36:25

<3Mbps>

Channel Separation Plot on Channel 00 - 01

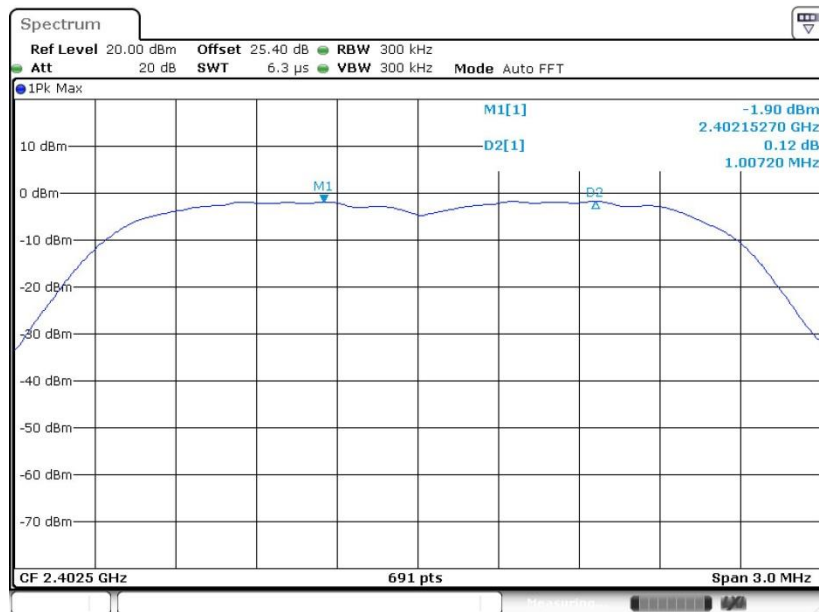

Date: 7.MAR.2019 12:24:29



Channel Separation Plot on Channel 39 - 40

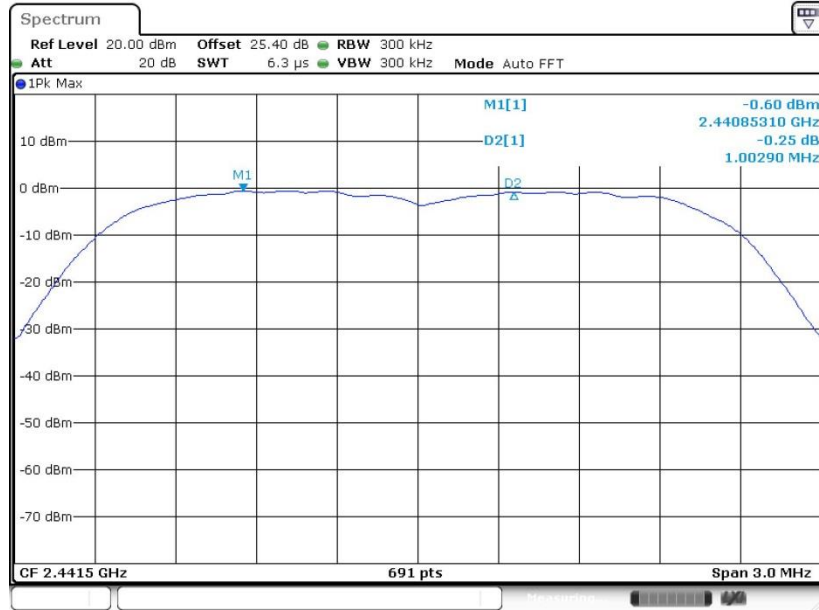

Date: 7.MAR.2019 12:22:15

Channel Separation Plot on Channel 77 - 78

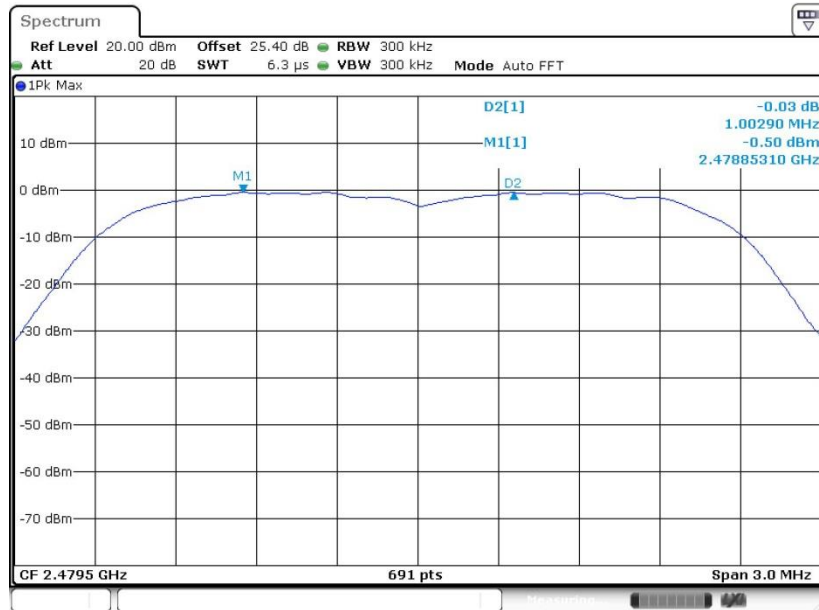

Date: 7.MAR.2019 12:00:32

### 3.3 Dwell Time Measurement

#### 3.3.1 Limit of Dwell Time

The average time of occupancy on any channel shall not be greater than 0.4 seconds within a period of 0.4 seconds multiplied by the number of hopping channels employed.

#### 3.3.2 Measuring Instruments

See list of measuring equipment of this test report.

#### 3.3.3 Test Procedures

1. The testing follows ANSI C63.10-2013 clause 7.8.4.
2. The RF output of EUT was connected to the spectrum analyzer by RF cable and attenuator. The path loss was compensated to the results for each measurement.
3. Set to the maximum power setting and enable the EUT transmit continuously.
4. Enable the EUT hopping function.
5. Use the following spectrum analyzer settings: Span = zero span, centered on a hopping channel; RBW = 1 MHz; VBW  $\geq$  RBW; Sweep = as necessary to capture the entire dwell time per hopping channel; Detector function = peak; Trace = max hold.
6. Measure and record the results in the test report.

#### 3.3.4 Test Setup

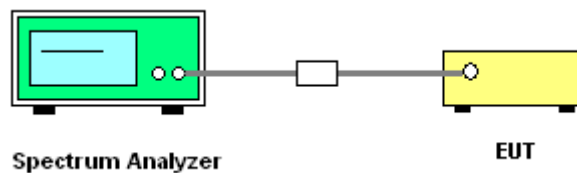



3.3.5 Test Result of Dwell Time

Test Engineer :	Howard Lin, Tommy Lee and Kai Liao	Temperature :	21~25°C
		Relative Humidity :	51~54%

Mod.	Hopping Channel Number Rate	Hops Over Occupancy Time(hops)	Package Transfer Time (msec) (MHz)	Dwell Time (sec)	Limits (sec)	Pass/Fail
Nomal	79	106.67	2.90	0.31	0.4	Pass
AFH	20	53.33	2.90	0.15	0.4	Pass

Package Transfer Time Plot

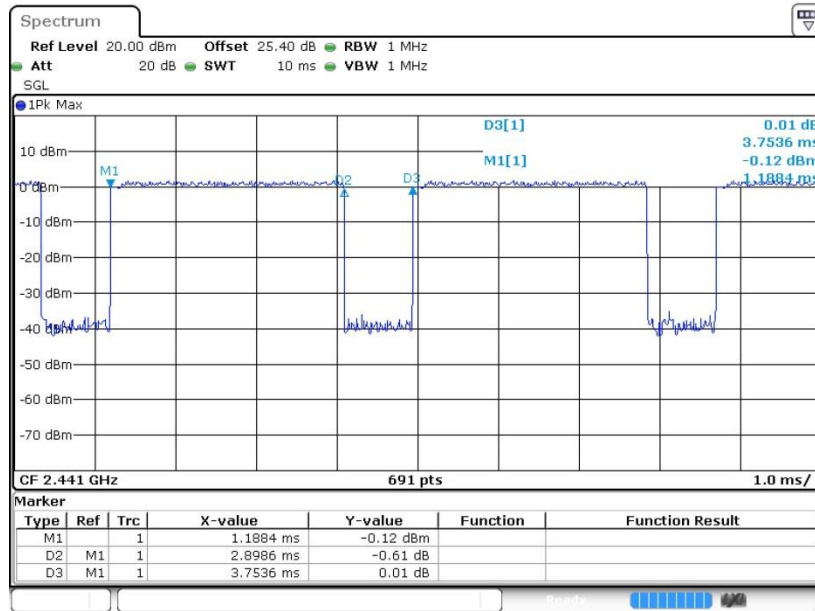

Date: 5.MAR.2019 17:38:07

Remark:

- In normal mode, hopping rate is 1600 hops/s with 6 slots in 79 hopping channels. With channel hopping rate (1600 / 6 / 79) in Occupancy Time Limit (0.4 x 79) (s), Hops Over Occupancy Time comes to (1600 / 6 / 79) x (0.4 x 79) = 106.67 hops.
- In AFH mode, hopping rate is 800 hops/s with 6 slots in 20 hopping channels. With channel hopping rate (800 / 6 / 20) in Occupancy Time Limit (0.4 x 20) (s), Hops Over Occupancy Time comes to (800 / 6 / 20) x (0.4 x 20) = 53.33 hops.
- Dwell Time(s) = Hops Over Occupancy Time (hops) x Package Transfer Time

### 3.4 20dB and 99% Bandwidth Measurement

#### 3.4.1 Limit of 20dB and 99% Bandwidth

Reporting only

#### 3.4.2 Measuring Instruments

See list of measuring equipment of this test report.

#### 3.4.3 Test Procedures

1. The testing follows ANSI C63.10-2013 clause 6.9.2 and 6.9.3.
2. The RF output of EUT was connected to the spectrum analyzer by RF cable and attenuator. The path loss was compensated to the results for each measurement.
3. Set to the maximum power setting and enable the EUT transmit continuously.
4. Use the following spectrum analyzer settings for 20dB Bandwidth measurement.  
Span = approximately 2 to 5 times the 20 dB bandwidth, centered on a hopping channel;  
RBW  $\geq$  1-5% of the OBW; VBW  $\geq$  RBW; Sweep = auto; Detector function = peak;  
Trace = max hold.
5. Use the following spectrum analyzer settings for 99 % Bandwidth measurement.  
Span = approximately 1.5 to 5 times the 99% bandwidth, centered on a hopping channel;  
RBW  $\geq$  1-5% of the 99% bandwidth; VBW  $\geq$  3 \* RBW; Sweep = auto; Detector function = peak;  
Trace = max hold.
6. Measure and record the results in the test report.

#### 3.4.4 Test Setup

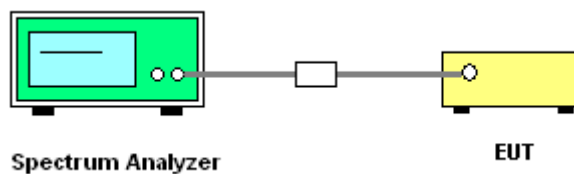





3.4.5 Test Result of 20dB Bandwidth

Test Engineer :	Howard Lin, Tommy Lee and Kai Liao	Temperature :	21~25°C
		Relative Humidity :	51~54%

Mod.	Data Rate	N <sub>TX</sub>	CH.	Freq. (MHz)	20db BW (MHz)	Pass/Fail
DH	1Mbps	1	0	2402	0.874	Pass
DH	1Mbps	1	39	2441	0.874	Pass
DH	1Mbps	1	78	2480	0.874	Pass
2DH	2Mbps	1	0	2402	1.255	Pass
2DH	2Mbps	1	39	2441	1.250	Pass
2DH	2Mbps	1	78	2480	1.255	Pass
3DH	3Mbps	1	0	2402	1.242	Pass
3DH	3Mbps	1	39	2441	1.242	Pass
3DH	3Mbps	1	78	2480	1.242	Pass

<1Mbps>

20 dB Bandwidth Plot on Channel 00

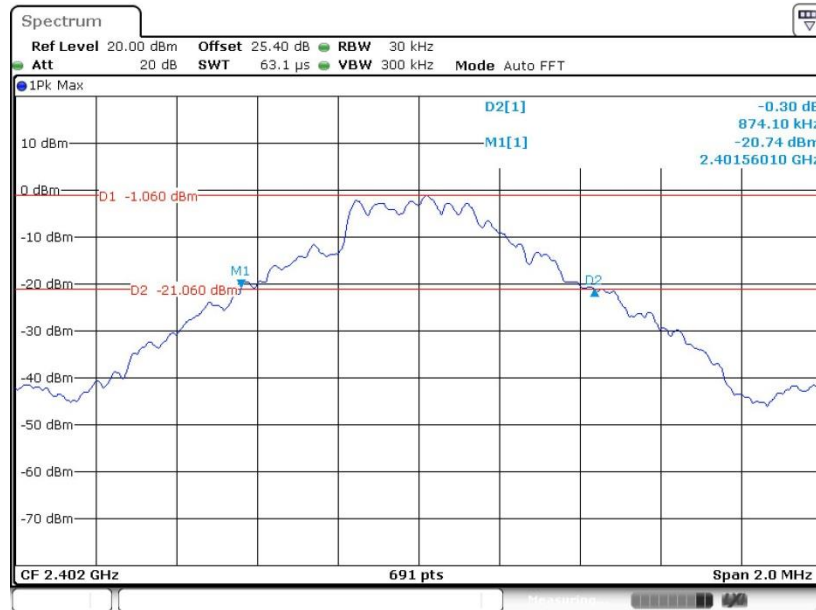

Date: 7.MAR.2019 09:02:49



### 20 dB Bandwidth Plot on Channel 39

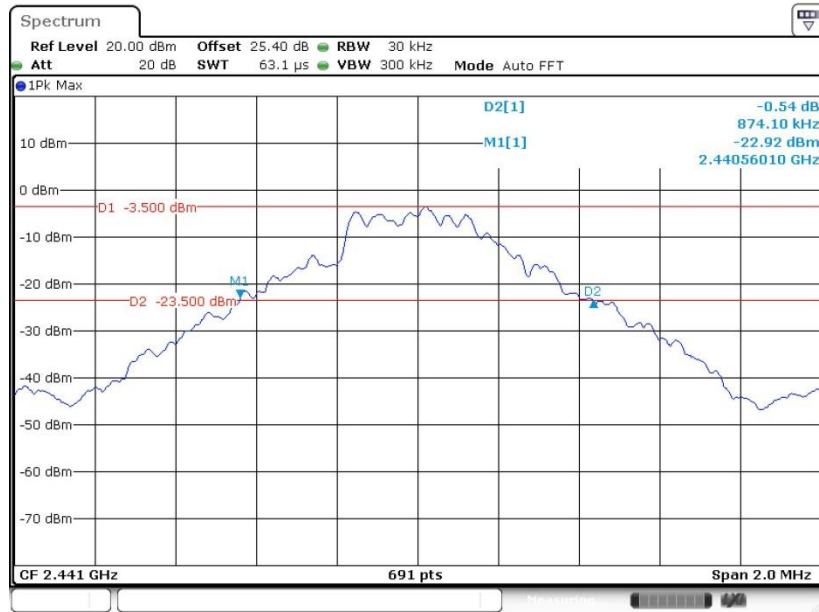

Date: 7.MAR.2019 09:16:45

### 20 dB Bandwidth Plot on Channel 78

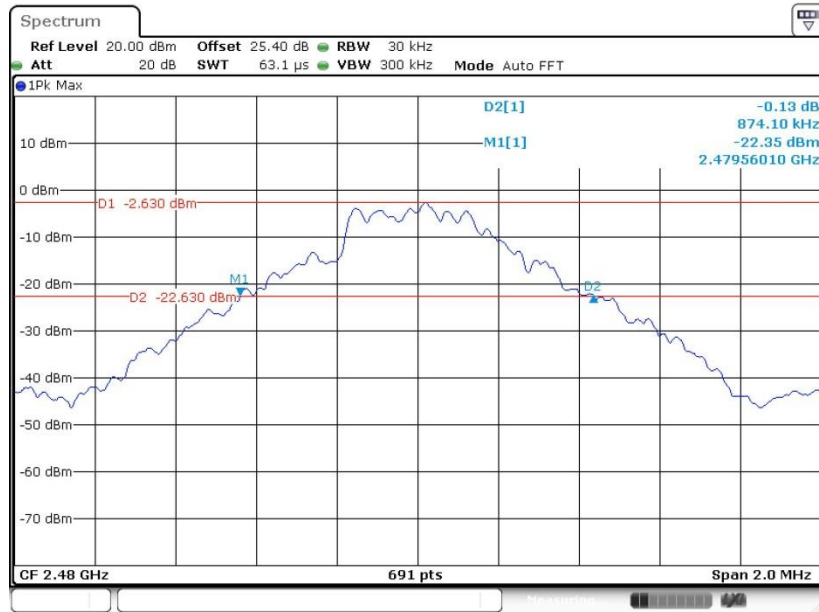

Date: 7.MAR.2019 09:26:00



<2Mbps>

20 dB Bandwidth Plot on Channel 00

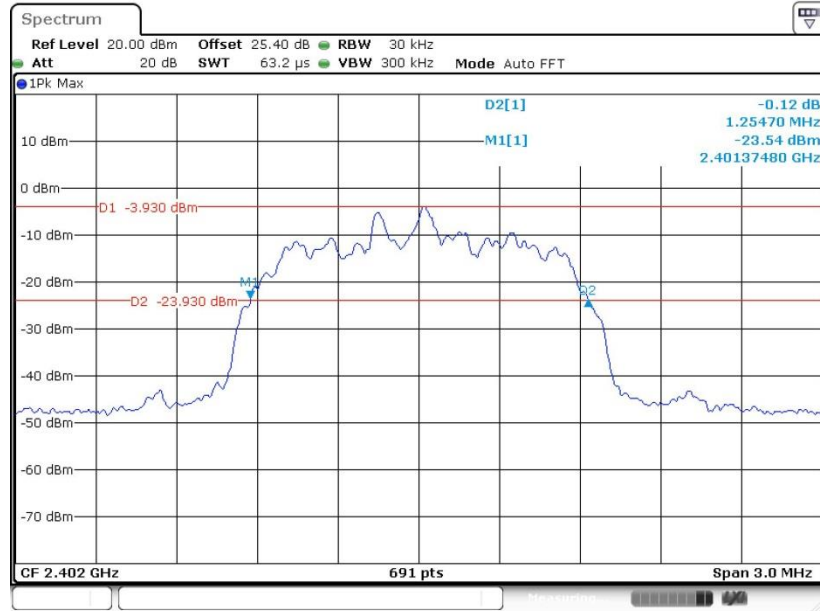

Date: 7.MAR.2019 10:58:42

20 dB Bandwidth Plot on Channel 39

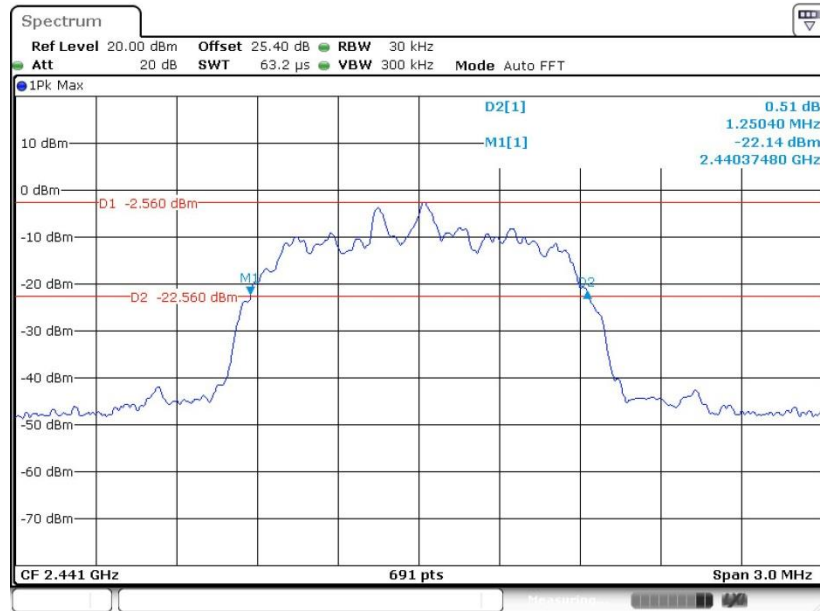

Date: 7.MAR.2019 11:18:40



20 dB Bandwidth Plot on Channel 78

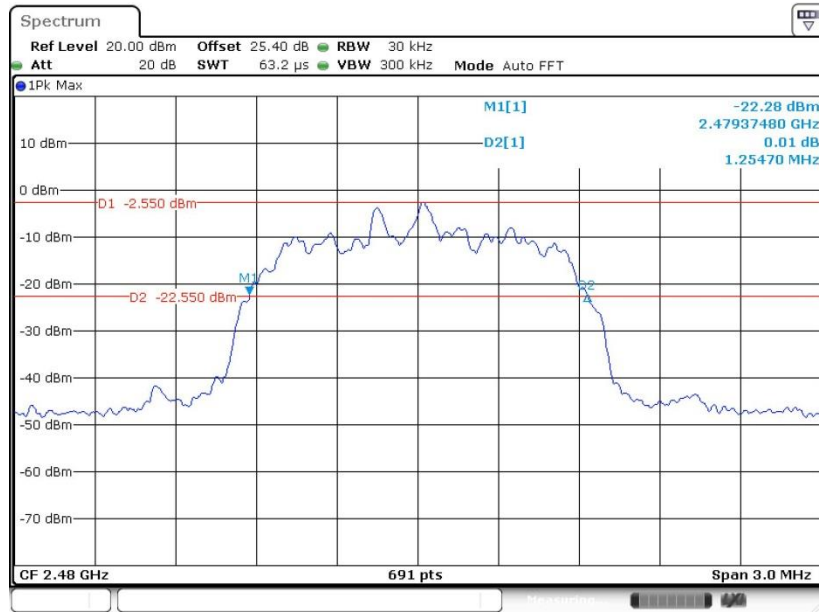

Date: 7.MAR.2019 11:47:28

<3Mbps>

20 dB Bandwidth Plot on Channel 00

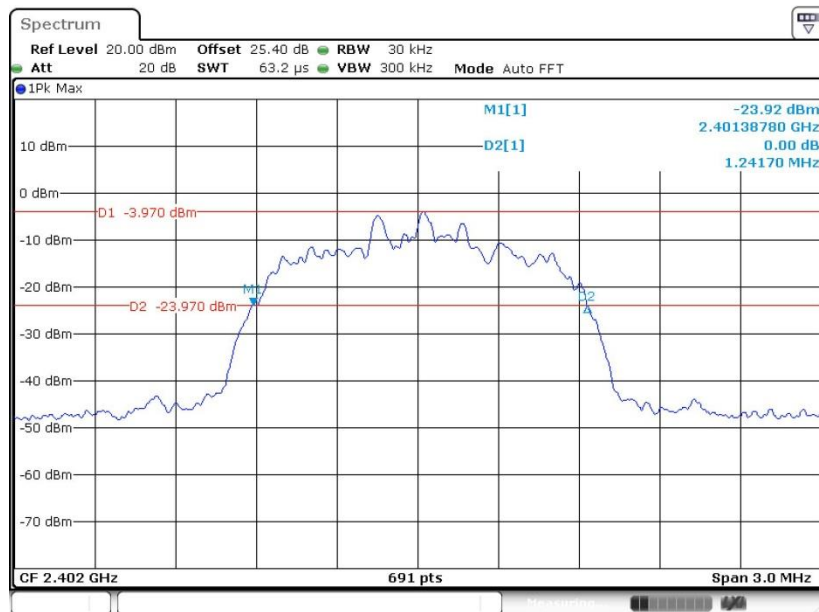

Date: 7.MAR.2019 12:27:26



20 dB Bandwidth Plot on Channel 39

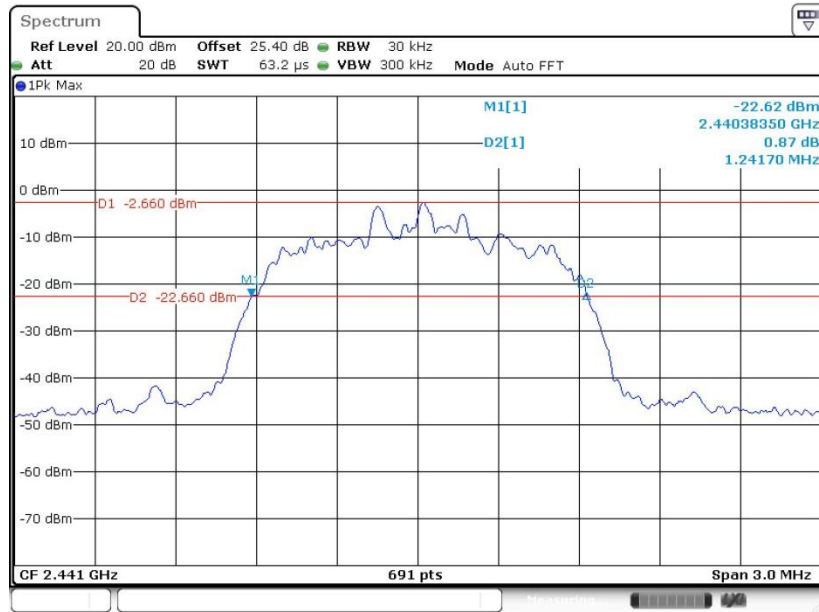

Date: 7.MAR.2019 12:21:05

20 dB Bandwidth Plot on Channel 78

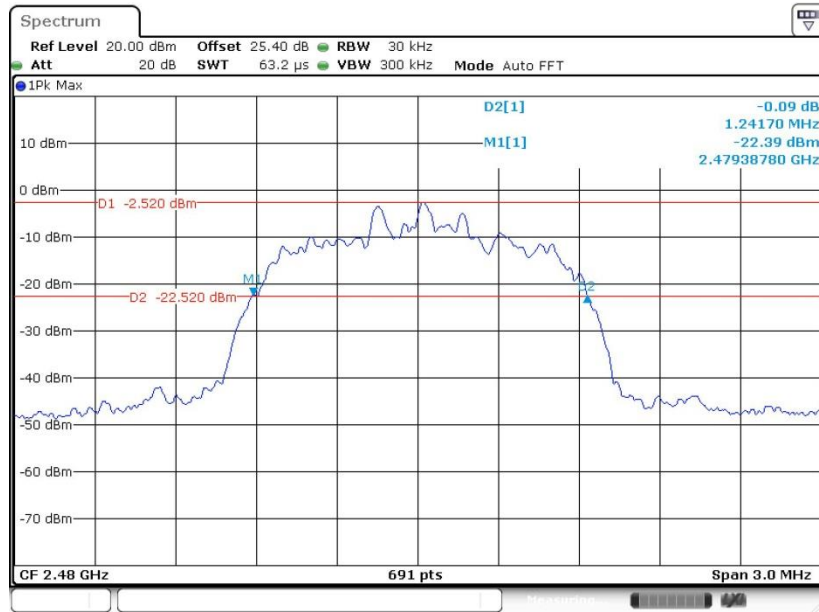

Date: 7.MAR.2019 12:10:38



3.4.6 Test Result of 99% Occupied Bandwidth

Test Engineer :	Howard Lin, Tommy Lee and Kai Liao	Temperature :	21~25°C
		Relative Humidity :	51~54%

Mod.	Data Rate	N <sub>TX</sub>	CH.	Freq. (MHz)	99% Bandwidth (MHz)	Pass/Fail
DH	1Mbps	1	0	2402	0.828	Pass
DH	1Mbps	1	39	2441	0.834	Pass
DH	1Mbps	1	78	2480	0.834	Pass
2DH	2Mbps	1	0	2402	1.166	Pass
2DH	2Mbps	1	39	2441	1.166	Pass
2DH	2Mbps	1	78	2480	1.166	Pass
3DH	3Mbps	1	0	2402	1.149	Pass
3DH	3Mbps	1	39	2441	1.149	Pass
3DH	3Mbps	1	78	2480	1.149	Pass

<1Mbps>

99% Occupied Bandwidth Plot on Channel 00



Date: 7.MAR.2019 08:54:43



### 99% Occupied Bandwidth Plot on Channel 39

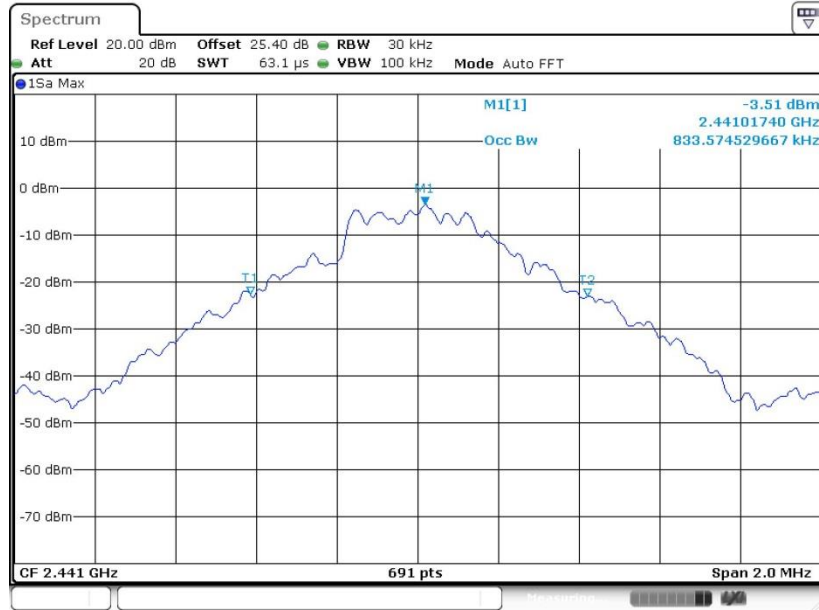

Date: 7.MAR.2019 09:13:40

### 99% Occupied Bandwidth Plot on Channel 78

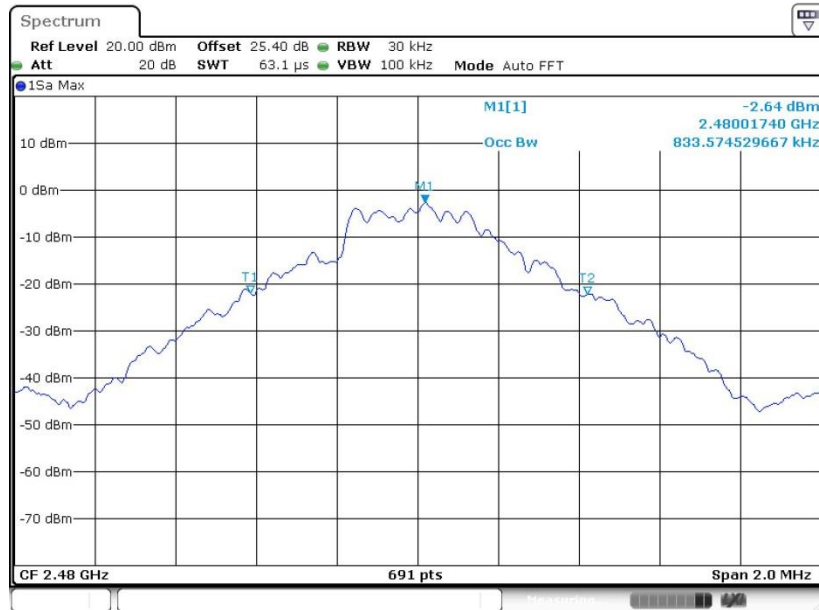

Date: 7.MAR.2019 09:23:05



<2Mbps>

99% Occupied Bandwidth Plot on Channel 00



Date: 7.MAR.2019 11:00:16

99% Occupied Bandwidth Plot on Channel 39

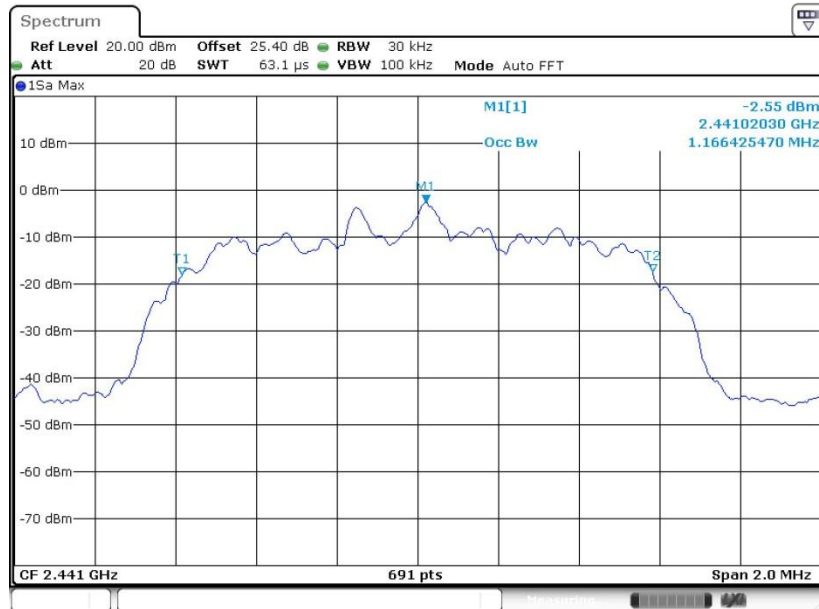

Date: 7.MAR.2019 11:19:20





99% Occupied Bandwidth Plot on Channel 78



Date: 7.MAR.2019 11:49:50

<3Mbps>

99% Occupied Bandwidth Plot on Channel 00

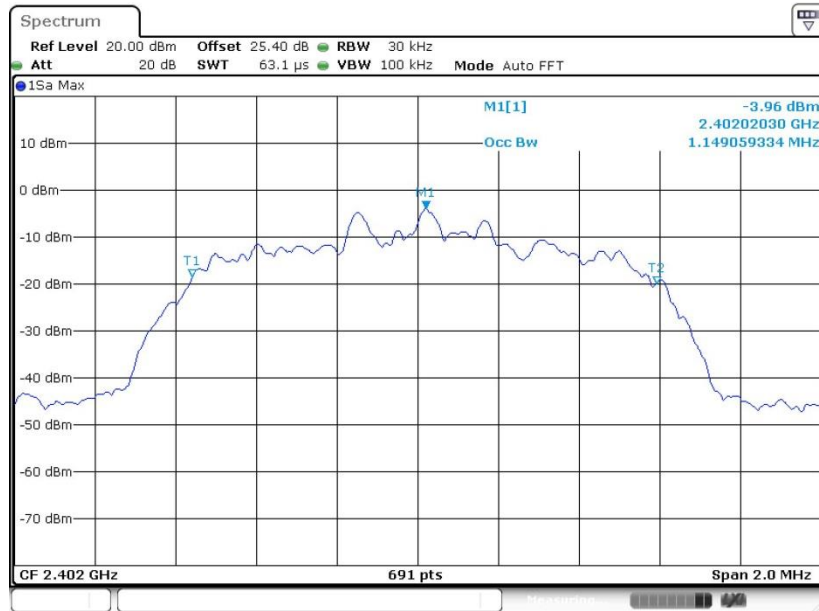

Date: 7.MAR.2019 12:28:28



99% Occupied Bandwidth Plot on Channel 39



Date: 7.MAR.2019 12:17:05

99% Occupied Bandwidth Plot on Channel 78



Date: 7.MAR.2019 12:12:18

Note: The occupied channel bandwidth is maintained within the band of operation for all of the modulations.

## 3.5 Output Power Measurement

### 3.5.1 Limit of Output Power

The maximum peak conducted output power of the intentional radiator shall not exceed the following:

(1) For frequency hopping systems operating in the 2400-2483.5 MHz band employing at least 75 non-overlapping hopping channels, and all frequency hopping systems in the 5725-5850 MHz band: 1 watt. For all other frequency hopping systems in the 2400-2483.5 MHz band 0.125 watts. The power limit for 1Mbps, 2Mbps, 3Mbps and AFH modes are 0.125 watts.

### 3.5.2 Measuring Instruments

See list of measuring equipment of this test report.

### 3.5.3 Test Procedures

1. The testing follows ANSI C63.10-2013 clause 7.8.5.
2. The RF output of EUT was connected to the power meter by RF cable and attenuator. The path loss was compensated to the results for each measurement.
3. Set to the maximum power setting and enable the EUT transmit continuously.
4. Measure the conducted output power with cable loss and record the results in the test report.
5. Measure and record the results in the test report.

### 3.5.4 Test Setup

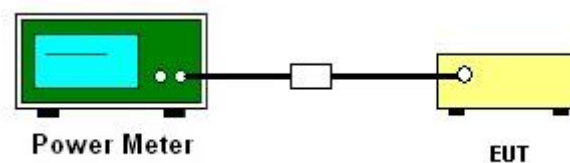



3.5.5 Test Result of Peak Output Power

Test Engineer :		Howard Lin, Tommy Lee and Kai Liao		Temperature :	21~25°C
				Relative Humidity :	51~54%

DH	CH.	N <sub>TX</sub>	Peak Power (dBm)	Power Limit (dBm)	Test Result
DH1	0	1	2.27	20.97	Pass
	39	1	<b>3.69</b>	20.97	Pass
	78	1	3.42	20.97	Pass

2DH	CH.	N <sub>TX</sub>	Peak Power (dBm)	Power Limit (dBm)	Test Result
2DH1	0	1	1.13	20.97	Pass
	39	1	<b>2.64</b>	20.97	Pass
	78	1	2.59	20.97	Pass

3DH	CH.	N <sub>TX</sub>	Peak Power (dBm)	Power Limit (dBm)	Test Result
3DH1	0	1	1.59	20.97	Pass
	39	1	<b>2.98</b>	20.97	Pass
	78	1	2.91	20.97	Pass

3.5.6 Test Result of Average Output Power (Reporting Only)

Test Engineer :		Howard Lin, Tommy Lee and Kai Liao		Temperature :	21~25°C
				Relative Humidity :	51~54%

DH	CH.	N <sub>TX</sub>	Average Power (dBm)	Duty Factor (dB)
DH1	0	1	1.57	5.19
	39	1	<b>3.17</b>	5.19
	78	1	2.89	5.19

2DH	CH.	N <sub>TX</sub>	Average Power (dBm)	Duty Factor (dB)
2DH1	0	1	-1.75	5.11
	39	1	<b>-0.26</b>	5.11
	78	1	-0.29	5.11

3DH	CH.	N <sub>TX</sub>	Average Power (dBm)	Duty Factor (dB)
3DH1	0	1	-1.75	5.11
	39	1	<b>-0.24</b>	5.11
	78	1	-0.27	5.11

## 3.6 Conducted Band Edges Measurement

### 3.6.1 Limit of Band Edges

In any 100 kHz bandwidth outside the intentional radiation frequency band, the radio frequency power shall be at least 20 dB below the highest level of the radiated power. In addition, radiated emissions which fall in the restricted bands must also comply with the radiated emission limits.

### 3.6.2 Measuring Instruments

See list of measuring equipment of this test report.

### 3.6.3 Test Procedures

1. The testing follows ANSI C63.10-2013 clause 7.8.6.
2. Set to the maximum power setting and enable the EUT transmit continuously.
3. Set RBW = 100kHz, VBW = 300kHz. Band edge emissions must be at least 20 dB down from the highest emission level within the authorized band as measured with a 100kHz RBW. The attenuation shall be 30 dB instead of 20 dB when RMS conducted output power procedure is used.
4. Enable hopping function of the EUT and then repeat step 2. and 3.
5. Measure and record the results in the test report.

### 3.6.4 Test Setup

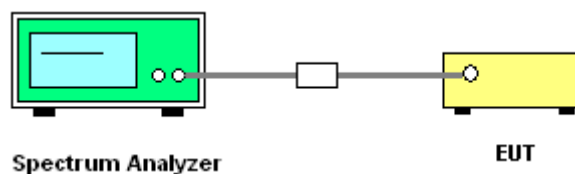



### 3.6.5 Test Result of Conducted Band Edges

Test Engineer :	Howard Lin, Tommy Lee and Kai Liao	Temperature :	21~25°C
		Relative Humidity :	51~54%

<1Mbps>

#### Low Band Edge Plot on Channel 00

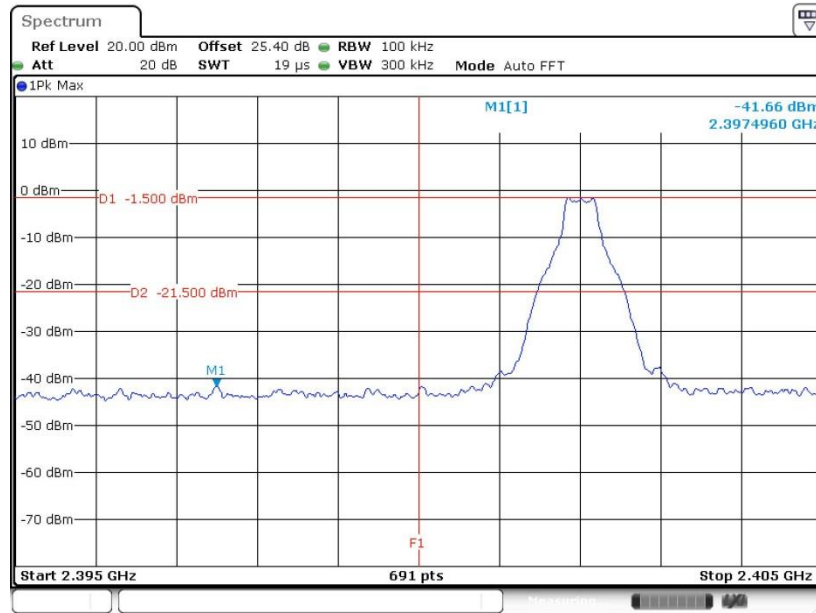

Date: 7.MAR.2019 09:07:27

#### High Band Edge Plot on Channel 78

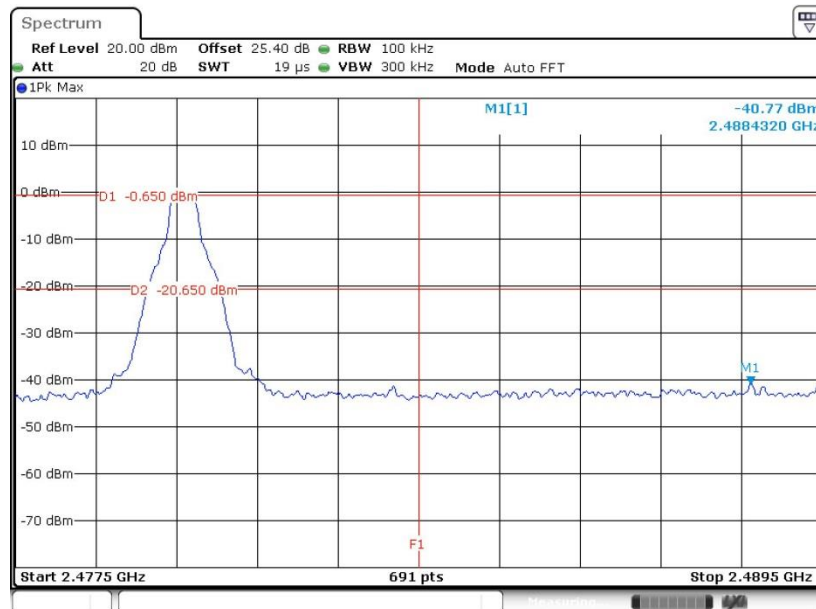

Date: 7.MAR.2019 09:29:53



<2Mbps>

Low Band Edge Plot on Channel 00

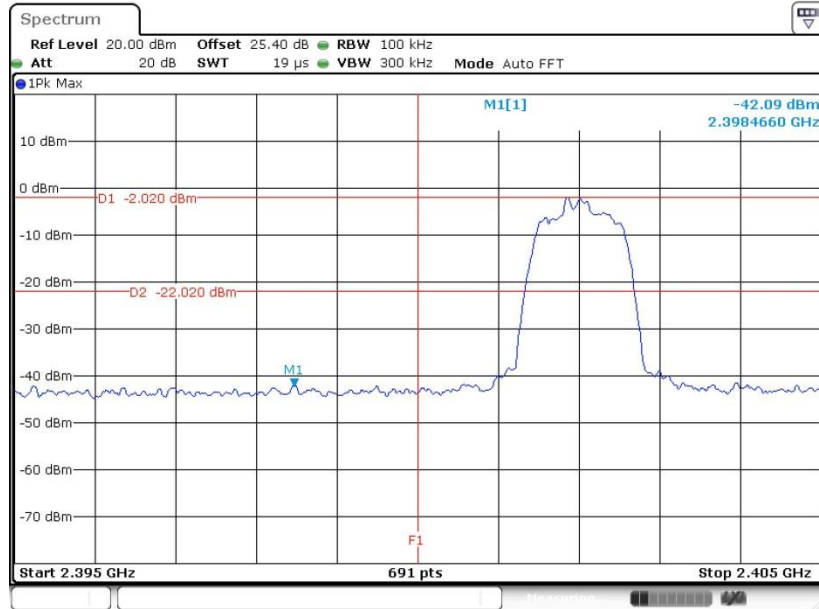

Date: 7.MAR.2019 10:59:10

High Band Edge Plot on Channel 78

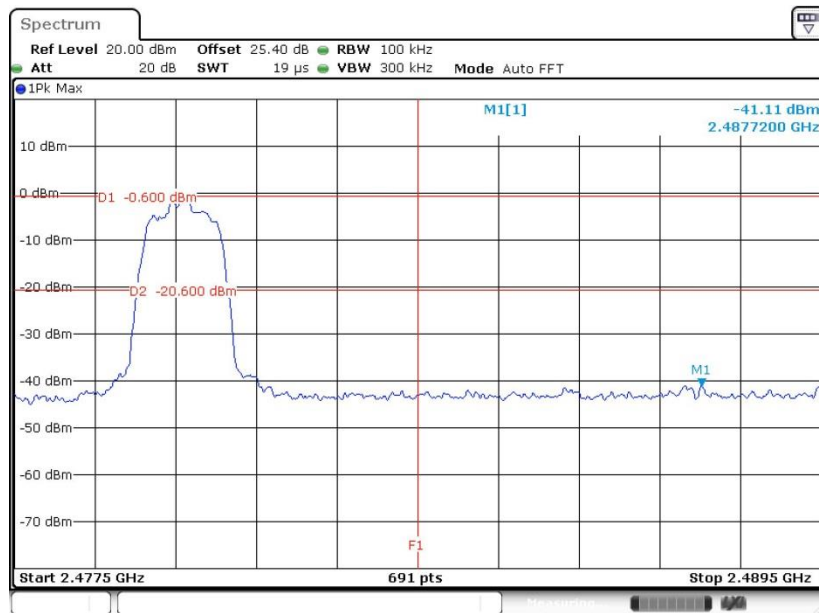

Date: 7.MAR.2019 11:49:06



<3Mbps>

Low Band Edge Plot on Channel 00

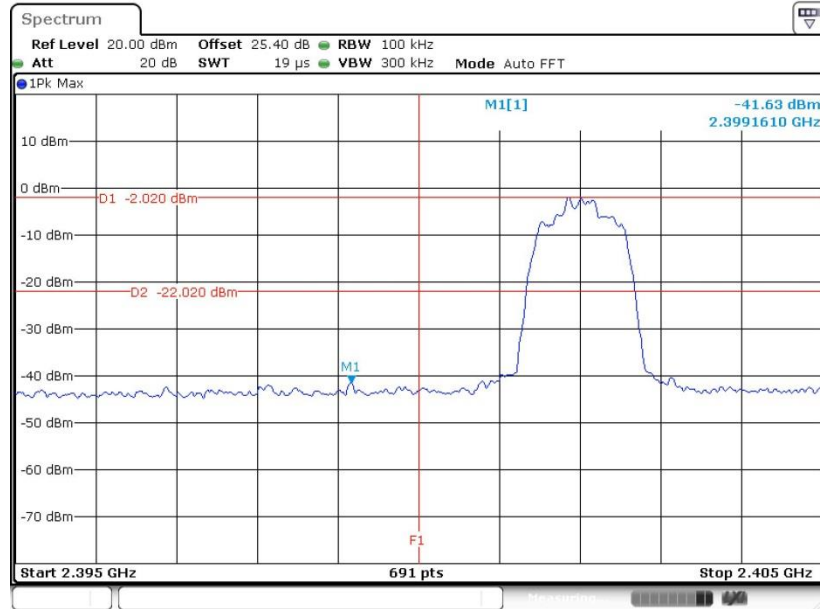

Date: 7.MAR.2019 12:27:47

High Band Edge Plot on Channel 78

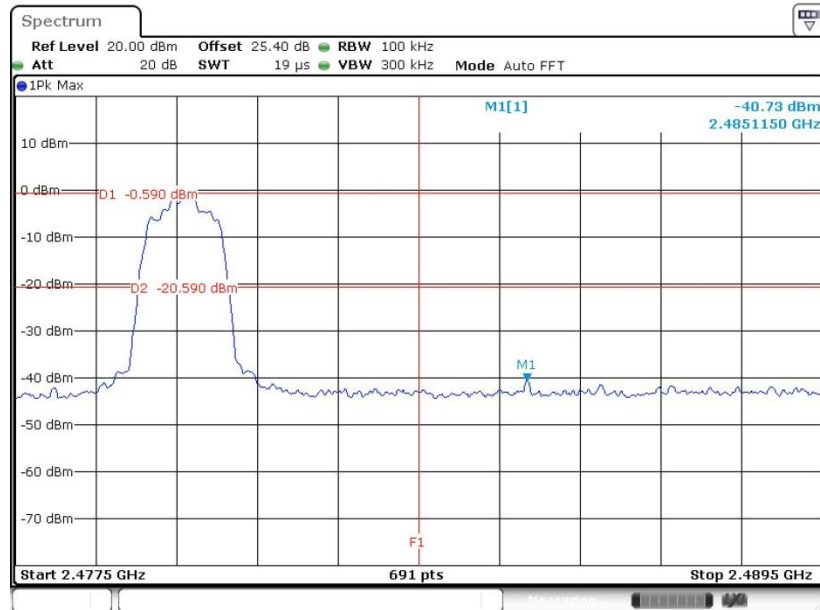

Date: 7.MAR.2019 12:11:06





### 3.6.6 Test Result of Conducted Hopping Mode Band Edges

<1Mbps>

#### Hopping Mode Low Band Edge Plot

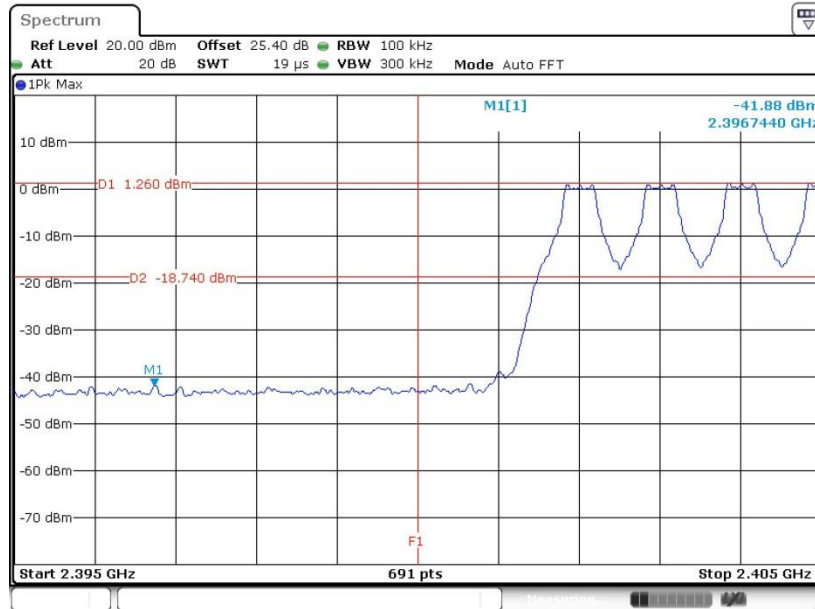

#### Hopping Mode High Band Edge Plot

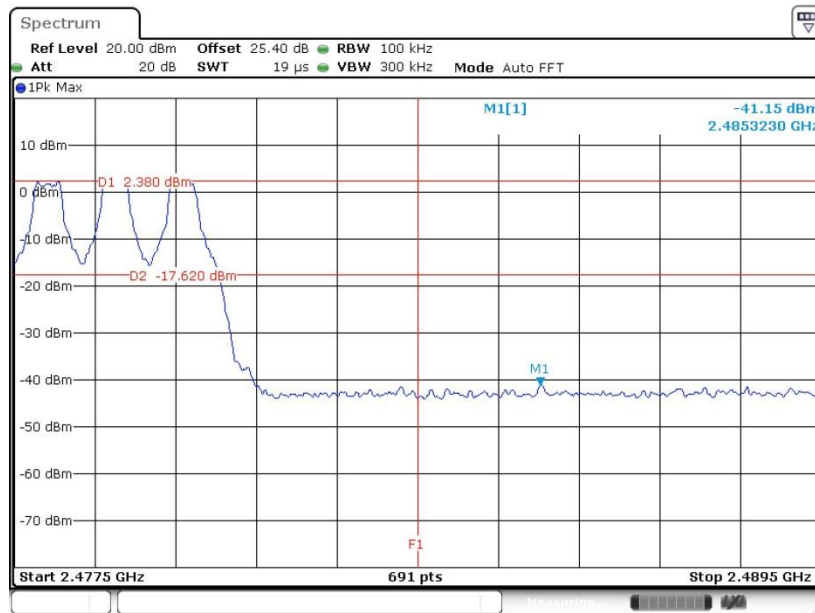



<2Mbps>

Hopping Mode Low Band Edge Plot

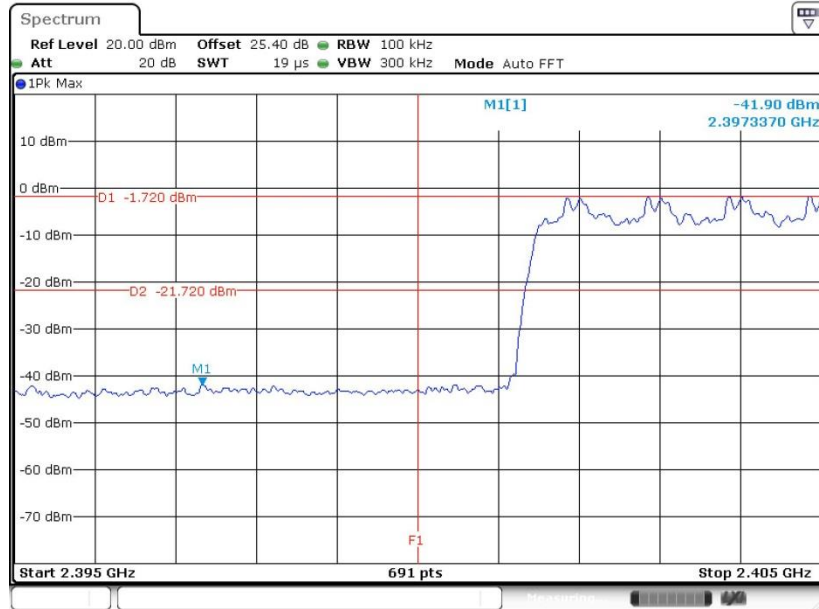

Date: 7.MAR.2019 11:55:24

Hopping Mode High Band Edge Plot

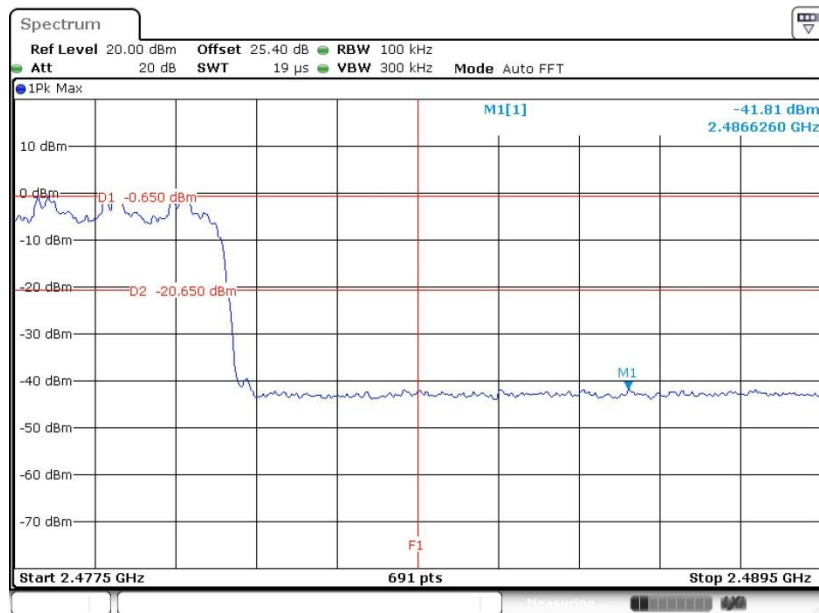

Date: 7.MAR.2019 11:54:40



<3Mbps>

Hopping Mode Low Band Edge Plot

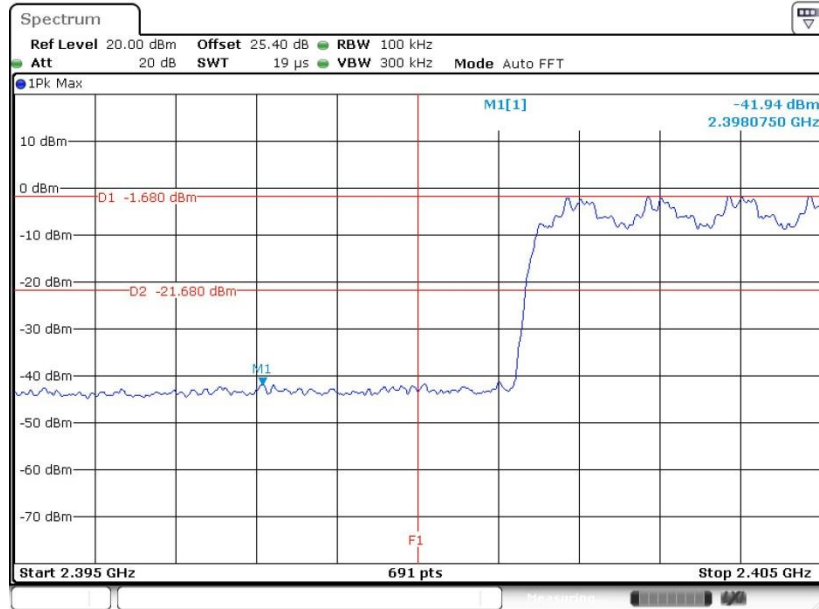

Date: 7.MAR.2019 11:56:46

Hopping Mode High Band Edge Plot

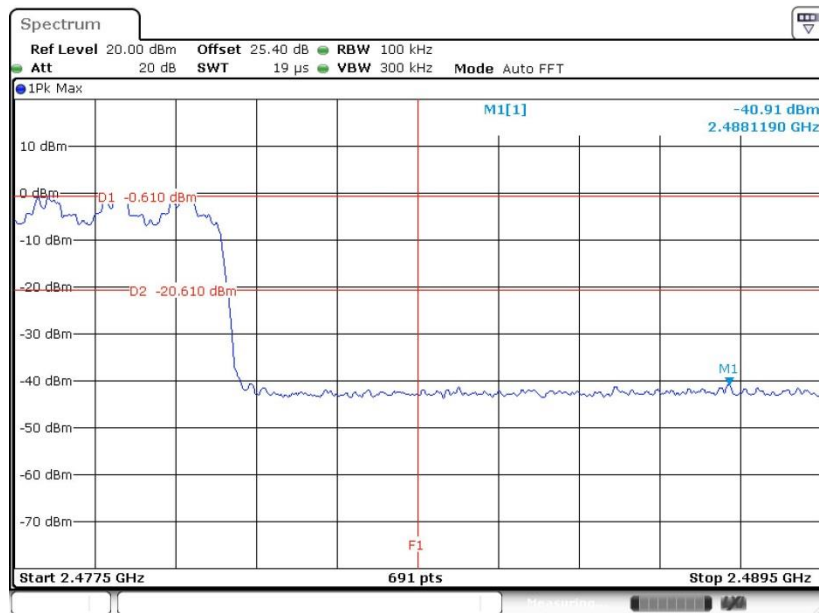

Date: 7.MAR.2019 11:57:52

## 3.7 Conducted Spurious Emission Measurement

### 3.7.1 Limit of Spurious Emission Measurement

In any 100 kHz bandwidth outside the intentional radiation frequency band, the radio frequency power shall be at least 20 dB below the highest level of the radiated power. In addition, radiated emissions which fall in the restricted bands must also comply with the radiated emission limits.

### 3.7.2 Measuring Instruments

See list of measuring equipment of this test report.

### 3.7.3 Test Procedure

1. The testing follows ANSI C63.10-2013 clause 7.8.8.
2. The RF output of EUT was connected to the spectrum analyzer by RF cable and attenuator. The path loss was compensated to the results for each measurement.
3. Set to the maximum power setting and enable the EUT transmit continuously.
4. Set RBW = 100 kHz, VBW = 300kHz, scan up through 10th harmonic. All harmonics / spurs must be at least 20 dB down from the highest emission level within the authorized band as measured with a 100 kHz RBW.
5. Measure and record the results in the test report.
6. The RF fundamental frequency should be excluded against the limit line in the operating frequency band.

### 3.7.4 Test Setup

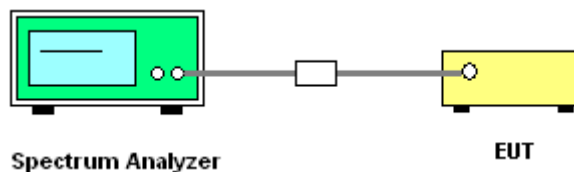



### 3.7.5 Test Result of Conducted Spurious Emission

Test Engineer :	Howard Lin, Tommy Lee and Kai Liao	Temperature :	21~25°C
		Relative Humidity :	51~54%

<1Mbps>

CSE Plot on Ch 00 between 30MHz ~ 3 GHz

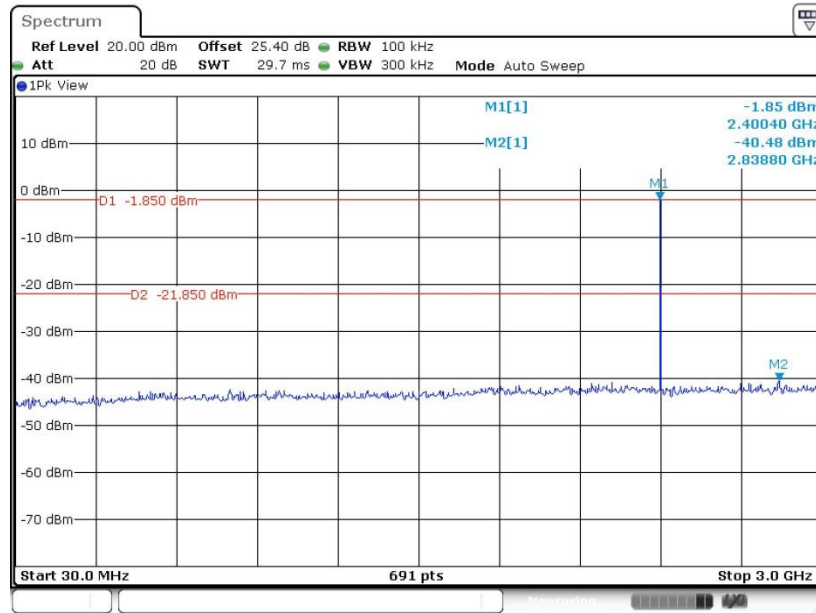

Date: 7.MAR.2019 09:05:26

1Mbps CSE Plot on Ch 00 between 2 GHz ~ 25 GHz

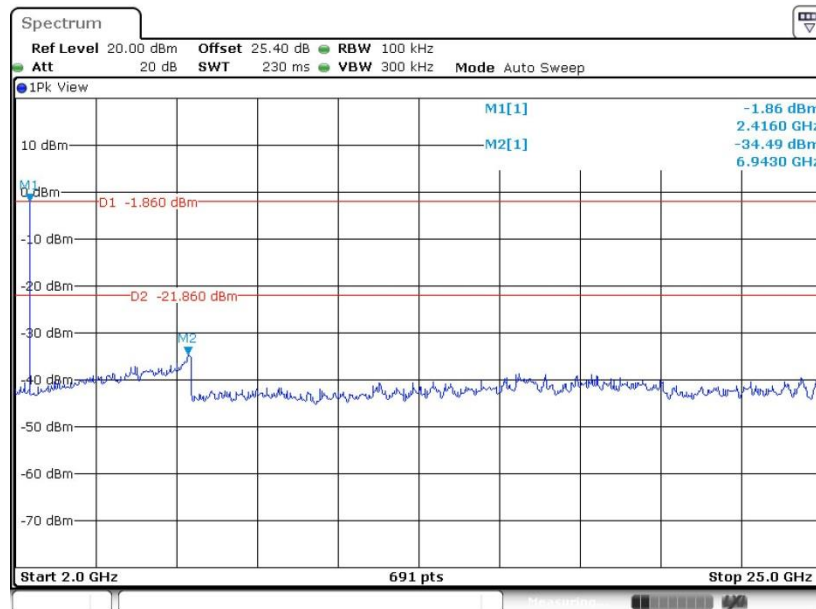

Date: 7.MAR.2019 09:06:01



CSE Plot on Ch 39 between 30MHz ~ 3 GHz

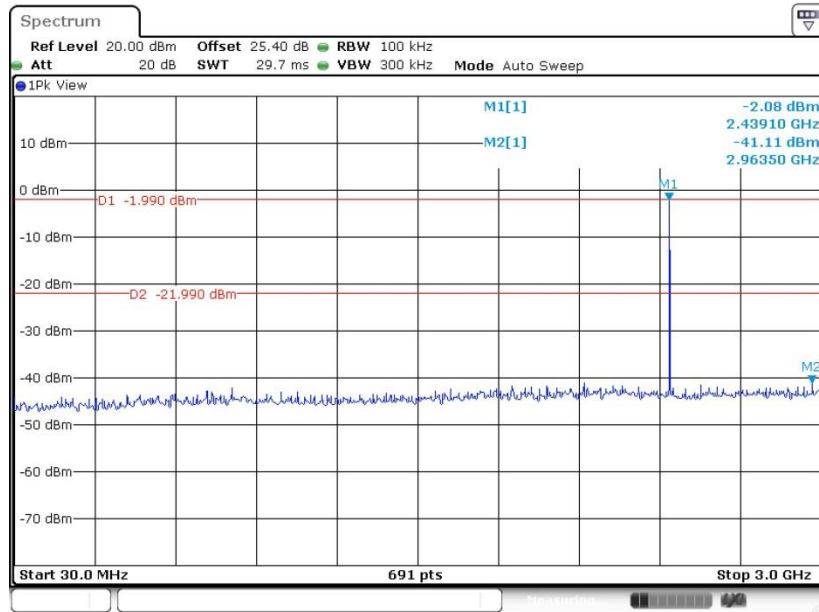

Date: 7.MAR.2019 09:18:15

CSE Plot on Ch 39 between 2 GHz ~ 25 GHz

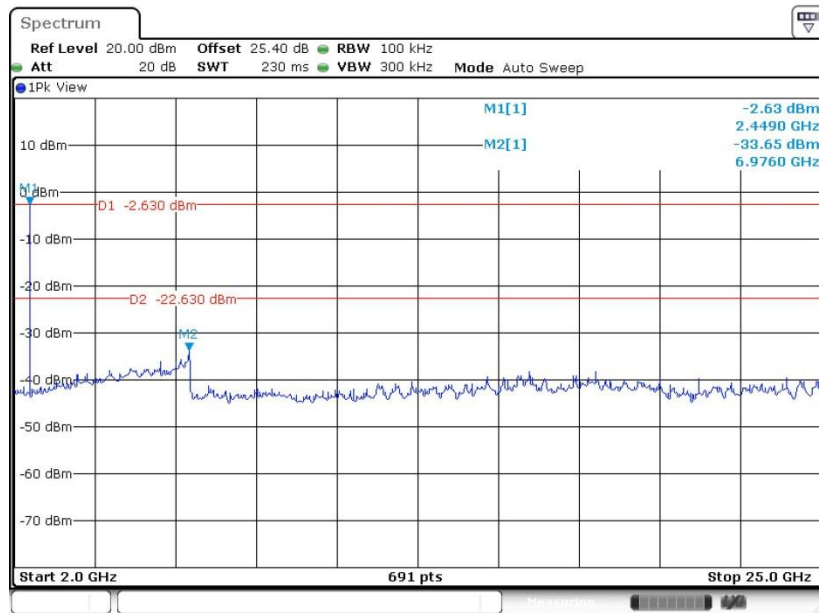

Date: 7.MAR.2019 09:18:49



CSE Plot on Ch 78 between 30MHz ~ 3 GHz

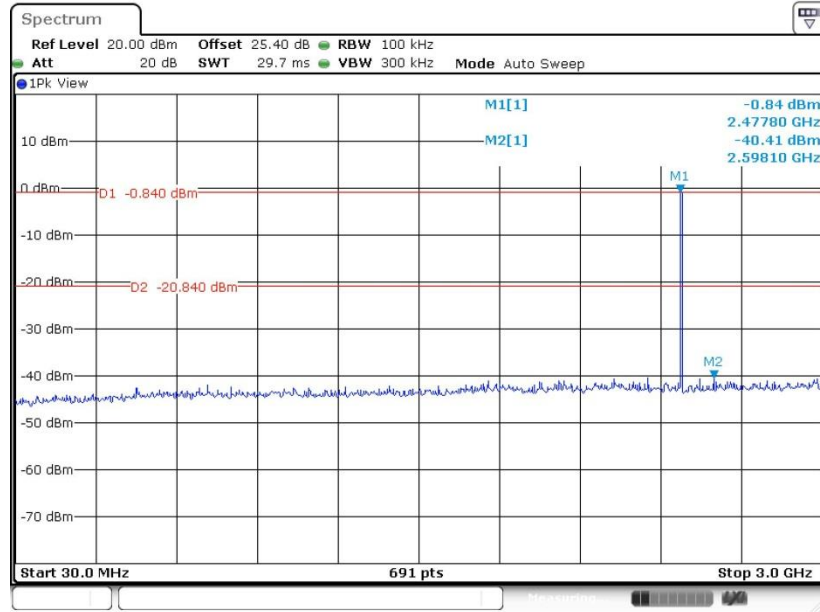

Date: 7.MAR.2019 09:33:47

CSE Plot on Ch 78 between 2 GHz ~ 25 GHz

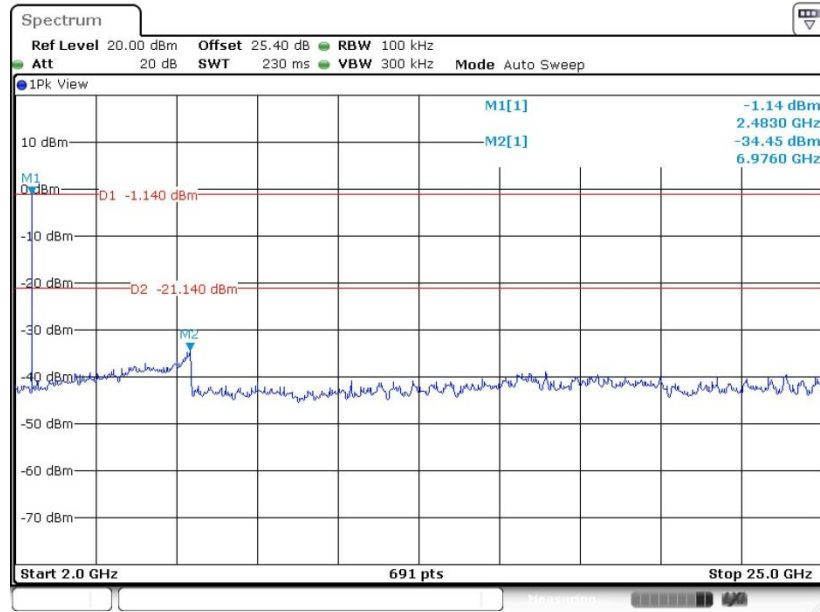

Date: 7.MAR.2019 09:34:31



<2Mbps>

CSE Plot on Ch 00 between 30MHz ~ 3 GHz

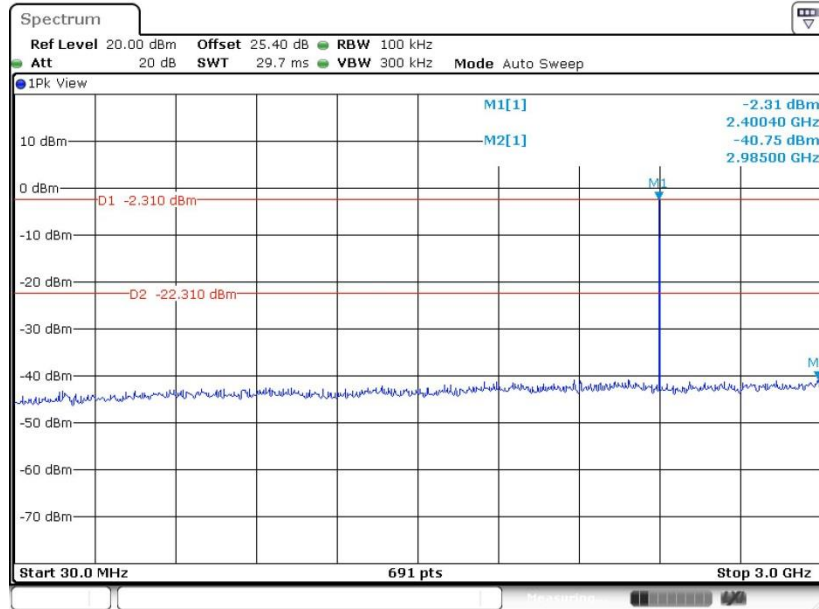

Date: 7.MAR.2019 11:02:04

CSE Plot on Ch 00 between 2 GHz ~ 25 GHz

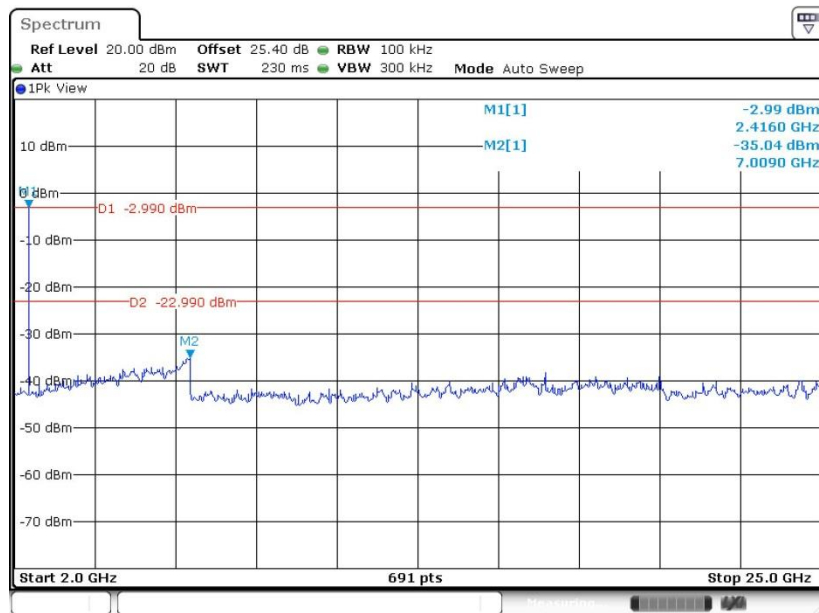

Date: 7.MAR.2019 11:09:36





CSE Plot on Ch 39 between 30MHz ~ 3 GHz

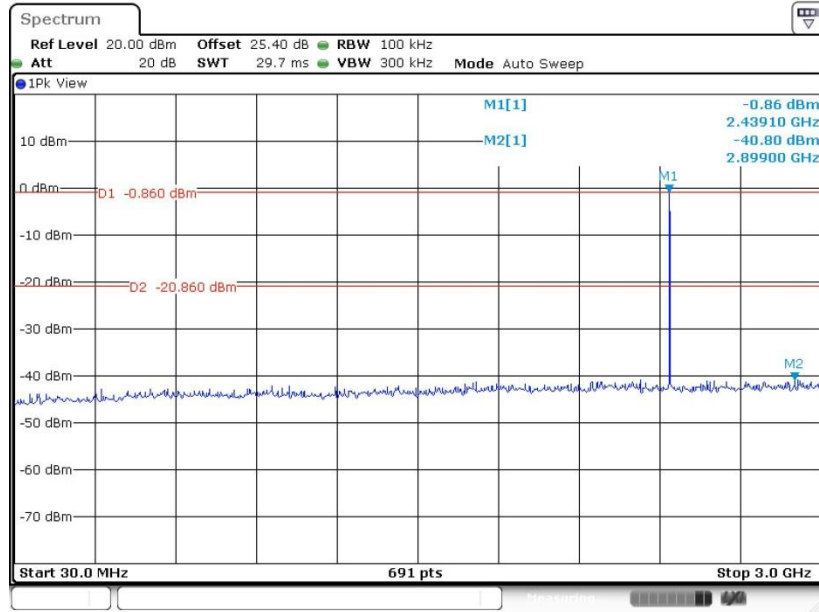

Date: 7.MAR.2019 11:20:39

CSE Plot on Ch 39 between 2 GHz ~ 25 GHz

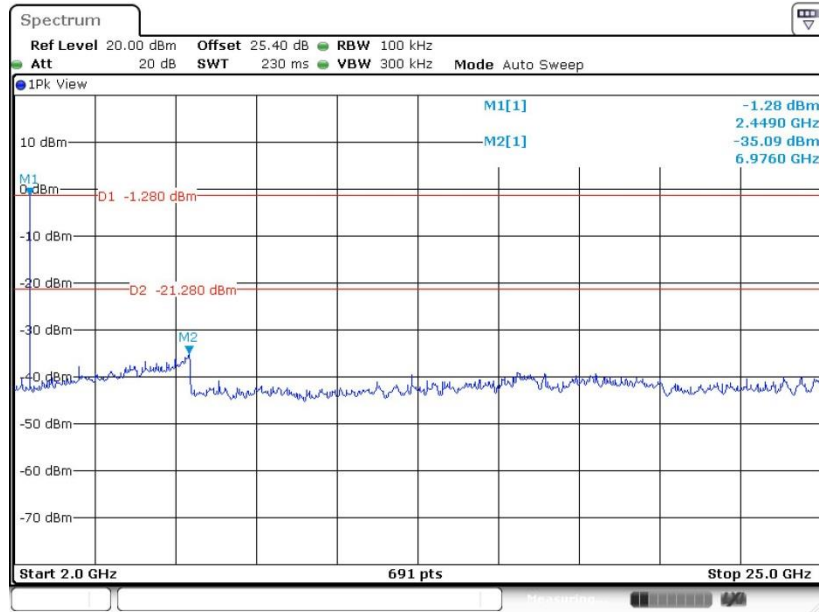

Date: 7.MAR.2019 11:21:18



CSE Plot on Ch 78 between 30MHz ~ 3 GHz

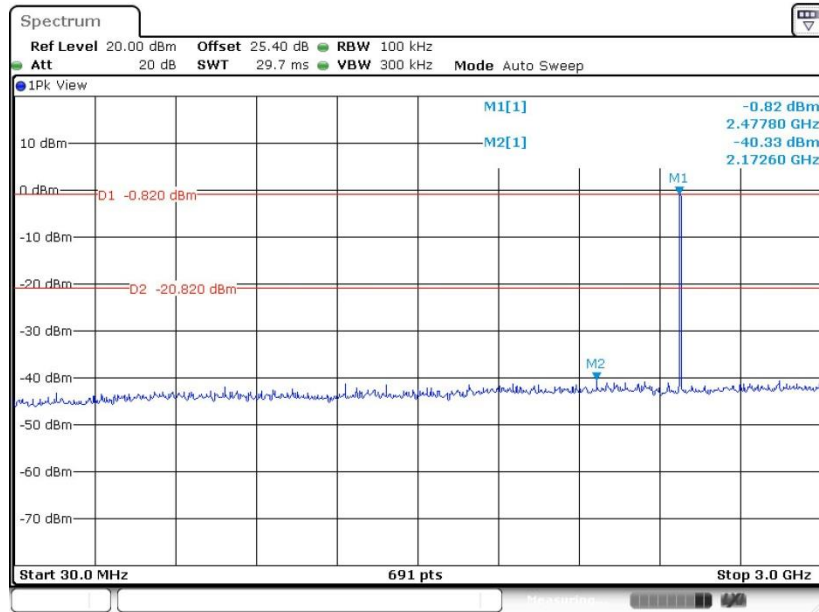

Date: 7.MAR.2019 11:51:13

CSE Plot on Ch 78 between 2 GHz ~ 25 GHz

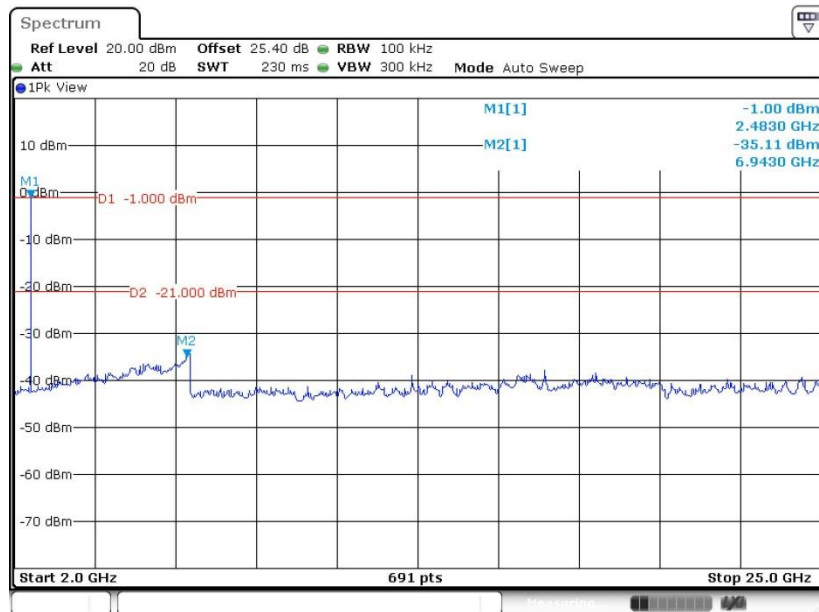

Date: 7.MAR.2019 11:53:48



<3Mbps>

CSE Plot on Ch 00 between 30MHz ~ 3 GHz

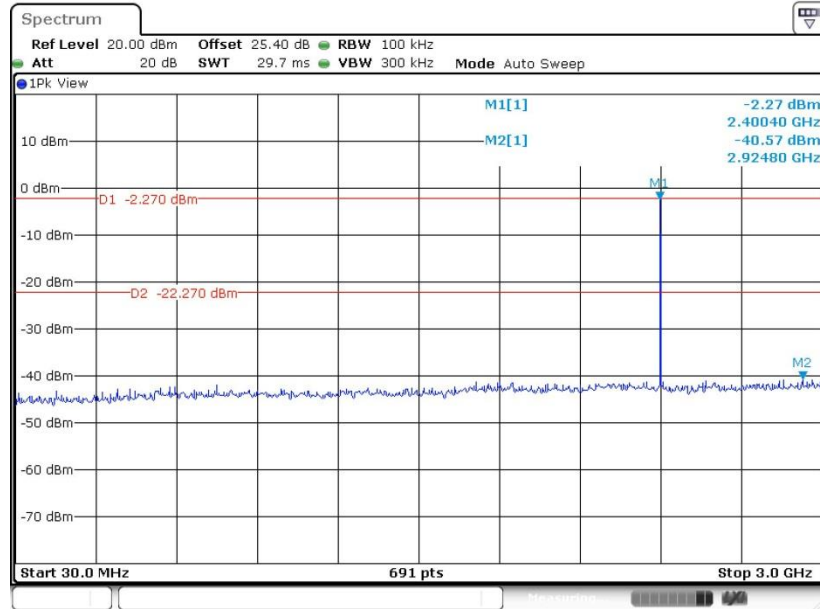

CSE Plot on Ch 00 between 2 GHz ~ 25 GHz

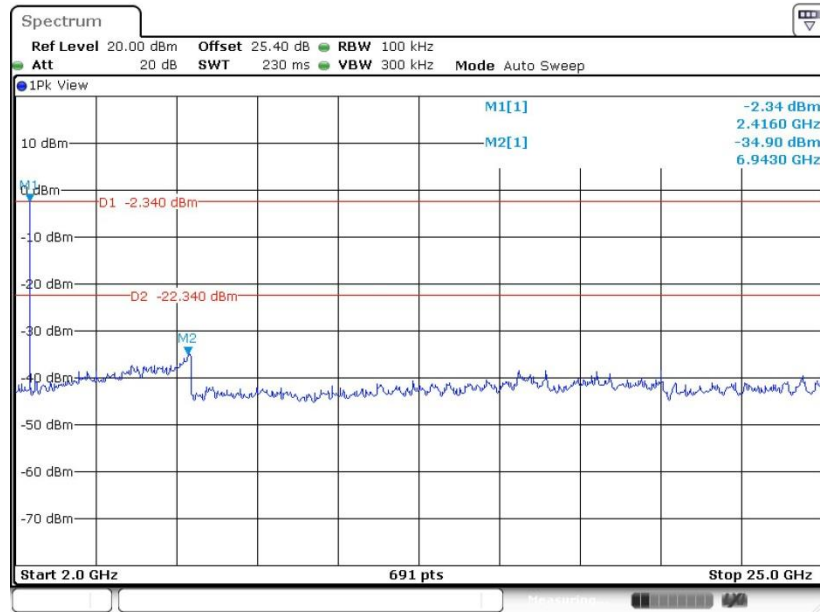



CSE Plot on Ch 39 between 30MHz ~ 3 GHz

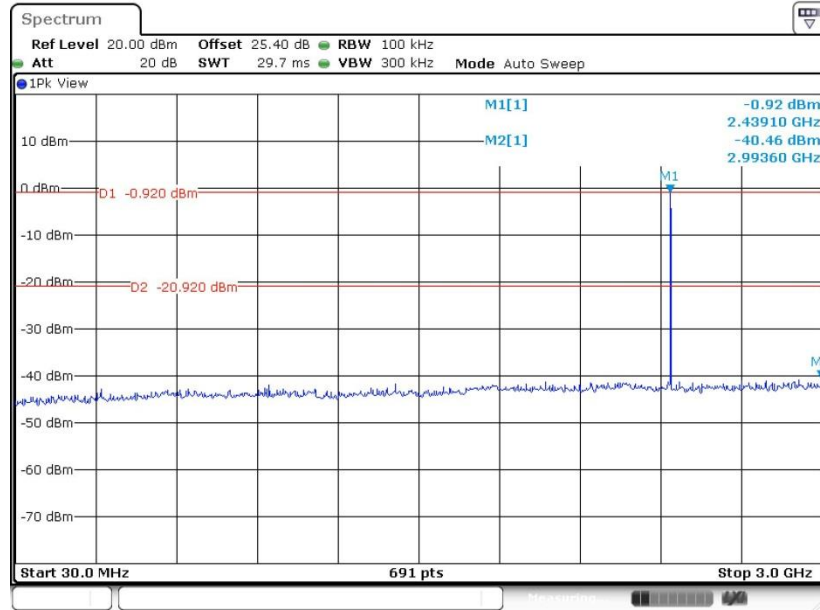

Date: 7.MAR.2019 12:14:38

CSE Plot on Ch 39 between 2 GHz ~ 25 GHz

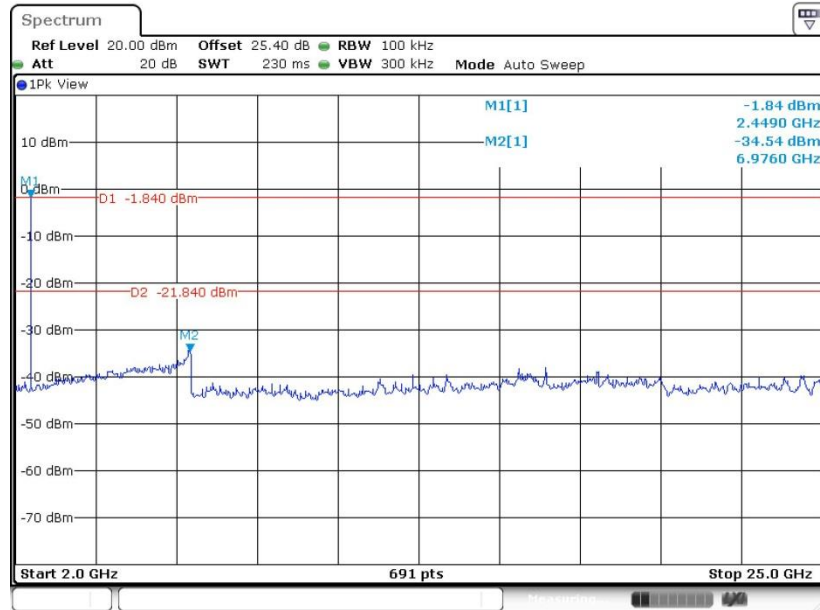

Date: 7.MAR.2019 12:16:26