



FCC RADIO TEST REPORT

FCC ID : UZ7MC930P
Equipment : Mobile computer
Brand Name : Zebra
Model Name : MC930P
Applicant : Zebra Technologies Corporation
1 Zebra Plaza, Holtsville, NY 11742
Manufacturer : Zebra Technologies Corporation
1 Zebra Plaza, Holtsville, NY 11742
Standard : FCC Part 15 Subpart C §15.247

The product was received on Nov. 26, 2018 and testing was started from Dec. 25, 2018 and completed on Mar. 11, 2019. We, SPORTON INTERNATIONAL INC. EMC & Wireless Communications Laboratory, would like to declare that the tested sample has been evaluated in accordance with the test procedures and has been in compliance with the applicable technical standards.

The report must not be used by the client to claim product certification, approval, or endorsement by TAF or any agency of government.

The test results in this report apply exclusively to the tested model / sample. Without written approval of SPORTON INTERNATIONAL INC. EMC & Wireless Communications Laboratory, the test report shall not be reproduced except in full.

Approved by: Jones Tsai

SPORTON INTERNATIONAL INC. EMC & Wireless Communications Laboratory

No. 52, Huaya 1st Rd., Guishan Dist., Taoyuan City, Taiwan (R.O.C.)



Table of Contents

| | |
|--|-----------|
| History of this test report..... | 3 |
| Summary of Test Result..... | 4 |
| 1 General Description..... | 5 |
| 1.1 Product Feature of Equipment Under Test..... | 5 |
| 1.2 Product Specification of Equipment Under Test..... | 6 |
| 1.3 Modification of EUT | 6 |
| 1.4 Testing Location | 7 |
| 1.5 Applicable Standards..... | 7 |
| 2 Test Configuration of Equipment Under Test..... | 8 |
| 2.1 Carrier Frequency Channel | 8 |
| 2.2 Test Mode..... | 9 |
| 2.3 Connection Diagram of Test System..... | 11 |
| 2.4 Support Unit used in test configuration and system | 12 |
| 2.5 EUT Operation Test Setup | 12 |
| 2.6 Measurement Results Explanation Example..... | 12 |
| 3 Test Result..... | 13 |
| 3.1 6dB and 99% Bandwidth Measurement | 13 |
| 3.2 Output Power Measurement..... | 22 |
| 3.3 Power Spectral Density Measurement | 24 |
| 3.4 Conducted Band Edges and Spurious Emission Measurement | 32 |
| 3.5 Radiated Band Edges and Spurious Emission Measurement | 41 |
| 3.6 AC Conducted Emission Measurement..... | 45 |
| 3.7 Antenna Requirements..... | 47 |
| 4 List of Measuring Equipment | 48 |
| 5 Uncertainty of Evaluation..... | 50 |
| Appendix A. AC Conducted Emission Test Result | |
| Appendix B. Radiated Spurious Emission | |
| Appendix C. Radiated Spurious Emission Plots | |
| Appendix D. Duty Cycle Plots | |
| Appendix E. Setup Photographs | |



Summary of Test Result

| Report Clause | Ref Std. Clause | Test Items | Result (PASS/FAIL) | Remark |
|---------------|-----------------------|--|--------------------|--|
| 3.1 | 15.247(a)(2) | 6dB Bandwidth | Pass | - |
| 3.1 | 2.1049 | 99% Occupied Bandwidth | Reporting only | - |
| 3.2 | 15.247(b)(3) | Output Power | Pass | - |
| 3.3 | 15.247(e) | Power Spectral Density | Pass | - |
| 3.4 | 15.247(d) | Conducted Band Edges and Spurious Emission | Pass | - |
| 3.5 | 15.247(d) | Radiated Band Edges and Spurious Emission | Pass | Under limit 3.18 dB at 946.800 MHz |
| 3.6 | 15.207 | AC Conducted Emission | Pass | Under limit 12.59 dB at 0.175 MHz |
| 3.7 | 15.203 & 15.247(b) | Antenna Requirement | Pass | - |

Declaration of Conformity:

The test results with all measurement uncertainty excluded are presented in accordance with the regulation limits or requirements declared by manufacturers.

Comments and Explanations:

The declared of product specification for EUT presented in the report are provided by the manufacturer, and the manufacturer takes all the responsibilities for the accuracy of product specification.

Reviewed by: Wii Chang**Report Producer: Yimin Ho**



1 General Description

1.1 Product Feature of Equipment Under Test

| Product Feature | |
|---------------------------------|---|
| Equipment | Mobile computer |
| Brand Name | Zebra |
| Model Name | MC930P |
| FCC ID | UZ7MC930P |
| Sample 1 | EUT with SKU 3 |
| Sample 2 | EUT with SKU 4 |
| Sample 3 | EUT with SKU 5 |
| Sample 4 | EUT with SKU 6 |
| Sample 5 | EUT with SKU 7 |
| EUT supports Radios application | NFC WLAN 11a/b/g/n HT20/HT40 WLAN 11ac VHT20/VHT40/VHT80 Bluetooth BR/EDR/LE |
| HW Version | EV1 |
| SW Version | 01-14-11.00-OG |
| MFD | 13NOV18 |
| EUT Stage | Engineering Sample |

Remark: The above EUT's information was declared by manufacturer.

| Specification of Accessories | | | | |
|------------------------------|------------|-------|-------------|--------------------|
| Adapter (5V/2.5A) | Brand Name | Zebra | Part Number | PWR-WUA5V12W0US |
| USB-C Adapter | Brand Name | Zebra | Part Number | CBL-MC93-USBCHG-01 |
| USB-C cable | Brand Name | Zebra | Part Number | CBL-TC2X-USBC-01 |
| Std Battery | Brand Name | Zebra | Part Number | BT-000370-00 |
| Fzr Battery | Brand Name | Zebra | Part Number | BT-000371-00 |
| Holster | Brand Name | Zebra | Part Number | 051607-79N1-18 |



<Sample Information>

| Model Name | MC930P | | | | |
|---------------------------------|---------------------|---------------------|---------------------|---------------------|---------------------|
| | SKU3 | SKU4 | SKU5 | SKU6 | SKU7 |
| Organization / Function / Group | EV1a-G21 | EV1a-G22 | EV1a-G23 | EV1a-F11 | EV1a-F13 |
| nm | G-2S-1D-53k | G-2S-2D-53k | G-2S-LRI-53k | G-1F-1D-53k | G-1F-LRI-53k |
| Product Number | MC930P-GSBDG 4NA | MC930P-GSDDG 4NA | MC930P-GSFDG 4NA | MC930P-GFADG 4NA | MC930P-GFEDG 4NA |
| Form factor | Gun | Gun | Gun | Gun | Gun |
| Package/ Component Category | Pkg2 | Pkg2 | Pkg2 | Pkg1 CS | Pkg 1 CS |
| NFC | YES | YES | YES | YES | YES |
| Vib | YES | YES | YES | YES | YES |
| Camera | YES | YES | YES | NO | NO |
| NI | NO | NO | NO | NO | NO |
| Side Trigger | NO | NO | NO | NO | NO |
| Display + TP Stackup | Option2 | Option2 | Option2 | Option5 | Option5 |
| Scanner | SE965 | SE4750SR | SE4850 | SE965 | SE4850 |
| Battery | Std | Std | Std | Fzr | Fzr |
| Keyboard | 53 Key | 53 Key | 53 Key | 53 Key | 53 Key |
| Build Date | Oct 2018 | Oct 2018 | Oct 2018 | Nov 2018 | Nov 2018 |

1.2 Product Specification of Equipment Under Test

| Standards-related Product Specification | |
|---|--|
| Tx/Rx Frequency Range | 2402 MHz ~ 2480 MHz |
| Number of Channels | 40 |
| Carrier Frequency of Each Channel | 40 Channel(37 hopping + 3 advertising channel) |
| Maximum Output Power to Antenna | 6.57 dBm (0.0045 W) for 1Mbps 6.56 dBm (0.0045 W) for 2Mbps |
| 99% Occupied Bandwidth | 1.030 MHz for 1Mbps 2.040 MHz for 2Mbps |
| Antenna Type / Gain | Patch Antenna with gain 3.85 dBi |
| Type of Modulation | Bluetooth LE : GFSK |

1.3 Modification of EUT

No modifications are made to the EUT during all test items.



1.4 Testing Location

| | | | |
|---------------------------|---|---------|-----------|
| Test Site | SPORTON INTERNATIONAL INC. | | |
| Test Site Location | No.52, Huaya 1st Rd., Guishan Dist., Taoyuan City, Taiwan (R.O.C.) TEL: +886-3-327-3456 FAX: +886-3-328-4978 | | |
| Test Site No. | Sporton Site No. | | |
| | TH05-HY | CO05-HY | 03CH07-HY |

Note: The test site complies with ANSI C63.4 2014 requirement.

FCC Designation No. TW1190

1.5 Applicable Standards

According to the specifications of the manufacturer, the EUT must comply with the requirements of the following standards:

- ♦ FCC Part 15 Subpart C §15.247
- ♦ FCC KDB Publication No. 558074 D01 DTS Meas. Guidance v05
- ♦ FCC KDB 414788 D01 Radiated Test Site v01r01.
- ♦ ANSI C63.10-2013

Remark:

1. All test items were verified and recorded according to the standards and without any deviation during the test.
2. This EUT has also been tested and complied with the requirements of FCC Part 15, Subpart B, recorded in a separate test report.



2 Test Configuration of Equipment Under Test

2.1 Carrier Frequency Channel

| Frequency Band | Channel | Freq. (MHz) | Channel | Freq. (MHz) |
|-----------------|---------|-------------|---------|-------------|
| 2400-2483.5 MHz | 0 | 2402 | 21 | 2444 |
| | 1 | 2404 | 22 | 2446 |
| | 2 | 2406 | 23 | 2448 |
| | 3 | 2408 | 24 | 2450 |
| | 4 | 2410 | 25 | 2452 |
| | 5 | 2412 | 26 | 2454 |
| | 6 | 2414 | 27 | 2456 |
| | 7 | 2416 | 28 | 2458 |
| | 8 | 2418 | 29 | 2460 |
| | 9 | 2420 | 30 | 2462 |
| | 10 | 2422 | 31 | 2464 |
| | 11 | 2424 | 32 | 2466 |
| | 12 | 2426 | 33 | 2468 |
| | 13 | 2428 | 34 | 2470 |
| | 14 | 2430 | 35 | 2472 |
| | 15 | 2432 | 36 | 2474 |
| | 16 | 2434 | 37 | 2476 |
| | 17 | 2436 | 38 | 2478 |
| | 18 | 2438 | 39 | 2480 |
| | 19 | 2440 | - | - |
| 20 | 2442 | - | - | |



2.2 Test Mode

| Channel | Frequency | Bluetooth – LE 1Mbps RF Average Output Power | |
|---------|-----------|--|--|
| | | Data Rate / Modulation | |
| | | GFSK | |
| | | 1Mbps | |
| Ch00 | 2402MHz | 3.83 dBm | |
| Ch19 | 2440MHz | 4.41 dBm | |
| Ch39 | 2480MHz | 5.85 dBm | |

| Channel | Frequency | Bluetooth – LE 1Mbps RF Peak Output Power | |
|---------|-----------|---|--|
| | | Data Rate / Modulation | |
| | | GFSK | |
| | | 1Mbps | |
| Ch00 | 2402MHz | 4.86 dBm | |
| Ch19 | 2440MHz | 5.40 dBm | |
| Ch39 | 2480MHz | 6.57 dBm | |

| Channel | Frequency | Bluetooth – LE 2Mbps RF Average Output Power | |
|---------|-----------|--|--|
| | | Data Rate / Modulation | |
| | | GFSK | |
| | | 2Mbps | |
| Ch00 | 2402MHz | 3.82 dBm | |
| Ch19 | 2440MHz | 4.39 dBm | |
| Ch39 | 2480MHz | 5.84 dBm | |

| Channel | Frequency | Bluetooth – LE 2Mbps RF Peak Output Power | |
|---------|-----------|---|--|
| | | Data Rate / Modulation | |
| | | GFSK | |
| | | 2Mbps | |
| Ch00 | 2402MHz | 4.82 dBm | |
| Ch19 | 2440MHz | 5.38 dBm | |
| Ch39 | 2480MHz | 6.56 dBm | |

- a. The EUT has been associated with peripherals and configuration operated in a manner tended to maximize its emission characteristics in a typical application. Frequency range investigated: conduction emission (150 kHz to 30 MHz), radiation emission (9 kHz to the 10th harmonic of the highest fundamental frequency or to 40 GHz, whichever is lower). For radiated measurement, pre-scanned in three orthogonal panels, X, Y, Z. The worst cases (X plane) were recorded in this report.
- b. AC power line Conducted Emission was tested under maximum output power.

The following summary table is showing all test modes to demonstrate in compliance with the standard.

| Summary table of Test Cases | |
|---|--|
| Test Item | Data Rate / Modulation |
| | Bluetooth – LE / GFSK |
| Conducted Test Cases | Mode 1: Bluetooth Tx CH00_2402 MHz_1Mbps Mode 2: Bluetooth Tx CH19_2440 MHz_1Mbps Mode 3: Bluetooth Tx CH39_2480 MHz_1Mbps Mode 4: Bluetooth Tx CH00_2402 MHz_2Mbps Mode 5: Bluetooth Tx CH19_2440 MHz_2Mbps Mode 6: Bluetooth Tx CH39_2480 MHz_2Mbps |
| Radiated Test Cases | Mode 1: Bluetooth Tx CH00_2402 MHz_1Mbps Mode 2: Bluetooth Tx CH19_2440 MHz_1Mbps Mode 3: Bluetooth Tx CH39_2480 MHz_1Mbps Mode 4: Bluetooth Tx CH00_2402 MHz_2Mbps Mode 5: Bluetooth Tx CH19_2440 MHz_2Mbps Mode 6: Bluetooth Tx CH39_2480 MHz_2Mbps |
| AC Conducted Emission | Mode 1: Bluetooth Link + WLAN (2.4GHz) Link + Scan + MP3 Play + Keypad (53) + Std Battery + USB-C Adapter + USB-C Cable + Data Link with Notebook (Notebook to SD Card) for Sample 2 |
| Remark: For Radiated Test Cases, the tests were performed with Std Battery and Sample 1. | |

2.3 Connection Diagram of Test System

<Bluetooth – LE Tx Mode>

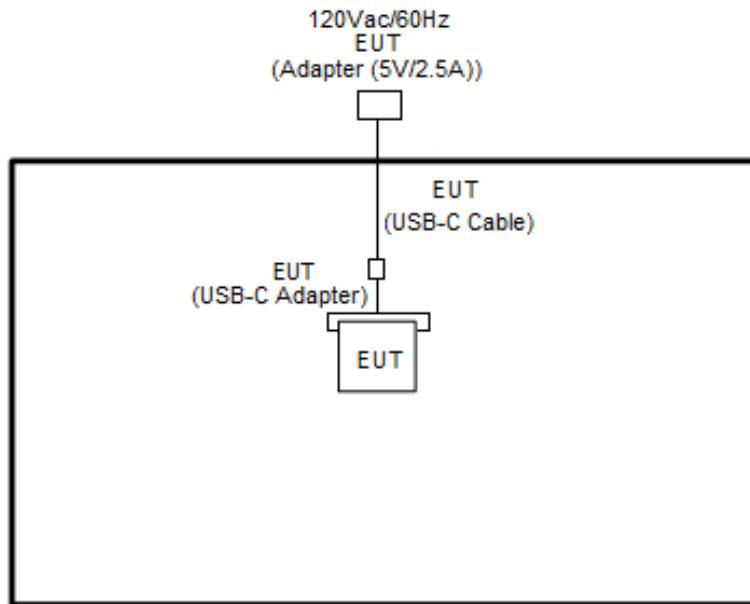

<AC Conducted Emission Mode>

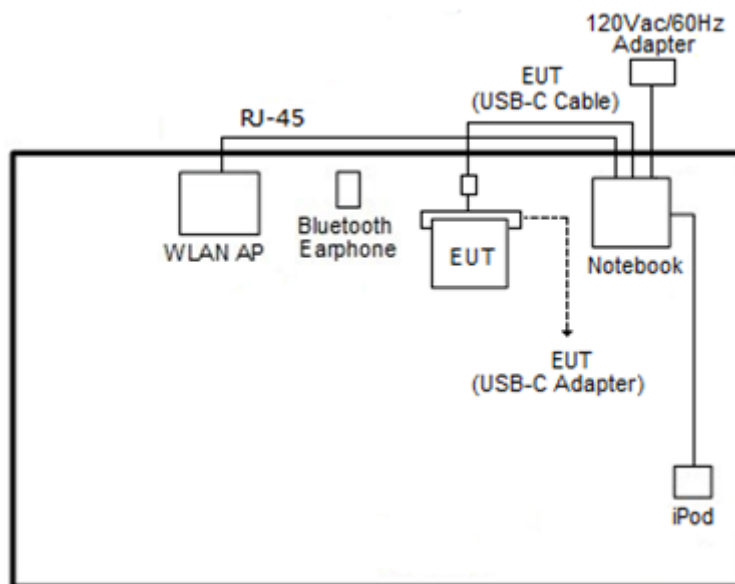

2.4 Support Unit used in test configuration and system

| Item | Equipment | Trade Name | Model Name | FCC ID | Data Cable | Power Cord |
|------|--------------------|---------------|----------------|--|-----------------|--|
| 1. | WLAN AP | ASUS | RT-AC66U | MSQ-RTAC66U | N/A | Unshielded, 1.8 m |
| 2. | Bluetooth Earphone | Sony Ericsson | MW600 | PY7DDA-2029 | N/A | N/A |
| 3. | Notebook | DELL | Latitude E6320 | FCC DoC/ Contains FCC ID: QDS-BRCM1054 | N/A | AC I/P: Unshielded, 1.2 m DC O/P: Shielded, 1.8 m |
| 4. | iPod | Apple | A1285 | FCC DoC | Shielded, 1.0 m | N/A |
| 5. | SD Card | SanDisk | MicroSD HC | FCC DoC | N/A | N/A |

2.5 EUT Operation Test Setup

The RF test items, utility “QRCT” was installed in Notebook which was programmed in order to make the EUT get into the engineering modes to provide channel selection, power level, data rate and the application type and for continuous transmitting signals.

2.6 Measurement Results Explanation Example

For all conducted test items:

The offset level is set in the spectrum analyzer to compensate the RF cable loss and attenuator factor between EUT conducted output port and spectrum analyzer. With the offset compensation, the spectrum analyzer reading level is exactly the EUT RF output level.

Example :

The spectrum analyzer offset is derived from RF cable loss and attenuator factor.

Offset = RF cable loss + attenuator factor.

Following shows an offset computation example with cable loss 4.2 dB and 10dB attenuator.

$$\begin{aligned}
 \text{Offset(dB)} &= \text{RF cable loss(dB)} + \text{attenuator factor(dB)}. \\
 &= 4.2 + 10 = 14.2 \text{ (dB)}
 \end{aligned}$$

3 Test Result

3.1 6dB and 99% Bandwidth Measurement

3.1.1 Limit of 6dB and 99% Bandwidth

The minimum 6 dB bandwidth shall be at least 500 kHz.

3.1.2 Measuring Instruments

See list of measuring equipment of this test report.

3.1.3 Test Procedures

1. The testing follows the ANSI C63.10 Section 6.9.3 (OBW) and 11.8.1 (6dB BW).
2. The RF output of EUT was connected to the spectrum analyzer by RF cable and attenuator. The path loss was compensated to the results for each measurement.
3. Set to the maximum power setting and enable the EUT transmit continuously.
4. Make the measurement with the spectrum analyzer's resolution bandwidth (RBW) = 100 kHz. Set the Video bandwidth (VBW) = 300 kHz. In order to make an accurate measurement. The 6 dB bandwidth must be greater than 500 kHz.
5. For 99% Bandwidth Measurement, the spectrum analyzer's resolution bandwidth (RBW) is set 1-5% of the emission bandwidth and set the Video bandwidth (VBW) $\geq 3 * RBW$.
6. Measure and record the results in the test report.

3.1.4 Test Setup





3.1.5 Test Result of 6dB Bandwidth

| | | | |
|-----------------|------------------------|---------------------|---------|
| Test Engineer : | Kai Liao and Luffy Lin | Temperature : | 21~25°C |
| | | Relative Humidity : | 51~54% |

| Mod. | Data Rate | NTX | CH. | Freq. (MHz) | 6dB BW (MHz) | 6dB BW Limit (MHz) | Pass/Fail |
|------|-----------|-----|-----|-------------|--------------|--------------------|-----------|
| BLE | 1Mbps | 1 | 0 | 2402 | 0.660 | 0.50 | Pass |
| BLE | 1Mbps | 1 | 19 | 2440 | 0.664 | 0.50 | Pass |
| BLE | 1Mbps | 1 | 39 | 2480 | 0.660 | 0.50 | Pass |
| BLE | 2Mbps | 1 | 0 | 2402 | 1.128 | 0.50 | Pass |
| BLE | 2Mbps | 1 | 19 | 2440 | 1.136 | 0.50 | Pass |
| BLE | 2Mbps | 1 | 39 | 2480 | 1.136 | 0.50 | Pass |

<1 Mbps>

6 dB Bandwidth Plot on Channel 00

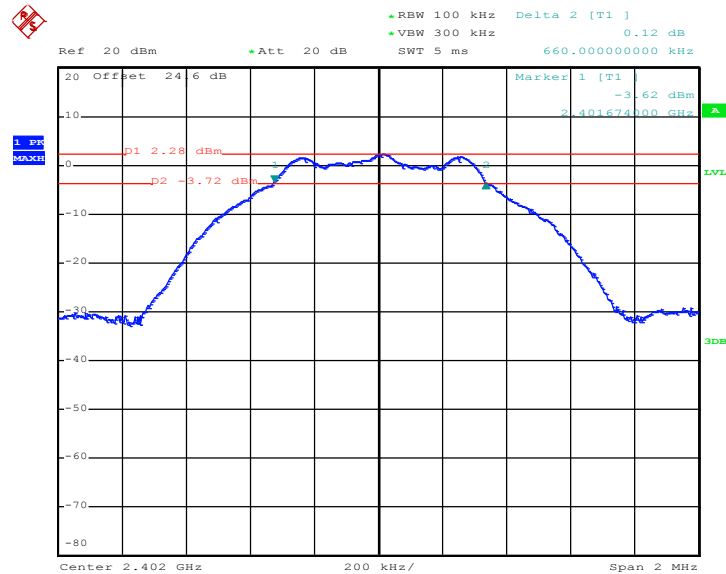

Date: 11.MAR.2019 11:13:48



6 dB Bandwidth Plot on Channel 19

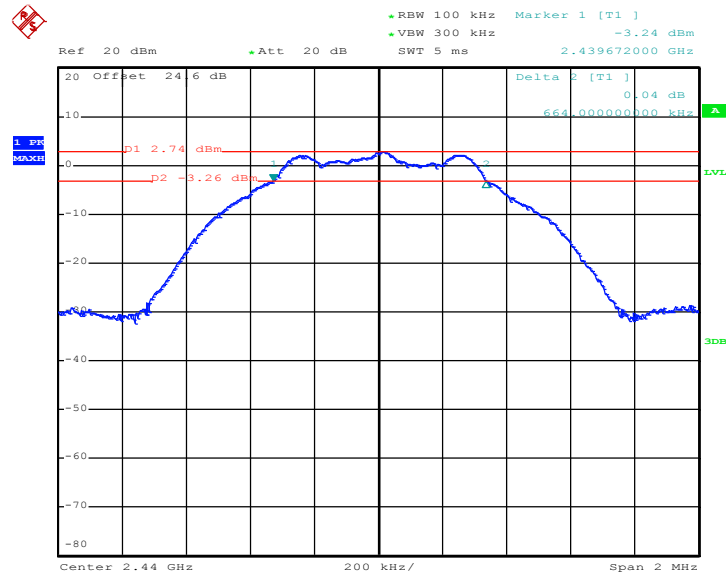

Date: 11.MAR.2019 11:18:50

6 dB Bandwidth Plot on Channel 39

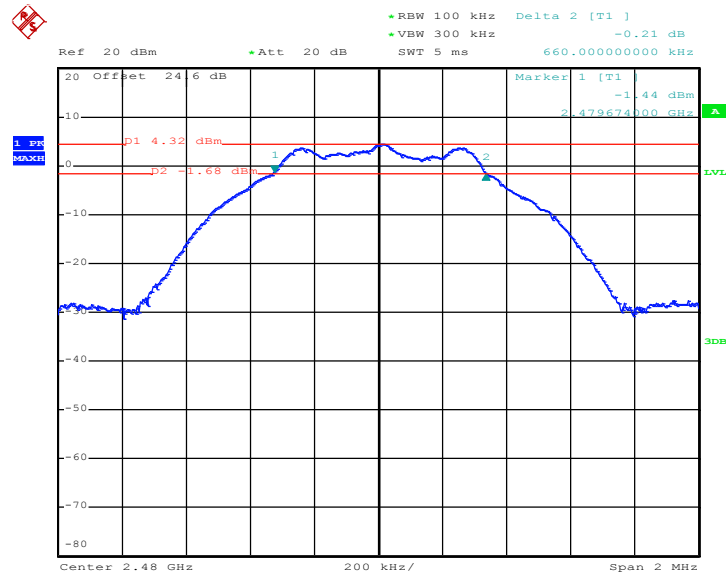

Date: 11.MAR.2019 11:22:08



<2 Mbps>

6 dB Bandwidth Plot on Channel 00

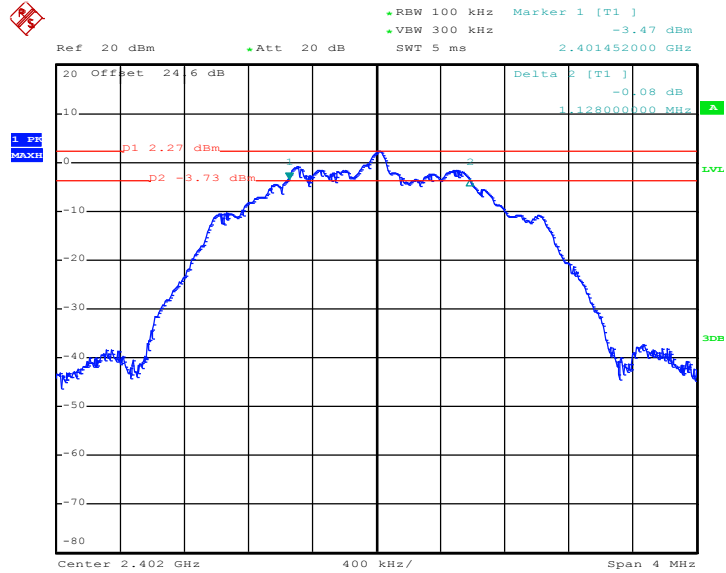

Date: 11.MAR.2019 11:27:26

6 dB Bandwidth Plot on Channel 19

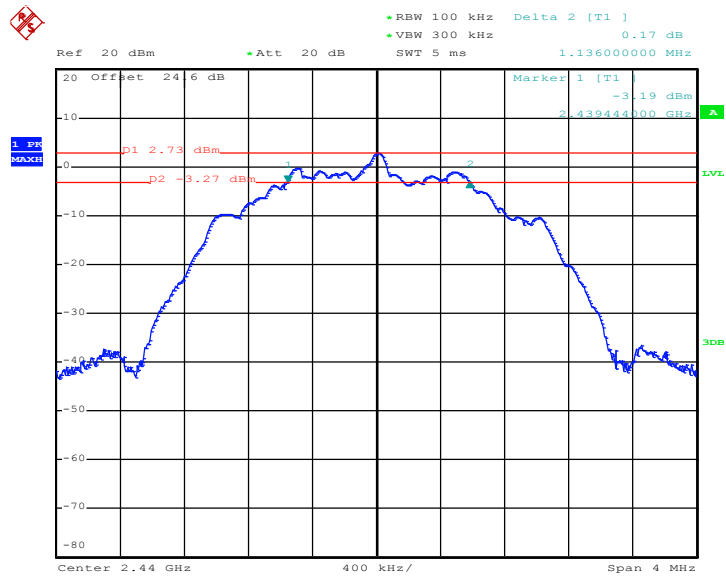

Date: 11.MAR.2019 11:31:51



6 dB Bandwidth Plot on Channel 39

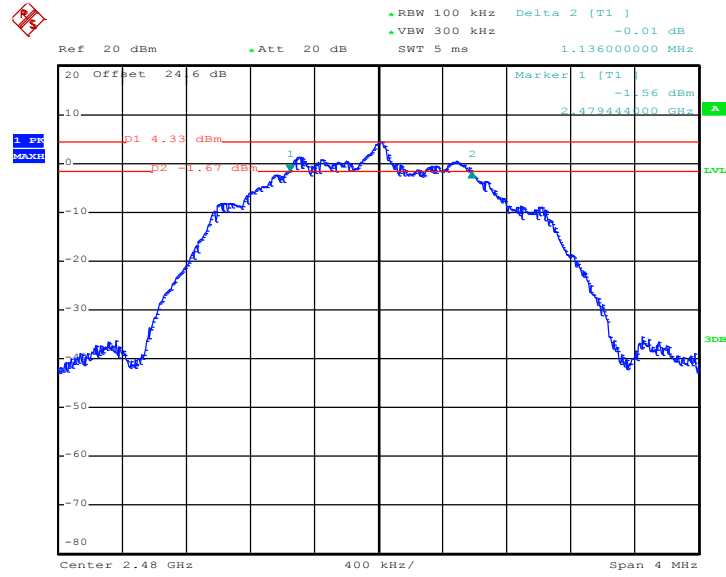

Date: 11.MAR.2019 11:37:02



3.1.6 Test Result of 99% Occupied Bandwidth

| | | | |
|-----------------|------------------------|---------------------|---------|
| Test Engineer : | Kai Liao and Luffy Lin | Temperature : | 21~25°C |
| | | Relative Humidity : | 51~54% |

| Mod. | Data Rate | NTX | CH. | Freq. (MHz) | 99% Occupied BW (MHz) | Pass/Fail |
|------|-----------|-----|-----|-------------|-----------------------|-----------|
| BLE | 1Mbps | 1 | 0 | 2402 | 1.028 | Pass |
| BLE | 1Mbps | 1 | 19 | 2440 | 1.028 | Pass |
| BLE | 1Mbps | 1 | 39 | 2480 | 1.030 | Pass |
| BLE | 2Mbps | 1 | 0 | 2402 | 2.040 | Pass |
| BLE | 2Mbps | 1 | 19 | 2440 | 2.040 | Pass |
| BLE | 2Mbps | 1 | 39 | 2480 | 2.040 | Pass |

<1 Mbps>

99% Bandwidth Plot on Channel 00

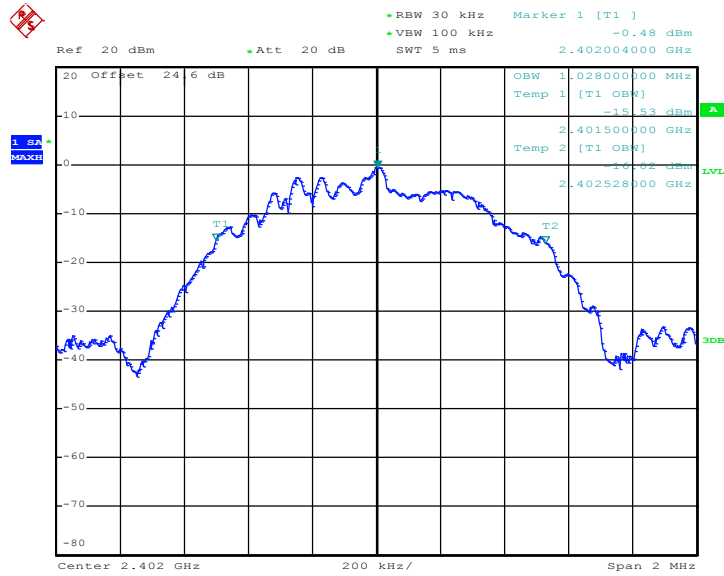

Date: 11.MAR.2019 11:16:28



99% Occupied Bandwidth Plot on Channel 19

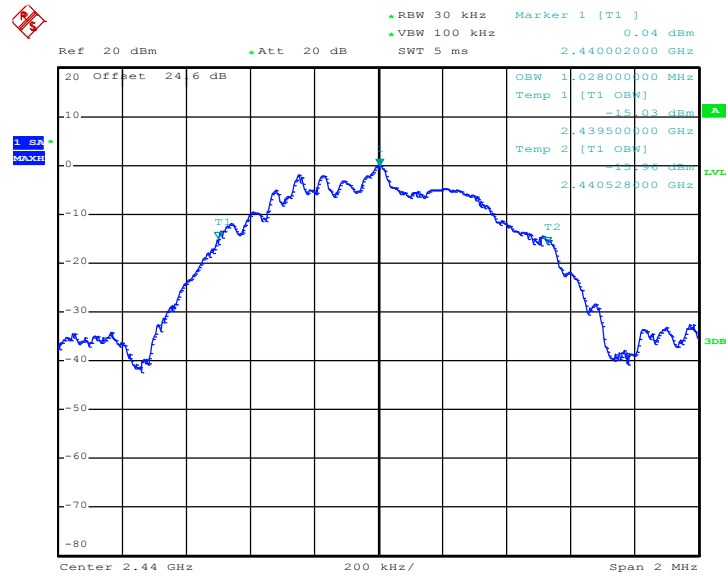

Date: 11.MAR.2019 11:20:08

99% Occupied Bandwidth Plot on Channel 39

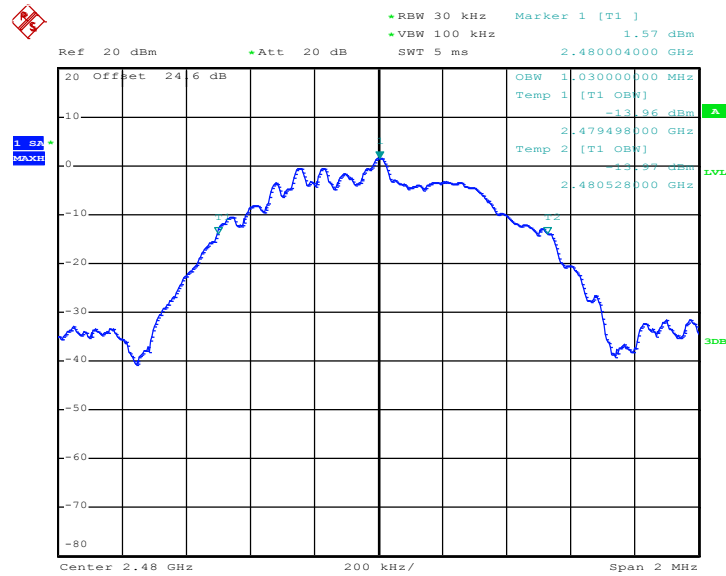

Date: 11.MAR.2019 11:24:21



<2 Mbps>

99% Bandwidth Plot on Channel 00

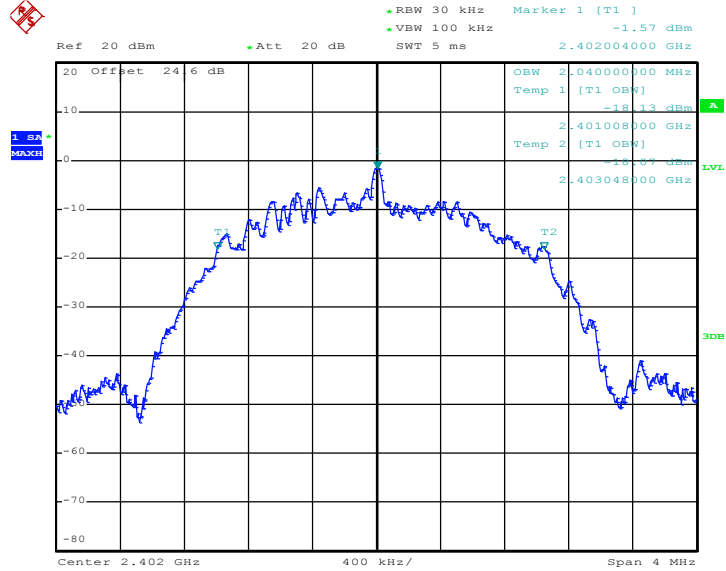

Date: 11.MAR.2019 11:30:26

99% Occupied Bandwidth Plot on Channel 19

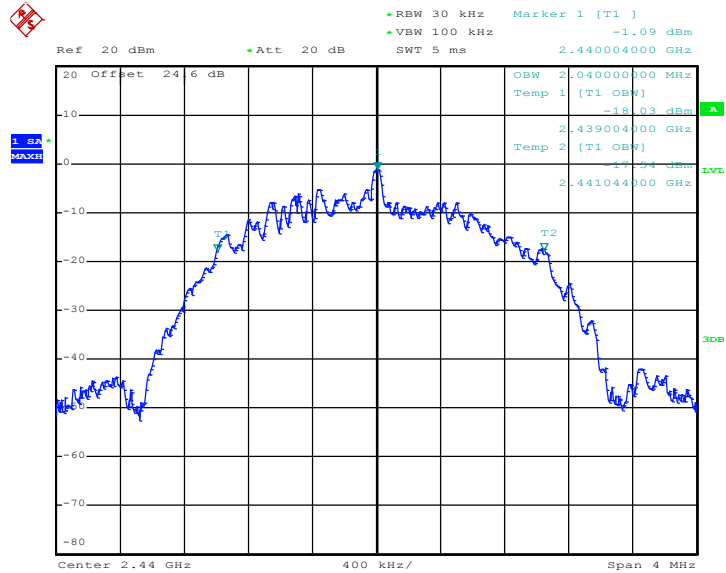

Date: 11.MAR.2019 11:33:38



99% Occupied Bandwidth Plot on Channel 39

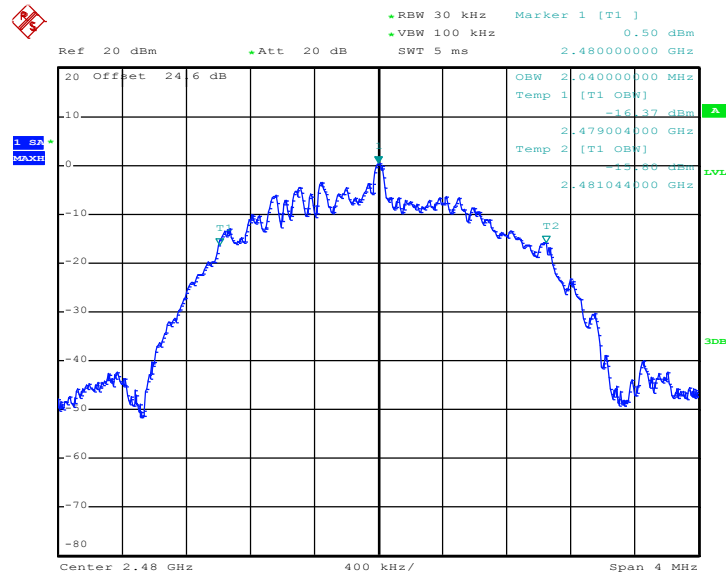

Date: 11.MAR.2019 11:41:05

Note: The occupied channel bandwidth is maintained within the band of operation for all of the modulations.

3.2 Output Power Measurement

3.2.1 Limit of Output Power

For systems using digital modulation in the 2400-2483.5MHz, the limit for peak output power is 30dBm. If transmitting antenna of directional gain greater than 6dBi is used, the peak output power from the intentional radiator shall be reduced below the above stated value by the amount in dB that the directional gain of the antenna exceeds 6 dBi. In case of point-to-point operation, the limit has to be reduced by 1dB for every 3dB that the directional gain of the antenna exceeds 6dBi.

3.2.2 Measuring Instruments

See list of measuring equipment of this test report.

3.2.3 Test Procedures

1. For Average Power, the testing follows ANSI C63.10 Section 11.9.2.3.2 Method AVGP-M-G.
2. The RF output of EUT was connected to the power meter by RF cable and attenuator.
3. The path loss was compensated to the results for each measurement.
4. Set to the maximum power setting and enable the EUT transmit continuously.
5. Measure the conducted output power and record the results in the test report.

3.2.4 Test Setup

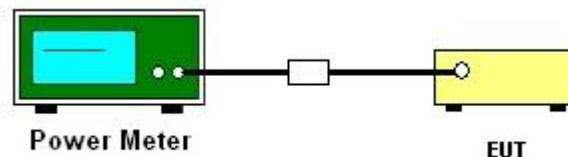



3.2.5 Test Result of Average Output Power

| | | | |
|-----------------|------------------------|---------------------|---------|
| Test Engineer : | Kai Liao and Luffy Lin | Temperature : | 21~25°C |
| | | Relative Humidity : | 51~54% |

| Mod. | Data Rate | NTX | CH. | Freq. (MHz) | Peak Conducted Power (dBm) | Conducted Power Limit (dBm) | DG (dBi) | EIRP Power (dBm) | EIRP Power Limit (dBm) | Pass /Fail |
|--------|-----------|-----|-----|-------------|----------------------------|-----------------------------|----------|------------------|------------------------|------------|
| BLE | 1Mbps | 1 | 0 | 2402 | 3.83 | 30.00 | 3.85 | 7.68 | 36.00 | Pass |
| BLE | 1Mbps | 1 | 19 | 2440 | 4.41 | 30.00 | 3.85 | 8.26 | 36.00 | Pass |
| BLE | 1Mbps | 1 | 39 | 2480 | 5.85 | 30.00 | 3.85 | 9.70 | 36.00 | Pass |
| BLE5.0 | 2Mbps | 1 | 0 | 2402 | 3.82 | 30.00 | 3.85 | 7.67 | 36.00 | Pass |
| BLE5.0 | 2Mbps | 1 | 19 | 2440 | 4.39 | 30.00 | 3.85 | 8.24 | 36.00 | Pass |
| BLE5.0 | 2Mbps | 1 | 39 | 2480 | 5.84 | 30.00 | 3.85 | 9.69 | 36.00 | Pass |

3.3 Power Spectral Density Measurement

3.3.1 Limit of Power Spectral Density

The peak power spectral density shall not be greater than 8dBm in any 3kHz band at any time interval of continuous transmission.

3.3.2 Measuring Instruments

See list of measuring equipment of this test report.

3.3.3 Test Procedures

1. The testing follows the ANSI C63.10 Section 11.10.2 Method PKPSD.
2. The RF output of EUT was connected to the spectrum analyzer by RF cable and attenuator. The path loss was compensated to the results for each measurement.
3. Set to the maximum power setting and enable the EUT transmit continuously.
4. Make the measurement with the spectrum analyzer's resolution bandwidth (RBW) = 3 kHz. Video bandwidth VBW = 10 kHz In order to make an accurate measurement, set the span to 1.5 times DTS Channel Bandwidth. (6dB BW)
5. Detector = peak, Sweep time = auto couple, Trace mode = max hold, Allow trace to fully stabilize. Use the peak marker function to determine the maximum power level.
6. Measure and record the results in the test report.
7. The Measured power density (dBm)/ 100kHz is a reference level and used as 20dBc down limit line for Conducted Band Edges and Conducted Spurious Emission.

3.3.4 Test Setup

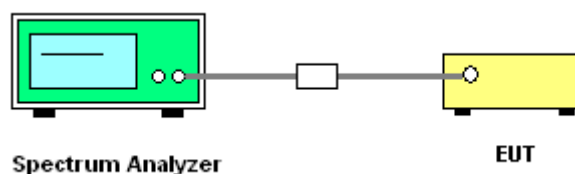



3.3.5 Test Result of Power Spectral Density

| | | | |
|-----------------|------------------------|---------------------|---------|
| Test Engineer : | Kai Liao and Luffy Lin | Temperature : | 21~25°C |
| | | Relative Humidity : | 51~54% |

| Mod. | Data Rate | NTX | CH. | Freq. (MHz) | Peak PSD (dBm /100kHz) | Peak PSD (dBm /3kHz) | DG (dBi) | Peak PSD Limit (dBm /3kHz) | Pass/Fail |
|------|-----------|-----|-----|-------------|------------------------|----------------------|----------|----------------------------|-----------|
| BLE | 1Mbps | 1 | 0 | 2402 | 2.27 | -12.56 | 3.85 | 8.00 | Pass |
| BLE | 1Mbps | 1 | 19 | 2440 | 2.73 | -12.00 | 3.85 | 8.00 | Pass |
| BLE | 1Mbps | 1 | 39 | 2480 | 4.32 | -10.48 | 3.85 | 8.00 | Pass |
| BLE | 2Mbps | 1 | 0 | 2402 | 2.27 | -16.01 | 3.85 | 8.00 | Pass |
| BLE | 2Mbps | 1 | 19 | 2440 | 2.73 | -15.51 | 3.85 | 8.00 | Pass |
| BLE | 2Mbps | 1 | 39 | 2480 | 4.34 | -14.05 | 3.85 | 8.00 | Pass |

3.3.6 Test Result of Power Spectral Density Plots (100kHz)

| | | | |
|-----------------|------------------------|---------------------|---------|
| Test Engineer : | Kai Liao and Luffy Lin | Temperature : | 21~25°C |
| | | Relative Humidity : | 51~54% |

<1 Mbps>

PSD 100kHz Plot on Channel 00

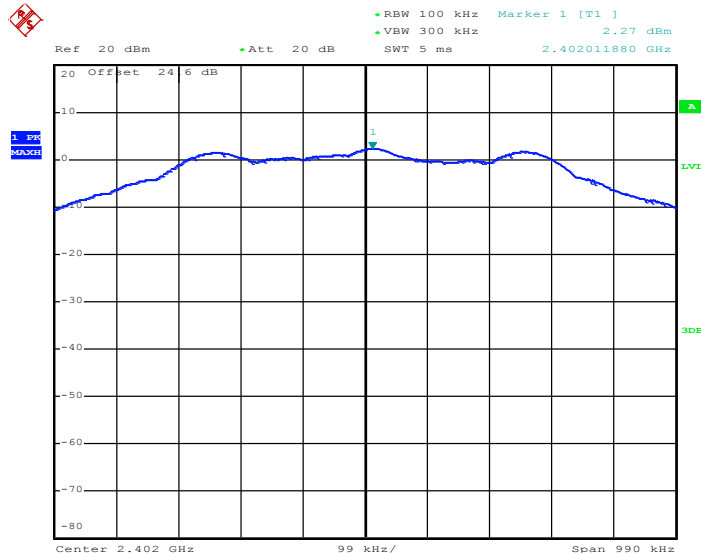

Date: 11.MAR.2019 11:15:28



PSD 100kHz Plot on Channel 19

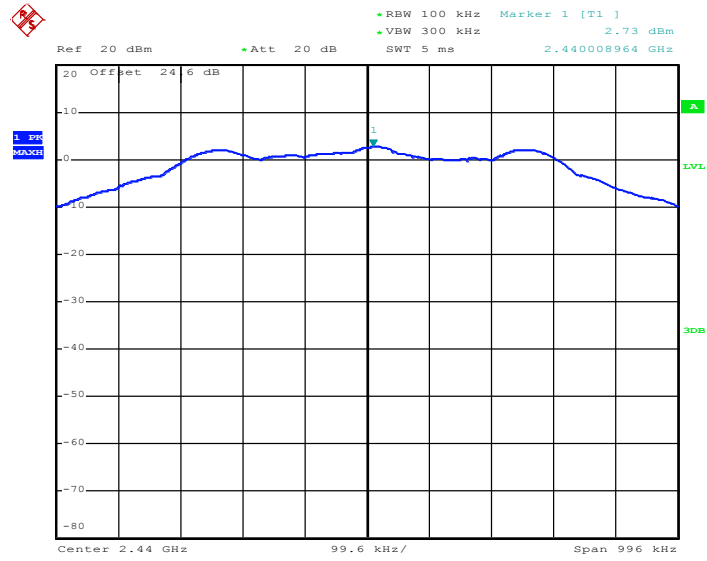

Date: 11.MAR.2019 11:19:25

PSD 100kHz Plot on Channel 39

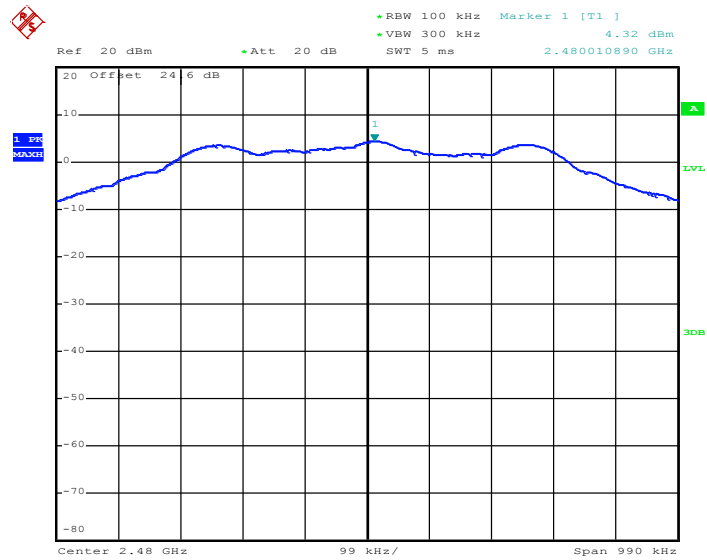

Date: 11.MAR.2019 11:23:07



<2 Mbps>

PSD 100kHz Plot on Channel 00

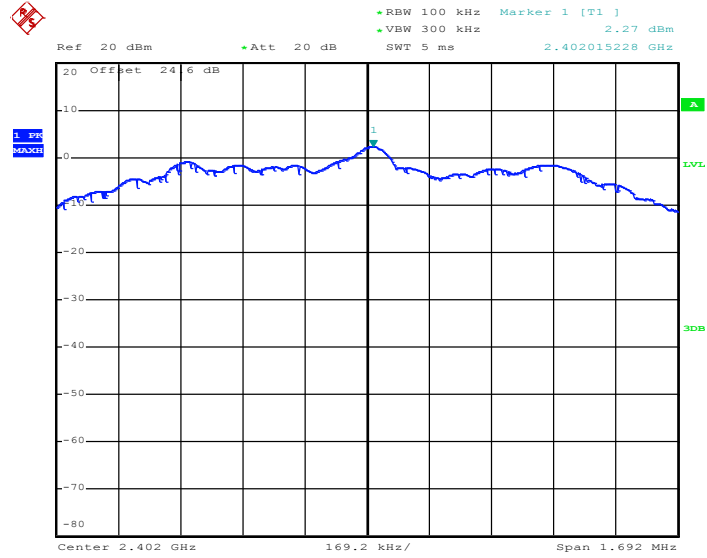

Date: 11.MAR.2019 11:28:00

PSD 100kHz Plot on Channel 19

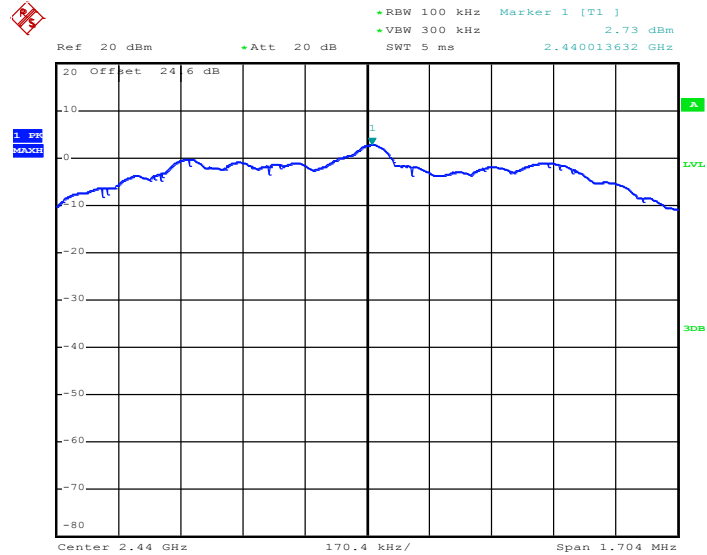

Date: 11.MAR.2019 11:32:46



PSD 100kHz Plot on Channel 39

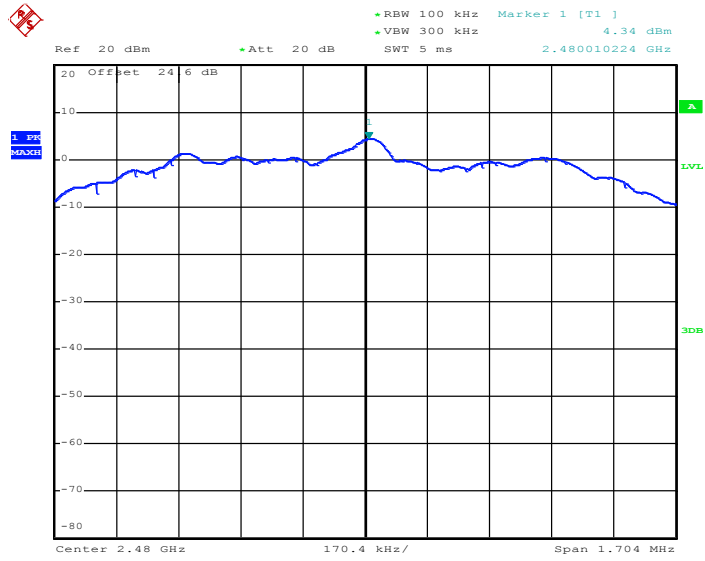

Date: 11.MAR.2019 11:37:46



3.3.7 Test Result of Power Spectral Density Plots (3kHz)

| | | | |
|-----------------|------------------------|---------------------|---------|
| Test Engineer : | Kai Liao and Luffy Lin | Temperature : | 21~25°C |
| | | Relative Humidity : | 51~54% |

<1 Mbps>

PSD 3kHz Plot on Channel 00

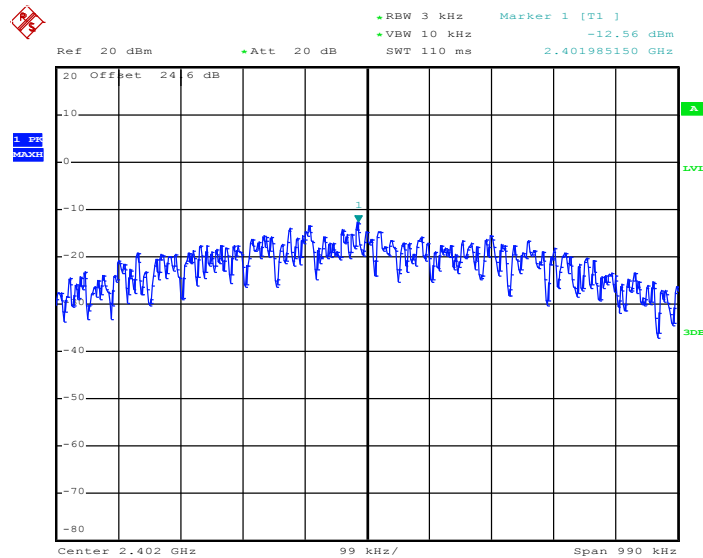

Date: 11.MAR.2019 11:14:57

PSD 3kHz Plot on Channel 19

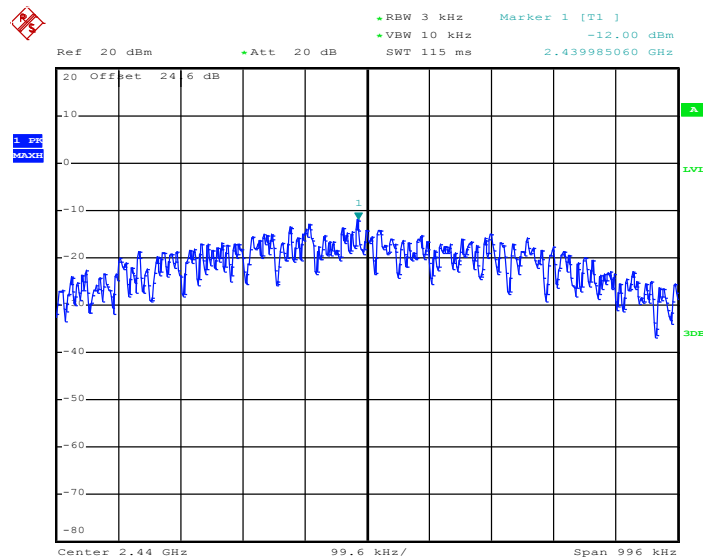

Date: 11.MAR.2019 11:19:10



PSD 3kHz Plot on Channel 39

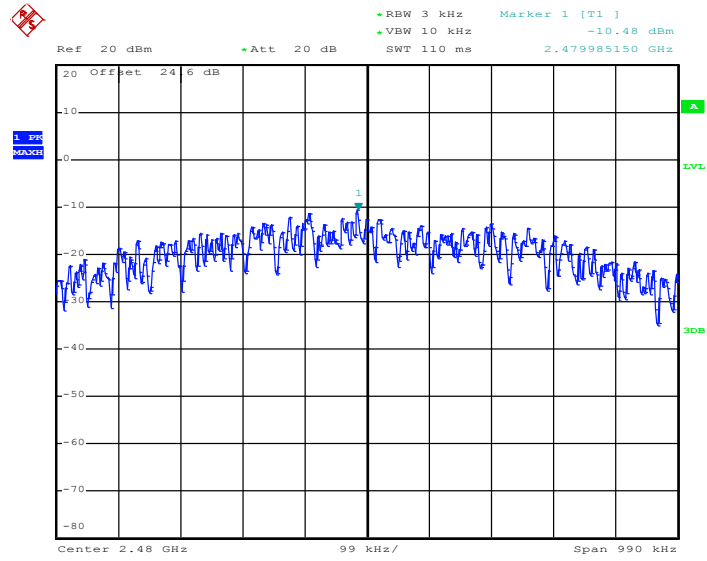

Date: 11.MAR.2019 11:22:55

<2 Mbps>

PSD 3kHz Plot on Channel 00

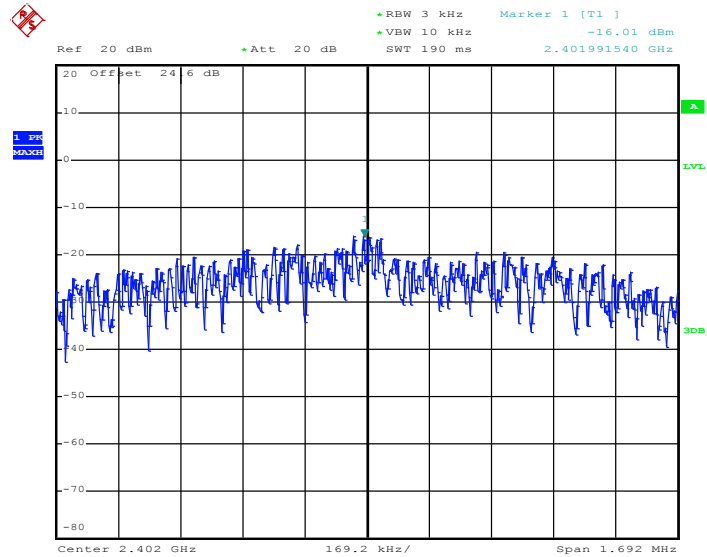

Date: 11.MAR.2019 11:27:46



PSD 3kHz Plot on Channel 19

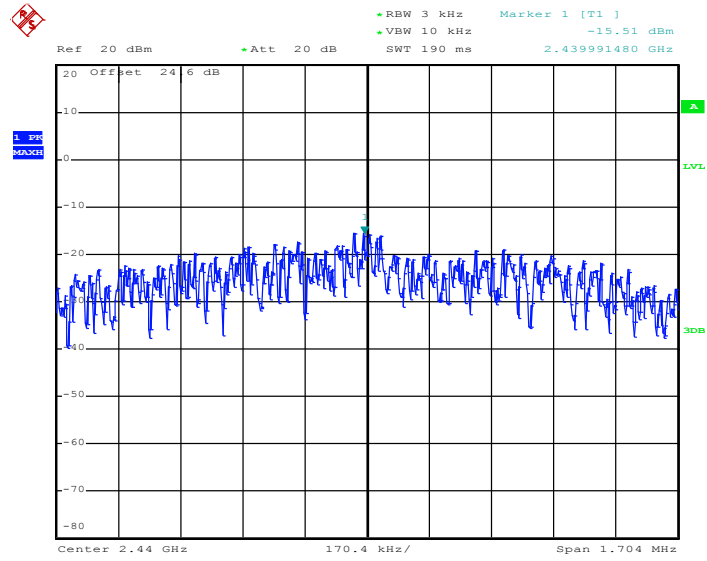

Date: 11.MAR.2019 11:32:30

PSD 3kHz Plot on Channel 39

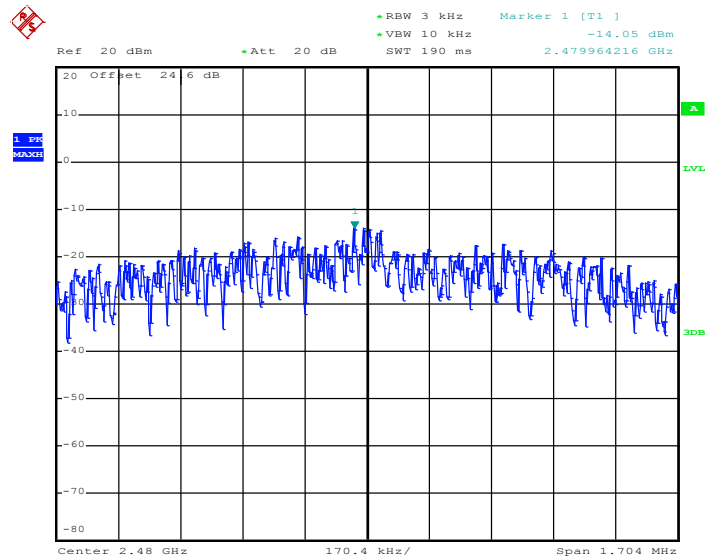

Date: 11.MAR.2019 11:37:29

3.4 Conducted Band Edges and Spurious Emission Measurement

3.4.1 Limit of Conducted Band Edges and Spurious Emission

All harmonics/spurious must be at least 30 dB down from the highest emission level within the authorized band.

3.4.2 Measuring Instruments

See list of measuring equipment of this test report.

3.4.3 Test Procedure

1. The testing follows the ANSI C63.10 Section 11.11.3 Emission level measurement.
2. The RF output of EUT was connected to the spectrum analyzer by RF cable and attenuator. The path loss was compensated to the results for each measurement.
3. Set to the maximum power setting and enable the EUT transmit continuously.
4. Set RBW = 100 kHz, VBW=300 kHz, Peak Detector. Unwanted Emissions measured in any 100 kHz bandwidth outside of the authorized frequency band shall be attenuated by at least 20 dB relative to the maximum in-band peak PSD level in 100 kHz when maximum peak conducted output power procedure is used. If the transmitter complies with the conducted power limits based on the use of RMS averaging over a time interval, the attenuation required under this paragraph shall be 30 dB instead of 20 dB.
5. Measure and record the results in the test report.
6. The RF fundamental frequency should be excluded against the limit line in the operating frequency band.

3.4.4 Test Setup

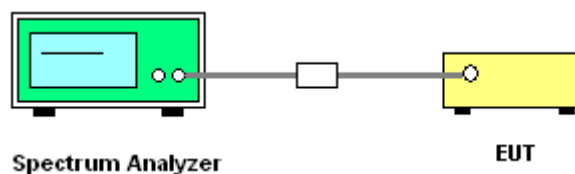



3.4.5 Test Result of Conducted Band Edges Plots

| | | | |
|-----------------|------------------------|---------------------|---------|
| Test Engineer : | Kai Liao and Luffy Lin | Temperature : | 21~25°C |
| | | Relative Humidity : | 51~54% |

<1 Mbps>

Low Band Edge Plot on Channel 00

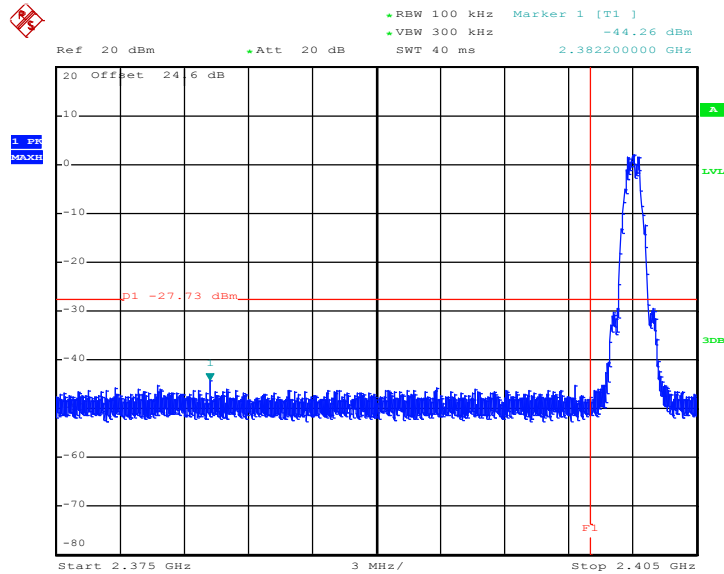

Date: 11.MAR.2019 11:15:43

High Band Edge Plot on Channel 39

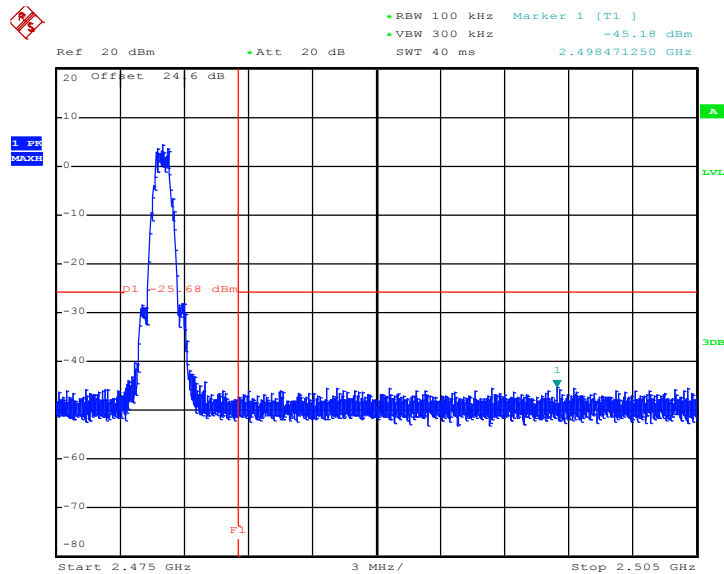

Date: 11.MAR.2019 11:23:26



<2 Mbps>

Low Band Edge Plot on Channel 00

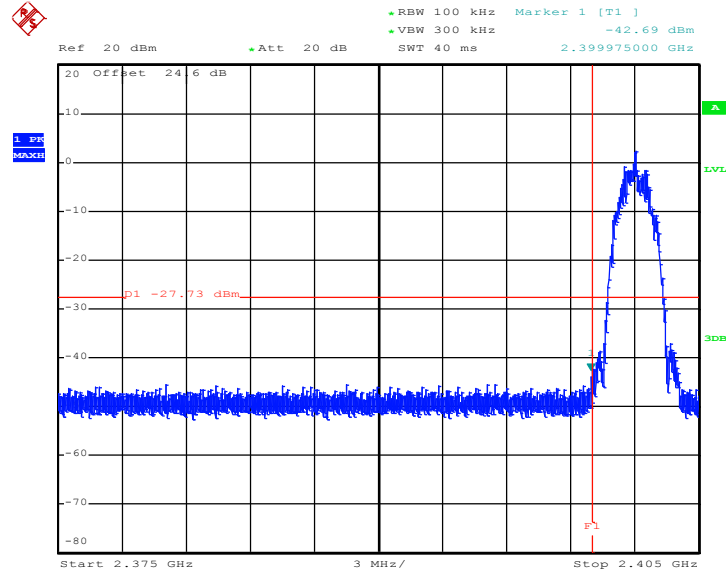

Date: 11.MAR.2019 11:29:02

High Band Edge Plot on Channel 39

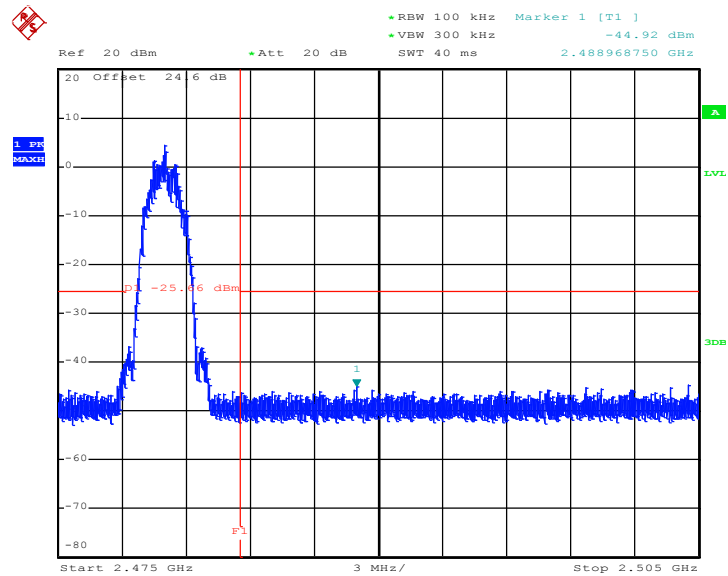

Date: 11.MAR.2019 11:38:00



3.4.6 Test Result of Conducted Spurious Emission Plots

| | | | |
|-----------------|------------------------|---------------------|---------|
| Test Engineer : | Kai Liao and Luffy Lin | Temperature : | 21~25°C |
| | | Relative Humidity : | 51~54% |

Conducted Spurious Emission Plot on Bluetooth LE 1Mbps GFSK Channel 00

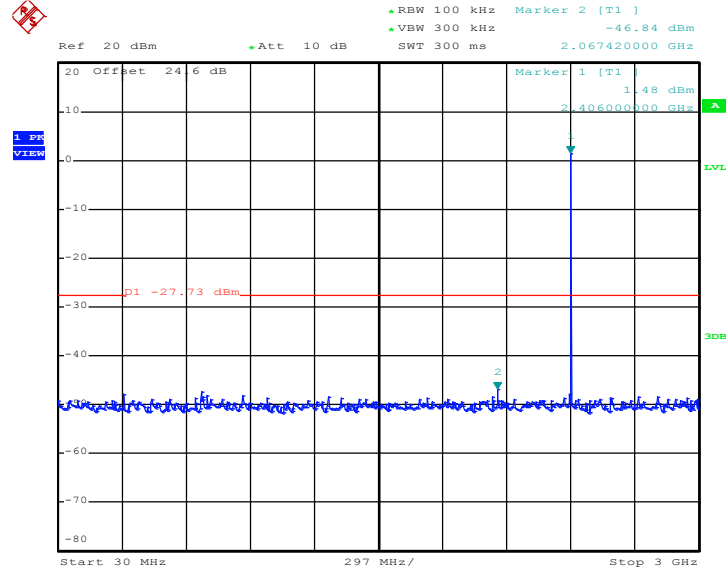

Date: 11.MAR.2019 11:16:00

Conducted Spurious Emission Plot on Bluetooth LE 1Mbps GFSK Channel 00

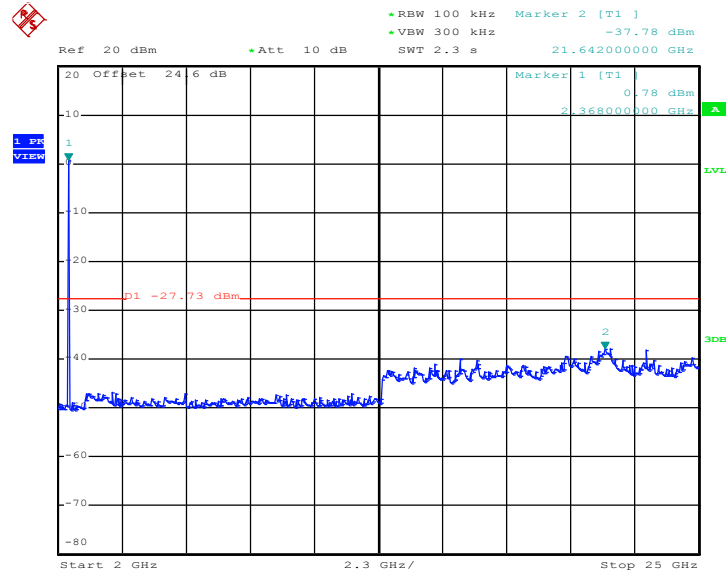

Date: 11.MAR.2019 11:16:14



Conducted Spurious Emission Plot on Bluetooth LE 1Mbps GFSK Channel 19

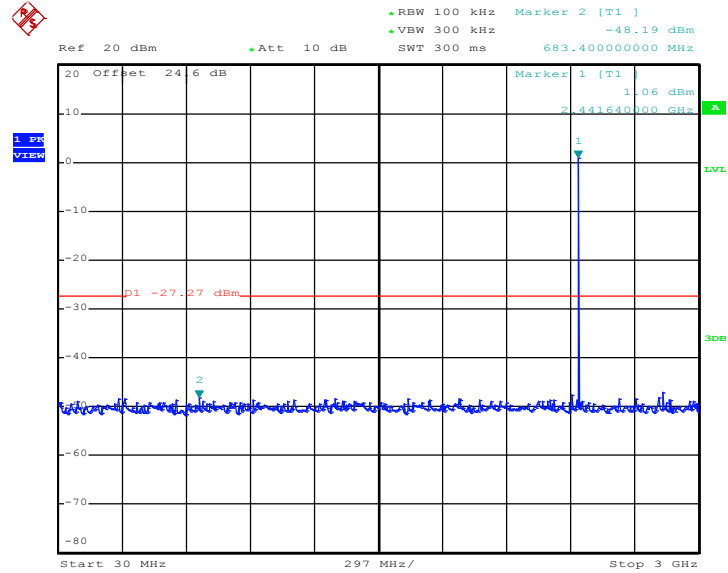

Date: 11.MAR.2019 11:19:41

Conducted Spurious Emission Plot on Bluetooth LE 1Mbps GFSK Channel 19

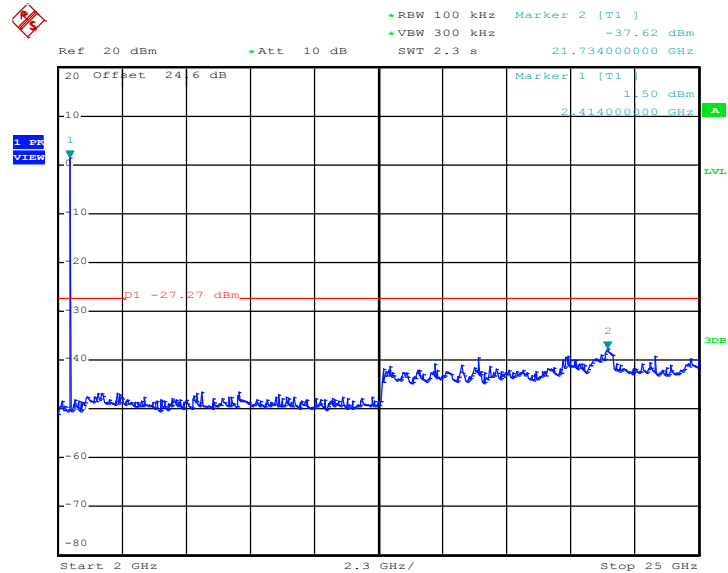

Date: 11.MAR.2019 11:19:55



Conducted Spurious Emission Plot on Bluetooth LE 1Mbps GFSK Channel 39

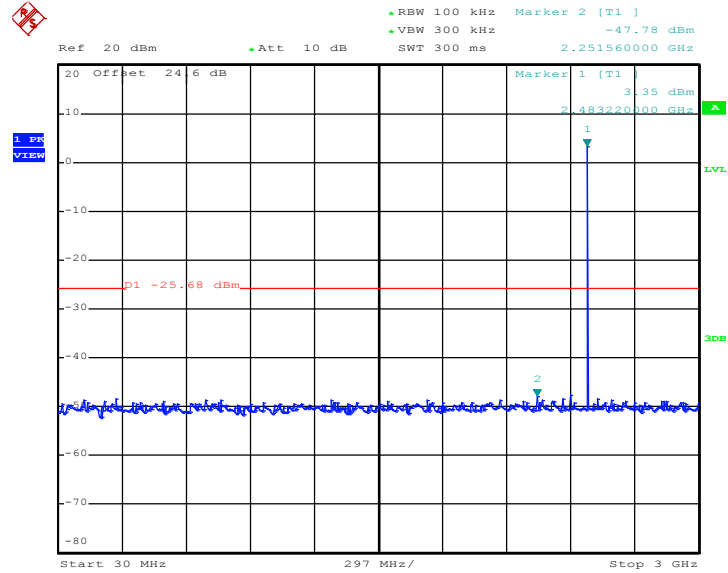

Date: 11.MAR.2019 11:24:36

Conducted Spurious Emission Plot on Bluetooth LE 1Mbps GFSK Channel 39

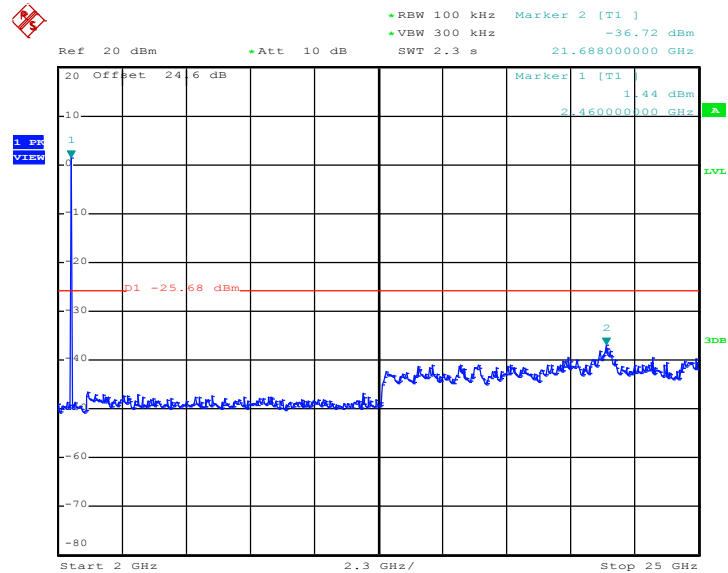

Date: 11.MAR.2019 11:24:51



Conducted Spurious Emission Plot on Bluetooth LE 2Mbps GFSK Channel 00

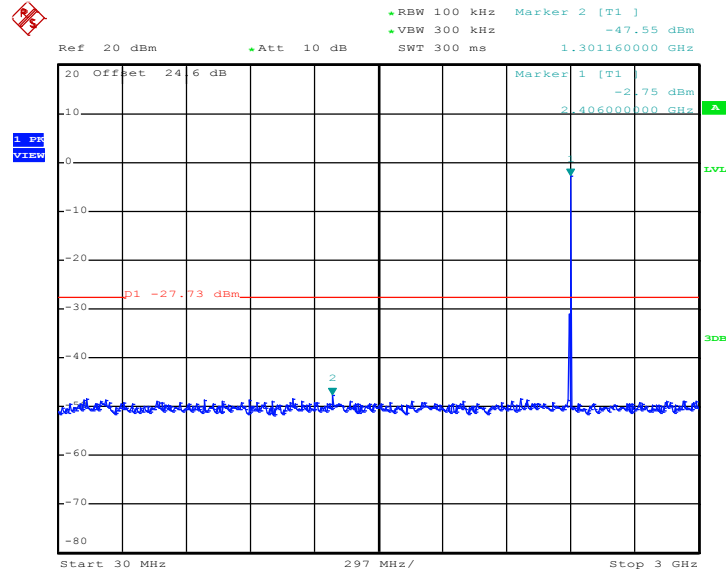

Date: 11.MAR.2019 11:29:55

Conducted Spurious Emission Plot on Bluetooth LE 2Mbps GFSK Channel 00

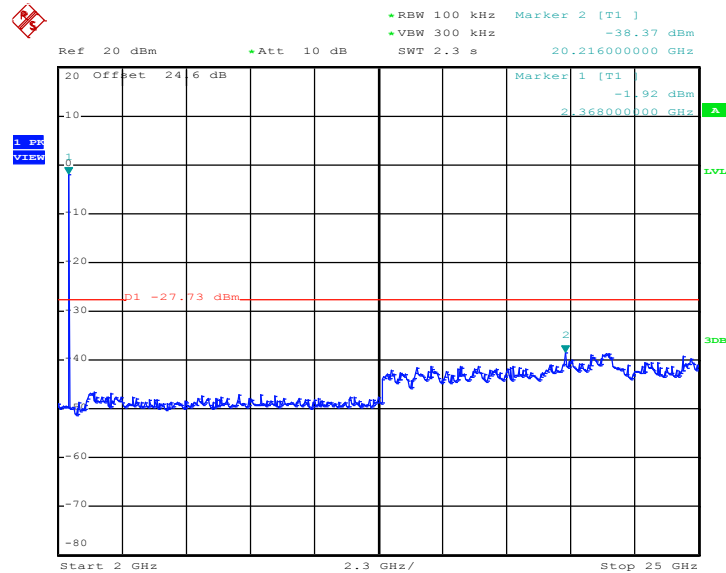

Date: 11.MAR.2019 11:30:09



Conducted Spurious Emission Plot on Bluetooth LE 2Mbps GFSK Channel 19

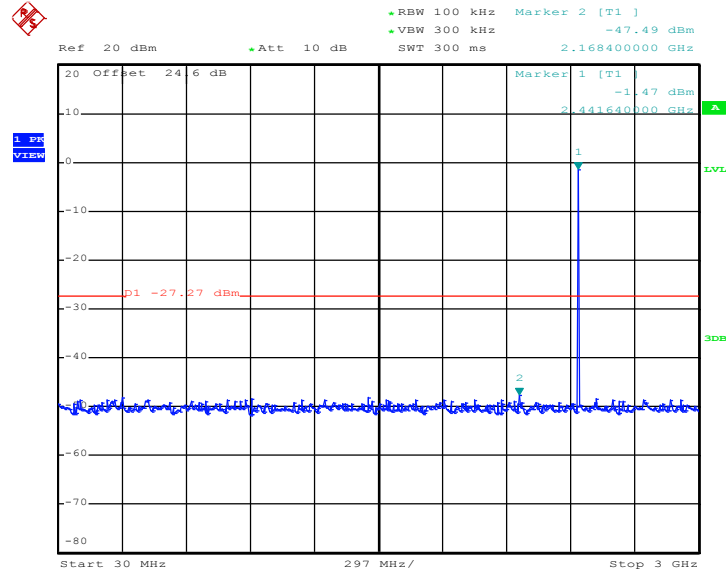

Date: 11.MAR.2019 11:33:05

Conducted Spurious Emission Plot on Bluetooth LE 2Mbps GFSK Channel 19

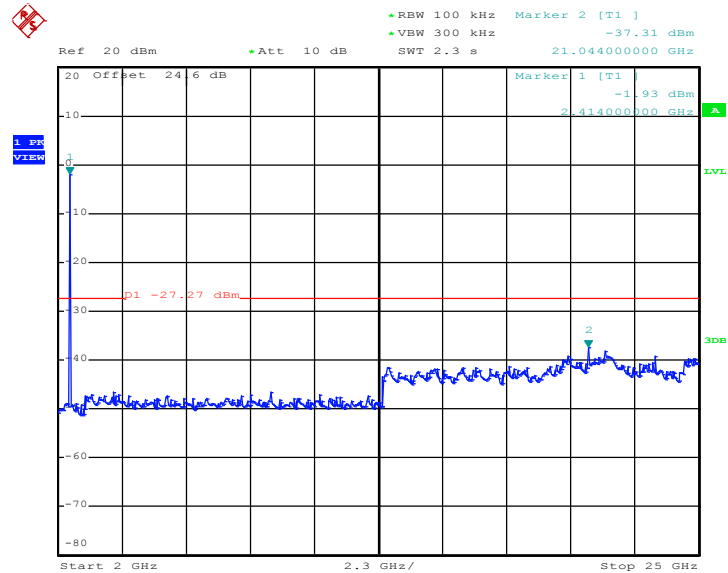

Date: 11.MAR.2019 11:33:20



Conducted Spurious Emission Plot on Bluetooth LE 2Mbps GFSK Channel 39

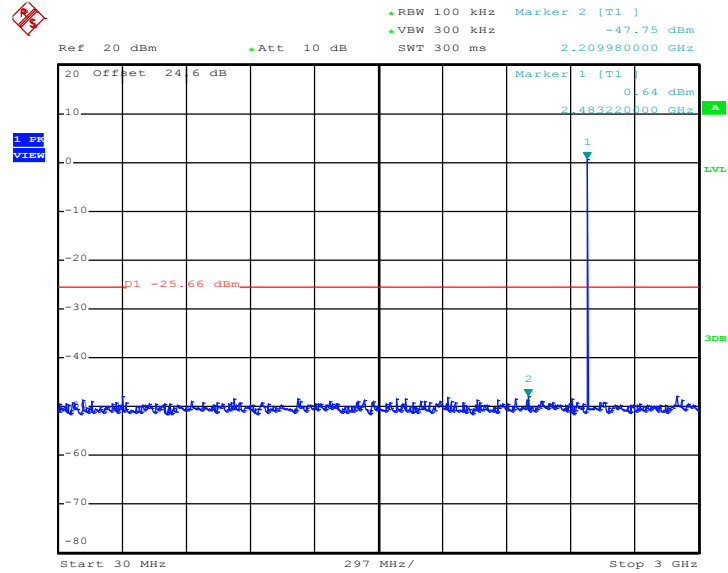

Date: 11.MAR.2019 11:40:24

Conducted Spurious Emission Plot on Bluetooth LE 2Mbps GFSK Channel 39

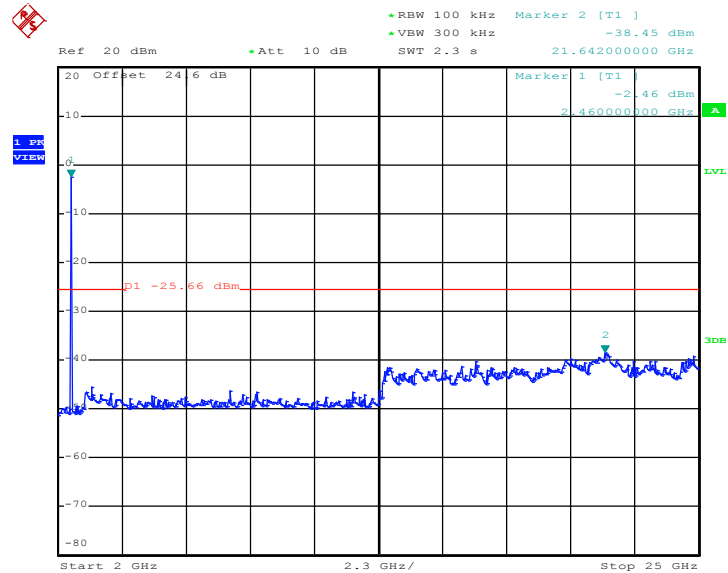

Date: 11.MAR.2019 11:40:43



3.5 Radiated Band Edges and Spurious Emission Measurement

3.5.1 Limit of Radiated Band Edges and Spurious Emission

In any 100 kHz bandwidth outside the intentional radiator frequency band, all harmonics/spurious must be at least 20 dB below the highest emission level within the authorized band. If the output power of this device was measured by spectrum analyzer, the attenuation under this paragraph shall be 30 dB instead of 20 dB. In addition, radiated emissions which fall in the restricted bands must also comply with the limits as below.

| Frequency (MHz) | Field Strength (microvolts/meter) | Measurement Distance (meters) |
|-----------------|-----------------------------------|-------------------------------|
| 0.009 – 0.490 | 2400/F(kHz) | 300 |
| 0.490 – 1.705 | 24000/F(kHz) | 30 |
| 1.705 – 30.0 | 30 | 30 |
| 30 – 88 | 100 | 3 |
| 88 – 216 | 150 | 3 |
| 216 - 960 | 200 | 3 |
| Above 960 | 500 | 3 |

3.5.2 Measuring Instruments

See list of measuring equipment of this test report.

**3.5.3 Test Procedures**

1. The testing follows the ANSI C63.10 Section 11.12.1 Radiated emission measurements.
2. The EUT was arranged to its worst case and then tune the antenna tower (from 1 m to 4 m) and turntable (from 0 degree to 360 degrees) to find the maximum reading. A pre-amp and a high pass filter are used for the test in order to get better signal level.
3. The EUT was placed on a turntable with 0.8 meter for frequency below 1GHz and 1.5 meter for frequency above 1GHz respectively above ground.
4. The EUT was set 3 meters from the interference receiving antenna, which was mounted on the top of a variable height antenna tower.
5. Corrected Reading: Antenna Factor + Cable Loss + Read Level - Preamp Factor = Level
6. For testing below 1GHz, if the emission level of the EUT in peak mode was 3 dB lower than the limit specified, then peak values of EUT will be reported, otherwise, the emissions will be repeated one by one using the CISPR quasi-peak method and reported.
7. For testing above 1GHz, the emission level of the EUT in peak mode was 20dB lower than average limit (that means the emission level in average mode also complies with the limit in average mode), then peak values of EUT will be reported, otherwise, the emissions will be measured in average mode again and reported.
8. Use the following spectrum analyzer settings:
 - (1) Span shall wide enough to fully capture the emission being measured;
 - (2) Set RBW=100 kHz for $f < 1$ GHz; $VBW \geq RBW$; Sweep = auto; Detector function = peak; Trace = max hold;
 - (3) Set RBW = 1 MHz, VBW= 3MHz for $f \geq 1$ GHz for peak measurement.
For average measurement:
 - $VBW = 10$ Hz, when duty cycle is no less than 98 percent.
 - $VBW \geq 1/T$, when duty cycle is less than 98 percent where T is the minimum transmission duration over which the transmitter is on and is transmitting at its maximum power control level for the tested mode of operation.

3.5.4 Test Setup

For radiated emissions below 30MHz

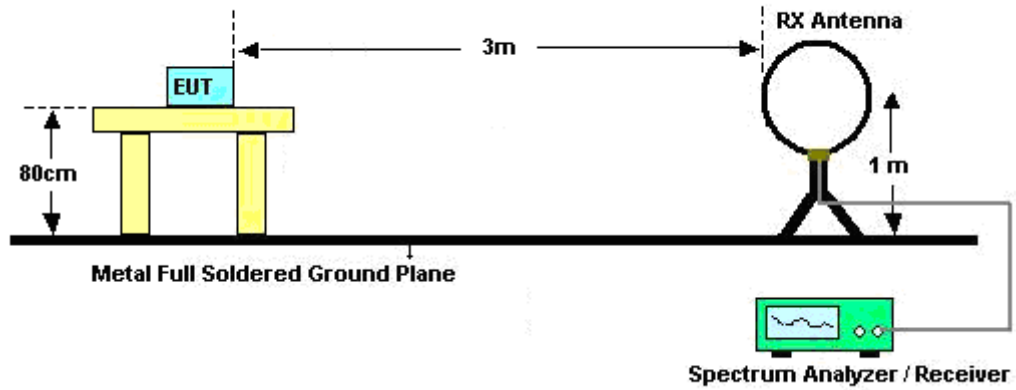

For radiated emissions from 30MHz to 1GHz

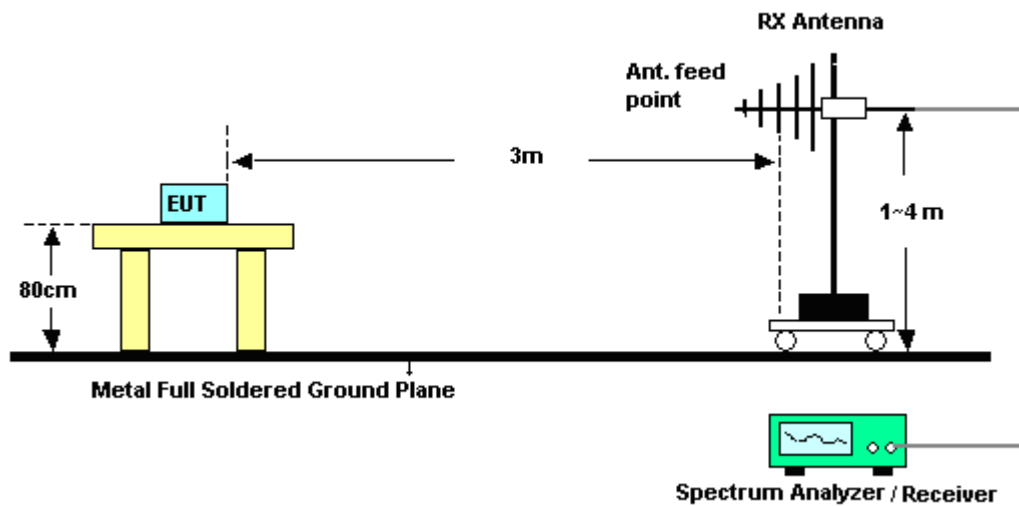

For radiated emissions above 1GHz

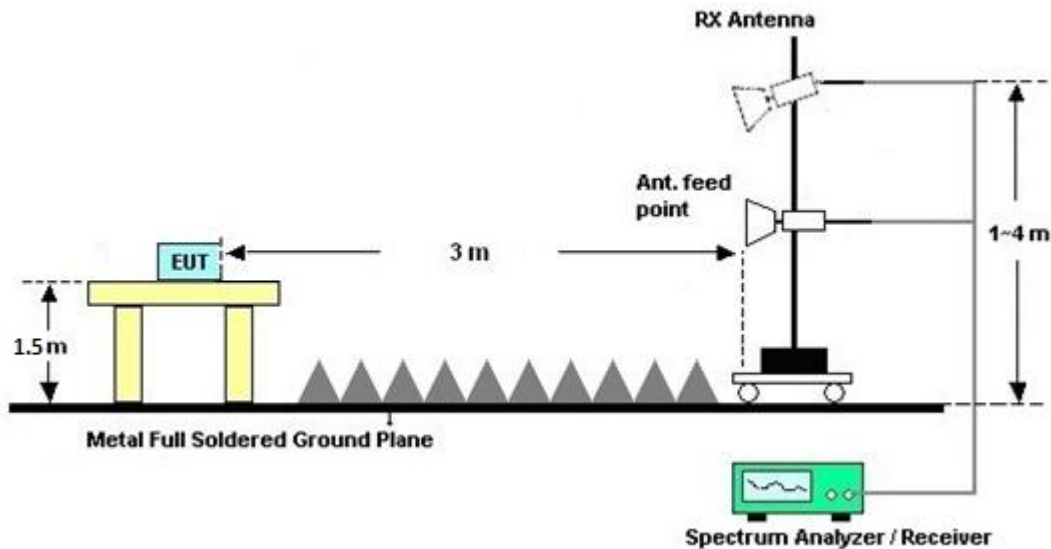

3.5.5 Test Results of Radiated Spurious Emissions (9 kHz ~ 30 MHz)

The low frequency, which started from 9 kHz to 30MHz, was pre-scanned and the result which was 20dB lower than the limit line was not reported.

There is a comparison data of both open-field test site and alternative test site - semi-Anechoic chamber according to 414788 D01 Radiated Test Site v01r01, and the result came out very similar.

3.5.6 Test Result of Radiated Spurious at Band Edges

Please refer to Appendix B and C.

3.5.7 Duty Cycle

Please refer to Appendix D.

3.5.8 Test Result of Radiated Spurious Emission (30MHz ~ 10th Harmonic)

Please refer to Appendix B and C.



3.6 AC Conducted Emission Measurement

3.6.1 Limit of AC Conducted Emission

For equipment that is designed to be connected to the public utility (AC) power line, the radio frequency voltage that is conducted back onto the AC power line on any frequency or frequencies within the band 150 kHz to 30 MHz shall not exceed the limits in the following table.

| Frequency of emission (MHz) | Conducted limit (dB μ V) | |
|-----------------------------|------------------------------|-----------|
| | Quasi-peak | Average |
| 0.15-0.5 | 66 to 56* | 56 to 46* |
| 0.5-5 | 56 | 46 |
| 5-30 | 60 | 50 |

*Decreases with the logarithm of the frequency.

3.6.2 Measuring Instruments

See list of measuring equipment of this test report.

3.6.3 Test Procedures

1. The EUT was placed 0.4 meter from the conducting wall of the shielding room was kept at least 80 centimeters from any other grounded conducting surface.
2. Connect EUT to the power mains through a line impedance stabilization network (LISN).
3. All the support units are connecting to the other LISN.
4. The LISN provides 50 ohm coupling impedance for the measuring instrument.
5. The FCC states that a 50 ohm, 50 microhenry LISN should be used.
6. Both sides of AC line were checked for maximum conducted interference.
7. The frequency range from 150 kHz to 30 MHz was searched.
8. Set the test-receiver system to Peak Detect Function and specified bandwidth (IF Bandwidth = 9kHz) with Maximum Hold Mode. Then measurement is also conducted by Average Detector and Quasi-Peak Detector Function respectively.

3.6.4 Test Setup

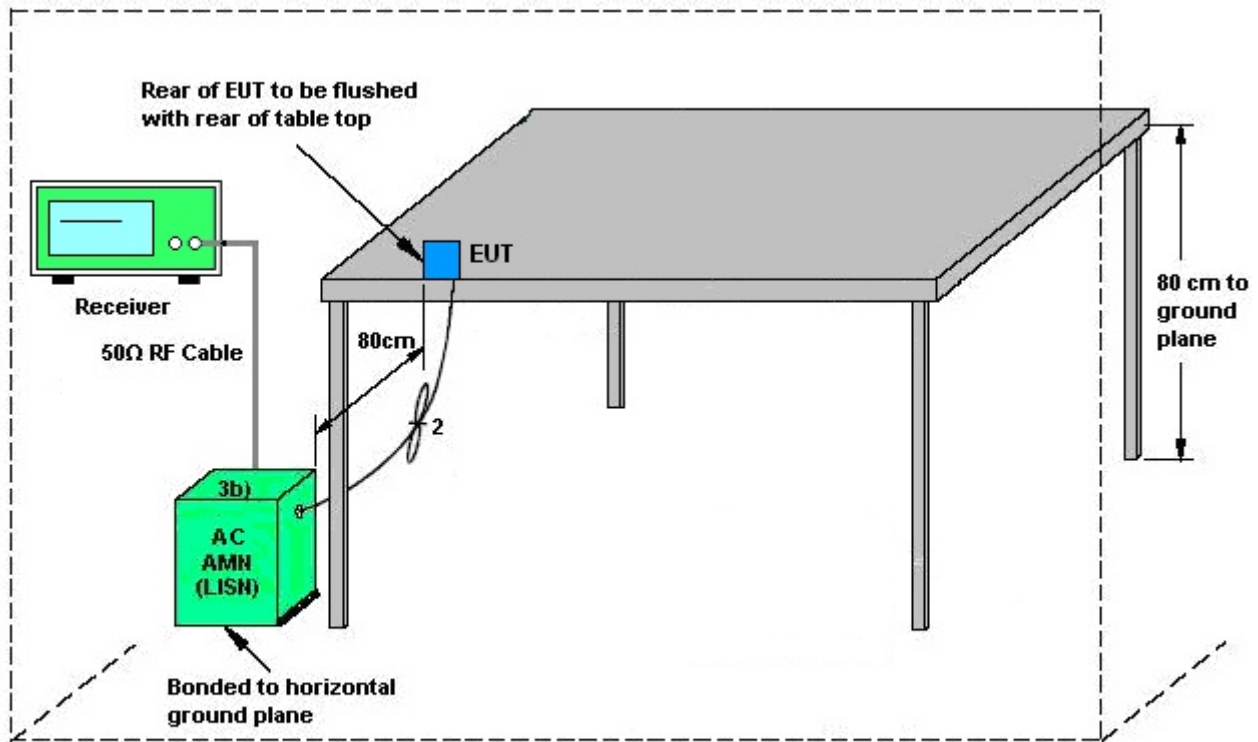

AMN = Artificial mains network (LISH)
AE = Associated equipment
EUT = Equipment under test
ISN = Impedance stabilization network

3.6.5 Test Result of AC Conducted Emission

Please refer to Appendix A.



3.7 Antenna Requirements

3.7.1 Standard Applicable

If directional gain of transmitting antennas is greater than 6dBi, the power shall be reduced by the same level in dB comparing to gain minus 6dBi. The use of a permanently attached antenna or of an antenna that uses a unique coupling to the intentional radiator shall be considered sufficient to comply with the rule.

3.7.2 Antenna Anti-Replacement Construction

An embedded-in antenna design is used.

3.7.3 Antenna Gain

The antenna peak gain of EUT is less than 6 dBi. Therefore, it is not necessary to reduce maximum peak output power limit.



4 List of Measuring Equipment

| Instrument | Manufacturer | Model No. | Serial No. | Characteristics | Calibration Date | Test Date | Due Date | Remark |
|-----------------------|-------------------|------------------|------------------|-----------------|------------------|----------------------------------|---------------|-------------------------|
| Power Meter | Agilent | E4416A | GB4129234 4 | N/A | Dec. 27, 2018 | Dec. 31, 2018 ~ Mar. 11, 2019 | Dec. 26, 2019 | Conducted (TH05-HY) |
| Power Sensor | Agilent | E9327A | US4044154 8 | 50MHz~18GHz | Dec. 27, 2018 | Dec. 31, 2018 ~ Mar. 11, 2019 | Dec. 26, 2019 | Conducted (TH05-HY) |
| Spectrum Analyzer | Rohde & Schwarz | FSV40 | 101397 | 10Hz~40GHz | Nov. 13, 2018 | Dec. 31, 2018 ~ Mar. 11, 2019 | Nov. 12, 2019 | Conducted (TH05-HY) |
| Switch Box & RF Cable | Burgeon | ETF-058 | EC1300484 | N/A | Apr. 17, 2018 | Dec. 31, 2018 ~ Mar. 11, 2019 | Apr. 16, 2019 | Conducted (TH05-HY) |
| AC Power Source | ChainTek | APC-1000W | N/A | N/A | N/A | Jan. 07, 2019 | N/A | Conduction (CO05-HY) |
| EMI Test Receiver | Rohde & Schwarz | ESR3 | 102388 | 9KHz~3.6GHz | Nov. 12, 2018 | Jan. 07, 2019 | Nov. 11, 2019 | Conduction (CO05-HY) |
| LISN | Rohde & Schwarz | ENV216 | 100080 | 9kHz~30MHz | Nov. 14, 2018 | Jan. 07, 2019 | Nov. 13, 2019 | Conduction (CO05-HY) |
| Software | Rohde & Schwarz | EMC32 V10.30 | N/A | N/A | N/A | Jan. 07, 2019 | N/A | Conduction (CO05-HY) |
| LF Cable | HUBER + SUHNER | RG-214/U | LF01 | N/A | Jan. 02, 2019 | Jan. 07, 2019 | Jan. 01, 2020 | Conduction (CO05-HY) |
| Pulse Limiter | SCHWARZBE CK | VTSD 9561-F N | 9561-F N00373 | 9kHz-200MHz | Nov. 08, 2018 | Jan. 07, 2019 | Nov. 07, 2019 | Conduction (CO05-HY) |



| Instrument | Manufacturer | Model No. | Serial No. | Characteristics | Calibration Date | Test Date | Due Date | Remark |
|---------------------------|-----------------|---------------------------------|---------------------------------------|-------------------------------------|------------------|-------------------------------|---------------|-----------------------|
| Preamplifier | Agilent | 8449B | 3008A01917 | 1GHz~26.5GHz | Apr. 23, 2018 | Dec. 25, 2018 ~ Mar. 06, 2019 | Apr. 22, 2019 | Radiation (03CH07-HY) |
| Bilog Antenna | TESEQ | CBL 6111D&0080 0N1D01N-06 | 35419&03 | 30MHz to 1GHz | Dec. 16, 2018 | Dec. 25, 2018 ~ Mar. 06, 2019 | Dec. 15, 2019 | Radiation (03CH07-HY) |
| Double Ridge Horn Antenna | ESCO | 3117 | 00075962 | 1GHz ~ 18GHz | Dec. 02, 2018 | Dec. 25, 2018 ~ Mar. 06, 2019 | Dec. 03, 2019 | Radiation (03CH07-HY) |
| Loop Antenna | Rohde & Schwarz | HFH2-Z2 | 100315 | 9 kHz~30 MHz | May 15, 2017 | Dec. 25, 2018 ~ Mar. 06, 2019 | May 14, 2019 | Radiation (03CH07-HY) |
| Preamplifier | MITEQ | AMF-7D-001 01800-30-10 P | 1590075 | 1GHz ~ 18GHz | Apr. 25, 2018 | Dec. 25, 2018 ~ Mar. 06, 2019 | Apr. 24, 2019 | Radiation (03CH07-HY) |
| Preamplifier | COM-POWER | PA-103A | 161241 | 10MHz-1GHz | May 21, 2018 | Dec. 25, 2018 ~ Mar. 06, 2019 | May 20, 2019 | Radiation (03CH07-HY) |
| RF Cable | HUBER + SUHNER | SUCOFLEX 104 | MY28655/4, MY24971/4, MY15682/4 | 30MHz~1GHz | Feb. 27, 2018 | Dec. 25, 2018 ~ Feb. 20, 2019 | Feb. 26, 2019 | Radiation (03CH07-HY) |
| RF Cable | HUBER + SUHNER | SUCOFLEX 104 | MY28655/4, MY24971/4, MY15682/4 | 1GHz~18GHz | Feb. 27, 2018 | Mar. 06, 2019 | Feb. 26, 2019 | Radiation (03CH07-HY) |
| RF Cable | HUBER + SUHNER | SUCOFLEX 102 | MY2858/2 | 18GHz~40GHz | Feb. 27, 2018 | Dec. 25, 2018 ~ Feb. 20, 2019 | Feb. 26, 2019 | Radiation (03CH07-HY) |
| RF Cable | HUBER + SUHNER | SUCOFLEX 102 | MY2858/2 | 18GHz~40GHz | Feb. 26, 2019 | Mar. 06, 2019 | Feb. 25, 2020 | Radiation (03CH07-HY) |
| Antenna Mast | Max-Full | MFA520BS | N/A | 1m~4m | N/A | Dec. 25, 2018 ~ Mar. 06, 2019 | N/A | Radiation (03CH07-HY) |
| Turn Table | ChainTek | Chaintek 3000 | N/A | 0~360 Degree | N/A | Dec. 25, 2018 ~ Mar. 06, 2019 | N/A | Radiation (03CH07-HY) |
| Amplifier | MITEQ | TTA1840-35- HG | 1871923 | 18GHz~40GHz, VSWR : 2.5:1 max | Jul. 16, 2018 | Dec. 25, 2018 ~ Mar. 06, 2019 | Jul. 15, 2019 | Radiation (03CH07-HY) |
| Software | Audix | E3 6.2009-8-24 | RK-001042 | N/A | N/A | Dec. 25, 2018 ~ Mar. 06, 2019 | N/A | Radiation (03CH07-HY) |
| SHF-EHF Horn Antenna | SCHWARZBE CK | BBHA 9170 | BBHA9170 251 | 18GHz- 40GHz | Nov. 20, 2018 | Dec. 25, 2018 ~ Mar. 06, 2019 | Nov. 19, 2019 | Radiation (03CH07-HY) |
| RF Cable | HUBER + SUHNER | SF102/2*11S K252 | MY4278/2 | 9kHz~40GHz | May 17, 2018 | Dec. 25, 2018 ~ Mar. 06, 2019 | May 16, 2019 | Radiation (03CH07-HY) |
| Spectrum Analyzer | Agilent | N9010A | MY5347011 8 | 10Hz~44GHz | Apr. 17, 2018 | Dec. 25, 2018 ~ Mar. 06, 2019 | Apr. 16, 2019 | Radiation (03CH07-HY) |



5 Uncertainty of Evaluation

Uncertainty of Conducted Emission Measurement (150 kHz ~ 30 MHz)

| | |
|---|-----|
| Measuring Uncertainty for a Level of Confidence of 95% ($U = 2Uc(y)$) | 2.2 |
|---|-----|

Uncertainty of Radiated Emission Measurement (30 MHz ~ 1000 MHz)

| | |
|---|-----|
| Measuring Uncertainty for a Level of Confidence of 95% ($U = 2Uc(y)$) | 5.7 |
|---|-----|

Uncertainty of Radiated Emission Measurement (1000 MHz ~ 18000 MHz)

| | |
|---|-----|
| Measuring Uncertainty for a Level of Confidence of 95% ($U = 2Uc(y)$) | 5.5 |
|---|-----|

Uncertainty of Radiated Emission Measurement (18000 MHz ~ 40000 MHz)

| | |
|---|-----|
| Measuring Uncertainty for a Level of Confidence of 95% ($U = 2Uc(y)$) | 5.2 |
|---|-----|



Appendix A. AC Conducted Emission Test Results

| | | | |
|-----------------|---------------|---------------------|---------|
| Test Engineer : | Jimmy Chang | Temperature : | 24~26°C |
| | | Relative Humidity : | 51~53% |
| Test Voltage : | 120Vac / 60Hz | Phase : | Line |

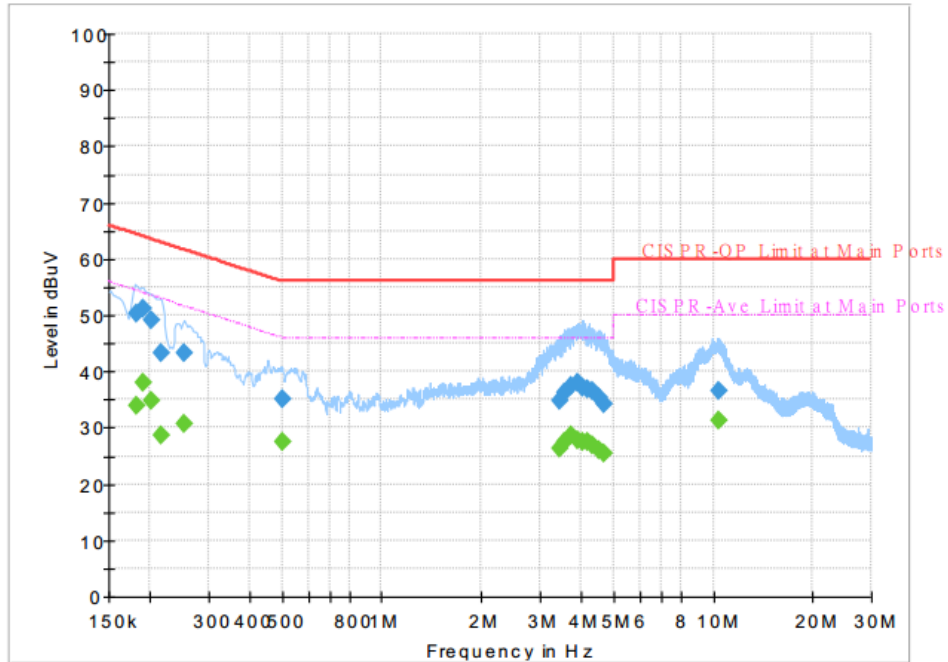

Final Result

| Frequency (MHz) | QuasiPeak (dBuV) | CAverage (dBuV) | Limit (dBuV) | Margin (dB) | Line | Filter | Corr. (dB) |
|-----------------|------------------|-----------------|--------------|-------------|------|--------|------------|
| 0.181500 | 50.16 | --- | 64.42 | 14.26 | L1 | OFF | 19.5 |
| 0.181500 | --- | 33.78 | 54.42 | 20.64 | L1 | OFF | 19.5 |
| 0.190500 | 51.12 | --- | 64.02 | 12.90 | L1 | OFF | 19.5 |
| 0.190500 | --- | 37.88 | 54.02 | 16.14 | L1 | OFF | 19.5 |
| 0.201750 | 49.03 | --- | 63.54 | 14.51 | L1 | OFF | 19.5 |
| 0.201750 | --- | 34.66 | 53.54 | 18.88 | L1 | OFF | 19.5 |
| 0.215250 | 43.33 | --- | 63.00 | 19.67 | L1 | OFF | 19.5 |
| 0.215250 | --- | 28.74 | 53.00 | 24.26 | L1 | OFF | 19.5 |
| 0.253500 | 43.22 | --- | 61.64 | 18.42 | L1 | OFF | 19.5 |
| 0.253500 | --- | 30.70 | 51.64 | 20.94 | L1 | OFF | 19.5 |
| 0.501000 | 34.97 | --- | 56.00 | 21.03 | L1 | OFF | 19.5 |
| 0.501000 | --- | 27.45 | 46.00 | 18.55 | L1 | OFF | 19.5 |
| 3.432750 | 34.74 | --- | 56.00 | 21.26 | L1 | OFF | 19.6 |
| 3.432750 | --- | 26.44 | 46.00 | 19.56 | L1 | OFF | 19.6 |
| 3.574500 | 36.24 | --- | 56.00 | 19.76 | L1 | OFF | 19.6 |
| 3.574500 | --- | 27.43 | 46.00 | 18.57 | L1 | OFF | 19.6 |
| 3.736500 | 37.41 | --- | 56.00 | 18.59 | L1 | OFF | 19.6 |
| 3.736500 | --- | 28.57 | 46.00 | 17.43 | L1 | OFF | 19.6 |
| 3.894000 | 38.05 | --- | 56.00 | 17.95 | L1 | OFF | 19.6 |
| 3.894000 | --- | 27.81 | 46.00 | 18.19 | L1 | OFF | 19.6 |



| | | | |
|-----------------|---------------|---------------------|---------|
| Test Engineer : | Jimmy Chang | Temperature : | 24~26°C |
| | | Relative Humidity : | 51~53% |
| Test Voltage : | 120Vac / 60Hz | Phase : | Line |

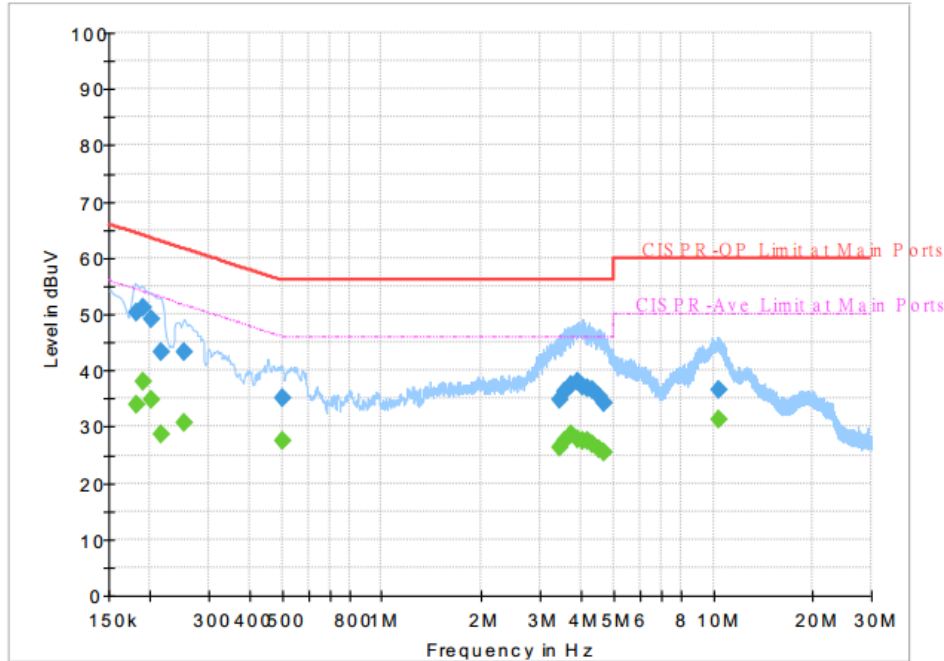

Final Result

| Frequency (MHz) | QuasiPeak (dBuV) | CAverage (dBuV) | Limit (dBuV) | Margin (dB) | Line | Filter | Corr. (dB) |
|-----------------|------------------|-----------------|--------------|-------------|------|--------|------------|
| 4.022250 | 37.23 | --- | 56.00 | 18.77 | L1 | OFF | 19.6 |
| 4.022250 | --- | 27.44 | 46.00 | 18.56 | L1 | OFF | 19.6 |
| 4.166250 | 36.87 | --- | 56.00 | 19.13 | L1 | OFF | 19.6 |
| 4.166250 | --- | 27.38 | 46.00 | 18.62 | L1 | OFF | 19.6 |
| 4.344000 | 36.57 | --- | 56.00 | 19.43 | L1 | OFF | 19.6 |
| 4.344000 | --- | 27.04 | 46.00 | 18.96 | L1 | OFF | 19.6 |
| 4.526250 | 35.26 | --- | 56.00 | 20.74 | L1 | OFF | 19.6 |
| 4.526250 | --- | 25.89 | 46.00 | 20.11 | L1 | OFF | 19.6 |
| 4.670250 | 34.27 | --- | 56.00 | 21.73 | L1 | OFF | 19.6 |
| 4.670250 | --- | 25.53 | 46.00 | 20.47 | L1 | OFF | 19.6 |
| 10.414500 | 36.55 | --- | 60.00 | 23.45 | L1 | OFF | 19.7 |
| 10.414500 | --- | 31.21 | 50.00 | 18.79 | L1 | OFF | 19.7 |



| | | | |
|-----------------|---------------|---------------------|---------|
| Test Engineer : | Jimmy Chang | Temperature : | 24~26°C |
| | | Relative Humidity : | 51~53% |
| Test Voltage : | 120Vac / 60Hz | Phase : | Neutral |

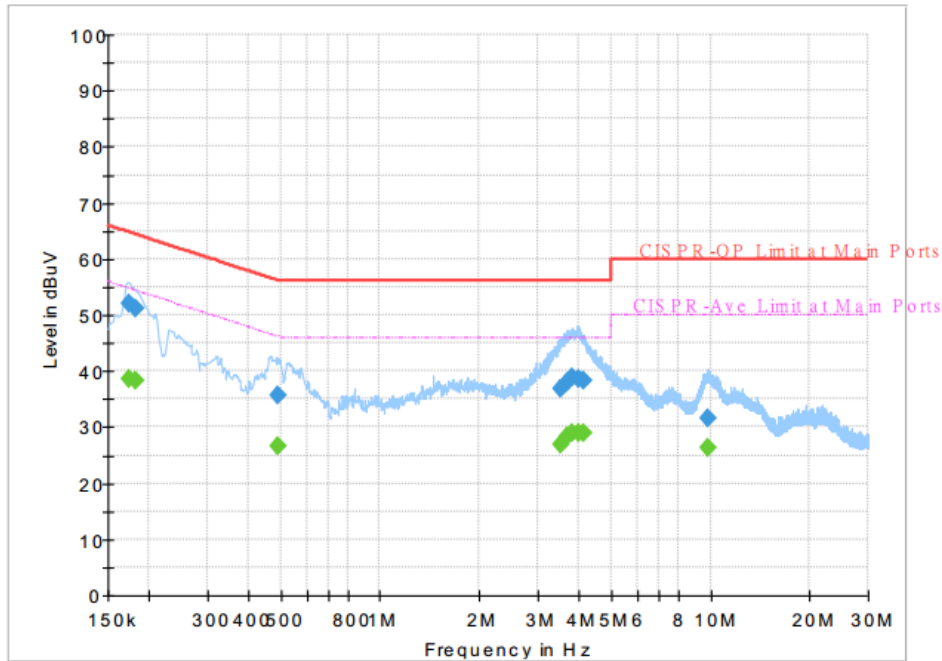

Final Result

| Frequency (MHz) | QuasiPeak (dBuV) | CAverage (dBuV) | Limit (dBuV) | Margin (dB) | Line | Filter | Corr. (dB) |
|-----------------|------------------|-----------------|--------------|-------------|------|--------|------------|
| 0.174750 | --- | 38.55 | 54.73 | 16.18 | N | OFF | 19.5 |
| 0.174750 | 52.14 | --- | 64.73 | 12.59 | N | OFF | 19.5 |
| 0.181500 | --- | 38.16 | 54.42 | 16.26 | N | OFF | 19.5 |
| 0.181500 | 51.23 | --- | 64.42 | 13.19 | N | OFF | 19.5 |
| 0.492000 | --- | 26.64 | 46.13 | 19.49 | N | OFF | 19.5 |
| 0.492000 | 35.57 | --- | 56.13 | 20.56 | N | OFF | 19.5 |
| 3.534000 | --- | 27.01 | 46.00 | 18.99 | N | OFF | 19.6 |
| 3.534000 | 36.71 | --- | 56.00 | 19.29 | N | OFF | 19.6 |
| 3.702750 | --- | 28.29 | 46.00 | 17.71 | N | OFF | 19.6 |
| 3.702750 | 37.93 | --- | 56.00 | 18.07 | N | OFF | 19.6 |
| 3.804000 | --- | 28.85 | 46.00 | 17.15 | N | OFF | 19.6 |
| 3.804000 | 38.97 | --- | 56.00 | 17.03 | N | OFF | 19.6 |
| 3.984000 | --- | 28.98 | 46.00 | 17.02 | N | OFF | 19.6 |
| 3.984000 | 38.74 | --- | 56.00 | 17.26 | N | OFF | 19.6 |
| 4.139250 | --- | 29.02 | 46.00 | 16.98 | N | OFF | 19.6 |
| 4.139250 | 38.18 | --- | 56.00 | 17.82 | N | OFF | 19.6 |
| 9.820500 | --- | 26.17 | 50.00 | 23.83 | N | OFF | 19.7 |
| 9.820500 | 31.66 | --- | 60.00 | 28.34 | N | OFF | 19.7 |



Appendix B. Radiated Spurious Emission

| | | | |
|-----------------|---|---------------------|---------|
| Test Engineer : | Jesse Wang, Stan Hsieh, and Troye Hsieh | Temperature : | 20~25°C |
| | | Relative Humidity : | 55~60% |

<1Mbps>

2.4GHz 2400~2483.5MHz

BLE (Band Edge @ 3m)

| BLE | Note | Frequency (MHz) | Level (dBµV/m) | Over Limit (dB) | Limit Line (dBµV/m) | Read Level (dBµV) | Antenna Factor (dB/m) | Path Loss (dB) | Preamp Factor (dB) | Ant Pos (cm) | Table Pos (deg) | Peak Avg. (P/A) | Pol. (H/V) | |
|-------------------------|------|----------------------|---------------------|-------------------------|-----------------------------|---------------------------|-------------------------------|------------------------|----------------------------|----------------------|-------------------------|-------------------------|-----------------|---|
| BLE CH 00 2402MHz | | 2319.765 | 55.01 | -18.99 | 74 | 40.55 | 31.8 | 17.59 | 34.93 | 354 | 2 | P | H | |
| | | 2382.975 | 46.08 | -7.92 | 54 | 31.35 | 31.93 | 17.74 | 34.94 | 354 | 2 | A | H | |
| | * | 2402 | 103.61 | - | - | 88.82 | 32 | 17.74 | 34.95 | 354 | 2 | P | H | |
| | * | 2402 | 102.96 | - | - | 88.17 | 32 | 17.74 | 34.95 | 354 | 2 | A | H | |
| | | | | | | | | | | | | | H | |
| | | | | | | | | | | | | | H | |
| | | | 2388.54 | 55.18 | -18.82 | 74 | 40.38 | 32 | 17.74 | 34.94 | 362 | 77 | P | V |
| | | | 2381.19 | 45.91 | -8.09 | 54 | 31.18 | 31.93 | 17.74 | 34.94 | 362 | 77 | A | V |
| | * | | 2402 | 97.12 | - | - | 82.33 | 32 | 17.74 | 34.95 | 362 | 77 | P | V |
| | * | | 2402 | 96.53 | - | - | 81.74 | 32 | 17.74 | 34.95 | 362 | 77 | A | V |
| | | | | | | | | | | | | | V | |
| | | | | | | | | | | | | | V | |
| BLE CH 19 2440MHz | | 2381.82 | 55.45 | -18.55 | 74 | 40.72 | 31.93 | 17.74 | 34.94 | 382 | 6 | P | H | |
| | | 2387.98 | 45.92 | -8.08 | 54 | 31.12 | 32 | 17.74 | 34.94 | 382 | 6 | A | H | |
| | * | 2440 | 105.81 | - | - | 90.78 | 32.2 | 17.79 | 34.96 | 382 | 6 | P | H | |
| | * | 2440 | 105.27 | - | - | 90.24 | 32.2 | 17.79 | 34.96 | 382 | 6 | A | H | |
| | | | 2488.8 | 55.44 | -18.56 | 74 | 40.37 | 32.2 | 17.84 | 34.97 | 382 | 6 | P | H |
| | | | 2488.38 | 46.18 | -7.82 | 54 | 31.11 | 32.2 | 17.84 | 34.97 | 382 | 6 | A | H |
| | | | 2310.56 | 54.93 | -19.07 | 74 | 40.46 | 31.8 | 17.59 | 34.92 | 394 | 82 | P | V |
| | | | 2373 | 46.07 | -7.93 | 54 | 31.41 | 31.93 | 17.67 | 34.94 | 394 | 82 | A | V |
| | * | | 2440 | 101.15 | - | - | 86.12 | 32.2 | 17.79 | 34.96 | 394 | 82 | P | V |
| | * | | 2440 | 100.52 | - | - | 85.49 | 32.2 | 17.79 | 34.96 | 394 | 82 | A | V |
| | | | 2495.31 | 54.94 | -19.06 | 74 | 39.88 | 32.2 | 17.84 | 34.98 | 394 | 82 | P | V |
| | | | 2496.22 | 46.09 | -7.91 | 54 | 31.03 | 32.2 | 17.84 | 34.98 | 394 | 82 | A | V |



| | | | | | | | | | | | | | |
|----------------------------------|---|---------|--------|--------|----|-------|------|-------|-------|-----|----|---|---|
| BLE CH 39 2480MHz | * | 2480 | 106.58 | - | - | 91.51 | 32.2 | 17.84 | 34.97 | 371 | 4 | P | H |
| | * | 2480 | 106.11 | - | - | 91.04 | 32.2 | 17.84 | 34.97 | 371 | 4 | A | H |
| | | 2497.72 | 55.82 | -18.18 | 74 | 40.76 | 32.2 | 17.84 | 34.98 | 371 | 4 | P | H |
| | | 2484.36 | 46.45 | -7.55 | 54 | 31.38 | 32.2 | 17.84 | 34.97 | 371 | 4 | A | H |
| | | | | | | | | | | | | | H |
| | | | | | | | | | | | | | H |
| | * | 2480 | 101.89 | - | - | 86.82 | 32.2 | 17.84 | 34.97 | 343 | 79 | P | V |
| | * | 2480 | 101.36 | - | - | 86.29 | 32.2 | 17.84 | 34.97 | 343 | 79 | A | V |
| | | 2488.48 | 55.3 | -18.7 | 74 | 40.23 | 32.2 | 17.84 | 34.97 | 343 | 79 | P | V |
| | | 2486.84 | 46.24 | -7.76 | 54 | 31.17 | 32.2 | 17.84 | 34.97 | 343 | 79 | A | V |
| | | | | | | | | | | | | | V |
| | | | | | | | | | | | | | V |
| Remark | <ol style="list-style-type: none"> 1. No other spurious found. 2. All results are PASS against Peak and Average limit line. | | | | | | | | | | | | |



2.4GHz 2400~2483.5MHz

BLE (Harmonic @ 3m)

| BLE | Note | Frequency | Level | Over Limit | Limit Line | Read Level | Antenna Factor | Path Loss | Preamp Factor | Ant Pos | Table Pos | Peak Avg. | Pol. |
|-------------------------|---|-----------|------------|------------|------------|------------|----------------|-----------|---------------|---------|-----------|-----------|---------|
| | | (MHz) | (dBμV/m) | (dB) | (dBμV/m) | (dBμV) | (dB/m) | (dB) | (dB) | (cm) | (deg) | (P/A) | (H/V) |
| BLE CH 00 2402MHz | | 4804 | 43.24 | -30.76 | 74 | 57.26 | 34 | 11.36 | 59.38 | 100 | 0 | P | H |
| | | | | | | | | | | | | | H |
| | | | | | | | | | | | | | H |
| | | | | | | | | | | | | | H |
| | | 4804 | 43.37 | -30.63 | 74 | 57.39 | 34 | 11.36 | 59.38 | 100 | 0 | P | V |
| | | | | | | | | | | | | | V |
| | | | | | | | | | | | | | V |
| | | | | | | | | | | | | | V |
| BLE CH 19 2440MHz | | 4880 | 42.72 | -31.28 | 74 | 56.41 | 34.13 | 11.42 | 59.24 | 100 | 0 | P | H |
| | | 7320 | 43.91 | -30.09 | 74 | 52.47 | 35.63 | 13.97 | 58.16 | 100 | 0 | P | H |
| | | | | | | | | | | | | | H |
| | | | | | | | | | | | | | H |
| | | 4880 | 43.8 | -30.2 | 74 | 57.49 | 34.13 | 11.42 | 59.24 | 100 | 0 | P | V |
| | | 7320 | 43.88 | -30.12 | 74 | 52.44 | 35.63 | 13.97 | 58.16 | 100 | 0 | P | V |
| | | | | | | | | | | | | | V |
| | | | | | | | | | | | | | V |
| BLE CH 39 2480MHz | | 4960 | 42.88 | -31.12 | 74 | 56.34 | 34.13 | 11.48 | 59.07 | 100 | 0 | P | H |
| | | 7440 | 43.92 | -30.08 | 74 | 52.66 | 35.5 | 14.09 | 58.33 | 100 | 0 | P | H |
| | | | | | | | | | | | | | H |
| | | | | | | | | | | | | | H |
| | | 4960 | 43.57 | -30.43 | 74 | 57.03 | 34.13 | 11.48 | 59.07 | 100 | 0 | P | V |
| | | 7440 | 48.58 | -25.42 | 74 | 57.32 | 35.5 | 14.09 | 58.33 | 100 | 0 | P | V |
| | | | | | | | | | | | | | V |
| | | | | | | | | | | | | | V |
| Remark | 1. No other spurious found. 2. All results are PASS against Peak and Average limit line. | | | | | | | | | | | | |



Emission below 1GHz

2.4GHz BLE (LF)

| BLE | Note | Frequency | Level | Over | Limit | Read | Antenna | Path | Preamp | Ant | Table | Peak | Pol. | |
|---------------------|--|-----------|------------|--------|------------|----------|----------|--------|--------|--------|---------|---------|---------|---|
| | | (MHz) | (dBμV/m) | (dB) | (dBμV/m) | (dBμV) | (dB/m) | (dB) | (dB) | (cm) | (deg) | (P/A) | (H/V) | |
| 2.4GHz BLE LF | | 30 | 32.02 | -7.98 | 40 | 36.27 | 24.6 | 1.33 | 30.18 | - | - | P | H | |
| | | 133.95 | 28.17 | -15.33 | 43.5 | 38.79 | 17.41 | 2.01 | 30.04 | - | - | P | H | |
| | | 197.94 | 29.52 | -13.98 | 43.5 | 42.22 | 14.88 | 2.38 | 29.96 | - | - | P | H | |
| | | 792.8 | 41.76 | -4.24 | 46 | 38.55 | 27.97 | 4.6 | 29.36 | - | - | P | H | |
| | | 902 | 41.86 | -4.14 | 46 | 37.03 | 28.76 | 4.96 | 28.89 | - | - | P | H | |
| | | 946.8 | 42.82 | -3.18 | 46 | 36.17 | 30.18 | 5.05 | 28.58 | 100 | 0 | P | H | |
| | | | | | | | | | | | | | | H |
| | | | | | | | | | | | | | | H |
| | | | | | | | | | | | | | | H |
| | | | | | | | | | | | | | | H |
| | | | | | | | | | | | | | | H |
| | | | | | | | | | | | | | | H |
| | | | 30.27 | 33.85 | -6.15 | 40 | 38.1 | 24.6 | 1.33 | 30.18 | - | - | P | V |
| | | | 42.69 | 33.77 | -6.23 | 40 | 44.83 | 17.76 | 1.34 | 30.16 | - | - | P | V |
| | | | 197.94 | 26.87 | -16.63 | 43.5 | 39.57 | 14.88 | 2.38 | 29.96 | - | - | P | V |
| | | | 902 | 40.06 | -5.94 | 46 | 35.23 | 28.76 | 4.96 | 28.89 | - | - | P | V |
| | | | 925.1 | 40.44 | -5.56 | 46 | 34.87 | 29.33 | 4.97 | 28.73 | 100 | 0 | P | V |
| | | | 968.5 | 41.67 | -12.33 | 54 | 34.19 | 30.86 | 5.06 | 28.44 | - | - | P | V |
| | | | | | | | | | | | | | V | |
| | | | | | | | | | | | | | V | |
| | | | | | | | | | | | | | V | |
| | | | | | | | | | | | | | V | |
| | | | | | | | | | | | | | V | |
| | | | | | | | | | | | | | V | |
| Remark | 1. No other spurious found. 2. All results are PASS against limit line. | | | | | | | | | | | | | |



<2Mbps>

2.4GHz 2400~2483.5MHz

BLE (Band Edge @ 3m)

| BLE | Note | Frequency (MHz) | Level (dBµV/m) | Over Limit (dB) | Limit Line (dBµV/m) | Read Level (dBµV) | Antenna Factor (dB/m) | Path Loss (dB) | Preamp Factor (dB) | Ant Pos (cm) | Table Pos (deg) | Peak Avg. (P/A) | Pol. (H/V) | |
|-------------------------|------|----------------------|---------------------|-------------------------|-----------------------------|---------------------------|-------------------------------|------------------------|----------------------------|----------------------|-------------------------|-------------------------|-----------------|---|
| BLE CH 00 2402MHz | | 2317.77 | 55.49 | -18.51 | 74 | 41.03 | 31.8 | 17.59 | 34.93 | 355 | 2 | P | H | |
| | | 2363.76 | 47.14 | -6.86 | 54 | 32.54 | 31.87 | 17.67 | 34.94 | 355 | 2 | A | H | |
| | * | 2402 | 102.63 | - | - | 87.84 | 32 | 17.74 | 34.95 | 355 | 2 | P | H | |
| | * | 2402 | 101.3 | - | - | 86.51 | 32 | 17.74 | 34.95 | 355 | 2 | A | H | |
| | | | | | | | | | | | | | H | |
| | | | | | | | | | | | | | | H |
| | | | 2384.655 | 55.56 | -18.44 | 74 | 40.83 | 31.93 | 17.74 | 34.94 | 362 | 77 | P | V |
| | | | 2323.65 | 47.29 | -6.71 | 54 | 32.83 | 31.8 | 17.59 | 34.93 | 362 | 77 | A | V |
| | * | | 2402 | 95.91 | - | - | 81.12 | 32 | 17.74 | 34.95 | 362 | 77 | P | V |
| | * | | 2402 | 94.38 | - | - | 79.59 | 32 | 17.74 | 34.95 | 362 | 77 | A | V |
| | | | | | | | | | | | | | | V |
| | | | | | | | | | | | | | | V |
| BLE CH 19 2440MHz | | 2374.82 | 54.98 | -19.02 | 74 | 40.32 | 31.93 | 17.67 | 34.94 | 382 | 6 | P | H | |
| | | 2373.56 | 47.28 | -6.72 | 54 | 32.62 | 31.93 | 17.67 | 34.94 | 382 | 6 | A | H | |
| | * | 2440 | 105.37 | - | - | 90.34 | 32.2 | 17.79 | 34.96 | 382 | 6 | P | H | |
| | * | 2440 | 104.12 | - | - | 89.09 | 32.2 | 17.79 | 34.96 | 382 | 6 | A | H | |
| | | | 2495.24 | 54.55 | -19.45 | 74 | 39.49 | 32.2 | 17.84 | 34.98 | 382 | 6 | P | H |
| | | | 2486.28 | 47.58 | -6.42 | 54 | 32.51 | 32.2 | 17.84 | 34.97 | 382 | 6 | A | H |
| | | | 2330.58 | 54.67 | -19.33 | 74 | 40.21 | 31.8 | 17.59 | 34.93 | 394 | 82 | P | V |
| | | | 2326.8 | 47.51 | -6.49 | 54 | 33.05 | 31.8 | 17.59 | 34.93 | 394 | 82 | A | V |
| | * | | 2440 | 100.55 | - | - | 85.52 | 32.2 | 17.79 | 34.96 | 394 | 82 | P | V |
| | * | | 2440 | 99.31 | - | - | 84.28 | 32.2 | 17.79 | 34.96 | 394 | 82 | A | V |
| | | | 2498.53 | 55.02 | -18.98 | 74 | 39.96 | 32.2 | 17.84 | 34.98 | 394 | 82 | P | V |
| | | | 2490.48 | 47.46 | -6.54 | 54 | 32.39 | 32.2 | 17.84 | 34.97 | 394 | 82 | A | V |



| | | | | | | | | | | | | | |
|----------------------------------|---|---------|--------|--------|----|-------|------|-------|-------|-----|----|---|---|
| BLE CH 39 2480MHz | * | 2480 | 105.75 | - | - | 90.68 | 32.2 | 17.84 | 34.97 | 371 | 4 | P | H |
| | * | 2480 | 104.42 | - | - | 89.35 | 32.2 | 17.84 | 34.97 | 371 | 4 | A | H |
| | | 2484.04 | 55.74 | -18.26 | 74 | 40.67 | 32.2 | 17.84 | 34.97 | 371 | 4 | P | H |
| | | 2483.52 | 48.03 | -5.97 | 54 | 32.96 | 32.2 | 17.84 | 34.97 | 371 | 4 | A | H |
| | | | | | | | | | | | | | H |
| | | | | | | | | | | | | | H |
| | * | 2480 | 101.23 | - | - | 86.16 | 32.2 | 17.84 | 34.97 | 343 | 79 | P | V |
| | * | 2480 | 100.04 | - | - | 84.97 | 32.2 | 17.84 | 34.97 | 343 | 79 | A | V |
| | | 2490.44 | 55.54 | -18.46 | 74 | 40.47 | 32.2 | 17.84 | 34.97 | 343 | 79 | P | V |
| | | 2484.6 | 48.1 | -5.9 | 54 | 33.03 | 32.2 | 17.84 | 34.97 | 343 | 79 | A | V |
| | | | | | | | | | | | | | V |
| | | | | | | | | | | | | | V |
| Remark | <ol style="list-style-type: none"> 1. No other spurious found. 2. All results are PASS against Peak and Average limit line. | | | | | | | | | | | | |



2.4GHz 2400~2483.5MHz

BLE (Harmonic @ 3m)

| BLE | Note | Frequency | Level | Over Limit | Limit Line | Read Level | Antenna Factor | Path Loss | Preamp Factor | Ant Pos | Table Pos | Peak Avg. | Pol. | |
|-------------------------|---|-----------|------------|------------|------------|------------|----------------|-----------|---------------|---------|-----------|-----------|---------|---|
| | | (MHz) | (dBμV/m) | (dB) | (dBμV/m) | (dBμV) | (dB/m) | (dB) | (dB) | (cm) | (deg) | (P/A) | (H/V) | |
| BLE CH 00 2402MHz | | 4804 | 43.32 | -30.68 | 74 | 57.34 | 34 | 11.36 | 59.38 | 100 | 0 | P | H | |
| | | | | | | | | | | | | | H | |
| | | | | | | | | | | | | | H | |
| | | | | | | | | | | | | | H | |
| | | | 4804 | 43.84 | -30.16 | 74 | 57.86 | 34 | 11.36 | 59.38 | 100 | 0 | P | V |
| | | | | | | | | | | | | | | V |
| | | | | | | | | | | | | | | V |
| | | | | | | | | | | | | | | V |
| BLE CH 19 2440MHz | | 4880 | 43.46 | -30.54 | 74 | 57.15 | 34.13 | 11.42 | 59.24 | 100 | 0 | P | H | |
| | | 7320 | 44.43 | -29.57 | 74 | 52.99 | 35.63 | 13.97 | 58.16 | 100 | 0 | P | H | |
| | | | | | | | | | | | | | H | |
| | | | | | | | | | | | | | H | |
| | | | 4880 | 43.12 | -30.88 | 74 | 56.81 | 34.13 | 11.42 | 59.24 | 100 | 0 | P | V |
| | | | 7320 | 43.7 | -30.3 | 74 | 52.26 | 35.63 | 13.97 | 58.16 | 100 | 0 | P | V |
| | | | | | | | | | | | | | | V |
| | | | | | | | | | | | | | | V |
| BLE CH 39 2480MHz | | 4960 | 43 | -31 | 74 | 56.46 | 34.13 | 11.48 | 59.07 | 100 | 0 | P | H | |
| | | 7440 | 44.36 | -29.64 | 74 | 53.1 | 35.5 | 14.09 | 58.33 | 100 | 0 | P | H | |
| | | | | | | | | | | | | | H | |
| | | | | | | | | | | | | | H | |
| | | | 4960 | 43.58 | -30.42 | 74 | 57.04 | 34.13 | 11.48 | 59.07 | 100 | 0 | P | V |
| | | | 7440 | 44.71 | -29.29 | 74 | 53.45 | 35.5 | 14.09 | 58.33 | 100 | 0 | P | V |
| | | | | | | | | | | | | | | V |
| | | | | | | | | | | | | | | V |
| Remark | 1. No other spurious found. 2. All results are PASS against Peak and Average limit line. | | | | | | | | | | | | | |



Emission below 1GHz

2.4GHz BLE (LF)

| BLE | Note | Frequency | Level | Over | Limit | Read | Antenna | Path | Preamp | Ant | Table | Peak | Pol. | |
|---------------------|--|-----------|------------|--------|------------|----------|----------|--------|--------|--------|---------|---------|---------|---|
| | | (MHz) | (dBμV/m) | (dB) | (dBμV/m) | (dBμV) | (dB/m) | (dB) | (dB) | (cm) | (deg) | (P/A) | (H/V) | |
| 2.4GHz BLE LF | | 30.27 | 23.4 | -16.6 | 40 | 27.65 | 24.6 | 1.33 | 30.18 | - | - | P | H | |
| | | 50.79 | 20.46 | -19.54 | 40 | 35.02 | 14.25 | 1.34 | 30.15 | - | - | P | H | |
| | | 147.45 | 30.07 | -13.43 | 43.5 | 40.7 | 17.15 | 2.24 | 30.02 | - | - | P | H | |
| | | 881.7 | 42.22 | -3.78 | 46 | 37.43 | 28.88 | 4.89 | 28.98 | 100 | 0 | P | H | |
| | | 903.4 | 41.95 | -4.05 | 46 | 37.09 | 28.78 | 4.96 | 28.88 | - | - | P | H | |
| | | 948.2 | 41.9 | -4.1 | 46 | 35.14 | 30.28 | 5.05 | 28.57 | - | - | P | H | |
| | | | | | | | | | | | | | | H |
| | | | | | | | | | | | | | | H |
| | | | | | | | | | | | | | | H |
| | | | | | | | | | | | | | | H |
| | | | | | | | | | | | | | | H |
| | | | | | | | | | | | | | | H |
| | | | 30 | 31.99 | -8.01 | 40 | 36.24 | 24.6 | 1.33 | 30.18 | - | - | P | V |
| | | | 62.4 | 27.49 | -12.51 | 40 | 44.04 | 11.87 | 1.71 | 30.13 | - | - | P | V |
| | | | 129.36 | 31.14 | -12.36 | 43.5 | 41.69 | 17.48 | 2.01 | 30.04 | - | - | P | V |
| | | | 881 | 40.53 | -5.47 | 46 | 35.73 | 28.89 | 4.89 | 28.98 | - | - | P | V |
| | | | 925.1 | 42.1 | -3.9 | 46 | 36.53 | 29.33 | 4.97 | 28.73 | 100 | 0 | P | V |
| | | | 946.8 | 41.32 | -4.68 | 46 | 34.67 | 30.18 | 5.05 | 28.58 | - | - | P | V |
| | | | | | | | | | | | | | V | |
| | | | | | | | | | | | | | V | |
| | | | | | | | | | | | | | V | |
| | | | | | | | | | | | | | V | |
| | | | | | | | | | | | | | V | |
| | | | | | | | | | | | | | V | |
| Remark | 1. No other spurious found. 2. All results are PASS against limit line. | | | | | | | | | | | | | |



Note symbol

| | |
|-----|--|
| * | Fundamental Frequency which can be ignored. However, the level of any unwanted emissions shall not exceed the level of the fundamental frequency. |
| ! | Test result is over limit line. |
| P/A | Peak or Average |
| H/V | Horizontal or Vertical |



A calculation example for radiated spurious emission is shown as below:

| BLE | Note | Frequency | Level | Over | Limit | Read | Antenna | Path | Preamp | Ant | Table | Peak | Pol. |
|-------------------------|------|-----------|------------|--------|------------|----------|----------|--------|--------|--------|---------|---------|---------|
| | | (MHz) | (dBμV/m) | (dB) | (dBμV/m) | (dBμV) | (dB/m) | (dB) | (dB) | (cm) | (deg) | (P/A) | (H/V) |
| BLE CH 00 2402MHz | | 2390 | 55.45 | -18.55 | 74 | 54.51 | 32.22 | 4.58 | 35.86 | 103 | 308 | P | H |
| | | 2390 | 43.54 | -10.46 | 54 | 42.6 | 32.22 | 4.58 | 35.86 | 103 | 308 | A | H |

1. Path Loss(dB) = Cable loss(dB) + Filter loss(dB) + Attenuator loss(dB)
2. Level(dBμV/m) =
Antenna Factor(dB/m) + Path Loss(dB) + Read Level(dBμV) - Preamp Factor(dB)
3. Over Limit(dB) = Level(dBμV/m) – Limit Line(dBμV/m)

For Peak Limit @ 2390MHz:

1. Level(dBμV/m)
= Antenna Factor(dB/m) + Path Loss(dB) + Read Level(dBμV) - Preamp Factor(dB)
= 32.22(dB/m) + 4.58(dB) + 54.51(dBμV) – 35.86 (dB)
= 55.45 (dBμV/m)
2. Over Limit(dB)
= Level(dBμV/m) – Limit Line(dBμV/m)
= 55.45(dBμV/m) – 74(dBμV/m)
= -18.55(dB)

For Average Limit @ 2390MHz:

1. Level(dBμV/m)
= Antenna Factor(dB/m) + Path Loss(dB) + Read Level(dBμV) - Preamp Factor(dB)
= 32.22(dB/m) + 4.58(dB) + 42.6(dBμV) – 35.86 (dB)
= 43.54 (dBμV/m)
2. Over Limit(dB)
= Level(dBμV/m) – Limit Line(dBμV/m)
= 43.54(dBμV/m) – 54(dBμV/m)
= -10.46(dB)

Both peak and average measured complies with the limit line, so test result is “PASS”.



Appendix C. Radiated Spurious Emission Plots

| | | | |
|------------------------|---|----------------------------|---------|
| Test Engineer : | Jesse Wang, Stan Hsieh, and Troye Hsieh | Temperature : | 20~25°C |
| | | Relative Humidity : | 55~60% |

Note symbol

| | |
|----|------------------------------|
| -L | Low channel location |
| -R | High channel location |



<1Mbps>

2.4GHz 2400~2483.5MHz

BLE (Band Edge @ 3m)

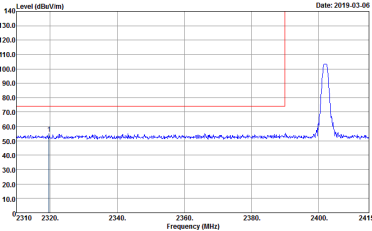
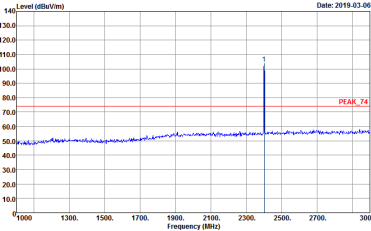
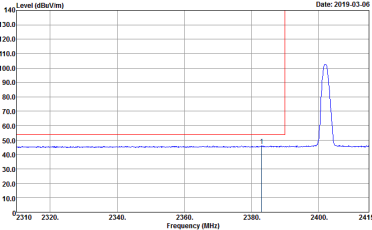
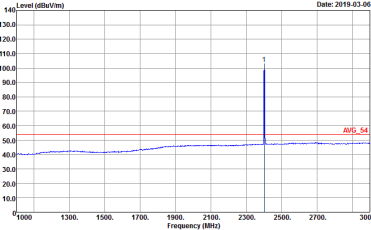
| BLE | 2.4GHz 2400~2483.5MHz Band Edge @ 3m | |
|------------------|---|---|
| BLE CH00 2402MHz | | |
| Horizontal | | Fundamental |
| Peak |  <p>Date: 2019-03-06</p> <p>Site : 03CH07-HY Condition : PEAK_BE_74 3m HF_ANT_00075962 HORIZONTAL : RBW:1000.000kHz VBW:3000.000kHz SWF:Auto Detector : Peak Project : 8N2626 Mode : 49</p> |  <p>Date: 2019-03-06</p> <p>Site : 03CH07-HY Condition : PEAK_74 3m HF_ANT_00075962 HORIZONTAL : RBW:1000.000kHz VBW:3000.000kHz SWF:Auto Detector : Peak Project : 8N2626 Mode : 49</p> |
| Avg. |  <p>Date: 2019-03-06</p> <p>Site : 03CH07-HY Condition : AVG_BE_54 3m HF_ANT_00075962 HORIZONTAL : RBW:1000.000kHz VBW:3.000kHz SWF:Auto Detector : Peak Project : 8N2626 Mode : 49</p> |  <p>Date: 2019-03-06</p> <p>Site : 03CH07-HY Condition : AVG_54 3m HF_ANT_00075962 HORIZONTAL : RBW:1000.000kHz VBW:3.000kHz SWF:Auto Detector : Peak Project : 8N2626 Mode : 49</p> |

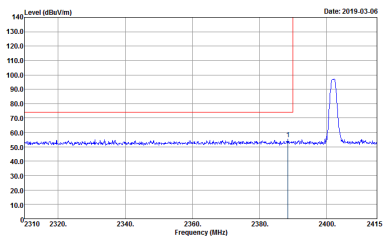
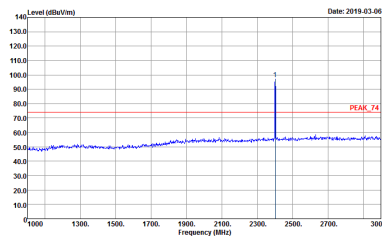
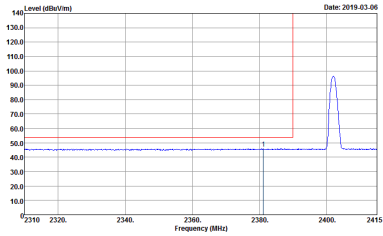
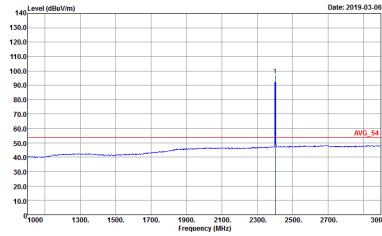

| BLE | 2.4GHz 2400~2483.5MHz Band Edge @ 3m | |
|------|---|---|
| | BLE CH00 2402MHz | |
| | Vertical | Fundamental |
| Peak |  <p>Site : 03CH07-HY Condition : PEAK_BE_74 3m HF_ANT_00075962 VERTICAL : RBW:1000.000KHz VBW:3000.000KHz SWT:Auto Detector : Peak Project : BN2626 Mode : 49</p> |  <p>Site : 03CH07-HY Condition : PEAK_74 3m HF_ANT_00075962 VERTICAL : RBW:1000.000KHz VBW:3000.000KHz SWT:Auto Detector : Peak Project : BN2626 Mode : 49</p> |
| Avg |  <p>Site : 03CH07-HY Condition : AVG_BE_54 3m HF_ANT_00075962 VERTICAL : RBW:1000.000KHz VBW:3.000KHz SWT:Auto Detector : Peak Project : BN2626 Mode : 49</p> |  <p>Site : 03CH07-HY Condition : AVG_54 3m HF_ANT_00075962 VERTICAL : RBW:1000.000KHz VBW:3.000KHz SWT:Auto Detector : Peak Project : BN2626 Mode : 49</p> |

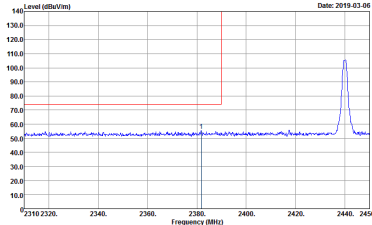
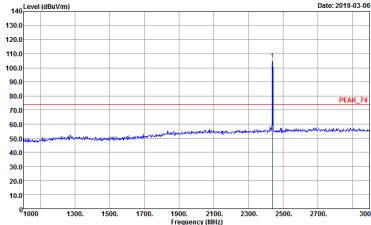
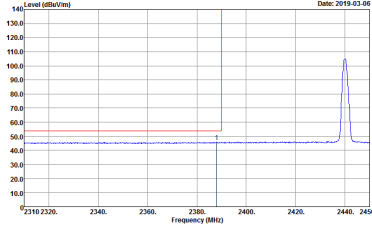
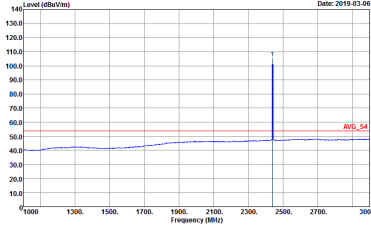

| BLE | 2.4GHz 2400~2483.5MHz Band Edge @ 3m | |
|------|---|---|
| | BLE CH19 2440MHz - L | |
| | Horizontal | Fundamental |
| Peak |  <p>Date: 2019-03-06</p> <p>Site : 03CH07-HY Condition : PEAK_BE_24 3m HF_ANT_00075962 HORIZONTAL : RBW:1000.000kHz VBW:3000.000kHz SWT:Auto Detector : Peak Project : 8N2626 Mode : 50</p> |  <p>Date: 2019-03-06</p> <p>Site : 03CH07-HY Condition : PEAK_24 3m HF_ANT_00075962 HORIZONTAL : RBW:1000.000kHz VBW:3000.000kHz SWT:Auto Detector : Peak Project : 8N2626 Mode : 50</p> |
| Avg. |  <p>Date: 2019-03-06</p> <p>Site : 03CH07-HY Condition : AVG_BE_54 3m HF_ANT_00075962 HORIZONTAL : RBW:1000.000kHz VBW:3.000kHz SWT:Auto Detector : Peak Project : 8N2626 Mode : 50</p> |  <p>Date: 2019-03-06</p> <p>Site : 03CH07-HY Condition : AVG_54 3m HF_ANT_00075962 HORIZONTAL : RBW:1000.000kHz VBW:3.000kHz SWT:Auto Detector : Peak Project : 8N2626 Mode : 50</p> |

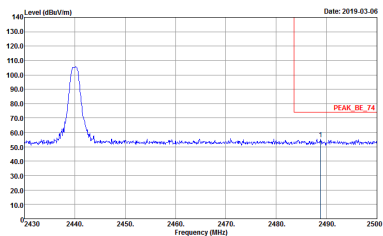
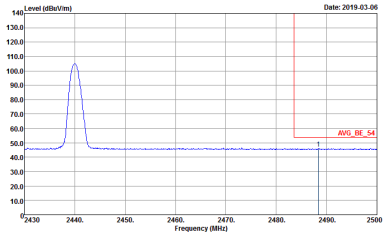

| BLE | 2.4GHz 2400~2483.5MHz Band Edge @ 3m | |
|--------------------|---|-------------------|
| | BLE CH19 2440MHz - R | |
| | Horizontal | Fundamental |
| <p>Peak</p> |  <p> Site : 03CH07-HY Condition : PEAK_BE_74 3m HF_ANT_00075962 HORIZONTAL : RBW:1000.000KHz VBW:3000.000KHz SWT:Auto Detector : Peak Project : BN2626 Mode : S0 </p> | <p>Left blank</p> |
| <p>Avg.</p> |  <p> Site : 03CH07-HY Condition : AVG_BE_54 3m HF_ANT_00075962 HORIZONTAL : RBW:1000.000KHz VBW:3.000KHz SWT:Auto Detector : Peak Project : BN2626 Mode : S0 </p> | <p>Left blank</p> |

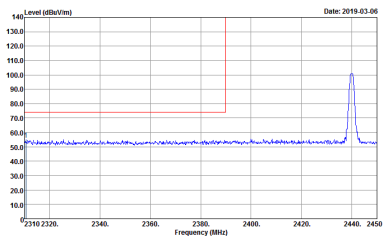
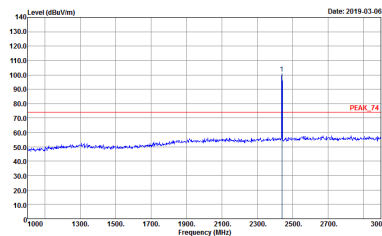
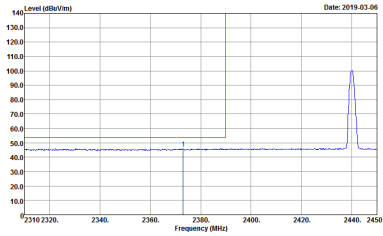
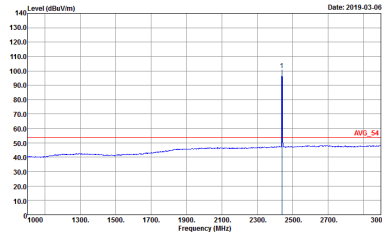

| BLE | 2.4GHz 2400~2483.5MHz Band Edge @ 3m | |
|------|---|---|
| | BLE CH19 2440MHz - L | |
| | Vertical | Fundamental |
| Peak |  <p>Site : 03CH07-HY Condition : PEAK_BE_74 3m HF_ANT_00075962 VERTICAL : RBW:1000.000KHz VBW:3000.000KHz SWT:Auto Detector : Peak Project : BN2626 Mode : 50</p> |  <p>Site : 03CH07-HY Condition : PEAK_74 3m HF_ANT_00075962 VERTICAL : RBW:1000.000KHz VBW:3000.000KHz SWT:Auto Detector : Peak Project : BN2626 Mode : 50</p> |
| Avg. |  <p>Site : 03CH07-HY Condition : AVG_BE_54 3m HF_ANT_00075962 VERTICAL : RBW:1000.000KHz VBW:3.000KHz SWT:Auto Detector : Peak Project : BN2626 Mode : 50</p> |  <p>Site : 03CH07-HY Condition : AVG_54 3m HF_ANT_00075962 VERTICAL : RBW:1000.000KHz VBW:3.000KHz SWT:Auto Detector : Peak Project : BN2626 Mode : 50</p> |

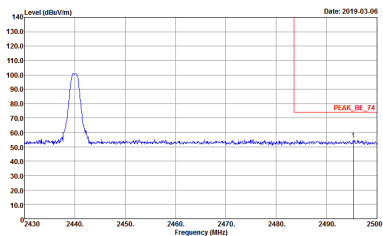
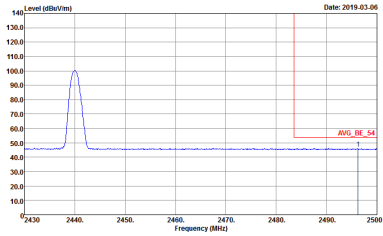

| BLE | 2.4GHz 2400~2483.5MHz Band Edge @ 3m | |
|--------------------|---|-------------------|
| | BLE CH19 2440MHz - R | |
| | Vertical | Fundamental |
| <p>Peak</p> |  <p>Site : 03CH07-HY Condition : PEAK_BE_74 3m HF_ANT_00075962 VERTICAL : RBW:1000.000KHz VBW:3000.000KHz SWF:Auto Detector : Peak Project : BN2626 Mode : S0</p> | <p>Left blank</p> |
| <p>Avg.</p> |  <p>Site : 03CH07-HY Condition : AVG_BE_54 3m HF_ANT_00075962 VERTICAL : RBW:1000.000KHz VBW:3.000KHz SWF:Auto Detector : Peak Project : BN2626 Mode : S0</p> | <p>Left blank</p> |

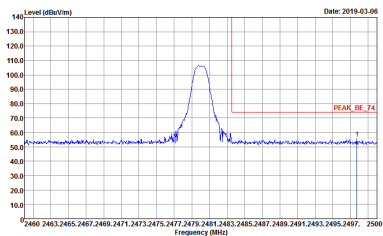
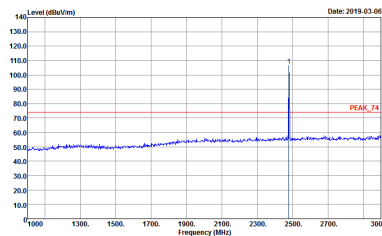
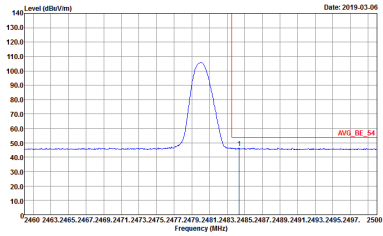
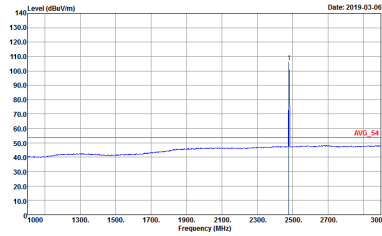

| BLE | 2.4GHz 2400~2483.5MHz Band Edge @ 3m | |
|--------------------|---|---|
| | BLE CH39 2480MHz | |
| | Horizontal | Fundamental |
| <p>Peak</p> |  <p>Date: 2019-03-06</p> <p>Site : 03CH07-HY Condition : PEAK_BE_74 3m HF_ANT_00075962 HORIZONTAL RBW:1000.000kHz VBW:3000.000kHz SWT:Auto Detector : Peak Project : BN2626 Mode : S1</p> |  <p>Date: 2019-03-06</p> <p>Site : 03CH07-HY Condition : PEAK_74 3m HF_ANT_00075962 HORIZONTAL RBW:1000.000kHz VBW:3000.000kHz SWT:Auto Detector : Peak Project : BN2626 Mode : S1</p> |
| <p>Avg.</p> |  <p>Date: 2019-03-06</p> <p>Site : 03CH07-HY Condition : AVG_BE_54 3m HF_ANT_00075962 HORIZONTAL RBW:1000.000kHz VBW:3.000kHz SWT:Auto Detector : Peak Project : BN2626 Mode : S1</p> |  <p>Date: 2019-03-06</p> <p>Site : 03CH07-HY Condition : AVG_54 3m HF_ANT_00075962 HORIZONTAL RBW:1000.000kHz VBW:3.000kHz SWT:Auto Detector : Peak Project : BN2626 Mode : S1</p> |

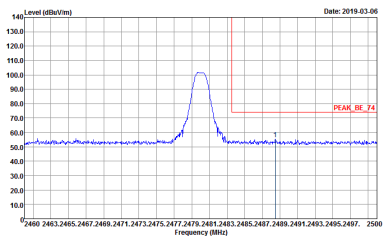
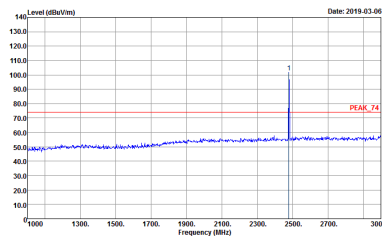
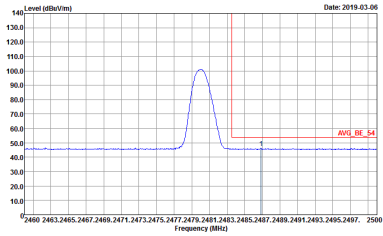
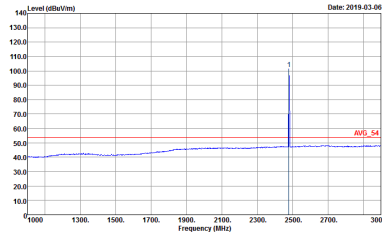

| BLE | 2.4GHz 2400~2483.5MHz Band Edge @ 3m | |
|------|--|--|
| | BLE CH39 2480MHz | |
| | Vertical | Fundamental |
| Peak |  <p>Site : 03CH07-HY Condition : PEAK_BE_74 3m HF_ANT_00075962 VERTICAL Detector : Peak Project : BN2626 Mode : S1</p> |  <p>Site : 03CH07-HY Condition : PEAK_74 3m HF_ANT_00075962 VERTICAL Detector : Peak Project : BN2626 Mode : S1</p> |
| Avg. |  <p>Site : 03CH07-HY Condition : AVG_BE_S4 3m HF_ANT_00075962 VERTICAL Detector : Peak Project : BN2626 Mode : S1</p> |  <p>Site : 03CH07-HY Condition : AVG_S4 3m HF_ANT_00075962 VERTICAL Detector : Peak Project : BN2626 Mode : S1</p> |



2.4GHz 2400~2483.5MHz

BLE (Harmonic @ 3m)

| BLE | 2.4GHz 2400~2483.5MHz Harmonic @ 3m | |
|---------------------------------------|---|---|
| | BLE CH00 2402MHz | |
| | Horizontal | Vertical |
| <p>Peak</p> <p>Avg.</p> | <p>Date: 2019-03-06</p> <p>Site : 03CH07-HY Condition : PEAK_74 3m SHF-EHF_131029 HORIZONTAL Detector : Peak Project : 8N2626 Mode : 49</p> | <p>Date: 2019-03-06</p> <p>Site : 03CH07-HY Condition : PEAK_74 3m SHF-EHF_131029 VERTICAL Detector : Peak Project : 8N2626 Mode : 49</p> |

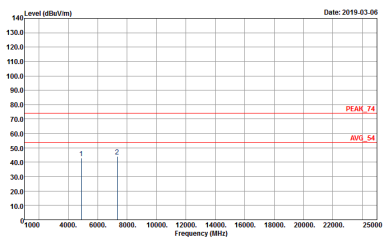
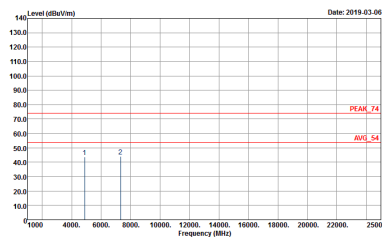

| | | |
|---------------------------------------|---|--|
| BLE | 2.4GHz 2400~2483.5MHz Harmonic @ 3m | |
| | BLE CH19 2440MHz | |
| | Horizontal | Vertical |
| <p>Peak</p> <p>Avg.</p> |  <p>Site : 03CH07-HY Condition : PEAK_74 3m SHF-EHF_131029 HORIZONTAL Detector : Peak Project : 8N2626 Mode : 50</p> |  <p>Site : 03CH07-HY Condition : PEAK_74 3m SHF-EHF_131029 VERTICAL Detector : Peak Project : 8N2626 Mode : 50</p> |

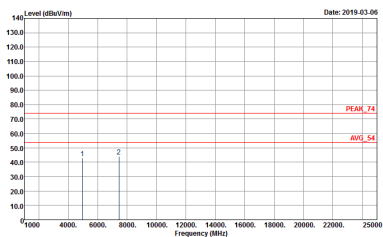
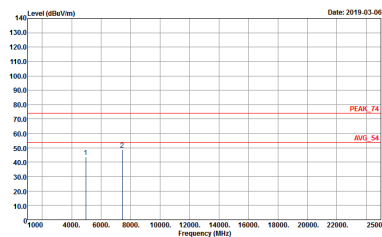

| | | |
|------|---|--|
| BLE | 2.4GHz 2400~2483.5MHz Harmonic @ 3m | |
| | BLE CH39 2480MHz | |
| | Horizontal | Vertical |
| Peak |  <p>Site : 03CH07-HY Condition : PEAK_74 3m SHF-EHF_131029 HORIZONTAL Detector : Peak Project : 8N2626 Mode : S1</p> |  <p>Site : 03CH07-HY Condition : PEAK_74 3m SHF-EHF_131029 VERTICAL Detector : Peak Project : 8N2626 Mode : S1</p> |



Emission below 1GHz

2.4GHz BLE (LF)

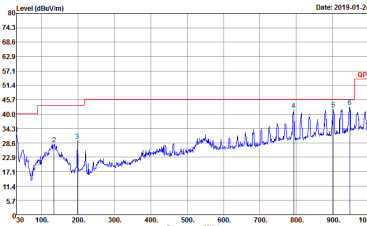
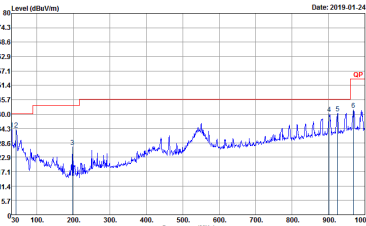
| BLE | 2.4GHz 2400~2483.5MHz | |
|----------------------|---|--|
| | BLE LF | |
| | Horizontal | Vertical |
| <p>QP / Peak</p> |  <p>Site : 03CH07-HY Condition : QP 3m LF-ANT-35419(G) HORIZONTAL Detector : Peak Project : 8N2626 Mode : 57</p> |  <p>Site : 03CH07-HY Condition : QP 3m LF-ANT-35419(G) VERTICAL Detector : Peak Project : 8N2626 Mode : 57</p> |



<2Mbps>

2.4GHz 2400~2483.5MHz

BLE (Band Edge @ 3m)

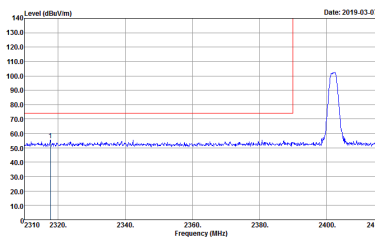
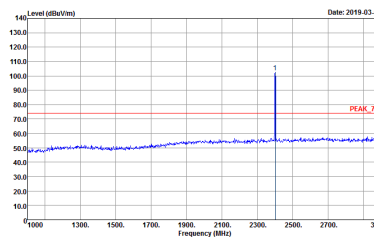
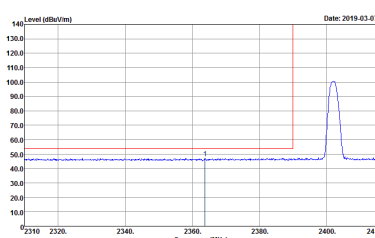
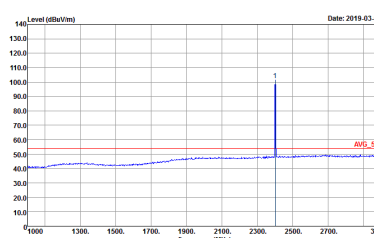
| BLE | 2.4GHz 2400~2483.5MHz Band Edge @ 3m | |
|--------------------|---|---|
| | BLE CH00 2402MHz | |
| | Horizontal | Fundamental |
| <p>Peak</p> |  <p>Date: 2019-03-07</p> <p>Site : 03CH07-HY Condition : PEAK_BE_74 3m HF_ANT_00075962 HORIZONTAL : RBW:1000.000KHz VBW:3000.000KHz SWT:Auto Detector : Peak Project : 8N2626 Mode : 64</p> |  <p>Date: 2019-03-07</p> <p>Site : 03CH07-HY Condition : PEAK_74 3m HF_ANT_00075962 HORIZONTAL : RBW:1000.000KHz VBW:3000.000KHz SWT:Auto Detector : Peak Project : 8N2626 Mode : 64</p> |
| <p>Avg.</p> |  <p>Date: 2019-03-07</p> <p>Site : 03CH07-HY Condition : AVG_BE_54 3m HF_ANT_00075962 HORIZONTAL : RBW:1000.000KHz VBW:10.000KHz SWT:Auto Detector : Peak Project : 8N2626 Mode : 64</p> |  <p>Date: 2019-03-07</p> <p>Site : 03CH07-HY Condition : AVG_54 3m HF_ANT_00075962 HORIZONTAL : RBW:1000.000KHz VBW:10.000KHz SWT:Auto Detector : Peak Project : 8N2626 Mode : 64</p> |

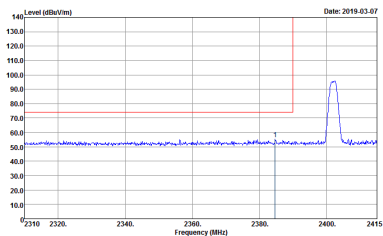
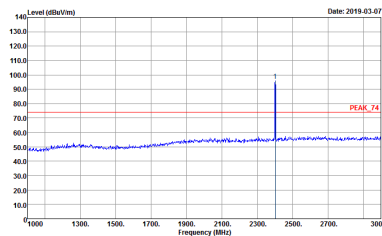
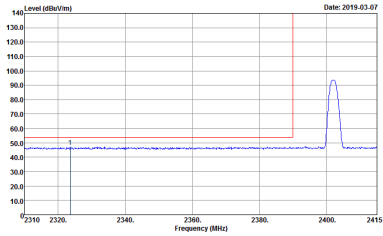
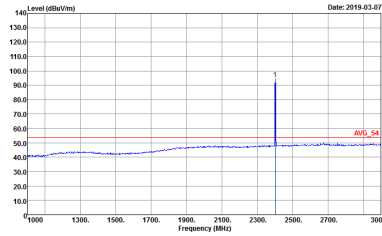

| BLE | 2.4GHz 2400~2483.5MHz Band Edge @ 3m | |
|------|---|---|
| | BLE CH00 2402MHz | |
| | Vertical | Fundamental |
| Peak |  <p>Site : 03CH07-HY Condition : PEAK_BE_74 3m HF_ANT_00075962 VERTICAL : RBW:1000.000KHz VBW:3000.000KHz SWT:Auto Detector : Peak Project : BN2626 Mode : 64</p> |  <p>Site : 03CH07-HY Condition : PEAK_74 3m HF_ANT_00075962 VERTICAL : RBW:1000.000KHz VBW:3000.000KHz SWT:Auto Detector : Peak Project : BN2626 Mode : 64</p> |
| Avg |  <p>Site : 03CH07-HY Condition : AVG_BE_54 3m HF_ANT_00075962 VERTICAL : RBW:1000.000KHz VBW:10.000KHz SWT:Auto Detector : Peak Project : BN2626 Mode : 64</p> |  <p>Site : 03CH07-HY Condition : AVG_54 3m HF_ANT_00075962 VERTICAL : RBW:1000.000KHz VBW:10.000KHz SWT:Auto Detector : Peak Project : BN2626 Mode : 64</p> |

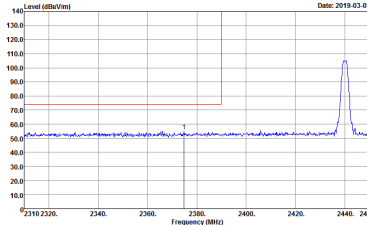
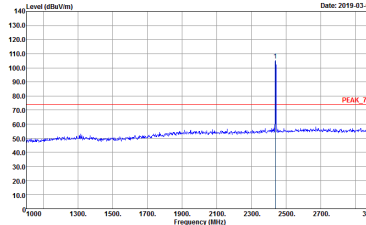
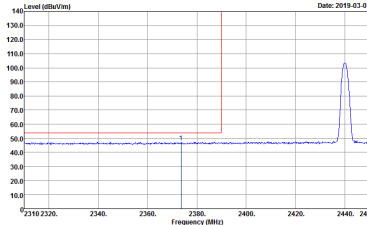
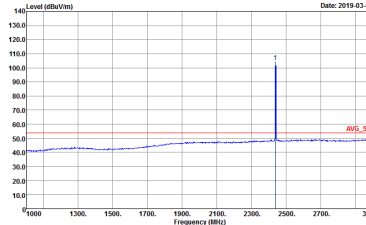

| BLE | 2.4GHz 2400~2483.5MHz Band Edge @ 3m | |
|------|---|---|
| | BLE CH19 2440MHz - L | |
| | Horizontal | Fundamental |
| Peak |  <p>Date: 2019-03-07</p> <p>Site : 03CH07-HY Condition : PEAK_BE_24 3m HF_ANT_00075962 HORIZONTAL : RBW:1000.000kHz VBW:3000.000kHz SWT:Auto Detector : Peak Project : 8N2626 Mode : 65</p> |  <p>Date: 2019-03-07</p> <p>Site : 03CH07-HY Condition : PEAK_24 3m HF_ANT_00075962 HORIZONTAL : RBW:1000.000kHz VBW:3000.000kHz SWT:Auto Detector : Peak Project : 8N2626 Mode : 65</p> |
| Avg. |  <p>Date: 2019-03-07</p> <p>Site : 03CH07-HY Condition : AVG_BE_24 3m HF_ANT_00075962 HORIZONTAL : RBW:1000.000kHz VBW:10.000kHz SWT:Auto Detector : Peak Project : 8N2626 Mode : 65</p> |  <p>Date: 2019-03-07</p> <p>Site : 03CH07-HY Condition : AVG_24 3m HF_ANT_00075962 HORIZONTAL : RBW:1000.000kHz VBW:10.000kHz SWT:Auto Detector : Peak Project : 8N2626 Mode : 65</p> |

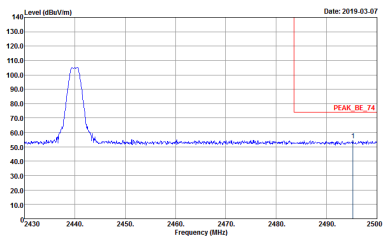
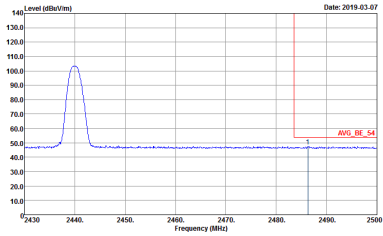

| BLE | 2.4GHz 2400~2483.5MHz Band Edge @ 3m | |
|--------------------|---|-------------------|
| | BLE CH19 2440MHz - R | |
| | Horizontal | Fundamental |
| <p>Peak</p> |  <p>Date: 2019-03-07</p> <p>Site : 03CH07-HY Condition : PEAK_BE_74 3m HF_ANT_00075962 HORIZONTAL : RBW:1000.000KHz VBW:3000.000KHz SWT:Auto Detector : Peak Project : BN2626 Mode : ES</p> | <p>Left blank</p> |
| <p>Avg.</p> |  <p>Date: 2019-03-07</p> <p>Site : 03CH07-HY Condition : AVG_BE_54 3m HF_ANT_00075962 HORIZONTAL : RBW:1000.000KHz VBW:10.000KHz SWT:Auto Detector : Peak Project : BN2626 Mode : ES</p> | <p>Left blank</p> |

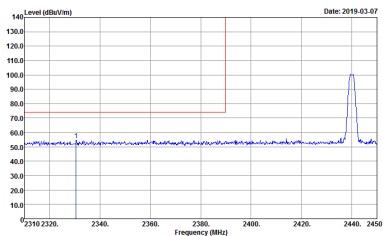
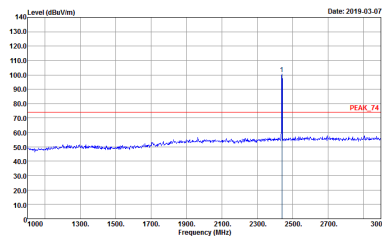
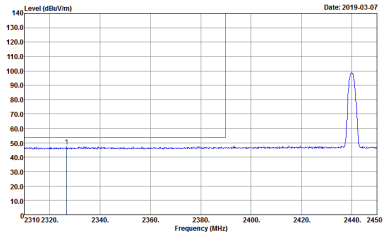
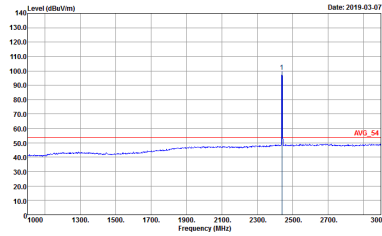

| BLE | 2.4GHz 2400~2483.5MHz Band Edge @ 3m | |
|------|---|---|
| | BLE CH19 2440MHz - L | |
| | Vertical | Fundamental |
| Peak |  <p>Date: 2019-03-07</p> <p>Site : 03CH07-HY Condition : PEAK_BE_74 3m HF_ANT_00075962 VERTICAL : RBW:1000.000KHz VBW:3000.000KHz SWT:Auto Detector : Peak Project : BN2626 Mode : 65</p> |  <p>Date: 2019-03-07</p> <p>Site : 03CH07-HY Condition : PEAK_74 3m HF_ANT_00075962 VERTICAL : RBW:1000.000KHz VBW:3000.000KHz SWT:Auto Detector : Peak Project : BN2626 Mode : 65</p> |
| Avg. |  <p>Date: 2019-03-07</p> <p>Site : 03CH07-HY Condition : AVG_BE_54 3m HF_ANT_00075962 VERTICAL : RBW:1000.000KHz VBW:10.000KHz SWT:Auto Detector : Peak Project : BN2626 Mode : 65</p> |  <p>Date: 2019-03-07</p> <p>Site : 03CH07-HY Condition : AVG_54 3m HF_ANT_00075962 VERTICAL : RBW:1000.000KHz VBW:10.000KHz SWT:Auto Detector : Peak Project : BN2626 Mode : 65</p> |

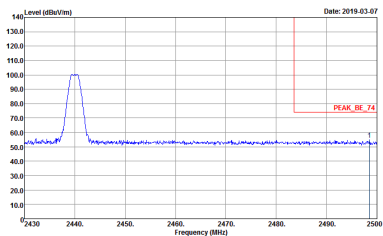
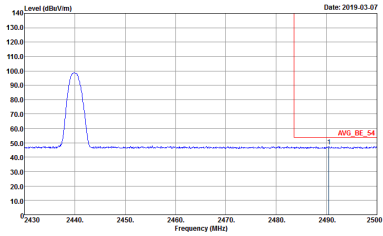

| BLE | 2.4GHz 2400~2483.5MHz Band Edge @ 3m | |
|--------------------|---|-------------------|
| | BLE CH19 2440MHz - R | |
| | Vertical | Fundamental |
| <p>Peak</p> |  <p>Date: 2019-03-07</p> <p>Site : 03CH07-HY Condition : PEAK_BE_74 3m HF_ANT_00075962 VERTICAL : RBW:1000.000KHz VBW:3000.000KHz SWT:Auto Detector : Peak Project : BN2626 Mode : GS</p> | <p>Left blank</p> |
| <p>Avg.</p> |  <p>Date: 2019-03-07</p> <p>Site : 03CH07-HY Condition : AVG_BE_54 3m HF_ANT_00075962 VERTICAL : RBW:1000.000KHz VBW:10.000KHz SWT:Auto Detector : Peak Project : BN2626 Mode : GS</p> | <p>Left blank</p> |

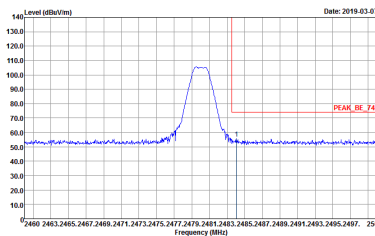
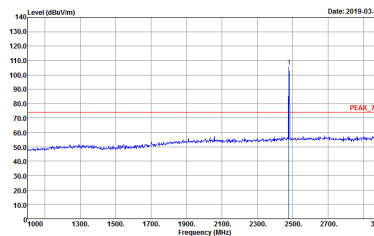
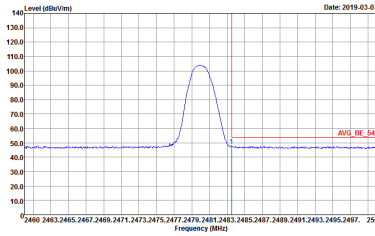
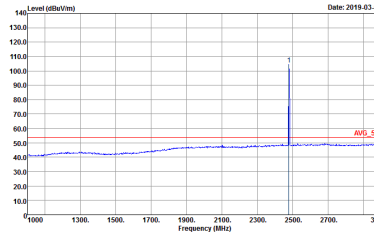

| BLE | 2.4GHz 2400~2483.5MHz Band Edge @ 3m | |
|--------------------|--|--|
| | BLE CH39 2480MHz | |
| | Horizontal | Fundamental |
| <p>Peak</p> |  <p>Site : 03CH07-HY Condition : PEAK_BE_74 3m HF_ANT_00075962 HORIZONTAL Detector : Peak Project : BN2626 Mode : 66</p> |  <p>Site : 03CH07-HY Condition : PEAK_74 3m HF_ANT_00075962 HORIZONTAL Detector : Peak Project : BN2626 Mode : 66</p> |
| <p>Avg.</p> |  <p>Site : 03CH07-HY Condition : AVG_BE_54 3m HF_ANT_00075962 HORIZONTAL Detector : Peak Project : BN2626 Mode : 66</p> |  <p>Site : 03CH07-HY Condition : AVG_54 3m HF_ANT_00075962 HORIZONTAL Detector : Peak Project : BN2626 Mode : 66</p> |

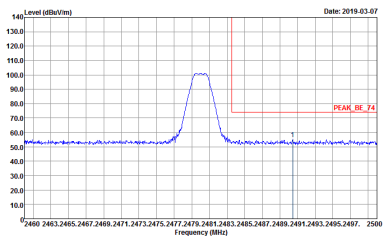
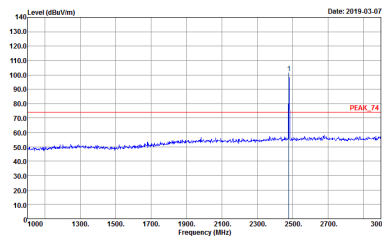
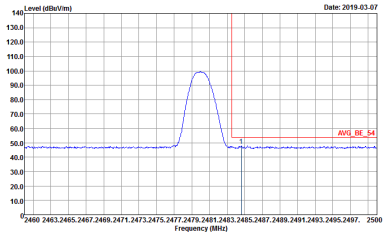
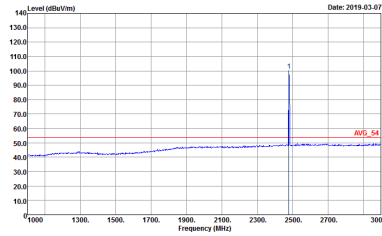

| BLE | 2.4GHz 2400~2483.5MHz Band Edge @ 3m | |
|------|---|---|
| | BLE CH39 2480MHz | |
| | Vertical | Fundamental |
| Peak |  <p>Date: 2019-03-07</p> <p>Site : 03CH07-HY Condition : PEAK_BE_74 3m HF_ANT_00075962 VERTICAL RBW:1000.000KHz VBW:3000.000KHz SWT:Auto Detector : Peak Project : BN2626 Mode : 66</p> |  <p>Date: 2019-03-07</p> <p>Site : 03CH07-HY Condition : PEAK_74 3m HF_ANT_00075962 VERTICAL RBW:1000.000KHz VBW:3000.000KHz SWT:Auto Detector : Peak Project : BN2626 Mode : 66</p> |
| Avg. |  <p>Date: 2019-03-07</p> <p>Site : 03CH07-HY Condition : AVG_BE_54 3m HF_ANT_00075962 VERTICAL RBW:1000.000KHz VBW:10.000KHz SWT:Auto Detector : Peak Project : BN2626 Mode : 66</p> |  <p>Date: 2019-03-07</p> <p>Site : 03CH07-HY Condition : AVG_54 3m HF_ANT_00075962 VERTICAL RBW:1000.000KHz VBW:10.000KHz SWT:Auto Detector : Peak Project : BN2626 Mode : 66</p> |



2.4GHz 2400~2483.5MHz

BLE (Harmonic @ 3m)

| | | |
|----------------------|---|---|
| BLE | 2.4GHz 2400~2483.5MHz Harmonic @ 3m | |
| | BLE CH00 2402MHz | |
| | Horizontal | Vertical |
| <p>Peak Avg.</p> | <p>Date: 2019-03-06</p> <p>Site : 03CH07-HY Condition : PEAK_74 3m SHF-EHF_131029 HORIZONTAL Detector : Peak Project : 8N2626 Mode : 64</p> | <p>Date: 2019-03-06</p> <p>Site : 03CH07-HY Condition : PEAK_74 3m SHF-EHF_131029 VERTICAL Detector : Peak Project : 8N2626 Mode : 64</p> |

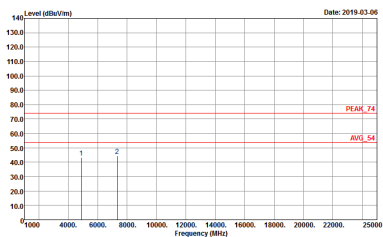
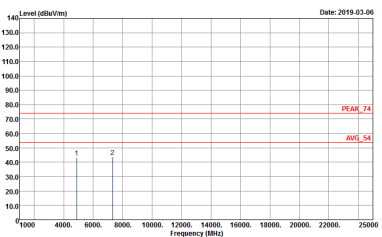

| | | |
|---------------------------------------|---|--|
| BLE | 2.4GHz 2400~2483.5MHz Harmonic @ 3m | |
| | BLE CH19 2440MHz | |
| | Horizontal | Vertical |
| <p>Peak</p> <p>Avg.</p> |  <p>Site : 03CH07-HY Condition : PEAK_74 3m SHF-EHF_131029 HORIZONTAL Detector : Peak Project : 8N2626 Mode : 65</p> |  <p>Site : 03CH07-HY Condition : PEAK_74 3m SHF-EHF_131029 VERTICAL Detector : Peak Project : 8N2626 Mode : 65</p> |

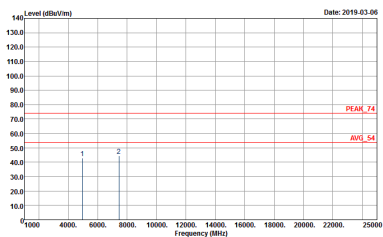
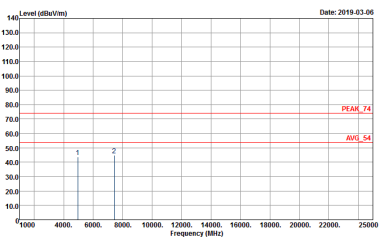

| | | |
|------|---|--|
| BLE | 2.4GHz 2400~2483.5MHz Harmonic @ 3m | |
| | BLE CH39 2480MHz | |
| | Horizontal | Vertical |
| Peak |  <p>Site : 03CH07-HY Condition : PEAK_74 3m SHF-EHF_131029 HORIZONTAL Detector : Peak Project : 8N2626 Mode : 66</p> |  <p>Site : 03CH07-HY Condition : PEAK_74 3m SHF-EHF_131029 VERTICAL Detector : Peak Project : 8N2626 Mode : 66</p> |



Emission below 1GHz

2.4GHz BLE (LF)

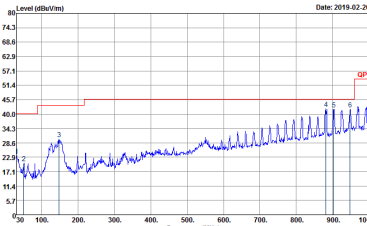
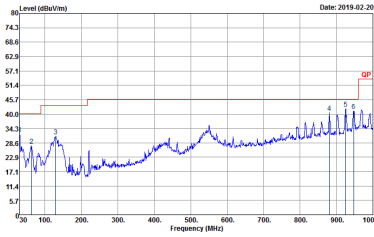
| BLE | 2.4GHz 2400~2483.5MHz | |
|----------------------|---|--|
| | BLE LF | |
| | Horizontal | Vertical |
| <p>QP / Peak</p> |  <p> Site : 03CH07-HY Condition : QP 3m LF-ANT-35419(G) HORIZONTAL Detector : Peak Project : 8N2626 Mode : 67 </p> |  <p> Site : 03CH07-HY Condition : QP 3m LF-ANT-35419(G) VERTICAL Detector : Peak Project : 8N2626 Mode : 67 </p> |



Appendix D. Duty Cycle Plots

| Band | Duty Cycle (%) | T(us) | 1/T(kHz) | VBW Setting | Duty Factor (dB) |
|----------------------|----------------|--------|----------|-------------|------------------|
| Bluetooth – LE 1Mbps | 62.30 | 390.00 | 2.56 | 3kHz | 2.06 |
| Bluetooth – LE 2Mbps | 32.59 | 204.00 | 4.90 | 10kHz | 4.87 |

<1 Mbps>

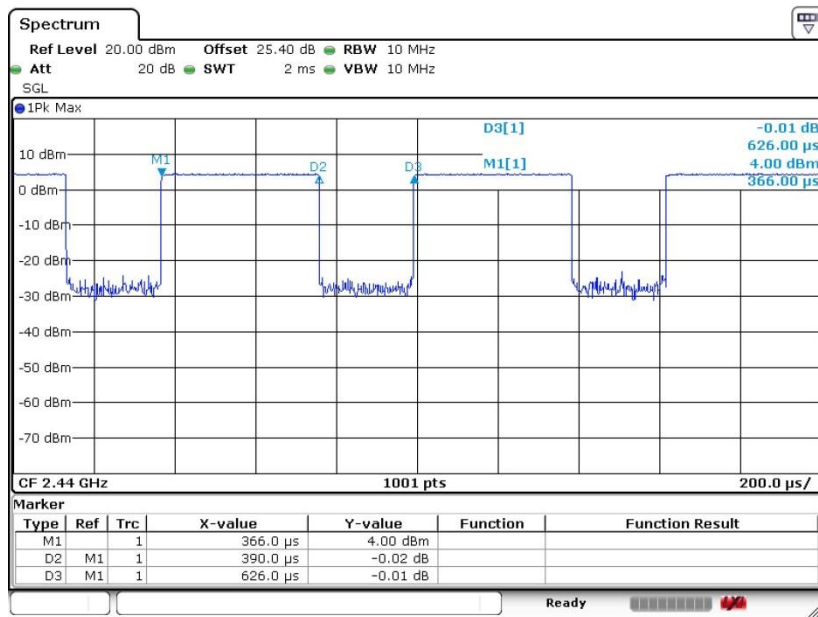

Date: 4.MAR.2019 02:19:46



<2 Mbps>

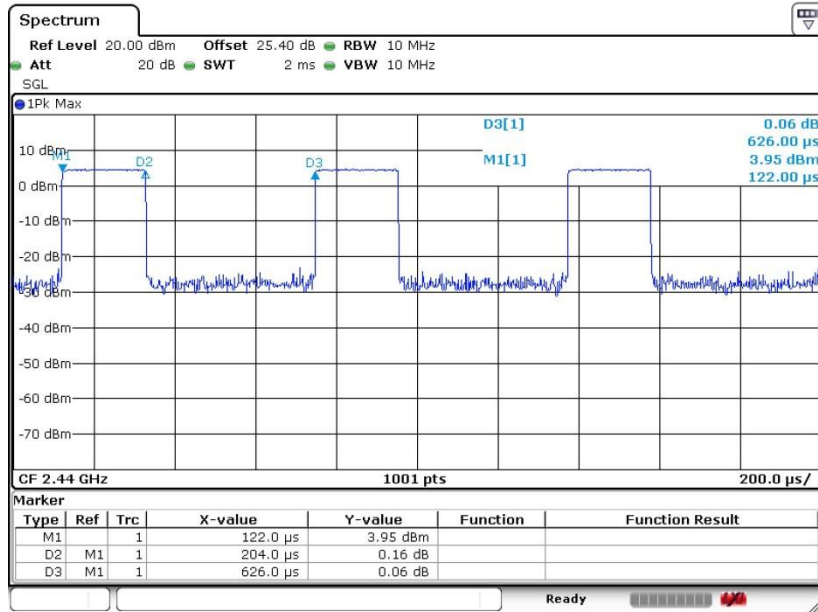

Date: 4.MAR.2019 02:22:57