



FCC RADIO TEST REPORT

FCC ID : UZ7MC930P
Equipment : Mobile computer
Brand Name : Zebra
Model name : MC930P
Applicant : Zebra Technologies Corporation
1 Zebra Plaza, Holtsville, NY 11742
Manufacturer : Zebra Technologies Corporation
1 Zebra Plaza, Holtsville, NY 11742
Standard : FCC Part 15 Subpart E §15.407

The product was received on Nov. 26, 2018 and testing was started from Nov. 27, 2018 and completed on Feb. 08, 2019. We, SPORTON INTERNATIONAL INC. EMC & Wireless Communications Laboratory, would like to declare that the tested sample has been evaluated in accordance with the test procedures and has been in compliance with the applicable technical standards.

The report must not be used by the client to claim product certification, approval, or endorsement by TAF or any agency of government.

The test results in this report apply exclusively to the tested model / sample. Without written approval of SPORTON INTERNATIONAL INC. EMC & Wireless Communications Laboratory, the test report shall not be reproduced except in full.

Approved by: Jones Tsai

SPORTON INTERNATIONAL INC. EMC & Wireless Communications Laboratory

No. 52, Huaya 1st Rd., Guishan Dist., Taoyuan City, Taiwan (R.O.C.)



Table of Contents

History of this test report.....	3
Summary of Test Result.....	4
1 General Description	5
1.1 Product Feature of Equipment Under Test.....	5
1.2 Product Specification of Equipment Under Test.....	7
1.3 Modification of EUT	8
1.4 Testing Location	9
1.5 Applicable Standards.....	9
2 Test Configuration of Equipment Under Test	10
2.1 Carrier Frequency and Channel	10
2.2 Test Mode.....	11
2.3 Connection Diagram of Test System.....	19
2.4 Support Unit used in test configuration and system	20
2.5 EUT Operation Test Setup	21
2.6 Measurement Results Explanation Example.....	21
3 Test Result	22
3.1 6dB and 26dB and 99% Occupied Bandwidth Measurement	22
3.2 Maximum Conducted Output Power Measurement	28
3.3 Power Spectral Density Measurement	32
3.4 Unwanted Emissions Measurement.....	38
3.5 AC Conducted Emission Measurement.....	44
3.6 Automatically Discontinue Transmission	46
3.7 Antenna Requirements.....	47
4 List of Measuring Equipment.....	49
5 Uncertainty of Evaluation.....	51
Appendix A. AC Conducted Emission Test Result	
Appendix B. Radiated Spurious Emission	
Appendix C. Radiated Spurious Emission Plots	
Appendix D. Duty Cycle Plots	
Appendix E. Setup Photographs	



History of this test report

Report No.	Version	Description	Issued Date
FR8N2626F	01	Initial issue of report	Feb. 26, 2019



Summary of Test Result

Report Clause	Ref Std. Clause	Test Items	Result (PASS/FAIL)	Remark
3.1	15.403 (i)	6dB & 26dB Bandwidth	Pass	-
3.1	2.1049	99% Occupied Bandwidth	Reporting only	-
3.2	15.407 (a)	Maximum Conducted Output Power	Pass	-
3.3	15.407 (a)	Power Spectral Density	Pass	-
3.4	15.407(b)	Unwanted Emissions	Pass	Under limit 2.18 dB at 5926.200 MHz
3.5	15.207	AC Conducted Emission	Pass	Under limit 13.85 dB at 0.164 MHz
3.6	15.407 (c)	Automatically Discontinue Transmission	Pass	-
3.7	15.203 & 15.407 (a)	Antenna Requirement	Pass	-

Declaration of Conformity:

The test results with all measurement uncertainty excluded are presented in accordance with the regulation limits or requirements declared by manufacturers.

Comments and Explanations:

The declared of product specification for EUT presented in the report are provided by the manufacturer, and the manufacturer takes all the responsibilities for the accuracy of product specification.

Reviewed by: Wii Chang

Report Producer: Maggie Chiang



1 General Description

1.1 Product Feature of Equipment Under Test

Product Feature	
Equipment	Mobile computer
Brand Name	Zebra
Model Name	MC930P
FCC ID	UZ7MC930P
Sample 1	EUT with SKU 3
Sample 2	EUT with SKU 4
Sample 3	EUT with SKU 5
Sample 4	EUT with SKU 6
Sample 5	EUT with SKU 7
EUT supports Radios application	NFC WLAN 11a/b/g/n HT20/HT40 WLAN 11ac VHT20/VHT40/VHT80 Bluetooth BR/EDR/LE
HW Version	EV1
SW Version	01-14-11.00-OG
FW Version	FUSION_QA_2_1.3.0.004_O
MFD	13NOV18
EUT Stage	Engineering Sample

Remark: The above EUT's information was declared by manufacturer.

Specification of Accessories				
Adapter (5V/2.5A)	Brand Name	Zebra	Part Number	PWR-WUA5V12W0US
USB-C Adapter	Brand Name	Zebra	Part Number	CBL-MC93-USBCHG-01
USB-C cable	Brand Name	Zebra	Part Number	CBL-TC2X-USBC-01
Std Battery	Brand Name	Zebra	Part Number	BT-000370-00
Fzr Battery	Brand Name	Zebra	Part Number	BT-000371-00
Holster	Brand Name	Zebra	Part Number	051607-79N1-18



<Sample Information>

Model Name	MC930P				
	SKU3	SKU4	SKU5	SKU6	SKU7
Organization / Function / Group	EV1a-G21	EV1a-G22	EV1a-G23	EV1a-F11	EV1a-F13
nm	G-2S-1D-53k	G-2S-2D-53k	G-2S-LRI-53k	G-1F-1D-53k	G-1F-LRI-53k
Product Number	MC930P-GSBDG 4NA	MC930P-GSDDG 4NA	MC930P-GSFDG 4NA	MC930P-GFADG 4NA	MC930P-GFEDG 4NA
Form factor	Gun	Gun	Gun	Gun	Gun
Package/ Component Category	Pkg2	Pkg2	Pkg2	Pkg1 CS	Pkg 1 CS
NFC	YES	YES	YES	YES	YES
Vib	YES	YES	YES	YES	YES
Camera	YES	YES	YES	NO	NO
NI	NO	NO	NO	NO	NO
Side Trigger	NO	NO	NO	NO	NO
Display + TP Stackup	Option2	Option2	Option2	Option5	Option5
Scanner	SE965	SE4750SR	SE4850	SE965	SE4850
Battery	Std	Std	Std	Fzr	Fzr
Keyboard	53 Key	53 Key	53 Key	53 Key	53 Key
Build Date	Oct 2018	Oct 2018	Oct 2018	Nov 2018	Nov 2018



1.2 Product Specification of Equipment Under Test

Standards-related Product Specification	
Tx/Rx Channel Frequency Range	5745 MHz ~ 5825 MHz
Maximum Output Power to Antenna <CDD Modes>	<p><Ant. 1> 802.11a : 18.89 dBm / 0.0774 W 802.11n HT20 : 18.70 dBm / 0.0741 W 802.11n HT40 : 18.83 dBm / 0.0764 W 802.11ac VHT20: 18.66 dBm / 0.0735 W 802.11ac VHT40: 18.80 dBm / 0.0759 W 802.11ac VHT80: 18.31 dBm / 0.0678 W</p> <p><Ant. 2> 802.11a : 18.79 dBm / 0.0757 W 802.11n HT20 : 18.56 dBm / 0.0718 W 802.11n HT40 : 18.76 dBm / 0.0752 W 802.11ac VHT20: 18.54 dBm / 0.0714 W 802.11ac VHT40: 18.64 dBm / 0.0731 W 802.11ac VHT80: 18.27 dBm / 0.0671 W</p> <p>MIMO <Ant. 1 + 2> 802.11a : 21.82 dBm / 0.1521 W 802.11n HT20 : 21.79 dBm / 0.1510 W 802.11n HT40 : 21.85 dBm / 0.1531 W 802.11ac VHT20: 21.77 dBm / 0.1503 W 802.11ac VHT40: 21.76 dBm / 0.1500 W 802.11ac VHT80: 21.33 dBm / 0.1358 W</p>
Maximum Output Power <TXBF Modes>	<p>MIMO <Ant. 1 + 2> 802.11ac VHT20: 21.66 dBm / 0.1466 W 802.11ac VHT40: 21.56 dBm / 0.1432 W 802.11ac VHT80: 20.36 dBm / 0.1086 W</p>
99% Occupied Bandwidth <CDD Modes>	<p><Ant. 1> 802.11a : 16.93 MHz 802.11n HT20 : 18.03 MHz 802.11n HT40 : 36.66 MHz 802.11ac VHT80 : 76.60 MHz</p> <p><Ant. 2> 802.11a : 16.88 MHz 802.11n HT20 : 17.98 MHz 802.11n HT40 : 36.66 MHz 802.11ac VHT80 : 76.24 MHz</p> <p>MIMO <Ant. 1> 802.11a : 16.98 MHz 802.11n HT20 : 18.08 MHz 802.11n HT40 : 36.76 MHz 802.11ac VHT80 : 76.36 MHz</p> <p>MIMO <Ant. 2> 802.11a : 16.68 MHz 802.11n HT20 : 17.93 MHz 802.11n HT40 : 36.46 MHz 802.11ac VHT80 : 76.24 MHz</p>

Standards-related Product Specification													
99% Occupied Bandwidth <TXBF Modes>	MIMO <Ant. 1> 802.11ac VHT20 : 18.08 MHz 802.11ac VHT40 : 36.76 MHz 802.11ac VHT80 : 76.72 MHz MIMO <Ant. 2> 802.11ac VHT20 : 17.88 MHz 802.11ac VHT40 : 36.66 MHz 802.11ac VHT80 : 76.60 MHz												
Antenna Gain / Gain	<Ant. 1> : Patch Antenna with gain 2.71 dBi <Ant. 2> : Patch Antenna with gain 3.35 dBi												
Type of Modulation	802.11a/n : OFDM (BPSK / QPSK / 16QAM / 64QAM) 802.11ac : OFDM (BPSK / QPSK / 16QAM / 64QAM / 256QAM)												
Antenna Function Description	<table border="1"> <thead> <tr> <th></th> <th>Ant. 1</th> <th>Ant. 2</th> </tr> </thead> <tbody> <tr> <td>802.11 a/n/ac</td> <td>V</td> <td>V</td> </tr> <tr> <td>802.11 a/n/ac MIMO</td> <td>V</td> <td>V</td> </tr> <tr> <td>802.11ac TXBF</td> <td>V</td> <td>V</td> </tr> </tbody> </table>		Ant. 1	Ant. 2	802.11 a/n/ac	V	V	802.11 a/n/ac MIMO	V	V	802.11ac TXBF	V	V
	Ant. 1	Ant. 2											
802.11 a/n/ac	V	V											
802.11 a/n/ac MIMO	V	V											
802.11ac TXBF	V	V											

Note: MIMO Ant. 1+2 is a calculated result from sum of the power MIMO Ant. 1 and MIMO Ant. 2.

1.3 Modification of EUT

No modifications are made to the EUT during all test items.



1.4 Testing Location

Test Site	SPORTON INTERNATIONAL INC.		
Test Site Location	No.52, Huaya 1st Rd., Guishan Dist., Taoyuan City, Taiwan (R.O.C.) TEL: +886-3-327-3456 FAX: +886-3-328-4978		
Test Site No.	Sporton Site No.		
	TH05-HY	CO05-HY	03CH07-HY

Note: The test site complies with ANSI C63.4 2014 requirement.

FCC Designation No. TW1190

1.5 Applicable Standards

According to the specifications of the manufacturer, the EUT must comply with the requirements of the following standards:

- ♦ FCC Part 15 Subpart E
- ♦ FCC KDB 789033 D02 General UNII Test Procedures New Rules v02r01.
- ♦ FCC KDB 414788 D01 Radiated Test Site v01r01.
- ♦ FCC KDB 662911 D01 Multiple Transmitter Output v02r01.
- ♦ ANSI C63.10-2013

Remark:

1. All test items were verified and recorded according to the standards and without any deviation during the test.
2. This EUT has also been tested and complied with the requirements of FCC Part 15, Subpart B, recorded in a separate test report.



2 Test Configuration of Equipment Under Test

- a. The EUT has been associated with peripherals and configuration operated in a manner tended to maximize its emission characteristics in a typical application. Frequency range investigated: conduction emission (150 kHz to 30 MHz), radiation emission (9 kHz to the 10th harmonic of the highest fundamental frequency or to 40 GHz, whichever is lower). For radiated measurement, pre-scanned in three orthogonal panels, X, Y, Z. The worst cases (Z plane) were recorded in this report.
- b. AC power line Conducted Emission was tested under maximum output power.

2.1 Carrier Frequency and Channel

Frequency Band	Channel	Freq. (MHz)	Channel	Freq. (MHz)
5725-5850 MHz Band 4 (U-NII-3)	149	5745	157	5785
	151*	5755	159*	5795
	153	5765	161	5805
	155 [#]	5775	165	5825

Note:

1. The above Frequency and Channel in "*" were 802.11n HT40 and 802.11ac VHT40.
2. The above Frequency and Channel in "[#]" were 802.11ac VHT80.



2.2 Test Mode

Final test modes are considering the modulation and worse data rates as below table.

Single Mode

Modulation	Data Rate
802.11a	6 Mbps
802.11n HT20	MCS0
802.11n HT40	MCS0
802.11ac VHT20 (Covered by HT20)	MCS0
802.11ac VHT40 (Covered by HT40)	MCS0
802.11ac VHT80	MCS0

MIMO Mode

Modulation	Data Rate
802.11a	6 Mbps
802.11n HT20	MCS0
802.11n HT40	MCS0
802.11ac VHT20 (Covered by HT20)	MCS0
802.11ac VHT40 (Covered by HT40)	MCS0
802.11ac VHT80	MCS0

TXBF Mode

Modulation	Data Rate
802.11ac VHT20	MCS0
802.11ac VHT40	MCS0
802.11ac VHT80	MCS0

Test Cases	
AC Conducted Emission	Mode 1 : WLAN (5GHz) Link + MP3 Play + Keypad (53) + Scan + Std Battery + USB-C Adapter + USB-C Cable + Data Link with Notebook (Notebook to SD Card) for Sample 2
Remark: For Radiated Test Cases, the tests were performed with Std Battery and Sample 1.	



Ch. #		Band IV : 5725-5850 MHz			
		802.11a	802.11n HT20	802.11n HT40	802.11ac VHT80
L	Low	149	149	151	-
M	Middle	157	157	-	155
H	High	165	165	159	-

<CDD Mode>

<Ant. 1>

802.11a RF Output Power (dBm)										
Power vs. Channel			Power vs Data Rate							
Channel	Frequency (MHz)	Data Rate (bps)	channel	Data Rate (bps)						
		6M		9M	12M	18M	24M	36M	48M	54M
Duty Cycle (%)		95.75		94.30	92.60	89.60	86.70	82.00	77.50	75.60
CH 149	5745	18.84	CH 157							
CH 157	5785	18.89		18.80	18.80	18.70	18.80	18.70	18.60	18.70
CH 165	5825	18.83								

802.11n HT20 RF Output Power (dBm)										
Power vs. Channel			Power vs Data Rate							
Channel	Frequency (MHz)	MCS Index	channel	MCS Index						
		MCS0		MCS1	MCS2	MCS3	MCS4	MCS5	MCS6	MCS7
Duty Cycle (%)		95.45		92.00	89.00	86.10	81.20	77.00	75.30	73.80
CH 149	5745	18.70	CH 149							
CH 157	5785	18.28		18.60	18.40	18.40	18.60	18.60	18.60	18.60
CH 165	5825	18.66								

802.11n HT40 RF Output Power (dBm)										
Power vs. Channel			Power vs Data Rate							
Channel	Frequency (MHz)	MCS Index	channel	MCS Index						
		MCS0		MCS1	MCS2	MCS3	MCS4	MCS5	MCS6	MCS7
Duty Cycle (%)		92.54		85.70	80.70	76.70	70.00	65.40	63.10	61.30
CH 151	5755	18.83	CH 151							
CH 159	5795	18.70		18.80	18.80	18.80	18.70	18.70	18.70	18.70



802.11ac VHT20 RF Output Power (dBm)											
Power vs. Channel			Power vs Data Rate								
Channel	Frequency (MHz)	MCS Index	channel	MCS Index							
		MCS0		MCS1	MCS2	MCS3	MCS4	MCS5	MCS6	MCS7	MCS8
Duty Cycle (%)		95.48		92.10	89.00	86.40	81.50	77.60	75.80	74.00	71.30
CH 149	5745	18.66	CH 149								
CH 157	5785	18.23		18.50	18.30	18.30	18.50	18.50	18.50	18.50	18.50
CH 165	5825	18.61									

802.11ac VHT40 RF Output Power (dBm)												
Power vs. Channel			Power vs Data Rate									
Channel	Frequency (MHz)	MCS Index	channel	MCS Index								
		MCS0		MCS1	MCS2	MCS3	MCS4	MCS5	MCS6	MCS7	MCS8	MCS9
Duty Cycle (%)		91.22		85.80	80.90	76.80	70.40	66.00	64.10	62.10	59.10	58.30
CH 151	5755	18.80	CH 151									
CH 159	5795	18.68		18.70	18.70	18.70	18.60	18.60	18.60	18.60	18.60	18.60

802.11ac VHT80 RF Output Power (dBm)												
Power vs. Channel			Power vs Data Rate									
Channel	Frequency (MHz)	MCS Index	channel	MCS Index								
		MCS0		MCS1	MCS2	MCS3	MCS4	MCS5	MCS6	MCS7	MCS8	MCS9
Duty Cycle (%)		85.39		75.80	69.60	64.50	58.30	54.40	52.30	51.10	48.40	46.80
CH155	5775	18.31	CH155	18.30	18.30	18.30	18.30	18.30	18.30	18.30	18.30	18.30



<Ant. 2>

802.11a RF Output Power (dBm)										
Power vs. Channel			Power vs Data Rate							
Channel	Frequency (MHz)	Data Rate (bps)	channel	Data Rate (bps)						
		6M		9M	12M	18M	24M	36M	48M	54M
Duty Cycle (%)		95.75		94.30	92.50	89.60	86.80	81.90	77.50	75.70
CH 149	5745	18.77	CH 157							
CH 157	5785	18.79		18.70	18.70	18.50	18.70	18.70	18.50	18.60
CH 165	5825	18.47								

802.11n HT20 RF Output Power (dBm)										
Power vs. Channel			Power vs Data Rate							
Channel	Frequency (MHz)	MCS Index	channel	MCS Index						
		MCS0		MCS1	MCS2	MCS3	MCS4	MCS5	MCS6	MCS7
Duty Cycle (%)		95.94		92.00	89.00	86.10	81.20	77.00	75.40	73.90
CH 149	5745	18.56	CH 149							
CH 157	5785	18.01		18.50	18.10	18.10	18.30	18.30	18.30	18.30
CH 165	5825	18.32								

802.11n HT40 RF Output Power (dBm)										
Power vs. Channel			Power vs Data Rate							
Channel	Frequency (MHz)	MCS Index	channel	MCS Index						
		MCS0		MCS1	MCS2	MCS3	MCS4	MCS5	MCS6	MCS7
Duty Cycle (%)		91.63		85.60	80.70	76.60	70.00	65.50	63.60	61.60
CH 151	5755	18.76	CH 151							
CH 159	5795	18.53		85.60	80.70	76.60	70.00	65.50	63.60	61.60



802.11ac VHT20 RF Output Power (dBm)											
Power vs. Channel			Power vs Data Rate								
Channel	Frequency (MHz)	MCS Index	channel	MCS Index							
		MCS0		MCS1	MCS2	MCS3	MCS4	MCS5	MCS6	MCS7	MCS8
Duty Cycle (%)		95.48		92.10	89.00	86.20	81.40	77.50	75.40	74.00	71.30
CH 149	5745	18.54	CH 149								
CH 157	5785	17.98		18.40	18.00	18.00	18.20	18.20	18.20	18.20	18.20
CH 165	5825	18.30									

802.11ac VHT40 RF Output Power (dBm)												
Power vs. Channel			Power vs Data Rate									
Channel	Frequency (MHz)	MCS Index	channel	MCS Index								
		MCS0		MCS1	MCS2	MCS3	MCS4	MCS5	MCS6	MCS7	MCS8	MCS9
Duty Cycle (%)		92.12		85.90	80.80	76.80	70.60	66.10	64.30	62.20	59.20	58.30
CH 151	5755	18.64	CH 151									
CH 159	5795	18.47		85.90	80.80	76.80	70.60	66.10	64.30	62.20	59.20	58.30

802.11ac VHT80 RF Output Power (dBm)												
Power vs. Channel			Power vs Data Rate									
Channel	Frequency (MHz)	MCS Index	channel	MCS Index								
		MCS0		MCS1	MCS2	MCS3	MCS4	MCS5	MCS6	MCS7	MCS8	MCS9
Duty Cycle (%)		85.39		75.70	69.70	64.90	58.40	54.40	52.20	51.20	48.40	47.10
CH155	5775	18.27	CH155	18.20	18.20	18.20	18.20	18.20	18.20	18.20	18.10	18.10



MIMO <Ant. 1+2>

802.11a RF Output Power (dBm)										
Power vs. Channel			Power vs Data Rate							
Channel	Frequency (MHz)	Data Rate (bps)	channel	Data Rate (bps)						
		6M		9M	12M	18M	24M	36M	48M	54M
Duty Cycle (%)										
CH 149	5745	21.82	CH 149							
CH 157	5785	21.45		21.81	21.76	21.61	21.71	21.66	21.51	21.66
CH 165	5825	21.76								

802.11n HT20 RF Output Power (dBm)										
Power vs. Channel			Power vs Data Rate							
Channel	Frequency (MHz)	MCS Index	channel	MCS Index						
		MCS0		MCS1	MCS2	MCS3	MCS4	MCS5	MCS6	MCS7
Duty Cycle (%)										
CH 149	5745	21.79	CH 149							
CH 157	5785	21.37		21.76	21.36	21.36	21.46	21.46	21.46	21.46
CH 165	5825	21.71								

802.11n HT40 RF Output Power (dBm)										
Power vs. Channel			Power vs Data Rate							
Channel	Frequency (MHz)	MCS Index	channel	MCS Index						
		MCS0		MCS1	MCS2	MCS3	MCS4	MCS5	MCS6	MCS7
Duty Cycle (%)										
CH 151	5755	21.85	CH 151							
CH 159	5795	21.71		21.81	21.81	21.81	21.76	21.76	21.71	21.66



802.11ac VHT20 RF Output Power (dBm)											
Power vs. Channel			Power vs Data Rate								
Channel	Frequency (MHz)	MCS Index	channel	MCS Index							
		MCS0		MCS1	MCS2	MCS3	MCS4	MCS5	MCS6	MCS7	MCS8
Duty Cycle (%)											
CH 149	5745	21.77									
CH 157	5785	21.33	CH 149	21.56	21.66	21.61	21.41	21.41	21.51	21.46	21.46
CH 165	5825	21.65									

802.11ac VHT40 RF Output Power (dBm)												
Power vs. Channel			Power vs Data Rate									
Channel	Frequency (MHz)	MCS Index	channel	MCS Index								
		MCS0		MCS1	MCS2	MCS3	MCS4	MCS5	MCS6	MCS7	MCS8	MCS9
Duty Cycle (%)												
CH 151	5755	21.76										
CH 159	5795	21.60	CH 151	21.71	21.71	21.71	21.66	21.66	21.61	21.56	21.56	21.56

802.11ac VHT80 RF Output Power (dBm)												
Power vs. Channel			Power vs Data Rate									
Channel	Frequency (MHz)	MCS Index	channel	MCS Index								
		MCS0		MCS1	MCS2	MCS3	MCS4	MCS5	MCS6	MCS7	MCS8	MCS9
Duty Cycle (%)												
CH155	5775	21.33	CH155	21.06	21.11	21.06	21.01	21.06	20.91	21.01	21.01	21.01



<TXBF Mode>

MIMO <Ant. 1+2>

802.11ac VHT20 RF Output Power (dBm)											
Power vs. Channel			Power vs Data Rate								
Channel	Frequency (MHz)	MCS Index	channel	MCS Index							
		MCS0		MCS1	MCS2	MCS3	MCS4	MCS5	MCS6	MCS7	MCS8
Duty Cycle (%)											
CH 149	5745	21.66	CH 149								
CH 157	5785	21.26		21.61	21.31	21.31	21.21	21.16	21.06	21.16	21.16
CH 165	5825	21.26									

802.11ac VHT40 RF Output Power (dBm)											
Power vs. Channel			Power vs Data Rate								
Channel	Frequency (MHz)	MCS Index	channel	MCS Index							
		MCS0		MCS1	MCS2	MCS3	MCS4	MCS5	MCS6	MCS7	MCS8
Duty Cycle (%)											
CH 151	5755	21.56	CH 151								
CH 159	5795	21.56		21.46	21.46	21.46	21.41	21.41	21.41	21.37	21.41

802.11ac VHT80 RF Output Power (dBm)												
Power vs. Channel			Power vs Data Rate									
Channel	Frequency (MHz)	MCS Index	channel	MCS Index								
		MCS0		MCS1	MCS2	MCS3	MCS4	MCS5	MCS6	MCS7	MCS8	MCS9
Duty Cycle (%)												
CH155	5775	20.36	CH155	20.11	20.21	20.21	20.06	20.06	20.06	20.06	19.97	19.91

2.3 Connection Diagram of Test System

<WLAN Tx CDD Mode>

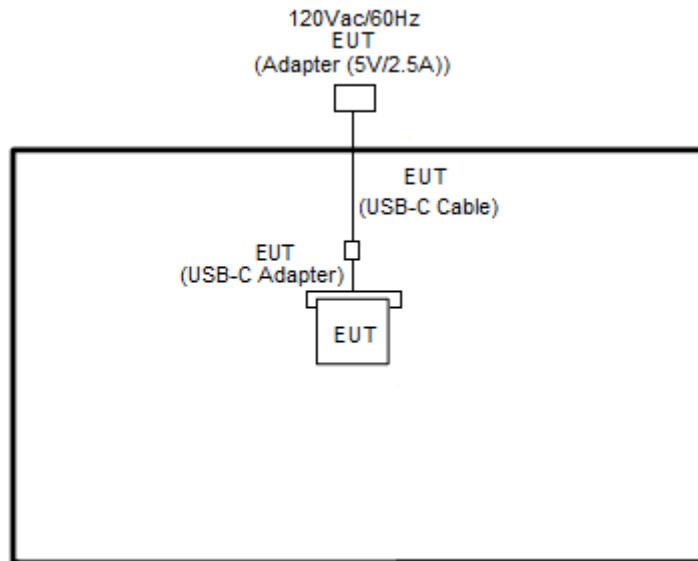

<WLAN TXBF Mode>

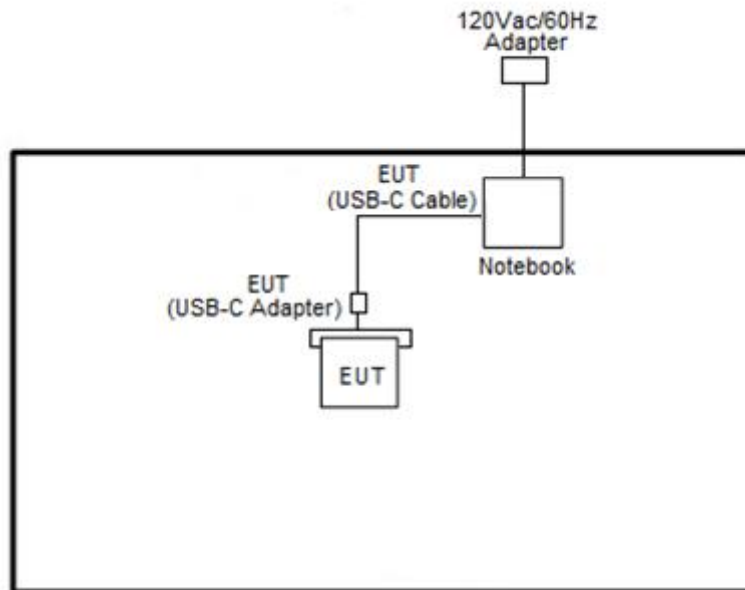

<AC Conducted Emission Mode>

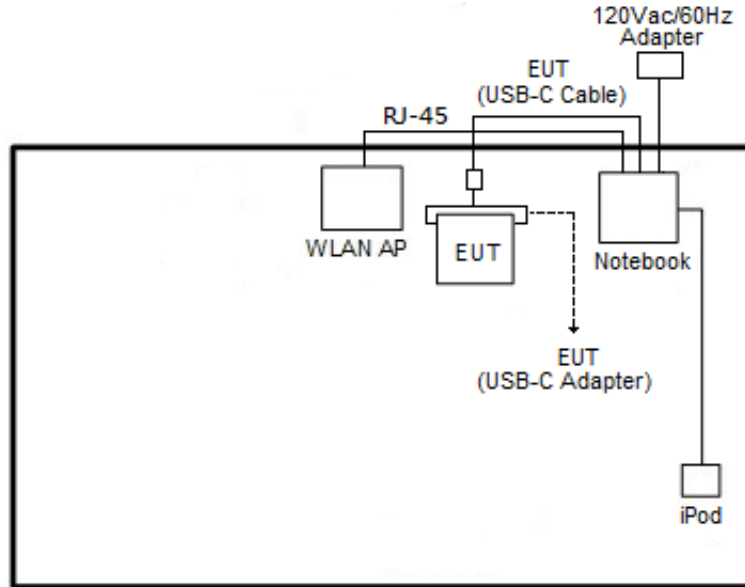

2.4 Support Unit used in test configuration and system

Item	Equipment	Trade Name	Model Name	FCC ID	Data Cable	Power Cord
1.	WLAN AP	ASUS	RT-AC66U	MSQ-RTAC66U	N/A	Unshielded, 1.8 m
2.	SD Card	SanDisk	MicroSD HC	FCC DoC	N/A	N/A
3.	iPod	Apple	A1285	FCC DoC	Shielded, 1.0 m	N/A
4.	Notebook	DELL	Latitude E6320	FCC DoC/ Contains FCC ID: QDS-BRCM1054	N/A	AC I/P: Unshielded, 1.2 m DC O/P: Shielded, 1.8 m
5.	Notebook	DELL	Latitude E3340	FCC DoC/ Contains FCC ID: PD97260NGU	N/A	AC I/P: Unshielded, 1.2 m DC O/P: Shielded, 1.8 m
6.	Notebook	DELL	P79G	FCC DoC	N/A	AC I/P: Unshielded, 1.2 m DC O/P: Shielded, 1.8 m



2.5 EUT Operation Test Setup

The RF test items, utility “QRCT” was installed in Notebook which was programmed in order to make the EUT get into the engineering modes to provide channel selection, power level, data rate and the application type and for continuous transmitting signals.

For TXBF mode, the modulation modes and data rates manipulated by the command lines in the engineering program made the EUT link to another EUT by power under the normal operation. The “adb” software tool was used to enable the EUT to transmit signals continuously.

2.6 Measurement Results Explanation Example

For all conducted test items:

The offset level is set in the spectrum analyzer to compensate the RF cable loss and attenuator factor between EUT conducted output port and spectrum analyzer. With the offset compensation, the spectrum analyzer reading level is exactly the EUT RF output level.

Example :

The spectrum analyzer offset is derived from RF cable loss and attenuator factor.

Offset = RF cable loss + attenuator factor.

Following shows an offset computation example with cable loss 4.2 dB and 10dB attenuator.

$$\begin{aligned} \text{Offset(dB)} &= \text{RF cable loss(dB)} + \text{attenuator factor(dB)}. \\ &= 4.2 + 10 = 14.2 \text{ (dB)} \end{aligned}$$

3 Test Result

3.1 6dB and 26dB and 99% Occupied Bandwidth Measurement

3.1.1 Description of 6dB and 26dB and 99% Occupied Bandwidth

The minimum 6 dB bandwidth shall be at least 500 kHz.

26dB and 99% Occupied bandwidth are reporting only.

3.1.2 Measuring Instruments

See list of measuring equipment of this test report.

3.1.3 Test Procedures

1. The testing follows FCC KDB 789033 D02 General UNII Test Procedures New Rules v02r01. Section C) Emission bandwidth for the band 5.725-5.85GHz
2. Set RBW = 100kHz.
3. Set the VBW $\geq 3 \times$ RBW.
4. Detector = Peak.
5. Trace mode = max hold
6. Measure the maximum width of the emission that is 6 dB down from the peak of the emission.
7. Measure and record the results in the test report.

3.1.4 Test Setup

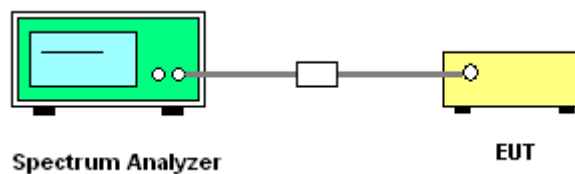



3.1.5 Test Result

Test Engineer :	Kai Liao and Luffy Lin	Temperature :	21~25°C
		Relative Humidity :	51~54%

<CDD Mode>

Band IV												
Mod.	Data Rate	NTX	CH.	Freq. (MHz)	99% Bandwidth (MHz)		26dB Bandwidth (MHz)		6 dB Bandwidth (MHz)		6 dB Bandwidth Min. Limit (MHz)	Pass/Fail
					Ant 1	Ant 2	Ant 1	Ant 2	Ant 1	Ant 2		
11a	6Mbps	1	149	5745	16.88	16.88	25.57	25.38	15.63	15.58	0.5	Pass
11a	6Mbps	1	157	5785	16.93	16.88	25.82	24.93	15.73	15.53	0.5	Pass
11a	6Mbps	1	165	5825	16.78	16.78	24.73	25.08	15.63	15.58	0.5	Pass
HT20	MCS0	1	149	5745	17.98	17.93	26.02	26.17	15.14	16.73	0.5	Pass
HT20	MCS0	1	157	5785	18.03	17.98	26.77	26.42	15.93	16.53	0.5	Pass
HT20	MCS0	1	165	5825	17.93	17.93	26.02	26.27	16.53	15.93	0.5	Pass
HT40	MCS0	1	151	5755	36.66	36.66	42.08	41.90	35.25	35.25	0.5	Pass
HT40	MCS0	1	159	5795	36.66	36.66	41.90	41.72	35.87	35.25	0.5	Pass
VHT80	MCS0	1	155	5775	76.60	76.24	96.70	83.92	75.13	75.13	0.5	Pass
11a	6Mbps	2	149	5745	16.88	16.68	25.38	24.58	15.14	15.04	0.5	Pass
11a	6Mbps	2	157	5785	16.93	16.68	25.67	24.58	15.29	15.34	0.5	Pass
11a	6Mbps	2	165	5825	16.98	16.68	25.33	24.78	15.68	15.63	0.5	Pass
HT20	MCS0	2	149	5745	18.08	17.93	26.92	25.52	16.53	16.73	0.5	Pass
HT20	MCS0	2	157	5785	17.98	17.93	26.72	25.33	16.53	15.44	0.5	Pass
HT20	MCS0	2	165	5825	17.93	17.88	0.00	25.03	15.09	15.68	0.5	Pass
HT40	MCS0	2	151	5755	36.56	36.46	42.08	41.90	35.07	35.07	0.5	Pass
HT40	MCS0	2	159	5795	36.76	36.46	41.81	42.17	35.25	35.25	0.5	Pass
VHT80	MCS0	2	155	5775	76.36	76.24	84.08	84.40	75.13	75.13	0.5	Pass

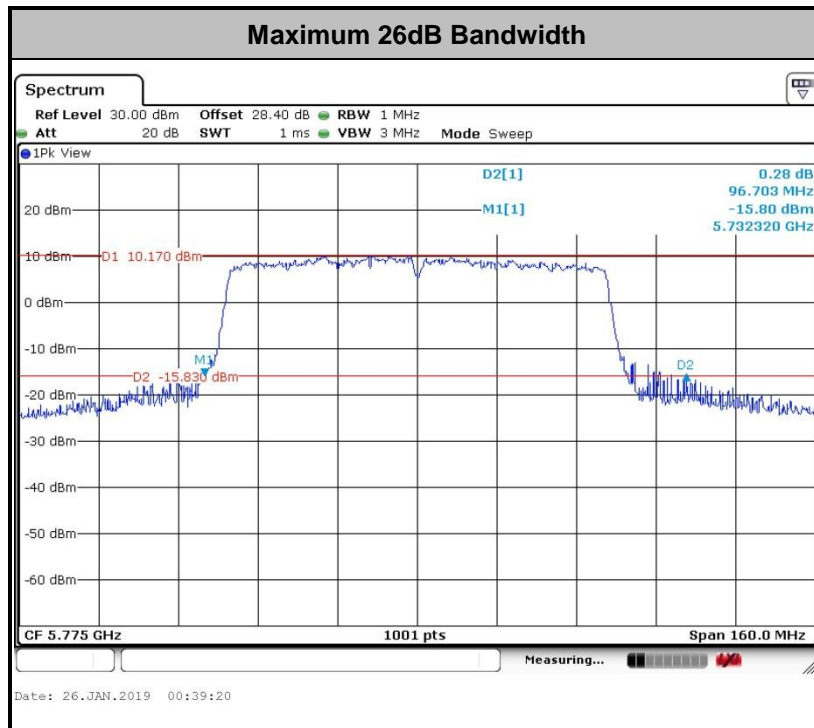
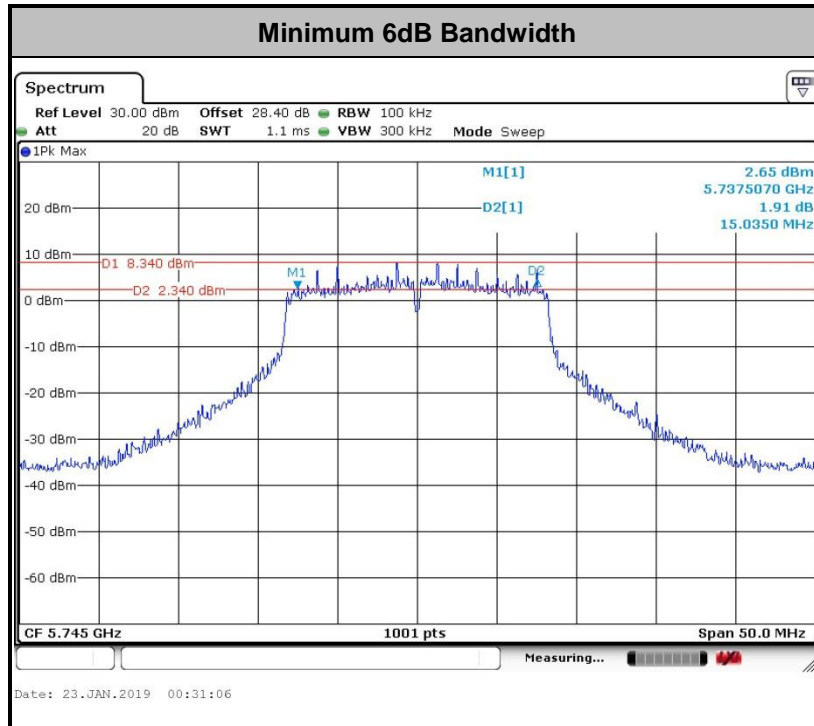

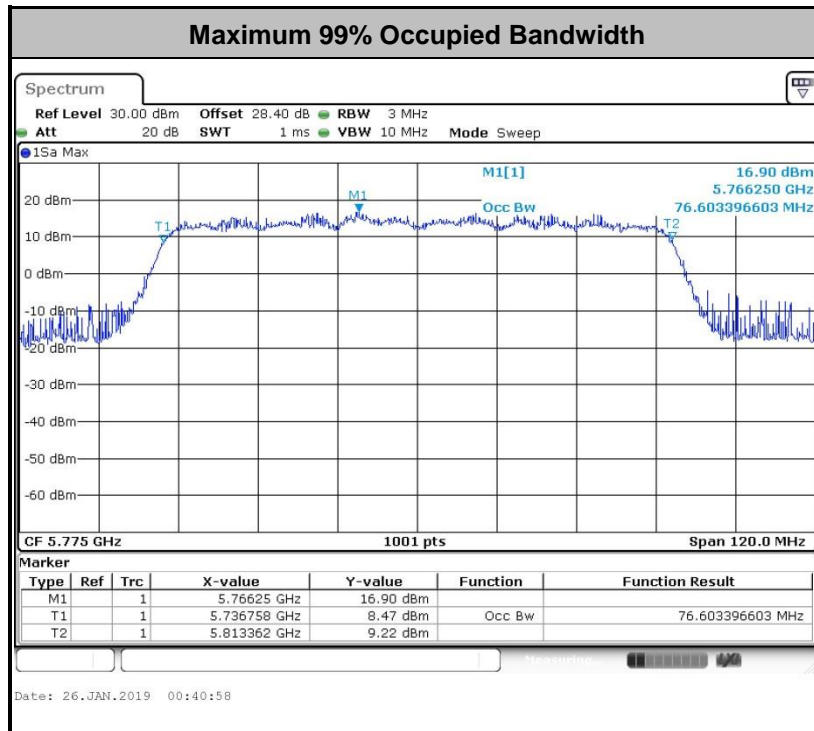

Note: The occupied channel bandwidth is maintained within the band of operation for all of the modulations.



Test Engineer :	Kai Liao	Temperature :	21~25°C
		Relative Humidity :	51~54%

<TXBF Modes>

Band IV												
Mod.	Data Rate	NTX	CH.	Freq. (MHz)	99% Bandwidth (MHz)		26dB Bandwidth (MHz)		6 dB Bandwidth (MHz)		6 dB Bandwidth Min. Limit (MHz)	Pass/Fail
					Ant 1	Ant 2	Ant 1	Ant 2	Ant 1	Ant 2		
VHT20	MCS0	2	149	5745	18.08	17.88	27.02	26.27	16.78	16.93	0.5	Pass
VHT20	MCS0	2	157	5785	18.08	17.88	26.82	26.07	16.48	17.28	0.5	Pass
VHT20	MCS0	2	165	5825	18.03	17.88	26.37	25.72	16.53	16.88	0.5	Pass
VHT40	MCS0	2	151	5755	36.76	36.66	44.24	41.99	35.25	36.23	0.5	Pass
VHT40	MCS0	2	159	5795	36.66	36.56	42.53	42.26	35.43	35.69	0.5	Pass
VHT80	MCS0	2	155	5775	76.72	76.60	84.08	83.92	75.28	75.12	0.5	Pass

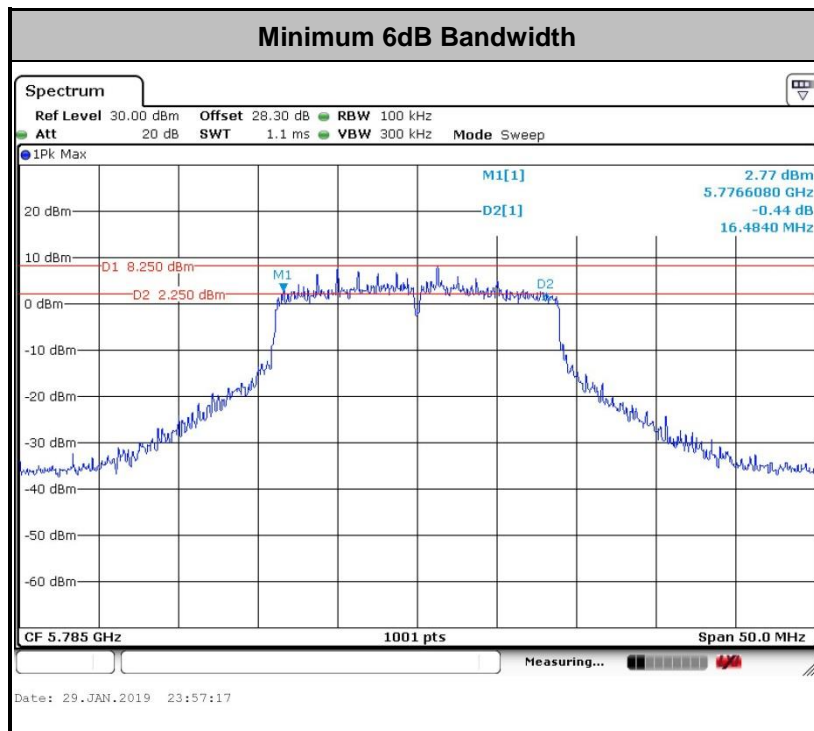

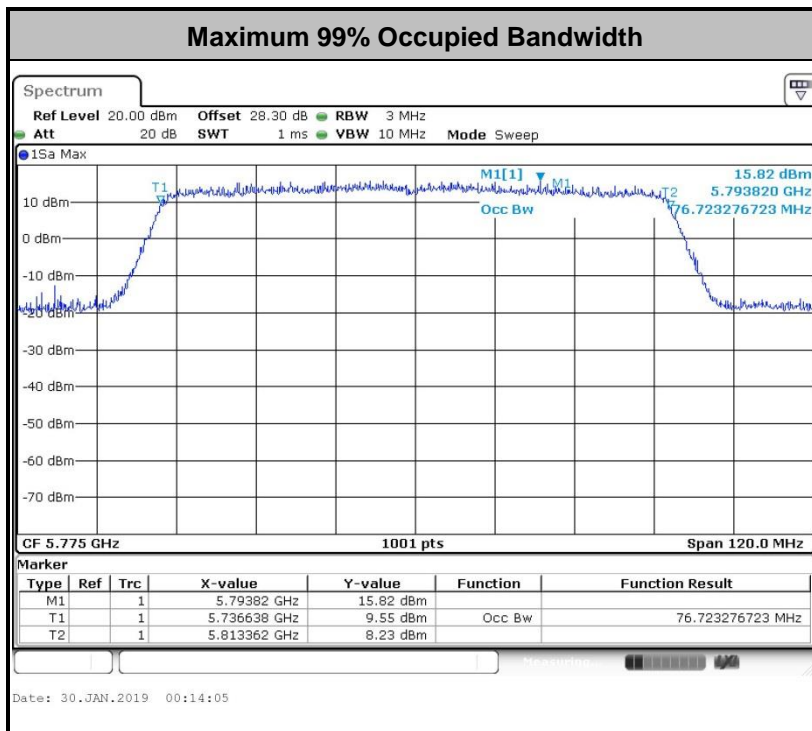
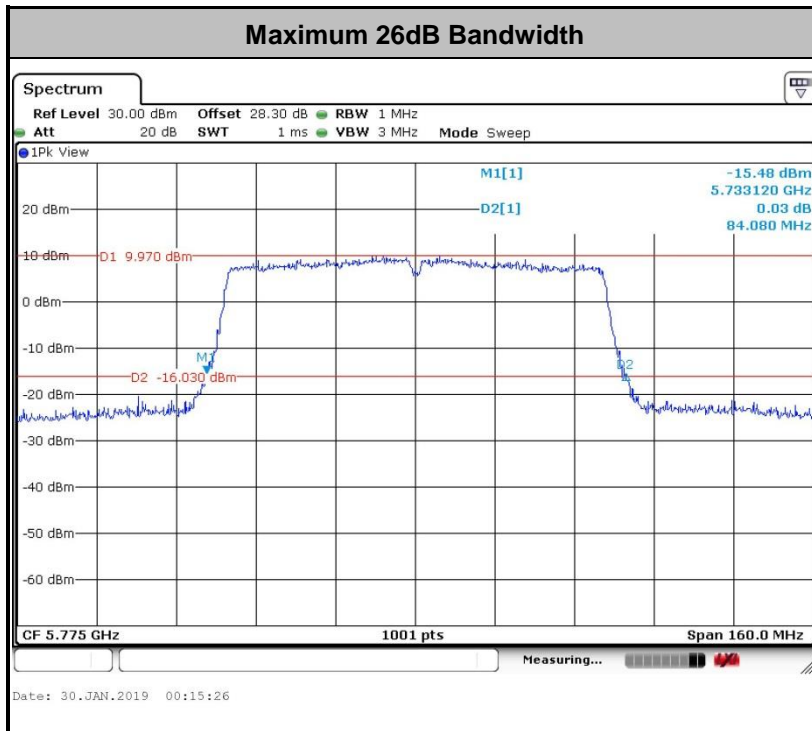

Note: The occupied channel bandwidth is maintained within the band of operation for all of the modulations.



3.2 Maximum Conducted Output Power Measurement

3.2.1 Limit of Maximum Conducted Output Power

For the band 5.725–5.85 GHz, the maximum conducted output power over the frequency band of operation shall not exceed 1 W.

If transmitting antennas of directional gain greater than 6 dBi are used, the peak output power shall be reduced by the amount in dB that the directional gain of the antenna exceeds 6 dBi.

3.2.2 Measuring Instruments

See list of measuring equipment of this test report.

3.2.3 Test Procedures

<CDD Modes>

The testing follows Method PM of FCC KDB 789033 D02 General UNII Test Procedures New Rules v02r01.

Method PM (Measurement using an RF average power meter):

1. Measurement is performed using a wideband RF power meter.
2. The EUT is configured to transmit continuously with a consistent duty cycle at its maximum power control level.
3. Measure the average power of the transmitter, and the average power is corrected with duty factor, $10 \log(1/x)$, where x is the duty cycle.

<TXBF Modes>

The testing follows Method PM-G of FCC KDB 789033 D02 General UNII Test Procedures New Rules v02r01 for TXBF modes.

Method PM-G (Measurement using a gated RF average power meter):

1. Measurement is performed using a wideband RF power meter.
2. The EUT is configured to transmit at its maximum power control level.
3. Measure the average power of the transmitter
4. Since the measurement is made only during the ON time of the transmitter, no duty cycle correction factor is required.

3.2.4 Test Setup

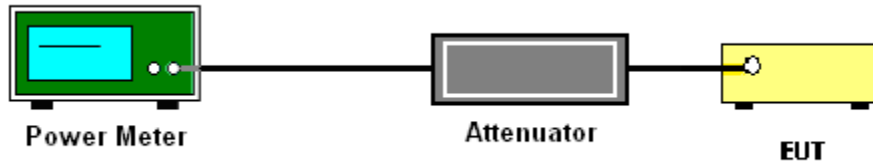

3.2.5 Test Result of Maximum Conducted Output Power

Test Engineer :	Kai Liao and Luffy Lin	Temperature :	21~25°C
		Relative Humidity :	51~54%

<CDD Mode>

Band IV														
Mod.	Data Rate	NTX	CH.	Freq. (MHz)	Duty Factor (dB)		Average Conducted Power (dBm)			FCC Conducted Power Limit (dBm)		DG (dBi)		Pass/Fail
					Ant 1	Ant 2	Ant 1	Ant 2	SUM	Ant 1	Ant 2	Ant 1	Ant 2	
11a	6Mbps	1	149	5745	0.19	0.19	18.84	18.77		30.00	30.00	2.71	3.35	Pass
11a	6Mbps	1	157	5785	0.19	0.19	18.89	18.79		30.00	30.00	2.71	3.35	Pass
11a	6Mbps	1	165	5825	0.19	0.19	18.83	18.47		30.00	30.00	2.71	3.35	Pass
HT20	MCS0	1	149	5745	0.20	0.18	18.70	18.56		30.00	30.00	2.71	3.35	Pass
HT20	MCS0	1	157	5785	0.20	0.18	18.28	18.01		30.00	30.00	2.71	3.35	Pass
HT20	MCS0	1	165	5825	0.20	0.18	18.66	18.32		30.00	30.00	2.71	3.35	Pass
HT40	MCS0	1	151	5755	0.34	0.38	18.83	18.76		30.00	30.00	2.71	3.35	Pass
HT40	MCS0	1	159	5795	0.34	0.38	18.70	18.53		30.00	30.00	2.71	3.35	Pass
VHT20	MCS0	1	149	5745	0.20	0.20	18.66	18.54		30.00	30.00	2.71	3.35	Pass
VHT20	MCS0	1	157	5785	0.20	0.20	18.23	17.98		30.00	30.00	2.71	3.35	Pass
VHT20	MCS0	1	165	5825	0.20	0.20	18.61	18.30		30.00	30.00	2.71	3.35	Pass
VHT40	MCS0	1	151	5755	0.40	0.36	18.80	18.64		30.00	30.00	2.71	3.35	Pass
VHT40	MCS0	1	159	5795	0.40	0.36	18.68	18.47		30.00	30.00	2.71	3.35	Pass
VHT80	MCS0	1	155	5775	0.69	0.69	18.31	18.27		30.00	30.00	2.71	3.35	Pass



Band IV														
Mod.	Data Rate	NTX	CH.	Freq. (MHz)	Duty Factor (dB)		Average Conducted Power (dBm)			FCC Conducted Power Limit (dBm)		DG (dBi)		Pass/Fail
					Ant 1	Ant 2	Ant 1	Ant 2	SUM	Ant 1	Ant 2	Ant 1	Ant 2	
11a	6Mbps	2	149	5745	0.19	0.19	18.84	18.79	21.82	30.00		3.35	Pass	
11a	6Mbps	2	157	5785	0.19	0.19	18.51	18.37	21.45	30.00		3.35	Pass	
11a	6Mbps	2	165	5825	0.19	0.19	18.92	18.58	21.76	30.00		3.35	Pass	
HT20	MCS0	2	149	5745	0.20	0.20	18.90	18.66	21.79	30.00		3.35	Pass	
HT20	MCS0	2	157	5785	0.20	0.20	18.45	18.27	21.37	30.00		3.35	Pass	
HT20	MCS0	2	165	5825	0.20	0.20	18.88	18.51	21.71	30.00		3.35	Pass	
HT40	MCS0	2	151	5755	0.40	0.36	18.86	18.81	21.85	30.00		3.35	Pass	
HT40	MCS0	2	159	5795	0.40	0.36	18.77	18.63	21.71	30.00		3.35	Pass	
VHT20	MCS0	2	149	5745	0.20	0.20	18.88	18.64	21.77	30.00		3.35	Pass	
VHT20	MCS0	2	157	5785	0.20	0.20	18.43	18.21	21.33	30.00		3.35	Pass	
VHT20	MCS0	2	165	5825	0.20	0.20	18.81	18.47	21.65	30.00		3.35	Pass	
VHT40	MCS0	2	151	5755	0.36	0.34	18.82	18.69	21.76	30.00		3.35	Pass	
VHT40	MCS0	2	159	5795	0.36	0.34	18.70	18.48	21.60	30.00		3.35	Pass	
VHT80	MCS0	2	155	5775	0.69	0.69	18.35	18.29	21.33	30.00		3.35	Pass	



Test Engineer :	Kai Liao	Temperature :	21~25°C
		Relative Humidity :	51~54%

<TXBF Mode>

Band IV														
Mod.	Data Rate	NTX	CH.	Freq. (MHz)	Duty Factor (dB)		Average Conducted Power (dBm)			FCC Conducted Power Limit (dBm)		DG (dBi)		Pass/Fail
					Ant 1	Ant 2	Ant 1	Ant 2	SUM	Ant 1	Ant 2	Ant 1	Ant 2	
VHT20	MCS0	2	149	5745	0.00	0.00	18.70	18.60	21.66	29.95	29.95	6.05	6.05	Pass
VHT20	MCS0	2	157	5785	0.00	0.00	18.30	18.20	21.26	29.95	29.95	6.05	6.05	Pass
VHT20	MCS0	2	165	5825	0.00	0.00	18.40	18.10	21.26	29.95	29.95	6.05	6.05	Pass
VHT40	MCS0	2	151	5755	0.00	0.00	18.70	18.40	21.56	29.95	29.95	6.05	6.05	Pass
VHT40	MCS0	2	159	5795	0.00	0.00	18.60	18.50	21.56	29.95	29.95	6.05	6.05	Pass
VHT80	MCS0	2	155	5775	0.00	0.00	17.40	17.30	20.36	29.95	29.95	6.05	6.05	Pass



3.3 Power Spectral Density Measurement

3.3.1 Limit of Power Spectral Density

For the band 5.725–5.85 GHz, the maximum power spectral density shall not exceed 30 dBm in any 500-kHz band.

If transmitting antennas of directional gain greater than 6 dBi are used, the peak output power shall be reduced by the amount in dB that the directional gain of the antenna exceeds 6 dBi.

3.3.2 Measuring Instruments

See list of measuring equipment of this test report.

3.3.3 Test Procedures

The testing follows FCC KDB 789033 D02 General UNII Test Procedures New Rules v02r01. Section F) Maximum power spectral density.

<CDD Modes>

Method SA-2

(trace averaging across on and off times of the EUT transmissions, followed by duty cycle correction).

- Measure the duty cycle.
- Set span to encompass the entire emission bandwidth (EBW) of the signal.
- Set RBW = 300 kHz.
- Set VBW \geq 1 MHz.
- Number of points in sweep \geq 2 Span / RBW.
- Sweep time = auto.
- Detector = RMS
- Trace average at least 100 traces in power averaging mode.
- Add $10 \log(500\text{kHz}/\text{RBW})$ to the test result.
- Add $10 \log(1/x)$, where x is the duty cycle, to the measured power in order to compute the average power during the actual transmission times. For example, add $10 \log(1/0.25) = 6$ dB if the duty cycle is 25 percent.

<TXBF Modes>**# Method SA-3 #**

(power averaging (rms) detection with max hold):

- Set span to encompass the entire emission bandwidth (EBW) of the signal.
 - Set RBW = 300 kHz.
 - Set VBW \geq 1 MHz.
 - Number of points in sweep \geq 2 Span / RBW.
 - Sweep time \leq (number of points in sweep) \times T, when duty cycle is less than 98 percent where T is the minimum transmission duration over which the transmitter is on and is transmitting at its maximum power control level for the tested mode of operation.
 - Detector = power averaging (rms).
 - Trace mode = max hold.
 - Allow max hold to run for at least 60 seconds, or longer as needed to allow the trace to stabilize.
1. The RF output of EUT was connected to the spectrum analyzer by a low loss cable.
 2. Each plot has already offset with cable loss, and attenuator loss. Measure the PPSD and record it.
 3. For MIMO mode, calculation method follows FCC KDB 662911 D01 Multiple Transmitter Output v02r01.

Method (c): Measure and add $10 \log(N_{ANT})$ dB.

With this technique, spectrum measurements are performed at each output of the device, but rather than summing the spectra or the spectral peaks across the outputs, the quantity $10 \log(N_{ANT})$ dB is added to each spectrum value before comparing to the emission limit. The addition of $10 \log(N_{ANT})$ dB serves to apportion the emission limit among the N_{ANT} outputs so that each output is permitted to contribute no more than $1/N_{ANT}^{th}$ of the PSD limit.

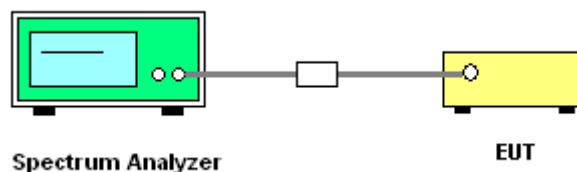
3.3.4 Test Setup



3.3.5 Test Result of Power Spectral Density

Test Engineer :	Kai Liao and Luffy Lin	Temperature :	21~25°C
		Relative Humidity :	51~54%

<CDD Mode>

Band IV																
Mod.	Data Rate	NTX	CH.	Freq. (MHz)	Duty Factor (dB)		10log (500kHz /RBW) Factor (dB)		Average Power Density (dBm/500kHz)			Average PSD Limit (dBm/500kHz)		DG (dBi)		Pass /Fail
					Ant 1	Ant 2	Ant 1	Ant 2	Ant 1	Ant 2	SUM	Ant 1	Ant 2	Ant 1	Ant 2	
11a	6Mbps	1	149	5745	0.19	0.19	2.22	2.22	4.90	4.89	-	30.00	30.00	2.71	3.35	Pass
11a	6Mbps	1	157	5785	0.19	0.19	2.22	2.22	4.74	4.19	-	30.00	30.00	2.71	3.35	Pass
11a	6Mbps	1	165	5825	0.19	0.19	2.22	2.22	5.15	4.51	-	30.00	30.00	2.71	3.35	Pass
HT20	MCS0	1	149	5745	0.20	0.18	2.22	2.22	5.04	5.15	-	30.00	30.00	2.71	3.35	Pass
HT20	MCS0	1	157	5785	0.20	0.18	2.22	2.22	4.31	4.46	-	30.00	30.00	2.71	3.35	Pass
HT20	MCS0	1	165	5825	0.20	0.18	2.22	2.22	4.87	4.73	-	30.00	30.00	2.71	3.35	Pass
HT40	MCS0	1	151	5755	0.34	0.38	2.22	2.22	2.17	2.18	-	30.00	30.00	2.71	3.35	Pass
HT40	MCS0	1	159	5795	0.34	0.38	2.22	2.22	1.71	1.79	-	30.00	30.00	2.71	3.35	Pass
VHT80	MCS0	1	155	5775	0.69	0.69	2.22	2.22	-0.98	-1.08	-	30.00	30.00	2.71	3.35	Pass
11a	6Mbps	2	149	5745	0.19	0.19	2.22	2.22	5.35	4.78	8.36	29.95	29.95	6.05	6.05	Pass
11a	6Mbps	2	157	5785	0.19	0.19	2.22	2.22	4.90	4.44	7.91	29.95	29.95	6.05	6.05	Pass
11a	6Mbps	2	165	5825	0.19	0.19	2.22	2.22	4.82	4.40	7.83	29.95	29.95	6.05	6.05	Pass
HT20	MCS0	2	149	5745	0.20	0.20	2.22	2.22	4.59	5.39	8.40	29.95	29.95	6.05	6.05	Pass
HT20	MCS0	2	157	5785	0.20	0.20	2.22	2.22	5.19	4.82	8.20	29.95	29.95	6.05	6.05	Pass
HT20	MCS0	2	165	5825	0.20	0.20	2.22	2.22	5.26	5.00	8.27	29.95	29.95	6.05	6.05	Pass
HT40	MCS0	2	151	5755	0.40	0.36	2.22	2.22	1.86	2.38	5.39	29.95	29.95	6.05	6.05	Pass
HT40	MCS0	2	159	5795	0.40	0.36	2.22	2.22	2.23	1.91	5.24	29.95	29.95	6.05	6.05	Pass
VHT80	MCS0	2	155	5775	0.69	0.69	2.22	2.22	-1.33	-1.09	1.92	29.95	29.95	6.05	6.05	Pass

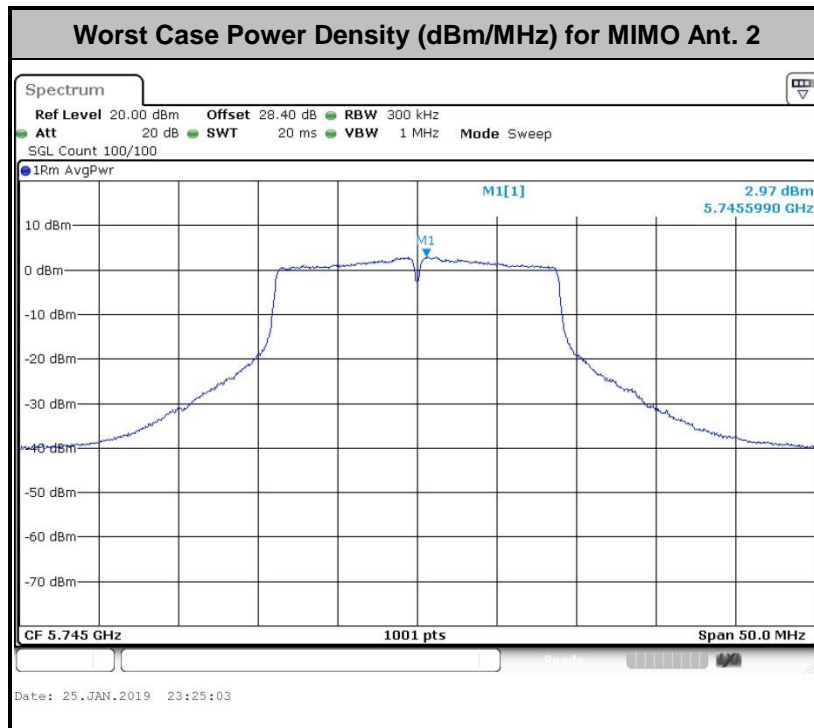
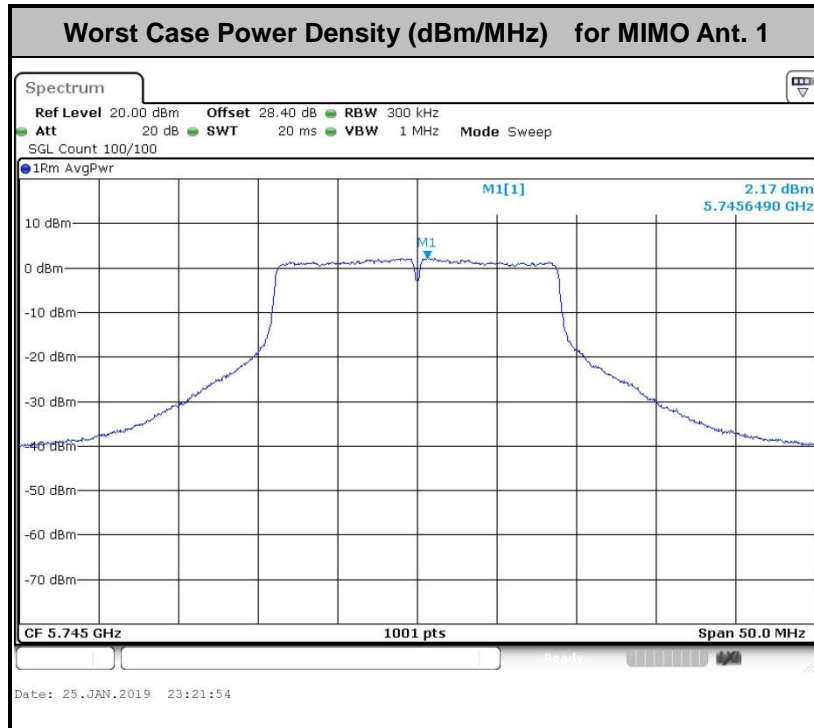



Test Engineer :	Kai Liao	Temperature :	21~25°C
		Relative Humidity :	51~54%

<TXBF Mode>

Band IV																
Mod.	Data Rate	NTX	CH.	Freq. (MHz)	Duty Factor (dB)		10log (500kHz /RBW) Factor (dB)		Average Power Density (dBm/500kHz)			Average PSD Limit (dBm/500kHz)		DG (dBi)		Pass /Fail
					Ant 1	Ant 2	Ant 1	Ant 2	Ant 1	Ant 2	SUM	Ant 1	Ant 2	Ant 1	Ant 2	
VHT20	MCS0	2	149	5745	0.00	0.00	2.22	9.36	9.20	12.37	29.95	6.05	6.05	Pass		
VHT20	MCS0	2	157	5785	0.00	0.00	2.22	8.87	8.25	11.88	29.95	6.05	6.05	Pass		
VHT20	MCS0	2	165	5825	0.00	0.00	2.22	9.19	8.87	12.20	29.95	6.05	6.05	Pass		
VHT40	MCS0	2	151	5755	0.00	0.00	2.22	5.70	5.23	8.71	29.95	6.05	6.05	Pass		
VHT40	MCS0	2	159	5795	0.00	0.00	2.22	4.90	5.32	8.33	29.95	6.05	6.05	Pass		
VHT80	MCS0	2	155	5775	0.00	0.00	2.22	2.43	2.59	5.60	29.95	6.05	6.05	Pass		

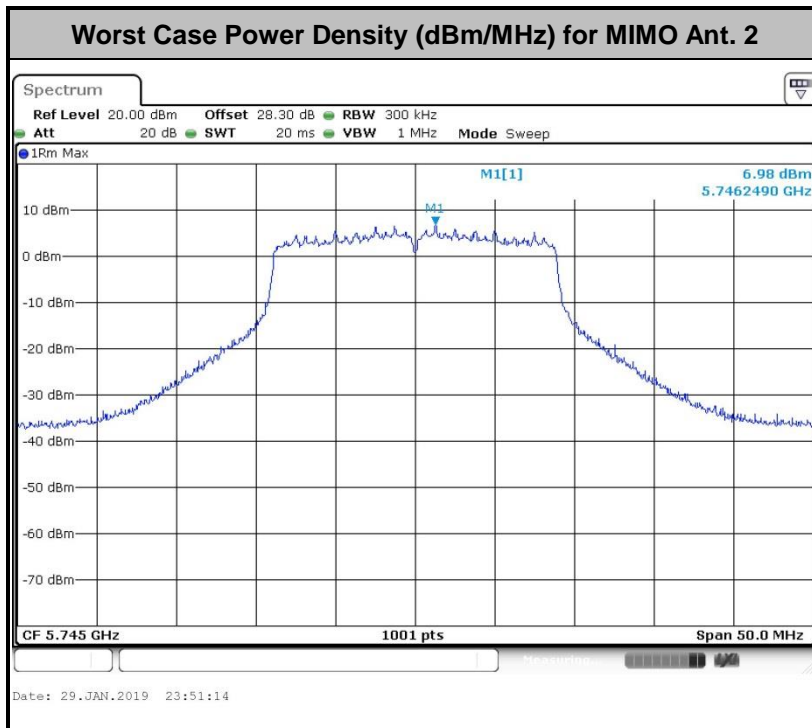
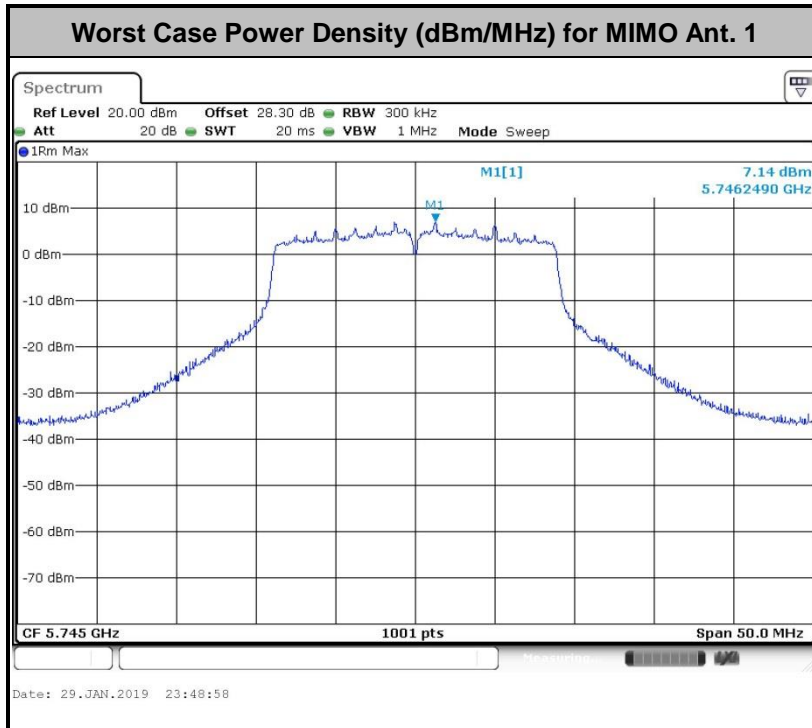



3.4 Unwanted Emissions Measurement

This section is to measure unwanted emissions through radiated measurement for band edge spurious emissions and out of band emissions measurement.

3.4.1 Limit of Unwanted Emissions

- (1) For transmitters operating in the 5.725-5.85 GHz band:
 15.407(b)(4)(i) All emissions shall be limited to a level of -27 dBm/MHz at 75 MHz or more above or below the band edge increasing linearly to 10 dBm/MHz at 25 MHz above or below the band edge, and from 25 MHz above or below the band edge increasing linearly to a level of 15.6 dBm/MHz at 5 MHz above or below the band edge, and from 5 MHz above or below the band edge increasing linearly to a level of 27 dBm/MHz at the band edge.
- (2) Unwanted spurious emissions fallen in restricted bands shall comply with the general field strength limits as below table,

Frequency (MHz)	Field Strength (microvolts/meter)	Measurement Distance (meters)
0.009 – 0.490	2400/F(kHz)	300
0.490 – 1.705	24000/F(kHz)	30
1.705 – 30.0	30	30
30 – 88	100	3
88 – 216	150	3
216 - 960	200	3
Above 960	500	3

Note: The following formula is used to convert the EIRP to field strength.

$$E = \frac{1000000\sqrt{30P}}{3} \text{ } \mu\text{V/m, where P is the eirp (Watts)}$$



EIRP (dBm)	Field Strength at 3m (dBμV/m)
- 27	68.3

(3) KDB789033 D02 v02r01 G)2)c)

- (i) Section 15.407(b)(1) to (b)(3) specify the unwanted emission limits for the U-NII-1 and U-NII-2 bands. As specified, emissions above 1000 MHz that are outside of the restricted bands are subject to a peak emission limit of -27 dBm/MHz.³
- (ii) Section 15.407(b)(4) specifies the unwanted emission limit for the U-NII-3 band. A band emissions mask is specified in Section 15.407(b)(4)(i). The emission limits are in terms of a Peak detector. An alternative to the band emissions mask is specified in Section 15.407(b)(4)(ii). The alternative limits are based on the highest antenna gain specified in the filing. There are also marketing and importation restrictions for the devices using the alternative limit.⁴

Note 3: An out-of-band emission that complies with both the average and peak limits of Section 15.209 is not required to satisfy the -27 dBm/MHz peak emission limit.

Note 4: Only devices with antenna gains of 10 dBi or less may be approved using the emission limits specified in Section 15.247(d) till March 2, 2018; all other devices operating in this band must use the mask specified in Section 15.407(b)(4)(i).

3.4.2 Measuring Instruments

See list of measuring equipment of this test report.

3.4.3 Test Procedures

1. The testing follows FCC KDB 789033 D02 General UNII Test Procedures New Rules v02r01. Section G) Unwanted emissions measurement.
 - (1) Procedure for Unwanted Emissions Measurements Below 1000MHz
 - RBW = 120 kHz
 - VBW = 300 kHz
 - Detector = Peak
 - Trace mode = max hold
 - (2) Procedure for Peak Unwanted Emissions Measurements Above 1000 MHz
 - RBW = 1 MHz
 - VBW ≥ 3 MHz
 - Detector = Peak
 - Sweep time = auto
 - Trace mode = max hold



(3) Procedures for Average Unwanted Emissions Measurements Above 1000MHz

- RBW = 1 MHz
 - VBW = 10 Hz, when duty cycle is no less than 98 percent.
 - $VBW \geq 1/T$, when duty cycle is less than 98 percent where T is the minimum transmission duration over which the transmitter is on and is transmitting at its maximum power control level for the tested mode of operation.
2. The EUT was placed on a turntable with 0.8 meter for frequency below 1GHz and 1.5 meter for frequency above 1GHz respectively above ground.
 3. The EUT was set 3 meters from the interference receiving antenna which was mounted on the top of a variable height antenna tower.
 4. The antenna is a broadband antenna and its height is adjusted between one meter and four meters above ground to find the maximum value of the field strength for both horizontal polarization and vertical polarization of the antenna.
 5. For each suspected emission, the EUT was arranged to its worst case and then adjust the antenna tower (from 1 m to 4 m) and turntable (from 0 degree to 360 degrees) to find the maximum reading.
 6. For testing below 1GHz, if the emission level of the EUT in peak mode was 3 dB lower than the limit specified, then peak values of EUT will be reported, otherwise, the emissions will be repeated one by one using the CISPR quasi-peak method and reported.
 7. For testing above 1GHz, the emission level of the EUT in peak mode was 20dB lower than average limit (that means the emission level in average mode also complies with the limit in average mode), then peak values of EUT will be reported, otherwise, the emissions will be measured in average mode again and reported.

3.4.4 Test Setup

For radiated emissions below 30MHz

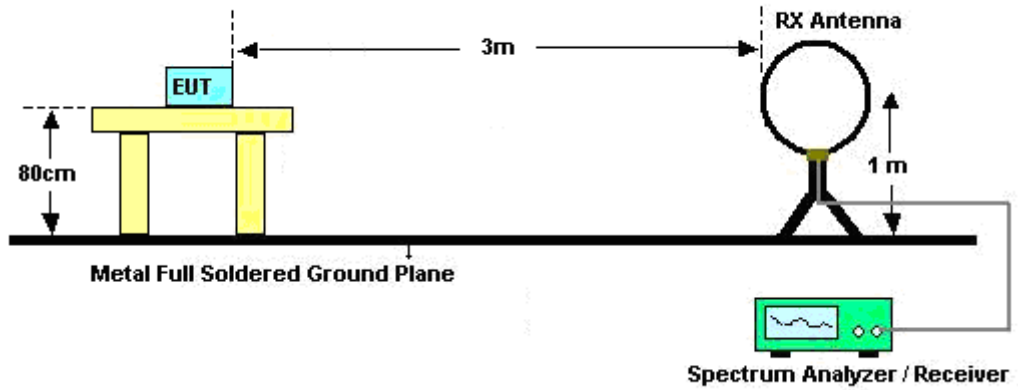

For radiated emissions from 30MHz to 1GHz

<CDD Mode>

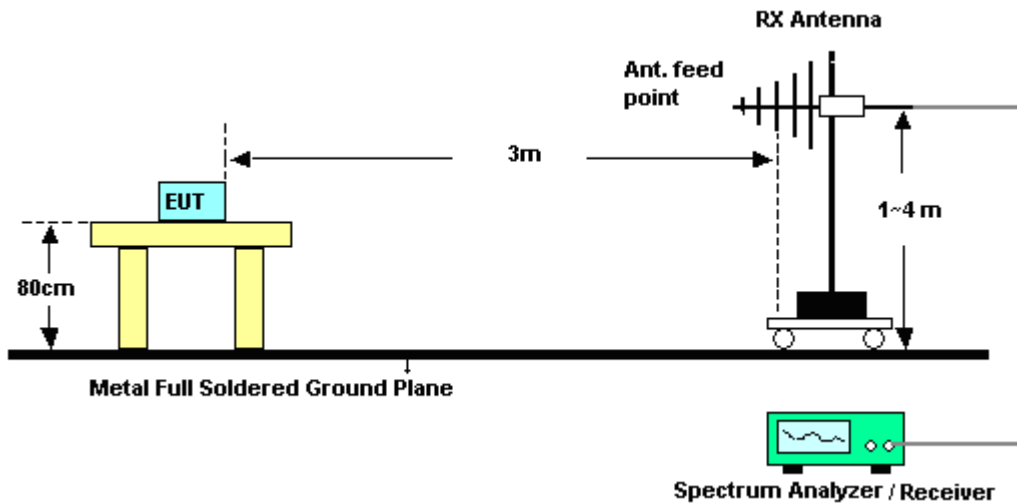

<TXBF Mode>

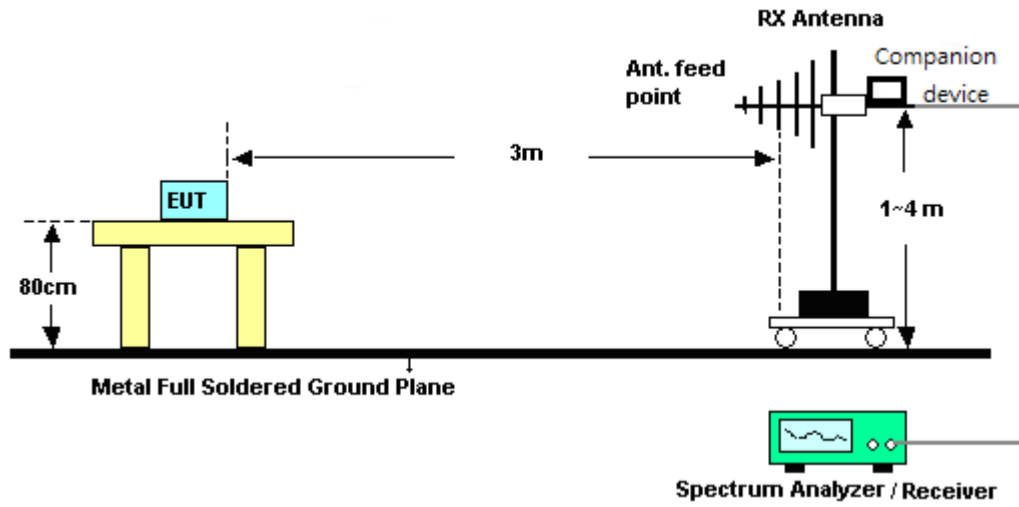

For radiated emissions above 1GHz

<CDD Mode>

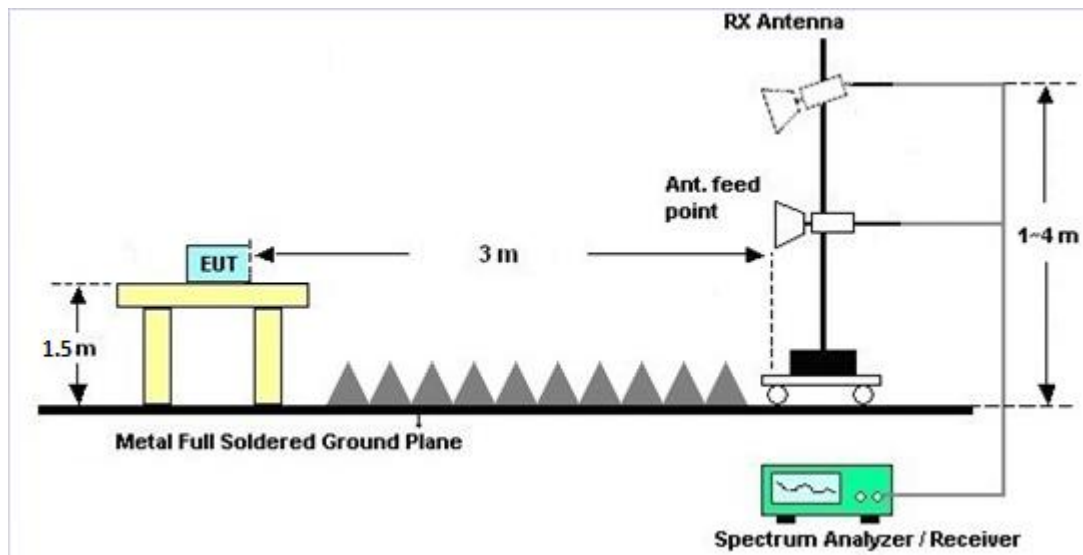

<TXBF Mode>

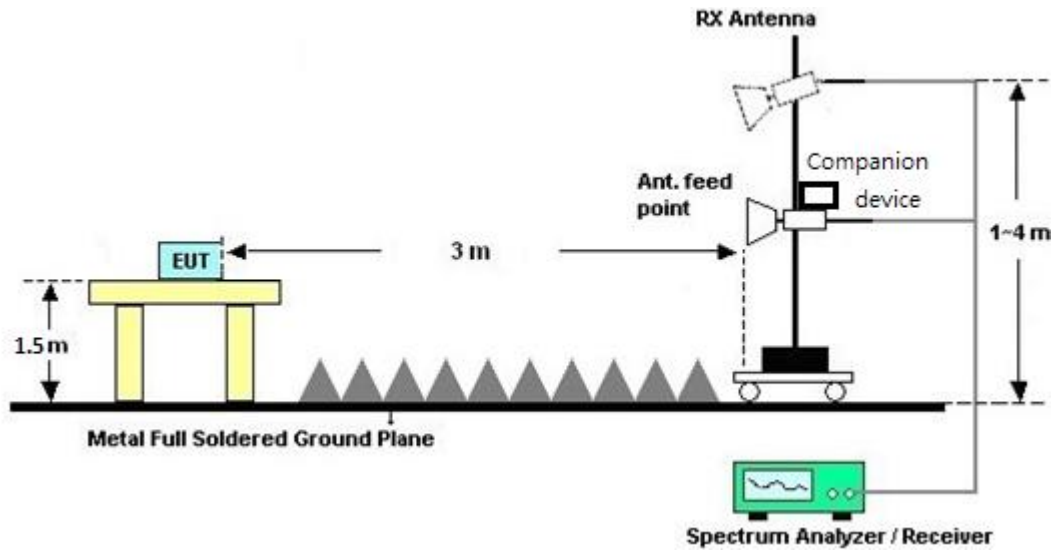

3.4.5 Test Results of Radiated Emissions (9 kHz ~ 30 MHz)

The low frequency, which started from 9 kHz to 30MHz, was pre-scanned and the result which was 20dB lower than the limit line was not reported.

There is a comparison data of both open-field test site and alternative test site - semi-Anechoic chamber according to 414788 D01 Radiated Test Site v01r01, and the result came out very similar.

3.4.6 Test Result of Radiated Band Edges

Please refer to Appendix B and C.

3.4.7 Duty Cycle

Please refer to Appendix D.

3.4.8 Test Result of Unwanted Radiated Emission (30MHz ~ 10th Harmonic)

Please refer to Appendix B and C.



3.5 AC Conducted Emission Measurement

3.5.1 Limit of AC Conducted Emission

For equipment that is designed to be connected to the public utility (AC) power line, the radio frequency voltage that is conducted back onto the AC power line on any frequency or frequencies within the band 150 kHz to 30 MHz shall not exceed the limits in the following table.

Frequency of emission (MHz)	Conducted limit (dB μ V)	
	Quasi-peak	Average
0.15-0.5	66 to 56*	56 to 46*
0.5-5	56	46
5-30	60	50

*Decreases with the logarithm of the frequency.

3.5.2 Measuring Instruments

See list of measuring equipment of this test report.

3.5.3 Test Procedures

1. The EUT was placed 0.4 meter from the conducting wall of the shielding room was kept at least 80 centimeters from any other grounded conducting surface.
2. Connect EUT to the power mains through a line impedance stabilization network (LISN).
3. All the support units are connecting to the other LISN.
4. The LISN provides 50 ohm coupling impedance for the measuring instrument.
5. The FCC states that a 50 ohm, 50 microhenry LISN should be used.
6. Both sides of AC line were checked for maximum conducted interference.
7. The frequency range from 150 kHz to 30 MHz was searched.
8. Set the test-receiver system to Peak Detect Function and specified bandwidth with Maximum Hold Mode.

3.5.4 Test Setup

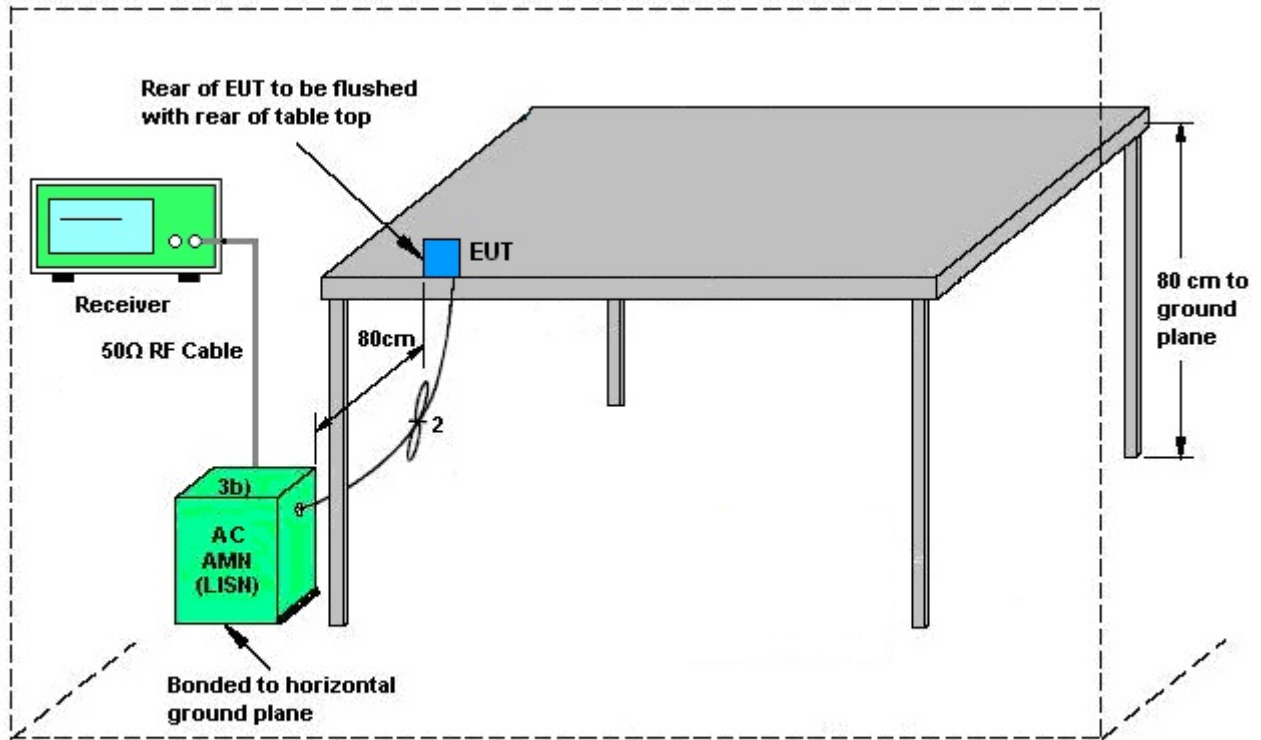

AMN = Artificial mains network (LISN)
AE = Associated equipment
EUT = Equipment under test
ISN = Impedance stabilization network

3.5.5 Test Result of AC Conducted Emission

Please refer to Appendix A.



3.6 Automatically Discontinue Transmission

3.6.1 Limit of Automatically Discontinue Transmission

The device shall automatically discontinue transmission in case of either absence of information to transmit or operational failure. These provisions are not intended to preclude the transmission of control or signaling information or the use of repetitive codes used by certain digital technologies to complete frame or burst intervals. Applicants shall include in their application for equipment authorization to describe how this requirement is met.

3.6.2 Measuring Instruments

See list of measuring equipment of this test report.

3.6.3 Test Result of Automatically Discontinue Transmission

While the EUT is not transmitting any information, the EUT can automatically discontinue transmission and become standby mode for power saving. The EUT can detect the controlling signal of ACK message transmitting from remote device and verify whether it shall resend or discontinue transmission.



3.7 Antenna Requirements

3.7.1 Standard Applicable

If transmitting antenna directional gain is greater than 6 dBi, both the peak transmit power and the peak power spectral density shall be reduced by the amount in dB that the directional gain of the antenna exceeds 6 dBi.

3.7.2 Antenna Anti-Replacement Construction

An embedded-in antenna design is used.

3.7.3 Antenna Gain

<CDD Mode>

FCC KDB 662911 D01 Multiple Transmitter Output v02r01

For CDD transmissions, directional gain is calculated as

Directional gain = GANT + Array Gain, where Array Gain is as follows.

For power spectral density (PSD) measurements on all devices,

Array Gain = 10 log(NANT/NSS=1) dB.

For power measurements on IEEE 802.11 devices,

Array Gain = 0 dB (i.e., no array gain) for NANT ≤ 4.

Directional gain may be calculated by using the formulas applicable to equal gain antennas with GANT set equal to the gain of the antenna having the highest gain;

The EUT supports CDD mode.

For power, the directional gain GANT is set equal to the antenna having the highest gain, i.e., F)2)f)i).

For PSD, the directional gain calculation is following F)2)f)ii) of KDB 662911 D01 v02r01.

The power and PSD limit should be modified if the directional gain of EUT is over 6 dBi,

The directional gain "DG" is calculated as following table.

<CDD Modes>						
			DG	DG	Power	PSD
			for	for	Limit	Limit
	Ant. 1	Ant. 2	Power	PSD	Reduction	Reduction
	(dBi)	(dBi)	(dBi)	(dBi)	(dB)	(dB)
Band IV	2.71	3.35	3.35	6.05	0.00	0.05

Power Limit Reduction = DG(Power) – 6dBi, (min = 0)

PSD Limit Reduction = DG(PSD) – 6dBi, (min = 0)

<TXBF Mode>

FCC KDB 662911 D01 Multiple Transmitter Output v02r01

For CDD transmissions, directional gain is calculated as

$$DirectionalGain = 10 \cdot \log \left[\frac{\sum_{j=1}^{N_{SS}} \left\{ \sum_{k=1}^{N_{ANT}} g_{j,k} \right\}^2}{N_{ANT}} \right]$$

where

Each antenna is driven by no more than one spatial stream;

N_{SS} = the number of independent spatial streams of data;

N_{ANT} = the total number of antennas

$g_{j,k} = 10^{G_k / 20}$ if the k th antenna is being fed by spatial stream j , or zero if it is not;
 G_k is the gain in dBi of the k th antenna.

The EUT supports beamforming for 802.11ac modes.

The directional gain calculation is following F)2)e)ii) of KDB 662911 D01 v02r01.

The power and PSD limit should be modified if the directional gain of EUT is over 6 dBi,

The directional gain “DG” is calculated as following table.

			DG	DG	Power	PSD
	Ant 1	Ant 2	for	for	Limit	Limit
	(dBi)	(dBi)	Power	PSD	Reduction	Reduction
	(dBi)	(dBi)	(dBi)	(dBi)	(dB)	(dB)
Band IV	2.71	3.35	6.05	6.05	0.05	0.05

$Power\ Limit\ Reduction = DG(Power) - 6dBi, (min = 0)$

$PSD\ Limit\ Reduction = DG(PSD) - 6dBi, (min = 0)$



4 List of Measuring Equipment

Instrument	Manufacturer	Model No.	Serial No.	Characteristics	Calibration Date	Test Date	Due Date	Remark
AC Power Source	ChainTek	APC-1000W	N/A	N/A	N/A	Jan. 07, 2019	N/A	Conduction (CO05-HY)
EMI Test Receiver	Rohde & Schwarz	ESR3	102388	9KHz~3.6GHz	Nov. 12, 2018	Jan. 07, 2019	Nov. 11, 2019	Conduction (CO05-HY)
LISN	Rohde & Schwarz	ENV216	100080	9kHz~30MHz	Nov. 14, 2018	Jan. 07, 2019	Nov. 13, 2019	Conduction (CO05-HY)
Software	Rohde & Schwarz	EMC32 V10.30	N/A	N/A	N/A	Jan. 07, 2019	N/A	Conduction (CO05-HY)
LF Cable	HUBER + SUHNER	RG-214/U	LF01	N/A	Jan. 02, 2019	Jan. 07, 2019	Jan. 01, 2020	Conduction (CO05-HY)
Pulse Limiter	SCHWARZBECK	VTSD 9561-FN	9561-FN00373	9kHz~200MHz	Nov. 08, 2018	Jan. 07, 2019	Nov. 07, 2019	Conduction (CO05-HY)
Preamplifier	Agilent	8449B	3008A01917	1GHz~26.5GHz	Apr. 23, 2018	Dec. 25, 2018~Jan. 25, 2019	Apr. 22, 2019	Radiation (03CH07-HY)
Bilog Antenna	TESEQ	CBL 6111D&00800 N1D01N-06	35419&03	30MHz to 1GHz	Dec. 16, 2018	Dec. 25, 2018~Jan. 25, 2019	Dec. 15, 2019	Radiation (03CH07-HY)
Double Ridge Horn Antenna	ESCO	3117	00075962	1GHz ~ 18GHz	Dec. 02, 2018	Dec. 25, 2018~Jan. 25, 2019	Dec. 03, 2019	Radiation (03CH07-HY)
Loop Antenna	Rohde & Schwarz	HFH2-Z2	100315	9 kHz~30 MHz	May 15, 2017	Dec. 25, 2018~Jan. 25, 2019	May 14, 2019	Radiation (03CH07-HY)
Preamplifier	MITEQ	AMF-7D-0010 1800-30-10P	1590075	1GHz ~ 18GHz	Apr. 25, 2018	Dec. 25, 2018~Jan. 25, 2019	Apr. 24, 2019	Radiation (03CH07-HY)
Preamplifier	COM-POWER	PA-103A	161241	10MHz-1GHz	May 21, 2018	Dec. 25, 2018~Jan. 25, 2019	May 20, 2019	Radiation (03CH07-HY)
RF Cable	HUBER + SUHNER	SUCOFLEX 104	MY28655/4, MY24971/4, MY15682/4	30MHz~1GHz	Feb. 27, 2018	Dec. 25, 2018~Jan. 25, 2019	Feb. 26, 2019	Radiation (03CH07-HY)
RF Cable	HUBER + SUHNER	SUCOFLEX 104	MY28655/4, MY24971/4, MY15682/4	1GHz~18GHz	Feb. 27, 2018	Dec. 25, 2018~Jan. 25, 2019	Feb. 26, 2019	Radiation (03CH07-HY)
Antenna Mast	Max-Full	MFA520BS	N/A	1m~4m	N/A	Dec. 25, 2018~Jan. 25, 2019	N/A	Radiation (03CH07-HY)
Turn Table	ChainTek	Chaintek 3000	N/A	0~360 Degree	N/A	Dec. 25, 2018~Jan. 25, 2019	N/A	Radiation (03CH07-HY)
Amplifier	MITEQ	TTA1840-35-HG	1871923	18GHz~40GHz, VSWR : 2.5:1 max	Jul. 16, 2018	Dec. 25, 2018~Jan. 25, 2019	Jul. 15, 2019	Radiation (03CH07-HY)
Software	Audix	E3 6.2009-8-24	RK-001042	N/A	N/A	Dec. 25, 2018~Jan. 25, 2019	N/A	Radiation (03CH07-HY)
SHF-EHF Horn Antenna	SCHWARZBECK	BBHA 9170	BBHA9170251	18GHz- 40GHz	Nov. 20, 2018	Dec. 25, 2018~Jan. 25, 2019	Nov. 19, 2019	Radiation (03CH07-HY)
RF Cable	HUBER + SUHNER	SF102/2*11S K252	MY4278/2	9kHz~40GHz	May 17, 2018	Dec. 25, 2018~Jan. 25, 2019	May 16, 2019	Radiation (03CH07-HY)
Spectrum Analyzer	Agilent	N9010A	MY53470118	10Hz~44GHz	Apr. 17, 2018	Dec. 25, 2018~Jan. 25, 2019	Apr. 16, 2019	Radiation (03CH07-HY)



Instrument	Manufacturer	Model No.	Serial No.	Characteristics	Calibration Date	Test Date	Due Date	Remark
<CDD Mode>								
Power Meter	Anritsu	ML2495A	1218006	N/A	Oct. 08, 2018	Nov. 27, 2018~ Feb. 08, 2019	Oct. 07, 2019	Conducted (TH05-HY)
Power Sensor	Anritsu	MA2411B	1207363	300MHz~ 40GHz	Oct. 08, 2018	Nov. 27, 2018~ Feb. 08, 2019	Oct. 07, 2019	Conducted (TH05-HY)
Spectrum Analyzer	Rohde & Schwarz	FSV40	101397	10Hz~40GHz	Nov. 13, 2018	Nov. 27, 2018~ Feb. 08, 2019	Nov. 12, 2019	Conducted (TH05-HY)
Switch Box & RF Cable	Burgeon	ETF-058	EC1300484	N/A	Mar. 01, 2018	Nov. 27, 2018~ Feb. 08, 2019	Feb. 28, 2019	Conducted (TH05-HY)
<TXBF Mode>								
Power Sensor	DARE	RadiPower	15I00041SNO0 9	10MHz~6GHz	May 07, 2018	Jan. 03, 2019~ Feb. 03, 2019	May 06, 2019	Conducted (TH05-HY)
Signal Analyzer	Rohde & Schwarz	FSV40	101397	10Hz~40GHz	Nov. 13, 2018	Jan. 03, 2019~ Feb. 03, 2019	Nov. 12, 2019	Conducted (TH05-HY)



5 Uncertainty of Evaluation

Uncertainty of Conducted Emission Measurement (150kHz ~ 30MHz)

Measuring Uncertainty for a Level of Confidence of 95% ($U = 2Uc(y)$)	2.2
---	-----

Uncertainty of Radiated Emission Measurement (30 MHz ~ 1000 MHz)

Measuring Uncertainty for a Level of Confidence of 95% ($U = 2Uc(y)$)	5.7
---	-----

Uncertainty of Radiated Emission Measurement (1000 MHz ~ 18000 MHz)

Measuring Uncertainty for a Level of Confidence of 95% ($U = 2Uc(y)$)	5.5
---	-----

Uncertainty of Radiated Emission Measurement (18000 MHz ~ 40000 MHz)

Measuring Uncertainty for a Level of Confidence of 95% ($U = 2Uc(y)$)	5.2
---	-----



Appendix A. AC Conducted Emission Test Results

Test Engineer :	Jimmy Chang	Temperature :	24~26°C
		Relative Humidity :	51~53%
Test Voltage :	120Vac / 60Hz	Phase :	Line
Remark :	All emissions not reported here are more than 10 dB below the prescribed limit.		

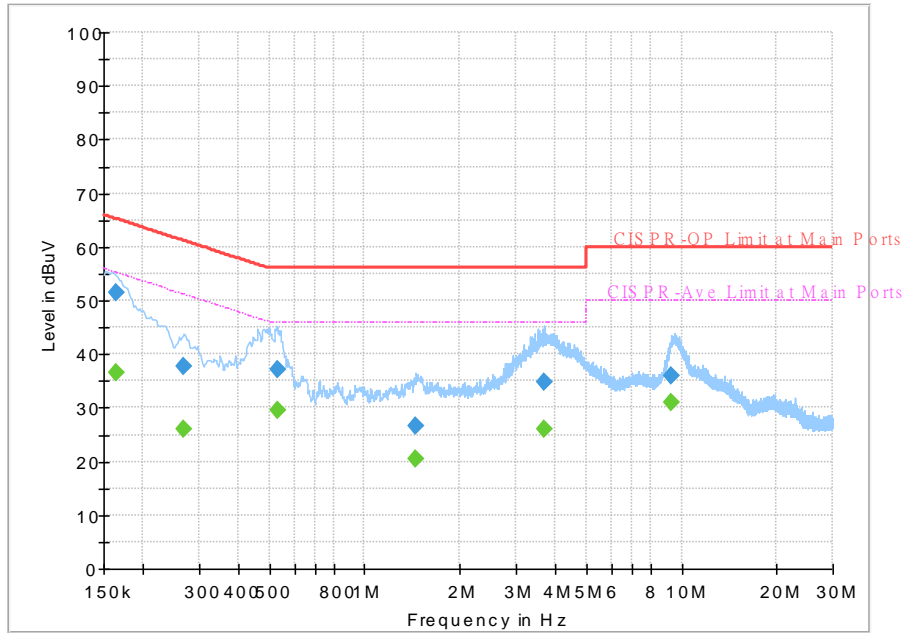

Final Result

Frequency (MHz)	QuasiPeak (dBuV)	CAverage (dBuV)	Limit (dBuV)	Margin (dB)	Line	Filter	Corr. (dB)
0.163500	---	36.51	55.28	18.77	L1	OFF	19.5
0.163500	51.43	---	65.28	13.85	L1	OFF	19.5
0.269250	---	26.16	51.14	24.98	L1	OFF	19.5
0.269250	37.65	---	61.14	23.49	L1	OFF	19.5
0.530250	---	29.45	46.00	16.55	L1	OFF	19.5
0.530250	37.20	---	56.00	18.80	L1	OFF	19.5
1.455000	---	20.48	46.00	25.52	L1	OFF	19.6
1.455000	26.56	---	56.00	29.44	L1	OFF	19.6
3.689250	---	25.98	46.00	20.02	L1	OFF	19.6
3.689250	34.90	---	56.00	21.10	L1	OFF	19.6
9.314250	---	30.86	50.00	19.14	L1	OFF	19.7
9.314250	36.00	---	60.00	24.00	L1	OFF	19.7



Test Engineer :	Jimmy Chang	Temperature :	24~26°C
		Relative Humidity :	51~53%
Test Voltage :	120Vac / 60Hz	Phase :	Neutral
Remark :	All emissions not reported here are more than 10 dB below the prescribed limit.		

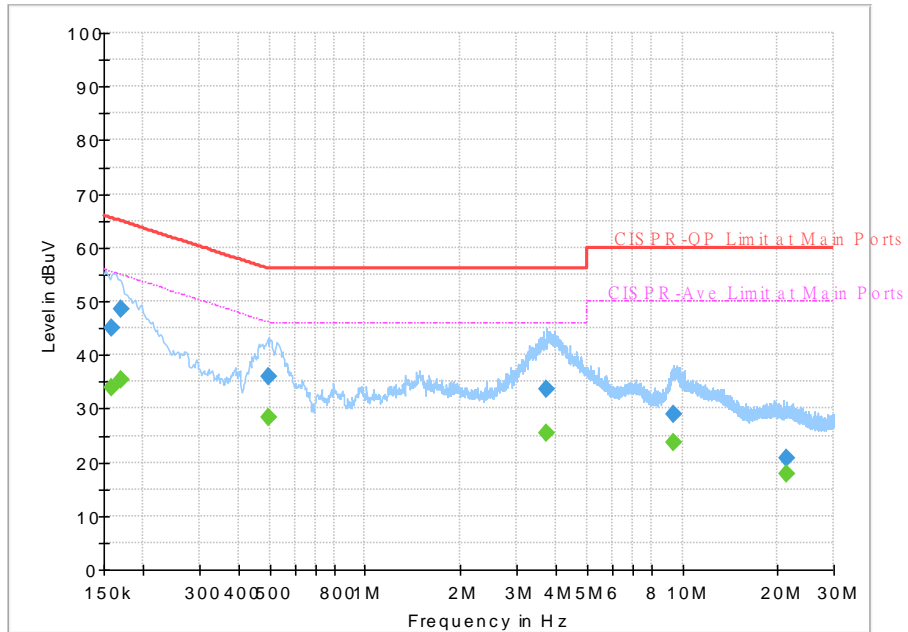

Final Result

Frequency (MHz)	QuasiPeak (dBuV)	CAverage (dBuV)	Limit (dBuV)	Margin (dB)	Line	Filter	Corr. (dB)
0.159000	---	34.05	55.52	21.47	N	OFF	19.5
0.159000	45.04	---	65.52	20.48	N	OFF	19.5
0.170250	---	35.39	54.95	19.56	N	OFF	19.5
0.170250	48.44	---	64.95	16.51	N	OFF	19.5
0.494250	---	28.33	46.10	17.77	N	OFF	19.5
0.494250	35.94	---	56.10	20.16	N	OFF	19.5
3.723000	---	25.47	46.00	20.53	N	OFF	19.6
3.723000	33.61	---	56.00	22.39	N	OFF	19.6
9.413250	---	23.63	50.00	26.37	N	OFF	19.7
9.413250	28.84	---	60.00	31.16	N	OFF	19.7
21.417000	---	17.72	50.00	32.28	N	OFF	19.9
21.417000	20.64	---	60.00	39.36	N	OFF	19.9



Appendix B. Radiated Spurious Emission

Test Engineer :	Jesse Wang, Stan Hsieh, and Troye Hsieh	Temperature :	20~25°C
		Relative Humidity :	55~60%

<CDD Mode>

Band 4 - 5725~5850MHz

WIFI 802.11a (Band Edge @ 3m)

WIFI Ant.	Note	Frequency (MHz)	Level (dBμV/m)	Over Limit (dB)	Limit Line (dBμV/m)	Read Level (dBμV)	Antenna Factor (dB/m)	Path Loss (dB)	Preamp Factor (dB)	Ant Pos (cm)	Table Pos (deg)	Peak Avg. (P/A)	Pol. (H/V)	
802.11a CH 149 5745MHz		5606.6	53.71	-14.49	68.2	41.49	34.8	11.4	33.98	289	40	P	H	
		5691.6	64.85	-34.16	99.01	52.47	34.9	11.46	33.98	289	40	P	H	
		5709.2	68.4	-39.38	107.78	56.01	34.87	11.5	33.98	289	40	P	H	
		5724.4	78.29	-42.54	120.83	65.94	34.83	11.5	33.98	289	40	P	H	
	*	5745	118.67	-	-	106.31	34.8	11.53	33.97	289	40	P	H	
	*	5745	111.32	-	-	98.96	34.8	11.53	33.97	289	40	A	H	
														H
														H
			5630.8	52.64	-15.56	68.2	40.46	34.73	11.43	33.98	390	266	P	V
			5698.2	59.61	-44.26	103.87	47.23	34.9	11.46	33.98	390	266	P	V
			5718.8	64.08	-46.38	110.46	51.73	34.83	11.5	33.98	390	266	P	V
			5724.6	73.4	-47.89	121.29	61.05	34.83	11.5	33.98	390	266	P	V
	*		5745	114.64	-	-	102.28	34.8	11.53	33.97	390	266	P	V
	*		5745	106.98	-	-	94.62	34.8	11.53	33.97	390	266	A	V
														V
														V



WIFI Ant. 1	Note	Frequency (MHz)	Level (dBμV/m)	Over Limit (dB)	Limit Line (dBμV/m)	Read Level (dBμV)	Antenna Factor (dB/m)	Path Loss (dB)	Preamp Factor (dB)	Ant Pos (cm)	Table Pos (deg)	Peak Avg. (P/A)	Pol. (H/V)
		5627.8	52.36	-15.84	68.2	40.18	34.73	11.43	33.98	286	35	P	H
		5698.4	53.68	-50.34	104.02	41.3	34.9	11.46	33.98	286	35	P	H
		5716.2	58.93	-50.81	109.74	46.54	34.87	11.5	33.98	286	35	P	H
		5723.8	60.57	-58.89	119.46	48.22	34.83	11.5	33.98	286	35	P	H
	*	5785	117.95	-	-	105.49	34.87	11.56	33.97	286	35	P	H
	*	5785	110.87	-	-	98.41	34.87	11.56	33.97	286	35	A	H
		5850	61.86	-60.34	122.2	49.43	34.8	11.6	33.97	286	35	P	H
		5857	59.79	-50.45	110.24	47.29	34.87	11.6	33.97	286	35	P	H
		5879.6	55.86	-45.92	101.78	43.25	34.93	11.65	33.97	286	35	P	H
		5933.6	52.14	-16.06	68.2	39.41	35	11.69	33.96	286	35	P	H
													H
													H
802.11a													
CH 157													
5785MHz		5604.8	52.23	-15.97	68.2	40.01	34.8	11.4	33.98	366	270	P	V
		5651.4	51.43	-17.81	69.24	39.38	34.6	11.43	33.98	366	270	P	V
		5715.8	53.44	-56.19	109.63	41.05	34.87	11.5	33.98	366	270	P	V
		5725	54.19	-68.01	122.2	41.84	34.83	11.5	33.98	366	270	P	V
	*	5785	113.55	-	-	101.09	34.87	11.56	33.97	366	270	P	V
	*	5785	106.23	-	-	93.77	34.87	11.56	33.97	366	270	A	V
		5851.8	51.72	-66.38	118.1	39.29	34.8	11.6	33.97	366	270	P	V
		5861.4	51.62	-57.39	109.01	39.07	34.87	11.65	33.97	366	270	P	V
		5924.4	52.41	-16.23	68.64	39.68	35	11.69	33.96	366	270	P	V
		5945.4	51.55	-16.65	68.2	38.77	35	11.74	33.96	366	270	P	V
													V
													V



WIFI Ant. 1	Note	Frequency (MHz)	Level (dBμV/m)	Over Limit (dB)	Limit Line (dBμV/m)	Read Level (dBμV)	Antenna Factor (dB/m)	Path Loss (dB)	Preamp Factor (dB)	Ant Pos (cm)	Table Pos (deg)	Peak Avg. (P/A)	Pol. (H/V)	
802.11a CH 165 5825MHz	*	5825	117.46	-	-	105	34.83	11.6	33.97	296	35	P	H	
	*	5825	109.83	-	-	97.37	34.83	11.6	33.97	296	35	A	H	
		5852.8	68	-47.82	115.82	55.57	34.8	11.6	33.97	296	35	P	H	
		5859.6	68.58	-40.93	109.51	56.08	34.87	11.6	33.97	296	35	P	H	
		5875.6	63.58	-41.17	104.75	50.97	34.93	11.65	33.97	296	35	P	H	
		5925.2	54.96	-13.24	68.2	42.23	35	11.69	33.96	296	35	P	H	
														H
														H
	*	5825	113.45	-	-	100.99	34.83	11.6	33.97	378	270	P	V	
	*	5825	105.78	-	-	93.32	34.83	11.6	33.97	378	270	A	V	
		5850.8	62.38	-58	120.38	49.95	34.8	11.6	33.97	378	270	P	V	
		5855	63.99	-46.81	110.8	51.49	34.87	11.6	33.97	378	270	P	V	
		5879.2	57.16	-44.92	102.08	44.55	34.93	11.65	33.97	378	270	P	V	
		5926.6	51.24	-16.96	68.2	38.51	35	11.69	33.96	378	270	P	V	
														V
														V
													V	
Remark	1. No other spurious found. 2. All results are PASS against Peak and Average limit line.													



Band 4 5725~5850MHz
WIFI 802.11a (Harmonic @ 3m)

WIFI Ant. 1	Note	Frequency (MHz)	Level (dBμV/m)	Over Limit (dB)	Limit Line (dBμV/m)	Read Level (dBμV)	Antenna Factor (dB/m)	Path Loss (dB)	Preamp Factor (dB)	Ant Pos (cm)	Table Pos (deg)	Peak Avg. (P/A)	Pol. (H/V)
802.11a CH 149 5745MHz		11490	48.87	-25.13	74	49.7	38.07	18.44	57.34	100	0	P	H
		17235	53.37	-14.83	68.2	45.75	41.57	21.8	55.75	100	0	P	H
													H
													H
		11490	48.46	-25.54	74	49.29	38.07	18.44	57.34	100	0	P	V
		17235	53.01	-15.19	68.2	45.39	41.57	21.8	55.75	100	0	P	V
													V
													V
802.11a CH 157 5785MHz		11570	47.42	-26.58	74	47.91	38.17	18.54	57.2	100	0	P	H
		17355	53.18	-15.02	68.2	45.45	41.55	21.91	55.73	100	0	P	H
													H
													H
		11570	47.64	-26.36	74	48.13	38.17	18.54	57.2	100	0	P	V
		17355	53.35	-14.85	68.2	45.62	41.55	21.91	55.73	100	0	P	V
													V
													V
802.11a CH 165 5825MHz		11650	48.54	-25.46	74	48.73	38.28	18.64	57.11	100	0	P	H
		17475	53.42	-14.78	68.2	45.79	41.33	22.01	55.71	100	0	P	H
													H
													H
		11650	49.28	-24.72	74	49.47	38.28	18.64	57.11	100	0	P	V
		17475	53.41	-14.79	68.2	45.78	41.33	22.01	55.71	100	0	P	V
													V
													V
Remark	1. No other spurious found. 2. All results are PASS against Peak and Average limit line.												



Band 4 5725~5850MHz
WIFI 802.11n HT20 (Band Edge @ 3m)

WIFI Ant. 1	Note	Frequency (MHz)	Level (dBμV/m)	Over Limit (dB)	Limit Line (dBμV/m)	Read Level (dBμV)	Antenna Factor (dB/m)	Path Loss (dB)	Preamp Factor (dB)	Ant Pos (cm)	Table Pos (deg)	Peak Avg. (P/A)	Pol. (H/V)	
802.11n HT20 CH 149 5745MHz		5648	54.73	-13.47	68.2	42.61	34.67	11.43	33.98	290	38	P	H	
		5699	65.93	-38.53	104.46	53.55	34.9	11.46	33.98	290	38	P	H	
		5712.4	69	-39.67	108.67	56.61	34.87	11.5	33.98	290	38	P	H	
		5724.6	78.3	-42.99	121.29	65.95	34.83	11.5	33.98	290	38	P	H	
	*	5745	118.73	-	-	106.37	34.8	11.53	33.97	290	38	P	H	
	*	5745	110.99	-	-	98.63	34.8	11.53	33.97	290	38	A	H	
														H
														H
			5635	52.97	-15.23	68.2	40.85	34.67	11.43	33.98	389	265	P	V
			5699.2	59.36	-45.25	104.61	46.98	34.9	11.46	33.98	389	265	P	V
			5718.6	62.17	-48.24	110.41	49.82	34.83	11.5	33.98	389	265	P	V
			5723.8	71.99	-47.47	119.46	59.64	34.83	11.5	33.98	389	265	P	V
	*		5745	114.06	-	-	101.7	34.8	11.53	33.97	389	265	P	V
	*		5745	106.59	-	-	94.23	34.8	11.53	33.97	389	265	A	V
														V
														V



WIFI Ant. 1	Note	Frequency (MHz)	Level (dBμV/m)	Over Limit (dB)	Limit Line (dBμV/m)	Read Level (dBμV)	Antenna Factor (dB/m)	Path Loss (dB)	Preamp Factor (dB)	Ant Pos (cm)	Table Pos (deg)	Peak Avg. (P/A)	Pol. (H/V)
		5636.8	53.18	-15.02	68.2	41.06	34.67	11.43	33.98	300	38	P	H
		5691.8	55.25	-43.9	99.15	42.87	34.9	11.46	33.98	300	38	P	H
		5713.6	57.02	-51.99	109.01	44.63	34.87	11.5	33.98	300	38	P	H
		5722.2	56.58	-59.24	115.82	44.23	34.83	11.5	33.98	300	38	P	H
	*	5785	118.96	-	-	106.5	34.87	11.56	33.97	300	38	P	H
	*	5785	110.65	-	-	98.19	34.87	11.56	33.97	300	38	A	H
		5850.4	61.9	-59.39	121.29	49.47	34.8	11.6	33.97	300	38	P	H
		5858.6	61.69	-48.1	109.79	49.19	34.87	11.6	33.97	300	38	P	H
		5879.8	60.06	-41.57	101.63	47.45	34.93	11.65	33.97	300	38	P	H
		5939	52.64	-15.56	68.2	39.91	35	11.69	33.96	300	38	P	H
802.11n													H
HT20													H
CH 157		5606.4	51.83	-16.37	68.2	39.61	34.8	11.4	33.98	400	264	P	V
5785MHz		5692.6	52.11	-47.63	99.74	39.73	34.9	11.46	33.98	400	264	P	V
		5715.2	52.85	-56.61	109.46	40.46	34.87	11.5	33.98	400	264	P	V
		5723	52.92	-64.72	117.64	40.57	34.83	11.5	33.98	400	264	P	V
	*	5785	113.28	-	-	100.82	34.87	11.56	33.97	400	264	P	V
	*	5785	105.12	-	-	92.66	34.87	11.56	33.97	400	264	A	V
		5852.4	55.15	-61.58	116.73	42.72	34.8	11.6	33.97	400	264	P	V
		5859.6	52.76	-56.75	109.51	40.26	34.87	11.6	33.97	400	264	P	V
		5907.4	52.24	-28.95	81.19	39.52	35	11.69	33.97	400	264	P	V
		5945.4	51.65	-16.55	68.2	38.87	35	11.74	33.96	400	264	P	V
													V
													V



WiFi Ant. 1	Note	Frequency (MHz)	Level (dBμV/m)	Over Limit (dB)	Limit Line (dBμV/m)	Read Level (dBμV)	Antenna Factor (dB/m)	Path Loss (dB)	Preamp Factor (dB)	Ant Pos (cm)	Table Pos (deg)	Peak Avg. (P/A)	Pol. (H/V)	
802.11n HT20 CH 165 5825MHz	*	5825	117.16	-	-	104.7	34.83	11.6	33.97	295	34	P	H	
	*	5825	109.33	-	-	96.87	34.83	11.6	33.97	295	34	A	H	
		5850.4	69.84	-51.45	121.29	57.41	34.8	11.6	33.97	295	34	P	H	
		5859.6	68.67	-40.84	109.51	56.17	34.87	11.6	33.97	295	34	P	H	
		5877	65.25	-38.46	103.71	52.64	34.93	11.65	33.97	295	34	P	H	
		5945	53.89	-14.31	68.2	41.11	35	11.74	33.96	295	34	P	H	
														H
														H
	*	5825	113.15	-	-	100.69	34.83	11.6	33.97	377	270	P	V	
	*	5825	105.26	-	-	92.8	34.83	11.6	33.97	377	270	A	V	
		5850	66.66	-55.54	122.2	54.23	34.8	11.6	33.97	377	270	P	V	
		5859.6	62.42	-47.09	109.51	49.92	34.87	11.6	33.97	377	270	P	V	
		5878	57.8	-45.17	102.97	45.19	34.93	11.65	33.97	377	270	P	V	
		5934	51.95	-16.25	68.2	39.22	35	11.69	33.96	377	270	P	V	
														V
													V	
Remark	1. No other spurious found. 2. All results are PASS against Peak and Average limit line.													



Band 4 5725~5850MHz
WIFI 802.11n HT20 (Harmonic @ 3m)

WIFI Ant. 1	Note	Frequency (MHz)	Level (dBμV/m)	Over Limit (dB)	Limit Line (dBμV/m)	Read Level (dBμV)	Antenna Factor (dB/m)	Path Loss (dB)	Preamp Factor (dB)	Ant Pos (cm)	Table Pos (deg)	Peak Avg. (P/A)	Pol. (H/V)
802.11n HT20 CH 149 5745MHz		11490	47.86	-26.14	74	48.69	38.07	18.44	57.34	100	0	P	H
		17235	51.23	-16.97	68.2	43.61	41.57	21.8	55.75	100	0	P	H
													H
													H
		11490	48.25	-25.75	74	49.08	38.07	18.44	57.34	100	0	P	V
		17235	51.39	-16.81	68.2	43.77	41.57	21.8	55.75	100	0	P	V
													V
													V
802.11n HT20 CH 157 5785MHz		11570	46.71	-27.29	74	47.2	38.17	18.54	57.2	100	0	P	H
		17355	53.11	-15.09	68.2	45.38	41.55	21.91	55.73	100	0	P	H
													H
													H
		11570	47.92	-26.08	74	48.41	38.17	18.54	57.2	100	0	P	V
		17355	53.27	-14.93	68.2	45.54	41.55	21.91	55.73	100	0	P	V
													V
													V
802.11n HT20 CH 165 5825MHz		11650	47.54	-26.46	74	47.73	38.28	18.64	57.11	100	0	P	H
		17475	52.08	-16.12	68.2	44.45	41.33	22.01	55.71	100	0	P	H
													H
													H
		11650	47.85	-26.15	74	48.04	38.28	18.64	57.11	100	0	P	V
		17475	52.49	-15.71	68.2	44.86	41.33	22.01	55.71	100	0	P	V
													V
													V
Remark	1. No other spurious found. 2. All results are PASS against Peak and Average limit line.												



Band 4 5725~5850MHz
WIFI 802.11n HT40 (Band Edge @ 3m)

WIFI Ant. 1	Note	Frequency (MHz)	Level (dBμV/m)	Over Limit (dB)	Limit Line (dBμV/m)	Read Level (dBμV)	Antenna Factor (dB/m)	Path Loss (dB)	Preamp Factor (dB)	Ant Pos (cm)	Table Pos (deg)	Peak Avg. (P/A)	Pol. (H/V)
		5649.8	57.36	-10.84	68.2	45.31	34.6	11.43	33.98	318	38	P	H
		5695.2	67.62	-34.04	101.66	55.24	34.9	11.46	33.98	318	38	P	H
		5720	82.99	-27.81	110.8	70.64	34.83	11.5	33.98	318	38	P	H
		5723.6	85.4	-33.61	119.01	73.05	34.83	11.5	33.98	318	38	P	H
	*	5755	117.64	-	-	105.25	34.83	11.53	33.97	318	38	P	H
	*	5755	110.24	-	-	97.85	34.83	11.53	33.97	318	38	A	H
		5852.6	57.8	-58.47	116.27	45.37	34.8	11.6	33.97	318	38	P	H
		5857	59.16	-51.08	110.24	46.66	34.87	11.6	33.97	318	38	P	H
		5882.2	56.42	-43.43	99.85	43.81	34.93	11.65	33.97	318	38	P	H
		5933.2	52.43	-15.77	68.2	39.7	35	11.69	33.96	318	38	P	H
802.11n													H
HT40													H
CH 151		5648.8	53.34	-14.86	68.2	41.22	34.67	11.43	33.98	389	264	P	V
5755MHz		5698.8	61.08	-43.24	104.32	48.7	34.9	11.46	33.98	389	264	P	V
		5719	79.92	-30.6	110.52	67.57	34.83	11.5	33.98	389	264	P	V
		5725	81.39	-40.81	122.2	69.04	34.83	11.5	33.98	389	264	P	V
	*	5755	115.71	-	-	103.32	34.83	11.53	33.97	389	264	P	V
	*	5755	105.3	-	-	92.91	34.83	11.53	33.97	389	264	A	V
		5851.4	54.96	-64.05	119.01	42.53	34.8	11.6	33.97	389	264	P	V
		5855.4	54.89	-55.8	110.69	42.39	34.87	11.6	33.97	389	264	P	V
		5876.4	53.41	-50.75	104.16	40.8	34.93	11.65	33.97	389	264	P	V
		5928.6	51.22	-16.98	68.2	38.49	35	11.69	33.96	389	264	P	V
													V
													V



WIFI Ant. 1	Note	Frequency (MHz)	Level (dBμV/m)	Over Limit (dB)	Limit Line (dBμV/m)	Read Level (dBμV)	Antenna Factor (dB/m)	Path Loss (dB)	Preamp Factor (dB)	Ant Pos (cm)	Table Pos (deg)	Peak Avg. (P/A)	Pol. (H/V)
		5645.6	53.34	-14.86	68.2	41.22	34.67	11.43	33.98	300	38	P	H
		5691.6	57.36	-41.65	99.01	44.98	34.9	11.46	33.98	300	38	P	H
		5719	63.87	-46.65	110.52	51.52	34.83	11.5	33.98	300	38	P	H
		5720.8	64.81	-47.81	112.62	52.46	34.83	11.5	33.98	300	38	P	H
	*	5795	116.7	-	-	104.21	34.9	11.56	33.97	300	38	P	H
	*	5795	108.7	-	-	96.21	34.9	11.56	33.97	300	38	A	H
		5852.6	68.67	-47.6	116.27	56.24	34.8	11.6	33.97	300	38	P	H
		5856.6	66.56	-43.79	110.35	54.06	34.87	11.6	33.97	300	38	P	H
		5883	62.09	-37.17	99.26	49.48	34.93	11.65	33.97	300	38	P	H
		5933.4	54.33	-13.87	68.2	41.6	35	11.69	33.96	300	38	P	H
802.11n													H
HT40													H
CH 159		5632	51.23	-16.97	68.2	39.05	34.73	11.43	33.98	400	264	P	V
5795MHz		5699.4	54.39	-50.37	104.76	42.01	34.9	11.46	33.98	400	264	P	V
		5718.8	58.08	-52.38	110.46	45.73	34.83	11.5	33.98	400	264	P	V
		5724.4	58	-62.83	120.83	45.65	34.83	11.5	33.98	400	264	P	V
	*	5795	111.78	-	-	99.29	34.9	11.56	33.97	400	264	P	V
	*	5795	103.8	-	-	91.31	34.9	11.56	33.97	400	264	A	V
		5850.4	61.87	-59.42	121.29	49.44	34.8	11.6	33.97	400	264	P	V
		5858	60.37	-49.59	109.96	47.87	34.87	11.6	33.97	400	264	P	V
		5878.8	54.95	-47.43	102.38	42.34	34.93	11.65	33.97	400	264	P	V
		5934.2	52.49	-15.71	68.2	39.76	35	11.69	33.96	400	264	P	V
													V
													V
Remark	1. No other spurious found. 2. All results are PASS against Peak and Average limit line.												



**Band 4 5725~5850MHz
WIFI 802.11n HT40 (Harmonic @ 3m)**

WIFI Ant. 1	Note	Frequency (MHz)	Level (dBμV/m)	Over Limit (dB)	Limit Line (dBμV/m)	Read Level (dBμV)	Antenna Factor (dB/m)	Path Loss (dB)	Preamp Factor (dB)	Ant Pos (cm)	Table Pos (deg)	Peak Avg. (P/A)	Pol. (H/V)
802.11n HT40 CH 151 5755MHz		11510	45.55	-28.45	74	46.26	38.1	18.49	57.3	100	0	P	H
		17265	49.35	-18.85	68.2	41.74	41.53	21.83	55.75	100	0	P	H
													H
													H
		11510	45.64	-28.36	74	46.35	38.1	18.49	57.3	100	0	P	V
		17265	49.2	-19	68.2	41.59	41.53	21.83	55.75	100	0	P	V
													V
													V
802.11n HT40 CH 159 5795MHz		11590	45.74	-28.26	74	46.15	38.18	18.59	57.18	100	0	P	H
		17385	49.78	-18.42	68.2	41.98	41.58	21.94	55.72	100	0	P	H
													H
													H
		11590	45.07	-28.93	74	45.48	38.18	18.59	57.18	100	0	P	V
		17385	50.83	-17.37	68.2	43.03	41.58	21.94	55.72	100	0	P	V
													V
													V
Remark	1. No other spurious found. 2. All results are PASS against Peak and Average limit line.												



Band 4 5725~5850MHz
WIFI 802.11ac VHT80 (Band Edge @ 3m)

WIFI Ant. 1	Note	Frequency (MHz)	Level (dBμV/m)	Over Limit (dB)	Limit Line (dBμV/m)	Read Level (dBμV)	Antenna Factor (dB/m)	Path Loss (dB)	Preamp Factor (dB)	Ant Pos (cm)	Table Pos (deg)	Peak Avg. (P/A)	Pol. (H/V)
		5643.4	64	-4.2	68.2	51.88	34.67	11.43	33.98	300	38	P	H
		5695.4	78.89	-22.92	101.81	66.51	34.9	11.46	33.98	300	38	P	H
		5717	83	-26.96	109.96	70.61	34.87	11.5	33.98	300	38	P	H
		5720.4	84.54	-27.17	111.71	72.19	34.83	11.5	33.98	300	38	P	H
	*	5775	114.29	-	-	101.86	34.87	11.53	33.97	300	38	P	H
	*	5775	105.79	-	-	93.36	34.87	11.53	33.97	300	38	A	H
		5850.6	81.52	-39.31	120.83	69.09	34.8	11.6	33.97	300	38	P	H
		5856.2	81.37	-29.09	110.46	68.87	34.87	11.6	33.97	300	38	P	H
		5880	74.59	-26.9	101.49	61.98	34.93	11.65	33.97	300	38	P	H
		5932	59.9	-8.3	68.2	47.17	35	11.69	33.96	300	38	P	H
802.11ac													H
VHT80													H
CH 155		5644.4	58.64	-9.56	68.2	46.52	34.67	11.43	33.98	367	264	P	V
5775MHz		5699.4	71.38	-33.38	104.76	59	34.9	11.46	33.98	367	264	P	V
		5717.8	76.11	-34.07	110.18	63.76	34.83	11.5	33.98	367	264	P	V
		5720.2	78.13	-33.13	111.26	65.78	34.83	11.5	33.98	367	264	P	V
	*	5775	109.68	-	-	97.25	34.87	11.53	33.97	367	264	P	V
	*	5775	100.02	-	-	87.59	34.87	11.53	33.97	367	264	A	V
		5852	73.34	-44.3	117.64	60.91	34.8	11.6	33.97	367	264	P	V
		5861.6	72.78	-36.17	108.95	60.23	34.87	11.65	33.97	367	264	P	V
		5875.4	69.18	-35.72	104.9	56.57	34.93	11.65	33.97	367	264	P	V
		5926.8	55	-13.2	68.2	42.27	35	11.69	33.96	367	264	P	V
													V
													V
Remark	1. No other spurious found. 2. All results are PASS against Peak and Average limit line.												



Band 4 5725~5850MHz

WIFI 802.11ac VHT80 (Harmonic @ 3m)

WIFI Ant. 1	Note	Frequency (MHz)	Level (dBμV/m)	Over Limit (dB)	Limit Line (dBμV/m)	Read Level (dBμV)	Antenna Factor (dB/m)	Path Loss (dB)	Preamp Factor (dB)	Ant Pos (cm)	Table Pos (deg)	Peak Avg. (P/A)	Pol. (H/V)	
802.11ac VHT80 CH 155 5775MHz		11550	45.38	-28.62	74	45.92	38.15	18.54	57.23	100	0	P	H	
		17325	50.36	-17.84	68.2	42.7	41.52	21.88	55.74	100	0	P	H	
													H	
													H	
			11550	45.32	-28.68	74	45.86	38.15	18.54	57.23	100	0	P	V
			17325	50.99	-17.21	68.2	43.33	41.52	21.88	55.74	100	0	P	V
														V
Remark	1. No other spurious found. 2. All results are PASS against Peak and Average limit line.													



Emission below 1GHz

5GHz WIFI 802.11ac VHT80 (LF @ 3m)

WIFI	Note	Frequency	Level	Over	Limit	Read	Antenna	Path	Preamp	Ant	Table	Peak	Pol.	
Ant.				Limit	Line	Level	Factor	Loss	Factor	Pos	Pos	Avg.		
1		(MHz)	(dBμV/m)	(dB)	(dBμV/m)	(dBμV)	(dB/m)	(dB)	(dB)	(cm)	(deg)	(P/A)	(H/V)	
5GHz 802.11ac VHT80 LF		30	23.81	-16.19	40	28.06	24.6	1.33	30.18	-	-	P	H	
		148.53	30.71	-12.79	43.5	41.39	17.1	2.24	30.02	-	-	P	H	
		220.35	29.72	-16.28	46	41.74	15.32	2.62	29.96	-	-	P	H	
		814.5	42.47	-3.53	46	39.31	27.83	4.6	29.27	-	-	P	H	
		927.2	42.78	-3.22	46	37.13	29.4	4.97	28.72	100	0	P	H	
		969.2	43.65	-10.35	54	36.16	30.86	5.06	28.43	-	-	P	H	
														H
														H
														H
														H
														H
														H
														H
														H
			30	32.56	-7.44	40	36.81	24.6	1.33	30.18	-	-	P	V
			119.1	29.32	-14.18	43.5	39.97	17.4	2.01	30.06	-	-	P	V
			126.66	31.94	-11.56	43.5	42.39	17.59	2.01	30.05	-	-	P	V
			925.1	41.3	-4.7	46	35.73	29.33	4.97	28.73	-	-	P	V
			946.1	41.89	-4.11	46	35.29	30.13	5.05	28.58	100	0	P	V
		969.9	43.01	-10.99	54	35.51	30.86	5.06	28.42	-	-	P	V	
													V	
													V	
													V	
													V	
													V	
													V	
Remark	1. No other spurious found. 2. All results are PASS against limit line.													



Band 4 - 5725~5850MHz
WIFI 802.11a (Band Edge @ 3m)

WIFI	Note	Frequency	Level	Over	Limit	Read	Antenna	Path	Preamp	Ant	Table	Peak	Pol.	
Ant.				Limit	Line	Level	Factor	Loss	Factor	Pos	Pos	Avg.		
2		(MHz)	(dBμV/m)	(dB)	(dBμV/m)	(dBμV)	(dB/m)	(dB)	(dB)	(cm)	(deg)	(P/A)	(H/V)	
802.11a CH 149 5745MHz		5646	53.75	-14.45	68.2	41.63	34.67	11.43	33.98	100	300	P	H	
		5687.6	62.78	-33.27	96.05	50.4	34.9	11.46	33.98	100	300	P	H	
		5717.2	69.41	-40.61	110.02	57.02	34.87	11.5	33.98	100	300	P	H	
		5725	74.48	-47.72	122.2	62.13	34.83	11.5	33.98	100	300	P	H	
	*	5745	117.61	-	-	105.25	34.8	11.53	33.97	100	300	P	H	
	*	5745	110.41	-	-	98.05	34.8	11.53	33.97	100	300	A	H	
														H
														H
			5629.6	52.76	-15.44	68.2	40.58	34.73	11.43	33.98	102	237	P	V
			5696.2	62.85	-39.55	102.4	50.47	34.9	11.46	33.98	102	237	P	V
			5716.8	65.18	-44.73	109.91	52.79	34.87	11.5	33.98	102	237	P	V
			5725	68.3	-53.9	122.2	55.95	34.83	11.5	33.98	102	237	P	V
	*		5745	113.18	-	-	100.82	34.8	11.53	33.97	102	237	P	V
	*		5745	105.48	-	-	93.12	34.8	11.53	33.97	102	237	A	V
														V
													V	



WIFI Ant. 2	Note	Frequency (MHz)	Level (dBμV/m)	Over Limit (dB)	Limit Line (dBμV/m)	Read Level (dBμV)	Antenna Factor (dB/m)	Path Loss (dB)	Preamp Factor (dB)	Ant Pos (cm)	Table Pos (deg)	Peak Avg. (P/A)	Pol. (H/V)
		5632	52.07	-16.13	68.2	39.89	34.73	11.43	33.98	100	301	P	H
		5691	57.04	-41.52	98.56	44.66	34.9	11.46	33.98	100	301	P	H
		5716.2	62.54	-47.2	109.74	50.15	34.87	11.5	33.98	100	301	P	H
		5722.4	63.63	-52.64	116.27	51.28	34.83	11.5	33.98	100	301	P	H
	*	5785	118.02	-	-	105.56	34.87	11.56	33.97	100	301	P	H
	*	5785	110.15	-	-	97.69	34.87	11.56	33.97	100	301	A	H
		5851.4	63.72	-55.29	119.01	51.29	34.8	11.6	33.97	100	301	P	H
		5855.4	64.09	-46.6	110.69	51.59	34.87	11.6	33.97	100	301	P	H
		5876.8	59.73	-44.13	103.86	47.12	34.93	11.65	33.97	100	301	P	H
		5936	53.73	-14.47	68.2	41	35	11.69	33.96	100	301	P	H
													H
													H
802.11a													
CH 157													
5785MHz		5639.4	51.93	-16.27	68.2	39.81	34.67	11.43	33.98	116	239	P	V
		5666.2	52.71	-27.51	80.22	40.63	34.6	11.46	33.98	116	239	P	V
		5710.8	56.27	-51.96	108.23	43.88	34.87	11.5	33.98	116	239	P	V
		5723.8	58.01	-61.45	119.46	45.66	34.83	11.5	33.98	116	239	P	V
	*	5785	111.95	-	-	99.49	34.87	11.56	33.97	116	239	P	V
	*	5785	104.25	-	-	91.79	34.87	11.56	33.97	116	239	A	V
		5850.2	55.94	-65.8	121.74	43.51	34.8	11.6	33.97	116	239	P	V
		5858.2	56.59	-53.31	109.9	44.09	34.87	11.6	33.97	116	239	P	V
		5877.4	53.16	-50.26	103.42	40.55	34.93	11.65	33.97	116	239	P	V
		5935.2	50.57	-17.63	68.2	37.84	35	11.69	33.96	116	239	P	V
													V
													V



WIFI Ant. 2	Note	Frequency (MHz)	Level (dBμV/m)	Over Limit (dB)	Limit Line (dBμV/m)	Read Level (dBμV)	Antenna Factor (dB/m)	Path Loss (dB)	Preamp Factor (dB)	Ant Pos (cm)	Table Pos (deg)	Peak Avg. (P/A)	Pol. (H/V)	
802.11a CH 165 5825MHz	*	5825	117.73	-	-	105.27	34.83	11.6	33.97	100	302	P	H	
	*	5825	109.71	-	-	97.25	34.83	11.6	33.97	100	302	A	H	
		5853.6	64.19	-49.8	113.99	51.69	34.87	11.6	33.97	100	302	P	H	
		5861.6	66.44	-42.51	108.95	53.89	34.87	11.65	33.97	100	302	P	H	
		5881.6	64.72	-35.58	100.3	52.11	34.93	11.65	33.97	100	302	P	H	
		5939.4	53.49	-14.71	68.2	40.76	35	11.69	33.96	100	302	P	H	
														H
														H
	*	5825	111.03	-	-	98.57	34.83	11.6	33.97	107	240	P	V	
	*	5825	103.36	-	-	90.9	34.83	11.6	33.97	107	240	A	V	
		5854.2	60.01	-52.61	112.62	47.51	34.87	11.6	33.97	107	240	P	V	
		5859.4	58.77	-50.8	109.57	46.27	34.87	11.6	33.97	107	240	P	V	
		5885	55.95	-41.82	97.77	43.34	34.93	11.65	33.97	107	240	P	V	
		5948.8	51.31	-16.89	68.2	38.53	35	11.74	33.96	107	240	P	V	
														V
														V
													V	
Remark	1. No other spurious found. 2. All results are PASS against Peak and Average limit line.													



Band 4 5725~5850MHz
WIFI 802.11a (Harmonic @ 3m)

WIFI Ant. 2	Note	Frequency (MHz)	Level (dBμV/m)	Over Limit (dB)	Limit Line (dBμV/m)	Read Level (dBμV)	Antenna Factor (dB/m)	Path Loss (dB)	Preamp Factor (dB)	Ant Pos (cm)	Table Pos (deg)	Peak Avg. (P/A)	Pol. (H/V)	
802.11a CH 149 5745MHz		11490	48.71	-25.29	74	49.54	38.07	18.44	57.34	100	0	P	H	
		17235	53.24	-14.96	68.2	45.62	41.57	21.8	55.75	100	0	P	H	
													H	
													H	
			11490	48.93	-25.07	74	49.76	38.07	18.44	57.34	100	0	P	V
			17235	52.7	-15.5	68.2	45.08	41.57	21.8	55.75	100	0	P	V
														V
802.11a CH 157 5785MHz		11570	48.55	-25.45	74	49.04	38.17	18.54	57.2	100	0	P	H	
		17355	53.2	-15	68.2	45.47	41.55	21.91	55.73	100	0	P	H	
													H	
													H	
			11570	48.66	-25.34	74	49.15	38.17	18.54	57.2	100	0	P	V
			17355	53.1	-15.1	68.2	45.37	41.55	21.91	55.73	100	0	P	V
														V
802.11a CH 165 5825MHz		11650	49.4	-24.6	74	49.59	38.28	18.64	57.11	100	0	P	H	
		17475	53.19	-15.01	68.2	45.56	41.33	22.01	55.71	100	0	P	H	
													H	
													H	
			11650	49.98	-24.02	74	50.17	38.28	18.64	57.11	100	0	P	V
			17475	53.69	-14.51	68.2	46.06	41.33	22.01	55.71	100	0	P	V
														V
Remark	1. No other spurious found.													
	2. All results are PASS against Peak and Average limit line.													



Band 4 5725~5850MHz
WIFI 802.11n HT20 (Band Edge @ 3m)

WIFI Ant. 2	Note	Frequency (MHz)	Level (dBμV/m)	Over Limit (dB)	Limit Line (dBμV/m)	Read Level (dBμV)	Antenna Factor (dB/m)	Path Loss (dB)	Preamp Factor (dB)	Ant Pos (cm)	Table Pos (deg)	Peak Avg. (P/A)	Pol. (H/V)	
802.11n HT20 CH 149 5745MHz		5643	54.51	-13.69	68.2	42.39	34.67	11.43	33.98	100	300	P	H	
		5699.4	65.76	-39	104.76	53.38	34.9	11.46	33.98	100	300	P	H	
		5715.8	69.83	-39.8	109.63	57.44	34.87	11.5	33.98	100	300	P	H	
		5724.8	74.83	-46.91	121.74	62.48	34.83	11.5	33.98	100	300	P	H	
	*	5745	117.57	-	-	105.21	34.8	11.53	33.97	100	300	P	H	
	*	5745	109.94	-	-	97.58	34.8	11.53	33.97	100	300	A	H	
														H
														H
			5610.8	52.62	-15.58	68.2	40.4	34.8	11.4	33.98	101	237	P	V
			5697.8	61.78	-41.8	103.58	49.4	34.9	11.46	33.98	101	237	P	V
			5718	63.33	-46.91	110.24	50.98	34.83	11.5	33.98	101	237	P	V
			5725	70.89	-51.31	122.2	58.54	34.83	11.5	33.98	101	237	P	V
	*		5745	112.82	-	-	100.46	34.8	11.53	33.97	101	237	P	V
	*		5745	104.99	-	-	92.63	34.8	11.53	33.97	101	237	A	V
														V
														V



WIFI Ant. 2	Note	Frequency (MHz)	Level (dBμV/m)	Over Limit (dB)	Limit Line (dBμV/m)	Read Level (dBμV)	Antenna Factor (dB/m)	Path Loss (dB)	Preamp Factor (dB)	Ant Pos (cm)	Table Pos (deg)	Peak Avg. (P/A)	Pol. (H/V)
		5646	52.48	-15.72	68.2	40.36	34.67	11.43	33.98	100	302	P	H
		5698	56.92	-46.81	103.73	44.54	34.9	11.46	33.98	100	302	P	H
		5715.8	59.2	-50.43	109.63	46.81	34.87	11.5	33.98	100	302	P	H
		5722	63.3	-52.06	115.36	50.95	34.83	11.5	33.98	100	302	P	H
	*	5785	117.05	-	-	104.59	34.87	11.56	33.97	100	302	P	H
	*	5785	109.2	-	-	96.74	34.87	11.56	33.97	100	302	A	H
		5850.6	58.28	-62.55	120.83	45.85	34.8	11.6	33.97	100	302	P	H
		5859.6	61.73	-47.78	109.51	49.23	34.87	11.6	33.97	100	302	P	H
		5879.4	58.58	-43.35	101.93	45.97	34.93	11.65	33.97	100	302	P	H
		5938.6	53.23	-14.97	68.2	40.5	35	11.69	33.96	100	302	P	H
802.11n													H
HT20													H
CH 157		5629.8	51.39	-16.81	68.2	39.21	34.73	11.43	33.98	100	239	P	V
5785MHz		5696	53.67	-48.58	102.25	41.29	34.9	11.46	33.98	100	239	P	V
		5713.6	57.15	-51.86	109.01	44.76	34.87	11.5	33.98	100	239	P	V
		5722.8	60.33	-56.85	117.18	47.98	34.83	11.5	33.98	100	239	P	V
	*	5785	111.98	-	-	99.52	34.87	11.56	33.97	100	239	P	V
	*	5785	103.83	-	-	91.37	34.87	11.56	33.97	100	239	A	V
		5851.6	52.71	-65.84	118.55	40.28	34.8	11.6	33.97	100	239	P	V
		5862.6	55.46	-53.21	108.67	42.91	34.87	11.65	33.97	100	239	P	V
		5917.4	50.99	-22.81	73.8	38.26	35	11.69	33.96	100	239	P	V
		5935.8	50.06	-18.14	68.2	37.33	35	11.69	33.96	100	239	P	V
													V
													V



WIFI Ant. 2	Note	Frequency (MHz)	Level (dBμV/m)	Over Limit (dB)	Limit Line (dBμV/m)	Read Level (dBμV)	Antenna Factor (dB/m)	Path Loss (dB)	Preamp Factor (dB)	Ant Pos (cm)	Table Pos (deg)	Peak Avg. (P/A)	Pol. (H/V)	
802.11n HT20 CH 165 5825MHz	*	5825	117.32	-	-	104.86	34.83	11.6	33.97	100	301	P	H	
	*	5825	109.36	-	-	96.9	34.83	11.6	33.97	100	301	A	H	
		5850.4	67.45	-53.84	121.29	55.02	34.8	11.6	33.97	100	301	P	H	
		5869.6	64.94	-41.77	106.71	52.39	34.87	11.65	33.97	100	301	P	H	
		5884.8	63.02	-34.9	97.92	50.41	34.93	11.65	33.97	100	301	P	H	
		5930.4	54.62	-13.58	68.2	41.89	35	11.69	33.96	100	301	P	H	
														H
														H
	*	5825	109.39	-	-	96.93	34.83	11.6	33.97	104	240	P	V	
	*	5825	102.89	-	-	90.43	34.83	11.6	33.97	104	240	A	V	
		5850.4	59.91	-61.38	121.29	47.48	34.8	11.6	33.97	104	240	P	V	
		5858	58.97	-50.99	109.96	46.47	34.87	11.6	33.97	104	240	P	V	
		5877.4	56.5	-46.92	103.42	43.89	34.93	11.65	33.97	104	240	P	V	
		5938.6	50.69	-17.51	68.2	37.96	35	11.69	33.96	104	240	P	V	
														V
													V	
Remark	1. No other spurious found. 2. All results are PASS against Peak and Average limit line.													



Band 4 5725~5850MHz
WIFI 802.11n HT20 (Harmonic @ 3m)

WIFI Ant. 2	Note	Frequency (MHz)	Level (dBμV/m)	Over Limit (dB)	Limit Line (dBμV/m)	Read Level (dBμV)	Antenna Factor (dB/m)	Path Loss (dB)	Preamp Factor (dB)	Ant Pos (cm)	Table Pos (deg)	Peak Avg. (P/A)	Pol. (H/V)
802.11n HT20 CH 149 5745MHz		11490	46.17	-27.83	74	47	38.07	18.44	57.34	100	0	P	H
		17235	49.71	-18.49	68.2	42.09	41.57	21.8	55.75	100	0	P	H
													H
													H
		11490	46.22	-27.78	74	47.05	38.07	18.44	57.34	100	0	P	V
		17235	48.36	-19.84	68.2	40.74	41.57	21.8	55.75	100	0	P	V
													V
													V
802.11n HT20 CH 157 5785MHz		11570	45.55	-28.45	74	46.04	38.17	18.54	57.2	100	0	P	H
		17355	49.59	-18.61	68.2	41.86	41.55	21.91	55.73	100	0	P	H
													H
													H
		11570	46.17	-27.83	74	46.66	38.17	18.54	57.2	100	0	P	V
		17355	49.26	-18.94	68.2	41.53	41.55	21.91	55.73	100	0	P	V
													V
													V
802.11n HT20 CH 165 5825MHz		11650	47.29	-26.71	74	47.48	38.28	18.64	57.11	100	0	P	H
		17475	49.61	-18.59	68.2	41.98	41.33	22.01	55.71	100	0	P	H
													H
													H
		11650	46.17	-27.83	74	46.36	38.28	18.64	57.11	100	0	P	V
		17475	49.78	-18.42	68.2	42.15	41.33	22.01	55.71	100	0	P	V
													V
													V
Remark	1. No other spurious found. 2. All results are PASS against Peak and Average limit line.												



**Band 4 5725~5850MHz
WIFI 802.11n HT40 (Band Edge @ 3m)**

WIFI Ant. 2	Note	Frequency (MHz)	Level (dBμV/m)	Over Limit (dB)	Limit Line (dBμV/m)	Read Level (dBμV)	Antenna Factor (dB/m)	Path Loss (dB)	Preamp Factor (dB)	Ant Pos (cm)	Table Pos (deg)	Peak Avg. (P/A)	Pol. (H/V)
		5645	57.1	-11.1	68.2	44.98	34.67	11.43	33.98	100	301	P	H
		5697.4	65.97	-37.31	103.28	53.59	34.9	11.46	33.98	100	301	P	H
		5719	82.32	-28.2	110.52	69.97	34.83	11.5	33.98	100	301	P	H
		5724.6	83.22	-38.07	121.29	70.87	34.83	11.5	33.98	100	301	P	H
	*	5755	115.44	-	-	103.05	34.83	11.53	33.97	100	301	P	H
	*	5755	107.55	-	-	95.16	34.83	11.53	33.97	100	301	A	H
		5851.4	62.62	-56.39	119.01	50.19	34.8	11.6	33.97	100	301	P	H
		5859.2	61.34	-48.28	109.62	48.84	34.87	11.6	33.97	100	301	P	H
		5883.2	58.01	-41.1	99.11	45.4	34.93	11.65	33.97	100	301	P	H
		5933.8	52.93	-15.27	68.2	40.2	35	11.69	33.96	100	301	P	H
802.11n													H
HT40													H
CH 151		5640.2	52.54	-15.66	68.2	40.42	34.67	11.43	33.98	100	240	P	V
5755MHz		5698.2	62.21	-41.66	103.87	49.83	34.9	11.46	33.98	100	240	P	V
		5719	77.97	-32.55	110.52	65.62	34.83	11.5	33.98	100	240	P	V
		5724	78.52	-41.4	119.92	66.17	34.83	11.5	33.98	100	240	P	V
	*	5755	110.3	-	-	97.91	34.83	11.53	33.97	100	240	P	V
	*	5755	102.27	-	-	89.88	34.83	11.53	33.97	100	240	A	V
		5851.4	55.2	-63.81	119.01	42.77	34.8	11.6	33.97	100	240	P	V
		5860.6	54.69	-54.54	109.23	42.14	34.87	11.65	33.97	100	240	P	V
		5888.8	51.9	-43.06	94.96	39.22	35	11.65	33.97	100	240	P	V
		5930.2	51.64	-16.56	68.2	38.91	35	11.69	33.96	100	240	P	V
													V
													V



WIFI Ant. 2	Note	Frequency (MHz)	Level (dBμV/m)	Over Limit (dB)	Limit Line (dBμV/m)	Read Level (dBμV)	Antenna Factor (dB/m)	Path Loss (dB)	Preamp Factor (dB)	Ant Pos (cm)	Table Pos (deg)	Peak Avg. (P/A)	Pol. (H/V)
		5618.4	52.59	-15.61	68.2	40.44	34.73	11.4	33.98	103	302	P	H
		5694.4	57.44	-43.63	101.07	45.06	34.9	11.46	33.98	103	302	P	H
		5717.6	64.57	-45.56	110.13	52.22	34.83	11.5	33.98	103	302	P	H
		5721.4	61.81	-52.18	113.99	49.46	34.83	11.5	33.98	103	302	P	H
	*	5795	115.18	-	-	102.69	34.9	11.56	33.97	103	302	P	H
	*	5795	107.4	-	-	94.91	34.9	11.56	33.97	103	302	A	H
		5853.8	68.51	-45.03	113.54	56.01	34.87	11.6	33.97	103	302	P	H
		5856.4	70.29	-40.12	110.41	57.79	34.87	11.6	33.97	103	302	P	H
		5880.4	64.48	-36.71	101.19	51.87	34.93	11.65	33.97	103	302	P	H
		5925.6	58.31	-9.89	68.2	45.58	35	11.69	33.96	103	302	P	H
802.11n													H
HT40													H
CH 159		5634.8	51.46	-16.74	68.2	39.34	34.67	11.43	33.98	100	239	P	V
5795MHz		5695.4	54.24	-47.57	101.81	41.86	34.9	11.46	33.98	100	239	P	V
		5719.8	56.64	-54.1	110.74	44.29	34.83	11.5	33.98	100	239	P	V
		5722	58.5	-56.86	115.36	46.15	34.83	11.5	33.98	100	239	P	V
	*	5795	109.93	-	-	97.44	34.9	11.56	33.97	100	239	P	V
	*	5795	102	-	-	89.51	34.9	11.56	33.97	100	239	A	V
		5854.2	62.21	-50.41	112.62	49.71	34.87	11.6	33.97	100	239	P	V
		5855.6	63.48	-47.15	110.63	50.98	34.87	11.6	33.97	100	239	P	V
		5881.8	58.72	-41.43	100.15	46.11	34.93	11.65	33.97	100	239	P	V
		5944.4	51.98	-16.22	68.2	39.2	35	11.74	33.96	100	239	P	V
													V
													V
Remark	1. No other spurious found. 2. All results are PASS against Peak and Average limit line.												



**Band 4 5725~5850MHz
WIFI 802.11n HT40 (Harmonic @ 3m)**

WIFI Ant. 2	Note	Frequency (MHz)	Level (dBμV/m)	Over Limit (dB)	Limit Line (dBμV/m)	Read Level (dBμV)	Antenna Factor (dB/m)	Path Loss (dB)	Preamp Factor (dB)	Ant Pos (cm)	Table Pos (deg)	Peak Avg. (P/A)	Pol. (H/V)
802.11n HT40 CH 151 5755MHz		11510	46.17	-27.83	74	46.88	38.1	18.49	57.3	100	0	P	H
		17265	49.08	-19.12	68.2	41.47	41.53	21.83	55.75	100	0	P	H
													H
													H
		11510	46.04	-27.96	74	46.75	38.1	18.49	57.3	100	0	P	V
		17265	51.21	-16.99	68.2	43.6	41.53	21.83	55.75	100	0	P	V
													V
													V
802.11n HT40 CH 159 5795MHz		11590	46.03	-27.97	74	46.44	38.18	18.59	57.18	100	0	P	H
		17385	50.01	-18.19	68.2	42.21	41.58	21.94	55.72	100	0	P	H
													H
													H
		11590	45.6	-28.4	74	46.01	38.18	18.59	57.18	100	0	P	V
		17385	49.79	-18.41	68.2	41.99	41.58	21.94	55.72	100	0	P	V
													V
													V
Remark	1. No other spurious found. 2. All results are PASS against Peak and Average limit line.												



Band 4 5725~5850MHz
WIFI 802.11ac VHT80 (Band Edge @ 3m)

WIFI Ant. 2	Note	Frequency (MHz)	Level (dBμV/m)	Over Limit (dB)	Limit Line (dBμV/m)	Read Level (dBμV)	Antenna Factor (dB/m)	Path Loss (dB)	Preamp Factor (dB)	Ant Pos (cm)	Table Pos (deg)	Peak Avg. (P/A)	Pol. (H/V)
		5646.6	60.79	-7.41	68.2	48.67	34.67	11.43	33.98	100	302	P	H
		5695.2	75.59	-26.07	101.66	63.21	34.9	11.46	33.98	100	302	P	H
		5720	80.36	-30.44	110.8	68.01	34.83	11.5	33.98	100	302	P	H
		5725	78.65	-43.55	122.2	66.3	34.83	11.5	33.98	100	302	P	H
	*	5775	111.34	-	-	98.91	34.87	11.53	33.97	100	302	P	H
	*	5775	103.71	-	-	91.28	34.87	11.53	33.97	100	302	A	H
		5851.2	77.99	-41.47	119.46	65.56	34.8	11.6	33.97	100	302	P	H
		5858	77.68	-32.28	109.96	65.18	34.87	11.6	33.97	100	302	P	H
		5875	71.79	-33.41	105.2	59.18	34.93	11.65	33.97	100	302	P	H
		5926.4	58.14	-10.06	68.2	45.41	35	11.69	33.96	100	302	P	H
													H
													H
802.11ac VHT80 CH 155 5775MHz		5644.6	58.36	-9.84	68.2	46.24	34.67	11.43	33.98	100	240	P	V
		5695	71.24	-30.27	101.51	58.86	34.9	11.46	33.98	100	240	P	V
		5718.8	75.16	-35.3	110.46	62.81	34.83	11.5	33.98	100	240	P	V
		5722.6	75.54	-41.19	116.73	63.19	34.83	11.5	33.98	100	240	P	V
	*	5775	106.28	-	-	93.85	34.87	11.53	33.97	100	240	P	V
	*	5775	98.56	-	-	86.13	34.87	11.53	33.97	100	240	A	V
		5853.6	72.34	-41.65	113.99	59.84	34.87	11.6	33.97	100	240	P	V
		5855.2	70.61	-40.13	110.74	58.11	34.87	11.6	33.97	100	240	P	V
		5875.2	66	-39.05	105.05	53.39	34.93	11.65	33.97	100	240	P	V
		5931	51.97	-16.23	68.2	39.24	35	11.69	33.96	100	240	P	V
													V
													V
Remark	1. No other spurious found. 2. All results are PASS against Peak and Average limit line.												



Band 4 5725~5850MHz

WIFI 802.11ac VHT80 (Harmonic @ 3m)

WIFI Ant. 2	Note	Frequency (MHz)	Level (dBμV/m)	Over Limit (dB)	Limit Line (dBμV/m)	Read Level (dBμV)	Antenna Factor (dB/m)	Path Loss (dB)	Preamp Factor (dB)	Ant Pos (cm)	Table Pos (deg)	Peak Avg. (P/A)	Pol. (H/V)	
802.11ac VHT80 CH 155 5775MHz		11550	45.97	-28.03	74	46.51	38.15	18.54	57.23	100	0	P	H	
		17325	49.86	-18.34	68.2	42.2	41.52	21.88	55.74	100	0	P	H	
													H	
													H	
			11550	46.34	-27.66	74	46.88	38.15	18.54	57.23	100	0	P	V
			17325	51.21	-16.99	68.2	43.55	41.52	21.88	55.74	100	0	P	V
														V
Remark	1. No other spurious found. 2. All results are PASS against Peak and Average limit line.													



Emission below 1GHz

5GHz WIFI 802.11ac VHT80 (LF @ 3m)

WIFI	Note	Frequency	Level	Over	Limit	Read	Antenna	Path	Preamp	Ant	Table	Peak	Pol.	
Ant.				Limit	Line	Level	Factor	Loss	Factor	Pos	Pos	Avg.		
2		(MHz)	(dBμV/m)	(dB)	(dBμV/m)	(dBμV)	(dB/m)	(dB)	(dB)	(cm)	(deg)	(P/A)	(H/V)	
5GHz 802.11ac VHT80 LF		30	31.89	-8.11	40	36.14	24.6	1.33	30.18	-	-	P	H	
		127.2	33.22	-10.28	43.5	43.67	17.59	2.01	30.05	-	-	P	H	
		139.62	32.54	-10.96	43.5	43.13	17.43	2.01	30.03	-	-	P	H	
		832.7	42.05	-3.95	46	38.24	28.27	4.74	29.2	-	-	P	H	
		861.4	42.01	-3.99	46	37.18	29.02	4.88	29.07	-	-	P	H	
		944	42.07	-3.93	46	35.59	30.03	5.05	28.6	100	0	P	H	
														H
														H
														H
														H
														H
														H
														H
			30.27	33.67	-6.33	40	37.92	24.6	1.33	30.18	-	-	P	V
			60.78	30.96	-9.04	40	47.51	11.88	1.7	30.13	-	-	P	V
			83.46	30.88	-9.12	40	45.63	13.63	1.72	30.1	-	-	P	V
			887.3	37.9	-8.1	46	33.14	28.83	4.89	28.96	-	-	P	V
			916.7	40.34	-5.66	46	35.08	29.08	4.97	28.79	-	-	P	V
			944	41.53	-4.47	46	35.05	30.03	5.05	28.6	100	0	P	V
														V
													V	
													V	
													V	
													V	
													V	
Remark	1. No other spurious found. 2. All results are PASS against limit line.													



Band 4 - 5725~5850MHz
WIFI 802.11a (Band Edge @ 3m)

WIFI	Note	Frequency	Level	Over	Limit	Read	Antenna	Path	Preamp	Ant	Table	Peak	Pol.	
Ant.				Limit	Line	Level	Factor	Loss	Factor	Pos	Pos	Avg.		
1+2		(MHz)	(dBμV/m)	(dB)	(dBμV/m)	(dBμV)	(dB/m)	(dB)	(dB)	(cm)	(deg)	(P/A)	(H/V)	
802.11a CH 149 5745MHz		5637	53.49	-14.71	68.2	42.47	34.67	11.43	35.08	217	298	P	H	
		5696.6	67.24	-35.45	102.69	55.97	34.9	11.46	35.09	217	298	P	H	
		5715.2	74.04	-35.42	109.46	62.77	34.87	11.5	35.1	217	298	P	H	
		5724.6	83.7	-37.59	121.29	72.47	34.83	11.5	35.1	217	298	P	H	
	*	5745	122.08	-	-	110.85	34.8	11.53	35.1	217	298	P	H	
	*	5745	114.91	-	-	103.68	34.8	11.53	35.1	217	298	A	H	
														H
														H
			5606	51.56	-16.64	68.2	40.44	34.8	11.4	35.08	178	356	P	V
			5696.4	61.01	-41.54	102.55	49.74	34.9	11.46	35.09	178	356	P	V
			5719	67.61	-42.91	110.52	56.38	34.83	11.5	35.1	178	356	P	V
			5723.4	75.35	-43.2	118.55	64.12	34.83	11.5	35.1	178	356	P	V
	*		5745	117.5	-	-	106.27	34.8	11.53	35.1	178	356	P	V
	*		5745	109.62	-	-	98.39	34.8	11.53	35.1	178	356	A	V
														V
													V	



WIFI Ant. 1+2	Note	Frequency (MHz)	Level (dBμV/m)	Over Limit (dB)	Limit Line (dBμV/m)	Read Level (dBμV)	Antenna Factor (dB/m)	Path Loss (dB)	Preamp Factor (dB)	Ant Pos (cm)	Table Pos (deg)	Peak Avg. (P/A)	Pol. (H/V)	
802.11a CH 157 5785MHz		5603.6	51.4	-16.8	68.2	40.28	34.8	11.4	35.08	210	300	P	H	
		5694.8	54.06	-47.31	101.37	42.79	34.9	11.46	35.09	210	300	P	H	
		5718.2	63.33	-46.97	110.3	52.1	34.83	11.5	35.1	210	300	P	H	
		5724.4	57.48	-63.35	120.83	46.25	34.83	11.5	35.1	210	300	P	H	
	*	5785	122.09	-	-	110.77	34.87	11.56	35.11	210	300	P	H	
	*	5785	114.65	-	-	103.33	34.87	11.56	35.11	210	300	A	H	
		5853.2	64.16	-50.74	114.9	52.88	34.8	11.6	35.12	210	300	P	H	
		5858.4	61.79	-48.06	109.85	50.44	34.87	11.6	35.12	210	300	P	H	
		5876.2	58.73	-45.58	104.31	47.27	34.93	11.65	35.12	210	300	P	H	
		5944.8	52.05	-16.15	68.2	40.44	35	11.74	35.13	210	300	P	H	
														H
														H
			5649	50.66	-17.54	68.2	39.64	34.67	11.43	35.08	192	357	P	V
			5699.8	52.6	-52.45	105.05	41.33	34.9	11.46	35.09	192	357	P	V
			5712.4	55.47	-53.2	108.67	44.2	34.87	11.5	35.1	192	357	P	V
			5722.8	57.6	-59.58	117.18	46.37	34.83	11.5	35.1	192	357	P	V
	*		5785	117.22	-	-	105.9	34.87	11.56	35.11	192	357	P	V
	*		5785	109.85	-	-	98.53	34.87	11.56	35.11	192	357	A	V
			5853.4	52.94	-61.51	114.45	41.66	34.8	11.6	35.12	192	357	P	V
			5861.2	56.43	-52.63	109.06	45.03	34.87	11.65	35.12	192	357	P	V
		5877	52.34	-51.37	103.71	40.88	34.93	11.65	35.12	192	357	P	V	
		5944.6	49.88	-18.32	68.2	38.27	35	11.74	35.13	192	357	P	V	
													V	
													V	



WiFi Ant. 1+2	Note	Frequency (MHz)	Level (dBμV/m)	Over Limit (dB)	Limit Line (dBμV/m)	Read Level (dBμV)	Antenna Factor (dB/m)	Path Loss (dB)	Preamp Factor (dB)	Ant Pos (cm)	Table Pos (deg)	Peak Avg. (P/A)	Pol. (H/V)	
802.11a CH 165 5825MHz	*	5825	121.41	-	-	110.09	34.83	11.6	35.11	216	302	P	H	
	*	5825	113.74	-	-	102.42	34.83	11.6	35.11	216	302	A	H	
		5850.8	71.09	-49.29	120.38	59.81	34.8	11.6	35.12	216	302	P	H	
		5858	70.78	-39.18	109.96	59.43	34.87	11.6	35.12	216	302	P	H	
		5875.4	68.17	-36.73	104.9	56.71	34.93	11.65	35.12	216	302	P	H	
		5935.2	55.99	-12.21	68.2	44.43	35	11.69	35.13	216	302	P	H	
														H
														H
	*	5825	116.52	-	-	105.2	34.83	11.6	35.11	190	358	P	V	
	*	5825	109.19	-	-	97.87	34.83	11.6	35.11	190	358	A	V	
		5851	67.8	-52.12	119.92	56.52	34.8	11.6	35.12	190	358	P	V	
		5856	66.5	-44.02	110.52	55.15	34.87	11.6	35.12	190	358	P	V	
		5877.8	61.24	-41.88	103.12	49.78	34.93	11.65	35.12	190	358	P	V	
		5935.2	50.17	-18.03	68.2	38.61	35	11.69	35.13	190	358	P	V	
														V
														V
													V	
Remark	1. No other spurious found. 2. All results are PASS against Peak and Average limit line.													



Band 4 5725~5850MHz
WIFI 802.11a (Harmonic @ 3m)

WIFI Ant. 1+2	Note	Frequency (MHz)	Level (dBμV/m)	Over Limit (dB)	Limit Line (dBμV/m)	Read Level (dBμV)	Antenna Factor (dB/m)	Path Loss (dB)	Preamp Factor (dB)	Ant Pos (cm)	Table Pos (deg)	Peak Avg. (P/A)	Pol. (H/V)	
802.11a CH 149 5745MHz		11490	48.57	-25.43	74	49.4	38.07	18.44	57.34	100	0	P	H	
		17235	52.95	-15.25	68.2	45.33	41.57	21.8	55.75	100	0	P	H	
													H	
													H	
			11490	48.73	-25.27	74	49.56	38.07	18.44	57.34	100	0	P	V
			17235	54.01	-14.19	68.2	46.39	41.57	21.8	55.75	100	0	P	V
														V
802.11a CH 157 5785MHz		11570	48.15	-25.85	74	48.64	38.17	18.54	57.2	100	0	P	H	
		17355	53.59	-14.61	68.2	45.86	41.55	21.91	55.73	100	0	P	H	
													H	
													H	
			11570	48.36	-25.64	74	48.85	38.17	18.54	57.2	100	0	P	V
			17355	53.06	-15.14	68.2	45.33	41.55	21.91	55.73	100	0	P	V
														V
802.11a CH 165 5825MHz		11650	49.36	-24.64	74	49.55	38.28	18.64	57.11	100	0	P	H	
		17475	53.54	-14.66	68.2	45.91	41.33	22.01	55.71	100	0	P	H	
													H	
													H	
			11650	49.32	-24.68	74	49.51	38.28	18.64	57.11	100	0	P	V
			17475	53.98	-14.22	68.2	46.35	41.33	22.01	55.71	100	0	P	V
														V
Remark	1. No other spurious found.													
	2. All results are PASS against Peak and Average limit line.													



Band 4 5725~5850MHz
WIFI 802.11n HT20 (Band Edge @ 3m)

WIFI Ant. 1+2	Note	Frequency (MHz)	Level (dBμV/m)	Over Limit (dB)	Limit Line (dBμV/m)	Read Level (dBμV)	Antenna Factor (dB/m)	Path Loss (dB)	Preamp Factor (dB)	Ant Pos (cm)	Table Pos (deg)	Peak Avg. (P/A)	Pol. (H/V)	
802.11n HT20 CH 149 5745MHz		5643.8	53.32	-14.88	68.2	42.3	34.67	11.43	35.08	216	300	P	H	
		5697.8	65.95	-37.63	103.58	54.68	34.9	11.46	35.09	216	300	P	H	
		5719.4	72.15	-38.48	110.63	60.92	34.83	11.5	35.1	216	300	P	H	
		5723.4	79.93	-38.62	118.55	68.7	34.83	11.5	35.1	216	300	P	H	
	*	5745	121.36	-	-	110.13	34.8	11.53	35.1	216	300	P	H	
	*	5745	113.62	-	-	102.39	34.8	11.53	35.1	216	300	A	H	
														H
														H
			5643.8	51.89	-16.31	68.2	40.87	34.67	11.43	35.08	179	356	P	V
			5699.4	62.04	-42.72	104.76	50.77	34.9	11.46	35.09	179	356	P	V
			5716.4	65.34	-44.45	109.79	54.07	34.87	11.5	35.1	179	356	P	V
			5725	77.09	-45.11	122.2	65.86	34.83	11.5	35.1	179	356	P	V
	*		5745	117.3	-	-	106.07	34.8	11.53	35.1	179	356	P	V
	*		5745	109.5	-	-	98.27	34.8	11.53	35.1	179	356	A	V
													V	
													V	



WIFI Ant. 1+2	Note	Frequency (MHz)	Level (dBμV/m)	Over Limit (dB)	Limit Line (dBμV/m)	Read Level (dBμV)	Antenna Factor (dB/m)	Path Loss (dB)	Preamp Factor (dB)	Ant Pos (cm)	Table Pos (deg)	Peak Avg. (P/A)	Pol. (H/V)	
802.11n HT20 CH 157 5785MHz		5603.8	53.43	-14.77	68.2	42.31	34.8	11.4	35.08	215	299	P	H	
		5693.4	54.45	-45.88	100.33	43.18	34.9	11.46	35.09	215	299	P	H	
		5719.4	62.07	-48.56	110.63	50.84	34.83	11.5	35.1	215	299	P	H	
		5723	64.59	-53.05	117.64	53.36	34.83	11.5	35.1	215	299	P	H	
	*	5785	120.84	-	-	109.52	34.87	11.56	35.11	215	299	P	H	
	*	5785	112.9	-	-	101.58	34.87	11.56	35.11	215	299	A	H	
		5851	63.86	-56.06	119.92	52.58	34.8	11.6	35.12	215	299	P	H	
		5857.6	62.33	-47.74	110.07	50.98	34.87	11.6	35.12	215	299	P	H	
		5875	60.62	-44.58	105.2	49.16	34.93	11.65	35.12	215	299	P	H	
		5928.6	52.78	-15.42	68.2	41.22	35	11.69	35.13	215	299	P	H	
														H
														H
			5631	50.54	-17.66	68.2	39.46	34.73	11.43	35.08	140	355	P	V
			5697.2	52.62	-50.52	103.14	41.35	34.9	11.46	35.09	140	355	P	V
			5715.8	57.11	-52.52	109.63	45.84	34.87	11.5	35.1	140	355	P	V
			5722.8	54.91	-62.27	117.18	43.68	34.83	11.5	35.1	140	355	P	V
	*		5785	117.39	-	-	106.07	34.87	11.56	35.11	140	355	P	V
	*		5785	109.43	-	-	98.11	34.87	11.56	35.11	140	355	A	V
			5851.6	58.48	-60.07	118.55	47.2	34.8	11.6	35.12	140	355	P	V
			5860.6	55.16	-54.07	109.23	43.76	34.87	11.65	35.12	140	355	P	V
		5876.8	51.9	-51.96	103.86	40.44	34.93	11.65	35.12	140	355	P	V	
		5930.8	50.07	-18.13	68.2	38.51	35	11.69	35.13	140	355	P	V	
													V	
													V	



WiFi Ant. 1+2	Note	Frequency (MHz)	Level (dBμV/m)	Over Limit (dB)	Limit Line (dBμV/m)	Read Level (dBμV)	Antenna Factor (dB/m)	Path Loss (dB)	Preamp Factor (dB)	Ant Pos (cm)	Table Pos (deg)	Peak Avg. (P/A)	Pol. (H/V)	
802.11n HT20 CH 165 5825MHz	*	5825	120.11	-	-	108.79	34.83	11.6	35.11	100	299	P	H	
	*	5825	112.91	-	-	101.59	34.83	11.6	35.11	100	299	A	H	
		5850.4	72.79	-48.5	121.29	61.51	34.8	11.6	35.12	100	299	P	H	
		5865.6	71.85	-35.98	107.83	60.45	34.87	11.65	35.12	100	299	P	H	
		5882	67.33	-32.67	100	55.87	34.93	11.65	35.12	100	299	P	H	
		5927.4	56.68	-11.52	68.2	45.12	35	11.69	35.13	100	299	P	H	
														H
														H
	*	5825	116.25	-	-	104.93	34.83	11.6	35.11	100	356	356	P	V
	*	5825	108.53	-	-	97.21	34.83	11.6	35.11	100	356	356	A	V
		5850	70.59	-51.61	122.2	59.31	34.8	11.6	35.12	100	356	356	P	V
		5865	63.93	-44.07	108	52.53	34.87	11.65	35.12	100	356	356	P	V
		5879	62.79	-39.44	102.23	51.33	34.93	11.65	35.12	100	356	356	P	V
		5927.2	50.54	-17.66	68.2	38.98	35	11.69	35.13	100	356	356	P	V
														V
													V	
Remark	1. No other spurious found. 2. All results are PASS against Peak and Average limit line.													



Band 4 5725~5850MHz
WIFI 802.11n HT20 (Harmonic @ 3m)

WIFI Ant. 1+2	Note	Frequency (MHz)	Level (dBμV/m)	Over Limit (dB)	Limit Line (dBμV/m)	Read Level (dBμV)	Antenna Factor (dB/m)	Path Loss (dB)	Preamp Factor (dB)	Ant Pos (cm)	Table Pos (deg)	Peak Avg. (P/A)	Pol. (H/V)
802.11n HT20 CH 149 5745MHz		11490	49.66	-24.34	74	50.49	38.07	18.44	57.34	100	0	P	H
		17235	52.61	-15.59	68.2	44.99	41.57	21.8	55.75	100	0	P	H
													H
													H
		11490	49.09	-24.91	74	49.92	38.07	18.44	57.34	100	0	P	V
		17235	54.07	-14.13	68.2	46.45	41.57	21.8	55.75	100	0	P	V
													V
													V
802.11n HT20 CH 157 5785MHz		11570	48.6	-25.4	74	49.09	38.17	18.54	57.2	100	0	P	H
		17355	53.25	-14.95	68.2	45.52	41.55	21.91	55.73	100	0	P	H
													H
													H
		11570	49.79	-24.21	74	50.28	38.17	18.54	57.2	100	0	P	V
		17355	52.94	-15.26	68.2	45.21	41.55	21.91	55.73	100	0	P	V
													V
													V
802.11n HT20 CH 165 5825MHz		11650	49.44	-24.56	74	49.63	38.28	18.64	57.11	100	0	P	H
		17475	53.57	-14.63	68.2	45.94	41.33	22.01	55.71	100	0	P	H
													H
													H
		11650	49.11	-24.89	74	49.3	38.28	18.64	57.11	100	0	P	V
		17475	53.26	-14.94	68.2	45.63	41.33	22.01	55.71	100	0	P	V
													V
													V
Remark	1. No other spurious found. 2. All results are PASS against Peak and Average limit line.												



Band 4 5725~5850MHz
WIFI 802.11n HT40 (Band Edge @ 3m)

WIFI Ant. 1+2	Note	Frequency (MHz)	Level (dBμV/m)	Over Limit (dB)	Limit Line (dBμV/m)	Read Level (dBμV)	Antenna Factor (dB/m)	Path Loss (dB)	Preamp Factor (dB)	Ant Pos (cm)	Table Pos (deg)	Peak Avg. (P/A)	Pol. (H/V)
		5649	56.04	-12.16	68.2	45.19	34.5	11.43	35.08	211	299	P	H
		5692.2	69.75	-29.7	99.45	58.88	34.5	11.46	35.09	211	299	P	H
		5718.2	84.04	-26.26	110.3	73.07	34.57	11.5	35.1	211	299	P	H
		5723	87.4	-30.24	117.64	76.43	34.57	11.5	35.1	211	299	P	H
	*	5755	118.46	-	-	107.36	34.67	11.53	35.1	211	299	P	H
	*	5755	110.94	-	-	99.84	34.67	11.53	35.1	211	299	A	H
		5851	57.65	-62.27	119.92	46.37	34.8	11.6	35.12	211	299	P	H
		5857.2	59.07	-51.11	110.18	47.79	34.8	11.6	35.12	211	299	P	H
		5877.4	53.6	-49.82	103.42	42.27	34.8	11.65	35.12	211	299	P	H
		5949.2	50.09	-18.11	68.2	38.58	34.9	11.74	35.13	211	299	P	H
802.11n													H
HT40													H
CH 151		5643	51.98	-16.22	68.2	41.13	34.5	11.43	35.08	187	353	P	V
5755MHz		5698	63.62	-40.11	103.73	52.75	34.5	11.46	35.09	187	353	P	V
		5718.8	81.16	-29.3	110.46	70.19	34.57	11.5	35.1	187	353	P	V
		5721	81.79	-31.29	113.08	70.82	34.57	11.5	35.1	187	353	P	V
	*	5755	114.71	-	-	103.61	34.67	11.53	35.1	187	353	P	V
	*	5755	106.99	-	-	95.89	34.67	11.53	35.1	187	353	A	V
		5852.4	53.83	-62.9	116.73	42.55	34.8	11.6	35.12	187	353	P	V
		5865.4	54.27	-53.62	107.89	42.94	34.8	11.65	35.12	187	353	P	V
		5878.6	50.97	-51.56	102.53	39.64	34.8	11.65	35.12	187	353	P	V
		5929.8	49.24	-18.96	68.2	37.81	34.87	11.69	35.13	187	353	P	V
													V
													V



WIFI Ant. 1+2	Note	Frequency (MHz)	Level (dBμV/m)	Over Limit (dB)	Limit Line (dBμV/m)	Read Level (dBμV)	Antenna Factor (dB/m)	Path Loss (dB)	Preamp Factor (dB)	Ant Pos (cm)	Table Pos (deg)	Peak Avg. (P/A)	Pol. (H/V)
		5624.6	51.79	-16.41	68.2	40.71	34.73	11.43	35.08	215	300	P	H
		5700	56.96	-48.24	105.2	45.69	34.9	11.46	35.09	215	300	P	H
		5719	64.53	-45.99	110.52	53.3	34.83	11.5	35.1	215	300	P	H
		5723.2	62.22	-55.88	118.1	50.99	34.83	11.5	35.1	215	300	P	H
	*	5795	118.23	-	-	106.88	34.9	11.56	35.11	215	300	P	H
	*	5795	110.95	-	-	99.6	34.9	11.56	35.11	215	300	A	H
		5852.8	68.51	-47.31	115.82	57.23	34.8	11.6	35.12	215	300	P	H
		5859.4	63.11	-46.46	109.57	51.76	34.87	11.6	35.12	215	300	P	H
		5876.8	60.16	-43.7	103.86	48.7	34.93	11.65	35.12	215	300	P	H
		5941.8	51.59	-16.61	68.2	39.98	35	11.74	35.13	215	300	P	H
802.11n													H
HT40													H
CH 159		5604.2	51.24	-16.96	68.2	40.12	34.8	11.4	35.08	204	355	P	V
5795MHz		5693.8	53.79	-46.84	100.63	42.52	34.9	11.46	35.09	204	355	P	V
		5720	60.32	-50.48	110.8	49.09	34.83	11.5	35.1	204	355	P	V
		5720	60.32	-50.48	110.8	49.09	34.83	11.5	35.1	204	355	P	V
	*	5795	114.19	-	-	102.84	34.9	11.56	35.11	204	355	P	V
	*	5795	106.47	-	-	95.12	34.9	11.56	35.11	204	355	A	V
		5850.2	63.86	-57.88	121.74	52.58	34.8	11.6	35.12	204	355	P	V
		5857.2	63.67	-46.51	110.18	52.32	34.87	11.6	35.12	204	355	P	V
		5878.2	57.46	-45.36	102.82	46	34.93	11.65	35.12	204	355	P	V
		5930	49.78	-18.42	68.2	38.22	35	11.69	35.13	204	355	P	V
													V
													V
Remark	1. No other spurious found. 2. All results are PASS against Peak and Average limit line.												



**Band 4 5725~5850MHz
WIFI 802.11n HT40 (Harmonic @ 3m)**

WIFI Ant. 1+2	Note	Frequency (MHz)	Level (dBμV/m)	Over Limit (dB)	Limit Line (dBμV/m)	Read Level (dBμV)	Antenna Factor (dB/m)	Path Loss (dB)	Preamp Factor (dB)	Ant Pos (cm)	Table Pos (deg)	Peak Avg. (P/A)	Pol. (H/V)	
802.11n HT40 CH 151 5755MHz		11510	49.15	-24.85	74	49.86	38.1	18.49	57.3	100	0	P	H	
		17265	53.63	-14.57	68.2	46.02	41.53	21.83	55.75	100	0	P	H	
													H	
													H	
			11510	48.56	-25.44	74	49.27	38.1	18.49	57.3	100	0	P	V
			17265	53.17	-15.03	68.2	45.56	41.53	21.83	55.75	100	0	P	V
														V
														V
802.11n HT40 CH 159 5795MHz		11590	48.39	-25.61	74	48.8	38.18	18.59	57.18	100	0	P	H	
		17385	53.34	-14.86	68.2	45.54	41.58	21.94	55.72	100	0	P	H	
													H	
													H	
			11590	48.32	-25.68	74	48.73	38.18	18.59	57.18	100	0	P	V
			17385	53.76	-14.44	68.2	45.96	41.58	21.94	55.72	100	0	P	V
														V
														V
Remark	1. No other spurious found. 2. All results are PASS against Peak and Average limit line.													



Band 4 5725~5850MHz
WIFI 802.11ac VHT80 (Band Edge @ 3m)

WIFI Ant. 1+2	Note	Frequency (MHz)	Level (dBμV/m)	Over Limit (dB)	Limit Line (dBμV/m)	Read Level (dBμV)	Antenna Factor (dB/m)	Path Loss (dB)	Preamp Factor (dB)	Ant Pos (cm)	Table Pos (deg)	Peak Avg. (P/A)	Pol. (H/V)	
		5648.8	61.84	-6.36	68.2	50.82	34.67	11.43	35.08	205	300	P	H	
		5687	75.46	-20.15	95.61	64.19	34.9	11.46	35.09	205	300	P	H	
		5718.8	78.52	-31.94	110.46	67.29	34.83	11.5	35.1	205	300	P	H	
		5723.6	78.61	-40.4	119.01	67.38	34.83	11.5	35.1	205	300	P	H	
	*	5775	114.41	-	-	103.11	34.87	11.53	35.1	205	300	P	H	
	*	5775	111	-	-	99.7	34.87	11.53	35.1	205	300	A	H	
		5852.8	83.32	-32.49	115.81	72.04	34.8	11.6	35.12	205	300	P	H	
		5868.4	81.3	-25.75	107.05	69.9	34.87	11.65	35.12	205	300	P	H	
		5883.4	72.23	-26.73	98.96	60.77	34.93	11.65	35.12	205	300	P	H	
		5926.2	66.02	-2.18	68.2	54.46	35	11.69	35.13	205	300	P	H	
802.11ac VHT80 CH 155 5775MHz													H	
													H	
			5630.8	58.14	-10.06	68.2	47.29	34.5	11.43	35.08	232	235	P	V
			5696.4	71.86	-30.69	102.55	60.99	34.5	11.46	35.09	232	235	P	V
			5718.8	76.39	-34.07	110.46	65.42	34.57	11.5	35.1	232	235	P	V
			5720.2	77.5	-33.76	111.26	66.53	34.57	11.5	35.1	232	235	P	V
		*	5775	108.7	-	-	97.54	34.73	11.53	35.1	232	235	P	V
		*	5775	99.42	-	-	88.26	34.73	11.53	35.1	232	235	A	V
			5851.6	72.93	-45.62	118.55	61.65	34.8	11.6	35.12	232	235	P	V
			5857.6	71.19	-38.88	110.07	59.91	34.8	11.6	35.12	232	235	P	V
			5878.6	64.61	-37.92	102.53	53.28	34.8	11.65	35.12	232	235	P	V
			5934.4	51.6	-16.6	68.2	40.17	34.87	11.69	35.13	232	235	P	V
														V
														V
	Remark	1. No other spurious found. 2. All results are PASS against Peak and Average limit line.												



Band 4 5725~5850MHz

WIFI 802.11ac VHT80 (Harmonic @ 3m)

WIFI Ant. 1+2	Note	Frequency (MHz)	Level (dBμV/m)	Over Limit (dB)	Limit Line (dBμV/m)	Read Level (dBμV)	Antenna Factor (dB/m)	Path Loss (dB)	Preamp Factor (dB)	Ant Pos (cm)	Table Pos (deg)	Peak Avg. (P/A)	Pol. (H/V)	
802.11ac VHT80 CH 155 5775MHz		11550	48.27	-25.73	74	48.81	38.15	18.54	57.23	100	0	P	H	
		17325	53.65	-14.55	68.2	45.99	41.52	21.88	55.74	100	0	P	H	
													H	
													H	
			11550	48.26	-25.74	74	48.8	38.15	18.54	57.23	100	0	P	V
			17325	53.69	-14.51	68.2	46.03	41.52	21.88	55.74	100	0	P	V
														V
Remark	1. No other spurious found. 2. All results are PASS against Peak and Average limit line.													



Emission below 1GHz

5GHz WIFI 802.11ac VHT80 (LF @ 3m)

WIFI	Note	Frequency	Level	Over	Limit	Read	Antenna	Path	Preamp	Ant	Table	Peak	Pol.	
Ant.				Limit	Line	Level	Factor	Loss	Factor	Pos	Pos	Avg.		
1+2		(MHz)	(dBμV/m)	(dB)	(dBμV/m)	(dBμV)	(dB/m)	(dB)	(dB)	(cm)	(deg)	(P/A)	(H/V)	
5GHz 802.11ac VHT80 LF		30	31.97	-8.03	40	36.22	24.6	1.33	30.18	-	-	P	H	
		125.58	33.35	-10.15	43.5	43.75	17.64	2.01	30.05	-	-	P	H	
		135.84	32.73	-10.77	43.5	43.35	17.41	2.01	30.04	-	-	P	H	
		829.9	42.53	-3.47	46	38.84	28.16	4.74	29.21	100	0	P	H	
		856.5	41.46	-4.54	46	36.88	28.93	4.74	29.09	-	-	P	H	
		939.8	42.07	-3.93	46	35.9	29.82	4.98	28.63	-	-	P	H	
														H
														H
														H
														H
														H
														H
														H
			30	34.17	-5.83	40	38.42	24.6	1.33	30.18	-	-	P	V
			61.86	30.97	-9.03	40	47.53	11.87	1.7	30.13	-	-	P	V
			78.33	31.36	-8.64	40	46.65	13.1	1.72	30.11	-	-	P	V
			913.2	41.45	-4.55	46	36.27	29.02	4.97	28.81	-	-	P	V
			941.2	42.52	-3.48	46	36.22	29.87	5.05	28.62	100	0	P	V
		995.8	38.77	-15.23	54	31.53	30.37	5.12	28.25	-	-	P	V	
													V	
													V	
													V	
													V	
													V	
													V	
Remark	1. No other spurious found. 2. All results are PASS against limit line.													



<TXBF Mode>

Band 4 - 5725~5850MHz

WIFI 802.11ac VHT20 (Band Edge @ 3m)

WIFI Ant.	Note	Frequency	Level	Over Limit	Limit Line	Read Level	Antenna Factor	Path Loss	Preamp Factor	Ant Pos	Table Pos	Peak Avg.	Pol.	
1+2		(MHz)	(dBμV/m)	(dB)	(dBμV/m)	(dBμV)	(dB/m)	(dB)	(dB)	(cm)	(deg)	(P/A)	(H/V)	
802.11ac VHT20 CH 149 5745MHz		5636.4	52.42	-15.78	68.2	40.3	34.67	11.43	33.98	100	299	P	H	
		5693.4	58.34	-41.99	100.33	45.96	34.9	11.46	33.98	100	299	P	H	
		5718.2	66.55	-43.75	110.3	54.2	34.83	11.5	33.98	100	299	P	H	
		5725	74.37	-47.83	122.2	62.02	34.83	11.5	33.98	100	299	P	H	
	*	5745	117.65	-	-	105.29	34.8	11.53	33.97	100	299	P	H	
	*	5745	109.6	-	-	97.24	34.8	11.53	33.97	100	299	A	H	
														H
														H
			5646.6	52.67	-15.53	68.2	40.55	34.67	11.43	33.98	100	241	P	V
			5689.8	60.2	-37.48	97.68	47.82	34.9	11.46	33.98	100	241	P	V
			5717	62.5	-47.46	109.96	50.11	34.87	11.5	33.98	100	241	P	V
			5724.2	70.71	-49.67	120.38	58.36	34.83	11.5	33.98	100	241	P	V
	*		5745	113.01	-	-	100.65	34.8	11.53	33.97	100	241	P	V
	*		5745	104.47	-	-	92.11	34.8	11.53	33.97	100	241	A	V
													V	
													V	



WIFI Ant. 1+2	Note	Frequency (MHz)	Level (dBμV/m)	Over Limit (dB)	Limit Line (dBμV/m)	Read Level (dBμV)	Antenna Factor (dB/m)	Path Loss (dB)	Preamp Factor (dB)	Ant Pos (cm)	Table Pos (deg)	Peak Avg. (P/A)	Pol. (H/V)
		5625.4	51.61	-16.59	68.2	39.43	34.73	11.43	33.98	100	299	P	H
		5689.8	52.98	-44.7	97.68	40.6	34.9	11.46	33.98	100	299	P	H
		5715.6	55.37	-54.2	109.57	42.98	34.87	11.5	33.98	100	299	P	H
		5722.4	54.32	-61.95	116.27	41.97	34.83	11.5	33.98	100	299	P	H
	*	5785	117.24	-	-	104.78	34.87	11.56	33.97	100	299	P	H
	*	5785	108.56	-	-	96.1	34.87	11.56	33.97	100	299	A	H
		5852.2	53.61	-63.57	117.18	41.18	34.8	11.6	33.97	100	299	P	H
		5857.4	54.92	-55.21	110.13	42.42	34.87	11.6	33.97	100	299	P	H
		5888.8	53.11	-41.85	94.96	40.43	35	11.65	33.97	100	299	P	H
		5931.4	50.97	-17.23	68.2	38.24	35	11.69	33.96	100	299	P	H
802.11ac													H
VHT20													H
CH 157		5605.4	50.58	-17.62	68.2	38.36	34.8	11.4	33.98	123	245	P	V
5785MHz		5686.4	49.98	-45.19	95.17	37.6	34.9	11.46	33.98	123	245	P	V
		5709	50.12	-57.6	107.72	37.73	34.87	11.5	33.98	123	245	P	V
		5724.4	51.83	-69	120.83	39.48	34.83	11.5	33.98	123	245	P	V
	*	5785	111.71	-	-	99.25	34.87	11.56	33.97	123	245	P	V
	*	5785	103.14	-	-	90.68	34.87	11.56	33.97	123	245	A	V
		5850.2	52.14	-69.6	121.74	39.71	34.8	11.6	33.97	123	245	P	V
		5866.2	52.27	-55.39	107.66	39.72	34.87	11.65	33.97	123	245	P	V
		5916.8	51.1	-23.15	74.25	38.37	35	11.69	33.96	123	245	P	V
		5943.2	50.14	-18.06	68.2	37.36	35	11.74	33.96	123	245	P	V
													V
													V



WiFi Ant. 1+2	Note	Frequency (MHz)	Level (dBμV/m)	Over Limit (dB)	Limit Line (dBμV/m)	Read Level (dBμV)	Antenna Factor (dB/m)	Path Loss (dB)	Preamp Factor (dB)	Ant Pos (cm)	Table Pos (deg)	Peak Avg. (P/A)	Pol. (H/V)	
802.11ac VHT20 CH 165 5825MHz	*	5825	117.62	-	-	105.16	34.83	11.6	33.97	101	300	P	H	
	*	5825	108.44	-	-	95.98	34.83	11.6	33.97	101	300	A	H	
		5850.4	69.59	-51.7	121.29	57.16	34.8	11.6	33.97	101	300	P	H	
		5862.2	68.93	-39.85	108.78	56.38	34.87	11.65	33.97	101	300	P	H	
		5875.4	68.28	-36.62	104.9	55.67	34.93	11.65	33.97	101	300	P	H	
		5930.4	52.83	-15.37	68.2	40.1	35	11.69	33.96	101	300	P	H	
														H
														H
	*	5825	111.06	-	-	98.6	34.83	11.6	33.97	100	238	P	V	
	*	5825	101.91	-	-	89.45	34.83	11.6	33.97	100	238	A	V	
		5850.8	59.9	-60.48	120.38	47.47	34.8	11.6	33.97	100	238	P	V	
		5856.8	56.4	-53.9	110.3	43.9	34.87	11.6	33.97	100	238	P	V	
		5875.8	51.92	-52.69	104.61	39.31	34.93	11.65	33.97	100	238	P	V	
		5945	50.04	-18.16	68.2	37.26	35	11.74	33.96	100	238	P	V	
														V
													V	
Remark	1. No other spurious found. 2. All results are PASS against Peak and Average limit line.													



Band 4 5725~5850MHz
WIFI 802.11ac VHT20 (Harmonic @ 3m)

WIFI Ant. 1+2	Note	Frequency (MHz)	Level (dBμV/m)	Over Limit (dB)	Limit Line (dBμV/m)	Read Level (dBμV)	Antenna Factor (dB/m)	Path Loss (dB)	Preamp Factor (dB)	Ant Pos (cm)	Table Pos (deg)	Peak Avg. (P/A)	Pol. (H/V)	
802.11ac VHT20 CH 149 5745MHz		11490	43.53	-30.47	74	44.36	38.07	18.44	57.34	100	0	P	H	
		17235	46.46	-21.74	68.2	38.84	41.57	21.8	55.75	100	0	P	H	
													H	
													H	
			11490	41.92	-32.08	74	42.75	38.07	18.44	57.34	100	0	P	V
			17235	44.4	-23.8	68.2	36.78	41.57	21.8	55.75	100	0	P	V
														V
802.11ac VHT20 CH 157 5785MHz		11570	46.15	-27.85	74	46.64	38.17	18.54	57.2	100	0	P	H	
		17355	48.06	-20.14	68.2	40.33	41.55	21.91	55.73	100	0	P	H	
													H	
													H	
			11570	43.39	-30.61	74	43.88	38.17	18.54	57.2	100	0	P	V
			17355	45.78	-22.42	68.2	38.05	41.55	21.91	55.73	100	0	P	V
														V
802.11ac VHT20 CH 165 5825MHz		11650	45.24	-28.76	74	45.43	38.28	18.64	57.11	100	0	P	H	
		17475	49.92	-18.28	68.2	42.29	41.33	22.01	55.71	100	0	P	H	
													H	
													H	
			11650	44.69	-29.31	74	44.88	38.28	18.64	57.11	100	0	P	V
			17475	50.63	-17.57	68.2	43	41.33	22.01	55.71	100	0	P	V
														V
Remark	1. No other spurious found.													
	2. All results are PASS against Peak and Average limit line.													



Band 4 5725~5850MHz
WIFI 802.11ac VHT40 (Band Edge @ 3m)

WIFI Ant. 1+2	Note	Frequency (MHz)	Level (dBμV/m)	Over Limit (dB)	Limit Line (dBμV/m)	Read Level (dBμV)	Antenna Factor (dB/m)	Path Loss (dB)	Preamp Factor (dB)	Ant Pos (cm)	Table Pos (deg)	Peak Avg. (P/A)	Pol. (H/V)	
		5646.6	55.72	-12.48	68.2	43.6	34.67	11.43	33.98	200	300	P	H	
		5688.2	71.79	-24.71	96.5	59.41	34.9	11.46	33.98	200	300	P	H	
		5719.4	86.11	-24.52	110.63	73.76	34.83	11.5	33.98	200	300	P	H	
		5723	88.41	-29.23	117.64	76.06	34.83	11.5	33.98	200	300	P	H	
	*	5755	116.45	-	-	104.06	34.83	11.53	33.97	200	300	P	H	
	*	5755	107.8	-	-	95.41	34.83	11.53	33.97	200	300	A	H	
		5850.8	55.6	-64.78	120.38	43.17	34.8	11.6	33.97	200	300	P	H	
		5855.2	59.73	-51.01	110.74	47.23	34.87	11.6	33.97	200	300	P	H	
		5899.8	52.91	-33.9	86.81	40.23	35	11.65	33.97	200	300	P	H	
		5930.2	51.23	-16.97	68.2	38.5	35	11.69	33.96	200	300	P	H	
802.11ac VHT40 CH 151 5755MHz													H	
													H	
			5638.6	50.47	-17.73	68.2	38.35	34.67	11.43	33.98	157	355	P	V
			5697.4	61.96	-41.32	103.28	49.58	34.9	11.46	33.98	157	355	P	V
			5719.6	76.6	-34.09	110.69	64.25	34.83	11.5	33.98	157	355	P	V
			5724.6	77.84	-43.45	121.29	65.49	34.83	11.5	33.98	157	355	P	V
		*	5755	112.07	-	-	99.68	34.83	11.53	33.97	157	355	P	V
		*	5755	104.13	-	-	91.74	34.83	11.53	33.97	157	355	A	V
			5853.2	53.11	-61.79	114.9	40.68	34.8	11.6	33.97	157	355	P	V
			5874.4	52.94	-52.43	105.37	40.33	34.93	11.65	33.97	157	355	P	V
			5875.6	51.8	-52.95	104.75	39.19	34.93	11.65	33.97	157	355	P	V
			5938	50.95	-17.25	68.2	38.22	35	11.69	33.96	157	355	P	V
														V
														V



WIFI Ant. 1+2	Note	Frequency (MHz)	Level (dBμV/m)	Over Limit (dB)	Limit Line (dBμV/m)	Read Level (dBμV)	Antenna Factor (dB/m)	Path Loss (dB)	Preamp Factor (dB)	Ant Pos (cm)	Table Pos (deg)	Peak Avg. (P/A)	Pol. (H/V)
		5601	51.69	-16.51	68.2	39.47	34.8	11.4	33.98	217	298	P	H
		5699	59.46	-45	104.46	47.08	34.9	11.46	33.98	217	298	P	H
		5719.4	62.65	-47.98	110.63	50.3	34.83	11.5	33.98	217	298	P	H
		5725	64.15	-58.05	122.2	51.8	34.83	11.5	33.98	217	298	P	H
	*	5795	116.1	-	-	103.61	34.9	11.56	33.97	217	298	P	H
	*	5795	107.83	-	-	95.34	34.9	11.56	33.97	217	298	A	H
		5852.2	65.81	-51.37	117.18	53.38	34.8	11.6	33.97	217	298	P	H
		5855.8	64.29	-46.29	110.58	51.79	34.87	11.6	33.97	217	298	P	H
		5882.2	59.49	-40.36	99.85	46.88	34.93	11.65	33.97	217	298	P	H
		5939.4	53.31	-14.89	68.2	40.58	35	11.69	33.96	217	298	P	H
802.11ac													H
VHT40													H
CH 159		5649.2	51.3	-16.9	68.2	39.18	34.67	11.43	33.98	180	356	P	V
5795MHz		5696	53.14	-49.11	102.25	40.76	34.9	11.46	33.98	180	356	P	V
		5720	60.51	-50.29	110.8	48.16	34.83	11.5	33.98	180	356	P	V
		5724.6	57.68	-63.61	121.29	45.33	34.83	11.5	33.98	180	356	P	V
	*	5795	111.69	-	-	99.2	34.9	11.56	33.97	180	356	P	V
	*	5795	104.24	-	-	91.75	34.9	11.56	33.97	180	356	A	V
		5851.2	62.53	-56.93	119.46	50.1	34.8	11.6	33.97	180	356	P	V
		5856.6	60.32	-50.03	110.35	47.82	34.87	11.6	33.97	180	356	P	V
		5876.8	56.02	-47.84	103.86	43.41	34.93	11.65	33.97	180	356	P	V
		5939.4	50.3	-17.9	68.2	37.57	35	11.69	33.96	180	356	P	V
													V
													V
Remark	<ol style="list-style-type: none"> No other spurious found. All results are PASS against Peak and Average limit line. 												



**Band 4 5725~5850MHz
WIFI 802.11ac VHT40 (Harmonic @ 3m)**

WIFI Ant. 1+2	Note	Frequency (MHz)	Level (dBμV/m)	Over Limit (dB)	Limit Line (dBμV/m)	Read Level (dBμV)	Antenna Factor (dB/m)	Path Loss (dB)	Preamp Factor (dB)	Ant Pos (cm)	Table Pos (deg)	Peak Avg. (P/A)	Pol. (H/V)	
802.11ac VHT40 CH 151 5755MHz		11510	46.73	-27.27	74	47.44	38.1	18.49	57.3	100	0	P	H	
		17265	51.75	-16.45	68.2	44.14	41.53	21.83	55.75	100	0	P	H	
													H	
													H	
			11510	46.06	-27.94	74	46.77	38.1	18.49	57.3	100	0	P	V
			17265	49.96	-18.24	68.2	42.35	41.53	21.83	55.75	100	0	P	V
														V
802.11ac VHT40 CH 159 5795MHz		11590	46.54	-27.46	74	46.95	38.18	18.59	57.18	100	0	P	H	
		17325	50.23	-17.97	68.2	42.57	41.52	21.88	55.74	100	0	P	H	
													H	
													H	
			11590	46.32	-27.68	74	46.73	38.18	18.59	57.18	100	0	P	V
			17325	50.74	-17.46	68.2	43.08	41.52	21.88	55.74	100	0	P	V
														V
Remark	1. No other spurious found.													
	2. All results are PASS against Peak and Average limit line.													



Band 4 5725~5850MHz
WIFI 802.11ac VHT80 (Band Edge @ 3m)

WIFI Ant. 1+2	Note	Frequency (MHz)	Level (dBμV/m)	Over Limit (dB)	Limit Line (dBμV/m)	Read Level (dBμV)	Antenna Factor (dB/m)	Path Loss (dB)	Preamp Factor (dB)	Ant Pos (cm)	Table Pos (deg)	Peak Avg. (P/A)	Pol. (H/V)	
		5623.6	62.93	-5.27	68.2	50.75	34.73	11.43	33.98	226	297	P	H	
		5698.2	82.07	-21.8	103.87	69.69	34.9	11.46	33.98	226	297	P	H	
		5719.8	84.39	-26.35	110.74	72.04	34.83	11.5	33.98	226	297	P	H	
		5723.2	85.95	-32.15	118.1	73.6	34.83	11.5	33.98	226	297	P	H	
	*	5775	113.09	-	-	100.66	34.87	11.53	33.97	226	297	P	H	
	*	5775	104.65	-	-	92.22	34.87	11.53	33.97	226	297	A	H	
		5851.8	80.76	-37.34	118.1	68.33	34.8	11.6	33.97	226	297	P	H	
		5857.8	78.34	-31.67	110.01	65.84	34.87	11.6	33.97	226	297	P	H	
		5876.6	71.26	-32.75	104.01	58.65	34.93	11.65	33.97	226	297	P	H	
		5933.4	57.71	-10.49	68.2	44.98	35	11.69	33.96	226	297	P	H	
802.11ac VHT80 CH 155 5775MHz													H	
													H	
			5644.6	57.6	-10.6	68.2	45.48	34.67	11.43	33.98	196	356	P	V
			5698	73.26	-30.47	103.73	60.88	34.9	11.46	33.98	196	356	P	V
			5714.4	78.8	-30.43	109.23	66.41	34.87	11.5	33.98	196	356	P	V
			5724	78.67	-41.25	119.92	66.32	34.83	11.5	33.98	196	356	P	V
		*	5775	109.1	-	-	96.67	34.87	11.53	33.97	196	356	P	V
		*	5775	100.02	-	-	87.59	34.87	11.53	33.97	196	356	A	V
			5851.2	76.84	-42.62	119.46	64.41	34.8	11.6	33.97	196	356	P	V
			5855.4	74.64	-36.05	110.69	62.14	34.87	11.6	33.97	196	356	P	V
			5877.6	67.87	-35.4	103.27	55.26	34.93	11.65	33.97	196	356	P	V
			5928	54.94	-13.26	68.2	42.21	35	11.69	33.96	196	356	P	V
														V
														V
	Remark	1. No other spurious found. 2. All results are PASS against Peak and Average limit line.												



Band 4 5725~5850MHz

WIFI 802.11ac VHT80 (Harmonic @ 3m)

WIFI Ant. 1+2	Note	Frequency (MHz)	Level (dBμV/m)	Over Limit (dB)	Limit Line (dBμV/m)	Read Level (dBμV)	Antenna Factor (dB/m)	Path Loss (dB)	Preamp Factor (dB)	Ant Pos (cm)	Table Pos (deg)	Peak Avg. (P/A)	Pol. (H/V)	
802.11ac VHT80 CH 155 5775MHz		11550	46.36	-27.64	74	46.9	38.15	18.54	57.23	100	0	P	H	
		17325	50.51	-17.69	68.2	42.85	41.52	21.88	55.74	100	0	P	H	
													H	
													H	
			11550	46	-28	74	46.54	38.15	18.54	57.23	100	0	P	V
			17325	50.33	-17.87	68.2	42.67	41.52	21.88	55.74	100	0	P	V
														V
Remark	1. No other spurious found. 2. All results are PASS against Peak and Average limit line.													



Emission below 1GHz

5GHz WIFI 802.11ac VHT80 (LF @ 3m)

WIFI	Note	Frequency	Level	Over	Limit	Read	Antenna	Path	Preamp	Ant	Table	Peak	Pol.	
Ant.				Limit	Line	Level	Factor	Loss	Factor	Pos	Pos	Avg.		
1+2		(MHz)	(dBμV/m)	(dB)	(dBμV/m)	(dBμV)	(dB/m)	(dB)	(dB)	(cm)	(deg)	(P/A)	(H/V)	
5GHz 802.11ac VHT80 LF		48.63	25.14	-14.86	40	38.88	15.07	1.34	30.15	-	-	P	H	
		125.85	27.59	-15.91	43.5	37.99	17.64	2.01	30.05	-	-	P	H	
		152.31	30.07	-13.43	43.5	40.9	16.94	2.25	30.02	-	-	P	H	
		925.8	42.1	-3.9	46	36.49	29.36	4.97	28.72	-	-	P	H	
		948.2	42.27	-3.73	46	35.51	30.28	5.05	28.57	100	0	P	H	
		969.2	43.56	-10.44	54	36.07	30.86	5.06	28.43			P	H	
													H	
													H	
													H	
													H	
													H	
													H	
													H	
													H	
													H	
			30.27	31.94	-8.06	40	36.19	24.6	1.33	30.18	-	-	P	V
			125.31	31.43	-12.07	43.5	41.78	17.69	2.01	30.05	-	-	P	V
			130.17	31.29	-12.21	43.5	41.89	17.43	2.01	30.04	-	-	P	V
		881.7	39.87	-6.13	46	35.08	28.88	4.89	28.98	-	-	P	V	
		926.5	40.39	-5.61	46	34.78	29.36	4.97	28.72	100	0	P	V	
		969.2	41.58	-12.42	54	34.09	30.86	5.06	28.43	-	-	P	V	
													V	
													V	
													V	
													V	
													V	
													V	
Remark	1. No other spurious found. 2. All results are PASS against limit line.													



Note symbol

*	Fundamental Frequency which can be ignored. However, the level of any unwanted emissions shall not exceed the level of the fundamental frequency.
!	Test result is over limit line.
P/A	Peak or Average
H/V	Horizontal or Vertical



A calculation example for radiated spurious emission is shown as below:

WIFI	Note	Frequency	Level	Over	Limit	Read	Antenna	Path	Preamp	Ant	Table	Peak	Pol.
Ant.				Limit	Line	Level	Factor	Loss	Factor	Pos	Pos	Avg.	
1		(MHz)	(dBμV/m)	(dB)	(dBμV/m)	(dBμV)	(dB/m)	(dB)	(dB)	(cm)	(deg)	(P/A)	(H/V)
802.11b		2390	55.45	-18.55	74	54.51	32.22	4.58	35.86	103	308	P	H
CH 01													
2412MHz		2390	43.54	-10.46	54	42.6	32.22	4.58	35.86	103	308	A	H

1. Path Loss(dB) = Cable loss(dB) + Filter loss(dB) + Attenuator loss(dB)
2. Level(dBμV/m) = Antenna Factor(dB/m) + Path Loss(dB) + Read Level(dBμV) - Preamp Factor(dB)
3. Over Limit(dB) = Level(dBμV/m) – Limit Line(dBμV/m)

For Peak Limit @ 2390MHz:

1. Level(dBμV/m)
= Antenna Factor(dB/m) + Path Loss(dB) + Read Level(dBμV) - Preamp Factor(dB)
= 32.22(dB/m) + 4.58(dB) + 54.51(dBμV) – 35.86 (dB)
= 55.45 (dBμV/m)
2. Over Limit(dB)
= Level(dBμV/m) – Limit Line(dBμV/m)
= 55.45(dBμV/m) – 74(dBμV/m)
= -18.55(dB)

For Average Limit @ 2390MHz:

1. Level(dBμV/m)
= Antenna Factor(dB/m) + Path Loss(dB) + Read Level(dBμV) - Preamp Factor(dB)
= 32.22(dB/m) + 4.58(dB) + 42.6(dBμV) – 35.86 (dB)
= 43.54 (dBμV/m)
2. Over Limit(dB) = Level(dBμV/m) – Limit Line(dBμV/m)
= 43.54(dBμV/m) – 54(dBμV/m)
= -10.46(dB)

Both peak and average measured complies with the limit line, so test result is “PASS”.



Appendix C. Radiated Spurious Emission Plots

Test Engineer :	Jesse Wang, Stan Hsieh, and Troye Hsieh	Temperature :	20~25°C
		Relative Humidity :	55~60%

Note symbol

-L	Low channel location
-R	High channel location



<CDD Mode>

Band 4 - 5725~5850MHz
WIFI 802.11a (Band Edge @ 3m)

WIFI	Band 4 5725~5850MHz Band Edge @ 3m	
ANT	802.11a CH149 5745MHz	
1	Horizontal	Fundamental
Peak	<p>Site : 09CH07-HY Condition : PEAK_RE(B4)_16-24 3m HF_ANT_00075962 HORIZONTAL RBW:1000.000kHz VBW:3000.000kHz SWT:Auto Detector : Peak Project : SR826G Mode : 82</p>	<p>Site : 09CH07-HY Condition : PEAK(FUN) 3m HF_ANT_00075962 HORIZONTAL RBW:1000.000kHz VBW:3000.000kHz SWT:Auto Detector : Peak Project : SR826G Mode : 82</p>



WIFI	Band 4 5725~5850MHz Band Edge @ 3m	
ANT	802.11a CH149 5745MHz	
1	Vertical	Fundamental
Peak	<p>Site : ESCH07-RY Condition : PEAK_BE(B4)_16-24 3m HF_ANT_00075962 VERTICAL Detector : RBW:1000.000kHz VBW:3000.000kHz SWT:Auto Project : 8N2626 Mode : 82</p>	<p>Site : ESCH07-RY Condition : PEAK(FUNB) 3m HF_ANT_00075962 VERTICAL Detector : RBW:1000.000kHz VBW:3000.000kHz SWT:Auto Project : 8N2626 Mode : 82</p>



WIFI	Band 4 5725~5850MHz Band Edge @ 3m	
ANT	802.11a CH157 5785MHz	
1	Horizontal	Fundamental
<p>Peak</p>	<p>Date: 2019-01-08 PEAK_BE(B4)_16-24</p> <p>Site : 03CH07-HY Condition : PEAK_BE(B4)_16-24 3m HF_ANT_00075962 HORIZONTAL Detector : Peak Project : BN2626 Mode : 83</p>	<p>Date: 2019-01-08 PEAK(B4)_16-24</p> <p>Site : 03CH07-HY Condition : PEAK(LUN1) 3m HF_ANT_00075962 HORIZONTAL Detector : Peak Project : BN2626 Mode : 83</p>
<p>Peak</p>	<p>Date: 2019-01-08 PEAK_BE(B4)_16-24</p> <p>Site : 03CH07-HY Condition : PEAK_BE(B4)_16-24 3m HF_ANT_00075962 HORIZONTAL Detector : Peak Project : BN2626 Mode : 83</p>	<p>Left blank</p>



WIFI	Band 4 5725~5850MHz Band Edge @ 3m	
ANT	802.11a CH157 5785MHz	
1	Vertical	Fundamental
Peak	<p>Date: 2019-01-08 PEAK_BE(B4)_16-24</p> <p>Site : 03CH07-HY Condition : PEAK_BE(B4)_16-24 3m HF_ANT_00075962 VERTICAL Detector : RBW:1000.000kHz VBW:3000.000kHz SWT:Auto Project : BN2626 Mode : 83</p>	<p>Date: 2019-01-08 PEAK(B4)_16-24 AVG_57</p> <p>Site : 03CH07-HY Condition : PEAK(LIN) 3m HF_ANT_00075962 VERTICAL Detector : RBW:1000.000kHz VBW:3000.000kHz SWT:Auto Project : BN2626 Mode : 83</p>
Peak	<p>Date: 2019-01-08 PEAK_BE(B4)_16-24</p> <p>Site : 03CH07-HY Condition : PEAK_BE(B4)_16-24 3m HF_ANT_00075962 VERTICAL Detector : RBW:1000.000kHz VBW:3000.000kHz SWT:Auto Project : BN2626 Mode : 83</p>	Left blank



WIFI	Band 4 5725~5850MHz Band Edge @ 3m	
ANT	802.11a CH165 5825MHz	
1	Horizontal	Fundamental
Peak	<p>Site : E3CH07-RV Condition : PEAK_BE(B4) 16-24 3m HF_ANT_00075962 HORIZONTAL Detector : Peak Project : 8N2626 Mode : 84</p>	<p>Site : E3CH07-RV Condition : PEAK(LIN) 3m HF_ANT_00075962 HORIZONTAL Detector : Peak Project : 8N2626 Mode : 84</p>



WIFI	Band 4 5725~5850MHz Band Edge @ 3m	
ANT	802.11a CH165 5825MHz	
1	Vertical	Fundamental
Peak	<p>Site : ESCH07-RV Condition : PEAK_BE(B4) 16-24 3m HF_ANT_00075962 VERTICAL Detector : Peak Project : 8N2626 Mode : 84</p>	<p>Site : ESCH07-RV Condition : PEAK(UIN) 3m HF_ANT_00075962 VERTICAL Detector : Peak Project : 8N2626 Mode : 84</p>



**Band 4 5725~5850MHz
WIFI 802.11n HT20 (Band Edge @ 3m)**

WIFI	Band 4 5725~5850MHz Band Edge @ 3m	
ANT	802.11n HT20 CH149 5745MHz	
1	Horizontal	Fundamental
Peak	<p>Site : 03CH07-HY Condition : PEAK_BE(B4)_16-24 3m HF_ANT_00075962 HORIZONTAL Detector : RBW:1000.000KHz VBW:3000.000KHz SWT:Auto Project : BN2626 Mode : 10B</p>	<p>Site : 03CH07-HY Condition : PEAK(LIN) 3m HF_ANT_00075962 HORIZONTAL Detector : Peak Project : BN2626 Mode : 10B</p>

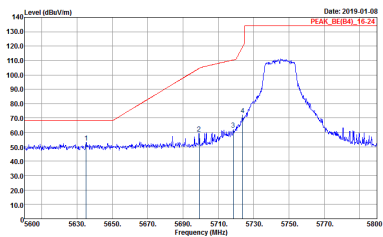
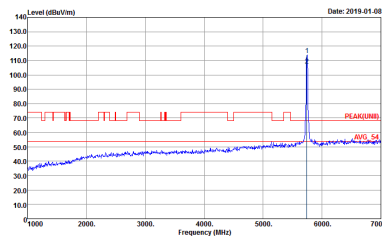

WIFI	Band 4 5725~5850MHz Band Edge @ 3m	
ANT	802.11n HT20 CH149 5745MHz	
1	Vertical	Fundamental
Peak	 <p>Site : ESCH07-RV Condition : PEAK_BE(B4) 16-24 3m HF_ANT_00075962 VERTICAL Detector : RBW:1000.000kHz VBW:3000.000kHz SWT:Auto Project : 8N2626 Mode : 108</p>	 <p>Site : ESCH07-RV Condition : PEAK(LIN) 3m HF_ANT_00075962 VERTICAL Detector : Peak Project : 8N2626 Mode : 108</p>



WIFI	Band 4 5725~5850MHz Band Edge @ 3m	
ANT	802.11n HT20 CH157 5785MHz	
1	Horizontal	Fundamental
<p>Peak</p>	<p>Date: 2019-01-08 PEAK_BE(B4)_16-24</p> <p>Site : 03CH07-HY Condition : PEAK_BE(B4)_16-24 3m HF_ANT_00075962 HORIZONTAL Detector : Peak Project : BN2626 Mode : 109</p>	<p>Date: 2019-01-08 PEAK(B4)_16-24</p> <p>Site : 03CH07-HY Condition : PEAK(LUN1) 3m HF_ANT_00075962 HORIZONTAL Detector : Peak Project : BN2626 Mode : 109</p>
<p>Peak</p>	<p>Date: 2019-01-08 PEAK_BE(B4)_16-24</p> <p>Site : 03CH07-HY Condition : PEAK_BE(B4)_16-24 3m HF_ANT_00075962 HORIZONTAL Detector : Peak Project : BN2626 Mode : 109</p>	<p>Left blank</p>



WIFI	Band 4 5725~5850MHz Band Edge @ 3m	
ANT	802.11n HT20 CH157 5785MHz	
1	Vertical	Fundamental
<p>Peak</p>	<p>Date: 2019-01-08 PEAK_BE(B4)_16-24</p> <p>Site : 03CH07-HY Condition : PEAK_BE(B4)_16-24 3m HF_ANT_00075962 VERTICAL Detector : RBW:1000.000kHz VBW:3000.000kHz SWT:Auto Project : BN2626 Mode : 109</p>	<p>Date: 2019-01-08 PEAK(B4)_16-24</p> <p>Site : 03CH07-HY Condition : PEAK(LUN1) 3m HF_ANT_00075962 VERTICAL Detector : RBW:1000.000kHz VBW:3000.000kHz SWT:Auto Project : BN2626 Mode : 109</p>
<p>Peak</p>	<p>Date: 2019-01-08 PEAK_BE(B4)_16-24</p> <p>Site : 03CH07-HY Condition : PEAK_BE(B4)_16-24 3m HF_ANT_00075962 VERTICAL Detector : RBW:1000.000kHz VBW:3000.000kHz SWT:Auto Project : BN2626 Mode : 109</p>	<p>Left blank</p>



WIFI	Band 4 5725~5850MHz Band Edge @ 3m	
ANT	802.11n HT20 CH165 5825MHz	
1	Horizontal	Fundamental
Peak	<p>Site : ESCH07-RV Condition : PEAK_BE(B4) 16-24 3m HF_ANT_00075962 HORIZONTAL Detector : RBW:1000.000kHz VBW:3000.000kHz SWT:Auto Project : 8N2626 Mode : 110</p>	<p>Site : ESCH07-RV Condition : PEAK(U1N) 3m HF_ANT_00075962 HORIZONTAL Detector : RBW:1000.000kHz VBW:3000.000kHz SWT:Auto Project : 8N2626 Mode : 110</p>

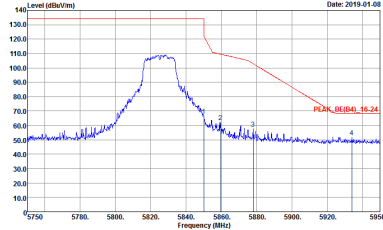
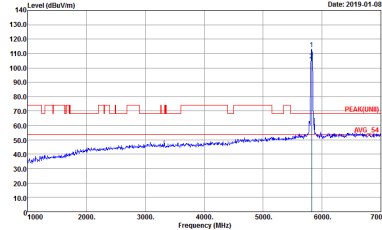

WIFI	Band 4 5725~5850MHz Band Edge @ 3m	
ANT	802.11n HT20 CH165 5825MHz	
1	Vertical	Fundamental
Peak	 <p>Site : ESCH07-RV Condition : PEAK_BE(B4) 16-24 3m HF_ANT_00075962 VERTICAL Detector : RBW:1000.000kHz VBW:3000.000kHz SWT:Auto Project : 8N2626 Mode : 110</p>	 <p>Site : ESCH07-RV Condition : PEAK(U/N1) 3m HF_ANT_00075962 VERTICAL Detector : Peak Project : 8N2626 Mode : 110</p>



Band 4 5725~5850MHz
WIFI 802.11n HT40 (Band Edge @ 3m)

WIFI	Band 4 5725~5850MHz Band Edge @ 3m	
ANT	802.11n HT40 CH151 5755MHz	
1	Horizontal	Fundamental
Peak	<p>Site : 03CH07-HY Condition : PEAK_BE(B4)_16-24 3m HF_ANT_00075962 HORIZONTAL Detector : Peak Project : BN2626 Mode : 132</p>	<p>Site : 03CH07-HY Condition : PEAK(LIN) 3m HF_ANT_00075962 HORIZONTAL Detector : Peak Project : BN2626 Mode : 132</p>
Peak	<p>Site : 03CH07-HY Condition : PEAK_BE(B4)_16-24 3m HF_ANT_00075962 HORIZONTAL Detector : Peak Project : BN2626 Mode : 132</p>	Left blank



WIFI	Band 4 5725~5850MHz Band Edge @ 3m	
ANT	802.11n HT40 CH151 5755MHz	
1	Vertical	Fundamental
Peak	<p>Site : 03CH07-HY Condition : PEAK_BE(B4)_16-24 3m HF_ANT_00075962 VERTICAL Detector : Peak Project : BN2626 Mode : 132</p>	<p>Site : 03CH07-HY Condition : PEAK(LN11) 3m HF_ANT_00075962 VERTICAL Detector : Peak Project : BN2626 Mode : 132</p>
Peak	<p>Site : 03CH07-HY Condition : PEAK_BE(B4)_16-24 3m HF_ANT_00075962 VERTICAL Detector : Peak Project : BN2626 Mode : 132</p>	Left blank



WIFI	Band 4 5725~5850MHz Band Edge @ 3m	
ANT	802.11n HT40 CH159 5795MHz	
1	Horizontal	Fundamental
<p>Peak</p>	<p>Date: 2019-01-08 PEAK_BE(B4)_16-24</p> <p>Site : 03CH07-HY Condition : PEAK_BE(B4)_16-24 3m HF_ANT_00075962 HORIZONTAL RBW:1000.000kHz VBW:3000.000kHz SWT:Auto Detector : Peak Project : BN2626 Mode : 132</p>	<p>Date: 2019-01-08 PEAK(B4)</p> <p>Site : 03CH07-HY Condition : PEAK(LIN) 3m HF_ANT_00075962 HORIZONTAL RBW:1000.000kHz VBW:3000.000kHz SWT:Auto Detector : Peak Project : BN2626 Mode : 132</p>
<p>Peak</p>	<p>Date: 2019-01-08 PEAK_BE(B4)_16-24</p> <p>Site : 03CH07-HY Condition : PEAK_BE(B4)_16-24 3m HF_ANT_00075962 HORIZONTAL RBW:1000.000kHz VBW:3000.000kHz SWT:Auto Detector : Peak Project : BN2626 Mode : 132</p>	<p>Left blank</p>



WIFI	Band 4 5725~5850MHz Band Edge @ 3m	
ANT	802.11n HT40 CH159 5795MHz	
1	Vertical	Fundamental
<p>Peak</p>	<p>Site : 03CH07-HY Condition : PEAK_BE(B4)_16-24 3m HF_ANT_00075962 VERTICAL Detector : Peak Project : BN2626 Mode : 132</p>	<p>Site : 03CH07-HY Condition : PEAK(LIN)I 3m HF_ANT_00075962 VERTICAL Detector : Peak Project : BN2626 Mode : 132</p>
<p>Peak</p>	<p>Site : 03CH07-HY Condition : PEAK_BE(B4)_16-24 3m HF_ANT_00075962 VERTICAL Detector : Peak Project : BN2626 Mode : 132</p>	<p>Left blank</p>



Band 4 5725~5850MHz
WIFI 802.11ac VHT80 (Band Edge @ 3m)

WIFI	Band 4 5725~5850MHz Band Edge @ 3m	
ANT	802.11ac VHT80 CH155 5775MHz	
1	Horizontal	Fundamental
Peak	<p>Site : 03CH07-HY Condition : PEAK_BE(B4)_16-24 3m HF_ANT_00075962 HORIZONTAL Detector : Peak Project : BN2626 Mode : 149</p>	<p>Site : 03CH07-HY Condition : PEAK(LIN) 3m HF_ANT_00075962 HORIZONTAL Detector : Peak Project : BN2626 Mode : 149</p>
Peak	<p>Site : 03CH07-HY Condition : PEAK_BE(B4)_16-24 3m HF_ANT_00075962 HORIZONTAL Detector : Peak Project : BN2626 Mode : 149</p>	Left blank



WIFI	Band 4 5725~5850MHz Band Edge @ 3m	
ANT	802.11ac VHT80 CH155 5775MHz	
1	Vertical	Fundamental
<p>Peak</p>	<p>Date: 2019-01-08 PEAK_BE(B4)_16-24</p> <p>Site : 03CH07-HY Condition : PEAK_BE(B4)_16-24 3m HF_ANT_00075962 VERTICAL Detector : Peak Project : 8N2626 Mode : 149</p>	<p>Date: 2019-01-08 PEAK(FUNB) AVG_25</p> <p>Site : 03CH07-HY Condition : PEAK(FUNB)_3m HF_ANT_00075962 VERTICAL Detector : Peak Project : 8N2626 Mode : 149</p>
<p>Peak</p>	<p>Date: 2019-01-08 PEAK_BE(B4)_16-24</p> <p>Site : 03CH07-HY Condition : PEAK_BE(B4)_16-24 3m HF_ANT_00075962 VERTICAL Detector : Peak Project : 8N2626 Mode : 149</p>	<p>Left blank</p>



Band 4 - 5725~5850MHz
WIFI 802.11a (Harmonic @ 3m)

WIFI	Band 4 5725~5850MHz Harmonic @ 3m	
ANT	802.11a CH149 5745MHz	
1	Horizontal	Vertical
Peak Avg.	<p>Site : 03CH07-HY Condition : PEAK(UWB) 3m SHF-EHF_131029 HORIZONTAL Detector : Peak Project : RN2626 Mode : S2</p>	<p>Site : 03CH07-HY Condition : PEAK(UWB) 3m SHF-EHF_131029 VERTICAL Detector : Peak Project : RN2626 Mode : S2</p>

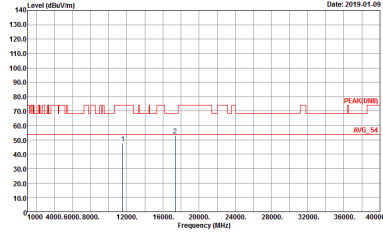
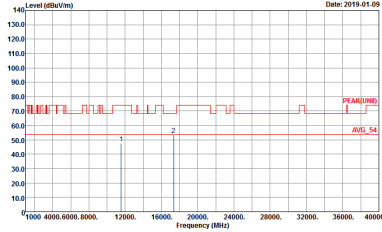

WIFI	Band 4 5725~5850MHz Harmonic @ 3m	
ANT	802.11a CH157 5785MHz	
1	Horizontal	Vertical
<p>Peak</p> <p>Avg.</p>	 <p>Site : ESCH07-11Y Condition : PEAK(LINE) 3m SHF-EHF_131029 HORIZONTAL Detector : Peak Project : RN2626 Mode : S3</p>	 <p>Site : ESCH07-11Y Condition : PEAK(LINE) 3m SHF-EHF_131029 VERTICAL Detector : Peak Project : RN2626 Mode : S3</p>

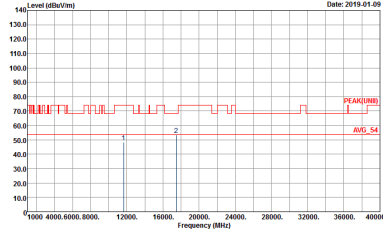
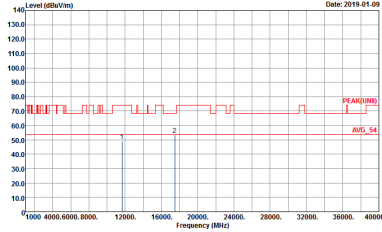

WIFI	Band 4 5725~5850MHz Harmonic @ 3m	
ANT	802.11a CH165 5825MHz	
1	Horizontal	Vertical
<p>Peak</p> <p>Avg.</p>	 <p>Date: 2019-01-09</p> <p>Site : ESCH07-11Y Condition : PEAK(LINE) 3m SHF-EHF_131029 HORIZONTAL Detector : Peak Project : 8N2626 Mode : S4</p>	 <p>Date: 2019-01-09</p> <p>Site : ESCH07-11Y Condition : PEAK(LINE) 3m SHF-EHF_131029 VERTICAL Detector : Peak Project : 8N2626 Mode : S4</p>



Band 4 5725~5850MHz
WIFI 802.11n HT20 (Harmonic @ 3m)

WIFI	Band 4 5725~5850MHz Harmonic @ 3m	
ANT	802.11n HT20 CH149 5745MHz	
1	Horizontal	Vertical
<p>Peak</p> <p>Avg.</p>	<p>Date: 2019-01-12</p> <p>Site : 03CH07-HY Condition : PEAK(UNII) 3m SHF-EHF_131029 HORIZONTAL Detector : Peak Project : 8N2626 Mode : 108</p>	<p>Date: 2019-01-12</p> <p>Site : 03CH07-HY Condition : PEAK(UNII) 3m SHF-EHF_131029 VERTICAL Detector : Peak Project : 8N2626 Mode : 108</p>

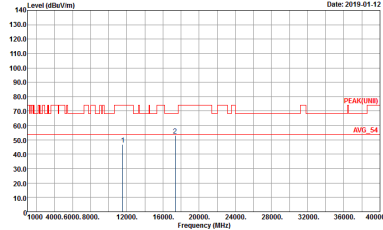
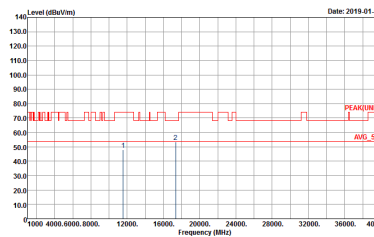

WIFI	Band 4 5725~5850MHz Harmonic @ 3m	
ANT	802.11n HT20 CH157 5785MHz	
1	Horizontal	Vertical
<p>Peak</p> <p>Avg.</p>	 <p>Site : E8CH07-RV Condition : PEAK(LINE) 3m SHF-EHF_131029 HORIZONTAL Detector : Peak Project : 8N2626 Mode : 109</p>	 <p>Site : E8CH07-RV Condition : PEAK(LINE) 3m SHF-EHF_131029 VERTICAL Detector : Peak Project : 8N2626 Mode : 109</p>

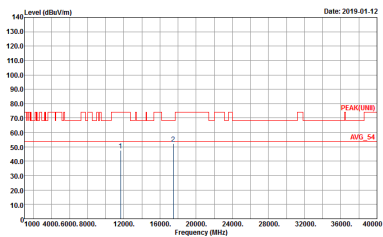
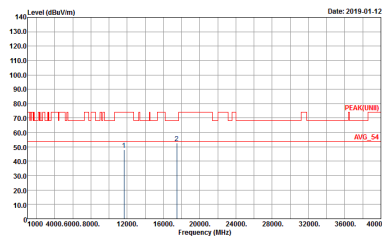

WIFI	Band 4 5725~5850MHz Harmonic @ 3m	
ANT	802.11n HT20 CH165 5825MHz	
1	Horizontal	Vertical
<p>Peak</p> <p>Avg.</p>	 <p>Site : ESCH07-RV Condition : PEAK(LIN) 3m SHF-EHF_131029 HORIZONTAL Detector : Peak Project : 8N2626 Mode : 110</p>	 <p>Site : ESCH07-RV Condition : PEAK(LIN) 3m SHF-EHF_131029 VERTICAL Detector : Peak Project : 8N2626 Mode : 110</p>



Band 4 5725~5850MHz
WIFI 802.11n HT40 (Harmonic @ 3m)

WIFI	Band 4 5725~5850MHz Harmonic @ 3m	
ANT	802.11n HT40 CH151 5755MHz	
1	Horizontal	Vertical
Peak Avg.	<p>Site : 03CH07-HY Condition : PEAK(LINII) 3m SHF-EHF_131029 HORIZONTAL Detector : Peak Project : 8N2626 Mode : 132</p>	<p>Site : 03CH07-HY Condition : PEAK(LINII) 3m SHF-EHF_131029 VERTICAL Detector : Peak Project : 8N2626 Mode : 132</p>

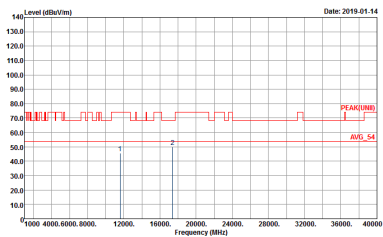
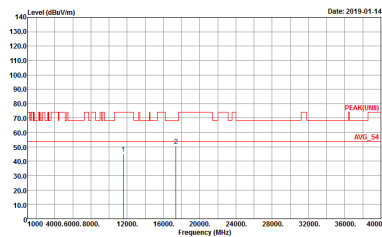

WIFI	Band 4 5725~5850MHz Harmonic @ 3m	
ANT	802.11n HT40 CH159 5795MHz	
1	Horizontal	Vertical
<p>Peak</p> <p>Avg.</p>	 <p>Site : ESCH07-RV Condition : PEAK(LIN) 3m SHF-EHF_131029 HORIZONTAL Detector : Peak Project : 8N2626 Mode : 133</p>	 <p>Site : ESCH07-RV Condition : PEAK(LIN) 3m SHF-EHF_131029 VERTICAL Detector : Peak Project : 8N2626 Mode : 133</p>

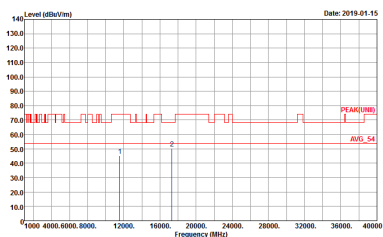
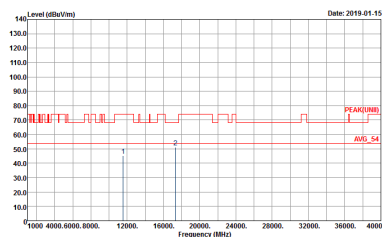

Band 4 5725~5850MHz
WIFI 802.11ac VHT80 (Harmonic @ 3m)

WIFI	Band 4 5725~5850MHz Harmonic @ 3m	
ANT	802.11ac VHT80 CH155 5775MHz	
1	Horizontal	Vertical
<p>Peak</p> <p>Avg.</p>	 <p>Site : 03CH07-HY Condition : PEAK(UNII) 3m SHF-EHF_131029 HORIZONTAL Detector : Peak Project : 8N2626 Mode : 149</p>	 <p>Site : 03CH07-HY Condition : PEAK(UNII) 3m SHF-EHF_131029 VERTICAL Detector : Peak Project : 8N2626 Mode : 149</p>



Emission below 1GHz
5GHz WIFI 802.11ac VHT80 (LF)

WIFI	5GHz 5725-5850MHz	
ANT	802.11ac VHT80 LF	
1	Horizontal	Vertical
QP / Peak	<p>Site : 03CH07-HY Condition : QP 3m LF-ANT-35419(G) HORIZONTAL Detector : Peak Project : 8N2626 Mode : 159</p>	<p>Site : 03CH07-HY Condition : QP 3m LF-ANT-35419(G) VERTICAL Detector : Peak Project : 8N2626 Mode : 159</p>



Band 4 - 5725~5850MHz
WIFI 802.11a (Band Edge @ 3m)

Table with 2 columns: WIFI (Band 4 5725~5850MHz Band Edge @ 3m), ANT (802.11a CH149 5745MHz). Row 2: 2, Horizontal, Fundamental. Includes two spectral plots and technical details like Site, Condition, Detector, Project, Mode.



WIFI	Band 4 5725~5850MHz Band Edge @ 3m	
ANT	802.11a CH149 5745MHz	
2	Vertical	Fundamental
Peak	<p>Site : ESCH07-RY Condition : PEAK_BE(B4)_16-24 3m HF_ANT_00075962 VERTICAL Detector : Peak Project : 8N2626 Mode : 95</p>	<p>Site : ESCH07-RY Condition : PEAK(LIN)1 3m HF_ANT_00075962 VERTICAL Detector : Peak Project : 8N2626 Mode : 95</p>



WIFI	Band 4 5725~5850MHz Band Edge @ 3m	
ANT	802.11a CH157 5785MHz	
2	Horizontal	Fundamental
<p>Peak</p>	<p>Site : 03CH07-HY Condition : PEAK_BE(B4)_16-24 3m HF_ANT_00075962 HORIZONTAL Detector : Peak Project : BN2626 Mode : 96</p>	<p>Site : 03CH07-HY Condition : PEAK(LIN) 3m HF_ANT_00075962 HORIZONTAL Detector : Peak Project : BN2626 Mode : 96</p>
<p>Peak</p>	<p>Site : 03CH07-HY Condition : PEAK_BE(B4)_16-24 3m HF_ANT_00075962 HORIZONTAL Detector : Peak Project : BN2626 Mode : 96</p>	<p>Left blank</p>



WIFI	Band 4 5725~5850MHz Band Edge @ 3m	
ANT	802.11a CH157 5785MHz	
2	Vertical	Fundamental
<p>Peak</p>	<p>Site : 03CH07-HY Condition : PEAK_BE(B4)_16-24 3m HF_ANT_00075962 VERTICAL Detector : Peak Project : BN2626 Mode : 96</p>	<p>Site : 03CH07-HY Condition : PEAK(LIN) 3m HF_ANT_00075962 VERTICAL Detector : Peak Project : BN2626 Mode : 96</p>
<p>Peak</p>	<p>Site : 03CH07-HY Condition : PEAK_BE(B4)_16-24 3m HF_ANT_00075962 VERTICAL Detector : Peak Project : BN2626 Mode : 96</p>	<p>Left blank</p>



WIFI	Band 4 5725~5850MHz Band Edge @ 3m	
ANT	802.11a CH165 5825MHz	
2	Horizontal	Fundamental
Peak		

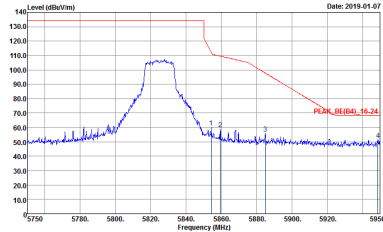
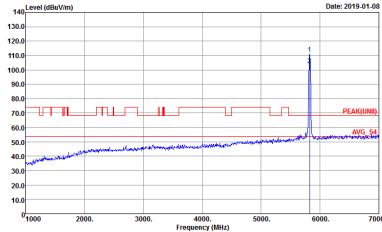

WIFI	Band 4 5725~5850MHz Band Edge @ 3m	
ANT	802.11a CH165 5825MHz	
2	Vertical	Fundamental
Peak	 <p>Site : ESCH07-RV Condition : PEAK_BE(B4) 16-24 3m HF_ANT_00075962 VERTICAL Detector : RBW:1000.000kHz VBW:3000.000kHz SWT:Auto Detector : Peak Project : 8N2626 Mode : 97</p>	 <p>Site : ESCH07-RV Condition : PEAK(U/N1) 3m HF_ANT_00075962 VERTICAL Detector : RBW:1000.000kHz VBW:3000.000kHz SWT:Auto Detector : Peak Project : 8N2626 Mode : 97</p>



**Band 4 5725~5850MHz
WIFI 802.11n HT20 (Band Edge @ 3m)**

WIFI	Band 4 5725~5850MHz Band Edge @ 3m	
ANT	802.11n HT20 CH149 5745MHz	
2	Horizontal	Fundamental
<p>Peak</p>		

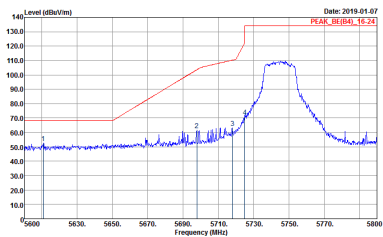
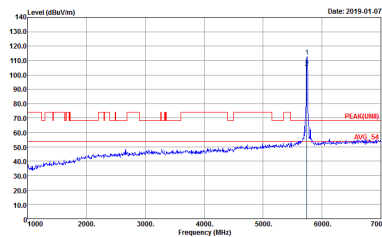

WIFI	Band 4 5725~5850MHz Band Edge @ 3m	
ANT	802.11n HT20 CH149 5745MHz	
2	Vertical	Fundamental
Peak	 <p>Site : ESCH07-RV Condition : PEAK_BE(B4) 16-24 3m HF_ANT_00075962 VERTICAL Detector : RBW:1000.000kHz VBW:3000.000kHz SWT:Auto Project : FR8N26 Mode : 121</p>	 <p>Site : ESCH07-RV Condition : PEAK(UIN) 3m HF_ANT_00075962 VERTICAL Detector : Peak Project : FR8N26 Mode : 121</p>



WIFI	Band 4 5725~5850MHz Band Edge @ 3m	
ANT	802.11n HT20 CH157 5785MHz	
2	Horizontal	Fundamental
<p>Peak</p>	<p>Date: 2019-01-09 PEAK_BE(B4)_16-24</p> <p>Site : 03CH07-HY Condition : PEAK_BE(B4)_16-24 3m HF_ANT_00075962 HORIZONTAL Detector : RBW:1000.000KHz VBW:3000.000KHz SWT:Auto Project : BN2626 Mode : 122</p>	<p>Date: 2019-01-09 PEAK(B4)_16-24 AVG 54</p> <p>Site : 03CH07-HY Condition : PEAK(LUN1) 3m HF_ANT_00075962 HORIZONTAL Detector : RBW:1000.000KHz VBW:3000.000KHz SWT:Auto Project : BN2626 Mode : 122</p>
<p>Peak</p>	<p>Date: 2019-01-09 PEAK_BE(B4)_16-24</p> <p>Site : 03CH07-HY Condition : PEAK_BE(B4)_16-24 3m HF_ANT_00075962 HORIZONTAL Detector : RBW:1000.000KHz VBW:3000.000KHz SWT:Auto Project : BN2626 Mode : 122</p>	<p>Left blank</p>



WIFI	Band 4 5725~5850MHz Band Edge @ 3m	
ANT	802.11n HT20 CH157 5785MHz	
2	Vertical	Fundamental
<p>Peak</p>	<p>Site : 03CH07-HY Condition : PEAK_BE(B4)_16-24 3m HF_ANT_00075962 VERTICAL Detector : Peak Project : BN2626 Mode : 122</p>	<p>Site : 03CH07-HY Condition : PEAK(LIN) 3m HF_ANT_00075962 VERTICAL Detector : Peak Project : BN2626 Mode : 122</p>
<p>Peak</p>	<p>Site : 03CH07-HY Condition : PEAK_BE(B4)_16-24 3m HF_ANT_00075962 VERTICAL Detector : Peak Project : BN2626 Mode : 122</p>	<p>Left blank</p>



WIFI	Band 4 5725~5850MHz Band Edge @ 3m	
ANT	802.11n HT20 CH165 5825MHz	
2	Horizontal	Fundamental
Peak	<p>Site : E8CH07-RV Condition : PEAK_BE(B4) 16-24 3m HF_ANT_00075962 HORIZONTAL Detector : RBW:1000.000kHz VBW:3000.000kHz SWT:Auto Project : FR8N26 Mode : 123</p>	<p>Site : E8CH07-RV Condition : PEAK(LIN) 3m HF_ANT_00075962 HORIZONTAL Detector : Peak Project : FR8N26 Mode : 123</p>



WIFI	Band 4 5725~5850MHz Band Edge @ 3m	
ANT	802.11n HT20 CH165 5825MHz	
2	Vertical	Fundamental
Peak	<p>Site : ESCH07-RV Condition : PEAK_BE(B4)_16-24 3m HF_ANT_00075962 VERTICAL Detector : Peak Project : FR8N26 Mode : 123</p>	<p>Site : ESCH07-RV Condition : PEAK(U/N1) 3m HF_ANT_00075962 VERTICAL Detector : Peak Project : FR8N26 Mode : 123</p>



**Band 4 5725~5850MHz
WIFI 802.11n HT40 (Band Edge @ 3m)**

WIFI	Band 4 5725~5850MHz Band Edge @ 3m	
ANT	802.11n HT40 CH151 5755MHz	
2	Horizontal	Fundamental
Peak	<p>Site : 03CH07-HY Condition : PEAK_BE(B4)_16-24 3m HF_ANT_00075962 HORIZONTAL Detector : Peak Project : BN2626 Mode : 142</p>	<p>Site : 03CH07-HY Condition : PEAK(LIN0) 3m HF_ANT_00075962 HORIZONTAL Detector : Peak Project : BN2626 Mode : 142</p>
Peak	<p>Site : 03CH07-HY Condition : PEAK_BE(B4)_16-24 3m HF_ANT_00075962 HORIZONTAL Detector : Peak Project : BN2626 Mode : 142</p>	Left blank

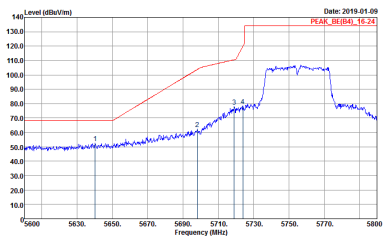
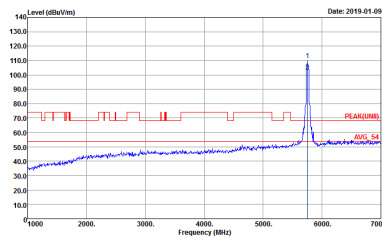
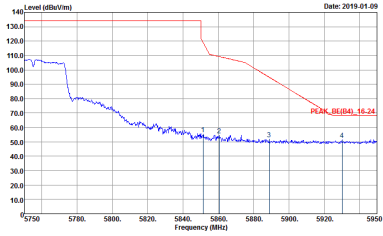

WIFI	Band 4 5725~5850MHz Band Edge @ 3m	
ANT	802.11n HT40 CH151 5755MHz	
2	Vertical	Fundamental
<p>Peak</p>	 <p>Site : 03CH07-HY Condition : PEAK_BE(B4)_16-24 3m HF_ANT_00075962 VERTICAL Detector : Peak Project : BN2626 Mode : 142</p>	 <p>Site : 03CH07-HY Condition : PEAK(LUN1) 3m HF_ANT_00075962 VERTICAL Detector : Peak Project : BN2626 Mode : 142</p>
<p>Peak</p>	 <p>Site : 03CH07-HY Condition : PEAK_BE(B4)_16-24 3m HF_ANT_00075962 VERTICAL Detector : Peak Project : BN2626 Mode : 142</p>	<p>Left blank</p>



WIFI	Band 4 5725~5850MHz Band Edge @ 3m	
ANT	802.11n HT40 CH159 5795MHz	
2	Horizontal	Fundamental
<p>Peak</p>	<p>Date: 2019-01-09 PEAK_BE(B4)_16-24</p> <p>Site : 03CH07-HY Condition : PEAK_BE(B4)_16-24 3m HF_ANT_00075962 HORIZONTAL RBW:1000.000kHz VBW:3000.000kHz SWT:Auto Detector : Peak Project : 8N2626 Mode : 143</p>	<p>Date: 2019-01-09 PEAKLMB AVG_S1</p> <p>Site : 03CH07-HY Condition : PEAKLMB 3m HF_ANT_00075962 HORIZONTAL RBW:1000.000kHz VBW:3000.000kHz SWT:Auto Detector : Peak Project : 8N2626 Mode : 143</p>
<p>Peak</p>	<p>Date: 2019-01-09 PEAK_BE(B4)_16-24</p> <p>Site : 03CH07-HY Condition : PEAK_BE(B4)_16-24 3m HF_ANT_00075962 HORIZONTAL RBW:1000.000kHz VBW:3000.000kHz SWT:Auto Detector : Peak Project : 8N2626 Mode : 143</p>	<p>Left blank</p>



WIFI	Band 4 5725~5850MHz Band Edge @ 3m	
ANT	802.11n HT40 CH159 5795MHz	
2	Vertical	Fundamental
Peak	<p>Site : 03CH07-HY Condition : PEAK_BE(B4)_16-24 3m HF_ANT_00075962 VERTICAL Detector : Peak Project : 8N2626 Mode : 143</p>	<p>Site : 03CH07-HY Condition : PEAK(LUN)I 3m HF_ANT_00075962 VERTICAL Detector : Peak Project : 8N2626 Mode : 143</p>
Peak	<p>Site : 03CH07-HY Condition : PEAK_BE(B4)_16-24 3m HF_ANT_00075962 VERTICAL Detector : Peak Project : 8N2626 Mode : 143</p>	Left blank



Band 4 5725~5850MHz
WIFI 802.11ac VHT80 (Band Edge @ 3m)

WIFI	Band 4 5725~5850MHz Band Edge @ 3m	
ANT	802.11ac VHT80 CH155 5775MHz	
2	Horizontal	Fundamental
Peak	<p>Site : 03CH07-HY Condition : PEAK_BE(B4)_16-24 3m HF_ANT_00075962 HORIZONTAL Detector : Peak Project : BN2626 Mode : 155</p>	<p>Site : 03CH07-HY Condition : PEAK(LIN) 3m HF_ANT_00075962 HORIZONTAL Detector : Peak Project : BN2626 Mode : 155</p>
Peak	<p>Site : 03CH07-HY Condition : PEAK_BE(B4)_16-24 3m HF_ANT_00075962 HORIZONTAL Detector : Peak Project : BN2626 Mode : 155</p>	Left blank



WIFI	Band 4 5725~5850MHz Band Edge @ 3m	
ANT	802.11ac VHT80 CH155 5775MHz	
2	Vertical	Fundamental
Peak	<p>Date: 2019-01-09 PEAK_BE(B4)_16-24</p> <p>Site : 03CH07-HY Condition : PEAK_BE(B4)_16-24 3m HF_ANT_00075962 VERTICAL RBW:1000.000kHz VBW:3000.000kHz SWT:Auto Detector : Peak Project : 8N/2626 Mode : 155</p>	<p>Date: 2019-01-09 PEAK(B4)</p> <p>Site : 03CH07-HY Condition : PEAK(LIN) 3m HF_ANT_00075962 VERTICAL RBW:1000.000kHz VBW:3000.000kHz SWT:Auto Detector : Peak Project : 8N/2626 Mode : 155</p>
Peak	<p>Date: 2019-01-09 PEAK_BE(B4)_16-24</p> <p>Site : 03CH07-HY Condition : PEAK_BE(B4)_16-24 3m HF_ANT_00075962 VERTICAL RBW:1000.000kHz VBW:3000.000kHz SWT:Auto Detector : Peak Project : 8N/2626 Mode : 155</p>	Left blank



Band 4 - 5725~5850MHz
WIFI 802.11a (Harmonic @ 3m)

WIFI	Band 4 5725~5850MHz Harmonic @ 3m	
ANT	802.11a CH149 5745MHz	
2	Horizontal	Vertical
Peak Avg.	<p>Site : 03CH07-HY Condition : PEAK(UWB) 3m SHF-EHF_131029 HORIZONTAL Detector : Peak Project : RN2626 Mode : 95</p>	<p>Site : 03CH07-HY Condition : PEAK(UWB) 3m SHF-EHF_131029 VERTICAL Detector : Peak Project : RN2626 Mode : 95</p>

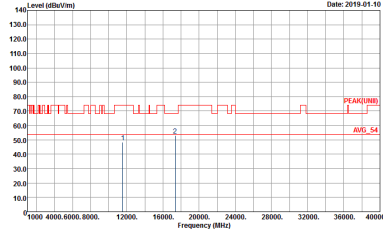
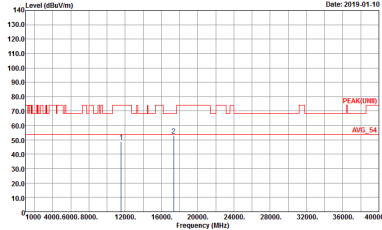

WIFI	Band 4 5725~5850MHz Harmonic @ 3m	
ANT	802.11a CH157 5785MHz	
2	Horizontal	Vertical
<p>Peak</p> <p>Avg.</p>	 <p>Site : ESCH07-11Y Condition : PEAK(LIN) 3m SHF-EHF_131029 HORIZONTAL Detector : Peak Project : 8N2626 Mode : 9G</p>	 <p>Site : ESCH07-11Y Condition : PEAK(LIN) 3m SHF-EHF_131029 VERTICAL Detector : Peak Project : 8N2626 Mode : 9G</p>



WIFI	Band 4 5725~5850MHz Harmonic @ 3m	
ANT	802.11a CH165 5825MHz	
2	Horizontal	Vertical
Peak Avg.	<p>Site : ESCH07-11Y Condition : PEAK(LIN) 3m SHF-EHF_131029 HORIZONTAL Detector : Peak Project : 8N2626 Mode : 97</p>	<p>Site : ESCH07-11Y Condition : PEAK(LIN) 3m SHF-EHF_131029 VERTICAL Detector : Peak Project : 8N2626 Mode : 97</p>



Band 4 5725~5850MHz
WIFI 802.11n HT20 (Harmonic @ 3m)

WIFI	Band 4 5725~5850MHz Harmonic @ 3m	
ANT	802.11n HT20 CH149 5745MHz	
2	Horizontal	Vertical
<p>Peak</p> <p>Avg.</p>	<p>Site : 03CH07-HY Condition : PEAK(UNII) 3m SHF-EHF_131029 HORIZONTAL Detector : Peak Project : 8N2626 Mode : 121</p>	<p>Site : 03CH07-HY Condition : PEAK(UNII) 3m SHF-EHF_131029 VERTICAL Detector : Peak Project : 8N2626 Mode : 121</p>

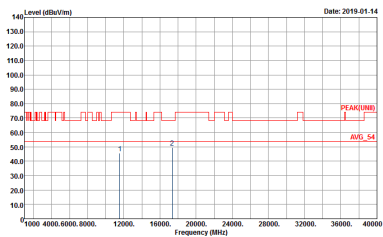
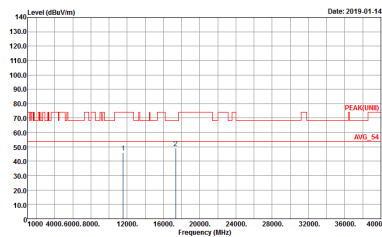

WIFI	Band 4 5725~5850MHz Harmonic @ 3m	
ANT	802.11n HT20 CH157 5785MHz	
2	Horizontal	Vertical
<p>Peak</p> <p>Avg.</p>	 <p>Site : ESCH07-11Y Condition : PEAK(LIN) 3m SHF-EHF_131029 HORIZONTAL Detector : Peak Project : 8N2626 Mode : 122</p>	 <p>Site : ESCH07-11Y Condition : PEAK(LIN) 3m SHF-EHF_131029 VERTICAL Detector : Peak Project : 8N2626 Mode : 122</p>

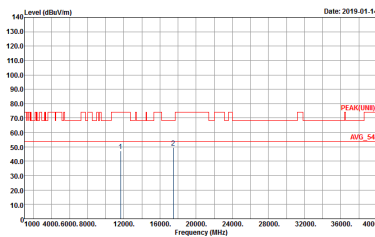
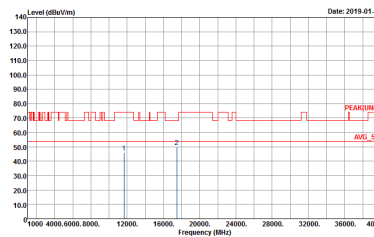

WIFI	Band 4 5725~5850MHz Harmonic @ 3m	
ANT	802.11n HT20 CH165 5825MHz	
2	Horizontal	Vertical
<p>Peak</p> <p>Avg.</p>	 <p>Site : ESCH07-11Y Condition : PEAK(LINE) 3m SHF-EHF_131029 HORIZONTAL Detector : Peak Project : 8N2626 Mode : 123</p>	 <p>Site : ESCH07-11Y Condition : PEAK(LINE) 3m SHF-EHF_131029 VERTICAL Detector : Peak Project : 8N2626 Mode : 123</p>



Band 4 5725~5850MHz
WIFI 802.11n HT40 (Harmonic @ 3m)

Table with 2 columns: Horizontal and Vertical. Each column contains a spectral plot showing Level (dBm/100MHz) vs Frequency (MHz) with Peak and Avg. markers. Includes metadata like Site, Condition, Detector, Project, and Mode.



WIFI	Band 4 5725~5850MHz Harmonic @ 3m	
ANT	802.11n HT40 CH159 5795MHz	
2	Horizontal	Vertical
Peak Avg.	<p>Site : ESCH07-11Y Condition : PEAK(LINE) 3m SHF-EHF_131029 HORIZONTAL Detector : Peak Project : 8N2626 Mode : 143</p>	<p>Site : ESCH07-11Y Condition : PEAK(LINE) 3m SHF-EHF_131029 VERTICAL Detector : Peak Project : 8N2626 Mode : 143</p>



Band 4 5725~5850MHz
WIFI 802.11ac VHT80 (Harmonic @ 3m)

Table with 4 columns: WIFI, ANT, 2, and two measurement plots (Horizontal and Vertical). Includes 'Peak' and 'Avg.' labels and technical details like Site, Condition, Detector, Project, and Mode.



Emission below 1GHz
5GHz WIFI 802.11ac VHT80 (LF)

WIFI	5GHz 5725~5850MHz	
ANT	802.11ac VHT80 LF	
2	Horizontal	Vertical
QP / Peak	<p>Site : 03CH07-HY Condition : QP 3m LF-ANT-35419(G) HORIZONTAL Detector : Peak Project : 8N2626 Mode : 161 Date: 2019-01-30</p>	<p>Site : 03CH07-HY Condition : QP 3m LF-ANT-35419(G) VERTICAL Detector : Peak Project : 8N2626 Mode : 161 Date: 2019-01-30</p>



Band 4 - 5725~5850MHz
WIFI 802.11a (Band Edge @ 3m)

WIFI	Band 4 5725~5850MHz Band Edge @ 3m	
ANT	802.11a CH149 5745MHz	
1+2	Horizontal	Fundamental
Peak	<p>Site : 09CH07-HY Condition : PEAK_RE(B4)_16-24 3m HF_ANT_00075962 HORIZONTAL Detector : Peak Project : BR2626 Mode : 11</p>	<p>Site : 09CH07-HY Condition : PEAK(FUN) 3m HF_ANT_00075962 HORIZONTAL Detector : Peak Project : BR2626 Mode : 11</p>



WIFI	Band 4 5725~5850MHz Band Edge @ 3m	
ANT	802.11a CH149 5745MHz	
1+2	Vertical	Fundamental
Peak	<p>Site : ESCH07-RV Condition : PEAK_BE(B4) 16-24 3m HF_ANT_00075962 VERTICAL Detector : Peak Project : 8N2626 Mode : 11</p>	<p>Site : ESCH07-RV Condition : PEAK(LIN) 3m HF_ANT_00075962 VERTICAL Detector : Peak Project : 8N2626 Mode : 11</p>



WIFI	Band 4 5725~5850MHz Band Edge @ 3m	
ANT	802.11a CH157 5785MHz	
1+2	Horizontal	Fundamental
<p>Peak</p>	<p>Date: 2018-12-29 PEAK_BE(B4)_16-24</p> <p>Site : 03CH07-HY Condition : PEAK_BE(B4)_16-24 3m HF_ANT_00075962 HORIZONTAL Detector : Peak Project : BN2626 Mode : 12</p>	<p>Date: 2018-12-29 PEAK(FUN)</p> <p>Site : 03CH07-HY Condition : PEAK(FUN) 3m HF_ANT_00075962 HORIZONTAL Detector : Peak Project : BN2626 Mode : 12</p>
<p>Peak</p>	<p>Date: 2018-12-29 PEAK_BE(B4)_16-24</p> <p>Site : 03CH07-HY Condition : PEAK_BE(B4)_16-24 3m HF_ANT_00075962 HORIZONTAL Detector : Peak Project : BN2626 Mode : 12</p>	<p>Left blank</p>



WIFI	Band 4 5725~5850MHz Band Edge @ 3m	
ANT	802.11a CH157 5785MHz	
1+2	Vertical	Fundamental
<p>Peak</p>	<p>Date: 2018-12-29 PEAK_BE(B4)_16-24</p> <p>Site : 03CH07-HY Condition : PEAK_BE(B4)_16-24 3m HF_ANT_00075962 VERTICAL Detector : Peak Project : BN2626 Mode : 12</p>	<p>Date: 2018-12-29 PEAK(B4)_16-24 AVG_54</p> <p>Site : 03CH07-HY Condition : PEAK(LUN1) 3m HF_ANT_00075962 VERTICAL Detector : Peak Project : BN2626 Mode : 12</p>
<p>Peak</p>	<p>Date: 2018-12-29 PEAK_BE(B4)_16-24</p> <p>Site : 03CH07-HY Condition : PEAK_BE(B4)_16-24 3m HF_ANT_00075962 VERTICAL Detector : Peak Project : BN2626 Mode : 12</p>	<p>Left blank</p>



WIFI	Band 4 5725~5850MHz Band Edge @ 3m	
ANT	802.11a CH165 5825MHz	
1+2	Horizontal	Fundamental
Peak		



WIFI	Band 4 5725~5850MHz Band Edge @ 3m	
ANT	802.11a CH165 5825MHz	
1+2	Vertical	Fundamental
Peak	<p>Site : ESCH07-RV Condition : PEAK_BE(B4) 16-24 3m HF_ANT_00075962 VERTICAL Detector : RBW:1000.000kHz VBW:3000.000kHz SWT:Auto Detector : Peak Project : FR8N26 Mode : 13</p>	<p>Site : ESCH07-RV Condition : PEAK(UIN) 3m HF_ANT_00075962 VERTICAL Detector : RBW:1000.000kHz VBW:3000.000kHz SWT:Auto Detector : Peak Project : FR8N26 Mode : 13</p>



**Band 4 5725~5850MHz
WIFI 802.11n HT20 (Band Edge @ 3m)**

WIFI	Band 4 5725~5850MHz Band Edge @ 3m	
ANT	802.11n HT20 CH149 5745MHz	
1+2	Horizontal	Fundamental
Peak	<p>Site : 03CH07-HY Condition : PEAK_BE(B4)_16-24 3m HF_ANT_00075962 HORIZONTAL Detector : RBW:1000.000KHz VBW:3000.000KHz SWT:Auto Project : BN2626 Mode : 24</p>	<p>Site : 03CH07-HY Condition : PEAK(LIN) 3m HF_ANT_00075962 HORIZONTAL Detector : Peak Project : BN2626 Mode : 24</p>



WIFI	Band 4 5725~5850MHz Band Edge @ 3m	
ANT	802.11n HT20 CH149 5745MHz	
1+2	Vertical	Fundamental
Peak	<p>Site : E8CH07-RV Condition : PEAK_BE(B4) 16-24 3m HF_ANT_00075962 VERTICAL Detector : Peak Project : 8N2626 Mode : 24</p>	<p>Site : E8CH07-RV Condition : PEAK(U11) 3m HF_ANT_00075962 VERTICAL Detector : Peak Project : 8N2626 Mode : 24</p>

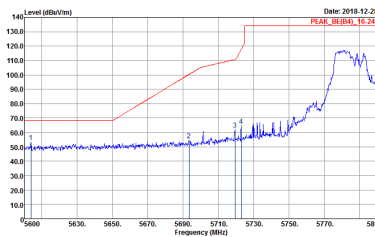
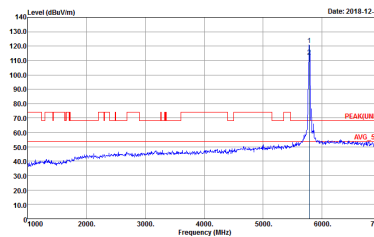
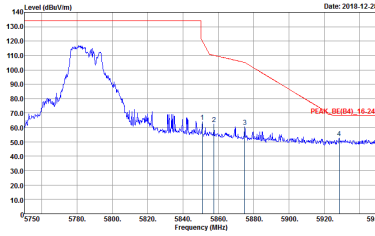

WIFI	Band 4 5725~5850MHz Band Edge @ 3m	
ANT	802.11n HT20 CH157 5785MHz	
1+2	Horizontal	Fundamental
<p>Peak</p>	 <p>Site : 03CH07-HY Condition : PEAK_BE(B4)_16-24 3m HF_ANT_00075962 HORIZONTAL Detector : Peak Project : BN2626 Mode : 25</p>	 <p>Site : 03CH07-HY Condition : PEAK(LIN) 3m HF_ANT_00075962 HORIZONTAL Detector : Peak Project : BN2626 Mode : 25</p>
<p>Peak</p>	 <p>Site : 03CH07-HY Condition : PEAK_BE(B4)_16-24 3m HF_ANT_00075962 HORIZONTAL Detector : Peak Project : BN2626 Mode : 25</p>	<p>Left blank</p>

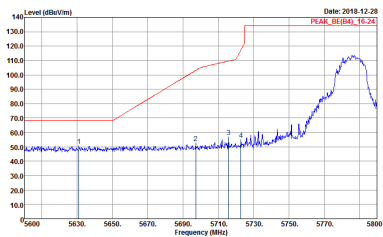
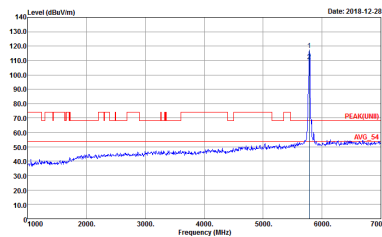
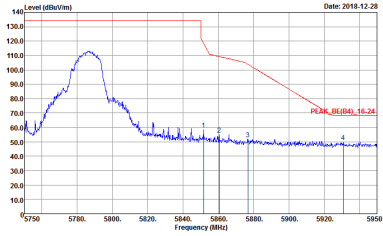

WIFI	Band 4 5725~5850MHz Band Edge @ 3m	
ANT	802.11n HT20 CH157 5785MHz	
1+2	Vertical	Fundamental
<p>Peak</p>	 <p>Date: 2018-12-28 PEAK_BE(B4)_16-24</p> <p>Site : 03CH07-HY Condition : PEAK_BE(B4)_16-24 3m HF_ANT_00075962 VERTICAL Detector : Peak Project : 8N2626 Mode : 25</p>	 <p>Date: 2018-12-28 PEAK(B4)_16-24</p> <p>Site : 03CH07-HY Condition : PEAK(B4)_16-24 3m HF_ANT_00075962 VERTICAL Detector : Peak Project : 8N2626 Mode : 25</p>
<p>Peak</p>	 <p>Date: 2018-12-28 PEAK_BE(B4)_16-24</p> <p>Site : 03CH07-HY Condition : PEAK_BE(B4)_16-24 3m HF_ANT_00075962 VERTICAL Detector : Peak Project : 8N2626 Mode : 25</p>	<p>Left blank</p>

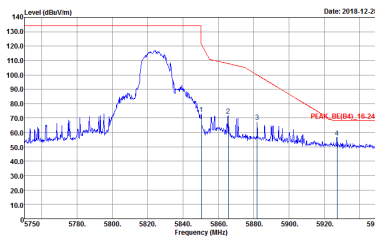
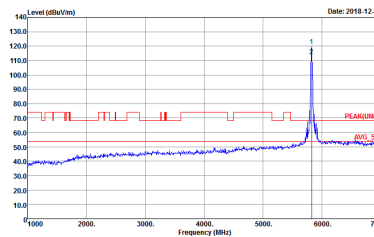

WIFI	Band 4 5725~5850MHz Band Edge @ 3m	
ANT	802.11n HT20 CH165 5825MHz	
1+2	Horizontal	Fundamental
Peak	 <p>Site : ESCH07-RV Condition : PEAK_BE(B4) 16.24 3m HF_ANT_00075962 HORIZONTAL Detector : RBW:1000.000kHz VBW:3000.000kHz SWT:Auto Project : FR8N26 Mode : 26</p>	 <p>Site : ESCH07-RV Condition : PEAK(U1) 3m HF_ANT_00075962 HORIZONTAL Detector : RBW:1000.000kHz VBW:3000.000kHz SWT:Auto Project : FR8N26 Mode : 26</p>



WIFI	Band 4 5725~5850MHz Band Edge @ 3m	
ANT	802.11n HT20 CH165 5825MHz	
1+2	Vertical	Fundamental
Peak	<p>Site : ESCH07-RV Condition : PEAK_BE(B4) 16-24 3m HF_ANT_00075962 VERTICAL Detector : RBW:1000.000kHz VBW:3000.000kHz SWT:Auto Detector : Peak Project : 8N2626 Mode : 26</p>	<p>Site : ESCH07-RV Condition : PEAK(U/N1) 3m HF_ANT_00075962 VERTICAL Detector : RBW:1000.000kHz VBW:3000.000kHz SWT:Auto Detector : Peak Project : 8N2626 Mode : 26</p>



Band 4 5725~5850MHz
WIFI 802.11n HT40 (Band Edge @ 3m)

WIFI	Band 4 5725~5850MHz Band Edge @ 3m	
ANT	802.11n HT40 CH151 5755MHz	
1+2	Horizontal	Fundamental
Peak	<p>Site : 03CH07-HY Condition : PEAK_BE(B4)_16-24 3m HF_ANT_00075962 HORIZONTAL Detector : RBW:1000.000kHz VBW:3000.000kHz SWT:Auto Project : BN2626 Mode : 35</p>	<p>Site : 03CH07-HY Condition : PEAK(LIN) 3m HF_ANT_00075962 HORIZONTAL Detector : Peak Project : BN2626 Mode : 35</p>
Peak	<p>Site : 03CH07-HY Condition : PEAK_BE(B4)_16-24 3m HF_ANT_00075962 HORIZONTAL Detector : Peak Project : BN2626 Mode : 35</p>	Left blank

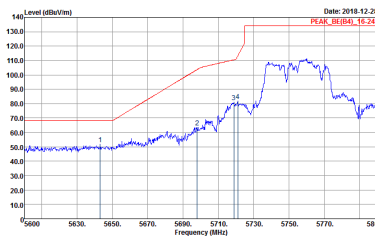
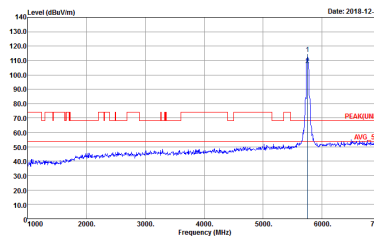
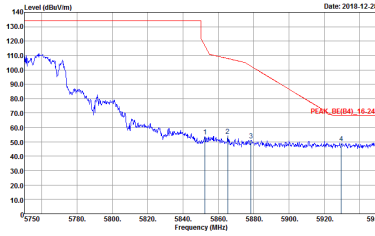

WIFI	Band 4 5725~5850MHz Band Edge @ 3m	
ANT	802.11n HT40 CH151 5755MHz	
1+2	Vertical	Fundamental
<p>Peak</p>	 <p>Date: 2018-12-28 PEAK_BE(B4)_16-24</p> <p>Site : 03CH07-HY Condition : PEAK_BE(B4)_16-24 3m HF_ANT_00075962 VERTICAL Detector : Peak Project : BN2626 Mode : 35</p>	 <p>Date: 2018-12-28 PEAK(B4)_16-24</p> <p>Site : 03CH07-HY Condition : PEAK(B4)_16-24 3m HF_ANT_00075962 VERTICAL Detector : Peak Project : BN2626 Mode : 35</p>
<p>Peak</p>	 <p>Date: 2018-12-28 PEAK_BE(B4)_16-24</p> <p>Site : 03CH07-HY Condition : PEAK_BE(B4)_16-24 3m HF_ANT_00075962 VERTICAL Detector : Peak Project : BN2626 Mode : 35</p>	<p>Left blank</p>



WIFI	Band 4 5725~5850MHz Band Edge @ 3m	
ANT	802.11n HT40 CH159 5795MHz	
1+2	Horizontal	Fundamental
<p>Peak</p>	<p>Date: 2018-12-28 PEAK_BE(B4)_16-24</p> <p>Site : 03CH07-HY Condition : PEAK_BE(B4)_16-24 3m HF_ANT_00075962 HORIZONTAL RBW:1000.000kHz VBW:3000.000kHz SWT:Auto Detector : Peak Project : BN2626 Mode : 36</p>	<p>Date: 2018-12-28 PEAKLMB AVG_S1</p> <p>Site : 03CH07-HY Condition : PEAKLMB 3m HF_ANT_00075962 HORIZONTAL RBW:1000.000kHz VBW:3000.000kHz SWT:Auto Detector : Peak Project : BN2626 Mode : 36</p>
<p>Peak</p>	<p>Date: 2018-12-28 PEAK_BE(B4)_16-24</p> <p>Site : 03CH07-HY Condition : PEAK_BE(B4)_16-24 3m HF_ANT_00075962 HORIZONTAL RBW:1000.000kHz VBW:3000.000kHz SWT:Auto Detector : Peak Project : BN2626 Mode : 36</p>	<p>Left blank</p>

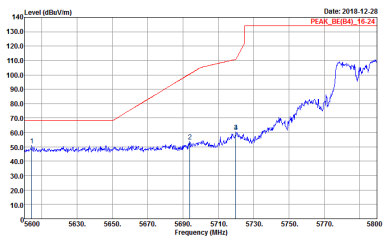
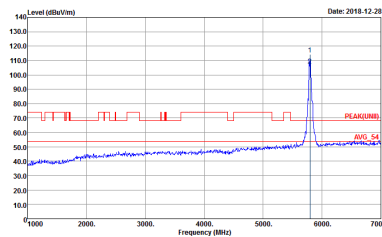
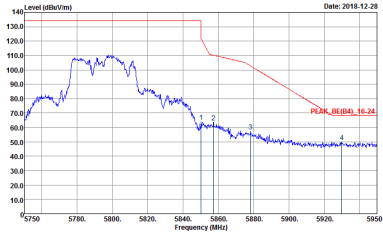

WIFI	Band 4 5725~5850MHz Band Edge @ 3m	
ANT	802.11n HT40 CH159 5795MHz	
1+2	Vertical	Fundamental
<p>Peak</p>	 <p>Date: 2018-12-28 PEAK_BE(B4)_16-24</p> <p>Site : 03CH07-HY Condition : PEAK_BE(B4)_16-24 3m HF_ANT_00075962 VERTICAL Detector : RBW:1000.000kHz VBW:3000.000kHz SWT:Auto Project : BN2626 Mode : 36</p>	 <p>Date: 2018-12-28 PEAK(FUN)</p> <p>Site : 03CH07-HY Condition : PEAK(FUN) 3m HF_ANT_00075962 VERTICAL Detector : RBW:1000.000kHz VBW:3000.000kHz SWT:Auto Project : BN2626 Mode : 36</p>
<p>Peak</p>	 <p>Date: 2018-12-28 PEAK_BE(B4)_16-24</p> <p>Site : 03CH07-HY Condition : PEAK_BE(B4)_16-24 3m HF_ANT_00075962 VERTICAL Detector : RBW:1000.000kHz VBW:3000.000kHz SWT:Auto Project : BN2626 Mode : 36</p>	<p>Left blank</p>



Band 4 5725~5850MHz
WIFI 802.11ac VHT80 (Band Edge @ 3m)

WIFI	Band 4 5725~5850MHz Band Edge @ 3m	
ANT	802.11ac VHT80 CH155 5775MHz	
1+2	Horizontal	Fundamental
Peak	<p>Site : 03CH07-HY Condition : PEAK_BE(B4)_16-24 3m HF_ANT_00075962 HORIZONTAL Detector : Peak Project : BN2626 Mode : 42</p>	<p>Site : 03CH07-HY Condition : PEAK(LIN) 3m HF_ANT_00075962 HORIZONTAL Detector : Peak Project : BN2626 Mode : 42</p>
Peak	<p>Site : 03CH07-HY Condition : PEAK_BE(B4)_16-24 3m HF_ANT_00075962 HORIZONTAL Detector : Peak Project : BN2626 Mode : 42</p>	Left blank

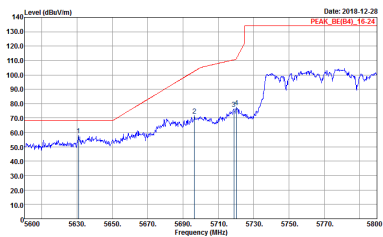
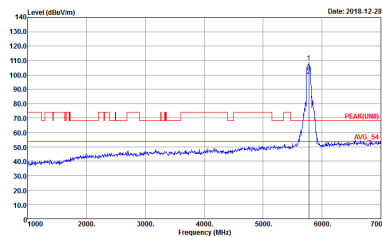
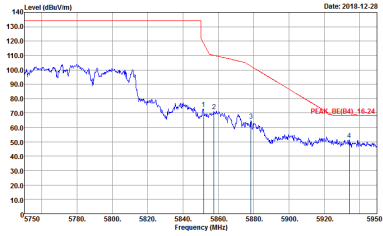

WIFI	Band 4 5725~5850MHz Band Edge @ 3m	
ANT	802.11ac VHT80 CH155 5775MHz	
1+2	Vertical	Fundamental
Peak	 <p>Date: 2018-12-28 PEAK_BE(B4)_16-24</p> <p>Site : 03CH07-HY Condition : PEAK_BE(B4)_16-24 3m HF_ANT_00075962 VERTICAL RBW:1000.000kHz VBW:3000.000kHz SWT:Auto Detector : Peak Project : BN2626 Mode : 42</p>	 <p>Date: 2018-12-28 PEAK(LNB) AVG_51</p> <p>Site : 03CH07-HY Condition : PEAK(LNB)_3m HF_ANT_00075962 VERTICAL RBW:1000.000kHz VBW:3000.000kHz SWT:Auto Detector : Peak Project : BN2626 Mode : 42</p>
Peak	 <p>Date: 2018-12-28 PEAK_BE(B4)_16-24</p> <p>Site : 03CH07-HY Condition : PEAK_BE(B4)_16-24 3m HF_ANT_00075962 VERTICAL RBW:1000.000kHz VBW:3000.000kHz SWT:Auto Detector : Peak Project : BN2626 Mode : 42</p>	Left blank



Band 4 - 5725~5850MHz
WIFI 802.11a (Harmonic @ 3m)

WIFI	Band 4 5725~5850MHz Harmonic @ 3m	
ANT	802.11a CH149 5745MHz	
1+2	Horizontal	Vertical
Peak Avg.	<p>Site : 03CH07-HY Condition : PEAK(UWB) 3m SHF-EHF_131029 HORIZONTAL Detector : Peak Project : RN2626 Mode : 11</p>	<p>Site : 03CH07-HY Condition : PEAK(UWB) 3m SHF-EHF_131029 VERTICAL Detector : Peak Project : RN2626 Mode : 11</p>

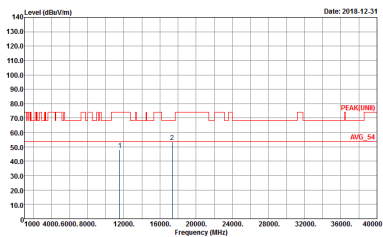
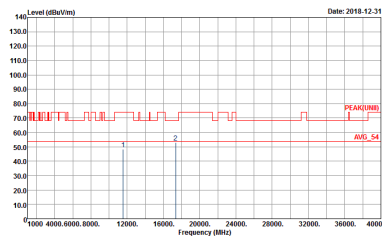

WIFI	Band 4 5725~5850MHz Harmonic @ 3m	
ANT	802.11a CH157 5785MHz	
1+2	Horizontal	Vertical
<p>Peak</p> <p>Avg.</p>	 <p>Site : ESCH07-RV Condition : PEAK(LINE) 3m SHF-EHF_131029 HORIZONTAL Detector : Peak Project : 8N2626 Mode : 12</p>	 <p>Site : ESCH07-RV Condition : PEAK(LINE) 3m SHF-EHF_131029 VERTICAL Detector : Peak Project : 8N2626 Mode : 12</p>



WIFI	Band 4 5725~5850MHz Harmonic @ 3m	
ANT	802.11a CH165 5825MHz	
1+2	Horizontal	Vertical
Peak Avg.	<p>Site : ESCH07-RV Condition : PEAK(LIN) 3m SHF-EHF_131029 HORIZONTAL Detector : Peak Project : 8N2626 Mode : 13</p>	<p>Site : ESCH07-RV Condition : PEAK(LIN) 3m SHF-EHF_131029 VERTICAL Detector : Peak Project : 8N2626 Mode : 13</p>



Band 4 5725~5850MHz
WIFI 802.11n HT20 (Harmonic @ 3m)

Table with 3 columns: WIFI, ANT, 1+2. It contains two spectral plots: Horizontal and Vertical. Each plot shows Level (dBm/100MHz) vs Frequency (MHz) with a peak at 5745MHz. Includes metadata like Site, Condition, Detector, Project, and Mode.



WIFI	Band 4 5725~5850MHz Harmonic @ 3m	
ANT	802.11n HT20 CH157 5785MHz	
1+2	Horizontal	Vertical
Peak Avg.	<p>Site : ESCH07-11Y Condition : PEAK(LIN) 3m SHF-EHF_131029 HORIZONTAL Detector : Peak Project : 8N2626 Mode : 25</p>	<p>Site : ESCH07-11Y Condition : PEAK(LIN) 3m SHF-EHF_131029 VERTICAL Detector : Peak Project : 8N2626 Mode : 25</p>



WIFI	Band 4 5725~5850MHz Harmonic @ 3m	
ANT	802.11n HT20 CH165 5825MHz	
1+2	Horizontal	Vertical
Peak Avg.	<p>Site : ESCH07-11Y Condition : PEAK(LIN) 3m SHF-EHF_131029 HORIZONTAL Detector : Peak Project : 8N2626 Mode : 26</p>	<p>Site : ESCH07-11Y Condition : PEAK(LIN) 3m SHF-EHF_131029 VERTICAL Detector : Peak Project : 8N2626 Mode : 26</p>



Band 4 5725~5850MHz
WIFI 802.11n HT40 (Harmonic @ 3m)

WIFI	Band 4 5725~5850MHz Harmonic @ 3m	
ANT	802.11n HT40 CH151 5755MHz	
1+2	Horizontal	Vertical
Peak Avg.	<p>Site : 03CH07-HY Condition : PEAK(UNII) 3m SHF-EHF_131029 HORIZONTAL Detector : Peak Project : 8N2626 Mode : 35</p>	<p>Site : 03CH07-HY Condition : PEAK(UNII) 3m SHF-EHF_131029 VERTICAL Detector : Peak Project : 8N2626 Mode : 35</p>

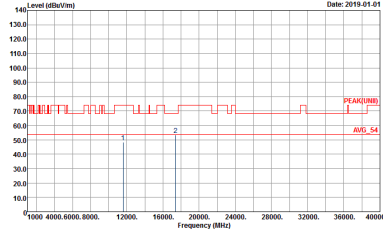
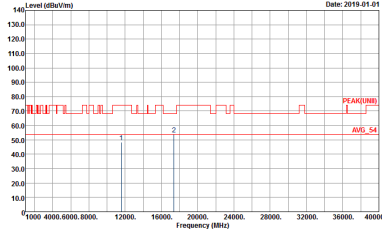

WIFI	Band 4 5725~5850MHz Harmonic @ 3m	
ANT	802.11n HT40 CH159 5795MHz	
1+2	Horizontal	Vertical
<p>Peak</p> <p>Avg.</p>	 <p>Site : ESCH07-11Y Condition : PEAK(LIN) 3m SHF-EHF_131029 HORIZONTAL Detector : Peak Project : 8N2626 Mode : 36</p>	 <p>Site : ESCH07-11Y Condition : PEAK(LIN) 3m SHF-EHF_131029 VERTICAL Detector : Peak Project : 8N2626 Mode : 36</p>



Band 4 5725~5850MHz
WIFI 802.11ac VHT80 (Harmonic @ 3m)

WIFI	Band 4 5725~5850MHz Harmonic @ 3m	
ANT	802.11ac VHT80 CH155 5775MHz	
1+2	Horizontal	Vertical
Peak Avg.	<p>Site : 03CH07-HY Condition : PEAK(UNII) 3m SHF-EHF_131029 HORIZONTAL Detector : Peak Project : 8N2626 Mode : 42</p>	<p>Site : 03CH07-HY Condition : PEAK(UNII) 3m SHF-EHF_131029 VERTICAL Detector : Peak Project : 8N2626 Mode : 42</p>



Emission below 1GHz
5GHz WIFI 802.11ac VHT80 (LF)

WIFI	5GHz 5725-5850MHz	
ANT	802.11ac VHT80 LF	
1+2	Horizontal	Vertical
QP / Peak	<p>Site : 03CH07-HY Condition : QP 3m LF-ANT-35419(G) HORIZONTAL Detector : Peak Project : 8N2626 Mode : 157</p>	<p>Site : 03CH07-HY Condition : QP 3m LF-ANT-35419(G) VERTICAL Detector : Peak Project : 8N2626 Mode : 157</p>



<TXBF Mode>

Band 4 - 5725~5850MHz

WIFI 802.11ac VHT20 (Band Edge @ 3m)

WIFI	Band 4 5725~5850MHz Band Edge @ 3m	
ANT	802.11ac VHT20 CH149 5745MHz	
1+2	Horizontal	Fundamental
Peak	<p>Site : 03CH07-HY Condition : PEAK_RE(B4)_16-24 3m HF_ANT_00075962 HORIZONTAL Detector : Peak Project : FR8N2626 Mode : 53</p>	<p>Site : 03CH07-HY Condition : PEAK(LNB) 3m HF_ANT_00075962 HORIZONTAL Detector : Peak Project : FR8N2626 Mode : 53</p>

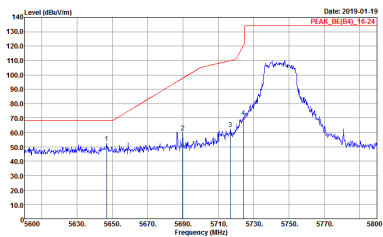
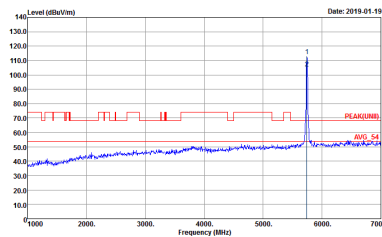

WIFI	Band 4 5725~5850MHz Band Edge @ 3m	
ANT	802.11ac VHT20 CH149 5745MHz	
1+2	Vertical	Fundamental
<p>Peak</p> <p>Avg.</p>	 <p>Site : ESCH07-RY Condition : PEAK_BE(B4)_16-24 3m HF_ANT_00075962 VERTICAL Detector : Peak Project : 8N2626 Mode : 53</p>	 <p>Site : ESCH07-RY Condition : PEAK(UIN) 3m HF_ANT_00075962 VERTICAL Detector : Peak Project : 8N2626 Mode : 53</p>



WIFI	Band 4 5725~5850MHz Band Edge @ 3m	
ANT	802.11ac VHT20 CH157 5785MHz	
1+2	Horizontal	Fundamental
<p>Peak</p>	<p>Date: 2019-01-19 PEAK_BE(B4)_16-24</p> <p>Site : 03CH07-HY Condition : PEAK_BE(B4)_16-24 3m HF_ANT_00075962 HORIZONTAL RBW:1000.000kHz VBW:3000.000kHz SWT:Auto Detector : Peak Project : BN2626 Mode : 54</p>	<p>Date: 2019-01-19 PEAK(B4)_16-24</p> <p>Site : 03CH07-HY Condition : PEAK(LUN1) 3m HF_ANT_00075962 HORIZONTAL RBW:1000.000kHz VBW:3000.000kHz SWT:Auto Detector : Peak Project : BN2626 Mode : 54</p>
<p>Peak</p>	<p>Date: 2019-01-19 PEAK_BE(B4)_16-24</p> <p>Site : 03CH07-HY Condition : PEAK_BE(B4)_16-24 3m HF_ANT_00075962 HORIZONTAL RBW:1000.000kHz VBW:3000.000kHz SWT:Auto Detector : Peak Project : BN2626 Mode : 54</p>	<p>Left blank</p>



WIFI	Band 4 5725~5850MHz Band Edge @ 3m	
ANT	802.11ac VHT20 CH157 5785MHz	
1+2	Vertical	Fundamental
<p>Peak</p>	<p>Site : 03CH07-HY Condition : PEAK_BE(B4)_16-24 3m HF_ANT_00075962 VERTICAL Detector : Peak Project : BN2626 Mode : 54</p>	<p>Site : 03CH07-HY Condition : PEAK(LIN) 3m HF_ANT_00075962 VERTICAL Detector : Peak Project : BN2626 Mode : 54</p>
<p>Peak</p>	<p>Site : 03CH07-HY Condition : PEAK_BE(B4)_16-24 3m HF_ANT_00075962 VERTICAL Detector : Peak Project : BN2626 Mode : 54</p>	<p>Left blank</p>



WIFI	Band 4 5725~5850MHz Band Edge @ 3m	
ANT	802.11ac VHT20 CH165 5825MHz	
1+2	Horizontal	Fundamental
Peak	<p>Site : E3CH07-RV Condition : PEAK_BE(B4)_16-24 3m HF_ANT_00075962 HORIZONTAL Detector : Peak Project : FR8N26 Mode : S5</p>	<p>Site : E3CH07-RV Condition : PEAK(LIN) 3m HF_ANT_00075962 HORIZONTAL Detector : Peak Project : FR8N26 Mode : S5</p>



WIFI	Band 4 5725~5850MHz Band Edge @ 3m	
ANT	802.11ac VHT20 CH165 5825MHz	
1+2	Vertical	Fundamental
<p>Peak</p> <p>Avg.</p>		



Band 4 5725~5850MHz
WIFI 802.11ac VHT40 (Band Edge @ 3m)

WIFI	Band 4 5725~5850MHz Band Edge @ 3m	
ANT	802.11ac VHT40 CH151 5755MHz	
1+2	Horizontal	Fundamental
Peak	<p>Site : 03CH07-HY Condition : PEAK_BE(B4)_16-24 3m HF_ANT_00075962 HORIZONTAL Detector : Peak Project : BN2626 Mode : 64</p>	<p>Site : 03CH07-HY Condition : PEAK(LNB) 3m HF_ANT_00075962 HORIZONTAL Detector : Peak Project : BN2626 Mode : 64</p>
Peak	<p>Site : 03CH07-HY Condition : PEAK_BE(B4)_16-24 3m HF_ANT_00075962 HORIZONTAL Detector : Peak Project : BN2626 Mode : 64</p>	Left blank

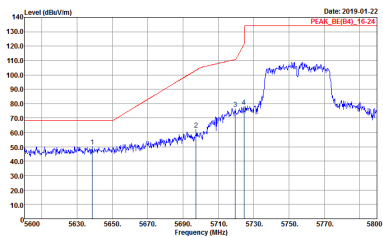
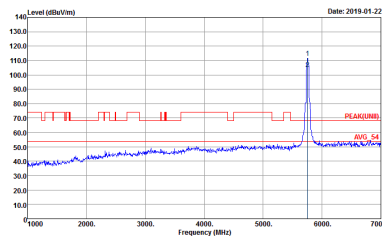
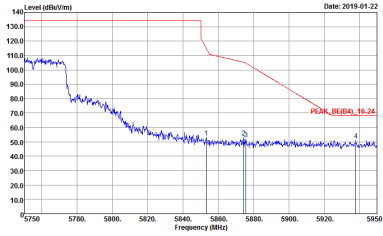

WIFI	Band 4 5725~5850MHz Band Edge @ 3m	
ANT	802.11ac VHT40 CH151 5755MHz	
1+2	Vertical	Fundamental
Peak	 <p>Date: 2019-01-22 PEAK_BE(B4)_16-24</p> <p>Site : 03CH07-HY Condition : PEAK_BE(B4)_16-24 3m HF_ANT_00075962 VERTICAL RBW:1000.000kHz VBW:3000.000kHz SWT:Auto Detector : Peak Project : BN2626 Mode : 64</p>	 <p>Date: 2019-01-22</p> <p>Site : 03CH07-HY Condition : PEAK(LIN) 3m HF_ANT_00075962 VERTICAL RBW:1000.000kHz VBW:3000.000kHz SWT:Auto Detector : Peak Project : BN2626 Mode : 64</p>
Peak	 <p>Date: 2019-01-22</p> <p>Site : 03CH07-HY Condition : PEAK_BE(B4)_16-24 3m HF_ANT_00075962 VERTICAL RBW:1000.000kHz VBW:3000.000kHz SWT:Auto Detector : Peak Project : BN2626 Mode : 64</p>	Left blank