



FCC CO-LOCATION RADIO TEST REPORT

FCC ID : UZ7MC930P
Equipment : Mobile computer
Brand Name : Zebra
Model Name : MC930P
Applicant : Zebra Technologies Corporation
1 Zebra Plaza Holtsville, NY 11742
Manufacturer : Zebra Technologies Corporation
1 Zebra Plaza Holtsville, NY 11742
Standard : FCC Part 15 Subpart E §15.407

The product was received on Nov. 26, 2018 and testing was started from Dec. 25, 2018 and completed on Jan. 25, 2018. We, SPORTON INTERNATIONAL INC. EMC & Wireless Communications Laboratory, would like to declare that the tested sample has been evaluated in accordance with the test procedures and has been in compliance with the applicable technical standards.

The report must not be used by the client to claim product certification, approval, or endorsement by TAF or any agency of government.

The test results in this report apply exclusively to the tested model / sample. Without written approval of SPORTON INTERNATIONAL INC. EMC & Wireless Communications Laboratory, the test report shall not be reproduced except in full.

Approved by: Jones Tsai

SPORTON INTERNATIONAL INC. EMC & Wireless Communications Laboratory
No. 52, Huaya 1st Rd., Guishan Dist., Taoyuan City, Taiwan (R.O.C.)



Table of Contents

History of this test report.....	3
Summary of Test Result.....	4
1 General Description	5
1.1 Product Feature of Equipment Under Test.....	5
1.2 Product Specification of Equipment Under Test.....	7
1.3 Modification of EUT	7
1.4 Testing Location	7
1.5 Applicable Standards.....	8
2 Test Configuration of Equipment Under Test	9
2.1 Carrier Frequency and Channel	9
2.2 Test Mode.....	9
2.3 Connection Diagram of Test System.....	10
2.4 Support Unit used in test configuration and system	10
2.5 EUT Operation Test Setup	10
3 Test Result	11
3.1 Unwanted Emissions Measurement.....	11
3.2 Antenna Requirements	15
4 List of Measuring Equipment.....	16
5 Uncertainty of Evaluation	17
Appendix A. Radiated Spurious Emission	
Appendix B. Radiated Spurious Emission Plots	
Appendix C. Duty Cycle Plots	
Appendix D. Setup Photographs	



Summary of Test Result

Report Clause	Ref Std. Clause	Test Items	Result (PASS/FAIL)	Remark
3.1	15.407(b)	Unwanted Emissions	Pass	Under limit 3.09 dB at 857.900 MHz
3.2	15.203 15.407(a)	Antenna Requirement	Pass	-

Declaration of Conformity:

The test results with all measurement uncertainty excluded are presented in accordance with the regulation limits or requirements declared by manufacturers.

Comments and Explanations:

The declared of product specification for EUT presented in the report are provided by the manufacturer, and the manufacturer takes all the responsibilities for the accuracy of product specification.

Reviewed by: Wii Chang

Report Producer: Nancy Yang



1 General Description

1.1 Product Feature of Equipment Under Test

Product Feature	
Equipment	Mobile computer
Brand Name	Zebra
Model Name	MC930P
FCC ID	UZ7MC930P
Sample 1	EUT with SKU 3
Sample 2	EUT with SKU 4
Sample 3	EUT with SKU 5
Sample 4	EUT with SKU 6
Sample 5	EUT with SKU 7
EUT supports Radios application	NFC WLAN 11a/b/g/n HT20/HT40 WLAN 11ac VHT20/VHT40/VHT80 Bluetooth BR/EDR/LE
HW Version	EV1
SW Version	01-14-11.00-OG
FW Version	FUSION_QA_2_1.3.0.004_O
MFD	13NOV18
EUT Stage	Engineering Sample

Remark: The above EUT's information was declared by manufacturer.

Specification of Accessories				
Adapter (5V/2.5A)	Brand Name	Zebra	Part Number	PWR-WUA5V12W0US
USB-C Adapter	Brand Name	Zebra	Part Number	CBL-MC93-USBCHG-01
USB-C cable	Brand Name	Zebra	Part Number	CBL-TC2X-USBC-01
Std Battery	Brand Name	Zebra	Part Number	BT-000370-00
Fzr Battery	Brand Name	Zebra	Part Number	BT-000371-00
Holster	Brand Name	Zebra	Part Number	051607-79N1-18



<Sample Information>

Model Name	MC930P				
	SKU3	SKU4	SKU5	SKU6	SKU7
Organization / Function / Group	EV1a-G21	EV1a-G22	EV1a-G23	EV1a-F11	EV1a-F13
nm	G-2S-1D-53k	G-2S-2D-53k	G-2S-LRI-53k	G-1F-1D-53k	G-1F-LRI-53k
Product Number	MC930P-GSBDG 4NA	MC930P-GSDDG 4NA	MC930P-GSFDG 4NA	MC930P-GFADG 4NA	MC930P-GFEDG 4NA
Form factor	Gun	Gun	Gun	Gun	Gun
Package/ Component Category	Pkg2	Pkg2	Pkg2	Pkg1 CS	Pkg 1 CS
NFC	YES	YES	YES	YES	YES
Vib	YES	YES	YES	YES	YES
Camera	YES	YES	YES	NO	NO
NI	NO	NO	NO	NO	NO
Side Trigger	NO	NO	NO	NO	NO
Display + TP Stackup	Option2	Option2	Option2	Option5	Option5
Scanner	SE965	SE4750SR	SE4850	SE965	SE4850
Battery	Std	Std	Std	Fzr	Fzr
Keyboard	53 Key	53 Key	53 Key	53 Key	53 Key
Build Date	Oct 2018	Oct 2018	Oct 2018	Nov 2018	Nov 2018



1.2 Product Specification of Equipment Under Test

Standards-related Product Specification	
Tx/Rx Frequency Range	WLAN 802.11b: 2412 MHz ~ 2462 MHz WLAN 802.11a: 5180 MHz ~ 5240 MHz; 5260 MHz ~ 5320 MHz; 5500 MHz ~ 5720 MHz; 5745 MHz ~ 5825 MHz Bluetooth: 2402 MHz ~ 2480 MHz
Antenna Type / Gain	<2412 MHz ~ 2462 MHz> Ant. 1 : Patch Antenna with gain 3.85 dBi Ant. 2 : Patch Antenna with gain 4.58 dBi <5150 MHz ~ 5250 MHz> Ant. 1 : Patch Antenna with gain 4.52 dBi Ant. 2 : Patch Antenna with gain 3.12 dBi <5250 MHz ~ 5350 MHz> Ant. 1 : Patch Antenna with gain 4.12 dBi Ant. 2 : Patch Antenna with gain 3.92 dBi <5470 MHz ~ 5725 MHz> Ant. 1 : Patch Antenna with gain 2.88 dBi Ant. 2 : Patch Antenna with gain 3.92 dBi <5725 MHz ~ 5850 MHz> Ant. 1 : Patch Antenna with gain 2.71 dBi Ant. 2 : Patch Antenna with gain 3.35 dBi <Bluetooth> Patch Antenna with gain 3.85 dBi
Type of Modulation	802.11b: DSSS (DBPSK / DQPSK / CCK) 802.11a: OFDM (BPSK / QPSK / 16QAM / 64QAM) Bluetooth BR (1Mbps): GFSK Bluetooth EDR (2Mbps): $\pi/4$ -DQPSK Bluetooth EDR (3Mbps): 8-DPSK Bluetooth LE: GFSK

1.3 Modification of EUT

No modifications are made to the EUT during all test items.

1.4 Testing Location

Test Site	SPORTON INTERNATIONAL INC.
Test Site Location	No.52, Huaya 1st Rd., Guishan Dist., Taoyuan City, Taiwan (R.O.C.) TEL: +886-3-327-3456 FAX: +886-3-328-4978
Test Site No.	Sporton Site No.
	03CH07-HY

Note: The test site complies with ANSI C63.4 2014 requirement.

FCC Designation No. TW1190



1.5 Applicable Standards

According to the specifications of the manufacturer, the EUT must comply with the requirements of the following standards:

- ♦ FCC Part 15 Subpart E
- ♦ FCC KDB 789033 D02 General UNII Test Procedures New Rules v02r01.
- ♦ FCC KDB 414788 D01 Radiated Test Site v01r01.
- ♦ FCC KDB 662911 D01 Multiple Transmitter Output v02r01.
- ♦ FCC KDB Publication No. 558074 D01 DTS Meas. Guidance v05
- ♦ ANSI C63.10-2013

Remark:

1. All test items were verified and recorded according to the standards and without any deviation during the test.
2. This EUT has also been tested and complied with the requirements of FCC Part 15, Subpart B, recorded in a separate test report.

2 Test Configuration of Equipment Under Test

The EUT has been associated with peripherals and configuration operated in a manner tended to maximize its emission characteristics in a typical application. Frequency range investigated: conduction emission (150 kHz to 30 MHz), radiation emission (9 kHz to the 10th harmonic of the highest fundamental frequency or to 40 GHz, whichever is lower). For radiated measurement, pre-scanned in three orthogonal panels, X, Y, Z. The worst cases (Z plane for WLAN2.4GHz + WLAN5GHz; Z plane for Bluetooth + WLAN5GHz; Y plane for Bluetooth-LE + WLAN2.4GHz) were recorded in this report.

2.1 Carrier Frequency and Channel

2400-2483.5 MHz Bluetooth		2400-2483.5 MHz Bluetooth - LE	
Channel	Freq. (MHz)	Channel	Freq. (MHz)
39	2441	00	2402

2400-2483.5 MHz 802.11b		2400-2483.5 MHz 802.11b	
Channel	Channel	Channel	Freq. (MHz)
06	2437	11	2462

5150-5250 MHz 802.11a		5250-5350 MHz 802.11a	
Channel	Channel	Channel	Freq. (MHz)
44	5220	60	5300

5470-5725 MHz 802.11a		5725-5850 MHz 802.11a	
Channel	Channel	Channel	Freq. (MHz)
116	5580	157	5785

2.2 Test Mode

Final test modes are considering the modulation and worse data rates as below table.

<Co-Location>

Modulation	Data Rate
802.11b for Ant. 1 + 802.11a for Ant. 2	1 Mbps + 6 Mbps
Bluetooth + 802.11a for Ant. 1	1 Mbps + 6 Mbps
Bluetooth-LE + 802.11b for Ant. 1	1 Mbps + 1 Mbps

2.3 Connection Diagram of Test System

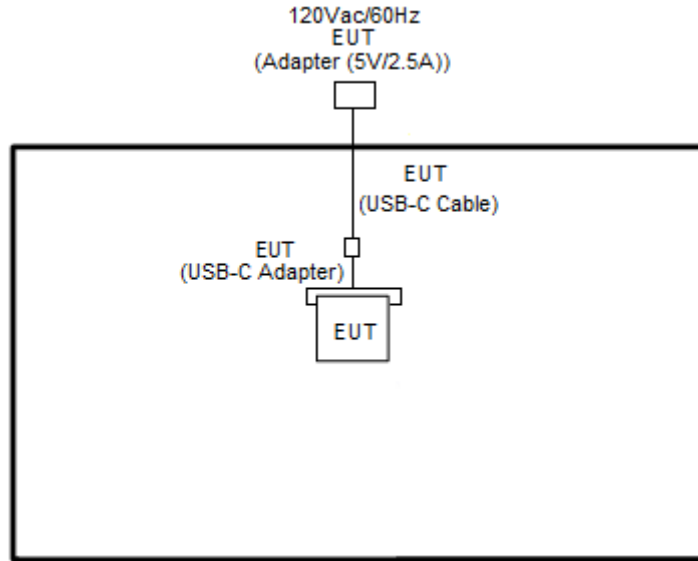

2.4 Support Unit used in test configuration and system

Item	Equipment	Trade Name	Model Name	FCC ID	Data Cable	Power Cord
1.	Notebook	DELL	Latitude E3340	FCC DoC/ Contains FCC ID: PD97260NGU	N/A	AC I/P: Unshielded, 1.2 m DC O/P: Shielded, 1.8 m
2.	Notebook	DELL	P79G	FCC DoC	N/A	AC I/P: Unshielded, 1.2 m DC O/P: Shielded, 1.8 m

2.5 EUT Operation Test Setup

The RF test items, utility “QRCT” was installed in Notebook which was programmed in order to make the EUT get into the engineering modes to provide channel selection, power level, data rate and the application type and for continuous transmitting signals.



3 Test Result

3.1 Unwanted Emissions Measurement

This section is to measure unwanted emissions through radiated measurement for band edge spurious emissions and out of band emissions measurement.

3.1.1 Limit of Unwanted Emissions

(1) Unwanted spurious emissions fallen in restricted bands shall comply with the general field strength limits as below table,

Frequency (MHz)	Field Strength (microvolts/meter)	Measurement Distance (meters)
0.009 – 0.490	2400/F(kHz)	300
0.490 – 1.705	24000/F(kHz)	30
1.705 – 30.0	30	30
30 – 88	100	3
88 – 216	150	3
216 - 960	200	3
Above 960	500	3

Note: The following formula is used to convert the EIRP to field strength.

$$E = \frac{1000000\sqrt{30P}}{3} \mu\text{V/m, where P is the eirp (Watts)}$$

EIRP (dBm)	Field Strength at 3m (dBμV/m)
- 27	68.3

(2) KDB789033 D02 v02r01 G)2)c)

- (i) Section 15.407(b)(1) to (b)(3) specify the unwanted emission limits for the U-NII-1 and U-NII-2 bands. As specified, emissions above 1000 MHz that are outside of the restricted bands are subject to a peak emission limit of -27 dBm/MHz.³
- (ii) Section 15.407(b)(4) specifies the unwanted emission limit for the U-NII-3 band. A band emissions mask is specified in Section 15.407(b)(4)(i). The emission limits are in terms of a Peak detector. An alternative to the band emissions mask is specified in Section 15.407(b)(4)(ii). The alternative limits are based on the highest antenna gain specified in the filing. There are also marketing and importation restrictions for the devices using the alternative limit.⁴

Note 3: An out-of-band emission that complies with both the average and peak limits of Section 15.209 is not required to satisfy the -27 dBm/MHz peak emission limit.

Note 4: Only devices with antenna gains of 10 dBi or less may be approved using the emission limits specified in Section 15.247(d) till March 2, 2018; all other devices operating in this band must use the mask specified in Section 15.407(b)(4)(i).



3.1.2 Measuring Instruments

See list of measuring equipment of this test report.

3.1.3 Test Procedures

1. The testing follows FCC KDB 789033 D02 General UNII Test Procedures New Rules **v02r01**.
Section G) Unwanted emissions measurement.
 - (1) Procedure for Unwanted Emissions Measurements Below 1000MHz
 - RBW = 120 kHz
 - VBW = 300 kHz
 - Detector = Peak
 - Trace mode = max hold
 - (2) Procedure for Peak Unwanted Emissions Measurements Above 1000 MHz
 - RBW = 1 MHz
 - VBW \geq 3 MHz
 - Detector = Peak
 - Sweep time = auto
 - Trace mode = max hold
 - (3) Procedures for Average Unwanted Emissions Measurements Above 1000MHz
 - RBW = 1 MHz
 - VBW = 10 Hz, when duty cycle is no less than 98 percent.
 - VBW \geq 1/T, when duty cycle is less than 98 percent where T is the minimum transmission duration over which the transmitter is on and is transmitting at its maximum power control level for the tested mode of operation.
2. The EUT was placed on a turntable with 0.8 meter for frequency below 1GHz and 1.5 meter for frequency above 1GHz respectively above ground.
3. The EUT was set 3 meters from the interference receiving antenna which was mounted on the top of a variable height antenna tower.
4. The antenna is a broadband antenna and its height is adjusted between one meter and four meters above ground to find the maximum value of the field strength for both horizontal polarization and vertical polarization of the antenna.
5. For each suspected emission, the EUT was arranged to its worst case and then adjust the antenna tower (from 1 m to 4 m) and turntable (from 0 degree to 360 degrees) to find the maximum reading.

6. For testing below 1GHz, if the emission level of the EUT in peak mode was 3 dB lower than the limit specified, then peak values of EUT will be reported, otherwise, the emissions will be repeated one by one using the CISPR quasi-peak method and reported.
7. For testing above 1GHz, the emission level of the EUT in peak mode was 20dB lower than average limit (that means the emission level in average mode also complies with the limit in average mode), then peak values of EUT will be reported, otherwise, the emissions will be measured in average mode again and reported.

3.1.4 Test Setup

For radiated emissions below 30MHz

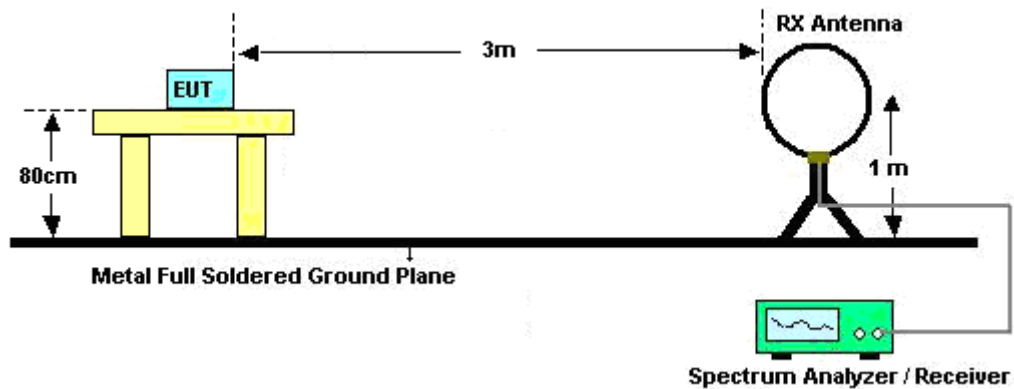

For radiated emissions from 30MHz to 1GHz

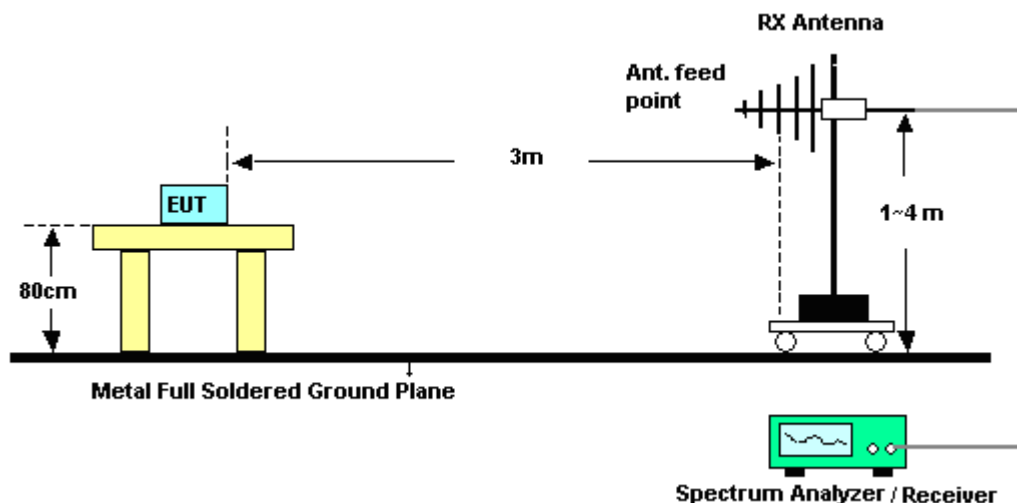

For radiated emissions above 1GHz

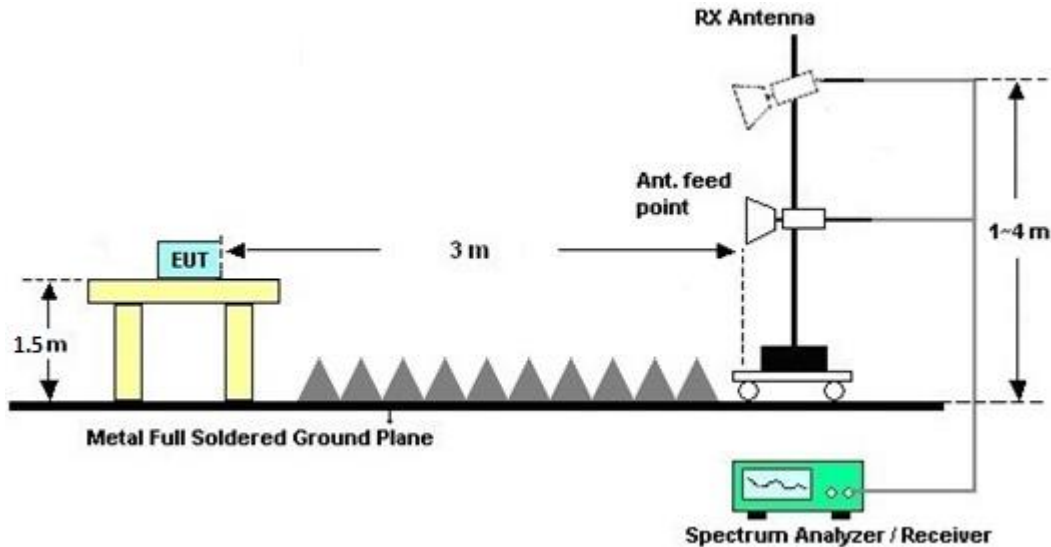

3.1.5 Test Results of Radiated Spurious Emissions (9 kHz ~ 30 MHz)

The low frequency, which started from 9 kHz to 30MHz, was pre-scanned and the result which was 20dB lower than the limit line was not reported.

There is a comparison data of both open-field test site and alternative test site - semi-Anechoic chamber according to 414788 D01 Radiated Test Site v01r01, and the result came out very similar.

3.1.6 Test Result of Radiated Spurious at Band Edges

Please refer to Appendix A and B.

3.1.7 Duty Cycle

Please refer to Appendix C.

3.1.8 Test Result of Radiated Spurious Emissions (30MHz ~ 10th Harmonic)

Please refer to Appendix A and B.



3.2 Antenna Requirements

3.2.1 Standard Applicable

If transmitting antenna directional gain is greater than 6 dBi, both the peak transmit power and the peak power spectral density shall be reduced by the amount in dB that the directional gain of the antenna exceeds 6 dBi.

3.2.2 Antenna Anti-Replacement Construction

An embedded-in antenna design is used.

3.2.3 Antenna Gain

The antenna peak gain of EUT is less than 6 dBi. Therefore, it is not necessary to reduce maximum peak output power limit.



4 List of Measuring Equipment

Instrument	Manufacturer	Model No.	Serial No.	Characteristics	Calibration Date	Test Date	Due Date	Remark
Preamplifier	Agilent	8449B	3008A0191 7	1GHz~ 26.5GHz	Apr. 23, 2018	Dec. 25, 2018~ Jan. 25, 2019	Apr. 22, 2019	Radiation (03CH07-HY)
Bilog Antenna	TESEQ	CBL 6111D&00800 N1D01N-06	35419&03	30MHz to 1GHz	Dec. 16, 2018	Dec. 25, 2018~ Jan. 25, 2019	Dec. 15, 2019	Radiation (03CH07-HY)
Double Ridge Horn Antenna	ESCO	3117	00075962	1GHz ~ 18GHz	Dec. 02, 2018	Dec. 25, 2018~ Jan. 25, 2019	Dec. 03, 2019	Radiation (03CH07-HY)
Loop Antenna	Rohde & Schwarz	HFH2-Z2	100315	9 kHz~30 MHz	May 15, 2017	Dec. 25, 2018~ Jan. 25, 2019	May 14, 2019	Radiation (03CH07-HY)
Preamplifier	MITEQ	AMF-7D-0010 1800-30-10P	1590075	1GHz ~ 18GHz	Apr. 25, 2018	Dec. 25, 2018~ Jan. 25, 2019	Apr. 24, 2019	Radiation (03CH07-HY)
Preamplifier	COM-POWER	PA-103A	161241	10MHz-1GHz	May 21, 2018	Dec. 25, 2018~ Jan. 25, 2019	May 20, 2019	Radiation (03CH07-HY)
RF Cable	HUBER + SUHNER	SUCOFLEX 104	MY28655/4, MY24971/4, MY15682/4	30MHz~1GHz	Feb. 27, 2018	Dec. 25, 2018~ Jan. 25, 2019	Feb. 26, 2019	Radiation (03CH07-HY)
RF Cable	HUBER + SUHNER	SUCOFLEX 104	MY28655/4, MY24971/4, MY15682/4	1GHz~18GHz	Feb. 27, 2018	Dec. 25, 2018~ Jan. 25, 2019	Feb. 26, 2019	Radiation (03CH07-HY)
Antenna Mast	Max-Full	MFA520BS	N/A	1m~4m	N/A	Dec. 25, 2018~ Jan. 25, 2019	N/A	Radiation (03CH07-HY)
Turn Table	ChainTek	Chaintek 3000	N/A	0~360 Degree	N/A	Dec. 25, 2018~ Jan. 25, 2019	N/A	Radiation (03CH07-HY)
Amplifier	MITEQ	TTA1840-35- HG	1871923	18GHz~40GHz, VSWR : 2.5:1 max	Jul. 16, 2018	Dec. 25, 2018~ Jan. 25, 2019	Jul. 15, 2019	Radiation (03CH07-HY)
Software	Audix	E3 6.2009-8-24	RK-001042	N/A	N/A	Dec. 25, 2018~ Jan. 25, 2019	N/A	Radiation (03CH07-HY)
SHF-EHF Horn Antenna	SCHWARZBE CK	BBHA 9170	BBHA9170 251	18GHz- 40GHz	Nov. 20, 2018	Dec. 25, 2018~ Jan. 25, 2019	Nov. 19, 2019	Radiation (03CH07-HY)
RF Cable	HUBER + SUHNER	SF102/2*11S K252	MY4278/2	9kHz~40GHz	May 17, 2018	Dec. 25, 2018~ Jan. 25, 2019	May 16, 2019	Radiation (03CH07-HY)
Spectrum Analyzer	Agilent	N9010A	MY5347011 8	10Hz~44GHz	Apr. 17, 2018	Dec. 25, 2018~ Jan. 25, 2019	Apr. 16, 2019	Radiation (03CH07-HY)



5 Uncertainty of Evaluation

Uncertainty of Radiated Emission Measurement (30 MHz ~ 1000 MHz)

Measuring Uncertainty for a Level of Confidence of 95% ($U = 2Uc(y)$)	5.7
---	-----

Uncertainty of Radiated Emission Measurement (1000 MHz ~ 18000 MHz)

Measuring Uncertainty for a Level of Confidence of 95% ($U = 2Uc(y)$)	5.5
---	-----

Uncertainty of Radiated Emission Measurement (18000 MHz ~ 40000 MHz)

Measuring Uncertainty for a Level of Confidence of 95% ($U = 2Uc(y)$)	5.2
---	-----



Appendix A. Radiated Spurious Emission

Test Engineer :	Jesse Wang, Stan Hsieh, and Troye Hsieh	Temperature :	20~25°C
		Relative Humidity :	55~56%

Co-location Mode

2.4GHz 2400~2483.5MHz + 5GHz Band 1 5150~5250MHz (Harmonic @ 3m)

WIFI Ant. Simultaneously	Note	Frequency (MHz)	Level (dBμV/m)	Over Limit (dB)	Limit Line (dBμV/m)	Read Level (dBμV)	Antenna Factor (dB/m)	Path Loss (dB)	Preamp Factor (dB)	Ant Pos (cm)	Table Pos (deg)	Peak Avg. (P/A)	Pol. (H/V)	
802.11b CH 06 2437MHz (Ant 1) + 802.11a CH 44 5220MHz (Ant 2)		4874	54.63	-19.37	74	43.46	34.13	10.6	33.99	288	323	P	H	
		4874	50.27	-3.73	54	39.1	34.13	10.6	33.99	288	323	P	H	
		7311	44.11	-29.89	74	52.64	35.7	13.19	58.13	100	0	P	H	
		10440	47.2	-21	68.2	51.97	37.4	16.31	59.27	100	0	P	H	
		15660	50.07	-23.93	74	45.77	40.3	19.67	56.57	100	0	P	H	
														H
														H
														H
			4874	54.19	-19.81	74	43.02	34.13	10.6	33.99	384	259	P	V
			4874	49.58	-4.42	54	38.41	34.13	10.6	33.99	384	259	P	V
			7311	44.3	-29.7	74	52.83	35.7	13.19	58.13	100	0	P	V
			10440	46.81	-21.39	68.2	51.58	37.4	16.31	59.27	100	0	P	V
			15660	50.54	-23.46	74	46.24	40.3	19.67	56.57	100	0	P	V
														V
														V
														V
	Remark	1. No other spurious found. 2. All results are PASS against Peak and Average limit line.												



2.4GHz 2400~2483.5MHz + 5GHz Band 2 5250~5350MHz (Harmonic @ 3m)

WIFI Ant. Simultaneously	Note	Frequency (MHz)	Level (dBμV/m)	Over Limit (dB)	Limit Line (dBμV/m)	Read Level (dBμV)	Antenna Factor (dB/m)	Path Loss (dB)	Preamp Factor (dB)	Ant Pos (cm)	Table Pos (deg)	Peak Avg. (P/A)	Pol. (H/V)	
802.11b CH 06 2437MHz (Ant 1) + 802.11a CH 60 5300MHz (Ant 2)		4874	54.41	-19.59	74	43.24	34.13	10.6	33.99	286	325	P	H	
		4874	50.32	-3.68	54	39.15	34.13	10.6	33.99	286	325	P	H	
		7311	44.07	-29.93	74	52.6	35.7	13.19	58.13	100	0	P	H	
		10600	48.17	-25.83	74	52.42	37.5	16.52	59.06	100	0	P	H	
		15900	50.47	-23.53	74	45.61	40.7	19.77	56.52	100	0	P	H	
														H
														H
														H
			4874	53.4	-20.6	74	42.23	34.13	10.6	33.99	388	260	P	V
			4874	49.43	-4.57	54	38.26	34.13	10.6	33.99	388	260	P	V
			7311	44.01	-29.99	74	52.54	35.7	13.19	58.13	100	0	P	V
			10600	47.75	-26.25	74	52	37.5	16.52	59.06	100	0	P	V
			15900	50.53	-23.47	74	45.67	40.7	19.77	56.52	100	0	P	V
														V
														V
													V	
Remark	1. No other spurious found. 2. All results are PASS against Peak and Average limit line.													



2.4GHz 2400~2483.5MHz + 5GHz Band 3 5470~5725MHz (Harmonic @ 3m)

WIFI Ant. Simultaneously	Note	Frequency (MHz)	Level (dBμV/m)	Over Limit (dB)	Limit Line (dBμV/m)	Read Level (dBμV)	Antenna Factor (dB/m)	Path Loss (dB)	Preamp Factor (dB)	Ant Pos (cm)	Table Pos (deg)	Peak Avg. (P/A)	Pol. (H/V)	
802.11b CH 06 2437MHz (Ant 1) + 802.11a CH 116 5580MHz (Ant 2)		4874	54.39	-19.61	74	43.22	34.13	10.6	33.99	266	328	P	H	
		4874	50.73	-3.27	54	39.56	34.13	10.6	33.99	266	328	P	H	
		7311	43.85	-30.15	74	52.38	35.7	13.19	58.13	100	0	P	H	
		11160	49.97	-24.03	74	52.15	37.9	17.24	58.1	100	0	P	H	
		16740	52.31	-15.89	68.2	44.64	42.32	20.41	56.01	100	0	P	H	
														H
														H
														H
			4874	53.73	-20.27	74	42.56	34.13	10.6	33.99	390	255	P	V
			4874	49.44	-4.56	54	38.27	34.13	10.6	33.99	390	255	P	V
			7311	43.66	-30.34	74	52.19	35.7	13.19	58.13	100	0	P	V
			11160	49.2	-24.8	74	51.38	37.9	17.24	58.1	100	0	P	V
			16740	53.33	-14.87	68.2	45.66	42.32	20.41	56.01	100	0	P	V
														V
														V
														V
Remark	1. No other spurious found. 2. All results are PASS against Peak and Average limit line.													



2.4GHz 2400~2483.5MHz + 5GHz Band 4 5725~5850MHz (Harmonic @ 3m)

WIFI Ant. Simultaneously	Note	Frequency (MHz)	Level (dBμV/m)	Over Limit (dB)	Limit Line (dBμV/m)	Read Level (dBμV)	Antenna Factor (dB/m)	Path Loss (dB)	Preamp Factor (dB)	Ant Pos (cm)	Table Pos (deg)	Peak Avg. (P/A)	Pol. (H/V)	
802.11b CH 06 2437MHz (Ant 1) + 802.11a CH 157 5785MHz (Ant 2)		4874	54.88	-19.12	74	43.71	34.13	10.6	33.99	267	322	P	H	
		4874	50.53	-3.47	54	39.36	34.13	10.6	33.99	267	322	P	H	
		7311	43.52	-30.48	74	52.05	35.7	13.19	58.13	100	0	P	H	
		11570	47.86	-26.14	74	48.35	38.17	17.76	57.2	100	0	P	H	
		17355	53.47	-14.73	68.2	45.74	41.55	20.93	55.73	100	0	P	H	
														H
														H
														H
			4874	53.36	-20.64	74	42.19	34.13	10.6	33.99	385	257	P	V
			4874	49.84	-4.16	54	38.67	34.13	10.6	33.99	385	257	P	V
			7311	43.61	-30.39	74	52.14	35.7	13.19	58.13	100	0	P	V
			11570	47.35	-26.65	74	47.84	38.17	17.76	57.2	100	0	P	V
			17355	53.72	-14.48	68.2	45.99	41.55	20.93	55.73	100	0	P	V
														V
														V
													V	
Remark	1. No other spurious found. 2. All results are PASS against Peak and Average limit line.													



2.4GHz 2400~2483.5MHz + 5GHz Band 1 5150~5250MHz (Harmonic @ 3m)

WIFI Ant. Simultaneously	Note	Frequency (MHz)	Level (dBμV/m)	Over Limit (dB)	Limit Line (dBμV/m)	Read Level (dBμV)	Antenna Factor (dB/m)	Path Loss (dB)	Preamp Factor (dB)	Ant Pos (cm)	Table Pos (deg)	Peak Avg. (P/A)	Pol. (H/V)	
BT(1M) CH 39 2480MHz + 802.11a CH 44 5220MHz (Ant 1)		4882	54.75	-19.25	74	43.58	34.13	10.6	33.99	100	0	P	H	
		4882	29.96	-24.04	54							A	H	
		7323	45.34	-28.66	74	53.97	35.63	13.19	58.16	100	0	P	H	
		7323	20.55	-33.45	54							A	H	
		10440	47.25	-20.95	68.2	52.02	37.4	16.31	59.27	100	0	P	H	
		15660	50.45	-23.55	74	46.15	40.3	19.67	56.57	100	0	P	H	
														H
														H
			4882	55.55	-18.45	74	44.38	34.13	10.6	33.99	100	0	P	V
			4882	30.76	-23.24	54							A	V
			7323	45.82	-28.18	74	54.45	35.63	13.19	58.16	100	0	P	V
			7323	21.03	-32.97	54							A	V
			10440	47.22	-20.98	68.2	51.99	37.4	16.31	59.27	100	0	P	V
			15660	50.86	-23.14	74	46.56	40.3	19.67	56.57	100	0	P	V
														V
														V
Remark	1. No other spurious found. 2. All results are PASS against Peak and Average limit line.													



2.4GHz 2400~2483.5MHz (Harmonic @ 3m)

WIFI Ant. Simultaneously	Note	Frequency (MHz)	Level (dBμV/m)	Over Limit (dB)	Limit Line (dBμV/m)	Read Level (dBμV)	Antenna Factor (dB/m)	Path Loss (dB)	Preamp Factor (dB)	Ant Pos (cm)	Table Pos (deg)	Peak Avg. (P/A)	Pol. (H/V)	
BLE CH 00 2437MHz + 802.11b CH 11 2462MHz (Ant 1)		4804	50.75	-23.25	74	39.83	34	10.5	34.01	100	0	P	H	
		4924	50.63	-23.37	74	39.35	34.17	10.66	33.98	100	0	P	H	
		7386	44.17	-29.83	74	52.93	35.5	13.29	58.26	100	0	P	H	
													H	
													H	
													H	
													H	
														H
														H
			4804	50.79	-23.21	74	39.87	34	10.5	34.01	100	0	P	V
			4924	50.25	-23.75	74	38.97	34.17	10.66	33.98	100	0	P	V
			7386	43.84	-30.16	74	52.6	35.5	13.29	58.26	100	0	P	V
														V
														V
														V
													V	
													V	
Remark	1. No other spurious found. 2. All results are PASS against Peak and Average limit line.													



Emission below 1GHz

2.4GHz 2400~2483.5MHz + 5GHz Band 1 5150~5250MHz (LF @ 3m)

WIFI Ant. Simultaneously	Note	Frequency (MHz)	Level (dBμV/m)	Over Limit (dB)	Limit Line (dBμV/m)	Read Level (dBμV)	Antenna Factor (dB/m)	Path Loss (dB)	Preamp Factor (dB)	Ant Pos (cm)	Table Pos (deg)	Peak Avg. (P/A)	Pol. (H/V)	
802.11b CH 06 2437MHz (Ant 1) + 802.11a CH 44 5220MHz (Ant 2)		30.27	31.68	-8.32	40	35.93	24.6	1.2	30.18	-	-	P	H	
		48.09	26.02	-13.98	40	39.76	15.07	1.2	30.15	-	-	P	H	
		190.92	29.4	-14.1	43.5	42.22	14.77	2.18	29.97	-	-	P	H	
		820.1	41.81	-4.19	46	38.52	27.81	4.45	29.25	100	0	P	H	
		847.4	40.78	-5.22	46	36.46	28.71	4.45	29.13	-	-	P	H	
		874	40.79	-5.21	46	35.98	28.94	4.58	29.01	-	-	P	H	
														H
														H
														H
														H
														H
			30.27	34.82	-5.18	40	39.07	24.6	1.2	30.18	100	0	P	V
			38.64	27.42	-12.58	40	36.37	19.88	1.2	30.17	-	-	P	V
			44.85	26.26	-13.74	40	38.37	16.71	1.2	30.16	-	-	P	V
			767.6	36.12	-9.88	46	33.21	27.89	4.18	29.44	-	-	P	V
			904.1	39.18	-6.82	46	34.28	28.81	4.64	28.87	-	-	P	V
			931.4	40.3	-5.7	46	34.48	29.53	4.64	28.68	-	-	P	V
														V
													V	
													V	
													V	
													V	
													V	
Remark	1. No other spurious found. 2. All results are PASS against limit line.													



Emission below 1GHz

2.4GHz 2400~2483.5MHz + 5GHz Band 2 5250~5350MHz (LF @ 3m)

WIFI Ant. Simultaneously	Note	Frequency (MHz)	Level (dBμV/m)	Over Limit (dB)	Limit Line (dBμV/m)	Read Level (dBμV)	Antenna Factor (dB/m)	Path Loss (dB)	Preamp Factor (dB)	Ant Pos (cm)	Table Pos (deg)	Peak Avg. (P/A)	Pol. (H/V)	
802.11b CH 06 2437MHz (Ant 1) + 802.11a CH 60 5300MHz (Ant 2)		30.27	32.41	-7.59	40	36.66	24.6	1.2	30.18	-	-	P	H	
		87.78	26.67	-13.33	40	40.71	14.34	1.55	30.1	-	-	P	H	
		137.19	32.8	-10.7	43.5	43.41	17.42	1.83	30.04	-	-	P	H	
		825	41.19	-4.81	46	37.7	27.99	4.45	29.23	-	-	P	H	
		853.7	41.25	-4.75	46	36.75	28.86	4.45	29.1	-	-	P	H	
		909.7	42.15	-3.85	46	37.09	28.93	4.64	28.83	100	0	P	H	
														H
														H
														H
														H
														H
			30.54	34.06	-5.94	40	38.82	24.09	1.2	30.18	-	-	P	V
			61.05	31.04	-8.96	40	47.59	11.88	1.55	30.13	-	-	P	V
			78.6	30.66	-9.34	40	45.95	13.1	1.55	30.11	-	-	P	V
			773.9	36.79	-9.21	46	33.81	27.94	4.18	29.42	-	-	P	V
			911.8	39.61	-6.39	46	34.49	28.98	4.64	28.82	-	-	P	V
			939.1	41.48	-4.52	46	35.35	29.79	4.64	28.64	100	0	P	V
														V
													V	
													V	
													V	
													V	
													V	
Remark	1. No other spurious found. 2. All results are PASS against limit line.													



Emission below 1GHz

2.4GHz 2400~2483.5MHz + 5GHz Band 3 5470~5725MHz (LF @ 3m)

WIFI Ant. Simultaneously	Note	Frequency (MHz)	Level (dBμV/m)	Over Limit (dB)	Limit Line (dBμV/m)	Read Level (dBμV)	Antenna Factor (dB/m)	Path Loss (dB)	Preamp Factor (dB)	Ant Pos (cm)	Table Pos (deg)	Peak Avg. (P/A)	Pol. (H/V)	
802.11b CH 06 2437MHz (Ant 1) + 802.11a CH 116 5580MHz (Ant 2)		30	31.55	-8.45	40	35.8	24.6	1.2	30.18	-	-	P	H	
		119.1	33.77	-9.73	43.5	44.42	17.4	1.83	30.06	-	-	P	H	
		125.58	33.76	-9.74	43.5	44.16	17.64	1.83	30.05	-	-	P	H	
		829.9	41.6	-4.4	46	37.91	28.16	4.45	29.21	-	-	P	H	
		857.9	42.91	-3.09	46	38.28	28.98	4.45	29.09	100	0	P	H	
		941.2	41.62	-4.38	46	35.32	29.87	4.71	28.62	-	-	P	H	
														H
														H
														H
														H
														H
			30	34.41	-5.59	40	38.66	24.6	1.2	30.18	-	-	P	V
			61.86	31.04	-8.96	40	47.6	11.87	1.55	30.13	-	-	P	V
			82.92	30.37	-9.63	40	45.12	13.63	1.55	30.1	-	-	P	V
			887.3	36.94	-9.06	46	32.18	28.83	4.58	28.96	-	-	P	V
			915.3	40.08	-5.92	46	34.85	29.06	4.64	28.8	-	-	P	V
			941.2	40.82	-5.18	46	34.52	29.87	4.71	28.62	100	0	P	V
														V
														V
														V
													V	
													V	
													V	
Remark	1. No other spurious found. 2. All results are PASS against limit line.													



Emission below 1GHz

2.4GHz 2400~2483.5MHz + Band 4 5725~5850MHz (LF @ 3m)

WIFI Ant. Simultaneously	Note	Frequency (MHz)	Level (dBμV/m)	Over Limit (dB)	Limit Line (dBμV/m)	Read Level (dBμV)	Antenna Factor (dB/m)	Path Loss (dB)	Preamp Factor (dB)	Ant Pos (cm)	Table Pos (deg)	Peak Avg. (P/A)	Pol. (H/V)	
802.11b CH 06 2437MHz (Ant 1) + 802.11a CH 157 5785MHz (Ant 2)		30	31.73	-8.27	40	35.98	24.6	1.2	30.18	-	-	P	H	
		120.72	33.48	-10.02	43.5	44.05	17.48	1.83	30.06	-	-	P	H	
		124.77	34.24	-9.26	43.5	44.59	17.69	1.83	30.05	-	-	P	H	
		833.4	41.53	-4.47	46	37.71	28.27	4.45	29.19	-	-	P	H	
		860.7	41.7	-4.3	46	36.86	29.03	4.58	29.07	-	-	P	H	
		943.3	41.84	-4.16	46	35.36	30.03	4.71	28.6	100	0	P	H	
														H
														H
														H
														H
														H
														H
														H
														H
														H
														H
			30	35.38	-4.62	40	39.63	24.6	1.2	30.18	-	-	P	V
			61.32	30.91	-9.09	40	47.46	11.88	1.55	30.13	-	-	P	V
		78.06	30.74	-9.26	40	46.03	13.1	1.55	30.11	-	-	P	V	
		776.7	37.9	-8.1	46	34.89	27.96	4.18	29.41	-	-	P	V	
		916	39.56	-6.44	46	34.32	29.06	4.64	28.79	-	-	P	V	
		941.9	41.78	-4.22	46	35.43	29.92	4.71	28.62	100	0	P	V	
													V	
													V	
													V	
													V	
													V	
													V	
													V	
Remark	1. No other spurious found. 2. All results are PASS against limit line.													



Emission below 1GHz

2.4GHz 2400~2483.5MHz + 5GHz Band 1 5150~5250MHz (LF @ 3m)

WIFI Ant. Simultaneously	Note	Frequency (MHz)	Level (dBμV/m)	Over Limit (dB)	Limit Line (dBμV/m)	Read Level (dBμV)	Antenna Factor (dB/m)	Path Loss (dB)	Preamp Factor (dB)	Ant Pos (cm)	Table Pos (deg)	Peak Avg. (P/A)	Pol. (H/V)	
BT(1M) CH 39 2480MHz + 802.11a CH 44 5220MHz (Ant 1)		30	31.66	-8.34	40	35.91	24.6	1.2	30.18	-	-	P	H	
		122.88	34.53	-8.97	43.5	44.98	17.59	1.83	30.05	-	-	P	H	
		126.12	34.86	-8.64	43.5	45.26	17.64	1.83	30.05	-	-	P	H	
		885.2	37.4	-8.6	46	32.63	28.85	4.58	28.97	-	-	P	H	
		913.9	40.41	-5.59	46	35.23	29.02	4.64	28.81	-	-	P	H	
		941.9	41.99	-4.01	46	35.64	29.92	4.71	28.62	100	0	P	H	
														H
														H
														H
														H
														H
														H
			30.27	35.23	-4.77	40	39.48	24.6	1.2	30.18	100	0	P	V
			61.32	31.01	-8.99	40	47.56	11.88	1.55	30.13	-	-	P	V
			82.11	31.33	-8.67	40	46.19	13.52	1.55	30.1	-	-	P	V
			801.9	38.51	-7.49	46	35.3	27.94	4.32	29.33	-	-	P	V
			828.5	40.12	-5.88	46	36.5	28.09	4.45	29.21	-	-	P	V
			911.8	41.06	-4.94	46	35.94	28.98	4.64	28.82	-	-	P	V
													V	
													V	
													V	
													V	
													V	
													V	
Remark	1. No other spurious found. 2. All results are PASS against limit line.													



Emission below 1GHz

2.4GHz 2400~2483.5MHz (LF @ 3m)

WIFI Ant. Simultaneously	Note	Frequency (MHz)	Level (dBμV/m)	Over Limit (dB)	Limit Line (dBμV/m)	Read Level (dBμV)	Antenna Factor (dB/m)	Path Loss (dB)	Preamp Factor (dB)	Ant Pos (cm)	Table Pos (deg)	Peak Avg. (P/A)	Pol. (H/V)	
BLE CH 00 2402MHz + 802.11b CH 11 2462MHz (Ant 1)		30	32.31	-7.69	40	36.56	24.6	1.2	30.18	-	-	P	H	
		118.83	34.22	-9.28	43.5	44.87	17.4	1.83	30.06	-	-	P	H	
		125.58	34.75	-8.75	43.5	45.15	17.64	1.83	30.05	-	-	P	H	
		885.2	37.09	-8.91	46	32.32	28.85	4.58	28.97	-	-	P	H	
		912.5	40.61	-5.39	46	35.46	29	4.64	28.81	-	-	P	H	
		937	42.87	-3.13	46	36.83	29.72	4.64	28.65	100	0	P	H	
														H
														H
														H
														H
														H
														H
			30	33.99	-6.01	40	38.24	24.6	1.2	30.18	-	-	P	V
			81.84	30.93	-9.07	40	45.91	13.4	1.55	30.1	-	-	P	V
			86.43	30.98	-9.02	40	45.33	14.03	1.55	30.1	-	-	P	V
			858.6	41.77	-4.23	46	37.13	28.98	4.45	29.08	100	0	P	V
			915.3	41.09	-4.91	46	35.86	29.06	4.64	28.8	-	-	P	V
			943.3	41.24	-4.76	46	34.76	30.03	4.71	28.6	-	-	P	V
													V	
													V	
													V	
													V	
													V	
													V	
Remark	1. No other spurious found. 2. All results are PASS against limit line.													



Note symbol

*	Fundamental Frequency which can be ignored. However, the level of any unwanted emissions shall not exceed the level of the fundamental frequency.
!	Test result is over limit line.
P/A	Peak or Average
H/V	Horizontal or Vertical



A calculation example for radiated spurious emission is shown as below:

WIFI	Note	Frequency	Level	Over	Limit	Read	Antenna	Path	Preamp	Ant	Table	Peak	Pol.
Ant.				Limit	Line	Level	Factor	Loss	Factor	Pos	Pos	Avg.	
0		(MHz)	(dBμV/m)	(dB)	(dBμV/m)	(dBμV)	(dB/m)	(dB)	(dB)	(cm)	(deg)	(P/A)	(H/V)
802.11b		2390	55.45	-18.55	74	54.51	32.22	4.58	35.86	103	308	P	H
CH 01													
2412MHz		2390	43.54	-10.46	54	42.6	32.22	4.58	35.86	103	308	A	H

1. Path Loss(dB) = Cable loss(dB) + Filter loss(dB) + Attenuator loss(dB)
2. Level(dBμV/m) =
Antenna Factor(dB/m) + Path Loss(dB) + Read Level(dBμV) - Preamp Factor(dB)
3. Over Limit(dB) = Level(dBμV/m) – Limit Line(dBμV/m)

For Peak Limit @ 2390MHz:

1. Level(dBμV/m)
= Antenna Factor(dB/m) + Path Loss(dB) + Read Level(dBμV) - Preamp Factor(dB)
= 32.22(dB/m) + 4.58(dB) + 54.51(dBμV) – 35.86 (dB)
= 55.45 (dBμV/m)
2. Over Limit(dB)
= Level(dBμV/m) – Limit Line(dBμV/m)
= 55.45(dBμV/m) – 74(dBμV/m)
= -18.55(dB)

For Average Limit @ 2390MHz:

1. Level(dBμV/m)
= Antenna Factor(dB/m) + Path Loss(dB) + Read Level(dBμV) - Preamp Factor(dB)
= 32.22(dB/m) + 4.58(dB) + 42.6(dBμV) – 35.86 (dB)
= 43.54 (dBμV/m)
2. Over Limit(dB)
= Level(dBμV/m) – Limit Line(dBμV/m)
= 43.54(dBμV/m) – 54(dBμV/m)
= -10.46(dB)

Both peak and average measured complies with the limit line, so test result is “PASS”.



Appendix B. Radiated Spurious Emission Plots

Test Engineer :	Jesse Wang, Stan Hsieh, and Troye Hsieh	Temperature :	20~25°C
		Relative Humidity :	55~56%

Note symbol

-L	Low channel location
-R	High channel location

Co-location Mode

11b_Tx_Ch06 + 11a_Tx_Ch44_Co-location

Ant.	11b_Tx_Ch06 + 11a_Tx_Ch44_Co-location	
	Horizontal	Vertical
Peak Avg.	<p>Site : 03CH07-HY Condition : PEAK(UNII) 3m SHF-EHF_131029 HORIZONTAL Detector : Peak Project : 8N2626 Mode : 152</p>	<p>Site : 03CH07-HY Condition : PEAK(UNII) 3m SHF-EHF_131029 VERTICAL Detector : Peak Project : 8N2626 Mode : 152</p>

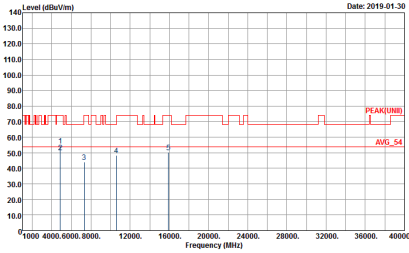
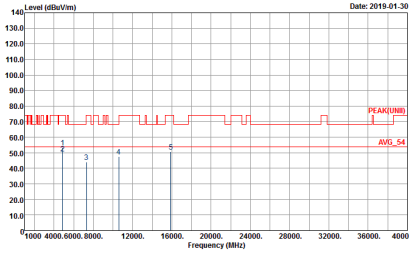

11b_Tx_Ch06 + 11a_Tx_Ch60_Co-location

Ant.	11b_Tx_Ch06 + 11a_Tx_Ch60_Co-location	
	Horizontal	Vertical
Peak Avg.	 <p data-bbox="347 766 614 824">Site : 03CH07-HY Condition : PEAK(LINI) 3m SHF-EHF_131029 HORIZONTAL Detector : Peak Project : BN2626 Mode : 163</p>	 <p data-bbox="941 766 1189 824">Site : 03CH07-HY Condition : PEAK(LINI) 3m SHF-EHF_131029 VERTICAL Detector : Peak Project : BN2626 Mode : 163</p>

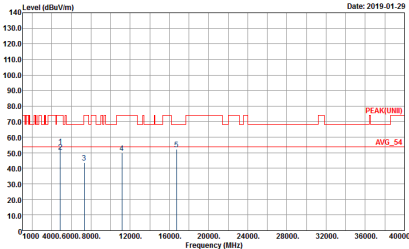
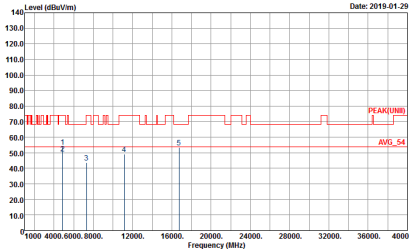

11b_Tx_Ch06 + 11a_Tx_Ch116_Co-location

Ant.	11b_Tx_Ch06 + 11a_Tx_Ch116_Co-location	
	Horizontal	Vertical
<p>Peak</p> <p>Avg.</p>	 <p>Date: 2019-01-29</p> <p>Site : 03CH07-HY Condition : PEAK(UNI) 3m SHF-EHF_131029 HORIZONTAL Detector : Peak Project : BN2626 Mode : 154</p>	 <p>Date: 2019-01-29</p> <p>Site : 03CH07-HY Condition : PEAK(UNI) 3m SHF-EHF_131029 VERTICAL Detector : Peak Project : BN2626 Mode : 154</p>

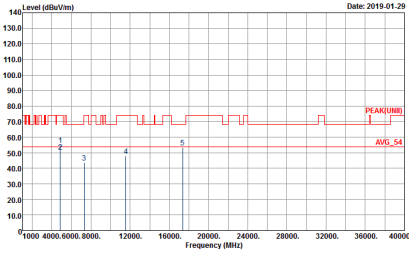
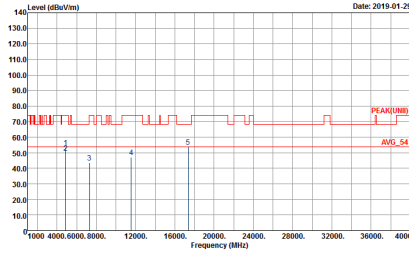

11b_Tx_Ch06 + 11a_Tx_Ch157_Co-location

Ant.	11b_Tx_Ch06 + 11a_Tx_Ch157_Co-location	
	Horizontal	Vertical
Peak Avg.	 <p>Date: 2019-01-29</p> <p>Site : 03CH07-HY Condition : PEAK(LINI) 3m SHF-EHF_131029 HORIZONTAL Detector : Peak Project : BN2626 Mode : 165</p>	 <p>Date: 2019-01-29</p> <p>Site : 03CH07-HY Condition : PEAK(LINI) 3m SHF-EHF_131029 VERTICAL Detector : Peak Project : BN2626 Mode : 165</p>

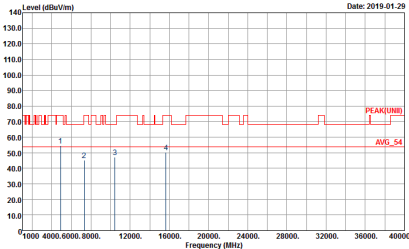
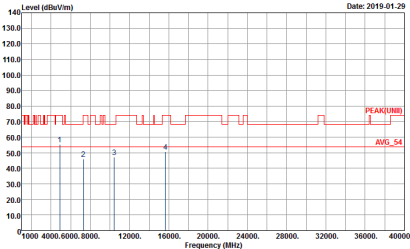

BT_Tx_Ch39 + 11a_Tx_Ch44_Co-location

Ant.	BT_Tx_Ch39 + 11a_Tx_Ch44_Co-location	
	Horizontal	Vertical
<p>Peak</p> <p>Avg.</p>	 <p>Date: 2019-01-29</p> <p>Site : 03CH07-HY Condition : PEAK(LINI) 3m SHF-EHF_131029 HORIZONTAL Detector : Peak Project : BN2626 Mode : 156</p>	 <p>Date: 2019-01-29</p> <p>Site : 03CH07-HY Condition : PEAK(LINI) 3m SHF-EHF_131029 VERTICAL Detector : Peak Project : BN2626 Mode : 156</p>

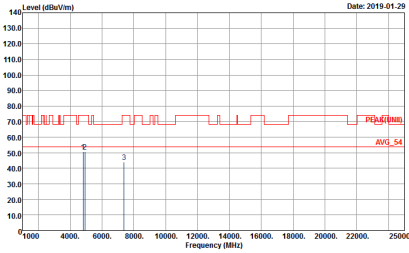
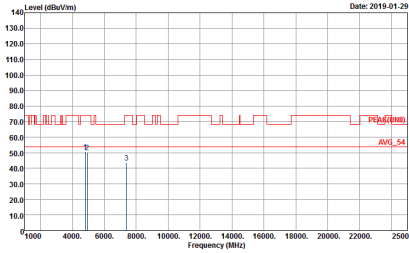

BLE_Tx_Ch00 + 11b_Tx_Ch11_Co-location

Ant.	BLE_Tx_Ch00 + 11b_Tx_Ch11_Co-location	
	Horizontal	Vertical
Peak Avg.	 <p>Site : 03CH07-HY Condition : PEAK(LINII) 3m SHF-EHF_131029 HORIZONTAL Detector : Peak Project : BN2626 Mode : 157</p>	 <p>Site : 03CH07-HY Condition : PEAK(LINII) 3m SHF-EHF_131029 VERTICAL Detector : Peak Project : BN2626 Mode : 157</p>

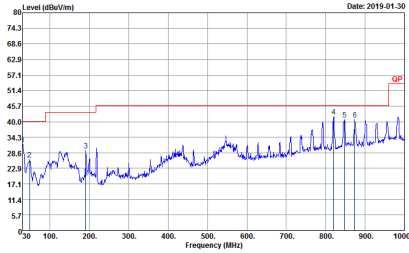
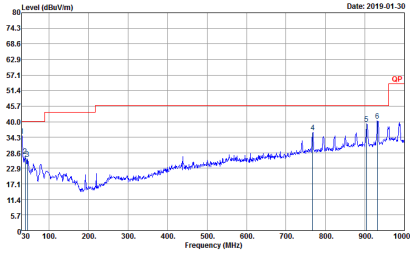

11b_Tx_Ch06 + 11a_Tx_Ch44_Co-location_LF

Ant.	11b_Tx_Ch06 + 11a_Tx_Ch44_Co-location_LF	
	Horizontal	Vertical
QP / Peak	 <p>Site : 03CH07-HY Condition : QP 3m LF-ANT-35419(6) HORIZONTAL Detector : Peak Project : BN2626 Mode : 15Z</p>	 <p>Site : 03CH07-HY Condition : QP 3m LF-ANT-35419(6) VERTICAL Detector : Peak Project : BN2626 Mode : 15Z</p>

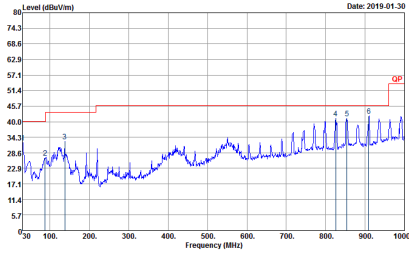
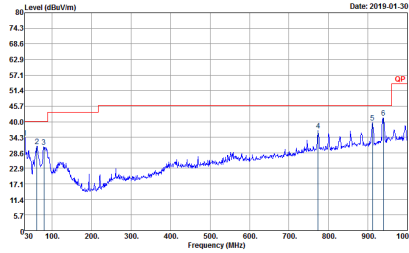

11b_Tx_Ch06 + 11a_Tx_Ch60_Co-location_LF

Ant.	11b_Tx_Ch06 + 11a_Tx_Ch60_Co-location_LF	
	Horizontal	Vertical
QP / Peak	 <p data-bbox="347 766 574 824">Site : 03CH07-HY Condition : QP 3m LF-ANT-35419(6) HORIZONTAL Detector : Peak Project : BN2626 Mode : 163</p>	 <p data-bbox="941 766 1168 824">Site : 03CH07-HY Condition : QP 3m LF-ANT-35419(6) VERTICAL Detector : Peak Project : BN2626 Mode : 163</p>

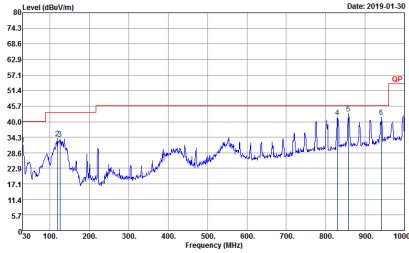
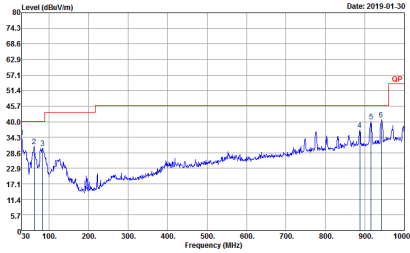

11b_Tx_Ch06 + 11a_Tx_Ch116_Co-location_LF

Ant.	11b_Tx_Ch06 + 11a_Tx_Ch116_Co-location_LF	
	Horizontal	Vertical
<p>QP / Peak</p>	 <p>Site : 03CH07-HY Condition : QP 3m LF-ANT-35419(6) HORIZONTAL Detector : Peak Project : BN2626 Mode : 154</p>	 <p>Site : 03CH07-HY Condition : QP 3m LF-ANT-35419(6) VERTICAL Detector : Peak Project : BN2626 Mode : 154</p>

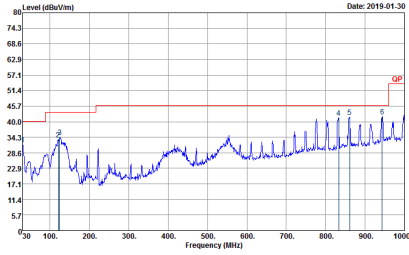
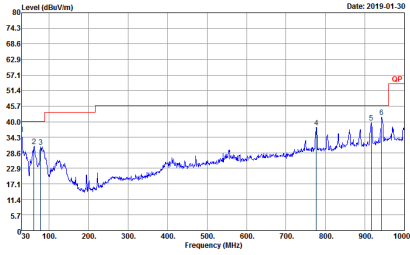

11b_Tx_Ch06 + 11a_Tx_Ch157_Co-location_LF

Ant.	11b_Tx_Ch06 + 11a_Tx_Ch157_Co-location_LF	
	Horizontal	Vertical
QP / Peak	 <p>Site : 03CH07-HY Condition : QP 3m LF-ANT-35419(6) HORIZONTAL Detector : Peak Project : BR2626 Mode : 165</p>	 <p>Site : 03CH07-HY Condition : QP 3m LF-ANT-35419(6) VERTICAL Detector : Peak Project : BR2626 Mode : 165</p>

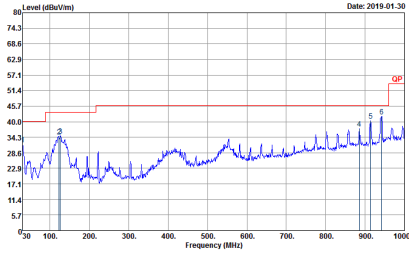
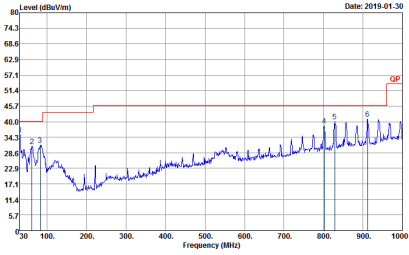

BT(1M)_Tx_Ch39 + 11a_Tx_Ch44_Co-location_LF

Ant.	BT(1M)_Tx_Ch39 + 11a_Tx_Ch44_Co-location_LF	
	Horizontal	Vertical
QP / Peak	 <p>Site : 03CH07-HY Condition : QP 3m LF-ANT-35419(6) HORIZONTAL Detector : Peak Project : BR2626 Mode : 166</p>	 <p>Site : 03CH07-HY Condition : QP 3m LF-ANT-35419(6) VERTICAL Detector : Peak Project : BR2626 Mode : 166</p>

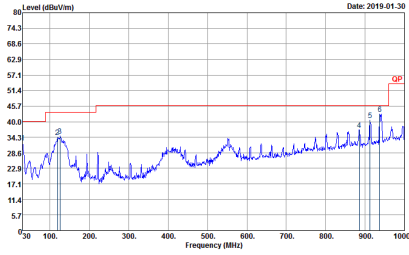
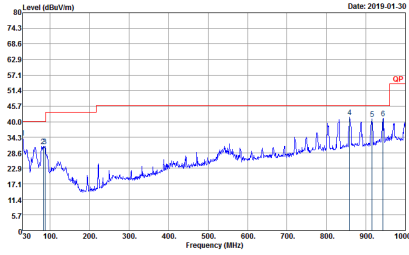

BLE_Tx_Ch00 + 11b_Tx_Ch11_Co-location_LF

Ant.	BLE_Tx_Ch00 + 11b_Tx_Ch11_Co-location_LF	
	Horizontal	Vertical
QP / Peak	 <p data-bbox="347 757 758 817">Site : 03CH07-HY Condition : QP 3m LF-ANT-35419(6) HORIZONTAL Detector : Peak Project : BR2626 Mode : 167</p>	 <p data-bbox="943 757 1353 817">Site : 03CH07-HY Condition : QP 3m LF-ANT-35419(6) VERTICAL Detector : Peak Project : BR2626 Mode : 167</p>



Appendix C. Duty Cycle Plots

<1Mbps>

DH5 on time (One Pulse) Plot on Channel 39

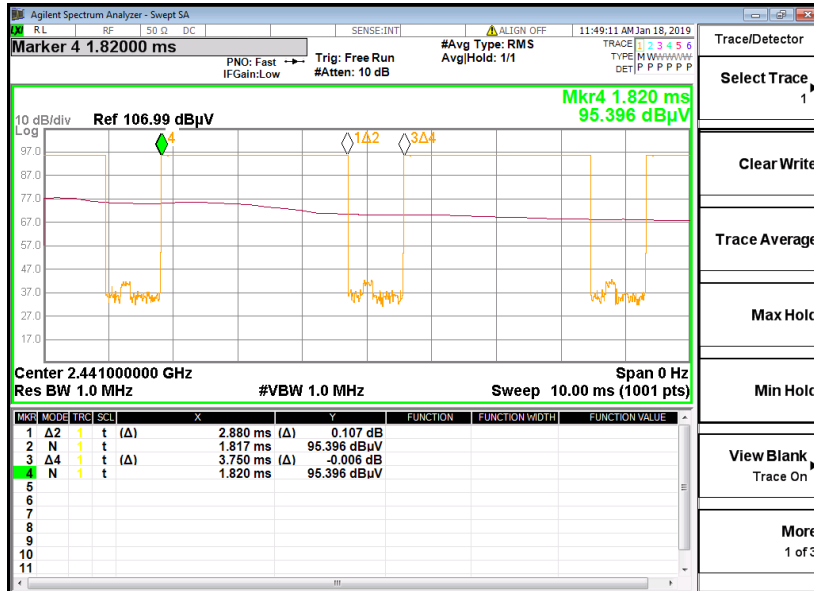

on time (Count Pulses) Plot on Channel 39

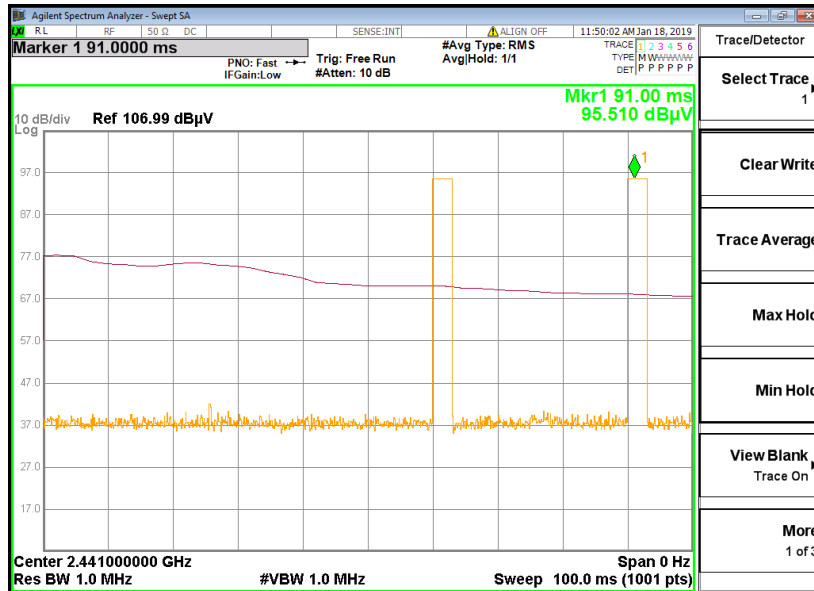

Note:

1. Worst case Duty cycle = on time/100 milliseconds = 2 * 2.88 / 100 = 5.76 %
2. Worst case Duty cycle correction factor = 20*log(Duty cycle) = -24.79 Db
3. DH5 has the highest duty cycle worst case and is reported.



<3Mbps>

3DH5 on time (One Pulse) Plot on Channel 39

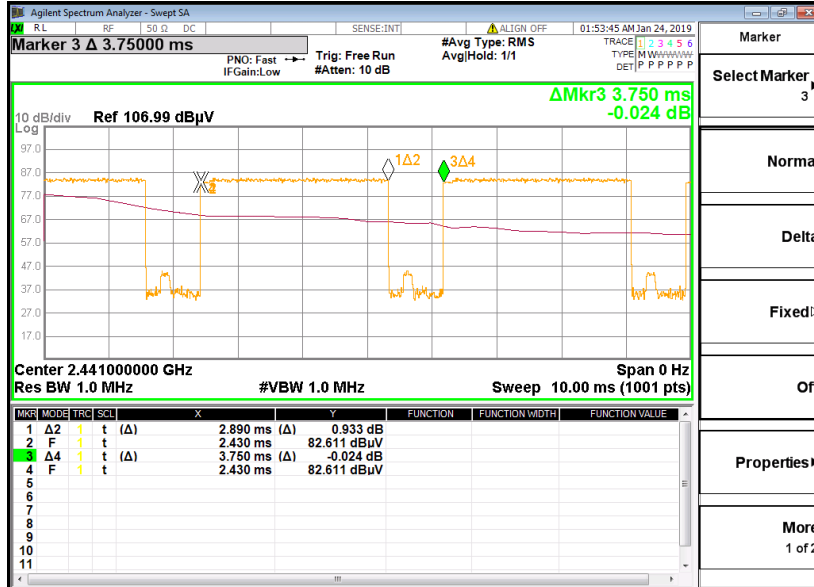

on time (Count Pulses) Plot on Channel 39

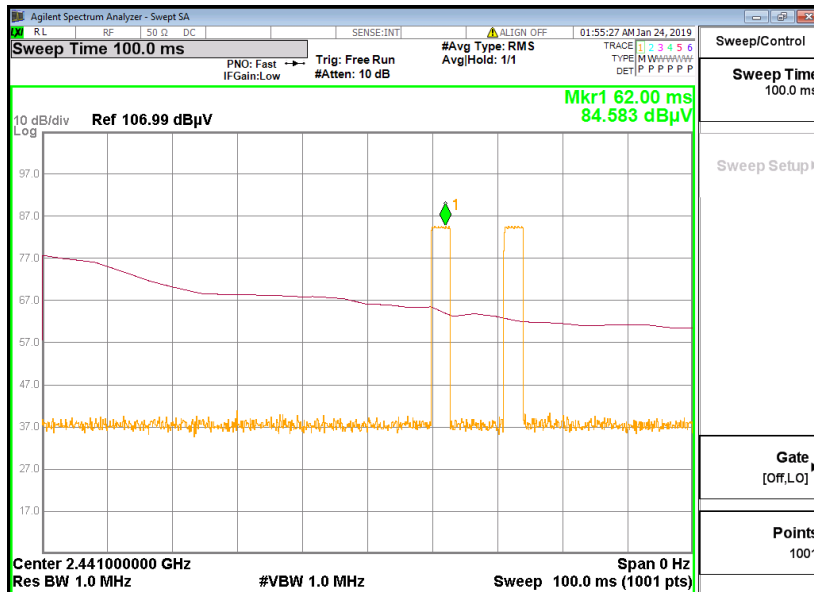

Note:

1. Worst case Duty cycle = on time/100 milliseconds = $2 * 2.89 / 100 = 5.78\%$
2. Worst case Duty cycle correction factor = $20 * \log(\text{Duty cycle}) = -24.76 \text{ dB}$
3. 3DH5 has the highest duty cycle worst case and is reported.



Duty Cycle Correction Factor Consideration for AFH mode:

Bluetooth normal hopping rate is 1600Hz and reduced to 800Hz in AFH mode; due to the reduced number of hopping frequencies, with the same packet configuration the dwell time in each channel frequency within 100msec period is longer in AFH mode than normal mode.

In AFH mode, the minimum hopping frequencies are 20, to get the longest dwell time DH5 packet is observed; the period to have DH5 packet completing one hopping sequence is

$$2.88 \text{ ms} \times 20 \text{ channels} = 57.6 \text{ ms}$$

There cannot be 2 complete hopping sequences within 100ms period, considering the random hopping behavior, maximum 2 hops can be possibly observed within the period. $[100\text{ms} / 57.6\text{ms}] = 2$ hops

Thus, the maximum possible ON time:

$$2.88 \text{ ms} \times 2 = 5.76 \text{ ms}$$

Worst case Duty Cycle Correction factor, which is derived from the maximum possible ON time,

$$20 \times \log(5.76 \text{ ms}/100\text{ms}) = -24.79 \text{ dB}$$



Antenna	Band	Duty Cycle (%)	T(us)	1/T(kHz)	VBW Setting	Duty Factor (dB)
-	Bluetooth – LE 1Mbps	62.62	392.00	2.55	3kHz	2.03
-	Bluetooth – LE 2Mbps	32.91	206.00	4.85	10kHz	4.83
1	802.11b	100.00	1500.00	0.67	10Hz	0.00
1	802.11a	95.75	2030.00	0.49	1kHz	0.19
2	802.11a	95.75	2030.00	0.49	1kHz	0.19

<1 Mbps>

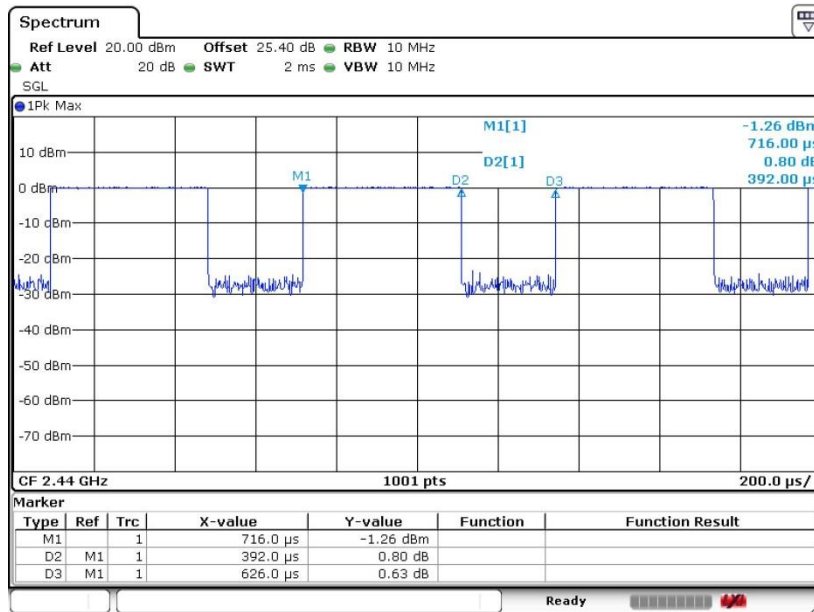

Date: 8.JAN.2019 00:50:40



<2 Mbps>

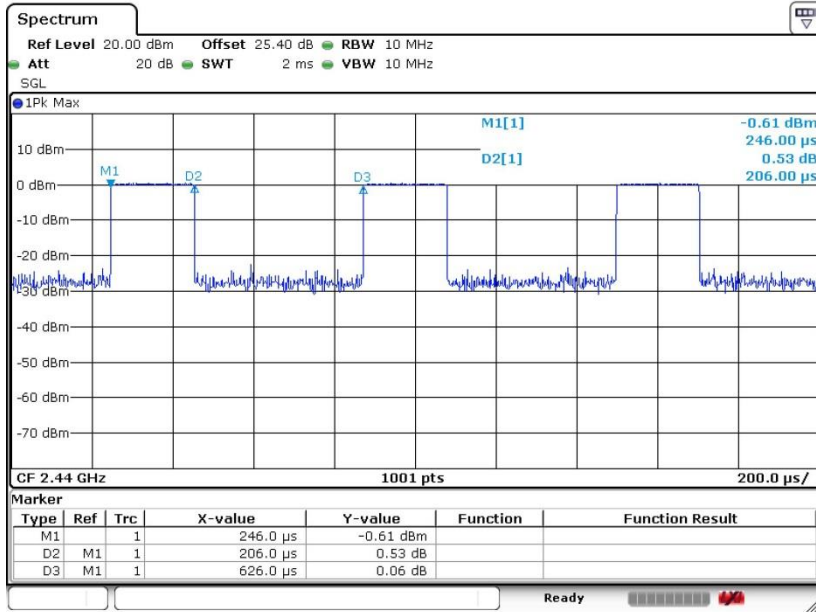

Date: 8.JAN.2019 00:49:35

<Ant. 1>

802.11b

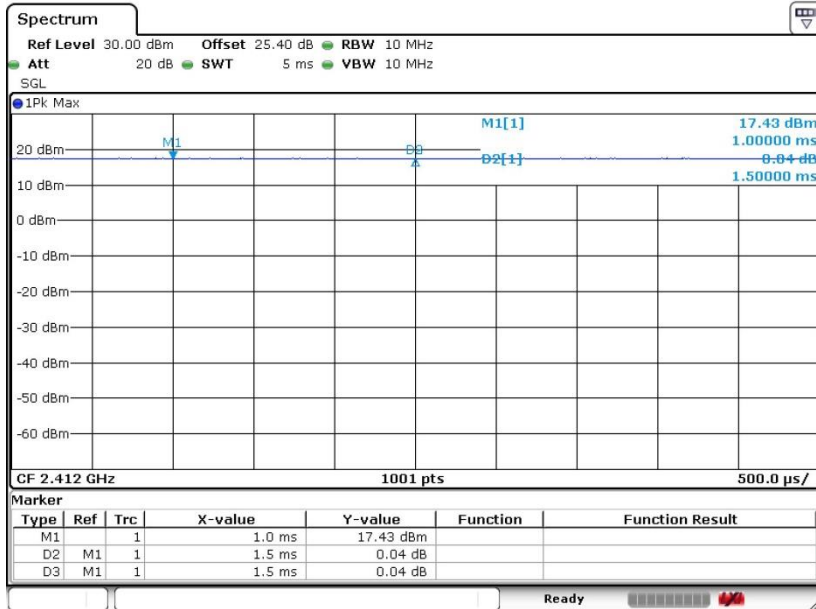

Date: 27.NOV.2018 23:53:04



<Ant. 1>

802.11a

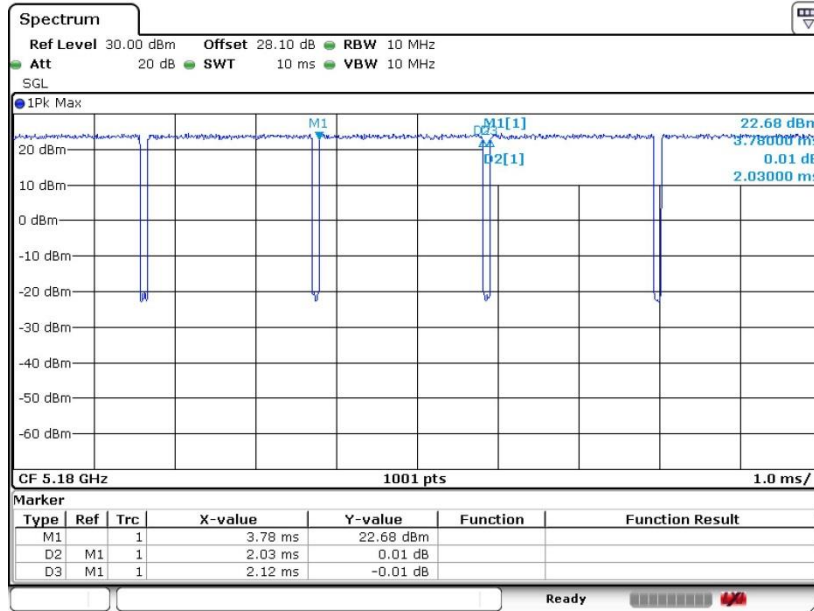

Date: 28.NOV.2018 00:34:26

<Ant. 2>

802.11a

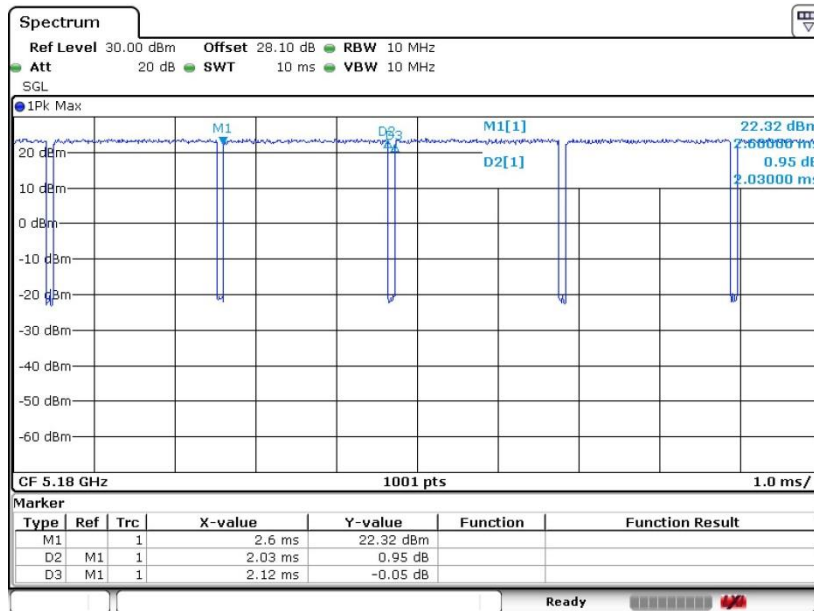

Date: 28.NOV.2018 00:35:01