

## Supplementary FCC Test Report (WLAN - 15.407)

**Report No.:** RF990809E03I-1

**FCC ID:** UZ7MC9190

**Test Model:** MC9190

**Received Date:** May 04, 2015

**Test Date:** May 14 to 29, 2015

**Issued Date:** July 07, 2015

**Applicant:** Zebra Technologies Corporation

**Address:** 1 Zebra Plaza, Holtsville, NY 11742

**Manufacturer:** Symbol Technologies, Inc.

**Address:** 1 Zebra Plaza, Holtsville, NY 11742

**Issued By:** Bureau Veritas Consumer Products Services (H.K.) Ltd., Taoyuan Branch  
Hsin Chu Laboratory

**Lab Address:** No. 81-1, Lu Liao Keng, 9th Ling, Wu Lung Tsuen, Chiung Lin Hsiang, Hsin  
Chu Hsien 307, Taiwan R.O.C.

**Test Location (1):** No. 81-1, Lu Liao Keng, 9th Ling, Wu Lung Tsuen, Chiung Lin Hsiang, Hsin  
Chu Hsien 307, Taiwan R.O.C.

**Test Location (2):** No. 49, Ln. 206, Wende Rd., Shangshan Tsuen, Chiung Lin Hsiang, Hsin  
Chu Hsien 307, Taiwan R.O.C.



This report is for your exclusive use. Any copying or replication of this report to or for any other person or entity, or use of our name or trademark, is permitted only with our prior written permission. This report sets forth our findings solely with respect to the test samples identified herein. The results set forth in this report are not indicative or representative of the quality or characteristics of the lot from which a test sample was taken or any similar or identical product unless specifically and expressly noted. Our report includes all of the tests requested by you and the results thereof based upon the information that you provided to us. You have 60 days from date of issuance of this report to notify us of any material error or omission caused by our negligence, provided, however, that such notice shall be in writing and shall specifically address the issue you wish to raise. A failure to raise such issue within the prescribed time shall constitute your unqualified acceptance of the completeness of this report, the tests conducted and the correctness of the report contents. Unless specific mention, the uncertainty of measurement has been explicitly taken into account to declare the compliance or non-compliance to the specification. The report must not be used by the client to claim product certification, approval, or endorsement by TAF or any government agencies.

**Table of Contents**

**Report Issue History Record of EUT (MC9190) ..... 4**

**Release Control Record ..... 4**

**1 Certificate of Conformity ..... 5**

**2 Summary of Test Results ..... 6**

    2.1 Measurement Uncertainty ..... 6

    2.2 Modification Record ..... 6

**3 General Information ..... 7**

    3.1 General Description of EUT (U-NII band 3) ..... 7

    3.2 Description of Test Modes ..... 11

    3.2.1 Test Mode Applicability and Tested Channel Detail ..... 12

    3.3 Duty Cycle of Test Signal ..... 14

    3.4 Description of Support Units ..... 15

    3.4.1 Configuration of System under Test ..... 16

    3.5 General Description of Applied Standard ..... 17

**4 Test Types and Results ..... 18**

    4.1 Radiated Emission and Bandedge Measurement ..... 18

    4.1.1 Limits of Radiated Emission and Bandedge Measurement ..... 18

    4.1.2 Test Instruments ..... 19

    4.1.3 Test Procedure ..... 21

    4.1.4 Deviation from Test Standard ..... 21

    4.1.5 Test Setup ..... 22

    4.1.6 EUT Operating Condition ..... 23

    4.1.7 Test Results ..... 24

    4.2 Conducted Emission Measurement ..... 28

    4.2.1 Limits of Conducted Emission Measurement ..... 28

    4.2.2 Test Instruments ..... 28

    4.2.3 Test Procedure ..... 29

    4.2.4 Deviation from Test Standard ..... 29

    4.2.5 Test Setup ..... 29

    4.2.6 EUT Operating Condition ..... 29

    4.2.7 Test Results ..... 30

    4.3 Transmit Power Measurement ..... 32

    4.3.1 Limits of Transmit Power Measurement ..... 32

    4.3.2 Test Setup ..... 32

    4.3.3 Test Instruments ..... 33

    4.3.4 Test Procedure ..... 33

    4.3.5 Deviation from Test Standard ..... 33

    4.3.6 EUT Operating Condition ..... 33

    4.3.7 Test Result ..... 34

    4.4 Peak Power Spectral Density Measurement ..... 35

    4.4.1 Limits of Peak Power Spectral Density Measurement ..... 35

    4.4.2 Test Setup ..... 35

    4.4.3 Test Instruments ..... 35

    4.4.4 Test Procedure ..... 36

    4.4.5 Deviation from Test Standard ..... 36

    4.4.6 EUT Operating Condition ..... 36

    4.4.7 Test Results ..... 37

    4.5 Frequency Stability Measurement ..... 38

    4.5.1 Limits of Frequency Stability Measurement ..... 38

    4.5.2 Test Setup ..... 38

    4.5.3 Test Instruments ..... 38

    4.5.4 Test Procedure ..... 38

4.5.5	Deviation from Test Standard .....	39
4.5.6	EUT Operating Condition .....	39
4.5.7	Test Results .....	40
4.6	6dB Bandwidth Measurement .....	41
4.6.1	Limits of 6dB Bandwidth Measurement .....	41
4.6.2	Test Setup .....	41
4.6.3	Test Instruments .....	41
4.6.4	Test Procedure .....	41
4.6.5	Deviation from Test Standard .....	41
4.6.6	EUT Operating Condition .....	41
4.6.7	Test Results .....	42
<b>5</b>	<b>Pictures of Test Arrangements .....</b>	<b>43</b>
	<b>Appendix – Information on the Testing Laboratories .....</b>	<b>44</b>



**Report Issue History Record of EUT (MC9190)**

Attachment No.	Issue Date	Description
990809E03B	Sep. 13, 2012	Changed the touch panel
990809E03I	July 07, 2015	Upgrade the versions of the standard to section 15.407 under new rule

**Release Control Record**

Issue No.	Description	Date Issued
RF990809E03I-1	Original release.	July 07, 2015



A D T

## 1 Certificate of Conformity

**Product:** Mobile Computer

**Brand:** Symbol

**Test Model:** MC9190

**Sample Status:** MASS-PRODUCTION

**Applicant:** Zebra Technologies Corporation

**Test Date:** May 14 to 29, 2015

**Standard:** 47 CFR FCC Part 15, Subpart E (Section 15.407)  
ANSI C63.10: 2009

The above equipment has been tested by **Bureau Veritas Consumer Products Services (H.K.) Ltd., Taoyuan Branch**, and found compliance with the requirement of the above standards. The test record, data evaluation & Equipment Under Test (EUT) configurations represented herein are true and accurate accounts of the measurements of the sample's EMC characteristics under the conditions specified in this report.

**Prepared by :**

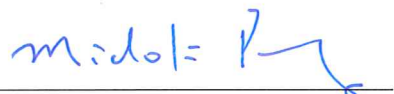

**Date:**

July 07, 2015

Midoli Peng / Specialist

**Approved by :**



**Date:**

July 07, 2015

May Chen / Manager

## 2 Summary of Test Results

47 CFR FCC Part 15, Subpart E (SECTION 15.407)			
FCC Clause	Test Item	Result	Remarks
15.407(b)(6)	AC Power Conducted Emissions	PASS	Meet the requirement of limit. Minimum passing margin is -27.76dB at 0.15781MHz.
15.407(b)(1/2/3/4/6)	Radiated Emissions & Band Edge Measurement	PASS	Meet the requirement of limit. Minimum passing margin is -3.9dB at 17235.00MHz , 17355.00MHz 17475.00MHz.
15.407(a)(1/2/3)	Max Average Transmit Power	PASS	Meet the requirement of limit.
15.407(a)(1/2/3)	Peak Power Spectral Density	PASS	Meet the requirement of limit.
15.407(e)	6dB bandwidth	PASS	Meet the requirement of limit. (U-NII-3 Band only)
15.407(g)	Frequency Stability	PASS	Meet the requirement of limit.
15.203	Antenna Requirement	PASS	Antenna connector is IPX not a standard connector.

### 2.1 Measurement Uncertainty

Where relevant, the following measurement uncertainty levels have been estimated for tests performed on the EUT as specified in CISPR 16-4-2:

Measurement	Frequency	Expanded Uncertainty (k=2) (±)
Conducted Emissions at mains ports	150kHz ~ 30MHz	2.86 dB
Radiated Emissions up to 1 GHz	30MHz ~ 1GHz	5.37 dB
Radiated Emissions above 1 GHz	1GHz ~ 6GHz	3.72 dB
	6GHz ~ 18GHz	4.00 dB
	18GHz ~ 40GHz	4.11 dB

### 2.2 Modification Record

There were no modifications required for compliance.

### 3 General Information

#### 3.1 General Description of EUT (U-NII band 3)

Product	Mobile Computer
Brand	Symbol
Test Model	MC9190
Status of EUT	MASS-PRODUCTION
Power Supply Rating	DC 7.4V from battery, DC 12V from cradle or power adapter
Modulation Type	64QAM, 16QAM, QPSK, BPSK for OFDM
Modulation Technology	DSSS, OFDM
Transfer Rate	up to 54Mbps
Operating Frequency	5.745 ~ 5.825GHz
Number of Channel	5
Output Power	26.363mW
Antenna Type	Please see Note
Antenna Connector	Please see Note
Accessory Device	Battery x 1 (Part No.: 21-65587-03) Cable adapters (Part No.: ADP9000-100R, ADP9000-110R) Holster (Part No.: SG-MC9121112-01R) Heated boot (Part No.: SG-MC9024242-01R) Snap on Mag Stripe Reader (Part No.: MSR9001-100R) Modem Module - Dongle (Part No.: MDM9000-100R) Headsets (Part No.:50-11300-050R, RCH50)
Data Cable Supplied	RS232 cable x 1 (Part No.: 25-62164-01R) USB cable x 1 (Part No.: 25-62166-01R)

Note:

- This report is prepared for FCC Class II change. The difference compared with the Report No.: RF990809E03B-1 design is as the following:
  - ◆ Upgrade the versions of the standard to section 15.407 under new rule

2. There are three antennas provided to this EUT, please refer to the following table:

WLAN								
No.	Brand	Model No.	Antenna Type	Gain (dBi)	Connector Type	Frequency range (MHz)	Cable Loss (dB)	Cable Length
1	WhaYu	Main (Tx & Rx)	PIFA	4.34 (2.4G) 5.54 (5G)	IPX	2400~2500 4900~5850	0.1	35mm
2	WhaYu	Aux (Rx only)	PIFA	3.83 (2.4G) 5.51 (5G)	IPX	2400~2500 4900~5850	0.24	85mm

Bluetooth						
No.	Brand	Model	Antenna Type	Gain (dBi)	Connector Type	Frequency range (MHz)
1	TY	AH104F2650S1-T	Chip	-3.73	SMT	2400~2500

3. The EUT configuration list:

	EUT_1	EUT_2	EUT_3	EUT_4	EUT_5	EUT_6
OS	WM6.5	WM6.5	<b>WM6.5</b>	WM6.5	WM6.5	WM6.5
CPU	806MHz	806MHz	<b>806MHz</b>	806MHz	806MHz	806MHz
RAM	256MB	256MB	<b>256MB</b>	256MB	256MB	256MB
Flash	1G	1G	<b>1G</b>	1G	1G	1G
Keypad	28/43/53keys	28/43/53keys	<b>28/43/53keys</b>	28/43/53keys	28/43/53keys	28/43/53keys
Battery	SYMBOL	SYMBOL	<b>SYMBOL</b>	SYMBOL	SYMBOL	SYMBOL
Scan	SE960	-	<b>SE1524</b>	-	-	-
Imager	-	SE4500-STD	-	SE4600-LR	SE4500-DL	SE4500-DPM
WLAN (a/b/g )	V	V	<b>V</b>	V	V	V
BT	V	V	<b>V</b>	V	V	V

The above configurations are available also with CR (Condensation Resistant).

The worst case is determined to be as **EUT\_3** (53keys), base on the investigation by measuring radiation emission and its data was recorded in this report.



4. The EUT could be supplied with a Cradle, power adapter and battery as below table:

Cradle 1 (1-slot, not for sale together)	
Brand:	SYMBOL
Model No.:	CRD9000-1000
Part No.:	CRD9000-1001SR
Input power :	+12V ----- 9A
I/O Ports:	USB Port x 1 RS232 Port x 1
Associated Devices	USB cable (Part No.:25-64396-01R) RS232 cable (Part No.:25-63852-01R) Adapter x 2 (Adapter 1: Part No.: 50-14000-148R) (Adapter 2: Part No.: PWRS-14000-148R)
Cradle 2 (4-slot, not for sale together)	
Brand:	SYMBOL
Model No.	CHS9000-4000C
Part No.:	CHS9000-4001CR
Input power :	+12V ----- 4A
Associated Devices	US AC line cord (Part No.: 23844-00-00R) DC Line Cord for Four Slot Cradles (Part No.:50-16002-029) Adapter x 2 (Adapter 3: Part No.: 50-14000-241R) (Adapter 4: Part No.: PWRS-14000-241R)
Cradle 3 (4-slot, not for sale together)	
Brand:	SYMBOL
Model No.:	CRD9000-4000E
Part No.:	CRD9000-4001ER
Input power :	+12V ----- 4A
I/O Ports:	Ethernet Port x 1
Associated Devices	US AC line cord (Part No.: 23844-00-00R) DC Line Cord for Four Slot Cradles (Part No.:50-16002-029) Adapter x 2 (Adapter 3: Part No.: 50-14000-241R) (Adapter 4: Part No.: PWRS-14000-241R)

<b>Adapter 1 (not for sale together)</b>	
Brand:	HIPRO
Model No.:	HP-O2040D43
Part No.:	50-14000-148R
Input power :	100-240V, 50-60Hz, 1.5A
Output power :	+12V ----- 3.33A DC output cable (unshielded, 1.8m with one core)
<b>Adapter 2 (not for sale together)</b>	
Brand:	HIPRO
Model No.:	HP-A0502R3D
Part No.:	PWRS-14000-148R
Input power :	100-240V, 50-60Hz, 2.4A
Output power	+12V ----- 4.16A DC output cable (unshielded, 1.8m with one core)
<b>Adapter 3 (only for Cradle 2, 3 use, not for sale together)</b>	
Brand:	Motorola / Symbol
Model No.:	50-14000-241R ver1 (level IV)
Input power :	100-240V, 50-60Hz, 3A
Output power :	+12V ----- 9A DC output cable (Part No.: 25-72614-01R)
<b>Adapter 4 (only for Cradle 2, 3 use, not for sale together)</b>	
Brand:	MOTOROLA / Symbol
Model No.	50-14000-241R ver2 (level V, p/n PWRS-14000-241R)
Input power :	100-240V, 50-60Hz, 3A
Output power	+12V ----- 9A DC output cable (Part No.: 25-72614-01R)
<b>Battery</b>	
Brand:	SYMBOL
Part No.:	21-65587-03
Rating:	7.4V, 2200mAh, 16.3Wh

5. Spurious emission of the simultaneous operation has been evaluated and no non-compliance was found.
6. The EUT operates in both the 5GHz and 2.4GHz Bands and compatibility with 802.11a, 802.11b, 802.11g and Bluetooth technology.
7. The above EUT information is declared by manufacturer and for more detailed features description, please refer to the manufacturer's specifications or user's manual.

### 3.2 Description of Test Modes

#### FOR 5745 ~ 5825MHz:

5 channels are provided for 802.11a:

Channel	Frequency	Channel	Frequency
149	5745MHz	161	5805MHz
153	5765MHz	165	5825MHz
157	5785MHz		

### 3.2.1 Test Mode Applicability and Tested Channel Detail

EUT CONFIGURE MODE	APPLICABLE TO				DESCRIPTION
	RE≥1G	RE<1G	PLC	APCM	
1	√	-	-	√	Y-Z plane: EUT_3 + Battery (21-65587-03) + Keypad: 53keys + ADP9000-100R connection adapter + 50-14000-148R PSU with its DC cord
2	-	√	√	-	EUT_3 + Battery (21-65587-03) + Keypad: 53keys + CRD9000-4001ER + PWRS-14000-241R PSU with its DC cord

Where **RE≥1G**: Radiated Emission above 1GHz      **RE<1G**: Radiated Emission below 1GHz  
**PLC**: Power Line Conducted Emission      **APCM**: Antenna Port Conducted Measurement

**NOTE:**

1. The test modes were reference to the worst cases in the original test report.
2. "-" means no effect.

#### **Radiated Emission Test (Above 1GHz):**

- Pre-Scan has been conducted to determine the worst-case mode from all possible combinations between available modulations, data rates and antenna ports (if EUT with antenna diversity architecture).
- Following channel(s) was (were) selected for the final test as listed below.

MODE	FREQ. BAND (MHz)	AVAILABLE CHANNEL	TESTED CHANNEL	MODULATION TECHNOLOGY	MODULATION TYPE	DATA RATE (Mbps)
802.11a	5745-5825	149 to 165	149, 157, 165	OFDM	BPSK	6

#### **Radiated Emission Test (Below 1GHz):**

- Pre-Scan has been conducted to determine the worst-case mode from all possible combinations between available modulations, data rates and antenna ports (if EUT with antenna diversity architecture).
- Following channel(s) was (were) selected for the final test as listed below.

MODE	FREQ. BAND (MHz)	AVAILABLE CHANNEL	TESTED CHANNEL	MODULATION TECHNOLOGY	MODULATION TYPE	DATA RATE (Mbps)
802.11a	5745-5825	149 to 165	157	OFDM	BPSK	6

#### **Power Line Conducted Emission Test:**

- Pre-Scan has been conducted to determine the worst-case mode from all possible combinations between available modulations, data rates and antenna ports (if EUT with antenna diversity architecture).
- Following channel(s) was (were) selected for the final test as listed below.

MODE	FREQ. BAND (MHz)	AVAILABLE CHANNEL	TESTED CHANNEL	MODULATION TECHNOLOGY	MODULATION TYPE	DATA RATE (Mbps)
802.11a	5745-5825	149 to 165	157	OFDM	BPSK	6

**Antenna Port Conducted Measurement:**

- This item includes all test value of each mode, but only includes spectrum plot of worst value of each mode.
- Pre-Scan has been conducted to determine the worst-case mode from all possible combinations between available modulations, data rates and antenna ports (if EUT with antenna diversity architecture).
- Following channel(s) was (were) selected for the final test as listed below.

MODE	FREQ. BAND (MHz)	AVAILABLE CHANNEL	TESTED CHANNEL	MODULATION TECHNOLOGY	MODULATION TYPE	DATA RATE (Mbps)
802.11a	5745-5825	149 to 165	149, 157, 165	OFDM	BPSK	6

**Test Condition:**

APPLICABLE TO	ENVIRONMENTAL CONDITIONS	INPUT POWER(SYSTEM)	TESTED BY
RE≥1G	24deg. C, 70%RH	120Vac, 60Hz	Robert Cheng
RE<1G	26deg. C, 72%RH	120Vac, 60Hz	Robert Cheng
PLC	25deg. C, 70%RH	120Vac, 60Hz	Mike Hsieh
APCM	25deg. C, 60%RH	120Vac, 60Hz	Robert Cheng

### 3.3 Duty Cycle of Test Signal

Duty cycle of test signal is  $\geq 98\%$ , duty factor is not required.

Duty cycle =  $1.433 \text{ ms} / 1.456 \text{ ms} = 0.984$

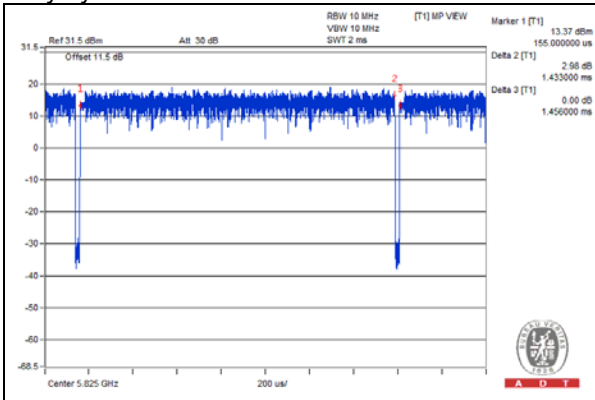

### 3.4 Description of Support Units

The EUT has been tested as an independent unit together with other necessary accessories or support units. The following support units or accessories were used to form a representative test configuration during the tests.

ID	Product	Brand	Model No.	Serial No.	FCC ID	Remarks
A.	NOTEBOOK COMPUTER	DELL	E5430	4YV4VY1	FCC DoC	Provided by Lab
B.	iPod shuffle	Apple	MC749TA/A	CC4DMFJUDFDM	NA	Provided by Lab
C.	HEADSET	MOTOROLA	RCH50	NA	NA	Supplied by Client
D.	CONNECTION 1	SYMBOL	P/N:ADP9000-1 00R	NA	NA	Supplied by Client
E.	Micro SD card	NA	NA	NA	NA	Provided by Lab

Note:

1. All power cords of the above support units are non-shielded (1.8m).

ID	Descriptions	Qty.	Length (m)	Shielding (Yes/No)	Cores (Qty.)	Remarks
1.	RS232 to USB	1	1.8	Yes	1	Supplied by Client
2.	Audio	1	0.9	No	1	Supplied by Client
3.	USB	1	0.1	Yes	1	Provided by Lab
4.	DC	1	1.8	Yes	1	Supplied by Client
5.	AC	1	1.8	Yes	1	Provided by Lab
6.	DC	1	1.8	Yes	2	Supplied by Client

Note: The core(s) is(are) originally attached to the cable(s).

### 3.4.1 Configuration of System under Test

#### For Radiated (above 1GHz) test

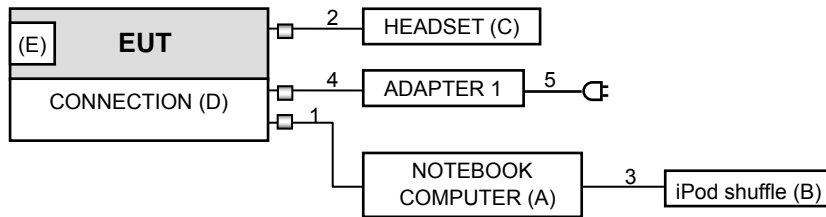

**NOTE:** 1. Item E is the Micro SD card.

#### For Radiated (below 1GHz) test

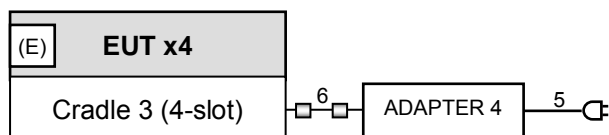

**NOTE:** 1. Item E is the Micro SD card.



### 3.5 General Description of Applied Standard

The EUT is a RF Product. According to the specifications of the manufacturer, it must comply with the requirements of the following standards:

**FCC Part 15, Subpart E (15.407)**  
**789033 D02 General UNII Test Procedure New Rules v01**  
ANSI C63.10-2009

All test items have been performed and recorded as per the above standards.

**NOTE:** The EUT has been verified to comply with the requirements of FCC Part 15, Subpart B, Class B (DoC).  
The test report has been issued separately.

## 4 Test Types and Results

### 4.1 Radiated Emission and Bandedge Measurement

#### 4.1.1 Limits of Radiated Emission and Bandedge Measurement

Radiated emissions which fall in the restricted bands must comply with the radiated emission limits specified as below table.

Frequencies (MHz)	Field Strength (microvolts/meter)	Measurement Distance (meters)
0.009 ~ 0.490	2400/F(kHz)	300
0.490 ~ 1.705	24000/F(kHz)	30
1.705 ~ 30.0	30	30
30 ~ 88	100	3
88 ~ 216	150	3
216 ~ 960	200	3
Above 960	500	3

**NOTE:**

1. The lower limit shall apply at the transition frequencies.
2. Emission level (dBuV/m) = 20 log Emission level (uV/m).
3. For frequencies above 1000MHz, the field strength limits are based on average detector, however, the peak field strength of any emission shall not exceed the maximum permitted average limits, specified above by more than 20dB under any condition of modulation.

**LIMITS OF UNWANTED EMISSION OUT OF THE RESTRICTED BANDS**

APPLICABLE TO	LIMIT	
789033 D02 General UNII Test Procedure New Rules v01	FIELD STRENGTH AT 3m	
	PK:74 (dBuV/m)	AV:54 (dBuV/m)
APPLICABLE TO	EIRP LIMIT	EQUIVALENT FIELD STRENGTH AT 3m
15.407(b)(1)	PK:-27 (dBm/MHz)	PK:68.2(dBuV/m)
15.407(b)(2)		
15.407(b)(3)		
15.407(b)(4)	PK:-27 (dBm/MHz) <sup>*1</sup> PK:-17 (dBm/MHz) <sup>*2</sup>	PK: 68.2(dBuV/m) <sup>*1</sup> PK:78.2 (dBuV/m) <sup>*2</sup>

**NOTE:** <sup>\*1</sup> beyond 10MHz of the band edge <sup>\*2</sup> within 10 MHz of band edge

The following formula is used to convert the equipment isotropic radiated power (eirp) to field strength:

$$E = \frac{1000000\sqrt{30P}}{3} \mu\text{V/m, where P is the eirp (Watts).$$

#### 4.1.2 Test Instruments

##### For above 1GHz test

DESCRIPTION & MANUFACTURER	MODEL NO.	SERIAL NO.	CALIBRATED DATE	CALIBRATED UNTIL
Test Receiver Agilent	N9038A	MY50010156	Aug. 11, 2014	Aug. 10, 2015
Pre-Amplifier Mini-Circuits	ZFL-1000VH2 B	AMP-ZFL-04	Nov. 12, 2014	Nov. 11, 2015
Trilog Broadband Antenna SCHWARZBECK	VULB 9168	9168-361	Feb. 09, 2015	Feb. 08, 2016
RF Cable	8D-FB	CHHCAB-001-1 CHHCAB-001-2	Oct. 05, 2014	Oct. 04, 2015
	RF-141	CHHCAB-004	Oct. 05, 2014	Oct. 04, 2015
Horn_Antenna AISI	AIH.8018	0000220091110	Feb. 06, 2015	Feb. 05, 2016
Pre-Amplifier Agilent	8449B	3008A01923	Oct. 28, 2014	Oct. 27, 2015
RF Cable	NA	131206 131213 131215 SNMY23685/4	Jan. 16, 2015	Jan. 15, 2016
Spectrum Analyzer R&S	FSV40	100964	July 05, 2014	July 04, 2015
Pre-Amplifier SPACEK LABS	SLKKa-48-6	9K16	Dec. 12, 2014	Dec. 11, 2015
Horn_Antenna SCHWARZBECK	BBHA 9170	9170-424	Feb. 05, 2015	Feb. 04, 2016
RF Cable	NA	329751/4 RF104-204	Dec. 11, 2014	Dec. 10, 2015
Software	ADT_Radiated _V8.7.07	NA	NA	NA
Antenna Tower & Turn Table CT	NA	NA	NA	NA

##### Note:

1. The calibration interval of the above test instruments is 12 months and the calibrations are traceable to NML/ROC and NIST/USA.
2. The test was performed in 966 Chamber No. H.
3. The FCC Site Registration No. is 797305.
4. The CANADA Site Registration No. is IC 7450H-3.
5. Tested Date: May 14, 2015

**For Below 1GHz test**

DESCRIPTION & MANUFACTURER	MODEL NO.	SERIAL NO.	CALIBRATED DATE	CALIBRATED UNTIL
Test Receiver Agilent	N9038A	MY51210105	July 21,2014	July 20,2015
Pre-Amplifier Mini-Circuits	ZFL-1000VH2 B	AMP-ZFL-03	Nov. 12, 2014	Nov. 11, 2015
Trilog Broadband Antenna SCHWARZBECK	VULB 9168	9168-360	Feb. 06, 2015	Feb. 05, 2016
RF Cable	8D-FB	CHGCAB-001 -1 CHGCAB-001 -2	Oct. 04, 2014	Oct. 03, 2015
	RF-141	CHGCAB-004	Oct. 04, 2014	Oct. 03, 2015
Horn_Antenna AISI	AIH.8018	000032009111 0	Feb. 09, 2015	Feb. 08, 2016
Pre-Amplifier Agilent	8449B	3008A02578	June 24, 2014	June 23, 2015
RF Cable	NA	131205 131216 131217 SNMY23684/ 4	Jan. 16, 2015	Jan. 15, 2016
Spectrum Analyzer R&S	FSV40	100964	July 05, 2014	July 04, 2015
Pre-Amplifier SPACEK LABS	SLKKa-48-6	9K16	Dec. 12, 2014	Dec. 11, 2015
Horn_Antenna SCHWARZBECK	BBHA 9170	9170-424	Feb. 05, 2015	Feb. 04, 2016
RF Cable	NA	329751/4 RF104-204	Dec. 11, 2014	Dec. 10, 2015
Software	ADT_Radiated _V8.7.07	NA	NA	NA
Antenna Tower & Turn Table CT	NA	NA	NA	NA

**Note:**

1. The calibration interval of the above test instruments is 12 months and the calibrations are traceable to NML/ROC and NIST/USA.
2. The test was performed in 966 Chamber No. G.
3. The FCC Site Registration No. is 966073.
4. The CANADA Site Registration No. is IC 7450H-2.
5. Tested Date: May 19, 2015

#### 4.1.3 Test Procedure

- a. The EUT was placed on the top of a rotating table 0.8 meters (for below 1GHz) / 1.5 meters (for above 1GHz) above the ground at 3 meter chamber room for test. The table was rotated 360 degrees to determine the position of the highest radiation.
- b. The EUT was set 3 meters away from the interference-receiving antenna, which was mounted on the top of a variable-height antenna tower.
- c. The height of antenna is varied from one meter to four meters above the ground to determine the maximum value of the field strength. Both horizontal and vertical polarizations of the antenna are set to make the measurement.
- d. For each suspected emission, the EUT was arranged to its worst case and then the antenna was tuned to heights from 1 meter to 4 meters and the rotatable table was turned from 0 degrees to 360 degrees to find the maximum reading.
- e. The test-receiver system was set to quasi-peak detect function and specified bandwidth with maximum hold mode when the test frequency is below 1 GHz.
- f. The test-receiver system was set to peak and average detect function and specified bandwidth with maximum hold mode when the test frequency is above 1 GHz. If the peak reading value also meets average limit, measurement with the average detector is unnecessary.

#### Note:

1. The resolution bandwidth and video bandwidth of test receiver/spectrum analyzer is 120kHz for Quasi-peak detection (QP) at frequency below 1GHz.
2. The resolution bandwidth of test receiver/spectrum analyzer is 1 MHz and the video bandwidth is 3 MHz for Peak detection (PK) at frequency above 1GHz.
3. The resolution bandwidth of test receiver/spectrum analyzer is 1MHz and the video bandwidth is 3MHz for RMS Average (Duty cycle < 98%) for Average detection (AV) at frequency above 1GHz, then the measurement results was added to a correction factor ( $10 \log(1/\text{duty cycle})$ ).
4. The resolution bandwidth of test receiver/spectrum analyzer is 1MHz and the video bandwidth is 10Hz (Duty cycle  $\geq 98\%$ ) for Average detection (AV) at frequency above 1GHz.
5. All modes of operation were investigated and the worst-case emissions are reported.

#### 4.1.4 Deviation from Test Standard

No deviation.

4.1.5 Test Setup

<Frequency Range below 1GHz>

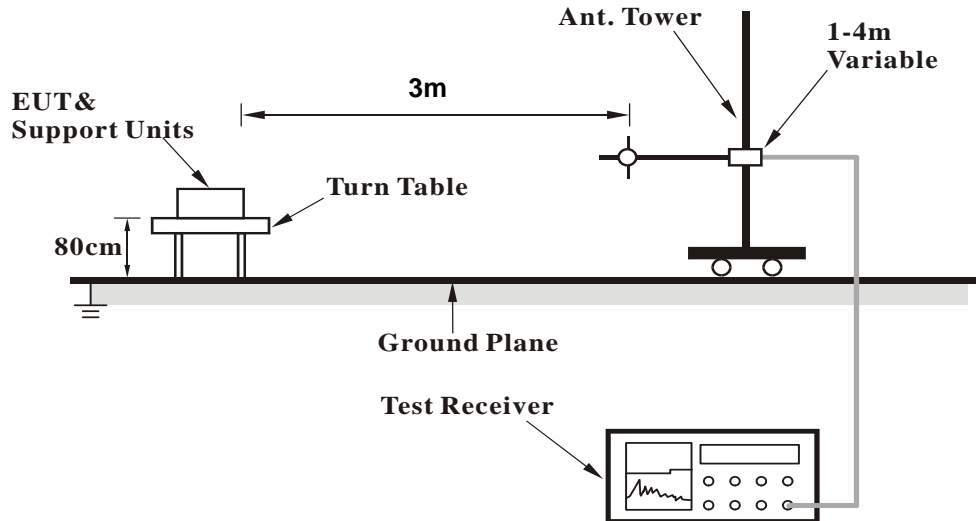

<Frequency Range above 1GHz>

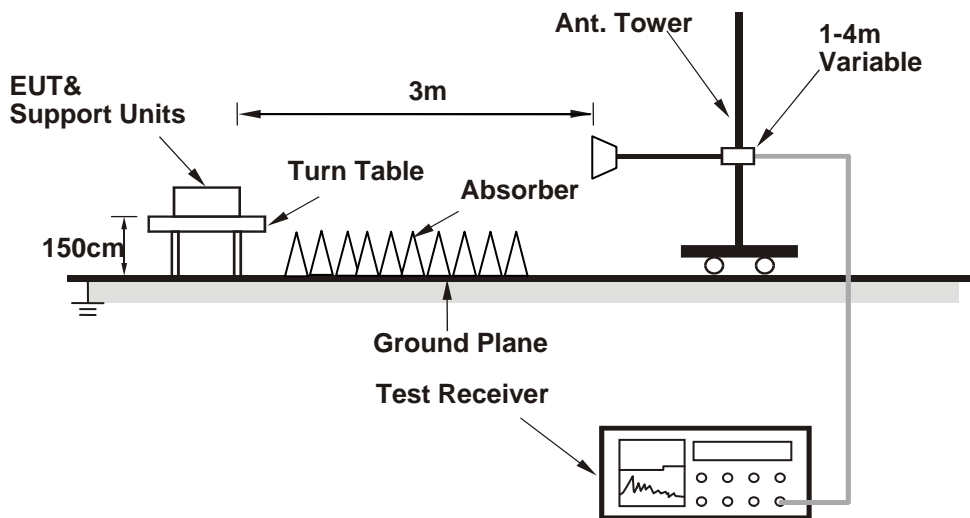

For the actual test configuration, please refer to the attached file (Test Setup Photo).

#### 4.1.6 EUT Operating Condition

- a. Turn on the power of EUT.
- b. The EUT run test program "CEcTxRx.exe" to enable EUT under transmission / receiver condition continuously at specific channel frequency.

**4.1.7 Test Results**

<b>CHANNEL</b>	TX Channel 149	<b>DETECTOR FUNCTION</b>	Peak (PK)
<b>FREQUENCY RANGE</b>	1GHz ~ 40GHz		Average (AV)

<b>ANTENNA POLARITY &amp; TEST DISTANCE: HORIZONTAL AT 3 M</b>								
<b>NO.</b>	<b>FREQ. (MHz)</b>	<b>EMISSION LEVEL (dBuV/m)</b>	<b>LIMIT (dBuV/m)</b>	<b>MARGIN (dB)</b>	<b>ANTENNA HEIGHT (m)</b>	<b>TABLE ANGLE (Degree)</b>	<b>RAW VALUE (dBuV)</b>	<b>CORRECTION FACTOR (dB/m)</b>
1	#5715.00	64.6 PK	74.0	-9.4	1.41 H	298	57.22	7.38
2	#5715.00	49.1 AV	54.0	-4.9	1.41 H	298	41.72	7.38
3	#5725.00	71.0 PK	78.2	-7.2	1.41 H	298	63.62	7.38
4	*5745.00	104.1 PK			1.41 H	298	96.72	7.38
5	*5745.00	94.8 AV			1.41 H	298	87.42	7.38
6	11490.00	59.0 PK	74.0	-15.0	1.02 H	32	44.48	14.52
7	11490.00	46.2 AV	54.0	-7.8	1.02 H	32	31.68	14.52
8	#17235.00	68.8 PK	74.0	-5.2	1.04 H	264	45.04	23.76
9	#17235.00	50.1 AV	54.0	-3.9	1.04 H	264	26.34	23.76

<b>ANTENNA POLARITY &amp; TEST DISTANCE: VERTICAL AT 3 M</b>								
<b>NO.</b>	<b>FREQ. (MHz)</b>	<b>EMISSION LEVEL (dBuV/m)</b>	<b>LIMIT (dBuV/m)</b>	<b>MARGIN (dB)</b>	<b>ANTENNA HEIGHT (m)</b>	<b>TABLE ANGLE (Degree)</b>	<b>RAW VALUE (dBuV)</b>	<b>CORRECTION FACTOR (dB/m)</b>
1	#5715.00	63.2 PK	74.0	-10.8	1.62 V	242	55.82	7.38
2	#5715.00	48.4 AV	54.0	-5.6	1.62 V	242	41.02	7.38
3	#5725.00	69.6 PK	78.2	-8.6	1.62 V	242	62.22	7.38
4	*5745.00	103.1 PK			1.62 V	243	95.72	7.38
5	*5745.00	93.7 AV			1.62 V	243	86.32	7.38
6	11490.00	57.1 PK	74.0	-16.9	1.01 V	251	42.58	14.52
7	11490.00	45.4 AV	54.0	-8.6	1.01 V	251	30.88	14.52
8	#17235.00	69.1 PK	74.0	-4.9	1.19 V	319	45.34	23.76
9	#17235.00	49.8 AV	54.0	-4.2	1.19 V	319	26.04	23.76

**REMARKS:**

1. Emission Level(dBuV/m) = Raw Value(dBuV) + Correction Factor(dB/m)
2. Correction Factor(dB/m) = Antenna Factor(dB/m) + Cable Factor(dB) – Pre-Amplifier Factor(dB)
3. The other emission levels were very low against the limit.
4. Margin value = Emission Level – Limit value
5. " \* ": Fundamental frequency.
6. " # ": The radiated frequency is out of the restricted band.



<b>CHANNEL</b>	TX Channel 157	<b>DETECTOR FUNCTION</b>	Peak (PK)
<b>FREQUENCY RANGE</b>	1GHz ~ 40GHz		Average (AV)

**ANTENNA POLARITY & TEST DISTANCE: HORIZONTAL AT 3 M**

NO.	FREQ. (MHz)	EMISSION LEVEL (dBuV/m)	LIMIT (dBuV/m)	MARGIN (dB)	ANTENNA HEIGHT (m)	TABLE ANGLE (Degree)	RAW VALUE (dBuV)	CORRECTION FACTOR (dB/m)
1	*5785.00	103.1 PK			1.43 H	289	95.72	7.38
2	*5785.00	93.8 AV			1.43 H	289	86.42	7.38
3	11570.00	58.6 PK	74.0	-15.4	1.02 H	44	44.03	14.57
4	11570.00	45.7 AV	54.0	-8.3	1.02 H	44	31.13	14.57
5	#17355.00	68.5 PK	74.0	-5.5	1.01 H	256	44.44	24.06
6	#17355.00	50.1 AV	54.0	-3.9	1.01 H	256	26.04	24.06

**ANTENNA POLARITY & TEST DISTANCE: VERTICAL AT 3 M**

NO.	FREQ. (MHz)	EMISSION LEVEL (dBuV/m)	LIMIT (dBuV/m)	MARGIN (dB)	ANTENNA HEIGHT (m)	TABLE ANGLE (Degree)	RAW VALUE (dBuV)	CORRECTION FACTOR (dB/m)
1	*5785.00	102.3 PK			1.63 V	232	94.92	7.38
2	*5785.00	93.0 AV			1.63 V	232	85.62	7.38
3	11570.00	57.5 PK	74.0	-16.5	1.00 V	256	42.93	14.57
4	11570.00	45.6 AV	54.0	-8.4	1.00 V	256	31.03	14.57
5	#17355.00	69.0 PK	74.0	-5.0	1.13 V	310	44.94	24.06
6	#17355.00	49.9 AV	54.0	-4.1	1.13 V	310	25.84	24.06

**REMARKS:**

1. Emission Level(dBuV/m) = Raw Value(dBuV) + Correction Factor(dB/m)
2. Correction Factor(dB/m) = Antenna Factor(dB/m) + Cable Factor(dB) – Pre-Amplifier Factor(dB)
3. The other emission levels were very low against the limit.
4. Margin value = Emission Level – Limit value
5. " \* ": Fundamental frequency.
6. " # ": The radiated frequency is out of the restricted band.

<b>CHANNEL</b>	TX Channel 165	<b>DETECTOR FUNCTION</b>	Peak (PK)
<b>FREQUENCY RANGE</b>	1GHz ~ 40GHz		Average (AV)

**ANTENNA POLARITY & TEST DISTANCE: HORIZONTAL AT 3 M**

NO.	FREQ. (MHz)	EMISSION LEVEL (dBuV/m)	LIMIT (dBuV/m)	MARGIN (dB)	ANTENNA HEIGHT (m)	TABLE ANGLE (Degree)	RAW VALUE (dBuV)	CORRECTION FACTOR (dB/m)
1	*5825.00	103.4 PK			1.38 H	297	96.09	7.31
2	*5825.00	94.2 AV			1.38 H	297	86.89	7.31
3	#5850.00	68.6 PK	78.2	-9.6	1.38 H	297	61.35	7.25
4	#5860.00	60.7 PK	74.0	-13.3	1.38 H	297	53.48	7.22
5	#5860.00	46.1 AV	54.0	-7.9	1.38 H	297	38.88	7.22
6	11650.00	58.1 PK	74.0	-15.9	1.00 H	35	43.43	14.67
7	11650.00	45.4 AV	54.0	-8.6	1.00 H	35	30.73	14.67
8	#17475.00	68.4 PK	74.0	-5.6	1.00 H	245	44.38	24.02
9	#17475.00	50.1 AV	54.0	-3.9	1.00 H	245	26.08	24.02

**ANTENNA POLARITY & TEST DISTANCE: VERTICAL AT 3 M**

NO.	FREQ. (MHz)	EMISSION LEVEL (dBuV/m)	LIMIT (dBuV/m)	MARGIN (dB)	ANTENNA HEIGHT (m)	TABLE ANGLE (Degree)	RAW VALUE (dBuV)	CORRECTION FACTOR (dB/m)
1	*5825.00	102.2 PK			1.63 V	239	94.89	7.31
2	*5825.00	93.1 AV			1.63 V	239	85.79	7.31
3	#5850.00	68.1 PK	78.2	-10.1	1.63 V	239	60.85	7.25
4	#5860.00	60.2 PK	74.0	-13.8	1.63 V	239	52.98	7.22
5	#5860.00	45.8 AV	54.0	-8.2	1.63 V	239	38.58	7.22
6	11650.00	57.1 PK	74.0	-16.9	1.00 V	241	42.43	14.67
7	11650.00	45.1 AV	54.0	-8.9	1.00 V	241	30.43	14.67
8	#17475.00	68.6 PK	74.0	-5.4	1.10 V	321	44.58	24.02
9	#17475.00	49.7 AV	54.0	-4.3	1.10 V	321	25.68	24.02

**REMARKS:**

1. Emission Level(dBuV/m) = Raw Value(dBuV) + Correction Factor(dB/m)
2. Correction Factor(dB/m) = Antenna Factor(dB/m) + Cable Factor(dB) – Pre-Amplifier Factor(dB)
3. The other emission levels were very low against the limit.
4. Margin value = Emission Level – Limit value
5. " \* ": Fundamental frequency.
6. " # ": The radiated frequency is out of the restricted band.

**BELOW 1GHz WORST-CASE DATA**

<b>CHANNEL</b>	TX Channel 157	<b>DETECTOR FUNCTION</b>	Quasi-Peak (QP)
<b>FREQUENCY RANGE</b>	Below 1GHz		

**ANTENNA POLARITY & TEST DISTANCE: HORIZONTAL AT 3 M**

NO.	FREQ. (MHz)	EMISSION LEVEL (dBuV/m)	LIMIT (dBuV/m)	MARGIN (dB)	ANTENNA HEIGHT (m)	TABLE ANGLE (Degree)	RAW VALUE (dBuV)	CORRECTION FACTOR (dB/m)
1	81.20	28.6 QP	40.0	-11.4	1.50 H	114	46.58	-17.98
2	111.12	32.4 QP	43.5	-11.1	1.80 H	113	48.15	-15.77
3	198.72	31.9 QP	43.5	-11.6	1.10 H	220	47.94	-16.02
4	287.41	36.6 QP	46.0	-9.5	1.20 H	156	48.98	-12.43
5	390.00	34.0 QP	46.0	-12.0	1.20 H	101	43.62	-9.60
6	560.15	35.9 QP	46.0	-10.1	1.10 H	214	41.53	-5.61

**ANTENNA POLARITY & TEST DISTANCE: VERTICAL AT 3 M**

NO.	FREQ. (MHz)	EMISSION LEVEL (dBuV/m)	LIMIT (dBuV/m)	MARGIN (dB)	ANTENNA HEIGHT (m)	TABLE ANGLE (Degree)	RAW VALUE (dBuV)	CORRECTION FACTOR (dB/m)
1	64.32	22.2 QP	40.0	-17.9	1.10 V	173	36.33	-14.18
2	75.12	21.6 QP	40.0	-18.4	1.10 V	184	38.11	-16.51
3	287.40	24.4 QP	46.0	-21.6	1.50 V	310	36.85	-12.43
4	385.71	28.4 QP	46.0	-17.6	1.10 V	340	38.13	-9.71
5	434.81	26.4 QP	46.0	-19.6	1.10 V	360	34.46	-8.08
6	560.15	28.1 QP	46.0	-17.9	1.20 V	119	33.73	-5.61

**REMARKS:**

1. Emission Level(dBuV/m) = Raw Value(dBuV) + Correction Factor(dB/m)
2. Correction Factor(dB/m) = Antenna Factor(dB/m) + Cable Factor(dB) – Pre-Amplifier Factor(dB)
3. The other emission levels were very low against the limit.
4. Margin value = Emission Level – Limit value

## 4.2 Conducted Emission Measurement

### 4.2.1 Limits of Conducted Emission Measurement

Frequency (MHz)	Conducted Limit (dBuV)	
	Quasi-peak	Average
0.15 - 0.5	66 - 56	56 - 46
0.50 - 5.0	56	46
5.0 - 30.0	60	50

Note: 1. The lower limit shall apply at the transition frequencies.

2. The limit decreases in line with the logarithm of the frequency in the range of 0.15 to 0.50MHz.

### 4.2.2 Test Instruments

DESCRIPTION & MANUFACTURER	MODEL NO.	SERIAL NO.	CALIBRATED DATE	CALIBRATED UNTIL
Test Receiver R&S	ESCS 30	100375	May 06, 2015	May 05, 2016
Line-Impedance Stabilization Network (for EUT) SCHWARZBECK	NSLK-8127	8127-522	Sep. 15, 2014	Sep. 14, 2015
Line-Impedance Stabilization Network (for Peripheral) ROHDE & SCHWARZ	ENV216	100071	Nov. 10, 2014	Nov. 09, 2015
RF Cable	5D-FB	COCCAB-001	Mar. 09, 2015	Mar. 08, 2016
50 ohms Terminator	N/A	EMC-03	Sep. 22, 2014	Sep. 21, 2015
50 ohms Terminator	N/A	EMC-02	Sep. 30, 2014	Sep. 29, 2015
Software BVADT	BVADT_Cond_ V7.3.7.3	NA	NA	NA

#### Note:

1. The calibration interval of the above test instruments are 12 months and the calibrations are traceable to NML/ROC and NIST/USA.
2. The test was performed in Shielded Room No. C.
3. The VCCI Con C Registration No. is C-3611.
4. Tested Date: May 19, 2015

#### 4.2.3 Test Procedure

- The EUT was placed 0.4 meters from the conducting wall of the shielded room with EUT being connected to the power mains through a line impedance stabilization network (LISN). Other support units were connected to the power mains through another LISN. The two LISNs provide 50 ohm/ 50uH of coupling impedance for the measuring instrument.
- Both lines of the power mains connected to the EUT were checked for maximum conducted interference.
- The frequency range from 150kHz to 30MHz was searched. Emission levels under (Limit - 20dB) was not recorded.

**NOTE:** All modes of operation were investigated and the worst-case emissions are reported.

#### 4.2.4 Deviation from Test Standard

No deviation.

#### 4.2.5 Test Setup

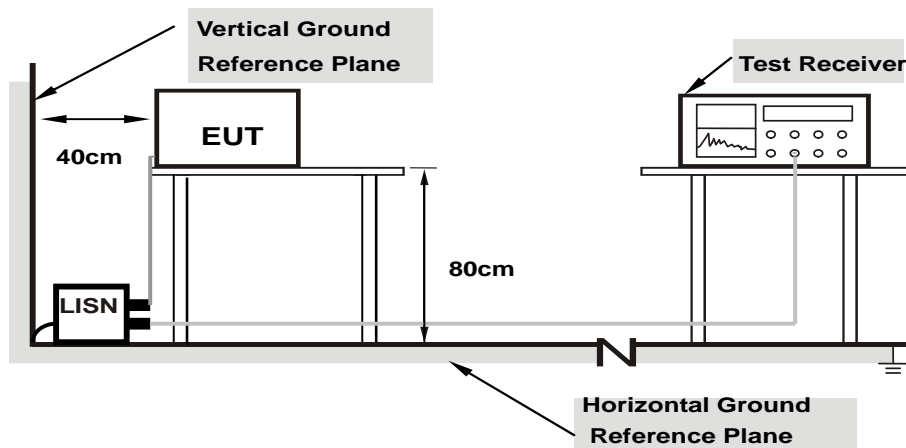

- Note:**
- Support units were connected to second LISN.
  - Both of LISNs (AMN) are 80 cm from EUT and at least 80 from other units and other metal planes

For the actual test configuration, please refer to the attached file (Test Setup Photo).

#### 4.2.6 EUT Operating Condition

Same as 4.1.6.

4.2.7 Test Results

Phase	Line (L)	Detector Function	Quasi-Peak (QP) / Average (AV)
-------	----------	-------------------	--------------------------------

Phase Of Power : Line (L)										
No	Frequency (MHz)	Correction Factor (dB)	Reading Value (dBuV)		Emission Level (dBuV)		Limit (dBuV)		Margin (dB)	
			Q.P.	AV.	Q.P.	AV.	Q.P.	AV.	Q.P.	AV.
1	0.15781	0.08	28.42	27.74	28.50	27.82	65.58	55.58	-37.08	-27.76
2	0.18125	0.09	23.27	22.37	23.36	22.46	64.43	54.43	-41.07	-31.97
3	0.59922	0.11	12.13	10.89	12.24	11.00	56.00	46.00	-43.76	-35.00
4	5.08594	0.26	17.22	12.18	17.48	12.44	60.00	50.00	-42.52	-37.56
5	15.16016	0.58	21.07	17.97	21.65	18.55	60.00	50.00	-38.35	-31.45
6	24.45313	0.80	20.32	14.23	21.12	15.03	60.00	50.00	-38.88	-34.97

**Remarks:**

1. Q.P. and AV. are abbreviations of quasi-peak and average individually.
2. The emission levels of other frequencies were very low against the limit.
3. Margin value = Emission level – Limit value
4. Correction factor = Insertion loss + Cable loss
5. Emission Level = Correction Factor + Reading Value

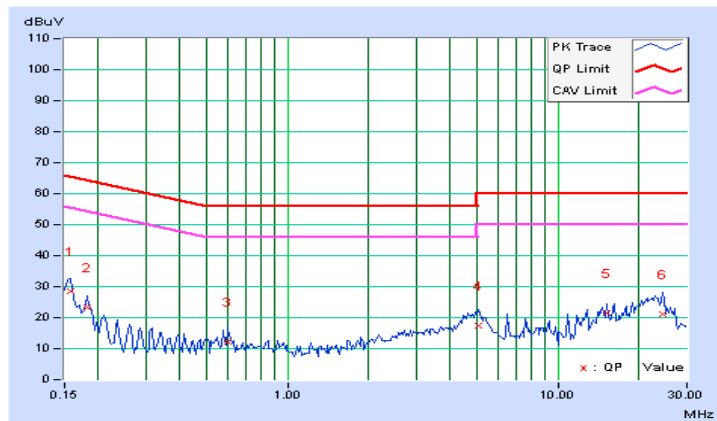

Phase	Neutral (N)	Detector Function	Quasi-Peak (QP) / Average (AV)
-------	-------------	-------------------	--------------------------------

Phase Of Power : Neutral (N)										
No	Frequency (MHz)	Correction Factor (dB)	Reading Value (dBuV)		Emission Level (dBuV)		Limit (dBuV)		Margin (dB)	
			Q.P.	AV.	Q.P.	AV.	Q.P.	AV.	Q.P.	AV.
1	0.16161	0.08	27.45	26.50	27.53	26.58	65.38	55.38	-37.85	-28.80
2	0.19297	0.08	26.32	16.97	26.40	17.05	63.91	53.91	-37.51	-36.86
3	0.26818	0.09	20.91	15.45	21.00	15.54	61.17	51.17	-40.18	-35.64
4	4.80469	0.26	18.99	10.66	19.25	10.92	56.00	46.00	-36.75	-35.08
5	15.16406	0.60	21.87	20.04	22.47	20.64	60.00	50.00	-37.53	-29.36
6	21.57422	0.78	21.11	15.78	21.89	16.56	60.00	50.00	-38.11	-33.44

**Remarks:**

1. Q.P. and AV. are abbreviations of quasi-peak and average individually.
2. The emission levels of other frequencies were very low against the limit.
3. Margin value = Emission level – Limit value
4. Correction factor = Insertion loss + Cable loss
5. Emission Level = Correction Factor + Reading Value

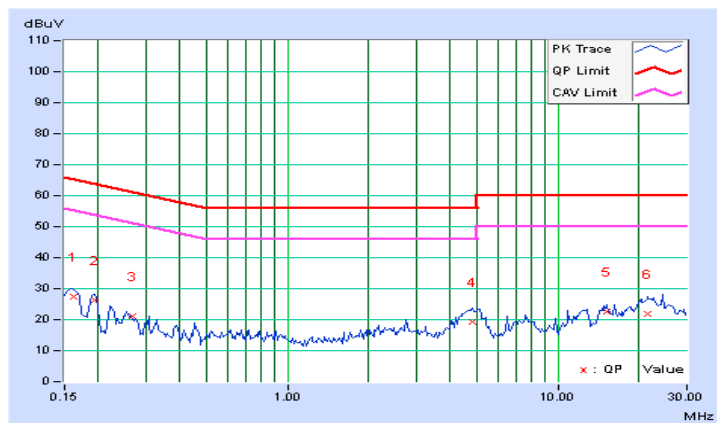

### 4.3 Transmit Power Measurement

#### 4.3.1 Limits of Transmit Power Measurement

Operation Band	EUT Category		LIMIT
U-NII-1		Outdoor Access Point	1 Watt (30 dBm) (Max. e.i.r.p $\leq$ 125mW(21 dBm) at any elevation angle above 30 degrees as measured from the horizon)
		Fixed point-to-point Access Point	1 Watt (30 dBm)
		Indoor Access Point	1 Watt (30 dBm)
		Mobile and Portable client device	250mW (24 dBm)
U-NII-2A			250mW (24 dBm) or 11 dBm+10 log B*
U-NII-2C			250mW (24 dBm) or 11 dBm+10 log B*
U-NII-3	√		1 Watt (30 dBm)

\*B is the 26 dB emission bandwidth in megahertz

Per KDB 662911 Method of conducted output power measurement on IEEE 802.11 devices,

Array Gain = 0 dB (i.e., no array gain) for  $N_{ANT} \leq 4$ ;

Array Gain = 0 dB (i.e., no array gain) for channel widths  $\geq 40$  MHz for any  $N_{ANT}$ ;

Array Gain =  $5 \log(N_{ANT}/N_{SS})$  dB or 3 dB, whichever is less for 20-MHz channel widths with  $N_{ANT} \geq 5$ .

For power measurements on all other devices: Array Gain =  $10 \log(N_{ANT}/N_{SS})$  dB.

#### 4.3.2 Test Setup

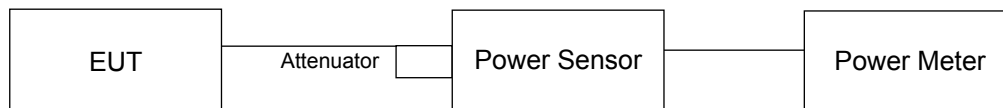



#### 4.3.3 Test Instruments

DESCRIPTION & MANUFACTURER	MODEL NO.	SERIAL NO.	CALIBRATED DATE	CALIBRATED UNTIL
Power Meter Anritsu	ML2495A	1014008	Apr. 28, 2015	Apr. 27, 2016
Power Sensor Anritsu	MA2411B	0917122	Apr. 28, 2015	Apr. 27, 2016

- NOTE:**
1. The test was performed in Oven room A.
  2. The calibration interval of the above test instruments is 12 months and the calibrations are traceable to NML/ROC and NIST/USA.
  3. Tested Date: May 14, 2015

#### 4.3.4 Test Procedure

Method PM is used to perform output power measurement, trigger and gating function of wide band power meter is enabled to measure max output power of TX on burst. Duty factor is not added to measured value.

#### 4.3.5 Deviation from Test Standard

No deviation.

#### 4.3.6 EUT Operating Condition

The software provided by client to enable the EUT under transmission condition continuously at lowest, middle and highest channel frequencies individually.

#### 4.3.7 Test Result

Chan.	Chan. Freq. (MHz)	Maximum Conducted Power (mW)	Maximum Conducted Power (dBm)	Power Limit (dBm)	Pass / Fail
149	5745	25.823	14.12	30	Pass
157	5785	26.363	14.21	30	Pass
165	5825	23.014	13.62	30	Pass

※Add test for each data rate output power (require by manufacturer):

Chan.	Chan. Freq. (MHz)	Average Power (dBm)							
		Data rate							
		6Mbps	9Mbps	12Mbps	18Mbps	24Mbps	36Mbps	48Mbps	54Mbps
149	5745	14.12	14.10	14.05	13.94	13.97	14	14.02	14.09
157	5785	14.21	14.18	14.15	14.15	14.02	14.2	14.12	14.1
165	5825	13.62	13.53	13.54	13.49	13.48	13.53	13.54	13.42

#### 4.4 Peak Power Spectral Density Measurement

##### 4.4.1 Limits of Peak Power Spectral Density Measurement

Operation Band	EUT Category		LIMIT
U-NII-1		Outdoor Access Point	17dBm/ MHz
		Fixed point-to-point Access Point	
		Indoor Access Point	
		Mobile and Portable client device	11dBm/ MHz
U-NII-2A			11dBm/ MHz
U-NII-2C			11dBm/ MHz
U-NII-3	√		30dBm/ 500kHz

##### 4.4.2 Test Setup



T

##### 4.4.3 Test Instruments

DESCRIPTION & MANUFACTURER	MODEL NO.	SERIAL NO.	CALIBRATED DATE	CALIBRATED UNTIL
SPECTRUM ANALYZER R&S	FSV 40	100964	July 05, 2014	July 04, 2015

- NOTE:**
1. The test was performed in Oven room A.
  2. The calibration interval of the above test instruments is 12 months and the calibrations are traceable to NML/ROC and NIST/USA.
  3. Tested Date: May 14, 2015

#### 4.4.4 Test Procedure

- 1) Set span to encompass the entire emission bandwidth (EBW) of the signal.
- 2) Set RBW = 300 kHz, Set VBW  $\geq$  1 MHz, Detector = RMS
- 3) Use the peak marker function to determine the maximum power level in any 300 kHz band segment within the fundamental EBW.
- 4) Scale the observed power level to an equivalent value in 500 kHz by adjusting (reducing) the measured power by a bandwidth correction factor (BWCF) where  $BWCF = 10\log(500 \text{ kHz}/300\text{kHz})$
- 5) Sweep time = auto, trigger set to "free run".
- 6) Trace average at least 100 traces in power averaging mode.
- 7) Record the max value

#### 4.4.5 Deviation from Test Standard

No deviation.

#### 4.4.6 EUT Operating Condition

Same as Item 4.3.6.

4.4.7 Test Results

Chan.	Chan. Freq. (MHz)	PSD		Total PSD (dBm/500kHz)	Limit (dBm/500kHz)	Pass /Fail
		(dBm/300kHz)	(dBm/500kHz)			
149	5745	-2.69	-0.47	-0.47	30	Pass
157	5785	-3.24	-1.02	-1.02	30	Pass
165	5825	-3.48	-1.26	-1.26	30	Pass

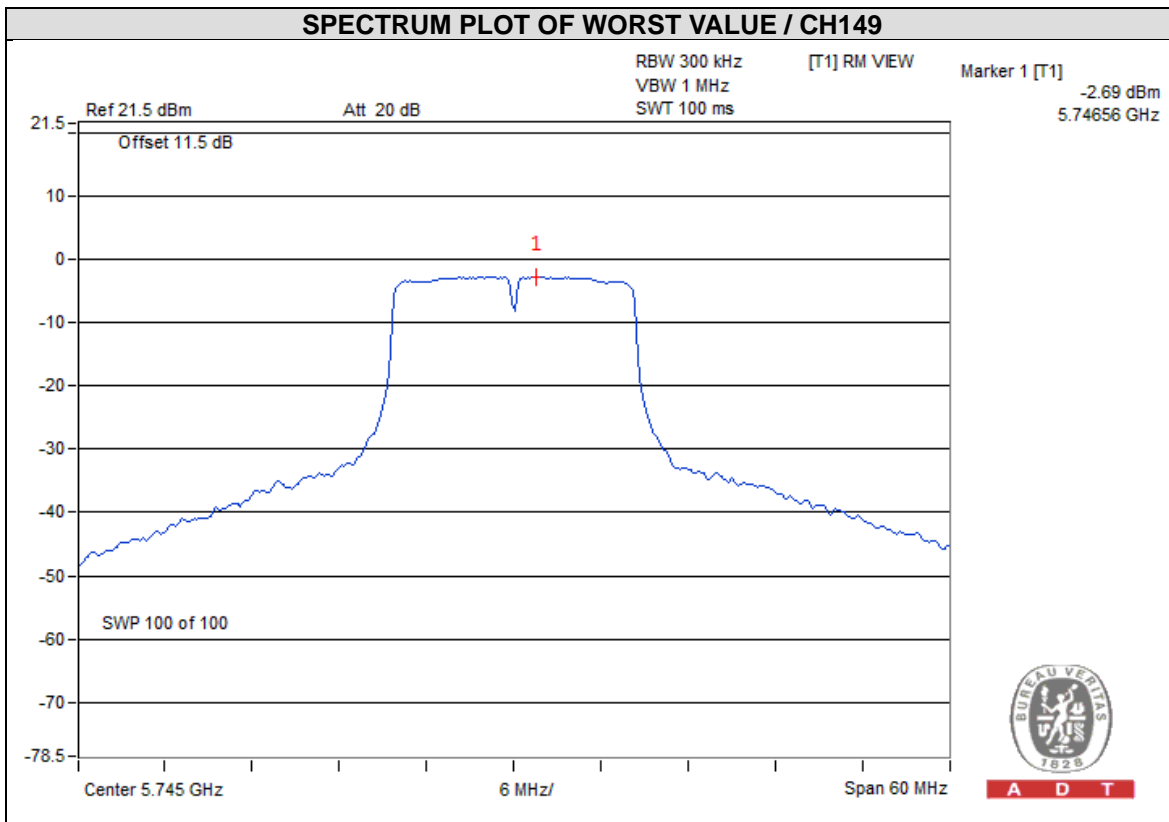

## 4.5 Frequency Stability Measurement

### 4.5.1 Limits of Frequency Stability Measurement

The frequency of the carrier signal shall be maintained within band of operation

### 4.5.2 Test Setup

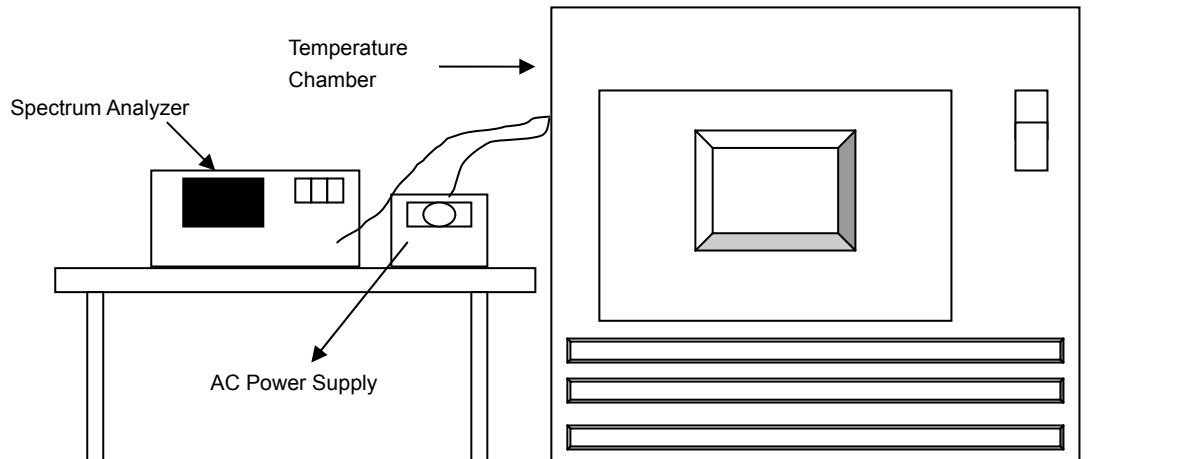

### 4.5.3 Test Instruments

DESCRIPTION & MANUFACTURER	MODEL NO.	SERIAL NO.	CALIBRATED DATE	CALIBRATED UNTIL
True RMS Multimeter FLUKE	87III	73680266	Nov. 07, 2014	Nov. 06, 2015
Temperature & Humidity Chamber GIANTFORCE	GTH-150-40-S P-AR	MAA0812-0 08	Jan. 12, 2015	Jan. 11, 2016

- NOTE:**
1. The test was performed in Oven room A.
  2. The calibration interval of the above test instruments is 12 months and the calibrations are traceable to NML/ROC and NIST/USA.
  3. Tested Date: May 14, 2015

### 4.5.4 Test Procedure

- a. The EUT was placed inside the environmental test chamber and powered by nominal AC voltage.
- b. Turn the EUT on and couple its output to a spectrum analyzer.
- c. Turn the EUT off and set the chamber to the highest temperature specified.
- d. Allow sufficient time (approximately 30 min) for the temperature of the chamber to stabilize, turn the EUT on and measure the operating frequency after 2, 5, and 10 minutes.
- e. Repeat step 2 and 3 with the temperature chamber set to the lowest temperature.
- f. The test chamber was allowed to stabilize at +20 degree C for a minimum of 30 minutes. The supply voltage was then adjusted on the EUT from 85% to 115% and the frequency record.

#### 4.5.5 Deviation from Test Standard

No deviation.

#### 4.5.6 EUT Operating Condition

Set the EUT transmit at un-modulation mode to test frequency stability.

**4.5.7 Test Results**

<b>FREQUENCY STABILITY VERSUS TEMP.</b>									
<b>OPERATING FREQUENCY: 5825MHz</b>									
<b>TEMP. (°C)</b>	<b>POWER SUPPLY (Vac)</b>	<b>0 MINUTE</b>		<b>2 MINUTE</b>		<b>5 MINUTE</b>		<b>10 MINUTE</b>	
		<b>Measured Frequency (MHz)</b>	<b>Frequency Drift (%)</b>	<b>Measured Frequency (MHz)</b>	<b>Frequency Drift (%)</b>	<b>Measured Frequency (MHz)</b>	<b>Frequency Drift (%)</b>	<b>Measured Frequency (MHz)</b>	<b>Frequency Drift (%)</b>
50	120	5825.0029	0.00005	5825.0015	0.00003	5825.0018	0.00003	5825.0032	0.00005
40	120	5824.9923	-0.00013	5824.9938	-0.00011	5824.9917	-0.00014	5824.9946	-0.00009
30	120	5825.0094	0.00016	5825.0101	0.00017	5825.009	0.00015	5825.0088	0.00015
20	120	5824.9982	-0.00003	5825.0001	0.00000	5824.9962	-0.00007	5824.9976	-0.00004
10	120	5825.0008	0.00001	5825.0014	0.00002	5825.0032	0.00005	5825.001	0.00002
0	120	5825.0187	0.00032	5825.0179	0.00031	5825.0163	0.00028	5825.0139	0.00024
-10	120	5825.0249	0.00043	5825.023	0.00039	5825.0232	0.00040	5825.0272	0.00047
-20	120	5824.9987	-0.00002	5825.0029	0.00005	5825.001	0.00002	5824.9988	-0.00002
-30	120	5825.0137	0.00024	5825.0132	0.00023	5825.0121	0.00021	5825.0145	0.00025

<b>FREQUENCY STABILITY VERSUS VOLTAGE</b>									
<b>OPERATING FREQUENCY: 5825MHz</b>									
<b>TEMP. (°C)</b>	<b>POWER SUPPLY (Vac)</b>	<b>0 MINUTE</b>		<b>2 MINUTE</b>		<b>5 MINUTE</b>		<b>10 MINUTE</b>	
		<b>Measured Frequency (MHz)</b>	<b>Frequency Drift (%)</b>	<b>Measured Frequency (MHz)</b>	<b>Frequency Drift (%)</b>	<b>Measured Frequency (MHz)</b>	<b>Frequency Drift (%)</b>	<b>Measured Frequency (MHz)</b>	<b>Frequency Drift (%)</b>
20	138	5824.9985	-0.00003	5825.0003	0.00001	5824.9951	-0.00008	5824.9975	-0.00004
	120	5824.9982	-0.00003	5825.0001	0.00000	5824.9962	-0.00007	5824.9976	-0.00004
	102	5824.9986	-0.00002	5824.9989	-0.00002	5824.9972	-0.00005	5824.9984	-0.00003



#### 4.6 6dB Bandwidth Measurement

##### 4.6.1 Limits of 6dB Bandwidth Measurement

The minimum of 6dB Bandwidth Measurement is 0.5MHz.

##### 4.6.2 Test Setup

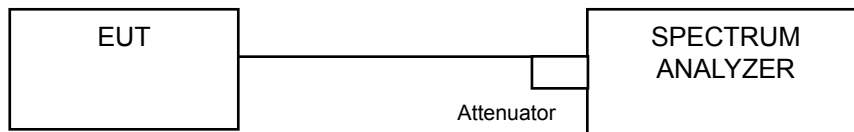

##### 4.6.3 Test Instruments

DESCRIPTION & MANUFACTURER	MODEL NO.	SERIAL NO.	CALIBRATED DATE	CALIBRATED UNTIL
SPECTRUM ANALYZER R&S	FSV 40	100964	July 05, 2014	July 04, 2015

- NOTE:**
1. The test was performed in Oven room A.
  2. The calibration interval of the above test instruments is 12 months and the calibrations are traceable to NML/ROC and NIST/USA.
  3. Tested Date: May 14, 2015

##### 4.6.4 Test Procedure

###### MEASUREMENT PROCEDURE REF

- a. Set resolution bandwidth (RBW) = 100kHz
- b. Set the video bandwidth (VBW)  $\geq 3 \times$  RBW, Detector = Peak.
- c. Trace mode = max hold.
- d. Sweep = auto couple.
- e. Measure the maximum width of the emission that is constrained by the frequencies associated with the two amplitude points (upper and lower) that are attenuated by 6 dB relative to the maximum level measured in the fundamental emission

##### 4.6.5 Deviation from Test Standard

No deviation.

##### 4.6.6 EUT Operating Condition

The software provided by client to enable the EUT under transmission condition continuously at lowest, middle and highest channel frequencies individually.

#### 4.6.7 Test Results

Channel	Frequency (MHz)	6dB Bandwidth (MHz)	Minimum Limit (MHz)	Pass / Fail
149	5745	16.36	0.5	PASS
157	5785	16.38	0.5	PASS
165	5825	16.38	0.5	PASS

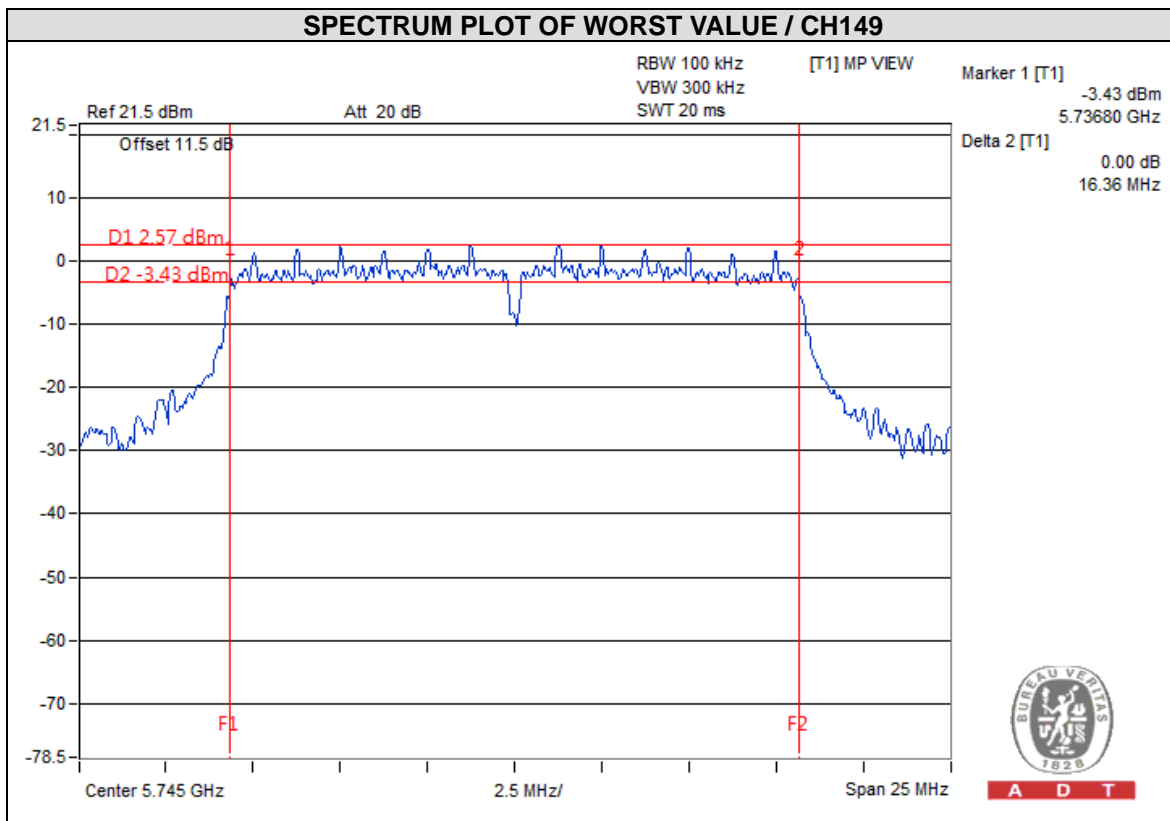

## 5 Pictures of Test Arrangements

Please refer to the attached file (Test Setup Photo).



## Appendix – Information on the Testing Laboratories

We, Bureau Veritas Consumer Products Services (H.K.) Ltd., Taoyuan Branch, were founded in 1988 to provide our best service in EMC, Radio, Telecom and Safety consultation. Our laboratories are accredited and approved according to ISO/IEC 17025.

If you have any comments, please feel free to contact us at the following:

**Linko EMC/RF Lab**

Tel: 886-2-26052180

Fax: 886-2-26051924

**Hsin Chu EMC/RF Lab/Telecom Lab**

Tel: 886-3-5935343

Fax: 886-3-5935342

**Hwa Ya EMC/RF/Safety**

Tel: 886-3-3183232

Fax: 886-3-3270892

**Email:** [service.adt@tw.bureauveritas.com](mailto:service.adt@tw.bureauveritas.com)

**Web Site:** [www.bureauveritas-adt.com](http://www.bureauveritas-adt.com)

The address and road map of all our labs can be found in our web site also.

--- END ---