

MC67 QUICK START GUIDE

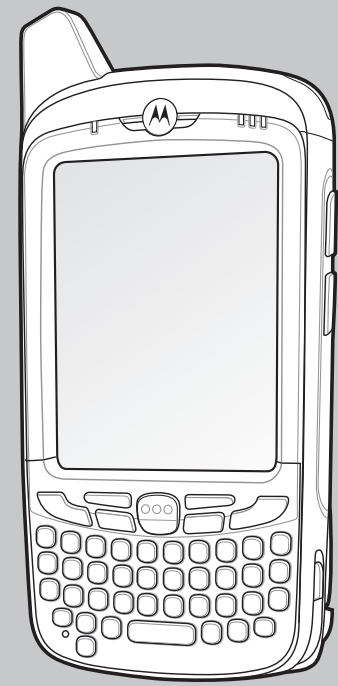

PRELIMINARY



FEATURES

Note: Remove protective shipping film that covers the touch screen, exit window and camera window before using.

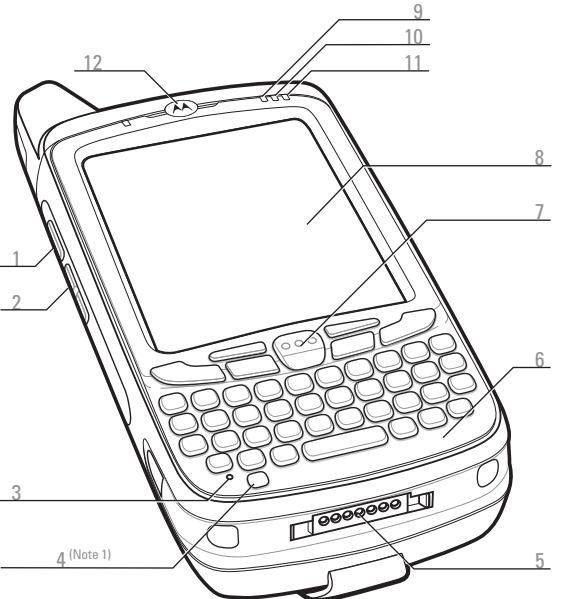

- 1 Scan/Action Button
- 2 Up/Down Button
- 3 Microphone
- 4 Power Button
- 5 I/O Connector
- 6 Keypad
- 7 Scan/Action Button
- 8 Touch Screen (with screen protector)
- 9 Data Capture LED
- 10 Charging/Battery Status LED
- 11 WAN Radio Status LED
- 12 Phone Speaker

Note 1: To reset the MC67, press and hold the Power button for five (5) seconds.

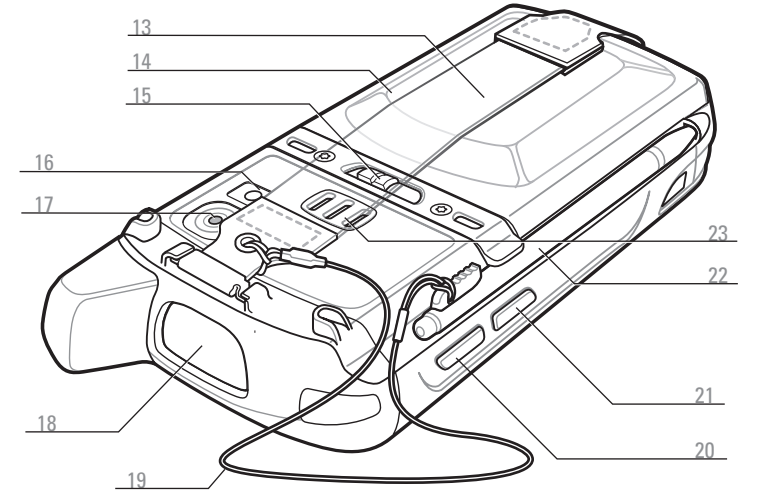

- 13 Handstrap
- 14 Battery
- 15 Battery Latch
- 16 Camera Flash (optional)
- 17 Camera (optional)
- 18 Exit Window (see Data Capture Options)
- 19 Tether
- 20 Scan/Action Button
- 21 Action Button
- 22 Stylus
- 23 Speaker

Notifications

Scan/Decode LED:

- Red: Scanning active
- Green: Good Decode

Radio Status LED:

- Green: RF active

Charging/Battery Status LED:

- Slow blinking amber: Battery charging
- Solid amber: Fully charged
- Fast blinking amber: Charging error

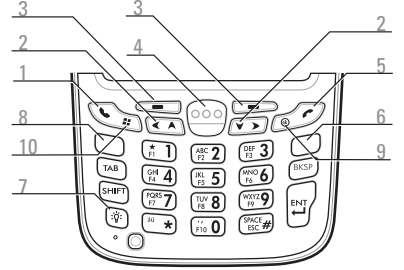
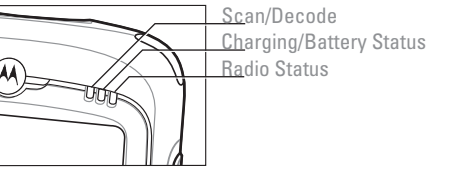

Numeric Keypad

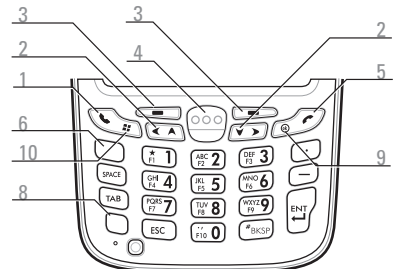

DSD Keypad

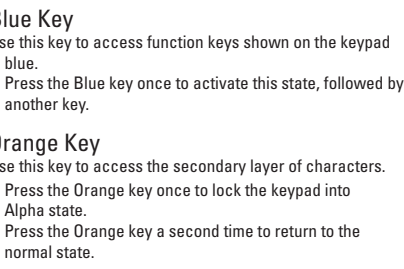

PIM Keypad

- 1 Talk
- 2 Navigation
- 3 Soft Key
- 4 Scan/Action Button
- 5 End

- 6 Orange Key
- 7 Backlight
- 8 Blue Key
- 9 OK
- 10 Start Menu

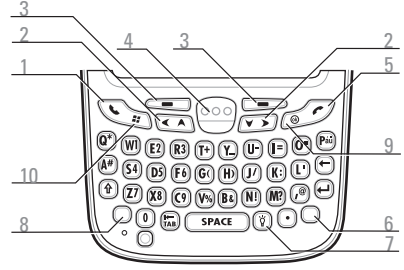

Alpha-Numeric Keypad

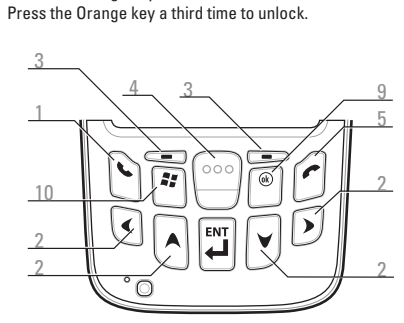
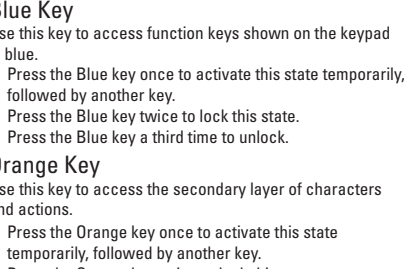

CARD INSTALLATION

MicroSD Card Installation (Optional)

1. Remove the handstrap.
2. Lift the rubber access door.
3. Slide the SIM card holder up to unlock.
4. Lift the SIM card holder.
5. Carefully lift the microSD card holder.
6. Insert the microSD card into the card holder.

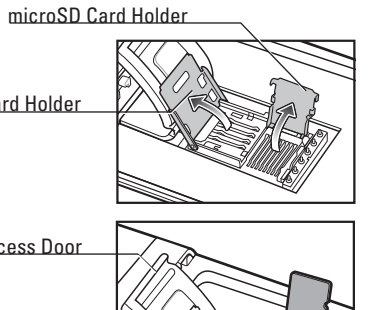

NOTE:

Proper position of the microSD card — the card connector (i.e., gold contacts) should be facing out as shown.

7. Gently lower the microSD card holder until it snaps into place.

SIM Card Installation (Optional)

8. Insert the SIM card into the SIM holder.

NOTE:

The proper position of the SIM card—the card connector (i.e., gold area) should be facing outward with the beveled corner facing away.

9. Lower the SIM card holder.
10. Slide the SIM card holder down to lock into place.
11. Close the rubber access door.
12. Install the battery.

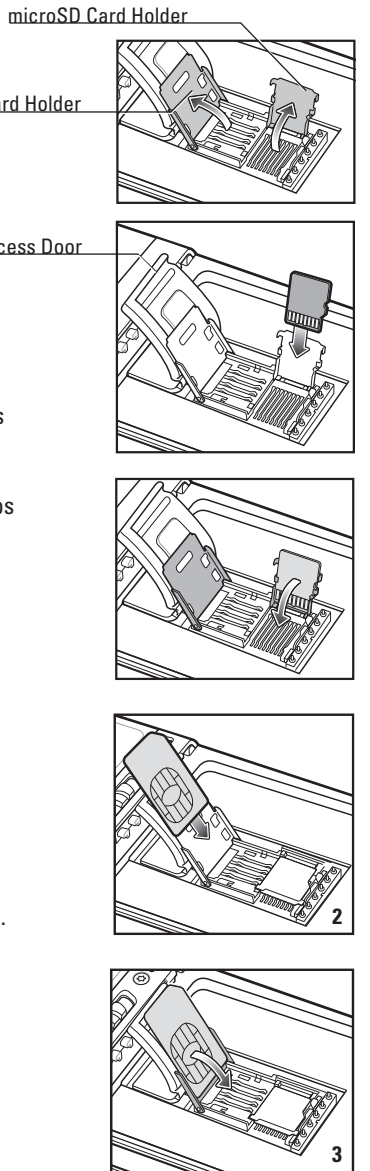

BATTERY INSTALLATION

1. Insert the battery, bottom first, into the battery compartment.
2. Press down on the battery until the battery latch snaps into place.
3. Replace the handstrap.

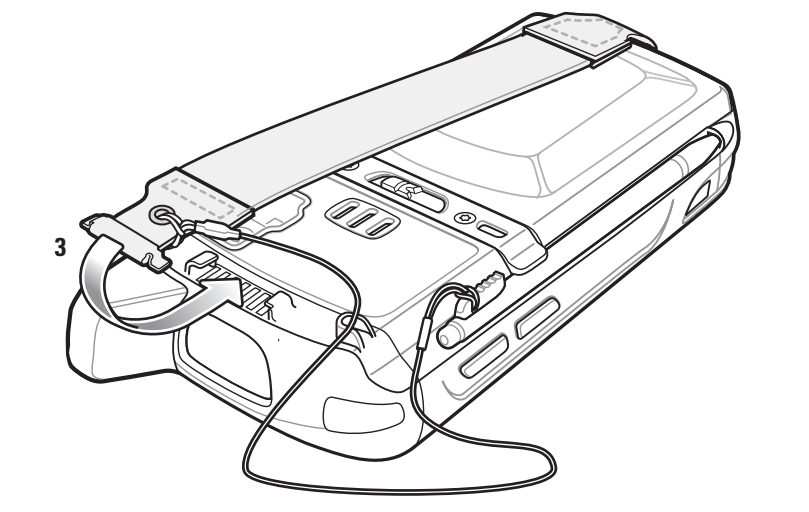
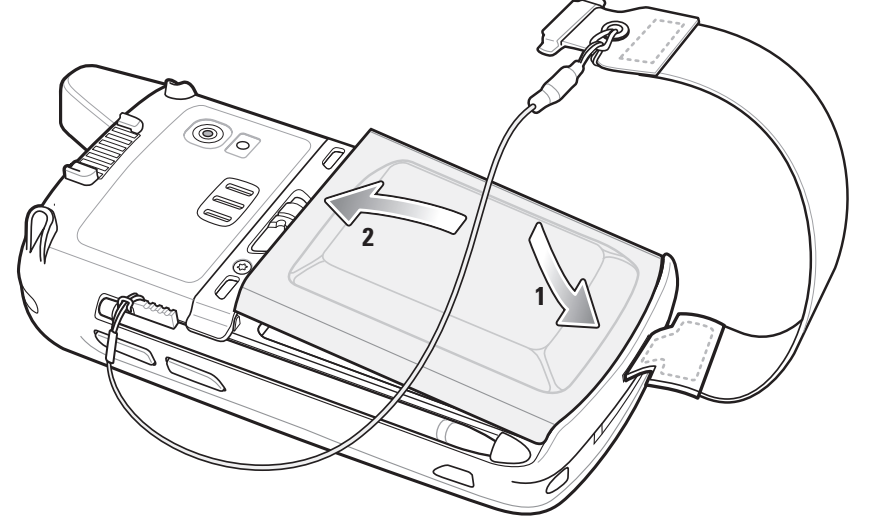

CHARGING

Using the Single-slot USB Cradle

Use the Single-slot USB cradle or Four-slot cradles (Charge Only or Ethernet) to charge the battery in the MC67.

Also charge a spare battery using the Single-slot cradle.

- Charging/Battery Status LED
- Slow Blinking Amber = Charging
- Solid Amber = Fully charged
- Fast Blinking Amber = Charging error

Using the Four-slot Cradles

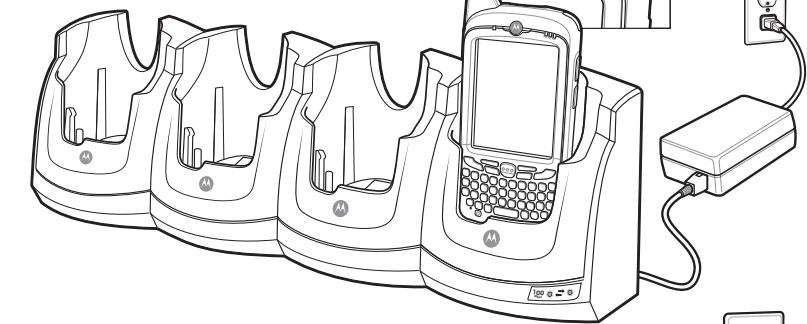

Using the Four-Slot Spare Battery Charger

Use the Four-slot Battery Charger to charge batteries separately.

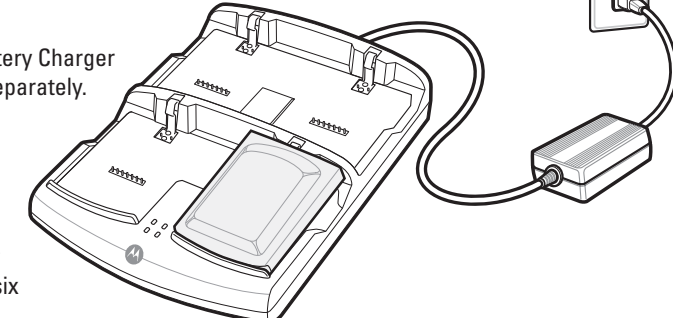

Note:

The 3600 mAh battery charges in less than six hours.

BATTERY REMOVAL

1. If the MC67 is in suspend mode, press the Power button to wake the MC67.
2. Press the Power button to place the MC67 in suspend mode.
3. Tap **Safe Battery Swap**.
4. Wait for the Data Capture LED to turn red and then turn off.
5. When the LED turns off, remove the handstrap.
6. Slide the battery latch to the right. The battery ejects slightly.
7. Grasp the battery and lift from the MC67.

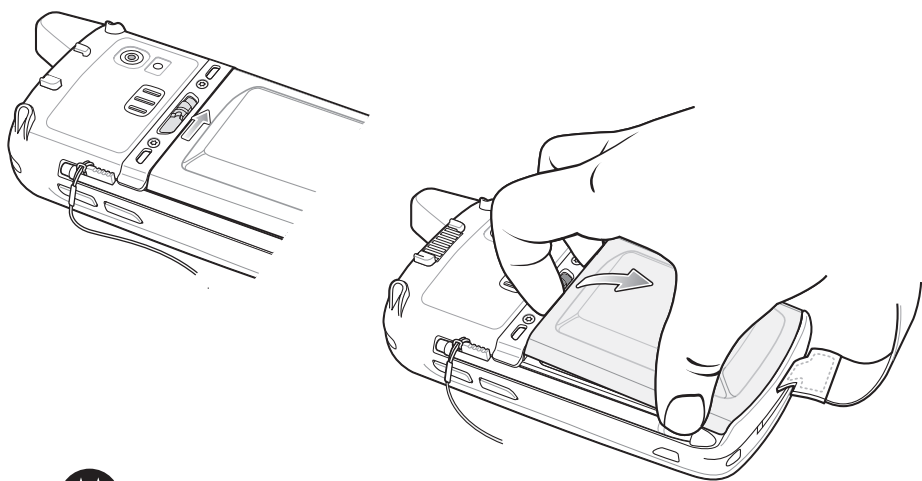

MOTOROLA

Motorola Solutions, Inc.
1301 E. Elgonquin Rd. Schaumburg, IL 60196-1078, U.S.A.
MOTOROLA, MOTO, MOTOROLA SOLUTIONS and the Stylized M Logo are trademarks or registered trademarks of Motorola Trademark Holdings, LLC and are used under license. All other trademarks are the property of their respective owners.
© 2012 Motorola Solutions, Inc. All Rights Reserved.



72-161172-01 Rev. 1 — February 2012

MC67

QUICK START GUIDE

COMMUNICATION

Install Synchronization Software

Download Microsoft® ActiveSync® (Windows® XP) or Windows Mobile Device Center (Windows 7) from <http://www.microsoft.com> and follow the instructions to install onto the host computer.

Communicate with Host

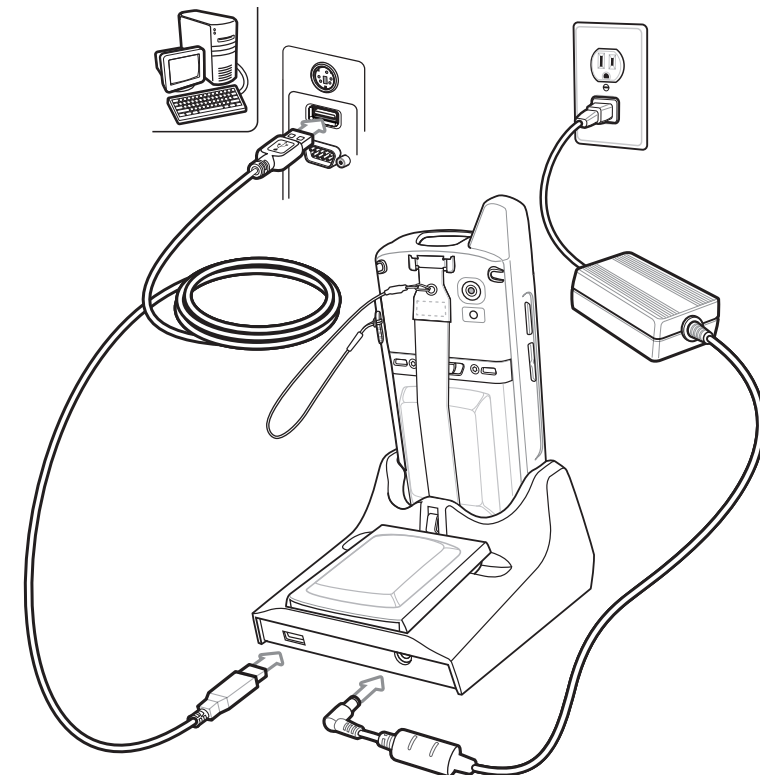

Create a Partnership

Follow the on-screen instructions to establish a connection between the MC67 and the host computer.

<http://www.motorolasolutions.com/MC67>

ACCESSORIES

Screen Protector

Motorola Solutions recommends the continued use of a screen protector to minimize wear and tear. Screen protectors enhance the usability and durability of touch screen displays. Benefits include:

- Protection from scratches and gouges
- Durable writing and touch surface with tactile feel
- Abrasion and chemical resistance
- Glare reduction
- Keeping the device's screen looking like new
- Quick and easy installation.

Not using a screen protector can affect your warranty coverage. An initial screen protector is already applied to your MC67. Contact your local account manager or Motorola Solutions, Inc. for more information and purchasing details. Part number: KT-67525-01R Screen Protector 3/pk.

Four-slot Charge Only Cradle Four-slot Ethernet Cradle

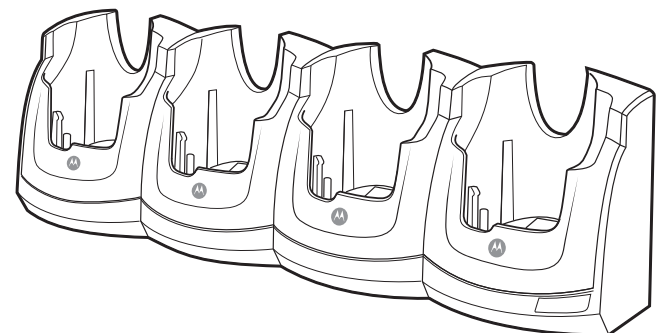

Four-slot Battery Charger Charge Only Cable USB/Charge Cable

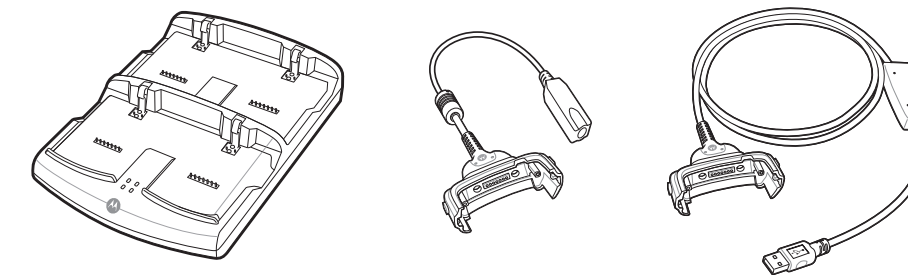

Magnetic Stripe Reader



Single-slot USB Cradle

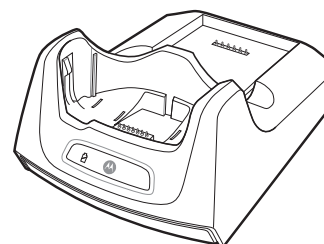

Vehicle Cradle

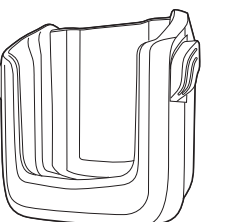

Trigger Handle

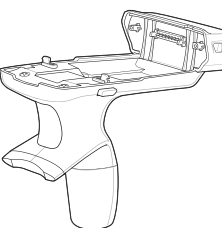

Auto Charge Cable

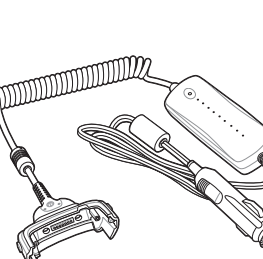

Vehicle Holder

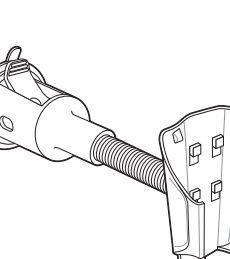

DATA CAPTURE OPTIONS

Imaging

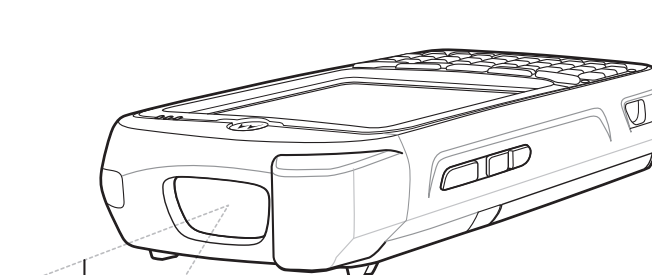

Camera Decode

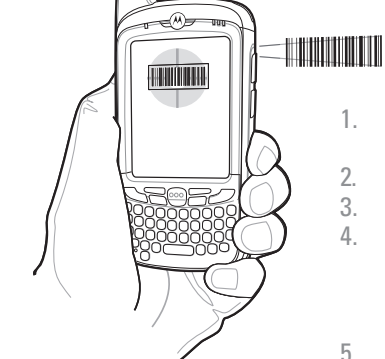

1. Launch a bar code reading application on the MC67.
2. Position the MC67 toward the bar code.
3. Press the **Scan** button.
4. In the image window align the red target over the bar code. When the MC67 decodes the bar code the Scan/Decode LED light green and a beep sounds.
5. Release the **Scan** button.

Camera Photo

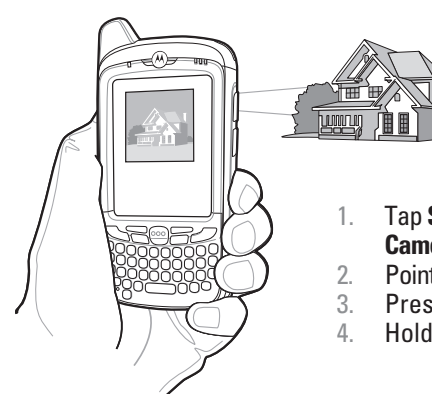

1. Tap **Start > Programs > Pictures & Videos > Camera**.
2. Point the MC67 at an object.
3. Press the **Enter** button.
4. Hold MC67 still until "Shutter Sound" is heard.

GPS Information

When using the GPS feature of the MC67:

- Acquiring satellite signals may take a few minutes. It is best to be outside and have a clear, unobstructed view of the sky.
- Without a clear view, acquisition takes much longer and could result in the MC67 being unable to compute the initial position quickly.
- Obtain a satellite fix before moving.
- Shutdown GPS application when not in use.

AVOID EXTREME WRIST ANGLES



AVOID EXTREME WRIST ANGLES

