



In Collaboration with
s p e a g
 CALIBRATION LABORATORY



中国认可
 国际互认
 校准
 CALIBRATION
 CNAS L0570

Add: No.51 Xueyuan Road, Haidian District, Beijing, 100191, China
 Tel: +86-10-62304633-2079 Fax: +86-10-62304633-2504
 E-mail: cttl@chinattl.com [Http://www.chinattl.cn](http://www.chinattl.cn)

Client **Sporton_TW**

Certificate No: **Z16-97130**

CALIBRATION CERTIFICATE

Object D2450V2 - SN: 736

Calibration Procedure(s) FD-Z11-2-003-01
 Calibration Procedures for dipole validation kits

Calibration date: August 30, 2016

This calibration Certificate documents the traceability to national standards, which realize the physical units of measurements(SI). The measurements and the uncertainties with confidence probability are given on the following pages and are part of the certificate.

All calibrations have been conducted in the closed laboratory facility: environment temperature(22±3)°C and humidity<70%.

Calibration Equipment used (M&TE critical for calibration)

Primary Standards	ID #	Cal Date(Calibrated by, Certificate No.)	Scheduled Calibration
Power Meter NRP2	101919	01-Jul-15 (CTTL, No.J15X04256)	Jun-16
Power sensor NRP-Z91	101547	01-Jul-15 (CTTL, No.J15X04256)	Jun-16
Reference Probe EX3DV4	SN 3801	29-Jun-16(SPEAG,No.EX3-3801_Jun16)	Jun-17
DAE4	SN 777	22-Aug-16(CTTL-SPEAG,No.Z16-97138)	Aug-17
Secondary Standards	ID #	Cal Date(Calibrated by, Certificate No.)	Scheduled Calibration
Signal Generator E4438C	MY49071430	01-Feb-16 (CTTL, No.J16X00893)	Jan-17
Network Analyzer E5071C	MY46110673	26-Jan-16 (CTTL, No.J16X00894)	Jan-17

	Name	Function	Signature
Calibrated by:	Zhao Jing	SAR Test Engineer	
Reviewed by:	Qi Dianyuan	SAR Project Leader	
Approved by:	Lu Bingsong	Deputy Director of the laboratory	

Issued: September 1, 2016

This calibration certificate shall not be reproduced except in full without written approval of the laboratory.



Glossary:

TSL	tissue simulating liquid
ConvF	sensitivity in TSL / NORM _{x,y,z}
N/A	not applicable or not measured

Calibration is Performed According to the Following Standards:

- IEEE Std 1528-2013, "IEEE Recommended Practice for Determining the Peak Spatial-Averaged Specific Absorption Rate (SAR) in the Human Head from Wireless Communications Devices: Measurement Techniques", June 2013
- IEC 62209-1, "Procedure to measure the Specific Absorption Rate (SAR) For hand-held devices used in close proximity to the ear (frequency range of 300MHz to 3GHz)", February 2005
- IEC 62209-2, "Procedure to measure the Specific Absorption Rate (SAR) For wireless communication devices used in close proximity to the human body (frequency range of 30MHz to 6GHz)", March 2010
- KDB865664, SAR Measurement Requirements for 100 MHz to 6 GHz

Additional Documentation:

- DASY4/5 System Handbook

Methods Applied and Interpretation of Parameters:

- Measurement Conditions:** Further details are available from the Validation Report at the end of the certificate. All figures stated in the certificate are valid at the frequency indicated.
- Antenna Parameters with TSL:** The dipole is mounted with the spacer to position its feed point exactly below the center marking of the flat phantom section, with the arms oriented parallel to the body axis.
- Feed Point Impedance and Return Loss:** These parameters are measured with the dipole positioned under the liquid filled phantom. The impedance stated is transformed from the measurement at the SMA connector to the feed point. The Return Loss ensures low reflected power. No uncertainty required.
- Electrical Delay:** One-way delay between the SMA connector and the antenna feed point. No uncertainty required.
- SAR measured:** SAR measured at the stated antenna input power.
- SAR normalized:** SAR as measured, normalized to an input power of 1 W at the antenna connector.
- SAR for nominal TSL parameters:** The measured TSL parameters are used to calculate the nominal SAR result.

The reported uncertainty of measurement is stated as the standard uncertainty of Measurement multiplied by the coverage factor $k=2$, which for a normal distribution Corresponds to a coverage probability of approximately 95%.



Add: No.51 Xueyuan Road, Haidian District, Beijing, 100191, China
 Tel: +86-10-62304633-2079 Fax: +86-10-62304633-2504
 E-mail: cttl@chinattl.com Http://www.chinattl.cn

Measurement Conditions

DASY system configuration, as far as not given on page 1.

DASY Version	DASY52	52.8.8.1258
Extrapolation	Advanced Extrapolation	
Phantom	Triple Flat Phantom 5.1C	
Distance Dipole Center - TSL	10 mm	with Spacer
Zoom Scan Resolution	dx, dy, dz = 5 mm	
Frequency	2450 MHz ± 1 MHz	

Head TSL parameters

The following parameters and calculations were applied.

	Temperature	Permittivity	Conductivity
Nominal Head TSL parameters	22.0 °C	39.2	1.80 mho/m
Measured Head TSL parameters	(22.0 ± 0.2) °C	39.5 ± 6 %	1.81 mho/m ± 6 %
Head TSL temperature change during test	<1.0 °C	----	----

SAR result with Head TSL

SAR averaged over 1 cm³ (1 g) of Head TSL	Condition	
SAR measured	250 mW input power	13.3 mW / g
SAR for nominal Head TSL parameters	normalized to 1W	53.1 mW / g ± 20.8 % (k=2)
SAR averaged over 10 cm³ (10 g) of Head TSL	Condition	
SAR measured	250 mW input power	6.24 mW / g
SAR for nominal Head TSL parameters	normalized to 1W	25.0 mW / g ± 20.4 % (k=2)

Body TSL parameters

The following parameters and calculations were applied.

	Temperature	Permittivity	Conductivity
Nominal Body TSL parameters	22.0 °C	52.7	1.95 mho/m
Measured Body TSL parameters	(22.0 ± 0.2) °C	52.0 ± 6 %	1.93 mho/m ± 6 %
Body TSL temperature change during test	<1.0 °C	----	----

SAR result with Body TSL

SAR averaged over 1 cm³ (1 g) of Body TSL	Condition	
SAR measured	250 mW input power	13.0 mW / g
SAR for nominal Body TSL parameters	normalized to 1W	52.1 mW / g ± 20.8 % (k=2)
SAR averaged over 10 cm³ (10 g) of Body TSL	Condition	
SAR measured	250 mW input power	6.10 mW / g
SAR for nominal Body TSL parameters	normalized to 1W	24.4 mW / g ± 20.4 % (k=2)



Add: No.51 Xueyuan Road, Haidian District, Beijing, 100191, China
Tel: +86-10-62304633-2079 Fax: +86-10-62304633-2504
E-mail: cttl@chinattl.com Http://www.chinattl.cn

Appendix

Antenna Parameters with Head TSL

Impedance, transformed to feed point	$52.5\Omega + 4.99j\Omega$
Return Loss	- 25.3dB

Antenna Parameters with Body TSL

Impedance, transformed to feed point	$48.0\Omega + 4.65j\Omega$
Return Loss	- 25.7dB

General Antenna Parameters and Design

Electrical Delay (one direction)	1.053 ns
----------------------------------	----------

After long term use with 100W radiated power, only a slight warming of the dipole near the feedpoint can be measured.

The dipole is made of standard semirigid coaxial cable. The center conductor of the feeding line is directly connected to the second arm of the dipole. The antenna is therefore short-circuited for DC-signals. On some of the dipoles, small end caps are added to the dipole arms in order to improve matching when loaded according to the position as explained in the "Measurement Conditions" paragraph. The SAR data are not affected by this change. The overall dipole length is still according to the Standard.

No excessive force must be applied to the dipole arms, because they might bend or the soldered connections near the feedpoint may be damaged.

Additional EUT Data

Manufactured by	SPEAG
-----------------	-------



Add: No.51 Xueyuan Road, Haidian District, Beijing, 100191, China
Tel: +86-10-62304633-2079 Fax: +86-10-62304633-2504
E-mail: cttl@chinattl.com Http://www.chinattl.cn

DASY5 Validation Report for Head TSL

Date: 08.30.2016

Test Laboratory: CTTL, Beijing, China

DUT: Dipole 2450 MHz; Type: D2450V2; Serial: D2450V2 - SN: 736

Communication System: UID 0, CW; Frequency: 2450 MHz; Duty Cycle: 1:1

Medium parameters used: $f = 2450$ MHz; $\sigma = 1.812$ S/m; $\epsilon_r = 39.54$; $\rho = 1000$ kg/m³

Phantom section: Right Section

Measurement Standard: DASY5 (IEEE/IEC/ANSI C63.19-2007)

DASY5 Configuration:

- Probe: EX3DV4 - SN3801; ConvF(6.67, 6.67, 6.67); Calibrated: 6/29/2016;
- Sensor-Surface: 2mm (Mechanical Surface Detection)
- Electronics: DAE4 Sn777; Calibrated: 8/22/2016
- Phantom: Triple Flat Phantom 5.1C; Type: QD 000 P51 CA; Serial: 1161/1
- Measurement SW: DASY52, Version 52.8 (8); SEMCAD X Version 14.6.10 (7372)

Dipole Calibration/Zoom Scan (7x7x7) (7x7x7)/Cube 0: Measurement grid: dx=5mm, dy=5mm, dz=5mm

Reference Value = 103.9 V/m; Power Drift = -0.03 dB

Peak SAR (extrapolated) = 26.9 W/kg

SAR(1 g) = 13.3 W/kg; SAR(10 g) = 6.24 W/kg

Maximum value of SAR (measured) = 20.2 W/kg

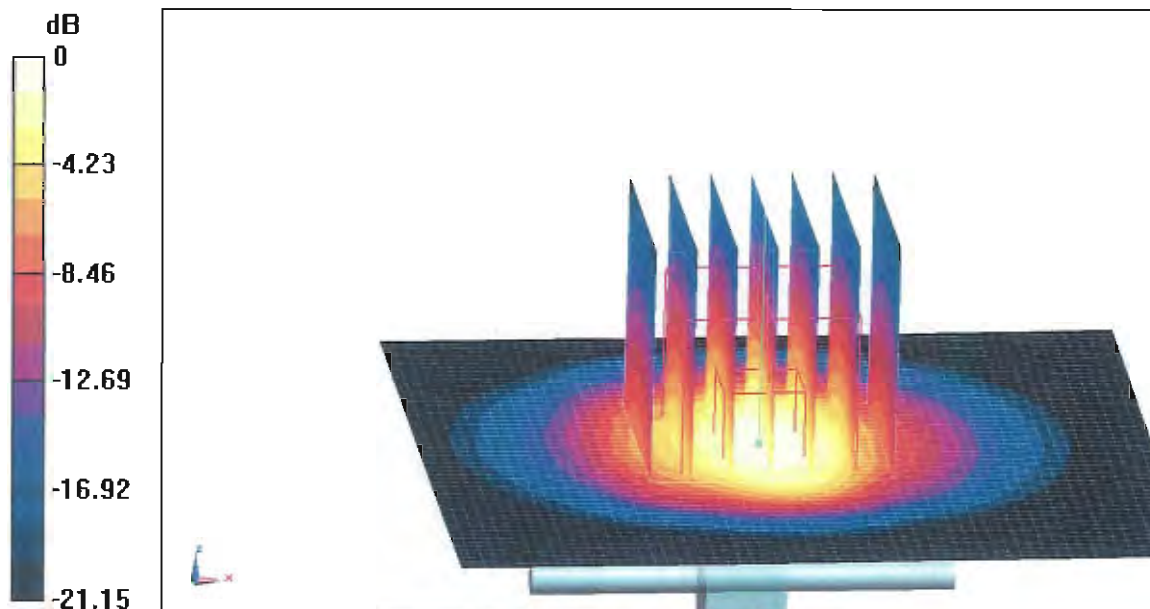

0 dB = 20.2 W/kg = 13.05 dBW/kg



Add: No.51 Xueyuan Road, Haidian District, Beijing, 100191, China
Tel: +86-10-62304633-2079 Fax: +86-10-62304633-2504
E-mail: cttl@chinattl.com Http://www.chinattl.cn

Impedance Measurement Plot for Head TSL

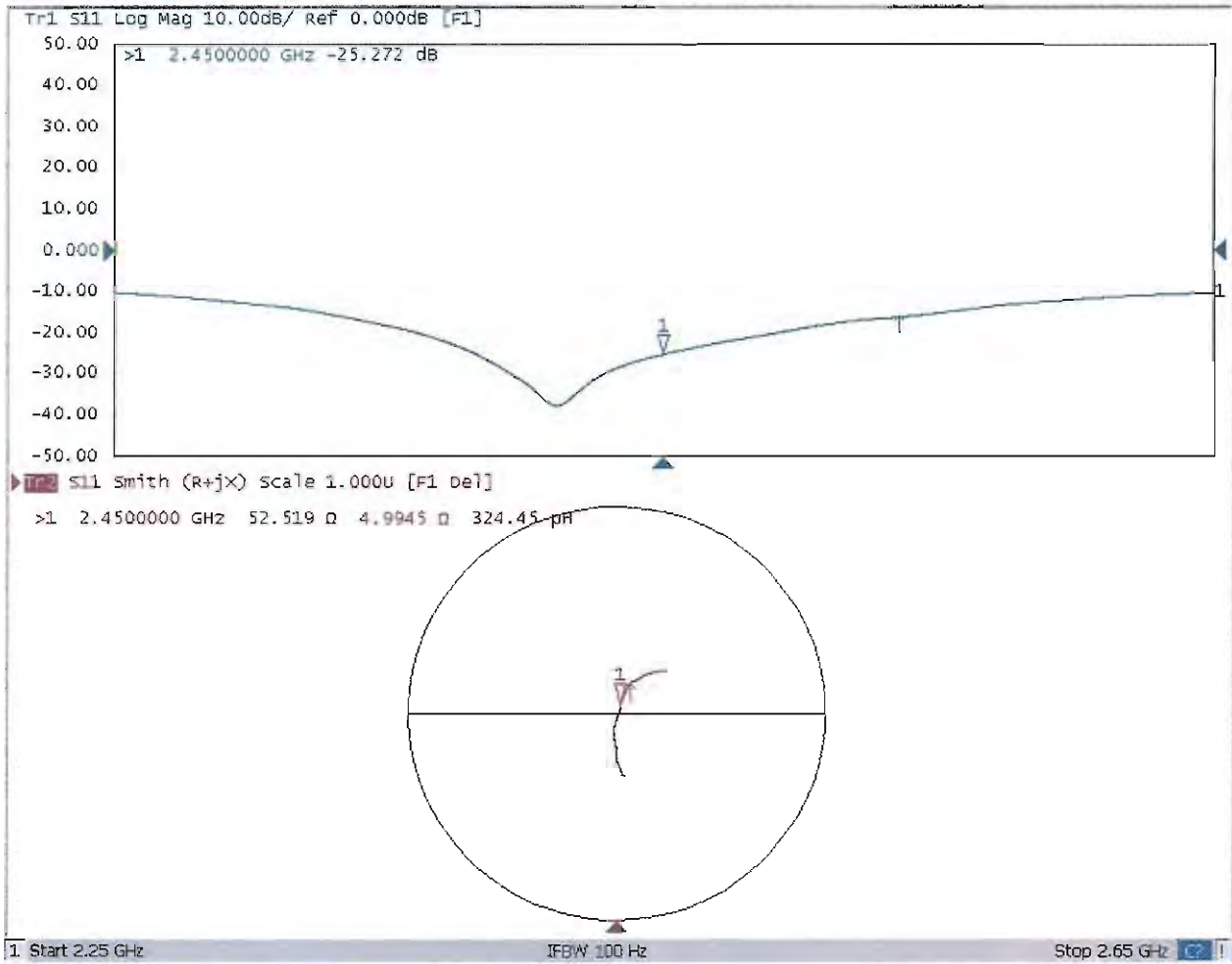



DASY5 Validation Report for Body TSL

Date: 08.30.2016

Test Laboratory: CTTL, Beijing, China

DUT: Dipole 2450 MHz; Type: D2450V2; Serial: D2450V2 - SN: 736

Communication System: UID 0, CW; Frequency: 2450 MHz; Duty Cycle: 1:1

Medium parameters used: $f = 2450$ MHz; $\sigma = 1.933$ S/m; $\epsilon_r = 51.96$; $\rho = 1000$ kg/m³

Phantom section: Center Section

Measurement Standard: DASY5 (IEEE/IEC/ANSI C63.19-2007)

DASY5 Configuration:

- Probe: EX3DV4 - SN3801; ConvF(6.88, 6.88, 6.88); Calibrated: 6/29/2016;
- Sensor-Surface: 2mm (Mechanical Surface Detection)
- Electronics: DAE4 Sn777; Calibrated: 8/22/2016
- Phantom: Triple Flat Phantom 5.1C; Type: QD 000 P51 CA; Serial: 1161/1
- Measurement SW: DASY52, Version 52.8 (8); SEMCAD X Version 14.6.10 (7372)

Dipole Calibration/Zoom Scan (7x7x7) (7x7x7)/Cube 0: Measurement grid: dx=5mm, dy=5mm, dz=5mm

Reference Value = 95.98 V/m; Power Drift = 0.04 dB

Peak SAR (extrapolated) = 26.1 W/kg

SAR(1 g) = 13 W/kg; SAR(10 g) = 6.1 W/kg

Maximum value of SAR (measured) = 19.6 W/kg

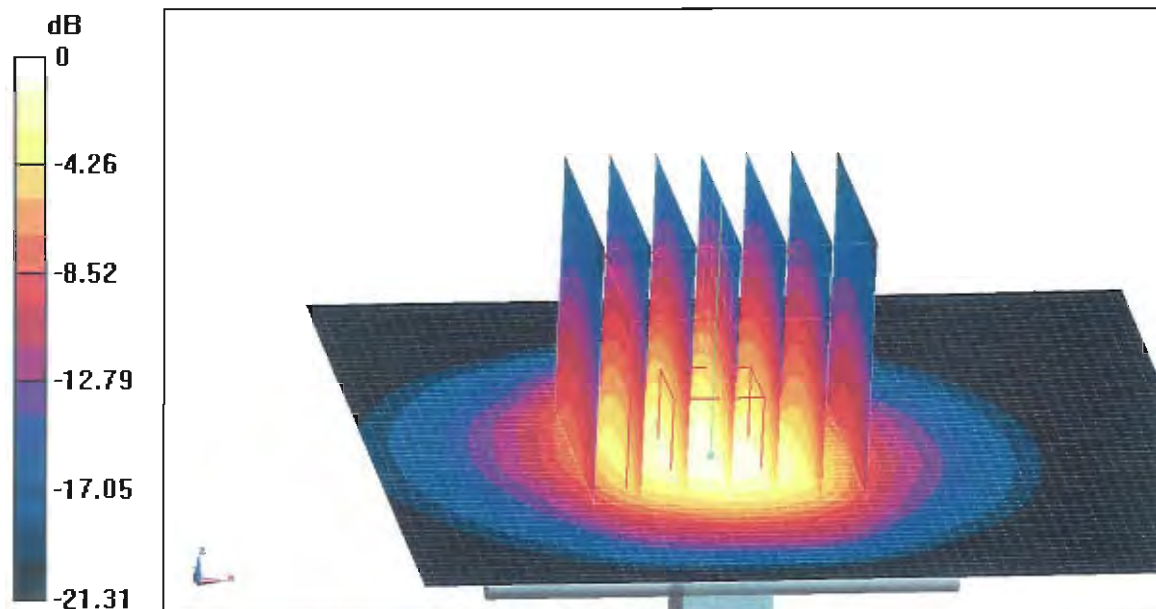

0 dB = 19.6 W/kg = 12.92 dBW/kg



Add: No.51 Xueyuan Road, Haidian District, Beijing, 100191, China
Tel: +86-10-62304633-2079 Fax: +86-10-62304633-2504
E-mail: cttl@chinattl.com Http://www.chinattl.cn

Impedance Measurement Plot for Body TSL

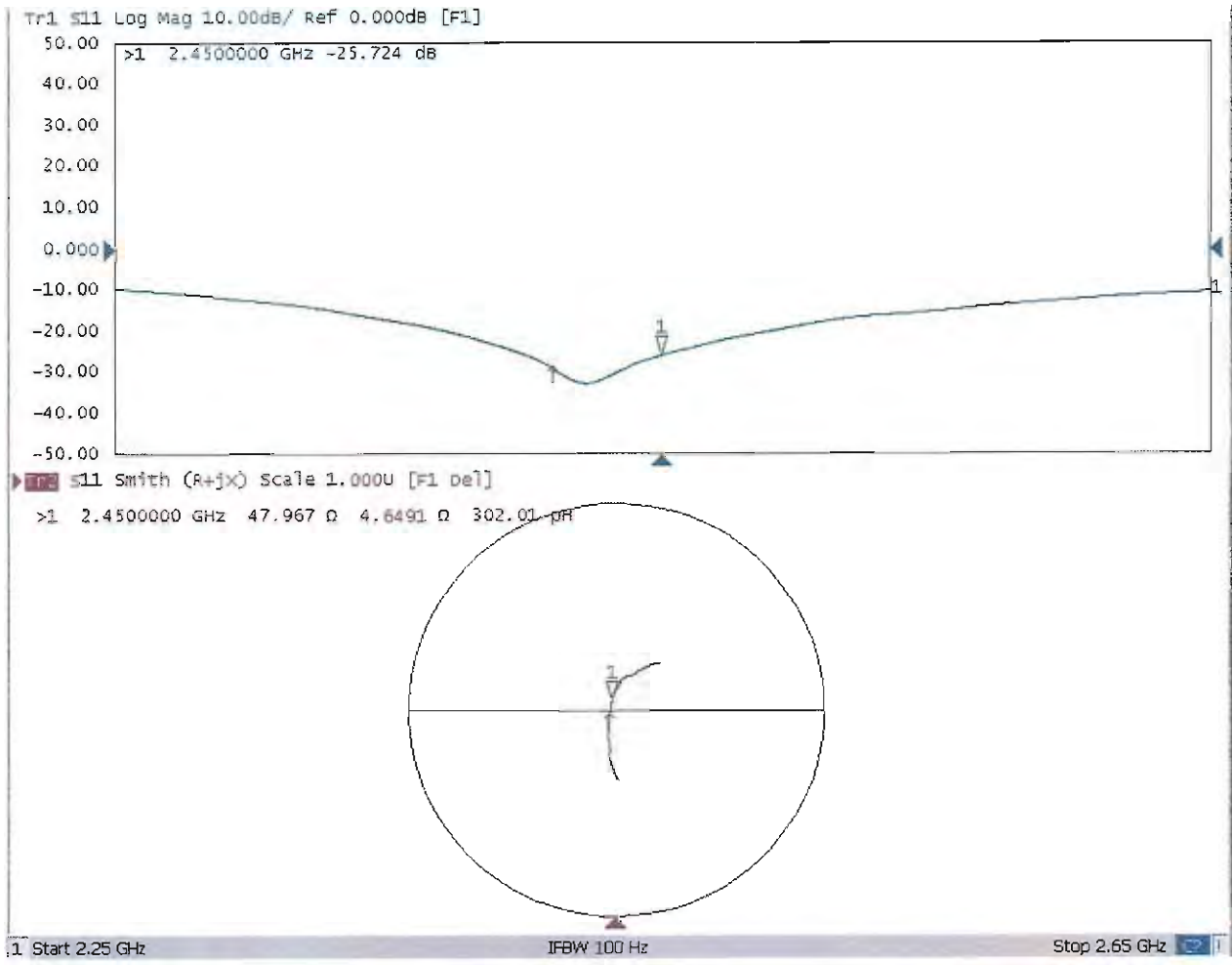



Accredited by the Swiss Accreditation Service (SAS)
The Swiss Accreditation Service is one of the signatories to the EA
Multilateral Agreement for the recognition of calibration certificates

Accreditation No.: **SCS 0108**

Client **Sporton-TW (Auden)**

Certificate No: **D5GHzV2-1006_Sep16**

CALIBRATION CERTIFICATE

Object **D5GHzV2 - SN:1006**

Calibration procedure(s) **QA CAL-22.v2**
Calibration procedure for dipole validation kits between 3-6 GHz

Calibration date: **September 27, 2016**

This calibration certificate documents the traceability to national standards, which realize the physical units of measurements (SI).
The measurements and the uncertainties with confidence probability are given on the following pages and are part of the certificate.

All calibrations have been conducted in the closed laboratory facility: environment temperature (22 ± 3)°C and humidity < 70%.

Calibration Equipment used (M&TE critical for calibration)

Primary Standards	ID #	Cal Date (Certificate No.)	Scheduled Calibration
Power meter NRP	SN: 104778	06-Apr-16 (No. 217-02288/02289)	Apr-17
Power sensor NRP-Z91	SN: 103244	06-Apr-16 (No. 217-02288)	Apr-17
Power sensor NRP-Z91	SN: 103245	06-Apr-16 (No. 217-02289)	Apr-17
Reference 20 dB Attenuator	SN: 5058 (20k)	05-Apr-16 (No. 217-02292)	Apr-17
Type-N mismatch combination	SN: 5047.2 / 06327	05-Apr-16 (No. 217-02295)	Apr-17
Reference Probe EX3DV4	SN: 3503	30-Jun-16 (No. EX3-3503_Jun16)	Jun-17
DAE4	SN: 601	30-Dec-15 (No. DAE4-601_Dec15)	Dec-16

Secondary Standards	ID #	Check Date (in house)	Scheduled Check
Power meter EPM-442A	SN: GB37480704	07-Oct-15 (No. 217-02222)	In house check: Oct-16
Power sensor HP 8481A	SN: US37292783	07-Oct-15 (No. 217-02222)	In house check: Oct-16
Power sensor HP 8481A	SN: MY41092317	07-Oct-15 (No. 217-02223)	In house check: Oct-16
RF generator R&S SMT-06	SN: 100972	15-Jun-15 (in house check Jun-15)	In house check: Oct-16
Network Analyzer HP 8753E	SN: US37390585	18-Oct-01 (in house check Oct-15)	In house check: Oct-16

Calibrated by: **Claudio Leubler** Name: Claudio Leubler Function: Laboratory Technician

Approved by: **Katja Pokovic** Name: Katja Pokovic Function: Technical Manager

Signature

Issued: September 27, 2016

This calibration certificate shall not be reproduced except in full without written approval of the laboratory.



Accredited by the Swiss Accreditation Service (SAS)
The Swiss Accreditation Service is one of the signatories to the EA
Multilateral Agreement for the recognition of calibration certificates

Accreditation No.: **SCS 0108**

Glossary:

TSL	tissue simulating liquid
ConvF	sensitivity in TSL / NORM x,y,z
N/A	not applicable or not measured

Calibration is Performed According to the Following Standards:

- IEEE Std 1528-2013, "IEEE Recommended Practice for Determining the Peak Spatial-Averaged Specific Absorption Rate (SAR) in the Human Head from Wireless Communications Devices: Measurement Techniques", June 2013
- IEC 62209-2, "Procedure to determine the Specific Absorption Rate (SAR) for wireless communication devices used in close proximity to the human body (frequency range of 30 MHz to 6 GHz)", March 2010
- KDB 865664, "SAR Measurement Requirements for 100 MHz to 6 GHz"

Additional Documentation:

- DASY4/5 System Handbook

Methods Applied and Interpretation of Parameters:

- Measurement Conditions:** Further details are available from the Validation Report at the end of the certificate. All figures stated in the certificate are valid at the frequency indicated.
- Antenna Parameters with TSL:** The dipole is mounted with the spacer to position its feed point exactly below the center marking of the flat phantom section, with the arms oriented parallel to the body axis.
- Feed Point Impedance and Return Loss:** These parameters are measured with the dipole positioned under the liquid filled phantom. The impedance stated is transformed from the measurement at the SMA connector to the feed point. The Return Loss ensures low reflected power. No uncertainty required.
- Electrical Delay:** One-way delay between the SMA connector and the antenna feed point. No uncertainty required.
- SAR measured:** SAR measured at the stated antenna input power.
- SAR normalized:** SAR as measured, normalized to an input power of 1 W at the antenna connector.
- SAR for nominal TSL parameters:** The measured TSL parameters are used to calculate the nominal SAR result.

The reported uncertainty of measurement is stated as the standard uncertainty of measurement multiplied by the coverage factor $k=2$, which for a normal distribution corresponds to a coverage probability of approximately 95%.

Measurement Conditions

DASY system configuration, as far as not given on page 1.

DASY Version	DASY5	V52.8.8
Extrapolation	Advanced Extrapolation	
Phantom	Modular Flat Phantom V5.0	
Distance Dipole Center - TSL	10 mm	with Spacer
Zoom Scan Resolution	dx, dy = 4.0 mm, dz = 1.4 mm	Graded Ratio = 1.4 (Z direction)
Frequency	5250 MHz ± 1 MHz 5600 MHz ± 1 MHz 5750 MHz ± 1 MHz	

Head TSL parameters at 5250 MHz

The following parameters and calculations were applied.

	Temperature	Permittivity	Conductivity
Nominal Head TSL parameters	22.0 °C	35.9	4.71 mho/m
Measured Head TSL parameters	(22.0 ± 0.2) °C	34.5 ± 6 %	4.59 mho/m ± 6 %
Head TSL temperature change during test	< 0.5 °C	----	----

SAR result with Head TSL at 5250 MHz

SAR averaged over 1 cm³ (1 g) of Head TSL	Condition	
SAR measured	100 mW input power	8.13 W/kg
SAR for nominal Head TSL parameters	normalized to 1W	80.6 W/kg ± 19.9 % (k=2)

SAR averaged over 10 cm³ (10 g) of Head TSL	condition	
SAR measured	100 mW input power	2.32 W/kg
SAR for nominal Head TSL parameters	normalized to 1W	22.9 W/kg ± 19.5 % (k=2)

Head TSL parameters at 5600 MHz

The following parameters and calculations were applied.

	Temperature	Permittivity	Conductivity
Nominal Head TSL parameters	22.0 °C	35.5	5.07 mho/m
Measured Head TSL parameters	(22.0 ± 0.2) °C	34.0 ± 6 %	4.93 mho/m ± 6 %
Head TSL temperature change during test	< 0.5 °C	----	----

SAR result with Head TSL at 5600 MHz

SAR averaged over 1 cm³ (1 g) of Head TSL	Condition	
SAR measured	100 mW input power	8.47 W/kg
SAR for nominal Head TSL parameters	normalized to 1W	83.8 W / kg ± 19.9 % (k=2)

SAR averaged over 10 cm³ (10 g) of Head TSL	condition	
SAR measured	100 mW input power	2.40 W/kg
SAR for nominal Head TSL parameters	normalized to 1W	23.7 W/kg ± 19.5 % (k=2)

Head TSL parameters at 5750 MHz

The following parameters and calculations were applied.

	Temperature	Permittivity	Conductivity
Nominal Head TSL parameters	22.0 °C	35.4	5.22 mho/m
Measured Head TSL parameters	(22.0 ± 0.2) °C	33.8 ± 6 %	5.08 mho/m ± 6 %
Head TSL temperature change during test	< 0.5 °C	----	----

SAR result with Head TSL at 5750 MHz

SAR averaged over 1 cm ³ (1 g) of Head TSL	Condition	
SAR measured	100 mW input power	8.14 W/kg
SAR for nominal Head TSL parameters	normalized to 1W	80.5 W/kg ± 19.9 % (k=2)

SAR averaged over 10 cm ³ (10 g) of Head TSL	condition	
SAR measured	100 mW input power	2.30 W/kg
SAR for nominal Head TSL parameters	normalized to 1W	22.7 W/kg ± 19.5 % (k=2)

Body TSL parameters at 5250 MHz

The following parameters and calculations were applied.

	Temperature	Permittivity	Conductivity
Nominal Body TSL parameters	22.0 °C	48.9	5.36 mho/m
Measured Body TSL parameters	(22.0 ± 0.2) °C	47.4 ± 6 %	5.52 mho/m ± 6 %
Body TSL temperature change during test	< 0.5 °C	----	----

SAR result with Body TSL at 5250 MHz

SAR averaged over 1 cm ³ (1 g) of Body TSL	Condition	
SAR measured	100 mW input power	7.59 W/kg
SAR for nominal Body TSL parameters	normalized to 1W	75.5 W/kg ± 19.9 % (k=2)

SAR averaged over 10 cm ³ (10 g) of Body TSL	condition	
SAR measured	100 mW input power	2.13 W/kg
SAR for nominal Body TSL parameters	normalized to 1W	21.2 W/kg ± 19.5 % (k=2)

Body TSL parameters at 5600 MHz

The following parameters and calculations were applied.

	Temperature	Permittivity	Conductivity
Nominal Body TSL parameters	22.0 °C	48.5	5.77 mho/m
Measured Body TSL parameters	(22.0 ± 0.2) °C	46.8 ± 6 %	6.00 mho/m ± 6 %
Body TSL temperature change during test	< 0.5 °C	----	----

SAR result with Body TSL at 5600 MHz

SAR averaged over 1 cm ³ (1 g) of Body TSL	Condition	
SAR measured	100 mW input power	7.90 W/kg
SAR for nominal Body TSL parameters	normalized to 1W	78.6 W/kg ± 19.9 % (k=2)

SAR averaged over 10 cm ³ (10 g) of Body TSL	condition	
SAR measured	100 mW input power	2.22 W/kg
SAR for nominal Body TSL parameters	normalized to 1W	22.0 W/kg ± 19.5 % (k=2)

Body TSL parameters at 5750 MHz

The following parameters and calculations were applied.

	Temperature	Permittivity	Conductivity
Nominal Body TSL parameters	22.0 °C	48.3	5.94 mho/m
Measured Body TSL parameters	(22.0 ± 0.2) °C	46.5 ± 6 %	6.21 mho/m ± 6 %
Body TSL temperature change during test	< 0.5 °C	----	----

SAR result with Body TSL at 5750 MHz

SAR averaged over 1 cm ³ (1 g) of Body TSL	Condition	
SAR measured	100 mW input power	7.50 W/kg
SAR for nominal Body TSL parameters	normalized to 1W	74.6 W/kg ± 19.9 % (k=2)

SAR averaged over 10 cm ³ (10 g) of Body TSL	condition	
SAR measured	100 mW input power	2.10 W/kg
SAR for nominal Body TSL parameters	normalized to 1W	20.8 W/kg ± 19.5 % (k=2)

Appendix (Additional assessments outside the scope of SCS 0108)

Antenna Parameters with Head TSL at 5250 MHz

Impedance, transformed to feed point	55.6 Ω - 6.5 j Ω
Return Loss	- 21.8 dB

Antenna Parameters with Head TSL at 5600 MHz

Impedance, transformed to feed point	57.5 Ω - 4.7 j Ω
Return Loss	- 21.7 dB

Antenna Parameters with Head TSL at 5750 MHz

Impedance, transformed to feed point	59.2 Ω + 5.8 j Ω
Return Loss	- 20.1 dB

Antenna Parameters with Body TSL at 5250 MHz

Impedance, transformed to feed point	55.5 Ω - 3.4 j Ω
Return Loss	- 24.2 dB

Antenna Parameters with Body TSL at 5600 MHz

Impedance, transformed to feed point	59.3 Ω - 1.9 j Ω
Return Loss	- 21.2 dB

Antenna Parameters with Body TSL at 5750 MHz

Impedance, transformed to feed point	58.8 Ω + 8.9 j Ω
Return Loss	- 18.8 dB

General Antenna Parameters and Design

Electrical Delay (one direction)	1.201 ns
----------------------------------	----------

After long term use with 100W radiated power, only a slight warming of the dipole near the feedpoint can be measured.

The dipole is made of standard semirigid coaxial cable. The center conductor of the feeding line is directly connected to the second arm of the dipole. The antenna is therefore short-circuited for DC-signals. On some of the dipoles, small end caps are added to the dipole arms in order to improve matching when loaded according to the position as explained in the "Measurement Conditions" paragraph. The SAR data are not affected by this change. The overall dipole length is still according to the Standard.

No excessive force must be applied to the dipole arms, because they might bend or the soldered connections near the feedpoint may be damaged.

Additional EUT Data

Manufactured by	SPEAG
Manufactured on	August 28, 2003

Test Laboratory: SPEAG, Zurich, Switzerland

DUT: Dipole D5GHzV2; Type: D5GHzV2; Serial: D5GHzV2 - SN:1006

Communication System: UID 0 - CW; Frequency: 5250 MHz, Frequency: 5600 MHz, Frequency: 5750 MHz

Medium parameters used: $f = 5250$ MHz; $\sigma = 4.59$ S/m; $\epsilon_r = 34.5$; $\rho = 1000$ kg/m³

Medium parameters used: $f = 5600$ MHz; $\sigma = 4.93$ S/m; $\epsilon_r = 34.0$; $\rho = 1000$ kg/m³

Medium parameters used: $f = 5750$ MHz; $\sigma = 5.08$ S/m; $\epsilon_r = 33.8$; $\rho = 1000$ kg/m³

Phantom section: Flat Section

Measurement Standard: DASY5 (IEEE/IEC/ANSI C63.19-2011)

DASY52 Configuration:

- Probe: EX3DV4 - SN3503; ConvF(5.42, 5.42, 5.42); Calibrated: 30.06.2016, ConvF(4.89, 4.89, 4.89); Calibrated: 30.06.2016, ConvF(4.85, 4.85, 4.85); Calibrated: 30.06.2016;
- Sensor-Surface: 1.4mm (Mechanical Surface Detection)
- Electronics: DAE4 Sn601; Calibrated: 30.12.2015
- Phantom: Flat Phantom 5.0 (front); Type: QD000P50AA; Serial: 1001
- DASY52 52.8.8(1258); SEMCAD X 14.6.10(7372)

Dipole Calibration for Head Tissue/Pin=100mW, dist=10mm, f=5250 MHz/Zoom Scan, dist=1.4mm (8x8x7)/Cube 0: Measurement grid: dx=4mm, dy=4mm, dz=1.4mm

Reference Value = 72.67 V/m; Power Drift = 0.03 dB

Peak SAR (extrapolated) = 29.4 W/kg

SAR(1 g) = 8.13 W/kg; SAR(10 g) = 2.32 W/kg

Maximum value of SAR (measured) = 18.2 W/kg

Dipole Calibration for Head Tissue/Pin=100mW, dist=10mm, f=5600 MHz/Zoom Scan, dist=1.4mm (8x8x7)/Cube 0: Measurement grid: dx=4mm, dy=4mm, dz=1.4mm

Reference Value = 72.60 V/m; Power Drift = 0.04 dB

Peak SAR (extrapolated) = 33.1 W/kg

SAR(1 g) = 8.47 W/kg; SAR(10 g) = 2.4 W/kg

Maximum value of SAR (measured) = 19.7 W/kg

Dipole Calibration for Head Tissue/Pin=100mW, dist=10mm, f=5750 MHz/Zoom Scan, dist=1.4mm (8x8x7)/Cube 0: Measurement grid: dx=4mm, dy=4mm, dz=1.4mm

Reference Value = 70.56 V/m; Power Drift = 0.03 dB

Peak SAR (extrapolated) = 33.0 W/kg

SAR(1 g) = 8.14 W/kg; SAR(10 g) = 2.3 W/kg

Maximum value of SAR (measured) = 19.2 W/kg

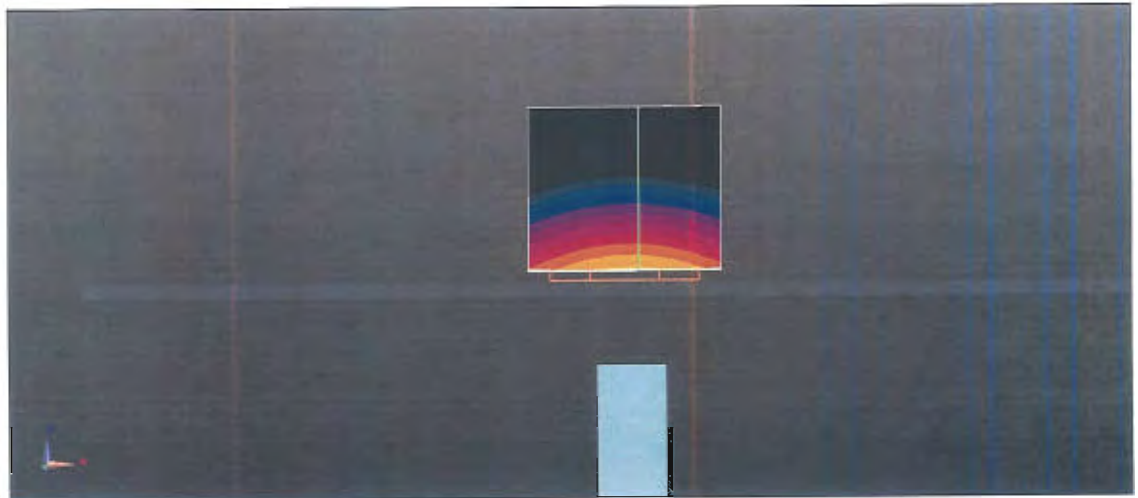
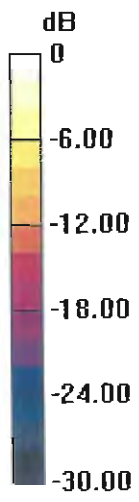

0 dB = 19.2 W/kg = 12.83 dBW/kg

Impedance Measurement Plot for Head TSL

27 Sep 2016 13:52:19

CH1 S11 1 U FS

1: 55.643 Ω -6.4844 Ω 4.6751 pF

5 250.000 000 MHz

De1
Cor
Avg 16
H1d

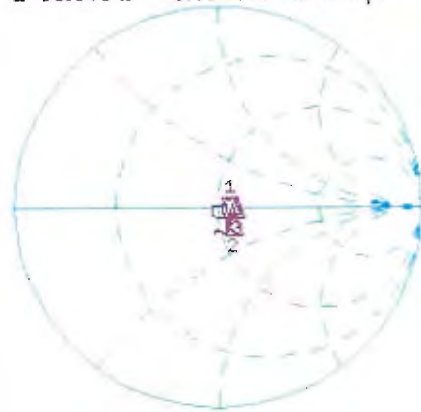

CH1 Markers
2: 57.496 Ω
-4.6836 Ω
5.60000 GHz
3: 59.191 Ω
5.8047 Ω
5.75000 GHz

CH2 S11 LOG 5 dB/REF -20 dB 1:-21.809 dB 5 250.000 000 MHz

Cor
Avg 16
H1d

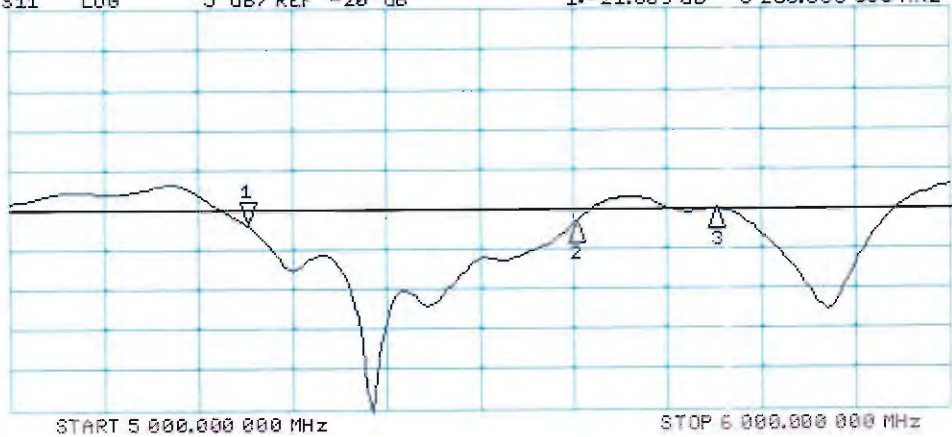

CH2 Markers
2:-21.707 dB
5.60000 GHz
3:-20.051 dB
5.75000 GHz

Test Laboratory: SPEAG, Zurich, Switzerland

DUT: Dipole D5GHzV2; Type: D5GHzV2; Serial: D5GHzV2 - SN:1006

Communication System: UID 0 - CW; Frequency: 5250 MHz, Frequency: 5600 MHz, Frequency: 5750 MHz

Medium parameters used: $f = 5250$ MHz; $\sigma = 5.52$ S/m; $\epsilon_r = 47.4$; $\rho = 1000$ kg/m³

Medium parameters used: $f = 5600$ MHz; $\sigma = 6.00$ S/m; $\epsilon_r = 46.8$; $\rho = 1000$ kg/m³

Medium parameters used: $f = 5750$ MHz; $\sigma = 6.21$ S/m; $\epsilon_r = 46.5$; $\rho = 1000$ kg/m³

Phantom section: Flat Section

Measurement Standard: DASY5 (IEEE/IEC/ANSI C63.19-2011)

DASY52 Configuration:

- Probe: EX3DV4 - SN3503; ConvF(4.85, 4.85, 4.85); Calibrated: 30.06.2016, ConvF(4.35, 4.35, 4.35); Calibrated: 30.06.2016, ConvF(4.3, 4.3, 4.3); Calibrated: 30.06.2016;
- Sensor-Surface: 1.4mm (Mechanical Surface Detection)
- Electronics: DAE4 Sn601; Calibrated: 30.12.2015
- Phantom: Flat Phantom 5.0 (back); Type: QD000P50AA; Serial: 1002
- DASY52 52.8.8(1258); SEMCAD X 14.6.10(7372)

Dipole Calibration for Body Tissue/Pin=100mW, dist=10mm, f=5250 MHz/Zoom Scan, dist=1.4mm (8x8x7)/Cube 0: Measurement grid: dx=4mm, dy=4mm, dz=1.4mm

Reference Value = 66.79 V/m; Power Drift = -0.07 dB

Peak SAR (extrapolated) = 28.8 W/kg

SAR(1 g) = 7.59 W/kg; SAR(10 g) = 2.13 W/kg

Maximum value of SAR (measured) = 17.9 W/kg

Dipole Calibration for Body Tissue/Pin=100mW, dist=10mm, f=5600 MHz/Zoom Scan, dist=1.4mm (8x8x7)/Cube 0: Measurement grid: dx=4mm, dy=4mm, dz=1.4mm

Reference Value = 67.00 V/m; Power Drift = -0.07 dB

Peak SAR (extrapolated) = 32.5 W/kg

SAR(1 g) = 7.9 W/kg; SAR(10 g) = 2.22 W/kg

Maximum value of SAR (measured) = 19.0 W/kg

Dipole Calibration for Body Tissue/Pin=100mW, dist=10mm, f=5750 MHz/Zoom Scan, dist=1.4mm (8x8x7)/Cube 0: Measurement grid: dx=4mm, dy=4mm, dz=1.4mm

Reference Value = 64.64 V/m; Power Drift = -0.03 dB

Peak SAR (extrapolated) = 32.2 W/kg

SAR(1 g) = 7.5 W/kg; SAR(10 g) = 2.1 W/kg

Maximum value of SAR (measured) = 18.5 W/kg

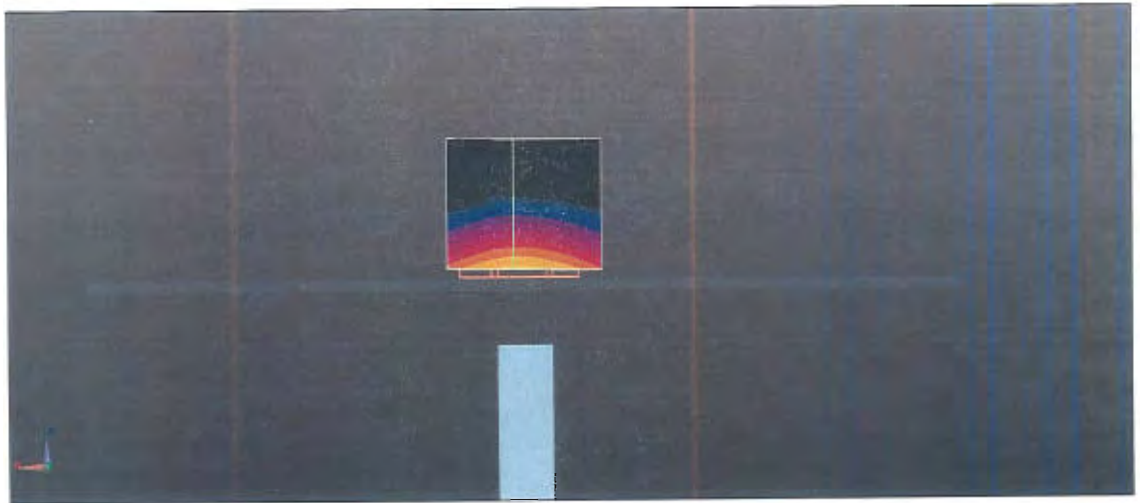
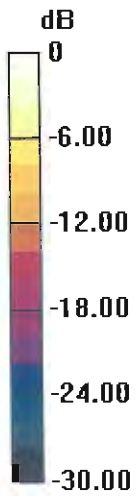

0 dB = 18.5 W/kg = 12.67 dBW/kg

Impedance Measurement Plot for Body TSL

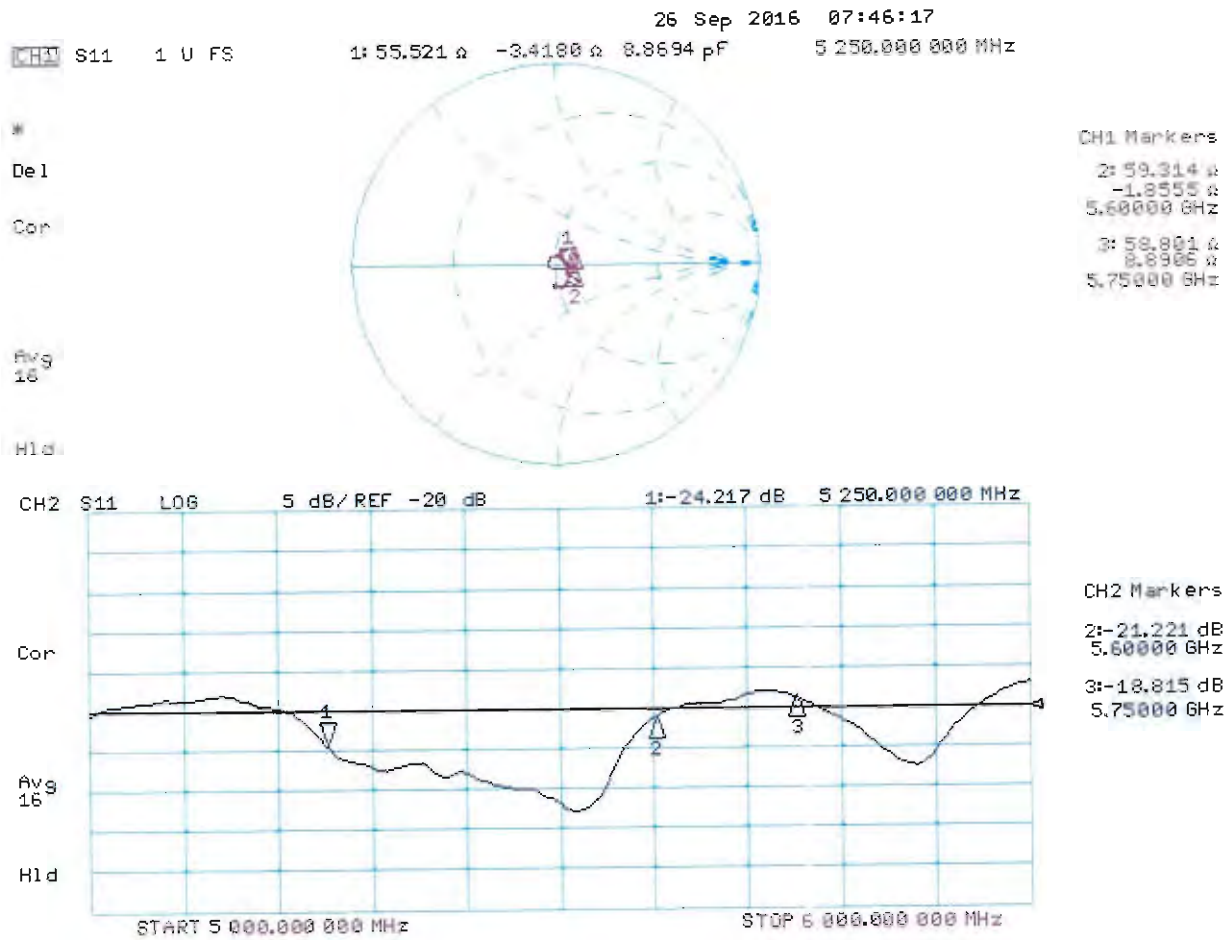



Accredited by the Swiss Accreditation Service (SAS)
The Swiss Accreditation Service is one of the signatories to the EA
Multilateral Agreement for the recognition of calibration certificates

Accreditation No.: **SCS 0108**

Client **Sporton (Auden)**

Certificate No: **DAE3-495_May17**

CALIBRATION CERTIFICATE

Object **DAE3 - SD 000 D03 AD - SN: 495**

Calibration procedure(s) **QA CAL-06.v29
Calibration procedure for the data acquisition electronics (DAE)**

Calibration date: **May 22, 2017**

This calibration certificate documents the traceability to national standards, which realize the physical units of measurements (SI).
The measurements and the uncertainties with confidence probability are given on the following pages and are part of the certificate.

All calibrations have been conducted in the closed laboratory facility: environment temperature (22 ± 3)°C and humidity < 70%.

Calibration Equipment used (M&TE critical for calibration)

Primary Standards	ID #	Cal Date (Certificate No.)	Scheduled Calibration
Keithley Multimeter Type 2001	SN: 0810278	09-Sep-16 (No:19065)	Sep-17
Secondary Standards	ID #	Check Date (in house)	Scheduled Check
Auto DAE Calibration Unit	SE UWS 053 AA 1001	05-Jan-17 (in house check)	In house check: Jan-18
Calibrator Box V2.1	SE UMS 006 AA 1002	05-Jan-17 (in house check)	In house check: Jan-18

Calibrated by:	Name Adrian Gehring	Function Technician	Signature
Approved by:	Name Fin Bomholt	Function Deputy Technical Manager	Signature

Issued: May 22, 2017

This calibration certificate shall not be reproduced except in full without written approval of the laboratory.



Accredited by the Swiss Accreditation Service (SAS)
The Swiss Accreditation Service is one of the signatories to the EA
Multilateral Agreement for the recognition of calibration certificates

Accreditation No.: **SCS 0108**

Glossary

DAE data acquisition electronics
Connector angle information used in DASY system to align probe sensor X to the robot coordinate system.

Methods Applied and Interpretation of Parameters

- *DC Voltage Measurement:* Calibration Factor assessed for use in DASY system by comparison with a calibrated instrument traceable to national standards. The figure given corresponds to the full scale range of the voltmeter in the respective range.
- *Connector angle:* The angle of the connector is assessed measuring the angle mechanically by a tool inserted. Uncertainty is not required.
- The following parameters as documented in the Appendix contain technical information as a result from the performance test and require no uncertainty.
 - *DC Voltage Measurement Linearity:* Verification of the Linearity at +10% and -10% of the nominal calibration voltage. Influence of offset voltage is included in this measurement.
 - *Common mode sensitivity:* Influence of a positive or negative common mode voltage on the differential measurement.
 - *Channel separation:* Influence of a voltage on the neighbor channels not subject to an input voltage.
 - *AD Converter Values with inputs shorted:* Values on the internal AD converter corresponding to zero input voltage
 - *Input Offset Measurement:* Output voltage and statistical results over a large number of zero voltage measurements.
 - *Input Offset Current:* Typical value for information; Maximum channel input offset current, not considering the input resistance.
 - *Input resistance:* Typical value for information: DAE input resistance at the connector, during internal auto-zeroing and during measurement.
 - *Low Battery Alarm Voltage:* Typical value for information. Below this voltage, a battery alarm signal is generated.
 - *Power consumption:* Typical value for information. Supply currents in various operating modes.

DC Voltage Measurement

A/D - Converter Resolution nominal

High Range: 1LSB = 6.1 μ V, full range = -100...+300 mV

Low Range: 1LSB = 61nV, full range = -1.....+3mV

DASY measurement parameters: Auto Zero Time: 3 sec; Measuring time: 3 sec

Calibration Factors	X	Y	Z
High Range	404.410 \pm 0.02% (k=2)	405.390 \pm 0.02% (k=2)	405.754 \pm 0.02% (k=2)
Low Range	3.95327 \pm 1.50% (k=2)	3.99222 \pm 1.50% (k=2)	3.96688 \pm 1.50% (k=2)

Connector Angle

Connector Angle to be used in DASY system	73.0 \pm 1 $^{\circ}$
---	-------------------------

Appendix (Additional assessments outside the scope of SCS0108)

1. DC Voltage Linearity

High Range	Reading (μV)	Difference (μV)	Error (%)
Channel X + Input	200036.32	-0.53	-0.00
Channel X + Input	20006.90	1.96	0.01
Channel X - Input	-20002.74	3.21	-0.02
Channel Y + Input	200037.97	0.48	0.00
Channel Y + Input	20003.40	-1.56	-0.01
Channel Y - Input	-20003.25	2.58	-0.01
Channel Z + Input	200036.42	-2.51	-0.00
Channel Z + Input	20006.90	2.06	0.01
Channel Z - Input	-20001.84	4.23	-0.02

Low Range	Reading (μV)	Difference (μV)	Error (%)
Channel X + Input	2001.22	0.30	0.02
Channel X + Input	200.83	-0.07	-0.04
Channel X - Input	-198.44	0.59	-0.29
Channel Y + Input	2000.13	-0.67	-0.03
Channel Y + Input	200.76	-0.02	-0.01
Channel Y - Input	-199.54	-0.36	0.18
Channel Z + Input	2000.82	0.09	0.00
Channel Z + Input	198.88	-1.81	-0.90
Channel Z - Input	-200.61	-1.37	0.69

2. Common mode sensitivity

DASY measurement parameters: Auto Zero Time: 3 sec; Measuring time: 3 sec

	Common mode Input Voltage (mV)	High Range Average Reading (μV)	Low Range Average Reading (μV)
Channel X	200	4.95	3.15
	- 200	-1.85	-3.32
Channel Y	200	-0.13	0.16
	- 200	-1.11	-1.51
Channel Z	200	1.66	1.87
	- 200	-4.35	-4.69

3. Channel separation

DASY measurement parameters: Auto Zero Time: 3 sec; Measuring time: 3 sec

	Input Voltage (mV)	Channel X (μV)	Channel Y (μV)	Channel Z (μV)
Channel X	200	-	-1.04	-2.16
Channel Y	200	8.07	-	-0.61
Channel Z	200	5.90	6.18	-

4. AD-Converter Values with inputs shorted

DASY measurement parameters: Auto Zero Time: 3 sec; Measuring time: 3 sec

	High Range (LSB)	Low Range (LSB)
Channel X	15813	17008
Channel Y	15760	16933
Channel Z	15907	17415

5. Input Offset Measurement

DASY measurement parameters: Auto Zero Time: 3 sec; Measuring time: 3 sec

Input 10M Ω

	Average (μ V)	min. Offset (μ V)	max. Offset (μ V)	Std. Deviation (μ V)
Channel X	-0.31	-1.54	1.33	0.59
Channel Y	1.19	-0.39	3.04	0.63
Channel Z	-1.55	-3.60	0.02	0.66

6. Input Offset Current

Nominal Input circuitry offset current on all channels: <25fA

7. Input Resistance (Typical values for information)

	Zeroing (kOhm)	Measuring (MOhm)
Channel X	200	200
Channel Y	200	200
Channel Z	200	200

8. Low Battery Alarm Voltage (Typical values for information)

Typical values	Alarm Level (VDC)
Supply (+ Vcc)	+7.9
Supply (- Vcc)	-7.6

9. Power Consumption (Typical values for information)

Typical values	Switched off (mA)	Stand by (mA)	Transmitting (mA)
Supply (+ Vcc)	+0.01	+6	+14
Supply (- Vcc)	-0.01	-8	-9



Accredited by the Swiss Accreditation Service (SAS)
The Swiss Accreditation Service is one of the signatories to the EA
Multilateral Agreement for the recognition of calibration certificates

Accreditation No.: **SCS 0108**

Client **Sporton - TW (Auden)**

Certificate No: **DAE3-577_Sep16**

CALIBRATION CERTIFICATE

Object **DAE3 - SD 000 D03 AA - SN: 577**

Calibration procedure(s) **QA CAL-06.v29
Calibration procedure for the data acquisition electronics (DAE)**

Calibration date: **September 28, 2016**

This calibration certificate documents the traceability to national standards, which realize the physical units of measurements (SI).
The measurements and the uncertainties with confidence probability are given on the following pages and are part of the certificate.

All calibrations have been conducted in the closed laboratory facility: environment temperature (22 ± 3)°C and humidity < 70%.

Calibration Equipment used (M&TE critical for calibration)

Primary Standards	ID #	Cal Date (Certificate No.)	Scheduled Calibration
Keithley Multimeter Type 2001	SN: 0810278	09-Sep-16 (No:19065)	Sep-17
Secondary Standards	ID #	Check Date (in house)	Scheduled Check
Auto DAE Calibration Unit	SE UWS 053 AA 1001	05-Jan-16 (in house check)	In house check: Jan-17
Calibrator Box V2.1	SE UMS 006 AA 1002	05-Jan-16 (in house check)	In house check: Jan-17

Calibrated by: **Name** Eric Hainfeld **Function** Technician

Signature

Approved by: **Name** Fin Bomholt **Function** Deputy Technical Manager

Issued: September 28, 2016

This calibration certificate shall not be reproduced except in full without written approval of the laboratory.



Accredited by the Swiss Accreditation Service (SAS)

The Swiss Accreditation Service is one of the signatories to the EA Multilateral Agreement for the recognition of calibration certificates

Accreditation No.: **SCS 0108**

Glossary

DAE	data acquisition electronics
Connector angle	information used in DASY system to align probe sensor X to the robot coordinate system.

Methods Applied and Interpretation of Parameters

- *DC Voltage Measurement:* Calibration Factor assessed for use in DASY system by comparison with a calibrated instrument traceable to national standards. The figure given corresponds to the full scale range of the voltmeter in the respective range.
- *Connector angle:* The angle of the connector is assessed measuring the angle mechanically by a tool inserted. Uncertainty is not required.
- The following parameters as documented in the Appendix contain technical information as a result from the performance test and require no uncertainty.
 - *DC Voltage Measurement Linearity:* Verification of the Linearity at +10% and -10% of the nominal calibration voltage. Influence of offset voltage is included in this measurement.
 - *Common mode sensitivity:* Influence of a positive or negative common mode voltage on the differential measurement.
 - *Channel separation:* Influence of a voltage on the neighbor channels not subject to an input voltage.
 - *AD Converter Values with inputs shorted:* Values on the internal AD converter corresponding to zero input voltage
 - *Input Offset Measurement:* Output voltage and statistical results over a large number of zero voltage measurements.
 - *Input Offset Current:* Typical value for information; Maximum channel input offset current, not considering the input resistance.
 - *Input resistance:* Typical value for information: DAE input resistance at the connector, during internal auto-zeroing and during measurement.
 - *Low Battery Alarm Voltage:* Typical value for information. Below this voltage, a battery alarm signal is generated.
 - *Power consumption:* Typical value for information. Supply currents in various operating modes.

DC Voltage Measurement

A/D - Converter Resolution nominal

High Range: 1LSB = 6.1 μ V, full range = -100...+300 mV

Low Range: 1LSB = 61nV, full range = -1.....+3mV

DASY measurement parameters: Auto Zero Time: 3 sec; Measuring time: 3 sec

Calibration Factors	X	Y	Z
High Range	403.533 \pm 0.02% (k=2)	403.512 \pm 0.02% (k=2)	403.819 \pm 0.02% (k=2)
Low Range	3.92648 \pm 1.50% (k=2)	3.94206 \pm 1.50% (k=2)	3.96074 \pm 1.50% (k=2)

Connector Angle

Connector Angle to be used in DASY system	190.0 $^{\circ}$ \pm 1 $^{\circ}$
---	-------------------------------------

Appendix (Additional assessments outside the scope of SCS0108)

1. DC Voltage Linearity

High Range		Reading (μV)	Difference (μV)	Error (%)
Channel X	+ Input	200038.14	2.56	0.00
Channel X	+ Input	20010.51	5.45	0.03
Channel X	- Input	-20002.01	3.17	-0.02
Channel Y	+ Input	200032.33	-3.18	-0.00
Channel Y	+ Input	20006.38	1.35	0.01
Channel Y	- Input	-20004.73	0.65	-0.00
Channel Z	+ Input	200031.49	-4.11	-0.00
Channel Z	+ Input	20005.92	0.98	0.00
Channel Z	- Input	-20007.03	-1.64	0.01

Low Range		Reading (μV)	Difference (μV)	Error (%)
Channel X	+ Input	2001.00	-0.10	-0.01
Channel X	+ Input	201.47	0.40	0.20
Channel X	- Input	-198.57	0.28	-0.14
Channel Y	+ Input	2001.38	0.31	0.02
Channel Y	+ Input	200.40	-0.54	-0.27
Channel Y	- Input	-199.63	-0.73	0.37
Channel Z	+ Input	2000.35	-0.56	-0.03
Channel Z	+ Input	199.97	-0.93	-0.46
Channel Z	- Input	-200.50	-1.56	0.79

2. Common mode sensitivity

DASY measurement parameters: Auto Zero Time: 3 sec; Measuring time: 3 sec

	Common mode Input Voltage (mV)	High Range Average Reading (μV)	Low Range Average Reading (μV)
Channel X	200	-2.76	-4.30
	- 200	6.04	3.73
Channel Y	200	-14.29	-14.35
	- 200	12.74	12.77
Channel Z	200	3.10	2.81
	- 200	-5.90	-5.65

3. Channel separation

DASY measurement parameters: Auto Zero Time: 3 sec; Measuring time: 3 sec

	Input Voltage (mV)	Channel X (μV)	Channel Y (μV)	Channel Z (μV)
Channel X	200	-	-1.07	-3.44
Channel Y	200	8.43	-	0.12
Channel Z	200	5.44	4.83	-

4. AD-Converter Values with inputs shorted

DASY measurement parameters: Auto Zero Time: 3 sec; Measuring time: 3 sec

	High Range (LSB)	Low Range (LSB)
Channel X	16132	16062
Channel Y	16099	16321
Channel Z	16116	15372

5. Input Offset Measurement

DASY measurement parameters: Auto Zero Time: 3 sec; Measuring time: 3 sec

Input 10M Ω

	Average (μ V)	min. Offset (μ V)	max. Offset (μ V)	Std. Deviation (μ V)
Channel X	0.37	-1.07	1.49	0.43
Channel Y	1.21	-0.41	3.21	0.59
Channel Z	-1.38	-2.63	-0.30	0.45

6. Input Offset Current

Nominal Input circuitry offset current on all channels: <25fA

7. Input Resistance (Typical values for information)

	Zeroing (kOhm)	Measuring (MOhm)
Channel X	200	200
Channel Y	200	200
Channel Z	200	200

8. Low Battery Alarm Voltage (Typical values for information)

Typical values	Alarm Level (VDC)
Supply (+ Vcc)	+7.9
Supply (- Vcc)	-7.6

9. Power Consumption (Typical values for information)

Typical values	Switched off (mA)	Stand by (mA)	Transmitting (mA)
Supply (+ Vcc)	+0.01	+6	+14
Supply (- Vcc)	-0.01	-8	-9



Accredited by the Swiss Accreditation Service (SAS)
 The Swiss Accreditation Service is one of the signatories to the EA
 Multilateral Agreement for the recognition of calibration certificates

Accreditation No.: **SCS 0108**

Client **Sporton (Auden)**

Certificate No: **EX3-3925_May17**

CALIBRATION CERTIFICATE

Object **EX3DV4 - SN:3925**

Calibration procedure(s) **QA CAL-01.v9, QA CAL-14.v4, QA CAL-23.v5, QA CAL-25.v6
 Calibration procedure for dosimetric E-field probes**

Calibration date: **May 24, 2017**

This calibration certificate documents the traceability to national standards, which realize the physical units of measurements (SI).
 The measurements and the uncertainties with confidence probability are given on the following pages and are part of the certificate.

All calibrations have been conducted in the closed laboratory facility: environment temperature (22 ± 3)°C and humidity < 70%.

Calibration Equipment used (M&TE critical for calibration)

Primary Standards	ID	Cal Date (Certificate No.)	Scheduled Calibration
Power meter NRP	SN: 104778	04-Apr-17 (No. 217-02521/02522)	Apr-18
Power sensor NRP-Z91	SN: 103244	04-Apr-17 (No. 217-02521)	Apr-18
Power sensor NRP-Z91	SN: 103245	04-Apr-17 (No. 217-02525)	Apr-18
Reference 20 dB Attenuator	SN: S5277 (20x)	07-Apr-17 (No. 217-02528)	Apr-18
Reference Probe ES3DV2	SN: 3013	31-Dec-16 (No. ES3-3013_Dec16)	Dec-17
DAE4	SN: 660	7-Dec-16 (No. DAE4-660_Dec16)	Dec-17
Secondary Standards	ID	Check Date (in house)	Scheduled Check
Power meter E4419B	SN: GB41293874	06-Apr-16 (in house check Jun-16)	In house check: Jun-18
Power sensor E4412A	SN: MY41498087	06-Apr-16 (in house check Jun-16)	In house check: Jun-18
Power sensor E4412A	SN: 000110210	06-Aug-16 (in house check Jun-16)	In house check: Jun-18
RF generator HP 8648C	SN: US3642U01700	04-Aug-99 (in house check Jun-16)	In house check: Jun-18
Network Analyzer HP 8753E	SN: US37390585	18-Oct-01 (in house check Oct-16)	In house check: Oct-17

Calibrated by:	Name Jeton Kastrati	Function Laboratory Technician	Signature
Approved by:	Name Katja Pokovic	Function Technical Manager	Signature

Issued: May 30, 2017

This calibration certificate shall not be reproduced except in full without written approval of the laboratory.



Accredited by the Swiss Accreditation Service (SAS)

Accreditation No.: **SCS 0108**

The Swiss Accreditation Service is one of the signatories to the EA
Multilateral Agreement for the recognition of calibration certificates

Glossary:

TSL	tissue simulating liquid
NORM _{x,y,z}	sensitivity in free space
ConvF	sensitivity in TSL / NORM _{x,y,z}
DCP	diode compression point
CF	crest factor (1/duty_cycle) of the RF signal
A, B, C, D	modulation dependent linearization parameters
Polarization φ	φ rotation around probe axis
Polarization ϑ	ϑ rotation around an axis that is in the plane normal to probe axis (at measurement center), i.e., $\vartheta = 0$ is normal to probe axis
Connector Angle	information used in DASY system to align probe sensor X to the robot coordinate system

Calibration is Performed According to the Following Standards:

- IEEE Std 1528-2013, "IEEE Recommended Practice for Determining the Peak Spatial-Averaged Specific Absorption Rate (SAR) in the Human Head from Wireless Communications Devices: Measurement Techniques", June 2013
- IEC 62209-1, "Procedure to measure the Specific Absorption Rate (SAR) for hand-held devices used in close proximity to the ear (frequency range of 300 MHz to 3 GHz)", February 2005
- IEC 62209-2, "Procedure to determine the Specific Absorption Rate (SAR) for wireless communication devices used in close proximity to the human body (frequency range of 30 MHz to 6 GHz)", March 2010
- KDB 865664, "SAR Measurement Requirements for 100 MHz to 6 GHz"

Methods Applied and Interpretation of Parameters:

- NORM_{x,y,z}**: Assessed for E-field polarization $\vartheta = 0$ ($f \leq 900$ MHz in TEM-cell; $f > 1800$ MHz: R22 waveguide). NORM_{x,y,z} are only intermediate values, i.e., the uncertainties of NORM_{x,y,z} does not affect the E^2 -field uncertainty inside TSL (see below *ConvF*).
- NORM(f)_{x,y,z}** = NORM_{x,y,z} * frequency_response (see Frequency Response Chart). This linearization is implemented in DASY4 software versions later than 4.2. The uncertainty of the frequency response is included in the stated uncertainty of *ConvF*.
- DCP_{x,y,z}**: DCP are numerical linearization parameters assessed based on the data of power sweep with CW signal (no uncertainty required). DCP does not depend on frequency nor media.
- PAR**: PAR is the Peak to Average Ratio that is not calibrated but determined based on the signal characteristics
- A_{x,y,z}; B_{x,y,z}; C_{x,y,z}; D_{x,y,z}; VR_{x,y,z}**: A, B, C, D are numerical linearization parameters assessed based on the data of power sweep for specific modulation signal. The parameters do not depend on frequency nor media. VR is the maximum calibration range expressed in RMS voltage across the diode.
- ConvF and Boundary Effect Parameters**: Assessed in flat phantom using E-field (or Temperature Transfer Standard for $f \leq 800$ MHz) and inside waveguide using analytical field distributions based on power measurements for $f > 800$ MHz. The same setups are used for assessment of the parameters applied for boundary compensation (alpha, depth) of which typical uncertainty values are given. These parameters are used in DASY4 software to improve probe accuracy close to the boundary. The sensitivity in TSL corresponds to NORM_{x,y,z} * ConvF whereby the uncertainty corresponds to that given for ConvF. A frequency dependent ConvF is used in DASY version 4.4 and higher which allows extending the validity from ± 50 MHz to ± 100 MHz.
- Spherical isotropy (3D deviation from isotropy)**: in a field of low gradients realized using a flat phantom exposed by a patch antenna.
- Sensor Offset**: The sensor offset corresponds to the offset of virtual measurement center from the probe tip (on probe axis). No tolerance required.
- Connector Angle**: The angle is assessed using the information gained by determining the NORM_x (no uncertainty required).

Probe EX3DV4

SN:3925

Manufactured: March 8, 2013
Calibrated: May 24, 2017

Calibrated for DASY/EASY Systems
(Note: non-compatible with DASY2 system!)

DASY/EASY - Parameters of Probe: EX3DV4 - SN:3925

Basic Calibration Parameters

	Sensor X	Sensor Y	Sensor Z	Unc (k=2)
Norm ($\mu V/(V/m)^2$) ^A	0.57	0.50	0.48	$\pm 10.1 \%$
DCP (mV) ^B	96.1	97.8	100.0	

Modulation Calibration Parameters

UID	Communication System Name		A dB	B dB $\sqrt{\mu V}$	C	D dB	VR mV	Unc ^E (k=2)
0	CW	X	0.0	0.0	1.0	0.00	145.7	$\pm 3.0 \%$
		Y	0.0	0.0	1.0		147.7	
		Z	0.0	0.0	1.0		149.4	

The reported uncertainty of measurement is stated as the standard uncertainty of measurement multiplied by the coverage factor k=2, which for a normal distribution corresponds to a coverage probability of approximately 95%.

^A The uncertainties of Norm X,Y,Z do not affect the E²-field uncertainty inside TSL (see Pages 5 and 6).

^B Numerical linearization parameter: uncertainty not required.

^E Uncertainty is determined using the max. deviation from linear response applying rectangular distribution and is expressed for the square of the field value.

DASY/EASY - Parameters of Probe: EX3DV4 - SN:3925

Calibration Parameter Determined in Head Tissue Simulating Media

f (MHz) ^C	Relative Permittivity ^F	Conductivity (S/m) ^F	ConvF X	ConvF Y	ConvF Z	Alpha ^G	Depth ^G (mm)	Unc (k=2)
750	41.9	0.89	10.82	10.82	10.82	0.48	0.91	± 12.0 %
835	41.5	0.90	10.41	10.41	10.41	0.52	0.80	± 12.0 %
900	41.5	0.97	10.14	10.14	10.14	0.48	0.80	± 12.0 %
1750	40.1	1.37	9.00	9.00	9.00	0.32	0.85	± 12.0 %
1900	40.0	1.40	8.73	8.73	8.73	0.34	0.84	± 12.0 %
2000	40.0	1.40	8.63	8.63	8.63	0.38	0.80	± 12.0 %
2450	39.2	1.80	7.85	7.85	7.85	0.39	0.80	± 12.0 %
2600	39.0	1.96	7.61	7.61	7.61	0.35	0.85	± 12.0 %
3500	37.9	2.91	7.56	7.56	7.56	0.24	1.20	± 13.1 %
5250	35.9	4.71	5.36	5.36	5.36	0.35	1.80	± 13.1 %
5600	35.5	5.07	4.72	4.72	4.72	0.40	1.80	± 13.1 %
5750	35.4	5.22	4.87	4.87	4.87	0.40	1.80	± 13.1 %

^C Frequency validity above 300 MHz of ± 100 MHz only applies for DASY v4.4 and higher (see Page 2), else it is restricted to ± 50 MHz. The uncertainty is the RSS of the ConvF uncertainty at calibration frequency and the uncertainty for the indicated frequency band. Frequency validity below 300 MHz is ± 10, 25, 40, 50 and 70 MHz for ConvF assessments at 30, 64, 128, 150 and 220 MHz respectively. Above 5 GHz frequency validity can be extended to ± 110 MHz.

^F At frequencies below 3 GHz, the validity of tissue parameters (ϵ and σ) can be relaxed to ± 10% if liquid compensation formula is applied to measured SAR values. At frequencies above 3 GHz, the validity of tissue parameters (ϵ and σ) is restricted to ± 5%. The uncertainty is the RSS of the ConvF uncertainty for indicated target tissue parameters.

^G Alpha/Depth are determined during calibration. SPEAG warrants that the remaining deviation due to the boundary effect after compensation is always less than ± 1% for frequencies below 3 GHz and below ± 2% for frequencies between 3-6 GHz at any distance larger than half the probe tip diameter from the boundary.

DASY/EASY - Parameters of Probe: EX3DV4 - SN:3925

Calibration Parameter Determined in Body Tissue Simulating Media

f (MHz) ^C	Relative Permittivity ^F	Conductivity (S/m) ^F	ConvF X	ConvF Y	ConvF Z	Alpha ^G	Depth ^G (mm)	Unc (k=2)
750	55.5	0.96	10.56	10.56	10.56	0.40	0.93	± 12.0 %
835	55.2	0.97	10.29	10.29	10.29	0.42	0.91	± 12.0 %
900	55.0	1.05	10.18	10.18	10.18	0.49	0.83	± 12.0 %
1750	53.4	1.49	8.51	8.51	8.51	0.45	0.80	± 12.0 %
1900	53.3	1.52	8.25	8.25	8.25	0.37	0.80	± 12.0 %
2000	53.3	1.52	8.42	8.42	8.42	0.40	0.82	± 12.0 %
2450	52.7	1.95	7.94	7.94	7.94	0.35	0.85	± 12.0 %
2600	52.5	2.16	7.68	7.68	7.68	0.32	0.95	± 12.0 %
3500	51.3	3.31	7.15	7.15	7.15	0.45	0.95	± 13.1 %
5250	48.9	5.36	4.59	4.59	4.59	0.45	1.90	± 13.1 %
5600	48.5	5.77	4.17	4.17	4.17	0.50	1.90	± 13.1 %
5750	48.3	5.94	4.14	4.14	4.14	0.50	1.90	± 13.1 %

^C Frequency validity above 300 MHz of ± 100 MHz only applies for DASY v4.4 and higher (see Page 2), else it is restricted to ± 50 MHz. The uncertainty is the RSS of the ConvF uncertainty at calibration frequency and the uncertainty for the indicated frequency band. Frequency validity below 300 MHz is ± 10, 25, 40, 50 and 70 MHz for ConvF assessments at 30, 64, 128, 150 and 220 MHz respectively. Above 5 GHz frequency validity can be extended to ± 110 MHz.

^F At frequencies below 3 GHz, the validity of tissue parameters (ϵ and σ) can be relaxed to ± 10% if liquid compensation formula is applied to measured SAR values. At frequencies above 3 GHz, the validity of tissue parameters (ϵ and σ) is restricted to ± 5%. The uncertainty is the RSS of the ConvF uncertainty for indicated target tissue parameters.

^G Alpha/Depth are determined during calibration. SPEAG warrants that the remaining deviation due to the boundary effect after compensation is always less than ± 1% for frequencies below 3 GHz and below ± 2% for frequencies between 3-6 GHz at any distance larger than half the probe tip diameter from the boundary.

Frequency Response of E-Field (TEM-Cell:ifi110 EXX, Waveguide: R22)

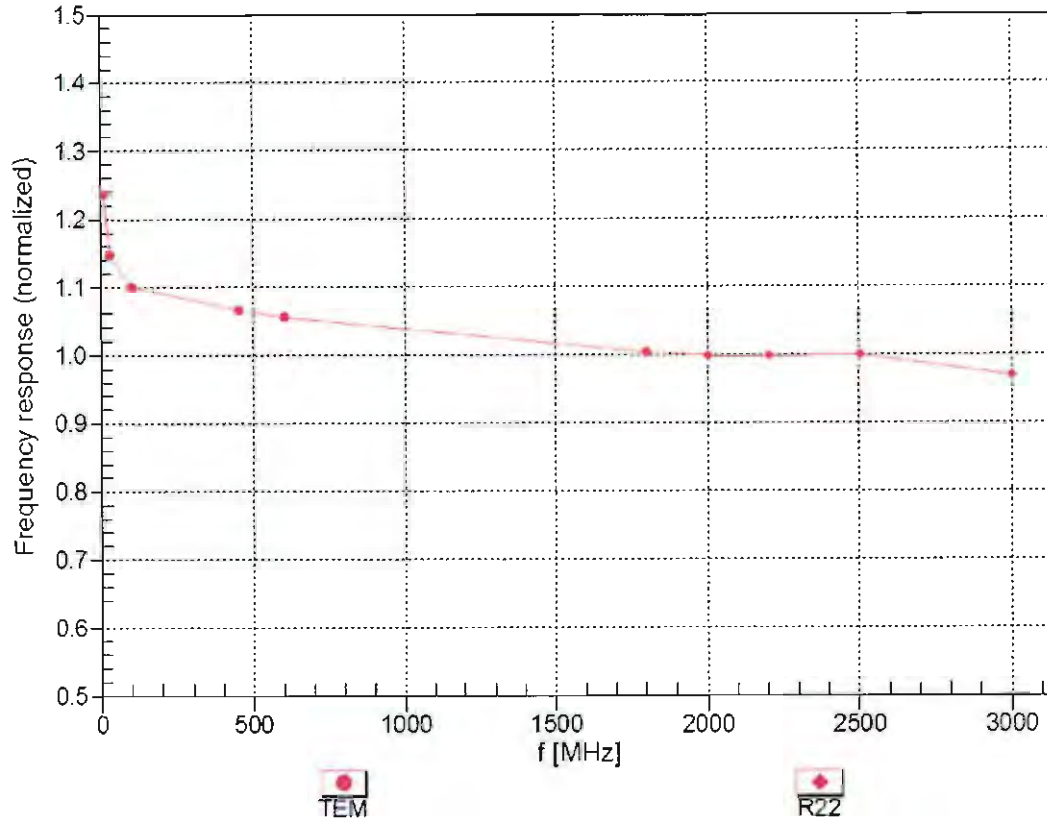

Uncertainty of Frequency Response of E-field: $\pm 6.3\%$ (k=2)

Receiving Pattern (ϕ), $\theta = 0^\circ$

f=600 MHz,TEM

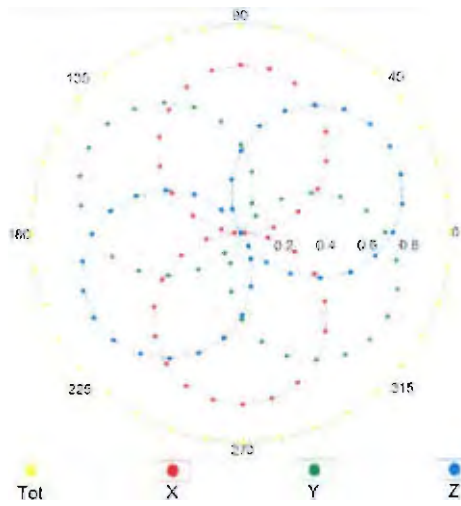

f=1800 MHz,R22

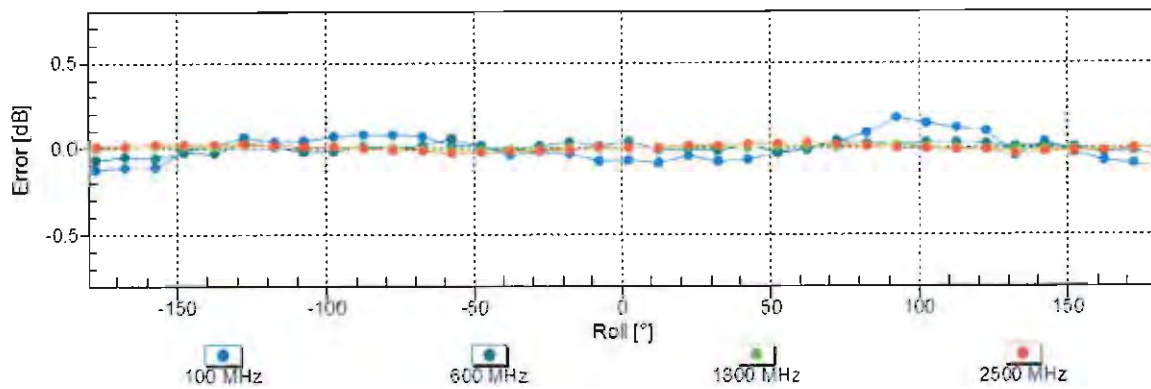
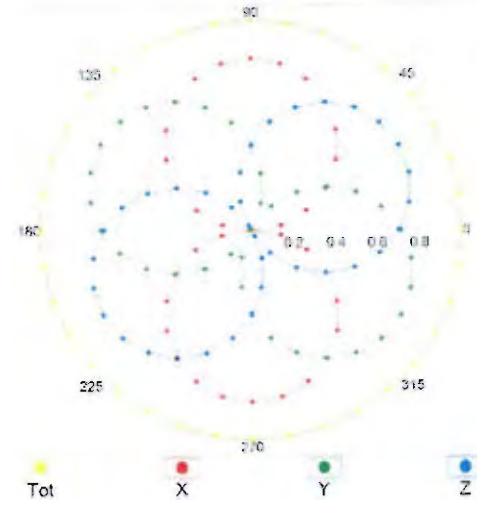

Uncertainty of Axial Isotropy Assessment: $\pm 0.5\%$ (k=2)

Dynamic Range $f(SAR_{head})$ (TEM cell , $f_{eval}= 1900$ MHz)

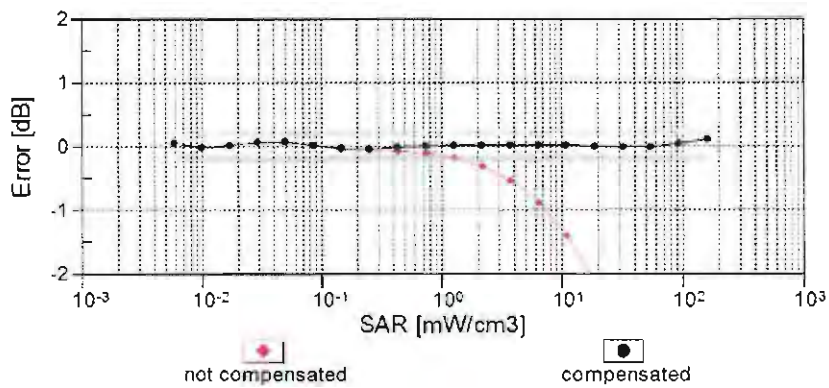
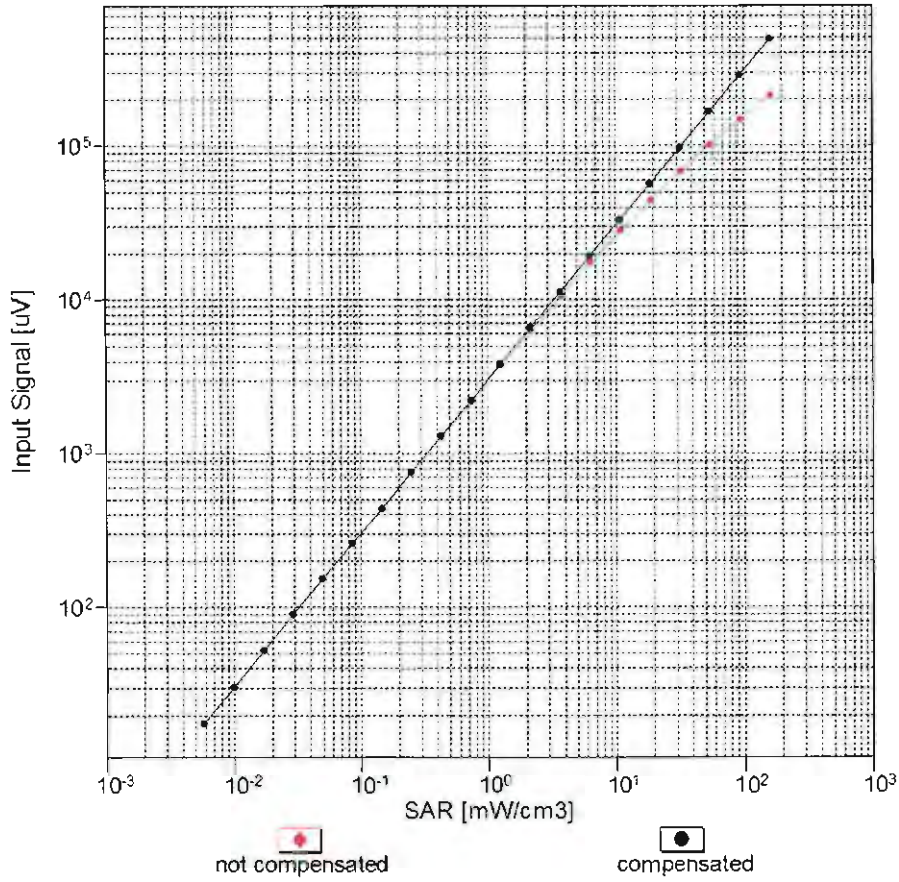

Uncertainty of Linearity Assessment: $\pm 0.6\%$ (k=2)

Conversion Factor Assessment

f = 835 MHz, WGLS R9 (H_convF)

f = 1900 MHz, WGLS R22 (H_convF)

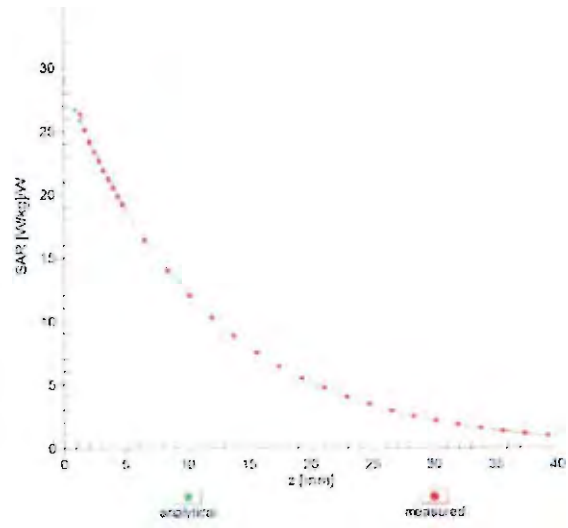
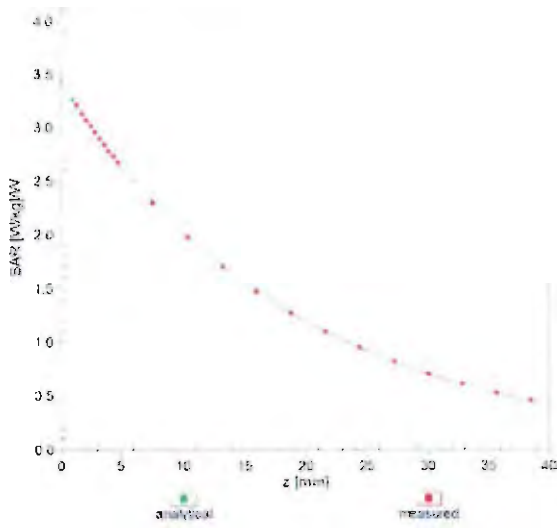

Deviation from Isotropy in Liquid

Error (ϕ, ϑ), f = 900 MHz

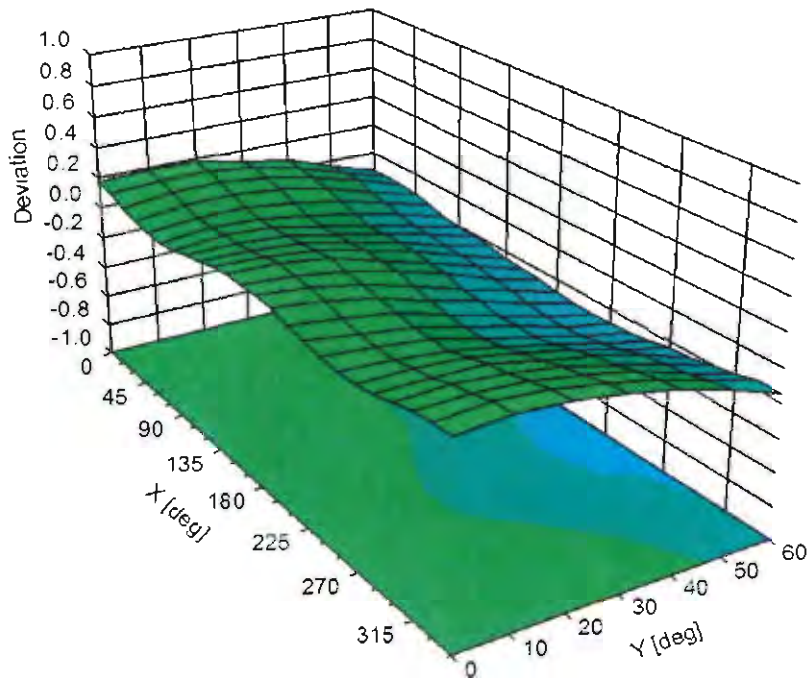

Uncertainty of Spherical Isotropy Assessment: $\pm 2.6\%$ (k=2)

DASY/EASY - Parameters of Probe: EX3DV4 - SN:3925

Other Probe Parameters

Sensor Arrangement	Triangular
Connector Angle (°)	92.4
Mechanical Surface Detection Mode	enabled
Optical Surface Detection Mode	disabled
Probe Overall Length	337 mm
Probe Body Diameter	10 mm
Tip Length	9 mm
Tip Diameter	2.5 mm
Probe Tip to Sensor X Calibration Point	1 mm
Probe Tip to Sensor Y Calibration Point	1 mm
Probe Tip to Sensor Z Calibration Point	1 mm
Recommended Measurement Distance from Surface	1.4 mm



Accreditation No.: **SCS 0108**

Accredited by the Swiss Accreditation Service (SAS)
The Swiss Accreditation Service is one of the signatories to the EA
Multilateral Agreement for the recognition of calibration certificates

Client **Sporton-TW (Auden)**

Certificate No: **EX3-3931_Oct16**

CALIBRATION CERTIFICATE

Object **EX3DV4 - SN:3931**

Calibration procedure(s) **QA CAL-01.v9, QA CAL-14.v4, QA CAL-23.v5, QA CAL-25.v6**
Calibration procedure for dosimetric E-field probes

Calibration date: **October 3, 2016**

This calibration certificate documents the traceability to national standards, which realize the physical units of measurements (SI).
The measurements and the uncertainties with confidence probability are given on the following pages and are part of the certificate.

All calibrations have been conducted in the closed laboratory facility: environment temperature $(22 \pm 3)^\circ\text{C}$ and humidity < 70%.

Calibration Equipment used (M&TE critical for calibration)

Primary Standards	ID	Cal Date (Certificate No.)	Scheduled Calibration
Power meter NRP	SN: 104778	06-Apr-16 (No. 217-02288/02289)	Apr-17
Power sensor NRP-Z91	SN: 103244	06-Apr-16 (No. 217-02288)	Apr-17
Power sensor NRP-Z91	SN: 103245	06-Apr-16 (No. 217-02289)	Apr-17
Reference 20 dB Attenuator	SN: S5277 (20x)	05-Apr-16 (No. 217-02293)	Apr-17
Reference Probe ES3DV2	SN: 3013	31-Dec-15 (No. ES3-3013_Dec15)	Dec-16
DAE4	SN: 660	23-Dec-15 (No. DAE4-660_Dec15)	Dec-16
Secondary Standards	ID	Check Date (in house)	Scheduled Check
Power meter E4419B	SN: GB41293874	06-Apr-16 (in house check Jun-16)	In house check: Jun-18
Power sensor E4412A	SN: MY41498087	06-Apr-16 (in house check Jun-16)	In house check: Jun-18
Power sensor E4412A	SN: 000110210	06-Apr-16 (in house check Jun-16)	In house check: Jun-18
RF generator HP 8648C	SN: US3642U01700	04-Aug-99 (in house check Jun-16)	In house check: Jun-18
Network Analyzer HP 8753E	SN: US37390585	18-Oct-01 (in house check Oct-15)	In house check: Oct-16

	Name	Function	Signature
Calibrated by:	Michael Weber	Laboratory Technician	
Approved by:	Katja Pokovic	Technical Manager	
			Issued: October 4, 2016
This calibration certificate shall not be reproduced except in full without written approval of the laboratory.			



Accredited by the Swiss Accreditation Service (SAS)

The Swiss Accreditation Service is one of the signatories to the EA
Multilateral Agreement for the recognition of calibration certificates

Accreditation No.: **SCS 0108**

Glossary:

TSL	tissue simulating liquid
NORM _{x,y,z}	sensitivity in free space
ConvF	sensitivity in TSL / NORM _{x,y,z}
DCP	diode compression point
CF	crest factor (1/duty_cycle) of the RF signal
A, B, C, D	modulation dependent linearization parameters
Polarization φ	φ rotation around probe axis
Polarization ϑ	ϑ rotation around an axis that is in the plane normal to probe axis (at measurement center), i.e., $\vartheta = 0$ is normal to probe axis
Connector Angle	information used in DASY system to align probe sensor X to the robot coordinate system

Calibration is Performed According to the Following Standards:

- IEEE Std 1528-2013, "IEEE Recommended Practice for Determining the Peak Spatial-Averaged Specific Absorption Rate (SAR) in the Human Head from Wireless Communications Devices: Measurement Techniques", June 2013
- IEC 62209-1, "Procedure to measure the Specific Absorption Rate (SAR) for hand-held devices used in close proximity to the ear (frequency range of 300 MHz to 3 GHz)", February 2005
- IEC 62209-2, "Procedure to determine the Specific Absorption Rate (SAR) for wireless communication devices used in close proximity to the human body (frequency range of 30 MHz to 6 GHz)", March 2010
- KDB 865664, "SAR Measurement Requirements for 100 MHz to 6 GHz"

Methods Applied and Interpretation of Parameters:

- NORM_{x,y,z}**: Assessed for E-field polarization $\vartheta = 0$ ($f \leq 900$ MHz in TEM-cell; $f > 1800$ MHz: R22 waveguide). NORM_{x,y,z} are only intermediate values, i.e., the uncertainties of NORM_{x,y,z} does not affect the E²-field uncertainty inside TSL (see below ConvF).
- NORM(f)_{x,y,z} = NORM_{x,y,z} * frequency_response** (see Frequency Response Chart). This linearization is implemented in DASY4 software versions later than 4.2. The uncertainty of the frequency response is included in the stated uncertainty of ConvF.
- DCP_{x,y,z}**: DCP are numerical linearization parameters assessed based on the data of power sweep with CW signal (no uncertainty required). DCP does not depend on frequency nor media.
- PAR**: PAR is the Peak to Average Ratio that is not calibrated but determined based on the signal characteristics
- A_{x,y,z}; B_{x,y,z}; C_{x,y,z}; D_{x,y,z}; VR_{x,y,z}**: A, B, C, D are numerical linearization parameters assessed based on the data of power sweep for specific modulation signal. The parameters do not depend on frequency nor media. VR is the maximum calibration range expressed in RMS voltage across the diode.
- ConvF and Boundary Effect Parameters**: Assessed in flat phantom using E-field (or Temperature Transfer Standard for $f \leq 800$ MHz) and inside waveguide using analytical field distributions based on power measurements for $f > 800$ MHz. The same setups are used for assessment of the parameters applied for boundary compensation (alpha, depth) of which typical uncertainty values are given. These parameters are used in DASY4 software to improve probe accuracy close to the boundary. The sensitivity in TSL corresponds to NORM_{x,y,z} * ConvF whereby the uncertainty corresponds to that given for ConvF. A frequency dependent ConvF is used in DASY version 4.4 and higher which allows extending the validity from ± 50 MHz to ± 100 MHz.
- Spherical isotropy (3D deviation from isotropy)**: in a field of low gradients realized using a flat phantom exposed by a patch antenna.
- Sensor Offset**: The sensor offset corresponds to the offset of virtual measurement center from the probe tip (on probe axis). No tolerance required.
- Connector Angle**: The angle is assessed using the information gained by determining the NORM_x (no uncertainty required).

Probe EX3DV4

SN:3931

Manufactured:	July 24, 2013
Repaired:	September 27, 2016
Calibrated:	October 3, 2016

Calibrated for DASV/EASY Systems
(Note: non-compatible with DASV2 system!)

DASY/EASY - Parameters of Probe: EX3DV4 - SN:3931

Basic Calibration Parameters

	Sensor X	Sensor Y	Sensor Z	Unc (k=2)
Norm ($\mu\text{V}/(\text{V}/\text{m})^2$) ^A	0.50	0.56	0.47	$\pm 10.1 \%$
DCP (mV) ^B	99.3	102.3	99.2	

Modulation Calibration Parameters

UID	Communication System Name		A dB	B dB $\sqrt{\mu\text{V}}$	C	D dB	VR mV	Unc ^E (k=2)
0	CW	X	0.0	0.0	1.0	0.00	165.2	$\pm 2.2 \%$
		Y	0.0	0.0	1.0		169.6	
		Z	0.0	0.0	1.0		158.4	

Note: For details on UID parameters see Appendix.

Sensor Model Parameters

	C1 fF	C2 fF	α V^{-1}	T1 $\text{ms}\cdot\text{V}^{-2}$	T2 $\text{ms}\cdot\text{V}^{-1}$	T3 ms	T4 V^{-2}	T5 V^{-1}	T6
X	39.73	299.4	36.38	13.81	1.099	5.004	0.119	0.351	1.005
Y	59.82	447.7	35.85	21.83	1.546	5.045	0.719	0.472	1.007
Z	54.23	405.8	35.74	19.34	1.491	5.007	0.433	0.514	1.005

The reported uncertainty of measurement is stated as the standard uncertainty of measurement multiplied by the coverage factor $k=2$, which for a normal distribution corresponds to a coverage probability of approximately 95%.

^A The uncertainties of Norm X,Y,Z do not affect the E^2 -field uncertainty inside TSL (see Pages 5 and 6).

^B Numerical linearization parameter: uncertainty not required.

^E Uncertainty is determined using the max. deviation from linear response applying rectangular distribution and is expressed for the square of the field value.

DASY/EASY - Parameters of Probe: EX3DV4 - SN:3931

Calibration Parameter Determined in Head Tissue Simulating Media

f (MHz) ^C	Relative Permittivity ^F	Conductivity (S/m) ^F	ConvF X	ConvF Y	ConvF Z	Alpha ^G	Depth ^G (mm)	Unc (k=2)
750	41.9	0.89	10.68	10.68	10.68	0.47	0.86	± 12.0 %
835	41.5	0.90	10.35	10.35	10.35	0.43	0.80	± 12.0 %
900	41.5	0.97	10.09	10.09	10.09	0.44	0.86	± 12.0 %
1450	40.5	1.20	8.73	8.73	8.73	0.45	0.80	± 12.0 %
1750	40.1	1.37	8.68	8.68	8.68	0.37	0.80	± 12.0 %
1900	40.0	1.40	8.42	8.42	8.42	0.34	0.80	± 12.0 %
2000	40.0	1.40	8.43	8.43	8.43	0.37	0.80	± 12.0 %
2300	39.5	1.67	7.94	7.94	7.94	0.28	0.86	± 12.0 %
2450	39.2	1.80	7.60	7.60	7.60	0.36	0.84	± 12.0 %
2600	39.0	1.96	7.37	7.37	7.37	0.31	0.97	± 12.0 %
5250	35.9	4.71	5.38	5.38	5.38	0.35	1.80	± 13.1 %
5600	35.5	5.07	4.68	4.68	4.68	0.40	1.80	± 13.1 %
5750	35.4	5.22	4.84	4.84	4.84	0.40	1.80	± 13.1 %

^C Frequency validity above 300 MHz of ± 100 MHz only applies for DASY v4.4 and higher (see Page 2), else it is restricted to ± 50 MHz. The uncertainty is the RSS of the ConvF uncertainty at calibration frequency and the uncertainty for the indicated frequency band. Frequency validity below 300 MHz is ± 10, 25, 40, 50 and 70 MHz for ConvF assessments at 30, 64, 128, 150 and 220 MHz respectively. Above 5 GHz frequency validity can be extended to ± 110 MHz.

^F At frequencies below 3 GHz, the validity of tissue parameters (ϵ and σ) can be relaxed to ± 10% if liquid compensation formula is applied to measured SAR values. At frequencies above 3 GHz, the validity of tissue parameters (ϵ and σ) is restricted to ± 5%. The uncertainty is the RSS of the ConvF uncertainty for indicated target tissue parameters.

^G Alpha/Depth are determined during calibration. SPEAG warrants that the remaining deviation due to the boundary effect after compensation is always less than ± 1% for frequencies below 3 GHz and below ± 2% for frequencies between 3-6 GHz at any distance larger than half the probe tip diameter from the boundary.

DASY/EASY - Parameters of Probe: EX3DV4 - SN:3931

Calibration Parameter Determined in Body Tissue Simulating Media

f (MHz) ^C	Relative Permittivity ^F	Conductivity (S/m) ^F	ConvF X	ConvF Y	ConvF Z	Alpha ^G	Depth ^G (mm)	Unc (k=2)
750	55.5	0.96	10.37	10.37	10.37	0.38	0.97	± 12.0 %
835	55.2	0.97	10.14	10.14	10.14	0.36	0.99	± 12.0 %
1450	54.0	1.30	8.53	8.53	8.53	0.31	0.80	± 12.0 %
1750	53.4	1.49	8.45	8.45	8.45	0.37	0.80	± 12.0 %
1900	53.3	1.52	8.14	8.14	8.14	0.33	0.90	± 12.0 %
2300	52.9	1.81	7.96	7.96	7.96	0.39	0.80	± 12.0 %
2450	52.7	1.95	7.73	7.73	7.73	0.38	0.85	± 12.0 %
2600	52.5	2.16	7.46	7.46	7.46	0.25	0.95	± 12.0 %
5250	48.9	5.36	4.57	4.57	4.57	0.50	1.90	± 13.1 %
5600	48.5	5.77	3.71	3.71	3.71	0.60	1.90	± 13.1 %
5750	48.3	5.94	4.01	4.01	4.01	0.60	1.90	± 13.1 %

^C Frequency validity above 300 MHz of ± 100 MHz only applies for DASY v4.4 and higher (see Page 2), else it is restricted to ± 50 MHz. The uncertainty is the RSS of the ConvF uncertainty at calibration frequency and the uncertainty for the indicated frequency band. Frequency validity below 300 MHz is ± 10, 25, 40, 50 and 70 MHz for ConvF assessments at 30, 64, 128, 150 and 220 MHz respectively. Above 5 GHz frequency validity can be extended to ± 110 MHz.

^F At frequencies below 3 GHz, the validity of tissue parameters (ϵ and σ) can be relaxed to ± 10% if liquid compensation formula is applied to measured SAR values. At frequencies above 3 GHz, the validity of tissue parameters (ϵ and σ) is restricted to ± 5%. The uncertainty is the RSS of the ConvF uncertainty for indicated target tissue parameters.

^G Alpha/Depth are determined during calibration. SPEAG warrants that the remaining deviation due to the boundary effect after compensation is always less than ± 1% for frequencies below 3 GHz and below ± 2% for frequencies between 3-6 GHz at any distance larger than half the probe tip diameter from the boundary.

Frequency Response of E-Field (TEM-Cell: ifi110 EXX, Waveguide: R22)

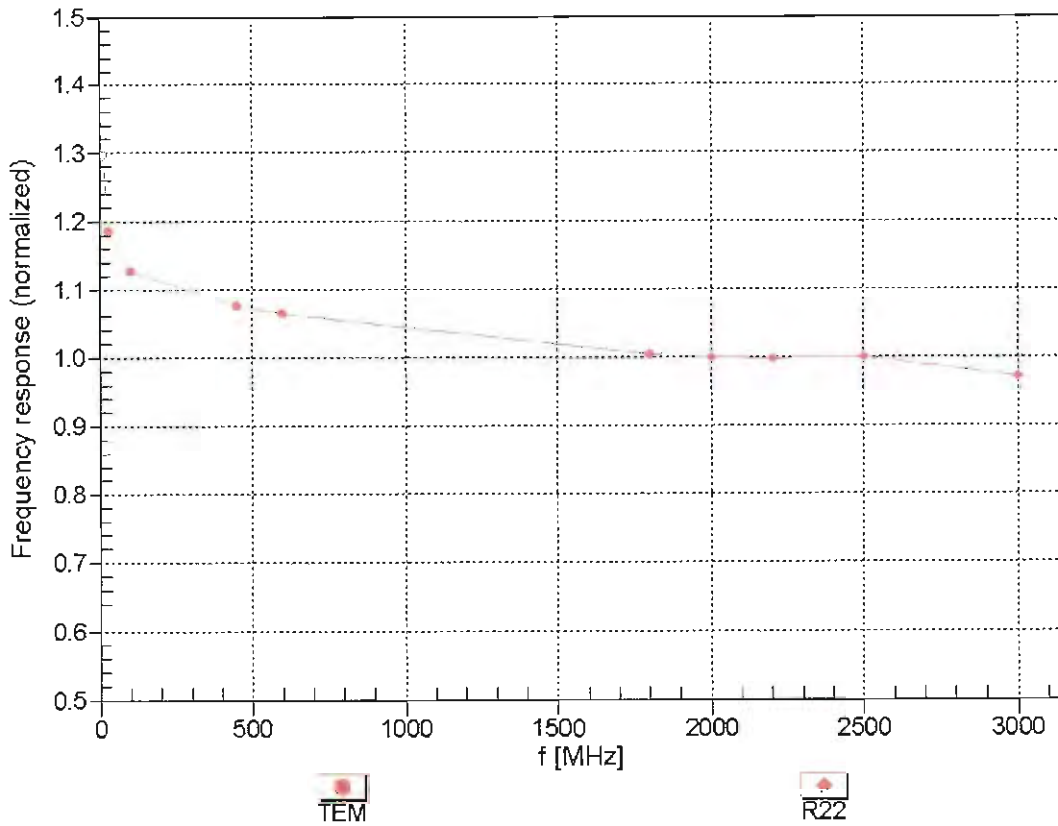

Uncertainty of Frequency Response of E-field: $\pm 6.3\%$ ($k=2$)

Receiving Pattern (ϕ), $\theta = 0^\circ$

f=600 MHz,TEM

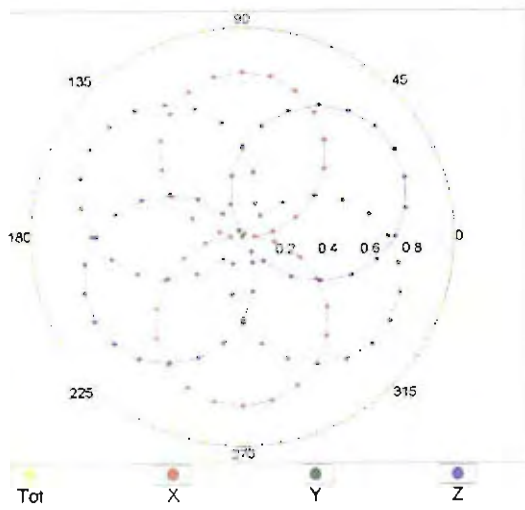

f=1800 MHz,R22

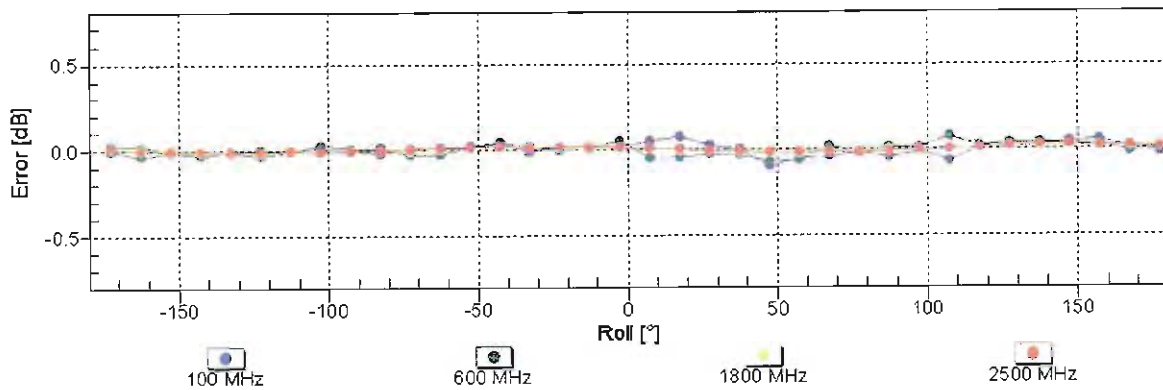
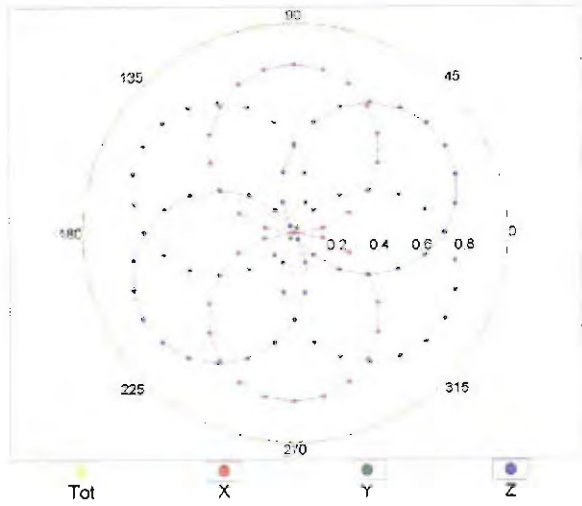

Uncertainty of Axial Isotropy Assessment: $\pm 0.5\%$ ($k=2$)

Dynamic Range $f(\text{SAR}_{\text{head}})$ (TEM cell, $f_{\text{eval}} = 1900 \text{ MHz}$)

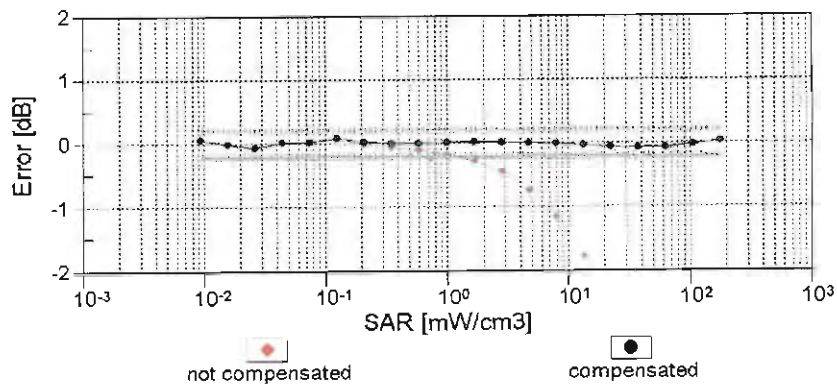
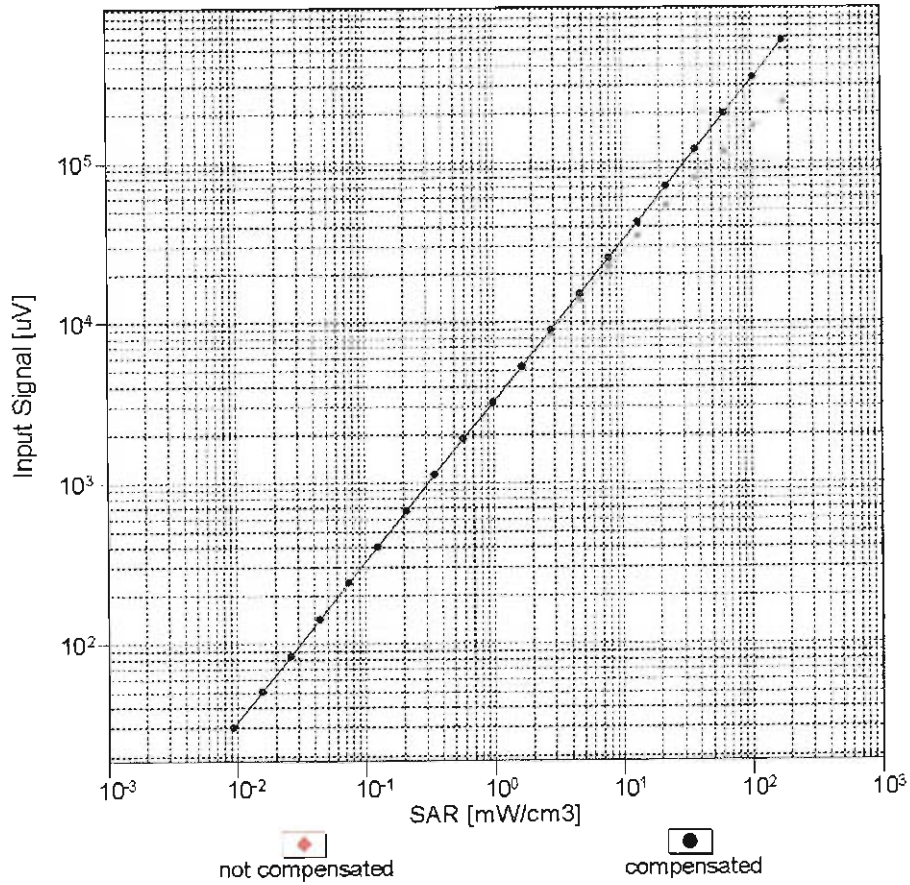

Uncertainty of Linearity Assessment: $\pm 0.6\%$ ($k=2$)

Conversion Factor Assessment

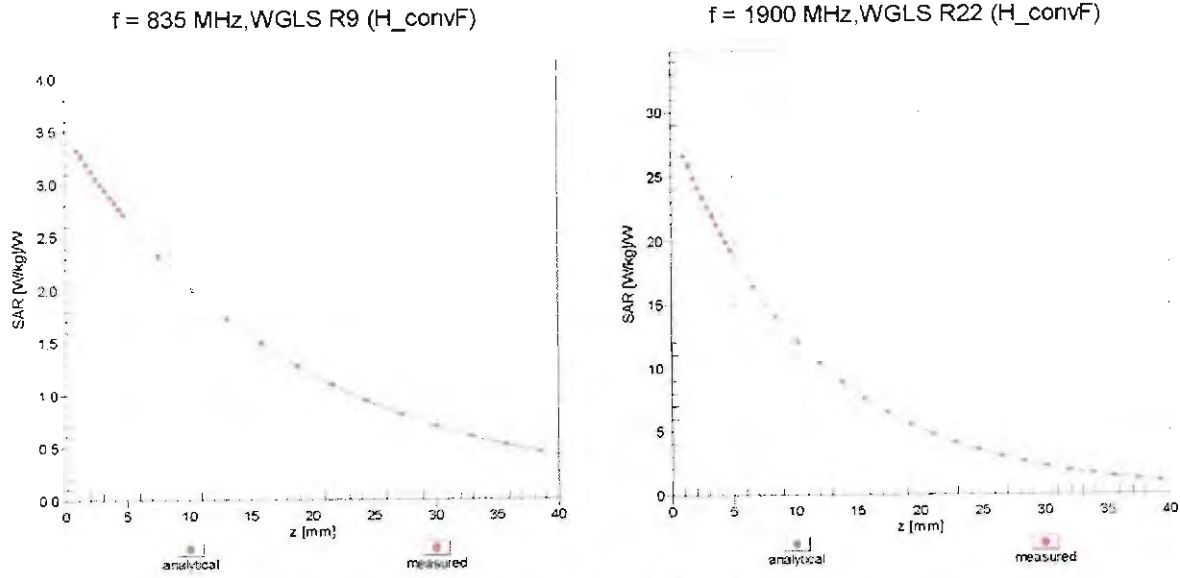

Deviation from Isotropy in Liquid Error (ϕ, ϑ), f = 900 MHz

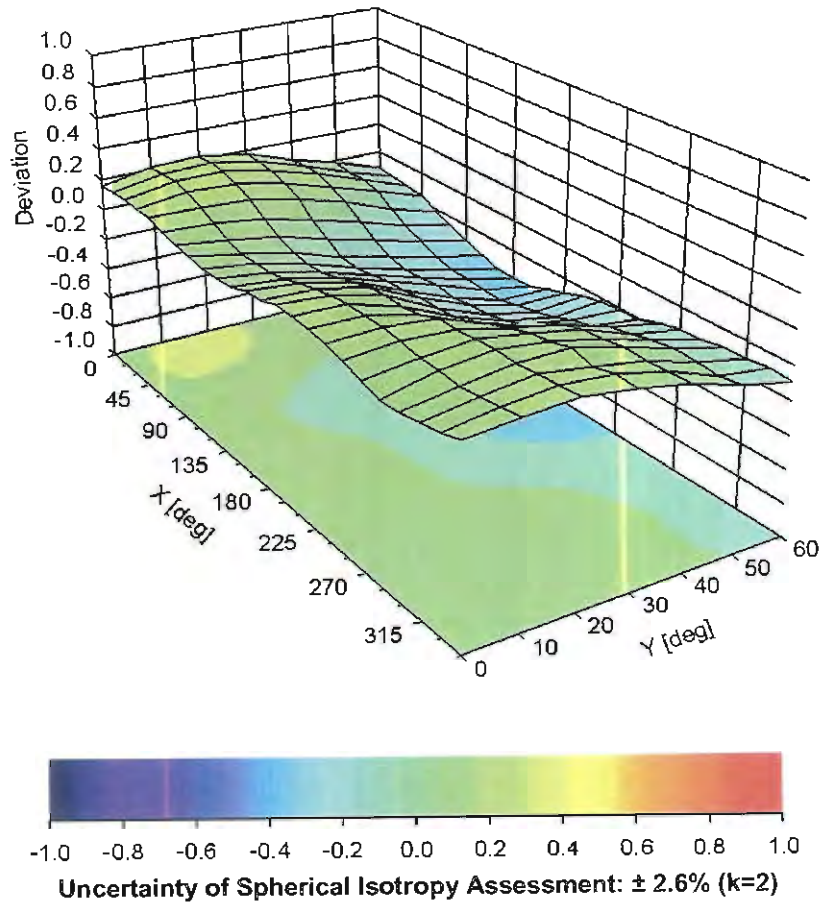

DASY/EASY - Parameters of Probe: EX3DV4 - SN:3931

Other Probe Parameters

Sensor Arrangement	Triangular
Connector Angle (°)	127.3
Mechanical Surface Detection Mode	enabled
Optical Surface Detection Mode	disabled
Probe Overall Length	337 mm
Probe Body Diameter	10 mm
Tip Length	9 mm
Tip Diameter	2.5 mm
Probe Tip to Sensor X Calibration Point	1 mm
Probe Tip to Sensor Y Calibration Point	1 mm
Probe Tip to Sensor Z Calibration Point	1 mm
Recommended Measurement Distance from Surface	1.4 mm

Appendix: Modulation Calibration Parameters

UID	Communication System Name		A dB	B dB $\sqrt{\mu V}$	C	D dB	VR mV	Max Unc ^E (k=2)
0	CW	X	0.00	0.00	1.00	0.00	165.2	$\pm 2.2\%$
		Y	0.00	0.00	1.00		169.6	
		Z	0.00	0.00	1.00		158.4	
10010- CAA	SAR Validation (Square, 100ms, 10ms)	X	3.48	69.31	12.63	10.00	20.0	$\pm 9.6\%$
		Y	5.87	75.87	16.27		20.0	
		Z	4.02	70.66	13.78		20.0	
10011- CAB	UMTS-FDD (WCDMA)	X	1.30	72.39	18.20	0.00	150.0	$\pm 9.6\%$
		Y	1.19	69.63	16.77		150.0	
		Z	1.01	66.38	14.76		150.0	
10012- CAB	IEEE 802.11b WiFi 2.4 GHz (DSSS, 1 Mbps)	X	1.24	65.29	16.42	0.41	150.0	$\pm 9.6\%$
		Y	1.26	64.91	16.05		150.0	
		Z	1.20	63.67	14.96		150.0	
10013- CAB	IEEE 802.11g WiFi 2.4 GHz (DSSS-OFDM, 6 Mbps)	X	4.82	66.95	17.27	1.46	150.0	$\pm 9.6\%$
		Y	5.04	66.77	17.23		150.0	
		Z	4.95	66.50	16.90		150.0	
10021- DAB	GSM-FDD (TDMA, GMSK)	X	100.00	114.09	27.93	9.39	50.0	$\pm 9.6\%$
		Y	100.00	118.26	30.54		50.0	
		Z	25.45	96.76	24.27		50.0	
10023- DAB	GPRS-FDD (TDMA, GMSK, TN 0)	X	83.93	111.52	27.32	9.57	50.0	$\pm 9.6\%$
		Y	99.99	118.26	30.60		50.0	
		Z	19.40	92.86	23.18		50.0	
10024- DAB	GPRS-FDD (TDMA, GMSK, TN 0-1)	X	100.00	112.26	25.94	6.56	60.0	$\pm 9.6\%$
		Y	100.00	115.42	28.11		60.0	
		Z	100.00	112.41	26.50		60.0	
10025- DAB	EDGE-FDD (TDMA, 8PSK, TN 0)	X	5.67	76.70	28.63	12.57	50.0	$\pm 9.6\%$
		Y	15.06	105.00	40.92		50.0	
		Z	5.92	75.84	27.63		50.0	
10026- DAB	EDGE-FDD (TDMA, 8PSK, TN 0-1)	X	9.71	91.87	32.18	9.56	60.0	$\pm 9.6\%$
		Y	18.06	104.69	36.55		60.0	
		Z	11.21	92.21	31.55		60.0	
10027- DAB	GPRS-FDD (TDMA, GMSK, TN 0-1-2)	X	100.00	112.68	25.31	4.80	80.0	$\pm 9.6\%$
		Y	100.00	114.88	27.06		80.0	
		Z	100.00	111.26	25.19		80.0	
10028- DAB	GPRS-FDD (TDMA, GMSK, TN 0-1-2-3)	X	100.00	114.77	25.52	3.55	100.0	$\pm 9.6\%$
		Y	100.00	115.72	26.71		100.0	
		Z	100.00	111.32	24.54		100.0	
10029- DAB	EDGE-FDD (TDMA, 8PSK, TN 0-1-2)	X	6.19	82.03	27.36	7.80	80.0	$\pm 9.6\%$
		Y	10.55	92.05	31.00		80.0	
		Z	7.53	83.82	27.35		80.0	
10030- CAA	IEEE 802.15.1 Bluetooth (GFSK, DH1)	X	100.00	110.56	24.66	5.30	70.0	$\pm 9.6\%$
		Y	100.00	113.96	26.95		70.0	
		Z	100.00	110.53	25.16		70.0	
10031- CAA	IEEE 802.15.1 Bluetooth (GFSK, DH3)	X	100.00	116.75	24.95	1.88	100.0	$\pm 9.6\%$
		Y	100.00	117.62	26.11		100.0	
		Z	100.00	110.75	23.01		100.0	

10032-CAA	IEEE 802.15.1 Bluetooth (GFSK, DH5)	X	100.00	131.18	29.75	1.17	100.0	± 9.6 %
		Y	100.00	125.29	28.26		100.0	
		Z	100.00	114.95	23.87		100.0	
10033-CAA	IEEE 802.15.1 Bluetooth (PI/4-DQPSK, DH1)	X	10.93	90.53	23.32	5.30	70.0	± 9.6 %
		Y	20.55	101.44	27.99		70.0	
		Z	7.67	84.45	21.88		70.0	
10034-CAA	IEEE 802.15.1 Bluetooth (PI/4-DQPSK, DH3)	X	5.70	84.58	20.06	1.88	100.0	± 9.6 %
		Y	5.85	85.75	22.03		100.0	
		Z	2.95	74.86	17.34		100.0	
10035-CAA	IEEE 802.15.1 Bluetooth (PI/4-DQPSK, DH5)	X	3.92	81.20	18.80	1.17	100.0	± 9.6 %
		Y	3.48	79.72	19.80		100.0	
		Z	2.10	71.76	15.97		100.0	
10036-CAA	IEEE 802.15.1 Bluetooth (8-DPSK, DH1)	X	15.13	95.54	24.90	5.30	70.0	± 9.6 %
		Y	28.86	107.18	29.66		70.0	
		Z	9.07	87.21	22.88		70.0	
10037-CAA	IEEE 802.15.1 Bluetooth (8-DPSK, DH3)	X	4.82	82.50	19.36	1.88	100.0	± 9.6 %
		Y	5.58	85.13	21.78		100.0	
		Z	2.82	74.36	17.11		100.0	
10038-CAA	IEEE 802.15.1 Bluetooth (8-DPSK, DH5)	X	4.08	82.09	19.24	1.17	100.0	± 9.6 %
		Y	3.57	80.38	20.14		100.0	
		Z	2.12	72.10	16.20		100.0	
10039-CAB	CDMA2000 (1xRTT, RC1)	X	5.80	88.31	21.06	0.00	150.0	± 9.6 %
		Y	2.44	75.65	18.16		150.0	
		Z	1.80	71.10	15.73		150.0	
10042-CAB	IS-54 / IS-136 FDD (TDMA/FDM, PI/4-DQPSK, Halfrate)	X	100.00	110.27	25.32	7.78	50.0	± 9.6 %
		Y	100.00	114.03	27.70		50.0	
		Z	32.06	97.64	22.93		50.0	
10044-CAA	IS-91/EIA/TIA-553 FDD (FDMA, FM)	X	0.00	105.67	0.52	0.00	150.0	± 9.6 %
		Y	0.00	101.10	0.34		150.0	
		Z	0.00	94.56	3.16		150.0	
10048-CAA	DECT (TDD, TDMA/FDM, GFSK, Full Slot, 24)	X	11.94	82.95	20.71	13.80	25.0	± 9.6 %
		Y	15.06	89.64	24.59		25.0	
		Z	9.78	81.31	21.11		25.0	
10049-CAA	DECT (TDD, TDMA/FDM, GFSK, Double Slot, 12)	X	15.54	88.48	21.39	10.79	40.0	± 9.6 %
		Y	23.79	97.14	25.51		40.0	
		Z	11.46	84.91	21.03		40.0	
10056-CAA	UMTS-TDD (TD-SCDMA, 1.28 Mcps)	X	13.32	89.14	23.36	9.03	50.0	± 9.6 %
		Y	16.34	93.59	26.16		50.0	
		Z	10.18	84.57	22.45		50.0	
10058-DAB	EDGE-FDD (TDMA, 8PSK, TN 0-1-2-3)	X	4.78	77.20	24.69	6.55	100.0	± 9.6 %
		Y	7.46	84.92	27.60		100.0	
		Z	5.76	78.94	24.73		100.0	
10059-CAB	IEEE 802.11b WiFi 2.4 GHz (DSSS, 2 Mbps)	X	1.30	66.67	17.10	0.61	110.0	± 9.6 %
		Y	1.37	66.65	16.91		110.0	
		Z	1.27	64.87	15.53		110.0	
10060-CAB	IEEE 802.11b WiFi 2.4 GHz (DSSS, 5.5 Mbps)	X	100.00	139.37	36.42	1.30	110.0	± 9.6 %
		Y	100.00	134.75	34.85		110.0	
		Z	5.80	90.90	23.07		110.0	

10061-CAB	IEEE 802.11b WiFi 2.4 GHz (DSSS, 11 Mbps)	X	4.16	86.26	24.31	2.04	110.0	± 9.6 %
		Y	6.78	92.08	26.03		110.0	
		Z	3.18	78.55	20.67		110.0	
10062-CAB	IEEE 802.11a/h WiFi 5 GHz (OFDM, 6 Mbps)	X	4.62	66.99	16.77	0.49	100.0	± 9.6 %
		Y	4.83	66.75	16.66		100.0	
		Z	4.75	66.51	16.38		100.0	
10063-CAB	IEEE 802.11a/h WiFi 5 GHz (OFDM, 9 Mbps)	X	4.64	67.08	16.86	0.72	100.0	± 9.6 %
		Y	4.86	66.87	16.78		100.0	
		Z	4.77	66.60	16.47		100.0	
10064-CAB	IEEE 802.11a/h WiFi 5 GHz (OFDM, 12 Mbps)	X	4.89	67.27	17.04	0.86	100.0	± 9.6 %
		Y	5.19	67.18	17.02		100.0	
		Z	5.08	66.89	16.71		100.0	
10065-CAB	IEEE 802.11a/h WiFi 5 GHz (OFDM, 18 Mbps)	X	4.77	67.14	17.11	1.21	100.0	± 9.6 %
		Y	5.06	67.12	17.13		100.0	
		Z	4.94	66.80	16.79		100.0	
10066-CAB	IEEE 802.11a/h WiFi 5 GHz (OFDM, 24 Mbps)	X	4.78	67.15	17.25	1.46	100.0	± 9.6 %
		Y	5.09	67.18	17.31		100.0	
		Z	4.97	66.83	16.94		100.0	
10067-CAB	IEEE 802.11a/h WiFi 5 GHz (OFDM, 36 Mbps)	X	5.07	67.35	17.68	2.04	100.0	± 9.6 %
		Y	5.38	67.26	17.72		100.0	
		Z	5.26	66.92	17.34		100.0	
10068-CAB	IEEE 802.11a/h WiFi 5 GHz (OFDM, 48 Mbps)	X	5.11	67.30	17.84	2.55	100.0	± 9.6 %
		Y	5.48	67.51	18.02		100.0	
		Z	5.34	67.10	17.60		100.0	
10069-CAB	IEEE 802.11a/h WiFi 5 GHz (OFDM, 54 Mbps)	X	5.18	67.33	18.03	2.67	100.0	± 9.6 %
		Y	5.55	67.43	18.19		100.0	
		Z	5.42	67.05	17.77		100.0	
10071-CAB	IEEE 802.11g WiFi 2.4 GHz (DSSS/OFDM, 9 Mbps)	X	4.92	67.02	17.54	1.99	100.0	± 9.6 %
		Y	5.15	66.91	17.55		100.0	
		Z	5.05	66.61	17.20		100.0	
10072-CAB	IEEE 802.11g WiFi 2.4 GHz (DSSS/OFDM, 12 Mbps)	X	4.89	67.32	17.73	2.30	100.0	± 9.6 %
		Y	5.18	67.36	17.81		100.0	
		Z	5.06	66.97	17.41		100.0	
10073-CAB	IEEE 802.11g WiFi 2.4 GHz (DSSS/OFDM, 18 Mbps)	X	4.97	67.51	18.05	2.83	100.0	± 9.6 %
		Y	5.26	67.57	18.16		100.0	
		Z	5.13	67.15	17.71		100.0	
10074-CAB	IEEE 802.11g WiFi 2.4 GHz (DSSS/OFDM, 24 Mbps)	X	4.97	67.45	18.19	3.30	100.0	± 9.6 %
		Y	5.25	67.52	18.35		100.0	
		Z	5.12	67.08	17.88		100.0	
10075-CAB	IEEE 802.11g WiFi 2.4 GHz (DSSS/OFDM, 36 Mbps)	X	5.01	67.53	18.46	3.82	90.0	± 9.6 %
		Y	5.35	67.85	18.77		90.0	
		Z	5.20	67.32	18.23		90.0	
10076-CAB	IEEE 802.11g WiFi 2.4 GHz (DSSS/OFDM, 48 Mbps)	X	5.05	67.39	18.61	4.15	90.0	± 9.6 %
		Y	5.33	67.57	18.84		90.0	
		Z	5.20	67.09	18.32		90.0	
10077-CAB	IEEE 802.11g WiFi 2.4 GHz (DSSS/OFDM, 54 Mbps)	X	5.08	67.49	18.72	4.30	90.0	± 9.6 %
		Y	5.35	67.63	18.93		90.0	
		Z	5.23	67.15	18.41		90.0	

10081-CAB	CDMA2000 (1xRTT, RC3)	X	1.31	72.98	15.39	0.00	150.0	± 9.6 %
		Y	1.11	69.20	15.13		150.0	
		Z	0.87	65.58	12.79		150.0	
10082-CAB	IS-54 / IS-136 FDD (TDMA/FDM, PI/4-DQPSK, Fullrate)	X	0.85	60.00	5.02	4.77	80.0	± 9.6 %
		Y	1.21	60.81	6.24		80.0	
		Z	1.05	60.00	5.50		80.0	
10090-DAB	GPRS-FDD (TDMA, GMSK, TN 0-4)	X	100.00	112.28	25.96	6.56	60.0	± 9.6 %
		Y	100.00	115.46	28.15		60.0	
		Z	100.00	112.45	26.54		60.0	
10097-CAB	UMTS-FDD (HSDPA)	X	2.10	70.95	17.43	0.00	150.0	± 9.6 %
		Y	1.95	68.39	16.42		150.0	
		Z	1.81	67.01	15.42		150.0	
10098-CAB	UMTS-FDD (HSUPA, Subtest 2)	X	2.06	70.93	17.43	0.00	150.0	± 9.6 %
		Y	1.91	68.38	16.41		150.0	
		Z	1.77	66.95	15.38		150.0	
10099-DAB	EDGE-FDD (TDMA, 8PSK, TN 0-4)	X	9.76	91.94	32.20	9.56	60.0	± 9.6 %
		Y	18.08	104.66	36.54		60.0	
		Z	11.25	92.22	31.54		60.0	
10100-CAB	LTE-FDD (SC-FDMA, 100% RB, 20 MHz, QPSK)	X	3.35	72.13	17.90	0.00	150.0	± 9.6 %
		Y	3.43	71.55	17.33		150.0	
		Z	3.14	69.99	16.48		150.0	
10101-CAB	LTE-FDD (SC-FDMA, 100% RB, 20 MHz, 16-QAM)	X	3.28	68.30	16.59	0.00	150.0	± 9.6 %
		Y	3.42	68.10	16.32		150.0	
		Z	3.28	67.37	15.82		150.0	
10102-CAB	LTE-FDD (SC-FDMA, 100% RB, 20 MHz, 64-QAM)	X	3.39	68.25	16.67	0.00	150.0	± 9.6 %
		Y	3.51	67.99	16.38		150.0	
		Z	3.39	67.35	15.92		150.0	
10103-CAB	LTE-TDD (SC-FDMA, 100% RB, 20 MHz, QPSK)	X	6.41	75.89	20.51	3.98	65.0	± 9.6 %
		Y	7.77	77.49	21.00		65.0	
		Z	6.54	74.47	19.52		65.0	
10104-CAB	LTE-TDD (SC-FDMA, 100% RB, 20 MHz, 16-QAM)	X	6.38	73.95	20.45	3.98	65.0	± 9.6 %
		Y	7.62	75.73	21.18		65.0	
		Z	6.97	74.03	20.17		65.0	
10105-CAB	LTE-TDD (SC-FDMA, 100% RB, 20 MHz, 64-QAM)	X	5.88	72.23	19.98	3.98	65.0	± 9.6 %
		Y	7.31	74.91	21.13		65.0	
		Z	6.85	73.64	20.32		65.0	
10108-CAC	LTE-FDD (SC-FDMA, 100% RB, 10 MHz, QPSK)	X	2.91	71.53	17.82	0.00	150.0	± 9.6 %
		Y	3.02	70.68	17.15		150.0	
		Z	2.76	69.18	16.29		150.0	
10109-CAC	LTE-FDD (SC-FDMA, 100% RB, 10 MHz, 16-QAM)	X	2.95	68.44	16.61	0.00	150.0	± 9.6 %
		Y	3.08	67.93	16.28		150.0	
		Z	2.95	67.17	15.72		150.0	
10110-CAC	LTE-FDD (SC-FDMA, 100% RB, 5 MHz, QPSK)	X	2.39	71.08	17.59	0.00	150.0	± 9.6 %
		Y	2.47	69.75	16.86		150.0	
		Z	2.25	68.18	15.88		150.0	
10111-CAC	LTE-FDD (SC-FDMA, 100% RB, 5 MHz, 16-QAM)	X	2.79	70.36	17.30	0.00	150.0	± 9.6 %
		Y	2.80	68.64	16.65		150.0	
		Z	2.65	67.83	16.01		150.0	

10112-CAC	LTE-FDD (SC-FDMA, 100% RB, 10 MHz, 64-QAM)	X	3.07	68.42	16.64	0.00	150.0	± 9.6 %
		Y	3.20	67.83	16.29		150.0	
		Z	3.07	67.16	15.79		150.0	
10113-CAC	LTE-FDD (SC-FDMA, 100% RB, 5 MHz, 64-QAM)	X	2.94	70.45	17.39	0.00	150.0	± 9.6 %
		Y	2.95	68.67	16.72		150.0	
		Z	2.81	67.97	16.15		150.0	
10114-CAB	IEEE 802.11n (HT Greenfield, 13.5 Mbps, BPSK)	X	5.09	67.47	16.77	0.00	150.0	± 9.6 %
		Y	5.23	67.24	16.53		150.0	
		Z	5.18	67.08	16.35		150.0	
10115-CAB	IEEE 802.11n (HT Greenfield, 81 Mbps, 16-QAM)	X	5.34	67.51	16.78	0.00	150.0	± 9.6 %
		Y	5.60	67.53	16.67		150.0	
		Z	5.52	67.36	16.50		150.0	
10116-CAB	IEEE 802.11n (HT Greenfield, 135 Mbps, 64-QAM)	X	5.18	67.67	16.79	0.00	150.0	± 9.6 %
		Y	5.36	67.51	16.58		150.0	
		Z	5.29	67.32	16.39		150.0	
10117-CAB	IEEE 802.11n (HT Mixed, 13.5 Mbps, BPSK)	X	5.07	67.38	16.74	0.00	150.0	± 9.6 %
		Y	5.24	67.25	16.55		150.0	
		Z	5.16	67.03	16.34		150.0	
10118-CAB	IEEE 802.11n (HT Mixed, 81 Mbps, 16-QAM)	X	5.42	67.71	16.89	0.00	150.0	± 9.6 %
		Y	5.67	67.69	16.76		150.0	
		Z	5.59	67.53	16.59		150.0	
10119-CAB	IEEE 802.11n (HT Mixed, 135 Mbps, 64-QAM)	X	5.17	67.64	16.79	0.00	150.0	± 9.6 %
		Y	5.33	67.45	16.57		150.0	
		Z	5.26	67.25	16.37		150.0	
10140-CAB	LTE-FDD (SC-FDMA, 100% RB, 15 MHz, 16-QAM)	X	3.41	68.25	16.57	0.00	150.0	± 9.6 %
		Y	3.56	67.99	16.30		150.0	
		Z	3.43	67.35	15.84		150.0	
10141-CAB	LTE-FDD (SC-FDMA, 100% RB, 15 MHz, 64-QAM)	X	3.54	68.37	16.75	0.00	150.0	± 9.6 %
		Y	3.68	68.01	16.43		150.0	
		Z	3.56	67.45	16.01		150.0	
10142-CAC	LTE-FDD (SC-FDMA, 100% RB, 3 MHz, QPSK)	X	2.25	71.96	17.48	0.00	150.0	± 9.6 %
		Y	2.26	69.83	16.74		150.0	
		Z	2.02	68.09	15.61		150.0	
10143-CAC	LTE-FDD (SC-FDMA, 100% RB, 3 MHz, 16-QAM)	X	2.82	72.22	17.26	0.00	150.0	± 9.6 %
		Y	2.71	69.55	16.65		150.0	
		Z	2.52	68.51	15.83		150.0	
10144-CAC	LTE-FDD (SC-FDMA, 100% RB, 3 MHz, 64-QAM)	X	2.29	68.06	14.75	0.00	150.0	± 9.6 %
		Y	2.50	67.47	15.19		150.0	
		Z	2.32	66.44	14.34		150.0	
10145-CAC	LTE-FDD (SC-FDMA, 100% RB, 1.4 MHz, QPSK)	X	1.16	65.56	11.35	0.00	150.0	± 9.6 %
		Y	1.65	68.53	14.65		150.0	
		Z	1.36	65.83	12.76		150.0	
10146-CAC	LTE-FDD (SC-FDMA, 100% RB, 1.4 MHz, 16-QAM)	X	1.35	63.40	9.39	0.00	150.0	± 9.6 %
		Y	3.12	72.00	15.52		150.0	
		Z	2.16	67.04	12.61		150.0	
10147-CAC	LTE-FDD (SC-FDMA, 100% RB, 1.4 MHz, 64-QAM)	X	1.53	64.72	10.19	0.00	150.0	± 9.6 %
		Y	4.03	75.63	17.18		150.0	
		Z	2.54	69.13	13.74		150.0	

10149-CAB	LTE-FDD (SC-FDMA, 50% RB, 20 MHz, 16-QAM)	X	2.96	68.52	16.66	0.00	150.0	± 9.6 %
		Y	3.09	67.99	16.32		150.0	
		Z	2.96	67.23	15.77		150.0	
10150-CAB	LTE-FDD (SC-FDMA, 50% RB, 20 MHz, 64-QAM)	X	3.08	68.50	16.69	0.00	150.0	± 9.6 %
		Y	3.21	67.88	16.33		150.0	
		Z	3.08	67.21	15.83		150.0	
10151-CAB	LTE-TDD (SC-FDMA, 50% RB, 20 MHz, QPSK)	X	7.03	79.10	21.82	3.98	65.0	± 9.6 %
		Y	8.21	79.75	22.00		65.0	
		Z	7.10	77.15	20.67		65.0	
10152-CAB	LTE-TDD (SC-FDMA, 50% RB, 20 MHz, 16-QAM)	X	5.92	73.94	20.06	3.98	65.0	± 9.6 %
		Y	7.21	75.88	21.03		65.0	
		Z	6.48	73.87	19.84		65.0	
10153-CAB	LTE-TDD (SC-FDMA, 50% RB, 20 MHz, 64-QAM)	X	6.35	75.11	20.94	3.98	65.0	± 9.6 %
		Y	7.55	76.62	21.69		65.0	
		Z	6.87	74.79	20.60		65.0	
10154-CAC	LTE-FDD (SC-FDMA, 50% RB, 10 MHz, QPSK)	X	2.46	71.67	17.92	0.00	150.0	± 9.6 %
		Y	2.54	70.24	17.15		150.0	
		Z	2.30	68.63	16.17		150.0	
10155-CAC	LTE-FDD (SC-FDMA, 50% RB, 10 MHz, 16-QAM)	X	2.79	70.40	17.33	0.00	150.0	± 9.6 %
		Y	2.80	68.64	16.65		150.0	
		Z	2.66	67.83	16.02		150.0	
10156-CAC	LTE-FDD (SC-FDMA, 50% RB, 5 MHz, QPSK)	X	2.17	72.73	17.45	0.00	150.0	± 9.6 %
		Y	2.14	70.24	16.79		150.0	
		Z	1.88	68.21	15.48		150.0	
10157-CAC	LTE-FDD (SC-FDMA, 50% RB, 5 MHz, 16-QAM)	X	2.21	69.24	14.98	0.00	150.0	± 9.6 %
		Y	2.36	68.31	15.46		150.0	
		Z	2.15	66.99	14.43		150.0	
10158-CAC	LTE-FDD (SC-FDMA, 50% RB, 10 MHz, 64-QAM)	X	2.95	70.56	17.46	0.00	150.0	± 9.6 %
		Y	2.95	68.72	16.76		150.0	
		Z	2.82	68.03	16.20		150.0	
10159-CAC	LTE-FDD (SC-FDMA, 50% RB, 5 MHz, 64-QAM)	X	2.36	69.87	15.32	0.00	150.0	± 9.6 %
		Y	2.49	68.78	15.76		150.0	
		Z	2.27	67.50	14.75		150.0	
10160-CAB	LTE-FDD (SC-FDMA, 50% RB, 15 MHz, QPSK)	X	2.90	70.47	17.47	0.00	150.0	± 9.6 %
		Y	2.94	69.28	16.77		150.0	
		Z	2.76	68.21	16.07		150.0	
10161-CAB	LTE-FDD (SC-FDMA, 50% RB, 15 MHz, 16-QAM)	X	2.98	68.55	16.64	0.00	150.0	± 9.6 %
		Y	3.10	67.79	16.29		150.0	
		Z	2.98	67.13	15.77		150.0	
10162-CAB	LTE-FDD (SC-FDMA, 50% RB, 15 MHz, 64-QAM)	X	3.10	68.74	16.76	0.00	150.0	± 9.6 %
		Y	3.21	67.84	16.35		150.0	
		Z	3.09	67.25	15.86		150.0	
10166-CAC	LTE-FDD (SC-FDMA, 50% RB, 1.4 MHz, QPSK)	X	3.31	69.42	19.40	3.01	150.0	± 9.6 %
		Y	3.85	69.94	19.41		150.0	
		Z	3.63	68.92	18.65		150.0	
10167-CAC	LTE-FDD (SC-FDMA, 50% RB, 1.4 MHz, 16-QAM)	X	3.89	72.11	19.78	3.01	150.0	± 9.6 %
		Y	4.89	73.20	20.04		150.0	
		Z	4.45	71.60	19.05		150.0	

10168-CAC	LTE-FDD (SC-FDMA, 50% RB, 1.4 MHz, 64-QAM)	X	4.43	75.02	21.48	3.01	150.0	± 9.6 %
		Y	5.37	75.20	21.21		150.0	
		Z	4.92	73.76	20.36		150.0	
10169-CAB	LTE-FDD (SC-FDMA, 1 RB, 20 MHz, QPSK)	X	2.61	67.65	18.68	3.01	150.0	± 9.6 %
		Y	3.41	71.01	19.90		150.0	
		Z	3.09	68.90	18.61		150.0	
10170-CAB	LTE-FDD (SC-FDMA, 1 RB, 20 MHz, 16-QAM)	X	3.32	73.16	21.10	3.01	150.0	± 9.6 %
		Y	5.09	78.14	22.55		150.0	
		Z	4.27	74.69	20.88		150.0	
10171-AAB	LTE-FDD (SC-FDMA, 1 RB, 20 MHz, 64-QAM)	X	2.74	69.02	18.13	3.01	150.0	± 9.6 %
		Y	4.10	73.53	19.72		150.0	
		Z	3.48	70.44	18.07		150.0	
10172-CAB	LTE-TDD (SC-FDMA, 1 RB, 20 MHz, QPSK)	X	5.53	83.56	25.72	6.02	65.0	± 9.6 %
		Y	21.34	105.31	32.41		65.0	
		Z	7.30	84.26	24.94		65.0	
10173-CAB	LTE-TDD (SC-FDMA, 1 RB, 20 MHz, 16-QAM)	X	10.58	92.60	26.95	6.02	65.0	± 9.6 %
		Y	29.30	105.74	30.57		65.0	
		Z	12.37	90.08	25.23		65.0	
10174-CAB	LTE-TDD (SC-FDMA, 1 RB, 20 MHz, 64-QAM)	X	7.41	85.53	24.05	6.02	65.0	± 9.6 %
		Y	21.20	98.69	27.99		65.0	
		Z	10.53	86.42	23.55		65.0	
10175-CAC	LTE-FDD (SC-FDMA, 1 RB, 10 MHz, QPSK)	X	2.58	67.36	18.42	3.01	150.0	± 9.6 %
		Y	3.37	70.66	19.64		150.0	
		Z	3.05	68.56	18.35		150.0	
10176-CAC	LTE-FDD (SC-FDMA, 1 RB, 10 MHz, 16-QAM)	X	3.33	73.19	21.11	3.01	150.0	± 9.6 %
		Y	5.10	78.16	22.56		150.0	
		Z	4.27	74.71	20.89		150.0	
10177-CAE	LTE-FDD (SC-FDMA, 1 RB, 5 MHz, QPSK)	X	2.60	67.50	18.51	3.01	150.0	± 9.6 %
		Y	3.40	70.83	19.75		150.0	
		Z	3.07	68.74	18.46		150.0	
10178-CAC	LTE-FDD (SC-FDMA, 1 RB, 5 MHz, 16-QAM)	X	3.30	73.00	21.00	3.01	150.0	± 9.6 %
		Y	5.02	77.85	22.40		150.0	
		Z	4.22	74.44	20.74		150.0	
10179-CAC	LTE-FDD (SC-FDMA, 1 RB, 10 MHz, 64-QAM)	X	3.00	71.00	19.50	3.01	150.0	± 9.6 %
		Y	4.55	75.67	20.98		150.0	
		Z	3.82	72.37	19.31		150.0	
10180-CAC	LTE-FDD (SC-FDMA, 1 RB, 5 MHz, 64-QAM)	X	2.73	68.97	18.09	3.01	150.0	± 9.6 %
		Y	4.08	73.43	19.65		150.0	
		Z	3.47	70.35	18.01		150.0	
10181-CAB	LTE-FDD (SC-FDMA, 1 RB, 15 MHz, QPSK)	X	2.59	67.48	18.51	3.01	150.0	± 9.6 %
		Y	3.39	70.81	19.74		150.0	
		Z	3.07	68.71	18.45		150.0	
10182-CAB	LTE-FDD (SC-FDMA, 1 RB, 15 MHz, 16-QAM)	X	3.30	72.98	20.99	3.01	150.0	± 9.6 %
		Y	5.01	77.82	22.39		150.0	
		Z	4.21	74.41	20.73		150.0	
10183-AAA	LTE-FDD (SC-FDMA, 1 RB, 15 MHz, 64-QAM)	X	2.73	68.94	18.08	3.01	150.0	± 9.6 %
		Y	4.07	73.40	19.64		150.0	
		Z	3.46	70.33	18.00		150.0	

10184-CAC	LTE-FDD (SC-FDMA, 1 RB, 3 MHz, QPSK)	X	2.60	67.52	18.53	3.01	150.0	± 9.6 %
		Y	3.40	70.86	19.76		150.0	
		Z	3.08	68.76	18.47		150.0	
10185-CAC	LTE-FDD (SC-FDMA, 1 RB, 3 MHz, 16-QAM)	X	3.31	73.05	21.03	3.01	150.0	± 9.6 %
		Y	5.04	77.90	22.43		150.0	
		Z	4.23	74.49	20.77		150.0	
10186-AAC	LTE-FDD (SC-FDMA, 1 RB, 3 MHz, 64-QAM)	X	2.74	69.01	18.12	3.01	150.0	± 9.6 %
		Y	4.10	73.47	19.68		150.0	
		Z	3.48	70.39	18.03		150.0	
10187-CAC	LTE-FDD (SC-FDMA, 1 RB, 1.4 MHz, QPSK)	X	2.61	67.58	18.60	3.01	150.0	± 9.6 %
		Y	3.41	70.90	19.81		150.0	
		Z	3.09	68.80	18.52		150.0	
10188-CAC	LTE-FDD (SC-FDMA, 1 RB, 1.4 MHz, 16-QAM)	X	3.41	73.70	21.42	3.01	150.0	± 9.6 %
		Y	5.24	78.69	22.84		150.0	
		Z	4.38	75.22	21.18		150.0	
10189-AAC	LTE-FDD (SC-FDMA, 1 RB, 1.4 MHz, 64-QAM)	X	2.80	69.41	18.40	3.01	150.0	± 9.6 %
		Y	4.20	73.97	19.98		150.0	
		Z	3.56	70.83	18.32		150.0	
10193-CAB	IEEE 802.11n (HT Greenfield, 6.5 Mbps, BPSK)	X	4.49	67.07	16.51	0.00	150.0	± 9.6 %
		Y	4.67	66.69	16.32		150.0	
		Z	4.59	66.49	16.09		150.0	
10194-CAB	IEEE 802.11n (HT Greenfield, 39 Mbps, 16-QAM)	X	4.64	67.34	16.63	0.00	150.0	± 9.6 %
		Y	4.86	67.05	16.43		150.0	
		Z	4.77	66.83	16.21		150.0	
10195-CAB	IEEE 802.11n (HT Greenfield, 65 Mbps, 64-QAM)	X	4.68	67.36	16.65	0.00	150.0	± 9.6 %
		Y	4.90	67.06	16.44		150.0	
		Z	4.82	66.86	16.22		150.0	
10196-CAB	IEEE 802.11n (HT Mixed, 6.5 Mbps, BPSK)	X	4.48	67.10	16.51	0.00	150.0	± 9.6 %
		Y	4.68	66.78	16.36		150.0	
		Z	4.60	66.57	16.12		150.0	
10197-CAB	IEEE 802.11n (HT Mixed, 39 Mbps, 16-QAM)	X	4.66	67.35	16.64	0.00	150.0	± 9.6 %
		Y	4.88	67.07	16.45		150.0	
		Z	4.79	66.86	16.22		150.0	
10198-CAB	IEEE 802.11n (HT Mixed, 65 Mbps, 64-QAM)	X	4.68	67.37	16.65	0.00	150.0	± 9.6 %
		Y	4.91	67.08	16.45		150.0	
		Z	4.82	66.87	16.23		150.0	
10219-CAB	IEEE 802.11n (HT Mixed, 7.2 Mbps, BPSK)	X	4.44	67.14	16.49	0.00	150.0	± 9.6 %
		Y	4.63	66.80	16.32		150.0	
		Z	4.55	66.58	16.08		150.0	
10220-CAB	IEEE 802.11n (HT Mixed, 43.3 Mbps, 16-QAM)	X	4.65	67.31	16.63	0.00	150.0	± 9.6 %
		Y	4.87	67.06	16.44		150.0	
		Z	4.79	66.83	16.21		150.0	
10221-CAB	IEEE 802.11n (HT Mixed, 72.2 Mbps, 64-QAM)	X	4.69	67.30	16.64	0.00	150.0	± 9.6 %
		Y	4.91	67.01	16.44		150.0	
		Z	4.83	66.81	16.22		150.0	
10222-CAB	IEEE 802.11n (HT Mixed, 15 Mbps, BPSK)	X	5.04	67.37	16.73	0.00	150.0	± 9.6 %
		Y	5.22	67.27	16.55		150.0	
		Z	5.14	67.04	16.34		150.0	

10223-CAB	IEEE 802.11n (HT Mixed, 90 Mbps, 16-QAM)	X	5.33	67.57	16.84	0.00	150.0	± 9.6 %
		Y	5.58	67.57	16.72		150.0	
		Z	5.46	67.24	16.46		150.0	
10224-CAB	IEEE 802.11n (HT Mixed, 150 Mbps, 64-QAM)	X	5.08	67.48	16.71	0.00	150.0	± 9.6 %
		Y	5.27	67.38	16.53		150.0	
		Z	5.19	67.14	16.31		150.0	
10225-CAB	UMTS-FDD (HSPA+)	X	2.82	67.14	15.84	0.00	150.0	± 9.6 %
		Y	2.95	66.38	15.78		150.0	
		Z	2.86	65.91	15.30		150.0	
10226-CAA	LTE-TDD (SC-FDMA, 1 RB, 1.4 MHz, 16-QAM)	X	11.41	94.07	27.52	6.02	65.0	± 9.6 %
		Y	31.67	107.27	31.09		65.0	
		Z	13.11	91.16	25.67		65.0	
10227-CAA	LTE-TDD (SC-FDMA, 1 RB, 1.4 MHz, 64-QAM)	X	11.04	92.14	26.24	6.02	65.0	± 9.6 %
		Y	24.12	100.92	28.72		65.0	
		Z	11.71	88.12	24.16		65.0	
10228-CAA	LTE-TDD (SC-FDMA, 1 RB, 1.4 MHz, QPSK)	X	7.63	90.07	28.10	6.02	65.0	± 9.6 %
		Y	23.55	107.62	33.18		65.0	
		Z	10.51	91.21	27.39		65.0	
10229-CAB	LTE-TDD (SC-FDMA, 1 RB, 3 MHz, 16-QAM)	X	10.66	92.71	26.99	6.02	65.0	± 9.6 %
		Y	29.42	105.79	30.60		65.0	
		Z	12.45	90.17	25.27		65.0	
10230-CAB	LTE-TDD (SC-FDMA, 1 RB, 3 MHz, 64-QAM)	X	10.25	90.80	25.74	6.02	65.0	± 9.6 %
		Y	22.68	99.76	28.30		65.0	
		Z	11.15	87.26	23.80		65.0	
10231-CAB	LTE-TDD (SC-FDMA, 1 RB, 3 MHz, QPSK)	X	7.27	89.04	27.66	6.02	65.0	± 9.6 %
		Y	22.20	106.36	32.73		65.0	
		Z	10.05	90.30	27.01		65.0	
10232-CAB	LTE-TDD (SC-FDMA, 1 RB, 5 MHz, 16-QAM)	X	10.64	92.69	26.99	6.02	65.0	± 9.6 %
		Y	29.42	105.80	30.60		65.0	
		Z	12.43	90.15	25.26		65.0	
10233-CAB	LTE-TDD (SC-FDMA, 1 RB, 5 MHz, 64-QAM)	X	10.23	90.76	25.73	6.02	65.0	± 9.6 %
		Y	22.67	99.78	28.30		65.0	
		Z	11.14	87.24	23.80		65.0	
10234-CAB	LTE-TDD (SC-FDMA, 1 RB, 5 MHz, QPSK)	X	6.99	88.15	27.23	6.02	65.0	± 9.6 %
		Y	20.93	105.02	32.23		65.0	
		Z	9.64	89.40	26.60		65.0	
10235-CAB	LTE-TDD (SC-FDMA, 1 RB, 10 MHz, 16-QAM)	X	10.65	92.73	27.00	6.02	65.0	± 9.6 %
		Y	29.50	105.86	30.62		65.0	
		Z	12.44	90.18	25.27		65.0	
10236-CAB	LTE-TDD (SC-FDMA, 1 RB, 10 MHz, 64-QAM)	X	10.34	90.92	25.77	6.02	65.0	± 9.6 %
		Y	22.93	99.94	28.35		65.0	
		Z	11.22	87.34	23.83		65.0	
10237-CAB	LTE-TDD (SC-FDMA, 1 RB, 10 MHz, QPSK)	X	7.28	89.10	27.69	6.02	65.0	± 9.6 %
		Y	22.38	106.55	32.79		65.0	
		Z	10.07	90.36	27.03		65.0	
10238-CAB	LTE-TDD (SC-FDMA, 1 RB, 15 MHz, 16-QAM)	X	10.61	92.67	26.98	6.02	65.0	± 9.6 %
		Y	29.40	105.80	30.59		65.0	
		Z	12.41	90.13	25.25		65.0	

10239-CAB	LTE-TDD (SC-FDMA, 1 RB, 15 MHz, 64-QAM)	X	10.19	90.73	25.72	6.02	65.0	± 9.6 %
		Y	22.65	99.78	28.31		65.0	
		Z	11.11	87.22	23.79		65.0	
10240-CAB	LTE-TDD (SC-FDMA, 1 RB, 15 MHz, QPSK)	X	7.26	89.06	27.67	6.02	65.0	± 9.6 %
		Y	22.30	106.48	32.77		65.0	
		Z	10.04	90.32	27.01		65.0	
10241-CAA	LTE-TDD (SC-FDMA, 50% RB, 1.4 MHz, 16-QAM)	X	7.75	81.08	25.21	6.98	65.0	± 9.6 %
		Y	10.21	83.82	26.43		65.0	
		Z	8.73	80.32	24.52		65.0	
10242-CAA	LTE-TDD (SC-FDMA, 50% RB, 1.4 MHz, 64-QAM)	X	6.80	78.38	24.02	6.98	65.0	± 9.6 %
		Y	9.63	82.52	25.83		65.0	
		Z	8.38	79.47	24.10		65.0	
10243-CAA	LTE-TDD (SC-FDMA, 50% RB, 1.4 MHz, QPSK)	X	5.61	75.06	23.46	6.98	65.0	± 9.6 %
		Y	7.74	79.46	25.50		65.0	
		Z	6.88	76.70	23.79		65.0	
10244-CAB	LTE-TDD (SC-FDMA, 50% RB, 3 MHz, 16-QAM)	X	4.85	72.20	16.09	3.98	65.0	± 9.6 %
		Y	8.02	78.99	20.43		65.0	
		Z	6.19	74.48	17.94		65.0	
10245-CAB	LTE-TDD (SC-FDMA, 50% RB, 3 MHz, 64-QAM)	X	4.70	71.53	15.74	3.98	65.0	± 9.6 %
		Y	7.89	78.48	20.19		65.0	
		Z	6.13	74.10	17.74		65.0	
10246-CAB	LTE-TDD (SC-FDMA, 50% RB, 3 MHz, QPSK)	X	5.22	76.54	18.28	3.98	65.0	± 9.6 %
		Y	8.14	82.43	21.79		65.0	
		Z	5.87	76.86	19.08		65.0	
10247-CAB	LTE-TDD (SC-FDMA, 50% RB, 5 MHz, 16-QAM)	X	4.92	73.01	17.55	3.98	65.0	± 9.6 %
		Y	6.62	76.59	20.16		65.0	
		Z	5.63	73.71	18.45		65.0	
10248-CAB	LTE-TDD (SC-FDMA, 50% RB, 5 MHz, 64-QAM)	X	4.84	72.32	17.23	3.98	65.0	± 9.6 %
		Y	6.62	76.08	19.95		65.0	
		Z	5.66	73.31	18.26		65.0	
10249-CAB	LTE-TDD (SC-FDMA, 50% RB, 5 MHz, QPSK)	X	7.10	81.85	21.45	3.98	65.0	± 9.6 %
		Y	9.09	84.35	23.13		65.0	
		Z	6.82	79.25	20.73		65.0	
10250-CAB	LTE-TDD (SC-FDMA, 50% RB, 10 MHz, 16-QAM)	X	6.14	76.72	21.07	3.98	65.0	± 9.6 %
		Y	7.40	78.29	22.09		65.0	
		Z	6.54	75.95	20.75		65.0	
10251-CAB	LTE-TDD (SC-FDMA, 50% RB, 10 MHz, 64-QAM)	X	5.70	74.17	19.61	3.98	65.0	± 9.6 %
		Y	7.04	76.19	20.94		65.0	
		Z	6.27	74.04	19.64		65.0	
10252-CAB	LTE-TDD (SC-FDMA, 50% RB, 10 MHz, QPSK)	X	7.47	82.32	22.88	3.98	65.0	± 9.6 %
		Y	8.82	83.02	23.29		65.0	
		Z	7.18	79.27	21.49		65.0	
10253-CAB	LTE-TDD (SC-FDMA, 50% RB, 15 MHz, 16-QAM)	X	5.82	73.49	19.80	3.98	65.0	± 9.6 %
		Y	6.99	75.20	20.79		65.0	
		Z	6.34	73.34	19.64		65.0	
10254-CAB	LTE-TDD (SC-FDMA, 50% RB, 15 MHz, 64-QAM)	X	6.20	74.53	20.56	3.98	65.0	± 9.6 %
		Y	7.35	75.96	21.41		65.0	
		Z	6.71	74.22	20.33		65.0	

10255-CAB	LTE-TDD (SC-FDMA, 50% RB, 15 MHz, QPSK)	X	6.71	78.47	21.74	3.98	65.0	± 9.6 %
		Y	7.84	79.18	22.03		65.0	
		Z	6.83	76.67	20.70		65.0	
10256-CAA	LTE-TDD (SC-FDMA, 100% RB, 1.4 MHz, 16-QAM)	X	3.47	67.38	12.72	3.98	65.0	± 9.6 %
		Y	6.90	76.38	18.57		65.0	
		Z	5.11	71.48	15.77		65.0	
10257-CAA	LTE-TDD (SC-FDMA, 100% RB, 1.4 MHz, 64-QAM)	X	3.38	66.76	12.32	3.98	65.0	± 9.6 %
		Y	6.74	75.67	18.20		65.0	
		Z	5.05	70.99	15.48		65.0	
10258-CAA	LTE-TDD (SC-FDMA, 100% RB, 1.4 MHz, QPSK)	X	3.49	70.18	14.59	3.98	65.0	± 9.6 %
		Y	6.78	79.22	19.98		65.0	
		Z	4.80	73.56	17.06		65.0	
10259-CAB	LTE-TDD (SC-FDMA, 100% RB, 3 MHz, 16-QAM)	X	5.42	74.50	18.87	3.98	65.0	± 9.6 %
		Y	6.93	77.16	20.83		65.0	
		Z	5.98	74.51	19.26		65.0	
10260-CAB	LTE-TDD (SC-FDMA, 100% RB, 3 MHz, 64-QAM)	X	5.41	74.15	18.72	3.98	65.0	± 9.6 %
		Y	6.95	76.90	20.74		65.0	
		Z	6.03	74.34	19.21		65.0	
10261-CAB	LTE-TDD (SC-FDMA, 100% RB, 3 MHz, QPSK)	X	6.87	81.15	21.70	3.98	65.0	± 9.6 %
		Y	8.53	83.00	22.95		65.0	
		Z	6.70	78.62	20.83		65.0	
10262-CAB	LTE-TDD (SC-FDMA, 100% RB, 5 MHz, 16-QAM)	X	6.12	76.64	21.02	3.98	65.0	± 9.6 %
		Y	7.39	78.26	22.06		65.0	
		Z	6.53	75.90	20.71		65.0	
10263-CAB	LTE-TDD (SC-FDMA, 100% RB, 5 MHz, 64-QAM)	X	5.69	74.15	19.60	3.98	65.0	± 9.6 %
		Y	7.03	76.18	20.94		65.0	
		Z	6.26	74.03	19.63		65.0	
10264-CAB	LTE-TDD (SC-FDMA, 100% RB, 5 MHz, QPSK)	X	7.38	82.08	22.77	3.98	65.0	± 9.6 %
		Y	8.75	82.86	23.22		65.0	
		Z	7.12	79.11	21.41		65.0	
10265-CAB	LTE-TDD (SC-FDMA, 100% RB, 10 MHz, 16-QAM)	X	5.92	73.94	20.06	3.98	65.0	± 9.6 %
		Y	7.20	75.88	21.03		65.0	
		Z	6.48	73.87	19.85		65.0	
10266-CAB	LTE-TDD (SC-FDMA, 100% RB, 10 MHz, 64-QAM)	X	6.35	75.09	20.93	3.98	65.0	± 9.6 %
		Y	7.55	76.61	21.68		65.0	
		Z	6.86	74.78	20.59		65.0	
10267-CAB	LTE-TDD (SC-FDMA, 100% RB, 10 MHz, QPSK)	X	7.01	79.05	21.80	3.98	65.0	± 9.6 %
		Y	8.19	79.71	21.98		65.0	
		Z	7.09	77.11	20.65		65.0	
10268-CAB	LTE-TDD (SC-FDMA, 100% RB, 15 MHz, 16-QAM)	X	6.54	73.87	20.51	3.98	65.0	± 9.6 %
		Y	7.70	75.41	21.18		65.0	
		Z	7.12	73.89	20.25		65.0	
10269-CAB	LTE-TDD (SC-FDMA, 100% RB, 15 MHz, 64-QAM)	X	6.52	73.47	20.39	3.98	65.0	± 9.6 %
		Y	7.63	74.96	21.06		65.0	
		Z	7.08	73.52	20.16		65.0	
10270-CAB	LTE-TDD (SC-FDMA, 100% RB, 15 MHz, QPSK)	X	6.72	76.10	20.81	3.98	65.0	± 9.6 %
		Y	7.77	76.91	21.02		65.0	
		Z	7.04	75.13	20.02		65.0	

10274-CAB	UMTS-FDD (HSUPA, Subtest 5, 3GPP Rel8.10)	X	2.68	67.93	16.00	0.00	150.0	± 9.6 %
		Y	2.70	66.71	15.69		150.0	
		Z	2.60	66.12	15.13		150.0	
10275-CAB	UMTS-FDD (HSUPA, Subtest 5, 3GPP Rel8.4)	X	1.86	71.35	17.51	0.00	150.0	± 9.6 %
		Y	1.79	69.27	16.54		150.0	
		Z	1.60	67.20	15.22		150.0	
10277-CAA	PHS (QPSK)	X	2.51	62.07	7.69	9.03	50.0	± 9.6 %
		Y	3.60	65.47	10.92		50.0	
		Z	3.21	64.00	9.69		50.0	
10278-CAA	PHS (QPSK, BW 884MHz, Rolloff 0.5)	X	4.14	68.90	13.57	9.03	50.0	± 9.6 %
		Y	8.03	79.56	19.93		50.0	
		Z	5.72	73.56	16.82		50.0	
10279-CAA	PHS (QPSK, BW 884MHz, Rolloff 0.38)	X	4.23	69.12	13.72	9.03	50.0	± 9.6 %
		Y	8.23	79.82	20.06		50.0	
		Z	5.85	73.80	16.95		50.0	
10290-AAB	CDMA2000, RC1, SO55, Full Rate	X	2.16	75.12	16.21	0.00	150.0	± 9.6 %
		Y	1.91	71.91	16.34		150.0	
		Z	1.49	68.32	14.21		150.0	
10291-AAB	CDMA2000, RC3, SO55, Full Rate	X	1.24	72.30	15.09	0.00	150.0	± 9.6 %
		Y	1.08	68.86	14.96		150.0	
		Z	0.85	65.38	12.66		150.0	
10292-AAB	CDMA2000, RC3, SO32, Full Rate	X	13.33	104.67	25.79	0.00	150.0	± 9.6 %
		Y	1.50	74.81	18.02		150.0	
		Z	1.03	68.79	14.75		150.0	
10293-AAB	CDMA2000, RC3, SO3, Full Rate	X	100.00	135.60	33.89	0.00	150.0	± 9.6 %
		Y	2.41	82.36	21.43		150.0	
		Z	1.44	73.75	17.42		150.0	
10295-AAB	CDMA2000, RC1, SO3, 1/8th Rate 25 fr.	X	11.05	85.41	22.93	9.03	50.0	± 9.6 %
		Y	8.87	82.92	23.80		50.0	
		Z	7.57	79.23	21.65		50.0	
10297-AAA	LTE-FDD (SC-FDMA, 50% RB, 20 MHz, QPSK)	X	2.93	71.67	17.91	0.00	150.0	± 9.6 %
		Y	3.03	70.79	17.22		150.0	
		Z	2.77	69.28	16.35		150.0	
10298-AAB	LTE-FDD (SC-FDMA, 50% RB, 3 MHz, QPSK)	X	1.80	70.98	15.29	0.00	150.0	± 9.6 %
		Y	1.94	70.01	16.02		150.0	
		Z	1.64	67.53	14.38		150.0	
10299-AAB	LTE-FDD (SC-FDMA, 50% RB, 3 MHz, 16-QAM)	X	2.25	68.93	13.39	0.00	150.0	± 9.6 %
		Y	3.57	73.44	16.90		150.0	
		Z	2.68	69.23	14.47		150.0	
10300-AAB	LTE-FDD (SC-FDMA, 50% RB, 3 MHz, 64-QAM)	X	1.52	63.47	9.92	0.00	150.0	± 9.6 %
		Y	2.60	68.00	13.77		150.0	
		Z	2.12	65.38	11.93		150.0	
10301-AAA	IEEE 802.16e WiMAX (29:18, 5ms, 10MHz, QPSK, PUSC)	X	4.73	66.14	17.79	4.17	50.0	± 9.6 %
		Y	5.14	66.14	17.98		50.0	
		Z	4.87	65.30	17.38		50.0	
10302-AAA	IEEE 802.16e WiMAX (29:18, 5ms, 10MHz, QPSK, PUSC, 3 CTRL symbols)	X	5.19	66.64	18.43	4.96	50.0	± 9.6 %
		Y	5.69	67.11	18.91		50.0	
		Z	5.42	66.20	18.24		50.0	

10303-AAA	IEEE 802.16e WiMAX (31:15, 5ms, 10MHz, 64QAM, PUSC)	X	4.96	66.34	18.27	4.96	50.0	± 9.6 %
		Y	5.48	66.96	18.88		50.0	
		Z	5.20	65.95	18.14		50.0	
10304-AAA	IEEE 802.16e WiMAX (29:18, 5ms, 10MHz, 64QAM, PUSC)	X	4.76	66.23	17.80	4.17	50.0	± 9.6 %
		Y	5.21	66.54	18.19		50.0	
		Z	4.96	65.68	17.56		50.0	
10305-AAA	IEEE 802.16e WiMAX (31:15, 10ms, 10MHz, 64QAM, PUSC, 15 symbols)	X	4.83	70.07	20.50	6.02	35.0	± 9.6 %
		Y	5.51	71.60	22.16		35.0	
		Z	4.98	69.23	20.55		35.0	
10306-AAA	IEEE 802.16e WiMAX (29:18, 10ms, 10MHz, 64QAM, PUSC, 18 symbols)	X	4.91	68.09	19.77	6.02	35.0	± 9.6 %
		Y	5.42	68.18	20.25		35.0	
		Z	5.11	67.47	19.73		35.0	
10307-AAA	IEEE 802.16e WiMAX (29:18, 10ms, 10MHz, QPSK, PUSC, 18 symbols)	X	4.83	68.37	19.78	6.02	35.0	± 9.6 %
		Y	5.47	69.61	21.06		35.0	
		Z	5.07	67.89	19.81		35.0	
10308-AAA	IEEE 802.16e WiMAX (29:18, 10ms, 10MHz, 16QAM, PUSC)	X	4.84	68.69	19.98	6.02	35.0	± 9.6 %
		Y	5.46	69.92	21.24		35.0	
		Z	5.05	68.12	19.96		35.0	
10309-AAA	IEEE 802.16e WiMAX (29:18, 10ms, 10MHz, 16QAM, AMC 2x3, 18 symbols)	X	4.94	68.23	19.88	6.02	35.0	± 9.6 %
		Y	5.52	68.51	20.43		35.0	
		Z	5.19	67.72	19.88		35.0	
10310-AAA	IEEE 802.16e WiMAX (29:18, 10ms, 10MHz, QPSK, AMC 2x3, 18 symbols)	X	4.88	68.25	19.79	6.02	35.0	± 9.6 %
		Y	5.44	69.18	20.91		35.0	
		Z	5.08	67.61	19.74		35.0	
10311-AAA	LTE-FDD (SC-FDMA, 100% RB, 15 MHz, QPSK)	X	3.31	70.70	17.41	0.00	150.0	± 9.6 %
		Y	3.40	70.05	16.83		150.0	
		Z	3.13	68.65	16.04		150.0	
10313-AAA	iDEN 1:3	X	4.31	74.90	16.96	6.99	70.0	± 9.6 %
		Y	5.76	76.90	17.84		70.0	
		Z	4.08	72.13	15.67		70.0	
10314-AAA	iDEN 1:6	X	7.33	84.94	23.33	10.00	30.0	± 9.6 %
		Y	7.31	83.11	22.80		30.0	
		Z	4.98	76.71	20.14		30.0	
10315-AAB	IEEE 802.11b WiFi 2.4 GHz (DSSS, 1 Mbps, 96pc duty cycle)	X	1.15	65.39	16.53	0.17	150.0	± 9.6 %
		Y	1.15	64.64	15.92		150.0	
		Z	1.10	63.46	14.86		150.0	
10316-AAB	IEEE 802.11g WiFi 2.4 GHz (ERP-OFDM, 6 Mbps, 96pc duty cycle)	X	4.52	67.01	16.57	0.17	150.0	± 9.6 %
		Y	4.73	66.76	16.44		150.0	
		Z	4.65	66.51	16.17		150.0	
10317-AAB	IEEE 802.11a WiFi 5 GHz (OFDM, 6 Mbps, 96pc duty cycle)	X	4.52	67.01	16.57	0.17	150.0	± 9.6 %
		Y	4.73	66.76	16.44		150.0	
		Z	4.65	66.51	16.17		150.0	
10400-AAC	IEEE 802.11ac WiFi (20MHz, 64-QAM, 99pc duty cycle)	X	4.62	67.36	16.62	0.00	150.0	± 9.6 %
		Y	4.87	67.12	16.43		150.0	
		Z	4.77	66.88	16.19		150.0	
10401-AAC	IEEE 802.11ac WiFi (40MHz, 64-QAM, 99pc duty cycle)	X	5.32	67.33	16.68	0.00	150.0	± 9.6 %
		Y	5.49	67.16	16.50		150.0	
		Z	5.43	67.01	16.32		150.0	

10402-AAC	IEEE 802.11ac WiFi (80MHz, 64-QAM, 99pc duty cycle)	X	5.60	67.66	16.72	0.00	150.0	± 9.6 %
		Y	5.79	67.68	16.60		150.0	
		Z	5.72	67.47	16.40		150.0	
10403-AAB	CDMA2000 (1xEV-DO, Rev. 0)	X	2.16	75.12	16.21	0.00	115.0	± 9.6 %
		Y	1.91	71.91	16.34		115.0	
		Z	1.49	68.32	14.21		115.0	
10404-AAB	CDMA2000 (1xEV-DO, Rev. A)	X	2.16	75.12	16.21	0.00	115.0	± 9.6 %
		Y	1.91	71.91	16.34		115.0	
		Z	1.49	68.32	14.21		115.0	
10406-AAB	CDMA2000, RC3, SO32, SCH0, Full Rate	X	100.00	127.59	32.37	0.00	100.0	± 9.6 %
		Y	100.00	123.98	31.83		100.0	
		Z	14.26	95.15	24.05		100.0	
10410-AAA	LTE-TDD (SC-FDMA, 1 RB, 10 MHz, QPSK, UL Subframe=2,3,4,7,8,9)	X	100.00	124.06	30.89	3.23	80.0	± 9.6 %
		Y	100.00	119.95	30.07		80.0	
		Z	11.66	89.63	21.52		80.0	
10415-AAA	IEEE 802.11b WiFi 2.4 GHz (DSSS, 1 Mbps, 99pc duty cycle)	X	1.06	64.51	16.01	0.00	150.0	± 9.6 %
		Y	1.04	63.51	15.25		150.0	
		Z	1.01	62.60	14.33		150.0	
10416-AAA	IEEE 802.11g WiFi 2.4 GHz (ERP-OFDM, 6 Mbps, 99pc duty cycle)	X	4.49	67.08	16.58	0.00	150.0	± 9.6 %
		Y	4.67	66.72	16.37		150.0	
		Z	4.59	66.53	16.14		150.0	
10417-AAA	IEEE 802.11a/h WiFi 5 GHz (OFDM, 6 Mbps, 99pc duty cycle)	X	4.49	67.08	16.58	0.00	150.0	± 9.6 %
		Y	4.67	66.72	16.37		150.0	
		Z	4.59	66.53	16.14		150.0	
10418-AAA	IEEE 802.11g WiFi 2.4 GHz (DSSS-OFDM, 6 Mbps, 99pc duty cycle, Long preamble)	X	4.49	67.30	16.63	0.00	150.0	± 9.6 %
		Y	4.65	66.87	16.37		150.0	
		Z	4.58	66.67	16.15		150.0	
10419-AAA	IEEE 802.11g WiFi 2.4 GHz (DSSS-OFDM, 6 Mbps, 99pc duty cycle, Short preamble)	X	4.50	67.22	16.62	0.00	150.0	± 9.6 %
		Y	4.68	66.82	16.38		150.0	
		Z	4.60	66.63	16.16		150.0	
10422-AAA	IEEE 802.11n (HT Greenfield, 7.2 Mbps, BPSK)	X	4.61	67.18	16.61	0.00	150.0	± 9.6 %
		Y	4.80	66.83	16.39		150.0	
		Z	4.73	66.64	16.18		150.0	
10423-AAA	IEEE 802.11n (HT Greenfield, 43.3 Mbps, 16-QAM)	X	4.75	67.46	16.71	0.00	150.0	± 9.6 %
		Y	5.00	67.20	16.53		150.0	
		Z	4.91	66.98	16.30		150.0	
10424-AAA	IEEE 802.11n (HT Greenfield, 72.2 Mbps, 64-QAM)	X	4.68	67.42	16.69	0.00	150.0	± 9.6 %
		Y	4.91	67.14	16.49		150.0	
		Z	4.82	66.93	16.27		150.0	
10425-AAA	IEEE 802.11n (HT Greenfield, 15 Mbps, BPSK)	X	5.29	67.59	16.82	0.00	150.0	± 9.6 %
		Y	5.47	67.41	16.61		150.0	
		Z	5.41	67.25	16.44		150.0	
10426-AAA	IEEE 802.11n (HT Greenfield, 90 Mbps, 16-QAM)	X	5.31	67.68	16.86	0.00	150.0	± 9.6 %
		Y	5.48	67.44	16.63		150.0	
		Z	5.41	67.26	16.44		150.0	

10427-AAA	IEEE 802.11n (HT Greenfield, 150 Mbps, 64-QAM)	X	5.29	67.52	16.78	0.00	150.0	± 9.6 %
		Y	5.50	67.46	16.63		150.0	
		Z	5.43	67.26	16.43		150.0	
10430-AAA	LTE-FDD (OFDMA, 5 MHz, E-TM 3.1)	X	4.63	73.67	19.48	0.00	150.0	± 9.6 %
		Y	4.38	70.39	18.28		150.0	
		Z	4.34	70.59	18.21		150.0	
10431-AAA	LTE-FDD (OFDMA, 10 MHz, E-TM 3.1)	X	4.15	67.84	16.60	0.00	150.0	± 9.6 %
		Y	4.40	67.31	16.45		150.0	
		Z	4.29	67.04	16.16		150.0	
10432-AAA	LTE-FDD (OFDMA, 15 MHz, E-TM 3.1)	X	4.45	67.57	16.66	0.00	150.0	± 9.6 %
		Y	4.69	67.19	16.47		150.0	
		Z	4.59	66.95	16.22		150.0	
10433-AAA	LTE-FDD (OFDMA, 20 MHz, E-TM 3.1)	X	4.70	67.46	16.71	0.00	150.0	± 9.6 %
		Y	4.93	67.18	16.52		150.0	
		Z	4.84	66.96	16.29		150.0	
10434-AAA	W-CDMA (BS Test Model 1, 64 DPCH)	X	4.94	75.22	19.61	0.00	150.0	± 9.6 %
		Y	4.49	71.19	18.31		150.0	
		Z	4.45	71.43	18.22		150.0	
10435-AAA	LTE-TDD (SC-FDMA, 1 RB, 20 MHz, QPSK, UL Subframe=2,3,4,7,8,9)	X	100.00	123.75	30.75	3.23	80.0	± 9.6 %
		Y	100.00	119.75	29.98		80.0	
		Z	11.13	88.92	21.27		80.0	
10447-AAA	LTE-FDD (OFDMA, 5 MHz, E-TM 3.1, Clipping 44%)	X	3.46	68.09	15.85	0.00	150.0	± 9.6 %
		Y	3.73	67.44	16.02		150.0	
		Z	3.59	67.02	15.56		150.0	
10448-AAA	LTE-FDD (OFDMA, 10 MHz, E-TM 3.1, Clipping 44%)	X	4.01	67.64	16.48	0.00	150.0	± 9.6 %
		Y	4.23	67.09	16.31		150.0	
		Z	4.12	66.82	16.01		150.0	
10449-AAA	LTE-FDD (OFDMA, 15 MHz, E-TM 3.1, Clipping 44%)	X	4.28	67.42	16.58	0.00	150.0	± 9.6 %
		Y	4.48	67.02	16.38		150.0	
		Z	4.39	66.78	16.12		150.0	
10450-AAA	LTE-FDD (OFDMA, 20 MHz, E-TM 3.1, Clipping 44%)	X	4.48	67.25	16.58	0.00	150.0	± 9.6 %
		Y	4.66	66.95	16.38		150.0	
		Z	4.58	66.72	16.14		150.0	
10451-AAA	W-CDMA (BS Test Model 1, 64 DPCH, Clipping 44%)	X	3.33	68.18	15.32	0.00	150.0	± 9.6 %
		Y	3.67	67.76	15.79		150.0	
		Z	3.50	67.23	15.24		150.0	
10456-AAA	IEEE 802.11ac WiFi (160MHz, 64-QAM, 99pc duty cycle)	X	6.23	68.21	17.00	0.00	150.0	± 9.6 %
		Y	6.33	68.03	16.78		150.0	
		Z	6.26	67.85	16.61		150.0	
10457-AAA	UMTS-FDD (DC-HSDPA)	X	3.79	65.76	16.30	0.00	150.0	± 9.6 %
		Y	3.86	65.36	16.10		150.0	
		Z	3.82	65.17	15.85		150.0	
10458-AAA	CDMA2000 (1xEV-DO, Rev. B, 2 carriers)	X	3.05	67.01	14.29	0.00	150.0	± 9.6 %
		Y	3.48	67.05	15.31		150.0	
		Z	3.32	66.56	14.71		150.0	
10459-AAA	CDMA2000 (1xEV-DO, Rev. B, 3 carriers)	X	4.19	65.60	15.56	0.00	150.0	± 9.6 %
		Y	4.63	65.36	16.07		150.0	
		Z	4.50	65.15	15.72		150.0	

10460-AAA	UMTS-FDD (WCDMA, AMR)	X	1.27	75.41	20.14	0.00	150.0	± 9.6 %
		Y	1.05	70.71	17.81		150.0	
		Z	0.86	66.76	15.37		150.0	
10461-AAA	LTE-TDD (SC-FDMA, 1 RB, 1.4 MHz, QPSK, UL Subframe=2,3,4,7,8,9)	X	100.00	127.84	32.72	3.29	80.0	± 9.6 %
		Y	100.00	123.27	31.69		80.0	
		Z	6.47	83.77	20.46		80.0	
10462-AAA	LTE-TDD (SC-FDMA, 1 RB, 1.4 MHz, 16-QAM, UL Subframe=2,3,4,7,8,9)	X	1.26	63.91	10.22	3.23	80.0	± 9.6 %
		Y	14.90	86.82	19.02		80.0	
		Z	1.81	64.45	10.77		80.0	
10463-AAA	LTE-TDD (SC-FDMA, 1 RB, 1.4 MHz, 64-QAM, UL Subframe=2,3,4,7,8,9)	X	0.85	60.00	7.76	3.23	80.0	± 9.6 %
		Y	4.74	73.69	14.47		80.0	
		Z	1.46	62.00	9.21		80.0	
10464-AAA	LTE-TDD (SC-FDMA, 1 RB, 3 MHz, QPSK, UL Subframe=2,3,4,7,8,9)	X	100.00	124.65	31.09	3.23	80.0	± 9.6 %
		Y	100.00	121.04	30.50		80.0	
		Z	5.02	79.91	18.70		80.0	
10465-AAA	LTE-TDD (SC-FDMA, 1 RB, 3 MHz, 16-QAM, UL Subframe=2,3,4,7,8,9)	X	1.13	62.86	9.67	3.23	80.0	± 9.6 %
		Y	9.25	81.62	17.45		80.0	
		Z	1.69	63.74	10.38		80.0	
10466-AAA	LTE-TDD (SC-FDMA, 1 RB, 3 MHz, 64-QAM, UL Subframe=2,3,4,7,8,9)	X	0.85	60.00	7.71	3.23	80.0	± 9.6 %
		Y	3.78	71.31	13.57		80.0	
		Z	1.40	61.59	8.96		80.0	
10467-AAA	LTE-TDD (SC-FDMA, 1 RB, 5 MHz, QPSK, UL Subframe=2,3,4,7,8,9)	X	100.00	125.03	31.26	3.23	80.0	± 9.6 %
		Y	100.00	121.26	30.60		80.0	
		Z	5.32	80.71	18.99		80.0	
10468-AAA	LTE-TDD (SC-FDMA, 1 RB, 5 MHz, 16-QAM, UL Subframe=2,3,4,7,8,9)	X	1.17	63.15	9.83	3.23	80.0	± 9.6 %
		Y	10.30	82.81	17.81		80.0	
		Z	1.71	63.90	10.47		80.0	
10469-AAA	LTE-TDD (SC-FDMA, 1 RB, 5 MHz, 64-QAM, UL Subframe=2,3,4,7,8,9)	X	0.85	60.00	7.71	3.23	80.0	± 9.6 %
		Y	3.80	71.39	13.60		80.0	
		Z	1.40	61.60	8.96		80.0	
10470-AAA	LTE-TDD (SC-FDMA, 1 RB, 10 MHz, QPSK, UL Subframe=2,3,4,7,8,9)	X	100.00	125.05	31.26	3.23	80.0	± 9.6 %
		Y	100.00	121.29	30.60		80.0	
		Z	5.31	80.70	18.98		80.0	
10471-AAA	LTE-TDD (SC-FDMA, 1 RB, 10 MHz, 16-QAM, UL Subframe=2,3,4,7,8,9)	X	1.16	63.09	9.79	3.23	80.0	± 9.6 %
		Y	10.21	82.69	17.77		80.0	
		Z	1.70	63.86	10.44		80.0	
10472-AAA	LTE-TDD (SC-FDMA, 1 RB, 10 MHz, 64-QAM, UL Subframe=2,3,4,7,8,9)	X	0.85	60.00	7.70	3.23	80.0	± 9.6 %
		Y	3.77	71.31	13.56		80.0	
		Z	1.40	61.57	8.94		80.0	
10473-AAA	LTE-TDD (SC-FDMA, 1 RB, 15 MHz, QPSK, UL Subframe=2,3,4,7,8,9)	X	100.00	125.02	31.24	3.23	80.0	± 9.6 %
		Y	100.00	121.25	30.59		80.0	
		Z	5.30	80.66	18.96		80.0	
10474-AAA	LTE-TDD (SC-FDMA, 1 RB, 15 MHz, 16-QAM, UL Subframe=2,3,4,7,8,9)	X	1.15	63.05	9.77	3.23	80.0	± 9.6 %
		Y	10.08	82.57	17.73		80.0	
		Z	1.70	63.84	10.43		80.0	
10475-AAA	LTE-TDD (SC-FDMA, 1 RB, 15 MHz, 64-QAM, UL Subframe=2,3,4,7,8,9)	X	0.85	60.00	7.70	3.23	80.0	± 9.6 %
		Y	3.75	71.25	13.54		80.0	
		Z	1.39	61.55	8.93		80.0	

10477-AAA	LTE-TDD (SC-FDMA, 1 RB, 20 MHz, 16-QAM, UL Subframe=2,3,4,7,8,9)	X	1.12	62.81	9.63	3.23	80.0	± 9.6 %
		Y	9.29	81.66	17.43		80.0	
		Z	1.68	63.69	10.35		80.0	
10478-AAA	LTE-TDD (SC-FDMA, 1 RB, 20 MHz, 64-QAM, UL Subframe=2,3,4,7,8,9)	X	0.85	60.00	7.69	3.23	80.0	± 9.6 %
		Y	3.71	71.13	13.49		80.0	
		Z	1.39	61.52	8.91		80.0	
10479-AAA	LTE-TDD (SC-FDMA, 50% RB, 1.4 MHz, QPSK, UL Subframe=2,3,4,7,8,9)	X	16.34	98.15	26.22	3.23	80.0	± 9.6 %
		Y	8.05	85.58	23.31		80.0	
		Z	4.44	75.80	19.08		80.0	
10480-AAA	LTE-TDD (SC-FDMA, 50% RB, 1.4 MHz, 16-QAM, UL Subframe=2,3,4,7,8,9)	X	8.15	82.28	19.17	3.23	80.0	± 9.6 %
		Y	9.14	82.89	20.82		80.0	
		Z	4.48	72.61	16.42		80.0	
10481-AAA	LTE-TDD (SC-FDMA, 50% RB, 1.4 MHz, 64-QAM, UL Subframe=2,3,4,7,8,9)	X	4.98	75.50	16.46	3.23	80.0	± 9.6 %
		Y	7.94	80.29	19.62		80.0	
		Z	4.00	70.70	15.36		80.0	
10482-AAA	LTE-TDD (SC-FDMA, 50% RB, 3 MHz, QPSK, UL Subframe=2,3,4,7,8,9)	X	3.11	72.47	16.27	2.23	80.0	± 9.6 %
		Y	4.49	76.30	19.03		80.0	
		Z	2.84	69.51	15.71		80.0	
10483-AAA	LTE-TDD (SC-FDMA, 50% RB, 3 MHz, 16-QAM, UL Subframe=2,3,4,7,8,9)	X	3.23	69.48	14.33	2.23	80.0	± 9.6 %
		Y	6.12	77.20	19.06		80.0	
		Z	3.70	69.78	15.41		80.0	
10484-AAA	LTE-TDD (SC-FDMA, 50% RB, 3 MHz, 64-QAM, UL Subframe=2,3,4,7,8,9)	X	2.99	68.30	13.84	2.23	80.0	± 9.6 %
		Y	5.80	76.19	18.70		80.0	
		Z	3.62	69.26	15.20		80.0	
10485-AAA	LTE-TDD (SC-FDMA, 50% RB, 5 MHz, QPSK, UL Subframe=2,3,4,7,8,9)	X	3.90	76.03	18.96	2.23	80.0	± 9.6 %
		Y	4.65	76.77	19.89		80.0	
		Z	3.19	70.88	17.04		80.0	
10486-AAA	LTE-TDD (SC-FDMA, 50% RB, 5 MHz, 16-QAM, UL Subframe=2,3,4,7,8,9)	X	3.22	69.78	15.73	2.23	80.0	± 9.6 %
		Y	4.07	71.59	17.54		80.0	
		Z	3.24	68.15	15.55		80.0	
10487-AAA	LTE-TDD (SC-FDMA, 50% RB, 5 MHz, 64-QAM, UL Subframe=2,3,4,7,8,9)	X	3.17	69.19	15.46	2.23	80.0	± 9.6 %
		Y	4.05	71.16	17.36		80.0	
		Z	3.26	67.91	15.45		80.0	
10488-AAA	LTE-TDD (SC-FDMA, 50% RB, 10 MHz, QPSK, UL Subframe=2,3,4,7,8,9)	X	3.89	74.31	19.36	2.23	80.0	± 9.6 %
		Y	4.74	75.31	19.78		80.0	
		Z	3.62	70.94	17.62		80.0	
10489-AAA	LTE-TDD (SC-FDMA, 50% RB, 10 MHz, 16-QAM, UL Subframe=2,3,4,7,8,9)	X	3.61	70.11	17.53	2.23	80.0	± 9.6 %
		Y	4.17	70.61	18.05		80.0	
		Z	3.61	68.29	16.66		80.0	
10490-AAA	LTE-TDD (SC-FDMA, 50% RB, 10 MHz, 64-QAM, UL Subframe=2,3,4,7,8,9)	X	3.68	69.86	17.43	2.23	80.0	± 9.6 %
		Y	4.25	70.34	17.96		80.0	
		Z	3.72	68.19	16.64		80.0	
10491-AAA	LTE-TDD (SC-FDMA, 50% RB, 15 MHz, QPSK, UL Subframe=2,3,4,7,8,9)	X	3.96	72.11	18.69	2.23	80.0	± 9.6 %
		Y	4.74	73.16	19.02		80.0	
		Z	3.92	70.03	17.39		80.0	
10492-AAA	LTE-TDD (SC-FDMA, 50% RB, 15 MHz, 16-QAM, UL Subframe=2,3,4,7,8,9)	X	3.88	69.01	17.48	2.23	80.0	± 9.6 %
		Y	4.46	69.66	17.87		80.0	
		Z	4.00	67.90	16.78		80.0	

10493-AAA	LTE-TDD (SC-FDMA, 50% RB, 15 MHz, 64-QAM, UL Subframe=2,3,4,7,8,9)	X	3.93	68.84	17.41	2.23	80.0	± 9.6 %
		Y	4.52	69.48	17.82		80.0	
		Z	4.08	67.81	16.77		80.0	
10494-AAA	LTE-TDD (SC-FDMA, 50% RB, 20 MHz, QPSK, UL Subframe=2,3,4,7,8,9)	X	4.32	73.69	19.20	2.23	80.0	± 9.6 %
		Y	5.29	75.06	19.58		80.0	
		Z	4.18	71.25	17.73		80.0	
10495-AAA	LTE-TDD (SC-FDMA, 50% RB, 20 MHz, 16-QAM, UL Subframe=2,3,4,7,8,9)	X	3.92	69.34	17.70	2.23	80.0	± 9.6 %
		Y	4.53	70.19	18.09		80.0	
		Z	4.04	68.27	16.95		80.0	
10496-AAA	LTE-TDD (SC-FDMA, 50% RB, 20 MHz, 64-QAM, UL Subframe=2,3,4,7,8,9)	X	3.98	69.05	17.60	2.23	80.0	± 9.6 %
		Y	4.58	69.81	17.97		80.0	
		Z	4.12	68.07	16.91		80.0	
10497-AAA	LTE-TDD (SC-FDMA, 100% RB, 1.4 MHz, QPSK, UL Subframe=2,3,4,7,8,9)	X	1.72	64.88	11.75	2.23	80.0	± 9.6 %
		Y	3.58	73.16	17.12		80.0	
		Z	2.20	66.42	13.58		80.0	
10498-AAA	LTE-TDD (SC-FDMA, 100% RB, 1.4 MHz, 16-QAM, UL Subframe=2,3,4,7,8,9)	X	1.30	60.00	8.13	2.23	80.0	± 9.6 %
		Y	2.81	67.13	13.70		80.0	
		Z	1.98	62.85	11.00		80.0	
10499-AAA	LTE-TDD (SC-FDMA, 100% RB, 1.4 MHz, 64-QAM, UL Subframe=2,3,4,7,8,9)	X	1.32	60.00	7.98	2.23	80.0	± 9.6 %
		Y	2.75	66.54	13.31		80.0	
		Z	1.95	62.46	10.68		80.0	
10500-AAA	LTE-TDD (SC-FDMA, 100% RB, 3 MHz, QPSK, UL Subframe=2,3,4,7,8,9)	X	3.82	75.04	19.03	2.23	80.0	± 9.6 %
		Y	4.55	75.62	19.66		80.0	
		Z	3.32	70.66	17.20		80.0	
10501-AAA	LTE-TDD (SC-FDMA, 100% RB, 3 MHz, 16-QAM, UL Subframe=2,3,4,7,8,9)	X	3.45	70.22	16.55	2.23	80.0	± 9.6 %
		Y	4.10	71.10	17.69		80.0	
		Z	3.41	68.23	15.99		80.0	
10502-AAA	LTE-TDD (SC-FDMA, 100% RB, 3 MHz, 64-QAM, UL Subframe=2,3,4,7,8,9)	X	3.48	69.95	16.36	2.23	80.0	± 9.6 %
		Y	4.15	70.89	17.57		80.0	
		Z	3.47	68.14	15.91		80.0	
10503-AAA	LTE-TDD (SC-FDMA, 100% RB, 5 MHz, QPSK, UL Subframe=2,3,4,7,8,9)	X	3.83	74.06	19.24	2.23	80.0	± 9.6 %
		Y	4.68	75.11	19.69		80.0	
		Z	3.58	70.77	17.54		80.0	
10504-AAA	LTE-TDD (SC-FDMA, 100% RB, 5 MHz, 16-QAM, UL Subframe=2,3,4,7,8,9)	X	3.59	69.99	17.46	2.23	80.0	± 9.6 %
		Y	4.16	70.53	18.00		80.0	
		Z	3.60	68.21	16.61		80.0	
10505-AAA	LTE-TDD (SC-FDMA, 100% RB, 5 MHz, 64-QAM, UL Subframe=2,3,4,7,8,9)	X	3.66	69.75	17.36	2.23	80.0	± 9.6 %
		Y	4.23	70.25	17.91		80.0	
		Z	3.70	68.11	16.59		80.0	
10506-AAA	LTE-TDD (SC-FDMA, 100% RB, 10 MHz, QPSK, UL Subframe=2,3,4,7,8,9)	X	4.28	73.52	19.12	2.23	80.0	± 9.6 %
		Y	5.24	74.92	19.51		80.0	
		Z	4.15	71.12	17.66		80.0	
10507-AAA	LTE-TDD (SC-FDMA, 100% RB, 10 MHz, 16-QAM, UL Subframe=2,3,4,7,8,9)	X	3.90	69.27	17.66	2.23	80.0	± 9.6 %
		Y	4.51	70.14	18.06		80.0	
		Z	4.02	68.21	16.91		80.0	

10508-AAA	LTE-TDD (SC-FDMA, 100% RB, 10 MHz, 64-QAM, UL Subframe=2,3,4,7,8,9)	X	3.97	68.96	17.55	2.23	80.0	± 9.6 %
		Y	4.57	69.75	17.93		80.0	
		Z	4.11	68.00	16.87		80.0	
10509-AAA	LTE-TDD (SC-FDMA, 100% RB, 15 MHz, QPSK, UL Subframe=2,3,4,7,8,9)	X	4.54	71.87	18.48	2.23	80.0	± 9.6 %
		Y	5.35	73.05	18.77		80.0	
		Z	4.54	70.32	17.38		80.0	
10510-AAA	LTE-TDD (SC-FDMA, 100% RB, 15 MHz, 16-QAM, UL Subframe=2,3,4,7,8,9)	X	4.34	68.76	17.59	2.23	80.0	± 9.6 %
		Y	4.97	69.73	17.95		80.0	
		Z	4.53	68.16	17.00		80.0	
10511-AAA	LTE-TDD (SC-FDMA, 100% RB, 15 MHz, 64-QAM, UL Subframe=2,3,4,7,8,9)	X	4.39	68.51	17.51	2.23	80.0	± 9.6 %
		Y	5.00	69.40	17.85		80.0	
		Z	4.59	67.95	16.96		80.0	
10512-AAA	LTE-TDD (SC-FDMA, 100% RB, 20 MHz, QPSK, UL Subframe=2,3,4,7,8,9)	X	4.78	73.48	18.98	2.23	80.0	± 9.6 %
		Y	5.80	75.09	19.41		80.0	
		Z	4.67	71.54	17.71		80.0	
10513-AAA	LTE-TDD (SC-FDMA, 100% RB, 20 MHz, 16-QAM, UL Subframe=2,3,4,7,8,9)	X	4.24	69.00	17.69	2.23	80.0	± 9.6 %
		Y	4.89	70.17	18.11		80.0	
		Z	4.41	68.40	17.07		80.0	
10514-AAA	LTE-TDD (SC-FDMA, 100% RB, 20 MHz, 64-QAM, UL Subframe=2,3,4,7,8,9)	X	4.26	68.58	17.56	2.23	80.0	± 9.6 %
		Y	4.87	69.63	17.95		80.0	
		Z	4.44	68.04	16.99		80.0	
10515-AAA	IEEE 802.11b WiFi 2.4 GHz (DSSS, 2 Mbps, 99pc duty cycle)	X	1.03	64.84	16.18	0.00	150.0	± 9.6 %
		Y	1.01	63.76	15.35		150.0	
		Z	0.97	62.74	14.37		150.0	
10516-AAA	IEEE 802.11b WiFi 2.4 GHz (DSSS, 5.5 Mbps, 99pc duty cycle)	X	1.37	87.37	25.57	0.00	150.0	± 9.6 %
		Y	0.82	76.24	20.55		150.0	
		Z	0.54	67.46	15.73		150.0	
10517-AAA	IEEE 802.11b WiFi 2.4 GHz (DSSS, 11 Mbps, 99pc duty cycle)	X	0.93	68.34	17.75	0.00	150.0	± 9.6 %
		Y	0.89	66.40	16.42		150.0	
		Z	0.81	64.28	14.78		150.0	
10518-AAA	IEEE 802.11a/h WiFi 5 GHz (OFDM, 9 Mbps, 99pc duty cycle)	X	4.48	67.19	16.57	0.00	150.0	± 9.6 %
		Y	4.66	66.80	16.35		150.0	
		Z	4.59	66.60	16.12		150.0	
10519-AAA	IEEE 802.11a/h WiFi 5 GHz (OFDM, 12 Mbps, 99pc duty cycle)	X	4.64	67.36	16.66	0.00	150.0	± 9.6 %
		Y	4.88	67.08	16.48		150.0	
		Z	4.79	66.86	16.25		150.0	
10520-AAA	IEEE 802.11a/h WiFi 5 GHz (OFDM, 18 Mbps, 99pc duty cycle)	X	4.50	67.33	16.59	0.00	150.0	± 9.6 %
		Y	4.73	67.07	16.42		150.0	
		Z	4.64	66.83	16.17		150.0	
10521-AAA	IEEE 802.11a/h WiFi 5 GHz (OFDM, 24 Mbps, 99pc duty cycle)	X	4.43	67.32	16.58	0.00	150.0	± 9.6 %
		Y	4.66	67.08	16.41		150.0	
		Z	4.57	66.82	16.16		150.0	
10522-AAA	IEEE 802.11a/h WiFi 5 GHz (OFDM, 36 Mbps, 99pc duty cycle)	X	4.49	67.45	16.68	0.00	150.0	± 9.6 %
		Y	4.71	67.07	16.44		150.0	
		Z	4.62	66.87	16.22		150.0	

10523-AAA	IEEE 802.11a/h WiFi 5 GHz (OFDM, 48 Mbps, 99pc duty cycle)	X	4.40	67.41	16.59	0.00	150.0	± 9.6 %
		Y	4.58	66.97	16.31		150.0	
		Z	4.50	66.74	16.07		150.0	
10524-AAA	IEEE 802.11a/h WiFi 5 GHz (OFDM, 54 Mbps, 99pc duty cycle)	X	4.44	67.39	16.66	0.00	150.0	± 9.6 %
		Y	4.66	67.02	16.43		150.0	
		Z	4.57	66.80	16.19		150.0	
10525-AAA	IEEE 802.11ac WiFi (20MHz, MCS0, 99pc duty cycle)	X	4.46	66.48	16.28	0.00	150.0	± 9.6 %
		Y	4.62	66.06	16.02		150.0	
		Z	4.54	65.85	15.79		150.0	
10526-AAA	IEEE 802.11ac WiFi (20MHz, MCS1, 99pc duty cycle)	X	4.60	66.79	16.40	0.00	150.0	± 9.6 %
		Y	4.82	66.46	16.16		150.0	
		Z	4.72	66.22	15.93		150.0	
10527-AAA	IEEE 802.11ac WiFi (20MHz, MCS2, 99pc duty cycle)	X	4.53	66.77	16.35	0.00	150.0	± 9.6 %
		Y	4.74	66.44	16.12		150.0	
		Z	4.64	66.19	15.88		150.0	
10528-AAA	IEEE 802.11ac WiFi (20MHz, MCS3, 99pc duty cycle)	X	4.54	66.78	16.38	0.00	150.0	± 9.6 %
		Y	4.75	66.46	16.15		150.0	
		Z	4.66	66.21	15.91		150.0	
10529-AAA	IEEE 802.11ac WiFi (20MHz, MCS4, 99pc duty cycle)	X	4.54	66.78	16.38	0.00	150.0	± 9.6 %
		Y	4.75	66.46	16.15		150.0	
		Z	4.66	66.21	15.91		150.0	
10531-AAA	IEEE 802.11ac WiFi (20MHz, MCS6, 99pc duty cycle)	X	4.52	66.84	16.38	0.00	150.0	± 9.6 %
		Y	4.76	66.60	16.18		150.0	
		Z	4.66	66.32	15.93		150.0	
10532-AAA	IEEE 802.11ac WiFi (20MHz, MCS7, 99pc duty cycle)	X	4.39	66.72	16.32	0.00	150.0	± 9.6 %
		Y	4.61	66.47	16.13		150.0	
		Z	4.51	66.18	15.86		150.0	
10533-AAA	IEEE 802.11ac WiFi (20MHz, MCS8, 99pc duty cycle)	X	4.55	66.87	16.39	0.00	150.0	± 9.6 %
		Y	4.77	66.48	16.13		150.0	
		Z	4.67	66.24	15.89		150.0	
10534-AAA	IEEE 802.11ac WiFi (40MHz, MCS0, 99pc duty cycle)	X	5.09	66.73	16.38	0.00	150.0	± 9.6 %
		Y	5.26	66.58	16.18		150.0	
		Z	5.19	66.36	15.98		150.0	
10535-AAA	IEEE 802.11ac WiFi (40MHz, MCS1, 99pc duty cycle)	X	5.14	66.89	16.46	0.00	150.0	± 9.6 %
		Y	5.33	66.72	16.24		150.0	
		Z	5.25	66.50	16.04		150.0	
10536-AAA	IEEE 802.11ac WiFi (40MHz, MCS2, 99pc duty cycle)	X	5.03	66.89	16.44	0.00	150.0	± 9.6 %
		Y	5.20	66.71	16.22		150.0	
		Z	5.12	66.47	16.01		150.0	
10537-AAA	IEEE 802.11ac WiFi (40MHz, MCS3, 99pc duty cycle)	X	5.08	66.84	16.42	0.00	150.0	± 9.6 %
		Y	5.27	66.68	16.21		150.0	
		Z	5.18	66.44	16.00		150.0	
10538-AAA	IEEE 802.11ac WiFi (40MHz, MCS4, 99pc duty cycle)	X	5.15	66.81	16.44	0.00	150.0	± 9.6 %
		Y	5.37	66.74	16.28		150.0	
		Z	5.28	66.49	16.06		150.0	
10540-AAA	IEEE 802.11ac WiFi (40MHz, MCS6, 99pc duty cycle)	X	5.09	66.80	16.45	0.00	150.0	± 9.6 %
		Y	5.28	66.69	16.27		150.0	
		Z	5.20	66.47	16.06		150.0	

10541-AAA	IEEE 802.11ac WiFi (40MHz, MCS7, 99pc duty cycle)	X	5.06	66.68	16.38	0.00	150.0	± 9.6 %
		Y	5.26	66.60	16.22		150.0	
		Z	5.18	66.36	16.00		150.0	
10542-AAA	IEEE 802.11ac WiFi (40MHz, MCS8, 99pc duty cycle)	X	5.22	66.77	16.43	0.00	150.0	± 9.6 %
		Y	5.41	66.64	16.25		150.0	
		Z	5.33	66.43	16.05		150.0	
10543-AAA	IEEE 802.11ac WiFi (40MHz, MCS9, 99pc duty cycle)	X	5.28	66.79	16.47	0.00	150.0	± 9.6 %
		Y	5.50	66.65	16.27		150.0	
		Z	5.41	66.46	16.08		150.0	
10544-AAA	IEEE 802.11ac WiFi (80MHz, MCS0, 99pc duty cycle)	X	5.42	66.77	16.34	0.00	150.0	± 9.6 %
		Y	5.55	66.69	16.17		150.0	
		Z	5.48	66.48	15.98		150.0	
10545-AAA	IEEE 802.11ac WiFi (80MHz, MCS1, 99pc duty cycle)	X	5.61	67.23	16.53	0.00	150.0	± 9.6 %
		Y	5.75	67.07	16.30		150.0	
		Z	5.67	66.87	16.11		150.0	
10546-AAA	IEEE 802.11ac WiFi (80MHz, MCS2, 99pc duty cycle)	X	5.46	66.92	16.38	0.00	150.0	± 9.6 %
		Y	5.64	66.96	16.27		150.0	
		Z	5.56	66.72	16.06		150.0	
10547-AAA	IEEE 802.11ac WiFi (80MHz, MCS3, 99pc duty cycle)	X	5.54	67.00	16.42	0.00	150.0	± 9.6 %
		Y	5.73	67.04	16.29		150.0	
		Z	5.64	66.77	16.07		150.0	
10548-AAA	IEEE 802.11ac WiFi (80MHz, MCS4, 99pc duty cycle)	X	5.73	67.79	16.78	0.00	150.0	± 9.6 %
		Y	5.99	67.96	16.73		150.0	
		Z	5.87	67.64	16.48		150.0	
10550-AAA	IEEE 802.11ac WiFi (80MHz, MCS6, 99pc duty cycle)	X	5.52	67.07	16.47	0.00	150.0	± 9.6 %
		Y	5.66	66.92	16.25		150.0	
		Z	5.58	66.70	16.06		150.0	
10551-AAA	IEEE 802.11ac WiFi (80MHz, MCS7, 99pc duty cycle)	X	5.47	66.93	16.36	0.00	150.0	± 9.6 %
		Y	5.67	66.99	16.25		150.0	
		Z	5.59	66.76	16.05		150.0	
10552-AAA	IEEE 802.11ac WiFi (80MHz, MCS8, 99pc duty cycle)	X	5.43	66.87	16.34	0.00	150.0	± 9.6 %
		Y	5.58	66.77	16.15		150.0	
		Z	5.50	66.55	15.96		150.0	
10553-AAA	IEEE 802.11ac WiFi (80MHz, MCS9, 99pc duty cycle)	X	5.49	66.84	16.35	0.00	150.0	± 9.6 %
		Y	5.67	66.82	16.21		150.0	
		Z	5.59	66.61	16.01		150.0	
10554-AAA	IEEE 1602.11ac WiFi (160MHz, MCS0, 99pc duty cycle)	X	5.84	67.09	16.40	0.00	150.0	± 9.6 %
		Y	5.94	67.05	16.25		150.0	
		Z	5.88	66.85	16.07		150.0	
10555-AAA	IEEE 1602.11ac WiFi (160MHz, MCS1, 99pc duty cycle)	X	5.95	67.36	16.52	0.00	150.0	± 9.6 %
		Y	6.09	67.37	16.39		150.0	
		Z	6.01	67.14	16.19		150.0	
10556-AAA	IEEE 1602.11ac WiFi (160MHz, MCS2, 99pc duty cycle)	X	5.98	67.45	16.56	0.00	150.0	± 9.6 %
		Y	6.10	67.39	16.39		150.0	
		Z	6.03	67.18	16.21		150.0	
10557-AAA	IEEE 1602.11ac WiFi (160MHz, MCS3, 99pc duty cycle)	X	5.93	67.31	16.50	0.00	150.0	± 9.6 %
		Y	6.09	67.35	16.39		150.0	
		Z	6.01	67.12	16.19		150.0	

10558-AAA	IEEE 1602.11ac WiFi (160MHz, MCS4, 99pc duty cycle)	X	5.96	67.43	16.58	0.00	150.0	± 9.6 %
		Y	6.14	67.53	16.50		150.0	
		Z	6.06	67.28	16.29		150.0	
10560-AAA	IEEE 1602.11ac WiFi (160MHz, MCS6, 99pc duty cycle)	X	5.96	67.30	16.55	0.00	150.0	± 9.6 %
		Y	6.14	67.38	16.46		150.0	
		Z	6.06	67.14	16.26		150.0	
10561-AAA	IEEE 1602.11ac WiFi (160MHz, MCS7, 99pc duty cycle)	X	5.90	67.30	16.59	0.00	150.0	± 9.6 %
		Y	6.05	67.33	16.47		150.0	
		Z	5.97	67.09	16.27		150.0	
10562-AAA	IEEE 1602.11ac WiFi (160MHz, MCS8, 99pc duty cycle)	X	5.97	67.52	16.70	0.00	150.0	± 9.6 %
		Y	6.20	67.78	16.70		150.0	
		Z	6.10	67.49	16.47		150.0	
10563-AAA	IEEE 1602.11ac WiFi (160MHz, MCS9, 99pc duty cycle)	X	6.05	67.43	16.61	0.00	150.0	± 9.6 %
		Y	6.51	68.26	16.88		150.0	
		Z	6.42	68.01	16.67		150.0	
10564-AAA	IEEE 802.11g WiFi 2.4 GHz (DSSS-OFDM, 9 Mbps, 99pc duty cycle)	X	4.79	67.15	16.65	0.46	150.0	± 9.6 %
		Y	4.99	66.89	16.50		150.0	
		Z	4.91	66.68	16.27		150.0	
10565-AAA	IEEE 802.11g WiFi 2.4 GHz (DSSS-OFDM, 12 Mbps, 99pc duty cycle)	X	5.00	67.58	16.97	0.46	150.0	± 9.6 %
		Y	5.25	67.37	16.83		150.0	
		Z	5.16	67.16	16.61		150.0	
10566-AAA	IEEE 802.11g WiFi 2.4 GHz (DSSS-OFDM, 18 Mbps, 99pc duty cycle)	X	4.83	67.41	16.78	0.46	150.0	± 9.6 %
		Y	5.08	67.24	16.66		150.0	
		Z	4.99	67.00	16.41		150.0	
10567-AAA	IEEE 802.11g WiFi 2.4 GHz (DSSS-OFDM, 24 Mbps, 99pc duty cycle)	X	4.88	67.87	17.20	0.46	150.0	± 9.6 %
		Y	5.11	67.62	16.99		150.0	
		Z	5.02	67.41	16.78		150.0	
10568-AAA	IEEE 802.11g WiFi 2.4 GHz (DSSS-OFDM, 36 Mbps, 99pc duty cycle)	X	4.73	67.14	16.52	0.46	150.0	± 9.6 %
		Y	4.99	66.97	16.41		150.0	
		Z	4.89	66.73	16.15		150.0	
10569-AAA	IEEE 802.11g WiFi 2.4 GHz (DSSS-OFDM, 48 Mbps, 99pc duty cycle)	X	4.86	68.08	17.32	0.46	150.0	± 9.6 %
		Y	5.05	67.63	17.01		150.0	
		Z	4.97	67.46	16.82		150.0	
10570-AAA	IEEE 802.11g WiFi 2.4 GHz (DSSS-OFDM, 54 Mbps, 99pc duty cycle)	X	4.87	67.85	17.21	0.46	150.0	± 9.6 %
		Y	5.09	67.48	16.95		150.0	
		Z	5.01	67.31	16.75		150.0	
10571-AAA	IEEE 802.11b WiFi 2.4 GHz (DSSS, 1 Mbps, 90pc duty cycle)	X	1.23	65.85	16.68	0.46	130.0	± 9.6 %
		Y	1.28	65.62	16.38		130.0	
		Z	1.20	64.12	15.14		130.0	
10572-AAA	IEEE 802.11b WiFi 2.4 GHz (DSSS, 2 Mbps, 90pc duty cycle)	X	1.26	66.61	17.14	0.46	130.0	± 9.6 %
		Y	1.30	66.27	16.76		130.0	
		Z	1.21	64.64	15.46		130.0	
10573-AAA	IEEE 802.11b WiFi 2.4 GHz (DSSS, 5.5 Mbps, 90pc duty cycle)	X	15.61	122.59	34.86	0.46	130.0	± 9.6 %
		Y	7.32	105.62	29.57		130.0	
		Z	1.41	77.28	19.61		130.0	
10574-AAA	IEEE 802.11b WiFi 2.4 GHz (DSSS, 11 Mbps, 90pc duty cycle)	X	1.59	75.46	21.51	0.46	130.0	± 9.6 %
		Y	1.56	73.46	20.23		130.0	
		Z	1.30	69.51	17.90		130.0	

10575-AAA	IEEE 802.11g WiFi 2.4 GHz (DSSS-OFDM, 6 Mbps, 90pc duty cycle)	X	4.57	66.90	16.65	0.46	130.0	± 9.6 %
		Y	4.78	66.67	16.55		130.0	
		Z	4.70	66.43	16.27		130.0	
10576-AAA	IEEE 802.11g WiFi 2.4 GHz (DSSS-OFDM, 9 Mbps, 90pc duty cycle)	X	4.60	67.11	16.74	0.46	130.0	± 9.6 %
		Y	4.81	66.83	16.61		130.0	
		Z	4.72	66.59	16.34		130.0	
10577-AAA	IEEE 802.11g WiFi 2.4 GHz (DSSS-OFDM, 12 Mbps, 90pc duty cycle)	X	4.78	67.36	16.89	0.46	130.0	± 9.6 %
		Y	5.04	67.16	16.78		130.0	
		Z	4.94	66.91	16.52		130.0	
10578-AAA	IEEE 802.11g WiFi 2.4 GHz (DSSS-OFDM, 18 Mbps, 90pc duty cycle)	X	4.68	67.55	17.03	0.46	130.0	± 9.6 %
		Y	4.93	67.32	16.88		130.0	
		Z	4.83	67.07	16.62		130.0	
10579-AAA	IEEE 802.11g WiFi 2.4 GHz (DSSS-OFDM, 24 Mbps, 90pc duty cycle)	X	4.43	66.68	16.24	0.46	130.0	± 9.6 %
		Y	4.71	66.69	16.25		130.0	
		Z	4.59	66.34	15.91		130.0	
10580-AAA	IEEE 802.11g WiFi 2.4 GHz (DSSS-OFDM, 36 Mbps, 90pc duty cycle)	X	4.47	66.74	16.26	0.46	130.0	± 9.6 %
		Y	4.75	66.68	16.26		130.0	
		Z	4.64	66.35	15.93		130.0	
10581-AAA	IEEE 802.11g WiFi 2.4 GHz (DSSS-OFDM, 48 Mbps, 90pc duty cycle)	X	4.59	67.62	16.99	0.46	130.0	± 9.6 %
		Y	4.83	67.38	16.83		130.0	
		Z	4.73	67.09	16.54		130.0	
10582-AAA	IEEE 802.11g WiFi 2.4 GHz (DSSS-OFDM, 54 Mbps, 90pc duty cycle)	X	4.35	66.42	16.00	0.46	130.0	± 9.6 %
		Y	4.66	66.46	16.06		130.0	
		Z	4.54	66.09	15.70		130.0	
10583-AAA	IEEE 802.11a/h WiFi 5 GHz (OFDM, 6 Mbps, 90pc duty cycle)	X	4.57	66.90	16.65	0.46	130.0	± 9.6 %
		Y	4.78	66.67	16.55		130.0	
		Z	4.70	66.43	16.27		130.0	
10584-AAA	IEEE 802.11a/h WiFi 5 GHz (OFDM, 9 Mbps, 90pc duty cycle)	X	4.60	67.11	16.74	0.46	130.0	± 9.6 %
		Y	4.81	66.83	16.61		130.0	
		Z	4.72	66.59	16.34		130.0	
10585-AAA	IEEE 802.11a/h WiFi 5 GHz (OFDM, 12 Mbps, 90pc duty cycle)	X	4.78	67.36	16.89	0.46	130.0	± 9.6 %
		Y	5.04	67.16	16.78		130.0	
		Z	4.94	66.91	16.52		130.0	
10586-AAA	IEEE 802.11a/h WiFi 5 GHz (OFDM, 18 Mbps, 90pc duty cycle)	X	4.68	67.55	17.03	0.46	130.0	± 9.6 %
		Y	4.93	67.32	16.88		130.0	
		Z	4.83	67.07	16.62		130.0	
10587-AAA	IEEE 802.11a/h WiFi 5 GHz (OFDM, 24 Mbps, 90pc duty cycle)	X	4.43	66.68	16.24	0.46	130.0	± 9.6 %
		Y	4.71	66.69	16.25		130.0	
		Z	4.59	66.34	15.91		130.0	
10588-AAA	IEEE 802.11a/h WiFi 5 GHz (OFDM, 36 Mbps, 90pc duty cycle)	X	4.47	66.74	16.26	0.46	130.0	± 9.6 %
		Y	4.75	66.68	16.26		130.0	
		Z	4.64	66.35	15.93		130.0	
10589-AAA	IEEE 802.11a/h WiFi 5 GHz (OFDM, 48 Mbps, 90pc duty cycle)	X	4.59	67.62	16.99	0.46	130.0	± 9.6 %
		Y	4.83	67.38	16.83		130.0	
		Z	4.73	67.09	16.54		130.0	
10590-AAA	IEEE 802.11a/h WiFi 5 GHz (OFDM, 54 Mbps, 90pc duty cycle)	X	4.35	66.42	16.00	0.46	130.0	± 9.6 %
		Y	4.66	66.46	16.06		130.0	
		Z	4.54	66.09	15.70		130.0	

10591-AAA	IEEE 802.11n (HT Mixed, 20MHz, MCS0, 90pc duty cycle)	X	4.72	66.97	16.76	0.46	130.0	± 9.6 %
		Y	4.93	66.73	16.63		130.0	
		Z	4.85	66.51	16.38		130.0	
10592-AAA	IEEE 802.11n (HT Mixed, 20MHz, MCS1, 90pc duty cycle)	X	4.85	67.28	16.89	0.46	130.0	± 9.6 %
		Y	5.10	67.07	16.76		130.0	
		Z	5.01	66.85	16.51		130.0	
10593-AAA	IEEE 802.11n (HT Mixed, 20MHz, MCS2, 90pc duty cycle)	X	4.77	67.16	16.75	0.46	130.0	± 9.6 %
		Y	5.03	67.02	16.67		130.0	
		Z	4.93	66.76	16.39		130.0	
10594-AAA	IEEE 802.11n (HT Mixed, 20MHz, MCS3, 90pc duty cycle)	X	4.83	67.35	16.92	0.46	130.0	± 9.6 %
		Y	5.08	67.17	16.80		130.0	
		Z	4.99	66.92	16.54		130.0	
10595-AAA	IEEE 802.11n (HT Mixed, 20MHz, MCS4, 90pc duty cycle)	X	4.79	67.31	16.82	0.46	130.0	± 9.6 %
		Y	5.06	67.14	16.71		130.0	
		Z	4.95	66.87	16.44		130.0	
10596-AAA	IEEE 802.11n (HT Mixed, 20MHz, MCS5, 90pc duty cycle)	X	4.73	67.29	16.82	0.46	130.0	± 9.6 %
		Y	4.99	67.14	16.71		130.0	
		Z	4.89	66.86	16.43		130.0	
10597-AAA	IEEE 802.11n (HT Mixed, 20MHz, MCS6, 90pc duty cycle)	X	4.68	67.16	16.68	0.46	130.0	± 9.6 %
		Y	4.95	67.07	16.62		130.0	
		Z	4.84	66.78	16.32		130.0	
10598-AAA	IEEE 802.11n (HT Mixed, 20MHz, MCS7, 90pc duty cycle)	X	4.67	67.44	16.97	0.46	130.0	± 9.6 %
		Y	4.93	67.31	16.88		130.0	
		Z	4.82	67.03	16.60		130.0	
10599-AAA	IEEE 802.11n (HT Mixed, 40MHz, MCS0, 90pc duty cycle)	X	5.39	67.39	16.95	0.46	130.0	± 9.6 %
		Y	5.60	67.32	16.82		130.0	
		Z	5.51	67.07	16.58		130.0	
10600-AAA	IEEE 802.11n (HT Mixed, 40MHz, MCS1, 90pc duty cycle)	X	5.51	67.80	17.12	0.46	130.0	± 9.6 %
		Y	5.77	67.81	17.04		130.0	
		Z	5.65	67.49	16.76		130.0	
10601-AAA	IEEE 802.11n (HT Mixed, 40MHz, MCS2, 90pc duty cycle)	X	5.41	67.56	17.02	0.46	130.0	± 9.6 %
		Y	5.64	67.51	16.91		130.0	
		Z	5.54	67.24	16.65		130.0	
10602-AAA	IEEE 802.11n (HT Mixed, 40MHz, MCS3, 90pc duty cycle)	X	5.54	67.73	17.02	0.46	130.0	± 9.6 %
		Y	5.72	67.51	16.82		130.0	
		Z	5.62	67.22	16.56		130.0	
10603-AAA	IEEE 802.11n (HT Mixed, 40MHz, MCS4, 90pc duty cycle)	X	5.62	68.07	17.33	0.46	130.0	± 9.6 %
		Y	5.82	67.83	17.11		130.0	
		Z	5.72	67.58	16.87		130.0	
10604-AAA	IEEE 802.11n (HT Mixed, 40MHz, MCS5, 90pc duty cycle)	X	5.49	67.68	17.12	0.46	130.0	± 9.6 %
		Y	5.60	67.27	16.82		130.0	
		Z	5.51	67.03	16.58		130.0	
10605-AAA	IEEE 802.11n (HT Mixed, 40MHz, MCS6, 90pc duty cycle)	X	5.51	67.70	17.12	0.46	130.0	± 9.6 %
		Y	5.70	67.55	16.96		130.0	
		Z	5.61	67.31	16.72		130.0	
10606-AAA	IEEE 802.11n (HT Mixed, 40MHz, MCS7, 90pc duty cycle)	X	5.26	67.01	16.63	0.46	130.0	± 9.6 %
		Y	5.49	67.08	16.60		130.0	
		Z	5.39	66.79	16.33		130.0	

10607-AAA	IEEE 802.11ac WiFi (20MHz, MCS0, 90pc duty cycle)	X	4.58	66.35	16.43	0.46	130.0	± 9.6 %
		Y	4.76	66.03	16.25		130.0	
		Z	4.68	65.79	15.98		130.0	
10608-AAA	IEEE 802.11ac WiFi (20MHz, MCS1, 90pc duty cycle)	X	4.73	66.71	16.58	0.46	130.0	± 9.6 %
		Y	4.98	66.46	16.42		130.0	
		Z	4.87	66.20	16.15		130.0	
10609-AAA	IEEE 802.11ac WiFi (20MHz, MCS2, 90pc duty cycle)	X	4.62	66.54	16.40	0.46	130.0	± 9.6 %
		Y	4.87	66.34	16.28		130.0	
		Z	4.76	66.05	15.99		130.0	
10610-AAA	IEEE 802.11ac WiFi (20MHz, MCS3, 90pc duty cycle)	X	4.68	66.72	16.58	0.46	130.0	± 9.6 %
		Y	4.92	66.49	16.43		130.0	
		Z	4.81	66.21	16.15		130.0	
10611-AAA	IEEE 802.11ac WiFi (20MHz, MCS4, 90pc duty cycle)	X	4.59	66.51	16.42	0.46	130.0	± 9.6 %
		Y	4.84	66.32	16.29		130.0	
		Z	4.73	66.02	16.00		130.0	
10612-AAA	IEEE 802.11ac WiFi (20MHz, MCS5, 90pc duty cycle)	X	4.59	66.66	16.46	0.46	130.0	± 9.6 %
		Y	4.85	66.48	16.33		130.0	
		Z	4.74	66.16	16.03		130.0	
10613-AAA	IEEE 802.11ac WiFi (20MHz, MCS6, 90pc duty cycle)	X	4.58	66.47	16.30	0.46	130.0	± 9.6 %
		Y	4.87	66.40	16.24		130.0	
		Z	4.75	66.06	15.92		130.0	
10614-AAA	IEEE 802.11ac WiFi (20MHz, MCS7, 90pc duty cycle)	X	4.55	66.74	16.59	0.46	130.0	± 9.6 %
		Y	4.80	66.57	16.46		130.0	
		Z	4.69	66.26	16.16		130.0	
10615-AAA	IEEE 802.11ac WiFi (20MHz, MCS8, 90pc duty cycle)	X	4.58	66.31	16.16	0.46	130.0	± 9.6 %
		Y	4.84	66.15	16.08		130.0	
		Z	4.73	65.83	15.77		130.0	
10616-AAA	IEEE 802.11ac WiFi (40MHz, MCS0, 90pc duty cycle)	X	5.21	66.65	16.56	0.46	130.0	± 9.6 %
		Y	5.41	66.58	16.44		130.0	
		Z	5.33	66.33	16.20		130.0	
10617-AAA	IEEE 802.11ac WiFi (40MHz, MCS1, 90pc duty cycle)	X	5.28	66.84	16.63	0.46	130.0	± 9.6 %
		Y	5.47	66.68	16.45		130.0	
		Z	5.38	66.45	16.22		130.0	
10618-AAA	IEEE 802.11ac WiFi (40MHz, MCS2, 90pc duty cycle)	X	5.18	66.90	16.68	0.46	130.0	± 9.6 %
		Y	5.37	66.76	16.51		130.0	
		Z	5.28	66.49	16.27		130.0	
10619-AAA	IEEE 802.11ac WiFi (40MHz, MCS3, 90pc duty cycle)	X	5.18	66.65	16.49	0.46	130.0	± 9.6 %
		Y	5.39	66.59	16.37		130.0	
		Z	5.30	66.32	16.11		130.0	
10620-AAA	IEEE 802.11ac WiFi (40MHz, MCS4, 90pc duty cycle)	X	5.26	66.66	16.54	0.46	130.0	± 9.6 %
		Y	5.51	66.68	16.46		130.0	
		Z	5.40	66.39	16.19		130.0	
10621-AAA	IEEE 802.11ac WiFi (40MHz, MCS5, 90pc duty cycle)	X	5.27	66.82	16.75	0.46	130.0	± 9.6 %
		Y	5.48	66.74	16.60		130.0	
		Z	5.39	66.50	16.37		130.0	
10622-AAA	IEEE 802.11ac WiFi (40MHz, MCS6, 90pc duty cycle)	X	5.27	66.93	16.80	0.46	130.0	± 9.6 %
		Y	5.48	66.86	16.65		130.0	
		Z	5.39	66.62	16.42		130.0	

10623-AAA	IEEE 802.11ac WiFi (40MHz, MCS7, 90pc duty cycle)	X	5.14	66.42	16.40	0.46	130.0	± 9.6 %
		Y	5.37	66.46	16.34		130.0	
		Z	5.27	66.17	16.07		130.0	
10624-AAA	IEEE 802.11ac WiFi (40MHz, MCS8, 90pc duty cycle)	X	5.34	66.68	16.59	0.46	130.0	± 9.6 %
		Y	5.56	66.62	16.48		130.0	
		Z	5.47	66.37	16.24		130.0	
10625-AAA	IEEE 802.11ac WiFi (40MHz, MCS9, 90pc duty cycle)	X	5.51	67.05	16.84	0.46	130.0	± 9.6 %
		Y	5.94	67.60	17.02		130.0	
		Z	5.85	67.36	16.78		130.0	
10626-AAA	IEEE 802.11ac WiFi (80MHz, MCS0, 90pc duty cycle)	X	5.53	66.66	16.50	0.46	130.0	± 9.6 %
		Y	5.68	66.62	16.38		130.0	
		Z	5.60	66.40	16.16		130.0	
10627-AAA	IEEE 802.11ac WiFi (80MHz, MCS1, 90pc duty cycle)	X	5.78	67.30	16.79	0.46	130.0	± 9.6 %
		Y	5.92	67.14	16.59		130.0	
		Z	5.84	66.92	16.37		130.0	
10628-AAA	IEEE 802.11ac WiFi (80MHz, MCS2, 90pc duty cycle)	X	5.53	66.65	16.39	0.46	130.0	± 9.6 %
		Y	5.74	66.79	16.36		130.0	
		Z	5.65	66.51	16.11		130.0	
10629-AAA	IEEE 802.11ac WiFi (80MHz, MCS3, 90pc duty cycle)	X	5.63	66.79	16.45	0.46	130.0	± 9.6 %
		Y	5.82	66.85	16.38		130.0	
		Z	5.74	66.60	16.14		130.0	
10630-AAA	IEEE 802.11ac WiFi (80MHz, MCS4, 90pc duty cycle)	X	5.95	67.97	17.05	0.46	130.0	± 9.6 %
		Y	6.32	68.49	17.20		130.0	
		Z	6.17	68.05	16.86		130.0	
10631-AAA	IEEE 802.11ac WiFi (80MHz, MCS5, 90pc duty cycle)	X	5.89	67.93	17.23	0.46	130.0	± 9.6 %
		Y	6.21	68.27	17.26		130.0	
		Z	6.09	67.93	17.00		130.0	
10632-AAA	IEEE 802.11ac WiFi (80MHz, MCS6, 90pc duty cycle)	X	5.77	67.44	17.00	0.46	130.0	± 9.6 %
		Y	5.90	67.22	16.76		130.0	
		Z	5.82	67.00	16.55		130.0	
10633-AAA	IEEE 802.11ac WiFi (80MHz, MCS7, 90pc duty cycle)	X	5.60	66.87	16.54	0.46	130.0	± 9.6 %
		Y	5.83	67.02	16.49		130.0	
		Z	5.72	66.69	16.23		130.0	
10634-AAA	IEEE 802.11ac WiFi (80MHz, MCS8, 90pc duty cycle)	X	5.59	66.92	16.62	0.46	130.0	± 9.6 %
		Y	5.81	67.01	16.55		130.0	
		Z	5.71	66.73	16.31		130.0	
10635-AAA	IEEE 802.11ac WiFi (80MHz, MCS9, 90pc duty cycle)	X	5.44	66.12	15.93	0.46	130.0	± 9.6 %
		Y	5.70	66.39	15.99		130.0	
		Z	5.59	66.05	15.69		130.0	
10636-AAA	IEEE 1602.11ac WiFi (160MHz, MCS0, 90pc duty cycle)	X	5.96	67.00	16.57	0.46	130.0	± 9.6 %
		Y	6.08	67.01	16.47		130.0	
		Z	6.01	66.78	16.25		130.0	
10637-AAA	IEEE 1602.11ac WiFi (160MHz, MCS1, 90pc duty cycle)	X	6.10	67.36	16.74	0.46	130.0	± 9.6 %
		Y	6.25	67.39	16.63		130.0	
		Z	6.17	67.14	16.41		130.0	
10638-AAA	IEEE 1602.11ac WiFi (160MHz, MCS2, 90pc duty cycle)	X	6.11	67.36	16.71	0.46	130.0	± 9.6 %
		Y	6.25	67.36	16.60		130.0	
		Z	6.17	67.12	16.38		130.0	

10639-AAA	IEEE 1602.11ac WiFi (160MHz, MCS3, 90pc duty cycle)	X	6.07	67.26	16.71	0.46	130.0	± 9.6 %
		Y	6.25	67.37	16.65		130.0	
		Z	6.16	67.11	16.42		130.0	
10640-AAA	IEEE 1602.11ac WiFi (160MHz, MCS4, 90pc duty cycle)	X	6.05	67.22	16.62	0.46	130.0	± 9.6 %
		Y	6.27	67.44	16.63		130.0	
		Z	6.17	67.12	16.37		130.0	
10641-AAA	IEEE 1602.11ac WiFi (160MHz, MCS5, 90pc duty cycle)	X	6.13	67.23	16.65	0.46	130.0	± 9.6 %
		Y	6.27	67.20	16.53		130.0	
		Z	6.19	66.96	16.31		130.0	
10642-AAA	IEEE 1602.11ac WiFi (160MHz, MCS6, 90pc duty cycle)	X	6.16	67.45	16.94	0.46	130.0	± 9.6 %
		Y	6.34	67.53	16.85		130.0	
		Z	6.25	67.29	16.64		130.0	
10643-AAA	IEEE 1602.11ac WiFi (160MHz, MCS7, 90pc duty cycle)	X	6.00	67.14	16.67	0.46	130.0	± 9.6 %
		Y	6.17	67.21	16.60		130.0	
		Z	6.08	66.93	16.36		130.0	
10644-AAA	IEEE 1602.11ac WiFi (160MHz, MCS8, 90pc duty cycle)	X	6.08	67.39	16.82	0.46	130.0	± 9.6 %
		Y	6.38	67.85	16.95		130.0	
		Z	6.26	67.49	16.66		130.0	
10645-AAA	IEEE 1602.11ac WiFi (160MHz, MCS9, 90pc duty cycle)	X	6.23	67.50	16.83	0.46	130.0	± 9.6 %
		Y	6.74	68.44	17.18		130.0	
		Z	6.68	68.29	17.00		130.0	
10646-AAB	LTE-TDD (SC-FDMA, 1 RB, 5 MHz, QPSK, UL Subframe=2,7)	X	13.71	101.95	34.43	9.30	60.0	± 9.6 %
		Y	31.42	116.20	38.46		60.0	
		Z	15.59	99.47	32.52		60.0	
10647-AAA	LTE-TDD (SC-FDMA, 1 RB, 20 MHz, QPSK, UL Subframe=2,7)	X	12.18	100.02	33.95	9.30	60.0	± 9.6 %
		Y	30.06	116.00	38.55		60.0	
		Z	14.66	98.82	32.42		60.0	
10648-AAA	CDMA2000 (1x Advanced)	X	0.74	65.73	11.50	0.00	150.0	± 9.6 %
		Y	0.86	65.73	12.88		150.0	
		Z	0.73	63.45	11.13		150.0	

^E Uncertainty is determined using the max. deviation from linear response applying rectangular distribution and is expressed for the square of the field value.