



# FCC RF Test Report

**APPLICANT** : Zebra Technologies Corporation  
**EQUIPMENT** : Enterprise Digital Assistant  
**BRAND NAME** : Zebra  
**MODEL NAME** : MC55E0  
**MARKETING NAME** : MC55E0  
**FCC ID** : UZ7MC55E0  
**STANDARD** : FCC Part 15 Subpart E §15.407  
**CLASSIFICATION** : (NII) Unlicensed National Information Infrastructure

The product was received on Jul. 11, 2017 and testing was completed on Aug. 10, 2017. We, SPORTON INTERNATIONAL INC., would like to declare that the tested sample has been evaluated in accordance with the test procedures and has been in compliance with the applicable technical standards.

The test results in this report apply exclusively to the tested model / sample. Without written approval of SPORTON INTERNATIONAL INC., the test report shall not be reproduced except in full.

Reviewed by: Joseph Lin / Supervisor

Approved by: Jones Tsai / Manager



Testing Laboratory  
1190

## **SPORTON INTERNATIONAL INC.**

**No. 52, Hwa Ya 1<sup>st</sup> Rd., Hwa Ya Technology Park, Kwei-Shan District, Tao Yuan City, Taiwan, R.O.C.**



# TABLE OF CONTENTS

**REVISION HISTORY ..... 3**

**SUMMARY OF TEST RESULT ..... 4**

**1 GENERAL DESCRIPTION ..... 5**

1.1 Applicant ..... 5

1.2 Manufacturer ..... 5

1.3 Product Feature of Equipment Under Test ..... 5

1.4 Product Specification of Equipment Under Test ..... 6

1.5 Modification of EUT ..... 6

1.6 Testing Location ..... 7

1.7 Applicable Standards ..... 7

**2 TEST CONFIGURATION OF EQUIPMENT UNDER TEST ..... 8**

2.1 Carrier Frequency and Channel ..... 8

2.2 Test Mode ..... 9

2.3 Connection Diagram of Test System ..... 10

2.4 Support Unit used in test configuration and system ..... 11

2.5 EUT Operation Test Setup ..... 11

2.6 Measurement Results Explanation Example ..... 12

**3 TEST RESULT ..... 13**

3.1 6dB and 26dB and 99% Occupied Bandwidth Measurement ..... 13

3.2 Maximum Conducted Output Power Measurement ..... 16

3.3 Power Spectral Density Measurement ..... 18

3.4 Unwanted Emissions Measurement ..... 21

3.5 AC Conducted Emission Measurement ..... 27

3.6 Frequency Stability Measurement ..... 29

3.7 Automatically Discontinue Transmission ..... 31

3.8 Antenna Requirements ..... 32

**4 LIST OF MEASURING EQUIPMENT ..... 33**

**5 UNCERTAINTY OF EVALUATION ..... 34**

**APPENDIX A. AC CONDUCTED EMISSION TEST RESULT**

**APPENDIX B. RADIATED SPURIOUS EMISSION**

**APPENDIX C. RADIATED SPURIOUS EMISSION PLOTS**

**APPENDIX D. DUTY CYCLE PLOTS**

**APPENDIX E. SETUP PHOTOGRAPHS**



### REVISION HISTORY

REPORT NO.	VERSION	DESCRIPTION	ISSUED DATE
FR771121D	Rev. 01	Initial issue of report	Sep. 12, 2017



### SUMMARY OF TEST RESULT

Report Section	FCC Rule	Description	Limit	Result	Remark
3.1	15.403(i)	6dB, 26dB and 99% Occupied Bandwidth	> 500kHz	Pass	-
3.2	15.407(a)	Maximum Conducted Output Power	≤ 30 dBm	Pass	-
3.3	15.407(a)	Power Spectral Density	≤ 30 dBm/500kHz	Pass	-
3.4	15.407(b)	Unwanted Emissions	15.407(b)(4)(i) & 15.209(a)	Pass	Under limit 9.27 dB at 30.000 MHz
3.5	15.207	AC Conducted Emission	15.207(a)	Pass	Under limit 3.60 dB at 0.782 MHz
3.6	15.407(g)	Frequency Stability	Within Operation Band	Pass	-
3.7	15.407(c)	Automatically Discontinue Transmission	Discontinue Transmission	Pass	-
3.8	15.203 & 15.407(a)	Antenna Requirement	N/A	Pass	-



# 1 General Description

## 1.1 Applicant

Zebra Technologies Corporation  
1 Zebra Plaza Holtsville, NY 11742

## 1.2 Manufacturer

Zebra Technologies Corporation  
1 Zebra Plaza Holtsville, NY 11742

## 1.3 Product Feature of Equipment Under Test

Product Feature	
Equipment	Enterprise Digital Assistant
Brand Name	Zebra
Model Name	MC55E0
FCC ID	UZ7MC55E0
EUT supports Radios application	WLAN 11a/b/g/n HT20 Bluetooth BR/EDR
HW Version	EV2
SW Version	1.57.0000
FW Version	FUSION X_2.03.0.0.018R
MFD	26JUN17
EUT Stage	Engineering sample

Remark: The above EUT's information was declared by manufacturer. Please refer to the specifications or user's manual for more detailed description.

Specification of Accessories				
Adapter (5.4V/1.2A)	Brand Name	Zebra	Part Number	PWR-BUA5V16W0WW
Battery 1 (White)	Brand Name	Zebra	Part Number	82-111094-02
Battery 2 (Black)	Brand Name	Zebra	Part Number	82-111094-01
USB Cable	Brand Name	Zebra	Part Number	25-108022-04R
DC Cable Line	Brand Name	Zebra	Part Number	CBL-DC-383A1-01
Holster 1	Brand Name	Zebra	Part Number	SG-MC5511110-01R
Holster 2	Brand Name	Zebra	Part Number	SG-MC5521110-01R



### 1.4 Product Specification of Equipment Under Test

Standards-related Product Specification	
<b>Tx/Rx Channel Frequency Range</b>	5745 MHz ~ 5825 MHz
<b>Maximum Output Power</b>	<b>&lt;5745 MHz ~ 5825 MHz&gt;</b> 802.11a : 14.52 dBm / 0.0283 W 802.11n HT20 : 14.67 dBm / 0.0293 W
<b>99% Occupied Bandwidth</b>	802.11a : 18.15 MHz 802.11n HT20 : 19.05 MHz
<b>Type of Modulation</b>	802.11a/n : OFDM (BPSK / QPSK / 16QAM / 64QAM)
<b>Antenna Type / Gain</b>	Fixed internal Antenna with gain 3.41 dBi

### 1.5 Modification of EUT

No modifications are made to the EUT during all test items.



### 1.6 Testing Location

Sporton Lab is accredited to ISO 17025 by Taiwan Accreditation Foundation (TAF code : 1190) and the FCC designation No. TW1190 under the FCC 2.948(e) by Mutual Recognition Agreement (MRA) in FCC Test.

<b>Test Site</b>	SPORTON INTERNATIONAL INC.		
<b>Test Site Location</b>	No. 52, Hwa Ya 1 <sup>st</sup> Rd., Hwa Ya Technology Park, Kwei-Shan District, Tao Yuan City, Taiwan, R.O.C. TEL: +886-3-327-3456 FAX: +886-3-328-4978		
<b>Test Site No.</b>	<b>Sporton Site No.</b>		
	TH05-HY	CO05-HY	03CH07-HY

**Note:** The test site complies with ANSI C63.4 2014 requirement.

### 1.7 Applicable Standards

According to the specifications of the manufacturer, the EUT must comply with the requirements of the following standards:

- ♦ FCC Part 15 Subpart E
- ♦ FCC KDB 789033 D02 General UNII Test Procedures New Rules v01r04
- ♦ ANSI C63.10-2013

**Remark:**

1. All test items were verified and recorded according to the standards and without any deviation during the test.
2. This EUT has also been tested and complied with the requirements of FCC Part 15, Subpart B, recorded in a separate test report.



## 2 Test Configuration of Equipment Under Test

The EUT has been associated with peripherals and configuration operated in a manner tended to maximize its emission characteristics in a typical application. Frequency range investigated: conducted emission (150 kHz to 30 MHz) and radiated emission (9 kHz to the 10th harmonic of the highest fundamental frequency or to 40 GHz, whichever is lower). For radiated measurement, pre-scanned in three orthogonal panels, X, Y, Z. The worst cases (Y plane) were recorded in this report.

### 2.1 Carrier Frequency and Channel

Frequency Band	Channel	Freq. (MHz)	Channel	Freq. (MHz)
5725-5850 MHz Band 4 (U-NII-3)	149	5745	157	5785
	-	-	-	-
	153	5765	161	5805
	-	-	165	5825





## 2.2 Test Mode

Final test mode of conducted test items and radiated spurious emissions are considering the modulation and worse data rates as below table.

Modulation	Data Rate
802.11a	6 Mbps
802.11n HT20	MCS0

<b>AC Conducted Emission</b>	Mode 1 : WLAN Link (5GHz) + Bluetooth Link + Qwerty Keypad + USB link (Senrial) with AC power + MP3 + Camera
	Mode 2 : WLAN Link (5GHz) + Bluetooth Link + Numeric Keypad + USB link (Senrial) with AC power + MP3 + without camera sample + Scanner

Ch. #		Band IV : 5725-5850 MHz	
		802.11a	802.11n HT20
L	Low	149	149
M	Middle	157	157
H	High	165	165

## 2.3 Connection Diagram of Test System

### <WLAN Tx Mode>

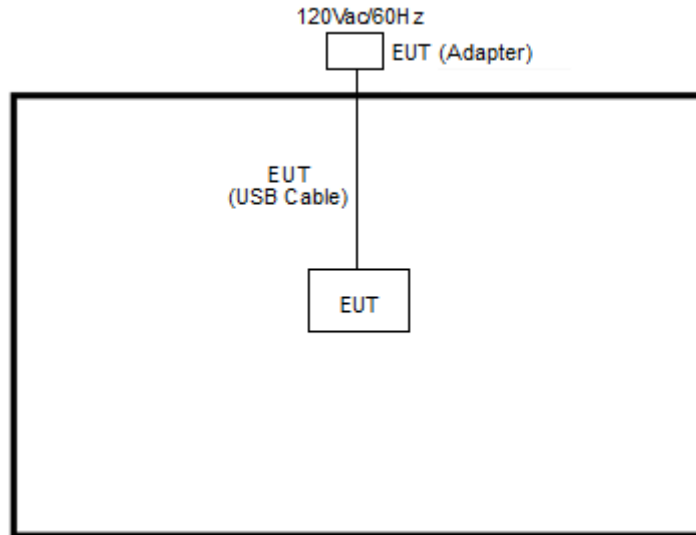

### <AC Conducted Emission Mode>

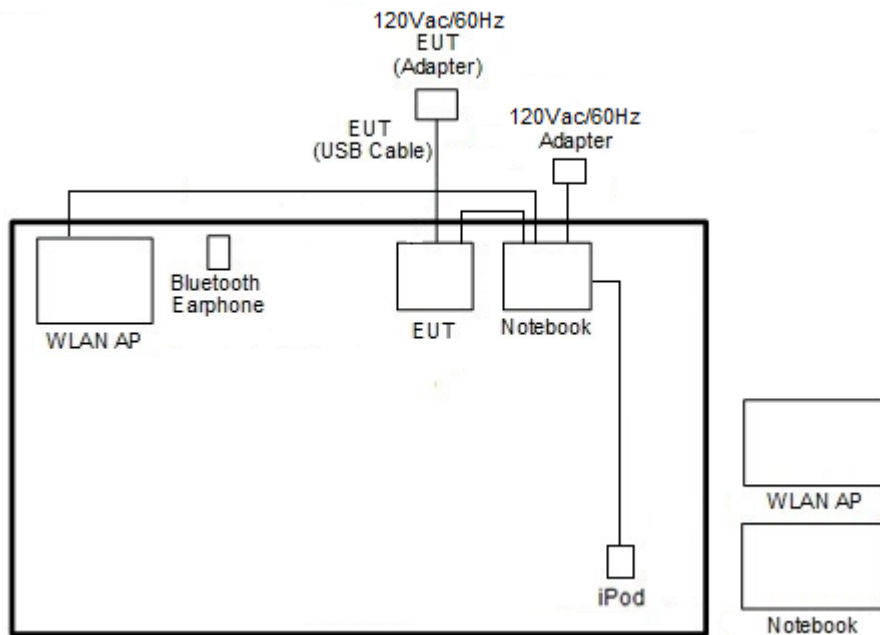



## 2.4 Support Unit used in test configuration and system

Item	Equipment	Trade Name	Model Name	FCC ID	Data Cable	Power Cord
1.	Bluetooth Earphone	Sony Ericsson	MW600	PY7DDA-2029	N/A	N/A
2.	WLAN AP	ASUS	RT-AC66U	MSQ-RTAC66U	N/A	Unshielded,1.8m
3.	iPod	Apple	A1285	DoC	Shielded, 1.0m	N/A
4.	NOTE BOOK	Dell	Latitude E6320	FCC DoC	AC I/P: Unshielded, 1.2m DC O/P: Shielded, 1.8m	
5.	SD Card	SanDisk	MicroSD HC	FCC DoC	N/A	N/A

## 2.5 EUT Operation Test Setup

The RF test items, programmed RF utility, "XW2DMT" installed in EUT make the EUT provide functions like channel selection and power level for continuous transmitting and receiving signals.



## 2.6 Measurement Results Explanation Example

For all conducted test items:

The offset level is set in the spectrum analyzer to compensate the RF cable loss and attenuator factor between EUT conducted output port and spectrum analyzer. With the offset compensation, the spectrum analyzer reading level is exactly the EUT RF output level.

Example :

The spectrum analyzer offset is derived from RF cable loss and attenuator factor.

*Offset = RF cable loss + attenuator factor.*

Following shows an offset computation example with cable loss 4.2 dB and 10dB attenuator.

$$\begin{aligned} \text{Offset(dB)} &= \text{RF cable loss(dB)} + \text{attenuator factor(dB)}. \\ &= 4.2 + 10 = 14.2 \text{ (dB)} \end{aligned}$$

### 3 Test Result

#### 3.1 6dB and 26dB and 99% Occupied Bandwidth Measurement

##### 3.1.1 Description of 6dB and 26dB and 99% Occupied Bandwidth

The minimum 6 dB bandwidth shall be at least 500 kHz.

26dB and 99% Occupied bandwidth are reporting only.

##### 3.1.2 Measuring Instruments

The measuring equipment is listed in the section 4 of this test report.

##### 3.1.3 Test Procedures

1. The testing follows FCC KDB 789033 D02 General UNII Test Procedures New Rules v01r03.  
Section C) Emission bandwidth for the band 5.725-5.85GHz
2. Set RBW = 100kHz.
3. Set the VBW  $\geq 3 \times$  RBW.
4. Detector = Peak.
5. Trace mode = max hold
6. Measure the maximum width of the emission that is 6 dB down from the peak of the emission.
7. Measure and record the results in the test report.

##### 3.1.4 Test Setup





3.1.5 Test Result of 6dB Bandwidth

Band IV									
Mod.	Data Rate	NTX	CH.	Freq. (MHz)	99% Bandwidth (MHz)	26 dB Bandwidth (MHz)	6 dB Bandwidth (MHz)	6dB Bandwidth min. Limit (MHz)	Pass/Fail
11a	6Mbps	1	149	5745	18.15	33.55	15.04	0.5	Pass
11a	6Mbps	1	157	5785	17.9	28.9	15.08	0.5	Pass
11a	6Mbps	1	165	5825	17.95	30	15.12	0.5	Pass
HT20	MCS 0	1	149	5745	19	30.6	15.08	0.5	Pass
HT20	MCS 0	1	157	5785	19.05	32.56	15.08	0.5	Pass
HT20	MCS 0	1	165	5825	19.05	31.55	15.1	0.5	Pass

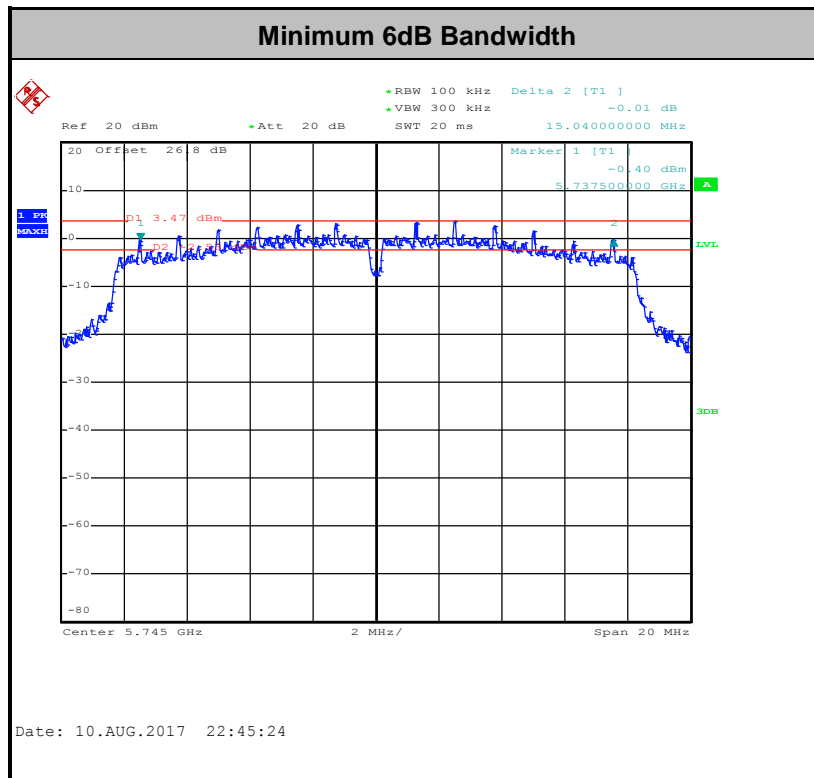

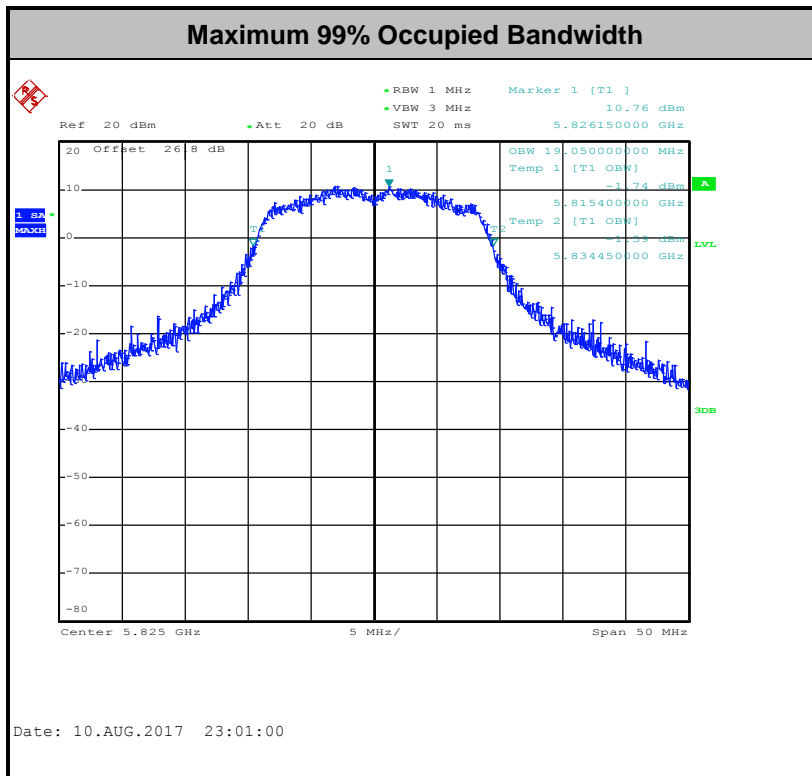
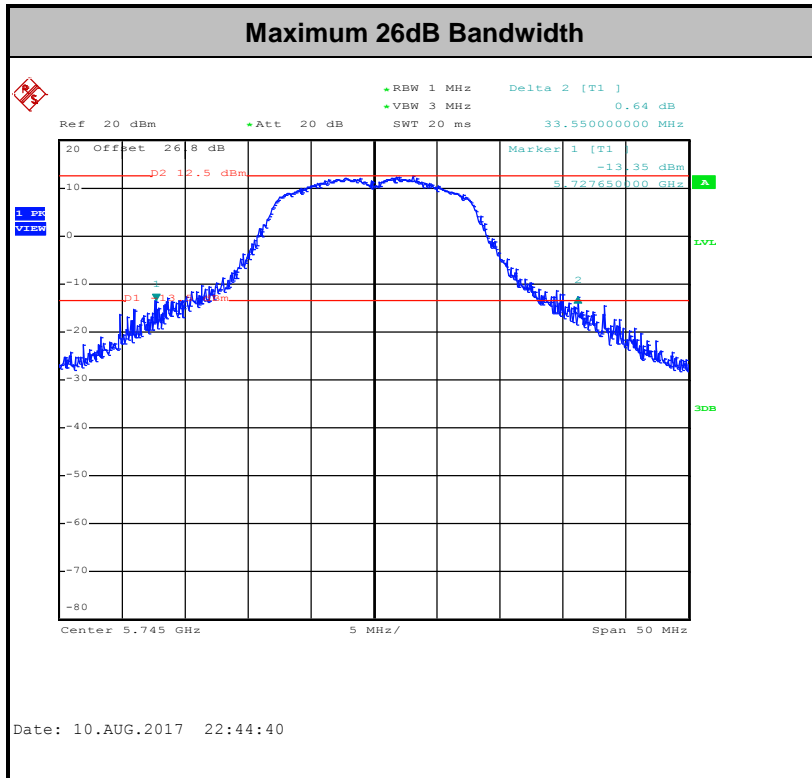

**Note:** The occupied channel bandwidth is maintained within the band of operation for all of the modulations.

## 3.2 Maximum Conducted Output Power Measurement

### 3.2.1 Limit of Maximum Conducted Output Power

For the band 5.725–5.85 GHz, the maximum conducted output power over the frequency band of operation shall not exceed 1 W.

If transmitting antennas of directional gain greater than 6 dBi are used, the peak output power shall be reduced by the amount in dB that the directional gain of the antenna exceeds 6 dBi.

### 3.2.2 Measuring Instruments

The measuring equipment is listed in the section 4 of this test report.

### 3.2.3 Test Procedures

The testing follows Method PM of FCC KDB 789033 D02 General UNII Test Procedures New Rules v01r04.

Method PM (Measurement using an RF average power meter):

1. Measurement is performed using a wideband RF power meter.
2. The EUT is configured to transmit continuously with a consistent duty cycle at its maximum power control level.
3. Measure the average power of the transmitter, and the average power is corrected with duty factor,  $10 \log(1/x)$ , where  $x$  is the duty cycle.

### 3.2.4 Test Setup

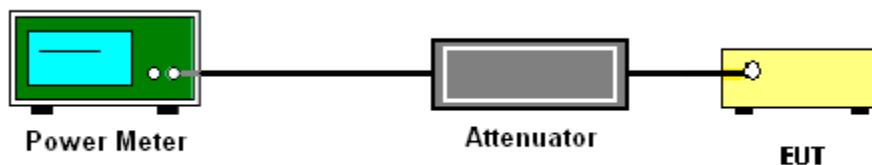





3.2.5 Test Result of Maximum Conducted Output Power

Band IV									
Mod.	Data Rate	NTX	CH.	Freq. (MHz)	Duty Factor (dB)	Average Conducted Power (dBm)	FCC Conducted Power Limit (dBm)	DG (dBi)	Pass/Fail
11a	6Mbps	1	149	5745	0.09	14.52	30.00	3.41	Pass
11a	6Mbps	1	157	5785	0.09	14.25	30.00	3.41	Pass
11a	6Mbps	1	165	5825	0.09	14.19	30.00	3.41	Pass
HT20	MCS 0	1	149	5745	0.09	14.67	30.00	3.41	Pass
HT20	MCS 0	1	157	5785	0.09	14.63	30.00	3.41	Pass
HT20	MCS 0	1	165	5825	0.09	14.36	30.00	3.41	Pass



### 3.3 Power Spectral Density Measurement

#### 3.3.1 Limit of Power Spectral Density

For the band 5.725–5.85 GHz, the maximum power spectral density shall not exceed 30 dBm in any 500-kHz band.

If transmitting antennas of directional gain greater than 6 dBi are used, the peak output power shall be reduced by the amount in dB that the directional gain of the antenna exceeds 6 dBi.

#### 3.3.2 Measuring Instruments

The measuring equipment is listed in the section 4 of this test report.

#### 3.3.3 Test Procedures

The testing follows FCC KDB 789033 D02 General UNII Test Procedures New Rules v01r04. Section F) Maximum power spectral density.

##### # Method SA-2 #

(trace averaging across on and off times of the EUT transmissions, followed by duty cycle correction).

- Measure the duty cycle.
- Set span to encompass the entire emission bandwidth (EBW) of the signal.
- Set RBW = 300 kHz.
- Set VBW  $\geq$  1 MHz.
- Number of points in sweep  $\geq$  2 Span / RBW.
- Sweep time = auto.
- Detector = RMS
- Trace average at least 100 traces in power averaging mode.
- Add  $10 \log(500\text{kHz}/\text{RBW})$  to the test result.
- Add  $10 \log(1/x)$ , where  $x$  is the duty cycle, to the measured power in order to compute the average power during the actual transmission times. For example, add  $10 \log(1/0.25) = 6$  dB if the duty cycle is 25 percent.

1. The RF output of EUT was connected to the spectrum analyzer by a low loss cable.
2. Each plot has already offset with cable loss, and attenuator loss. Measure the PPSD and record it.

### 3.3.4 Test Setup

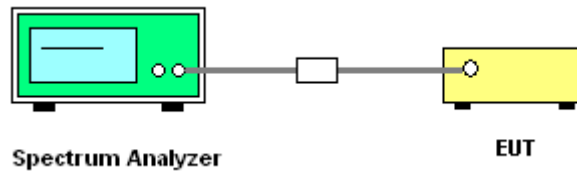



### 3.3.5 Test Result of Power Spectral Density

Band IV										
Mod.	Data Rate	NTX	CH.	Freq. (MHz)	Duty Factor (dB)	10log (500kHz /RBW) Factor (dB)	Average Power Density (dBm/500kHz)	Average PSD Limit (dBm/500kHz)	DG (dBi)	Pass/Fail
11a	6Mbps	1	149	5745	0.09	2.22	0.97	30.00	3.41	Pass
11a	6Mbps	1	157	5785	0.09	2.22	0.09	30.00	3.41	Pass
11a	6Mbps	1	165	5825	0.09	2.22	-0.95	30.00	3.41	Pass
HT20	MCS 0	1	149	5745	0.09	2.22	0.27	30.00	3.41	Pass
HT20	MCS 0	1	157	5785	0.09	2.22	0.10	30.00	3.41	Pass
HT20	MCS 0	1	165	5825	0.09	2.22	-0.73	30.00	3.41	Pass

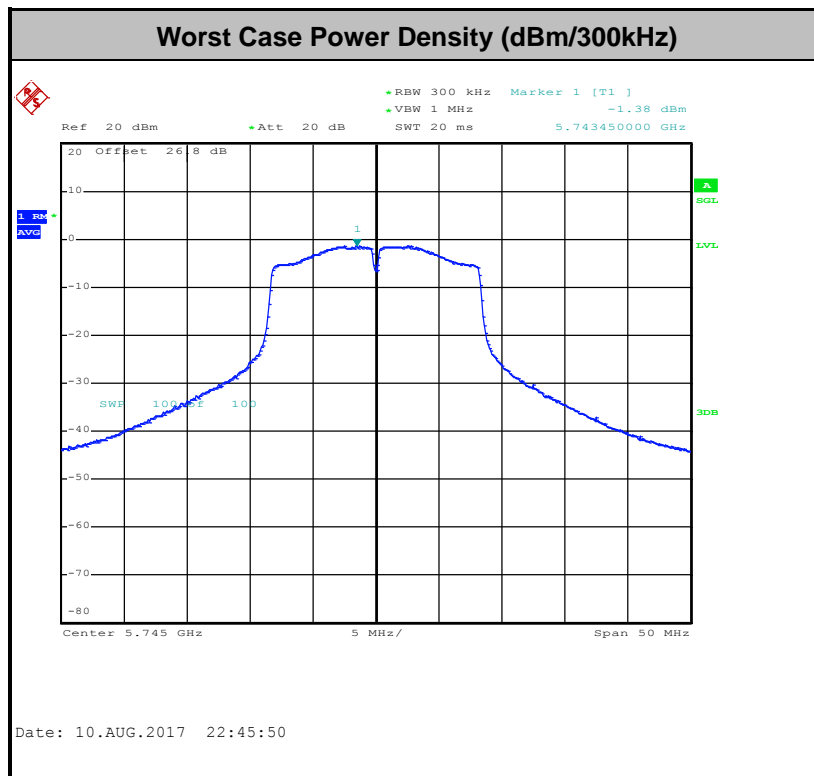



### 3.4 Unwanted Emissions Measurement

This section as specified in FCC Part 15.407(b) is to measure unwanted emissions through radiated measurement for band edge spurious emissions and out of band emissions measurement. The unwanted emissions shall comply with 15.407(b)(1) to (6), and restricted bands per FCC Part15.205.

#### 3.4.1 Limit of Unwanted Emissions

(1) For transmitters operating in the 5.725-5.85 GHz band:

15.407(b)(4)(i) All emissions shall be limited to a level of -27 dBm/MHz at 75 MHz or more above or below the band edge increasing linearly to 10 dBm/MHz at 25 MHz above or below the band edge, and from 25 MHz above or below the band edge increasing linearly to a level of 15.6 dBm/MHz at 5 MHz above or below the band edge, and from 5 MHz above or below the band edge increasing linearly to a level of 27 dBm/MHz at the band edge.

(2) Unwanted spurious emissions fallen in restricted bands per FCC Part15.205 shall comply with the general field strength limits set forth in § 15.209 as below table,

Frequency (MHz)	Field Strength (microvolts/meter)	Measurement Distance (meters)
0.009 – 0.490	2400/F(kHz)	300
0.490 – 1.705	24000/F(kHz)	30
1.705 – 30.0	30	30
30 – 88	100	3
88 – 216	150	3
216 - 960	200	3
Above 960	500	3

**Note:** The following formula is used to convert the EIRP to field strength.

$$E = \frac{1000000\sqrt{30P}}{3} \mu\text{V/m, where P is the eirp (Watts)}$$



EIRP (dBm)	Field Strength at 3m (dBμV/m)
-17	78.3
- 27	68.3

(3) KDB789033 D01 v01r04 G)2)c)

- (i) Section 15.407(b)(1) to (b)(3) specify the unwanted emission limits for the U-NII-1 and U-NII-2 bands. As specified, emissions above 1000 MHz that are outside of the restricted bands are subject to a peak emission limit of -27 dBm/MHz.<sup>3</sup>
- (ii) Section 15.407(b)(4) specifies the unwanted emission limit for the U-NII-3 band. A band emissions mask is specified in Section 15.407(b)(4)(i). The emission limits are in terms of a Peak detector. An alternative to the band emissions mask is specified in Section 15.407(b)(4)(ii). The alternative limits are based on the highest antenna gain specified in the filing. There are also marketing and importation restrictions for the devices using the alternative limit.<sup>4</sup>

**Note 3:** An out-of-band emission that complies with both the average and peak limits of Section 15.209 is not required to satisfy the -27 dBm/MHz peak emission limit.

**Note 4:** Only devices with antenna gains of 10 dBi or less may be approved using the emission limits specified in Section 15.247(d) till March 2, 2018; all other devices operating in this band must use the mask specified in Section 15.407(b)(4)(i).

### 3.4.2 Measuring Instruments

The measuring equipment is listed in the section 4 of this test report.



### **3.4.3 Test Procedures**

1. The testing follows FCC KDB 789033 D02 General UNII Test Procedures New Rules v01r03. Section G) Unwanted emissions measurement.

(1) Procedure for Unwanted Emissions Measurements Below 1000MHz

- RBW = 120 kHz
- VBW = 300 kHz
- Detector = Peak
- Trace mode = max hold

(2) Procedure for Peak Unwanted Emissions Measurements Above 1000 MHz

- RBW = 1 MHz
- VBW  $\geq$  3 MHz
- Detector = Peak
- Sweep time = auto
- Trace mode = max hold

(3) Procedures for Average Unwanted Emissions Measurements Above 1000MHz

- RBW = 1 MHz
- VBW = 10 Hz, when duty cycle is no less than 98 percent.
- VBW  $\geq$  1/T, when duty cycle is less than 98 percent where T is the minimum transmission duration over which the transmitter is on and is transmitting at its maximum power control level for the tested mode of operation.

2. The EUT was placed on a turntable with 0.8 meter for frequency below 1GHz and 1.5 meter for frequency above 1GHz respectively above ground.
3. The EUT was set 3 meters from the interference receiving antenna which was mounted on the top of a variable height antenna tower.
4. The antenna is a broadband antenna and its height is adjusted between one meter and four meters above ground to find the maximum value of the field strength for both horizontal polarization and vertical polarization of the antenna.
5. For each suspected emission, the EUT was arranged to its worst case and then adjust the antenna tower (from 1 m to 4 m) and turntable (from 0 degree to 360 degrees) to find the maximum reading.
6. For testing below 1GHz, if the emission level of the EUT in peak mode was 3 dB lower than the limit specified, then peak values of EUT will be reported, otherwise, the emissions will be repeated one by one using the CISPR quasi-peak method and reported.
7. For testing above 1GHz, the emission level of the EUT in peak mode was 20dB lower than average limit (that means the emission level in average mode also complies with the limit in average mode), then peak values of EUT will be reported, otherwise, the emissions will be measured in average mode again and reported.

### 3.4.4 Test Setup

For radiated emissions below 30MHz

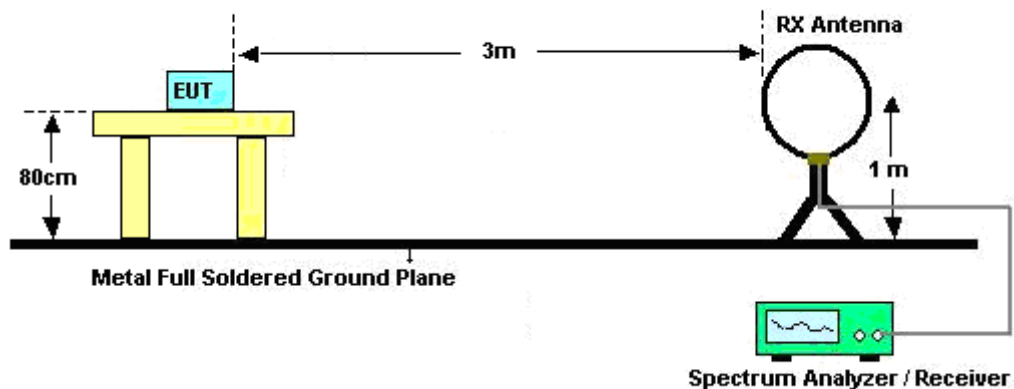



For radiated emissions from 30MHz to 1GHz

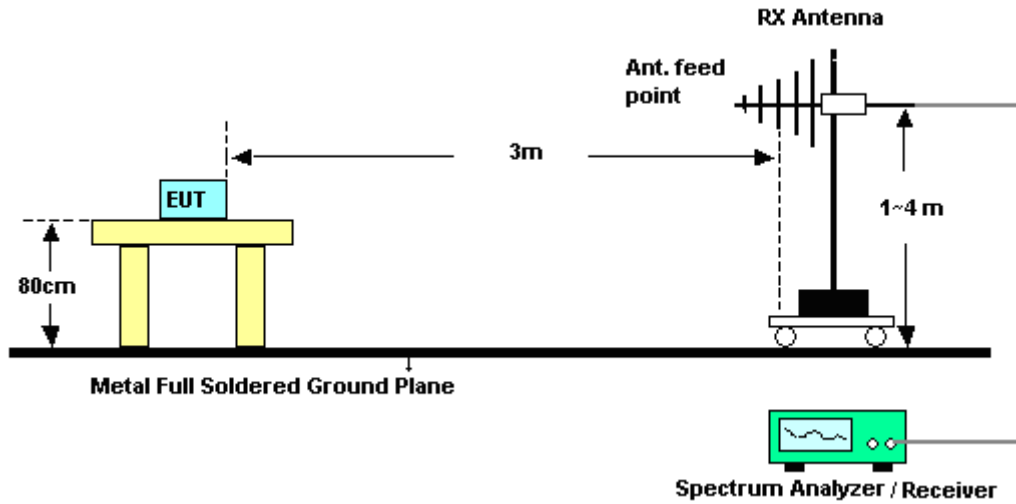

For radiated emissions above 1GHz

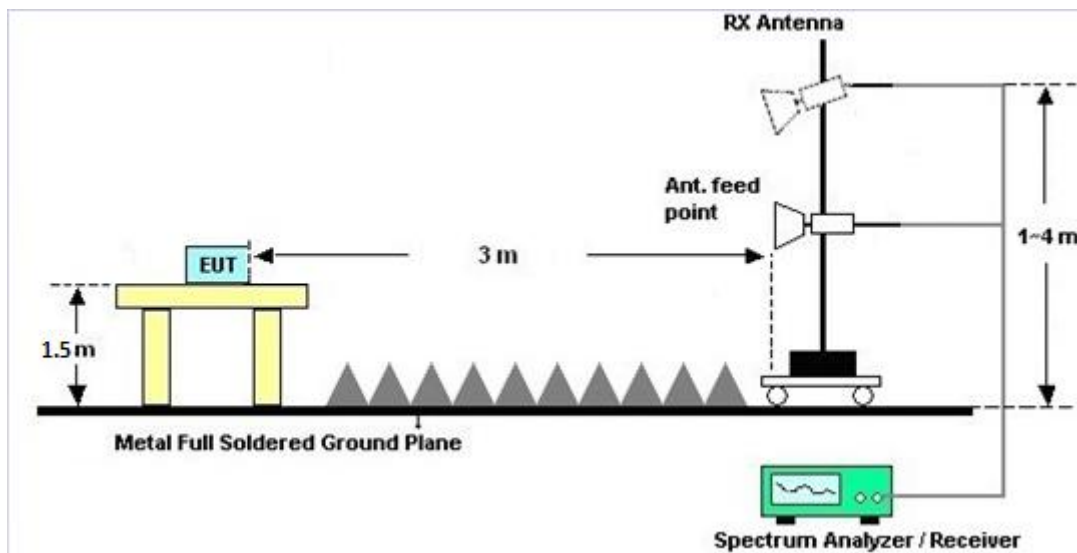



### **3.4.5 Test Results of Radiated Emissions (9 kHz ~ 30 MHz)**

The low frequency, which started from 9 kHz to 30MHz, was pre-scanned and the result which was 20dB lower than the limit line per 15.31(o) was not reported.

### **3.4.6 Test Result of Radiated Band Edges**

Please refer to Appendix B and C.

### **3.4.7 Duty Cycle**

Please refer to Appendix D.

### **3.4.8 Test Result of Unwanted Radiated Emission (30MHz ~ 10th Harmonic)**

Please refer to Appendix B and C.



### 3.5 AC Conducted Emission Measurement

#### 3.5.1 Limit of AC Conducted Emission

For equipment that is designed to be connected to the public utility (AC) power line, the radio frequency voltage that is conducted back onto the AC power line on any frequency or frequencies within the band 150 kHz to 30 MHz shall not exceed the limits in the following table.

Frequency of emission (MHz)	Conducted limit (dB $\mu$ V)	
	Quasi-peak	Average
0.15-0.5	66 to 56*	56 to 46*
0.5-5	56	46
5-30	60	50

\*Decreases with the logarithm of the frequency.

#### 3.5.2 Measuring Instruments

The measuring equipment is listed in the section 4 of this test report.

#### 3.5.3 Test Procedures

1. The EUT was placed 0.4 meter from the conducting wall of the shielding room was kept at least 80 centimeters from any other grounded conducting surface.
2. Connect EUT to the power mains through a line impedance stabilization network (LISN).
3. All the support units are connecting to the other LISN.
4. The LISN provides 50 ohm coupling impedance for the measuring instrument.
5. The FCC states that a 50 ohm, 50 microhenry LISN should be used.
6. Both sides of AC line were checked for maximum conducted interference.
7. The frequency range from 150 kHz to 30 MHz was searched.
8. Set the test-receiver system to Peak Detect Function and specified bandwidth with Maximum Hold Mode.

### 3.5.4 Test Setup

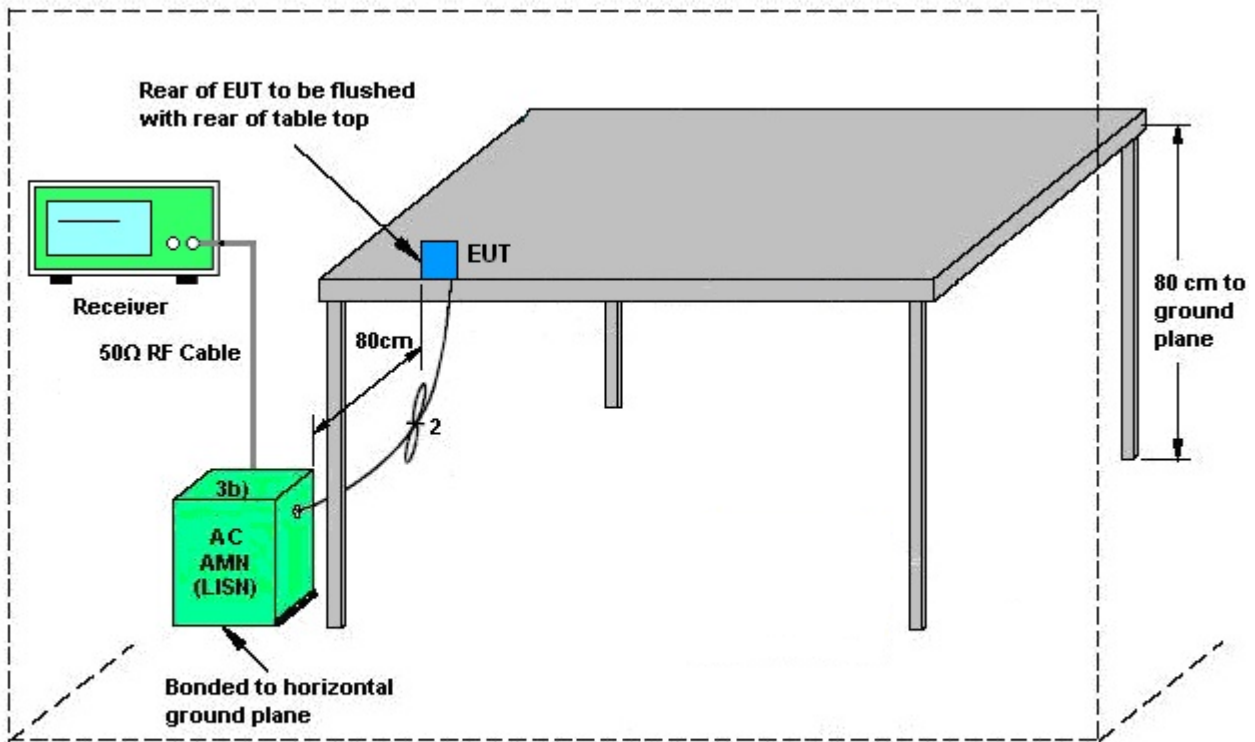

AMN = Artificial mains network (LISN)  
AE = Associated equipment  
EUT = Equipment under test  
ISN = Impedance stabilization network

### 3.5.5 Test Result of AC Conducted Emission

Please refer to Appendix A.

### **3.6 Frequency Stability Measurement**

#### **3.6.1 Limit of Frequency Stability**

Manufacturers of U-NII devices are responsible for ensuring frequency stability such that an emission is maintained within the band of operation under all conditions of normal operation as specified in the user's manual.

#### **3.6.2 Measuring Instruments**

The measuring equipment is listed in the section 4 of this test report.

#### **3.6.3 Test Procedures**

1. To ensure emission at the band edge is maintained within the authorized band, those values shall be measured by radiation emissions at upper and lower frequency points, and finally compensated by frequency deviation as procedures below.
2. The EUT was operated at the maximum output power, and connected to the spectrum analyzer, which is set to maximum hold function and peak detector. The peak value of the power envelope was measured and noted. The upper and lower frequency points were respectively measured relatively 10dB lower than the measured peak value.
3. The frequency deviation was calculated by adding the upper frequency point and the lower frequency point divided by two. Those detailed values of frequency deviation are provided in table below.

#### **3.6.4 Test Setup**

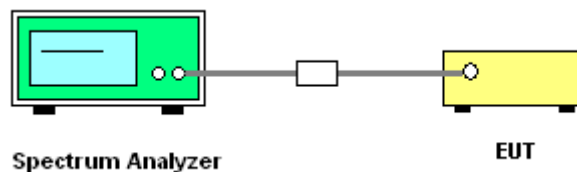



3.6.5 Test Result of Frequency Stability

Band IV									
Mod.	Data Rate	NTX	CH.	Freq. (MHz)	Center Frequency (MHz)	Frequency Deviation (MHz)	Frequency Stability (ppm)	Temperature (°C)	Voltage (V)
11a	6M bps	1	149	5745	5745.000	0.000	0.00	50	3.7
11a	6M bps	1	149	5745	5745.000	0.000	0.00	-30	3.7
11a	6M bps	1	149	5745	5745.000	0.000	0.00	20	4.2
11a	6M bps	1	149	5745	5745.000	0.000	0.00	20	3.2
11a	6M bps	1	149	5745	5745.000	0.000	0.00	20	3.7



## **3.7 Automatically Discontinue Transmission**

### **3.7.1 Limit of Automatically Discontinue Transmission**

The device shall automatically discontinue transmission in case of either absence of information to transmit or operational failure. These provisions are not intended to preclude the transmission of control or signaling information or the use of repetitive codes used by certain digital technologies to complete frame or burst intervals. Applicants shall include in their application for equipment authorization to describe how this requirement is met.

### **3.7.2 Measuring Instruments**

The measuring equipment is listed in the section 4 of this test report.

### **3.7.3 Test Result of Automatically Discontinue Transmission**

While the EUT is not transmitting any information, the EUT can automatically discontinue transmission and become standby mode for power saving. The EUT can detect the controlling signal of ACK message transmitting from remote device and verify whether it shall resend or discontinue transmission.



## **3.8 Antenna Requirements**

### **3.8.1 Standard Applicable**

According to FCC 47 CFR Section 15.407(a)(1)(2) ,if transmitting antenna directional gain is greater than 6 dBi, both the peak transmit power and the peak power spectral density shall be reduced by the amount in dB that the directional gain of the antenna exceeds 6 dBi.

### **3.8.2 Antenna Anti-Replacement Construction**

An embedded-in antenna design is used.

### **3.8.3 Antenna Gain**

The antenna peak gain of EUT is less than 6 dBi. Therefore, it is not necessary to reduce maximum peak output power limit.





## 4 List of Measuring Equipment

Instrument	Manufacturer	Model No.	Serial No.	Characteristics	Calibration Date	Test Date	Due Date	Remark
Power Meter	Anritsu	ML2495A	0932001	300MHz~40GHz	Sep. 29, 2016	Jul. 18, 2017 ~ Aug. 10, 2017	Sep. 28, 2017	Conducted (TH05-HY)
Power Sensor	Anritsu	MA2411B	0846202	300MHz~40GHz	Sep. 29, 2016	Jul. 18, 2017 ~ Aug. 10, 2017	Sep. 28, 2017	Conducted (TH05-HY)
Spectrum Analyzer	Rohde & Schwarz	FSP40	100057	9kHz-40GHz	Nov. 25, 2016	Jul. 18, 2017 ~ Aug. 10, 2017	Nov. 24, 2017	Conducted (TH05-HY)
Temperature Chamber	ESPEC	SH-641	92013720	-40°C ~90°C	Sep. 01, 2016	Jul. 18, 2017 ~ Aug. 10, 2017	Aug. 31, 2017	Conducted (TH05-HY)
Programmable Power Supply	GW Instek	PSS-2005	EL890094	1V~20V 0.5A~5A	Oct. 11, 2016	Jul. 18, 2017 ~ Aug. 10, 2017	Oct. 10, 2017	Conducted (TH05-HY)
AC Power Source	AC POWER	AFC-500W	F104070011	50Hz~60Hz	Dec 01.2016	Jul. 18, 2017 ~ Aug. 10, 2017	Nov 30 2017	Conducted (TH05-HY)
AC Power Source	ChainTek	APC-1000W	N/A	N/A	N/A	Jul. 19, 2017	N/A	Conduction (CO05-HY)
EMI Test Receiver	Rohde & Schwarz	ESCI 7	100724	9kHz~7GHz	Aug. 30, 2016	Jul. 19, 2017	Aug. 29, 2017	Conduction (CO05-HY)
LISN	Rohde & Schwarz	ENV216	100080	9kHz~30MHz	Nov. 29, 2016	Jul. 19, 2017	Nov. 28, 2017	Conduction (CO05-HY)
LISN	Rohde & Schwarz	ENV216	100081	9kHz~30MHz	Dec. 06, 2016	Jul. 19, 2017	Dec. 05, 2017	Conduction (CO05-HY)
Bilog Antenna	TESEQ	CBL 6111D&00800 N1D01N-06	35419&03	30MHz to 1GHz	Jan. 07, 2017	Aug. 03, 2017 ~ Aug. 07, 2017	Jan. 06, 2018	Radiation (03CH07-HY)
Double Ridge Horn Antenna	ESCO	3117	00075962	1GHz ~ 18GHz	Aug. 19, 2016	Aug. 03, 2017 ~ Aug. 07, 2017	Aug. 18, 2017	Radiation (03CH07-HY)
EMI Test Receiver	Keysight	N9038A(MXE)	MY54130085	20Hz ~ 8.4GHz	Oct. 26, 2016	Aug. 03, 2017 ~ Aug. 07, 2017	Oct. 25, 2017	Radiation (03CH07-HY)
Loop Antenna	Rohde & Schwarz	HFH2-Z2	100315	9 kHz~30 MHz	May 15, 2017	Aug. 03, 2017 ~ Aug. 07, 2017	May 14, 2019	Radiation (03CH07-HY)
Preamplifier	MITEQ	AMF-7D-0010 1800-30-10P	1590075	1GHz ~ 18GHz	Apr. 25, 2017	Aug. 03, 2017 ~ Aug. 07, 2017	Apr. 24, 2018	Radiation (03CH07-HY)
Preamplifier	COM-POWER	PA-103A	161241	10MHz-1GHz	Mar. 14, 2017	Aug. 03, 2017 ~ Aug. 07, 2017	Mar. 13, 2018	Radiation (03CH07-HY)
Preamplifier	Agilent	8449B	3008A02362	1GHz~ 26.5GHz	Oct. 12, 2016	Aug. 03, 2017 ~ Aug. 07, 2017	Oct. 11, 2017	Radiation (03CH07-HY)
Spectrum Analyzer	Agilent	N9010A	MY53470118	10Hz~44GHz	Apr. 17, 2017	Aug. 03, 2017 ~ Aug. 07, 2017	Apr. 16, 2018	Radiation (03CH07-HY)
Antenna Mast	Max-Full	MFA520BS	N/A	1m~4m	N/A	Aug. 03, 2017 ~ Aug. 07, 2017	N/A	Radiation (03CH07-HY)
Turn Table	ChainTek	Chaintek 3000	N/A	0~360 Degree	N/A	Aug. 03, 2017 ~ Aug. 07, 2017	N/A	Radiation (03CH07-HY)
Amplifier	MITEQ	TTA1840-35-H G	1871923	18GHz~40GHz, VSWR : 2.5:1 max	Jul. 18, 2017	Aug. 03, 2017 ~ Aug. 07, 2017	Jul. 17, 2018	Radiation (03CH07-HY)
SHF-EHF Horn Antenna	SCHWARZBE CK	BBHA 9170	BBHA917058 4	18GHz- 40GHz	Nov. 08, 2016	Aug. 03, 2017 ~ Aug. 07, 2017	Nov. 07, 2017	Radiation (03CH07-HY)



## 5 Uncertainty of Evaluation

### Uncertainty of Conducted Emission Measurement (150kHz ~ 30MHz)

Measuring Uncertainty for a Level of Confidence of 95% ( $U = 2Uc(y)$ )	2.26
---	------

### Uncertainty of Radiated Emission Measurement (30 MHz ~ 1000 MHz)

Measuring Uncertainty for a Level of Confidence of 95% ( $U = 2Uc(y)$ )	5.70
---	------

### Uncertainty of Radiated Emission Measurement (1000 MHz ~ 18000 MHz)

Measuring Uncertainty for a Level of Confidence of 95% ( $U = 2Uc(y)$ )	5.50
---	------

### Uncertainty of Radiated Emission Measurement (18000 MHz ~ 40000 MHz)

Measuring Uncertainty for a Level of Confidence of 95% ( $U = 2Uc(y)$ )	5.20
---	------



# Appendix A. AC Conducted Emission Test Result

Test Engineer :	Poching Li	Temperature :	26°C
		Relative Humidity :	40%

### EUT Information

Report NO : 771121  
 Test Mode : Mode 1  
 Test Voltage : 120Vac/60Hz  
 Phase : Line

ENV216 Auto Test-L

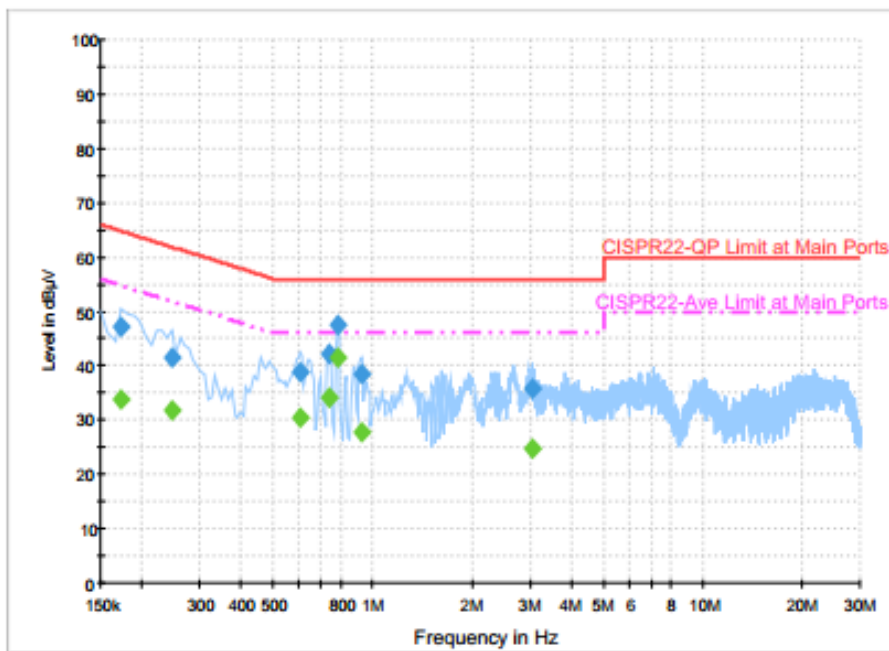

### Final Result 1

Frequency (MHz)	QuasiPeak (dBµV)	Filter	Line	Corr. (dB)	Margin (dB)	Limit (dBµV)
0.174000	47.0	Off	L1	19.5	17.8	64.8
0.246000	41.6	Off	L1	19.5	20.3	61.9
0.606000	38.8	Off	L1	19.5	17.2	56.0
0.742000	42.0	Off	L1	19.5	14.0	56.0
0.782000	47.3	Off	L1	19.5	8.7	56.0
0.926000	38.5	Off	L1	19.5	17.5	56.0
3.038000	35.9	Off	L1	19.5	20.1	56.0

### Final Result 2

Frequency (MHz)	Average (dBµV)	Filter	Line	Corr. (dB)	Margin (dB)	Limit (dBµV)
0.174000	33.7	Off	L1	19.5	21.1	54.8
0.246000	31.9	Off	L1	19.5	20.0	51.9
0.606000	30.5	Off	L1	19.5	15.5	46.0
0.742000	34.1	Off	L1	19.5	11.9	46.0
0.782000	41.5	Off	L1	19.5	4.5	46.0
0.926000	27.7	Off	L1	19.5	18.3	46.0
3.038000	24.7	Off	L1	19.5	21.3	46.0



**EUT Information**

Report NO : 771121  
 Test Mode : Mode 1  
 Test Voltage : 120Vac/60Hz  
 Phase : Neutral

ENV216 Auto Test-N

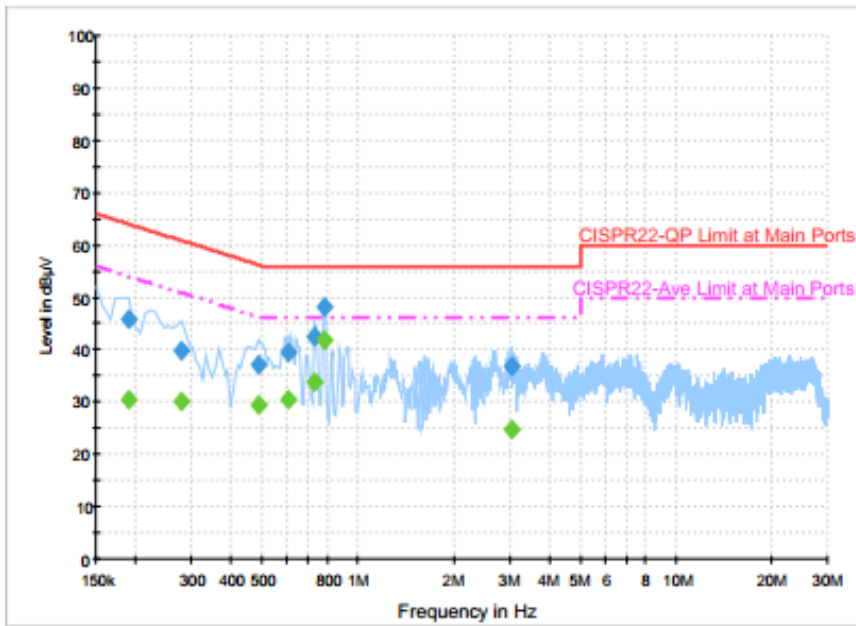

**Final Result 1**

Frequency (MHz)	QuasiPeak (dBµV)	Filter	Line	Corr. (dB)	Margin (dB)	Limit (dBµV)
0.190000	45.9	Off	N	19.5	18.1	64.0
0.278000	39.9	Off	N	19.5	21.0	60.9
0.486000	37.3	Off	N	19.5	18.9	56.2
0.606000	39.3	Off	N	19.5	16.7	56.0
0.734000	42.6	Off	N	19.5	13.4	56.0
0.782000	48.2	Off	N	19.5	7.8	56.0
3.038000	36.7	Off	N	19.5	19.3	56.0

**Final Result 2**

Frequency (MHz)	Average (dBµV)	Filter	Line	Corr. (dB)	Margin (dB)	Limit (dBµV)
0.190000	30.3	Off	N	19.5	23.7	54.0
0.278000	30.2	Off	N	19.5	20.7	50.9
0.486000	29.3	Off	N	19.5	16.9	46.2
0.606000	30.6	Off	N	19.5	15.4	46.0
0.734000	33.9	Off	N	19.5	12.1	46.0
0.782000	42.0	Off	N	19.5	4.0	46.0
3.038000	24.9	Off	N	19.5	21.1	46.0



**EUT Information**

Report NO : 771121  
 Test Mode : Mode 2  
 Test Voltage : 120Vac/60Hz  
 Phase : Line

ENV216 Auto Test-L

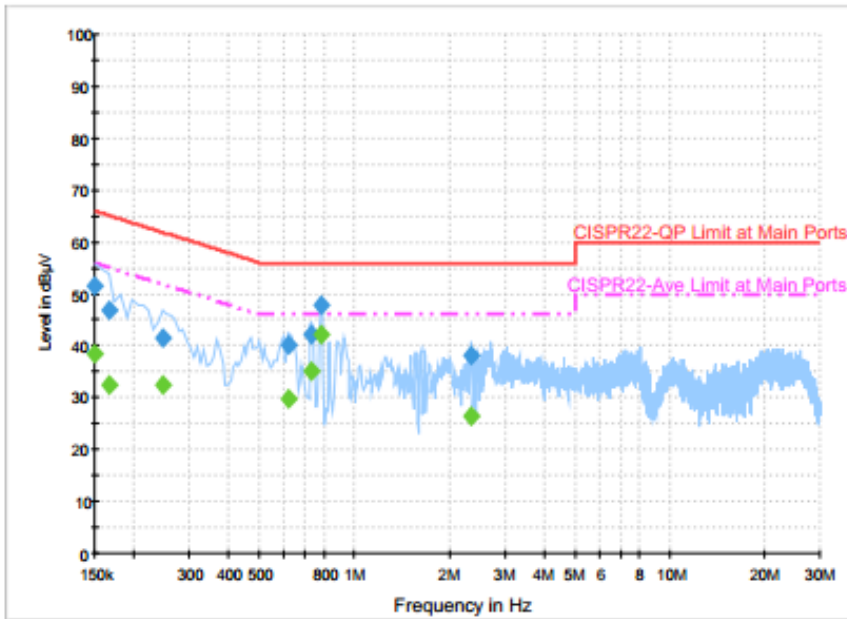

**Final Result 1**

Frequency (MHz)	QuasiPeak (dBµV)	Filter	Line	Corr. (dB)	Margin (dB)	Limit (dBµV)
0.150000	51.7	Off	L1	19.6	14.3	66.0
0.166000	46.9	Off	L1	19.5	18.3	65.2
0.246000	41.5	Off	L1	19.5	20.4	61.9
0.622000	40.2	Off	L1	19.5	15.8	56.0
0.734000	42.2	Off	L1	19.5	13.8	56.0
0.782000	47.7	Off	L1	19.5	8.3	56.0
2.350000	38.2	Off	L1	18.9	17.8	56.0

**Final Result 2**

Frequency (MHz)	Average (dBµV)	Filter	Line	Corr. (dB)	Margin (dB)	Limit (dBµV)
0.150000	38.4	Off	L1	19.6	17.6	56.0
0.166000	32.3	Off	L1	19.5	22.9	55.2
0.246000	32.3	Off	L1	19.5	19.6	51.9
0.622000	29.7	Off	L1	19.5	16.3	46.0
0.734000	35.0	Off	L1	19.5	11.0	46.0
0.782000	42.2	Off	L1	19.5	3.8	46.0
2.350000	26.3	Off	L1	18.9	19.7	46.0



**EUT Information**

Report NO : 771121  
 Test Mode : Mode 2  
 Test Voltage : 120Vac/60Hz  
 Phase : Neutral

ENV216 Auto Test-N

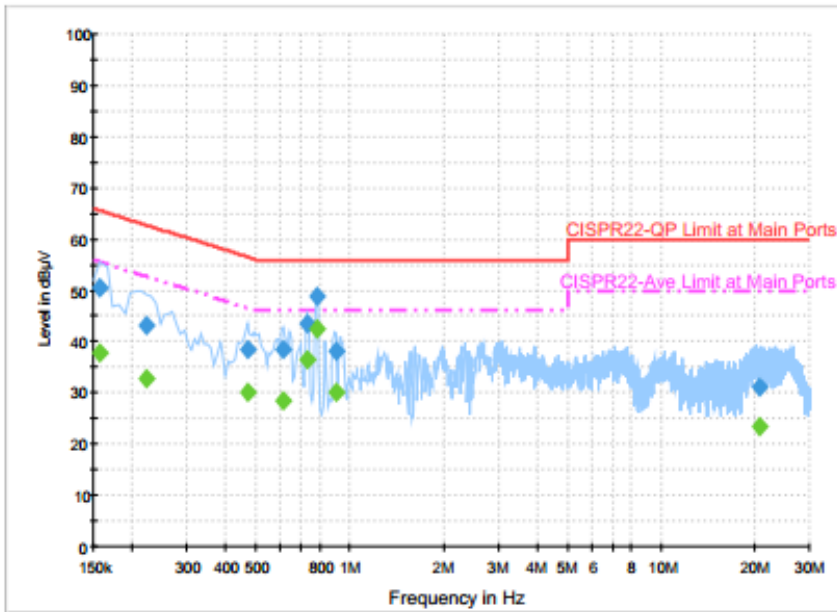

**Final Result 1**

Frequency (MHz)	QuasiPeak (dBµV)	Filter	Line	Corr. (dB)	Margin (dB)	Limit (dBµV)
0.158000	50.7	Off	N	19.5	14.9	65.6
0.222000	43.0	Off	N	19.5	19.7	62.7
0.470000	38.6	Off	N	19.5	17.9	56.5
0.614000	38.4	Off	N	19.5	17.6	56.0
0.734000	43.4	Off	N	19.5	12.6	56.0
0.782000	48.8	Off	N	19.5	7.2	56.0
0.902000	38.0	Off	N	19.5	18.0	56.0
20.758000	31.2	Off	N	19.9	28.8	60.0

**Final Result 2**

Frequency (MHz)	Average (dBµV)	Filter	Line	Corr. (dB)	Margin (dB)	Limit (dBµV)
0.158000	37.7	Off	N	19.5	17.9	55.6
0.222000	32.7	Off	N	19.5	20.0	52.7
0.470000	30.2	Off	N	19.5	16.3	46.5
0.614000	28.5	Off	N	19.5	17.5	46.0
0.734000	36.6	Off	N	19.5	9.4	46.0
0.782000	42.4	Off	N	19.5	3.6	46.0
0.902000	30.0	Off	N	19.5	16.0	46.0
20.758000	23.3	Off	N	19.9	26.7	50.0



## Appendix B. Radiated Spurious Emission

Test Engineer :	Jesse Wang, James Chiu and Potter Liu	Temperature :	22~26°C
		Relative Humidity :	52~57%

### Band 4 - 5725~5850MHz

#### WIFI 802.11a (Band Edge @ 3m)

WIFI Ant. 1	Note	Frequency ( MHz )	Level ( dBμV/m )	Over Limit ( dB )	Limit Line ( dBμV/m )	Read Level ( dBμV )	Antenna Factor ( dB/m )	Cable Loss ( dB )	Preamp Factor ( dB )	Ant Pos ( cm )	Table Pos ( deg )	Peak Avg. ( P/A )	Pol. ( H/V )	
802.11a CH 149 5745MHz		5635.6	51.95	-16.25	68.2	39.87	34.6	12.61	35.13	200	322	P	H	
		5697	54.68	-48.31	102.99	42.55	34.6	12.67	35.14	200	322	P	H	
		5715.2	66.43	-43.03	109.46	54.24	34.6	12.73	35.14	200	322	P	H	
		5724.8	71.19	-50.55	121.74	59	34.6	12.73	35.14	200	322	P	H	
	*	5745	108.67	-	-	96.43	34.6	12.79	35.15	200	322	P	H	
	*	5745	102.05	-	-	89.81	34.6	12.79	35.15	200	322	A	H	
														H
														H
			5620.4	51.65	-16.55	68.2	39.56	34.6	12.61	35.12	300	77	P	V
			5687.2	52.76	-43	95.76	40.63	34.6	12.67	35.14	300	77	P	V
			5717.2	64.78	-45.24	110.02	52.59	34.6	12.73	35.14	300	77	P	V
			5724.6	67.71	-53.58	121.29	55.52	34.6	12.73	35.14	300	77	P	V
	*		5745	105.67	-	-	93.43	34.6	12.79	35.15	300	77	P	V
	*		5745	99.12	-	-	86.88	34.6	12.79	35.15	300	77	A	V
														V
													V	



WIFI Ant. 1	Note	Frequency ( MHz )	Level ( dBμV/m )	Over Limit ( dB )	Limit Line ( dBμV/m )	Read Level ( dBμV )	Antenna Factor ( dB/m )	Cable Loss ( dB )	Preamp Factor ( dB )	Ant Pos ( cm )	Table Pos ( deg )	Peak Avg. ( P/A )	Pol. ( H/V )
		5631.6	52.66	-15.54	68.2	40.58	34.6	12.61	35.13	200	323	P	H
		5699.8	52.63	-52.42	105.05	40.5	34.6	12.67	35.14	200	323	P	H
		5718.6	52.29	-58.12	110.41	40.1	34.6	12.73	35.14	200	323	P	H
		5723.6	51.09	-67.92	119.01	38.9	34.6	12.73	35.14	200	323	P	H
	*	5785	108.08	-	-	95.79	34.6	12.85	35.16	200	323	P	H
	*	5785	101.36	-	-	89.07	34.6	12.85	35.16	200	323	A	H
		5854	50.57	-62.51	113.08	38.2	34.6	12.94	35.17	200	323	P	H
		5858.2	51.14	-58.76	109.9	38.78	34.6	12.94	35.18	200	323	P	H
		5910.4	51.59	-27.38	78.97	39.07	34.6	13.11	35.19	200	323	P	H
		5942.4	51.54	-16.66	68.2	38.94	34.6	13.2	35.2	200	323	P	H
													H
													H
<b>802.11a</b>													
<b>CH 157</b>													
<b>5785MHz</b>		5637.6	52.22	-15.98	68.2	40.14	34.6	12.61	35.13	300	75	P	V
		5663.6	52.2	-26.1	78.3	40.06	34.6	12.67	35.13	300	75	P	V
		5715.4	51.55	-57.96	109.51	39.36	34.6	12.73	35.14	300	75	P	V
		5725	51.4	-70.8	122.2	39.21	34.6	12.73	35.14	300	75	P	V
	*	5785	106	-	-	93.71	34.6	12.85	35.16	300	75	P	V
	*	5785	99.3	-	-	87.01	34.6	12.85	35.16	300	75	A	V
		5852	50.95	-66.69	117.64	38.58	34.6	12.94	35.17	300	75	P	V
		5863.4	50.95	-57.5	108.45	38.51	34.6	13.02	35.18	300	75	P	V
		5890.6	50.96	-42.66	93.62	38.53	34.6	13.02	35.19	300	75	P	V
		5935	49.9	-18.3	68.2	37.39	34.6	13.11	35.2	300	75	P	V
													V
													V





WIFI Ant. 1	Note	Frequency ( MHz )	Level ( dBμV/m )	Over Limit ( dB )	Limit Line ( dBμV/m )	Read Level ( dBμV )	Antenna Factor ( dB/m )	Cable Loss ( dB )	Preamp Factor ( dB )	Ant Pos ( cm )	Table Pos ( deg )	Peak Avg. ( P/A )	Pol. ( H/V )	
802.11a CH 165 5825MHz	*	5825	107.48	-	-	95.11	34.6	12.94	35.17	200	328	P	H	
	*	5825	100.84	-	-	88.47	34.6	12.94	35.17	200	328	A	H	
		5850	64	-58.2	122.2	51.63	34.6	12.94	35.17	200	328	P	H	
		5856.6	58.3	-52.05	110.35	45.93	34.6	12.94	35.17	200	328	P	H	
		5900.4	50.79	-35.57	86.36	38.27	34.6	13.11	35.19	200	328	P	H	
		5938.4	50.38	-17.82	68.2	37.87	34.6	13.11	35.2	200	328	P	H	
														H
														H
	*	5825	104.87	-	-	92.5	34.6	12.94	35.17	300	74	P	V	
	*	5825	98.14	-	-	85.77	34.6	12.94	35.17	300	74	A	V	
		5853.4	61.85	-52.6	114.45	49.48	34.6	12.94	35.17	300	74	P	V	
		5857.8	56.35	-53.66	110.01	43.99	34.6	12.94	35.18	300	74	P	V	
		5891.6	50.4	-42.48	92.88	37.97	34.6	13.02	35.19	300	74	P	V	
		5936.8	50.53	-17.67	68.2	38.02	34.6	13.11	35.2	300	74	P	V	
														V
														V
														V
	<b>Remark</b>	1. No other spurious found. 2. All results are PASS against Peak and Average limit line.												



**Band 4 5725~5850MHz**  
**WIFI 802.11a (Harmonic @ 3m)**

WIFI Ant. 1	Note	Frequency ( MHz )	Level ( dBμV/m )	Over Limit ( dB )	Limit Line ( dBμV/m )	Read Level ( dBμV )	Antenna Factor ( dB/m )	Cable Loss ( dB )	Preamp Factor ( dB )	Ant Pos ( cm )	Table Pos ( deg )	Peak Avg. ( P/A )	Pol. ( H/V )
802.11a CH 149 5745MHz		11490	45.66	-28.34	74	44.85	39.27	18.88	57.34	100	0	P	H
		17232	51.2	-17	68.2	41.19	42.43	23.38	55.8	100	0	P	H
													H
													H
		11490	45.52	-28.48	74	44.71	39.27	18.88	57.34	100	0	P	V
		17232	50.29	-17.91	68.2	40.28	42.43	23.38	55.8	100	0	P	V
													V
													V
802.11a CH 157 5785MHz		11570	44.43	-29.57	74	43.47	39.2	18.95	57.19	100	0	P	H
		17352	50.67	-17.53	68.2	40.78	42.24	23.45	55.8	100	0	P	H
													H
													H
		11570	45.76	-28.24	74	44.8	39.2	18.95	57.19	100	0	P	V
		17352	50.36	-17.84	68.2	40.47	42.24	23.45	55.8	100	0	P	V
													V
													V
802.11a CH 165 5825MHz		11650	45.45	-28.55	74	44.39	39.11	19.03	57.08	100	0	P	H
		17472	50.26	-17.94	68.2	40.49	42.05	23.52	55.8	100	0	P	H
													H
													H
		11650	45.64	-28.36	74	44.58	39.11	19.03	57.08	100	0	P	V
		17472	49.8	-18.4	68.2	40.03	42.05	23.52	55.8	100	0	P	V
													V
													V
Remark	1. No other spurious found. 2. All results are PASS against Peak and Average limit line.												



**Band 4 5725~5850MHz**  
**WIFI 802.11n HT20 (Band Edge @ 3m)**

WIFI Ant. 1	Note	Frequency ( MHz )	Level ( dBμV/m )	Over Limit ( dB )	Limit Line ( dBμV/m )	Read Level ( dBμV )	Antenna Factor ( dB/m )	Cable Loss ( dB )	Preamp Factor ( dB )	Ant Pos ( cm )	Table Pos ( deg )	Peak Avg. ( P/A )	Pol. ( H/V )	
802.11n HT20 CH 149 5745MHz		5639.8	52.86	-15.34	68.2	40.78	34.6	12.61	35.13	200	323	P	H	
		5699.2	57.87	-46.74	104.61	45.74	34.6	12.67	35.14	200	323	P	H	
		5715.8	69.36	-40.27	109.63	57.17	34.6	12.73	35.14	200	323	P	H	
		5722.8	73.52	-43.66	117.18	61.33	34.6	12.73	35.14	200	323	P	H	
	*	5745	109.07	-	-	96.83	34.6	12.79	35.15	200	323	P	H	
	*	5745	102.02	-	-	89.78	34.6	12.79	35.15	200	323	A	H	
														H
														H
			5634.6	51.8	-16.4	68.2	39.72	34.6	12.61	35.13	300	75	P	V
			5658	52.84	-21.3	74.14	40.76	34.6	12.61	35.13	300	75	P	V
			5720	65.21	-45.59	110.8	53.02	34.6	12.73	35.14	300	75	P	V
			5725	70.11	-52.09	122.2	57.92	34.6	12.73	35.14	300	75	P	V
	*		5745	106.07	-	-	93.83	34.6	12.79	35.15	300	75	P	V
	*		5745	99	-	-	86.76	34.6	12.79	35.15	300	75	A	V
														V
													V	



WIFI Ant. 1	Note	Frequency ( MHz )	Level ( dBμV/m )	Over Limit ( dB )	Limit Line ( dBμV/m )	Read Level ( dBμV )	Antenna Factor ( dB/m )	Cable Loss ( dB )	Preamp Factor ( dB )	Ant Pos ( cm )	Table Pos ( deg )	Peak Avg. (P/A)	Pol. (H/V)
		5638.2	52.82	-15.38	68.2	40.74	34.6	12.61	35.13	200	326	P	H
		5683	52.59	-40.07	92.66	40.46	34.6	12.67	35.14	200	326	P	H
		5712.8	51.15	-57.64	108.79	38.96	34.6	12.73	35.14	200	326	P	H
		5722.6	52.77	-63.96	116.73	40.58	34.6	12.73	35.14	200	326	P	H
	*	5785	108.8	-	-	96.51	34.6	12.85	35.16	200	326	P	H
	*	5785	101.72	-	-	89.43	34.6	12.85	35.16	200	326	A	H
		5854.4	50.12	-62.05	112.17	37.75	34.6	12.94	35.17	200	326	P	H
		5863.2	50.5	-58	108.5	38.06	34.6	13.02	35.18	200	326	P	H
		5912	51.15	-26.64	77.79	38.63	34.6	13.11	35.19	200	326	P	H
		5931.6	50.6	-17.6	68.2	38.08	34.6	13.11	35.19	200	326	P	H
802.11n													H
HT20													H
CH 157		5608.6	51.56	-16.64	68.2	39.52	34.6	12.56	35.12	300	75	P	V
5785MHz		5660.6	52.45	-23.62	76.07	40.31	34.6	12.67	35.13	300	75	P	V
		5718.8	51.31	-59.15	110.46	39.12	34.6	12.73	35.14	300	75	P	V
		5724.8	51.95	-69.79	121.74	39.76	34.6	12.73	35.14	300	75	P	V
	*	5785	106.5	-	-	94.21	34.6	12.85	35.16	300	75	P	V
	*	5785	99.38	-	-	87.09	34.6	12.85	35.16	300	75	A	V
		5852.4	49.76	-66.97	116.73	37.39	34.6	12.94	35.17	300	75	P	V
		5859.4	50.83	-58.74	109.57	38.47	34.6	12.94	35.18	300	75	P	V
		5876.2	50.75	-53.56	104.31	38.31	34.6	13.02	35.18	300	75	P	V
		5943.6	50.52	-17.68	68.2	37.92	34.6	13.2	35.2	300	75	P	V
													V
													V



WIFI Ant. 1	Note	Frequency ( MHz )	Level ( dBμV/m )	Over Limit ( dB )	Limit Line ( dBμV/m )	Read Level ( dBμV )	Antenna Factor ( dB/m )	Cable Loss ( dB )	Preamp Factor ( dB )	Ant Pos ( cm )	Table Pos ( deg )	Peak Avg. ( P/A )	Pol. ( H/V )	
802.11n HT20 CH 165 5825MHz	*	5825	108.24	-	-	95.87	34.6	12.94	35.17	200	327	P	H	
	*	5825	101.15	-	-	88.78	34.6	12.94	35.17	200	327	A	H	
		5850	67.34	-54.86	122.2	54.97	34.6	12.94	35.17	200	327	P	H	
		5855.4	62.99	-47.7	110.69	50.62	34.6	12.94	35.17	200	327	P	H	
		5882.2	51.29	-48.56	99.85	38.85	34.6	13.02	35.18	200	327	P	H	
		5942.8	50.96	-17.24	68.2	38.36	34.6	13.2	35.2	200	327	P	H	
														H
														H
	*	5825	105.48	-	-	93.11	34.6	12.94	35.17	300	74	P	V	
	*	5825	98.45	-	-	86.08	34.6	12.94	35.17	300	74	A	V	
		5851	63.5	-56.42	119.92	51.13	34.6	12.94	35.17	300	74	P	V	
		5855.2	61.93	-48.81	110.74	49.56	34.6	12.94	35.17	300	74	P	V	
		5895.2	50.69	-39.52	90.21	38.26	34.6	13.02	35.19	300	74	P	V	
		5942	50.7	-17.5	68.2	38.1	34.6	13.2	35.2	300	74	P	V	
														V
													V	
<b>Remark</b>	1. No other spurious found. 2. All results are PASS against Peak and Average limit line.													



**Band 4 5725~5850MHz**  
**WIFI 802.11n HT20 (Harmonic @ 3m)**

WIFI Ant. 1	Note	Frequency ( MHz )	Level ( dBμV/m )	Over Limit ( dB )	Limit Line ( dBμV/m )	Read Level ( dBμV )	Antenna Factor ( dB/m )	Cable Loss ( dB )	Preamp Factor ( dB )	Ant Pos ( cm )	Table Pos ( deg )	Peak Avg. ( P/A )	Pol. ( H/V )
802.11n HT20 CH 149 5745MHz		11490	45.02	-28.98	74	44.21	39.27	18.88	57.34	100	0	P	H
		17232	50.56	-17.64	68.2	40.55	42.43	23.38	55.8	100	0	P	H
													H
													H
		11490	44.66	-29.34	74	43.85	39.27	18.88	57.34	100	0	P	V
		17232	50.56	-17.64	68.2	40.55	42.43	23.38	55.8	100	0	P	V
													V
802.11n HT20 CH 157 5785MHz		11570	45.37	-28.63	74	44.41	39.2	18.95	57.19	100	0	P	H
		17352	51.2	-17	68.2	41.31	42.24	23.45	55.8	100	0	P	H
													H
													H
		11570	44.69	-29.31	74	43.73	39.2	18.95	57.19	100	0	P	V
		17352	49.93	-18.27	68.2	40.04	42.24	23.45	55.8	100	0	P	V
													V
802.11n HT20 CH 165 5825MHz		11650	44.9	-29.1	74	43.84	39.11	19.03	57.08	100	0	P	H
		17472	49.85	-18.35	68.2	40.08	42.05	23.52	55.8	100	0	P	H
													H
													H
		11650	45.7	-28.3	74	44.64	39.11	19.03	57.08	100	0	P	V
		17472	50.3	-17.9	68.2	40.53	42.05	23.52	55.8	100	0	P	V
													V
Remark	1. No other spurious found.												
	2. All results are PASS against Peak and Average limit line.												



Emission below 1GHz

5GHz WIFI 802.11n HT20 (LF @ 3m)

WIFI	Note	Frequency	Level	Over	Limit	Read	Antenna	Cable	Preamp	Ant	Table	Peak	Pol.	
Ant.				Limit	Line	Level	Factor	Loss	Factor	Pos	Pos	Avg.		
1		( MHz )	( dBμV/m )	( dB )	( dBμV/m )	( dBμV )	( dB/m )	( dB )	( dB )	( cm )	( deg )	( P/A )	( H/V )	
5GHz 802.11n HT20 LF		30	27.76	-12.24	40	31.4	26	1.71	31.35	-	-	P	H	
		140.43	31.19	-12.31	43.5	42.12	17.97	2.62	31.52	-	-	P	H	
		298.38	27.89	-18.11	46	36.12	19.79	3.28	31.3	-	-	P	H	
		351.1	30.66	-15.34	46	37.08	21.22	3.57	31.21	-	-	P	H	
		910.4	33.79	-12.21	46	29.72	29.26	5.33	30.52	-	-	P	H	
		951	34.42	-11.58	46	29.33	30.2	5.4	30.51	100	110	P	H	
														H
														H
														H
														H
														H
														H
														H
														H
														H
														H
			30	30.73	-9.27	40	34.37	26	1.71	31.35	100	276	P	V
			135.3	33.17	-10.33	43.5	44.23	18.12	2.34	31.52	-	-	P	V
		216.57	25.61	-20.39	46	37.95	16.36	2.72	31.42	-	-	P	V	
		372.8	29.51	-16.49	46	35.38	21.74	3.57	31.18	-	-	P	V	
		925.8	33.65	-12.35	46	29.2	29.64	5.33	30.52	-	-	P	V	
		956.6	34.29	-11.71	46	29.19	30.21	5.4	30.51	-	-	P	V	
													V	
													V	
													V	
													V	
													V	
													V	
													V	
<b>Remark</b>	1. No other spurious found. 2. All results are PASS against limit line.													



**Note symbol**

*	<b>Fundamental Frequency</b> which can be ignored. However, the level of any unwanted emissions shall not exceed the level of the fundamental frequency.
!	Test result is <b>over limit</b> line.
P/A	<b>Peak</b> or <b>Average</b>
H/V	<b>Horizontal</b> or <b>Vertical</b>





A calculation example for radiated spurious emission is shown as below:

WIFI	Note	Frequency	Level	Over	Limit	Read	Antenna	Cable	Preamp	Ant	Table	Peak	Pol.
Ant.				Limit	Line	Level	Factor	Loss	Factor	Pos	Pos	Avg.	
1		( MHz )	( dBμV/m )	( dB )	( dBμV/m )	( dBμV )	( dB/m )	( dB )	( dB )	( cm )	( deg )	( P/A )	( H/V )
802.11b		2390	55.45	-18.55	74	54.51	32.22	4.58	35.86	103	308	P	H
CH 01													
2412MHz		2390	43.54	-10.46	54	42.6	32.22	4.58	35.86	103	308	A	H

- Level(dBμV/m) =  
Antenna Factor(dB/m) + Cable Loss(dB) + Read Level(dBμV) - Preamp Factor(dB)
- Over Limit(dB) = Level(dBμV/m) – Limit Line(dBμV/m)

**For Peak Limit @ 2390MHz:**

- Level(dBμV/m)  
= Antenna Factor(dB/m) + Cable Loss(dB) + Read Level(dBμV) - Preamp Factor(dB)  
= 32.22(dB/m) + 4.58(dB) + 54.51(dBμV) – 35.86 (dB)  
= 55.45 (dBμV/m)
- Over Limit(dB)  
= Level(dBμV/m) – Limit Line(dBμV/m)  
= 55.45(dBμV/m) – 74(dBμV/m)  
= -18.55(dB)

**For Average Limit @ 2390MHz:**

- Level(dBμV/m)  
= Antenna Factor(dB/m) + Cable Loss(dB) + Read Level(dBμV) - Preamp Factor(dB)  
= 32.22(dB/m) + 4.58(dB) + 42.6(dBμV) – 35.86 (dB)  
= 43.54 (dBμV/m)
- Over Limit(dB)  
= Level(dBμV/m) – Limit Line(dBμV/m)  
= 43.54(dBμV/m) – 54(dBμV/m)  
= -10.46(dB)

Both peak and average measured complies with the limit line, so test result is “PASS”.



## Appendix C. Radiated Spurious Emission Plots

Test Engineer :	Jesse Wang, James Chiu and Potter Liu	Temperature :	22~26°C
		Relative Humidity :	52~57%

### Note symbol

-L	Low channel location
-R	High channel location



**Band 4 - 5725~5850MHz**  
**WIFI 802.11a (Band Edge @ 3m)**

WIFI	Band 4 5725~5850MHz Band Edge @ 3m	
ANT	802.11a CH149 5745MHz	
1	Horizontal	Fundamental
<b>Peak</b>	<p>Date: 2017.09.04 PEAK_BE(04)_16.33</p> <p>Site : 03CH07-11Y Condition : PEAK_BE(04)_16.24 3m HF-ANT_130829 HORIZONTAL Detector : Peak Project : 771121 Mode : 14</p>	<p>Date: 2017.09.04 PEAK(UNB)_16.33</p> <p>Site : 03CH07-11Y Condition : PEAK(UNB)_16.24 3m HF-ANT_130829 HORIZONTAL Detector : Peak Project : 771121 Mode : 14</p>



WIFI	Band 4 5725~5850MHz Band Edge @ 3m	
ANT	802.11a CH149 5745MHz	
1	Vertical	Fundamental
Peak	<p>Date: 2017.08.04 PEAK_BE(B4)_15.24</p> <p>Site : 03CH07-HY Condition : PEAK_BE(B4)_15.24 3m HF-ANT_130829 VERTICAL REW: 1000.000KHz VBW: 3000.000KHz SWT: Auto Detector : Peak Project : 771121 Mode : 14</p>	<p>Date: 2017.08.04</p> <p>Site : 03CH07-HY Condition : PEAK(LNB) 3m HF-ANT_130829 VERTICAL REW: 1000.000KHz VBW: 3000.000KHz SWT: Auto Detector : Peak Project : 771121 Mode : 14</p>



WIFI	Band 4 5725~5850MHz Band Edge @ 3m	
ANT	802.11a CH157 5785MHz	
1	Horizontal	Fundamental
Peak	<p>Site : 03CH07-HY            Condition : PEAK_BE(B4)_16.24 3m HF-ANT_130829 HORIZONTAL            Detector : Peak            Project : 771121            Mode : 15</p>	<p>Site : 03CH07-HY            Condition : PEAK(LUMI) 3m HF-ANT_130829 HORIZONTAL            Detector : Peak            Project : 771121            Mode : 15</p>
Peak	<p>Site : 03CH07-HY            Condition : PEAK_BE(B4)_16.24 3m HF-ANT_130829 HORIZONTAL            Detector : Peak            Project : 771121            Mode : 15</p>	Left blank



WIFI	Band 4 5725~5850MHz Band Edge @ 3m	
ANT	802.11a CH157 5785MHz	
1	Vertical	Fundamental
Peak	<p>Site : 03CH07-HY            Condition : PEAK_BE(B4)_16.24 3m HF-ANT_13829 VERTICAL            Detector : Peak            Project : 771121            Mode : 15</p>	<p>Site : 03CH07-HY            Condition : PEAK_BE(B4)_16.24 3m HF-ANT_13829 VERTICAL            Detector : Peak            Project : 771121            Mode : 15</p>
Peak	<p>Site : 03CH07-HY            Condition : PEAK_BE(B4)_16.24 3m HF-ANT_13829 VERTICAL            Detector : Peak            Project : 771121            Mode : 15</p>	Left blank



WIFI	Band 4 5725~5850MHz Band Edge @ 3m	
ANT	802.11a CH165 5825MHz	
1	Horizontal	Fundamental
Peak	<p>Site : 03CH07-HY            Condition : PEAK_BE(B4)_16.24 3m HF-ANT_130829 HORIZONTAL            Detector : Peak            Project : 771121            Mode : 16</p>	<p>Site : 03CH07-HY            Condition : PEAK(LUMI) 3m HF-ANT_130829 HORIZONTAL            Detector : Peak            Project : 771121            Mode : 16</p>



WIFI	Band 4 5725~5850MHz Band Edge @ 3m	
ANT	802.11a CH165 5825MHz	
1	Vertical	Fundamental
Peak	<p>Site : 03CH07-HY          Condition : PEAK_BE(B4)_16.24 3m HF-ANT_130829 VERTICAL          Detector : Peak          Project : 771121          Mode : 16</p>	<p>Site : 03CH07-HY          Condition : PEAK(LUMI) 3m HF-ANT_130829 VERTICAL          Detector : Peak          Project : 771121          Mode : 16</p>



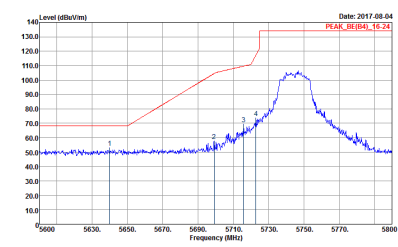
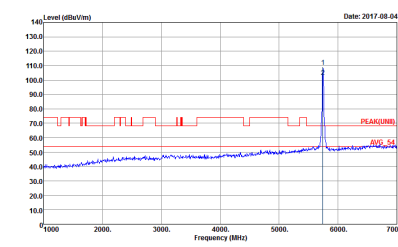

**Band 4 5725~5850MHz**  
**WIFI 802.11n HT20 (Band Edge @ 3m)**

WIFI	Band 4 5725~5850MHz Band Edge @ 3m	
ANT	802.11n HT20 CH149 5745MHz	
1	Horizontal	Fundamental
Peak	 <p>Site : 03CH07-HY          Condition : PEAK_BB(SHA) 16.24 3m HF-ANT_130829 HORIZONTAL          Detector : Peak          Project : 771121          Mode : 26</p>	 <p>Site : 03CH07-HY          Condition : PEAK(LIN) 3m HF-ANT_130829 HORIZONTAL          Detector : Peak          Project : 771121          Mode : 26</p>



WIFI	Band 4 5725~5850MHz Band Edge @ 3m	
ANT	802.11n HT20 CH149 5745MHz	
1	Vertical	Fundamental
Peak	<p>Site : 03CH07-HY          Condition : PEAK_BE(B4), 16.24 3m HF-ANT, 130829 VERTICAL          Detector : RSW, 1000.000KHz VBW, 3000.000KHz SWT, Auto          Detector : Peak          Project : 771121          Mode : 25</p>	<p>Site : 03CH07-HY          Condition : PEAK(LINE) 3m HF-ANT, 130829 VERTICAL          Detector : RSW, 1000.000KHz VBW, 3000.000KHz SWT, Auto          Detector : Peak          Project : 771121          Mode : 25</p>



WIFI	Band 4 5725~5850MHz Band Edge @ 3m	
ANT	802.11n HT20 CH157 5785MHz	
1	Horizontal	Fundamental
Peak	<p>Site : 03CH07-HY            Condition : PEAK_BE(B4)_16.24 3m HF-ANT_130829 HORIZONTAL            Detector : Peak            Project : 771121            Mode : 27</p>	<p>Site : 03CH07-HY            Condition : PEAK(B4)_16.24 3m HF-ANT_130829 HORIZONTAL            Detector : Peak            Project : 771121            Mode : 27</p>
Peak	<p>Site : 03CH07-HY            Condition : PEAK_BE(B4)_16.24 3m HF-ANT_130829 HORIZONTAL            Detector : Peak            Project : 771121            Mode : 27</p>	Left blank



WIFI	Band 4 5725~5850MHz Band Edge @ 3m	
ANT	802.11n HT20 CH157 5785MHz	
1	Vertical	Fundamental
Peak	<p>Date: 2017.08.05 PEAK_BE(B4)_16.24</p> <p>Site : 03CH07-HY Condition : PEAK_BE(B4)_16.24 3m HF-ANT_130829 VERTICAL Detector : Peak Project : 771121 Mode : 27</p>	<p>Date: 2017.08.05 PEAK(BE(B4)_16.24</p> <p>Site : 03CH07-HY Condition : PEAK(LUMI) 3m HF-ANT_130829 VERTICAL Detector : Peak Project : 771121 Mode : 27</p>
Peak	<p>Date: 2017.08.05 PEAK_BE(B4)_16.24</p> <p>Site : 03CH07-HY Condition : PEAK_BE(B4)_16.24 3m HF-ANT_130829 VERTICAL Detector : Peak Project : 771121 Mode : 27</p>	Left blank



WIFI	Band 4 5725~5850MHz Band Edge @ 3m	
ANT	802.11n HT20 CH165 5825MHz	
1	Horizontal	Fundamental
Peak	<p>Site : 03CH07-HY            Condition : PEAK_BE(B4)_16.24 3m HF-ANT_130829 HORIZONTAL            Detector : Peak            Project : 771121            Mode : 29</p>	<p>Site : 03CH07-HY            Condition : PEAK(LUMI) 3m HF-ANT_130829 HORIZONTAL            Detector : Peak            Project : 771121            Mode : 29</p>



WIFI	Band 4 5725~5850MHz Band Edge @ 3m	
ANT	802.11n HT20 CH165 5825MHz	
1	Vertical	Fundamental
Peak	<p>Site : 03CH07-HY          Condition : PEAK_BE(B4)_16-24 3m HF-ANT_130829 VERTICAL          Detector : Peak          Project : 771121          Mode : 25</p>	<p>Site : 03CH07-HY          Condition : PEAK(LINE) 3m HF-ANT_130829 VERTICAL          Detector : Peak          Project : 771121          Mode : 25</p>

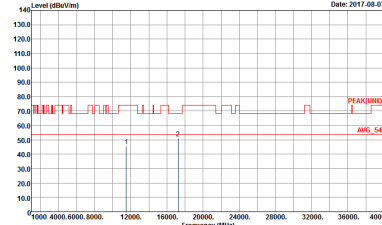
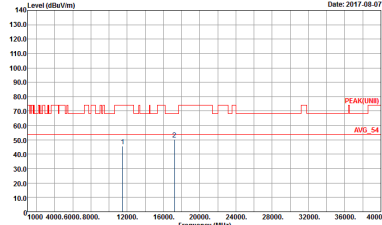

**Band 4 - 5725~5850MHz**  
**WIFI 802.11a (Harmonic @ 3m)**

WIFI	Band 4 5725~5850MHz Harmonic @ 3m	
ANT	802.11a CH149 5745MHz	
1	Horizontal	Vertical
<p><b>Peak</b></p> <p><b>Avg.</b></p>	 <p>Site : 03CH074NY            Condition : PEAK(UM) 3m SHF-EHF_131029 HORIZONTAL            Detector : Peak            Project : 771121            Mode : 14</p>	 <p>Site : 03CH074NY            Condition : PEAK(UM) 3m SHF-EHF_131029 VERTICAL            Detector : Peak            Project : 771121            Mode : 14</p>



WIFI	Band 4 5725~5850MHz Harmonic @ 3m	
ANT	802.11a CH157 5785MHz	
1	Horizontal	Vertical
Peak Avg.	<p>Site : 03CH07-HY Condition : PEAQ(UWB) 3m SHF-EHF_131029 HORIZONTAL Detector : Peak Project : 771121 Mode : 15</p>	<p>Site : 03CH07-HY Condition : PEAQ(UWB) 3m SHF-EHF_131029 VERTICAL Detector : Peak Project : 771121 Mode : 15</p>





WIFI	Band 4 5725~5850MHz Harmonic @ 3m	
ANT	802.11a CH165 5825MHz	
1	Horizontal	Vertical
Peak Avg.	<p>Site : 03CH07-HY Condition : PEAQ(UWB) 3m SHF-EHF_131029 HORIZONTAL Detector : Peak Project : 771121 Mode : 16</p>	<p>Site : 03CH07-HY Condition : PEAQ(UWB) 3m SHF-EHF_131029 VERTICAL Detector : Peak Project : 771121 Mode : 16</p>



**Band 4 5725~5850MHz  
WIFI 802.11n HT20 (Harmonic @ 3m)**

<b>WIFI</b>	<b>Band 4 5725~5850MHz Harmonic @ 3m</b>	
<b>ANT</b>	<b>802.11n HT20 CH149 5745MHz</b>	
<b>1</b>	<b>Horizontal</b>	<b>Vertical</b>
<b>Peak Avg.</b>		



WIFI	Band 4 5725~5850MHz Harmonic @ 3m	
ANT	802.11n HT20 CH157 5785MHz	
1	Horizontal	Vertical
Peak Avg.	<p>Site : 03CH07-HY Condition : PEAQ(UWB) 3m SHF-EHF_131029 HORIZONTAL Detector : Peak Project : 771121 Mode : 27</p>	<p>Site : 03CH07-HY Condition : PEAQ(UWB) 3m SHF-EHF_131029 VERTICAL Detector : Peak Project : 771121 Mode : 27</p>



WIFI	Band 4 5725~5850MHz Harmonic @ 3m	
ANT	802.11n HT20 CH165 5825MHz	
1	Horizontal	Vertical
Peak Avg.		



Emission below 1GHz  
5GHz WIFI 802.11n HT20 (LF)

WIFI	5GHz 5725~5850MHz	
ANT	802.11n HT20 LF	
1	Horizontal	Vertical
QP / Peak	<p>Site : 03CH07-HY Condition : QP 3m LF-ANT-35419(E) HORIZONTAL Detector : Peak Project : 771121 Mode : 30</p>	<p>Site : 03CH07-HY Condition : QP 3m LF-ANT-35419(E) VERTICAL Detector : Peak Project : 771121 Mode : 30</p>



## Appendix D. Duty Cycle Plots

Band	Duty Cycle(%)	T(us)	1/T(kHz)	VBW Setting
802.11a	98.052	-	-	10Hz
5GHz 802.11n HT20	98.052	-	-	10Hz



802.11a

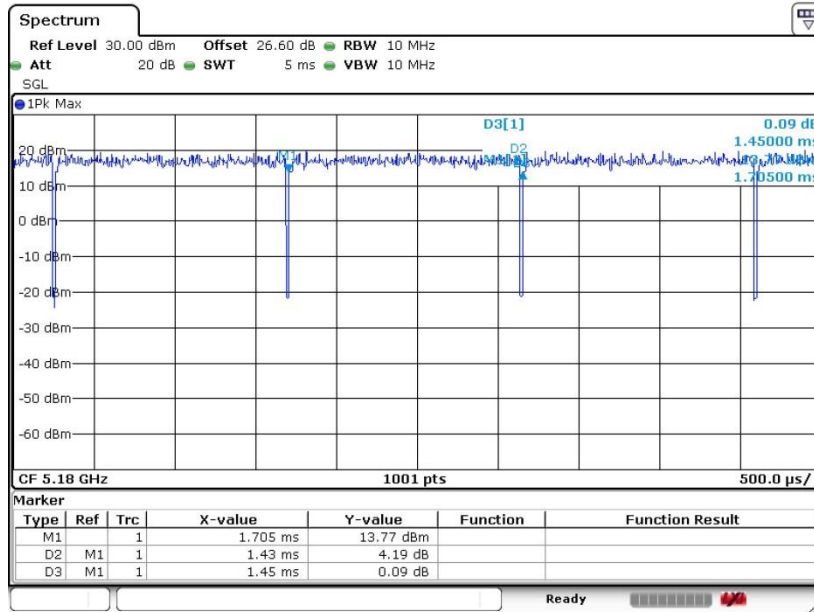

Date: 17.JUL.2017 16:38:06

802.11n HT20

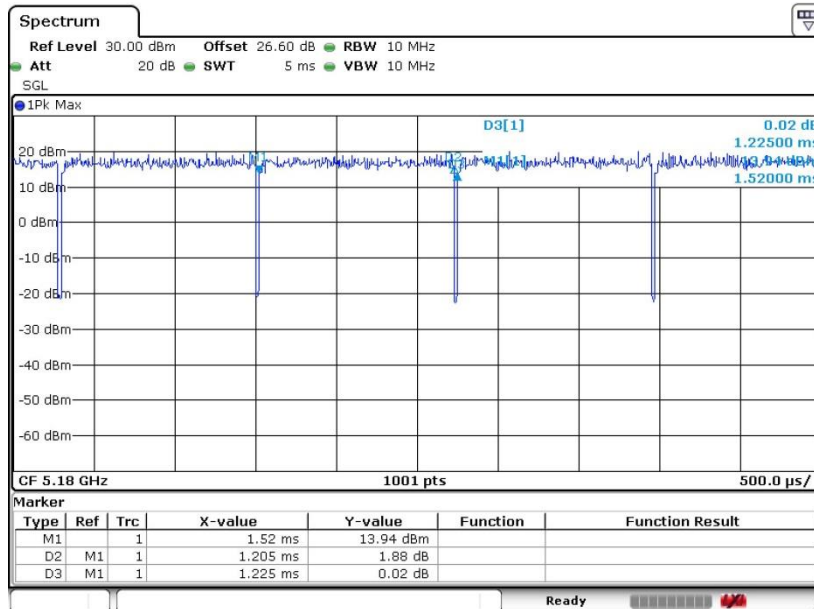

Date: 17.JUL.2017 16:39:53