



# FCC RF Test Report

**APPLICANT** : Zebra Technologies Corporation  
**EQUIPMENT** : Enterprise Digital Assistant  
**BRAND NAME** : Zebra  
**MODEL NAME** : MC55E0  
**MARKETING NAME** : MC55E0  
**FCC ID** : UZ7MC55E0  
**STANDARD** : FCC Part 15 Subpart E §15.407  
**CLASSIFICATION** : (NII) Unlicensed National Information Infrastructure

The product was received on Jul. 11, 2017 and testing was completed on Aug. 10, 2017. We, SPORTON INTERNATIONAL INC., would like to declare that the tested sample has been evaluated in accordance with the test procedures and has been in compliance with the applicable technical standards.

The test results in this report apply exclusively to the tested model / sample. Without written approval of SPORTON INTERNATIONAL INC., the test report shall not be reproduced except in full.

Reviewed by: Joseph Lin / Supervisor

Approved by: Jones Tsai / Manager



## **SPORTON INTERNATIONAL INC.**

**No. 52, Hwa Ya 1<sup>st</sup> Rd., Hwa Ya Technology Park, Kwei-Shan District, Tao Yuan City, Taiwan, R.O.C.**

---

**SPORTON INTERNATIONAL INC.**

TEL : 886-3-327-3456

FAX : 886-3-328-4978

FCC ID : UZ7MC55E0

Page Number : 1 of 36

Report Issued Date : Sep. 12, 2017

Report Version : Rev. 01

Report Template No.: BU5-FR15EWL MA Version 2.0



# TABLE OF CONTENTS

**REVISION HISTORY.....3**

**SUMMARY OF TEST RESULT .....4**

**1 GENERAL DESCRIPTION .....5**

    1.1 Applicant .....5

    1.2 Manufacturer.....5

    1.3 Feature of Equipment Under Test .....5

    1.4 Modification of EUT .....6

    1.5 Testing Location .....7

    1.6 Applicable Standards.....7

**2 TEST CONFIGURATION OF EQUIPMENT UNDER TEST .....8**

    2.1 Carrier Frequency and Channel .....8

    2.2 Test Mode.....9

    2.3 Connection Diagram of Test System.....10

    2.4 Support Unit used in test configuration and system .....11

    2.5 EUT Operation Test Setup .....11

    2.6 Measurement Results Explanation Example.....11

**3 TEST RESULT.....12**

    3.1 26dB & 99% Occupied Bandwidth Measurement .....12

    3.2 Maximum Conducted Output Power Measurement .....16

    3.3 Power Spectral Density Measurement .....19

    3.4 Unwanted Emissions Measurement.....23

    3.5 AC Conducted Emission Measurement.....29

    3.6 Frequency Stability Measurement.....31

    3.7 Automatically Discontinue Transmission .....34

    3.8 Antenna Requirements.....34

**4 LIST OF MEASURING EQUIPMENT .....35**

**5 UNCERTAINTY OF EVALUATION .....36**

**APPENDIX A. AC CONDUCTED EMISSION TEST RESULT**

**APPENDIX B. RADIATED SPURIOUS EMISSION**

**APPENDIX C. RADIATED SPURIOUS EMISSION PLOTS**

**APPENDIX D. DUTY CYCLE PLOTS**

**APPENDIX E. SETUP PHOTOGRAPHS**



### REVISION HISTORY

REPORT NO.	VERSION	DESCRIPTION	ISSUED DATE
FR771121C	Rev. 01	Initial issue of report	Sep. 12, 2017



### SUMMARY OF TEST RESULT

Report Section	FCC Rule	Description	Limit	Result	Remark
3.1	2.1049 15.403(i)	26dB & 99% Bandwidth	-	Pass	-
3.2	15.407(a)	Maximum Conducted Output Power	FCC ≤ 24 dBm (depend on band)	Pass	-
3.3	15.407(a)	Power Spectral Density	FCC ≤ 11 dBm (depend on band)	Pass	-
3.4	15.407(b)	Unwanted Emissions	≤ -17, -27 dBm (depend on band)&15.209(a)	Pass	Under limit 2.39 dB at 5725.960 MHz
3.5	15.207	AC Conducted Emission	15.207(a)	Pass	Under limit 3.6 dB at 0.782 MHz
3.6	15.407(g)	Frequency Stability	Within Operation Band	Pass	-
3.7	15.407(c)	Automatically Discontinue Transmission	Discontinue Transmission	Pass	-
3.8	15.203 & 15.407(a)	Antenna Requirement	N/A	Pass	-



# 1 General Description

## 1.1 Applicant

**Zebra Technologies Corporation**  
1 Zebra Plaza Holtsville, NY 11742

## 1.2 Manufacturer

**Zebra Technologies Corporation**  
1 Zebra Plaza Holtsville, NY 11742

## 1.3 Feature of Equipment Under Test

Product Feature	
Equipment	Enterprise Digital Assistant
Brand Name	Zebra
Model Name	MC55E0
FCC ID	UZ7MC55E0
EUT supports Radios application	WLAN 11a/b/g/n HT20 BluetoothBR/EDR
HW Version	EV2
SW Version	1.57.0000
FW Version	FUSION X_2.03.0.0.018R
MFD	26JUN17
EUT Stage	Engineering sample

**Remark:** The above EUT's information was declared by manufacturer. Please refer to the specifications or user's manual for more detailed description.

Specification of Accessories				
Adapter (5.4V/1.2A)	Brand Name	Zebra	Part Number	PWR-BUA5V16W0WW
Battery 1 (White)	Brand Name	Zebra	Part Number	82-111094-02
Battery 2 (Black)	Brand Name	Zebra	Part Number	82-111094-01
USB Cable	Brand Name	Zebra	Part Number	25-108022-04R
DC Cable Line	Brand Name	Zebra	Part Number	CBL-DC-383A1-01
Holster 1	Brand Name	Zebra	Part Number	SG-MC551110-01R
Holster 2	Brand Name	Zebra	Part Number	SG-MC552110-01R



### 1.4 Modification of EUT

Standards-related Product Specification	
<b>Tx/Rx Frequency Range</b>	5180 MHz ~ 5240 MHz 5260 MHz ~ 5320 MHz 5500 MHz ~ 5700 MHz
<b>Maximum Output Power to Antenna</b>	<b>&lt;5180 MHz ~ 5240 MHz&gt;</b> 802.11a : 11.85 dBm / 0.0153 W 802.11n HT20 : 11.39 dBm / 0.0138 W
	<b>&lt;5260 MHz ~ 5320 MHz&gt;</b> 802.11a : 13.13 dBm / 0.0206 W 802.11n HT20 : 12.85 dBm / 0.0193 W
	<b>&lt;5500 MHz ~ 5700 MHz&gt;</b> 802.11a : 13.58 dBm / 0.0228 W 802.11n HT20 : 12.94 dBm / 0.0197 W
<b>99% Occupied Bandwidth</b>	<b>&lt;5180 MHz ~ 5240 MHz&gt;</b> 802.11a : 17.95 MHz 802.11n HT20 : 18.95 MHz
	<b>&lt;5260 MHz ~ 5320 MHz&gt;</b> 802.11a : 17.80 MHz 802.11n HT20 : 18.95 MHz
	<b>&lt;5500 MHz ~ 5700 MHz&gt;</b> 802.11a : 17.90 MHz 802.11n HT20 : 19.00 MHz
<b>Antenna Type / Gain</b>	<b>&lt;5180 MHz ~ 5240 MHz&gt;</b> Fixed Internal Antenna with gain 3.41 dBi
	<b>&lt;5260 MHz ~ 5320 MHz&gt;</b> Fixed Internal Antenna with gain 3.41 dBi
	<b>&lt;5500 MHz ~ 5700 MHz&gt;</b> Fixed Internal Antenna with gain 3.41 dBi
<b>Type of Modulation</b>	802.11a/n : OFDM (BPSK / QPSK / 16QAM / 64QAM)



### 1.5 Testing Location

Sporton Lab is accredited to ISO 17025 by Taiwan Accreditation Foundation (TAF code : 1190) and the FCC designation No. TW1190 under the FCC 2.948(e) by Mutual Recognition Agreement (MRA) in FCC Test.

<b>Test Site</b>	SPORTON INTERNATIONAL INC.		
<b>Test Site Location</b>	No. 52, Hwa Ya 1 <sup>st</sup> Rd., Hwa Ya Technology Park, Kwei-Shan District, Tao Yuan City, Taiwan, R.O.C. TEL: +886-3-327-3456 FAX: +886-3-328-4978		
<b>Test Site No.</b>	<b>Sporton Site No.</b>		
	TH05-HY	CO05-HY	03CH07-HY

**Note:** The test site complies with ANSI C63.4 2014 requirement.

### 1.6 Applicable Standards

According to the specifications of the manufacturer, the EUT must comply with the requirements of the following standards:

- ♦ FCC Part 15 Subpart E
- ♦ FCC KDB 789033 D02 General UNII Test Procedures New Rules v01r04
- ♦ ANSI C63.10-2013

**Remark:**

1. All test items were verified and recorded according to the standards and without any deviation during the test.
2. This EUT has also been tested and complied with the requirements of FCC Part 15, Subpart B, recorded in a separate test report.



## 2 Test Configuration of Equipment Under Test

- a. The EUT has been associated with peripherals and configuration operated in a manner tended to maximize its emission characteristics in a typical application. Frequency range investigated: conduction emission (150 kHz to 30 MHz), radiation emission (9 kHz to the 10th harmonic of the highest fundamental frequency or to 40 GHz, whichever is lower). For radiated measurement, pre-scanned in three orthogonal panels, X, Y, Z. The worst cases (Z plane) were recorded in this report.
- b. AC power line Conducted Emission was tested under maximum output power.

### 2.1 Carrier Frequency and Channel

Frequency Band	Channel	Freq. (MHz)	Channel	Freq. (MHz)
5150-5250 MHz Band 1 (U-NII-1)	36	5180	44	5220
	-	-	-	-
	40	5200	48	5240
	-	-	-	-

Frequency Band	Channel	Freq. (MHz)	Channel	Freq. (MHz)
5250-5350 MHz Band 2 (U-NII-2A)	52	5260	60	5300
	-	-	-	-
	56	5280	64	5320
	-	-	-	-

Frequency Band	Channel	Freq. (MHz)	Channel	Freq. (MHz)
5470-5725 MHz Band 3 (U-NII-2C)	100	5500	112	5560
	-	-	116	5580
	104	5520	132	5660
	-	-	-	-
	108	5540	136	5680
	-	-	140	5700

Frequency Band	Channel	Freq. (MHz)	Channel	Freq. (MHz)
TDWR Channel	-	-	124	5620
	120	5600	-	-
	-	-	128	5640





## 2.2 Test Mode

Final test mode of conducted test items and radiated spurious emissions are considering the modulation and worse data rates as below table.

Modulation	Data Rate
802.11a	6 Mbps
802.11n HT20	MCS0

Test Cases	
AC Conducted Emission	Mode 1 : WLAN Link (5GHz) + Bluetooth Link + Qwerty Keypad + USB link (Senrial) with AC power + MP3 + Camera
	Mode 2 : WLAN Link (5GHz) + Bluetooth Link + Numeric Keypad + USB link (Senrial) with AC power + MP3 + without camera sample + Scanner

Ch. #		Band I : 5150-5250 MHz	Band II : 5250-5350 MHz	Band III : 5470-5725MHz
		802.11a	802.11a	802.11a
L	Low	36	52	100
M	Middle	44	60	116
H	High	48	64	140

Ch. #		Band I : 5150-5250 MHz	Band II : 5250-5350 MHz	Band III : 5470-5725MHz
		802.11n HT20	802.11n HT20	802.11n HT20
L	Low	36	52	100
M	Middle	44	60	116
H	High	48	64	140

## 2.3 Connection Diagram of Test System

<WLAN Tx Mode>

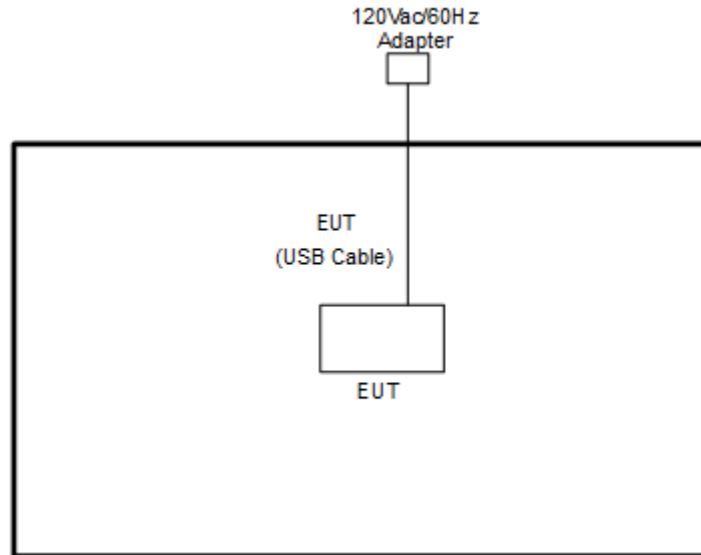

<AC Conducted Emission Mode>

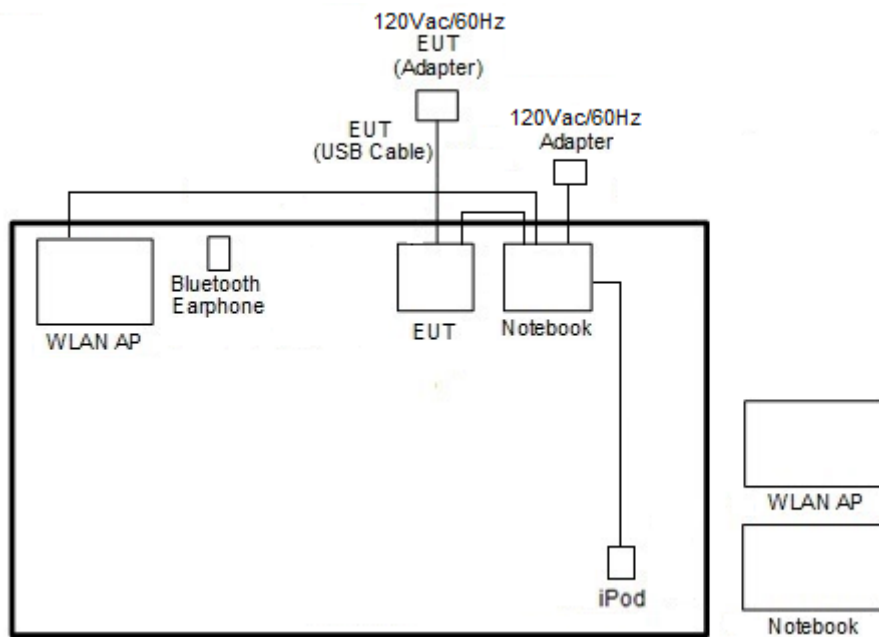



## 2.4 Support Unit used in test configuration and system

Item	Equipment	Trade Name	Model Name	FCC ID	Data Cable	Power Cord
1.	Bluetooth Earphone	SonyEricsson	MW600	PY700A2029	N/A	N/A
2.	WLAN AP	ASUS	RT-AC66U	MSQ-RTAC66U	N/A	Unshielded, 1.8 m
3.	iPod	Apple	A1285	DoC	Shielded, 1.0 m	N/A
4.	NOTE BOOK	DELL	Latitude E6320	FCC DoC	N/A	AC I/P: Unshielded, 1.2 m
5.	SD Card	SanDisk	MicroSD HC	FCC DoC	N/A	N/A

## 2.5 EUT Operation Test Setup

The RF test items, programmed RF utility, "XW2DMT" installed in the notebook make the EUT provide functions like channel selection and power level for continuous transmitting and receiving signals.

## 2.6 Measurement Results Explanation Example

**For all conducted test items:**

The offset level is set in the spectrum analyzer to compensate the RF cable loss and attenuator factor between EUT conducted output port and spectrum analyzer. With the offset compensation, the spectrum analyzer reading level is exactly the EUT RF output level.

Example :

The spectrum analyzer offset is derived from RF cable loss and attenuator factor.

*Offset = RF cable loss + attenuator factor.*

Following shows an offset computation example with cable loss 4.2 dB and 10dB attenuator.

$$\begin{aligned} \text{Offset(dB)} &= \text{RF cable loss(dB)} + \text{attenuator factor(dB)}. \\ &= 4.2 + 10 = 14.2 \text{ (dB)} \end{aligned}$$

### 3 Test Result

#### 3.1 26dB & 99% Occupied Bandwidth Measurement

##### 3.1.1 Description of 26dB & 99% Occupied Bandwidth

This section is for reporting purpose only.

There is no restriction limits for bandwidth.

##### 3.1.2 Measuring Instruments

The measuring equipment is listed in the section 4 of this test report.

##### 3.1.3 Test Procedures

1. The testing follows FCC KDB 789033 D02 General UNII Test Procedures New Rules v01r04.  
Section C) Emission bandwidth
2. Set RBW = approximately 1% of the emission bandwidth.
3. Set the VBW > RBW.
4. Detector = Peak.
5. Trace mode = max hold
6. Measure the maximum width of the emission that is 26 dB down from the peak of the emission.  
Compare this with the RBW setting of the analyzer. Readjust RBW and repeat measurement as needed until the RBW/EBW ratio is approximately 1%.
7. For 99% Bandwidth Measurement, the spectrum analyzer's resolution bandwidth (RBW) is set 1MHz and set the Video bandwidth (VBW)  $\geq 3 * RBW$ .
8. Measure and record the results in the test report.

##### 3.1.4 Test Setup

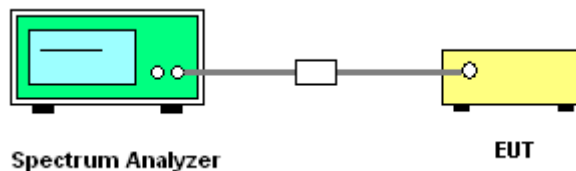



3.1.5 Test Result of 26dB & 99% Occupied Bandwidth

Band I						
Mod.	Data Rate	NTX	CH.	Freq. (MHz)	99% Bandwidth (MHz)	26 dB Bandwidth (MHz)
11a	6Mbps	1	36	5180	17.95	25.70
11a	6Mbps	1	44	5220	17.85	25.90
11a	6Mbps	1	48	5240	17.70	25.50
HT20	MCS0	1	36	5180	<b>18.95</b>	26.45
HT20	MCS0	1	44	5220	18.85	<b>27.75</b>
HT20	MCS0	1	48	5240	18.75	26.50

Band II						
Mod.	Data Rate	NTX	CH.	Freq. (MHz)	99% Bandwidth (MHz)	26 dB Bandwidth (MHz)
11a	6M bps	1	52	5260	17.80	25.70
11a	6M bps	1	60	5300	17.80	26.17
11a	6M bps	1	64	5320	17.80	26.25
HT20	MCS 0	1	52	5260	18.80	26.90
HT20	MCS 0	1	60	5300	18.90	<b>27.10</b>
HT20	MCS 0	1	64	5320	<b>18.95</b>	26.50



Band III						
Mod.	Data Rate	NTX	CH.	Freq. (MHz)	99% Bandwidth (MHz)	26 dB Bandwidth (MHz)
11a	6M bps	1	100	5500	17.90	26.15
11a	6M bps	1	116	5580	17.90	25.90
11a	6M bps	1	140	5700	17.85	<b>28.22</b>
HT20	MCS 0	1	100	5500	18.95	26.95
HT20	MCS 0	1	116	5580	<b>19.00</b>	26.93
HT20	MCS 0	1	140	5700	18.95	26.50

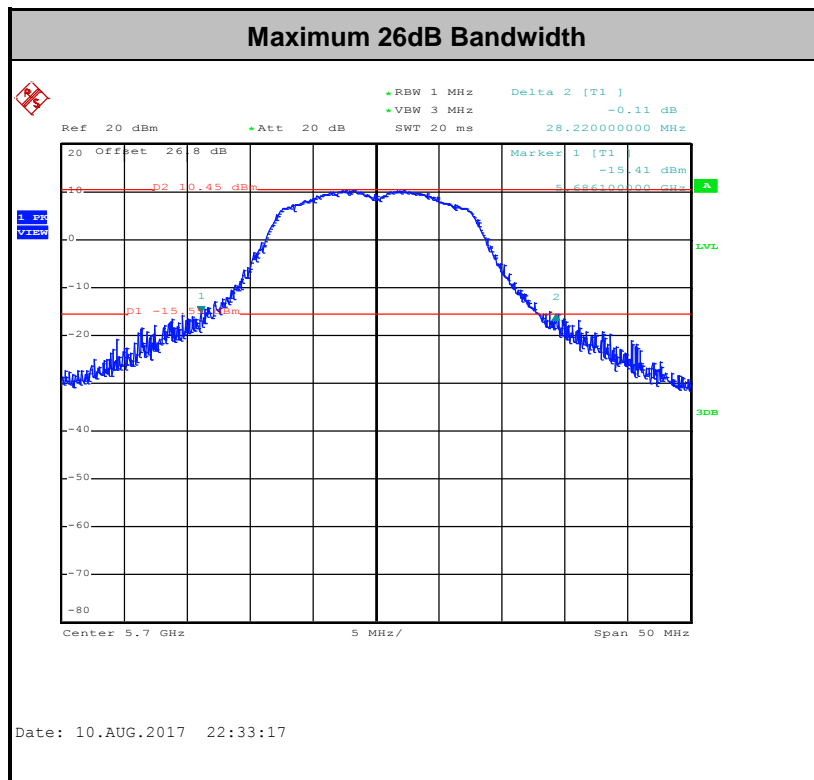

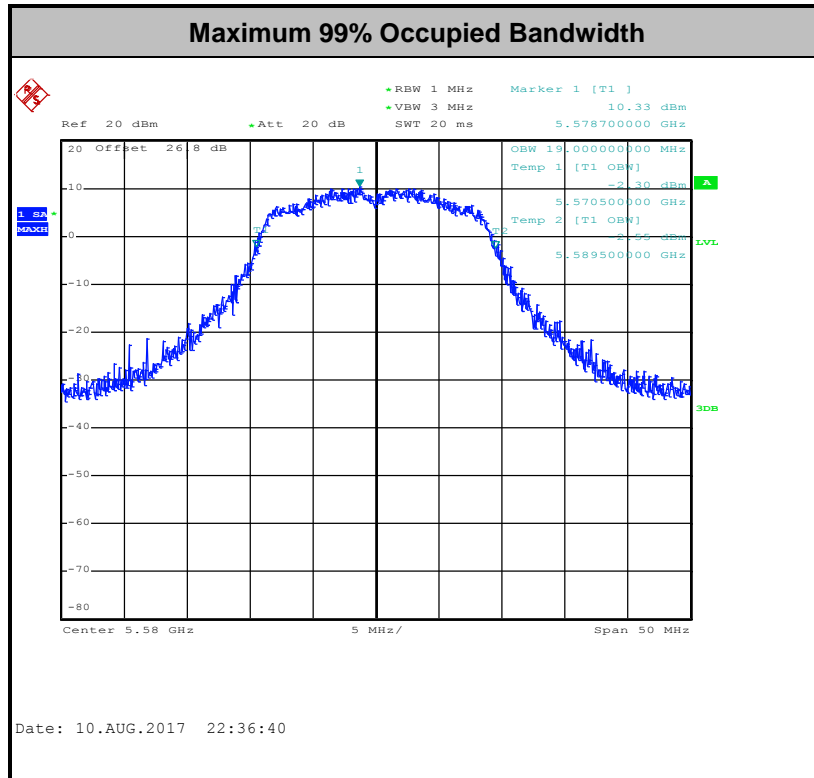

**Note:** The occupied channel bandwidth is maintained within the band of operation for all of the modulations.



## 3.2 Maximum Conducted Output Power Measurement

### 3.2.1 Limit of Maximum Conducted Output Power

<FCC 14-30 CFR 15.407>

For mobile and portable client devices in the 5.15–5.25 GHz band, the maximum conducted output power over the frequency band of operation shall not exceed 250 mW.

For the 5.25–5.725 GHz bands, the maximum conducted output power over the frequency bands of operation shall not exceed the lesser of 250 mW or  $11 \text{ dBm} + 10 \log B$ , where B is the 26 dB emission bandwidth in megahertz.

If transmitting antennas of directional gain greater than 6 dBi are used, the peak output power shall be reduced by the amount in dB that the directional gain of the antenna exceeds 6 dBi.

Note that U-NII-2 band, devices with a maximum e.i.r.p. greater than 500 mW shall implement TPC in order to have the capability to operate at least 6 dB below the maximum permitted e.i.r.p. of 1 W.

### 3.2.2 Measuring Instruments

The measuring equipment is listed in the section 4 of this test report.

### 3.2.3 Test Procedures

The testing follows Method PM of FCC KDB 789033 D02 General UNII Test Procedures New Rules v01r04.

Method PM (Measurement using an RF average power meter):

1. Measurement is performed using a wideband RF power meter.
2. The EUT is configured to transmit continuously with a consistent duty cycle at its maximum power control level.
3. Measure the average power of the transmitter, and the average power is corrected with duty factor,  $10 \log(1/x)$ , where x is the duty cycle.



### 3.2.4 Test Setup

For normal channel:

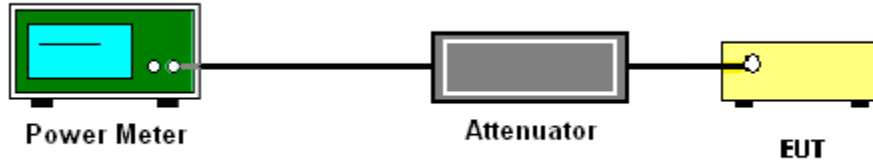

### 3.2.5 Test Result of Maximum Conducted Output Power

Band I									
Mod.	Data Rate	NTX	CH.	Freq. (MHz)	Duty Factor (dB)	Average Conducted Power (dBm)	FCC Conducted Power Limit (dBm)	DG (dBi)	Pass/Fail
11a	6Mbps	1	36	5180	0.09	11.67	24.00	3.41	Pass
11a	6Mbps	1	44	5220	0.09	<b>11.85</b>	24.00	3.41	Pass
11a	6Mbps	1	48	5240	0.09	11.66	24.00	3.41	Pass
HT20	MCS0	1	36	5180	0.09	11.11	24.00	3.41	Pass
HT20	MCS0	1	44	5220	0.09	11.39	24.00	3.41	Pass
HT20	MCS0	1	48	5240	0.09	11.37	24.00	3.41	Pass

Band II										
Mod.	Data Rate	NTX	CH.	Freq. (MHz)	Duty Factor (dB)	Average Conducted Power (dBm)	FCC Conducted Power Limit (dBm)	DG (dBi)	EIRP Power Limit (dBm)	Pass/Fail
11a	6M bps	1	52	5260	0.09	13.02	23.98	3.41	26.99	Pass
11a	6M bps	1	60	5300	0.09	12.62	23.98	3.41	26.99	Pass
11a	6M bps	1	64	5320	0.09	<b>13.13</b>	23.98	3.41	26.99	Pass
HT20	MCS 0	1	52	5260	0.09	12.85	23.98	3.41	26.99	Pass
HT20	MCS 0	1	60	5300	0.09	12.51	23.98	3.41	26.99	Pass
HT20	MCS 0	1	64	5320	0.09	12.12	23.98	3.41	26.99	Pass



Band III										
Mod.	Data Rate	NTX	CH.	Freq. (MHz)	Duty Factor (dB)	Average Conducted Power (dBm)	FCC Conducted Power Limit (dBm)	DG (dBi)	EIRP Power Limit (dBm)	Pass/Fail
11a	6M bps	1	100	5500	0.09	12.87	23.98	3.41	26.99	Pass
11a	6M bps	1	116	5580	0.09	12.50	23.98	3.41	26.99	Pass
11a	6M bps	1	140	5700	0.09	<b>13.58</b>	23.98	3.41	26.99	Pass
HT20	MCS 0	1	100	5500	0.09	12.68	23.98	3.41	26.99	Pass
HT20	MCS 0	1	116	5580	0.09	12.94	23.98	3.41	26.99	Pass
HT20	MCS 0	1	140	5700	0.09	11.13	23.98	3.41	26.99	Pass



### **3.3 Power Spectral Density Measurement**

#### **3.3.1 Limit of Power Spectral Density**

**<FCC 14-30 CFR 15.407>**

For mobile and portable client devices in the 5.15–5.25 GHz band, the maximum power spectral density shall not exceed 11dBm in any 1 megahertz band.

For the 5.25–5.725 GHz bands, the maximum power spectral density shall not exceed 11 dBm in any 1 megahertz band.

If transmitting antennas of directional gain greater than 6 dBi are used, the peak output power shall be reduced by the amount in dB that the directional gain of the antenna exceeds 6 dBi.

#### **3.3.2 Measuring Instruments**

The measuring equipment is listed in the section 4 of this test report.



### **3.3.3 Test Procedures**

The testing follows FCC KDB 789033 D02 General UNII Test Procedures New Rules v01r04.  
Section F) Maximum power spectral density.

#### **# Method SA-2 #**

(trace averaging across on and off times of the EUT transmissions, followed by duty cycle correction).

1. The testing follows Method SA-2 of FCC KDB 789033 D02 General UNII Test Procedures New Rules v01r04.
  - Measure the duty cycle.
  - Set span to encompass the entire emission bandwidth (EBW) of the signal.
  - Set RBW = 1 MHz.
  - Set VBW  $\geq$  3 MHz.
  - Number of points in sweep  $\geq$  2 Span / RBW.
  - Sweep time = auto.
  - Detector = RMS
  - Trace average at least 100 traces in power averaging mode.
  - Add  $10 \log(1/x)$ , where x is the duty cycle, to the measured power in order to compute the average power during the actual transmission times. For example, add  $10 \log(1/0.25) = 6$  dB if the duty cycle is 25 percent.
2. The RF output of EUT was connected to the spectrum analyzer by a low loss cable.
3. Each plot has already offset with cable loss, and attenuator loss. Measure the PPSD and record it.

### 3.3.4 Test Setup

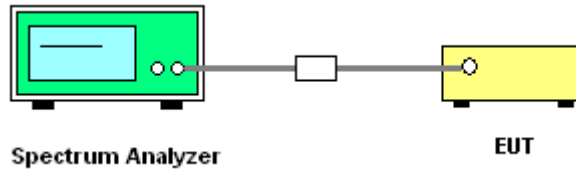

### 3.3.5 Test Result of Power Spectral Density

Band I									
Mod.	Data Rate	NTX	CH.	Freq. (MHz)	Duty Factor (dB)	Average Power Density (dBm/MHz)	Average PSD Limit (dBm/MHz)	DG (dBi)	Pass/Fail
11a	6Mbps	1	36	5180	0.09	<b>1.88</b>	11.00	3.41	Pass
11a	6Mbps	1	44	5220	0.09	1.63	11.00	3.41	Pass
11a	6Mbps	1	48	5240	0.09	0.43	11.00	3.41	Pass
HT20	MCS0	1	36	5180	0.09	1.08	11.00	3.41	Pass
HT20	MCS0	1	44	5220	0.09	0.23	11.00	3.41	Pass
HT20	MCS0	1	48	5240	0.09	0.18	11.00	3.41	Pass

Band II									
Mod.	Data Rate	NTX	CH.	Freq. (MHz)	Duty Factor (dB)	Average Power Density (dBm/MHz)	Average PSD Limit (dBm/MHz)	DG (dBi)	Pass/Fail
11a	6M bps	1	52	5260	0.09	1.83	11.00	3.41	Pass
11a	6M bps	1	60	5300	0.09	1.64	11.00	3.41	Pass
11a	6M bps	1	64	5320	0.09	<b>2.25</b>	11.00	3.41	Pass
HT20	MCS 0	1	52	5260	0.09	1.92	11.00	3.41	Pass
HT20	MCS 0	1	60	5300	0.09	1.03	11.00	3.41	Pass
HT20	MCS 0	1	64	5320	0.09	0.82	11.00	3.41	Pass



Band III									
Mod.	Data Rate	NTX	CH.	Freq. (MHz)	Duty Factor (dB)	Average Power Density (dBm/MHz)	Average PSD Limit (dBm/MHz)	DG (dBi)	Pass/Fail
11a	6M bps	1	100	5500	0.09	2.49	11.00	3.41	Pass
11a	6M bps	1	116	5580	0.09	1.95	11.00	3.41	Pass
11a	6M bps	1	140	5700	0.09	1.76	11.00	3.41	Pass
HT20	MCS 0	1	100	5500	0.09	2.20	11.00	3.41	Pass
HT20	MCS 0	1	116	5580	0.09	1.92	11.00	3.41	Pass
HT20	MCS 0	1	140	5700	0.09	-0.61	11.00	3.41	Pass

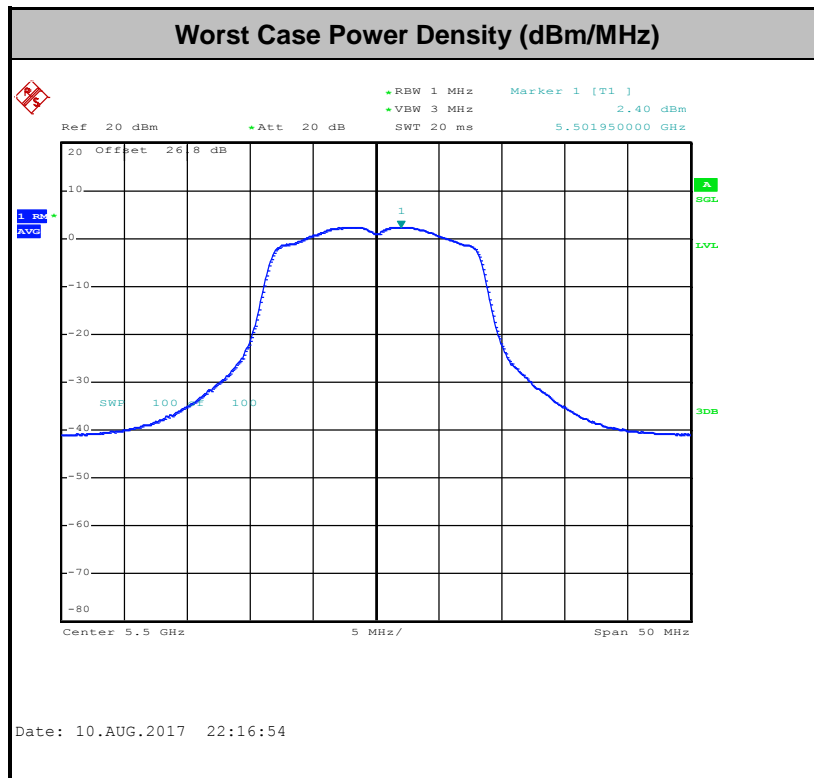



### 3.4 Unwanted Emissions Measurement

This section is to measure unwanted emissions through radiated measurement for band edge spurious emissions and out of band emissions measurement.

#### 3.4.1 Limit of Unwanted Emissions

- (1) For transmitters operating in the 5150-5250 MHz band: all emissions outside of the 5150-5350 MHz band shall not exceed an EIRP of -27dBm/MHz.

For transmitters operating in the 5250-5350 MHz band: all emissions outside of the 5150-5350 MHz band shall not exceed an EIRP of -27 dBm/MHz. Devices operating in the 5250-5350 MHz band that generate emissions in the 5150-5250 MHz band must meet all applicable technical requirements for operation in the 5150-5250 MHz band (including indoor use) or alternatively meet an out-of-band emission EIRP limit of -27 dBm/MHz in the 5150-5250 MHz band.

For transmitters operating in the 5470-5600 MHz and 5650-5725MHz band: all emissions outside of the 5470-5600 MHz and 5650-5725MHz band shall not exceed an EIRP of -27 dBm/MHz.

- (2) Unwanted spurious emissions fallen in restricted bands shall comply with the general field strength limits as below table

Frequency (MHz)	Field Strength (microvolts/meter)	Measurement Distance (meters)
0.009 – 0.490	2400/F(kHz)	300
0.490 – 1.705	24000/F(kHz)	30
1.705 – 30.0	30	30
30 – 88	100	3
88 – 216	150	3
216 - 960	200	3
Above 960	500	3

**Note:** The following formula is used to convert the EIRP to field strength.

$$E = \frac{1000000\sqrt{30P}}{3} \mu\text{V/m, where P is the eirp (Watts)}$$



EIRP (dBm)	Field Strength at 3m (dBμV/m)
- 27	68.3

(3) KDB789033 D01 v01r04 G)2)c)

- (i) Section 15.407(b)(1) to (b)(3) specify the unwanted emission limits for the U-NII-1 and U-NII-2 bands. As specified, emissions above 1000 MHz that are outside of the restricted bands are subject to a peak emission limit of -27 dBm/MHz.<sup>3</sup>
- (ii) Section 15.407(b)(4) specifies the unwanted emission limit for the U-NII-3 band. A band emissions mask is specified in Section 15.407(b)(4)(i). The emission limits are in terms of a Peak detector. An alternative to the band emissions mask is specified in Section 15.407(b)(4)(ii). The alternative limits are based on the highest antenna gain specified in the filing. There are also marketing and importation restrictions for the devices using the alternative limit.<sup>4</sup>

**Note 3:** An out-of-band emission that complies with both the average and peak limits of Section 15.209 is not required to satisfy the -27 dBm/MHz peak emission limit.

**Note 4:** Only devices with antenna gains of 10 dBi or less may be approved using the emission limits specified in Section 15.247(d) till March 2, 2018; all other devices operating in this band must use the mask specified in Section 15.407(b)(4)(i).





### **3.4.2 Measuring Instruments**

The measuring equipment is listed in the section 4 of this test report.

### **3.4.3 Test Procedures**

1. The testing follows FCC KDB 789033 D02 General UNII Test Procedures New Rules v01r04. Section G) Unwanted emissions measurement.

(1) Procedure for Unwanted Emissions Measurements Below 1000MHz

- RBW = 120 kHz
- VBW = 300 kHz
- Detector = Peak
- Trace mode = max hold

(2) Procedure for Peak Unwanted Emissions Measurements Above 1000 MHz

- RBW = 1 MHz
- VBW  $\geq$  3 MHz
- Detector = Peak
- Sweep time = auto
- Trace mode = max hold

(3) Procedures for Average Unwanted Emissions Measurements Above 1000MHz

- RBW = 1 MHz
- VBW = 10 Hz, when duty cycle is no less than 98 percent.
- VBW  $\geq$  1/T, when duty cycle is less than 98 percent where T is the minimum transmission duration over which the transmitter is on and is transmitting at its maximum power control level for the tested mode of operation.

2. The EUT was placed on a turntable with 0.8 meter for frequency below 1GHz and 1.5 meter for frequency above 1GHz respectively above ground.
3. The EUT was set 3 meters from the interference receiving antenna which was mounted on the top of a variable height antenna tower.
4. The antenna is a broadband antenna and its height is adjusted between one meter and four meters above ground to find the maximum value of the field strength for both horizontal polarization and vertical polarization of the antenna.
5. For each suspected emission, the EUT was arranged to its worst case and then adjust the antenna tower (from 1 m to 4 m) and turntable (from 0 degree to 360 degrees) to find the maximum reading.
6. For testing below 1GHz, if the emission level of the EUT in peak mode was 3 dB lower than the limit specified, then peak values of EUT will be reported, otherwise, the emissions will be repeated one by one using the CISPR quasi-peak method and reported.
7. For testing above 1GHz, the emission level of the EUT in peak mode was 20dB lower than average limit (that means the emission level in average mode also complies with the limit in average mode), then peak values of EUT will be reported, otherwise, the emissions will be measured in average mode again and reported.

### 3.4.4 Test Setup

For radiated emissions below 30MHz

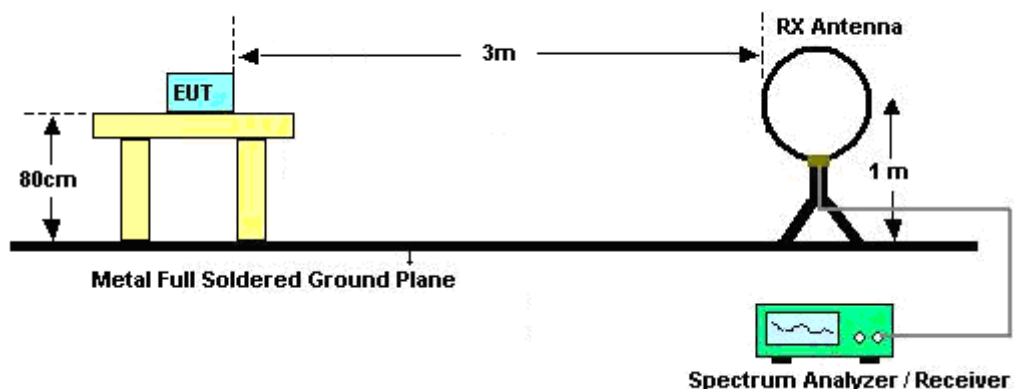

For radiated emissions from 30MHz to 1GHz

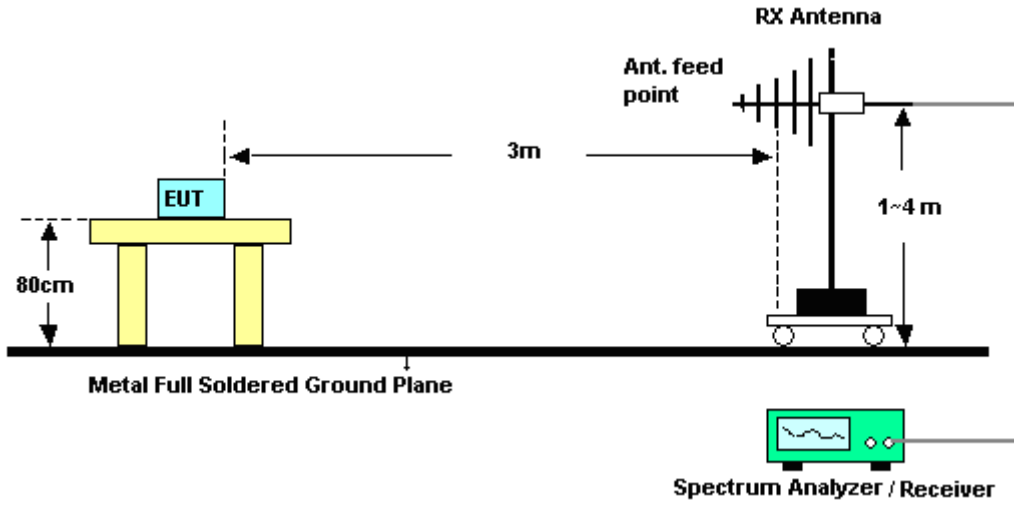

For radiated emissions above 1GHz

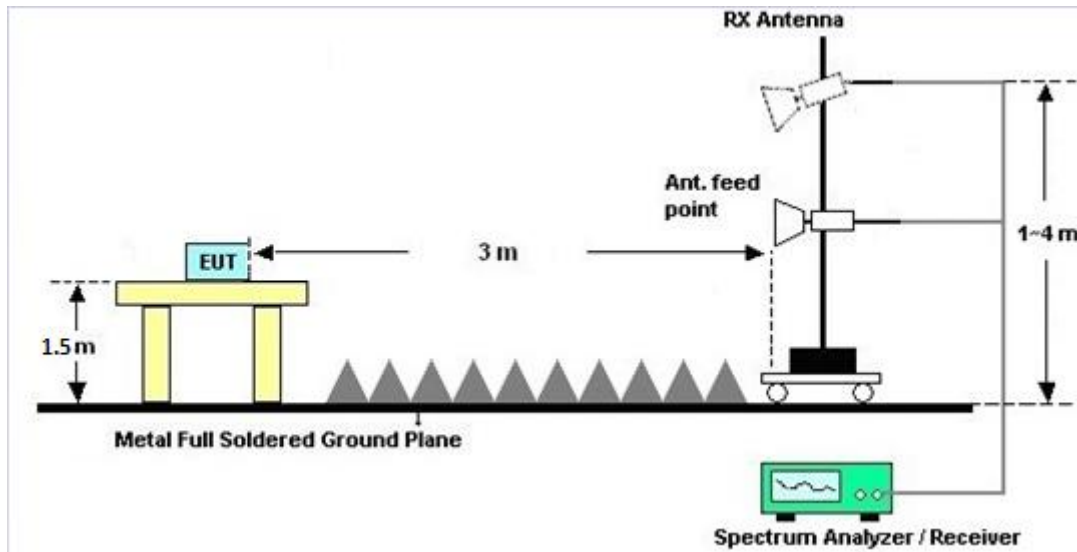



### **3.4.5 Test Results of Radiated Spurious Emissions (9 kHz ~ 30 MHz)**

The low frequency, which started from 9 kHz to 30MHz, was pre-scanned and the result which was 20dB lower than the limit line per 15.31(o) was not reported.

### **3.4.6 Test Result of Radiated Spurious at Band Edges**

Please refer to Appendix B and C.

### **3.4.7 Duty Cycle**

Please refer to Appendix D.

### **3.4.8 Test Result of Radiated Spurious Emissions (30MHz ~ 10th Harmonic)**

Please refer to Appendix B and C.



### 3.5 AC Conducted Emission Measurement

#### 3.5.1 Limit of AC Conducted Emission

For equipment that is designed to be connected to the public utility (AC) power line, the radio frequency voltage that is conducted back onto the AC power line on any frequency or frequencies within the band 150 kHz to 30 MHz shall not exceed the limits in the following table.

Frequency of emission (MHz)	Conducted limit (dB $\mu$ V)	
	Quasi-peak	Average
0.15-0.5	66 to 56*	56 to 46*
0.5-5	56	46
5-30	60	50

\*Decreases with the logarithm of the frequency.

#### 3.5.2 Measuring Instruments

The measuring equipment is listed in the section 4 of this test report.

#### 3.5.3 Test Procedures

1. The EUT was placed 0.4 meter from the conducting wall of the shielding room was kept at least 80 centimeters from any other grounded conducting surface.
2. Connect EUT to the power mains through a line impedance stabilization network (LISN).
3. All the support units are connecting to the other LISN.
4. The LISN provides 50 ohm coupling impedance for the measuring instrument.
5. The FCC states that a 50 ohm, 50 microhenry LISN should be used.
6. Both sides of AC line were checked for maximum conducted interference.
7. The frequency range from 150 kHz to 30 MHz was searched.
8. Set the test-receiver system to Peak Detect Function and specified bandwidth with Maximum Hold Mode.

### 3.5.4 Test Setup

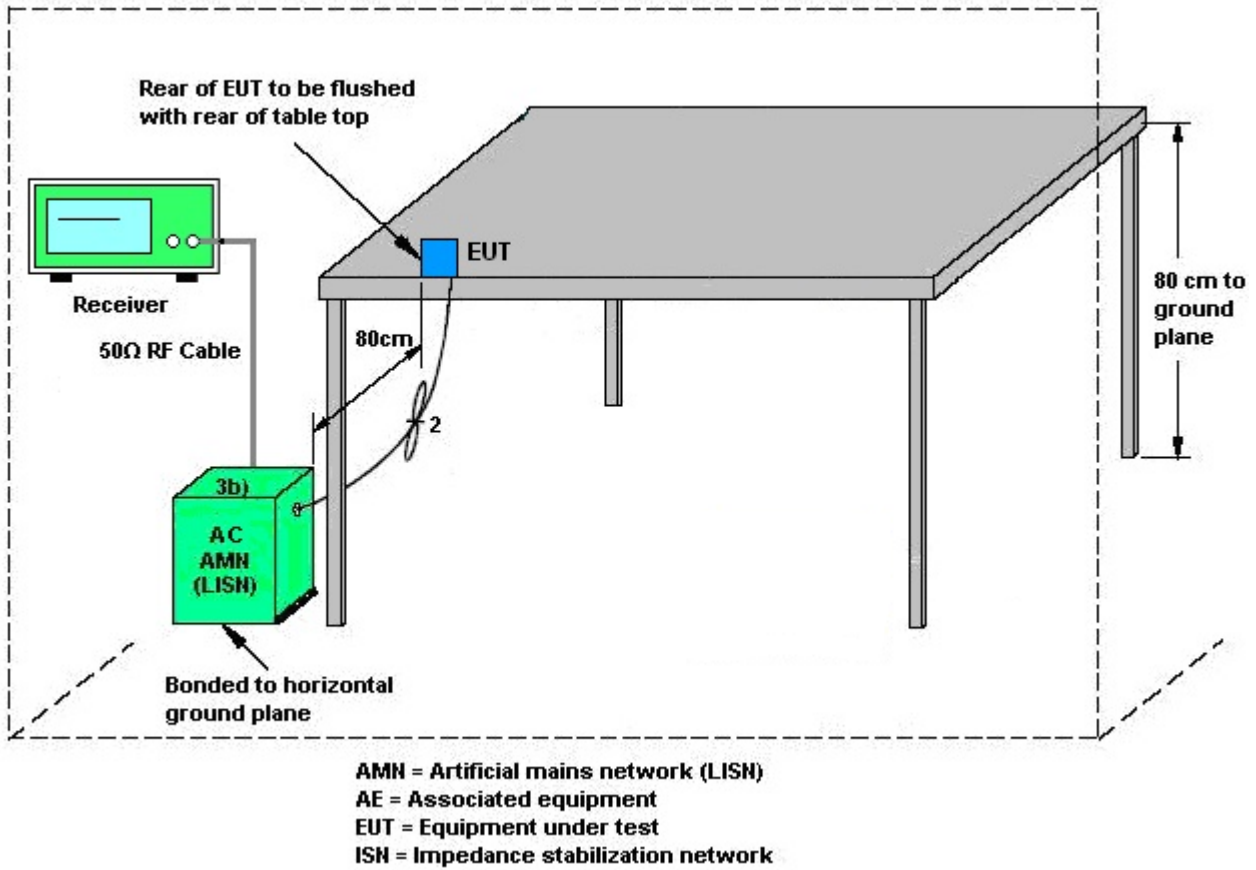

### 3.5.5 Test Result of AC Conducted Emission

Please refer to Appendix A.

## 3.6 Frequency Stability Measurement

### 3.6.1 Limit of Frequency Stability

Manufacturers of U-NII devices are responsible for ensuring frequency stability such that an emission is maintained within the band of operation under all conditions of normal operation as specified in the user's manual.

### 3.6.2 Measuring Instruments

The measuring equipment is listed in the section 4 of this test report.

### 3.6.3 Test Procedures

1. To ensure emission at the band edge is maintained within the authorized band, those values shall be measured by radiation emissions at upper and lower frequency points, and finally compensated by frequency deviation as procedures below.
2. The EUT was operated at the maximum output power, and connected to the spectrum analyzer, which is set to maximum hold function and peak detector. The peak value of the power envelope was measured and noted. The upper and lower frequency points were respectively measured relatively 10dB lower than the measured peak value.
3. The frequency deviation was calculated by adding the upper frequency point and the lower frequency point divided by two. Those detailed values of frequency deviation are provided in table below.

### 3.6.4 Test Setup





3.6.5 Test Result of Frequency Stability

Band I									
Mod.	Data Rate	NTX	CH.	Freq. (MHz)	Center Frequency (MHz)	Frequency Deviation (MHz)	Frequency Stability (ppm)	Temperature (°C)	Voltage (V)
11a	6Mbps	1	36	5180	5180.000	0.000	0.00	50	3.7
11a	6Mbps	1	36	5180	5180.000	0.000	0.00	-30	3.7
11a	6Mbps	1	36	5180	5180.000	0.000	0.00	20	4.2
11a	6Mbps	1	36	5180	5180.000	0.000	0.00	20	3.2
11a	6Mbps	1	36	5180	5180.000	0.000	0.00	20	3.7

Band II									
Mod.	Data Rate	NTX	CH.	Freq. (MHz)	Center Frequency (MHz)	Frequency Deviation (MHz)	Frequency Stability (ppm)	Temperature (°C)	Voltage (V)
11a	6Mbps	1	64	5320	5320.000	0.000	0.00	50	3.7
11a	6Mbps	1	64	5320	5320.000	0.000	0.00	-30	3.7
11a	6Mbps	1	64	5320	5320.000	0.000	0.00	20	4.2
11a	6Mbps	1	64	5320	5320.000	0.000	0.00	20	3.2
11a	6Mbps	1	64	5320	5320.000	0.000	0.00	20	3.7





Band III									
Mod.	Data Rate	NTX	CH.	Freq. (MHz)	Center Frequency (MHz)	Frequency Deviation (MHz)	Frequency Stability (ppm)	Temperature (°C)	Voltage (V)
11a	6Mbps	1	100	5500	5500.000	0.000	0.00	50	3.7
11a	6Mbps	1	100	5500	5500.000	0.000	0.00	-30	3.7
11a	6Mbps	1	100	5500	5500.000	0.000	0.00	20	4.2
11a	6Mbps	1	100	5500	5500.000	0.000	0.00	20	3.2
11a	6Mbps	1	100	5500	5500.000	0.000	0.00	20	3.7



## **3.7 Automatically Discontinue Transmission**

### **3.7.1 Limit of Automatically Discontinue Transmission**

The device shall automatically discontinue transmission in case of either absence of information to transmit or operational failure. These provisions are not intended to preclude the transmission of control or signaling information or the use of repetitive codes used by certain digital technologies to complete frame or burst intervals. Applicants shall include in their application for equipment authorization to describe how this requirement is met.

### **3.7.2 Measuring Instruments**

The measuring equipment is listed in the section 4 of this test report.

### **3.7.3 Test Result of Automatically Discontinue Transmission**

While the EUT is not transmitting any information, the EUT can automatically discontinue transmission and become standby mode for power saving. The EUT can detect the controlling signal of ACK message transmitting from remote device and verify whether it shall resend or discontinue transmission.

## **3.8 Antenna Requirements**

### **3.8.1 Standard Applicable**

If transmitting antenna directional gain is greater than 6 dBi, both the peak transmit power and the peak power spectral density shall be reduced by the amount in dB that the directional gain of the antenna exceeds 6 dBi.

### **3.8.2 Antenna Anti-Replacement Construction**

An embedded-in antenna design is used.

### **3.8.3 Antenna Gain**

The antenna peak gain of EUT is less than 6 dBi. Therefore, it is not necessary to reduce maximum peak output power limit.



## 4 List of Measuring Equipment

Instrument	Manufacturer	Model No.	Serial No.	Characteristics	Calibration Date	Test Date	Due Date	Remark
Power Meter	Anritsu	ML2495A	0932001	300MHz~40GHz	Sep. 29, 2016	Jul. 18, 2017~ Aug. 10, 2017	Sep. 28, 2017	Conducted (TH05-HY)
Power Sensor	Anritsu	MA2411B	0846202	300MHz~40GHz	Sep. 29, 2016	Jul. 18, 2017~ Aug. 10, 2017	Sep. 28, 2017	Conducted (TH05-HY)
Spectrum Analyzer	Rohde & Schwarz	FSP40	100057	9kHz-40GHz	Nov. 25, 2016	Jul. 18, 2017~ Aug. 10, 2017	Nov. 24, 2017	Conducted (TH05-HY)
Temperature Chamber	ESPEC	SH-641	92013720	-40°C ~90°C	Sep. 01, 2016	Jul. 18, 2017~ Aug. 10, 2017	Aug. 31, 2017	Conducted (TH05-HY)
Programmable Power Supply	GW Instek	PSS-2005	EL890094	1V~20V 0.5A~5A	Oct. 11, 2016	Jul. 18, 2017~ Aug. 10, 2017	Oct. 10, 2017	Conducted (TH05-HY)
AC Power Source	AC POWER	AFC-500W	F104070011	50Hz~60Hz	Dec 01.2016	Jul. 18, 2017~ Aug. 10, 2017	Nov 30 2017	Conducted (TH05-HY)
AC Power Source	ChainTek	APC-1000W	N/A	N/A	N/A	Jul. 19, 2017	N/A	Conduction (CO05-HY)
EMI Test Receiver	Rohde & Schwarz	ESCI 7	100724	9kHz~7GHz	Aug. 30, 2016	Jul. 19, 2017	Aug. 29, 2017	Conduction (CO05-HY)
LISN	Rohde & Schwarz	ENV216	100080	9kHz~30MHz	Nov. 29, 2016	Jul. 19, 2017	Nov. 28, 2017	Conduction (CO05-HY)
LISN	Rohde & Schwarz	ENV216	100081	9kHz~30MHz	Dec. 06, 2016	Jul. 19, 2017	Dec. 05, 2017	Conduction (CO05-HY)
Bilog Antenna	TESEQ	CBL 6111D&00800 N1D01N-06	35419&03	30MHz to 1GHz	Jan. 07, 2017	Aug. 03, 2017~ Aug. 07, 2017	Jan. 06, 2018	Radiation (03CH07-HY)
Double Ridge Horn Antenna	ESCO	3117	00075962	1GHz ~ 18GHz	Aug. 19, 2016	Aug. 03, 2017~ Aug. 07, 2017	Aug. 18, 2017	Radiation (03CH07-HY)
EMI Test Receiver	Keysight	N9038A(MXE)	MY54130085	20Hz ~ 8.4GHz	Oct. 26, 2016	Aug. 03, 2017~ Aug. 07, 2017	Oct. 25, 2017	Radiation (03CH07-HY)
Loop Antenna	Rohde & Schwarz	HFH2-Z2	100315	9 kHz~30 MHz	May 15, 2017	Aug. 03, 2017~ Aug. 07, 2017	May 14, 2019	Radiation (03CH07-HY)
Preamplifier	MITEQ	AMF-7D-0010 1800-30-10P	1590075	1GHz ~ 18GHz	Apr. 25, 2017	Aug. 03, 2017~ Aug. 07, 2017	Apr. 24, 2018	Radiation (03CH07-HY)
Preamplifier	COM-POWER	PA-103A	161241	10MHz-1GHz	Mar. 14, 2017	Aug. 03, 2017~ Aug. 07, 2017	Mar. 13, 2018	Radiation (03CH07-HY)
Preamplifier	Agilent	8449B	3008A02362	1GHz~ 26.5GHz	Oct. 12, 2016	Aug. 03, 2017~ Aug. 07, 2017	Oct. 11, 2017	Radiation (03CH07-HY)
Spectrum Analyzer	Agilent	N9010A	MY53470118	10Hz~44GHz	Apr. 17, 2017	Aug. 03, 2017~ Aug. 07, 2017	Apr. 16, 2018	Radiation (03CH07-HY)
Antenna Mast	Max-Full	MFA520BS	N/A	1m~4m	N/A	Aug. 03, 2017~ Aug. 07, 2017	N/A	Radiation (03CH07-HY)
Turn Table	ChainTek	Chaintek 3000	N/A	0~360 Degree	N/A	Aug. 03, 2017~ Aug. 07, 2017	N/A	Radiation (03CH07-HY)
Amplifier	MITEQ	TTA1840-35-H G	1871923	18GHz~40GHz, VSWR : 2.5:1 max	Jul. 18, 2017	Aug. 03, 2017~ Aug. 07, 2017	Jul. 17, 2018	Radiation (03CH07-HY)
SHF-EHF Horn Antenna	SCHWARZBE CK	BBHA 9170	BBHA917058 4	18GHz- 40GHz	Nov. 08, 2016	Aug. 03, 2017~ Aug. 07, 2017	Nov. 07, 2017	Radiation (03CH07-HY)



## 5 Uncertainty of Evaluation

### Uncertainty of Conducted Emission Measurement (150kHz ~ 30MHz)

Measuring Uncertainty for a Level of Confidence of 95% ( $U = 2Uc(y)$ )	2.70
---	------

### Uncertainty of Radiated Emission Measurement (30 MHz ~ 1000 MHz)

Measuring Uncertainty for a Level of Confidence of 95% ( $U = 2Uc(y)$ )	5.70
---	------

### Uncertainty of Radiated Emission Measurement (1000 MHz ~ 18000 MHz)

Measuring Uncertainty for a Level of Confidence of 95% ( $U = 2Uc(y)$ )	5.50
---	------

### Uncertainty of Radiated Emission Measurement (18000 MHz ~ 40000 MHz)

Measuring Uncertainty for a Level of Confidence of 95% ( $U = 2Uc(y)$ )	5.20
---	------



# Appendix A. AC Conducted Emission Test Results

Test Engineer : Poching Li	Temperature :	26°C
	Relative Humidity :	40%

### EUT Information

Report NO : 771121  
 Test Mode : Mode 1  
 Test Voltage : 120Vac/60Hz  
 Phase : Line

ENV216 Auto Test-L

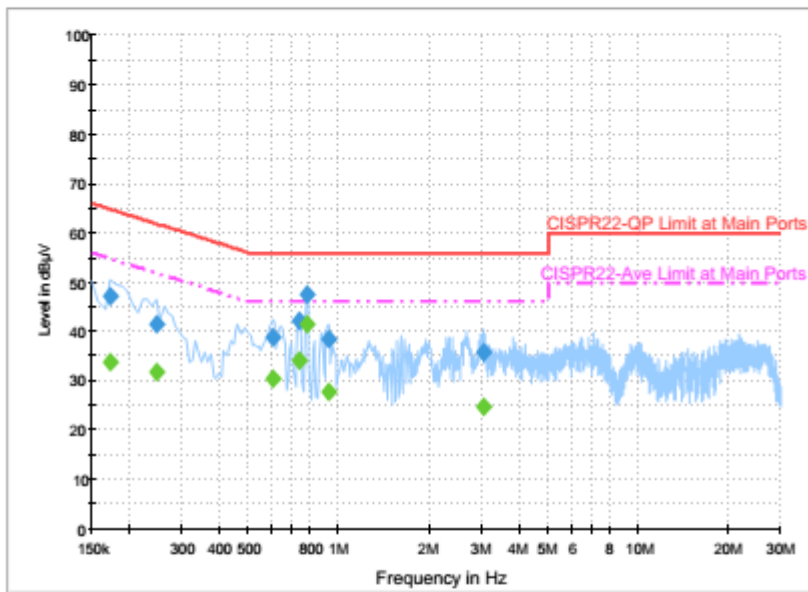

### Final Result 1

Frequency (MHz)	QuasiPeak (dBµV)	Filter	Line	Corr. (dB)	Margin (dB)	Limit (dBµV)
0.174000	47.0	Off	L1	19.5	17.8	64.8
0.246000	41.6	Off	L1	19.5	20.3	61.9
0.606000	38.8	Off	L1	19.5	17.2	56.0
0.742000	42.0	Off	L1	19.5	14.0	56.0
0.782000	47.3	Off	L1	19.5	8.7	56.0
0.926000	38.5	Off	L1	19.5	17.5	56.0
3.038000	35.9	Off	L1	19.5	20.1	56.0

### Final Result 2

Frequency (MHz)	Average (dBµV)	Filter	Line	Corr. (dB)	Margin (dB)	Limit (dBµV)
0.174000	33.7	Off	L1	19.5	21.1	54.8
0.246000	31.9	Off	L1	19.5	20.0	51.9
0.606000	30.5	Off	L1	19.5	15.5	46.0
0.742000	34.1	Off	L1	19.5	11.9	46.0
0.782000	41.5	Off	L1	19.5	4.5	46.0
0.926000	27.7	Off	L1	19.5	18.3	46.0
3.038000	24.7	Off	L1	19.5	21.3	46.0



**EUT Information**

Report NO : 771121  
 Test Mode : Mode 1  
 Test Voltage : 120Vac/60Hz  
 Phase : Neutral

ENV216 Auto Test-N

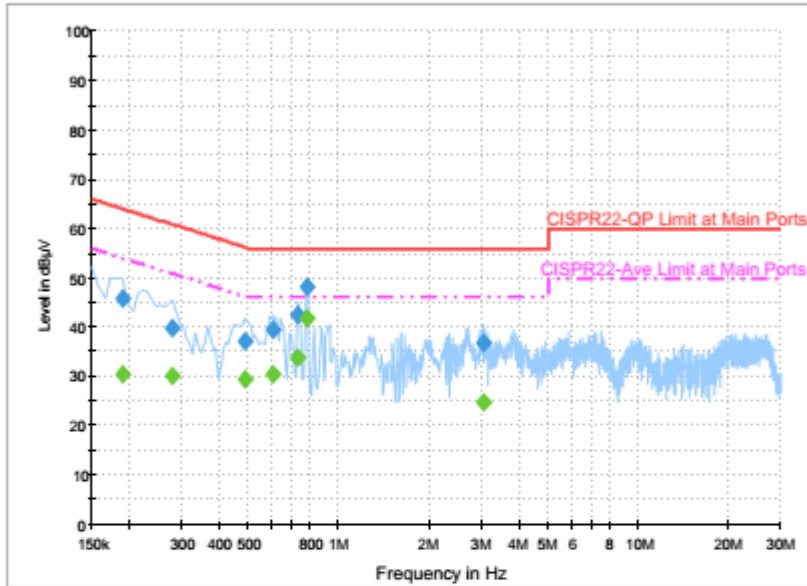

**Final Result 1**

Frequency (MHz)	QuasiPeak (dBµV)	Filter	Line	Corr. (dB)	Margin (dB)	Limit (dBµV)
0.190000	45.9	Off	N	19.5	18.1	64.0
0.278000	39.9	Off	N	19.5	21.0	60.9
0.486000	37.3	Off	N	19.5	18.9	56.2
0.606000	39.3	Off	N	19.5	16.7	56.0
0.734000	42.6	Off	N	19.5	13.4	56.0
0.782000	48.2	Off	N	19.5	7.8	56.0
3.038000	36.7	Off	N	19.5	19.3	56.0

**Final Result 2**

Frequency (MHz)	Average (dBµV)	Filter	Line	Corr. (dB)	Margin (dB)	Limit (dBµV)
0.190000	30.3	Off	N	19.5	23.7	54.0
0.278000	30.2	Off	N	19.5	20.7	50.9
0.486000	29.3	Off	N	19.5	16.9	46.2
0.606000	30.6	Off	N	19.5	15.4	46.0
0.734000	33.9	Off	N	19.5	12.1	46.0
0.782000	42.0	Off	N	19.5	4.0	46.0
3.038000	24.9	Off	N	19.5	21.1	46.0



**EUT Information**

Report NO : 771121  
 Test Mode : Mode 2  
 Test Voltage : 120Vac/60Hz  
 Phase : Line

ENV216 Auto Test-L

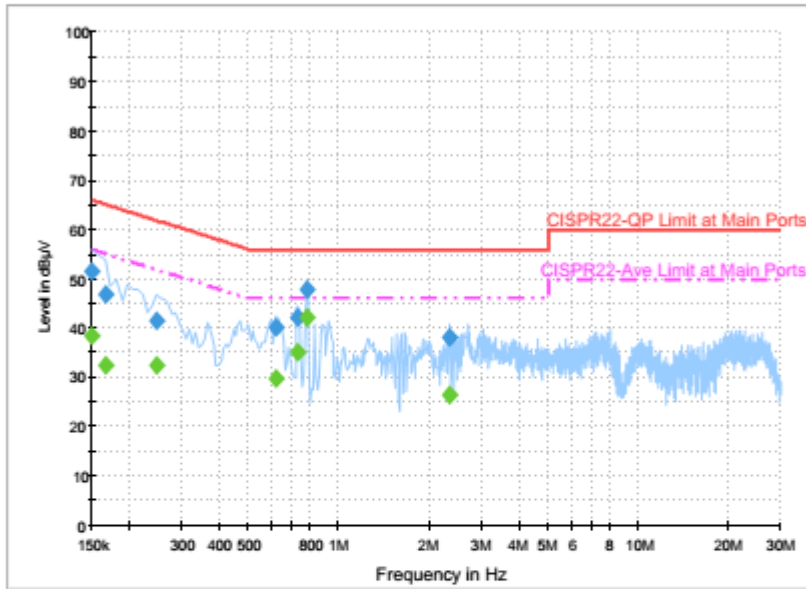

**Final Result 1**

Frequency (MHz)	QuasiPeak (dBµV)	Filter	Line	Corr. (dB)	Margin (dB)	Limit (dBµV)
0.150000	51.7	Off	L1	19.6	14.3	66.0
0.166000	46.9	Off	L1	19.5	18.3	65.2
0.246000	41.5	Off	L1	19.5	20.4	61.9
0.622000	40.2	Off	L1	19.5	15.8	56.0
0.734000	42.2	Off	L1	19.5	13.8	56.0
0.782000	47.7	Off	L1	19.5	8.3	56.0
2.350000	38.2	Off	L1	18.9	17.8	56.0

**Final Result 2**

Frequency (MHz)	Average (dBµV)	Filter	Line	Corr. (dB)	Margin (dB)	Limit (dBµV)
0.150000	38.4	Off	L1	19.6	17.6	56.0
0.166000	32.3	Off	L1	19.5	22.9	55.2
0.246000	32.3	Off	L1	19.5	19.6	51.9
0.622000	29.7	Off	L1	19.5	16.3	46.0
0.734000	35.0	Off	L1	19.5	11.0	46.0
0.782000	42.2	Off	L1	19.5	3.8	46.0
2.350000	26.3	Off	L1	18.9	19.7	46.0



**EUT Information**

Report NO : 771121  
 Test Mode : Mode 2  
 Test Voltage : 120Vac/60Hz  
 Phase : Neutral

ENV216 Auto Test-N

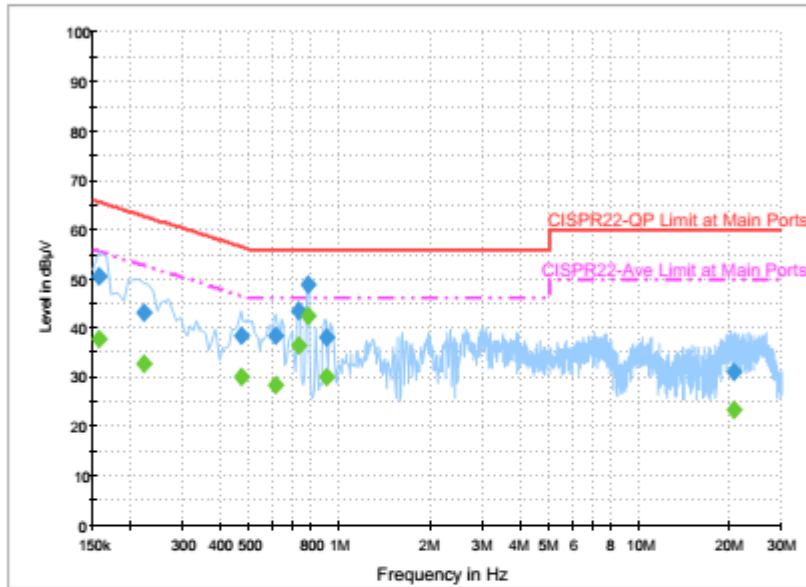

**Final Result 1**

Frequency (MHz)	QuasiPeak (dBµV)	Filter	Line	Corr. (dB)	Margin (dB)	Limit (dBµV)
0.158000	50.7	Off	N	19.5	14.9	65.6
0.222000	43.0	Off	N	19.5	19.7	62.7
0.470000	38.6	Off	N	19.5	17.9	56.5
0.614000	38.4	Off	N	19.5	17.6	56.0
0.734000	43.4	Off	N	19.5	12.6	56.0
0.782000	48.8	Off	N	19.5	7.2	56.0
0.902000	38.0	Off	N	19.5	18.0	56.0
20.758000	31.2	Off	N	19.9	28.8	60.0

**Final Result 2**

Frequency (MHz)	Average (dBµV)	Filter	Line	Corr. (dB)	Margin (dB)	Limit (dBµV)
0.158000	37.7	Off	N	19.5	17.9	55.6
0.222000	32.7	Off	N	19.5	20.0	52.7
0.470000	30.2	Off	N	19.5	16.3	46.5
0.614000	28.5	Off	N	19.5	17.5	46.0
0.734000	36.6	Off	N	19.5	9.4	46.0
0.782000	42.4	Off	N	19.5	3.6	46.0
0.902000	30.0	Off	N	19.5	16.0	46.0
20.758000	23.3	Off	N	19.9	26.7	50.0





## Appendix B. Radiated Spurious Emission

Test Engineer :	Jesse Wang, James Chiu and Potter Liu	Temperature :	22~26°C
		Relative Humidity :	52~57%

### Band 1 - 5150~5250MHz

#### WIFI 802.11a (Band Edge @ 3m)

WIFI Ant.	Note	Frequency ( MHz )	Level ( dBμV/m )	Over Limit ( dB )	Limit Line ( dBμV/m )	Read Level ( dBμV )	Antenna Factor ( dB/m )	Cable Loss ( dB )	Preamp Factor ( dB )	Ant Pos ( cm )	Table Pos ( deg )	Peak Avg. ( P/A )	Pol. ( H/V )	
802.11a CH 36 5180MHz		5123.76	49.17	-24.83	74	38.65	33.65	11.95	35.08	100	244	P	H	
		5150	40.13	-13.87	54	29.53	33.69	11.99	35.08	100	244	A	H	
	*	5180	98.75	-	-	88.06	33.78	11.99	35.08	100	244	P	H	
	*	5180	90.96	-	-	80.27	33.78	11.99	35.08	100	244	A	H	
													H	
														H
			5147.16	49.64	-24.36	74	39.04	33.69	11.99	35.08	378	358	P	V
			5150	41.27	-12.73	54	30.67	33.69	11.99	35.08	378	358	A	V
	*		5180	105.36	-	-	94.67	33.78	11.99	35.08	378	358	P	V
	*		5180	96.67	-	-	85.98	33.78	11.99	35.08	378	358	A	V
														V
														V
802.11a CH 44 5220MHz		5098.28	49.91	-24.09	74	39.52	33.56	11.9	35.07	100	256	P	H	
		5150	39.5	-14.5	54	28.9	33.69	11.99	35.08	100	256	A	H	
	*	5220	99.33	-	-	88.51	33.86	12.04	35.08	100	256	P	H	
	*	5220	91.5	-	-	80.68	33.86	12.04	35.08	100	256	A	H	
			5381.6	51.01	-22.99	74	39.15	34.3	12.65	35.09	100	256	P	H
			5460	40.55	-13.45	54	28.54	34.47	12.63	35.09	100	256	A	H
			5026.78	49.88	-24.12	74	39.71	33.39	11.85	35.07	372	352	P	V
			5135.72	39.57	-14.43	54	29.05	33.65	11.95	35.08	372	352	A	V
	*		5220	105.95	-	-	95.13	33.86	12.04	35.08	372	352	P	V
	*		5220	97.19	-	-	86.37	33.86	12.04	35.08	372	352	A	V
			5459.16	50.84	-23.16	74	38.83	34.47	12.63	35.09	372	352	P	V
			5459.16	40.67	-13.33	54	28.66	34.47	12.63	35.09	372	352	A	V



<b>802.11a CH 48 5240MHz</b>		5106.34	49.38	-24.62	74	38.9	33.6	11.95	35.07	100	242	P	H
		5150	39.43	-14.57	54	28.83	33.69	11.99	35.08	100	242	A	H
	*	5240	99.56	-	-	88.57	33.91	12.16	35.08	100	242	P	H
	*	5240	91.64	-	-	80.65	33.91	12.16	35.08	100	242	A	H
		5350.24	50.47	-23.53	74	38.81	34.21	12.53	35.08	100	242	P	H
		5459.44	40.63	-13.37	54	28.62	34.47	12.63	35.09	100	242	A	H
		5138.58	49.5	-24.5	74	38.98	33.65	11.95	35.08	367	352	P	V
		5137.28	39.59	-14.41	54	29.07	33.65	11.95	35.08	367	352	A	V
	*	5240	105.05	-	-	94.06	33.91	12.16	35.08	367	352	P	V
	*	5240	96.76	-	-	85.77	33.91	12.16	35.08	367	352	A	V
		5418.28	50.7	-23.3	74	38.76	34.38	12.65	35.09	367	352	P	V
		5459.44	40.61	-13.39	54	28.6	34.47	12.63	35.09	367	352	A	V
<b>Remark</b>	1. No other spurious found. 2. All results are PASS against Peak and Average limit line.												



**Band 1 5150~5250MHz**  
**WIFI 802.11a (Harmonic @ 3m)**

WIFI Ant. 1	Note	Frequency ( MHz )	Level ( dBμV/m )	Over Limit ( dB )	Limit Line ( dBμV/m )	Read Level ( dBμV )	Antenna Factor ( dB/m )	Cable Loss ( dB )	Preamp Factor ( dB )	Ant Pos ( cm )	Table Pos ( deg )	Peak Avg. ( P/A )	Pol. ( H/V )
802.11a CH 36 5180MHz		10360	47.45	-26.55	74	49.84	39.09	17.83	59.31	100	0	P	H
		15540	50.82	-23.18	74	44.46	41.07	22.16	56.87	100	0	P	H
													H
													H
		10360	48.27	-25.73	74	50.66	39.09	17.83	59.31	100	0	P	V
		15540	50.29	-23.71	74	43.93	41.07	22.16	56.87	100	0	P	V
													V
													V
802.11a CH 44 5220MHz		10440	47.38	-26.62	74	49.57	39.15	17.91	59.25	100	0	P	H
		15660	50.54	-23.46	74	43.72	41.31	22.29	56.78	100	0	P	H
													H
													H
		10440	47.39	-26.61	74	49.58	39.15	17.91	59.25	100	0	P	V
		15660	50.16	-23.84	74	43.34	41.31	22.29	56.78	100	0	P	V
													V
													V
802.11a CH 48 5240MHz		10480	46.76	-27.24	74	48.84	39.19	17.94	59.21	100	0	P	H
		15720	50.4	-23.6	74	43.3	41.45	22.37	56.72	100	0	P	H
													H
													H
		10480	47.68	-26.32	74	49.76	39.19	17.94	59.21	100	0	P	V
		15720	49.77	-24.23	74	42.67	41.45	22.37	56.72	100	0	P	V
													V
													V
<b>Remark</b>	1. No other spurious found. 2. All results are PASS against Peak and Average limit line.												



**Band 1 5150~5250MHz**  
**WIFI 802.11n HT20 (Band Edge @ 3m)**

WIFI Ant. 1	Note	Frequency ( MHz )	Level ( dBμV/m )	Over Limit ( dB )	Limit Line ( dBμV/m )	Read Level ( dBμV )	Antenna Factor ( dB/m )	Cable Loss ( dB )	Preamp Factor ( dB )	Ant Pos ( cm )	Table Pos ( deg )	Peak Avg. ( P/A )	Pol. ( H/V )	
802.11n HT20 CH 36 5180MHz		5149.76	50.94	-23.06	74	40.34	33.69	11.99	35.08	253	57	P	H	
		5150	41.86	-12.14	54	31.26	33.69	11.99	35.08	253	57	A	H	
	*	5180	103.35	-	-	92.66	33.78	11.99	35.08	253	57	P	H	
	*	5180	94.85	-	-	84.16	33.78	11.99	35.08	253	57	A	H	
													H	
														H
			5149.76	53.86	-20.14	74	43.26	33.69	11.99	35.08	100	102	P	V
			5150	43.58	-10.42	54	32.98	33.69	11.99	35.08	100	102	A	V
		*	5180	106.81	-	-	96.12	33.78	11.99	35.08	100	102	P	V
		*	5180	97.93	-	-	87.24	33.78	11.99	35.08	100	102	A	V
													V	
													V	
802.11n HT20 CH 44 5220MHz		5101.14	50.31	-23.69	74	39.87	33.56	11.95	35.07	249	57	P	H	
		5150	39.87	-14.13	54	29.27	33.69	11.99	35.08	249	57	A	H	
		*	5220	103.64	-	-	92.82	33.86	12.04	35.08	249	57	P	H
		*	5220	94.73	-	-	83.91	33.86	12.04	35.08	249	57	A	H
			5433.96	50.52	-23.48	74	38.55	34.43	12.63	35.09	249	57	P	H
			5446.28	40.72	-13.28	54	28.71	34.47	12.63	35.09	249	57	A	H
			5130	50.63	-23.37	74	40.11	33.65	11.95	35.08	101	96	P	V
			5149.24	40.12	-13.88	54	29.52	33.69	11.99	35.08	101	96	A	V
		*	5220	106.33	-	-	95.51	33.86	12.04	35.08	101	96	P	V
		*	5220	97.47	-	-	86.65	33.86	12.04	35.08	101	96	A	V
		5386.36	51.09	-22.91	74	39.23	34.3	12.65	35.09	101	96	P	V	
		5433.96	40.78	-13.22	54	28.81	34.43	12.63	35.09	101	96	A	V	



<b>802.11n</b>  <b>HT20</b>  <b>CH 48</b>  <b>5240MHz</b>		5139.62	49.22	-24.78	74	38.66	33.69	11.95	35.08	261	57	P	H
		5149.5	39.68	-14.32	54	29.08	33.69	11.99	35.08	261	57	A	H
	*	5240	103.03	-	-	92.04	33.91	12.16	35.08	261	57	P	H
	*	5240	94.29	-	-	83.3	33.91	12.16	35.08	261	57	A	H
		5418.28	51.31	-22.69	74	39.37	34.38	12.65	35.09	261	57	P	H
		5460	40.86	-13.14	54	28.85	34.47	12.63	35.09	261	57	A	H
		5139.62	49.89	-24.11	74	39.33	33.69	11.95	35.08	100	102	P	V
		5149.76	40.05	-13.95	54	29.45	33.69	11.99	35.08	100	102	A	V
	*	5240	106.49	-	-	95.5	33.91	12.16	35.08	100	102	P	V
	*	5240	97.41	-	-	86.42	33.91	12.16	35.08	100	102	A	V
		5364.8	51.27	-22.73	74	39.57	34.25	12.53	35.08	100	102	P	V
		5460	40.84	-13.16	54	28.83	34.47	12.63	35.09	100	102	A	V
<b>Remark</b>	1. No other spurious found. 2. All results are PASS against Peak and Average limit line.												



**Band 1 5150~5250MHz**  
**WIFI 802.11n HT20 (Harmonic @ 3m)**

WIFI Ant. 1	Note	Frequency ( MHz )	Level ( dBμV/m )	Over Limit ( dB )	Limit Line ( dBμV/m )	Read Level ( dBμV )	Antenna Factor ( dB/m )	Cable Loss ( dB )	Preamp Factor ( dB )	Ant Pos ( cm )	Table Pos ( deg )	Peak Avg. ( P/A )	Pol. ( H/V )
802.11n HT20 CH 36 5180MHz		10360	47.83	-26.17	74	50.22	39.09	17.83	59.31	100	0	P	H
		15540	49.18	-24.82	74	42.82	41.07	22.16	56.87	100	0	P	H
													H
													H
		10360	46.32	-27.68	74	48.71	39.09	17.83	59.31	100	0	P	V
		15540	49.17	-24.83	74	42.81	41.07	22.16	56.87	100	0	P	V
													V
802.11n HT20 CH 44 5220MHz		10440	46.98	-27.02	74	49.17	39.15	17.91	59.25	100	0	P	H
		15660	49.79	-24.21	74	42.97	41.31	22.29	56.78	100	0	P	H
													H
													H
		10440	47.26	-26.74	74	49.45	39.15	17.91	59.25	100	0	P	V
		15660	50.18	-23.82	74	43.36	41.31	22.29	56.78	100	0	P	V
													V
802.11n HT20 CH 48 5240MHz		10480	46.6	-27.4	74	48.68	39.19	17.94	59.21	100	0	P	H
		15720	49.15	-24.85	74	42.05	41.45	22.37	56.72	100	0	P	H
													H
													H
		10480	47.17	-26.83	74	49.25	39.19	17.94	59.21	100	0	P	V
		15720	49.96	-24.04	74	42.86	41.45	22.37	56.72	100	0	P	V
													V
Remark	1. No other spurious found.												
	2. All results are PASS against Peak and Average limit line.												



**Band 2 - 5250~5350MHz**  
**WIFI 802.11a (Band Edge @ 3m)**

WIFI	Note	Frequency	Level	Over	Limit	Read	Antenna	Cable	Preamp	Ant	Table	Peak	Pol.
Ant.				Limit	Line	Level	Factor	Loss	Factor	Pos	Pos	Avg.	
1		( MHz )	( dBμV/m )	( dB )	( dBμV/m )	( dBμV )	( dB/m )	( dB )	( dB )	( cm )	( deg )	(P/A)	(H/V)
802.11a CH 52 5260MHz		5134.75	49.76	-24.24	74	39.24	33.65	11.95	35.08	380	108	P	H
		5137.2	39.61	-14.39	54	29.09	33.65	11.95	35.08	380	108	A	H
	*	5260	103.53	-	-	92.46	33.99	12.16	35.08	380	108	P	H
	*	5260	95.34	-	-	84.27	33.99	12.16	35.08	380	108	A	H
		5438.4	50.5	-23.5	74	38.53	34.43	12.63	35.09	380	108	P	H
		5457.6	40.58	-13.42	54	28.57	34.47	12.63	35.09	380	108	A	H
		5071.05	50.07	-23.93	74	39.77	33.47	11.9	35.07	323	331	P	V
		5128.45	39.79	-14.21	54	29.27	33.65	11.95	35.08	323	331	A	V
	*	5260	107.65	-	-	96.58	33.99	12.16	35.08	323	331	P	V
	*	5260	99.44	-	-	88.37	33.99	12.16	35.08	323	331	A	V
		5384.88	51.02	-22.98	74	39.16	34.3	12.65	35.09	323	331	P	V
		5434.32	40.67	-13.33	54	28.7	34.43	12.63	35.09	323	331	A	V
802.11a CH 60 5300MHz		5071.75	50.01	-23.99	74	39.66	33.52	11.9	35.07	374	111	P	H
		5138.6	39.58	-14.42	54	29.06	33.65	11.95	35.08	374	111	A	H
	*	5300	103.85	-	-	92.57	34.08	12.28	35.08	374	111	P	H
	*	5300	95.49	-	-	84.21	34.08	12.28	35.08	374	111	A	H
		5416.08	51.06	-22.94	74	39.12	34.38	12.65	35.09	374	111	P	H
		5445.84	40.63	-13.37	54	28.62	34.47	12.63	35.09	374	111	A	H
		5120.75	49.1	-24.9	74	38.63	33.6	11.95	35.08	380	360	P	V
		5149.8	39.71	-14.29	54	29.11	33.69	11.99	35.08	380	360	A	V
	*	5300	106.81	-	-	95.53	34.08	12.28	35.08	380	360	P	V
	*	5300	98.74	-	-	87.46	34.08	12.28	35.08	380	360	A	V
		5392.32	51.06	-22.94	74	39.2	34.3	12.65	35.09	380	360	P	V
		5445.6	41.01	-12.99	54	29	34.47	12.63	35.09	380	360	A	V



<b>802.11a</b> <b>CH 64</b> <b>5320MHz</b>	*	5320	103.83	-	-	92.38	34.12	12.41	35.08	372	108	P	H
	*	5320	95.51	-	-	84.06	34.12	12.41	35.08	372	108	A	H
		5350.24	53.29	-20.71	74	41.63	34.21	12.53	35.08	372	108	P	H
		5350.08	42.93	-11.07	54	31.27	34.21	12.53	35.08	372	108	A	H
													H
													H
	*	5320	107.91	-	-	96.46	34.12	12.41	35.08	380	360	P	V
	*	5320	99.05	-	-	87.6	34.12	12.41	35.08	380	360	A	V
		5350.08	56.08	-17.92	74	44.42	34.21	12.53	35.08	380	360	P	V
		5350.08	45.17	-8.83	54	33.51	34.21	12.53	35.08	380	360	A	V
													V
													V
<b>Remark</b>	1. No other spurious found. 2. All results are PASS against Peak and Average limit line.												





**Band 2 5250~5350MHz**  
**WIFI 802.11a (Harmonic @ 3m)**

WIFI Ant. 1	Note	Frequency ( MHz )	Level ( dBμV/m )	Over Limit ( dB )	Limit Line ( dBμV/m )	Read Level (dBμV)	Antenna Factor ( dB/m )	Cable Loss ( dB )	Preamp Factor ( dB )	Ant Pos ( cm )	Table Pos ( deg )	Peak Avg. (P/A)	Pol. (H/V)
802.11a CH 52 5260MHz		10520	47.07	-26.93	74	49.09	39.18	17.98	59.18	100	0	P	H
		15780	50.68	-23.32	74	43.4	41.55	22.41	56.68	100	0	P	H
													H
													H
		10520	47.92	-26.08	74	49.94	39.18	17.98	59.18	100	0	P	V
		15780	50.14	-23.86	74	42.86	41.55	22.41	56.68	100	0	P	V
													V
													V
802.11a CH 60 5300MHz		10600	48.36	-25.64	74	50.32	39.06	18.06	59.08	100	0	P	H
		15900	50.83	-23.17	74	43.09	41.79	22.53	56.58	100	0	P	H
													H
													H
		10600	47.65	-26.35	74	49.61	39.06	18.06	59.08	100	0	P	V
		15900	49.91	-24.09	74	42.17	41.79	22.53	56.58	100	0	P	V
													V
													V
802.11a CH 64 5320MHz		10640	48.61	-25.39	74	50.54	39.01	18.09	59.03	100	0	P	H
		15960	50.35	-23.65	74	42.34	41.93	22.61	56.53	100	0	P	H
													H
													H
		10640	47.74	-26.26	74	49.67	39.01	18.09	59.03	100	0	P	V
		15960	50.18	-23.82	74	42.17	41.93	22.61	56.53	100	0	P	V
													V
													V
<b>Remark</b>	1. No other spurious found. 2. All results are PASS against Peak and Average limit line.												



**Band 2 5250~5350MHz**  
**WIFI 802.11n HT20 (Band Edge @ 3m)**

WIFI Ant. 1	Note	Frequency ( MHz )	Level ( dBμV/m )	Over Limit ( dB )	Limit Line ( dBμV/m )	Read Level ( dBμV )	Antenna Factor ( dB/m )	Cable Loss ( dB )	Preamp Factor ( dB )	Ant Pos ( cm )	Table Pos ( deg )	Peak Avg. ( P/A )	Pol. ( H/V )
802.11n HT20 CH 52 5260MHz		5006.65	49.67	-24.33	74	39.59	33.34	11.81	35.07	380	109	P	H
		5136.15	39.67	-14.33	54	29.15	33.65	11.95	35.08	380	109	A	H
	*	5260	104.44	-	-	93.37	33.99	12.16	35.08	380	109	P	H
	*	5260	95.67	-	-	84.6	33.99	12.16	35.08	380	109	A	H
		5451.84	51.84	-22.16	74	39.83	34.47	12.63	35.09	380	109	P	H
		5460	40.65	-13.35	54	28.64	34.47	12.63	35.09	380	109	A	H
		5002.1	48.77	-25.23	74	38.73	33.3	11.81	35.07	323	331	P	V
		5137.2	39.88	-14.12	54	29.36	33.65	11.95	35.08	323	331	A	V
	*	5260	108.43	-	-	97.36	33.99	12.16	35.08	323	331	P	V
	*	5260	100.04	-	-	88.97	33.99	12.16	35.08	323	331	A	V
		5426.4	50.74	-23.26	74	38.82	34.38	12.63	35.09	323	331	P	V
		5434.32	40.76	-13.24	54	28.79	34.43	12.63	35.09	323	331	A	V
802.11n HT20 CH 60 5300MHz		5122.85	49.27	-24.73	74	38.75	33.65	11.95	35.08	374	110	P	H
		5149.45	39.63	-14.37	54	29.03	33.69	11.99	35.08	374	110	A	H
	*	5300	103.93	-	-	92.65	34.08	12.28	35.08	374	110	P	H
	*	5300	95.38	-	-	84.1	34.08	12.28	35.08	374	110	A	H
		5447.52	51.49	-22.51	74	39.48	34.47	12.63	35.09	374	110	P	H
		5444.16	40.75	-13.25	54	28.78	34.43	12.63	35.09	374	110	A	H
		5060.2	49.32	-24.68	74	39.02	33.47	11.9	35.07	302	327	P	V
		5150	39.83	-14.17	54	29.23	33.69	11.99	35.08	302	327	A	V
	*	5300	107.13	-	-	95.85	34.08	12.28	35.08	302	327	P	V
	*	5300	98.7	-	-	87.42	34.08	12.28	35.08	302	327	A	V
	5430.96	50.86	-23.14	74	38.89	34.43	12.63	35.09	302	327	P	V	
	5458.56	40.88	-13.12	54	28.87	34.47	12.63	35.09	302	327	A	V	



<b>802.11n</b> <b>HT20</b> <b>CH 64</b> <b>5320MHz</b>	*	5320	103.17	-	-	91.72	34.12	12.41	35.08	372	108	P	H
	*	5320	94.45	-	-	83	34.12	12.41	35.08	372	108	A	H
		5352.32	51.05	-22.95	74	39.39	34.21	12.53	35.08	372	108	P	H
		5350.08	41.96	-12.04	54	30.3	34.21	12.53	35.08	372	108	A	H
													H
													H
	*	5320	107.13	-	-	95.68	34.12	12.41	35.08	374	336	P	V
	*	5320	98.37	-	-	86.92	34.12	12.41	35.08	374	336	A	V
		5351.04	56.97	-17.03	74	45.31	34.21	12.53	35.08	374	336	P	V
		5350.08	44.56	-9.44	54	32.9	34.21	12.53	35.08	374	336	A	V
													V
													V
<b>Remark</b>	1. No other spurious found. 2. All results are PASS against Peak and Average limit line.												



**Band 2 5250~5350MHz**  
**WIFI 802.11n HT20 (Harmonic @ 3m)**

WIFI Ant. 1	Note	Frequency ( MHz )	Level ( dBμV/m )	Over Limit ( dB )	Limit Line ( dBμV/m )	Read Level ( dBμV )	Antenna Factor ( dB/m )	Cable Loss ( dB )	Preamp Factor ( dB )	Ant Pos ( cm )	Table Pos ( deg )	Peak Avg. ( P/A )	Pol. ( H/V )	
802.11n HT20 CH 52 5260MHz		10520	46.72	-27.28	74	48.74	39.18	17.98	59.18	100	0	P	H	
		15780	50.19	-23.81	74	42.91	41.55	22.41	56.68	100	0	P	H	
													H	
													H	
			10520	47.41	-26.59	74	49.43	39.18	17.98	59.18	100	0	P	V
			15780	49.94	-24.06	74	42.66	41.55	22.41	56.68	100	0	P	V
														V
802.11n HT20 CH 60 5300MHz		10600	46.91	-27.09	74	48.87	39.06	18.06	59.08	100	0	P	H	
		15900	50.64	-23.36	74	42.9	41.79	22.53	56.58	100	0	P	H	
													H	
													H	
			10600	46.84	-27.16	74	48.8	39.06	18.06	59.08	100	0	P	V
			15900	50.41	-23.59	74	42.67	41.79	22.53	56.58	100	0	P	V
														V
802.11n HT20 CH 64 5320MHz		10640	47.79	-26.21	74	49.72	39.01	18.09	59.03	100	0	P	H	
		15960	50.89	-23.11	74	42.88	41.93	22.61	56.53	100	0	P	H	
													H	
													H	
			10640	47.91	-26.09	74	49.84	39.01	18.09	59.03	100	0	P	V
			15960	50.1	-23.9	74	42.09	41.93	22.61	56.53	100	0	P	V
														V
Remark	1. No other spurious found.													
	2. All results are PASS against Peak and Average limit line.													



**Band 3 - 5470~5725MHz**  
**WIFI 802.11a (Band Edge @ 3m)**

WIFI	Note	Frequency	Level	Over	Limit	Read	Antenna	Cable	Preamp	Ant	Table	Peak	Pol.	
Ant.				Limit	Line	Level	Factor	Loss	Factor	Pos	Pos	Avg.		
1		( MHz )	( dBµV/m )	( dB )	( dBµV/m )	( dBµV )	( dB/m )	( dB )	( dB )	( cm )	( deg )	(P/A)	(H/V)	
802.11a CH 100 5500MHz		5443.6	50.58	-23.42	74	38.61	34.43	12.63	35.09	100	241	P	H	
		5469.52	53.51	-14.69	68.2	41.48	34.51	12.61	35.09	100	241	P	H	
		5460	41.01	-12.99	54	29	34.47	12.63	35.09	100	241	A	H	
	*	5500	102.07	-	-	89.95	34.6	12.61	35.09	100	241	P	H	
	*	5500	93.4	-	-	81.28	34.6	12.61	35.09	100	241	A	H	
														H
			5459.98	50.46	-23.54	74	38.45	34.47	12.63	35.09	368	349	P	V
			5469.2	52.4	-15.8	68.2	40.37	34.51	12.61	35.09	368	349	P	V
			5460	41.3	-12.7	54	29.29	34.47	12.63	35.09	368	349	A	V
	*		5500	106.27	-	-	94.15	34.6	12.61	35.09	368	349	P	V
	*		5500	98.17	-	-	86.05	34.6	12.61	35.09	368	349	A	V
														V
802.11a CH 116 5580MHz		5454.4	50.36	-23.64	74	38.35	34.47	12.63	35.09	100	239	P	H	
		5469.76	49.9	-18.3	68.2	37.87	34.51	12.61	35.09	100	239	P	H	
		5456.8	40.57	-13.43	54	28.56	34.47	12.63	35.09	100	239	A	H	
	*	5580	101.77	-	-	89.7	34.6	12.58	35.11	100	239	P	H	
	*	5580	93.72	-	-	81.65	34.6	12.58	35.11	100	239	A	H	
			5730.665	51.39	-16.81	68.2	39.21	34.6	12.73	35.15	100	239	P	H
			5458.72	51.9	-22.1	74	39.89	34.47	12.63	35.09	357	360	P	V
			5466.4	50.5	-17.7	68.2	38.47	34.51	12.61	35.09	357	360	P	V
			5437.12	40.87	-13.13	54	28.9	34.43	12.63	35.09	357	360	A	V
	*		5580	106.44	-	-	94.37	34.6	12.58	35.11	357	360	P	V
	*		5580	98.25	-	-	86.18	34.6	12.58	35.11	357	360	A	V
			5739.8	51.83	-16.37	68.2	39.65	34.6	12.73	35.15	357	360	P	V



<b>802.11a CH 140 5700MHz</b>	*	5700	101	-	-	88.87	34.6	12.67	35.14	100	238	P	H
	*	5700	93.39	-	-	81.26	34.6	12.67	35.14	100	238	A	H
		5726.28	59.57	-8.63	68.2	47.38	34.6	12.73	35.14	100	238	P	H
													H
													H
													H
	*	5700	107.36	-	-	95.23	34.6	12.67	35.14	380	360	P	V
	*	5700	99.16	-	-	87.03	34.6	12.67	35.14	380	360	A	V
		5725.96	65.81	-2.39	68.2	53.62	34.6	12.73	35.14	380	360	P	V
													V
													V
													V
<b>Remark</b>	<ol style="list-style-type: none"> <li>1. No other spurious found.</li> <li>2. All results are PASS against Peak and Average limit line.</li> </ol>												



**Band 3 - 5470~5725MHz**  
**WIFI 802.11a (Harmonic @ 3m)**

WIFI Ant. 1	Note	Frequency ( MHz )	Level ( dBμV/m )	Over Limit ( dB )	Limit Line ( dBμV/m )	Read Level ( dBμV )	Antenna Factor ( dB/m )	Cable Loss ( dB )	Preamp Factor ( dB )	Ant Pos ( cm )	Table Pos ( deg )	Peak Avg. ( P/A )	Pol. ( H/V )
802.11a CH 100 5500MHz		11000	44.45	-29.55	74	46.12	38.5	18.43	58.6	100	0	P	H
		16500	50.38	-17.82	68.2	40.55	43	22.93	56.1	100	0	P	H
													H
													H
		11000	45.31	-28.69	74	46.98	38.5	18.43	58.6	100	0	P	V
		16500	49.59	-18.61	68.2	39.76	43	22.93	56.1	100	0	P	V
													V
													V
802.11a CH 116 5580MHz		11160	46.21	-27.79	74	47.03	38.77	18.58	58.17	100	0	P	H
		16740	50	-18.2	68.2	39.99	42.9	23.07	55.96	100	0	P	H
													H
													H
		11160	46.43	-27.57	74	47.25	38.77	18.58	58.17	100	0	P	V
		16740	49.92	-18.28	68.2	39.91	42.9	23.07	55.96	100	0	P	V
													V
													V
802.11a CH 140 5700MHz		11400	44.34	-29.66	74	43.96	39.14	18.8	57.56	100	0	P	H
		17100	49.57	-18.63	68.2	39.45	42.64	23.28	55.8	100	0	P	H
													H
													H
		11400	45.33	-28.67	74	44.95	39.14	18.8	57.56	100	0	P	V
		17100	49.18	-19.02	68.2	39.06	42.64	23.28	55.8	100	0	P	V
													V
													V
<b>Remark</b>	1. No other spurious found. 2. All results are PASS against Peak and Average limit line.												



**Band 3 - 5470~5725MHz**  
**WIFI 802.11n HT20 (Band Edge @ 3m)**

WIFI Ant. 1	Note	Frequency ( MHz )	Level ( dBμV/m )	Over Limit ( dB )	Limit Line ( dBμV/m )	Read Level ( dBμV )	Antenna Factor ( dB/m )	Cable Loss ( dB )	Preamp Factor ( dB )	Ant Pos ( cm )	Table Pos ( deg )	Peak Avg. ( P/A )	Pol. ( H/V )	
802.11n HT20 CH 100 5500MHz		5459.12	52.25	-21.75	74	40.24	34.47	12.63	35.09	100	242	P	H	
		5469.52	56.66	-11.54	68.2	44.63	34.51	12.61	35.09	100	242	P	H	
		5460	42	-12	54	29.99	34.47	12.63	35.09	100	242	A	H	
	*	5500	104.04	-	-	91.92	34.6	12.61	35.09	100	242	P	H	
	*	5500	95.67	-	-	83.55	34.6	12.61	35.09	100	242	A	H	
														H
			5459.76	51.27	-22.73	74	39.26	34.47	12.63	35.09	372	3	P	V
			5468.56	62.6	-5.6	68.2	50.57	34.51	12.61	35.09	372	3	P	V
			5460	42.81	-11.19	54	30.8	34.47	12.63	35.09	372	3	A	V
	*		5500	107.92	-	-	95.8	34.6	12.61	35.09	372	3	P	V
	*		5500	99.72	-	-	87.6	34.6	12.61	35.09	372	3	A	V
													V	
802.11n HT20 CH 116 5580MHz		5436.88	51.18	-22.82	74	39.21	34.43	12.63	35.09	100	242	P	H	
		5468.32	50.3	-17.9	68.2	38.27	34.51	12.61	35.09	100	242	P	H	
		5459.44	40.79	-13.21	54	28.78	34.47	12.63	35.09	100	242	A	H	
	*	5580	104	-	-	91.93	34.6	12.58	35.11	100	242	P	H	
	*	5580	95.32	-	-	83.25	34.6	12.58	35.11	100	242	A	H	
			5748.305	51.09	-17.11	68.2	38.85	34.6	12.79	35.15	100	242	P	H
			5442.16	51.89	-22.11	74	39.92	34.43	12.63	35.09	380	0	P	V
			5463.76	50.64	-17.56	68.2	38.61	34.51	12.61	35.09	380	0	P	V
			5457.52	41.01	-12.99	54	29	34.47	12.63	35.09	380	0	A	V
	*		5580	107.27	-	-	95.2	34.6	12.58	35.11	380	0	P	V
	*		5580	98.87	-	-	86.8	34.6	12.58	35.11	380	0	A	V
		5752.4	51.4	-16.8	68.2	39.16	34.6	12.79	35.15	380	0	P	V	





<b>802.11n</b> <b>HT20</b> <b>CH 140</b> <b>5700MHz</b>	*	5700	102.38	-	-	90.25	34.6	12.67	35.14	101	120	P	H
	*	5700	93.92	-	-	81.79	34.6	12.67	35.14	101	120	A	H
		5726.12	57.74	-10.46	68.2	45.55	34.6	12.73	35.14	101	120	P	H
													H
													H
													H
	*	5700	106.05	-	-	93.92	34.6	12.67	35.14	380	0	P	V
	*	5700	97.7	-	-	85.57	34.6	12.67	35.14	380	0	A	V
		5725.64	61.48	-6.72	68.2	49.29	34.6	12.73	35.14	380	0	P	V
													V
													V
													V
<b>Remark</b>	1. No other spurious found. 2. All results are PASS against Peak and Average limit line.												



**Band 3 - 5470~5725MHz**  
**WIFI 802.11n HT20 (Harmonic @ 3m)**

WIFI Ant. 1	Note	Frequency ( MHz )	Level ( dBμV/m )	Over Limit ( dB )	Limit Line ( dBμV/m )	Read Level ( dBμV )	Antenna Factor ( dB/m )	Cable Loss ( dB )	Preamp Factor ( dB )	Ant Pos ( cm )	Table Pos ( deg )	Peak Avg. ( P/A )	Pol. ( H/V )	
802.11n HT20 CH 100 5500MHz		11000	45.28	-28.72	74	46.95	38.5	18.43	58.6	100	0	P	H	
		16500	50.67	-17.53	68.2	40.84	43	22.93	56.1	100	0	P	H	
													H	
													H	
			11000	45.11	-28.89	74	46.78	38.5	18.43	58.6	100	0	P	V
			16500	50.26	-17.94	68.2	40.43	43	22.93	56.1	100	0	P	V
														V
802.11n HT20 CH 116 5580MHz		11160	46.26	-27.74	74	47.08	38.77	18.58	58.17	100	0	P	H	
		16740	49.75	-18.45	68.2	39.74	42.9	23.07	55.96	100	0	P	H	
													H	
													H	
			11160	46.45	-27.55	74	47.27	38.77	18.58	58.17	100	0	P	V
			16740	50.21	-17.99	68.2	40.2	42.9	23.07	55.96	100	0	P	V
														V
802.11n HT20 CH 140 5700MHz		11400	44.44	-29.56	74	44.06	39.14	18.8	57.56	100	0	P	H	
		17100	50.39	-17.81	68.2	40.27	42.64	23.28	55.8	100	0	P	H	
													H	
													H	
			11400	45.12	-28.88	74	44.74	39.14	18.8	57.56	100	0	P	V
			17100	49.51	-18.69	68.2	39.39	42.64	23.28	55.8	100	0	P	V
														V
Remark	1. No other spurious found.													
	2. All results are PASS against Peak and Average limit line.													



Emission below 1GHz

WIFI 802.11a (LF @ 3m)

WIFI	Note	Frequency	Level	Over	Limit	Read	Antenna	Cable	Preamp	Ant	Table	Peak	Pol.	
Ant.				Limit	Line	Level	Factor	Loss	Factor	Pos	Pos	Avg.		
1		( MHz )	( dBμV/m )	( dB )	( dBμV/m )	( dBμV )	( dB/m )	( dB )	( dB )	( cm )	( deg )	( P/A )	( H/V )	
802.11a LF		30.27	28.14	-11.86	40	31.78	26	1.71	31.35	-	-	P	H	
		140.43	31.41	-12.09	43.5	42.34	17.97	2.62	31.52	-	-	P	H	
		296.76	27.82	-18.18	46	36.07	19.77	3.28	31.3	-	-	P	H	
		361.6	31.34	-14.66	46	37.49	21.48	3.57	31.2	-	-	P	H	
		895	33.87	-12.13	46	30.15	28.97	5.27	30.52	-	-	P	H	
		951	34.54	-11.46	46	29.45	30.2	5.4	30.51	100	112	P	H	
													H	
													H	
													H	
													H	
													H	
													H	
													H	
													H	
													H	
													H	
													H	
			31.08	31.4	-8.6	40	35.59	25.46	1.71	31.36	100	247	P	V
			136.11	32.99	-10.51	43.5	44.05	18.12	2.34	31.52	-	-	P	V
		216.57	25.84	-20.16	46	38.18	16.36	2.72	31.42	-	-	P	V	
		372.1	29.38	-16.62	46	35.25	21.74	3.57	31.18	-	-	P	V	
		879.6	34.11	-11.89	46	30.49	28.88	5.27	30.53	-	-	P	V	
		945.4	34.62	-11.38	46	29.63	30.11	5.4	30.52	-	-	P	V	
													V	
													V	
													V	
													V	
													V	
													V	
													V	
Remark	1. No other spurious found. 2. All results are PASS against limit line.													



Note symbol

*	<b>Fundamental Frequency</b> which can be ignored. However, the level of any unwanted emissions shall not exceed the level of the fundamental frequency.
!	Test result is <b>over limit</b> line.
P/A	<b>Peak</b> or <b>Average</b>
H/V	<b>Horizontal</b> or <b>Vertical</b>



A calculation example for radiated spurious emission is shown as below:

WIFI	Note	Frequency	Level	Over	Limit	Read	Antenna	Cable	Preamp	Ant	Table	Peak	Pol.
Ant.				Limit	Line	Level	Factor	Loss	Factor	Pos	Pos	Avg.	
1		( MHz )	( dBμV/m )	( dB )	( dBμV/m )	( dBμV )	( dB/m )	( dB )	( dB )	( cm )	( deg )	( P/A )	( H/V )
802.11b		2390	55.45	-18.55	74	54.51	32.22	4.58	35.86	103	308	P	H
CH 01													
2412MHz		2390	43.54	-10.46	54	42.6	32.22	4.58	35.86	103	308	A	H

- Level(dBμV/m) =  
Antenna Factor(dB/m) + Cable Loss(dB) + Read Level(dBμV) - Preamp Factor(dB)
- Over Limit(dB) = Level(dBμV/m) – Limit Line(dBμV/m)

**For Peak Limit @ 2390MHz:**

- Level(dBμV/m)  
= Antenna Factor(dB/m) + Cable Loss(dB) + Read Level(dBμV) - Preamp Factor(dB)  
= 32.22(dB/m) + 4.58(dB) + 54.51(dBμV) – 35.86 (dB)  
= 55.45 (dBμV/m)
- Over Limit(dB)  
= Level(dBμV/m) – Limit Line(dBμV/m)  
= 55.45(dBμV/m) – 74(dBμV/m)  
= -18.55(dB)

**For Average Limit @ 2390MHz:**

- Level(dBμV/m)  
= Antenna Factor(dB/m) + Cable Loss(dB) + Read Level(dBμV) - Preamp Factor(dB)  
= 32.22(dB/m) + 4.58(dB) + 42.6(dBμV) – 35.86 (dB)  
= 43.54 (dBμV/m)
- Over Limit(dB)  
= Level(dBμV/m) – Limit Line(dBμV/m)  
= 43.54(dBμV/m) – 54(dBμV/m)  
= -10.46(dB)

Both peak and average measured complies with the limit line, so test result is “PASS”.



## Appendix C. Radiated Spurious Emission

Test Engineer :	Jesse Wang, James Chiu and Potter Liu	Temperature :	22~26°C
		Relative Humidity :	52~57%

### Note symbol

-L	Low channel location
-R	High channel location

### Band 1 - 5150~5250MHz WIFI 802.11a (Band Edge @ 3m)

WIFI	Band 1 5150~5250MHz Band Edge @ 3m	
ANT	802.11a CH36 5180MHz	
1	Horizontal	Fundamental
Peak	<p>Site : 03CH07-HY Condition : PEAK_BE_74 3m HF-ANT_130829 HORIZONTAL Detector : Peak Project : 771121 Mode : 5</p>	<p>Site : 03CH07-HY Condition : PEAK_74 3m HF-ANT_130829 HORIZONTAL Detector : Peak Project : 771121 Mode : 5</p>

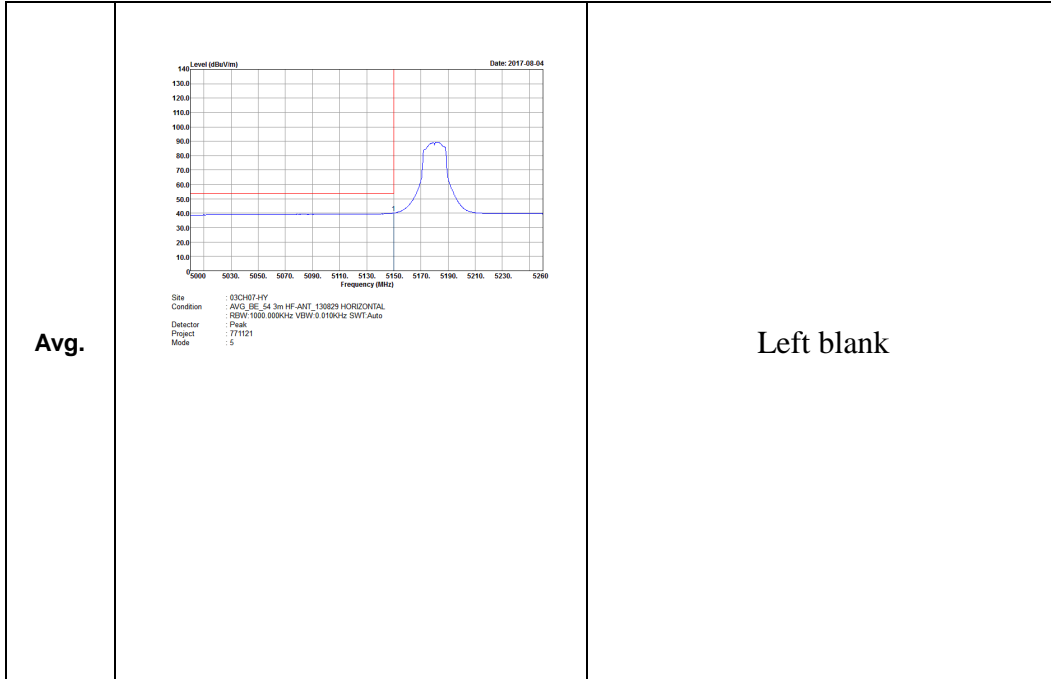



WIFI	Band 1 5150~5250MHz Band Edge @ 3m	
ANT	802.11a CH36 5180MHz	
1	Vertical	Fundamental
Peak	<p>Site : 03CH07-HY            Condition : PEAK_BE_74 3m HF-ANT_130829 VERTICAL            Detector : Peak            Project : 771121            Mode : S</p>	<p>Site : 03CH07-HY            Condition : PEAK_74 3m HF-ANT_130829 VERTICAL            Detector : Peak            Project : 771121            Mode : S</p>
Avg.	<p>Site : 03CH07-HY            Condition : AVG_BE_54 3m HF-ANT_130829 VERTICAL            Detector : Peak            Project : 771121            Mode : S</p>	Left blank





WIFI	Band 1 5150~5250MHz Band Edge @ 3m	
ANT	802.11a CH44 5220MHz - L	
1	Horizontal	Fundamental
Peak	<p>Site : 03CH07-HY            Condition : PEAK_BE_74 3m HF-ANT_130829 HORIZONTAL            Detector : Peak            Project : 771121            Mode : 6</p>	<p>Site : 03CH07-HY            Condition : PEAK_74 3m HF-ANT_130829 HORIZONTAL            Detector : Peak            Project : 771121            Mode : 6</p>
Avg.	<p>Site : 03CH07-HY            Condition : AVG_BE_74 3m HF-ANT_130829 HORIZONTAL            Detector : Peak            Project : 771121            Mode : 6</p>	Left blank

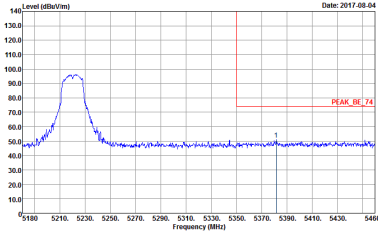
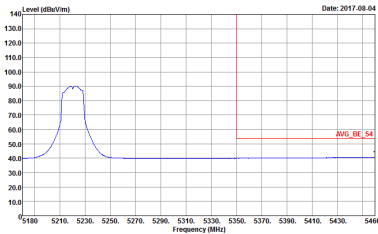

WIFI	Band 1 5150~5250MHz Band Edge @ 3m	
ANT	802.11a CH44 5220MHz - R	
1	Horizontal	Fundamental
Peak	 <p>Site : 03CH074HY            Condition : PEAK_BE_74 3m HF-ANT_130829 HORIZONTAL            Detector : Peak            Project : 771121            Mode : 6</p>	Left blank
Avg.	 <p>Site : 03CH074HY            Condition : AVG_BE_54 3m HF-ANT_130829 HORIZONTAL            Detector : Peak            Project : 771121            Mode : 6</p>	Left blank



WIFI	Band 1 5150~5250MHz Band Edge @ 3m	
ANT	802.11a CH44 5220MHz - L	
1	Vertical	Fundamental
Peak	<p>Site : 03CH07-HY            Condition : PEAK_BE_74 3m HF-ANT_130829 VERTICAL            Detector : Peak            Project : 771121            Mode : 6</p>	<p>Site : 03CH07-HY            Condition : PEAK_74 3m HF-ANT_130829 VERTICAL            Detector : Peak            Project : 771121            Mode : 6</p>
Avg.	<p>Site : 03CH07-HY            Condition : AVG_BE_74 3m HF-ANT_130829 VERTICAL            Detector : Peak            Project : 771121            Mode : 6</p>	Left blank



WIFI	Band 1 5150~5250MHz Band Edge @ 3m	
ANT	802.11a CH44 5220MHz - R	
1	Vertical	Fundamental
Peak	<p>Site : 03CH074HY            Condition : PEAK_BE_74 3m HF-ANT_130829 VERTICAL            Detector : Peak            Project : 771121            Mode : 6</p>	Left blank
Avg.	<p>Site : 03CH074HY            Condition : AVG_BE_54 3m HF-ANT_130829 VERTICAL            Detector : Peak            Project : 771121            Mode : 6</p>	Left blank

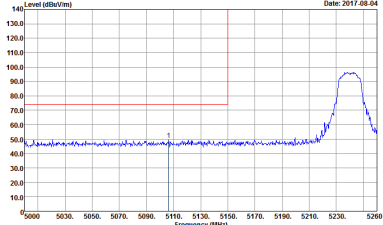
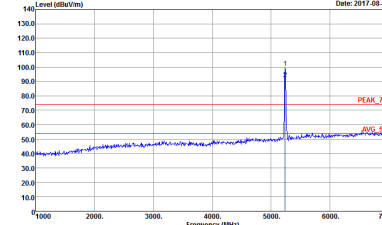
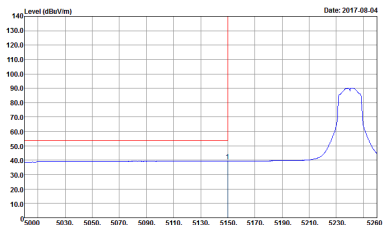

WIFI	Band 1 5150~5250MHz Band Edge @ 3m	
ANT	802.11a CH48 5240MHz - L	
1	Horizontal	Fundamental
Peak	 <p>Site : 03CH07-HY            Condition : PEAK_BE_74 3m HF-ANT_130829 HORIZONTAL            Detector : Peak            Project : 771121            Mode : 7</p>	 <p>Site : 03CH07-HY            Condition : PEAK_74 3m HF-ANT_130829 HORIZONTAL            Detector : Peak            Project : 771121            Mode : 7</p>
Avg.	 <p>Site : 03CH07-HY            Condition : AVG_BE_54 3m HF-ANT_130829 HORIZONTAL            Detector : Peak            Project : 771121            Mode : 7</p>	Left blank

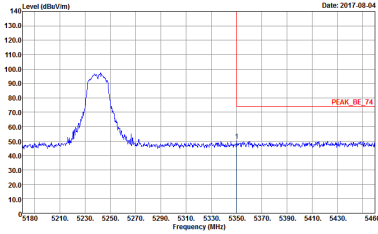
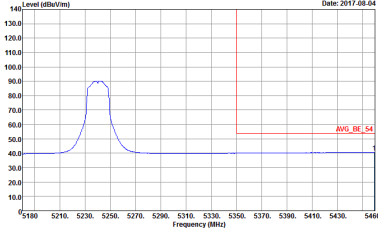

WIFI	Band 1 5150~5250MHz Band Edge @ 3m	
ANT	802.11a CH48 5240MHz - R	
1	Horizontal	Fundamental
<p><b>Peak</b></p>	 <p>Site : 03CH074HY            Condition : PEAK_BE_74 3m HF-ANT_130829 HORIZONTAL            Detector : Peak            Project : 771121            Mode : 7</p>	<p>Left blank</p>
<p><b>Avg.</b></p>	 <p>Site : 03CH074HY            Condition : AVG_BE_54 3m HF-ANT_130829 HORIZONTAL            Detector : Peak            Project : 771121            Mode : 7</p>	<p>Left blank</p>

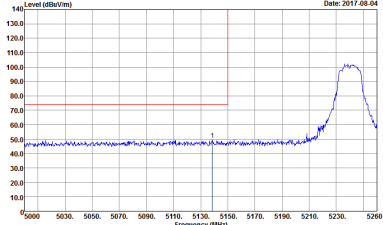
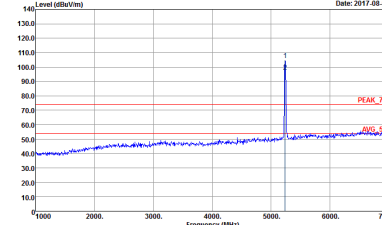
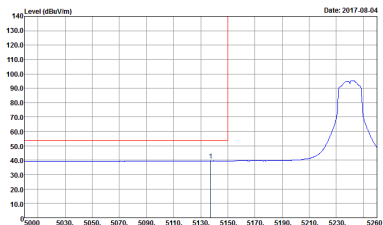

WIFI	Band 1 5150~5250MHz Band Edge @ 3m	
ANT	802.11a CH48 5240MHz - L	
1	Vertical	Fundamental
Peak	 <p>Site : 03CH07-HY            Condition : PEAK_BE_74 3m HF-ANT_130829 VERTICAL            Detector : Peak            Project : 771121            Mode : 7</p>	 <p>Site : 03CH07-HY            Condition : PEAK_74 3m HF-ANT_130829 VERTICAL            Detector : Peak            Project : 771121            Mode : 7</p>
Avg.	 <p>Site : 03CH07-HY            Condition : AVG_BE_74 3m HF-ANT_130829 VERTICAL            Detector : Peak            Project : 771121            Mode : 7</p>	Left blank



WIFI	Band 1 5150~5250MHz Band Edge @ 3m	
ANT	802.11a CH48 5240MHz - R	
1	Vertical	Fundamental
Peak	<p>Site : 03CH074HY            Condition : PEAK_BE_74 3m HF-ANT_130829 VERTICAL            Detector : Peak            Project : 771121            Mode : F</p>	Left blank
Avg.	<p>Site : 03CH074HY            Condition : AVG_BE_54 3m HF-ANT_130829 VERTICAL            Detector : Peak            Project : 771121            Mode : F</p>	Left blank



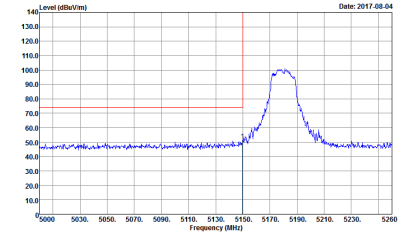
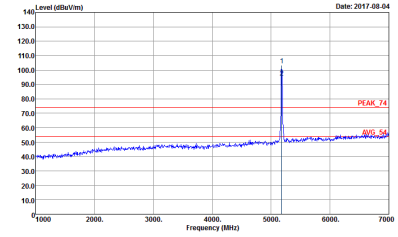
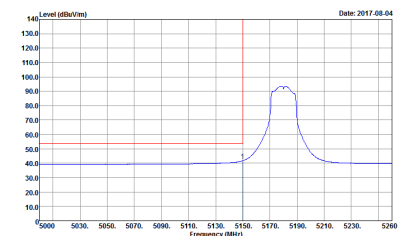

**Band 1 5150~5250MHz**  
**WIFI 802.11n HT20 (Band Edge @ 3m)**

WIFI	Band 1 5150~5250MHz Band Edge @ 3m	
ANT	802.11n HT20 CH36 5180MHz	
1	Horizontal	Fundamental
Peak	 <p>Site : 03CH07-FY            Condition : PEAK_BE_74 3m HF-ANT_130829 HORIZONTAL            Detector : Peak            Project : 771121            Mode : 17</p>	 <p>Site : 03CH07-FY            Condition : PEAK_74 3m HF-ANT_130829 HORIZONTAL            Detector : Peak            Project : 771121            Mode : 17</p>
Avg.	 <p>Site : 03CH07-FY            Condition : AVG_BE_54 3m HF-ANT_130829 HORIZONTAL            Detector : Peak            Project : 771121            Mode : 17</p>	Left blank

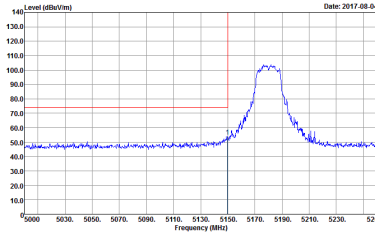
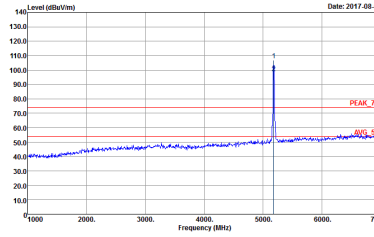
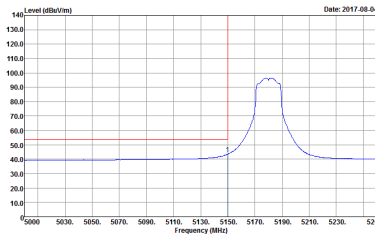

WIFI	Band 1 5150~5250MHz Band Edge @ 3m	
ANT	802.11n HT20 CH36 5180MHz	
1	Vertical	Fundamental
Peak	 <p>Site : 03CH074HY            Condition : PEAK_BE_74 3m HF-ANT_130829 VERTICAL            Detector : Peak            Project : 771121            Mode : 17</p>	 <p>Site : 03CH074HY            Condition : PEAK_74 3m HF-ANT_130829 VERTICAL            Detector : Peak            Project : 771121            Mode : 17</p>
Avg.	 <p>Site : 03CH074HY            Condition : AVG_BE_74 3m HF-ANT_130829 VERTICAL            Detector : Peak            Project : 771121            Mode : 17</p>	Left blank

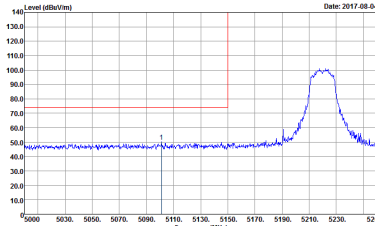
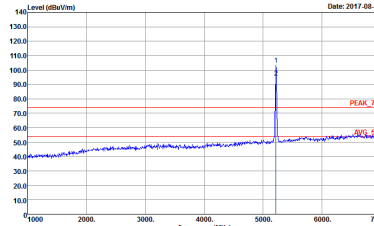
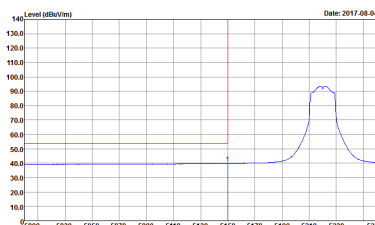

WIFI	Band 1 5150~5250MHz Band Edge @ 3m	
ANT	802.11n HT20 CH44 5220MHz - L	
1	Horizontal	Fundamental
Peak	 <p>Date: 2017.08.04</p> <p>Site : 03CH07-HY            Condition : PEAK_BE_74 3m HF-ANT_130829 HORIZONTAL            RBW:1000.000kHz VBW:3000.000kHz SWT:Auto            Detector : Peak            Project : 771121            Mode : 18</p>	 <p>Date: 2017.08.04</p> <p>Site : 03CH07-HY            Condition : PEAK_74 3m HF-ANT_130829 HORIZONTAL            RBW:1000.000kHz VBW:3000.000kHz SWT:Auto            Detector : Peak            Project : 771121            Mode : 18</p>
Avg.	 <p>Date: 2017.08.04</p> <p>Site : 03CH07-HY            Condition : AVG_BE_74 3m HF-ANT_130829 HORIZONTAL            RBW:1000.000kHz VBW:9.010kHz SWT:Auto            Detector : Peak            Project : 771121            Mode : 18</p>	Left blank



WIFI	Band 1 5150~5250MHz Band Edge @ 3m	
ANT	802.11n HT20 CH44 5220MHz - R	
1	Horizontal	Fundamental
Peak		Left blank
Avg.		Left blank

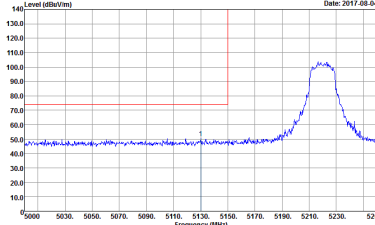
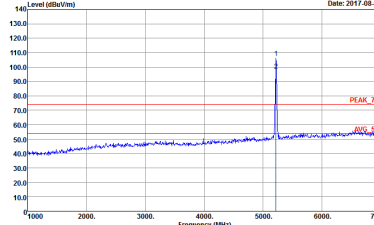
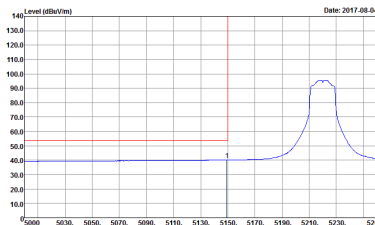

WIFI	Band 1 5150~5250MHz Band Edge @ 3m	
ANT	802.11n HT20 CH44 5220MHz - L	
1	Vertical	Fundamental
Peak	 <p>Site : 03CH07-HY            Condition : PEAK_BE_74 3m HF-ANT_130829 VERTICAL            Detector : Peak            Project : 771121            Mode : 18</p>	 <p>Site : 03CH07-HY            Condition : PEAK_74 3m HF-ANT_130829 VERTICAL            Detector : Peak            Project : 771121            Mode : 18</p>
Avg.	 <p>Site : 03CH07-HY            Condition : AVG_BE_74 3m HF-ANT_130829 VERTICAL            Detector : Peak            Project : 771121            Mode : 18</p>	Left blank

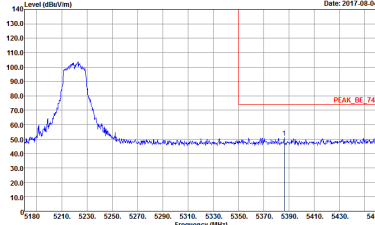
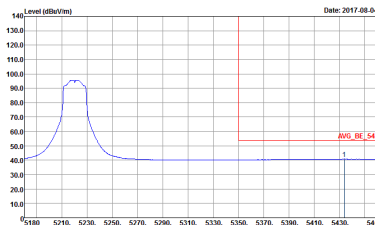

WIFI	Band 1 5150~5250MHz Band Edge @ 3m	
ANT	802.11n HT20 CH44 5220MHz - R	
1	Vertical	Fundamental
Peak	 <p>Site : 03CH074HY            Condition : PEAK_BE_74 3m HF-ANT_130829 VERTICAL            Detector : Peak            Project : 771121            Mode : IS</p>	Left blank
Avg.	 <p>Site : 03CH074HY            Condition : AVG_BE_54 3m HF-ANT_130829 VERTICAL            Detector : Peak            Project : 771121            Mode : IS</p>	Left blank



WIFI	Band 1 5150~5250MHz Band Edge @ 3m	
ANT	802.11n HT20 CH48 5240MHz - L	
1	Horizontal	Fundamental
Peak	<p>Site : 03CH07-HY            Condition : PEAK_BE_74 3m HF-ANT_130829 HORIZONTAL            Detector : Peak            Project : 771121            Mode : 19</p>	<p>Site : 03CH07-HY            Condition : PEAK_74 3m HF-ANT_130829 HORIZONTAL            Detector : Peak            Project : 771121            Mode : 19</p>
Avg.	<p>Site : 03CH07-HY            Condition : AVG_BE_54 3m HF-ANT_130829 HORIZONTAL            Detector : Peak            Project : 771121            Mode : 19</p>	Left blank



WIFI	Band 1 5150~5250MHz Band Edge @ 3m	
ANT	802.11n HT20 CH48 5240MHz - R	
1	Horizontal	Fundamental
Peak	<p>Site : 03CH074HY            Condition : PEAK_BE_74 3m HF-ANT_130829 HORIZONTAL            Detector : Peak            Project : 771121            Mode : 19</p>	Left blank
Avg.	<p>Site : 03CH074HY            Condition : AVG_BE_54 3m HF-ANT_130829 HORIZONTAL            Detector : Peak            Project : 771121            Mode : 19</p>	Left blank





WIFI	Band 1 5150~5250MHz Band Edge @ 3m	
ANT	802.11n HT20 CH48 5240MHz - L	
1	Vertical	Fundamental
Peak	<p>Site : 03CH07-HY            Condition : PEAK_BE_74 3m HF-ANT_130829 VERTICAL            Detector : Peak            Project : 771121            Mode : 19</p>	<p>Site : 03CH07-HY            Condition : PEAK_74 3m HF-ANT_130829 VERTICAL            Detector : Peak            Project : 771121            Mode : 19</p>
Avg.	<p>Site : 03CH07-HY            Condition : AVG_BE_54 3m HF-ANT_130829 VERTICAL            Detector : Peak            Project : 771121            Mode : 19</p>	Left blank

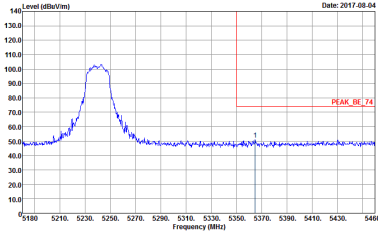
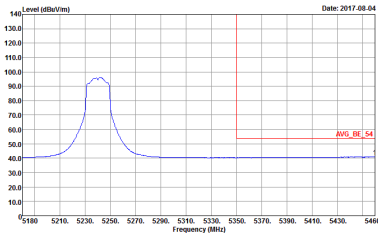

WIFI	Band 1 5150~5250MHz Band Edge @ 3m	
ANT	802.11n HT20 CH48 5240MHz - R	
1	Vertical	Fundamental
Peak	 <p>Site : 03CH074HY            Condition : PEAK_BE_74 3m HF-ANT_130829 VERTICAL            Detector : Peak            Project : 771121            Mode : 19</p>	Left blank
Avg.	 <p>Site : 03CH074HY            Condition : AVG_BE_54 3m HF-ANT_130829 VERTICAL            Detector : Peak            Project : 771121            Mode : 19</p>	Left blank



**Band 1 - 5150~5250MHz**  
**WIFI 802.11a (Harmonic @ 3m)**

WIFI	Band 1 5150~5250MHz Harmonic @ 3m	
ANT	802.11a CH36 5180MHz	
1	Horizontal	Vertical
<b>Peak</b> <b>Avg.</b>	<p>Site : 03CH074YY            Condition : PEAK_74 3m SHF-EHF_131029 HORIZONTAL            Detector : Peak            Project : 771121            Mode : 5</p>	<p>Site : 03CH074YY            Condition : PEAK_74 3m SHF-EHF_131029 VERTICAL            Detector : Peak            Project : 771121            Mode : 5</p>



WIFI	Band 1 5150~5250MHz Harmonic @ 3m	
ANT	802.11a CH44 5220MHz	
1	Horizontal	Vertical
<p><b>Peak</b></p> <p><b>Avg.</b></p>	<p>Site : 03CH07-HY            Condition : PEAK_74 3m SHF-EHF_131029 HORIZONTAL            Detector : Peak            Project : 771121            Mode : 6</p>	<p>Site : 03CH07-HY            Condition : PEAK_74 3m SHF-EHF_131029 VERTICAL            Detector : Peak            Project : 771121            Mode : 6</p>



WIFI	Band 1 5150~5250MHz Harmonic @ 3m	
ANT	802.11a CH48 5240MHz	
1	Horizontal	Vertical
<b>Peak</b> <b>Avg.</b>	<p>Site : 03CH07-HY Condition : PEAk_74 3m SHF-EHF_131029 HORIZONTAL Detector : Peak Project : 771121 Mode : 7</p>	<p>Site : 03CH07-HY Condition : PEAk_74 3m SHF-EHF_131029 VERTICAL Detector : Peak Project : 771121 Mode : 7</p>



**Band 1 5150~5250MHz  
WIFI 802.11n HT20 (Harmonic @ 3m)**

<b>WIFI</b>	<b>Band 1 5150~5250MHz Harmonic @ 3m</b>	
<b>ANT</b>	<b>802.11n HT20 CH36 5180MHz</b>	
<b>1</b>	<b>Horizontal</b>	<b>Vertical</b>
<b>Peak</b> <b>Avg.</b>	<p>Site : 03CH7-HY Condition : PEAK_T4 3m SHF-EHF_131029 HORIZONTAL Detector : Peak Project : 771121 Mode : 17</p>	<p>Site : 03CH7-HY Condition : PEAK_T4 3m SHF-EHF_131029 VERTICAL Detector : Peak Project : 771121 Mode : 17</p>



WIFI	Band 1 5150~5250MHz Harmonic @ 3m	
ANT	802.11n HT20 CH44 5220MHz	
1	Horizontal	Vertical
Peak Avg.	<p>Site : 03CH07-HY Condition : PEAK_74 3m SHF-EHF_131029 HORIZONTAL Detector : Peak Project : 771121 Mode : 18</p>	<p>Site : 03CH07-HY Condition : PEAK_74 3m SHF-EHF_131029 VERTICAL Detector : Peak Project : 771121 Mode : 18</p>

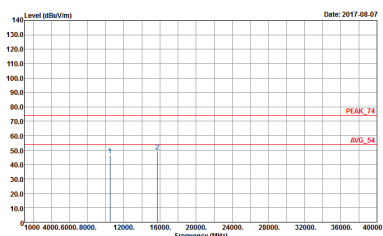
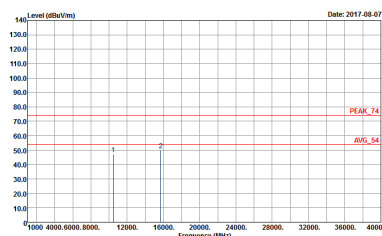

WIFI	Band 1 5150~5250MHz Harmonic @ 3m	
ANT	802.11n HT20 CH48 5240MHz	
1	Horizontal	Vertical
Peak Avg.	 <p>Site : 03CH07-HY Condition : PEAK_74 3m SHF-EHF_131029 HORIZONTAL Detector : Peak Project : 771121 Mode : 19</p>	 <p>Site : 03CH07-HY Condition : PEAK_74 3m SHF-EHF_131029 VERTICAL Detector : Peak Project : 771121 Mode : 19</p>





**Band 2 - 5250~5350MHz**  
**WIFI 802.11a (Band Edge @ 3m)**

WIFI	Band 2 5250~5350MHz Band Edge @ 3m	
ANT	802.11a CH52 5260MHz - L	
1	Horizontal	Fundamental
<b>Peak</b>	<p>Site : 03CH074HY Condition : PEAK_BE_74 3m HF-ANT_130829 HORIZONTAL RBW: 1000.000kHz VBW: 3000.000kHz SWT: Auto Detector : Peak Project : 771121 Mode : S</p>	<p>Site : 03CH074HY Condition : PEAK_74 3m HF-ANT_130829 HORIZONTAL RBW: 1000.000kHz VBW: 3000.000kHz SWT: Auto Detector : Peak Project : 771121 Mode : S</p>
<b>Avg.</b>	<p>Site : 03CH074HY Condition : AVG_BE_54 3m HF-ANT_130829 HORIZONTAL RBW: 1000.000kHz VBW: 0.0100kHz SWT: Auto Detector : Peak Project : 771121 Mode : S</p>	<b>Left blank</b>



WIFI	Band 2 5250~5350MHz Band Edge @ 3m	
ANT	802.11a CH52 5260MHz - R	
1	Horizontal	Fundamental
Peak	<p>Site : 03CH074HY            Condition : PEAK_BE_74 3m HF-ANT_130829 HORIZONTAL            Detector : Peak            Project : 771121            Mode : 0</p>	Left blank
Avg.	<p>Site : 03CH074HY            Condition : AVG_BE_54 3m HF-ANT_130829 HORIZONTAL            Detector : Peak            Project : 771121            Mode : 0</p>	Left blank

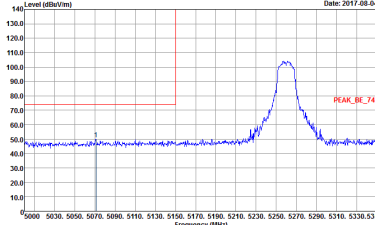
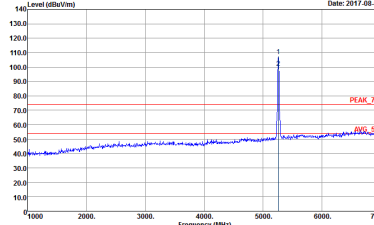
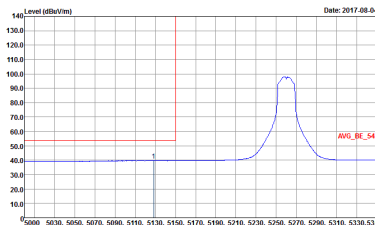

WIFI	Band 2 5250~5350MHz Band Edge @ 3m	
ANT	802.11a CH52 5260MHz - L	
1	Vertical	Fundamental
Peak	 <p>Site : 03CH07-HY            Condition : PEAK_BE_74 3m HF-ANT_130829 VERTICAL            Detector : Peak            Project : 771121            Mode : S</p>	 <p>Site : 03CH07-HY            Condition : PEAK_74 3m HF-ANT_130829 VERTICAL            Detector : Peak            Project : 771121            Mode : S</p>
Avg.	 <p>Site : 03CH07-HY            Condition : AVG_BE_54 3m HF-ANT_130829 VERTICAL            Detector : Peak            Project : 771121            Mode : S</p>	Left blank

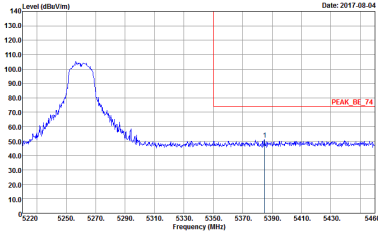
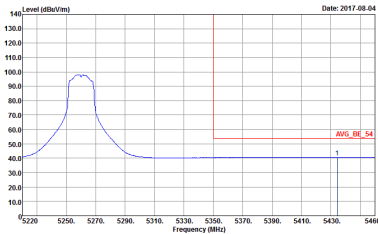

WIFI	Band 2 5250~5350MHz Band Edge @ 3m	
ANT	802.11a CH52 5260MHz - R	
1	Vertical	Fundamental
Peak	 <p>Site : 03CH074HY            Condition : PEAK_BE_74 3m HF-ANT_130829 VERTICAL            Detector : Peak            Project : 771121            Mode : S</p>	Left blank
Avg.	 <p>Site : 03CH074HY            Condition : AVG_BE_54 3m HF-ANT_130829 VERTICAL            Detector : Peak            Project : 771121            Mode : S</p>	Left blank



WIFI	Band 2 5250~5350MHz Band Edge @ 3m	
ANT	802.11a CH60 5300MHz - L	
1	Horizontal	Fundamental
Peak	<p>Site : 03CH07-HY            Condition : PEAK_BE_74 3m HF-ANT_130829 HORIZONTAL            Detector : Peak            Project : 771121            Mode : 9</p>	<p>Site : 03CH07-HY            Condition : PEAK_74 3m HF-ANT_130829 HORIZONTAL            Detector : Peak            Project : 771121            Mode : 9</p>
Avg.	<p>Site : 03CH07-HY            Condition : AVE_BE_54 3m HF-ANT_130829 HORIZONTAL            Detector : Peak            Project : 771121            Mode : 9</p>	Left blank

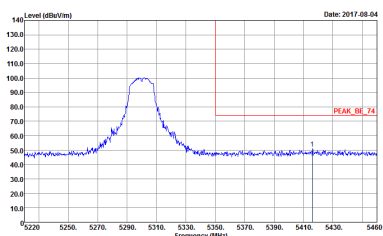
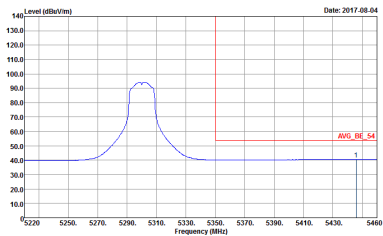

WIFI	Band 2 5250~5350MHz Band Edge @ 3m	
ANT	802.11a CH60 5300MHz - R	
1	Horizontal	Fundamental
Peak	 <p>Site : 03CH074Y            Condition : PEAK_BE_74 3m HF-ANT_130829 HORIZONTAL            Detector : Peak            Project : 771121            Mode : 9</p>	Left blank
Avg.	 <p>Site : 03CH074Y            Condition : AVG_BE_54 3m HF-ANT_130829 HORIZONTAL            Detector : Peak            Project : 771121            Mode : 9</p>	Left blank



WIFI	Band 2 5250~5350MHz Band Edge @ 3m	
ANT	802.11a CH60 5300MHz - L	
1	Vertical	Fundamental
Peak	<p>Site : 03CH07-HY            Condition : PEAK_BE_74 3m HF-ANT_130829 VERTICAL            Detector : Peak            Project : 771121            Mode : 9</p>	<p>Site : 03CH07-HY            Condition : PEAK_74 3m HF-ANT_130829 VERTICAL            Detector : Peak            Project : 771121            Mode : 9</p>
Avg.	<p>Site : 03CH07-HY            Condition : AVG_BE_54 3m HF-ANT_130829 VERTICAL            Detector : Peak            Project : 771121            Mode : 9</p>	Left blank



WIFI	Band 2 5250~5350MHz Band Edge @ 3m	
ANT	802.11a CH60 5300MHz - R	
1	Vertical	Fundamental
Peak	<p>Site : 03CH074Y            Condition : PEAK_BE_74 3m HF-ANT_130829 VERTICAL            Detector : Peak            Project : 771121            Mode : 9</p>	Left blank
Avg.	<p>Site : 03CH074Y            Condition : AVG_BE_54 3m HF-ANT_130829 VERTICAL            Detector : Peak            Project : 771121            Mode : 9</p>	Left blank





WIFI	Band 2 5250~5350MHz Band Edge @ 3m	
ANT	802.11a CH64 5320MHz	
1	Horizontal	Fundamental
Peak	<p>Site : 03CH07-HY            Condition : PEAK_BE_74 3m HF-ANT_130829 HORIZONTAL            Detector : Peak            Project : 771121            Mode : 10</p>	<p>Site : 03CH07-HY            Condition : PEAK_74 3m HF-ANT_130829 HORIZONTAL            Detector : Peak            Project : 771121            Mode : 10</p>
Avg.	<p>Site : 03CH07-HY            Condition : AVG_BE_54 3m HF-ANT_130829 HORIZONTAL            Detector : Peak            Project : 771121            Mode : 10</p>	Left blank



WIFI	Band 2 5250~5350MHz Band Edge @ 3m	
ANT	802.11a CH64 5320MHz	
1	Vertical	Fundamental
Peak	<p>Site : 03CH07-HY            Condition : PEAK_BE_74 3m HF-ANT_130829 VERTICAL            Detector : Peak            Project : 771121            Mode : 10</p>	<p>Site : 03CH07-HY            Condition : PEAK_74 3m HF-ANT_130829 VERTICAL            Detector : Peak            Project : 771121            Mode : 10</p>
Avg.	<p>Site : 03CH07-HY            Condition : AVG_BE_54 3m HF-ANT_130829 VERTICAL            Detector : Peak            Project : 771121            Mode : 10</p>	Left blank

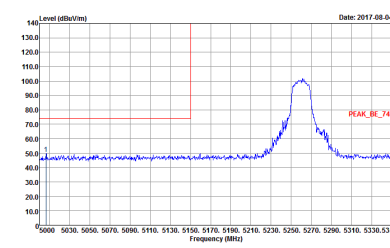
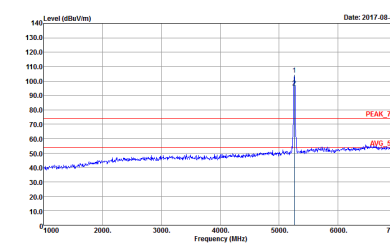
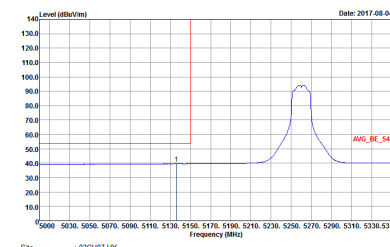

**Band 2 5250~5350MHz**  
**WIFI 802.11n HT20 (Band Edge @ 3m)**

WIFI	Band 2 5250~5350MHz Band Edge @ 3m	
ANT	802.11n HT20 CH52 5260MHz - L	
1	Horizontal	Fundamental
Peak	 <p>Level (dBu/m) vs Frequency (MHz) plot showing a peak at approximately 5260 MHz. The y-axis ranges from 10.0 to 140.0 dBu/m, and the x-axis ranges from 5000 to 5350 MHz. A red vertical line is at 5260 MHz, and a red horizontal line is at approximately 75 dBu/m. The peak is labeled 'PEAK_BE_74'.</p> <p>Site : 03CH07-HY            Condition : PEAK_BE_74 3m HF-ANT_130829 HORIZONTAL            Detector : Peak            Project : 771121            Mode : 20</p>	 <p>Level (dBu/m) vs Frequency (MHz) plot showing a peak at approximately 5260 MHz. The y-axis ranges from 10.0 to 140.0 dBu/m, and the x-axis ranges from 1000 to 7000 MHz. A red vertical line is at 5260 MHz, and a red horizontal line is at approximately 75 dBu/m. The peak is labeled 'PEAK_74' and the baseline is labeled 'AVG_51'.</p> <p>Site : 03CH07-HY            Condition : PEAK_74 3m HF-ANT_130829 HORIZONTAL            Detector : Peak            Project : 771121            Mode : 20</p>
Avg.	 <p>Level (dBu/m) vs Frequency (MHz) plot showing a peak at approximately 5260 MHz. The y-axis ranges from 10.0 to 140.0 dBu/m, and the x-axis ranges from 5000 to 5350 MHz. A red vertical line is at 5260 MHz, and a red horizontal line is at approximately 45 dBu/m. The peak is labeled 'AVG_BE_54'.</p> <p>Site : 03CH07-HY            Condition : AVG_BE_54 3m HF-ANT_130829 HORIZONTAL            Detector : Peak            Project : 771121            Mode : 20</p>	Left blank



WIFI	Band 2 5250~5350MHz Band Edge @ 3m	
ANT	802.11n HT20 CH52 5260MHz - R	
1	Horizontal	Fundamental
<p><b>Peak</b></p>		<p>Left blank</p>
<p><b>Avg.</b></p>		<p>Left blank</p>

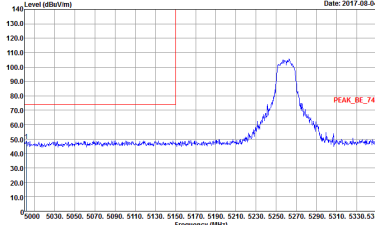
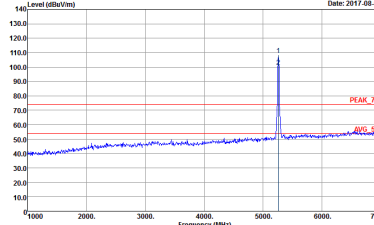
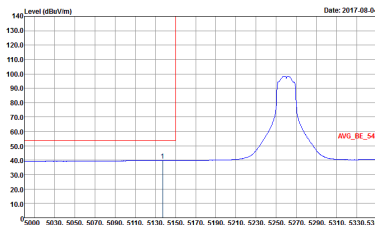

WIFI	Band 2 5250~5350MHz Band Edge @ 3m	
ANT	802.11n HT20 CH52 5260MHz - L	
1	Vertical	Fundamental
Peak	 <p>Site : 03CH07-HY            Condition : PEAK_BE_74 3m HF-ANT_130829 VERTICAL            Detector : Peak            Project : 771121            Mode : 20</p>	 <p>Site : 03CH07-HY            Condition : PEAK_74 3m HF-ANT_130829 VERTICAL            Detector : Peak            Project : 771121            Mode : 20</p>
Avg.	 <p>Site : 03CH07-HY            Condition : AVG_BE_54 3m HF-ANT_130829 VERTICAL            Detector : Peak            Project : 771121            Mode : 20</p>	Left blank



WIFI	Band 2 5250~5350MHz Band Edge @ 3m	
ANT	802.11n HT20 CH52 5260MHz - R	
1	Vertical	Fundamental
Peak		Left blank
Avg.		Left blank



WIFI	Band 2 5250~5350MHz Band Edge @ 3m	
ANT	802.11n HT20 CH60 5300MHz - L	
1	Horizontal	Fundamental
Peak	<p>Site : 03CH07-HY            Condition : PEAK_BE_74 3m HF-ANT_130829 HORIZONTAL            Detector : Peak            Project : 771121            Mode : Z1</p>	<p>Site : 03CH07-HY            Condition : PEAK_74 3m HF-ANT_130829 HORIZONTAL            Detector : Peak            Project : 771121            Mode : Z1</p>
Avg.	<p>Site : 03CH07-HY            Condition : AVG_BE_54 3m HF-ANT_130829 HORIZONTAL            Detector : Peak            Project : 771121            Mode : Z1</p>	Left blank



WIFI	Band 2 5250~5350MHz Band Edge @ 3m	
ANT	802.11n HT20 CH60 5300MHz - R	
1	Horizontal	Vertical
Peak	<p>Site : 03CH074Y Condition : PEAK_BE_74 3m HF-ANT_130829 HORIZONTAL Detector : Peak Project : 771121 Mode : 21</p>	Left blank
Avg.	<p>Site : 03CH074Y Condition : AVG_BE_54 3m HF-ANT_130829 HORIZONTAL Detector : Peak Project : 771121 Mode : 21</p>	Left blank





WIFI	Band 2 5250~5350MHz Band Edge @ 3m	
ANT	802.11n HT20 CH60 5300MHz - L	
1	Vertical	Fundamental
Peak	<p>Site : 03CH07-HY            Condition : PEAK_BE_74 3m HF-ANT_130829 VERTICAL            Detector : Peak            Project : 771121            Mode : Z1</p>	<p>Site : 03CH07-HY            Condition : PEAK_74 3m HF-ANT_130829 VERTICAL            Detector : Peak            Project : 771121            Mode : Z1</p>
Avg.	<p>Site : 03CH07-HY            Condition : AVG_BE_54 3m HF-ANT_130829 VERTICAL            Detector : Peak            Project : 771121            Mode : Z1</p>	Left blank



WIFI	Band 2 5250~5350MHz Band Edge @ 3m	
ANT	802.11n HT20 CH60 5300MHz - R	
1	Vertical	Fundamental
Peak		Left blank
Avg.		Left blank



WIFI	Band 2 5250~5350MHz Band Edge @ 3m	
ANT	802.11n HT20 CH64 5320MHz	
1	Horizontal	Fundamental
Peak	<p>Site : 03CH07-HY            Condition : PEAK_BE_74 3m HF-ANT_130829 HORIZONTAL            Detector : Peak            Project : 771121            Mode : Z2</p>	<p>Site : 03CH07-HY            Condition : PEAK_74 3m HF-ANT_130829 HORIZONTAL            Detector : Peak            Project : 771121            Mode : Z2</p>
Avg.	<p>Site : 03CH07-HY            Condition : AVG_BE_54 3m HF-ANT_130829 HORIZONTAL            Detector : Peak            Project : 771121            Mode : Z2</p>	Left blank



WIFI	Band 2 5250~5350MHz Band Edge @ 3m	
ANT	802.11n HT20 CH64 5320MHz	
1	Vertical	Fundamental
Peak	<p>Site : 03CH07-HY            Condition : PEAK_BE_74 3m HF-ANT_130829 VERTICAL            Detector : Peak            Project : 771121            Mode : Z</p>	<p>Site : 03CH07-HY            Condition : PEAK_74 3m HF-ANT_130829 VERTICAL            Detector : Peak            Project : 771121            Mode : Z</p>
Avg.	<p>Site : 03CH07-HY            Condition : AVG_BE_54 3m HF-ANT_130829 VERTICAL            Detector : Peak            Project : 771121            Mode : Z</p>	Left blank



**Band 2 - 5250~5350MHz**  
**WIFI 802.11a (Harmonic @ 3m)**

<b>WIFI</b>	<b>Band 2 5250~5350MHz Harmonic @ 3m</b>	
<b>ANT</b>	<b>802.11a CH52 5260MHz</b>	
<b>1</b>	<b>Horizontal</b>	<b>Vertical</b>
<b>Peak</b> <b>Avg.</b>	<p>Site : 03CH074YY          Condition : PEAK_74 3m SHF-EHF_131029 HORIZONTAL          Detector : Peak          Project : 771121          Mode : S</p>	<p>Site : 03CH074YY          Condition : PEAK_74 3m SHF-EHF_131029 VERTICAL          Detector : Peak          Project : 771121          Mode : S</p>

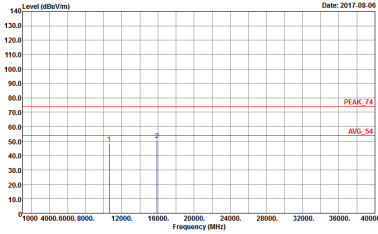
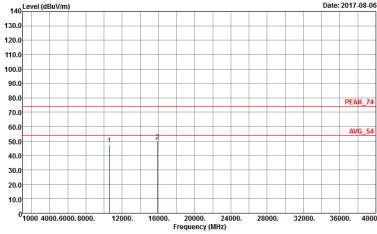

WIFI	Band 2 5250~5350MHz Harmonic @ 3m	
ANT	802.11a CH60 5300MHz	
1	Horizontal	Vertical
Peak Avg.	 <p>Site : 03CH07-HY Condition : PEAK_74 3m SHF-EHF_131029 HORIZONTAL Detector : Peak Project : 771121 Mode : 9</p>	 <p>Site : 03CH07-HY Condition : PEAK_74 3m SHF-EHF_131029 VERTICAL Detector : Peak Project : 771121 Mode : 9</p>



WIFI	Band 2 5250~5350MHz Harmonic @ 3m	
ANT	802.11a CH64 5320MHz	
1	Horizontal	Vertical
<b>Peak</b> <b>Avg.</b>	<p>Site : 03CH07-HY Condition : PEAK_74 3m SHF-EHF_131029 HORIZONTAL Detector : Peak Project : 771121 Mode : 10</p>	<p>Site : 03CH07-HY Condition : PEAK_74 3m SHF-EHF_131029 VERTICAL Detector : Peak Project : 771121 Mode : 10</p>



**Band 2 5250~5350MHz  
WIFI 802.11n HT20 (Harmonic @ 3m)**

<b>WIFI</b>	<b>Band 2 5250~5350MHz Harmonic @ 3m</b>	
<b>ANT</b>	<b>802.11n HT20 CH52 5260MHz</b>	
<b>1</b>	<b>Horizontal</b>	<b>Vertical</b>
<b>Peak</b> <b>Avg.</b>	<p>Site : 03CH7-HY Condition : PEAK_T4 3m SHF-EHF_131029 HORIZONTAL Detector : Peak Project : 771121 Mode : 20</p>	<p>Site : 03CH7-HY Condition : PEAK_T4 3m SHF-EHF_131029 VERTICAL Detector : Peak Project : 771121 Mode : 20</p>





WIFI	Band 2 5250~5350MHz Harmonic @ 3m													
ANT	802.11n HT20 CH60 5300MHz													
1	Horizontal	Vertical												
Peak Avg.	<p>Horizontal Spectrum Plot Data:</p> <table border="1"> <thead> <tr> <th>Frequency (MHz)</th> <th>Level (dBuV/m)</th> </tr> </thead> <tbody> <tr> <td>12000</td> <td>~55</td> </tr> <tr> <td>16000</td> <td>~55</td> </tr> </tbody> </table>	Frequency (MHz)	Level (dBuV/m)	12000	~55	16000	~55	<p>Vertical Spectrum Plot Data:</p> <table border="1"> <thead> <tr> <th>Frequency (MHz)</th> <th>Level (dBuV/m)</th> </tr> </thead> <tbody> <tr> <td>12000</td> <td>~55</td> </tr> <tr> <td>16000</td> <td>~55</td> </tr> </tbody> </table>	Frequency (MHz)	Level (dBuV/m)	12000	~55	16000	~55
Frequency (MHz)	Level (dBuV/m)													
12000	~55													
16000	~55													
Frequency (MHz)	Level (dBuV/m)													
12000	~55													
16000	~55													



WIFI	Band 2 5250~5350MHz Harmonic @ 3m	
ANT	802.11n HT20 CH64 5320MHz	
1	Horizontal	Vertical
Peak Avg.	<p>Site : 03CH07-HY Condition : PEAK_74 3m SHF-EHF_131029 HORIZONTAL Detector : Peak Project : 771121 Mode : ZZ</p>	<p>Site : 03CH07-HY Condition : PEAK_74 3m SHF-EHF_131029 VERTICAL Detector : Peak Project : 771121 Mode : ZZ</p>



**Band 3 - 5470~5725MHz**  
**WIFI 802.11a (Band Edge @ 3m)**

WIFI	Band 3 5470~5725MHz Band Edge @ 3m	
ANT	802.11a CH100 5500MHz	
1	Horizontal	Fundamental
<b>Peak</b>	<p>Site : 03CH074HY            Condition : PEAK_BE(LIN), E3 3m HF-ANT_130829 HORIZONTAL            RBW: 1000.000kHz VBW: 3000.000kHz SWT: Auto            Detector : Peak            Project : 771121            Mode : 11</p>	<p>Site : 03CH074HY            Condition : PEAK(LIN) 3m HF-ANT_130829 HORIZONTAL            RBW: 1000.000kHz VBW: 3000.000kHz SWT: Auto            Detector : Peak            Project : 771121            Mode : 11</p>
<b>Avg.</b>	<p>Site : 03CH074HY            Condition : AVG_SIC(LIN), E3 3m HF-ANT_130829 HORIZONTAL            RBW: 1000.000kHz VBW: 0.010kHz SWT: Auto            Detector : Peak            Project : 771121            Mode : 11</p>	Left blank



WIFI	Band 3 5470~5725MHz Band Edge @ 3m	
ANT	802.11a CH100 5500MHz	
1	Vertical	Fundamental
Peak	<p>Site : 03CH074HY            Condition : PEAK_BE(UNI)_B3 3m HF-ANT_130829 VERTICAL            Detector : Peak            Project : 771121            Mode : 11</p>	<p>Site : 03CH074HY            Condition : PEAK(UNI) 3m HF-ANT_130829 VERTICAL            Detector : Peak            Project : 771121            Mode : 11</p>
Avg.	<p>Site : 03CH074HY            Condition : AVG_BE(UNI)_B3 3m HF-ANT_130829 VERTICAL            Detector : Peak            Project : 771121            Mode : 11</p>	Left blank



WIFI	Band 3 5470~5725MHz Band Edge @ 3m	
ANT	802.11a CH116 5580MHz - L	
1	Horizontal	Fundamental
Peak	<p>Site : 03CH074HY            Condition : PEAK_BE(UNI)_B3 3m HF-ANT_130829 HORIZONTAL            Detector : Peak            Project : 771121            Mode : 12</p>	<p>Site : 03CH074HY            Condition : PEAK(UNI)_B3 3m HF-ANT_130829 HORIZONTAL            Detector : Peak            Project : 771121            Mode : 12</p>
Avg.	<p>Site : 03CH074HY            Condition : AVG_BE(UNI)_B3 3m HF-ANT_130829 HORIZONTAL            Detector : Peak            Project : 771121            Mode : 12</p>	Left blank



WIFI	Band 3 5470~5725MHz Band Edge @ 3m	
ANT	802.11a CH116 5580MHz - R	
1	Horizontal	Fundamental
Peak	<p>Site : 03CH07-1Y Condition : PEAK_BE(UNI)_B3 3m HF-ANT_130829 HORIZONTAL Detector : Peak Project : 771121 Mode : 12</p>	Left blank



WIFI	Band 3 5470~5725MHz Band Edge @ 3m	
ANT	802.11a CH116 5580MHz - L	
1	Vertical	Fundamental
Peak	<p>Site : 03CH074HY            Condition : PEAK_BE(UNI)_B3 3m HF-ANT_130829 VERTICAL            Detector : Peak            Project : 771121            Mode : 12</p>	<p>Site : 03CH074HY            Condition : PEAK(UNI)_3m HF-ANT_130829 VERTICAL            Detector : Peak            Project : 771121            Mode : 12</p>
Avg.	<p>Site : 03CH074HY            Condition : AVG_BE(UNI)_B3 3m HF-ANT_130829 VERTICAL            Detector : Peak            Project : 771121            Mode : 12</p>	Left blank



WIFI	Band 3 5470~5725MHz Band Edge @ 3m	
ANT	802.11a CH116 5580MHz - R	
1	Vertical	Fundamental
Peak	<p>Site : 03CH07-1Y Condition : PEAK_BE(UNI)_B3 3m HF-ANT_130829 VERTICAL Detector : Peak Project : 771121 Mode : 12</p>	Left blank





WIFI	Band 3 5470~5725MHz Band Edge @ 3m	
ANT	802.11a CH140 5700MHz	
1	Horizontal	Fundamental
Peak	<p>Site : 03CH07-HY            Condition : PEAK_BE(UNI)_B3 3m HF-ANT_130829 HORIZONTAL            Detector : Peak            Project : 771121            Mode : 13</p>	<p>Site : 03CH07-HY            Condition : PEAK(UNI)_B3 3m HF-ANT_130829 HORIZONTAL            Detector : Peak            Project : 771121            Mode : 13</p>



WIFI	Band 3 5470~5725MHz Band Edge @ 3m	
ANT	802.11a CH140 5700MHz	
1	Vertical	Fundamental
Peak	<p>Site : 03CH07-HY            Condition : PEAK_BE(UMI)_B3 3m HF-ANT_130829 VERTICAL            Detector : Peak            Project : 771121            Mode : 13</p>	<p>Site : 03CH07-HY            Condition : PEAK_UMI 3m HF-ANT_130829 VERTICAL            Detector : Peak            Project : 771121            Mode : 13</p>

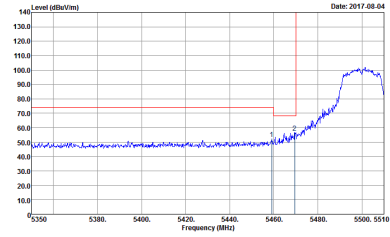
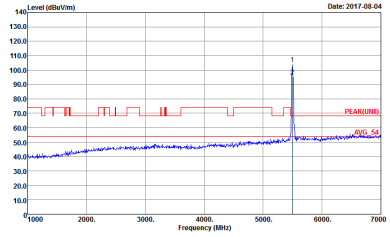
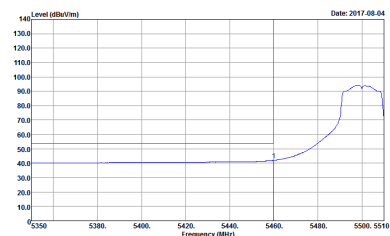

**Band 3 5470~5725MHz**  
**WIFI 802.11n HT20 (Band Edge @ 3m)**

WIFI	Band 3 5470~5725MHz Band Edge @ 3m	
ANT	802.11n HT20 CH100 5500MHz	
1	Horizontal	Fundamental
Peak	 <p>Date: 2017-08-04</p> <p>Site : 03CH07-HY            Condition : PEAK_BE(UM), E3 3m HF-ANT, 130829 HORIZONTAL            Detector : Peak            Project : 771121            Mode : 23</p>	 <p>Date: 2017-08-04</p> <p>Site : 03CH07-HY            Condition : PEAK(UM) 3m HF-ANT, 130829 HORIZONTAL            Detector : Peak            Project : 771121            Mode : 23</p>
Avg.	 <p>Date: 2017-08-04</p> <p>Site : 03CH07-HY            Condition : AVG_BE(UM), E3 3m HF-ANT, 130829 HORIZONTAL            Detector : Peak            Project : 771121            Mode : 23</p>	Left blank



WIFI	Band 3 5470~5725MHz Band Edge @ 3m	
ANT	802.11n HT20 CH100 5500MHz	
1	Vertical	Fundamental
Peak	<p>Site : 03CH074HY            Condition : PEAK_BE(UNI)_B3 3m HF-ANT_130829 VERTICAL            Detector : Peak            Project : 771121            Mode : Z3</p>	<p>Site : 03CH074HY            Condition : PEAK(UNI) 3m HF-ANT_130829 VERTICAL            Detector : Peak            Project : 771121            Mode : Z3</p>
Avg.	<p>Site : 03CH074HY            Condition : AVG_BE(UNI)_B3 3m HF-ANT_130829 VERTICAL            Detector : Peak            Project : 771121            Mode : Z3</p>	Left blank



WIFI	Band 3 5470~5725MHz Band Edge @ 3m	
ANT	802.11n HT20 CH116 5580MHz - L	
1	Horizontal	Fundamental
Peak	<p>Site : 03CH074HY            Condition : PEAK_BE(UNI)_B3 3m HF-ANT_130829 HORIZONTAL            Detector : Peak            Project : 771121            Mode : 24</p>	<p>Site : 03CH074HY            Condition : PEAK(UNI)_B3 3m HF-ANT_130829 HORIZONTAL            Detector : Peak            Project : 771121            Mode : 24</p>
Avg.	<p>Site : 03CH074HY            Condition : AVG_BE(UNI)_B3 3m HF-ANT_130829 HORIZONTAL            Detector : Peak            Project : 771121            Mode : 24</p>	Left blank



WIFI	Band 3 5470~5725MHz Band Edge @ 3m	
ANT	802.11n HT20 CH116 5580MHz - R	
1	Horizontal	Fundamental
Peak	<p>Site : 03CH07-1Y Condition : PEAK_BE(UNI)_B3 3m HF-ANT_130829 HORIZONTAL Detector : Peak Project : 771121 Mode : 24</p>	Left blank

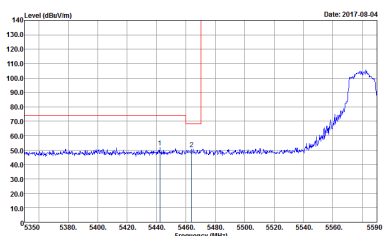
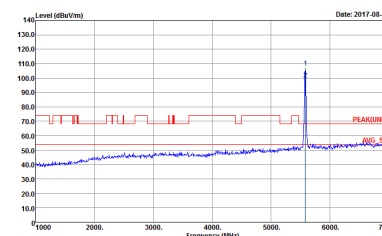
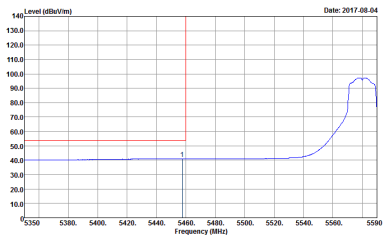

WIFI	Band 3 5470~5725MHz Band Edge @ 3m	
ANT	802.11n HT20 CH116 5580MHz - L	
1	Vertical	Fundamental
Peak	 <p>Site : 03CH074HY            Condition : PEAK_BE(UNI)_B3 3m HF-ANT_130829 VERTICAL            Detector : Peak            Project : 771121            Mode : 24</p>	 <p>Site : 03CH074HY            Condition : PEAK(UNI) 3m HF-ANT_130829 VERTICAL            Detector : Peak            Project : 771121            Mode : 24</p>
Avg.	 <p>Site : 03CH074HY            Condition : AVG_BE(UNI)_B3 3m HF-ANT_130829 VERTICAL            Detector : Peak            Project : 771121            Mode : 24</p>	Left blank



WIFI	Band 3 5470~5725MHz Band Edge @ 3m	
ANT	802.11n HT20 CH116 5580MHz - R	
1	Vertical	Fundamental
Peak	<p>Site : 03CH07-1Y Condition : PEAK_BE(UNI)_B3 3m HF-ANT_130829 VERTICAL Detector : Peak Project : 771121 Mode : 24</p>	Left blank



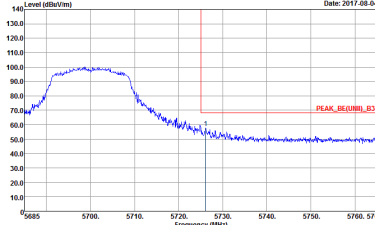
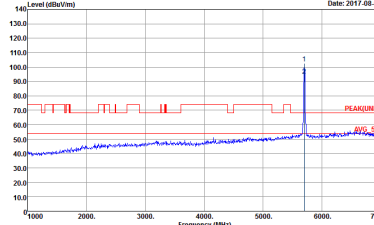

WIFI	Band 3 5470~5725MHz Band Edge @ 3m	
ANT	802.11n HT20 CH140 5700MHz	
1	Horizontal	Fundamental
Peak	 <p>Date: 2017.08.04</p> <p>Level (dBuV/m)</p> <p>Frequency (MHz)</p> <p>PEAK_BE(UNI)_B3</p> <p>Site : 03CH07-HY            Condition : PEAK_BE(UNI)_B3 3m HF-ANT_130829 HORIZONTAL            ResW: 1000.000KHz VBW: 3000.000KHz SWT: Auto            Detector : Peak            Project : 771121            Mode : ZS</p>	 <p>Date: 2017.08.04</p> <p>Level (dBuV/m)</p> <p>Frequency (MHz)</p> <p>PEAK(UNI)_B3</p> <p>Site : 03CH07-HY            Condition : PEAK(UNI)_B3 3m HF-ANT_130829 HORIZONTAL            ResW: 1000.000KHz VBW: 3000.000KHz SWT: Auto            Detector : Peak            Project : 771121            Mode : ZS</p>

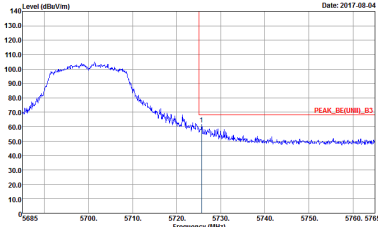
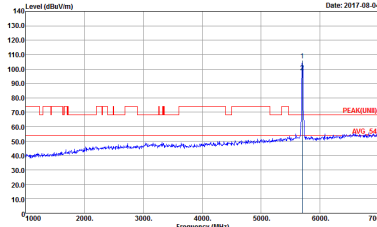

WIFI	Band 3 5470~5725MHz Band Edge @ 3m	
ANT	802.11n HT20 CH140 5700MHz	
1	Vertical	Fundamental
<p>Peak.</p>	 <p>Date: 2017.08.04</p> <p>Site : 03CH07-HY            Condition : PEAK_BE(UMI)_B3 3m HF-ANT_130829 VERTICAL            Detector : Peak            Project : 771121            Mode : ZS</p>	 <p>Date: 2017.08.04</p> <p>Site : 03CH07-HY            Condition : PEAK(UMI)_B3 3m HF-ANT_130829 VERTICAL            Detector : Peak            Project : 771121            Mode : ZS</p>



**Band 3 - 5470~5725MHz**  
**WIFI 802.11a (Harmonic @ 3m)**

WIFI	Band 3 5470~5725MHz Harmonic @ 3m	
ANT	802.11a CH100 5500MHz	
1	Horizontal	Vertical
<p><b>Peak</b> <b>Avg.</b></p>	<p>Date: 2017.08.06</p> <p>Site : 03CH074NY          Condition : PEAK(UM) 3m SHF-EHF_131029 HORIZONTAL          Detector : Peak          Project : 771121          Mode : 11</p>	<p>Date: 2017.08.06</p> <p>Site : 03CH074NY          Condition : PEAK(UM) 3m SHF-EHF_131029 VERTICAL          Detector : Peak          Project : 771121          Mode : 11</p>



WIFI	Band 3 5470~5725MHz Harmonic @ 3m	
ANT	802.11a CH116 5580MHz	
1	Horizontal	Vertical
Peak Avg.	<p>Site : 03CH07-HY Condition : PEAQ(UWB) 3m SHF-EHF_131029 HORIZONTAL Detector : Peak Project : 771121 Mode : 12</p>	<p>Site : 03CH07-HY Condition : PEAQ(UWB) 3m SHF-EHF_131029 VERTICAL Detector : Peak Project : 771121 Mode : 12</p>



WIFI	Band 3 5470~5725MHz Harmonic @ 3m	
ANT	802.11a CH140 5700MHz	
1	Horizontal	Vertical
Peak Avg.	<p>Site : 03CH07-HY Condition : PEAQ(UWB) 3m SHF-EHF_131029 HORIZONTAL Detector : Peak Project : 771121 Mode : 13</p>	<p>Site : 03CH07-HY Condition : PEAQ(UWB) 3m SHF-EHF_131029 VERTICAL Detector : Peak Project : 771121 Mode : 13</p>



**Band 3 5470~5725MHz  
WIFI 802.11n HT20 (Harmonic @ 3m)**

<b>WIFI</b>	<b>Band 3 5470~5725MHz Harmonic @ 3m</b>	
<b>ANT</b>	<b>802.11n HT20 CH100 5500MHz</b>	
<b>1</b>	<b>Horizontal</b>	<b>Vertical</b>
<b>Peak</b> <b>Avg.</b>	<p>Site : 03CH07-HY Condition : [PEAK(AVG)] 3m SHF-EHF_131029 HORIZONTAL Detector : Peak Project : 771121 Mode : Z3</p>	<p>Site : 03CH07-HY Condition : [PEAK(AVG)] 3m SHF-EHF_131029 VERTICAL Detector : Peak Project : 771121 Mode : Z3</p>

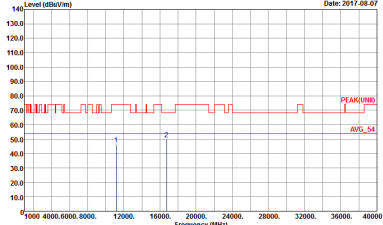
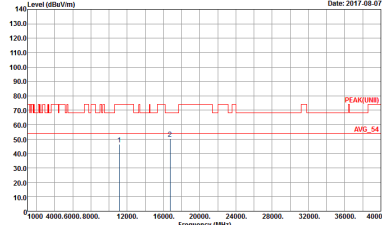

WIFI	Band 3 5470~5725MHz Harmonic @ 3m	
ANT	802.11n HT20 CH116 5580MHz	
1	Horizontal	Vertical
Peak Avg.	 <p>Site : 03CH07-HY Condition : PEAQ(UWB) 3m SHF-EHF_131029 HORIZONTAL Detector : Peak Project : 771121 Mode : 24</p>	 <p>Site : 03CH07-HY Condition : PEAQ(UWB) 3m SHF-EHF_131029 VERTICAL Detector : Peak Project : 771121 Mode : 24</p>

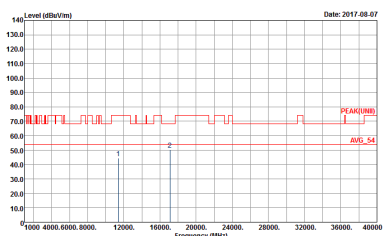
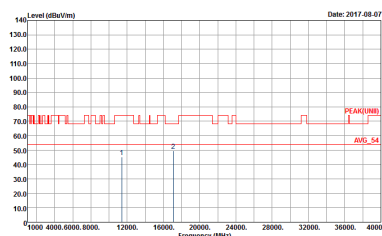

WIFI	Band 3 5470~5725MHz Harmonic @ 3m	
ANT	802.11n HT20 CH140 5700MHz	
1	Horizontal	Vertical
Peak Avg.	 <p>Site : 03CH07-HY Condition : PEAQ(U) 3m SHF-EHF_131029 HORIZONTAL Detector : Peak Project : 771121 Mode : 25</p>	 <p>Site : 03CH07-HY Condition : PEAQ(U) 3m SHF-EHF_131029 VERTICAL Detector : Peak Project : 771121 Mode : 25</p>





Emission below 1GHz  
5GHz WIFI 802.11a (LF)

WIFI	5GHz WIFI	
ANT	802.11a LF	
1	Horizontal	Vertical
QP / Peak	<p>Site : 03CH07-HY Condition : QP 3m LF-ANT-35419(E) HORIZONTAL Detector : Peak Project : 771121 Mode : 29</p>	<p>Site : 03CH07-HY Condition : QP 3m LF-ANT-35419(E) VERTICAL Detector : Peak Project : 771121 Mode : 29</p>



## Appendix D. Duty Cycle Plots

Band	Duty Cycle(%)	T(us)	1/T(kHz)	VBW Setting
802.11a	98.052	-	-	10Hz
802.11n HT20	98.052	-	-	10Hz



802.11a

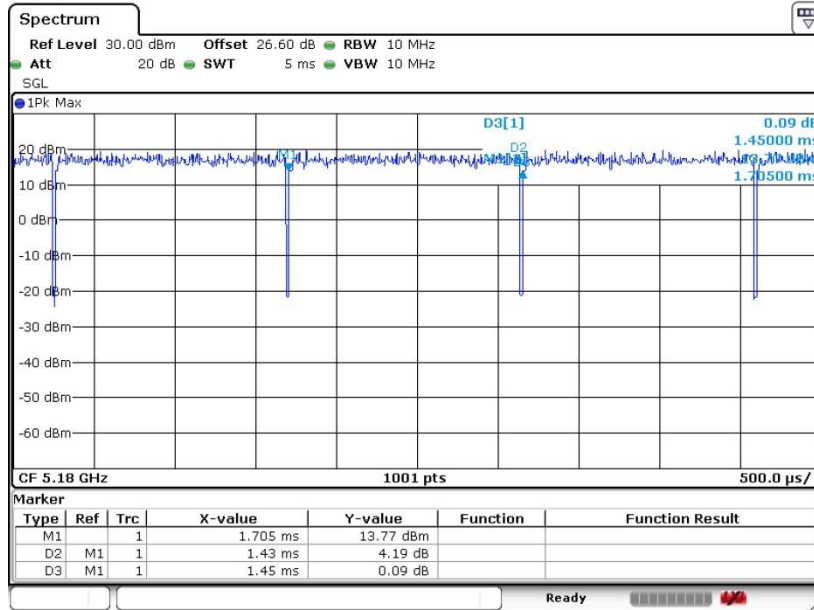

Date: 17.JUL.2017 16:38:06

802.11n HT20

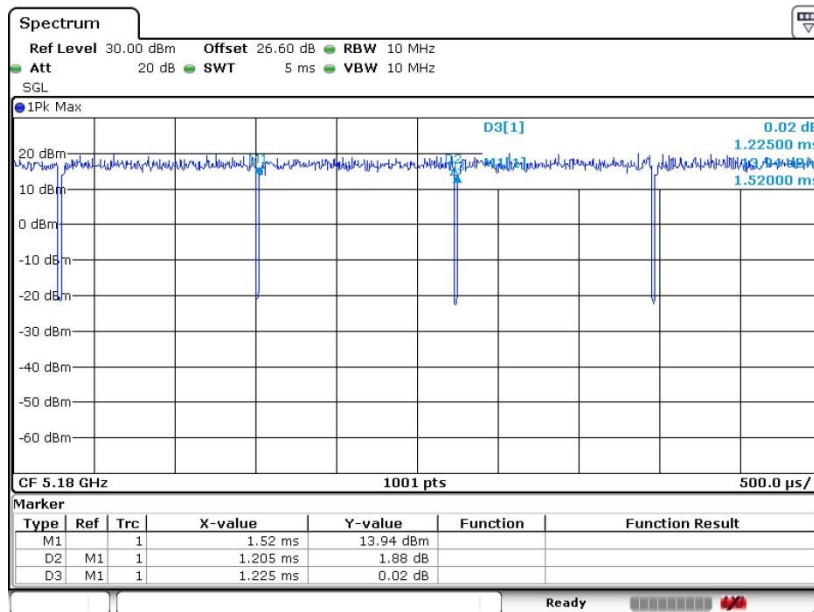

Date: 17.JUL.2017 16:39:53