



FCC RF Test Report

APPLICANT : Zebra Technologies Corporation
EQUIPMENT : Mobile Computer
BRAND NAME : Zebra
MODEL NAME : MC330K
FCC ID : UZ7MC330K
STANDARD : FCC Part 15 Subpart C §15.247
CLASSIFICATION : (DTS) Digital Transmission System

The product was received on Sep. 01, 2017 and testing was completed on Oct. 10, 2017. We, SPORTON INTERNATIONAL INC., would like to declare that the tested sample has been evaluated in accordance with the test procedures and has been in compliance with the applicable technical standards.

The test results in this report apply exclusively to the tested model / sample. Without written approval of SPORTON INTERNATIONAL INC., the test report shall not be reproduced except in full.

Reviewed by: Joseph Lin / Supervisor

Approved by: Jones Tsai / Manager



SPORTON INTERNATIONAL INC.

No. 52, Hwa Ya 1st Rd., Hwa Ya Technology Park, Kwei-Shan District, Tao Yuan City, Taiwan, R.O.C.

SPORTON INTERNATIONAL INC.

TEL : 886-3-327-3456

FAX : 886-3-328-4978

FCC ID : UZ7MC330K

Page Number : 1 of 45

Report Issued Date : Nov. 02, 2017

Report Version : Rev. 01

Report Template No.: BU5-FR15CBT4.0 Version 2.0



TABLE OF CONTENTS

SUMMARY OF TEST RESULT 4

1 GENERAL DESCRIPTION..... 5

1.1 Applicant 5

1.2 Manufacturer..... 5

1.3 Product Feature of Equipment Under Test..... 5

1.4 Product Specification of Equipment Under Test..... 7

1.5 Modification of EUT 7

1.6 Testing Location 8

1.7 Applicable Standards..... 8

2 TEST CONFIGURATION OF EQUIPMENT UNDER TEST..... 9

2.1 Carrier Frequency Channel 9

2.2 Test Mode..... 10

2.3 Connection Diagram of Test System..... 12

2.4 Support Unit used in test configuration and system 13

2.5 EUT Operation Test Setup 13

2.6 Measurement Results Explanation Example..... 14

3 TEST RESULT 15

3.1 6dB and 99% Bandwidth Measurement 15

3.2 Peak Output Power Measurement 20

3.3 Power Spectral Density Measurement 22

3.4 Conducted Band Edges and Spurious Emission Measurement 27

3.5 Radiated Band Edges and Spurious Emission Measurement 36

3.6 AC Conducted Emission Measurement..... 40

3.7 Antenna Requirements 42

4 LIST OF MEASURING EQUIPMENT 43

5 UNCERTAINTY OF EVALUATION..... 45

APPENDIX A. AC CONDUCTED EMISSION TEST RESULT

APPENDIX B. RADIATED SPURIOUS EMISSION

APPENDIX C. RADIATED SPURIOUS EMISSION PLOTS

APPENDIX D. DUTY CYCLE PLOTS

APPENDIX E. SETUP PHOTOGRAPHS



REVISION HISTORY

REPORT NO.	VERSION	DESCRIPTION	ISSUED DATE
FR790120B	Rev. 01	Initial issue of report	Nov. 02, 2017



SUMMARY OF TEST RESULT

Report Section	FCC Rule	Description	Limit	Result	Remark
3.1	15.247(a)(2)	6dB Bandwidth	$\geq 0.5\text{MHz}$	Pass	-
3.1	-	99% Bandwidth	-	Pass	-
3.2	15.247(b)(3)	Peak Output Power	$\leq 30\text{dBm}$	Pass	-
3.3	15.247(e)	Power Spectral Density	$\leq 8\text{dBm}/3\text{kHz}$	Pass	-
3.4	15.247(d)	Conducted Band Edges and Spurious Emission	$\leq 20\text{dBc}$	Pass	-
3.5	15.247(d)	Radiated Band Edges and Spurious Emission	15.209(a) & 15.247(d)	Pass	Under limit 1.07 dB at 37.560 MHz
3.6	15.207	AC Conducted Emission	15.207(a)	Pass	Under limit 8.20 dB at 13.558 MHz
3.7	15.203 & 15.247(b)	Antenna Requirement	N/A	Pass	-



1 General Description

1.1 Applicant

Zebra Technologies Corporation
1 Zebra Plaza, Holtsville, NY 11742

1.2 Manufacturer

Zebra Technologies Corporation
1 Zebra Plaza, Holtsville, NY 11742

1.3 Product Feature of Equipment Under Test

Product Feature	
Equipment	Mobile Computer
Brand Name	Zebra
Model Name	MC330K
FCC ID	UZ7MC330K
EUT supports Radios application	NFC WLAN 11a/b/g/n HT20/HT40 WLAN 11ac VHT20/VHT40/VHT80 Bluetooth BR/EDR/LE
HW Version	EV1b
SW Version	Android Version 7.1.2
FW Version	W10: Aug 4 2017 12:57:11 version 7.35.205.8 (r) FWID 01-895bc792
MFD	30AUG17
EUT Stage	Engineering Sample

Remark: The above EUT's information was declared by manufacturer. Please refer to the specifications or user's manual for more detailed description.



<SKU list>

Premium+					
SKU	Type-scanner	camera	Audio Jack	NFC	Speaker
1	GUN-SE4850	X	X	V	V
2	GUN-SE4750	X	X	V	V
3	GUN-SE965	X	X	V	V
4	Brick-SE4850	V	V	V	V
5	Brick-SE4750	V	V	V	V
6	Brick-SE965	V	V	V	V
7	Rotate	V	V	V	V

Premium					
SKU	Type-scanner	camera	Audio Jack	NFC	Speaker
8	Brick-SE4850	X	V	V	V
9	Brick-SE4750	X	V	V	V
10	Brick-SE965	X	V	V	V
11	Rotate	X	V	V	V

Specification of Accessories				
Sentry 1X Battery	Brand Name	Zebra	Part Number	BT-000338-01
Sentry 2X Battery	Brand Name	Zebra	Part Number	BT-000337-01
MC32 1X Battery	Brand Name	Symbol	Part Number	82-000011-01
MC32 2X Battery	Brand Name	Symbol	Part Number	82-000012-02
Wall wart power supply(18W)	Brand Name	Zebra	Part Number	PWR-WUA5V12W0US
Charge Cable for Wall wart power supply	Brand Name	Zebra	Part Number	PWRS-14000-249R
HS2100 Earphone	Brand Name	Symbol	Part Number	HS2100-OTH
Quick Disconnect cable for HS2100 Headset	Brand Name	Symbol	Part Number	CBL-HS2100-QDC1-01
RCH51 Earphone	Brand Name	Symbol	Part Number	RCH51
Cable for RCH51 earphone	Brand Name	Symbol	Part Number	25-124411-02R
U cable	Brand Name	Symbol	Part Number	CBL-MC33-USBCHG-01
Gun Holster MC3000	Brand Name	Symbol	Model Name	SG-MC3021212-01R
Holster MC30XX	Brand Name	Symbol	Model Name	11-69293-01R



1.4 Product Specification of Equipment Under Test

Standards-related Product Specification	
Tx/Rx Frequency Range	2402 MHz ~ 2480 MHz
Number of Channels	40
Carrier Frequency of Each Channel	40 Channel(37 hopping + 3 advertising channel)
Maximum Output Power to Antenna	3.42 dBm (0.0022 W)
99% Occupied Bandwidth	1.052MHz
Antenna Type / Gain	<Ant. 1> : PIFA Antenna type with gain 3.86 dBi <Ant. 2> : PIFA Antenna type with gain 3.63 dBi
Type of Modulation	Bluetooth LE : GFSK

1.5 Modification of EUT

No modifications are made to the EUT during all test items.



1.6 Testing Location

Sporton Lab is accredited to ISO 17025 by Taiwan Accreditation Foundation (TAF code : 1190) and the FCC designation No. TW0007 under the FCC 2.948(e) by Mutual Recognition Agreement (MRA) in FCC Test.

Test Site	SPORTON INTERNATIONAL INC.	
Test Site Location	No. 52, Hwa Ya 1 st Rd., Hwa Ya Technology Park, Kwei-Shan District, Tao Yuan City, Taiwan, R.O.C. TEL: +886-3-327-3456 FAX: +886-3-328-4978	
Test Site No.	Sporton Site No.	
	TH05-HY	CO05-HY

Note: The test site complies with ANSI C63.4 2014 requirement.

Test Site	SPORTON INTERNATIONAL INC.	
Test Site Location	No.58, Aly. 75, Ln. 564, Wenhua 3rd Rd. Guishan Dist, Taoyuan City, Taiwan (R.O.C.) TEL: +886-3-327-0868 FAX: +886-3-327-0855	
Test Site No.	Sporton Site No.	
	03CH12-HY	

Note: The test site complies with ANSI C63.4 2014 requirement.

1.7 Applicable Standards

According to the specifications of the manufacturer, the EUT must comply with the requirements of the following standards:

- ♦ FCC Part 15 Subpart C §15.247
- ♦ FCC KDB Publication No. 558074 D01 DTS Meas. Guidance v04
- ♦ ANSI C63.10-2013

Remark:

1. All test items were verified and recorded according to the standards and without any deviation during the test.
2. This EUT has also been tested and complied with the requirements of FCC Part 15, Subpart B, recorded in a separate test report.



2 Test Configuration of Equipment Under Test

2.1 Carrier Frequency Channel

Frequency Band	Channel	Freq. (MHz)	Channel	Freq. (MHz)
2400-2483.5 MHz	0	2402	21	2444
	1	2404	22	2446
	2	2406	23	2448
	3	2408	24	2450
	4	2410	25	2452
	5	2412	26	2454
	6	2414	27	2456
	7	2416	28	2458
	8	2418	29	2460
	9	2420	30	2462
	10	2422	31	2464
	11	2424	32	2466
	12	2426	33	2468
	13	2428	34	2470
	14	2430	35	2472
	15	2432	36	2474
	16	2434	37	2476
	17	2436	38	2478
	18	2438	39	2480
	19	2440	-	-
20	2442	-	-	



2.2 Test Mode

Channel	Frequency	Bluetooth – LE RF Average Output Power	
		Data Rate / Modulation	
		GFSK	
		1Mbps	
Ch00	2402MHz	1.37 dBm	
Ch19	2440MHz	2.88 dBm	
Ch39	2480MHz	2.33 dBm	

Channel	Frequency	Bluetooth – LE RF Peak Output Power	
		Data Rate / Modulation	
		GFSK	
		1Mbps	
Ch00	2402MHz	2.17 dBm	
Ch19	2440MHz	3.42 dBm	
Ch39	2480MHz	3.00 dBm	



- a. The EUT has been associated with peripherals and configuration operated in a manner tended to maximize its emission characteristics in a typical application. Frequency range investigated: conduction emission (150 kHz to 30 MHz), radiation emission (9 kHz to the 10th harmonic of the highest fundamental frequency or to 40 GHz, whichever is lower). For radiated measurement, pre-scanned in three orthogonal panels, X, Y, Z. The worst cases (Y plane) were recorded in this report.
- b. AC power line Conducted Emission was tested under maximum output power.

The following summary table is showing all test modes to demonstrate in compliance with the standard.

Summary table of Test Cases	
Test Item	Data Rate / Modulation
	Bluetooth – LE / GFSK
Conducted TCs	Mode 1: Bluetooth Tx CH00_2402 MHz_1Mbps Mode 2: Bluetooth Tx CH19_2440 MHz_1Mbps Mode 3: Bluetooth Tx CH39_2480 MHz_1Mbps
Radiated TCs	Mode 1: Bluetooth Tx CH00_2402 MHz_1Mbps Mode 2: Bluetooth Tx CH19_2440 MHz_1Mbps Mode 3: Bluetooth Tx CH39_2480 MHz_1Mbps
AC Conducted Emission	Mode 1: MP3 play + WLAN (2.4GHz) Link + Bluetooth Link + NFC On + Sentry 2X + PWR-WUA5V12W0US (LV6) + RCH51(5) + USB link with adapter + Keypad (38) + SKU 5
Remark: For radiated test cases, the test was performed with SKU 7, Keypad (47), MC32 1X Battery, USB Link with Adapter, PWR-WUA5V12W0US(LV6).	

2.3 Connection Diagram of Test System

<Bluetooth Tx Mode>

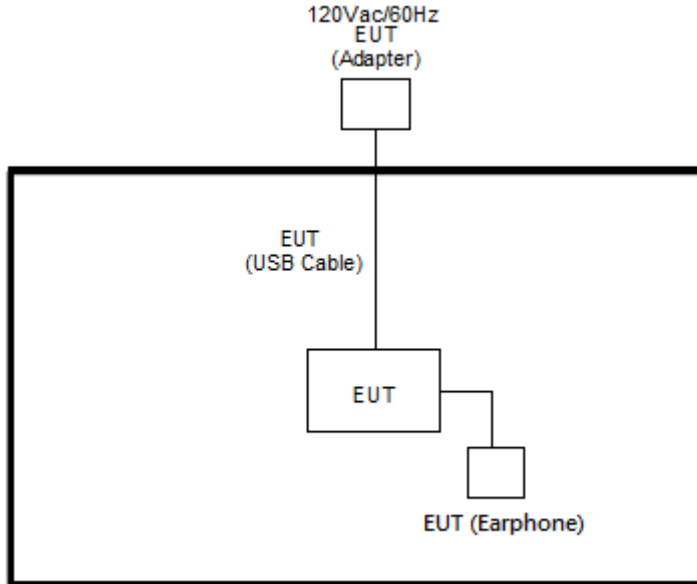

<AC Conducted Emission Mode>

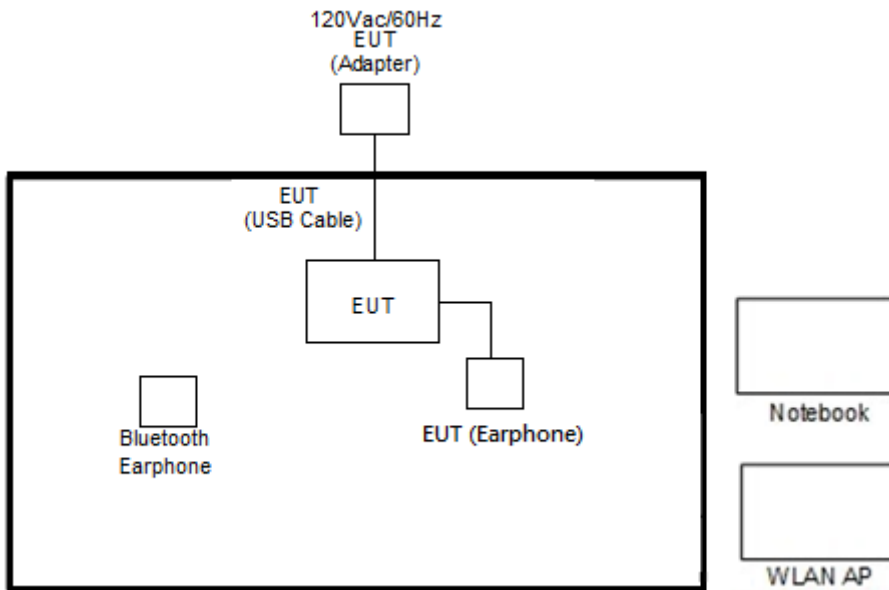



2.4 Support Unit used in test configuration and system

Item	Equipment	Trade Name	Model Name	FCC ID	Data Cable	Power Cord
1.	Bluetooth Earphone	SonyEricsson	MW600	PY700A2029	N/A	N/A
2.	WLAN AP	ASUS	RT-AC66U	MSQ-RTAC66U	N/A	Unshielded, 1.8m
3.	NoteBook	DELL	Latitude E6320	FCC DoC	AC I/P: Unshielded, 1.2 m DC O/P: Shielded, 1.8 m	
4.	NoteBook-40 (Tx)	Lenovo	E335	N/A	N/A	N/A
5.	NoteBook-53 (Rx)	ASUS	K42J	N/A	N/A	N/A
6.	SD Card	SanDisk	MicroSD HC	FCC DoC	N/A	N/A

2.5 EUT Operation Test Setup

The RF test items, programmed RF utility, "CMD" installed in the notebook make the EUT provide functions like channel selection and power level for continuous transmitting and receiving signals.



2.6 Measurement Results Explanation Example

For all conducted test items:

The offset level is set in the spectrum analyzer to compensate the RF cable loss and attenuator factor between EUT conducted output port and spectrum analyzer. With the offset compensation, the spectrum analyzer reading level is exactly the EUT RF output level.

Example :

The spectrum analyzer offset is derived from RF cable loss and attenuator factor.

Offset = RF cable loss + attenuator factor.

Following shows an offset computation example with cable loss 4.2 dB and 10dB attenuator.

$$\begin{aligned} \text{Offset(dB)} &= \text{RF cable loss(dB)} + \text{attenuator factor(dB)}. \\ &= 4.2 + 10 = 14.2 \text{ (dB)} \end{aligned}$$

3 Test Result

3.1 6dB and 99% Bandwidth Measurement

3.1.1 Limit of 6dB and 99% Bandwidth

The minimum 6 dB bandwidth shall be at least 500 kHz.

3.1.2 Measuring Instruments

The section 4.0 of List of Measuring Equipment of this test report is used for test.

3.1.3 Test Procedures

1. The testing follows FCC KDB Publication No. 558074 D01 DTS Meas. Guidance v04.
2. The RF output of EUT was connected to the spectrum analyzer by RF cable and attenuator. The path loss was compensated to the results for each measurement.
3. Set to the maximum power setting and enable the EUT transmit continuously.
4. Make the measurement with the spectrum analyzer's resolution bandwidth (RBW) = 100 kHz. Set the Video bandwidth (VBW) = 300 kHz. In order to make an accurate measurement. The 6 dB bandwidth must be greater than 500 kHz.
5. For 99% Bandwidth Measurement, the spectrum analyzer's resolution bandwidth (RBW) is set 30kHz and set the Video bandwidth (VBW) = 100kHz.
6. Measure and record the results in the test report.

3.1.4 Test Setup





3.1.5 Test Result of 6dB Bandwidth

Mod.	Data Rate	NtX	CH.	Freq. (MHz)	6dB BW (MHz)	6dB BW Limit (MHz)	Pass/Fail
BLE	1Mbps	1	0	2402	0.712	0.50	Pass
BLE	1Mbps	1	19	2440	0.704	0.50	Pass
BLE	1Mbps	1	39	2480	0.708	0.50	Pass

6 dB Bandwidth Plot on Channel 00

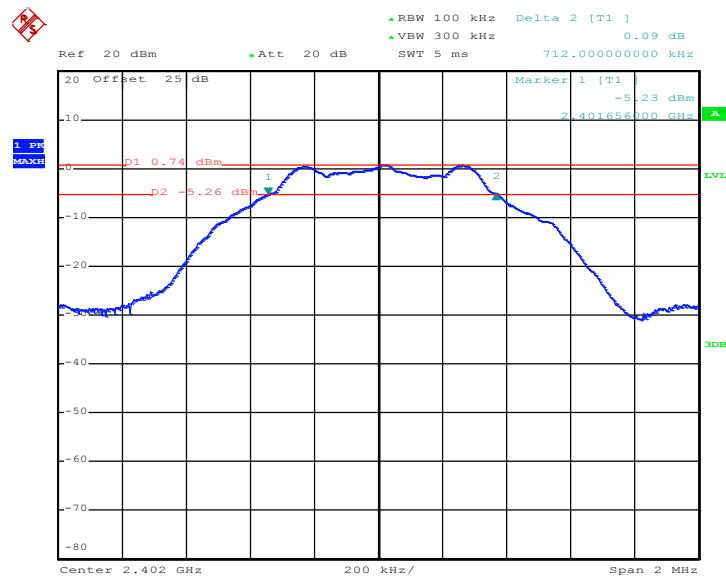

Date: 10.OCT.2017 10:33:48



6 dB Bandwidth Plot on Channel 19

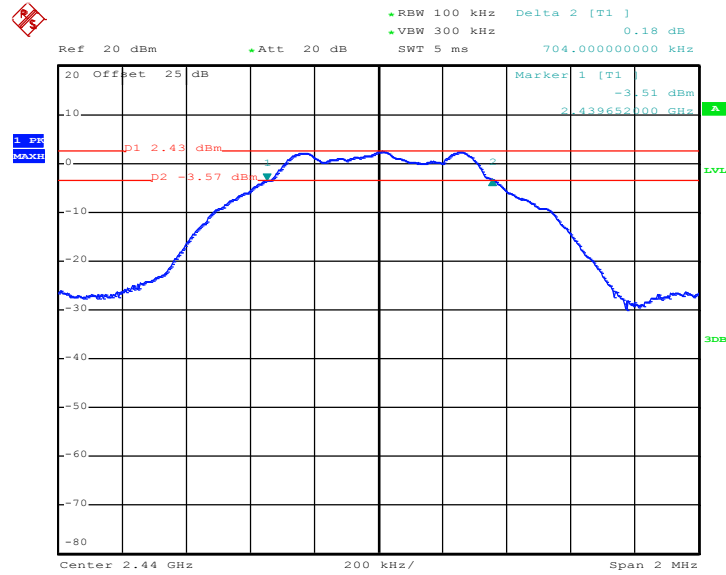

Date: 10.OCT.2017 10:37:30

6 dB Bandwidth Plot on Channel 39

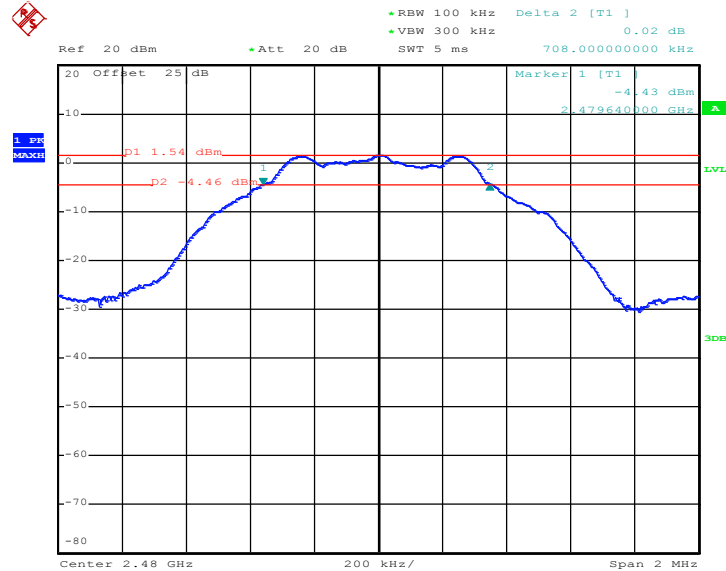

Date: 10.OCT.2017 10:39:47



3.1.6 Test Result of 99% Occupied Bandwidth

Mod.	Data Rate	NTX	CH.	Freq. (MHz)	99% Occupied BW (MHz)	Pass/Fail
BLE	1Mbps	1	0	2402	1.050	Pass
BLE	1Mbps	1	19	2440	1.052	Pass
BLE	1Mbps	1	39	2480	1.052	Pass

99% Bandwidth Plot on Channel 00

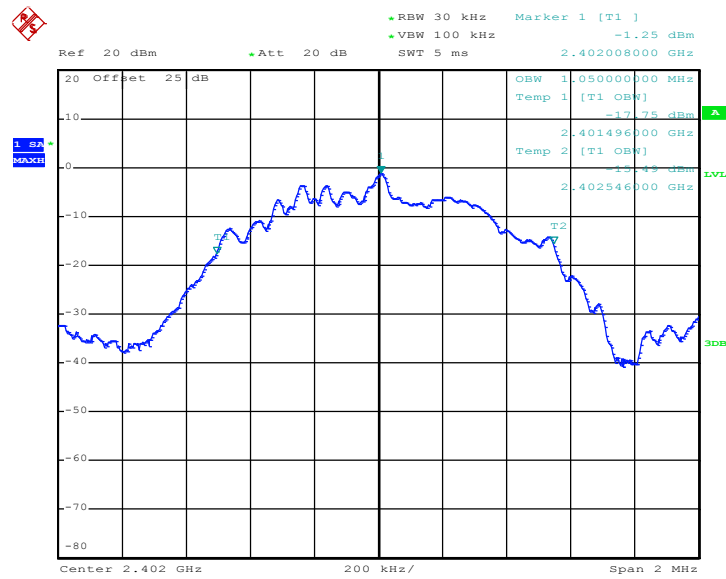

Date: 10.OCT.2017 10:36:07



99% Occupied Bandwidth Plot on Channel 19

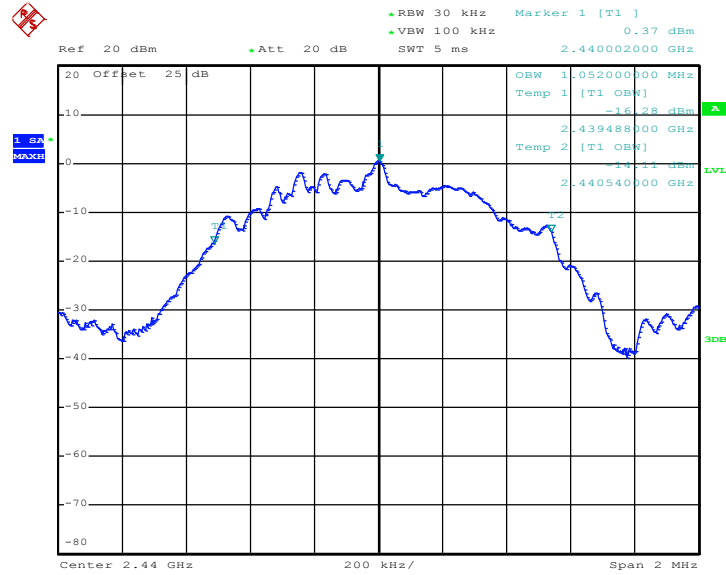

Date: 10.OCT.2017 10:38:36

99% Occupied Bandwidth Plot on Channel 39

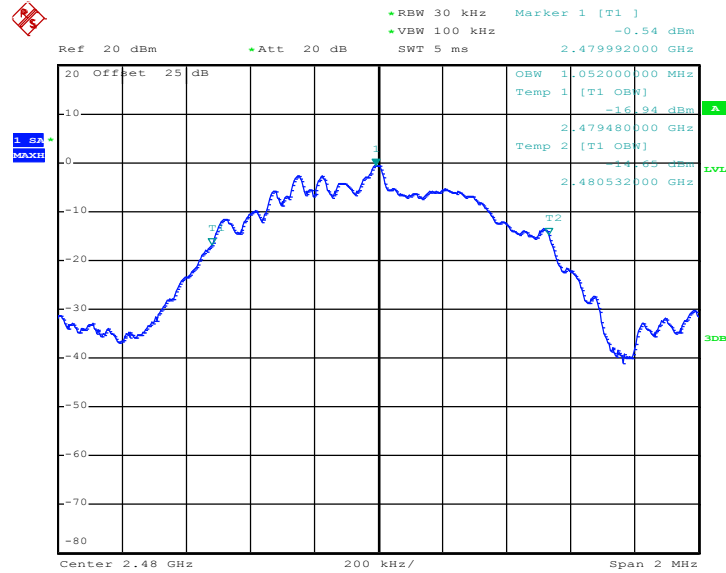

Date: 10.OCT.2017 10:41:40

Note : The occupied channel bandwidth is maintained within the band of operation for all of the modulations.

3.2 Peak Output Power Measurement

3.2.1 Limit of Peak Output Power

For systems using digital modulation in the 2400-2483.5MHz, the limit for peak output power is 30dBm. If transmitting antenna of directional gain greater than 6dBi is used, the peak output power from the intentional radiator shall be reduced below the above stated value by the amount in dB that the directional gain of the antenna exceeds 6 dBi. In case of point-to-point operation, the limit has to be reduced by 1dB for every 3dB that the directional gain of the antenna exceeds 6dBi.

3.2.2 Measuring Instruments

The section 4.0 of List of Measuring Equipment of this test report is used for test.

3.2.3 Test Procedures

1. The testing follows the Measurement Procedure of FCC KDB No. 558074 DTS D01 Meas. Guidance v04 section 9.1.2 PKPM1 Peak power meter method.
2. The RF output of EUT was connected to the power meter by RF cable and attenuator. The path loss was compensated to the results for each measurement.
3. Set to the maximum power setting and enable the EUT transmit continuously.
4. Measure the conducted output power and record the results in the test report.

3.2.4 Test Setup

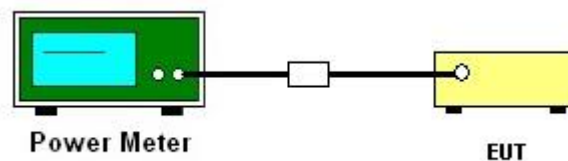



3.2.5 Test Result of Peak Output Power

Mod.	Data Rate	NTX	CH.	Freq. (MHz)	Peak Conducted Power (dBm)	Conducted Power Limit (dBm)	DG (dBi)	EIRP Power (dBm)	EIRP Power Limit (dBm)	Pass /Fail
BLE	1Mbps	1	0	2402	2.17	30.00	3.86	6.03	36.00	Pass
BLE	1Mbps	1	19	2440	3.42	30.00	3.86	7.28	36.00	Pass
BLE	1Mbps	1	39	2480	3.00	30.00	3.86	6.86	36.00	Pass

3.3 Power Spectral Density Measurement

3.3.1 Limit of Power Spectral Density

The peak power spectral density shall not be greater than 8dBm in any 3kHz band at any time interval of continuous transmission.

3.3.2 Measuring Instruments

The section 4.0 of List of Measuring Equipment of this test report is used for test.

3.3.3 Test Procedures

1. The testing follows Measurement Procedure 10.2 Method PKPSD of FCC KDB Publication No. 558074 D01 DTS Meas. Guidance v04
2. The RF output of EUT was connected to the spectrum analyzer by RF cable and attenuator. The path loss was compensated to the results for each measurement.
3. Set to the maximum power setting and enable the EUT transmit continuously.
4. Make the measurement with the spectrum analyzer's resolution bandwidth (RBW) = 3 kHz. Video bandwidth VBW = 10 kHz In order to make an accurate measurement, set the span to 1.5 times DTS Channel Bandwidth. (6dB BW)
5. Detector = peak, Sweep time = auto couple, Trace mode = max hold, Allow trace to fully stabilize. Use the peak marker function to determine the maximum power level.
6. Measure and record the results in the test report.
7. The Measured power density (dBm)/ 100kHz is a reference level and used as 20dBc down limit line for Conducted Band Edges and Conducted Spurious Emission.

3.3.4 Test Setup





3.3.5 Test Result of Power Spectral Density

Mod.	Data Rate	NTX	CH.	Freq. (MHz)	Peak PSD (dBm /100kHz)	Peak PSD (dBm /3kHz)	DG (dBi)	Peak PSD Limit (dBm /3kHz)	Pass/Fail
BLE	1Mbps	1	0	2402	0.76	-13.38	3.86	8.00	Pass
BLE	1Mbps	1	19	2440	2.44	-11.68	3.86	8.00	Pass
BLE	1Mbps	1	39	2480	1.53	-12.61	3.86	8.00	Pass

3.3.6 Test Result of Power Spectral Density Plots (100kHz)

PSD 100kHz Plot on Channel 00

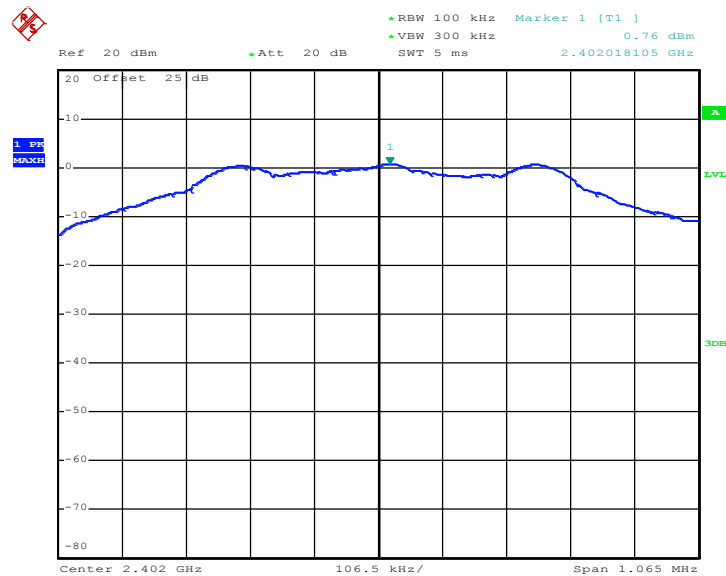

Date: 10.OCT.2017 10:34:48



PSD 100kHz Plot on Channel 19

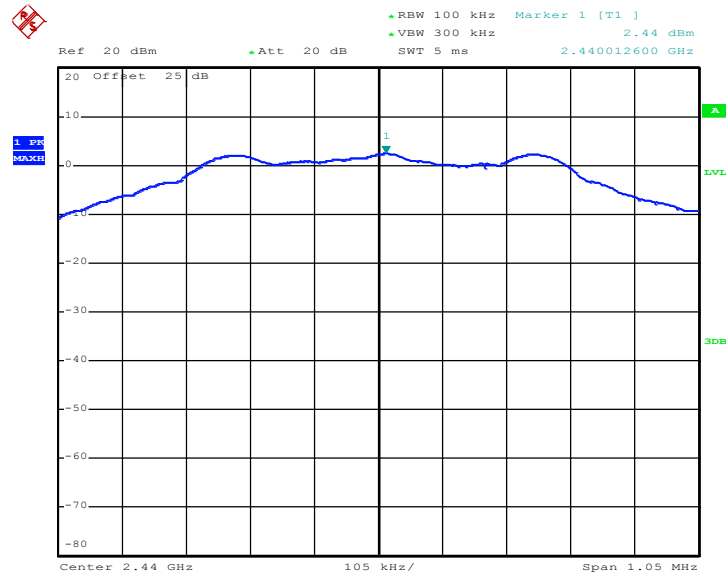

Date: 10.OCT.2017 10:37:57

PSD 100kHz Plot on Channel 39

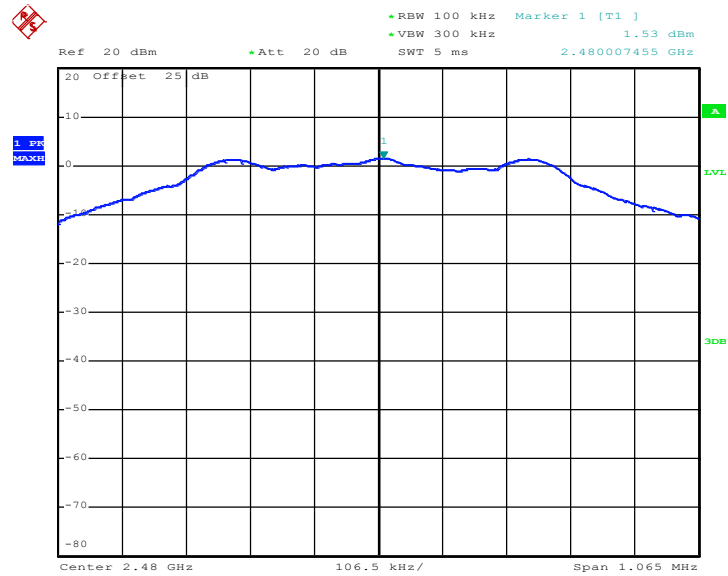

Date: 10.OCT.2017 10:40:16



3.3.7 Test Result of Power Spectral Density Plots (3kHz)

PSD 3kHz Plot on Channel 00

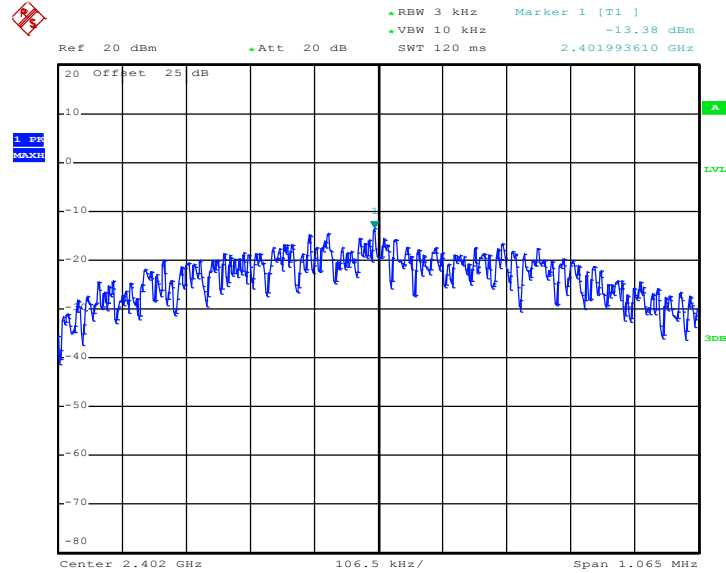

Date: 10.OCT.2017 10:34:27



PSD 3kHz Plot on Channel 19

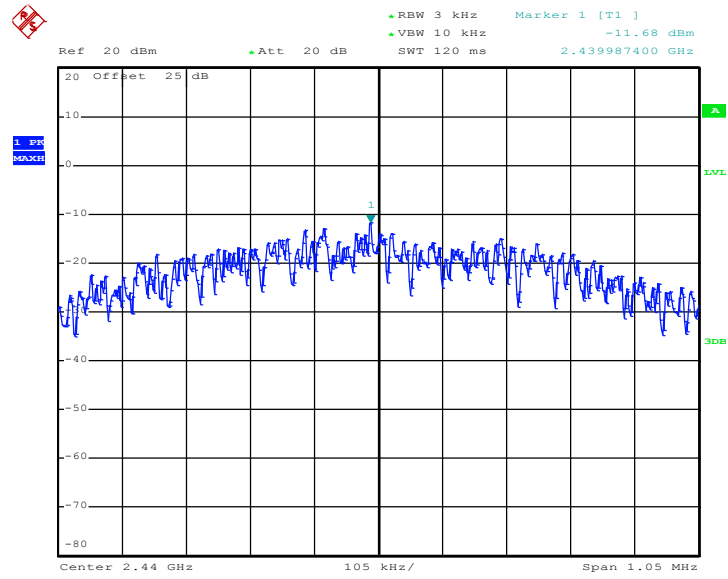

Date: 10.OCT.2017 10:37:43

PSD 3kHz Plot on Channel 39

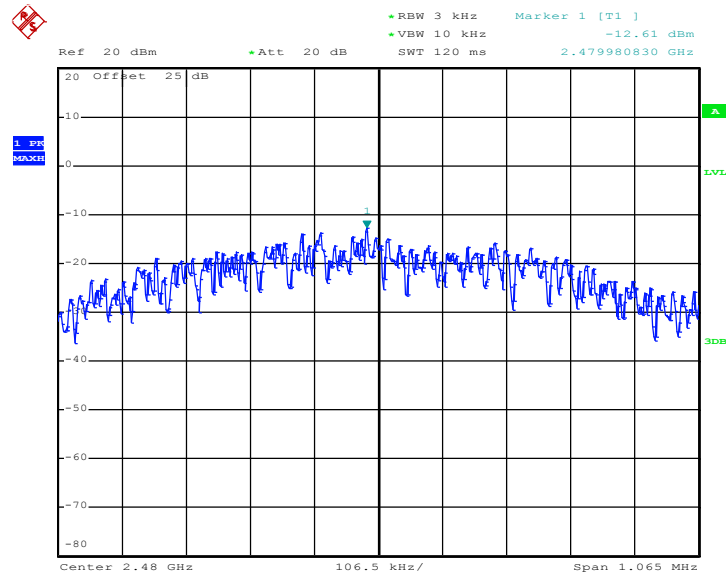

Date: 10.OCT.2017 10:40:01

3.4 Conducted Band Edges and Spurious Emission Measurement

3.4.1 Limit of Conducted Band Edges and Spurious Emission

All harmonics/spurious must be at least 20 dB down from the highest emission level within the authorized band.

3.4.2 Measuring Instruments

The section 4.0 of List of Measuring Equipment of this test report is used for test.

3.4.3 Test Procedure

1. The testing follows FCC KDB Publication No. 558074 D01 DTS Meas. Guidance v04.
2. The RF output of EUT was connected to the spectrum analyzer by RF cable and attenuator. The path loss was compensated to the results for each measurement.
3. Set to the maximum power setting and enable the EUT transmit continuously.
4. Set RBW = 100 kHz, VBW=300 kHz, Peak Detector. Unwanted Emissions measured in any 100 kHz bandwidth outside of the authorized frequency band shall be attenuated by at least 20 dB relative to the maximum in-band peak PSD level in 100 kHz when maximum peak conducted output power procedure is used. If the transmitter complies with the conducted power limits based on the use of RMS averaging over a time interval, the attenuation required under this paragraph shall be 30 dB instead of 20 dB.
5. Measure and record the results in the test report.
6. The RF fundamental frequency should be excluded against the limit line in the operating frequency band.

3.4.4 Test Setup

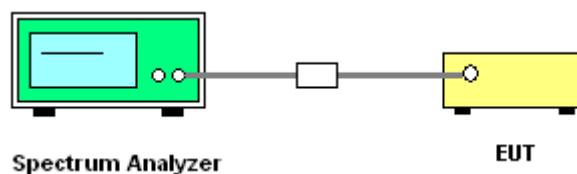



3.4.5 Test Result of Conducted Band Edges Plots

Low Band Edge Plot on Channel 00

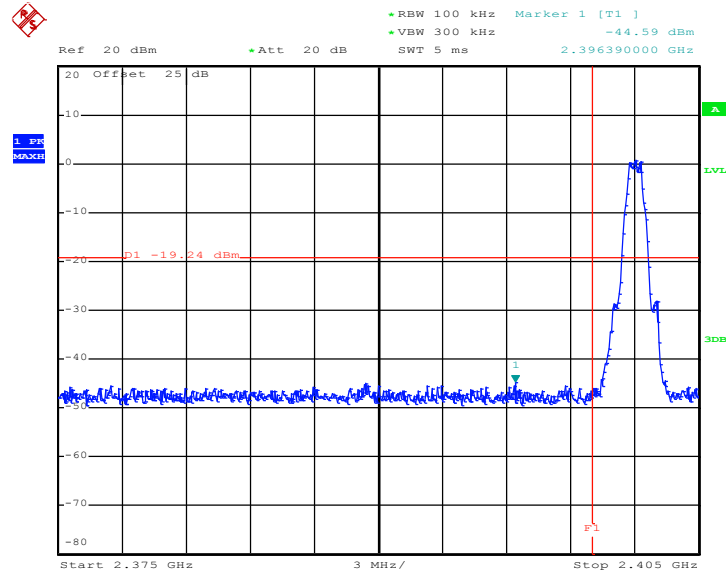

Date: 10.OCT.2017 10:35:05



High Band Edge Plot on Channel 39

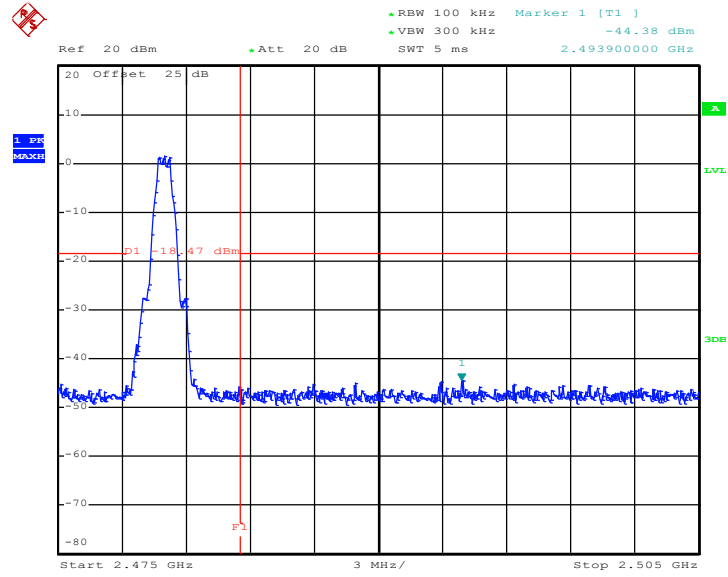

Date: 10.OCT.2017 10:40:32



3.4.6 Test Result of Conducted Spurious Emission Plots

Conducted Spurious Emission Plot on Bluetooth LE 1Mbps GFSK Channel 00

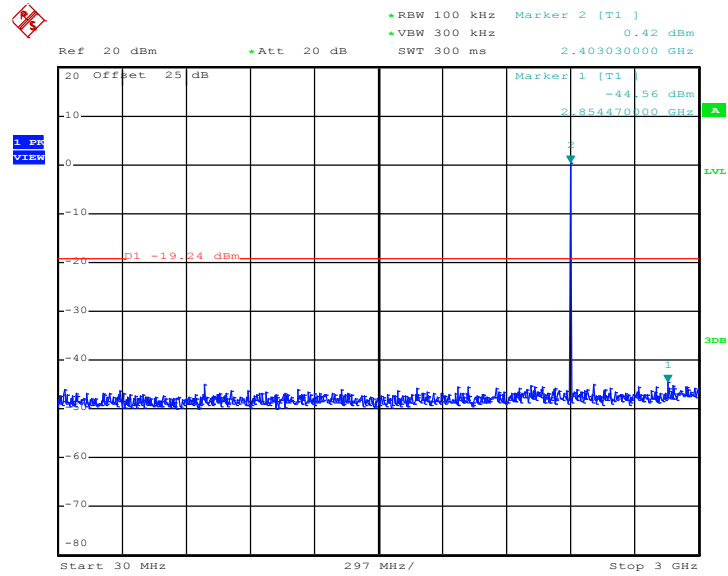

Date: 10.OCT.2017 10:35:17



Conducted Spurious Emission Plot on Bluetooth LE 1Mbps GFSK Channel 00

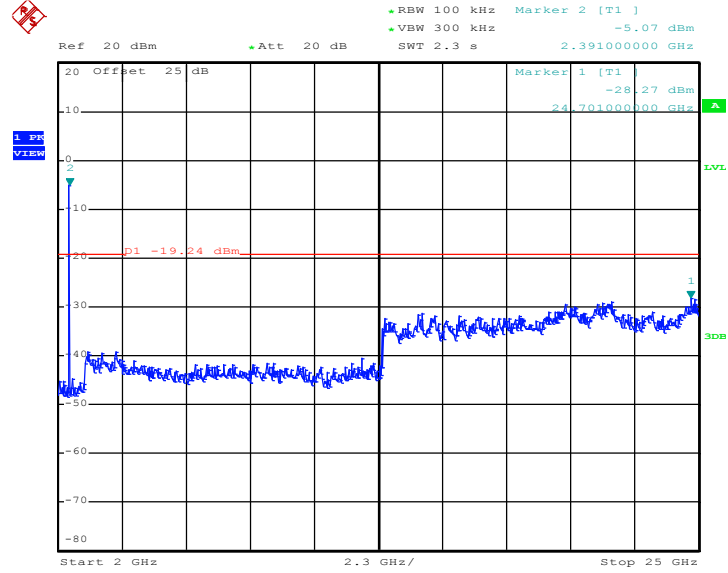

Date: 10.OCT.2017 10:35:25



Conducted Spurious Emission Plot on Bluetooth LE 1Mbps GFSK Channel 19

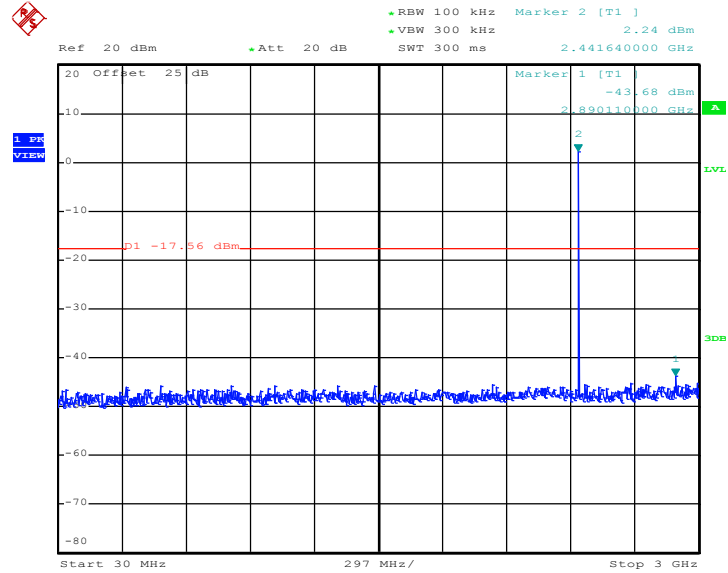

Date: 10.OCT.2017 10:38:09



Conducted Spurious Emission Plot on Bluetooth LE 1Mbps GFSK Channel 19

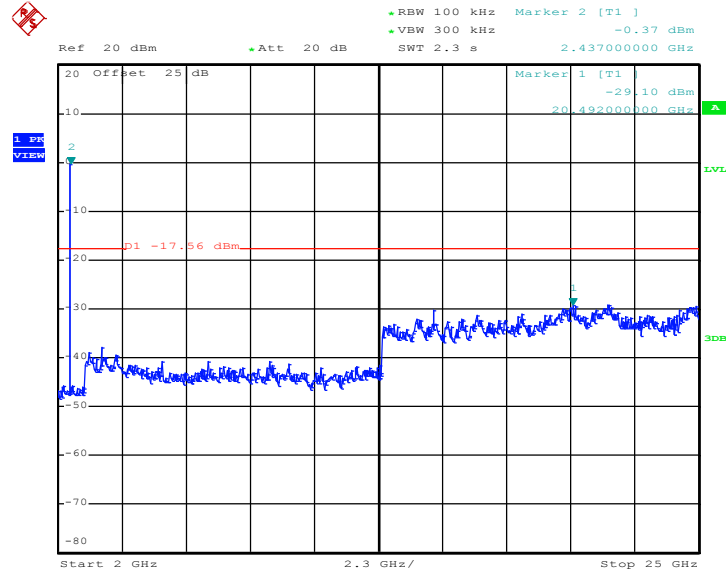

Date: 10.OCT.2017 10:38:17



Conducted Spurious Emission Plot on Bluetooth LE 1Mbps GFSK Channel 39

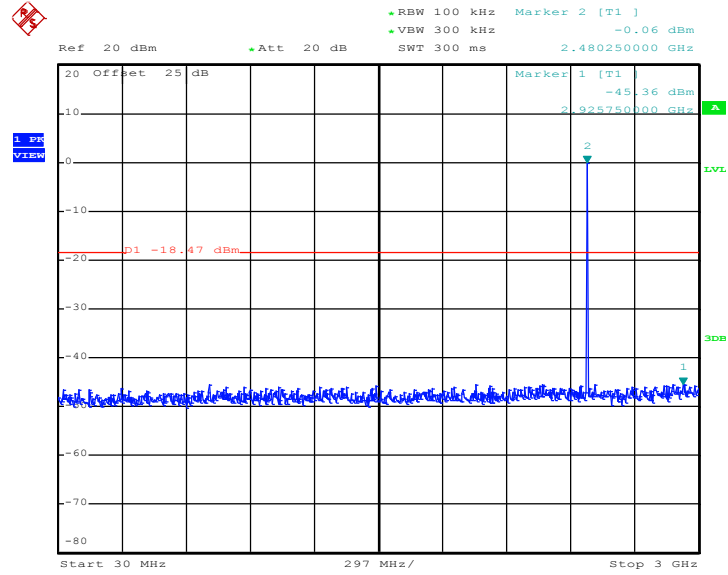

Date: 10.OCT.2017 10:40:44



Conducted Spurious Emission Plot on Bluetooth LE 1Mbps GFSK Channel 39

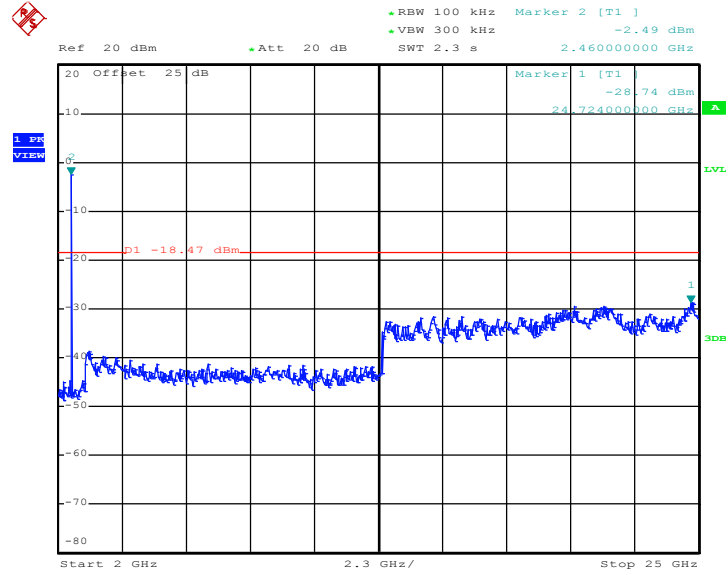

Date: 10.OCT.2017 10:40:53



3.5 Radiated Band Edges and Spurious Emission Measurement

3.5.1 Limit of Radiated Band Edges and Spurious Emission

In any 100 kHz bandwidth outside the intentional radiator frequency band, all harmonics/spurious must be at least 20 dB below the highest emission level within the authorized band. If the output power of this device was measured by spectrum analyzer, the attenuation under this paragraph shall be 30 dB instead of 20 dB. In addition, radiated emissions which fall in the restricted bands must also comply with the limits as below.

Frequency (MHz)	Field Strength (microvolts/meter)	Measurement Distance (meters)
0.009 – 0.490	2400/F(kHz)	300
0.490 – 1.705	24000/F(kHz)	30
1.705 – 30.0	30	30
30 – 88	100	3
88 – 216	150	3
216 - 960	200	3
Above 960	500	3

3.5.2 Measuring Instruments

The section 4.0 of List of Measuring Equipment of this test report is used for test.



3.5.3 Test Procedures

1. The testing follows FCC KDB Publication No. 558074 D01 DTS Meas. Guidance v04.
2. The EUT was arranged to its worst case and then tune the antenna tower (from 1 m to 4 m) and turntable (from 0 degree to 360 degrees) to find the maximum reading. A pre-amp and a high pass filter are used for the test in order to get better signal level.
3. The EUT was placed on a turntable with 0.8 meter for frequency below 1GHz and 1.5 meter for frequency above 1GHz respectively above ground.
4. The EUT was set 3 meters from the interference receiving antenna, which was mounted on the top of a variable height antenna tower.
5. Corrected Reading: Antenna Factor + Cable Loss + Read Level - Preamp Factor = Level
6. For measurement below 1GHz, If the emission level of the EUT measured by the peak detector is 3 dB lower than the applicable limit, the peak emission level will be reported. Otherwise, the emission measurement will be repeated using the quasi-peak detector and reported.
7. Use the following spectrum analyzer settings:
 - (1) Span shall wide enough to fully capture the emission being measured;
 - (2) Set RBW=100 kHz for $f < 1$ GHz; VBW \geq RBW; Sweep = auto; Detector function = peak; Trace = max hold;
 - (3) Set RBW = 1 MHz, VBW= 3MHz for $f \geq 1$ GHz for peak measurement.
For average measurement:
 - VBW = 10 Hz, when duty cycle is no less than 98 percent.
 - VBW $\geq 1/T$, when duty cycle is less than 98 percent where T is the minimum transmission duration over which the transmitter is on and is transmitting at its maximum power control level for the tested mode of operation.

3.5.4 Test Setup

For radiated emissions below 30MHz

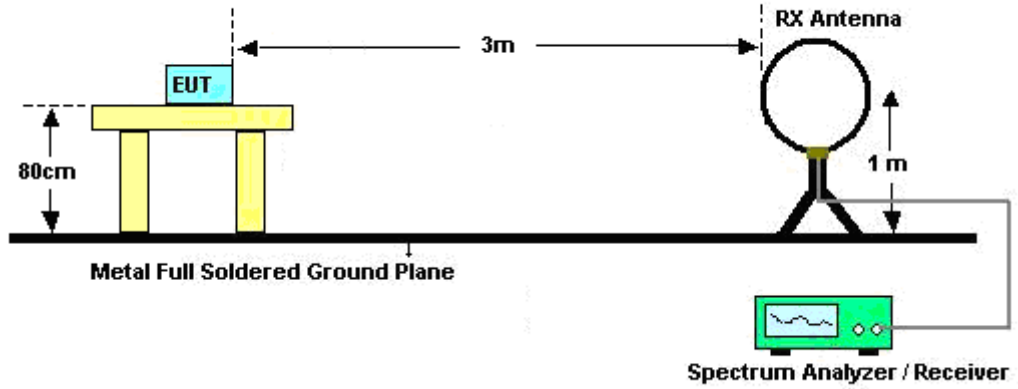

For radiated emissions from 30MHz to 1GHz

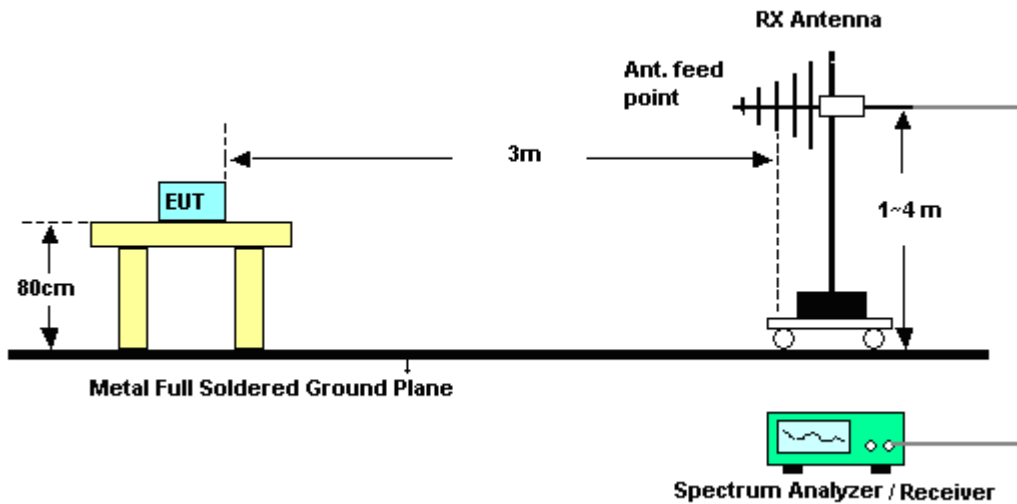

For radiated emissions above 1GHz

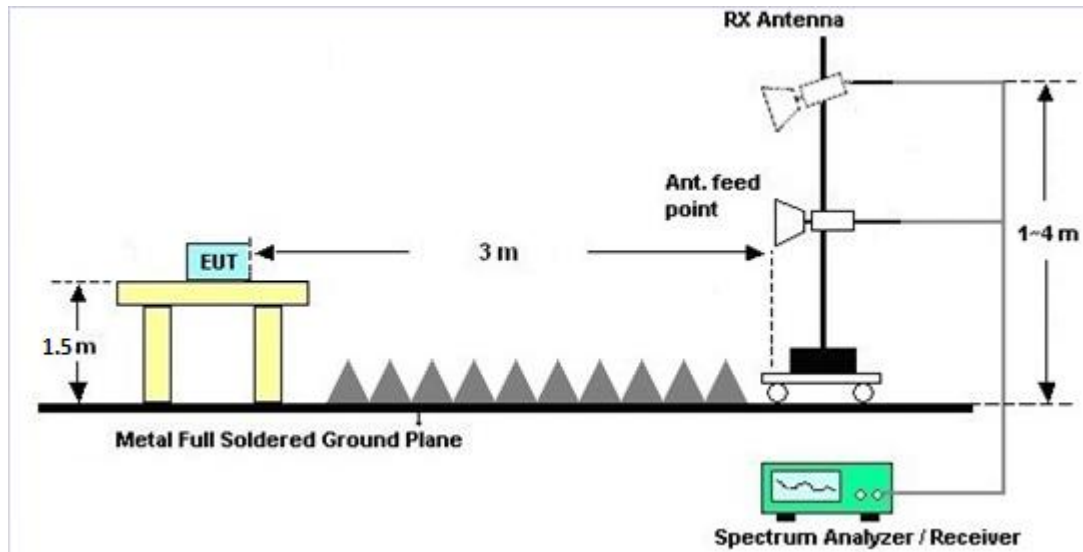

3.5.5 Test Results of Radiated Spurious Emissions (9 kHz ~ 30 MHz)

The low frequency, which started from 9 kHz to 30MHz, was pre-scanned and the result which was 20dB lower than the limit line was not reported.

3.5.6 Test Result of Radiated Spurious at Band Edges

Please refer to Appendix B and C.

3.5.7 Duty Cycle

Please refer to Appendix D.

3.5.8 Test Result of Radiated Spurious Emission (30MHz ~ 10th Harmonic)

Please refer to Appendix B and C.



3.6 AC Conducted Emission Measurement

3.6.1 Limit of AC Conducted Emission

For equipment that is designed to be connected to the public utility (AC) power line, the radio frequency voltage that is conducted back onto the AC power line on any frequency or frequencies within the band 150 kHz to 30 MHz shall not exceed the limits in the following table.

Frequency of emission (MHz)	Conducted limit (dBµV)	
	Quasi-peak	Average
0.15-0.5	66 to 56*	56 to 46*
0.5-5	56	46
5-30	60	50

*Decreases with the logarithm of the frequency.

3.6.2 Measuring Instruments

The section 4.0 of List of Measuring Equipment of this test report is used for test.

3.6.3 Test Procedures

1. The EUT was placed 0.4 meter from the conducting wall of the shielding room was kept at least 80 centimeters from any other grounded conducting surface.
2. Connect EUT to the power mains through a line impedance stabilization network (LISN).
3. All the support units are connecting to the other LISN.
4. The LISN provides 50 ohm coupling impedance for the measuring instrument.
5. The FCC states that a 50 ohm, 50 microhenry LISN should be used.
6. Both sides of AC line were checked for maximum conducted interference.
7. The frequency range from 150 kHz to 30 MHz was searched.
8. Set the test-receiver system to Peak Detect Function and specified bandwidth (IF Bandwidth = 9kHz) with Maximum Hold Mode. Then measurement is also conducted by Average Detector and Quasi-Peak Detector Function respectively.

3.6.4 Test Setup

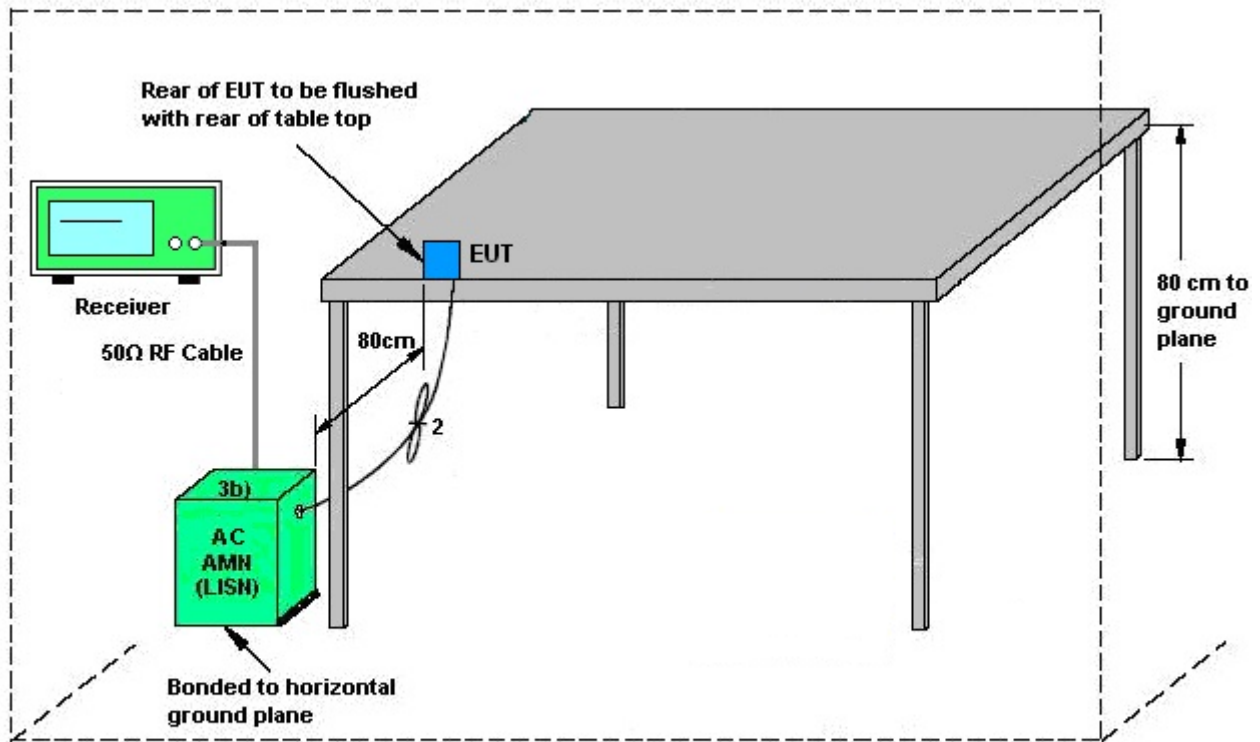

AMN = Artificial mains network (LISH)
 AE = Associated equipment
 EUT = Equipment under test
 ISN = Impedance stabilization network

3.6.5 Test Result of AC Conducted Emission

Please refer to Appendix A.



3.7 Antenna Requirements

3.7.1 Standard Applicable

If directional gain of transmitting antennas is greater than 6dBi, the power shall be reduced by the same level in dB comparing to gain minus 6dBi. The use of a permanently attached antenna or of an antenna that uses a unique coupling to the intentional radiator shall be considered sufficient to comply with the rule.

3.7.2 Antenna Anti-Replacement Construction

An embedded-in antenna design is used.

3.7.3 Antenna Gain

The antenna peak gain of EUT is less than 6 dBi. Therefore, it is not necessary to reduce maximum peak output power limit.



4 List of Measuring Equipment

Instrument	Manufacturer	Model No.	Serial No.	Characteristics	Calibration Date	Test Date	Due Date	Remark
Power Meter	Anritsu	ML2495A	1036004	N/A	Jul. 28, 2017	Sep. 07, 2017~ Oct. 10, 2017	Jul. 27, 2018	Conducted (TH05-HY)
Power Sensor	Agilent	E9327A	US404415 48	50MHz~18GHz	Dec. 26, 2016	Sep. 07, 2017~ Oct. 10, 2017	Dec. 25, 2017	Conducted (TH05-HY)
Spectrum Analyzer	Rohde & Schwarz	FSP30	101067	9kHz ~ 30GHz	Nov. 17, 2016	Sep. 07, 2017~ Oct. 10, 2017	Nov. 16, 2017	Conducted (TH05-HY)
AC Power Source	ChainTek	APC-1000W	N/A	N/A	N/A	Sep. 24, 2017	N/A	Conduction (CO05-HY)
EMI Test Receiver	Rohde & Schwarz	ESCI 7	100724	9kHz~7GHz	Sep. 20, 2017	Sep. 24, 2017	Sep. 19, 2018	Conduction (CO05-HY)
LISN	Rohde & Schwarz	ENV216	100080	9kHz~30MHz	Nov. 29, 2016	Sep. 24, 2017	Nov. 28, 2017	Conduction (CO05-HY)
Amplifier	SONOMA	310N	187312	9kHz~1GHz	Nov. 10, 2016	Sep. 06, 2017~ Sep. 29, 2017	Nov. 09, 2017	Radiation (03CH12-HY)
Bilog Antenna	TESEQ	CBL 6111D&00800 N1D01N-06	37059&01	30MHz~1GHz	Oct. 15, 2016	Sep. 06, 2017~ Sep. 29, 2017	Oct. 14, 2017	Radiation (03CH12-HY)
EMI Test Receiver	Rohde & Schwarz	ESU26	100390	20Hz~26.5GHz	Dec. 23, 2016	Sep. 06, 2017~ Sep. 29, 2017	Dec. 22, 2017	Radiation (03CH12-HY)
Horn Antenna	SCHWARZBE CK	BBHA 9120D	9120D-132 8	1GHz ~ 18GHz	Oct. 25, 2016	Sep. 06, 2017~ Sep. 29, 2017	Oct. 24, 2017	Radiation (03CH12-HY)
Preamplifier	MITEQ	AMF-7D-0010 1800-30-10P	1815698	1GHz~18GHz	Dec. 01, 2016	Sep. 06, 2017~ Sep. 29, 2017	Nov. 30, 2017	Radiation (03CH12-HY)
Preamplifier	Keysight	83017A	MY532701 48	1GHz~26.5GHz	Jan. 12, 2017	Sep. 06, 2017~ Sep. 29, 2017	Jan. 11, 2018	Radiation (03CH12-HY)



Instrument	Manufacturer	Model No.	Serial No.	Characteristics	Calibration Date	Test Date	Due Date	Remark
Antenna Mast	EMEC	AM-BS-4500-B	N/A	1m~4m	N/A	Sep. 06, 2017~ Sep. 29, 2017	N/A	Radiation (03CH12-HY)
Turn Table	EMEC	TT2000	N/A	0~360 Degree	N/A	Sep. 06, 2017~ Sep. 29, 2017	N/A	Radiation (03CH12-HY)
Attenuator	Fairview Microwave	SA18S5W-10	n/a	10db	Mar. 24, 2017	Sep. 06, 2017~ Sep. 29, 2017	Mar. 23, 2018	Radiation (03CH12-HY)
SHF-EHF Horn Antenna	SCHWARZBE CK	BBHA 9170	BBHA9170 576	18GHz ~ 40GHz	Apr. 27, 2017	Sep. 06, 2017~ Sep. 29, 2017	Apr. 26, 2018	Radiation (03CH12-HY)
Preamplifier	MITEQ	TTA1840-35- HG	1887435	18GHz~40GHz	Oct. 13, 2016	Sep. 06, 2017~ Sep. 29, 2017	Oct. 12, 2017	Radiation (03CH12-HY)



5 Uncertainty of Evaluation

Uncertainty of Conducted Emission Measurement (150 kHz ~ 30 MHz)

Measuring Uncertainty for a Level of Confidence of 95% ($U = 2Uc(y)$)	2.7
---	-----

Uncertainty of Radiated Emission Measurement (30 MHz ~ 1000 MHz)

Measuring Uncertainty for a Level of Confidence of 95% ($U = 2Uc(y)$)	5.1
---	-----

Uncertainty of Radiated Emission Measurement (1000 MHz ~ 18000 MHz)

Measuring Uncertainty for a Level of Confidence of 95% ($U = 2Uc(y)$)	5.2
---	-----

Uncertainty of Radiated Emission Measurement (18000 MHz ~ 40000 MHz)

Measuring Uncertainty for a Level of Confidence of 95% ($U = 2Uc(y)$)	4.7
---	-----



Appendix A. AC Conducted Emission Test Results

Test Engineer :	Arthur Hsieh	Temperature :	21~24°C
		Relative Humidity :	51~55%

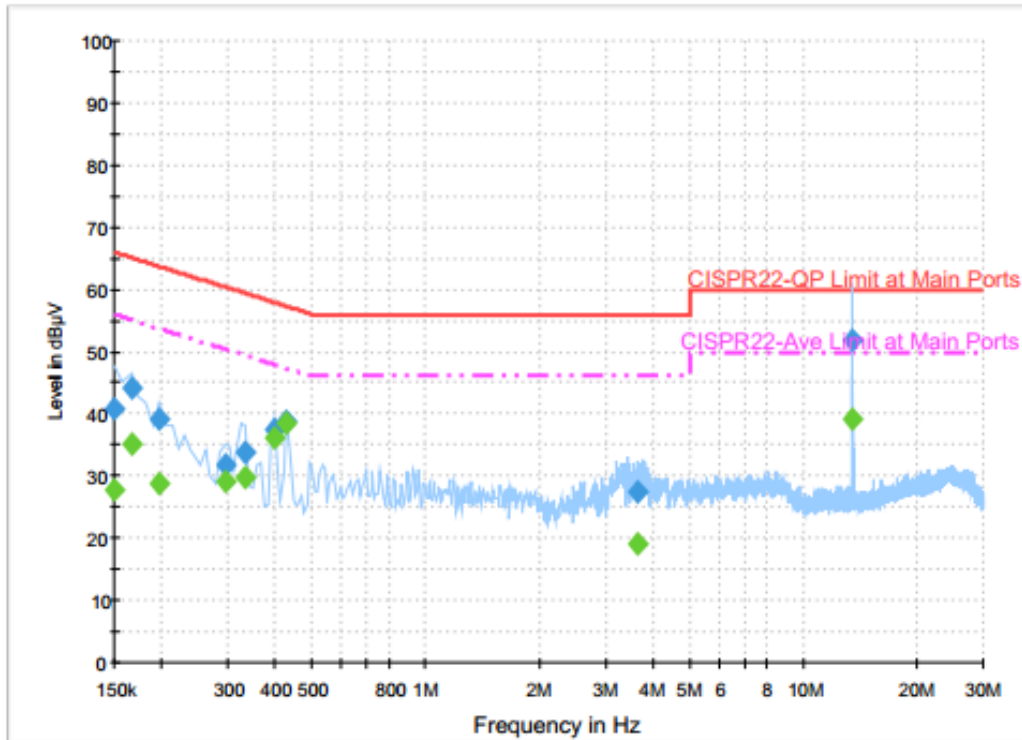

Final Result 1

Frequency (MHz)	QuasiPeak (dBµV)	Filter	Line	Corr. (dB)	Margin (dB)	Limit (dBµV)
0.150000	40.8	Off	L1	19.6	25.2	66.0
0.166000	44.1	Off	L1	19.6	21.1	65.2
0.198000	39.0	Off	L1	19.6	24.7	63.7
0.294000	31.8	Off	L1	19.6	28.6	60.4
0.334000	33.9	Off	L1	19.6	25.5	59.4
0.398000	37.3	Off	L1	19.6	20.6	57.9
0.430000	38.7	Off	L1	19.6	18.6	57.3
3.638000	27.5	Off	L1	19.7	28.5	56.0
13.558000	51.7	Off	L1	20.2	8.3	60.0

Final Result 2

Frequency (MHz)	Average (dBµV)	Filter	Line	Corr. (dB)	Margin (dB)	Limit (dBµV)
0.150000	27.7	Off	L1	19.6	28.3	56.0
0.166000	35.1	Off	L1	19.6	20.1	55.2
0.198000	28.9	Off	L1	19.6	24.8	53.7
0.294000	29.1	Off	L1	19.6	21.3	50.4
0.334000	29.7	Off	L1	19.6	19.7	49.4
0.398000	36.0	Off	L1	19.6	11.9	47.9
0.430000	38.4	Off	L1	19.6	8.9	47.3
3.638000	19.2	Off	L1	19.7	26.8	46.0
13.558000	39.1	Off	L1	20.2	10.9	50.0

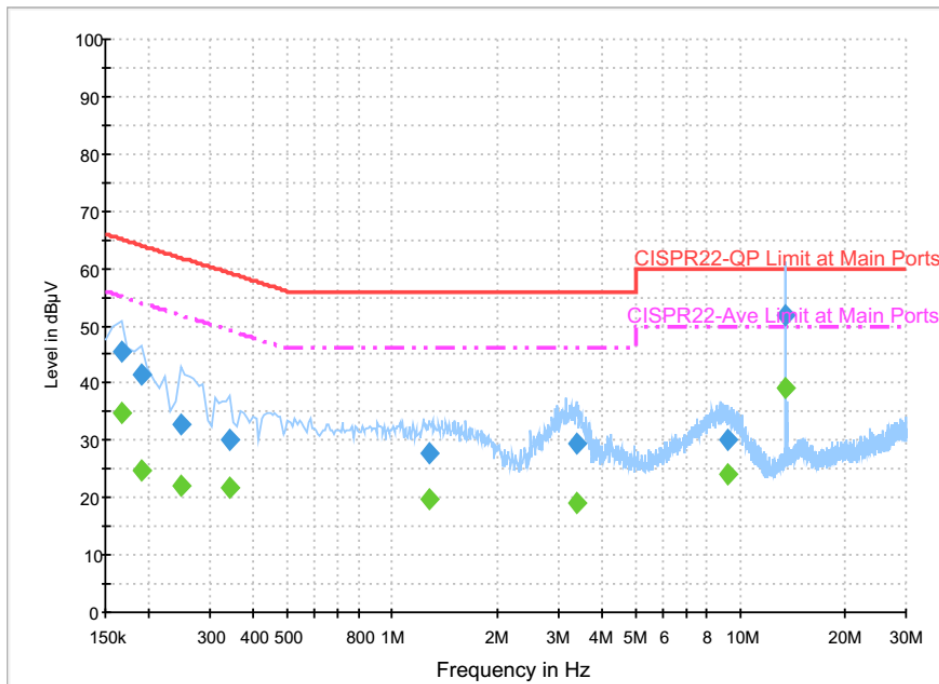

Final Result 1

Frequency (MHz)	QuasiPeak (dBµV)	Filter	Line	Corr. (dB)	Margin (dB)	Limit (dBµV)
0.166000	45.5	Off	N	19.5	19.7	65.2
0.190000	41.4	Off	N	19.5	22.6	64.0
0.246000	32.9	Off	N	19.5	29.0	61.9
0.342000	30.2	Off	N	19.5	29.0	59.2
1.278000	27.7	Off	N	19.6	28.3	56.0
3.382000	29.3	Off	N	19.6	26.7	56.0
9.222000	30.2	Off	N	20.0	29.8	60.0
13.558000	52.0	Off	N	20.3	8.0	60.0

Final Result 2

Frequency (MHz)	Average (dBµV)	Filter	Line	Corr. (dB)	Margin (dB)	Limit (dBµV)
0.166000	34.8	Off	N	19.5	20.4	55.2
0.190000	24.7	Off	N	19.5	29.3	54.0
0.246000	22.1	Off	N	19.5	29.8	51.9
0.342000	21.8	Off	N	19.5	27.4	49.2
1.278000	19.6	Off	N	19.6	26.4	46.0
3.382000	19.1	Off	N	19.6	26.9	46.0
9.222000	24.0	Off	N	20.0	26.0	50.0
13.558000	39.2	Off	N	20.3	10.8	50.0



Appendix B. Radiated Spurious Emission

Test Engineer :	Peter Liao, Ray Chen and Nick Yu	Temperature :	23~25°C
		Relative Humidity :	59~63%

2.4GHz 2400~2483.5MHz

BLE (Band Edge @ 3m)

BLE	Note	Frequency (MHz)	Level (dBμV/m)	Over Limit (dB)	Limit Line (dBμV/m)	Read Level (dBμV)	Antenna Factor (dB/m)	Cable Loss (dB)	Preamp Factor (dB)	Ant Pos (cm)	Table Pos (deg)	Peak Avg. (P/A)	Pol. (H/V)	
BLE CH 00 2402MHz		2366.805	53.51	-20.49	74	43.96	27	4.01	31.49	100	307	P	H	
		2369.64	42.87	-11.13	54	33.31	27.01	4.01	31.49	100	307	A	H	
	*	2402	89.84	-	-	80.15	27.11	4.04	31.49	100	307	P	H	
	*	2402	88.81	-	-	79.12	27.11	4.04	31.49	100	307	A	H	
													H	
														H
			2388.435	53.31	-20.69	74	43.67	27.07	4.03	31.49	147	6	P	V
			2380.665	42.9	-11.1	54	33.29	27.04	4.03	31.49	147	6	A	V
	*		2402	99.89	-	-	90.2	27.11	4.04	31.49	147	6	P	V
	*		2402	98.74	-	-	89.05	27.11	4.04	31.49	147	6	A	V
														V
														V
BLE CH 19 2440MHz		2374.68	53.63	-20.37	74	44.06	27.02	4.01	31.49	102	311	P	H	
		2349.48	42.95	-11.05	54	33.47	26.95	4	31.5	102	311	A	H	
	*	2440	90.87	-	-	81.03	27.22	4.07	31.48	102	311	P	H	
	*	2440	89.78	-	-	79.94	27.22	4.07	31.48	102	311	A	H	
			2484.04	53.37	-20.63	74	43.35	27.35	4.11	31.47	102	311	P	H
			2495.94	43.16	-10.84	54	33.09	27.39	4.11	31.46	102	311	A	H
			2364.18	53.49	-20.51	74	43.96	26.99	4.01	31.5	185	14	P	V
			2384.48	42.85	-11.15	54	33.23	27.05	4.03	31.49	185	14	A	V
	*		2440	99.57	-	-	89.73	27.22	4.07	31.48	185	14	P	V
	*		2440	98.43	-	-	88.59	27.22	4.07	31.48	185	14	A	V
			2486.42	53.48	-20.52	74	43.45	27.36	4.11	31.47	185	14	P	V
			2494.12	43.1	-10.9	54	33.04	27.38	4.11	31.46	185	14	A	V



BLE CH 39 2480MHz	*	2480	90.13	-	-	80.14	27.34	4.09	31.47	102	311	P	H
	*	2480	88.93	-	-	78.94	27.34	4.09	31.47	102	311	A	H
		2492.72	54.25	-19.75	74	44.19	27.38	4.11	31.46	102	311	P	H
		2496.12	43.24	-10.76	54	33.17	27.39	4.11	31.46	102	311	A	H
													H
													H
	*	2480	99.07	-	-	89.08	27.34	4.09	31.47	186	286	P	V
	*	2480	97.97	-	-	87.98	27.34	4.09	31.47	186	286	A	V
		2488.76	54.79	-19.21	74	44.75	27.37	4.11	31.47	186	286	P	V
		2494.44	43.28	-10.72	54	33.22	27.38	4.11	31.46	186	286	A	V
													V
													V
Remark	1. No other spurious found. 2. All results are PASS against Peak and Average limit line.												



2.4GHz 2400~2483.5MHz
BLE (Harmonic @ 3m)

BLE	Note	Frequency (MHz)	Level (dBµV/m)	Over Limit (dB)	Limit Line (dBµV/m)	Read Level (dBµV)	Antenna Factor (dB/m)	Cable Loss (dB)	Preamp Factor (dB)	Ant Pos (cm)	Table Pos (deg)	Peak Avg. (P/A)	Pol. (H/V)
BLE CH 00 2402MHz		4804	38.47	-35.53	74	57.95	32.15	6.16	58.33	100	0	P	H
													H
													H
													H
													V
													V
													V
BLE CH 19 2440MHz		4880	40.06	-33.94	74	59.29	32.28	6.21	58.24	100	0	P	H
		7320	44.9	-29.1	74	58.94	37	7.72	59.1	100	0	P	H
													H
													H
													V
													V
													V
BLE CH 39 2480MHz		4960	39.68	-34.32	74	58.64	32.43	6.26	58.14	100	0	P	H
		7440	44.37	-29.63	74	58.14	37.33	7.75	59.17	100	0	P	H
													H
													H
													V
													V
													V
Remark	1. No other spurious found. 2. All results are PASS against Peak and Average limit line.												



Emission below 1GHz

2.4GHz BLE (LF)

BLE	Note	Frequency	Level	Over	Limit	Read	Antenna	Cable	Preamp	Ant	Table	Peak	Pol.	
		(MHz)	(dBμV/m)	(dB)	(dBμV/m)	(dBμV)	(dB/m)	(dB)	(dB)	(cm)	(deg)	(P/A)	(H/V)	
2.4GHz BLE LF		33.78	27	-13	40	34.29	22.49	0.48	30.23	-	-	P	H	
		46.2	27.74	-12.26	40	41.55	15.99	0.6	30.41	100	50	P	H	
		79.95	27.24	-12.76	40	43.53	13.31	0.76	30.42	-	-	P	H	
		787.9	29.87	-16.13	46	28.57	28.28	2.26	29.36	-	-	P	H	
		860.7	30.87	-15.13	46	28.15	29.46	2.36	29.23	-	-	P	H	
		946.8	32.09	-13.91	46	27.69	30.74	2.49	29.07	-	-	P	H	
														H
														H
														H
														H
														H
														H
			37.56	36.53	-3.47	40	45.81	20.55	0.48	30.29	100	185	P	V
			37.56	38.93	-1.07	40	48.21	20.55	0.48	30.29	100	185	P	V
			46.47	33.68	-6.32	40	47.49	15.99	0.6	30.41	-	-	P	V
			64.56	33.27	-6.73	40	51.04	11.95	0.68	30.44	-	-	P	V
			843.9	30.65	-15.35	46	28.31	29.14	2.34	29.26	-	-	P	V
			884.5	30.9	-15.1	46	28.32	29.2	2.42	29.19	-	-	P	V
			939.8	31.3	-14.7	46	27.1	30.56	2.49	29.08	-	-	P	V
														V
													V	
													V	
													V	
													V	
Remark	1. No other spurious found. 2. All results are PASS against limit line.													



Note symbol

*	Fundamental Frequency which can be ignored. However, the level of any unwanted emissions shall not exceed the level of the fundamental frequency.
!	Test result is over limit line.
P/A	Peak or Average
H/V	Horizontal or Vertical



A calculation example for radiated spurious emission is shown as below:

WIFI	Note	Frequency	Level	Over	Limit	Read	Antenna	Cable	Preamp	Ant	Table	Peak	Pol.
Ant.				Limit	Line	Level	Factor	Loss	Factor	Pos	Pos	Avg.	
1+2		(MHz)	(dBμV/m)	(dB)	(dBμV/m)	(dBμV)	(dB/m)	(dB)	(dB)	(cm)	(deg)	(P/A)	(H/V)
802.11b		2390	55.45	-18.55	74	54.51	32.22	4.58	35.86	103	308	P	H
CH 01													
2412MHz		2390	43.54	-10.46	54	42.6	32.22	4.58	35.86	103	308	A	H

- Level(dBμV/m) =
Antenna Factor(dB/m) + Cable Loss(dB) + Read Level(dBμV) - Preamp Factor(dB)
- Over Limit(dB) = Level(dBμV/m) – Limit Line(dBμV/m)

For Peak Limit @ 2390MHz:

- Level(dBμV/m)
= Antenna Factor(dB/m) + Cable Loss(dB) + Read Level(dBμV) - Preamp Factor(dB)
= 32.22(dB/m) + 4.58(dB) + 54.51(dBμV) – 35.86 (dB)
= 55.45 (dBμV/m)
- Over Limit(dB)
= Level(dBμV/m) – Limit Line(dBμV/m)
= 55.45(dBμV/m) – 74(dBμV/m)
= -18.55(dB)

For Average Limit @ 2390MHz:

- Level(dBμV/m)
= Antenna Factor(dB/m) + Cable Loss(dB) + Read Level(dBμV) - Preamp Factor(dB)
= 32.22(dB/m) + 4.58(dB) + 42.6(dBμV) – 35.86 (dB)
= 43.54 (dBμV/m)
- Over Limit(dB)
= Level(dBμV/m) – Limit Line(dBμV/m)
= 43.54(dBμV/m) – 54(dBμV/m)
= -10.46(dB)

Both peak and average measured complies with the limit line, so test result is “PASS”.



Appendix C. Radiated Spurious Emission Plots

Test Engineer : Peter Liao, Ray Chen and Nick Yu	Temperature :	23~25°C
	Relative Humidity :	59~63%



2.4GHz 2400~2483.5MHz

BLE (Band Edge @ 3m)

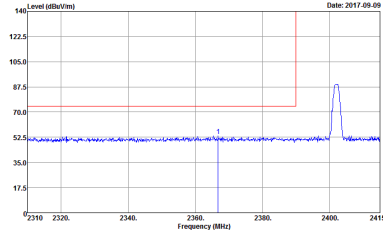
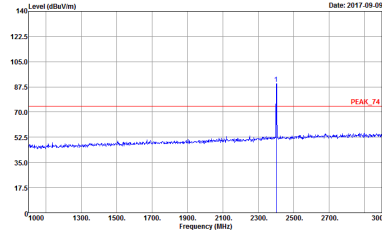
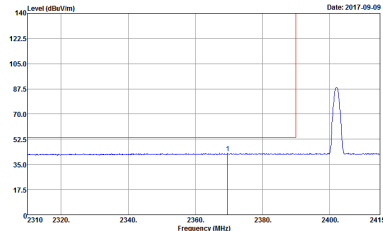
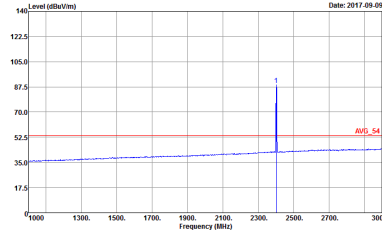
BLE	2.4GHz 2400~2483.5MHz Band Edge @ 3m	
ANT	BLE CH00 2402MHz	
	Horizontal	Fundamental
Peak	 <p>Site : 03CH12-HY Condition : PEAK_BE_74 3m HORN_9120D_1328 HORIZONTAL : RBW:1000.000kHz VBW:3000.000kHz SWT:Auto Detector : Peak Project : 790120 Mode : 77</p>	 <p>Site : 03CH12-HY Condition : PEAK_74 3m HORN_9120D_1328 HORIZONTAL : RBW:1000.000kHz VBW:3000.000kHz SWT:Auto Detector : Peak Project : 790120 Mode : 77</p>
Avg.	 <p>Site : 03CH12-HY Condition : AVG_BE_54 3m HORN_9120D_1328 HORIZONTAL : RBW:1000.000kHz VBW:3.000kHz SWT:Auto Detector : Peak Project : 790120 Mode : 77</p>	 <p>Site : 03CH12-HY Condition : AVG_54 3m HORN_9120D_1328 HORIZONTAL : RBW:1000.000kHz VBW:3.000kHz SWT:Auto Detector : Peak Project : 790120 Mode : 77</p>



BLE	2.4GHz 2400~2483.5MHz Band Edge @ 3m	
ANT	BLE CH00 2402MHz	
	Vertical	Fundamental
Peak	<p>Date: 2017-09-09</p> <p>Site : 03CH12-HY Condition : PEAK_BE_74 3m HORN_9120D_1328 VERTICAL : RBW:1000.000kHz VBW:3000.000kHz SWT:Auto Detector : Peak Project : 790120 Mode : 77</p>	<p>Date: 2017-09-09</p> <p>Site : 03CH12-HY Condition : PEAK_74 3m HORN_9120D_1328 VERTICAL : RBW:1000.000kHz VBW:3000.000kHz SWT:Auto Detector : Peak Project : 790120 Mode : 77</p>
Avg	<p>Date: 2017-09-09</p> <p>Site : 03CH12-HY Condition : AVG_BE_54 3m HORN_9120D_1328 VERTICAL : RBW:1000.000kHz VBW:3.000kHz SWT:Auto Detector : Peak Project : 790120 Mode : 77</p>	<p>Date: 2017-09-09</p> <p>Site : 03CH12-HY Condition : AVG_54 3m HORN_9120D_1328 VERTICAL : RBW:1000.000kHz VBW:3.000kHz SWT:Auto Detector : Peak Project : 790120 Mode : 77</p>

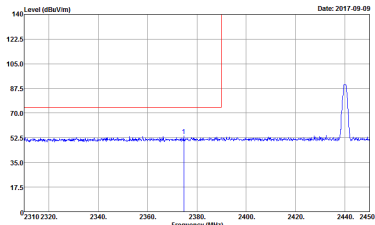
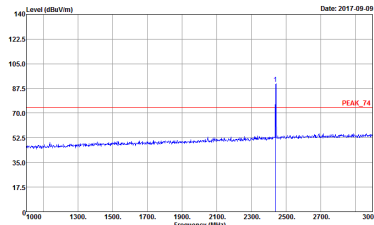
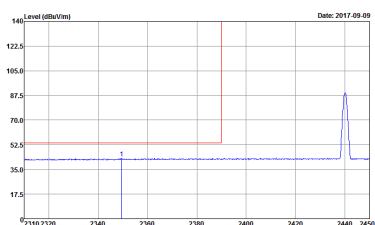
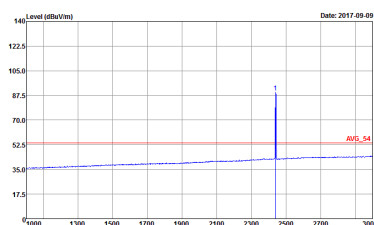

BLE	2.4GHz 2400~2483.5MHz Band Edge @ 3m	
ANT	BLE CH19 2440MHz - L	
	Horizontal	Fundamental
Peak	 <p>Level (dBμV/m) vs Frequency (MHz) plot for Horizontal orientation. The y-axis ranges from 0 to 140 dBμV/m, and the x-axis ranges from 2310 to 2450 MHz. A sharp peak is visible at approximately 2440 MHz. A red box highlights the peak area.</p> <p>Site : 03CH12-HY Condition : PEAK_BE_74 3m HORN_9120D_1328 HORIZONTAL RBW:1000.000KHz VBW:3000.000KHz SWT:Auto Detector : Peak Project : 790120 Mode : 78</p>	 <p>Level (dBμV/m) vs Frequency (MHz) plot for Fundamental orientation. The y-axis ranges from 0 to 140 dBμV/m, and the x-axis ranges from 1000 to 3000 MHz. A sharp peak is visible at approximately 2440 MHz. A red box highlights the peak area.</p> <p>Site : 03CH12-HY Condition : PEAK_74 3m HORN_9120D_1328 HORIZONTAL RBW:1000.000KHz VBW:3000.000KHz SWT:Auto Detector : Peak Project : 790120 Mode : 78</p>
Avg.	 <p>Level (dBμV/m) vs Frequency (MHz) plot for Horizontal orientation. The y-axis ranges from 0 to 140 dBμV/m, and the x-axis ranges from 2310 to 2450 MHz. A sharp peak is visible at approximately 2440 MHz. A red box highlights the peak area.</p> <p>Site : 03CH12-HY Condition : AVG_BE_54 3m HORN_9120D_1328 HORIZONTAL RBW:1000.000KHz VBW:3.000KHz SWT:Auto Detector : Peak Project : 790120 Mode : 78</p>	 <p>Level (dBμV/m) vs Frequency (MHz) plot for Fundamental orientation. The y-axis ranges from 0 to 140 dBμV/m, and the x-axis ranges from 1000 to 3000 MHz. A sharp peak is visible at approximately 2440 MHz. A red box highlights the peak area.</p> <p>Site : 03CH12-HY Condition : AVG_54 3m HORN_9120D_1328 HORIZONTAL RBW:1000.000KHz VBW:3.000KHz SWT:Auto Detector : Peak Project : 790120 Mode : 78</p>

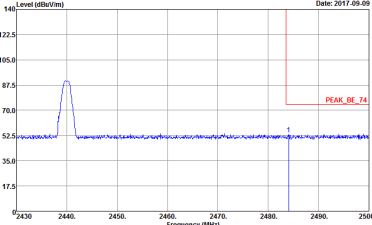
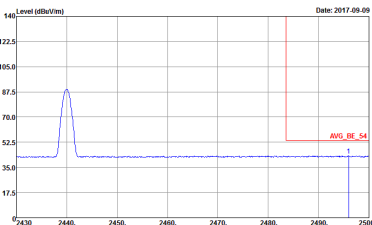

BLE	2.4GHz 2400~2483.5MHz Band Edge @ 3m	
ANT	BLE CH19 2440MHz - R	
	Horizontal	Fundamental
<p>Peak</p>	 <p>Site : 03CH12-HY Condition : PEAK_BE_74 3m HORN_91200_1328 HORIZONTAL Detector : RBW:1000.000KHz VBW:3000.000KHz SWT:Auto Project : 790120 Mode : 78</p>	<p>Left blank</p>
<p>Avg.</p>	 <p>Site : 03CH12-HY Condition : AVG_BE_54 3m HORN_91200_1328 HORIZONTAL Detector : RBW:1000.000KHz VBW:3.000KHz SWT:Auto Project : 790120 Mode : 78</p>	<p>Left blank</p>

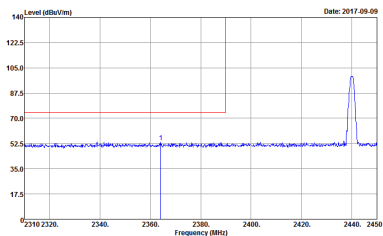
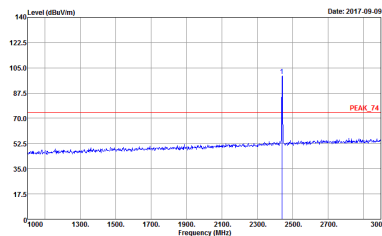
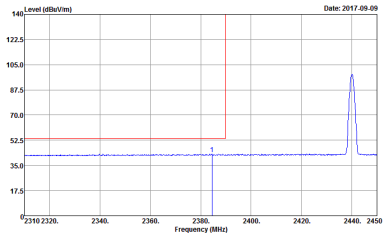
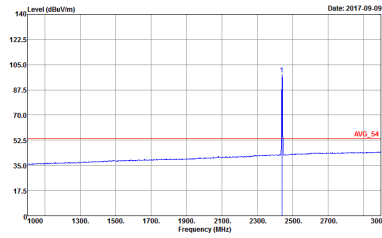

BLE	2.4GHz 2400~2483.5MHz Band Edge @ 3m	
ANT	BLE CH19 2440MHz - L	
	Vertical	Fundamental
<p>Peak</p>	 <p>Site: -03CH12-HY Condition: PEAK_BE_74 3m HORN_9120D_1328 VERTICAL RBW:1000.000kHz VBW:3000.000kHz SWT:Auto Detector: Peak Project: 790120 Mode: 78</p>	 <p>Site: -03CH12-HY Condition: PEAK_74 3m HORN_9120D_1328 VERTICAL RBW:1000.000kHz VBW:3000.000kHz SWT:Auto Detector: Peak Project: 790120 Mode: 78</p>
<p>Avg.</p>	 <p>Site: -03CH12-HY Condition: AVG_BE_54 3m HORN_9120D_1328 VERTICAL RBW:1000.000kHz VBW:3.000kHz SWT:Auto Detector: Peak Project: 790120 Mode: 78</p>	 <p>Site: -03CH12-HY Condition: AVG_54 3m HORN_9120D_1328 VERTICAL RBW:1000.000kHz VBW:3.000kHz SWT:Auto Detector: Peak Project: 790120 Mode: 78</p>

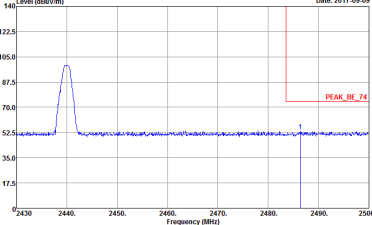
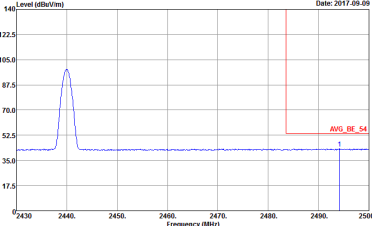

BLE	2.4GHz 2400~2483.5MHz Band Edge @ 3m	
ANT	BLE CH19 2440MHz - R	
	Vertical	Fundamental
<p>Peak</p>	 <p>Date: 2017-09-09</p> <p>Site : 03CH12-HY Condition : PEAK_BE_74 3m HORN_9120D_1338 VERTICAL : RBW:1000.000kHz VBW:3000.000kHz SWT:Auto Detector : Peak Project : 790120 Mode : 78</p>	<p>Left blank</p>
<p>Avg.</p>	 <p>Date: 2017-09-09</p> <p>Site : 03CH12-HY Condition : AVG_BE_54 3m HORN_9120D_1338 VERTICAL : RBW:1000.000kHz VBW:3.000kHz SWT:Auto Detector : Peak Project : 790120 Mode : 78</p>	<p>Left blank</p>

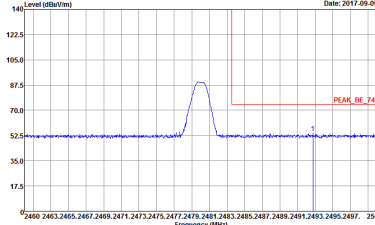
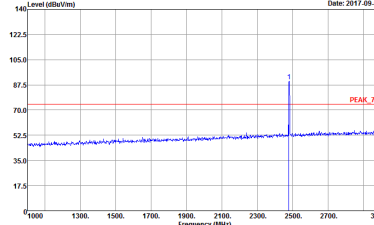
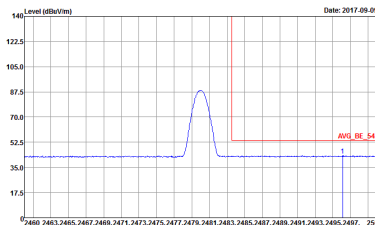
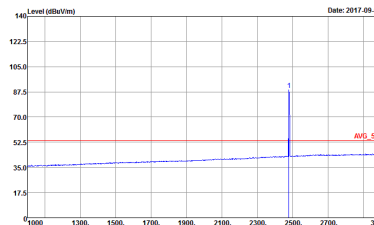

BLE	2.4GHz 2400~2483.5MHz Band Edge @ 3m	
ANT	BLE CH39 2480MHz	
	Horizontal	Fundamental
Peak	 <p>Site : 03CH12-HY Condition : PEAK_BE_74 3m HORN_9120D_1328 HORIZONTAL Detector : RBW:1000.000kHz VBW:3000.000kHz SWT:Auto Project : Peak Mode : 790120 Mode : 79</p>	 <p>Site : 03CH12-HY Condition : PEAK_74 3m HORN_9120D_1328 HORIZONTAL Detector : RBW:1000.000kHz VBW:3000.000kHz SWT:Auto Project : Peak Mode : 790120 Mode : 79</p>
Avg.	 <p>Site : 03CH12-HY Condition : AVG_BE_54 3m HORN_9120D_1328 HORIZONTAL Detector : RBW:1000.000kHz VBW:3.000kHz SWT:Auto Project : Peak Mode : 790120 Mode : 79</p>	 <p>Site : 03CH12-HY Condition : AVG_54 3m HORN_9120D_1328 HORIZONTAL Detector : RBW:1000.000kHz VBW:3.000kHz SWT:Auto Project : Peak Mode : 790120 Mode : 79</p>

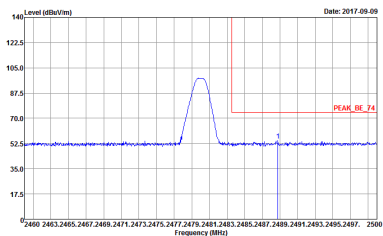
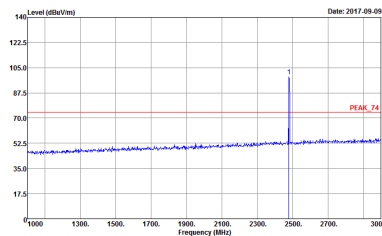
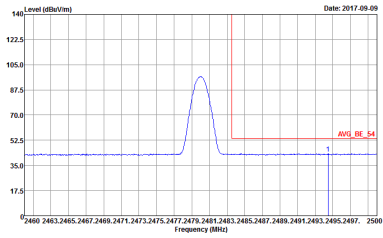
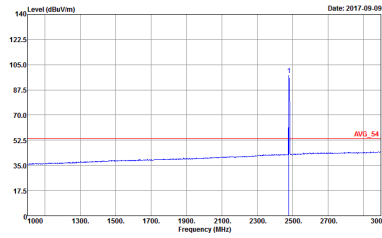

BLE	2.4GHz 2400~2483.5MHz Band Edge @ 3m	
ANT	BLE CH39 2480MHz	
	Vertical	Fundamental
Peak	 <p>Date: 2017-09-09</p> <p>Site : 03CH12-HY Condition : PEAK_BE_74 3m HORN_9120D_1328 VERTICAL : RBW:1000.000KHz VBW:3000.000KHz SWT:Auto Detector : Peak Project : 790120 Mode : 79</p>	 <p>Date: 2017-09-09</p> <p>Site : 03CH12-HY Condition : PEAK_74 3m HORN_9120D_1328 VERTICAL : RBW:1000.000KHz VBW:3000.000KHz SWT:Auto Detector : Peak Project : 790120 Mode : 79</p>
Avg.	 <p>Date: 2017-09-09</p> <p>Site : 03CH12-HY Condition : AVG_BE_54 3m HORN_9120D_1328 VERTICAL : RBW:1000.000KHz VBW:3.000KHz SWT:Auto Detector : Peak Project : 790120 Mode : 79</p>	 <p>Date: 2017-09-09</p> <p>Site : 03CH12-HY Condition : AVG_54 3m HORN_9120D_1328 VERTICAL : RBW:1000.000KHz VBW:3.000KHz SWT:Auto Detector : Peak Project : 790120 Mode : 79</p>



2.4GHz 2400~2483.5MHz
BLE (Harmonic @ 3m)

BLE	2.4GHz 2400~2483.5MHz Harmonic @ 3m	
ANT	BLE CH00 2402MHz	
	Horizontal	Vertical
Peak Avg.	<p>Site : 03CH12-HY Condition : PEAK_74 3m HORN_9120D_1328 HORIZONTAL Detector : Peak Project : 790120 Mode : 77</p>	<p>Site : 03CH12-HY Condition : PEAK_74 3m HORN_9120D_1328 VERTICAL Detector : Peak Project : 790120 Mode : 77</p>

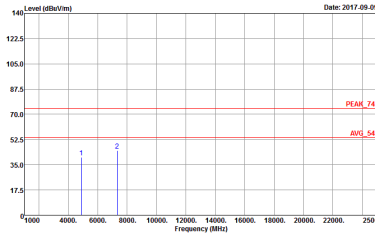
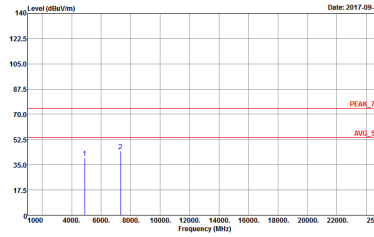

BLE	2.4GHz 2400~2483.5MHz Harmonic @ 3m	
ANT	BLE CH19 2440MHz	
	Horizontal	Vertical
<p>Peak</p> <p>Avg.</p>	 <p>Site : -03CH12-HY Condition : PEAK_74 3m HORN_9120D_1328 HORIZONTAL Detector : Peak Project : 790120 Mode : 78</p>	 <p>Site : -03CH12-HY Condition : PEAK_74 3m HORN_9120D_1328 VERTICAL Detector : Peak Project : 790120 Mode : 78</p>

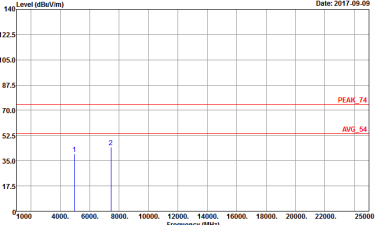
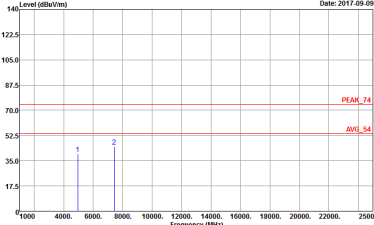

BLE	2.4GHz 2400~2483.5MHz Harmonic @ 3m	
ANT	BLE CH39 2480MHz	
	Horizontal	Vertical
Peak	 <p>Site : -03CH12-HY Condition : PEAK_74 3m HORN_9120D_1328 HORIZONTAL Detector : Peak Project : 750120 Mode : 79</p>	 <p>Site : -03CH12-HY Condition : PEAK_74 3m HORN_9120D_1328 VERTICAL Detector : Peak Project : 750120 Mode : 79</p>



Emission below 1GHz
2.4GHz BLE (LF)

BLE	2.4GHz 2400~2483.5MHz	
ANT	BLE LF	
	Horizontal	Vertical
<p>QP / Peak</p>	<p>Site : 03CH12-HY Condition : QP 3m BILOG_6111D_37059 HORIZONTAL Detector : Peak Project : 790120 Mode : IS</p>	<p>Site : 03CH12-HY Condition : QP 3m BILOG_6111D_37059 VERTICAL Detector : Peak Project : 790120 Mode : IS</p>



Appendix D. Duty Cycle Plots

Band	Duty Cycle(%)	T(us)	1/T(kHz)	VBW Setting
Bluetooth -LE	61.29	380	2.63	3kHz

Bluetooth - LE

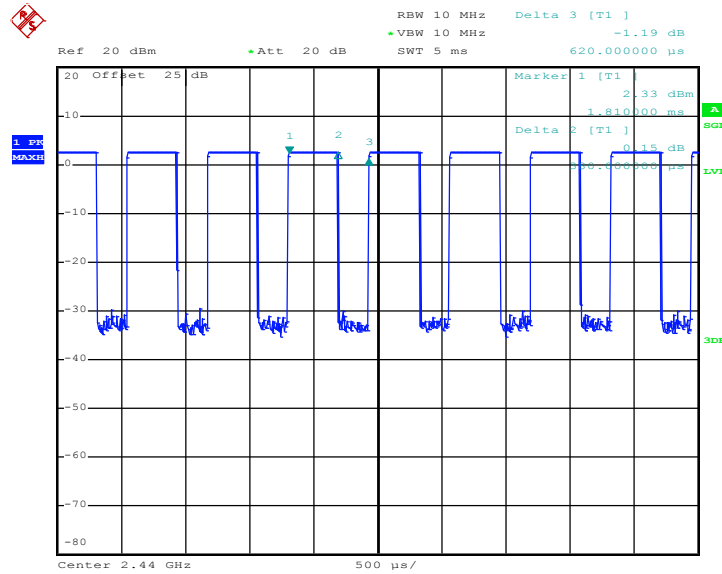

Date: 7.SEP.2017 20:07:38