



FCC RADIO TEST REPORT

FCC ID : UZ7MC330L
Equipment : Mobile Computer
Brand Name : Zebra
Model Name : MC330L
Applicant : Zebra Technologies Corporation
1 Zebra Plaza, Holtsville, NY 11742
Manufacturer : Zebra Technologies Corporation
1 Zebra Plaza, Holtsville, NY 11742
Standard : FCC Part 15 Subpart C §15.225

The product was received on Aug. 12, 2019 and testing was started from Aug. 24, 2019 and completed on Sep. 02, 2019. We, SPORTON INTERNATIONAL INC., EMC & Wireless Communications Laboratory, would like to declare that the tested sample has been evaluated in accordance with the test procedures and has been in compliance with the applicable technical standards.

The report must not be used by the client to claim product certification, approval, or endorsement by TAF or any agency of government.

The test results in this report apply exclusively to the tested model / sample. Without written approval of SPORTON INTERNATIONAL INC. EMC & Wireless Communications Laboratory, the test report shall not be reproduced except in full.

Louis Wu

Approved by: Louis Wu

SPORTON INTERNATIONAL INC. EMC & Wireless Communications Laboratory
No. 52, Huaya 1st Rd., Guishan Dist., Taoyuan City, Taiwan (R.O.C.)



Table of Contents

History of this test report.....	3
Summary of Test Result.....	4
1. General Description	5
1.1 Product Feature of Equipment Under Test	5
1.2 Product Specification of Equipment Under Test	9
1.3 Modification of EUT	9
1.4 Testing Location	9
1.5 Applicable Standards.....	9
2. Test Configuration of Equipment Under Test.....	10
2.1 Descriptions of Test Mode	10
2.2 Connection Diagram of Test System	10
2.3 Table for Supporting Units	11
2.4 EUT Operation Test Setup	11
3. Test Results	12
3.1 AC Power Line Conducted Emissions Measurement	12
3.2 20dB and 99% OBW Spectrum Bandwidth Measurement.....	14
3.3 Frequency Stability Measurement	15
3.4 Field Strength of Fundamental Emissions and Mask Measurement.....	16
3.5 Radiated Emissions Measurement	18
3.6 Antenna Requirements.....	21
4. List of Measuring Equipment	22
5. Uncertainty of Evaluation	23
Appendix A. Test Results of Conducted Emission Test	
Appendix B. Test Results of Conducted Test Items	
B1. Test Result of 20dB Spectrum Bandwidth	
B2. Test Result of Frequency Stability	
Appendix C. Test Results of Radiated Test Items	
C1. Test Result of Field Strength of Fundamental Emissions	
C2. Results of Radiated Emissions (9 kHz~30MHz)	
C3. Results of Radiated Emissions (30MHz~1GHz)	
Appendix D. Setup Photographs	



History of this test report

Report No.	Version	Description	Issued Date
FR981244D	01	Initial issue of report	Nov. 29, 2019



Summary of Test Result

Report Clause	Ref Std. Clause	Test Items	Result (PASS/FAIL)	Remark
3.1	15.207	AC Power Line Conducted Emissions	Pass	Under limit 11.40 dB at 13.560MHz
3.2	15.215(c)	20dB Spectrum Bandwidth	Pass	-
	2.1049	99% OBW Spectrum Bandwidth	Reporting only	-
3.3	15.225(e)	Frequency Stability	Pass	-
3.4	15.225(a)(b)(c)	Field Strength of Fundamental Emissions	Pass	Max level 22.54 dB μ V/m at 13.560 MHz
3.5	15.225(d) 15.209	Radiated Spurious Emissions	Pass	Under limit 9.36 dB at 40.800MHz
3.6	15.203	Antenna Requirements	Pass	-

Declaration of Conformity:

The test results with all measurement uncertainty excluded are presented in accordance with the regulation limits or requirements declared by manufacturers.

Comments and Explanations:

The declared of product specification for EUT presented in the report are provided by the manufacturer, and the manufacturer takes all the responsibilities for the accuracy of product specification.

Reviewed by: Wii Chang

Report Producer: Jessie Ho



1. General Description

1.1 Product Feature of Equipment Under Test

Product Feature	
Equipment	Mobile Computer
Brand Name	Zebra
Model Name	MC330L
FCC ID	UZ7MC330L
EUT supports Radios application	NFC WLAN 11a/b/g/n HT20/HT40 WLAN 11ac VHT20/VHT40/VHT80 Bluetooth BR/EDR/LE
HW Version	DV
SW Version_Gun	Android Version 9
SW Version_Brick	Android Version 9
SW Version_Rotate	Android Version 9
FW Version_Gun	Terminal Version: 02-11-08.00-PG-U00-PLT
FW Version_Brick	Terminal Version: 02-11-08.00-PG-U00-PLT
FW Version_Rotate	Terminal Version: 02-11-08.00-PG-U00-PLT
MFD_Gun	01AUG19
MFD_Brick	02AUG19
MFD_Rotate	27JUL19
EUT Stage	Identical Prototype

Remark: The above EUT's information was declared by manufacturer.



Specification of Accessories				
Adapter	Brand Name	Zebra	Part Number	PWR-WUA5V12W0US
U cable	Brand Name	Symbol	Model Name	CBL-MC33-USBCHG-01
MC32 1X battery (Inventus)	Brand Name	Symbol	Model Number	82-000011-01
MC32 2X battery (Inventus)	Brand Name	Symbol	Model Number	82-000012-02
MC32 2X battery (TWS)	Brand Name	Symbol	Model Number	82-000012-02
MC33 1X battery (Inventus)	Brand Name	Zebra	Model Number	BT-000338
MC33 2X battery (Inventus)	Brand Name	Zebra	Model Number	BT-000337
MC33 2X battery (TWS)	Brand Name	Zebra	Model Number	BT-000337A
MC33 7000mA 2X (Inventus)	Brand Name	Zebra	Model Number	BT-000375
Holster for MC3XXX Gun configuration	Brand Name	Zebra	Model Number	SG-MC3021212-01R
Rigid holster for MC3XXX Gun configuration	Brand Name	Zebra	Model Number	SG-MC33-RDHLST-01
Holster for MC3XXXX Brick configuration	Brand Name	Zebra	Model Number	11-69293-01R
Rigid holster for MC3XXX Brick configuration	Brand Name	Zebra	Model Number	SG-MC33-RDHLST-01
Lanyard for MC3XXX Brick Configuration	Brand Name	Zebra	Model Number	SG-MC33-LNYDB-01
Protective boot for MC3XXX straight shooter	Brand Name	Zebra	Model Number	SG-MC33-RBTG-01
Protective boot for MC3XXX Turret Cup of Rotate configuration	Brand Name	Zebra	Model Number	SG-MC33-RBTRT-01
Protective boot for MC3XXX Rotate configuration	Brand Name	Zebra	Model Number	SG-MC33-RBTRD-01

**<Sample Information>**

Organization / Function / Group	SKU1	SKU2	SKU3	SKU4	SKU5
Phase	DV	DV	DV	DV	DV
Configuration					
Form Factor	Gun	Gun	Gun - Amazon	Gun China	Rotate
Scanner	SE965	SE4850 new 20-4850-IM001R	SE4770	SE4720	SE965
Keypad	Numeric (29Key)	Function Numeric (47Key)	AlphaNum (47Key)	Function Numeric (38Key)	Numeric (47Key)
Tier	Base	Base	Base	Base	Base
NFC	Yes	Yes	Yes	Yes	Yes
Camera	NA	NA	NA	NA	No
Audio Jack (NA)	NA	NA	NA	NA	No
Back Hsg	Gun 18D	Gun 18D	Gun 18D	Gun 18D	Rotate Head
Screen Protector	No	Yes	Yes	No	No
RFID Tag	Yes	Yes	Yes	Yes	No
Hand strap	No	Yes	Yes	No	No
USB Charge cable in box	No	No	No	Yes	No
Wal wart adaptor	No	No	No	Yes	No
PCB	Tripod	Tripod	Tripod	Tripod	Tripod
DRAM/eMMC	4/32 GB MLC	4/32 GB MLC	4/32 GB MLC	4/16 GB MLC	4/32 GB MLC
DRAM/eMMC Mfr main source	Hynix/Hynix	Hynix/Hynix	Hynix/Hynix	Hynix/Hynix	Hynix/Hynix



Organization / Function / Group	SKU6	SKU7	SKU8	SKU9	SKU10
Phase	DV	DV	DV	DV	DV
Configuration					
Form Factor	Straight (S)	Straight (S)	Straight (S) China	Straight (L)	Straight(45)
Scanner	SE965	SE4770	SE4720	SE4850 new 20-4850-IM001R	SE4770
Keypad	AlphaNum (47Key)	Function Numeric (38Key)	Function Numeric (38Key)	Numeric (29Key)	Function Numeric (38Key)
Tier	Base + Camera	Base + Camera	Base	Base + Camera	Base + Camera
NFC	Yes	Yes	Yes	Yes	Yes
Camera	Yes	Yes	No	Yes	Yes
Audio Jack (NA)	No	No	No	No	No
Back Hsg	22 Deg ST	22 Deg ST	22 Deg ST	18 deg ST	45 deg ST
Screen Protector	No	No	No	Yes	Yes
RFID Tag	No	No	No	No	No
Hand strap	Yes	No	No	No	Yes
USB Charge cable in box	No	No	Yes	No	No
Wal wart adaptor	No	No	Yes	No	No
PCB	Tripod	Tripod	Tripod	Tripod	Tripod
DRAM/eMMC	4/32 GB MLC	4/32 GB MLC	4/16 GB MLC	4/32 GB MLC	4/32 GB MLC
DRAM/eMMC Mfr main source	Hynix/Hynix	Hynix/Hynix	Hynix/Hynix	Hynix/Hynix	Hynix/Hynix

1.2 Product Specification of Equipment Under Test

Standards-related Product Specification	
Tx/Rx Frequency Range	13.553 ~ 13.567MHz
Channel Number	1
20dBW	2.66 KHz
99%OBW	2.26 KHz
Antenna Type	Loop Antenna
Type of Modulation	ASK

Remark: The above EUT's information was declared by manufacturer.

1.3 Modification of EUT

No modifications are made to the EUT during all test items.

1.4 Testing Location

Test Site	SPORTON INTERNATIONAL INC. EMC & Wireless Communications Laboratory		
Test Site Location	No.52, Huaya 1st Rd., Guishan Dist., Taoyuan City, Taiwan (R.O.C.) TEL: +886-3-327-3456 FAX: +886-3-328-4978		
Test Site No.	Sporton Site No.		
	TH03-HY	CO05-HY	03CH07-HY
Test Engineer	Benjamin Lin	Louis Chung	Jesse Wang and Stan Hsieh
Temperature	22~24	25.2~26.2	22~25
Relative Humidity	53~55	47.4~58.2	63~64

Note: The test site complies with ANSI C63.4 2014 requirement.

FCC designation No.: TW1190

1.5 Applicable Standards

According to the specifications of the manufacturer, the EUT must comply with the requirements of the following standards:

- ♦ FCC Part 15 Subpart C §15.225
- ♦ FCC KDB 414788 D01 Radiated Test Site v01r01
- ♦ ANSI C63.10-2013

2. Test Configuration of Equipment Under Test

2.1 Descriptions of Test Mode

Investigation has been done on all the possible configurations.

The following table is a list of the test modes shown in this test report.

Test Items	
AC Power Line Conducted Emissions	Field Strength of Fundamental Emissions
20dB Spectrum Bandwidth	Frequency Stability
Radiated Emissions 9kHz~30MHz	Radiated Emissions 30MHz~1GHz

The EUT pre-scanned in four NFC type, A, B, F, V. The worst type (type F) was recorded in this report. Pre-scanned tests, X, Y, Z in three orthogonal panels to determine the final configuration (Z plane as worst plane) from all possible combinations.

Test Cases	
AC Conducted Emission	Mode 1 : SKU 5 + Keypad (47) + WLAN (2.4GHz) Link + Bluetooth Link + NFC Link + Color Bar + MC33 Inventus 7000mA 2X + USB Cable (Data Link with Notebook) (eMMC to Notebook)
Remark: For Radiated Test Cases, the tests were performed with SKU 1.	

2.2 Connection Diagram of Test System

<Radiated Emission Mode>

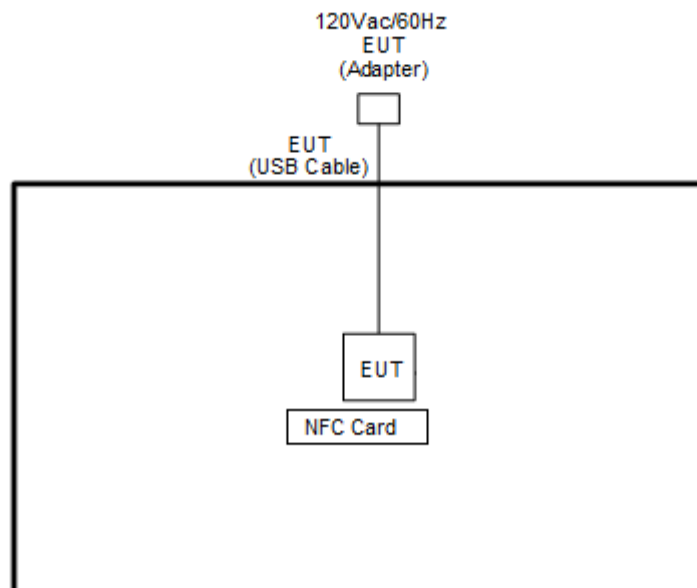

<AC Conducted Emission Mode>

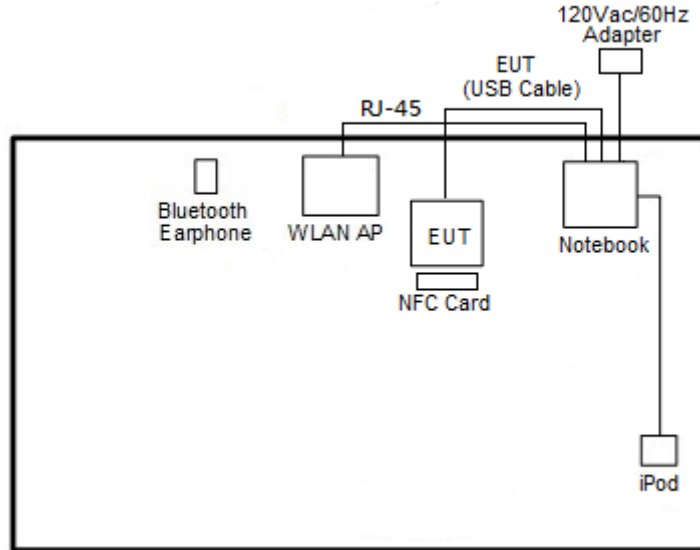

2.3 Table for Supporting Units

Item	Equipment	Trade Name	Model Name	FCC ID	Data Cable	Power Cord
1.	WLAN AP	ASUS	RT-AC66U	MSQ-RTAC66U	N/A	Unshielded, 1.8 m
2.	Bluetooth Earphone	Sony Ericsson	MW600	PY7DDA-2029	N/A	N/A
3.	Notebook	DELL	Latitude E5570	FCC DoC	N/A	AC I/P: Unshielded, 1.2 m DC O/P: Shielded, 1.8 m
4.	iPod	Apple	A1285	FCC DoC	Shielded, 1.0 m	N/A
5.	SD Card	SanDisk	MicroSD HC	FCC DoC	N/A	N/A
6.	NFC Card	N/A	N/A	N/A	N/A	N/A

2.4 EUT Operation Test Setup

The EUT was programmed to be in continuously transmitting mode.

The ancillary equipment, NFC card, is used to make the EUT (NFC) continuously transmit at 13.56MHz and is placed around 0 cm gap to the EUT.



3. Test Results

3.1 AC Power Line Conducted Emissions Measurement

3.1.1 Limit of AC Conducted Emission

For equipment that is designed to be connected to the public utility (AC) power line, the radio frequency voltage that is conducted back onto the AC power line on any frequency or frequencies within the band 150 kHz to 30 MHz shall not exceed the limits in the following table.

Frequency of Emission (MHz)	Conducted Limit (dB μ V)	
	Quasi-Peak	Average
0.15-0.5	66 to 56*	56 to 46*
0.5-5	56	46
5-30	60	50

*Decreases with the logarithm of the frequency.

3.1.2 Measuring Instruments

See list of measuring equipment of this test report.

3.1.3 Test Procedures

1. The EUT was placed 0.4 meter from the conducting wall of the shielding room, and it was kept at least 80 centimeters from any other grounded conducting surface.
2. Connect EUT to the power mains through a line impedance stabilization network (LISN).
3. All the support units are connecting to the other LISN.
4. The LISN provides 50 ohm coupling impedance for the measuring instrument.
5. The FCC states that a 50 ohm, 50 microhenry LISN should be used.
6. Both sides of AC line were checked for maximum conducted interference.
7. The frequency range from 150 kHz to 30 MHz was searched.
8. Set the test-receiver system to Peak Detect Function and specified bandwidth (IF Bandwidth = 9kHz) with Maximum Hold Mode. Then measurement is also conducted by Average Detector and Quasi-Peak Detector Function respectively.

3.1.4 Test setup

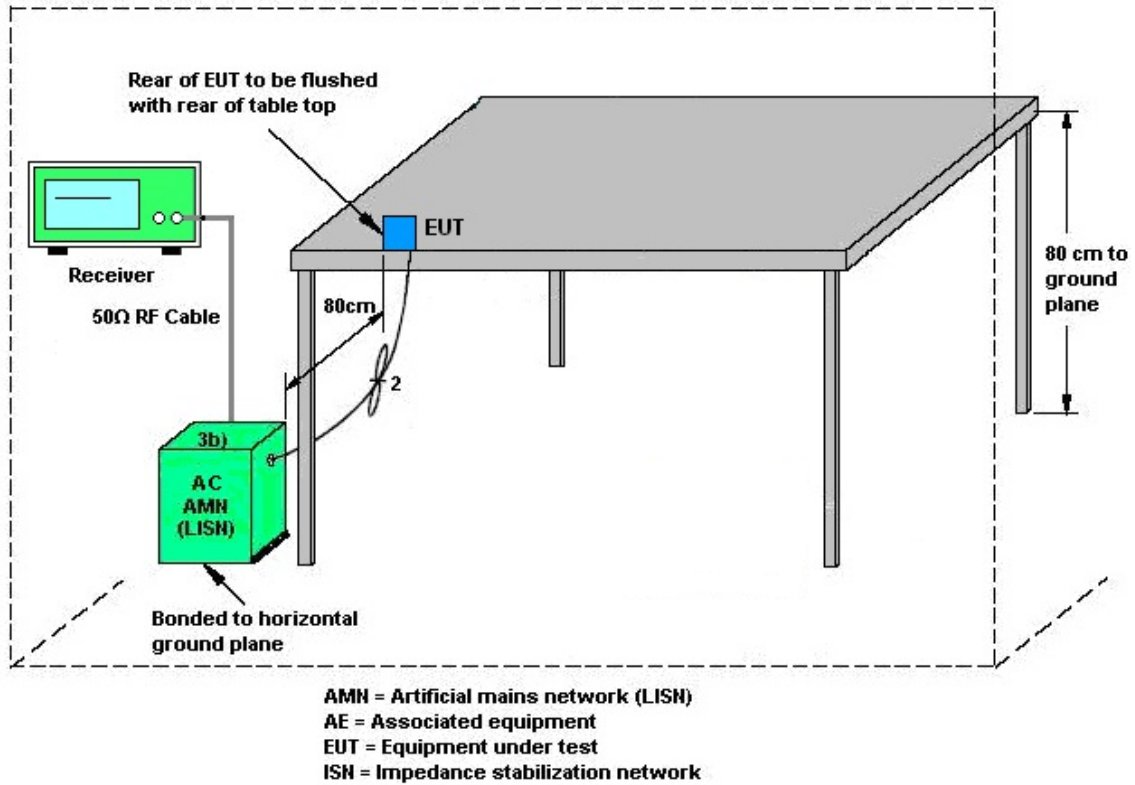

3.1.5 Test Result of AC Conducted Emission

Please refer to Appendix A.

3.2 20dB and 99% OBW Spectrum Bandwidth Measurement

3.2.1 Limit

Intentional radiators must be designed to ensure that the 20dB and 99% emission bandwidth in the specific band 13.553~13.567MHz.

3.2.2 Measuring Instruments

See list of measuring instruments of this test report.

3.2.3 Test Procedures

1. The spectrum analyzer connected via a receive antenna placed near the EUT in peak Max hold mode.
2. The resolution bandwidth of 1 kHz and the video bandwidth of 3 kHz were used.
3. Measured the spectrum width with power higher than 20dB below carrier.
4. Measured the 99% OBW.

3.2.4 Test Setup

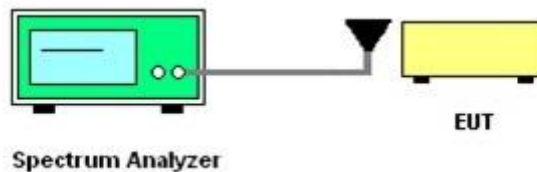

3.2.5 Test Result of Conducted Test Items

Please refer to Appendix B.

3.3 Frequency Stability Measurement

3.3.1 Limit

The frequency tolerance of the carrier signal shall be maintained within +/- 0.01% (100ppm) of the operating frequency over a temperature variation of -20 degrees to +50 degrees C at normal supply voltage, and for a variation in the primary supply voltage from 85% to 115% of the rated supply voltage at a temperature of 20 degrees C. For battery operated equipment, the equipment tests shall be performed using a new battery.

3.3.2 Measuring Instruments

See list of measuring instruments of this test report.

3.3.3 Test Procedures

1. The spectrum analyzer connected via a receive antenna placed near the EUT.
2. EUT have transmitted signal and fixed channelize.
3. Set the spectrum analyzer span to view the entire emissions bandwidth.
4. Set RBW = 1 kHz, VBW = 3 kHz with peak detector and maxhold settings.
5. The f_c is declaring of channel frequency. Then the frequency error formula is $(f_c - f) / f_c \times 10^6$ ppm and the limit is less than ± 100 ppm.
6. Extreme temperature rule is -20°C~50°C.

3.3.4 Test Setup

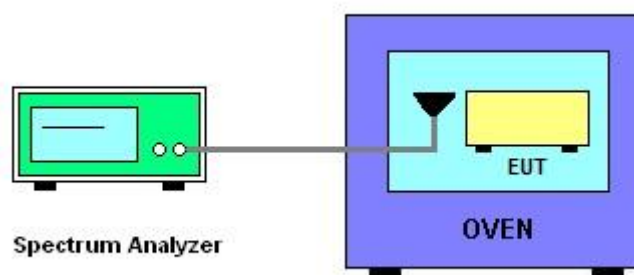

3.3.5 Test Result of Conducted Test Items

Please refer to Appendix B.

3.4 Field Strength of Fundamental Emissions and Mask Measurement

3.4.1 Limit

Rules and specifications	FCC CFR 47 Part 15 section 15.225			
Description	Compliance with the spectrum mask is tested with RBW set to 9kHz.			
Freq. of Emission (MHz)	Field Strength (μV/m) at 30m	Field Strength (dBμV/m) at 30m	Field Strength (dBμV/m) at 10m	Field Strength (dBμV/m) at 3m
1.705~13.110	30	29.5	48.58	69.5
13.110~13.410	106	40.5	59.58	80.5
13.410~13.553	334	50.5	69.58	90.5
13.553~13.567	15848	84.0	103.08	124.0
13.567~13.710	334	50.5	69.58	90.5
13.710~14.010	106	40.5	59.58	80.5
14.010~30.000	30	29.5	48.58	69.5

3.4.2 Measuring Instruments

See list of measuring instruments of this test report.

3.4.3 Test Procedures

1. Configure the EUT according to ANSI C63.10. The EUT was placed on the top of the turntable 0.8 meter above ground. The phase center of the loop receiving antenna mounted antenna tower was placed 3 meters far away from the turntable.
2. Power on the EUT and all the supporting units. The turntable was rotated by 360 degrees to determine the position of the highest radiation.
3. The height of the receiving antenna was fixed at one meter above ground to find the maximum emissions field strength.
4. For Fundamental emissions, use the receiver to measure QP reading.
5. When the radiated emissions limits are expressed in terms of the average value of the emissions, and pulsed operation is employed, the measurement field strength shall be determined by averaging over one complete pulse train, including blanking intervals, as long as the pulse train does not exceed 0.1 seconds. As an alternative (provided the transmitter operates for longer than 0.1 seconds) or in cases where the pulse train exceeds 0.1 seconds, the measured field strength shall be determined from the average absolute voltage during a 0.1 second interval during which the field strength is at its maximum value.
6. Compliance with the spectrum mask is tested with RBW set to 9kHz.

Note: Emission level (dBμV/m) = 20 log Emission level (μV/m).

3.4.4 Test Setup

For radiated emissions below 30MHz

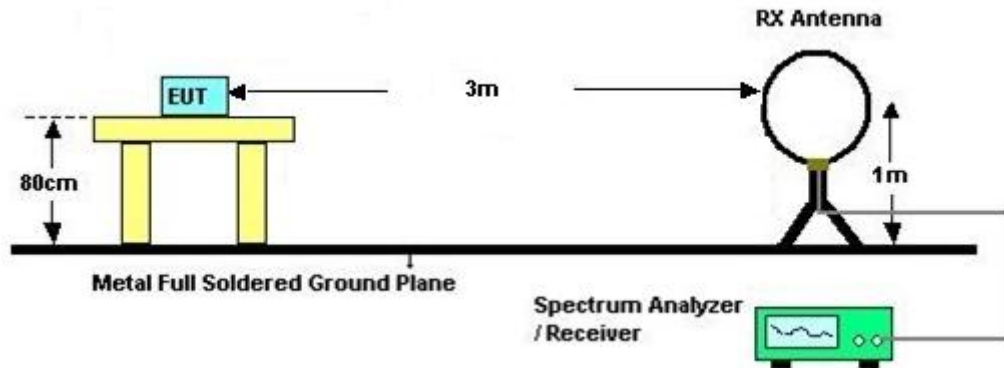

3.4.5 Test Result of Field Strength of Fundamental Emissions and Mask

Please refer to Appendix C.



3.5 Radiated Emissions Measurement

3.5.1 Limit

The field strength of any emissions which appear outside of 13.110 ~14.010MHz band shall not exceed the general radiated emissions limits.

Frequencies (MHz)	Field Strength (µV/m)	Measurement Distance (meters)
0.009~0.490	2400/F(kHz)	300
0.490~1.705	24000/F(kHz)	30
1.705~30.0	30	30
30~88	100	3
88~216	150	3
216~960	200	3
Above 960	500	3

3.5.2 Measuring Instruments

See list of measuring instruments of this test report.

3.5.3 Measuring Instrument Setting

The following table is the setting of receiver:

Receiver Parameter	Setting
Attenuation	Auto
Frequency Range: 9kHz~150kHz	RBW 200Hz for QP
Frequency Range: 150kHz~30MHz	RBW 9kHz for QP
Frequency Range: 30MHz~1000MHz	RBW 120kHz for Peak

Note: The emission limits shown in the above table are based on measurements employing a CISPR quasi-peak detector except for the frequency bands 9-90 kHz and 110-490 kHz. Radiated emission limits in these two bands are based on measurements employing an average detector.



3.5.4 Test Procedures

1. Configure the EUT according to ANSI C63.10. The EUT was placed on the top of the turntable 0.8 meter above ground. The phase center of the receiving antenna mounted on the top of a height-variable antenna tower was placed 3 meters far away from the turntable.
2. Power on the EUT and all the supporting units. The turntable was rotated by 360 degrees to determine the position of the highest radiation.
3. The height of the broadband receiving antenna was varied between one meter and four meters above ground to find the maximum emissions field strength of both horizontal and vertical polarization.
4. For each suspected emissions, the antenna tower was scan (from 1 M to 4 M) and then the turntable was rotated (from 0 degree to 360 degrees) to find the maximum reading.
5. Set the test-receiver system to Peak or CISPR quasi-peak Detect Function with specified bandwidth under Maximum Hold Mode.
6. When the radiated emissions limits are expressed in terms of the average value of the emissions, and pulsed operation is employed, the measurement field strength shall be determined by averaging over one complete pulse train, including blanking intervals, as long as the pulse train does not exceed 0.1 seconds. As an alternative (provided the transmitter operates for longer than 0.1 seconds) or in cases where the pulse train exceeds 0.1 seconds, the measured field strength shall be determined from the average absolute voltage during a 0.1 second interval during which the field strength is at its maximum value.
7. In case the emission is lower than 30MHz, loop antenna has to be used for measurement and the recorded data should be QP measured by receiver.

3.5.5 Test Setup

For radiated emissions below 30MHz

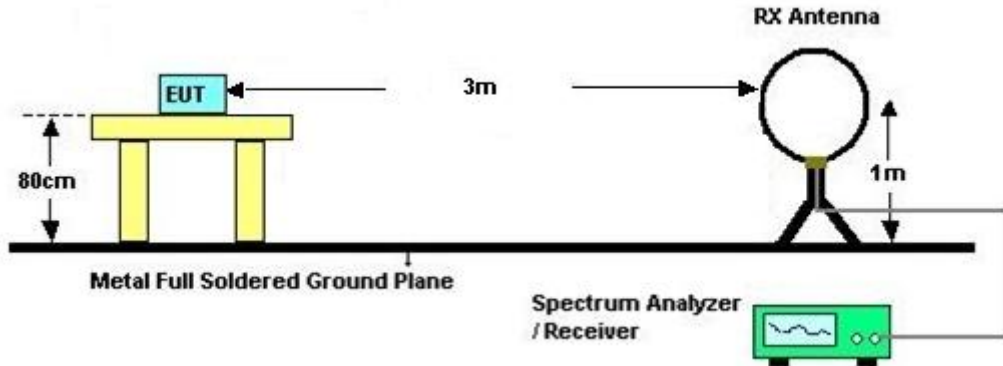

For radiated emissions above 30MHz

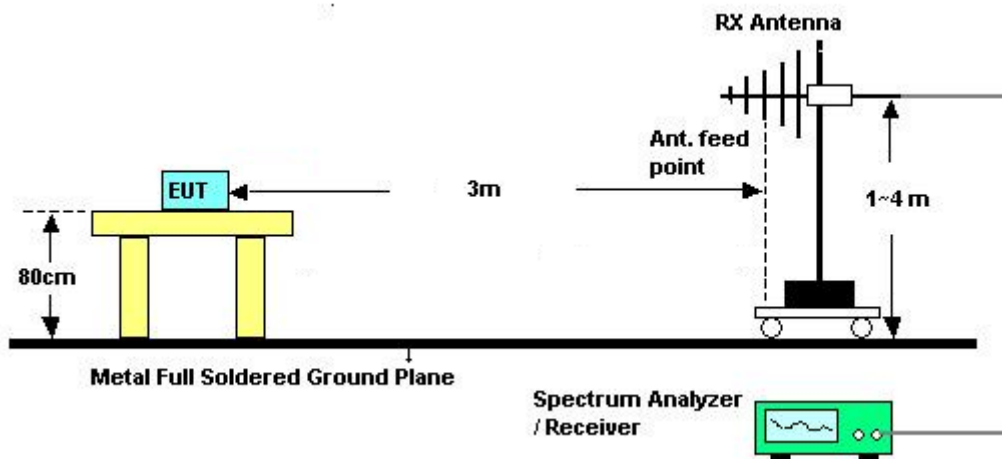

3.5.6 Test Result of Radiated Emissions Measurement

Please refer to Appendix C.

Remark: There is a comparison data of both open-field test site and alternative test site - semi-Anechoic chamber according to 414788 D01 Radiated Test Site v01r01, and the result came out very similar.



3.6 Antenna Requirements

3.6.1 Standard Applicable

Except for special regulations, the Low-power Radio-frequency Devices must not be equipped with any jacket for installing an antenna with extension cable. An intentional radiator shall be designed to ensure that no antenna other than that furnished by the responsible party shall be used with the device. The use of a permanently attached antenna or of an antenna that uses a unique coupling to the intentional radiator shall be considered sufficient to comply with the provisions of this Section. The manufacturer may design the unit so that the user can replace a broken antenna, but the use of a standard antenna jack or electrical connector is prohibited.

The use of a permanently attached antenna or of an antenna that uses a unique coupling to the intentional radiator shall be considered sufficient to comply with the rule.

3.6.2 Antenna Anti-Replacement Construction

An embedded-in antenna design is used.



4. List of Measuring Equipment

Instrument	Manufacturer	Model No.	Serial No.	Characteristics	Calibration Date	Test Date	Due Date	Remark
AC Power Source	ChainTek	APC-1000W	N/A	N/A	N/A	Aug. 24, 2019	N/A	Conduction (CO05-HY)
EMI Test Receiver	Rohde & Schwarz	ESR3	102388	9kHz~3.6GHz	Nov. 12, 2018	Aug. 24, 2019	Nov. 11, 2019	Conduction (CO05-HY)
LISN	Rohde & Schwarz	ENV216	100080	9kHz~30MHz	Nov. 14, 2018	Aug. 24, 2019	Nov. 13, 2019	Conduction (CO05-HY)
LISN	Rohde & Schwarz	ENV216	100081	9kHz~30MHz	Nov. 09, 2018	Aug. 24, 2019	Nov. 08, 2019	Conduction (CO05-HY)
Software	Rohde & Schwarz	EMC32 V10.30	N/A	N/A	N/A	Aug. 24, 2019	N/A	Conduction (CO05-HY)
LF Cable	HUBER + SUHNER	RG-214/U	LF01	N/A	Dec. 31, 2018	Aug. 24, 2019	Dec. 30, 2019	Conduction (CO05-HY)
Pulse Limiter	Rohde & Schwarz	ESH3-Z2	100851	N/A	Dec. 31, 2018	Aug. 24, 2019	Dec. 30, 2019	Conduction (CO05-HY)
Bilog Antenna	TESEQ	CBL 6111D & 00800N1D01 N-06	35419 & 03	30MHz~1GHz	Apr. 30, 2019	Aug. 29, 2019	Apr. 29, 2020	Radiation (03CH07-HY)
EMI Test Receiver	Agilent	N9038A (MXE)	MY532900 53	20Hz~26.5GHz	Jan. 23, 2019	Aug. 29, 2019	Jan. 22, 2020	Radiation (03CH07-HY)
Loop Antenna	Rohde & Schwarz	HFH2-Z2	100315	9 kHz~30 MHz	Jan. 11, 2019	Aug. 29, 2019	Jan. 10, 2020	Radiation (03CH07-HY)
Preamplifier	COM-POWER	PA-103A	161241	10MHz~1GHz	May 20, 2019	Aug. 29, 2019	May 19, 2020	Radiation (03CH07-HY)
RF Cable	HUBER + SUHNER	SUCOFLEX 104	MY24971/4,MY2865 5/4	9kHz~30MHz	Feb. 26, 2019	Aug. 29, 2019	Feb. 25, 2020	Radiation (03CH07-HY)
RF Cable	HUBER + SUHNER	SUCOFLEX 104	MY28655/4,MY2497 1/4,MY156 82/4	30MHz~1GHz	Feb. 26, 2019	Aug. 29, 2019	Feb. 25, 2020	Radiation (03CH07-HY)
Software	Audix	E3 6.2009-8-24	805040046 56H	N/A	N/A	Aug. 29, 2019	N/A	Radiation (03CH07-HY)
Antenna Mast	Max-Full	MFA520BS	N/A	1m~4m	N/A	Aug. 29, 2019	N/A	Radiation (03CH07-HY)
Turn Table	ChainTek	Chaintek 3000	N/A	0~360 Degree	N/A	Aug. 29, 2019	N/A	Radiation (03CH07-HY)
AC Power Source	AC POWER	AFC-500W	F10407001 1	50Hz~60Hz	Apr. 12, 2019	Sep. 02, 2019	Apr. 11, 2020	Conducted (TH03-HY)
Spectrum Analyzer	Rohde & Schwarz	FSP30	101067	9kHz~30GHz	Jun. 13, 2019	Sep. 02, 2019	Jun. 12, 2020	Conducted (TH03-HY)
Temperature Chamber	ESPEC	SU-641	92013721	-30℃ ~70℃	Nov. 28, 2018	Sep. 02, 2019	Nov. 27, 2019	Conducted (TH03-HY)



5. Uncertainty of Evaluation

Uncertainty of Conducted Emission Measurement (150 kHz ~ 30 MHz)

Measuring Uncertainty for a Level of Confidence of 95% ($U = 2Uc(y)$)	2.2
---	-----

Uncertainty of Radiated Emission Measurement (9 kHz ~ 30 MHz)

Measuring Uncertainty for a Level of Confidence of 95% ($U = 2Uc(y)$)	3.4
---	-----

Uncertainty of Radiated Emission Measurement (30 MHz ~ 1000 MHz)

Measuring Uncertainty for a Level of Confidence of 95% ($U = 2Uc(y)$)	5.7
---	-----



Appendix A. Test Results of Conducted Emission Test

Test Engineer :	Louis Chung	Temperature :	25.2~26.2°C
		Relative Humidity :	47.4~58.2%
Test Voltage :	120Vac / 60Hz	Phase :	Line

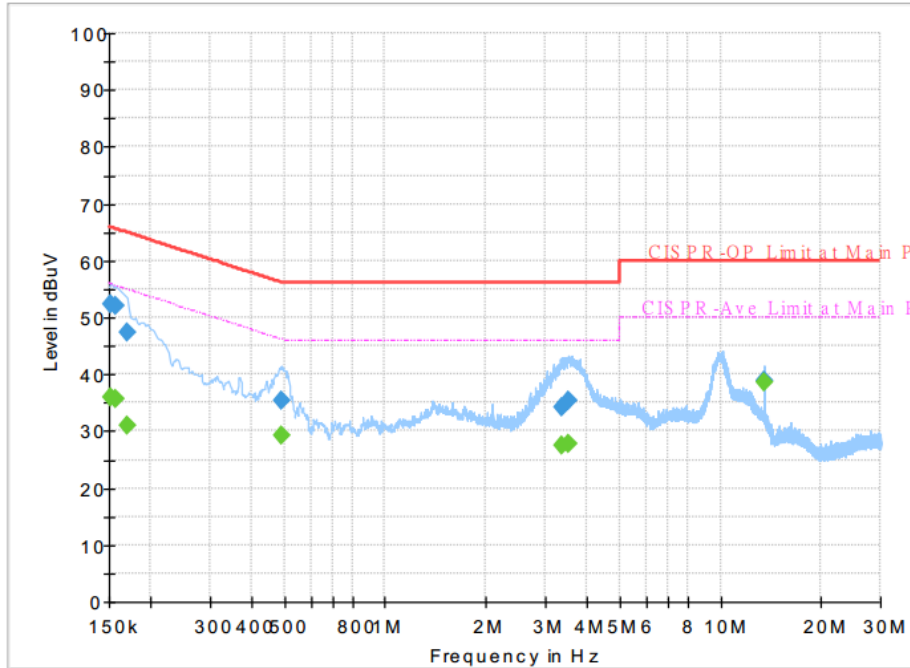

Final Result :

Frequency (MHz)	QuasiPeak (dBuV)	CAverage (dBuV)	Limit (dBuV)	Margin (dB)	Line	Filter	Corr. (dB)
0.152250	---	35.91	55.88	19.97	L1	OFF	19.4
0.152250	52.44	---	65.88	13.44	L1	OFF	19.4
0.156750	---	35.76	55.63	19.87	L1	OFF	19.4
0.156750	51.96	---	65.63	13.67	L1	OFF	19.4
0.170250	---	30.89	54.95	24.06	L1	OFF	19.4
0.170250	47.45	---	64.95	17.50	L1	OFF	19.4
0.489750	---	29.36	46.17	16.81	L1	OFF	19.4
0.489750	35.49	---	56.17	20.68	L1	OFF	19.4
3.349500	---	27.39	46.00	18.61	L1	OFF	19.5
3.349500	34.34	---	56.00	21.66	L1	OFF	19.5
3.522750	---	27.92	46.00	18.08	L1	OFF	19.5
3.522750	35.27	---	56.00	20.73	L1	OFF	19.5
13.560000	---	38.47	50.00	11.53	L1	OFF	19.6
13.560000	38.97	---	60.00	21.03	L1	OFF	19.6



Test Engineer :	Louis Chung	Temperature :	25.2~26.2°C
		Relative Humidity :	47.4~58.2%
Test Voltage :	120Vac / 60Hz	Phase :	Neutral

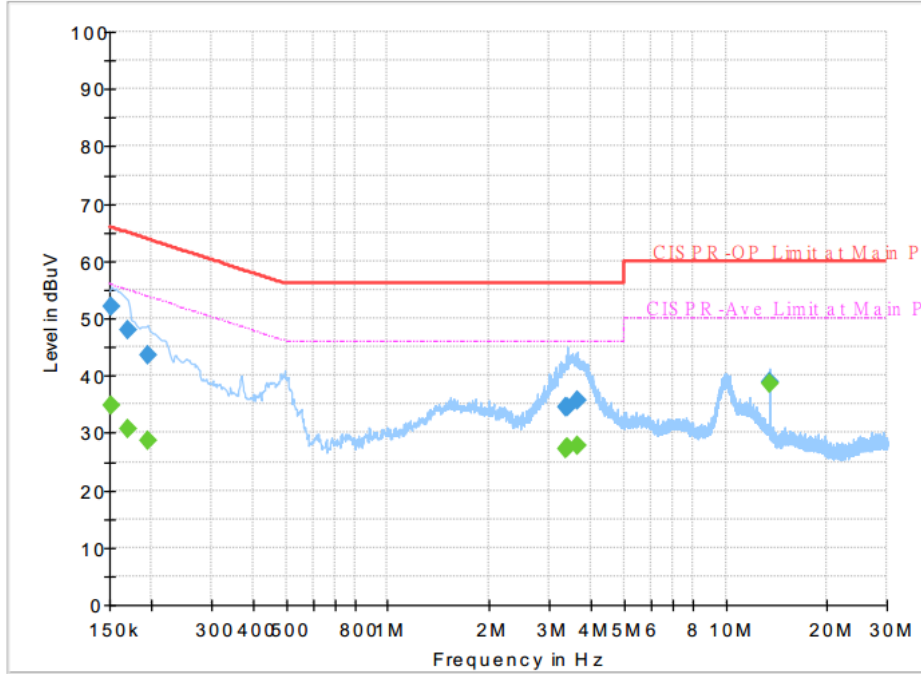

Final Result :

Frequency (MHz)	QuasiPeak (dBuV)	CAverage (dBuV)	Limit (dBuV)	Margin (dB)	Line	Filter	Corr. (dB)
0.152250	---	34.77	55.88	21.11	N	OFF	19.4
0.152250	52.13	---	65.88	13.75	N	OFF	19.4
0.170250	---	30.64	54.95	24.31	N	OFF	19.4
0.170250	47.87	---	64.95	17.08	N	OFF	19.4
0.195000	---	28.60	53.82	25.22	N	OFF	19.4
0.195000	43.52	---	63.82	20.30	N	OFF	19.4
3.356250	---	27.19	46.00	18.81	N	OFF	19.5
3.356250	34.50	---	56.00	21.50	N	OFF	19.5
3.417000	---	27.38	46.00	18.62	N	OFF	19.5
3.417000	34.59	---	56.00	21.41	N	OFF	19.5
3.639750	---	27.75	46.00	18.25	N	OFF	19.5
3.639750	35.57	---	56.00	20.43	N	OFF	19.5
13.560000	---	38.60	50.00	11.40	N	OFF	19.7
13.560000	38.81	---	60.00	21.19	N	OFF	19.7



Appendix B. Test Results of Conducted Test Items

B1. Test Result of 20dB Spectrum Bandwidth

Test mode	NFC Tx	Test Frequency (MHz)	13.56
Date: 2.SEP.2019 11:15:17		Date: 2.SEP.2019 11:16:16	
20dB Bandwidth (kHz)	2.66	99% OccupiedBW(kHz)	2.26
Frequency range (MHz)	$f_L > 13.553$	13.55868	Test Result
	$f_H < 13.567$	13.56134	Complies

Remark: Because the measured signal is CW adjusting the RBW per C63.10 would not be practical since measured bandwidth will always follow the RBW and the result will be approximately twice the RBW.



B2. Test Result of Frequency Stability

Voltage vs. Frequency Stability		Temperature vs. Frequency Stability		
Voltage (Vac)	Measurement Frequency (MHz)	Temperature (°C)	Time	Measurement Frequency (MHz)
120	13.560010	-20	0	13.560010
102	13.560020		2	13.560010
138	13.560020		5	13.560010
			10	13.560010
		-10	0	13.560010
			2	13.560000
			5	13.560000
			10	13.560020
		0	0	13.560010
			2	13.560020
			5	13.560010
			10	13.560010
		10	0	13.560020
			2	13.560000
			5	13.560000
			10	13.560010
		20	0	13.560010
			2	13.560000
			5	13.560000
			10	13.560000
		30	0	13.560010
			2	13.560010
			5	13.560010
			10	13.560010
		40	0	13.560000
			2	13.560000
			5	13.560010
			10	13.560000



Voltage vs. Frequency Stability		Temperature vs. Frequency Stability		
Voltage (Vac)	Measurement Frequency (MHz)	Temperature (°C)	Time	Measurement Frequency (MHz)
		50	0	13.560010
			2	13.560010
			5	13.560000
			10	13.560000
Max.Deviation (MHz)	0.000020	Max.Deviation (MHz)		0.000020
Max.Deviation (ppm)	1.4749	Max.Deviation (ppm)		1.4749
Limit	FS < ±100 ppm	Limit		FS < ±100 ppm
Test Result	PASS	Test Result		PASS



Appendix C. Test Results of Radiated Test Items

C1. Test Result of Field Strength of Fundamental Emissions

Test Mode :	NFC Tx	Test Frequency (MHz)	13.56						
<p>Site : 03CH07-HY Condition : 15.225 3m LOOP_ANT(H)_100315 HORIZONTAL : RBW:9.000KHz VBW:9.000KHz SWT:Auto Project : 981244 Mode : 1</p>									
	Over	Limit	ReadAntenna	Cable	A/Pos	T/Pos			
Freq	Level	Limit	Level	Loss			Remark		
MHz	dBuV/m	dB	dBuV/m	dBuV	dB/m	dB	cm	deg	
1	13.56	22.54	-61.46	84.00	42.18	19.80	0.56	100	3 QP
<p>Site : 03CH07-HY Condition : 15.225 3m LOOP_ANT(V)_100315 VERTICAL : RBW:9.000KHz VBW:9.000KHz SWT:Auto Project : 981244 Mode : 1</p>									
	Over	Limit	ReadAntenna	Cable	A/Pos	T/Pos			
Freq	Level	Limit	Level	Loss			Remark		
MHz	dBuV/m	dB	dBuV/m	dBuV	dB/m	dB	cm	deg	
1	13.56	19.94	-64.06	84.00	39.58	19.80	0.56	100	264 QP



C2. Results of Radiated Spurious Emissions (9 kHz~30MHz)

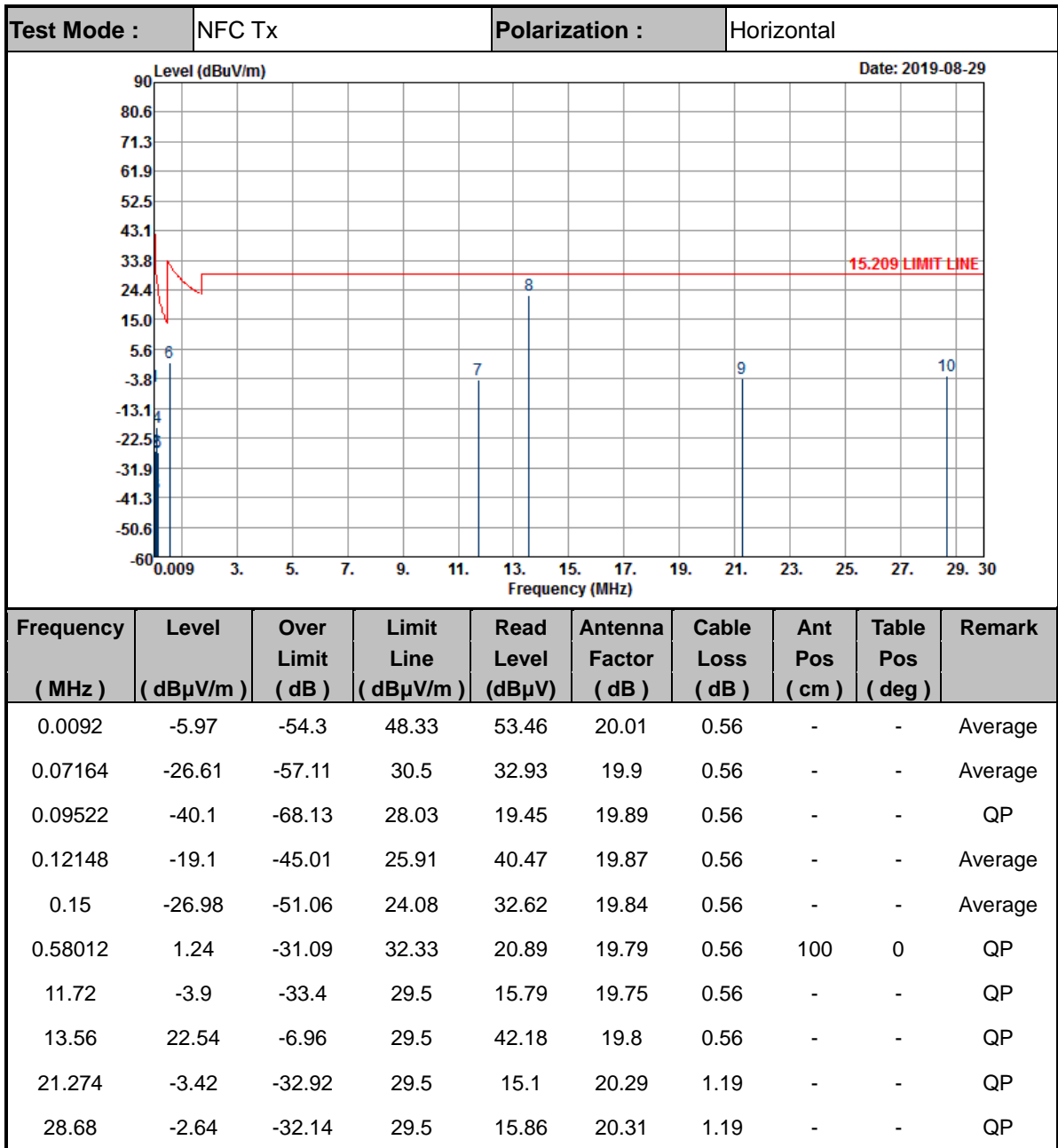

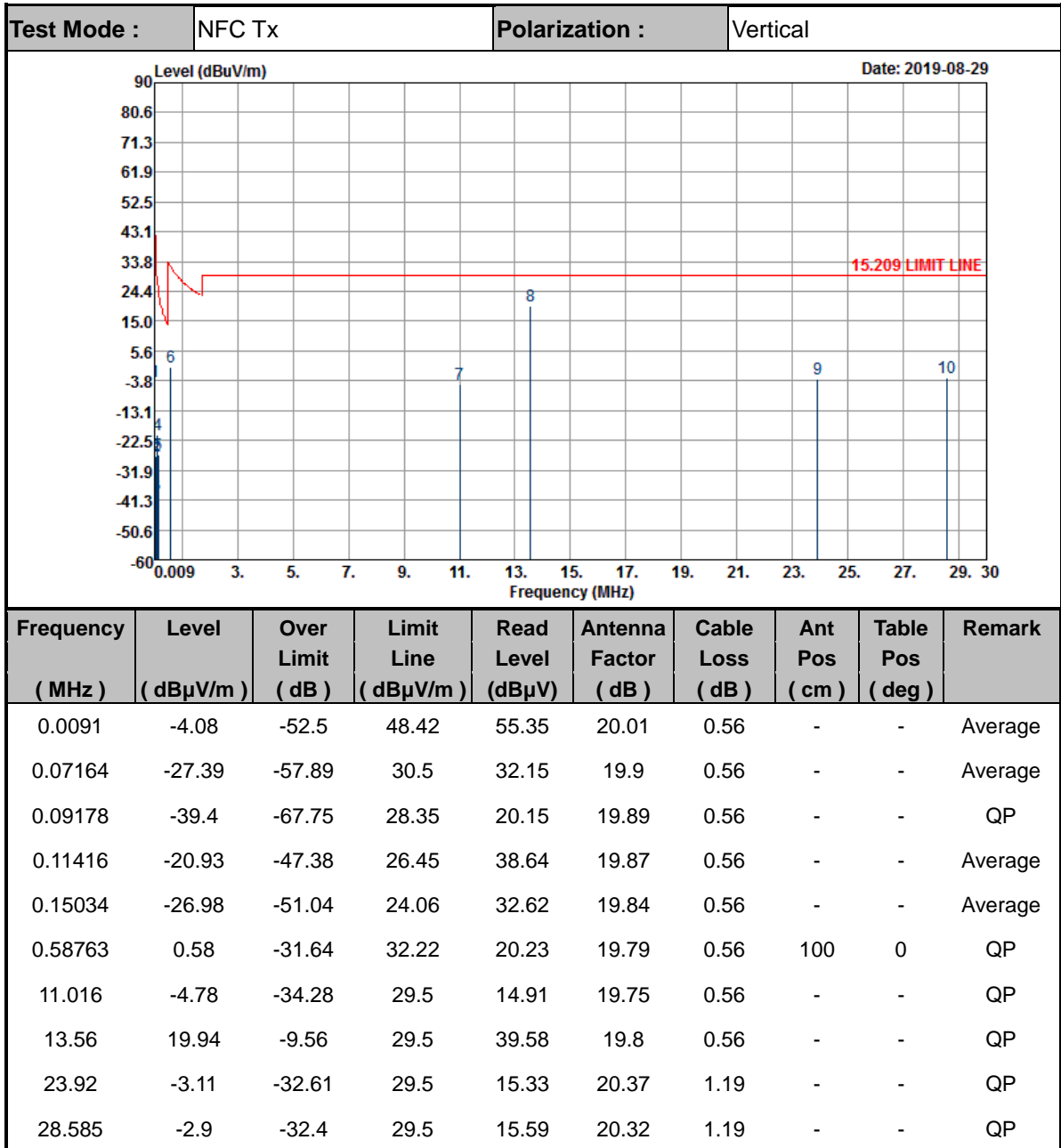

Note:

1. 13.56 MHz is fundamental signal which can be ignored.
2. The amplitude of spurious emissions which are attenuated by more than 20dB below the permissible value has no need to be reported.
3. Distance extrapolation factor = 40 log (specific distance / test distance) (dB);
4. Limit line = specific limits (dBuV) + distance extrapolation factor.



C3. Results of Radiated Spurious Emissions (30MHz~1GHz)

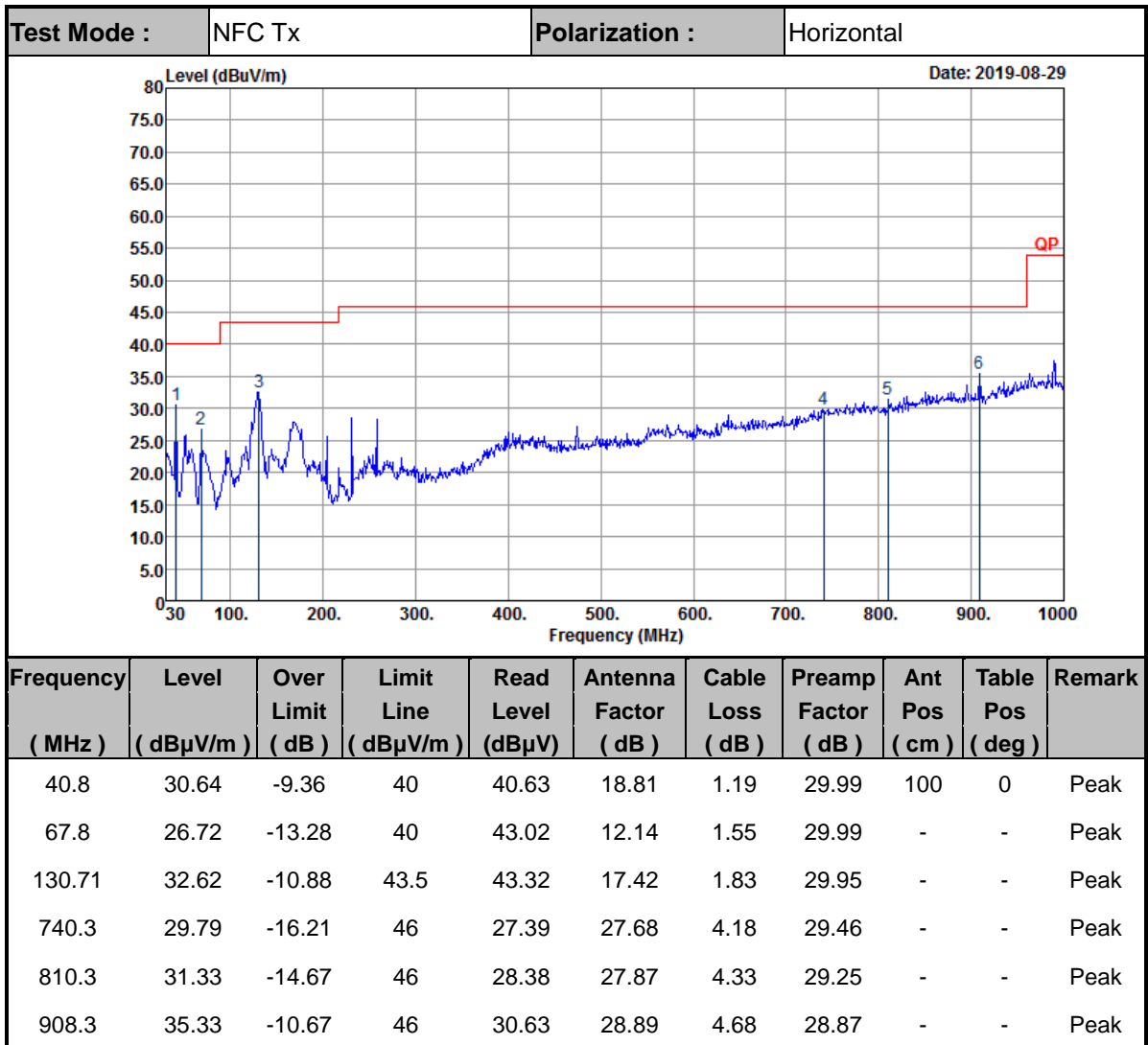

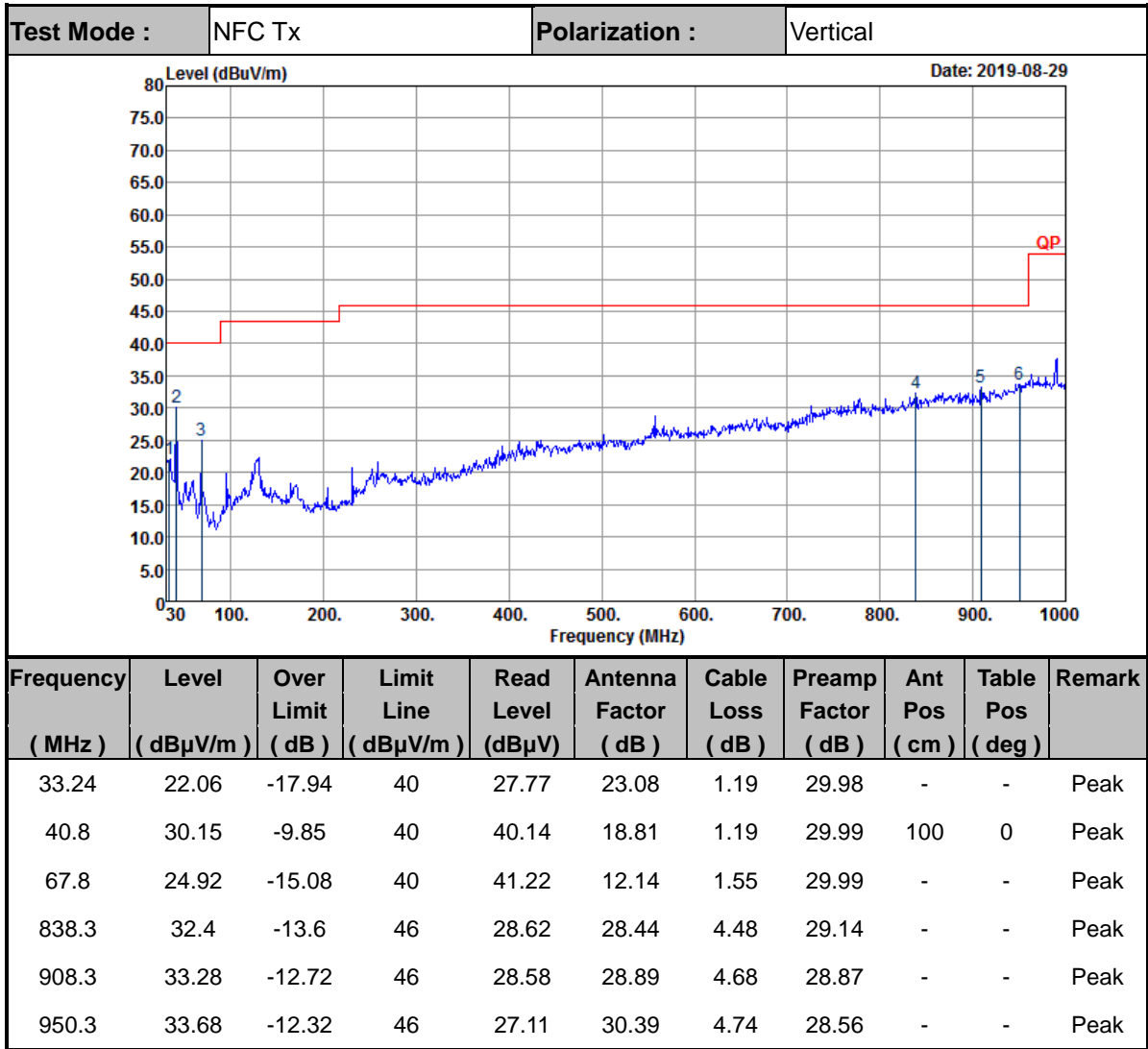

Note:

1. The amplitude of spurious emissions which are attenuated by more than 20dB below the permissible value has no need to be reported.
2. Emission level (dBμV/m) = 20 log Emission level (μV/m).
3. Corrected Reading: Antenna Factor + Cable Loss + Read Level - Preamp Factor= Level.